

FCC 47 CFR PART 22H and 24E

RF Test Report

Product Type : LE910-NA V2
Applicant : Telit Communications S.p.A.
Address : Viale Stazione di Prosecco 5/B, 34010 Sgonico- Trieste- Italy
Trade Name : Telit
Model Number : LE910-NA V2
Test Specification : FCC 47 CFR PART 22H: Oct, 2014
FCC 47 CFR PART 24E: Oct, 2014
ANSI/TIA/EIA-603-C
Application Purpose : Original
Receive Date : Jun. 04, 2015
Test Period : Jun. 10 ~ 18, 2015
Issue Date : Aug. 03, 2015

Issue by

A Test Lab Techno Corp.
No. 140-1, Changan Street, Bade City,
Taoyuan County 334, Taiwan R.O.C.
Tel : +886-3-2710188 / Fax : +886-3-2710190



Taiwan Accreditation Foundation accreditation number: 1330

Note: This report shall not be reproduced except in full, without the written approval of A Test Lab Techno Corp. This document may be altered or revised by A Test Lab Techno Corp. personnel only, and shall be noted in the revision section of the document. The client should not use it to claim product endorsement by TAF, or any government agencies. The test results in the report only apply to the tested sample.

Revision History

Rev.	Issue Date	Revisions	Revised By
00	Jul. 28, 2015	Initial Issue	
01	Aug. 03, 2015	Revised report information.	Peggy Chang

Verification of Compliance

Issued Date: 08/03/2015

Product Type : LE910-NA V2
Applicant : Telit Communications S.p.A.
Address : Viale Stazione di Prosecco 5/B, 34010 Sgonico- Trieste- Italy
Trade Name : Telit
Model Number : LE910-NA V2
EUT Rated Voltage : DC 3.4V / 3.8V / 4.2V
Test Voltage : DC 3.8V
Applicable Standard : FCC 47 CFR PART 22H: Oct, 2014
FCC 47 CFR PART 24E: Oct, 2014
ANSI/TIA/EIA-603-C
Application Purpose : Original
Test Result : Complied
Performing Lab. : A Test Lab Techno Corp.

No. 140-1, Changan Street, Bade City,
Taoyuan County 334, Taiwan R.O.C.
Tel : +886-3-2710188 / Fax : +886-3-2710190



Taiwan Accreditation Foundation accreditation number: 1330
<http://www.atl-lab.com.tw/e-index.htm>

The above equipment was tested by A Test Lab Techno Corp. The test data, data evaluation, test procedures, and equipment configurations shown in this report were made in accordance with the procedures given in ANSI C63.4: 2009 and the energy emitted by the sample tested as described in this report is in compliance with the requirements of FCC Rules Part 22H, Part 24E.

The test results of this report relate only to the tested sample identified in this report.

Approved By : Fly Lu Reviewed By : Eric Ou Yang
(Manager) (Fly Lu) (Testing Engineer) (Eric Ou Yang)

TABLE OF CONTENTS

1	General Information	6
1.1.	EUT Description	6
1.2.	Mode of Operation.....	7
1.3.	EUT Exercise Software	7
1.4.	Configuration of Test System Details	7
1.5.	Test Site Environment	8
1.6.	Summary of Test Result	8
2	RF Output Power Test	9
2.1.	Limit	9
2.2.	Test Instruments	9
2.3.	Test Setup.....	9
2.4.	Test Procedure	9
2.5.	Uncertainty	9
2.6.	Test Result.....	10
3	Effective Radiated Power / Equivalent Isotropic Radiated Power Test.....	12
3.1.	Limit	12
3.2.	Test Instruments	12
3.3.	Test Setup.....	12
3.4.	Test Procedure	12
3.5.	Uncertainty	12
3.6.	Test Result.....	13
4	Peak to Average Ratio Test.....	14
4.1.	Limit	14
4.2.	Test Instruments	14
4.3.	Setup	14
4.4.	Test Procedure	14
4.5.	Uncertainty	15
4.6.	Test Result	15
4.7.	Test Graphs	16
5	Emission Bandwidth & Occupied Bandwidth Test.....	17
5.1.	Limit	17
5.2.	Test Instruments	17
5.3.	Setup	17
5.4.	Test Procedure	18
5.5.	Uncertainty	18
5.6.	Test Result.....	18
5.7.	Test Graphs	19

6	Band Edge Test	21
6.1.	Limit	21
6.2.	Test Instruments	21
6.3.	Setup	21
6.4.	Test Procedure	22
6.5.	Uncertainty	22
6.6.	Test Result.....	22
6.7.	Test Graphs	23
7	Conducted Spurious Emission and Radiation Emission Test	25
7.1.	Limit	25
7.2.	Test Instruments	25
7.3.	Setup	25
7.4.	Test Procedure	26
7.5.	Uncertainty	26
7.6.	Test Result.....	26
8	Field Strength of Spurious Radiation Test.....	61
8.1.	Limit	61
8.2.	Test Instruments	61
8.3.	Setup	62
8.4.	Test Procedure	64
8.5.	Uncertainty	64
8.6.	Test Result.....	65
9	Frequency Stability (Temperature & Voltage Variation) Test.....	68
9.1.	Limit	68
9.2.	Test Instruments	68
9.3.	Setup	68
9.4.	Test Procedure	69
9.5.	Uncertainty	69
9.6.	Test Result.....	70

1 General Information

1.1. EUT Description

Applicant		Telit Communications S.p.A.			
Applicant Address		Viale Stazione di Prosecco 5/B, 34010 Sgonico- Trieste- Italy			
Manufacturer		Telit Communications S.p.A.			
Manufacturer Address		Viale Stazione di Prosecco 5/B, 34010 Sgonico- Trieste- Italy			
Product Type		LE910-NA V2			
Trade Name		Telit			
Model Number		LE910-NA V2			
Hardware Version		00			
Software Version		20.00.501			
Radio Hardware Version		00			
Radio Software Version		20.00.501			
Mode	WCDMA (RMC12.2K)/ HSDPA/ HSUPA/	Band	UL Frequency (MHz)	DL Frequency (MHz)	Modulation
		II	1852.4 ~ 1907.6	1932.4 ~ 1987.6	QPSK
		V	826.4 ~ 846.6	871.4 ~ 891.6	QPSK
Channel Control		Auto			
Antenna Gain (dBi)		WCDMA/ HSDPA/ HSUPA Band II : 2.14 dBi WCDMA/ HSDPA/ HSUPA Band V : 2.14 dBi			
Max. RF Output power (Avg.)		WCDMA/ HSDPA/ HSUPA Band II : 23.66 dBm / 0.232 W WCDMA/ HSDPA/ HSUPA Band V : 23.59 dBm / 0.229 W			
Max. ERP/EIRP		WCDMA Band II : 25.80 dBm / 0.38 W WCDMA Band V : 23.58 dBm / 0.23 W			
Emission Designator		WCDMA Band II : 4M09F9W WCDMA Band V : 4M08F9W			

1.2. Mode of Operation

ATL has verified the construction and function in typical operation. All the test modes were carried out with the EUT in normal operation, which was shown in this test report and defined as:

Test Mode
Mode 1: WCDMA Band II Link Mode
Mode 2: WCDMA Band V Link Mode

Note: Regards to the frequency band operation: the lowest, middle and highest frequency of channel were selected to perform the test, then shown on this report.

1.3. EUT Exercise Software

1	Setup the EUT and Base Station (CMU200) as shown on 1.4.
2	Turn on the power of all equipment.

1.4. Configuration of Test System Details

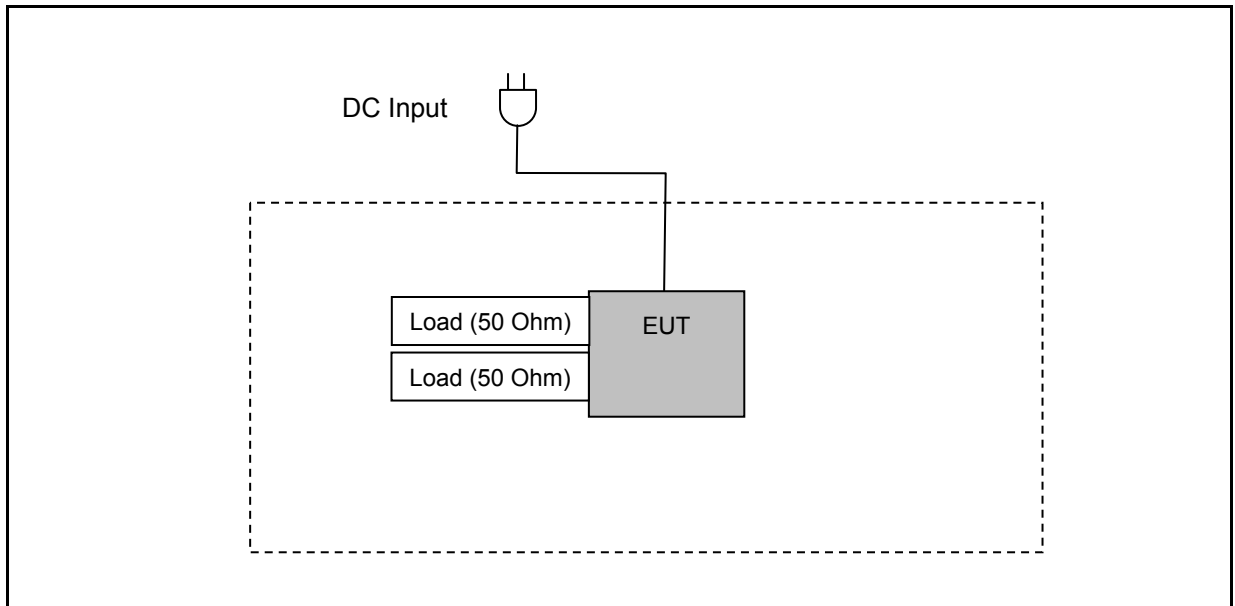

1.5. Test Site Environment

Items	Required (IEC 60068-1)	Actual
Temperature (°C)	15-35	26
Humidity (%RH)	25-75	60
Barometric pressure (mbar)	860-1060	950

1.6. Summary of Test Result

Description	FCC Rule	Limit	Result
Conducted Output Power	§2.1046	N/A	Pass
Effective Radiated Power	§22.913(a)(2)	< 7 Watts for FCC	Pass
Equivalent Isotropic Radiated Power	§24.232(c)	≤ 11.5 Watts	Pass
Peak to average ratio	§24.232(d)	< 13 dB	Pass
Emission Bandwidth & Occupied Bandwidth	§2.1049 §22.917(a) §24.238(a)	N/A	Pass
Band Edge Measurement	§2.1051 §22.917(a) §24.238(a)	< 43+10log ₁₀ (P[Watts])	Pass
Conducted Spurious Emission	§2.1051 §22.917(a) §24.238(a)	< 43+10log ₁₀ (P[Watts])	Pass
Field Strength of Spurious Radiation	§2.1053 §22.917(a) §24.238(a)	< 43+10log ₁₀ (P[Watts])	Pass
Frequency Stability for Temperature & Voltage	§2.1055 §22.355 §24.235	< 2.5 ppm	Pass

2 RF Output Power Test

2.1. Limit

N/A

2.2. Test Instruments

Equipment	Manufacturer	Model Number	Serial Number	Cal. Date	Remark
Universal Radio Communication Tester	R & S	CMU200	109369	10/21/2014	(2)
Single Channel PK Power Sensor	Agilent	N1911A	MY45101619	12/15/2014	(1)
Wideband Power Meter	Agilent	N1921A	MY45241957	12/15/2014	(1)
Test Site	ATL	TE05	TE05	N.C.R.	-----

Remark: ⁽¹⁾ Calibration period 1 year. ⁽²⁾ Calibration period 2 years.

Note: N.C.R. = No Calibration Request.

2.3. Test Setup

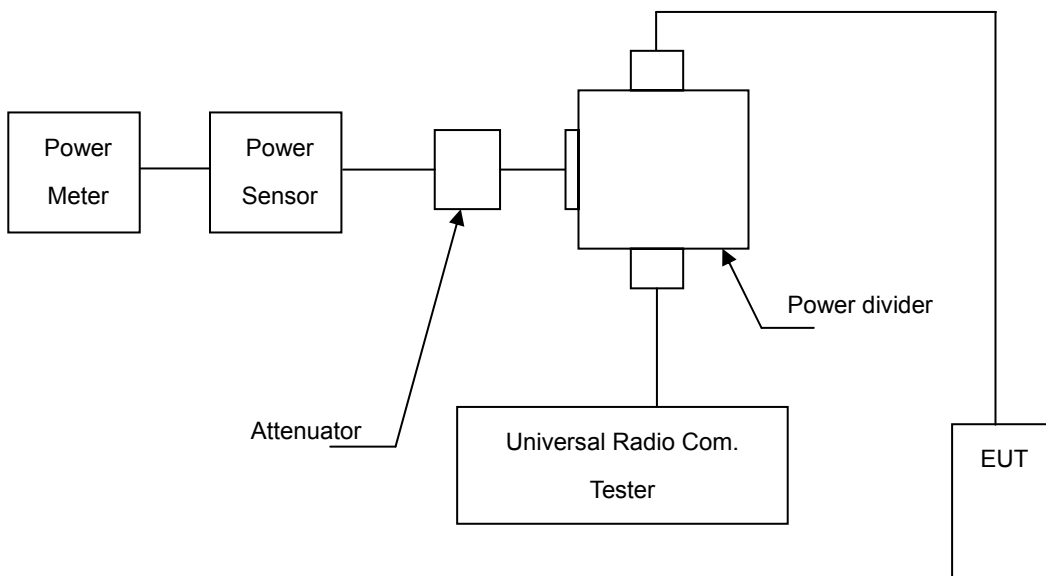

2.4. Test Procedure

The measurement is made according to as follows:

1. The transmitter output was connected to power meter and base station through Power Divider.
2. Set base station for EUT at GSM 850: PCL=5 and PCS 1900: PCL=0.
3. Set base station for EUT at WCDMA Band V and WCDMA Band II, power level was set to maximum.
4. Select lowest, middle, and highest channels for each band.

2.5. Uncertainty

The measurement uncertainty is defined as for RF output power measurement is 1.2 dB.

2.6. Test Result

Model Number	LE910-NA V2				
Test Item	RF Output Power				
Date of Test	06/18/2015			Test Site	TE05
Bands	Modulation Type	Sub-Test	Frequency (MHz)	Burst Average Power	
				(dBm)	(W)
WCDMA Band II	QPSK	-----	1852.4	23.66	0.232
			1880.0	23.64	0.231
			1907.6	23.57	0.228
HSDPA Band II	QPSK	1	1852.4	22.61	0.182
			1880.0	22.57	0.181
			1907.6	22.49	0.177
		2	1852.4	22.48	0.177
			1880.0	22.42	0.175
			1907.6	22.32	0.171
		3	1852.4	22.08	0.161
			1880.0	22.01	0.159
			1907.6	21.91	0.155
		4	1852.4	22.04	0.160
			1880.0	21.96	0.157
			1907.6	21.86	0.153
HSUPA/HSPA+ Band II	QPSK	1	1852.4	21.98	0.158
			1880.0	21.91	0.155
			1907.6	21.81	0.152
		2	1852.4	19.95	0.099
			1880.0	19.87	0.097
			1907.6	19.76	0.095
		3	1852.4	20.92	0.124
			1880.0	20.82	0.121
			1907.6	20.70	0.117
		4	1852.4	19.92	0.098
			1880.0	19.83	0.096
			1907.6	19.72	0.094
		5	1852.4	21.87	0.154
			1880.0	21.77	0.150
			1907.6	21.65	0.146

Note: The peak power testing result was used peak detector.

Model Number	LE910-NA V2				
Test Item	RF Output Power				
Date of Test	07/23/2013			Test Site	TE05
Bands	Modulation Type	Sub-Test	Frequency (MHz)	Burst Average Power	
				(dBm)	(W)
WCDMA Band V	QPSK	-----	826.4	23.55	0.226
			836.6	23.59	0.229
			846.6	23.46	0.222
HSDPA Band V	QPSK	1	826.4	22.51	0.178
			836.6	22.56	0.180
			846.6	22.40	0.174
		2	826.4	22.36	0.172
			836.6	22.41	0.174
			846.6	22.23	0.167
		3	826.4	21.98	0.158
			836.6	22.05	0.160
			846.6	21.86	0.153
		4	826.4	21.93	0.156
			836.6	21.99	0.158
			846.6	21.78	0.151
HSUPA/HSPA+ Band V	QPSK	1	826.4	21.84	0.153
			836.6	21.88	0.154
			846.6	21.71	0.148
		2	826.4	19.80	0.095
			836.6	19.86	0.097
			846.6	19.65	0.092
		3	826.4	20.78	0.120
			836.6	20.84	0.121
			846.6	20.62	0.115
		4	826.4	19.75	0.094
			836.6	19.81	0.096
			846.6	19.58	0.091
		5	826.4	21.69	0.148
			836.6	21.75	0.150
			846.6	21.54	0.143

Note: The peak power testing result was used peak detector.

3 Effective Radiated Power / Equivalent Isotropic Radiated Power Test

3.1. Limit

For FCC Part 22.913(a)(2): The ERP of mobile transmitters and auxiliary test transmitters must not exceed 7 Watts.

For FCC Part 24.232(b): The EIRP of mobile transmitters and auxiliary test transmitters must not exceed 2 Watts.

3.2. Test Instruments

Equipment	Manufacturer	Model Number	Serial Number	Cal. Date	Remark
Universal Radio Communication Tester	R & S	CMU200	109369	10/21/2014	(2)
Single Channel PK Power Sensor	Agilent	N1911A	MY45101619	12/15/2014	(1)
Wideband Power Meter	Agilent	N1921A	MY45241957	12/15/2014	(1)
Test Site	ATL	TE05	TE05	N.C.R.	-----

Remark: ⁽¹⁾ Calibration period 1 year. ⁽²⁾ Calibration period 2 years.

Note: N.C.R. = No Calibration Request.

3.3. Test Setup

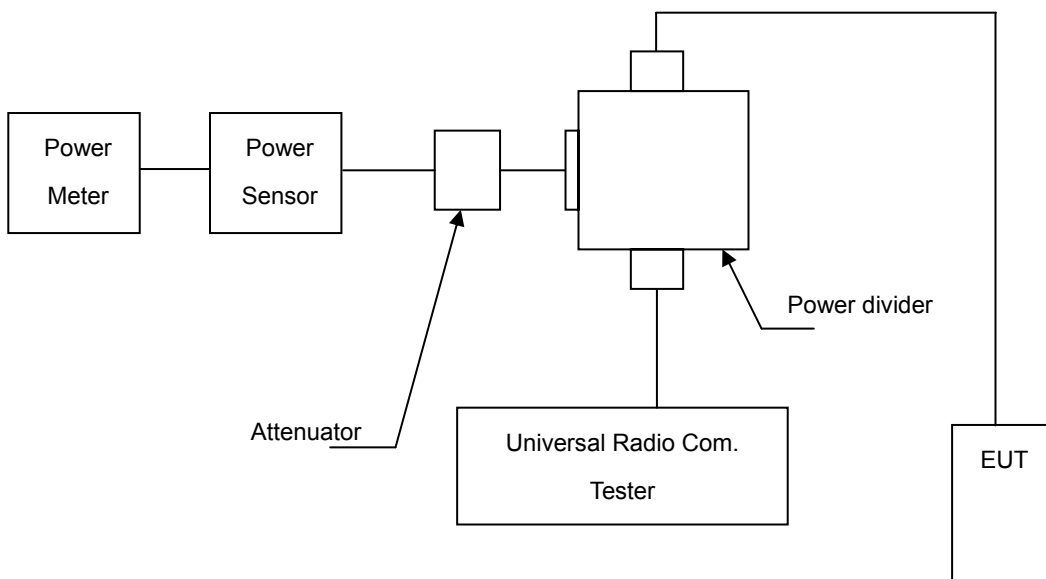

3.4. Test Procedure

The measurement is made according to as follows:

1. The transmitter output was connected to power meter and base station through Power Divider.
2. Set base station for EUT at GSM 850: PCL=5 and PCS 1900: PCL=0.
3. Set base station for EUT at WCDMA Band V and WCDMA Band II, power level was set to maximum.
4. Select lowest, middle, and highest channels for each band.

3.5. Uncertainty

The measurement uncertainty is defined as for RF output power measurement is 1.2 dB.

3.6. Test Result

Model Number	LE910-NA V2						
Test Item	ERP/EIRP						
Date of Test	06/18/2015				Test Site	TE01	
Bands	Modulation Type	Frequency (MHz)	Burst Average Power (dBm)	Antenna Gain (dBi)	EIRP		Limit
					(dBm)	(W)	
WCDMA Band II	QPSK	1852.4	23.66	2.14	25.80	0.38	< 2W
		1880.0	23.64	2.14	25.78	0.38	< 2W
		1907.6	23.57	2.14	25.71	0.37	< 2W

Model Number	LE910-NA V2						
Test Item	ERP/EIRP						
Date of Test	06/18/2015				Test Site	TE01	
Bands	Modulation Type	Frequency (MHz)	Burst Average Power (dBm)	Antenna Gain (dBi)	ERP		Limit
					(dBm)	(W)	
WCDMA Band V	QPSK	826.4	23.55	2.14	23.54	0.23	< 7W
		836.6	23.59	2.14	23.58	0.23	< 7W
		846.6	23.46	2.14	23.45	0.22	< 7W

Note: ERP = Peak Conducted power + Antenna Gain - 2.15, EIRP = Peak Conducted power + Antenna Gain

4 Peak to Average Ratio Test

4.1. Limit

In measuring transmissions in this band using an average power technique, the peak to-average ratio (PAR) of the transmission may not exceed 13 dB.

4.2. Test Instruments

Equipment	Manufacturer	Model No.	Serial No.	Cal. Date	Remark
Spectrum Analyzer	Agilent	E4445A	MY46181986	05/14/2015	(¹)
Wideband Radio Communication Test	R & S	CMW500	103168	11/05/2014	(¹)
Attenuator	RADIALL	R41572000	0603033073	N.C.R.	----
Power divider	Agilent	87302C	3239A00760	N.C.R.	----
Test Site	ATL	TE05	TE05	N.C.R.	----

Remark: (¹) Calibration period 1 year. (²) Calibration period 2 years.

Note: N.C.R. = No Calibration Request.

4.3. Setup

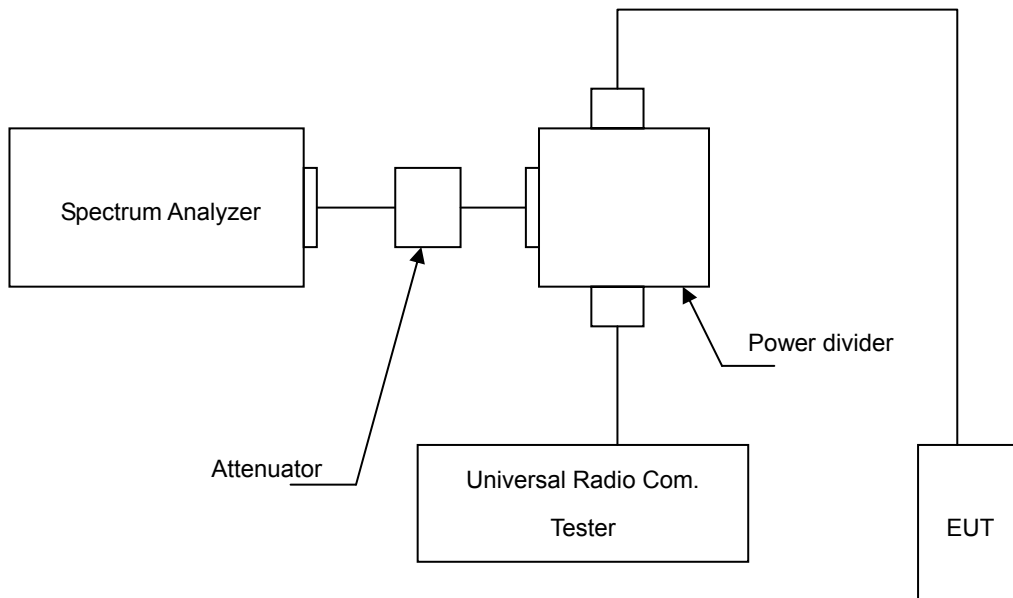

4.4. Test Procedure

The measurement is made according to FCC rules part 24:

- Set resolution/measurement bandwidth signal's occupied bandwidth;
- Set the number of counts to a value that stabilizes the measured CCDF curve;
- Record the maximum PAPR level associated with a probability of 0.1%.

4.5. Uncertainty

The measurement uncertainty is defined as for Conducted Power measurement is 1.2 dB.

4.6. Test Result

Model Number	LE910-NA V2				
Test Item	Peak to Average Ratio				
Date of Test	06/10/2015			Test Site	TE05
Bands	Channel	Frequency (MHz)	Peak to Average Ratio (dB)	Limit (dB)	
WCDMA Band II	9262	1852.4	3.36	< 13	
	9400	1880.0	3.17	< 13	
	9538	1907.6	3.19	< 13	

4.7. Test Graphs

Mode 1: WCDMA Band II Link Mode																	
1850.20 MHz	<p>Average Power 23.66 dBm 52.57 % at 0dB</p> <table border="1"> <tr><td>10.0 %</td><td>1.77 dB</td></tr> <tr><td>1.0 %</td><td>2.78 dB</td></tr> <tr><td>0.1 %</td><td>3.36 dB</td></tr> <tr><td>0.01 %</td><td>3.61 dB</td></tr> <tr><td>0.001 %</td><td>3.75 dB</td></tr> <tr><td>0.0001 %</td><td>3.86 dB</td></tr> <tr><td>Peak</td><td>3.86 dB</td></tr> <tr><td></td><td>27.52 dBm</td></tr> </table> <p>Center Freq: 1.852400000 GHz Trig: Free Run #Att: 40 dB Counts: 2.68 M5.00 Mpt Radio Std: None Info BW 5.0000 MHz</p>	10.0 %	1.77 dB	1.0 %	2.78 dB	0.1 %	3.36 dB	0.01 %	3.61 dB	0.001 %	3.75 dB	0.0001 %	3.86 dB	Peak	3.86 dB		27.52 dBm
10.0 %	1.77 dB																
1.0 %	2.78 dB																
0.1 %	3.36 dB																
0.01 %	3.61 dB																
0.001 %	3.75 dB																
0.0001 %	3.86 dB																
Peak	3.86 dB																
	27.52 dBm																
1880.00 MHz	<p>Average Power 23.65 dBm 53.11 % at 0dB</p> <table border="1"> <tr><td>10.0 %</td><td>1.73 dB</td></tr> <tr><td>1.0 %</td><td>2.65 dB</td></tr> <tr><td>0.1 %</td><td>3.17 dB</td></tr> <tr><td>0.01 %</td><td>3.38 dB</td></tr> <tr><td>0.001 %</td><td>3.50 dB</td></tr> <tr><td>0.0001 %</td><td>3.59 dB</td></tr> <tr><td>Peak</td><td>3.61 dB</td></tr> <tr><td></td><td>27.26 dBm</td></tr> </table> <p>Center Freq: 1.880000000 GHz Trig: Free Run #Att: 40 dB Counts: 4.49 M5.00 Mpt Radio Std: None Info BW 5.0000 MHz</p>	10.0 %	1.73 dB	1.0 %	2.65 dB	0.1 %	3.17 dB	0.01 %	3.38 dB	0.001 %	3.50 dB	0.0001 %	3.59 dB	Peak	3.61 dB		27.26 dBm
10.0 %	1.73 dB																
1.0 %	2.65 dB																
0.1 %	3.17 dB																
0.01 %	3.38 dB																
0.001 %	3.50 dB																
0.0001 %	3.59 dB																
Peak	3.61 dB																
	27.26 dBm																
1909.80 MHz	<p>Average Power 23.57 dBm 52.78 % at 0dB</p> <table border="1"> <tr><td>10.0 %</td><td>1.74 dB</td></tr> <tr><td>1.0 %</td><td>2.69 dB</td></tr> <tr><td>0.1 %</td><td>3.19 dB</td></tr> <tr><td>0.01 %</td><td>3.41 dB</td></tr> <tr><td>0.001 %</td><td>3.55 dB</td></tr> <tr><td>0.0001 %</td><td>3.61 dB</td></tr> <tr><td>Peak</td><td>3.63 dB</td></tr> <tr><td></td><td>27.20 dBm</td></tr> </table> <p>Center Freq: 1.907800000 GHz Trig: Free Run #Att: 40 dB Counts: 3.39 M5.00 Mpt Radio Std: None Info BW 5.0000 MHz</p>	10.0 %	1.74 dB	1.0 %	2.69 dB	0.1 %	3.19 dB	0.01 %	3.41 dB	0.001 %	3.55 dB	0.0001 %	3.61 dB	Peak	3.63 dB		27.20 dBm
10.0 %	1.74 dB																
1.0 %	2.69 dB																
0.1 %	3.19 dB																
0.01 %	3.41 dB																
0.001 %	3.55 dB																
0.0001 %	3.61 dB																
Peak	3.63 dB																
	27.20 dBm																

5 Emission Bandwidth & Occupied Bandwidth Test

5.1. Limit

The Occupied Bandwidth Limit:

N/A.

5.2. Test Instruments

Equipment	Manufacturer	Model Number	Serial Number	Cal. Date	Remark
Universal Radio Communication Tester	R & S	CMU200	109369	10/21/2014	(2)
Spectrum Analyzer	Agilent	E4445A	MY46181986	05/14/2015	(1)
Attenuator	RADIALL	R41572000	0603033073	N.C.R.	-----
Power Divider	Agilent	87302C	3239A00760	N.C.R.	-----
Test Site	ATL	TE05	TE05	N.C.R.	-----

Remark: ⁽¹⁾ Calibration period 1 year. ⁽²⁾ Calibration period 2 years.

Note: N.C.R. = No Calibration Request.

5.3. Setup

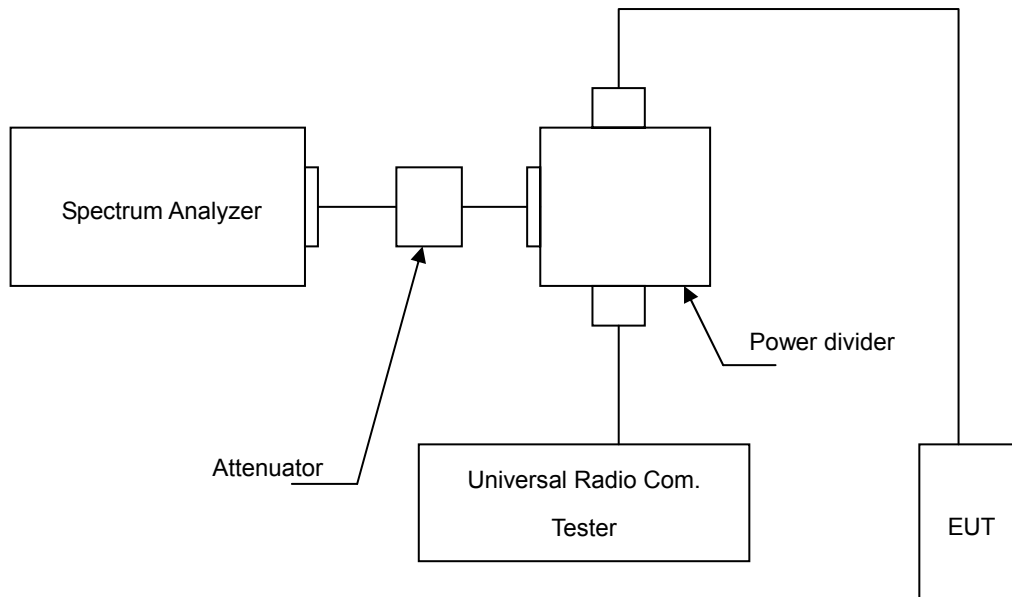

5.4. Test Procedure

The measurement is made according to FCC rules part 22 and 24:

1. The EUT was connected to Spectrum Analyzer and Base Station via Power Divider.
2. The occupied bandwidth of middle channel for the highest and lowest RF powers was measured.

5.5. Uncertainty

The measurement uncertainty is defined as $\pm 10\text{Hz}$

5.6. Test Result

Model Number	LE910-NA V2				
Test Item	Emission Bandwidth & Occupied Bandwidth				
Date of Test	06/10/2015			Test Site	TE05
Bands	Channel	Frequency (MHz)	-26dB Bandwidth (MHz)	99% Bandwidth (MHz)	Note
WCDMA Band II	9262	1852.4	4.631	4.0606	RBW:100KHz , VBW:300KHz
	9400	1880.0	4.663	4.0892	RBW:100KHz , VBW:300KHz
	9538	1907.6	4.671	4.0699	RBW:100KHz , VBW:300KHz
WCDMA Band V	4132	826.4	4.665	4.0772	RBW:100KHz , VBW:300KHz
	4183	836.6	4.640	4.0491	RBW:100KHz , VBW:300KHz
	4233	846.6	4.610	4.0651	RBW:100KHz , VBW:300KHz

5.7. Test Graphs

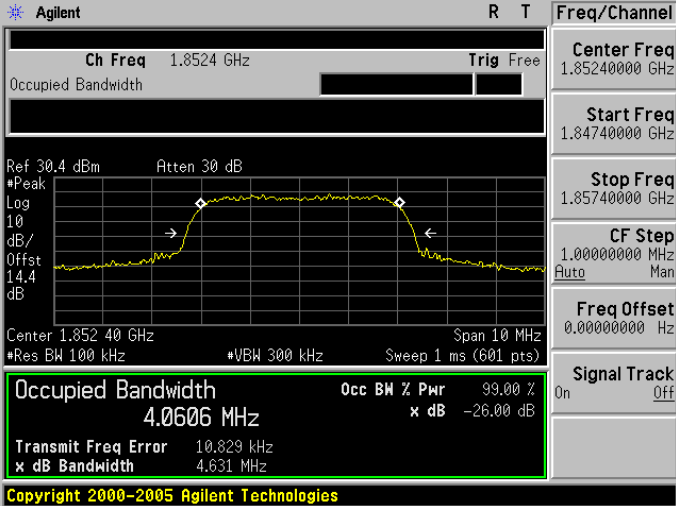
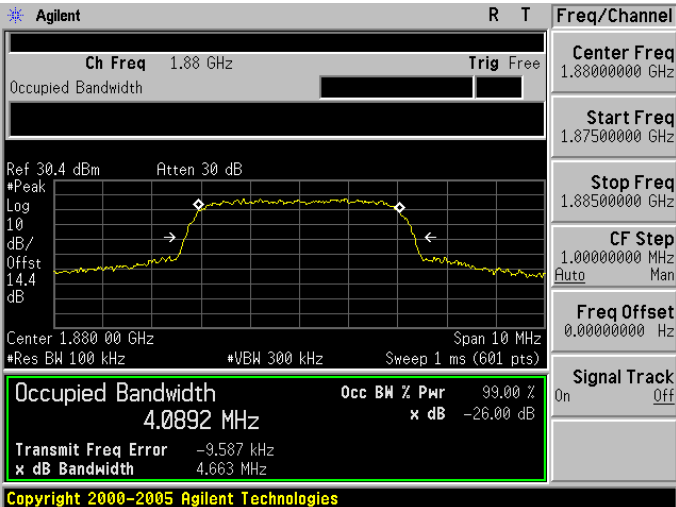
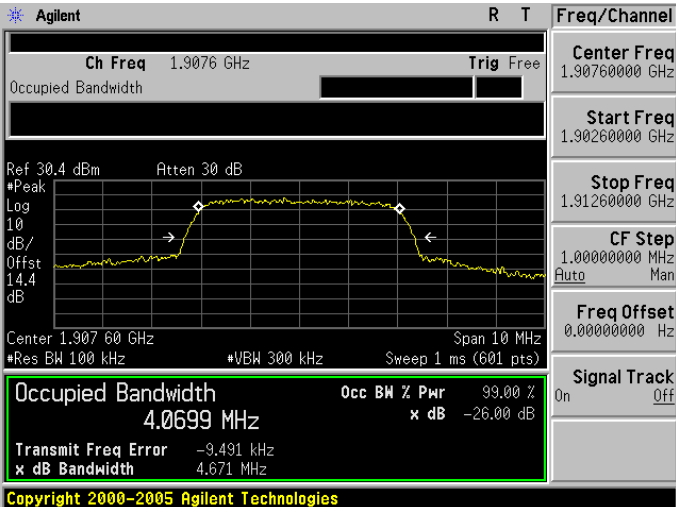
Mode 1: WCDMA Band II Link Mode	
1850.20 MHz	 <p>Agilent R T Freq/Channel</p> <p>Ch Freq 1.8524 GHz Trig Free</p> <p>Center Freq 1.85240000 GHz</p> <p>Start Freq 1.84740000 GHz</p> <p>Stop Freq 1.85740000 GHz</p> <p>CF Step 1.00000000 MHz Auto Man</p> <p>Freq Offset 0.00000000 Hz</p> <p>Signal Track On Off</p> <p>Ref 30.4 dBm Atten 30 dB</p> <p>#Peak Log 10 dB/Offst 14.4 dB</p> <p>Center 1.852 40 GHz Span 10 MHz</p> <p>#Res BW 100 kHz #VBW 300 kHz Sweep 1 ms (601 pts)</p> <p>Occupied Bandwidth 4.0606 MHz Occ BH % Pwr 99.00 % x dB -26.00 dB</p> <p>Transmit Freq Error 10.829 kHz</p> <p>x dB Bandwidth 4.631 MHz</p> <p>Copyright 2000-2005 Agilent Technologies</p>
1880.00 MHz	 <p>Agilent R T Freq/Channel</p> <p>Ch Freq 1.88 GHz Trig Free</p> <p>Center Freq 1.88000000 GHz</p> <p>Start Freq 1.87500000 GHz</p> <p>Stop Freq 1.88500000 GHz</p> <p>CF Step 1.00000000 MHz Auto Man</p> <p>Freq Offset 0.00000000 Hz</p> <p>Signal Track On Off</p> <p>Ref 30.4 dBm Atten 30 dB</p> <p>#Peak Log 10 dB/Offst 14.4 dB</p> <p>Center 1.880 00 GHz Span 10 MHz</p> <p>#Res BW 100 kHz #VBW 300 kHz Sweep 1 ms (601 pts)</p> <p>Occupied Bandwidth 4.0892 MHz Occ BH % Pwr 99.00 % x dB -26.00 dB</p> <p>Transmit Freq Error -9.587 kHz</p> <p>x dB Bandwidth 4.663 MHz</p> <p>Copyright 2000-2005 Agilent Technologies</p>
1909.80 MHz	 <p>Agilent R T Freq/Channel</p> <p>Ch Freq 1.9076 GHz Trig Free</p> <p>Center Freq 1.90760000 GHz</p> <p>Start Freq 1.90260000 GHz</p> <p>Stop Freq 1.91260000 GHz</p> <p>CF Step 1.00000000 MHz Auto Man</p> <p>Freq Offset 0.00000000 Hz</p> <p>Signal Track On Off</p> <p>Ref 30.4 dBm Atten 30 dB</p> <p>#Peak Log 10 dB/Offst 14.4 dB</p> <p>Center 1.907 60 GHz Span 10 MHz</p> <p>#Res BW 100 kHz #VBW 300 kHz Sweep 1 ms (601 pts)</p> <p>Occupied Bandwidth 4.0699 MHz Occ BH % Pwr 99.00 % x dB -26.00 dB</p> <p>Transmit Freq Error -9.491 kHz</p> <p>x dB Bandwidth 4.671 MHz</p> <p>Copyright 2000-2005 Agilent Technologies</p>

Mode 2: WCDMA Band V Link Mode

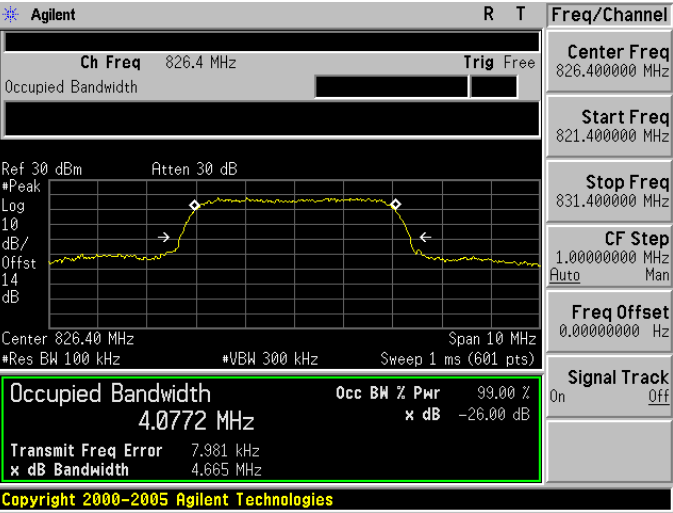
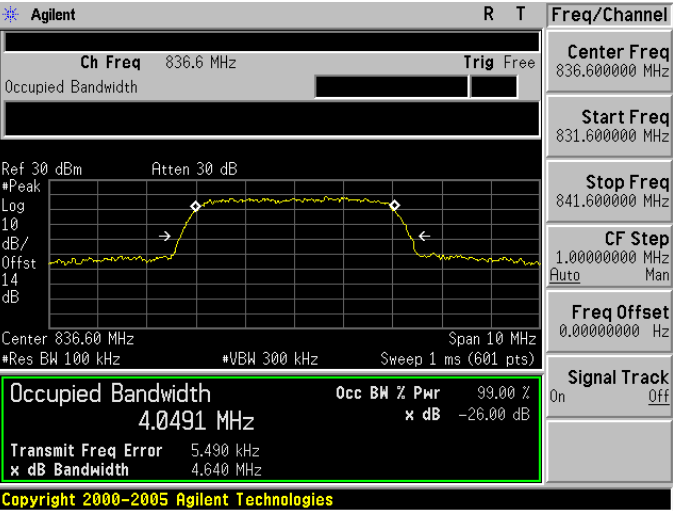
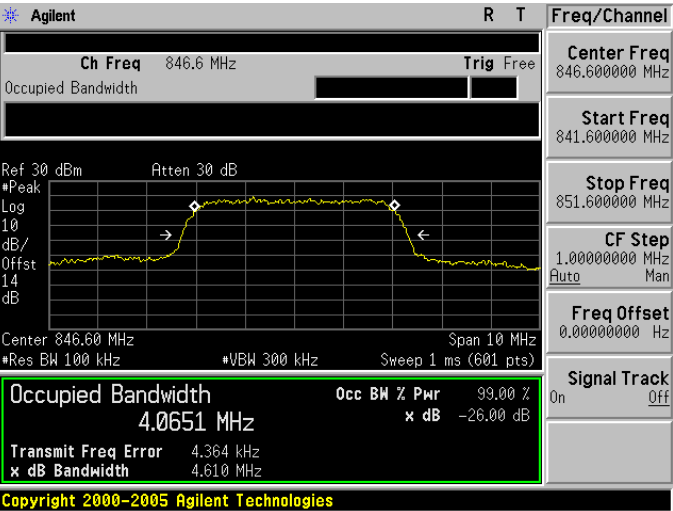
<p>826.4 MHz</p>	 <p>Agilent R T Freq/Channel</p> <p>Ch Freq 826.4 MHz Trig Free</p> <p>Center Freq 826.400000 MHz</p> <p>Start Freq 821.400000 MHz</p> <p>Stop Freq 831.400000 MHz</p> <p>CF Step 1.00000000 MHz Auto Man</p> <p>Freq Offset 0.00000000 Hz</p> <p>Signal Track On Off</p> <p>Ref 30 dBm Atten 30 dB</p> <p>Peak</p> <p>Log</p> <p>10 dB/Offst 14 dB</p> <p>Center 826.40 MHz Span 10 MHz</p> <p>Res BW 100 kHz VBW 300 kHz Sweep 1 ms (601 pts)</p> <p>Occupied Bandwidth 4.0772 MHz Occ BW % Pwr 99.00 % x dB -26.00 dB</p> <p>Transmit Freq Error 7.981 kHz x dB Bandwidth 4.665 MHz</p> <p>Copyright 2000-2005 Agilent Technologies</p>
<p>836.6 MHz</p>	 <p>Agilent R T Freq/Channel</p> <p>Ch Freq 836.6 MHz Trig Free</p> <p>Center Freq 836.600000 MHz</p> <p>Start Freq 831.600000 MHz</p> <p>Stop Freq 841.600000 MHz</p> <p>CF Step 1.00000000 MHz Auto Man</p> <p>Freq Offset 0.00000000 Hz</p> <p>Signal Track On Off</p> <p>Ref 30 dBm Atten 30 dB</p> <p>Peak</p> <p>Log</p> <p>10 dB/Offst 14 dB</p> <p>Center 836.60 MHz Span 10 MHz</p> <p>Res BW 100 kHz VBW 300 kHz Sweep 1 ms (601 pts)</p> <p>Occupied Bandwidth 4.0491 MHz Occ BW % Pwr 99.00 % x dB -26.00 dB</p> <p>Transmit Freq Error 5.490 kHz x dB Bandwidth 4.640 MHz</p> <p>Copyright 2000-2005 Agilent Technologies</p>
<p>846.6 MHz</p>	 <p>Agilent R T Freq/Channel</p> <p>Ch Freq 846.6 MHz Trig Free</p> <p>Center Freq 846.600000 MHz</p> <p>Start Freq 841.600000 MHz</p> <p>Stop Freq 851.600000 MHz</p> <p>CF Step 1.00000000 MHz Auto Man</p> <p>Freq Offset 0.00000000 Hz</p> <p>Signal Track On Off</p> <p>Ref 30 dBm Atten 30 dB</p> <p>Peak</p> <p>Log</p> <p>10 dB/Offst 14 dB</p> <p>Center 846.60 MHz Span 10 MHz</p> <p>Res BW 100 kHz VBW 300 kHz Sweep 1 ms (601 pts)</p> <p>Occupied Bandwidth 4.0651 MHz Occ BW % Pwr 99.00 % x dB -26.00 dB</p> <p>Transmit Freq Error 4.364 kHz x dB Bandwidth 4.610 MHz</p> <p>Copyright 2000-2005 Agilent Technologies</p>

6 Band Edge Test

6.1. Limit

The Band Edge Limit:

The power of any emission outside of the authorized operating frequency ranges must be attenuated below the transmitting power (P) by a factor of at least $43 + 10\log(P)$ dB.

6.2. Test Instruments

Equipment	Manufacturer	Model Number	Serial Number	Cal. Date	Remark
Universal Radio Communication Tester	R & S	CMU200	109369	10/21/2014	(2)
Spectrum Analyzer	Agilent	E4445A	MY46181986	05/14/2015	(1)
Attenuator	RADIALL	R41572000	0603033073	N.C.R.	-----
Power Divider	Agilent	87302C	3239A00760	N.C.R.	-----
Test Site	ATL	TE05	TE05	N.C.R.	-----

Remark: ⁽¹⁾ Calibration period 1 year. ⁽²⁾ Calibration period 2 years.

Note: N.C.R. = No Calibration Request.

6.3. Setup

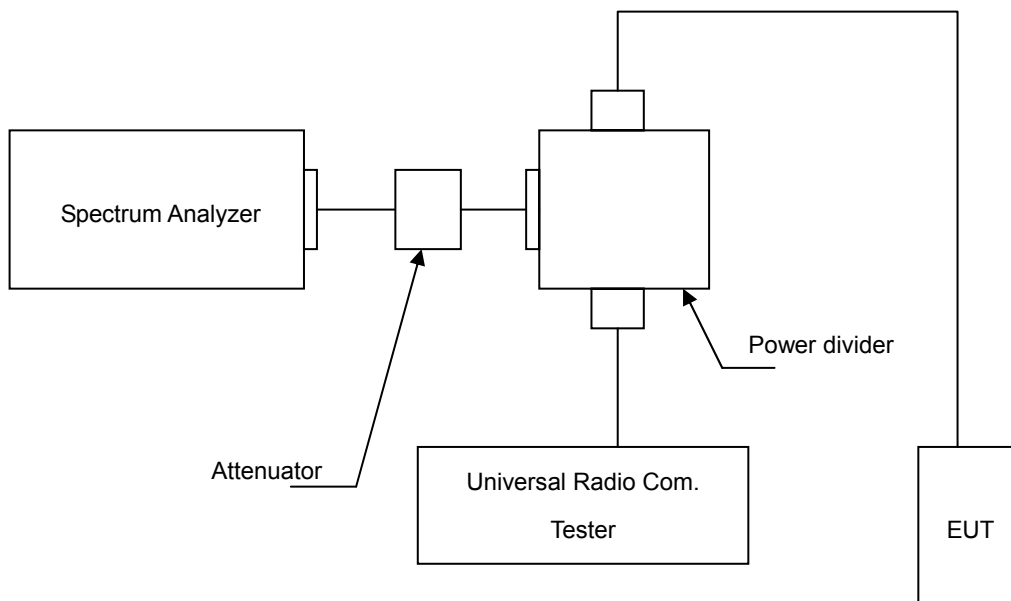

6.4. Test Procedure

The measurement is made according to FCC rules part 22 and 24:

1. The EUT was connected to Spectrum Analyzer and Base Station via Power Divider.
2. The band edge of low and high channels for the highest RF powers within the transmitting frequency band were measured. Setting RBW as roughly BW/100.
3. The band edge setting:
 - a. RB=10 kHz; VB=30 kHz for GSM 850 and PCS 1900.
 - b. RB=51 kHz; VB=160 kHz for WCDMA Band V and WCDMA Band II.

6.5. Uncertainty

The measurement uncertainty is defined as $\pm 10\text{Hz}$

6.6. Test Result

Model Number		LE910-NA V2				
Test Item		Band Edge				
Date of Test		06/10/2015			Test Site	TE05
Bands		Channel	Frequency (MHz)	Bandwidth (dBm)	Limit (dBm)	Result
WCDMA Band II	Lower	9262	1850.000	-30.71	-13	Pass
	Higher	9538	1910.000	-28.97	-13	Pass
WCDMA Band V	Lower	4132	824.0000	-20.85	-13	Pass
	Higher	4233	849.0000	-21.09	-13	Pass

6.7. Test Graphs

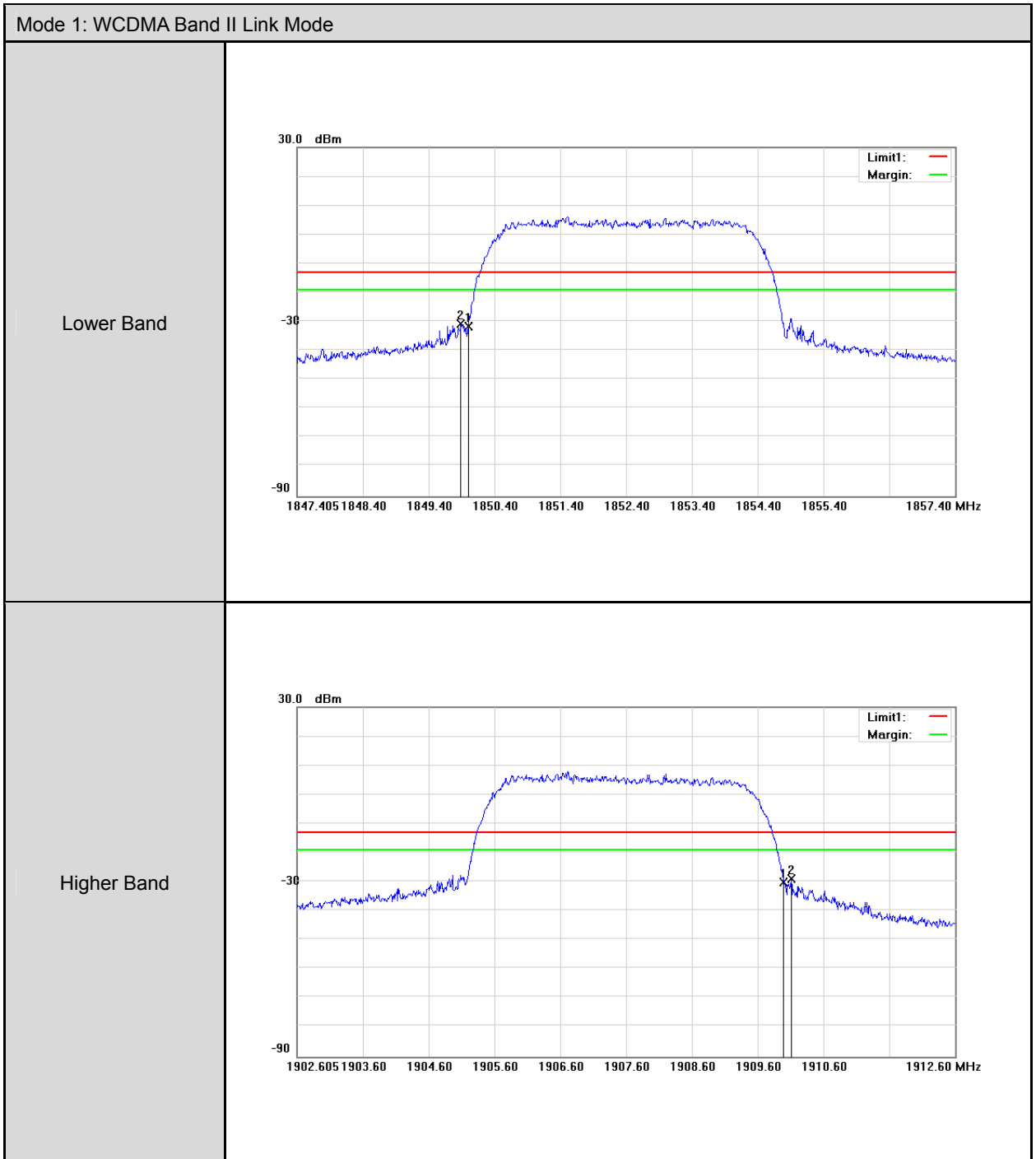

Mode 2: WCDMA Band V Link Mode

Lower Band

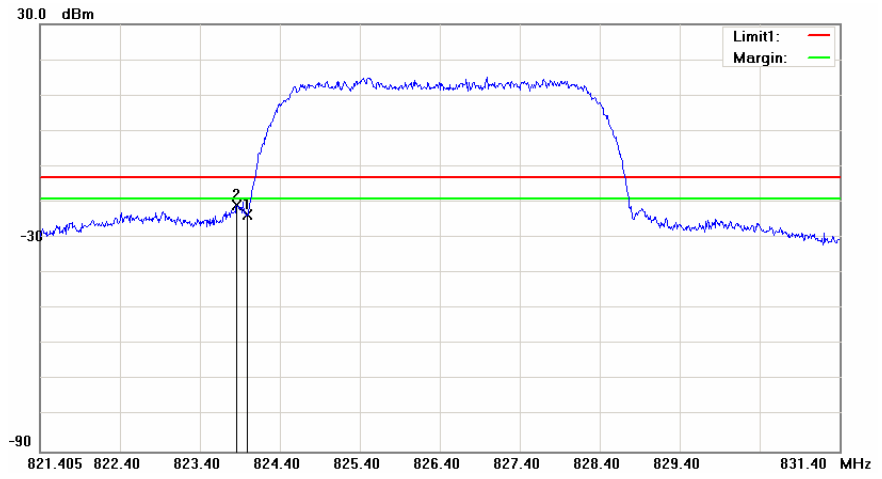

Higher Band

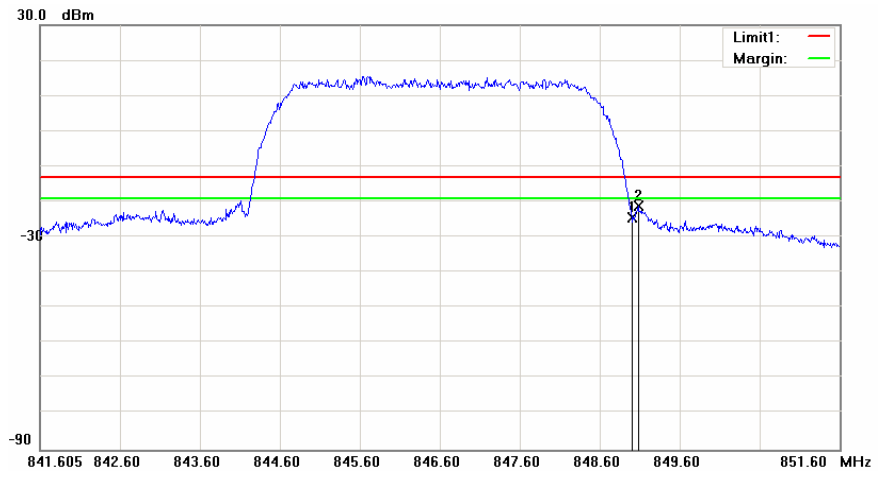

7 Conducted Spurious Emission and Radiation Emission Test

7.1. Limit

The power of any emission outside of the authorized operating frequency ranges must be attenuated below the transmitting power (P) by a factor of at least $43 + 10\log(P)$ dB.

7.2. Test Instruments

Equipment	Manufacturer	Model Number	Serial Number	Cal. Date	Remark
Universal Radio Communication Tester	R & S	CMU200	109369	10/21/2014	(2)
Spectrum Analyzer	Agilent	E4445A	MY46181986	05/14/2015	(1)
Attenuator	RADIALL	R41572000	0603033073	N.C.R.	-----
Power Divider	Agilent	87302C	3239A00760	N.C.R.	-----
Test Site	ATL	TE05	TE05	N.C.R.	-----

Remark: ⁽¹⁾ Calibration period 1 year. ⁽²⁾ Calibration period 2 years.

Note: N.C.R. = No Calibration Request.

7.3. Setup

Below 2.8GHz

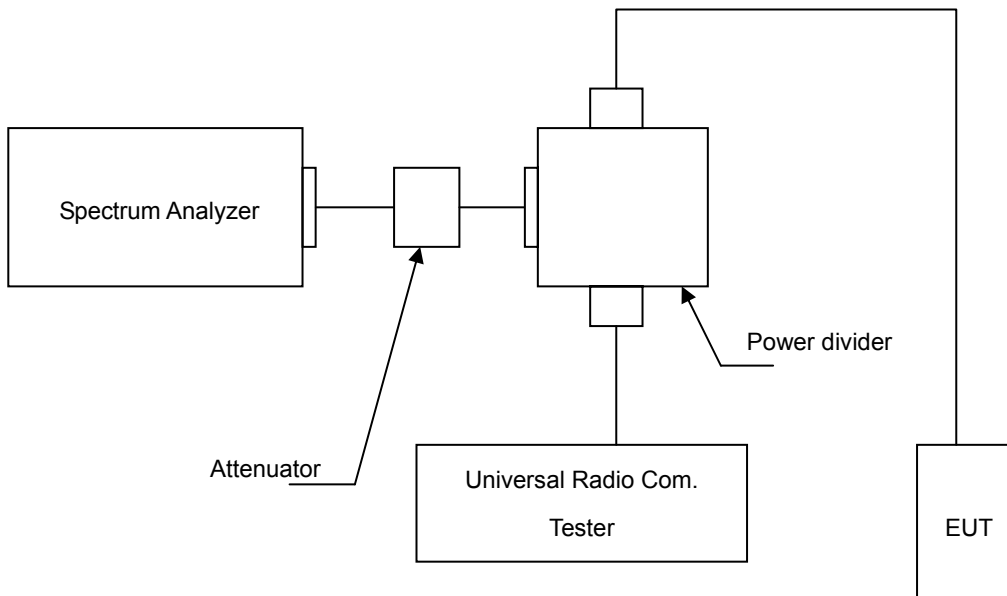

Above 2.8GHz

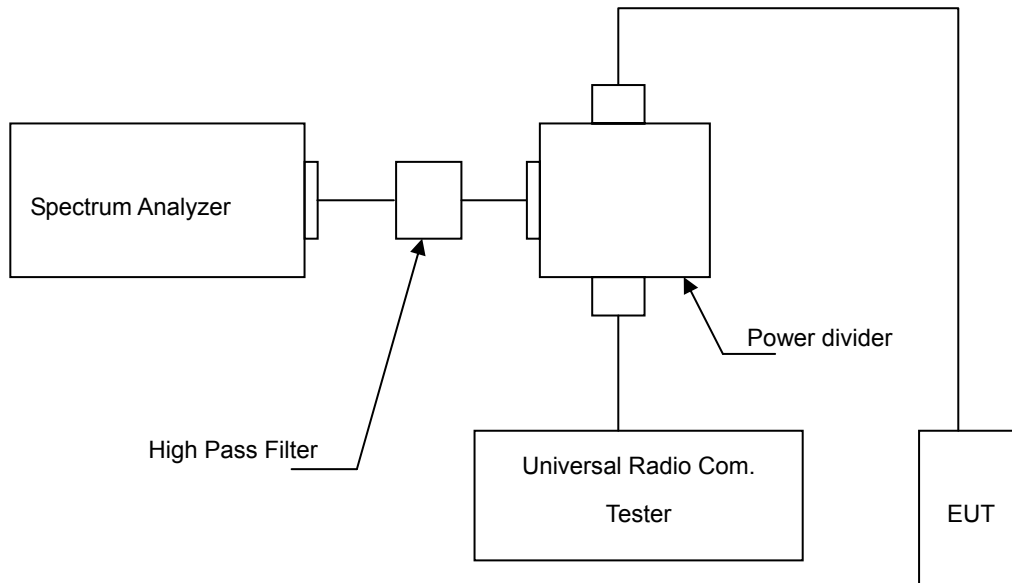

7.4. Test Procedure

1. The EUT was connected to Spectrum Analyzer and Base Station via Power Divider.
2. The middle channel for the highest RF power within the transmitting frequency was measured.
3. The conducted spurious emission for the whole frequency range was taken.

7.5. Uncertainty

The measurement uncertainty is evaluated as ± 2.24 dB.

7.6. Test Result

Model Number	LE910-NA V2		
Test Item	Conducted Emission		
Test Mode	Mode 1 / Mode 2		
Date of Test	06/23/2015	Test Site	TE05

File :LE910 NA V2(CH9262)

Data :#1

Date: 2015/6/10

Time: 下午 04:01:49

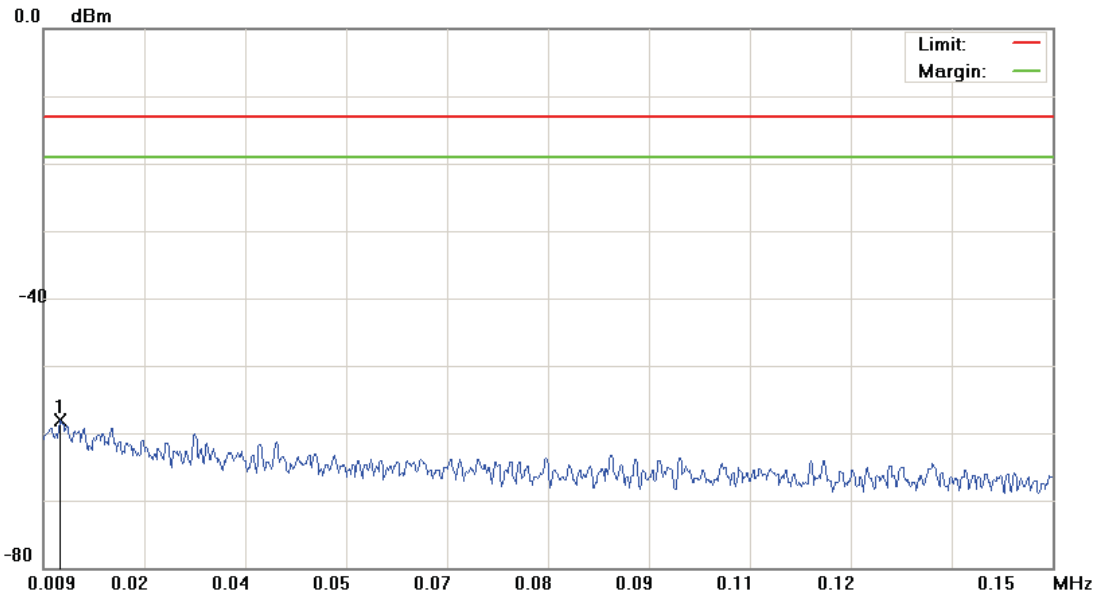

Site: site #1	Polarization: Conducted Power	Temperature: 26 °C
Limit: FCC Part 24 conducted(9k-26.5G)	Power: DC 3.8V	Humidity: 55 %
EUT: LE910-NA V2	Distance:	RBW: 1 KHz VBW: 3 KHz
M/N: LE910-NA V2		
Mode: WCDMA Band II		
Note:		

No.	Mk.	Freq.	Reading Level	Correct Factor	Measurement	Limit	Over	Antenna Height	Table Degree	
		MHz	dBm	dB	dBm	dBm	dB	cm	degree	Comment
1	*	0.0114	-69.47	11.35	-58.12	-13.00	-45.12	peak		

*:Maximum data x:Over limit !:over margin

File :LE910 NA V2(CH9262)

Data :#2

Date: 2015/6/10

Time: 下午 04:02:13

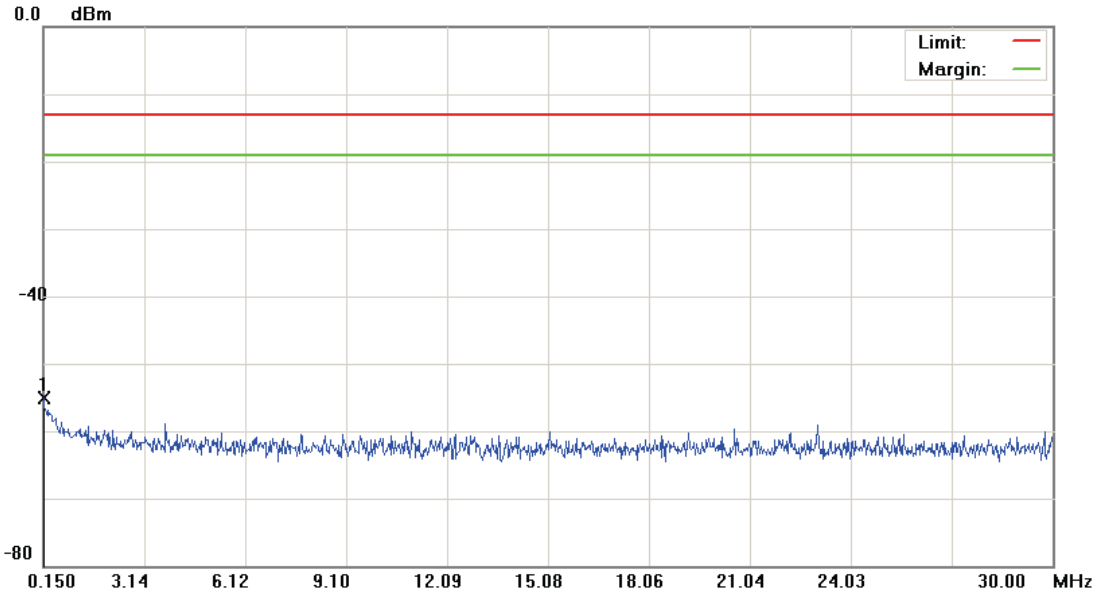

Site: site #1	Polarization: Conducted Power	Temperature: 26 °C
Limit: FCC Part 24 conducted(9k-26.5G)	Power: DC 3.8V	Humidity: 55 %
EUT: LE910-NA V2	Distance:	RBW: 10 KHz VBW: 30 KHz
M/N: LE910-NA V2		
Mode: WCDMA Band II		
Note:		

No.	Mk.	Freq.	Reading Level	Correct Factor	Measurement	Limit	Over	Antenna Height	Table Degree	
		MHz	dBm	dB	dBm	dBm	dB	cm	degree	Comment
1	*	0.1500	-67.48	12.47	-55.01	-13.00	-42.01	peak		

*:Maximum data x:Over limit !:over margin

File :LE910 NA V2(CH9262)

Data :#3

Date: 2015/6/10

Time: 下午 04:02:37

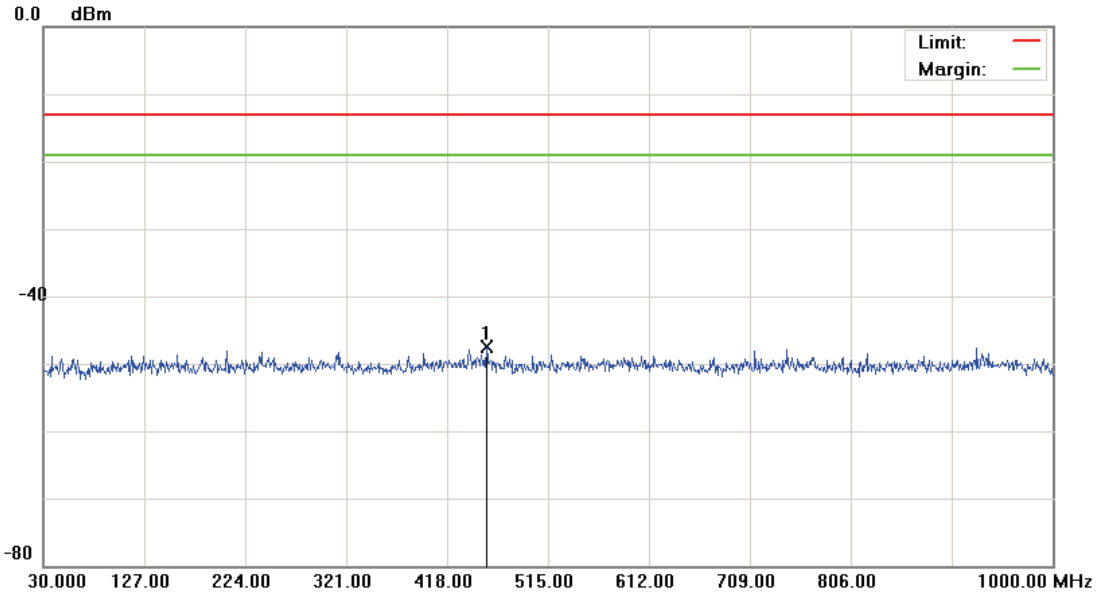

Site: site #1	Polarization: Conducted Power	Temperature: 26 °C
Limit: FCC Part 24 conducted(9k-26.5G)	Power: DC 3.8V	Humidity: 55 %
EUT: LE910-NA V2	Distance:	RBW: 100 KHz VBW: 300 KHz
M/N: LE910-NA V2		
Mode: WCDMA Band II		
Note:		

No.	Mk.	Freq.	Reading Level	Correct Factor	Measurement	Limit	Over	Antenna Height	Table Degree	
		MHz	dBm	dB	dBm	dBm	dB	cm	degree	Comment
1	*	455.8300	-60.69	13.22	-47.47	-13.00	-34.47	peak		

*:Maximum data x:Over limit !:over margin

File :LE910 NA V2(CH9262)

Data :#4

Date: 2015/6/10

Time: 下午 04:09:49

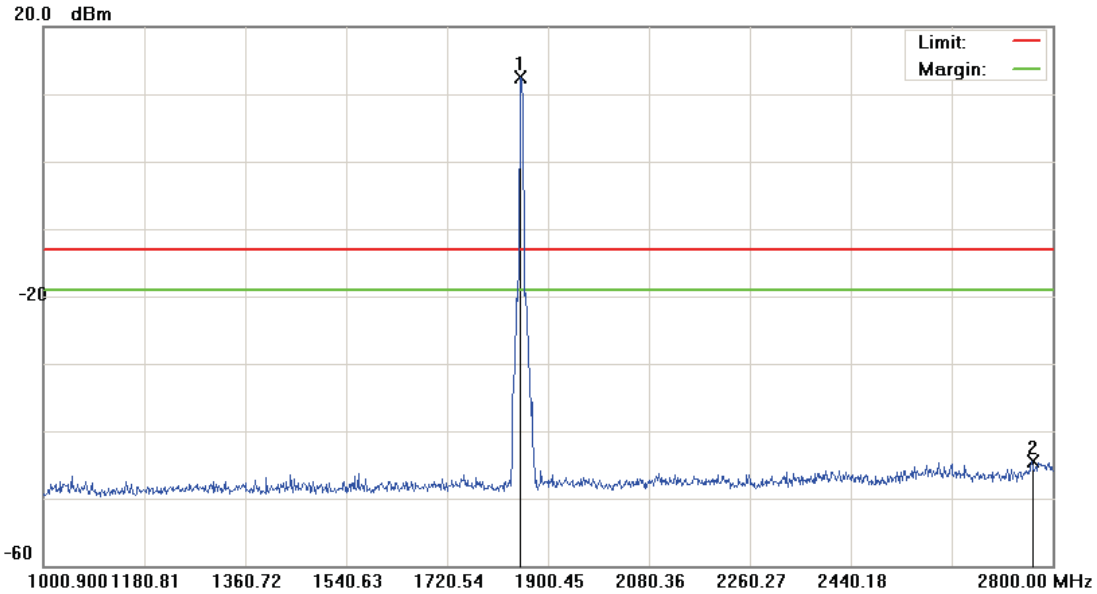

Site: site #1	Polarization: Conducted Power	Temperature: 26 °C
Limit: FCC Part 24 conducted(9k-26.5G)	Power: DC 3.8V	Humidity: 55 %
EUT: LE910-NA V2	Distance:	RBW: 1000 KHz VBW: 3000 KHz
M/N: LE910-NA V2		
Mode: WCDMA Band II		
Note:		

No.	Mk.	Freq. MHz	Reading Level dBm	Correct Factor dB	Measure- ment dBm	Limit dBm	Over dB	Detector	Antenna Height cm	Table Degree	Comment
1	*	1850.500	8.16	4.26	12.42	-13.00	25.42	peak			Tx
2		2763.100	-50.16	5.64	-44.52	-13.00	-31.52	peak			

*:Maximum data x:Over limit !:over margin

File :LE910 NA V2(CH9262)

Data :#5

Date: 2015/6/10

Time: 下午 04:46:30

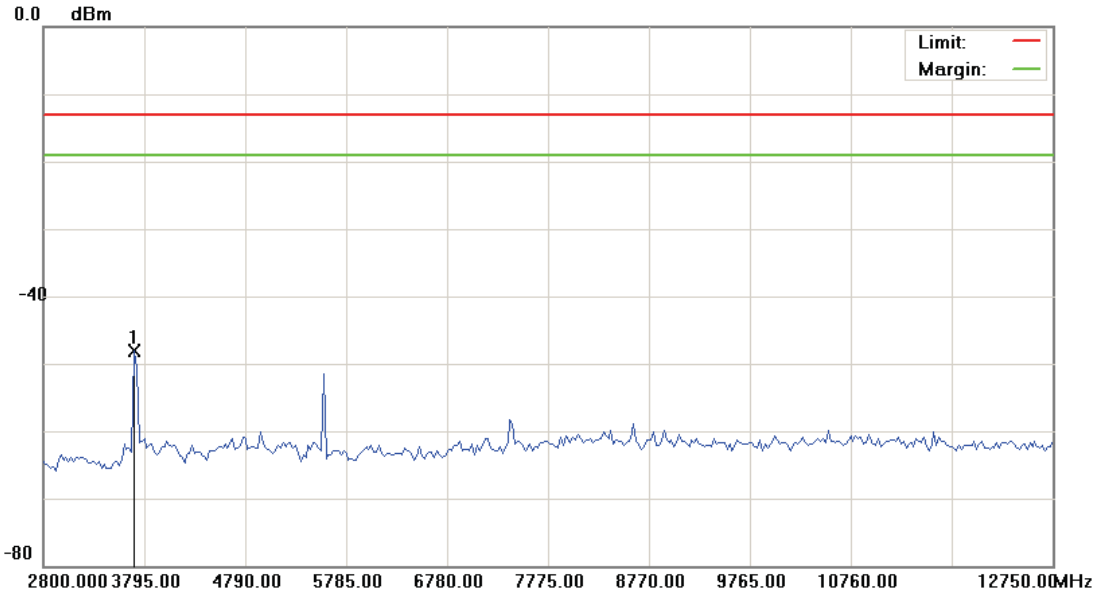

Site: site #1	Polarization: Conducted Power	Temperature: 26 °C
Limit: FCC Part 24 conducted(9k-26.5G)	Power: DC 3.8V	Humidity: 55 %
EUT: LE910-NA V2	Distance:	RBW: 1000 KHz VBW: 3000 KHz
M/N: LE910-NA V2		
Mode: WCDMA Band II		
Note:		

No.	Mk.	Freq.	Reading Level	Correct Factor	Measurement	Limit	Over	Antenna Height	Table Degree	
		MHz	dBm	dB	dBm	dBm	dB	cm	degree	Comment
1	*	3695.500	-53.02	4.87	-48.15	-13.00	-35.15	peak		

*:Maximum data x:Over limit !:over margin

File :LE910 NA V2(CH9262)

Data :#6

Date: 2015/6/10

Time: 下午 04:46:49

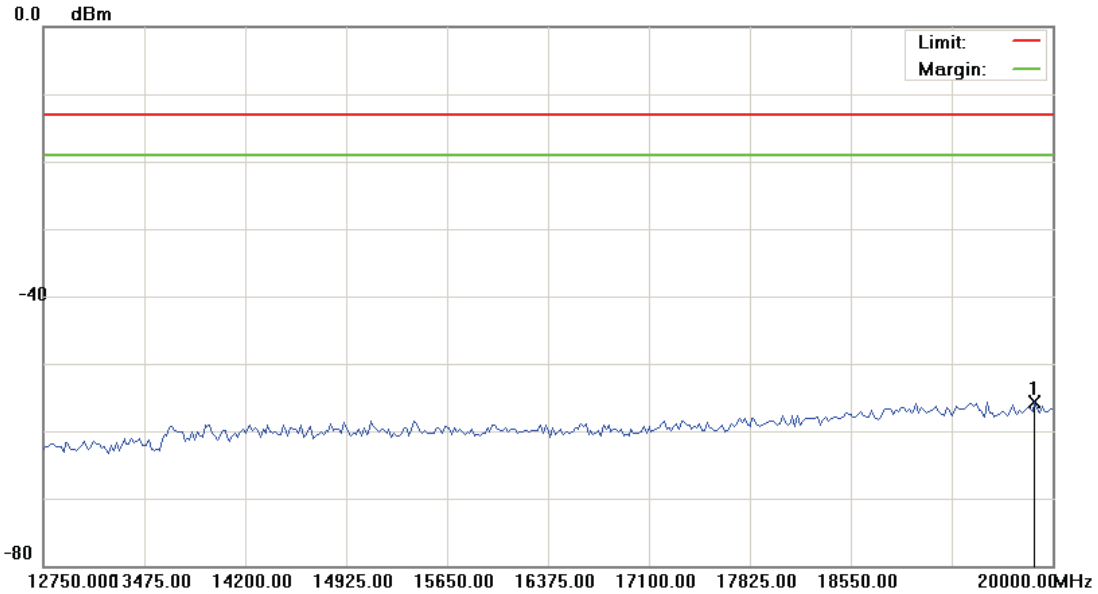

Site: site #1	Polarization: Conducted Power	Temperature: 26 °C
Limit: FCC Part 24 conducted(9k-26.5G)	Power: DC 3.8V	Humidity: 55 %
EUT: LE910-NA V2	Distance:	RBW: 1000 KHz VBW: 3000 KHz
M/N: LE910-NA V2		
Mode: WCDMA Band II		
Note:		

No.	Mk.	Freq.	Reading Level	Correct Factor	Measurement	Limit	Over	Antenna Height	Table Degree	
		MHz	dBm	dB	dBm	dBm	dB	cm	degree	Comment
1	*	19873.125	-63.01	7.40	-55.61	-13.00	-42.61	peak		

*:Maximum data x:Over limit !:over margin

File :LE910 NA V2(CH9400)

Data :#1

Date: 2015/6/10

Time: 下午 04:03:29

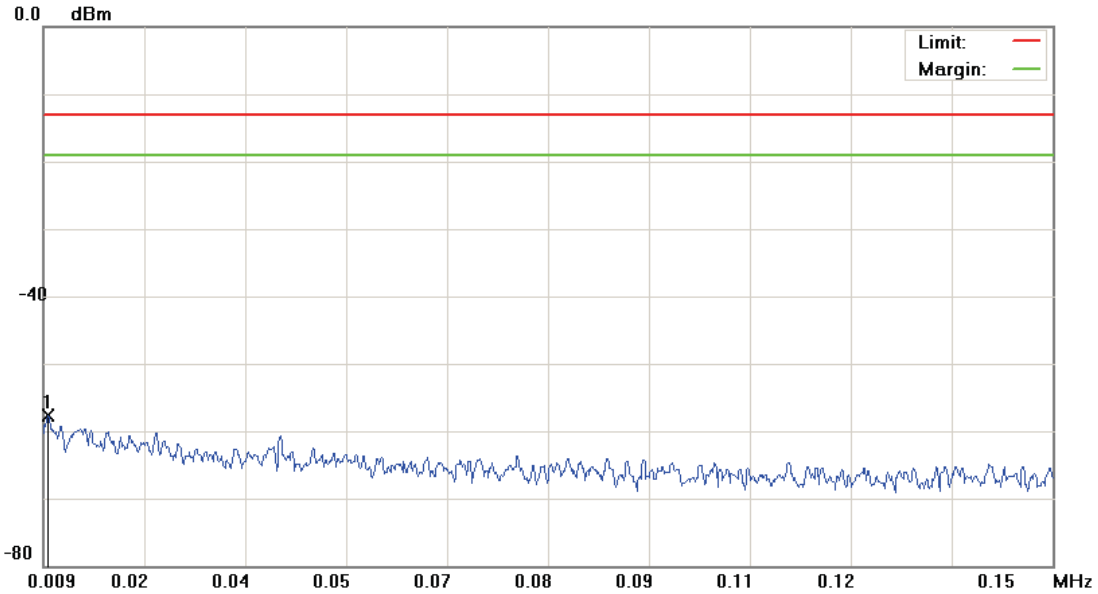

Site: site #1	Polarization: Conducted Power	Temperature: 26 °C
Limit: FCC Part 24 conducted(9k-26.5G)	Power: DC 3.8V	Humidity: 55 %
EUT: LE910-NA V2	Distance:	RBW: 1 KHz VBW: 3 KHz
M/N: LE910-NA V2		
Mode: WCDMA Band II		
Note:		

No.	Mk.	Freq.	Reading Level	Correct Factor	Measurement	Limit	Over	Antenna Height	Table Degree	
		MHz	dBm	dB	dBm	dBm	dB	cm	degree	Comment
1	*	0.0097	-69.09	11.33	-57.76	-13.00	-44.76	peak		

*:Maximum data x:Over limit !:over margin

File :LE910 NA V2(CH9400)

Data :#2

Date: 2015/6/10

Time: 下午 04:03:53

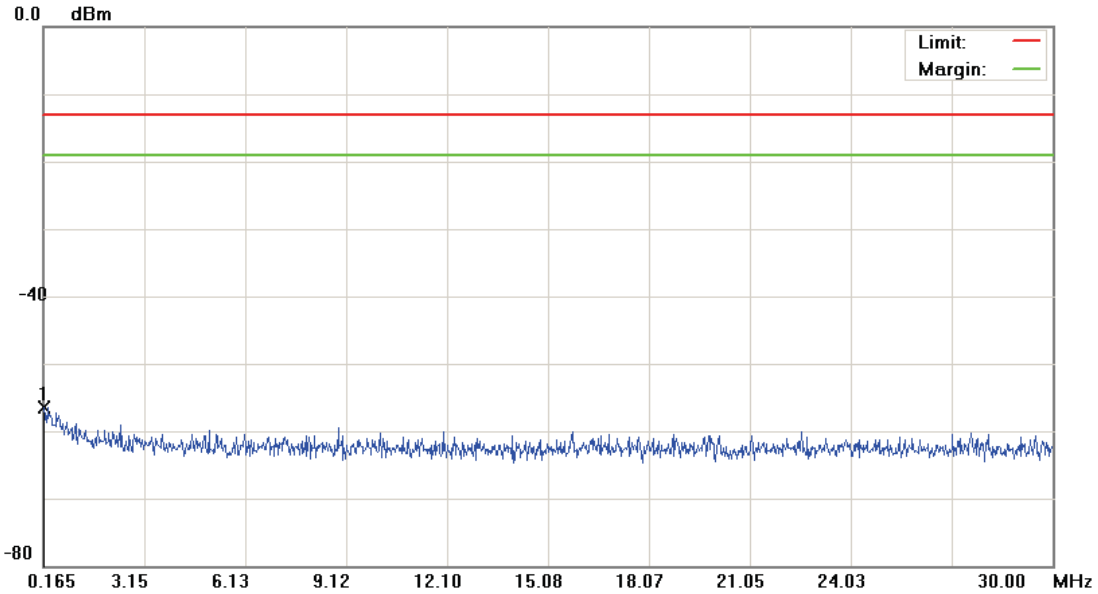

Site: site #1	Polarization: Conducted Power	Temperature: 26 °C
Limit: FCC Part 24 conducted(9k-26.5G)	Power: DC 3.8V	Humidity: 55 %
EUT: LE910-NA V2	Distance:	RBW: 10 KHz VBW: 30 KHz
M/N: LE910-NA V2		
Mode: WCDMA Band II		
Note:		

No.	Mk.	Freq.	Reading Level	Correct Factor	Measurement	Limit	Over	Antenna Height	Table Degree	
		MHz	dBm	dB	dBm	dBm	dB	cm	degree	Comment
1	*	0.1948	-68.90	12.45	-56.45	-13.00	-43.45	peak		

*:Maximum data x:Over limit !:over margin

File :LE910 NA V2(CH9400)

Data :#3

Date: 2015/6/10

Time: 下午 04:04:17

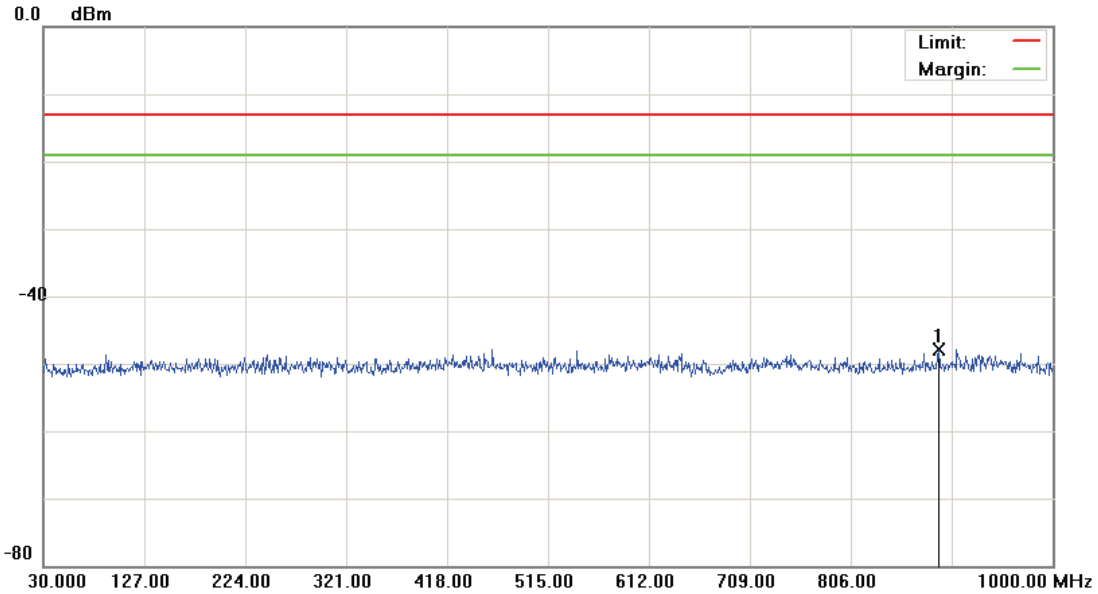

Site: site #1	Polarization: Conducted Power	Temperature: 26 °C
Limit: FCC Part 24 conducted(9k-26.5G)	Power: DC 3.8V	Humidity: 55 %
EUT: LE910-NA V2	Distance:	RBW: 100 KHz VBW: 300 KHz
M/N: LE910-NA V2		
Mode: WCDMA Band II		
Note:		

No.	Mk.	Freq.	Reading Level	Correct Factor	Measurement	Limit	Over	Antenna Height	Table Degree	
		MHz	dBm	dB	dBm	dBm	dB	cm	degree	Comment
1	*	890.3900	-61.07	13.22	-47.85	-13.00	-34.85	peak		

*:Maximum data x:Over limit !:over margin

File :LE910 NA V2(CH9400)

Data :#4

Date: 2015/6/10

Time: 下午 04:12:05

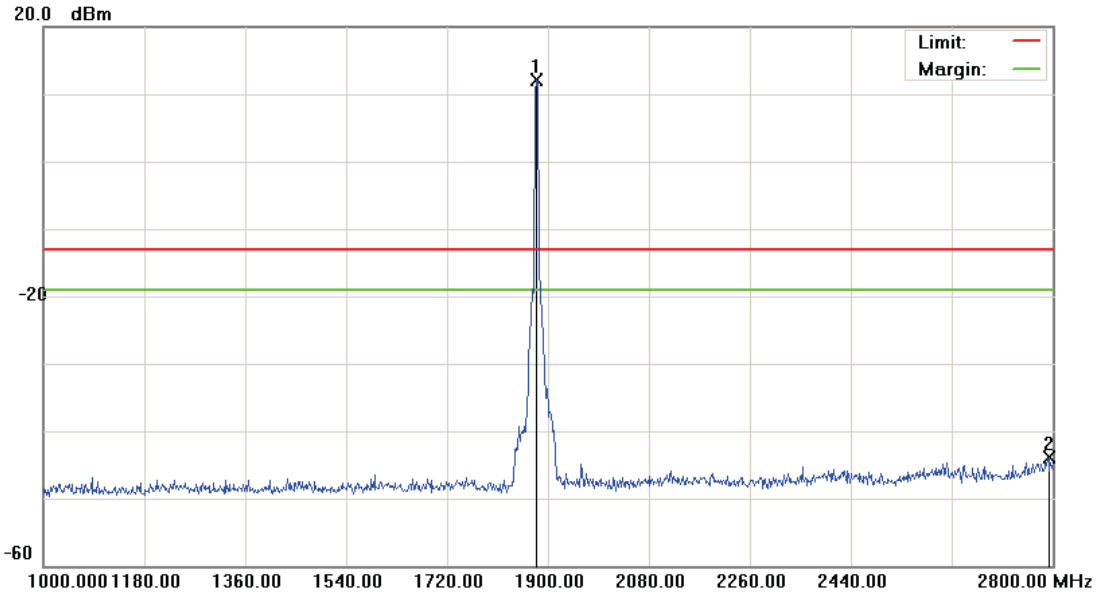

Site: site #1	Polarization: Conducted Power	Temperature: 26 °C
Limit: FCC Part 24 conducted(9k-26.5G)	Power: DC 3.8V	Humidity: 55 %
EUT: LE910-NA V2	Distance:	RBW: 1000 KHz VBW: 3000 KHz
M/N: LE910-NA V2		
Mode: WCDMA Band II		
Note:		

No.	Mk.	Freq. MHz	Reading Level dBm	Correct Factor dB	Measure- ment dBm	Limit dBm	Over dB	Detector	Antenna Height cm	Table Degree degree	Comment
1	*	1878.400	7.45	4.61	12.06	-13.00	25.06	peak			Tx
2		2792.800	-49.84	5.90	-43.94	-13.00	-30.94	peak			

*:Maximum data x:Over limit !:over margin

File :LE910 NA V2(CH9400)

Data :#5

Date: 2015/6/10

Time: 下午 04:47:18

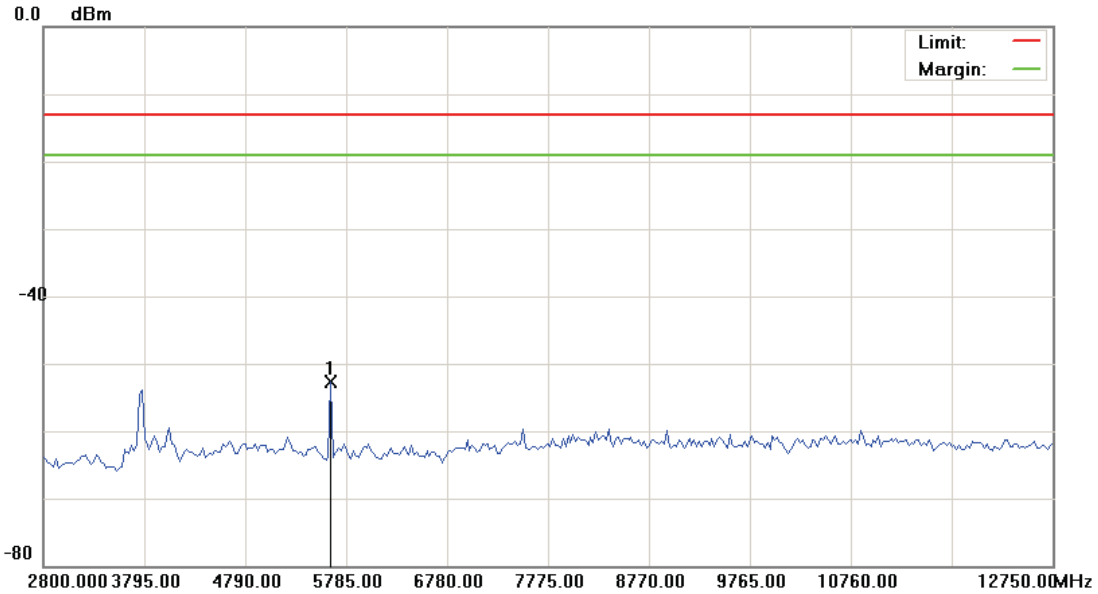

Site: site #1	Polarization: Conducted Power	Temperature: 26 °C
Limit: FCC Part 24 conducted(9k-26.5G)	Power: DC 3.8V	Humidity: 55 %
EUT: LE910-NA V2	Distance:	RBW: 1000 KHz VBW: 3000 KHz
M/N: LE910-NA V2		
Mode: WCDMA Band II		
Note:		

No.	Mk.	Freq. MHz	Reading Level dBm	Correct Factor dB	Measure- ment dBm	Limit dBm	Over dB	Antenna Height cm	Table Degree	Detector	Comment
1	*	5635.750	-57.52	4.86	-52.66	-13.00	-39.66			peak	

*:Maximum data x:Over limit !:over margin

File :LE910 NA V2(CH9400)

Data :#6

Date: 2015/6/10

Time: 下午 04:47:37

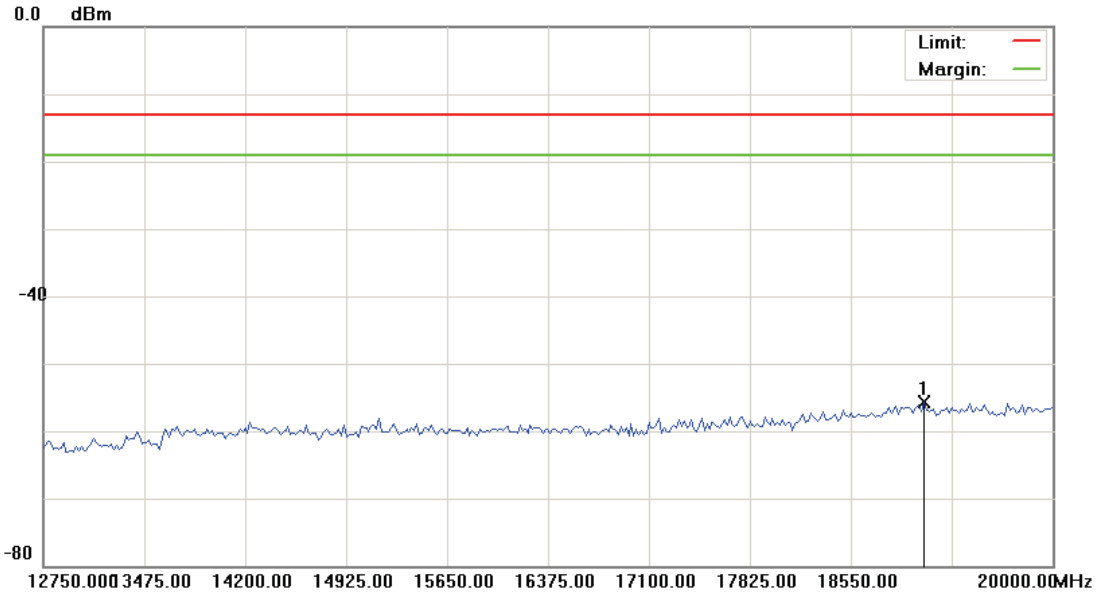

Site: site #1	Polarization: Conducted Power	Temperature: 26 °C
Limit: FCC Part 24 conducted(9k-26.5G)	Power: DC 3.8V	Humidity: 55 %
EUT: LE910-NA V2	Distance:	RBW: 1000 KHz VBW: 3000 KHz
M/N: LE910-NA V2		
Mode: WCDMA Band II		
Note:		

No.	Mk.	Freq.	Reading Level	Correct Factor	Measurement	Limit	Over	Antenna Height	Table Degree	
		MHz	dBm	dB	dBm	dBm	dB	cm	degree	Comment
1	*	19075.625	-62.90	7.18	-55.72	-13.00	-42.72	peak		

*:Maximum data x:Over limit !:over margin

File :LE910 NA V2(CH9538)

Data :#1

Date: 2015/6/10

Time: 下午 04:05:32

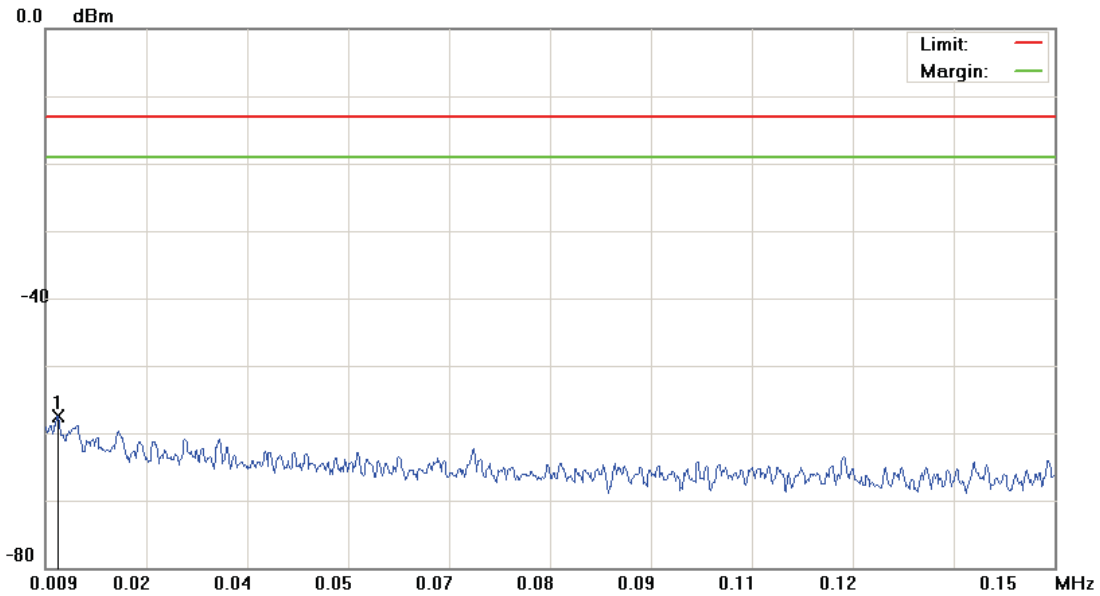

Site: site #1	Polarization: Conducted Power	Temperature: 26 °C
Limit: FCC Part 24 conducted(9k-26.5G)	Power: DC 3.8V	Humidity: 55 %
EUT: LE910-NA V2	Distance:	RBW: 1 KHz VBW: 3 KHz
M/N: LE910-NA V2		
Mode: WCDMA Band II		
Note:		

No.	Mk.	Freq.	Reading Level	Correct Factor	Measurement	Limit	Over	Antenna Height	Table Degree	
		MHz	dBm	dB	dBm	dBm	dB	cm	degree	Comment
1	*	0.0107	-68.74	11.34	-57.40	-13.00	-44.40	peak		

*:Maximum data x:Over limit !:over margin

File :LE910 NA V2(CH9538)

Data :#2

Date: 2015/6/10

Time: 下午 04:05:56

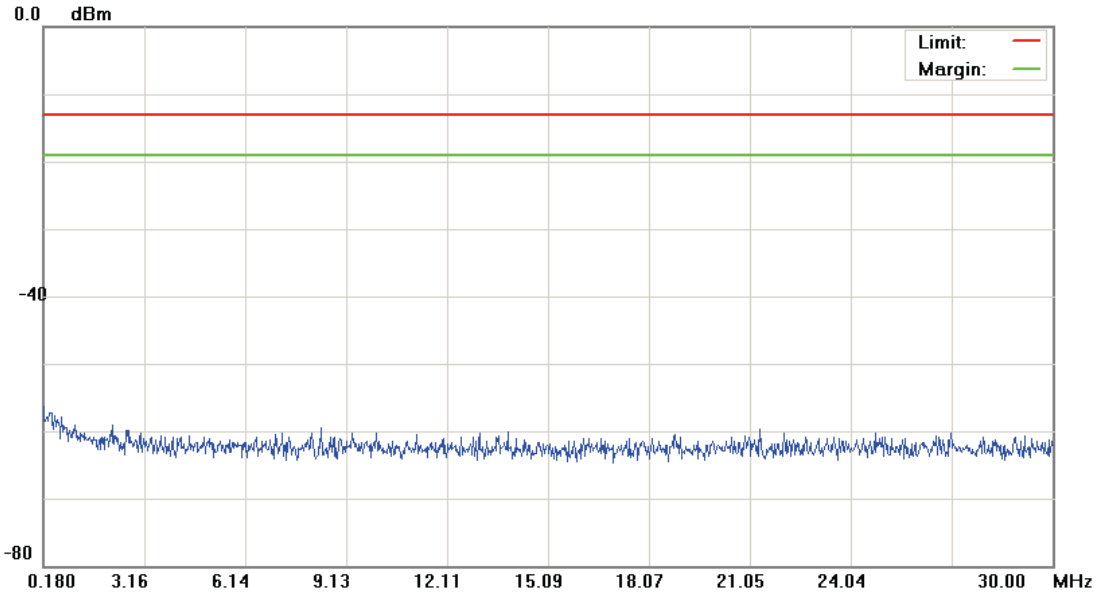

Site: site #1	Polarization: Conducted Power	Temperature: 26 °C
Limit: FCC Part 24 conducted(9k-26.5G)	Power: DC 3.8V	Humidity: 55 %
EUT: LE910-NA V2	Distance:	RBW: 10 KHz VBW: 30 KHz
M/N: LE910-NA V2		
Mode: WCDMA Band II		
Note:		

No.	Mk.	Freq.	Reading Level	Correct Factor	Measurement	Limit	Over	Antenna Height	Table Degree	
		MHz	dBm	dB	dBm	dBm	dB	cm	degree	Comment
1	*	0.1798	-68.83	12.45	-56.38	-13.00	-43.38	peak		

*:Maximum data x:Over limit !:over margin

File :LE910 NA V2(CH9538)

Data :#3

Date: 2015/6/10

Time: 下午 04:06:20

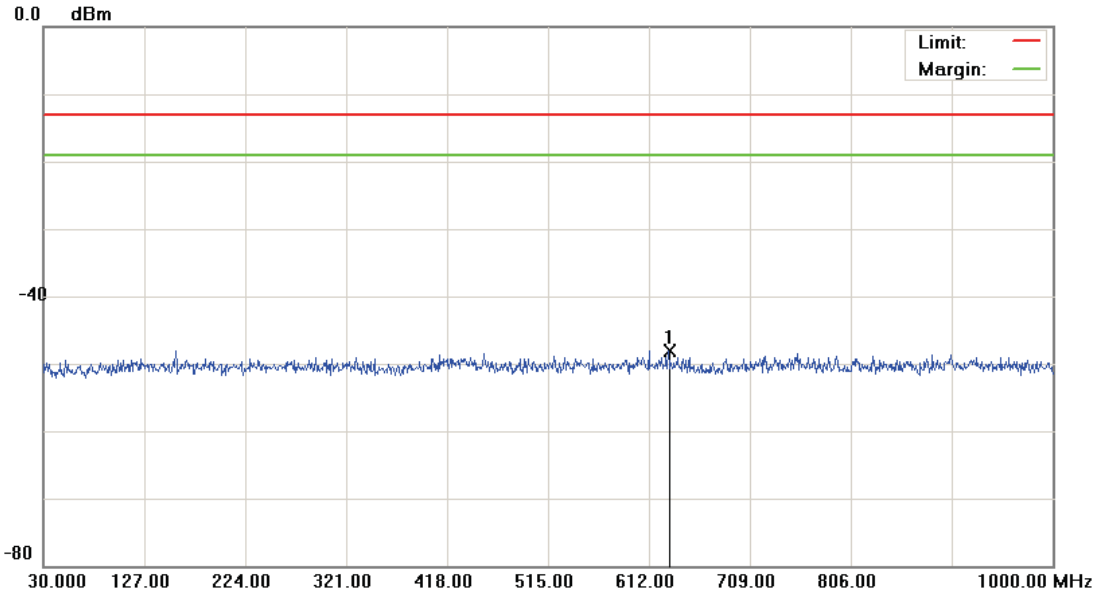

Site: site #1	Polarization: Conducted Power	Temperature: 26 °C
Limit: FCC Part 24 conducted(9k-26.5G)	Power: DC 3.8V	Humidity: 55 %
EUT: LE910-NA V2	Distance:	RBW: 100 KHz VBW: 300 KHz
M/N: LE910-NA V2		
Mode: WCDMA Band II		
Note:		

No.	Mk.	Freq.	Reading Level	Correct Factor	Measurement	Limit	Over	Antenna Height	Table Degree	
		MHz	dBm	dB	dBm	dBm	dB	cm	degree	Comment
1	*	630.9150	-61.29	13.13	-48.16	-13.00	-35.16	peak		

*:Maximum data x:Over limit !:over margin

File :LE910 NA V2(CH9538)

Data :#4

Date: 2015/6/10

Time: 下午 04:13:07

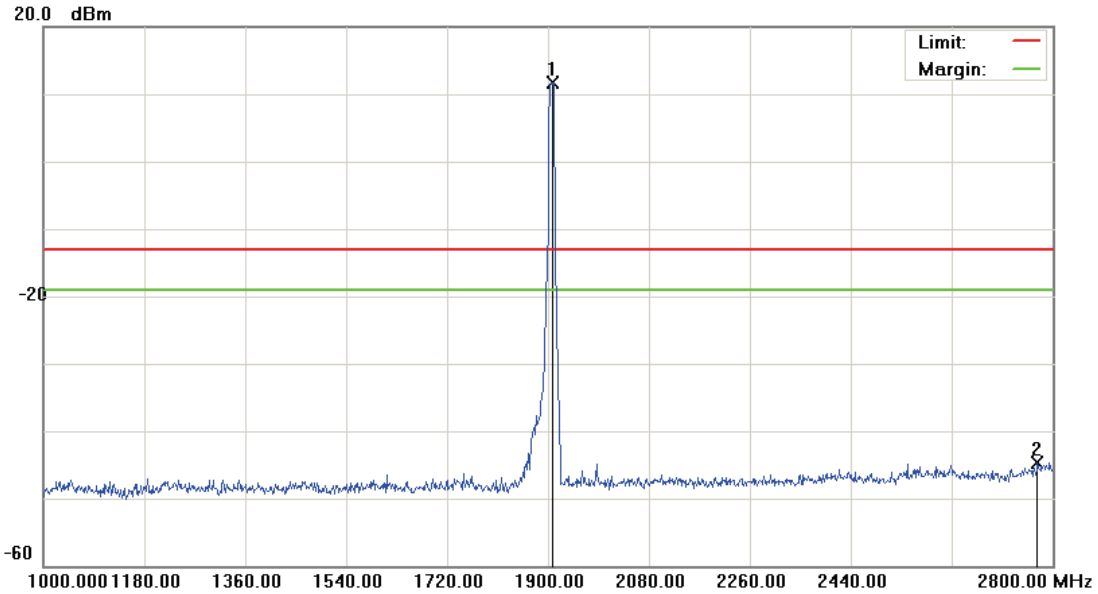

Site: site #1	Polarization: Conducted Power	Temperature: 26 °C
Limit: FCC Part 24 conducted(9k-26.5G)	Power: DC 3.8V	Humidity: 55 %
EUT: LE910-NA V2	Distance:	RBW: 1000 KHz VBW: 3000 KHz
M/N: LE910-NA V2		
Mode: WCDMA Band II		
Note:		

No.	Mk.	Freq. MHz	Reading Level dBm	Correct Factor dB	Measure- ment dBm	Limit dBm	Over dB	Detector	Antenna Height cm	Table Degree	Comment
1	*	1906.300	5.69	6.05	11.74	-13.00	24.74	peak			Tx
2		2773.000	-50.39	5.78	-44.61	-13.00	-31.61	peak			

*:Maximum data x:Over limit !:over margin

File :LE910 NA V2(CH9538)

Data :#5

Date: 2015/6/10

Time: 下午 04:48:48

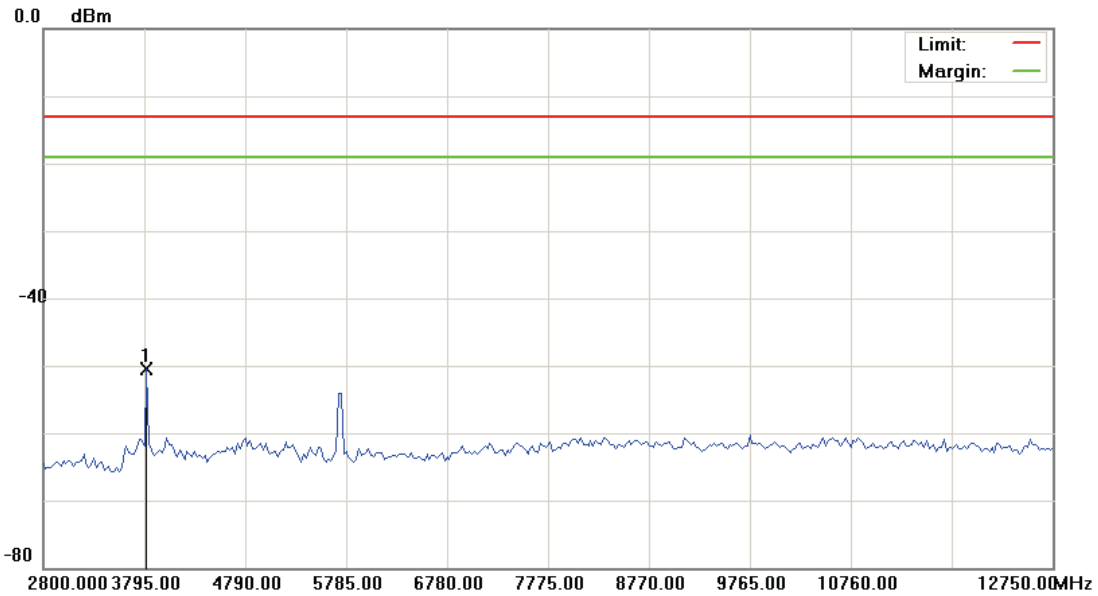

Site: site #1	Polarization: Conducted Power	Temperature: 26 °C
Limit: FCC Part 24 conducted(9k-26.5G)	Power: DC 3.8V	Humidity: 55 %
EUT: LE910-NA V2	Distance:	RBW: 1000 KHz VBW: 3000 KHz
M/N: LE910-NA V2		
Mode: WCDMA Band II		
Note:		

No.	Mk.	Freq. MHz	Reading Level dBm	Correct Factor dB	Measure- ment dBm	Limit dBm	Over dB	Antenna Height cm	Table Degree	Detector	Comment
1	*	3819.875	-55.44	4.91	-50.53	-13.00	-37.53			peak	

*:Maximum data x:Over limit !:over margin

File :LE910 NA V2(CH9538)

Data :#6

Date: 2015/6/10

Time: 下午 04:49:07

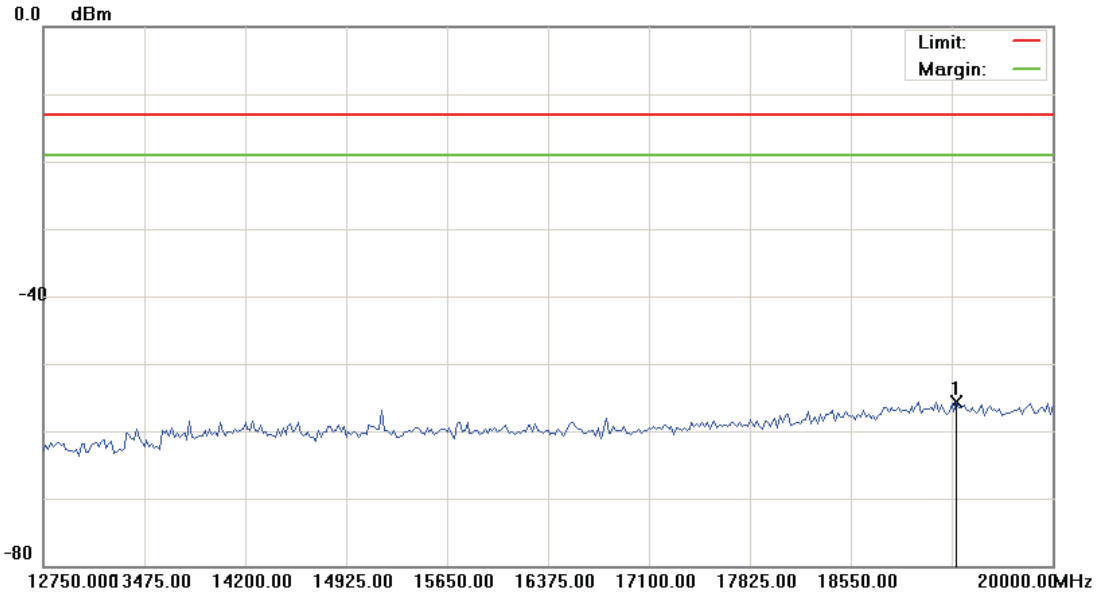

Site: site #1	Polarization: Conducted Power	Temperature: 26 °C
Limit: FCC Part 24 conducted(9k-26.5G)	Power: DC 3.8V	Humidity: 55 %
EUT: LE910-NA V2	Distance:	RBW: 1000 KHz VBW: 3000 KHz
M/N: LE910-NA V2		
Mode: WCDMA Band II		
Note:		

No.	Mk.	Freq.	Reading Level	Correct Factor	Measurement	Limit	Over	Antenna Height	Table Degree	
		MHz	dBm	dB	dBm	dBm	dB	cm	degree	Comment
1	*	19311.250	-62.89	7.24	-55.65	-13.00	-42.65	peak		

*:Maximum data x:Over limit !:over margin

File :LE910 NA V2(CH4132)

Data :#1

Date: 2015/6/10

Time: 下午 04:15:07

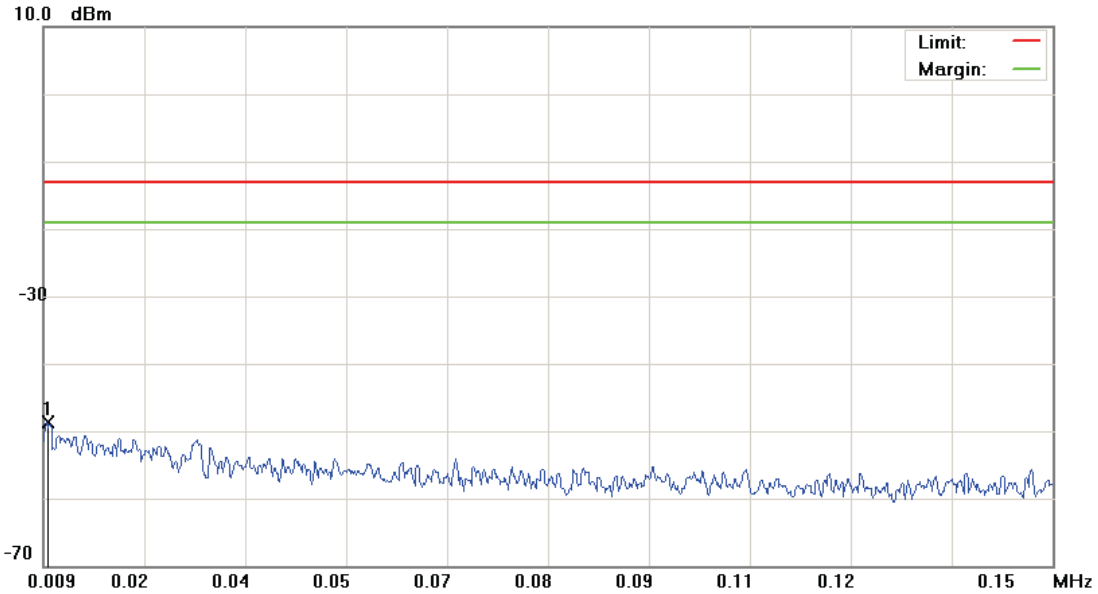

Site: site #1	Polarization: Conducted Power	Temperature: 26 °C
Limit: FCC Part 22 conducted(9k-12.75G)	Power: DC 3.8V	Humidity: 55 %
EUT: LE910-NA V2	Distance:	RBW: 1 KHz VBW: 3 KHz
M/N: LE910-NA V2		
Mode: WCDMA Band V		
Note:		

No.	Mk.	Freq.	Reading Level	Correct Factor	Measurement	Limit	Over	Antenna Height	Table Degree	
		MHz	dBm	dB	dBm	dBm	dB	cm	degree	Comment
1	*	0.0095	-79.36	30.58	-48.78	-13.00	-35.78	peak		

*:Maximum data x:Over limit !:over margin

File :LE910 NA V2(CH4132)

Data :#2

Date: 2015/6/10

Time: 下午 04:15:31

20.0 dBm

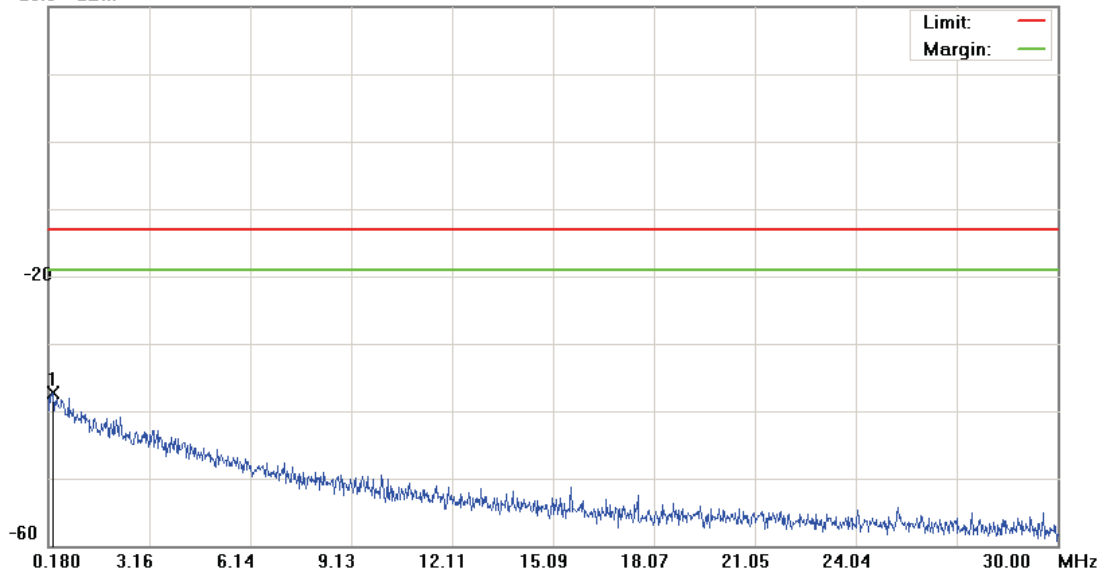

Site: site #1	Polarization: Conducted Power	Temperature: 26 °C
Limit: FCC Part 22 conducted(9k-12.75G)	Power: DC 3.8V	Humidity: 55 %
EUT: LE910-NA V2	Distance:	RBW: 10 KHz VBW: 30 KHz
M/N: LE910-NA V2		
Mode: WCDMA Band V		
Note:		

No.	Mk.	Freq.	Reading Level	Correct Factor	Measurement	Limit	Over	Antenna Height	Table Degree	
		MHz	dBm	dB	dBm	dBm	dB	cm	degree	Comment
1	*	0.2993	-69.03	31.73	-37.30	-13.00	-24.30	peak		

*:Maximum data x:Over limit !:over margin

File :LE910 NA V2(CH4132)

Data :#3

Date: 2015/6/10

Time: 下午 04:15:55

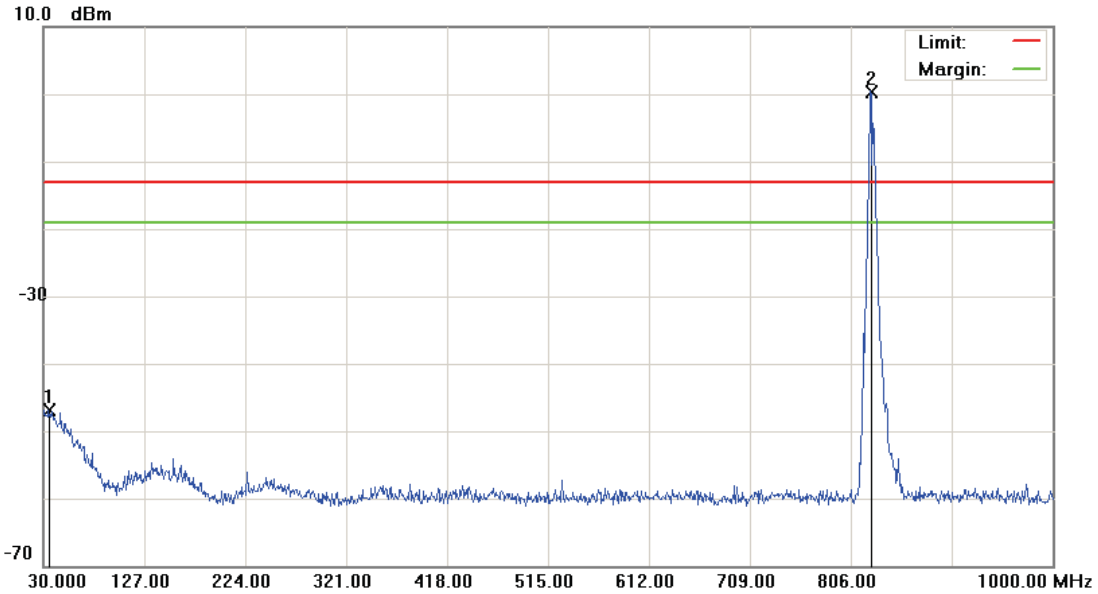

Site: site #1	Polarization: Conducted Power	Temperature: 26 °C
Limit: FCC Part 22 conducted(9k-12.75G)	Power: DC 3.8V	Humidity: 55 %
EUT: LE910-NA V2	Distance:	RBW: 100 KHz VBW: 300 KHz
M/N: LE910-NA V2		
Mode: WCDMA Band V		
Note:		

No.	Mk.	Freq.	Reading Level	Correct Factor	Measurement	Limit	Over	Antenna Height	Table Degree	
		MHz	dBm	dB	dBm	dBm	dB	cm	degree	Comment
1		35.3350	-63.44	16.61	-46.83	-13.00	-33.83			peak
2	*	824.9150	-3.44	3.84	0.40	-13.00	13.40			peak Tx

*:Maximum data x:Over limit !:over margin

File :LE910 NA V2(CH4132)

Data :#4

Date: 2015/6/10

Time: 下午 04:41:27

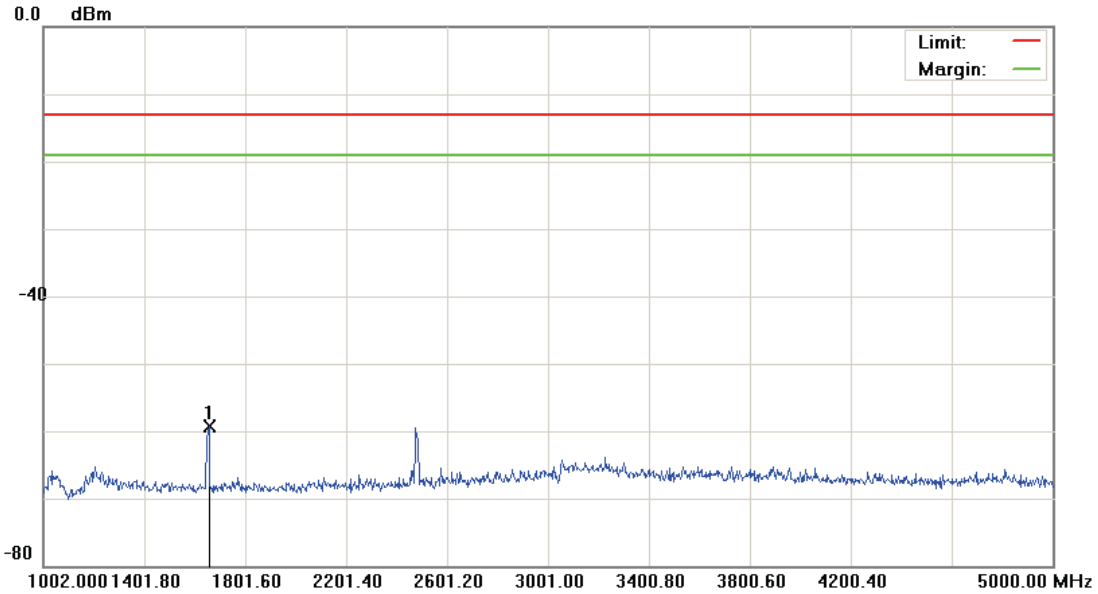

Site: site #1	Polarization: Conducted Power	Temperature: 26 °C
Limit: FCC Part 22 conducted(9k-12.75G)	Power: DC 3.8V	Humidity: 55 %
EUT: LE910-NA V2	Distance:	RBW: 1000 KHz VBW: 3000 KHz
M/N: LE910-NA V2		
Mode: WCDMA Band V		
Note:		

No.	Mk.	Freq.	Reading Level	Correct Factor	Measurement	Limit	Over	Antenna Height	Table Degree	
		MHz	dBm	dB	dBm	dBm	dB	cm	degree	Comment
1	*	1656.000	-63.81	4.45	-59.36	-13.00	-46.36	peak		

*:Maximum data x:Over limit !:over margin

File :LE910 NA V2(CH4132)

Data :#5

Date: 2015/6/10

Time: 下午 04:41:50

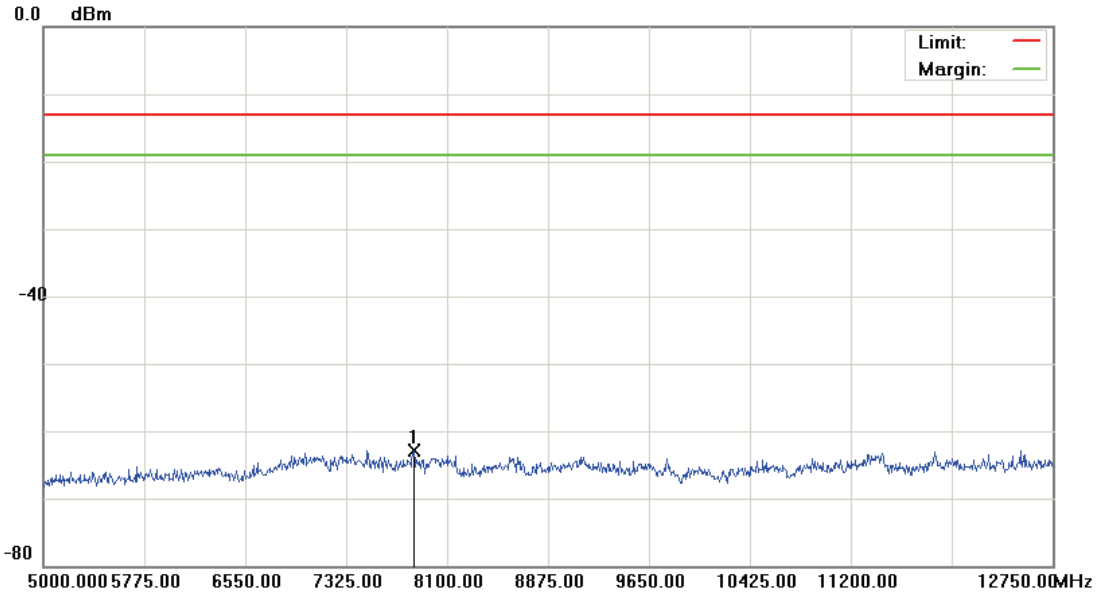

Site: site #1	Polarization: Conducted Power	Temperature: 26 °C
Limit: FCC Part 22 conducted(9k-12.75G)	Power: DC 3.8V	Humidity: 55 %
EUT: LE910-NA V2	Distance:	RBW: 1000 KHz VBW: 3000 KHz
M/N: LE910-NA V2		
Mode: WCDMA Band V		
Note:		

No.	Mk.	Freq.	Reading Level	Correct Factor	Measurement	Limit	Over	Antenna Height	Table Degree	
		MHz	dBm	dB	dBm	dBm	dB	cm	degree	Comment
1	*	7844.250	-68.45	5.61	-62.84	-13.00	-49.84	peak		

*:Maximum data x:Over limit !:over margin

File :LE910 NA V2(CH4183)

Data :#1

Date: 2015/6/10

Time: 下午 04:20:02

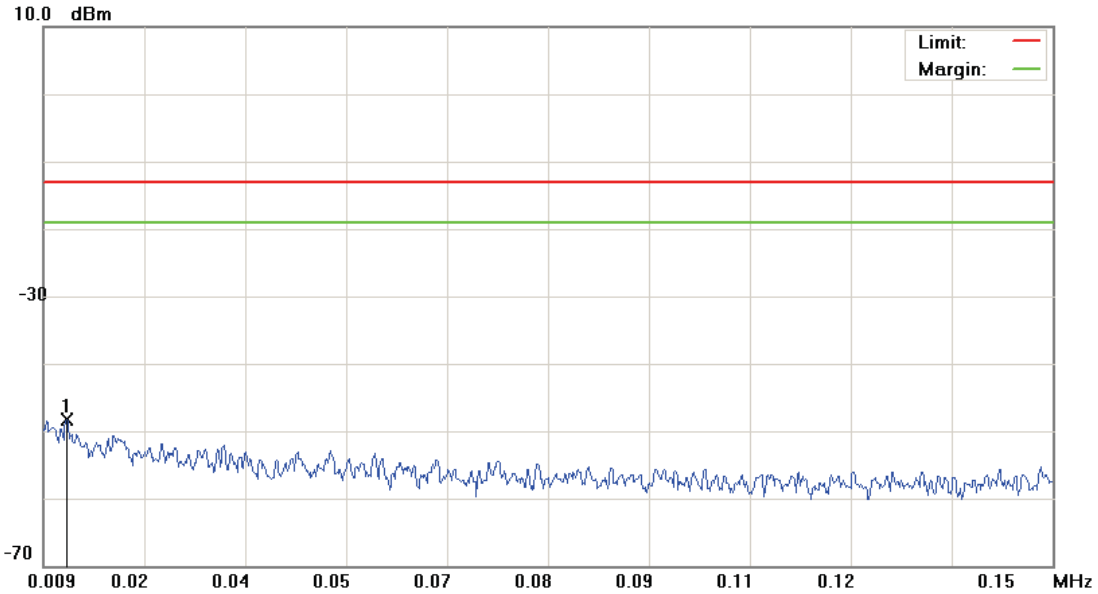

Site: site #1	Polarization: Conducted Power	Temperature: 26 °C
Limit: FCC Part 22 conducted(9k-12.75G)	Power: DC 3.8V	Humidity: 55 %
EUT: LE910-NA V2	Distance:	RBW: 1 KHz VBW: 3 KHz
M/N: LE910-NA V2		
Mode: WCDMA Band V		
Note:		

No.	Mk.	Freq.	Reading Level	Correct Factor	Measurement	Limit	Over	Antenna Height	Table Degree	
		MHz	dBm	dB	dBm	dBm	dB	Detector	cm	degree
1	*	0.0122	-78.86	30.57	-48.29	-13.00	-35.29	peak		Comment

*:Maximum data x:Over limit !:over margin

File :LE910 NA V2(CH4183)

Data :#2

Date: 2015/6/10

Time: 下午 04:20:27

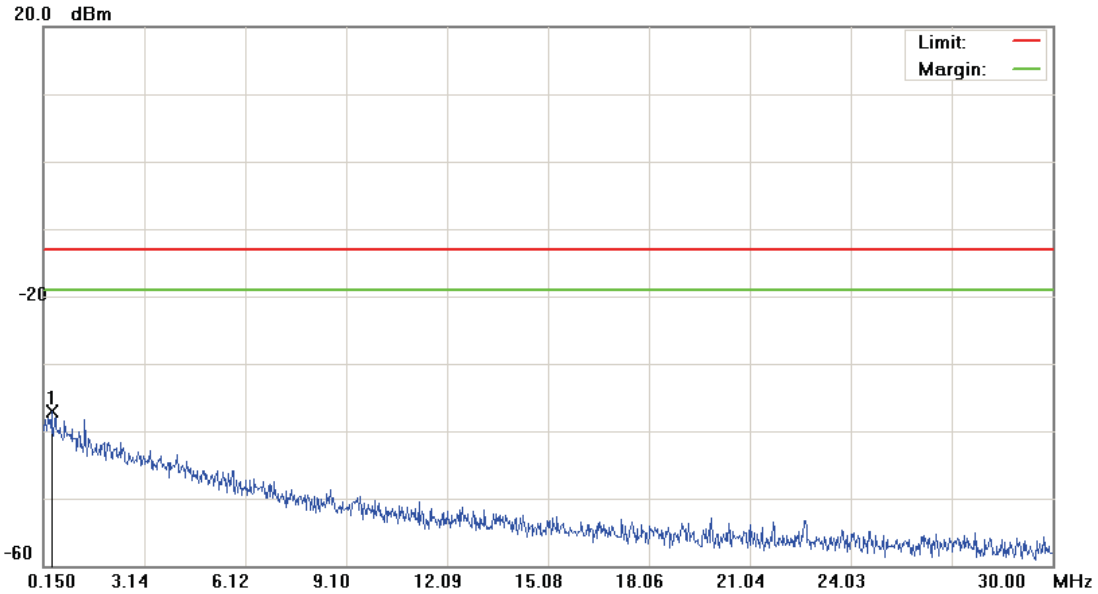

Site: site #1	Polarization: Conducted Power	Temperature: 26 °C
Limit: FCC Part 22 conducted(9k-12.75G)	Power: DC 3.8V	Humidity: 55 %
EUT: LE910-NA V2	Distance:	RBW: 10 KHz VBW: 30 KHz
M/N: LE910-NA V2		
Mode: WCDMA Band V		
Note:		

No.	Mk.	Freq.	Reading Level	Correct Factor	Measurement	Limit	Over	Antenna Height	Table Degree	
		MHz	dBm	dB	dBm	dBm	dB	cm	degree	Comment
1	*	0.4037	-69.09	31.91	-37.18	-13.00	-24.18	peak		

*:Maximum data x:Over limit !:over margin

File :LE910 NA V2(CH4183)

Data :#3

Date: 2015/6/10

Time: 下午 04:20:51

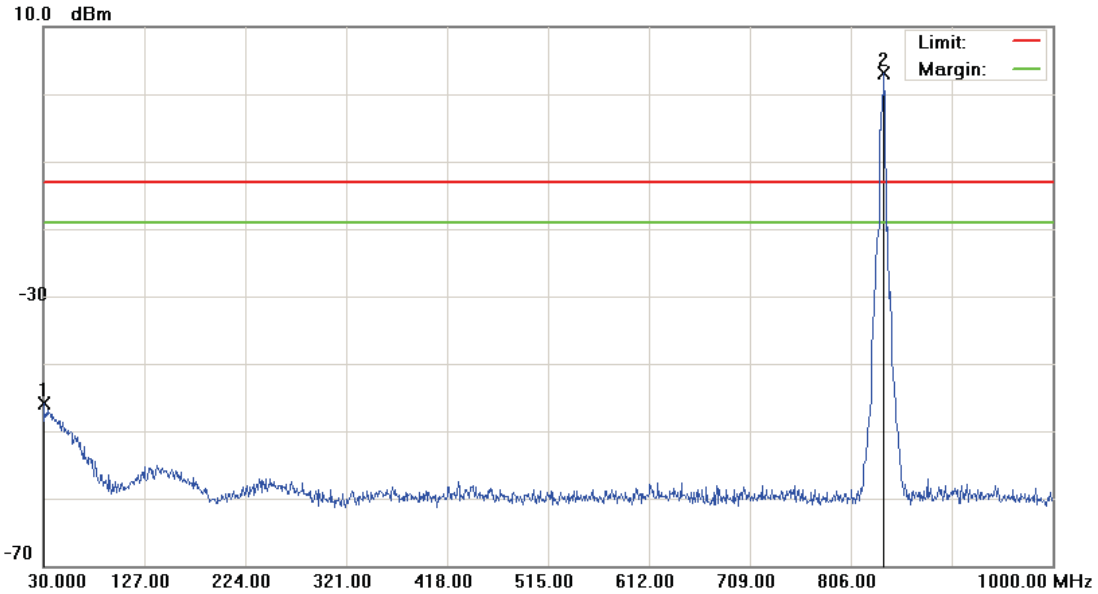

Site: site #1	Polarization: Conducted Power	Temperature: 26 °C
Limit: FCC Part 22 conducted(9k-12.75G)	Power: DC 3.8V	Humidity: 55 %
EUT: LE910-NA V2	Distance:	RBW: 100 KHz VBW: 300 KHz
M/N: LE910-NA V2		
Mode: WCDMA Band V		
Note:		

No.	Mk.	Freq.	Reading Level	Correct Factor	Measurement	Limit	Over	Antenna Height	Table Degree	
		MHz	dBm	dB	dBm	dBm	dB	cm	degree	Comment
1		30.0000	-63.06	17.21	-45.85	-13.00	-32.85	peak		
2	*	838.0100	-0.93	3.97	3.04	-13.00	16.04	peak		Tx

*:Maximum data x:Over limit !:over margin

File :LE910 NA V2(CH4183)

Data :#4

Date: 2015/6/10

Time: 下午 04:42:27

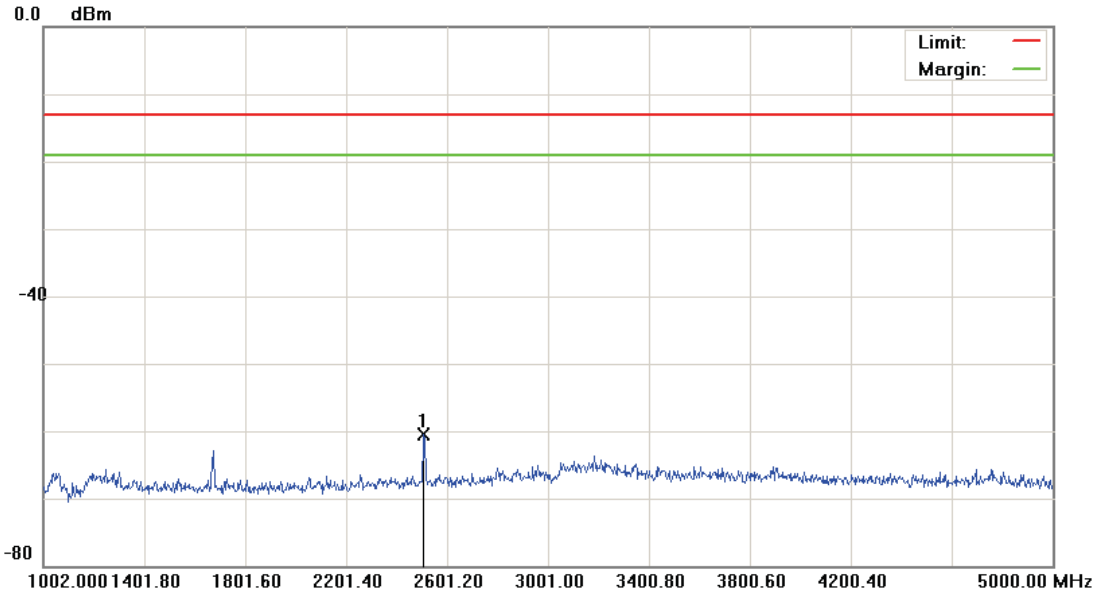

Site: site #1	Polarization: Conducted Power	Temperature: 26 °C
Limit: FCC Part 22 conducted(9k-12.75G)	Power: DC 3.8V	Humidity: 55 %
EUT: LE910-NA V2	Distance:	RBW: 1000 KHz VBW: 3000 KHz
M/N: LE910-NA V2		
Mode: WCDMA Band V		
Note:		

No.	Mk.	Freq.	Reading Level	Correct Factor	Measurement	Limit	Over	Antenna Height	Table Degree	
		MHz	dBm	dB	dBm	dBm	dB	cm	degree	Comment
1	*	2508.000	-64.84	4.36	-60.48	-13.00	-47.48	peak		

*:Maximum data x:Over limit !:over margin

File :LE910 NA V2(CH4183)

Data :#5

Date: 2015/6/10

Time: 下午 04:42:50

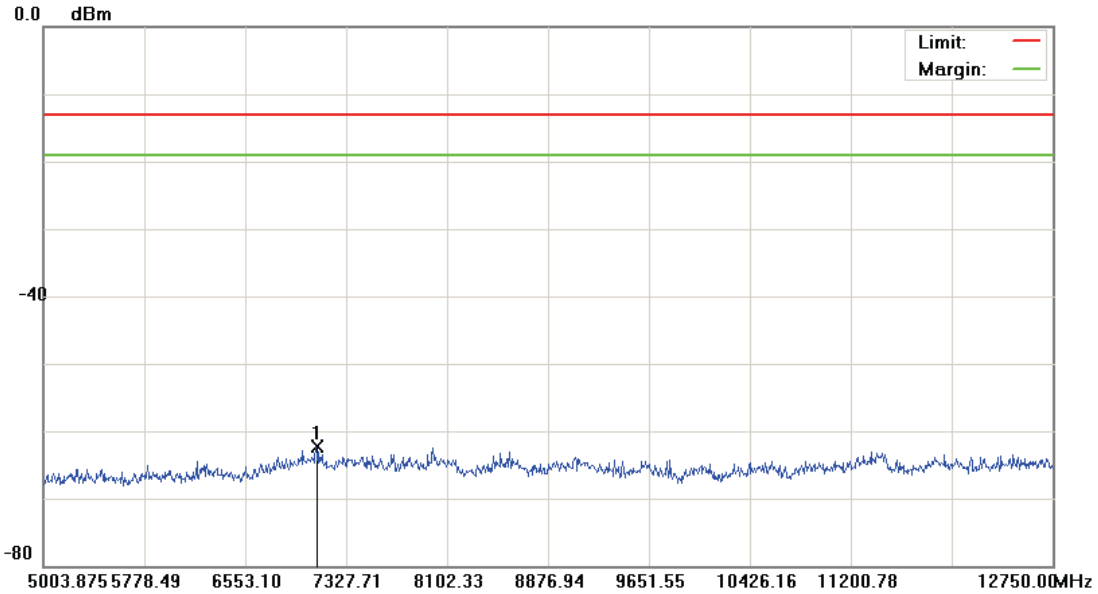

Site: site #1	Polarization: Conducted Power	Temperature: 26 °C
Limit: FCC Part 22 conducted(9k-12.75G)	Power: DC 3.8V	Humidity: 55 %
EUT: LE910-NA V2	Distance:	RBW: 1000 KHz VBW: 3000 KHz
M/N: LE910-NA V2		
Mode: WCDMA Band V		
Note:		

No.	Mk.	Freq.	Reading Level	Correct Factor	Measurement	Limit	Over	Antenna Height	Table Degree	
		MHz	dBm	dB	dBm	dBm	dB	cm	degree	Comment
1	*	7096.375	-67.40	5.07	-62.33	-13.00	-49.33	peak		

*:Maximum data x:Over limit !:over margin

File :LE910 NA V2(CH4233)

Data :#1

Date: 2015/6/10

Time: 下午 04:22:46

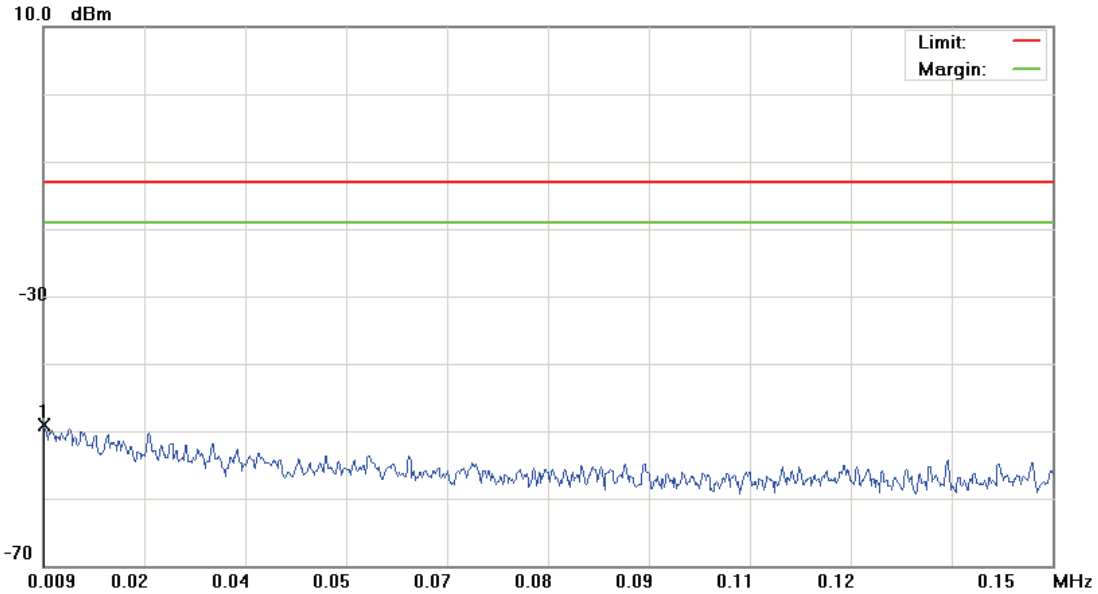

Site: site #1	Polarization: Conducted Power	Temperature: 26 °C
Limit: FCC Part 22 conducted(9k-12.75G)	Power: DC 3.8V	Humidity: 55 %
EUT: LE910-NA V2	Distance:	RBW: 1 KHz VBW: 3 KHz
M/N: LE910-NA V2		
Mode: WCDMA Band V		
Note:		

No.	Mk.	Freq.	Reading Level	Correct Factor	Measurement	Limit	Over	Antenna Height	Table Degree	
		MHz	dBm	dB	dBm	dBm	dB	cm	degree	Comment
1	*	0.0090	-79.61	30.58	-49.03	-13.00	-36.03	peak		

*:Maximum data x:Over limit !:over margin

File :LE910 NA V2(CH4233)

Data :#2

Date: 2015/6/10

Time: 下午 04:23:10

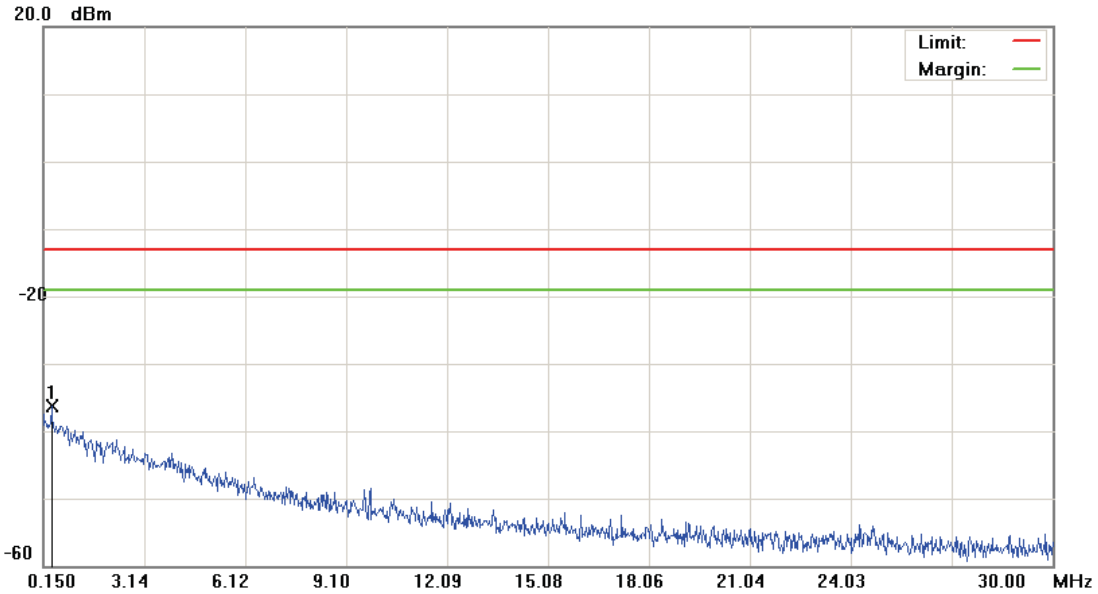

Site: site #1	Polarization: Conducted Power	Temperature: 26 °C
Limit: FCC Part 22 conducted(9k-12.75G)	Power: DC 3.8V	Humidity: 55 %
EUT: LE910-NA V2	Distance:	RBW: 10 KHz VBW: 30 KHz
M/N: LE910-NA V2		
Mode: WCDMA Band V		
Note:		

No.	Mk.	Freq.	Reading Level	Correct Factor	Measurement	Limit	Over	Antenna Height	Table Degree	
		MHz	dBm	dB	dBm	dBm	dB	cm	degree	Comment
1	*	0.4037	-68.28	31.91	-36.37	-13.00	-23.37	peak		

*:Maximum data x:Over limit !:over margin

File :LE910 NA V2(CH4233)

Data :#3

Date: 2015/6/10

Time: 下午 04:23:34

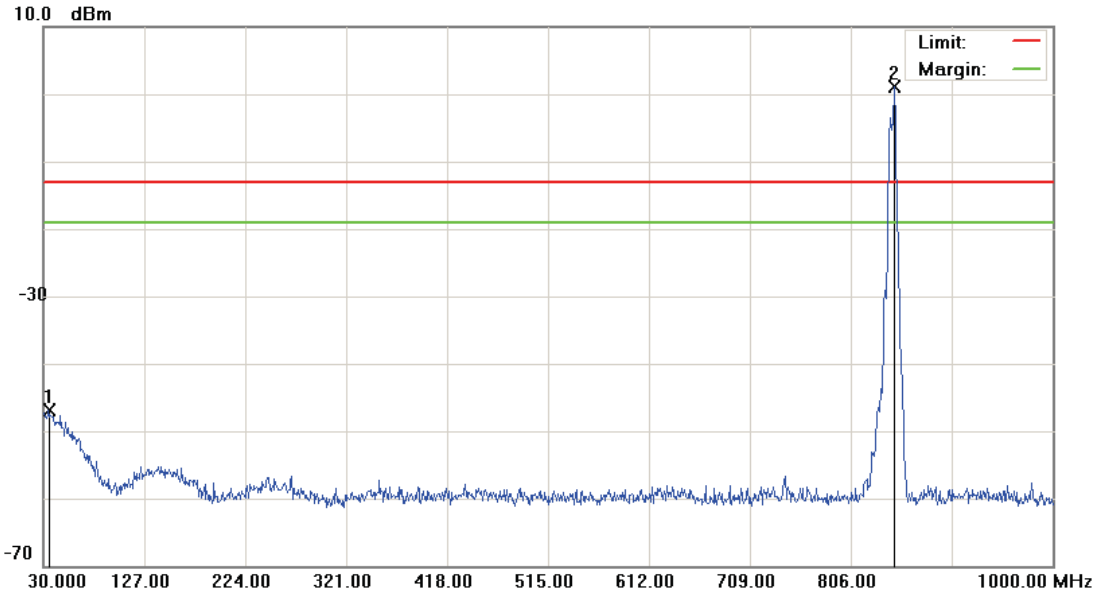

Site: site #1

Polarization: Conducted Power

Temperature: 26 °C

Limit: FCC Part 22 conducted(9k-12.75G)

Power: DC 3.8V

Humidity: 55 %

EUT: LE910-NA V2

Distance:

RBW: 100 KHz VBW: 300 KHz

M/N: LE910-NA V2

Mode: WCDMA Band V

Note:

No.	Mk.	Freq.	Reading Level	Correct Factor	Measurement	Limit	Over	Antenna Height	Table Degree	
		MHz	dBm	dB	dBm	dBm	dB	cm	degree	Comment
1		35.3350	-63.44	16.61	-46.83	-13.00	-33.83	peak		
2	*	847.7100	-2.84	3.98	1.14	-13.00	14.14	peak		Tx

*:Maximum data x:Over limit !:over margin

File :LE910 NA V2(CH4233)

Data :#4

Date: 2015/6/10

Time: 下午 04:43:27

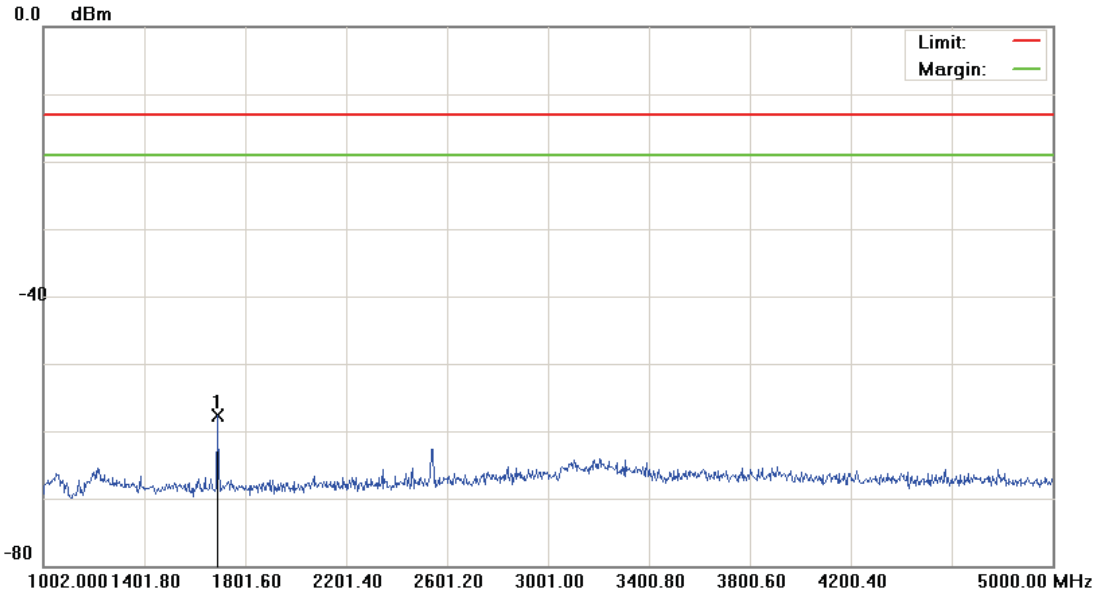

Site: site #1	Polarization: Conducted Power	Temperature: 26 °C
Limit: FCC Part 22 conducted(9k-12.75G)	Power: DC 3.8V	Humidity: 55 %
EUT: LE910-NA V2	Distance:	RBW: 1000 KHz VBW: 3000 KHz
M/N: LE910-NA V2		
Mode: WCDMA Band V		
Note:		

No.	Mk.	Freq.	Reading Level	Correct Factor	Measurement	Limit	Over	Antenna Height	Table Degree	
		MHz	dBm	dB	dBm	dBm	dB	cm	degree	Comment
1	*	1690.000	-62.27	4.47	-57.80	-13.00	-44.80	peak		

*:Maximum data x:Over limit !:over margin

File :LE910 NA V2(CH4233)

Data :#5

Date: 2015/6/10

Time: 下午 04:43:50

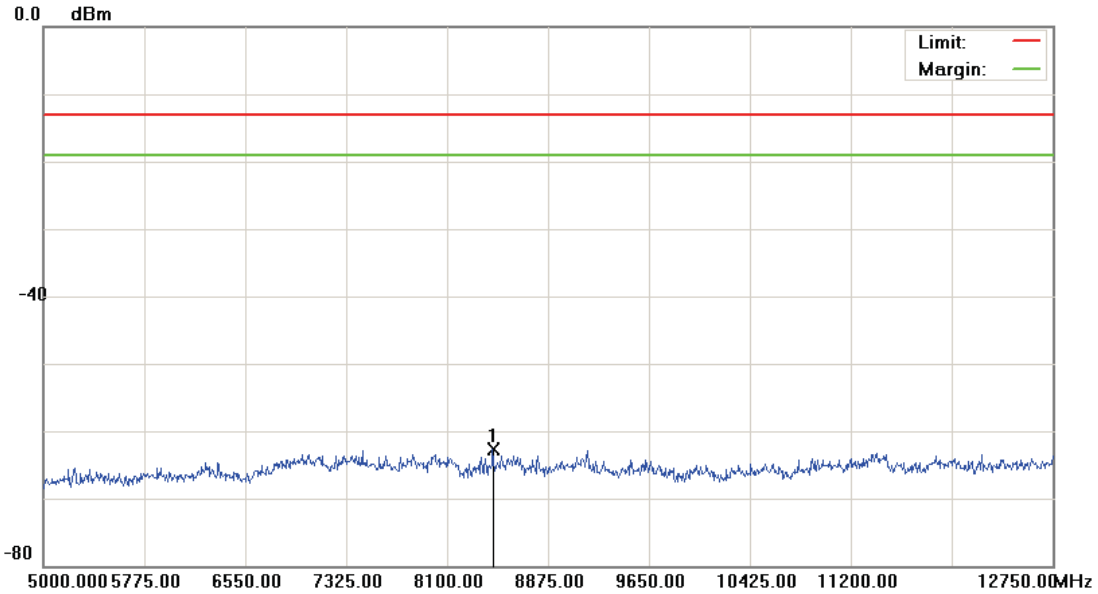

Site: site #1	Polarization: Conducted Power	Temperature: 26 °C
Limit: FCC Part 22 conducted(9k-12.75G)	Power: DC 3.8V	Humidity: 55 %
EUT: LE910-NA V2	Distance:	RBW: 1000 KHz VBW: 3000 KHz
M/N: LE910-NA V2		
Mode: WCDMA Band V		
Note:		

No.	Mk.	Freq.	Reading Level	Correct Factor	Measurement	Limit	Over	Antenna Height	Table Degree	
		MHz	dBm	dB	dBm	dBm	dB	cm	degree	Comment
1	*	8452.625	-68.13	5.49	-62.64	-13.00	-49.64	peak		

*:Maximum data x:Over limit !:over margin

Model Number	LE910-NA V2		
Test Item	Radiation Emission		
Test Mode	Mode 1 / Mode 2		
Date of Test	06/18/2015	Test Site	TE05

Band	CH	Frequency (MHz)	Measurement (dBm)	Antanna Gain (dBi)	EIRP (dBm)	ERP (dBm)	Limit (dBm)	Over (dB)
WCDMA Band II	9262	0.0114	-58.12	2.14	-55.98	-58.13	-13.00	-45.13
		0.1500	-55.01	2.14	-52.87	-55.02	-13.00	-42.02
		455.8300	-47.47	2.14	-45.33	-47.48	-13.00	-34.48
		2763.1000	-44.52	2.14	-42.38		-13.00	-29.38
		3695.5000	-48.15	2.14	-46.01		-13.00	-33.01
		19873.1250	-55.61	2.14	-53.47		-13.00	-40.47
	9400	0.0097	-57.76	2.14	-55.62	-57.77	-13.00	-44.77
		0.1948	-56.45	2.14	-54.31	-56.46	-13.00	-43.46
		890.3900	-47.85	2.14	-45.71	-47.86	-13.00	-34.86
		2792.8000	-43.94	2.14	-41.80		-13.00	-28.80
		5635.7500	-52.66	2.14	-50.52		-13.00	-37.52
		19075.6250	-55.72	2.14	-53.58		-13.00	-40.58
	9538	0.0107	-57.40	2.14	-55.26	-57.41	-13.00	-44.41
		0.1798	-56.38	2.14	-54.24	-56.39	-13.00	-43.39
		630.9150	-48.16	2.14	-46.02	-48.17	-13.00	-35.17
		2773.0000	-44.61	2.14	-42.47		-13.00	-29.47
		3819.8750	-50.53	2.14	-48.39		-13.00	-35.39
		19311.2500	-55.65	2.14	-53.51		-13.00	-40.51

Band	CH	Frequency (MHz)	Measurement (dBm)	Antanna Gain (dBi)	EIRP (dBm)	ERP (dBm)	Limit (dBm)	Over (dB)
WCDMA Band V	4132	0.0095	-48.78	2.14	-46.64	-48.79	-13.00	-35.79
		0.2993	-37.30	2.14	-35.16	-37.31	-13.00	-24.31
		35.3350	-46.83	2.14	-44.69	-46.84	-13.00	-33.84
		1656.0000	-59.36	2.14	-57.22		-13.00	-44.22
		7844.2500	-62.84	2.14	-60.70		-13.00	-47.70
	4183	0.0122	-48.29	2.14	-46.15	-48.30	-13.00	-35.30
		0.4037	-37.18	2.14	-35.04	-37.19	-13.00	-24.19
		30.0000	-45.85	2.14	-43.71	-45.86	-13.00	-32.86
		2508.0000	-60.48	2.14	-58.34		-13.00	-45.34
		7096.3750	-62.33	2.14	-60.19		-13.00	-47.19
	4233	0.0090	-49.03	2.14	-46.89	-49.04	-13.00	-36.04
		0.4037	-36.37	2.14	-34.23	-36.38	-13.00	-23.38
		35.3350	-46.83	2.14	-44.69	-46.84	-13.00	-33.84
		1690.0000	-57.80	2.14	-55.66		-13.00	-42.66
		8452.6250	-62.64	2.14	-60.50		-13.00	-47.50

8 Field Strength of Spurious Radiation Test

8.1. Limit

The power of any emission outside of the authorized operating frequency ranges must be attenuated below the transmitting power (P) by a factor of at least $43 + 10\log(P)$ dB.

It is measured by means of a calibrated spectrum analyzer and scanned from 30 MHz up to a frequency including its 10th harmonic.

8.2. Test Instruments

3 Meter Chamber					
Equipment	Manufacturer	Model Number	Serial Number	Cal. Date	Remark
RF Pre-selector	Agilent	N9039A	MY46520256	01/06/2015	(1)
Spectrum Analyzer	Agilent	E4446A	MY46180578	01/06/2015	(1)
Pre Amplifier	Agilent	8449B	3008A02237	02/24/2015	(1)
Pre Amplifier	Agilent	8447D	2944A10961	02/24/2015	(1)
Broadband Antenna (30MHz~1GHz)	SCHWARZBECK MESS-ELEKTRONIK	VULB9163	9163-270	07/22/2014	(1)
Horn Antenna (1~18GHz)	SCHWARZBECK MESS-ELEKTRONIK	BBHA9120D	9120D-550	06/12/2015	(1)
Horn Antenna (18~40GHz)	SCHWARZBECK MESS-ELEKTRONIK	BBHA9170	9170-320	07/02/2014	(1)
Test Site	ATL	TE01	888001	08/28/2014	(1)

Remark: ⁽¹⁾ Calibration period 1 year. ⁽²⁾ Calibration period 2 years.

Note: N.C.R. = No Calibration Request.

8.3. Setup

Below 1GHz

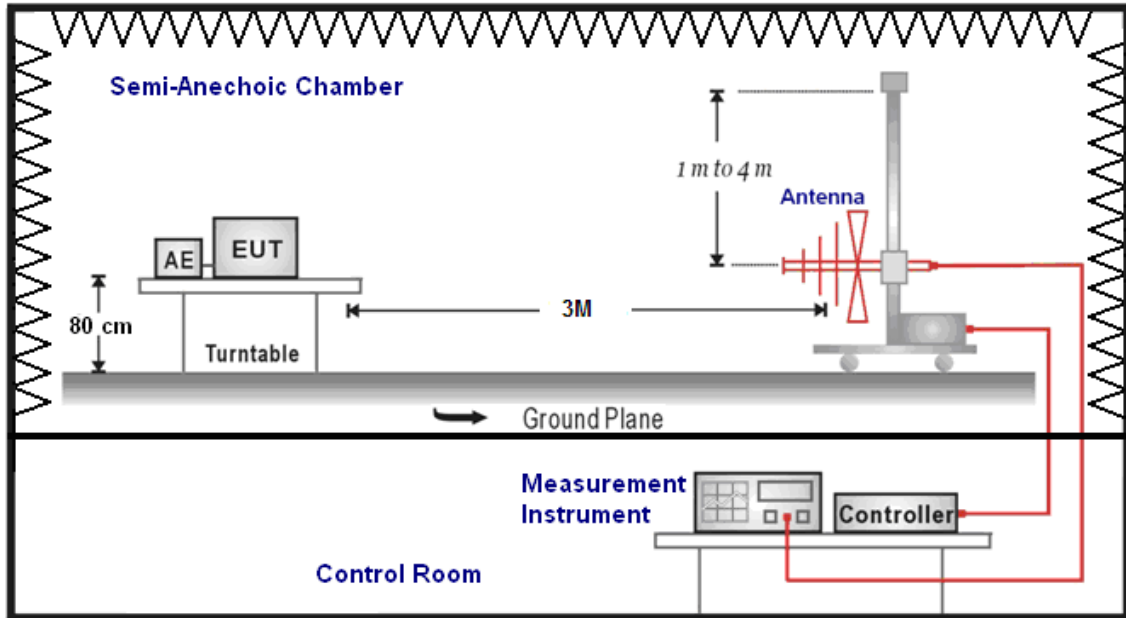

Above 1GHz

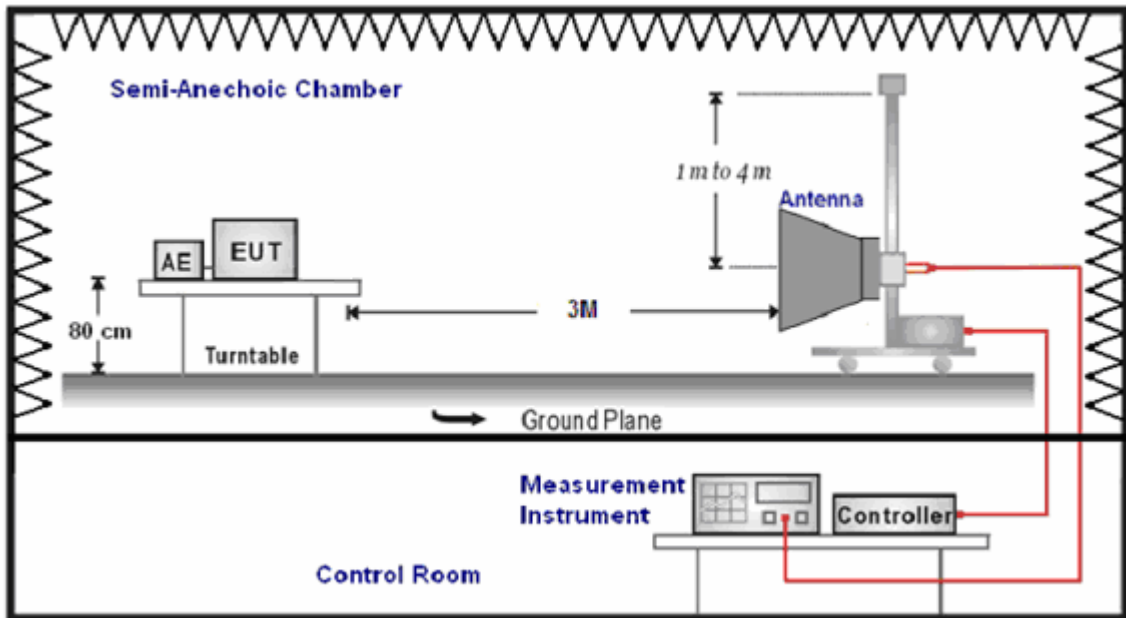

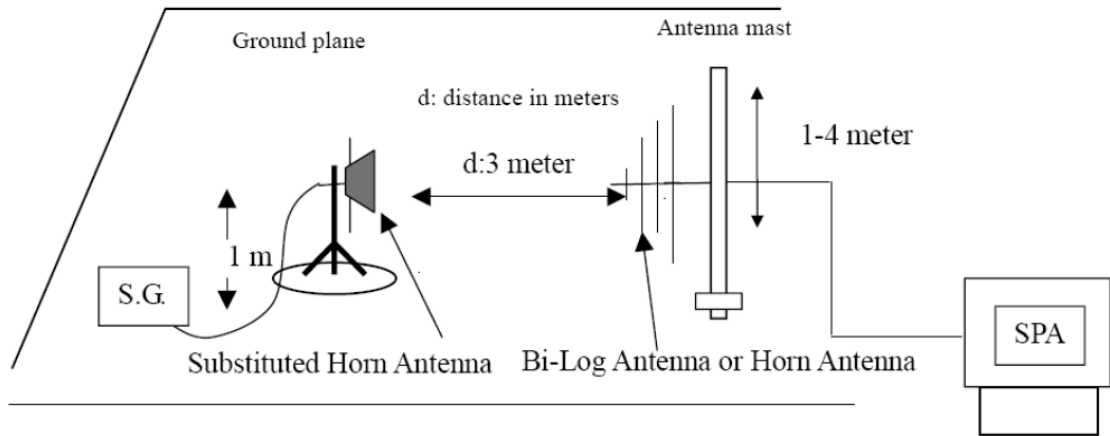

8.4. Test Procedure

- a. The EUT was set up for the maximum power with LTE link data modulation. The power was measured with Spectrum Analyzer. All measurements were done at 3 channels (low, middle and high operational frequency range). RWB and VBW is 1MHz for LTE and WCDMA mode.
- b. Radiation Emission measurement. In the semi-anechoic chamber, EUT placed on the 0.8m height of Turn Table, rotated the table around 360 degrees to search the maximum radiation power and receiver antenna shall be rotated vertical and horizontal polarization and moved height from 1m to 4m to find the maximum polar radiated power. The "Read Value" is the spectrum reading the maximum power value.
- c. The substitution horn antenna is substituted for EUT at the same position and signals generator export the CW signal to the substitution antenna via a TX cable. Rotated the Turn Table and moved receiving antenna to find the maximum radiation power. Adjust output power level of S.G to get a Value of spectrum reading equal to "Read Value" of step a. Record the power level of S.G.
- d. E.I.R.P. = Output power level of S.G - TX cable loss + Antenna gain of substitution horn
- e. E.R.P. = E.I.R.P- 2.15 dB

8.5. Uncertainty

The measurement uncertainty is defined as for Field Strength of Spurious Radiation measurement is ± 3.072 dB.

8.6. Test Result

Standard:	FCC Part 24	Test Distance:	3m
Test item:	Radiated Emission	Power:	DC 3.8V
Model Number:	LE910-NA V2	Temp.(°C)/Hum.(%RH):	26(°C)/60%RH
Mode:	1	Date:	06/18/2015
Frequency:	1852.4 MHz	Test By:	Eric Ou Yang

Frequency (MHz)	Reading (dBm)	Correct Factor (dB)	Result (dBm)	Limit (dBm)	Margin (dB)	Remark	Ant.Polar. H / V
4204.000	-72.19	21.26	-50.93	-13.00	-37.93	peak	H
4132.000	-71.57	21.03	-50.54	-13.00	-37.54	peak	V

Standard:	FCC Part 24	Test Distance:	3m
Test item:	Radiated Emission	Power:	DC 3.8V
Model Number:	LE910-NA V2	Temp.(°C)/Hum.(%RH):	26(°C)/60%RH
Mode:	1	Date:	06/18/2015
Frequency:	1880.0 MHz	Test By:	Eric Ou Yang

Frequency (MHz)	Reading (dBm)	Correct Factor (dB)	Result (dBm)	Limit (dBm)	Margin (dB)	Remark	Ant.Polar. H / V
4960.000	-72.78	22.93	-49.85	-13.00	-36.85	peak	H
3256.000	-69.90	19.42	-50.48	-13.00	-37.48	peak	V

Standard:	FCC Part 24	Test Distance:	3m
Test item:	Radiated Emission	Power:	DC 3.8V
Model Number:	LE910-NA V2	Temp.(°C)/Hum.(%RH):	26(°C)/60%RH
Mode:	1	Date:	06/18/2015
Frequency:	1907.6 MHz	Test By:	Eric Ou Yang

Frequency (MHz)	Reading (dBm)	Correct Factor (dB)	Result (dBm)	Limit (dBm)	Margin (dB)	Remark	Ant.Polar. H / V
4192.000	-72.00	21.22	-50.78	-13.00	-37.78	peak	H
6676.000	-72.41	24.87	-47.54	-13.00	-34.54	peak	V

Standard:	FCC Part 22	Test Distance:	3m
Test item:	Radiated Emission	Power:	DC 3.8V
Model Number:	LE910-NA V2	Temp.(°C)/Hum.(%RH):	26(°C)/60%RH
Mode:	2	Date:	06/18/2015
Frequency:	826.4 MHz	Test By:	Eric Ou Yang

Frequency (MHz)	Reading (dBm)	Correct Factor (dB)	Result (dBm)	Limit (dBm)	Margin (dB)	Remark	Ant.Polar. H / V
5668.000	-74.05	24.02	-50.03	-13.00	-37.03	peak	H
4756.000	-73.06	22.59	-50.47	-13.00	-37.47	peak	V

Standard:	FCC Part 22	Test Distance:	3m
Test item:	Radiated Emission	Power:	DC 3.8V
Model Number:	LE910-NA V2	Temp.(°C)/Hum.(%RH):	26(°C)/60%RH
Mode:	2	Date:	06/18/2015
Frequency:	836.6 MHz	Test By:	Eric Ou Yang

Frequency (MHz)	Reading (dBm)	Correct Factor (dB)	Result (dBm)	Limit (dBm)	Margin (dB)	Remark	Ant.Polar. H / V
6424.000	-73.73	24.66	-49.07	-13.00	-36.07	peak	H
4060.000	-71.83	20.81	-51.02	-13.00	-38.02	peak	V

Standard:	FCC Part 22	Test Distance:	3m
Test item:	Radiated Emission	Power:	DC 3.8V
Model Number:	LE910-NA V2	Temp.(°C)/Hum.(%RH):	26(°C)/60%RH
Mode:	2	Date:	06/18/2015
Frequency:	846.6 MHz	Test By:	Eric Ou Yang

Frequency (MHz)	Reading (dBm)	Correct Factor (dB)	Result (dBm)	Limit (dBm)	Margin (dB)	Remark	Ant.Polar. H / V
3628.000	-72.17	20.46	-51.71	-13.00	-38.71	peak	H
6904.000	-73.73	25.15	-48.58	-13.00	-35.58	peak	V

9 Frequency Stability (Temperature & Voltage Variation) Test

9.1. Limit

The frequency stability shall be measured by variation of ambient temperature and variation of primary supply voltage to ensure that the fundamental emission stays within the authorized frequency block. The frequency stability of the transmitter shall be maintained within $\pm 0.00025\%$ ($\pm 2.5\text{ppm}$) of the center frequency.

9.2. Test Instruments

Equipment	Manufacturer	Model Number	Serial Number	Cal. Date	Remark
Universal Radio Communication Tester	R & S	CMU200	109369	10/21/2014	(2)
Temperature & Humidity Chamber	TAICHY	MHU-225LA	980729	04/27/2015	(1)
Test Site	ATL	TE05	TE05	N.C.R.	-----

Remark: ⁽¹⁾ Calibration period 1 year. ⁽²⁾ Calibration period 2 years.

Note: N.C.R. = No Calibration Request.

9.3. Setup

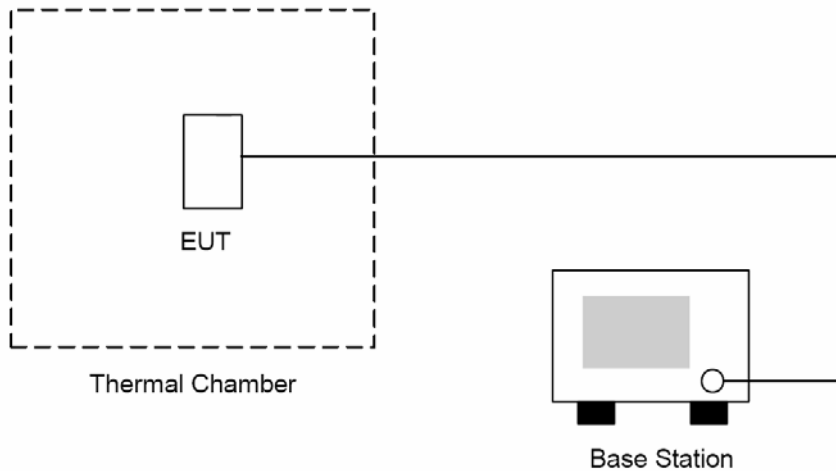

9.4. Test Procedure

The measurement is made according to FCC rules part 22 and 24:

1. The EUT and test equipment were set up as shown on the following section.
2. With all power removed, the temperature was decreased to -30°C and permitted to stabilize for three hours. Power was applied and the maximum change in frequency was note within one minute.
3. With power OFF, the temperature was raised in 10°C steps. The sample was permitted to stabilize at each step for at least one-half hour. Power was applied and the maximum frequency change was noted within one minute.
4. The EUT was placed in a temperature chamber at $25 \pm 5^{\circ}\text{C}$ and connected as the following section.
5. The power supply voltage to the EUT was varied from BEP to 115% of the nominal value measured at the input to the EUT.
6. The temperature tests were performed for the worst case.
7. Test data was recorded.

9.5. Uncertainty

The measurement uncertainty is defined as for Frequency Stability (Temperature Variation) measurement is $\pm 10\text{Hz}$.

9.6. Test Result

Model Number	LE910-NA V2					
Test Item	Frequency Stability (Temperature & Voltage Variation)					
Test Mode	Mode 1					
Date of Test	06/16/2015				Test Site	TE05
Level	Voltage [Vdc]	Temperature (°C)	Deviation (Hz)	Deviation (ppm)	Limit (ppm)	Result
Normal	3.80	-10	5.31	0.006	±2.5	Pass
Normal	3.80	0	12.92	0.015	±2.5	Pass
Normal	3.80	10	-13.64	-0.016	±2.5	Pass
Battery full point	4.20	20	-5.99	-0.007	±2.5	Pass
Normal	3.80	20	2.76	0.003	±2.5	Pass
Battery cut-off point	3.40	20	12.7	0.015	±2.5	Pass
Normal	3.80	30	4.35	0.005	±2.5	Pass
Normal	3.80	40	-5.42	-0.006	±2.5	Pass
Normal	3.80	50	-2.86	-0.003	±2.5	Pass
Normal	3.80	55	2.69	0.003	±2.5	Pass

Model Number	LE910-NA V2					
Test Item	Frequency Stability (Temperature & Voltage Variation)					
Test Mode	Mode 2					
Date of Test	06/16/2015				Test Site	TE05
Level	Voltage [Vdc]	Temperature (°C)	Deviation (Hz)	Deviation (ppm)	Limit (ppm)	Result
Normal	3.80	-10	5.37	0.003	±2.5	Pass
Normal	3.80	0	11.05	0.006	±2.5	Pass
Normal	3.80	10	-13.55	-0.007	±2.5	Pass
Battery full point	4.20	20	3.98	0.002	±2.5	Pass
Normal	3.80	20	11.50	0.006	±2.5	Pass
Battery cut-off point	3.40	20	-15.81	-0.008	±2.5	Pass
Normal	3.80	30	6.64	0.004	±2.5	Pass
Normal	3.80	40	4.33	0.002	±2.5	Pass
Normal	3.80	50	-2.54	-0.001	±2.5	Pass
Normal	3.80	55	1.36	0.001	±2.5	Pass

Note: This device temperature only support -10°C to +55°C.