

**TEST REPORT**

**Report Number: 3047435-0013047393-001**

**Project Number: 3047393**

**September 28, 2003**

**Evaluation of the  
CDMA 800/1900 Wireless Desk Phone  
Model Number: Phonenumber SX4T (CDMA) 800-1x and Phonenumber SX4T (CDMA) 1900-1x  
FCC ID:  
MTF010147 and MTF071473**

**FCC Part 2  
FCC Part 15  
FCC Part 24 Subpart E**

**For**

**Telular, Inc.**

Test Performed by:

Intertek  
731 Enterprise Drive  
Lexington, KY 40510

Test Authorized by:

Telular, Inc.  
580 Old Willets Path  
Hauppauge, NY 11788

Prepared By:  Date: 10/17/03  
**Bryan C. Taylor, Team Leader**

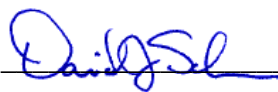
Approved By:  Date: 10/17/03  
**David Schramm, EMC Team Leader**



This report may be reproduced only with the written permission of Intertek and if reproduced must be reproduced in its entirety.

This report must not be used to claim product endorsement by NVLAP or any agency of the U.S. Government.

The results contained in this report were derived from measurements performed on the identified test samples. Any implied performance of other samples based on this report is dependent on the representative adequacy of the samples tested.

**TABLE OF CONTENTS**

**1 EXECUTIVE SUMMARY..... 4**

**2 JOB DESCRIPTION..... 5**

2.1 CLIENT INFORMATION .....5

2.2 TEST PLAN REFERENCE: .....5

2.3 EQUIPMENT UNDER TEST (EUT).....6

    2.3.1 System Support Equipment..... 7

    2.3.2 Cables associated with EUT..... 7

    2.3.3 System Block Diagram..... 7

    2.3.4 Justification ..... 8

    2.3.5 Mode(s) of operation ..... 8

2.4 MODIFICATIONS REQUIRED FOR COMPLIANCE .....8

2.5 RELATED SUBMITTAL(S) GRANTS .....8

**3 TEST FACILITY..... 9**

**4 CONDUCTED RF POWER..... 10**

4.1 TEST PROCEDURE..... 10

4.2 TEST EQUIPMENT ..... 10

4.3 TEST RESULTS ..... 10

**5 RADIATED RF POWER..... 11**

5.1 TEST PROCEDURE..... 11

5.2 TEST EQUIPMENT ..... 11

5.3 TEST RESULTS ..... 12

**6 EMISSION LIMITATIONS, OCCUPIED BANDWIDTH..... 13**

6.1 TEST PROCEDURE..... 13

6.2 TEST EQUIPMENT ..... 13

6.3 TEST RESULTS ..... 14

**7 OUT OF BAND EMISSION AT ANTENNA TERMINALS ..... 21**

7.1 TEST PROCEDURE..... 21

7.2 TEST EQUIPMENT ..... 21

7.3 TEST RESULTS ..... 22

**8 FIELD STRENGTH OF SPURIOUS RADIATION ..... 28**

8.1 TEST PROCEDURE..... 28

---

Evaluation For: Telular, Inc. FCC ID: MTF010147 and MTF071473  
Model No: Phonecell SX4T (CDMA) 800-1x and Phonecell SX4T (CDMA) 1900-1x

8.2	TEST EQUIPMENT .....	28
8.3	TEST RESULTS .....	29
<b>9</b>	<b>POWER LINE CONDUCTED EMISSIONS.....</b>	<b>41</b>
9.1	TEST PROCEDURE.....	41
9.2	TEST EQUIPMENT .....	41
9.3	TEST RESULTS .....	42
<b>10</b>	<b>RECEIVER SPURIOUS EMISSIONS.....</b>	<b>44</b>
10.1	TEST LIMITS .....	44
10.2	TEST EQUIPMENT .....	44
10.3	TEST PROCEDURE.....	44
10.4	TEST RESULTS .....	45
<b>11</b>	<b>FREQUENCY STABILITY VS TEMPERATURE.....</b>	<b>49</b>
11.1	TEST PROCEDURE.....	49
11.2	TEST EQUIPMENT .....	49
11.3	TEST RESULTS .....	49
<b>12</b>	<b>FREQUENCY STABILITY VS VOLTAGE .....</b>	<b>51</b>
12.1	TEST PROCEDURE.....	51
12.2	TEST EQUIPMENT .....	51
12.3	TEST RESULTS .....	51

Evaluation For: Telular, Inc.

FCC ID: MTF010147 and MTF071473

Model No: Phonicell SX4T (CDMA) 800-1x and Phonicell SX4T (CDMA) 1900-1x

**1 EXECUTIVE SUMMARY**

Testing performed for: Telular, Inc.

Equipment Under Test: Phonicell SX4T (CDMA) 800-1x and Phonicell SX4T (CDMA) 1900-1x, CDMA 800/1900 Wireless Desk Phone

FCC RULE	IC RULE	DESCRIPTION OF TEST	RESULT	PAGE
§2.1046	RSS-129 §7.1, §9.1 RSS-133 §6.2	RF Power Output	Passed	10
§22.913, §24.232	RSS-129 §7.1, §9.1 RSS-133 §6.2	ERP, EIRP	Passed	12
§2.1049 §22.917(b)(d)	RSS-129 §6.3, RSS-129 §8.1	Emission Limitation, Occupied Bandwidth	Passed	13
§2.1051 §22.917(e) §22.917(f) §24.238(a)	RSS-129 §6.3, §7.2.2, §8.1.1, §10 RSS-133 §6.3	Out of Band Emissions at Antenna Terminals Mobile Emissions In Base Frequency Range	Passed	21
§2.1053	RSS-129 §8.1	Field Strength of Spurious Radiation	Passed	28
§2.1091, §2.1093	RSS-129 §11, RSS-133 §8	Specific Absorption Rate	N/S	See Note <sup>1</sup>
§15.107, §15.207	IC ES-003	Power Line Conducted Emissions	Passed	41
§15.109	IC ES-003 RSS-129 §10, RSS-133 §9	Receiver Spurious Emission	Passed	44
§2.1055, §22.355, §24.235	RSS-133 §7	Frequency Stability vs. Temperature	Passed	49
§2.1055, §22.355, §24.235	--	Frequency Stability vs. Voltage	Passed	51

N/S: Not under scope of this evaluation

<sup>1</sup> Specific Absorption Rate testing was not under the scope of this evaluation.

Evaluation For: Telular, Inc.

FCC ID: MTF010147 and MTF071473

Model No: Phonenumber SX4T (CDMA) 800-1x and Phonenumber SX4T (CDMA) 1900-1x

## **2 JOB DESCRIPTION**

### **2.1 Client information**

The CDMA 800/1900 Wireless Desk Phone has been tested at the request of

**Company:** Telular, Inc.  
580 Old Willets Path  
Hauppauge, NY 11788

**Name of contact:** Matt McKiernan  
**Telephone:** (631)-232-6070  
**Fax:** (631)-232-6082

### **2.2 Test plan reference:**

Tests were performed to the following standards:

- FCC Part 2
- FCC Part 15
- FCC Part 24 Subpart E rules for an intentional radiator
- FCC Part 22 Subpart H rules for an intentional radiator

The test procedures described in this test report and ANSI C63.4: 1992 were employed.

Evaluation For: Telular, Inc.

FCC ID: MTF010147 and MTF071473

Model No: Phonicell SX4T (CDMA) 800-1x and Phonicell SX4T (CDMA) 1900-1x

**2.3 Equipment Under Test (EUT)**

The Equipment Under Test (EUT) was a wireless desk phone that operated in the CDMA800 and CDMA1900 modes. This device enabled the user to connect a regular land line telephone to the wireless network.

<b>Product</b>	CDMA 800/1900 Wireless Desk Phone	
<b>EUT Model Number</b>	Phonicell SX4T (CDMA) 800-1x and Phonicell SX4T (CDMA) 1900-1x	
<b>EUT Serial Number</b>	1644851682 and 1644851584	
<b>Whether quantity (&gt;1) production is planned</b>	Quantity production is planned.	
<b>Cellular Phone standards</b>	CDMA 800 and 1900	
<b>Type(s) of Emission</b>	1M29G9W	
<b>RF Output Power</b>	25.7 dBm – CDMA 800 25.1 dBm – CDMA1900	
<b>Frequency Range</b>	824.7 – 848.31 MHz	CDMA800
	1850 – 1910 MHz	CDMA1900
<b>Antenna &amp; Gain</b>	External Whip Type Folding Antenna	
<b>Detachable Antenna ?</b>	Yes	
<b>External input</b>	<input checked="" type="checkbox"/> Audio	<input type="checkbox"/> Digital Data

EUT receive date: 8/25/2003

EUT receive condition: The EUT was received in good condition with no apparent damage.

Test start date: 8/25/2003

Test completion date: 9/19/2003

The test results in this report pertain only to the item tested.

### 2.3.1 System Support Equipment

Table 2-1 contains the details of the support equipment associated with the Equipment Under Test during the FCC Part 15 testing.

*Table 2-1: System Support Equipment*

Description	Manufacturer	Model Number	Serial Number	FCC ID number
12 Volt DC Power Supply	Telular Corp.	1B01A043	EU0307000148	None
RS-232 Data Cable	Telular Corp.	1L01A038	None	None

### 2.3.2 Cables associated with EUT

Table 2-2 contains the details of the cables associated with the EUT.

*Table 2-2: Interconnecting cables between modules of EUT*

Description	Length	Shielding	Ferrites	Cables	
				Connection	
				From	To
RJ-11 to RJ-11 Phone Cord	6 ft	None	None	Telephone	RJ-11 Connection on EUT
ACW-1XDC (RS-232 Data Cable	4 ft	None	Yes	Data Port on EUT	Un-terminated
DC Power Supply Cable	10 ft	None	Yes	Telular Corp. Power Supply	DC Power Port on EUT
AC Power Cable	5 ft	None	None	120 VAC Power Source	AC Power Input to Telular Corp. Power Supply

### 2.3.3 System Block Diagram

The diagram shown below details the interconnection of the EUT and its accessories during FCC Part 15 testing. For specific layout, refer to the test configuration photograph in the relevant section of this report.

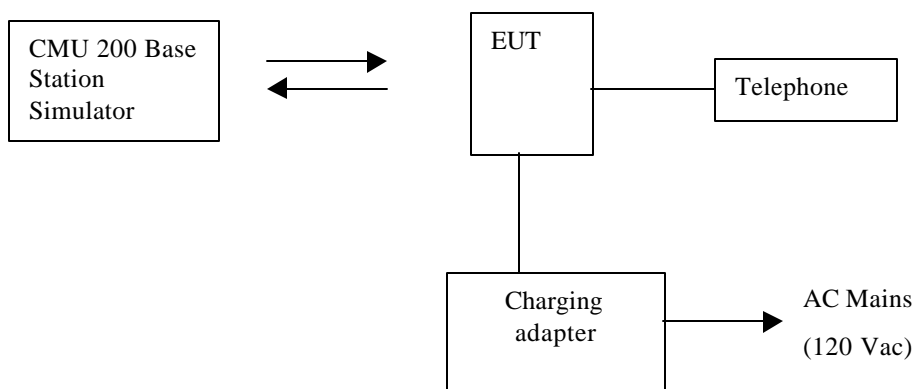

---

Evaluation For: Telular, Inc.

FCC ID: MTF010147 and MTF071473

Model No: Phonecell SX4T (CDMA) 800-1x and Phonecell SX4T (CDMA) 1900-1x

#### **2.3.4 Justification**

The EUT was operated in the stand-alone configuration.

#### **2.3.5 Mode(s) of operation**

The EUT was powered from 120VAC.

#### **2.4 Modifications required for compliance**

No modifications were implemented by Intertek.

#### **2.5 Related Submittal(s) Grants**

None



Evaluation For: Telular, Inc.

FCC ID: MTF010147 and MTF071473

Model No: Phonecell SX4T (CDMA) 800-1x and Phonecell SX4T (CDMA) 1900-1x

### 3 TEST FACILITY

The INTERTEK-Lexington is located at 731 Enterprise Drive, Lexington Kentucky, 40510. The radiated emission test site is a 10-meter semi-anechoic chamber. The chamber meets the characteristics of CISPR 16-1: 1993 and ANSI C63.4: 1992. For measurements, a remotely controlled flush-mount metal-top turntable is used to rotate the EUT a full 360 degrees. A remote controlled non-conductive antenna mast is used to scan the antenna height from one to four meters.

*Figure 3-1: 10-Meter EMC Site*



**4 CONDUCTED RF POWER**

FCC §2.1046

**4.1 Test Procedure**

The transmitter output was connected to a calibrated coaxial cable, the other end of which was connected to a CMU-200 Base Station Simulator. The Base Station Simulator was set to force the EUT to its maximum power setting. The EUT was placed into a call and the transmitter output was read off the CMU-200 in dBm. The power output at the transmitter antenna port was determined by adding the value of the cable insertion loss to the CMU-200 power reading.

Tests were performed at three frequencies (low, middle, and high channels) and on the highest power levels, which can be setup on the transmitters.

**4.2 Test Equipment**

Description	Manufacturer	Model Number	Serial Number	Calibration due date
Base Station Simulator	Rohde & Schwarz	CMU-200	1100.0008.02	8/2004

**4.3 Test Results**

The CDMA 800/1900 Wireless Desk Phone met the RF power output requirements of FCC Part 22 Subpart H and FCC Part FCC Part 24 Subpart E. The test results are located in Table 4-1.

*Table 4-1 RF Power Variation with temperature*

EUT Mode	Frequency MHz	Channel	Measured Power dBm		
			+60°C	+20°C	-30°C
CDMA1900	1850.20	25	23.57	23.9	24.24
	1880.00	600	23.15	23.65	23.85
	1909.80	1175	21.16	22.19	25.70
CDMA800	836.52	384	24.03	23.86	24.8
	848.31	777	23.03	23.96	25.1
	824.70	1013	24.08	23.85	24.95

**5 RADIATED RF POWER**

FCC §22.913: The Effective Radiated Power (ERP) of mobile transmitters and auxiliary test transmitters must not exceed 7 Watts.

FCC §24.232: The equivalent Isotropic Radiated Power (EIRP) must not exceed 2 Watts.

**5.1 Test Procedure**

The EUT was placed on a non-conductive turntable. The radiated emission at the fundamental frequency was measured at 3m with a test antenna and EMI receiver. This was performed with the antenna in both vertical and horizontal polarities.

During the measurement of the EUT, the receiver resolution bandwidth was set to 3 MHz and the video bandwidth was set to 10 kHz. These settings matched the power readings of a power meter with a thermocouple power sensor. The highest emission was recorded with the rotation of the turntable and the raising and lowering of the test antenna. The receiver reading was recorded and the field strength (E in dBμV/m) was calculated.

EIRP in frequency band 1851.25-1910 MHz were measured using a substitution method. The EUT was replaced by a horn antenna (1851.25-1910 MHz) connected to a signal generator, which was set to -10 dBm. The receiver reading was recorded and EIRP was calculated as follows:

$$EIRP = E_1 - E_2 + V_g + G$$

where,

$E_1$  is the receiver reading in dBμV/m when measuring the field strength of the EUT

$E_2$  is the receiver reading in dBμV/m when measured field strength from the generator

$V_g$  is the generator output in dBm

G is the gain of the transmitting antenna in dBi.

**5.2 Test Equipment**

Description	Manufacturer	Model Number	Serial Number	Calibration due date
Signal Generator	HP	83620B	3614A00199	8/2004
Horn Antenna	Antenna Research	DRG-118/A	1086	3/7/2007
Horn Antenna	EMCO	3115	6556	7/11/2004
EMI Receiver	Rohde & Schwarz	ESI 26	1088.7490	11/27/2003

### 5.3 Test Results

The CDMA 800/1900 Wireless Desk Phone met the radiated power requirements of FCC §24.232. The test results are located in Table 5-1.

*Table 5-1 Radiated RF Power*

EUT Mode	Channel	Frequency (MHz)	Antenna Polarity	Measurement Method (ERP/EIRP)	EUT Reading (dBuV)	Substitution Reading (dBuV)	Cable Reading (dBm)	Tx Antenna Gain (dBi)	ERP / EIRP (dBm)
CDMA PCS	25	1851.25	V	EIRP	85.27	58.74	-14.62	7.1	19.01
CDMA PCS	600	1880	V	EIRP	78.28	58.07	-14.61	7.1	12.7
CDMA PCS	1175	1908.75	V	EIRP	81.84	57.36	-14.73	7.1	16.85
CDMA PCS	25	1851.25	H	EIRP	89.15	59.23	-14.62	7.1	22.4
CDMA PCS	600	1880	H	EIRP	81.45	58.71	-14.61	7.1	15.23
CDMA PCS	1175	1908.75	H	EIRP	77.71	58.26	-14.73	7.1	11.82
CDMA Cell	384	836.52	V	ERP	97.1	61.95	-12.9	0	22.25
CDMA Cell	777	848.31	V	ERP	100.46	60.98	-12.89	0	26.59
CDMA Cell	1013	824.7	V	ERP	100.62	62.05	-12.89	0	25.68
CDMA Cell	384	836.52	H	ERP	94.79	64.32	-12.9	0	17.57
CDMA Cell	777	848.31	H	ERP	98.93	63.91	-12.89	0	22.13
CDMA Cell	1013	824.7	H	ERP	97.07	64.4	-12.89	0	19.78

**6 EMISSION LIMITATIONS, OCCUPIED BANDWIDTH**

CFR 47 §2.1049

The occupied bandwidth is the frequency bandwidth such that, below its lower and above its upper frequency limits, the mean powers radiated are each equal to 0.5 percent of the total mean power radiated by a given emission.

**6.1 Test Procedure**

In both CDMA 800 and 1900 modes the antenna port of the EUT was connected to a spectrum analyzer using a calibrated coaxial cable and directional coupler. The EUT was placed into a call using a CMU – 200 base station simulator. The occupied bandwidth function of the analyzer was used to automatically generate the occupied bandwidth plots below.

**6.2 Test Equipment**

Description	Manufacturer	Model Number	Serial Number	Calibration due date
Base Station Simulator	Rohde & Schwarz	CMU-200	1100.0008.02	8/2004
EMI Receiver	Rohde & Schwarz	ESI 26	1088.7490	11/27/2003
Directional Coupler	Amplifier Research	DC7144	22729	8/2004

**6.3 Test Results**

The following is the occupied bandwidth data for the CDMA 800/1900 Wireless Desk Phone .

*Table 6-1: Occupied bandwidth measurements for CDMA modes*

Mode	Channel	Resolution Bandwidth	Video Bandwidth	Sweep time	Measured Bandwidth MHz
CDMA800	384	30 kHz	300 kHz	3 S	1.27
CDMA 1XRTT	384	30 kHz	300 kHz	3 S	1.27
CDMA800	1013	30 kHz	300 kHz	3 S	1.28
CDMA 1XRTT	1013	30 kHz	300 kHz	3 S	1.27
CDMA800	777	30 kHz	300 kHz	3 S	1.26
CDMA 1XRTT	777	30 kHz	300 kHz	3 S	1.27
CDMA1900	25	30 kHz	300 kHz	3 S	1.27
CDMA 1XRTT	25	30 kHz	300 kHz	3 S	1.27
CDMA1900	600	30 kHz	300 kHz	3 S	1.29
CDMA 1XRTT	600	30 kHz	300 kHz	3 S	1.27
CDMA1900	1175	30 kHz	300 kHz	3 S	1.29
CDMA 1XRTT	1175	30 kHz	300 kHz	3 S	1.28

Evaluation For: Telular, Inc.

FCC ID: MTF010147 and MTF071473

Model No: Phonecell SX4T (CDMA) 800-1x and Phonecell SX4T (CDMA) 1900-1x

*Figure 6-1: Occupied Bandwidth – Cell Channel 384*

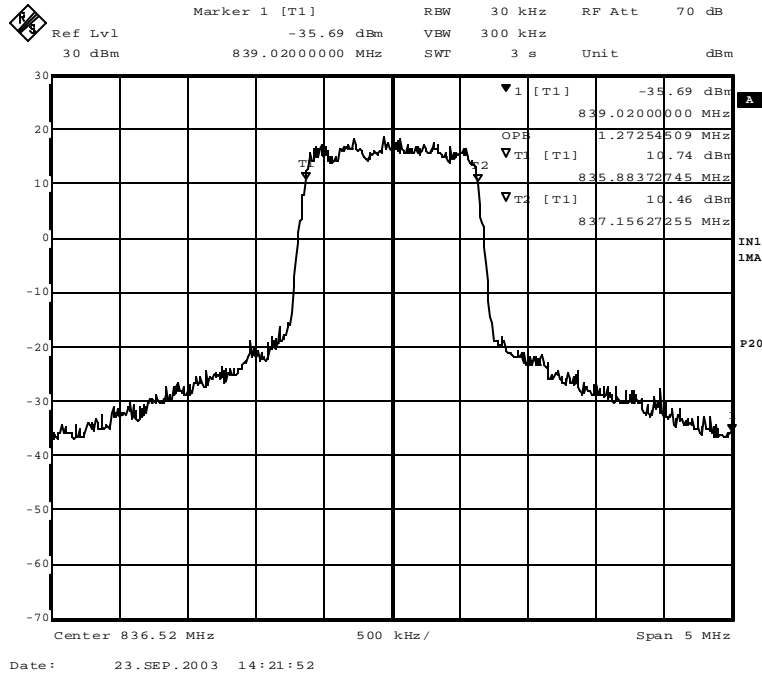

*Figure 6-2: Occupied Bandwidth – Cell Channel 384 (1xrtt)*

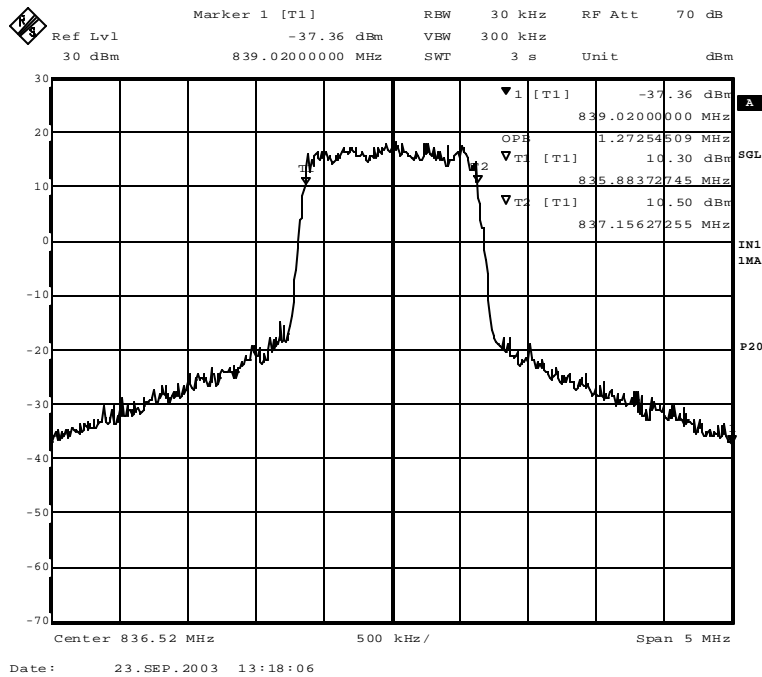

Evaluation For: Telular, Inc.

FCC ID: MTF010147 and MTF071473

Model No: Phonecell SX4T (CDMA) 800-1x and Phonecell SX4T (CDMA) 1900-1x

*Figure 6-3: Occupied Bandwidth – Cell Channel 777*

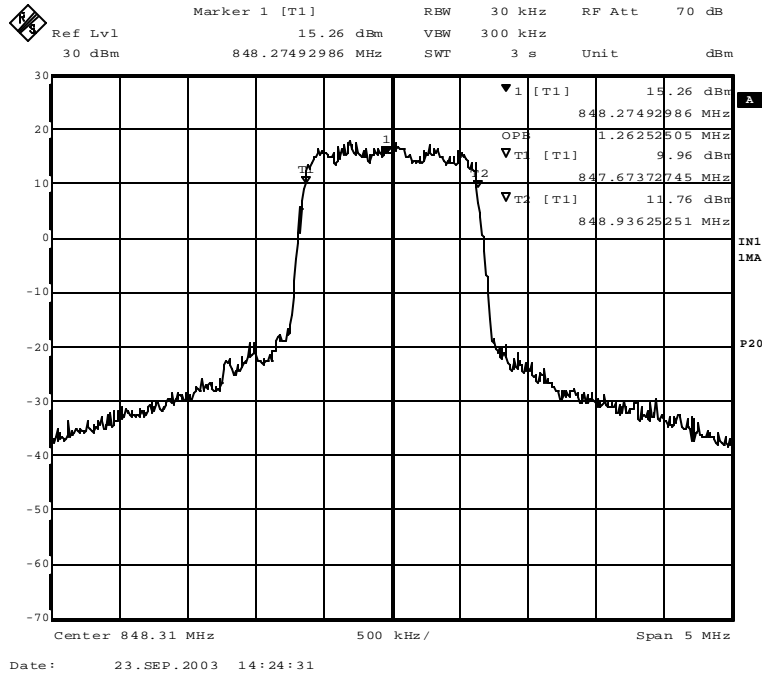

*Figure 6-4: Occupied Bandwidth – Cell Channel 777 (1xrtt)*

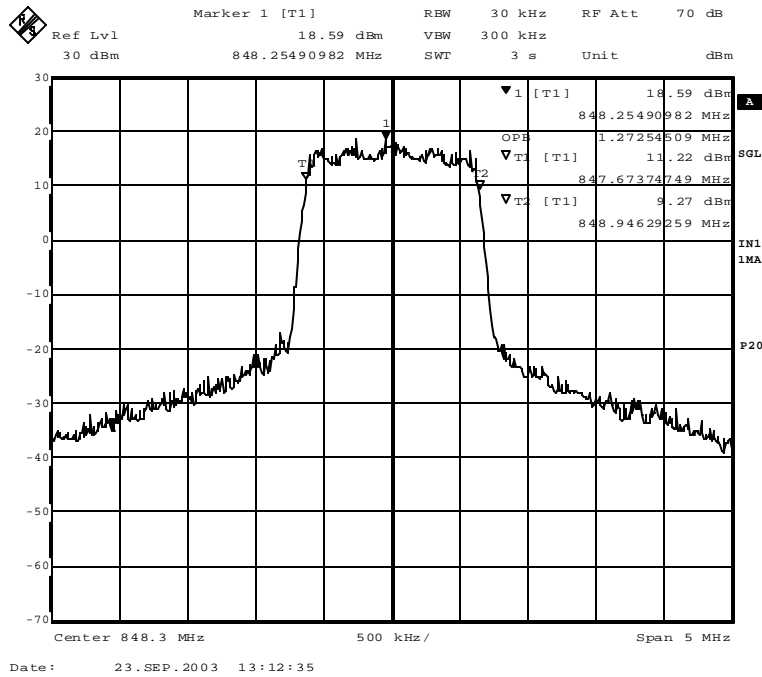



Evaluation For: Telular, Inc.

FCC ID: MTF010147 and MTF071473

Model No: Phonecell SX4T (CDMA) 800-1x and Phonecell SX4T (CDMA) 1900-1x

Figure 6-5: Occupied Bandwidth – Cell Channel 1013

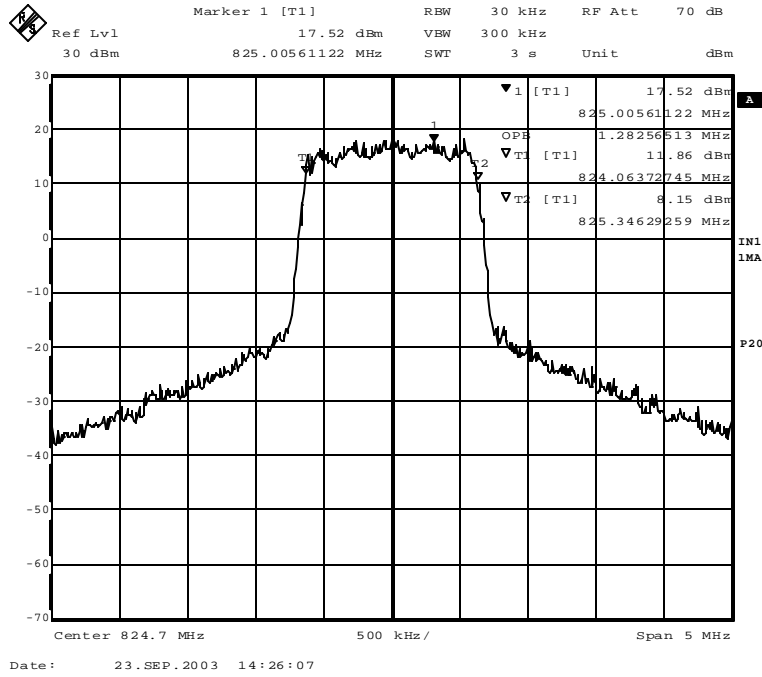
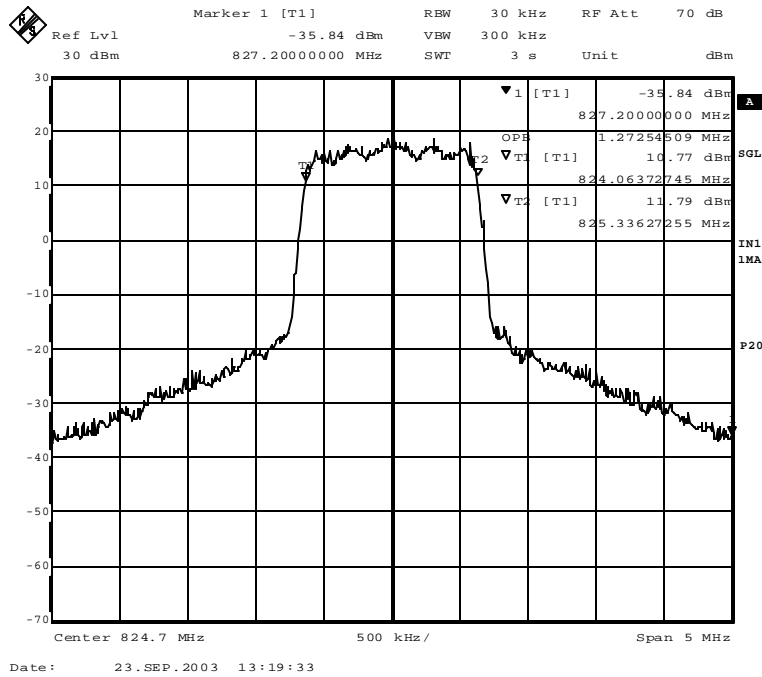

Figure 6-6: Occupied Bandwidth – Cell Channel 1013 (1xrtt)



Evaluation For: Telular, Inc.

FCC ID: MTF010147 and MTF071473

Model No: Phonecell SX4T (CDMA) 800-1x and Phonecell SX4T (CDMA) 1900-1x

*Figure 6-7: Occupied Bandwidth – PCS Channel 25*

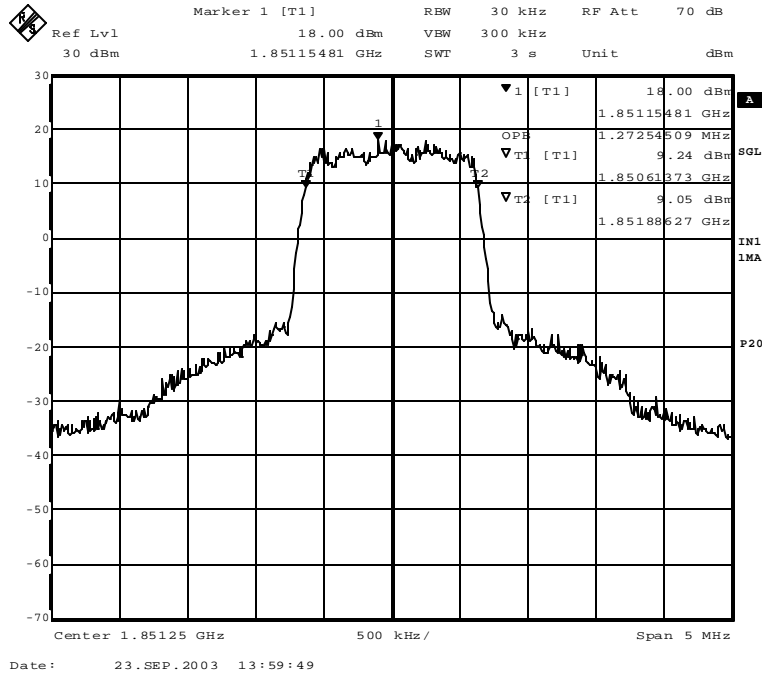

*Figure 6-8: Occupied Bandwidth – PCS Channel 25 (1xrtt)*

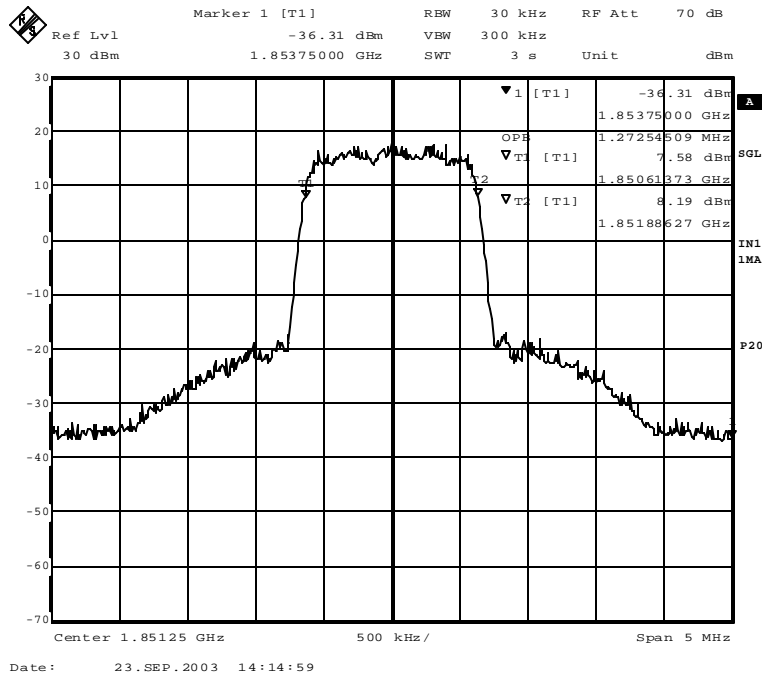

Evaluation For: Telular, Inc.

FCC ID: MTF010147 and MTF071473

Model No: Phonedcell SX4T (CDMA) 800-1x and Phonedcell SX4T (CDMA) 1900-1x

Figure 6-9: Occupied Bandwidth – PCS Channel 600

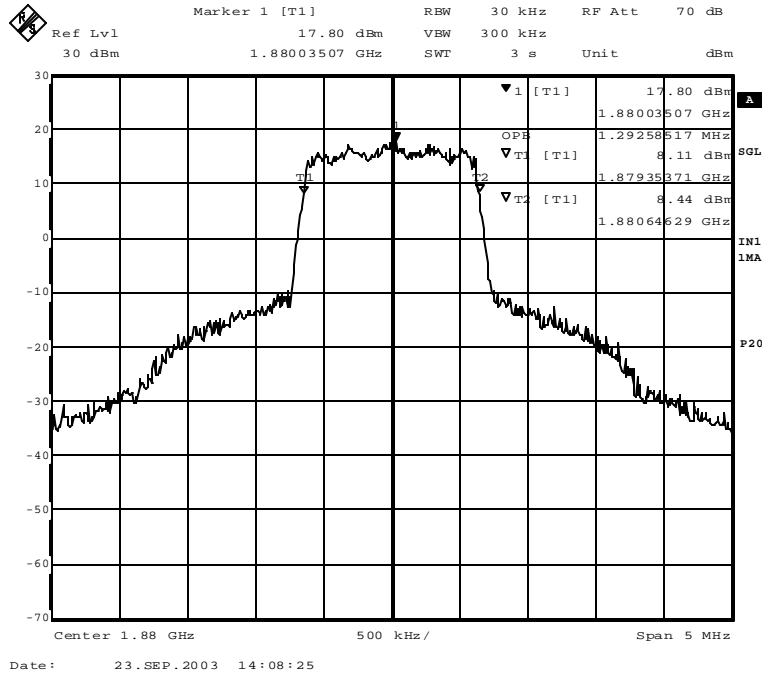
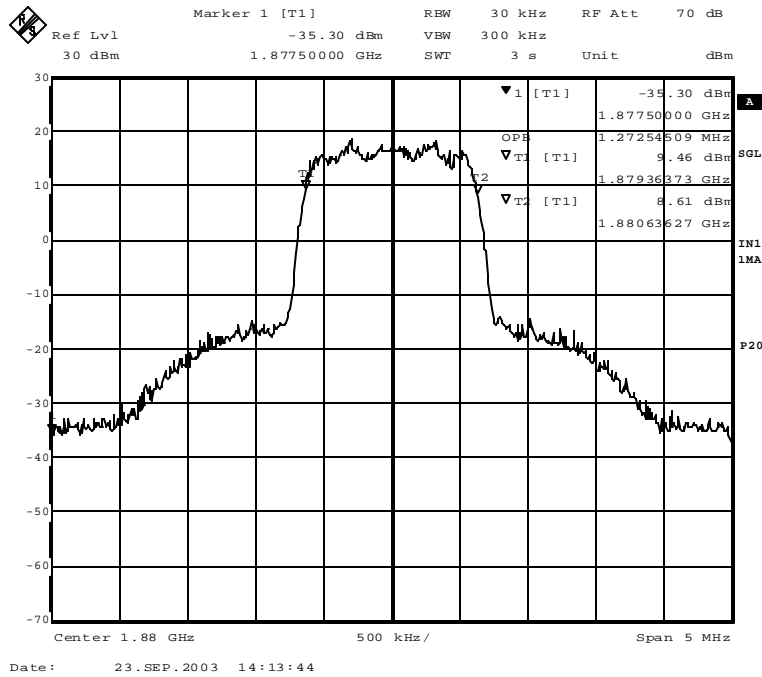

Figure 6-10: Occupied Bandwidth – PCS Channel 600 (1xrtt)



Evaluation For: Telular, Inc.

FCC ID: MTF010147 and MTF071473

Model No: Phonedcell SX4T (CDMA) 800-1x and Phonedcell SX4T (CDMA) 1900-1x

*Figure 6-11: Occupied Bandwidth – PCS Channel 1175*

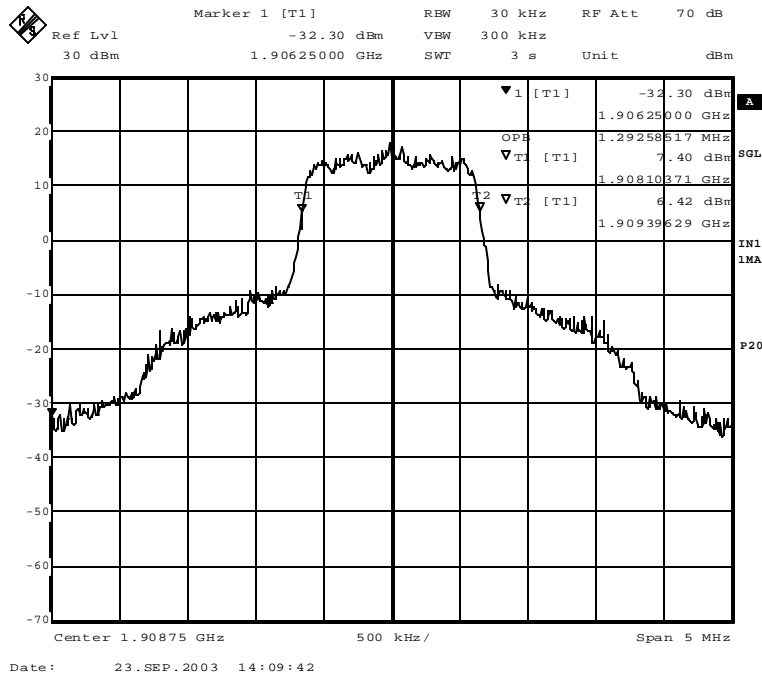

*Figure 6-12: Occupied Bandwidth – PCS Channel 1175 (1xrtt)*

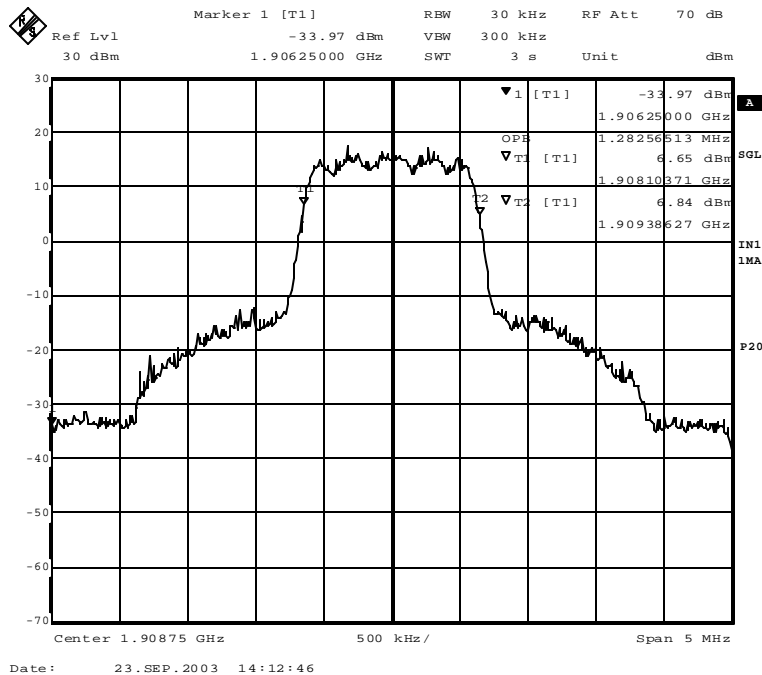

**7 OUT OF BAND EMISSION AT ANTENNA TERMINALS**

FCC §2.1049, FCC §2.1051, §22.917(a), FCC §24.238(a)

Out of Band Emissions: The power of any emission outside of the authorized operating frequency ranges must be attenuated below the transmitting power (P) by a factor of at least  $43 + 10 \log(P)$  dB.

**7.1 Test Procedure**

Compliance with these rules is based on the use of measurement instrumentation employing a resolution bandwidth of 100 kHz or greater for the Cellular band and 1 MHz or greater in the PCS band. In the 1 MHz bands immediately outside and adjacent to the frequency block a resolution bandwidth of at least one percent of the emission bandwidth of the fundamental emission of the transmitter may be employed. A narrower resolution bandwidth is permitted in all cases to improve measurement accuracy provided the measured power is integrated over the full required measurement bandwidth (*i.e.* 100 kHz or 1 percent of emission bandwidth, as specified). The emission bandwidth is defined as the width of the signal between two points, one below the carrier center frequency and one above the carrier center frequency, outside of which all emissions are attenuated at least 26 dB below the transmitter power.

The RF output of the transceiver was connected to a spectrum analyzer through appropriate attenuation. The resolution bandwidth of the spectrum analyzer was set at 1 MHz. The audio modulating signal was adjusted like it is described in Section 6.1 of this report. Sufficient scans were taken to show the out of band Emissions if any up to 10th harmonic.

**7.2 Test Equipment**

Description	Manufacturer	Model Number	Serial Number	Calibration due date
Base Station Simulator	Rohde & Schwarz	CMU-200	1100.0008.02	8/2004
EMI Receiver	Rohde & Schwarz	ESI 26	1088.7490	11/27/2003
Directional Coupler	Amplifier Research	DC7144	22729	8/2004

**7.3 Test Results**

The CDMA 800/1900 Wireless Desk Phone met the out of band emission at antenna terminal requirements.

*Table 7-1: Summary of test result locations*

Location	Mode (Band)	Channel	Description
Figure 7-1	CDMA Cell	384	Conducted spurious emissions, 30MHz to 20 GHz
Figure 7-2	CDMA Cell	777	Conducted spurious emissions, 30MHz to 20 GHz
Figure 7-3	CDMA Cell	1013	Conducted spurious emissions, 30MHz to 20 GHz
Figure 7-4	CDMA PCS	25	Conducted spurious emissions, 30MHz to 20 GHz
Figure 7-5	CDMA PCS	600	Conducted spurious emissions, 30MHz to 20 GHz
Figure 7-6	CDMA PCS	1175	Conducted spurious emissions, 30MHz to 20 GHz
Figure 7-7	CDMA Cell	1013	Emissions within 1 MHz of band edge
Figure 7-8	CDMA Cell	777	Emissions within 1 MHz of band edge
Figure 7-9	CDMA PCS	25	Emissions within 1 MHz of band edge
Figure 7-10	CDMA PCS	1175	Emissions within 1 MHz of band edge

Evaluation For: Telular, Inc.

FCC ID: MTF010147 and MTF071473

Model No: Phonecell SX4T (CDMA) 800-1x and Phonecell SX4T (CDMA) 1900-1x

Figure 7-1: Out of band emissions at antenna terminals – CDMA 800 Channel 384

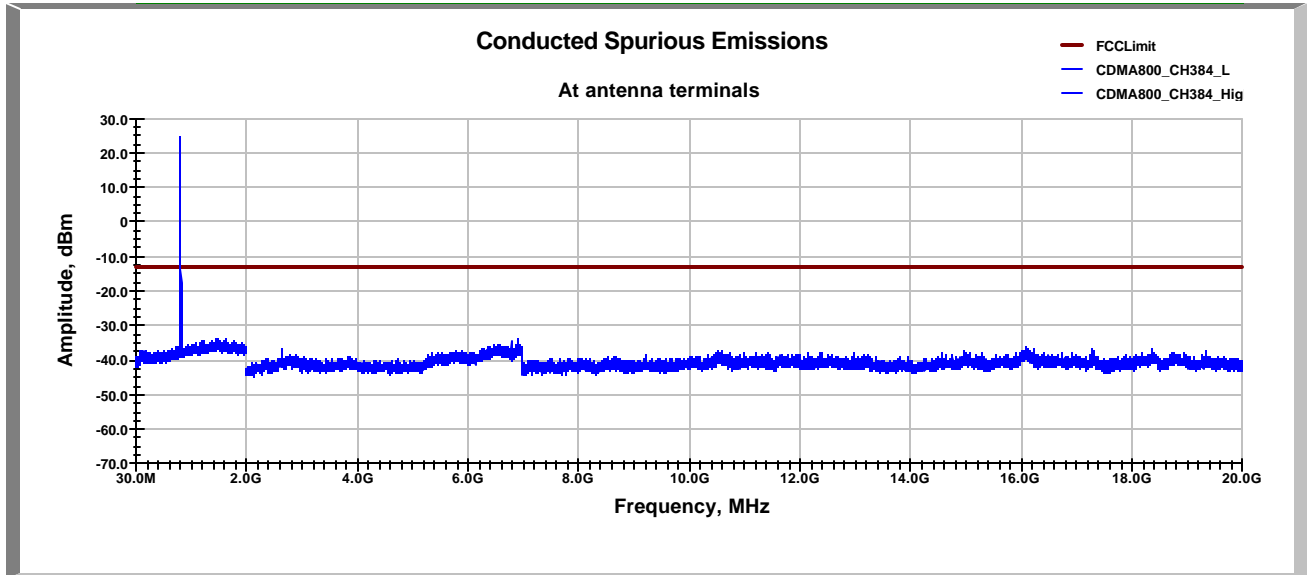

Figure 7-2: Out of band emissions at antenna terminals – CDMA 800 Channel 777

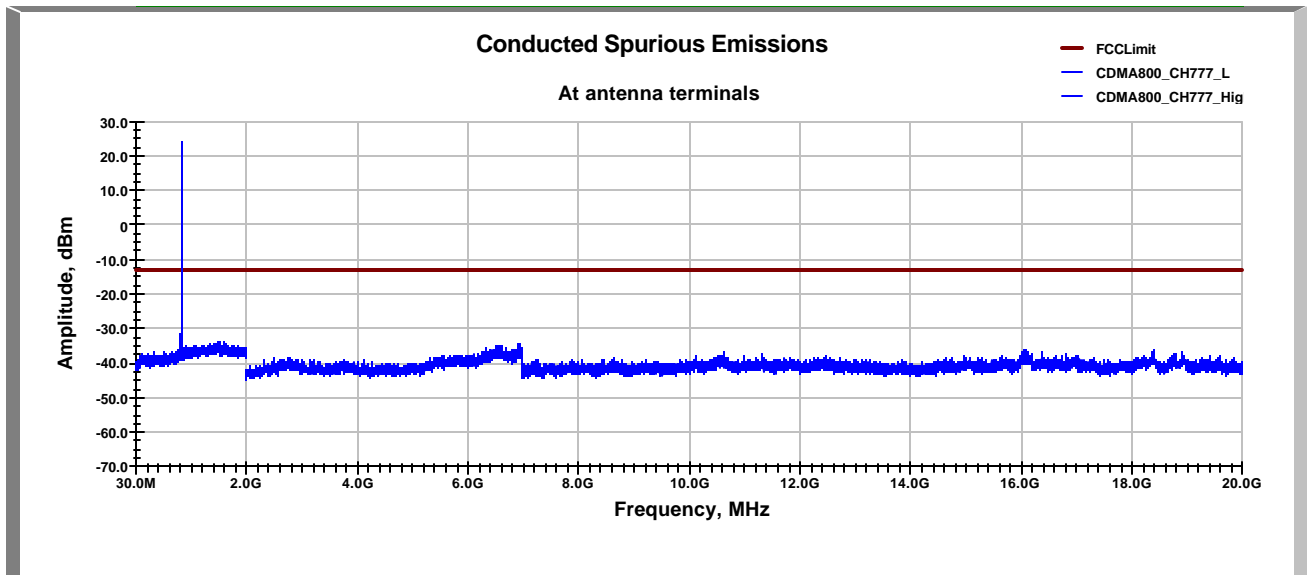

Figure 7-3: Out of band emissions at antenna terminals – CDMA 800 Channel 1013

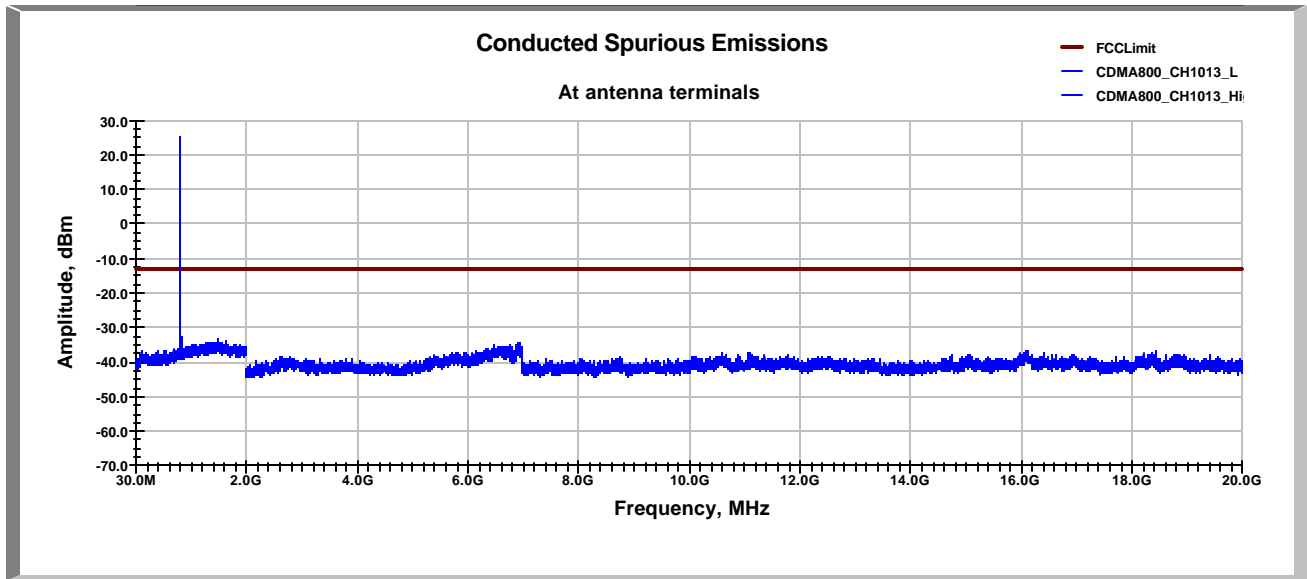

Figure 7-4: Out of band emissions at antenna terminals – CDMA1900 Channel 25

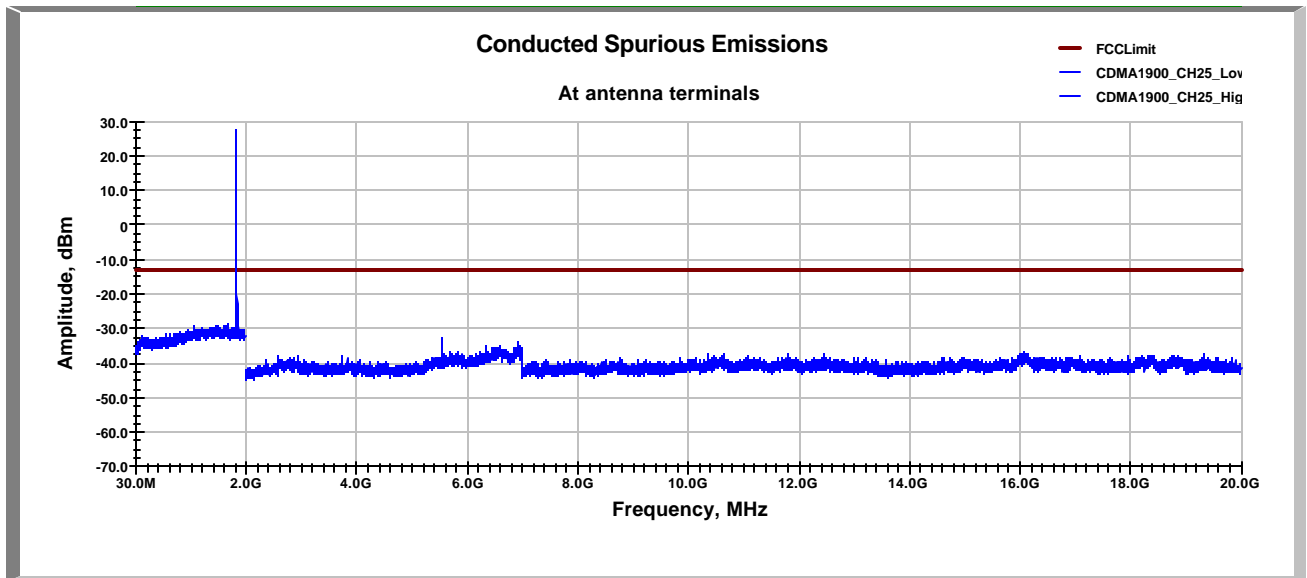



Figure 7-5: Out of band emissions at antenna terminals – CDMA1900 Channel 600

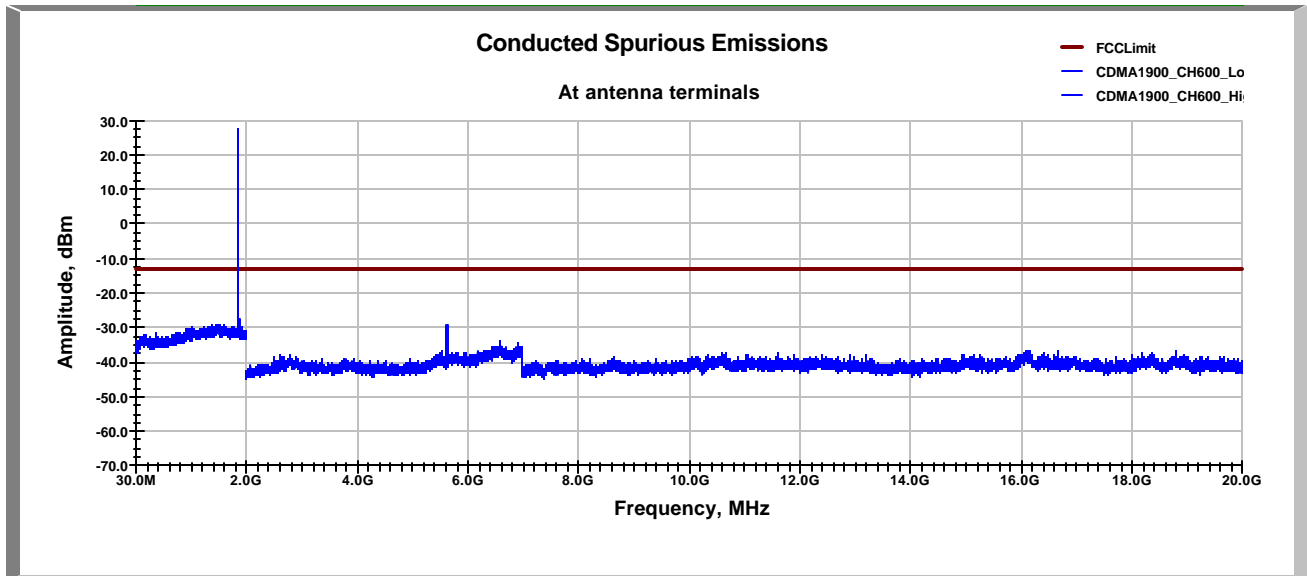

Figure 7-6: Out of band emissions at antenna terminals – CDMA1900 Channel 1175

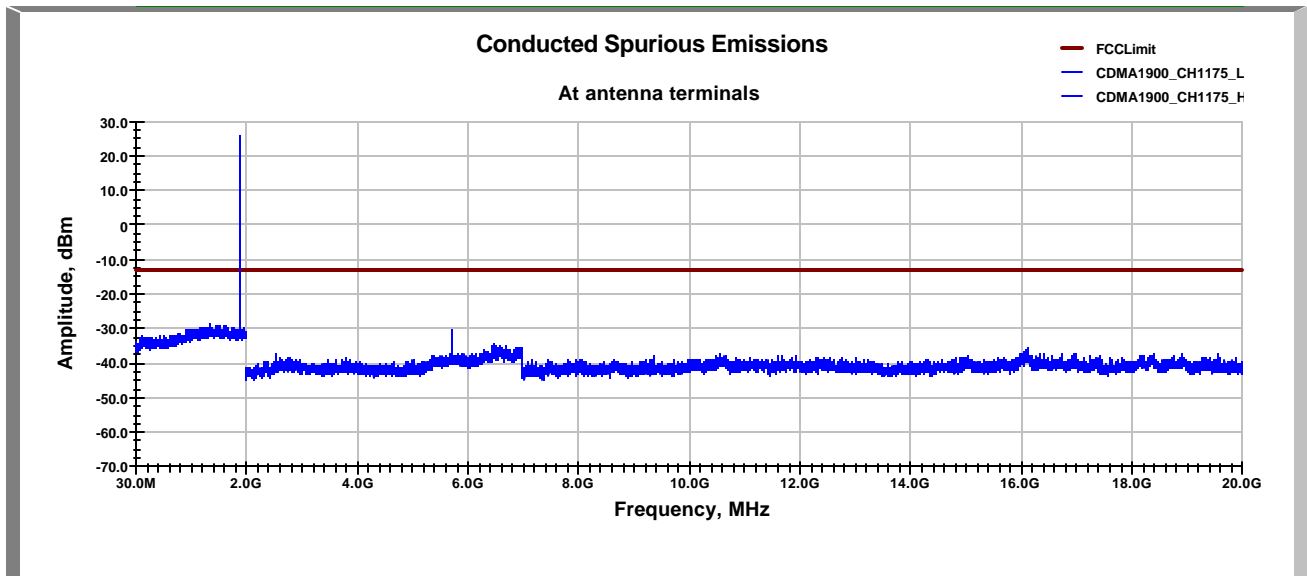

Figure 7-7: Emissions within 1 MHz of band edge, CDMA 800 Channel 1013

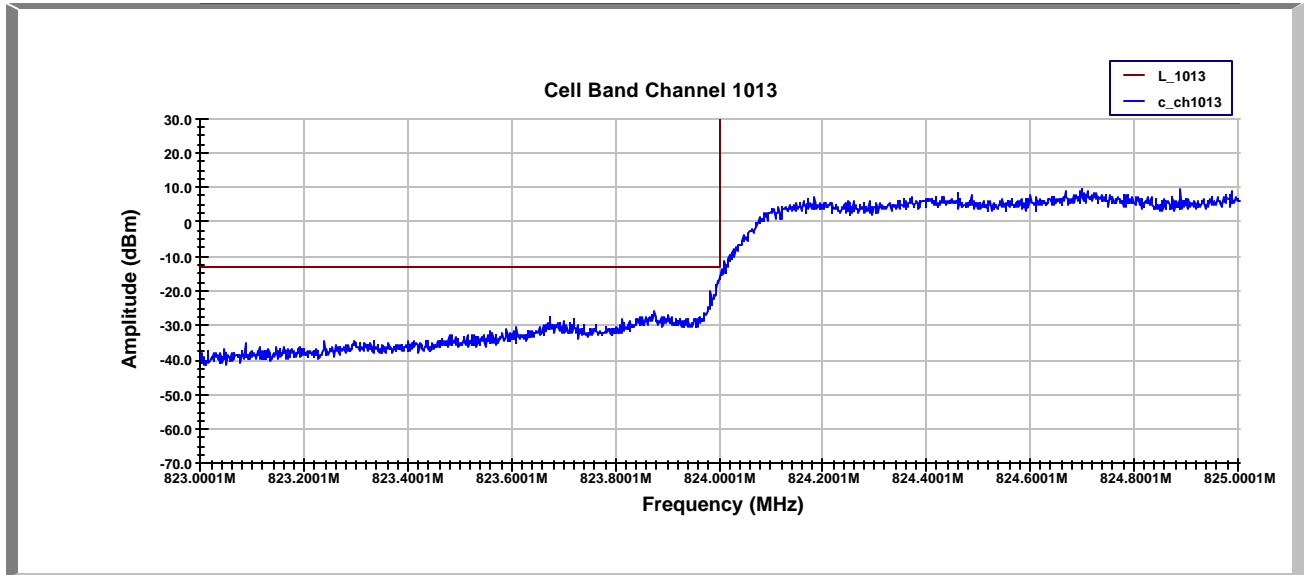

Figure 7-8: Emissions within 1 MHz of band edge, CDMA 800 Channel 777

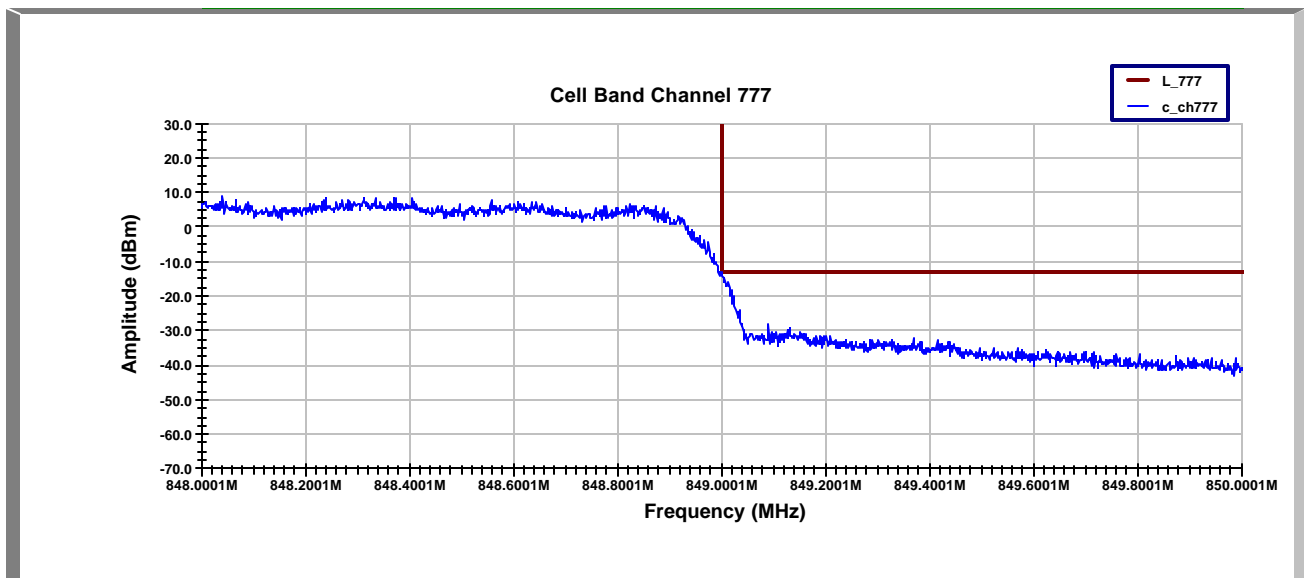

Figure 7-9: Emissions within 1 MHz of band edge, CDMA 1900 Channel 25

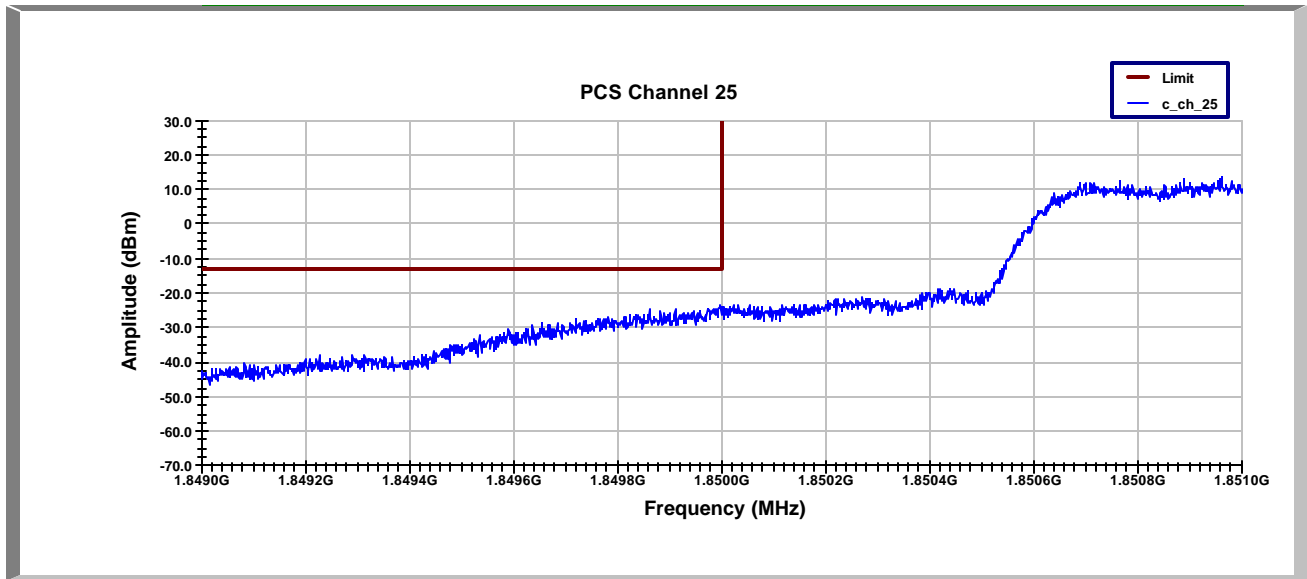
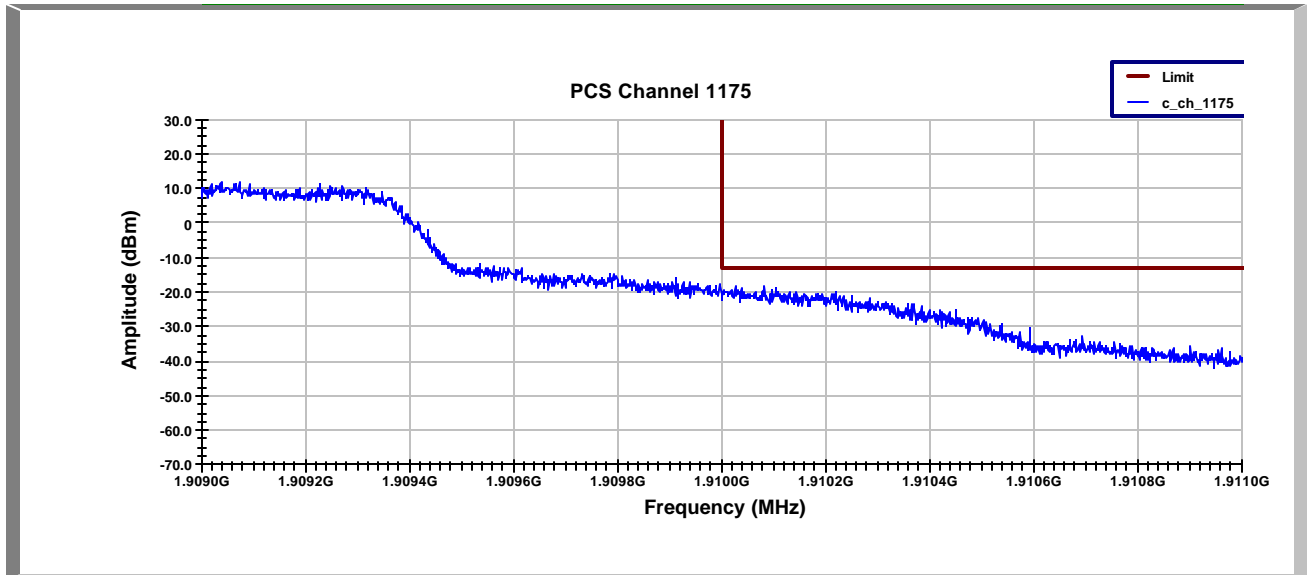

Figure 7-10: Emissions within 1 MHz of band edge, CDMA 1900 Channel 1175



**8 FIELD STRENGTH OF SPURIOUS RADIATION**

FCC §2.1053

**8.1 Test Procedure**

The EUT was placed on a non-conductive turntable. The measurement antenna was placed at a distance of 3 meters from the EUT. During the tests, the antenna height and EUT azimuth were varied in order to identify the maximum level of emissions from the EUT. This maximization process was repeated with the EUT positioned in each of its three orthogonal orientations.

The frequency range up to tenth harmonic was investigated for each of three fundamental frequencies (low, middle, and high channels). Once spurious emissions were identified, the power of the emission was determined using the substitution method.

The spurious emissions attenuation was calculated as the difference between radiated power at the fundamental frequency and at the spurious emissions frequency.

**8.2 Test Equipment**

Description	Manufacturer	Model Number	Serial Number	Calibration due date
Base Station Simulator	Rohde & Schwarz	CMU-200	1100.0008.02	8/2004
Signal Generator	HP	83620B	3614A00199	8/2004
Horn Antenna	Antenna Research	DRG-118/A	1086	3/7/2007
Horn Antenna	EMCO	3115	6556	7/11/2004
EMI Receiver	Rohde & Schwarz	ESI 26	1088.7490	11/27/2003
LISN	FCC	FCC-LISN-50-50-2M	1026	12/2003
Bilog Antenna	EMCO	3142B	1674	8/2004
Preamplifier	HP	8449B	3008A00775	12/2003
High Pass Filter	Filtek	HP12/2000-5AB	15B61	8/2004

**8.3 Test Results**

The CDMA 800/1900 Wireless Desk Phone met the field strength of spurious radiation requirements of FCC §2.1053. Emissions within 20 dB of the limit were measured using a substitution method and are reported in Table 8-1.

*Table 8-1: Substitution Measurements on Emissions Within 20 dB of the Limit*

Frequency (MHz)	Antenna Polarity	Measurement Method (ERP/EIRP)	EUT Reading (dBuV)	Substitution Reading (dBuV)	Cable Reading (dBm)	Tx Antenna Gain (dBi)	ERP / EIRP (dBm)
5550	H	EIRP	52.15	70.63	-22.2	10.6	-7.88
7520	H	EIRP	54.9	60.17	-28.9	9.5	-24.67
7630	H	EIRP	49.29	60.22	-28.77	9.3	-26.91
5550	V	EIRP	57.58	71.14	-22	10.8	-24.76
7520	V	EIRP	51.72	61.53	-28.9	9.5	-29.21
7630	V	EIRP	52.78	62.61	-28.77	9.3	-29.3

*Figure 8-1: Field Strength of Spurious Radiation (30 MHz – 1 GHz), CDMA 800 Channel 384, 777, and 1013*

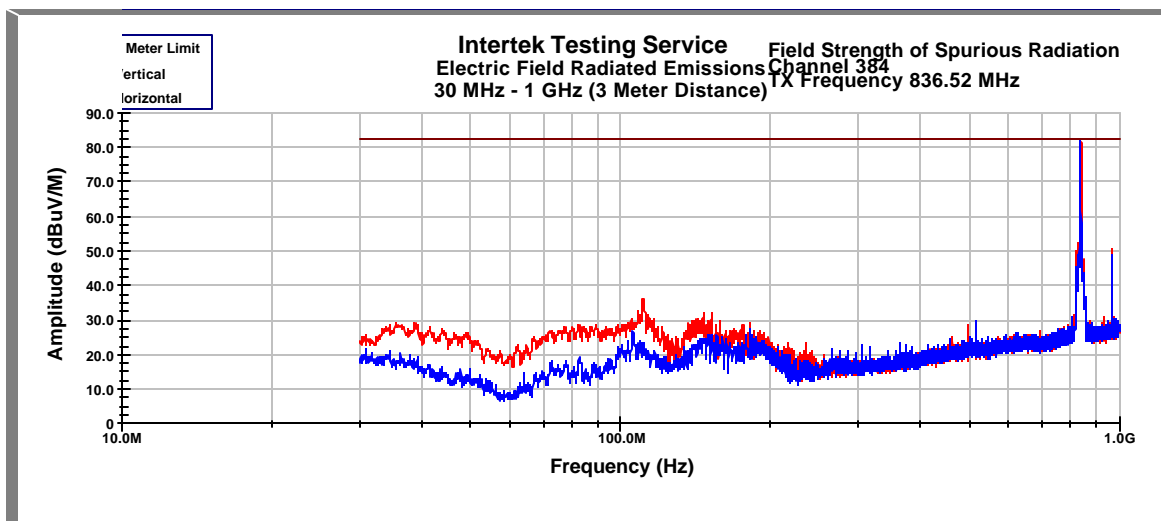

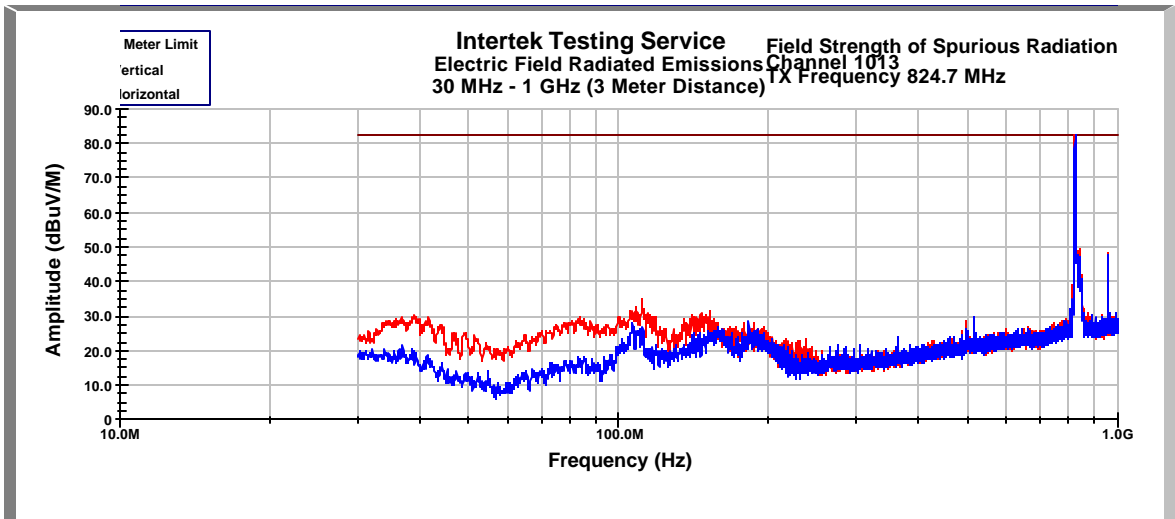
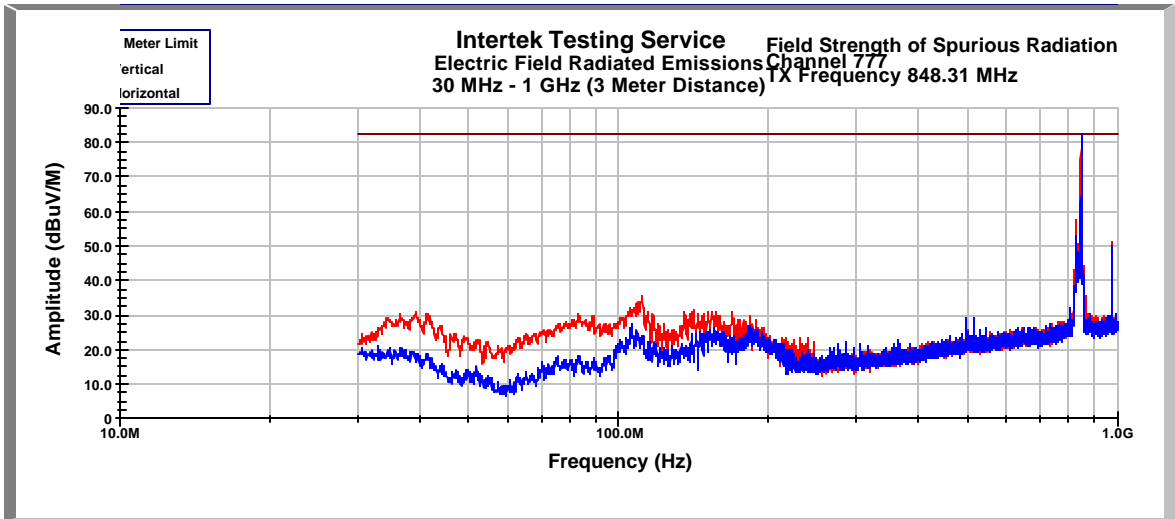

Evaluation For: Telular, Inc.

FCC ID: MTF010147 and MTF071473

Model No: Phonecell SX4T (CDMA) 800-1x and Phonecell SX4T (CDMA) 1900-1x

Figure 8-2: Field Strength of Spurious Radiation (1 GHz – 3 GHz), CDMA 800 Channel 384, 777, 1013

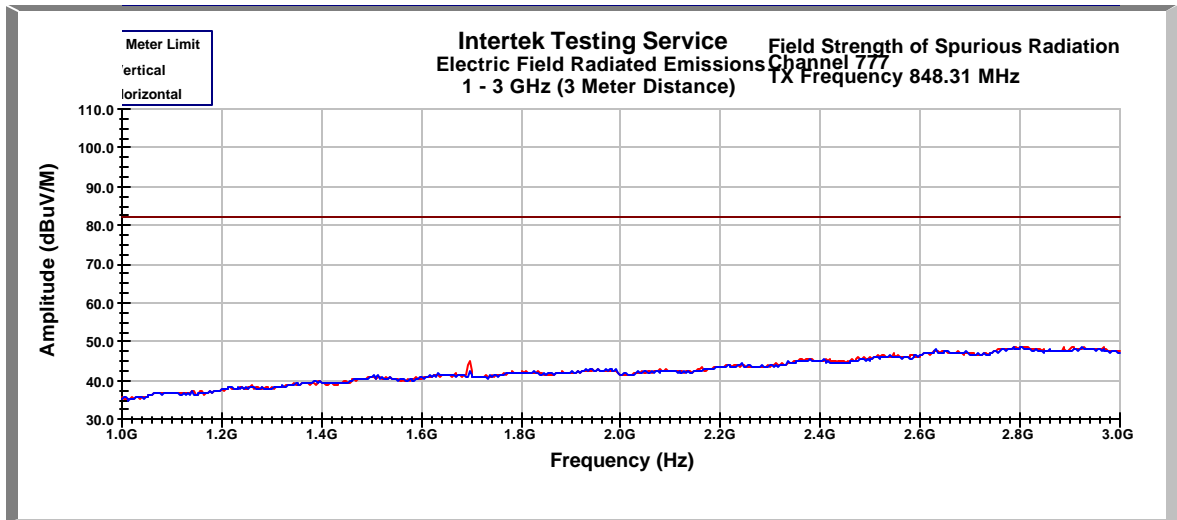
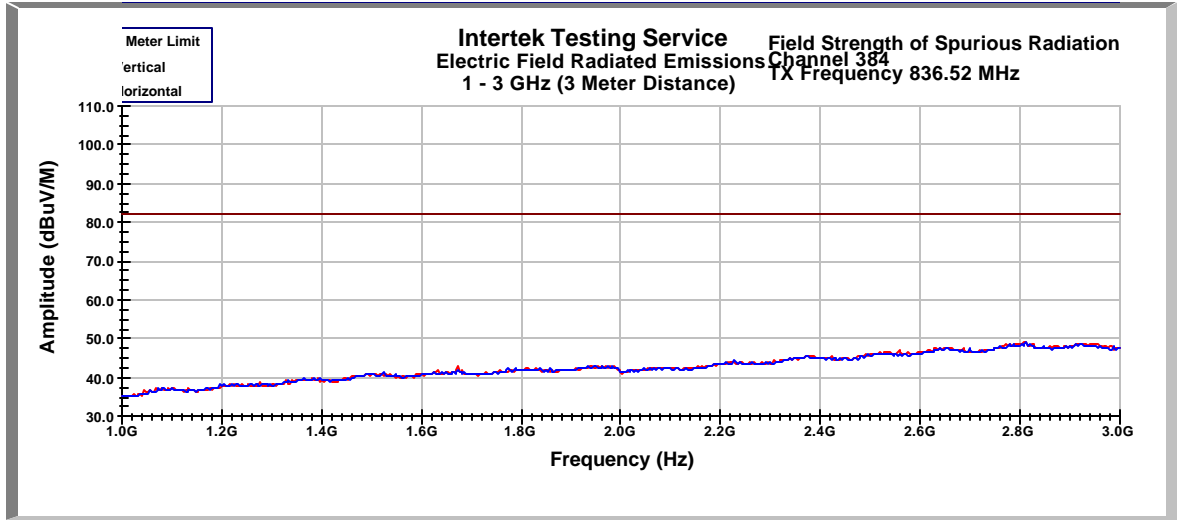

Evaluation For: Telular, Inc.

FCC ID: MTF010147 and MTF071473

Model No: Phonecell SX4T (CDMA) 800-1x and Phonecell SX4T (CDMA) 1900-1x

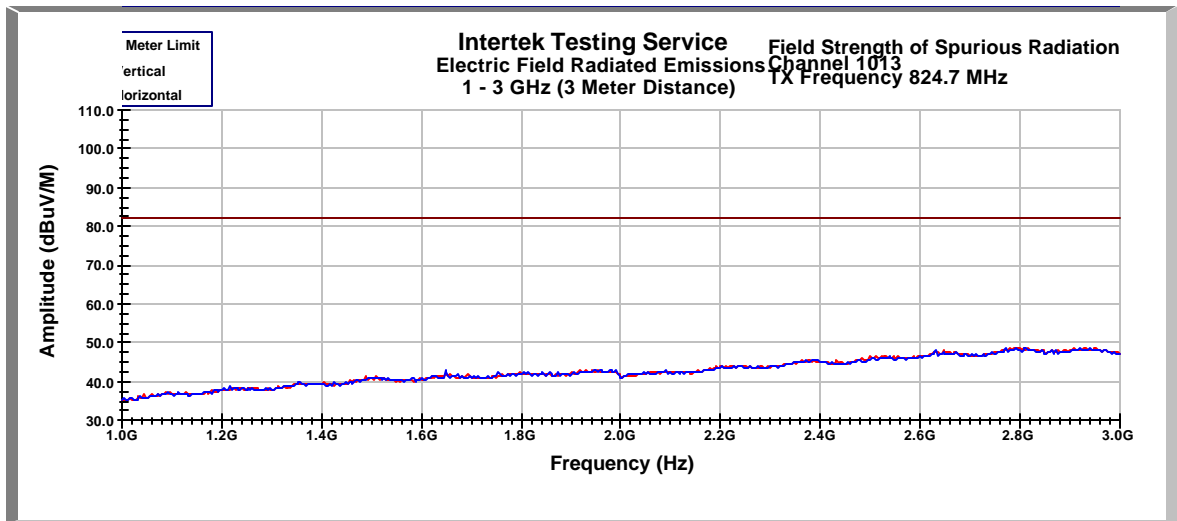



Evaluation For: Telular, Inc.

FCC ID: MTF010147 and MTF071473

Model No: Phonecell SX4T (CDMA) 800-1x and Phonecell SX4T (CDMA) 1900-1x

Figure 8-3: Field Strength of Spurious Radiation (3GHz – 20GHz), CDMA 800 Channel 384, 777, and 1013

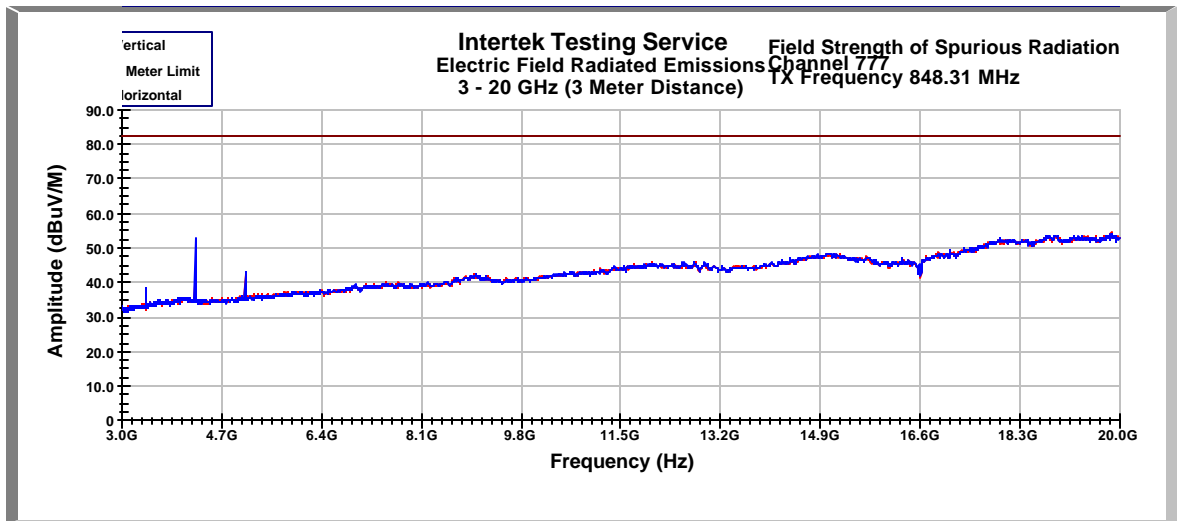
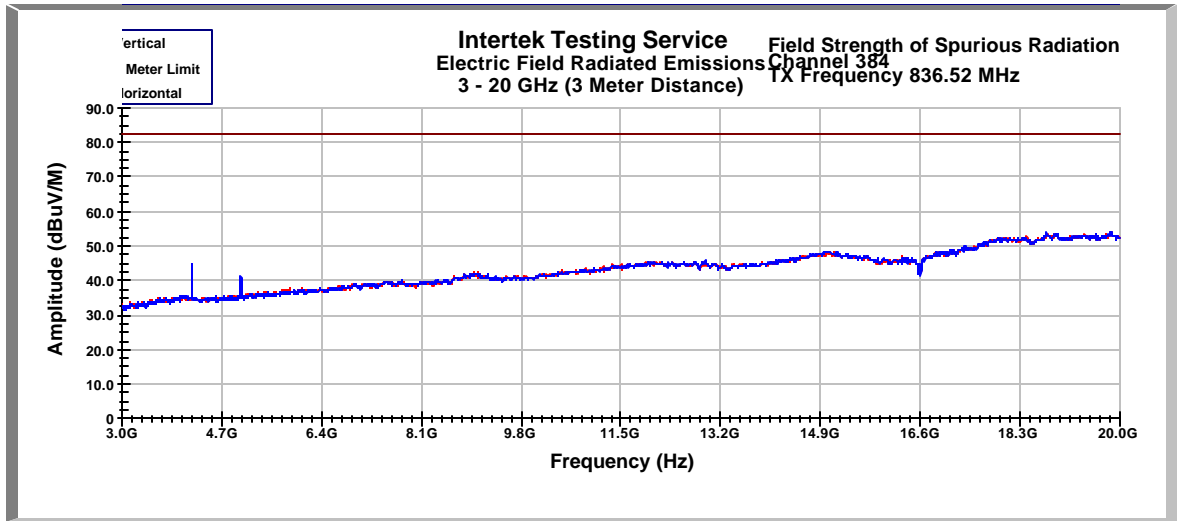

Evaluation For: Telular, Inc.

FCC ID: MTF010147 and MTF071473

Model No: Phonecell SX4T (CDMA) 800-1x and Phonecell SX4T (CDMA) 1900-1x

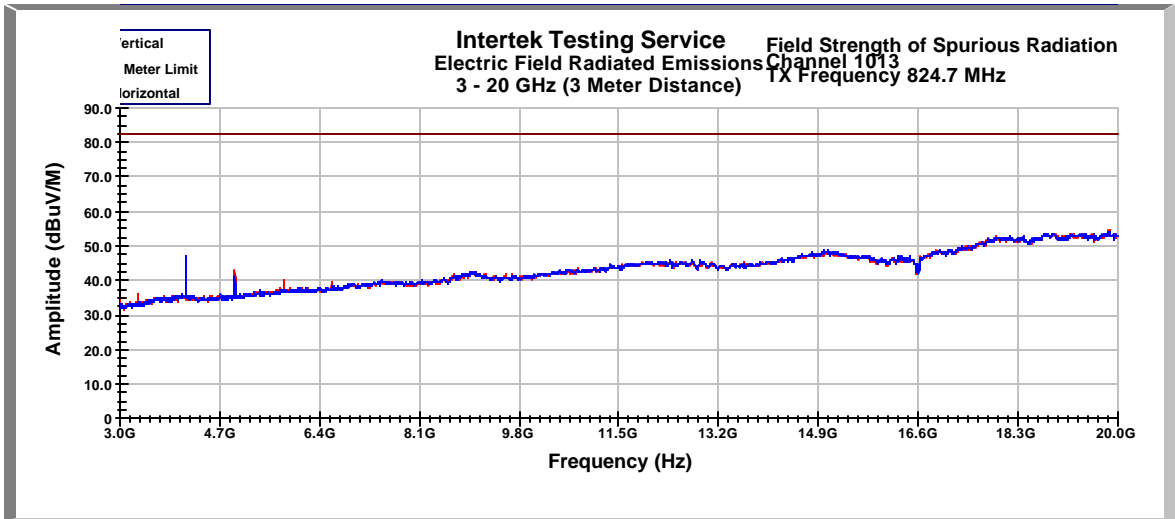
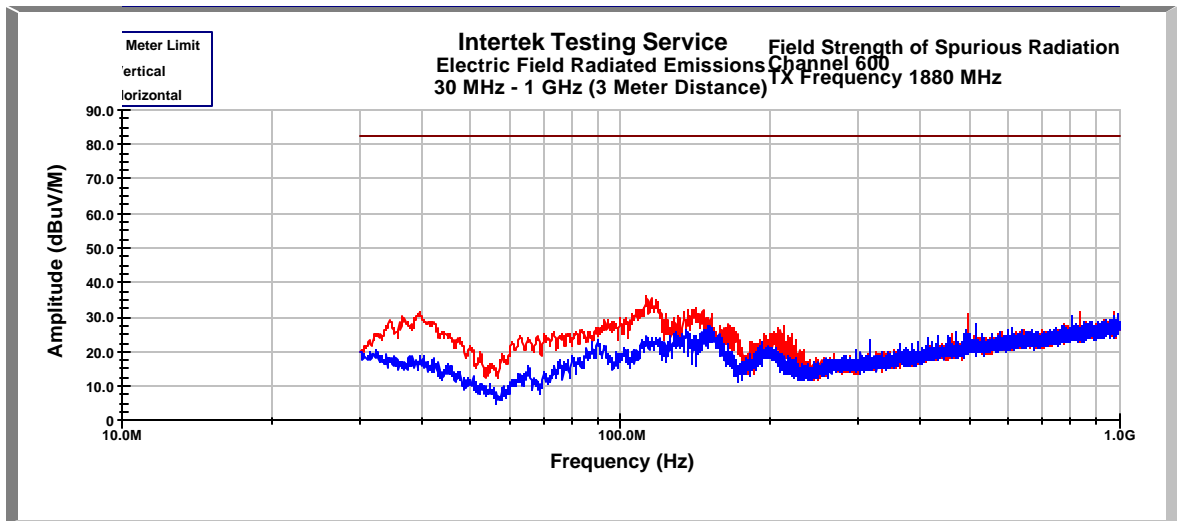
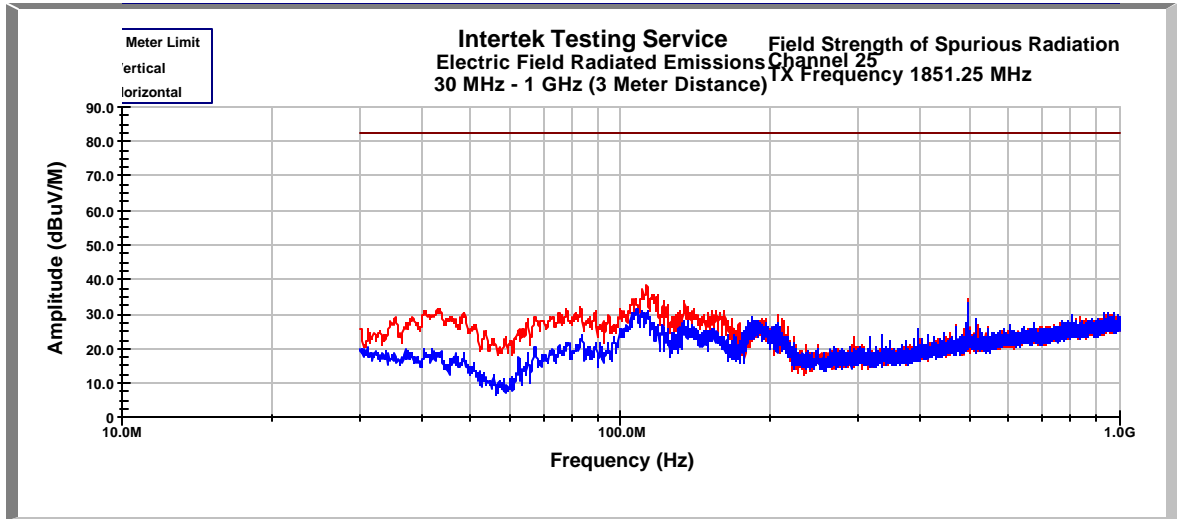
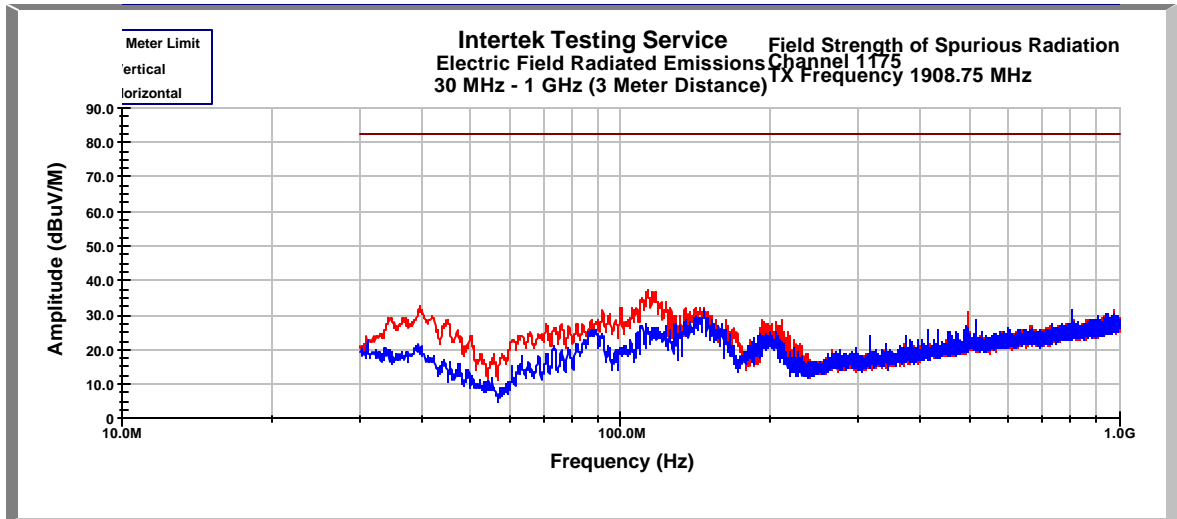

Figure 8-4: Field Strength of Spurious Radiation (30 MHz – 1 GHz), CDMA 1900 Channel 25, 675, and 1175





Evaluation For: Telular, Inc.

FCC ID: MTF010147 and MTF071473

Model No: Phonecell SX4T (CDMA) 800-1x and Phonecell SX4T (CDMA) 1900-1x

Figure 8-5: Field Strength of Spurious Radiation (1 GHz – 3 GHz), CDMA 1900 Channel 25, 675, and 1175

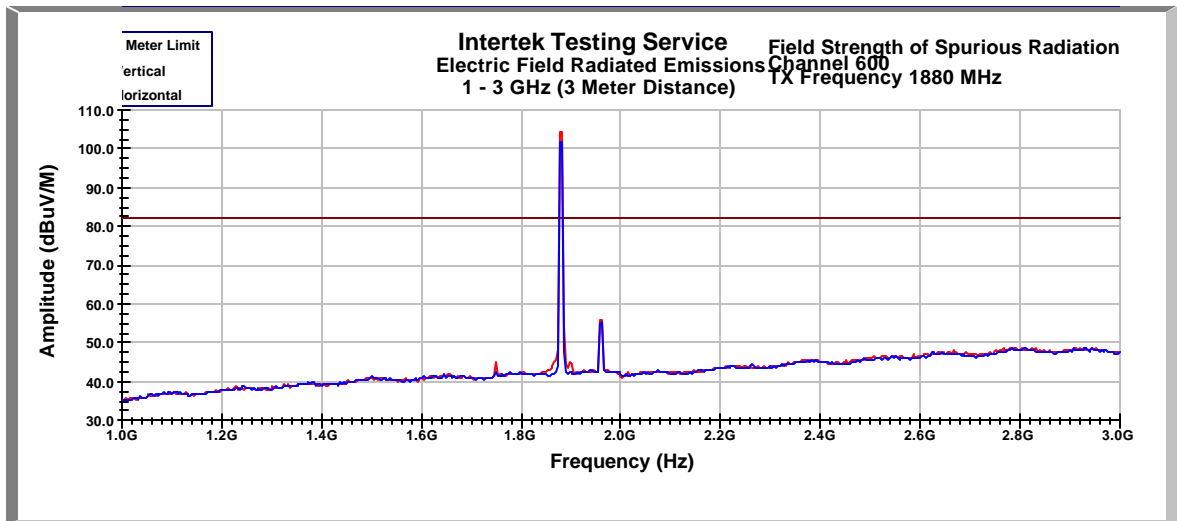
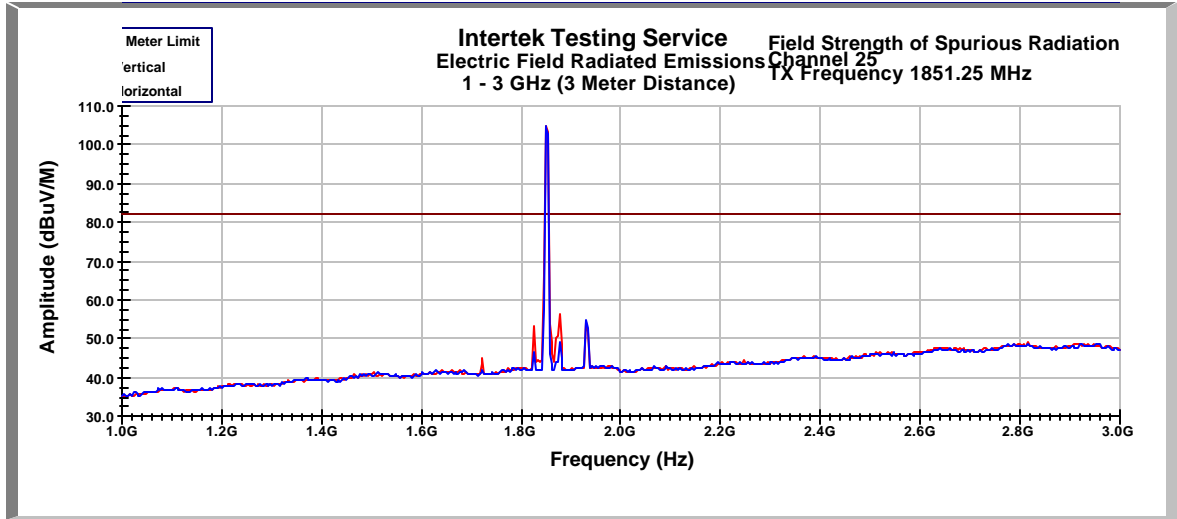

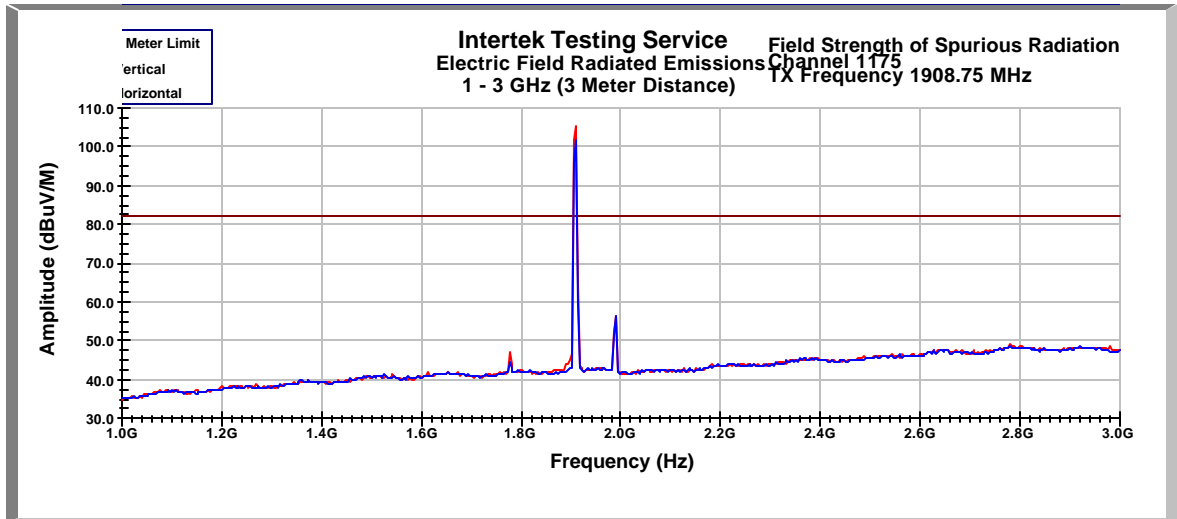

Evaluation For: Telular, Inc.

FCC ID: MTF010147 and MTF071473

Model No: Phonecell SX4T (CDMA) 800-1x and Phonecell SX4T (CDMA) 1900-1x

Figure 8-6: Field Strength of Spurious Radiation (3GHz – 20GHz), CDMA 1900 Channel 25, 675, and 1175

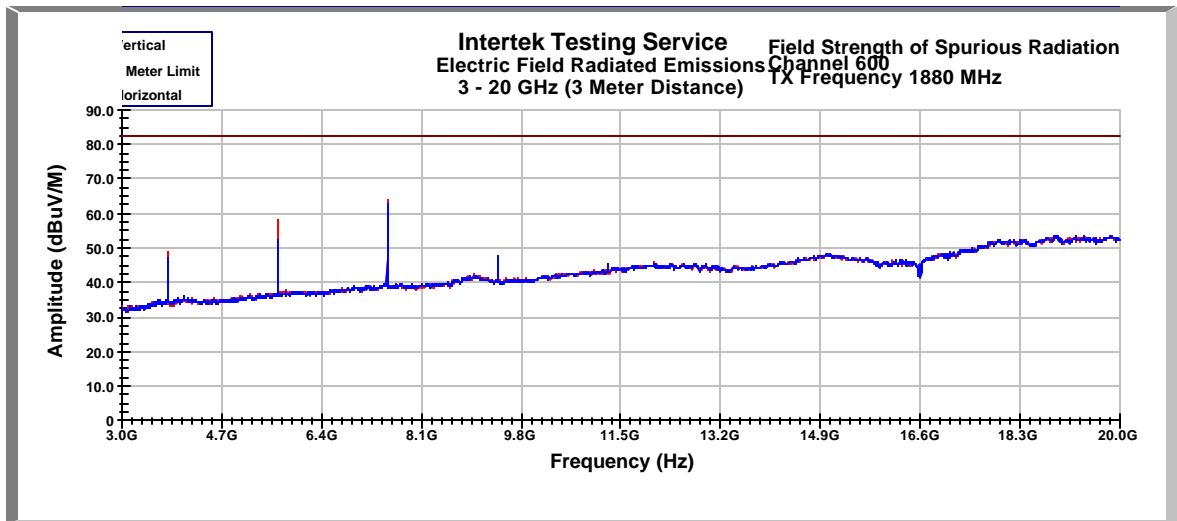
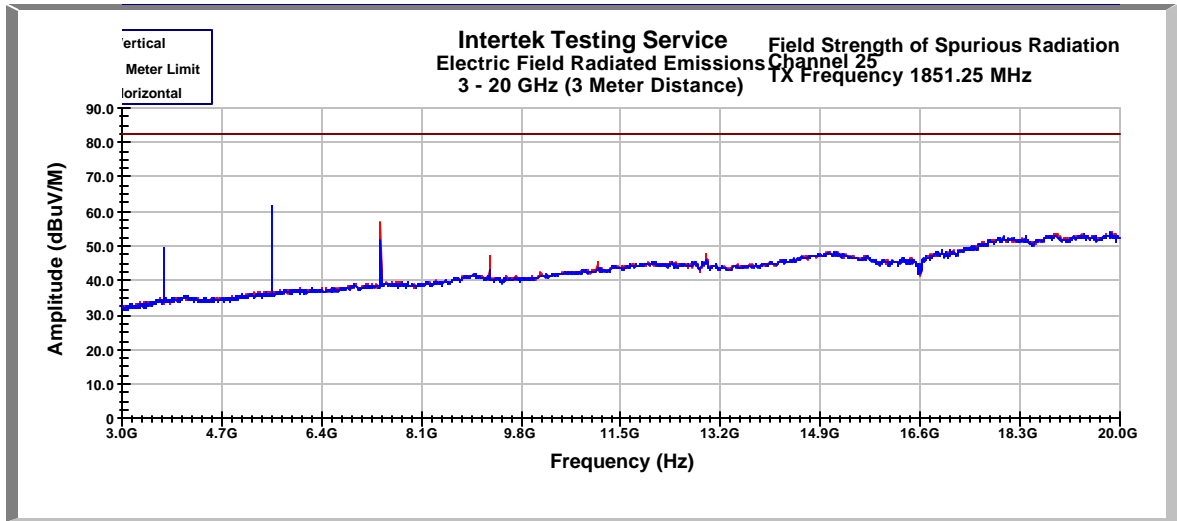

Evaluation For: Telular, Inc.

FCC ID: MTF010147 and MTF071473

Model No: Phonicell SX4T (CDMA) 800-1x and Phonicell SX4T (CDMA) 1900-1x

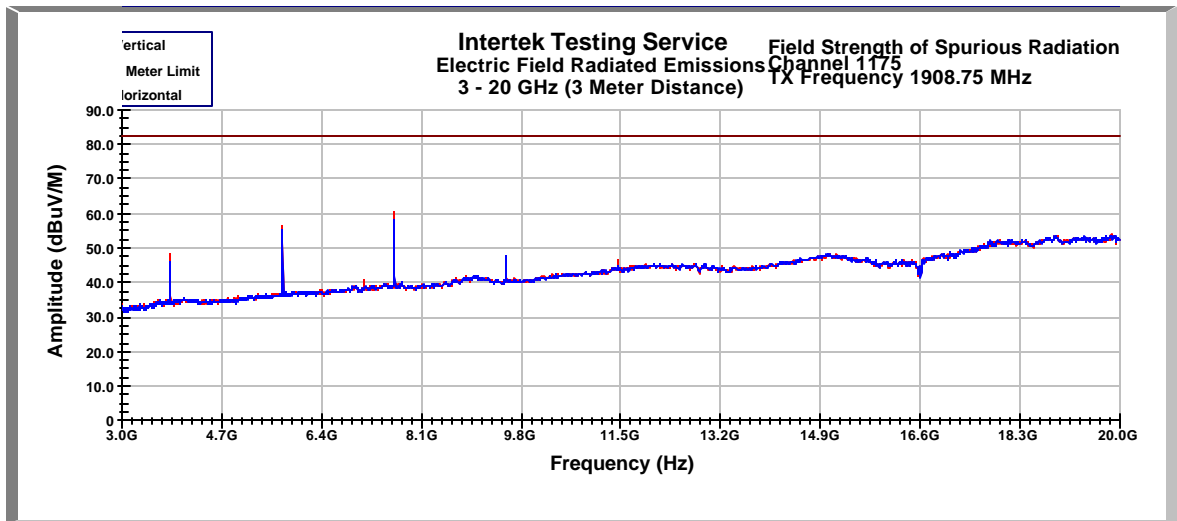



**9 POWER LINE CONDUCTED EMISSIONS**

FCC §15.107, FCC §15.207

**9.1 Test Procedure**

Measurements are carried out using quasi-peak and average detector receivers in accordance with CISPR 16. An AMN is required to provide a defined impedance at high frequencies across the power feed at the point of measurement of terminal voltage and also to provide isolation of the circuit under test from the ambient noise on the power lines. An AMN as defined in CISPR 16 shall be used.

The EUT is located so that the distance between the boundary of the EUT and the closest surface of the AMN is 0.8m.

Where a flexible mains cord is provided by the manufacturer, this shall be 1m long or if in excess of 1m, the excess cable is folded back and forth as far as possible so as to form a bundle not exceeding 0.4m in length.

The EUT is arranged and connected with cables terminated in accordance with the product specification.

Conducted disturbance is measured between the phase lead and the reference ground, and between the neutral lead and the reference ground. Both measured values are reported.

The EUT, where intended for tabletop use, is placed on a table whose top is 0.8m above the ground plane. A vertical, metal reference plane is placed 0.4m from the EUT. The vertical metal reference-plane is at least 2m by 2m. The EUT shall be kept at least 0.8m from any other metal surface or other ground plane not being part of the EUT. The table is constructed of non-conductive materials. Its dimensions are 1m by 1.5m, but may be extended for larger EUT.

Floor standing EUTs are placed on a horizontal metal ground plane and isolated from the ground plane by 3 to 12 mm of insulating material. The metal ground plane extends at least 0.5m beyond the boundaries of the EUT and has minimum dimensions of 2m by 2m.

Equipment setup for conducted disturbance tests followed the guidelines of ANSI C63.4: 1992.

**9.2 Test Equipment**

Description	Manufacturer	Model Number	Serial Number	Calibration due date
Base Station Simulator	Rohde & Schwarz	CMU-200	1100.0008.02	8/2004
EMI Receiver	Rohde & Schwarz	ESI 26	1088.7490	11/27/2003
LISN	FCC	FCC-LISN-50-50-2M	1026	12/2003

### 9.3 Test Results

The CDMA 800/1900 Wireless Desk Phone met the power line conducted emission requirements of FCC §15.107 and §15.207. The test results are located in Figure 9-1 through Figure 9-4. The graphical data, measured with peak detection, was all below the class B quasi-peak and average limits.

Figure 9-1: FCC §15.107 and §15.207 power line conducted emissions (Line 1 on the CDMA1900 Phone)

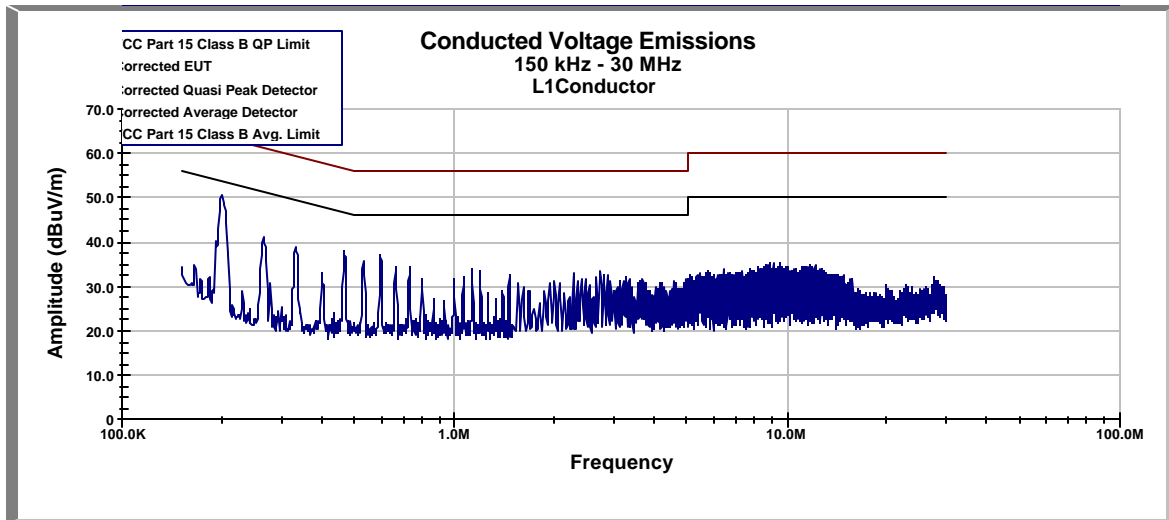
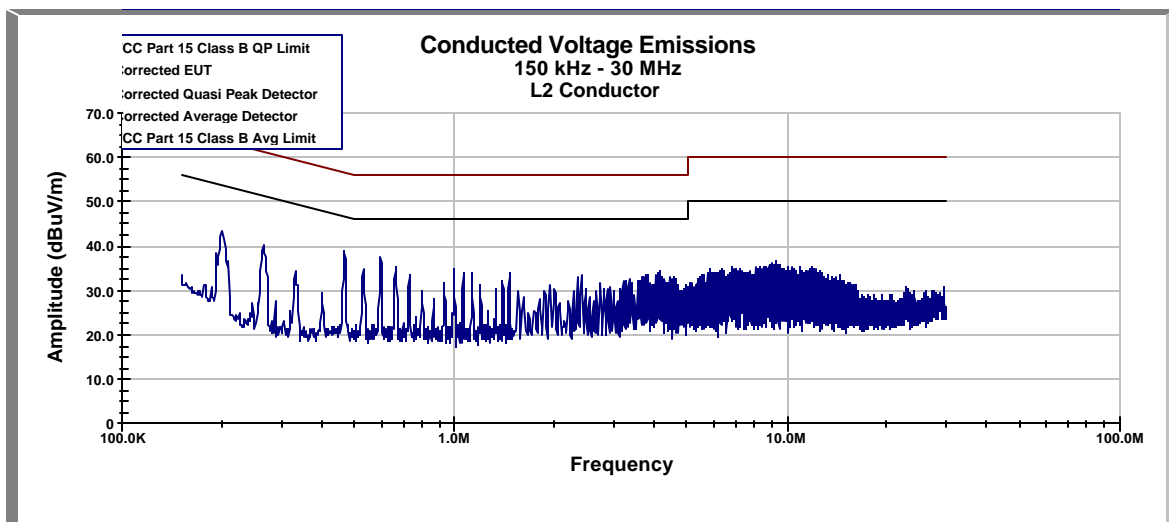

Figure 9-2: FCC §15.107 and §15.207 power line conducted emissions (Line 2 on the CDMA1900 Phone)



Evaluation For: Telular, Inc.

FCC ID: MTF010147 and MTF071473

Model No: Phonecell SX4T (CDMA) 800-1x and Phonecell SX4T (CDMA) 1900-1x

Figure 9-3: FCC §15.107 and §15.207 power line conducted emissions (Line 1 on the CDMA800 Phone)

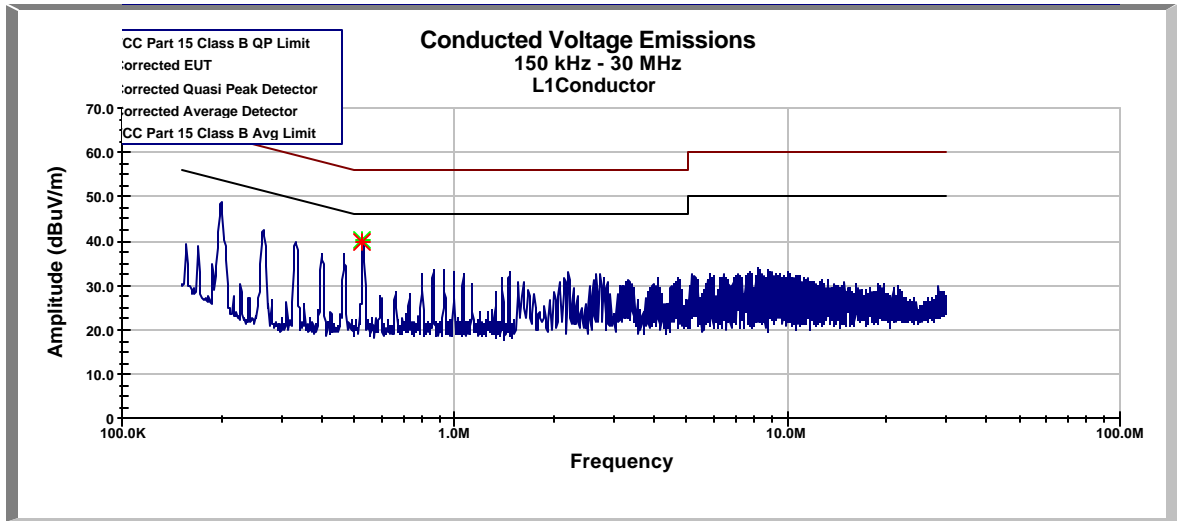
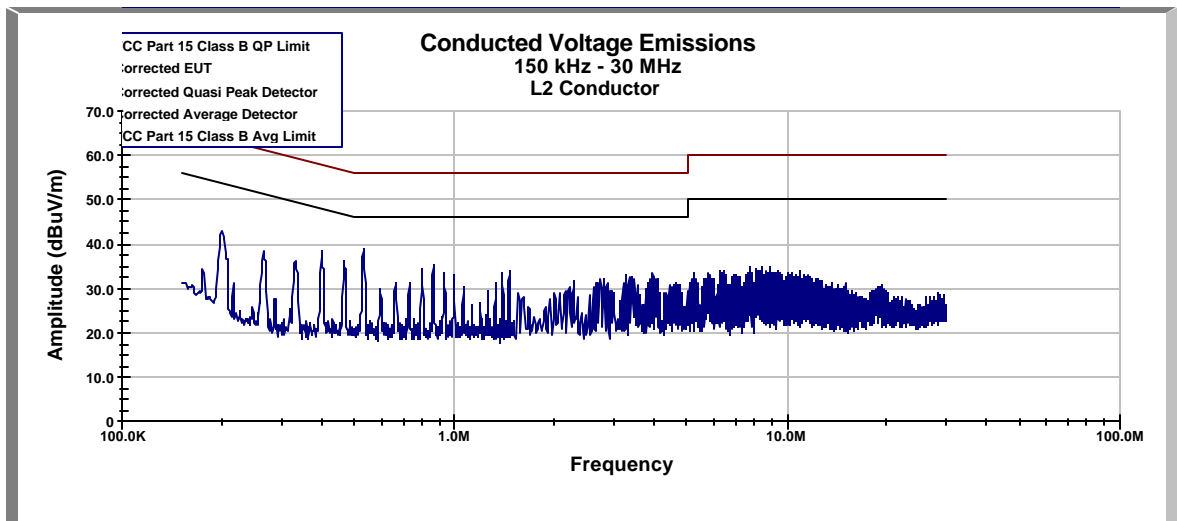

Figure 9-4: FCC §15.107 and §15.207 power line conducted emissions (Line 2 on the CDMA800 Phone)



**10 RECEIVER SPURIOUS EMISSIONS**

**10.1 Test Limits**

*Table 10-1 Radiated Emission Limit for FCC §15.109*

Radiated Emission Limits at 3 meters	
Frequency (MHz)	Quasi-Peak limits, dB (mV/m)
30 to 88	40.0
88 to 216	43.5
216 to 960	46.0
960 and up	54.0

**10.2 Test Equipment**

Description	Manufacturer	Model Number	Serial Number	Calibration due date
Horn Antenna	Antenna Research	DRG-118/A	1086	3/7/2007
Horn Antenna	EMCO	3115	6556	7/11/2004
EMI Receiver	Rohde & Schwarz	ESI 26	1088.7490	11/27/2003
Bilog Antenna	EMCO	3142B	1674	8/2004
Preamplifier	HP	8449B	3008A00775	12/2003

**10.3 Test Procedure**

Measurements are made over the frequency range of 30 MHz to five times the highest frequency operating within the device. The measuring receiver meets the requirements of Section One of CISPR 16 and the measuring antenna correlates to a balanced dipole. From 30 to 1000 MHz, a quasi-peak detector was used for measurement. Above 1000 MHz, average measurements were performed.

Measurements of the radiated field are made with the antenna located at a distance of 3 meters from the EUT. If the field-strength measurements at 3m cannot be made because of high ambient noise level or for other reasons, measurements may be made at a closer distance, for example 1m. An inverse proportionality factor of 20 dB per decade should be used to normalize the measured data to the specified distance for determining compliance.

The antenna is adjusted between 1m and 4m in height above the ground plane for maximum meter reading at each test frequency.

The antenna-to-EUT azimuth is varied during the measurement to find the maximum field-strength readings.

The antenna-to-EUT polarization (horizontal and vertical) is varied during the measurements to find the maximum field-strength readings.

The EUT, where intended for tabletop use, is placed on a table whose top is 0.8m above the ground plane. The table is constructed of non-conductive materials. Its dimensions are 1m by 1.5m, but may be extended for larger EUT.

Equipment setup for radiated disturbance tests followed the guidelines of ANSI C63.4: 1992.

Evaluation For: Telular, Inc.

FCC ID: MTF010147 and MTF071473

Model No: Phonicell SX4T (CDMA) 800-1x and Phonicell SX4T (CDMA) 1900-1x

**10.4 Test Results**

The CDMA 800/1900 Wireless Desk Phone met the radiated disturbance requirements of FCC §15.109. The maximized quasi peak data can be found in Figure 10-3. There were no other emissions detected within 10 dB of the limit.

*Figure 10-1 FCC §15.109Worse Case Receiver Spurious Emission (Horizontal – CDMA 800 Phone)*

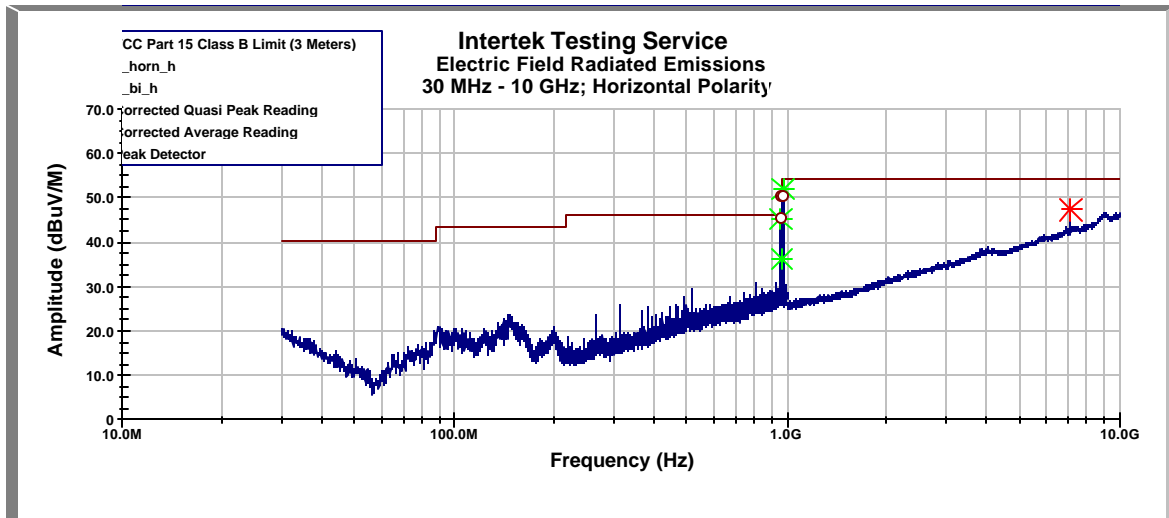

*Figure 10-2 FCC §15.109Worse Case Receiver Spurious Emission (Vertical – CDMA 800 Phone)*

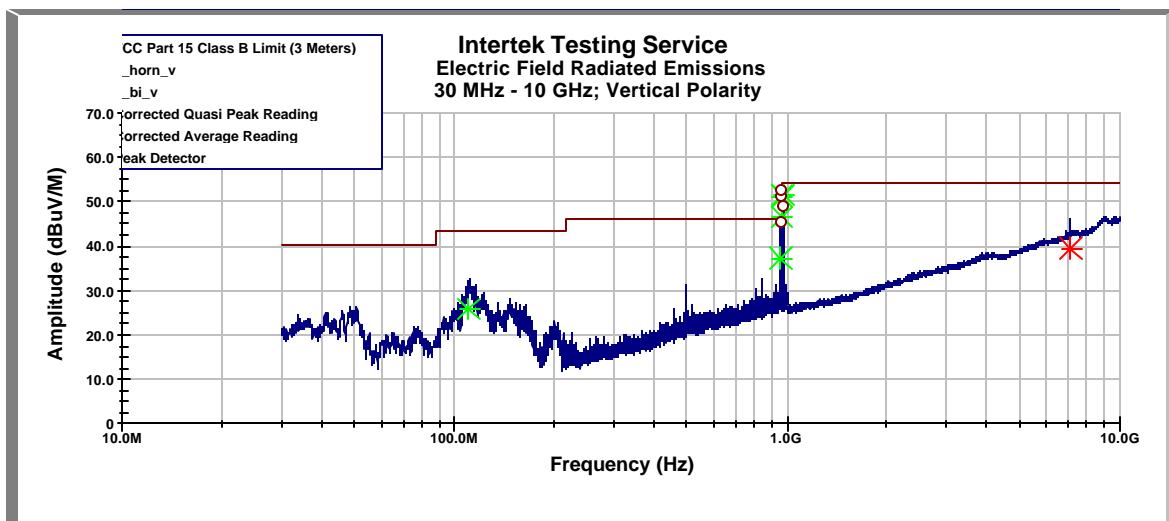

*Figure 10-3 FCC §15.109 Maximized Quasi Peak Emissions (CDMA 800 Phone)*

<b>Frequency (MHz)</b>	<b>Polarity (H/V)</b>	<b>Cab. (dB)</b>	<b>Ant. (dB)</b>	<b>Corr. Reading. (dBuV/m)</b>	<b>Limit (dBuV/m)</b>	<b>Delta (dB)</b>	<b>Azimuth (deg)</b>	<b>Tower (cm)</b>	<b>Results</b>
958.71 MHz	H	2.52	22.2	45.24	46.02	-0.78	86	161	<b>Compliant</b>
975.5 MHz	H	2.5	22.1	51.94	53.98	-2.04	205	292	<b>Compliant</b>
976.11 MHz	V	2.51	22.1	51.41	53.98	-2.57	312	101	<b>Compliant</b>
963.87 MHz	V	2.49	22.2	51.16	53.98	-2.82	312	101	<b>Compliant</b>
963.87 MHz	V	2.49	22.2	46.43	53.98	-7.55	312	101	<b>Compliant</b>
958.71 MHz	V	2.52	22.2	37.21	46.02	-8.81	279	101	<b>Compliant</b>
110.18 MHz	V	0.83	12.04	25.79	43.52	-17.73	184	100	<b>Compliant</b>
963.51 MHz	H	2.49	22.2	36.22	53.98	-17.76	80	124	<b>Compliant</b>

Evaluation For: Telular, Inc.

FCC ID: MTF010147 and MTF071473

Model No: Phonecell SX4T (CDMA) 800-1x and Phonecell SX4T (CDMA) 1900-1x

Figure 10-4 FCC §15.109Worse Case Receiver Spurious Emission (Horizontal – CDMA 1900 Phone)

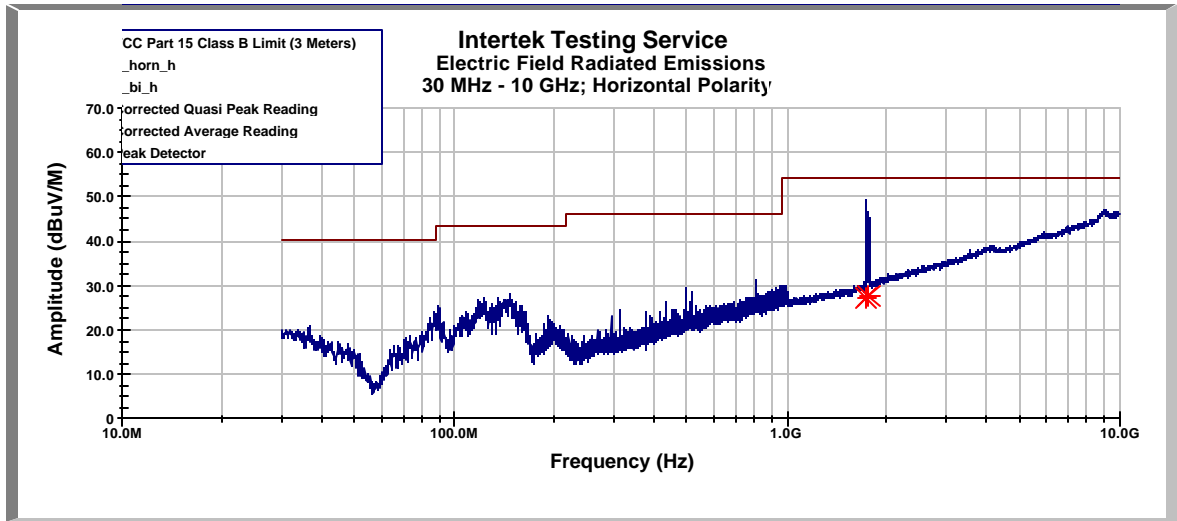
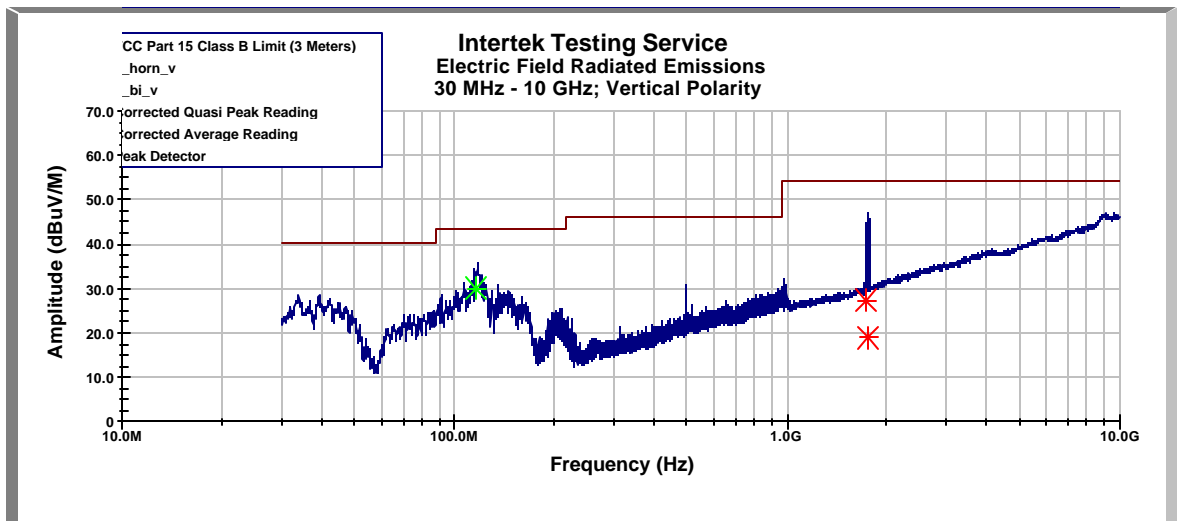

Figure 10-5 FCC §15.109Worse Case Receiver Spurious Emission (Vertical – CDMA 1900 Phone)



Evaluation For: Telular, Inc.

FCC ID: MTF010147 and MTF071473

Model No: Phonecell SX4T (CDMA) 800-1x and Phonecell SX4T (CDMA) 1900-1x

*Figure 10-6 FCC §15.109 Maximized Quasi Peak Emissions (CDMA 1900 Phone)*

Frequency (GHz)	Polarity (H/V)	Cab. (dB)	Ant. (dB)	Corr. Reading. (dBuV/m)	Limit (dBuV/m)	Delta (dB)	Azimuth (deg)	Tower (cm)	Results
1.7594 GHz	H	-29.83	27.95	27.58	53.98	-26.4	336	128	<b>Compliant</b>
1.7292 GHz	V	-29.85	27.8	27.3	53.98	-26.68	88	328	<b>Compliant</b>
1.7276 GHz	H	-29.86	27.79	27.12	53.98	-26.86	-1	185	<b>Compliant</b>
1.7561 GHz	V	-29.86	27.93	18.94	53.98	-35.04	129	100	<b>Compliant</b>



Evaluation For: Telular, Inc.

FCC ID: MTF010147 and MTF071473

Model No: Phonicell SX4T (CDMA) 800-1x and Phonicell SX4T (CDMA) 1900-1x

## 11 FREQUENCY STABILITY VS TEMPERATURE

FCC §2.1055, FCC §22.355, FCC §24.235

Frequency tolerance: 2.5ppm

### 11.1 Test Procedure

The equipment under test was connected to an external DC power supply and the RF output was connected to a CMU-200 Base Station Simulator. The EUT was placed inside the temperature chamber. The DC leads and RF output cable exited the chamber through an opening made for that purpose. After the temperature stabilized for approximately 30 minutes, the frequency error was read from the CMU-200.

### 11.2 Test Equipment

Description	Manufacturer	Model Number	Serial Number	Calibration due date
Base Station Simulator	Rohde & Schwarz	CMU-200	1100.0008.02	8/2004
Environmental Chamber	Thermotron	SM-8C	32692	12/2003

### 11.3 Test Results

The CDMA 800/1900 Wireless Desk Phone met the frequency stability requirements of FCC §2.1055, FCC §22.355 and FCC §24.235. The test results are located in Table 11-1.

*Table 11-1: Frequency stability vs. Temperature*

CDMA 1900 Tolerance: +/-4700 Hz; CDMA 800 Tolerance: +/-2091 Hz

<b>Frequency Stability (Hz) vs. Temp.</b>						
	<b>CDMA 1900</b>			<b>CDMA 800</b>		
<b>Temp (C)</b>	<b>25</b>	<b>600</b>	<b>1175</b>	<b>384</b>	<b>777</b>	<b>1013</b>
60	22	-19	-4	54	57	-46
50	-16	14	-12	55	-49	-63
40	-16	-15	-20	-56	56	65
30	-18	-20	-26	-12	2	4
20	-44	-58	-60	8	-6	-8
10	22	-56	-64	-5	-11	5
0	34	41	21	-15	-8	12
-10	33	45	39	-5	-20	8
-20	21	25	28	-13	-3	-4
-30	20	33	28	-3	-15	-7

**12 FREQUENCY STABILITY VS VOLTAGE**

FCC §2.1055, FCC §22.355

Frequency tolerance: 2.5ppm

**12.1 Test Procedure**

An external variable DC power supply was connected to the battery terminals of the equipment under test. The voltage was set to 115% of the nominal value and was then decreased to the battery end point, which was determined by Telular, Inc. to be 85% of the nominal value. The output frequency was recorded for each battery voltage.

**12.2 Test Equipment**

Description	Manufacturer	Model Number	Serial Number	Calibration due date
Variable Frequency AC Power Source	Elgar	501SL	149	1/2004
Temperature Chamber	Thermotron	SM-8C	32692	12/2003
Base Station Simulator	Rohde & Schwarz	CMU-200	1100.0008.02	8/2004

**12.3 Test Results**

The CDMA 800/1900 Wireless Desk Phone met the frequency stability requirements of FCC §2.1055 and FCC §22.355. The test results are located in Table 12-1.

*Table 12-1: CDMA 1900 Channel 600, Frequency stability vs. input voltage*

CDMA 1900 Tolerance: +/-4700 Hz; CDMA 800 Tolerance: +/-2091 Hz

Frequency Stability (Hz) vs. Voltage						
Vac	CDMA 1900			CDMA 800		
	25	600	1175	384	777	1013
135.25	-7	-5	-6	42	39	47
120	-11	-8	-7	42	-41	52
97.75	-4	-9	-8	-49	-46	46