



May 29, 2002

Telular Corporation
647 North Lakeview Parkway
Vernon Hills, IL 60061

Reference: Phonecell SX5
FCC ID: MTF052651

Dear Mr. Jeff Hickey:

Enclosed is the EMC Test Report for the Telular Corporation Phonecell SX5. The Telular Corporation Phonecell SX5 was tested to the requirements of the FCC Rules and Regulations, Part 24 Subpart E, of Title 47 of the CFR, for a Broadband PCS device.

Thank you for using the testing services of MET Laboratories. If you have any questions regarding these results, or if MET can be of further assistance to you, please feel free to contact me. We appreciate your business and look forward to working with you again soon.

Kindest Regards,
MET LABORATORIES, INC.

A handwritten signature in blue ink that reads "Marianne Bosley".

Marianne T. Bosley
Documentation Department

Enclosures: (\Telular Corporation\EMC12089-FCC24.rpt)



**Electro-Magnetic Compatibility
Test Report**

for the

Phonocell SX5

Tested Under

FCC Part 24, Subpart E
Title 47 of the CFR
for Broadband PCS Devices

MET REPORT: EMC12089-FCC24

May 29, 2002

PREPARED FOR:

Telular Corporation
647 North Lakeview Parkway
Vernon Hills, IL 60061

PREPARED BY:

MET Laboratories, Inc.
914 West Patapsco Avenue
Baltimore, Maryland 21230-3432



**Electro-Magnetic Compatibility
Test Report**
for the

Phonecell SX5

Tested Under

FCC Part 24 Subpart E
Title 47 of the CFR
for Broadband PCS Devices

MET REPORT: **EMC12089-FCC24**
May 29, 2002

PREPARED FOR:

Telular Corporation
647 North Lakeview Parkway
Vernon Hills, IL 60061

Report Prepared By:

Marianne T. Bosley
EMC ADMINISTRATOR

Report Reviewed By:

Liming Xu
PROJECT ENGINEER

Final Review By:



CHRISTOPHER R. HARVEY
EMC LAB DIRECTOR

Engineering Statement: The measurements shown in this report were made in accordance with the procedures indicated, and the emissions from this equipment were found to be within the limits applicable. I assume full responsibility for the accuracy and completeness of these measurements, and for the qualifications of all persons taking them. It is further stated that upon the basis of the measurements made, the equipment tested is capable of operation in accordance with the requirements of Part 24, Subpart E, of the FCC Rules under normal use and maintenance.



Liming Xu
PROJECT ENGINEER



TABLE OF CONTENTS

- I. Executive Summary 7
 - A. Purpose of Test 8
 - B. Executive Summary 8
- II. General 9
 - A. Test Site 10
 - B. Description of Test Sample 10
 - C. General Test Setup 10
 - D. Mode of Operation 10
 - E. Test Types 13
 - F. Modifications 13
 - G. Disposition of Test Sample 13
- III. Electromagnetic Compatibility RF Power Output Requirements 14
- IV. Electromagnetic Compatibility Modulation Characteristics Requirements 18
- V. Electromagnetic Compatibility Occupied Bandwidth Requirements 21
- VI. Electromagnetic Compatibility Spurious Emissions at Antenna Terminals Requirements 23
- VII. Electromagnetic Compatibility Spurious Emissions at Antenna Terminals at Frequency Block Edges 29
- VIII. Electromagnetic Compatibility Radiated Emissions Requirements 33
- IX. Electromagnetic Compatibility Frequency Stability over Temperature Variations Requirements 36
- X. Electromagnetic Compatibility Frequency Stability over Voltage Variations Requirements 38
- XI. Test Equipment 40
- XII. Certification Label & User's Manual Information 42
 - A. Certification Information 43
 - B. Label and User's Manual Information 46



List of Tables

Table 1.	Summary of Test Results	6
Table 2.	Summary of Test Data	6
Table 3.	References	8
Table 4.	Spurious Emissions Measurements (Antenna Terminals)	24
Table 5.	Spurious Emissions (Block Edges)	30
Table 6.	EIRP Measurements	35
Table 7.	Carrier Frequency Deviations Due to Temperature Instability	37
Table 8.	Carrier Frequency Deviations Due to Voltage Variations	39
Table 9.	Test Equipment List	41

List of Figures

Figure 1.	Test Configuration	11
Figure 2.	Test Setup Photo for Part 24 Tests	17



List of Terms and Abbreviations

AC	Alternating Current
Cal	Calibration
<i>d</i>	Measurement Distance
dB	Decibels
dBFA	Decibels above one microamp
dBV	Decibels above one microvolt
dBFA/m	Decibels above one microamp per meter
dBV/m	Decibels above one microvolt per meter
DC	Direct Current
E	Electric Field
DSL	Digital Subscriber Line
ESD	Electrostatic Discharge
EUT	Equipment Under Test
<i>f</i>	Frequency
FCC	Federal Communications Commission
CISPR	Comite International Special des Perturbations Radioelectriques (International Special Committee on Radio Interference)
GRP	Ground Reference Plane
H	Magnetic Field
HCP	Horizontal Coupling Plane
Hz	Hertz
IEC	International Electrotechnical Commission
kHz	kilohertz
kPa	kilopascal
kV	kilovolt
LISN	Line Impedance Stabilization Network
MHz	Megahertz
FH	microhenry
FF	microfarad
Fs	microseconds
NEBS	Network Equipment-Building System
PRF	Pulse Repetition Frequency
RF	Radio Frequency
RMS	Root-Mean-Square
TWT	Traveling Wave Tube
V/m	Volts per meter
VCP	Vertical Coupling Plane



Summary of Test Results

These tests were conducted on a sample of the equipment for the purpose of demonstrating compliance with Part 24, Subpart E. All tests were conducted using measurement procedure ANSI C63.4-1992.

Type of Submission/Rule Part:	Original Filing Part 24 Subpart E
EUT:	Telular Corporation Phonocell SX5 Pre-Production Unit
FCC ID:	MTF052651
Type of Emissions:	2K43GXW (GSM)
RF Power Output	Conducted Output Power - 0.857 W GSM: 1.6 Watts (1850.7MHz) 1.6 Watts (1879.7MHz) 1.4 Watts (1910.0MHz)
Frequency Range (MHz):	1850.4 - 1909.6
Frequency Stability:	+/- 50Hz

Table 1.

Summary of Test Data

Name of Test	FCC Rule Part/Section	Results
RF Power Output	2.1046; 24.232(a), (c)	Complies
Modulation Characteristics	2.1047(a)	Complies
Occupied Bandwidth, Input vs. Output	2.1049	Complies
Spurious Emissions at Antenna Terminals uplink & downlink	2.1051; 24.238(a)	Complies
Spurious Emissions at Antenna Terminals Frequency Block Edges	2.1051; 24.238(b)	Complies
Radiated Spurious Emissions	2.1053; 24.238(a)	Complies
Frequency Stability over temperature variations	2.1055(a)(1)	Complies
Frequency Stability over battery power	2.1055(d)(2)	Complies

Table 2.



I. Executive Summary



I. Executive Summary

A. Purpose of Test

An EMC evaluation to determine compliance of the Telular Corporation Phonecell SX5 with the requirements of Part 24, Subpart E, was conducted. (All references are to the most current version of Title 47 of the Code of Federal Regulations in effect). In accordance with §2.1033, the following data is presented in support of the Certification of the EUT. Telular Corporation, should retain a copy of this document, and it should be kept on file for at least five years after the manufacturing of the Phonecell SX5 has been **permanently** discontinued.

B. Executive Summary

The EUT, as supplied to MET Laboratories, complied with the requirements stated in this test report.

References	Description
Purchase Order # 220011784	Telular Corporation Purchase Order for the Phonecell SX5 Testing
ANSI-C63.4:1992	Methods and Measurements of Radio-Noise Emissions from Low-Voltage Electrical And Electronic Equipment in the Range of 9 kHz to 40 Ghz
FCC 47CFR, Chapter 1, Part 2	Title 47 Code of Federal Regulations Part 2 - Frequency Allocations and Radio Treaty Matters; General Rules and Regulations
FCC 47CFR, Chapter 1, Part 15	Title 47 Code of Federal Regulations Part 15 - Radio Frequency Devices
FCC 47CFR, Chapter 1, Part 24	Title 47 Code of Federal Regulations Part 24 - Personal Communications Services

Table 3. References



II. General



II. General

A. Test Site

All testing was conducted at MET Laboratories, Inc., 914 West Patapsco Avenue, Baltimore, Maryland 21230-3432. Radiated Emissions measurements were performed inside of a three-meter Semi Anechoic Chamber (equivalent to an Open Area Test Site, OATS). In accordance with §2.948(a)(2), a complete site description is filed with the Commission's Laboratory in Columbia, Maryland. MET Laboratories has been accredited by the National Voluntary Laboratory Accreditation Program (Lab Code: 100273-0)

B. Description of Test Sample

The EUT is comprised of two separate devices. Internally the two devices are identical. They function as Cellular PCS transceivers. However, externally, both in appearance and functionality, the two devices differ. The Phonocell® SX5D appears as a standard telephone handset, however it includes a keyboard port for text messaging and an auxiliary phone port for an extension telephone or communications device. The Phonocell SX5e included in testing uses the same internal circuitry, however does not utilize all of the functions on the circuit board.

C. General Test Setup

The Telular Corporation Phonocell SX5s are connected to AC power via one wall transformer per device. Un-terminated telco wires are connected to the two RJ-11 jacks on the SX5e. Also on the SX5e, there is an un-terminated 9 pin serial cable connected to the DB-9 connector and an antenna is connected to its respective port.

On the SX5D, a keyboard is connected to the PS-2 port, an un-terminated telco wire is connected to the one of the RJ-11 ports, and a common telephone handset is connected to the other. An un-terminated serial cable is connected to the DB-9 connector.

D. Mode of Operation

The Telular Corporation Phonocell SX5s were configured with test cards installed on the circuit boards in order to provide continuous communications with the base station upon power-up. The test engineer uses a PCS test set to place the units into their operational modes.

II. General

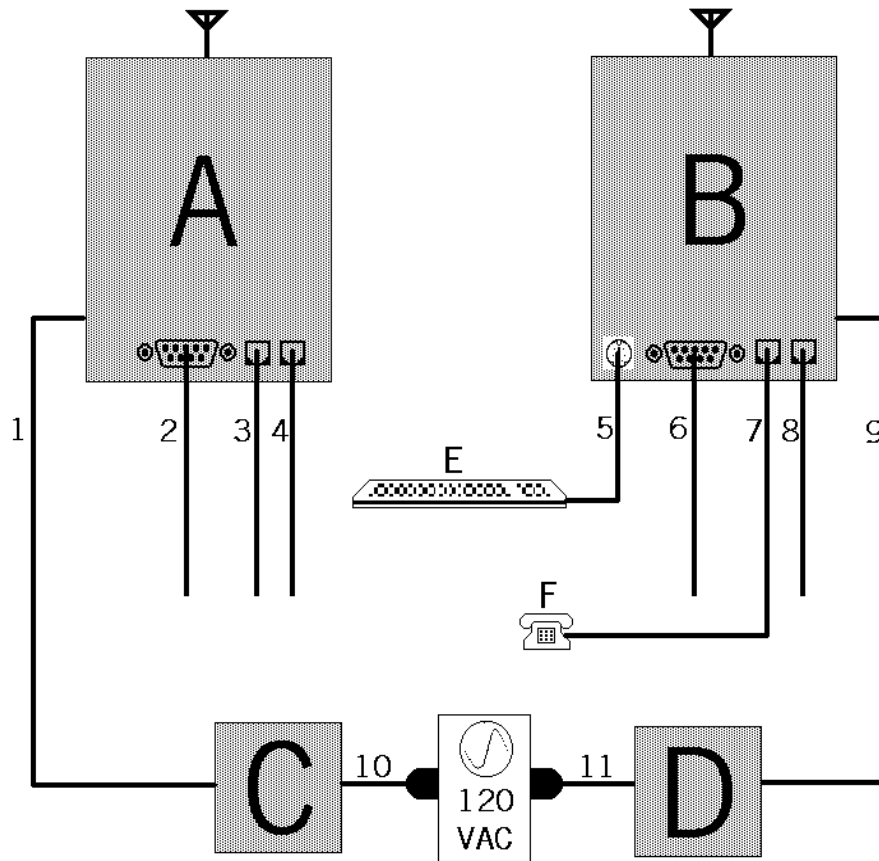

Figure 1. Configuration



II. General

EUT

Reference to Test Configuration	Description/ Nomenclature	Model #	Serial #	Revision
A	Fixed Wireless Terminal	SX5e	417	-----
B	Deskphone	SX5D	408	-----
C	Power Adapter	TMG-0716	0716000512	-----
D	Power Adapter	TMG-0716	0716000304	-----

Support Equipment

Reference to Test Configuration	Description/ Nomenclature	Manufacturer	Model #	Serial #
E	Keyboard	Toshiba	E06150US002-C	J9645-1
F	Telephone Handset	Lenoxx Sound	HAC PH-300	03120167

Ports and Cables

Ref ID	Port name on EUT	Type of Cable or reason for no cable	How many by default?	Length (m)	Shielded?	Termination Box ID & Port ID
1	(A) DC Input	20AWG, 2c.	1	1.5	N	(C) DC Power Supply
2	(A) Serial I/O	DB-9 Serial Cable	1	1.5	N	Un-terminated
3	(A) RJ-11 Jack	RJ-11 Telco wire	1	1.5	N	Un-terminated
4	(A) RJ-11 Jack	RJ-11 Telco wire	1	1.5	N	Un-terminated
5	(B) Keyboard connector	Keyboard cable	1	1.5	N	(E) Keyboard
6	(B) Serial I/O	DB-9 Serial Cable	1	1.5	N	Un-terminated
7	(B) RJ-11 Jack	RJ-11 Telco wire	1	1.5	N	(F) Telephone Handset
8	(B) RJ-11 Jack	RJ-11 Telco wire	1	1.5	N	Un-terminated
9	(B) DC Input	20AWG, 2c.	1	1.5	N	(D) DC Power Supply
10	(C) AC Input	18AWG, 2c.	1	1.5	N	AC Mains
11	(D) AC Input	18AWG, 2c.	1	1.5	N	AC Mains



II. General

E. Test Type(s):

1. RF Power Output: 47CFR 2.1046, 24.232(a), (c)
2. Modulation Characteristics: 47CFR 2.1047(a)
3. Occupied Bandwidth: 47CFR 2.1049
4. Spurious Emissions at Antenna Terminals:(uplink & downlink): 47CFR 2.1051, 24.238(a)
6. Spurious Emissions at Antenna Terminals Frequency Block Edges: 47CFR 2.1051; 24.238(b)
7. Radiated Emissions: 47CFR 2.1053, 24.238(a)
8. Frequency Stability over temperature variations: 47CFR 2.1055(a)(1)
9. Frequency Stability over supply voltage variations: 47CFR 2.1055(d)(1)

F. Modifications (Digital Portion):

Modifications made by Telular Corporation were as follows: a small piece of RF Absorber has been added to FWT version motherboard, just above the location of unused LCD display connector J10.

G. Disposition of Test Sample:

Telular Technology Center
580 Old Willets Path
Hauppauge, NY 11788



III. Electromagnetic Compatibility RF Power Output Requirements



III. Electromagnetic Compatibility RF Power Output Requirements

Test Type: RF Power Output

Technical Specifications: §2.1046 and §24.232(a), (c)

Measurement Procedures:

As required by 47 CFR 2.1046, *RF power output measurements* were made at the RF output terminals using an attenuator and spectrum analyzer. This test was performed with carrier modulated by a GSM, modulated signal.

Results:

Equipment complies with 47CFR 2.1046 and 24.232(a)(c). The Phonecell SX5 does not exceed limit at the carrier frequency.

All RF Power output measurements were conducted peak envelope power with instrument set RBW=1 or 2 MHz; the results are the same, which verified by a digital power meter (HP436A power meter and HP8481B power sensor).

Antenna Gain = 2.15 dBi max

Cable and Splitter loss = 2dB

The following pages show measurements of RF Power output(conducted):

Plots of the RF output Power level of the Digitally modulated carrier, as measured at the RF output terminals of the EUT appear on the following pages.



III. Electromagnetic Compatibility RF Power Output Requirements

RF conducted power at antenna port GSM1900 Met12089

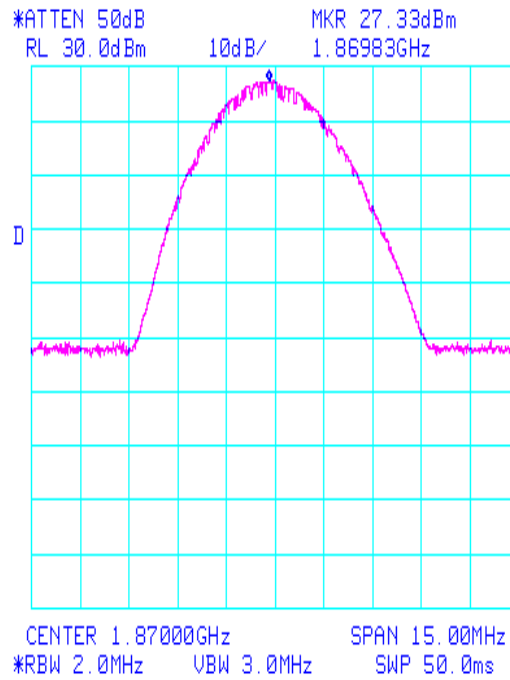



III. Electromagnetic Compatibility RF Power Output Requirements

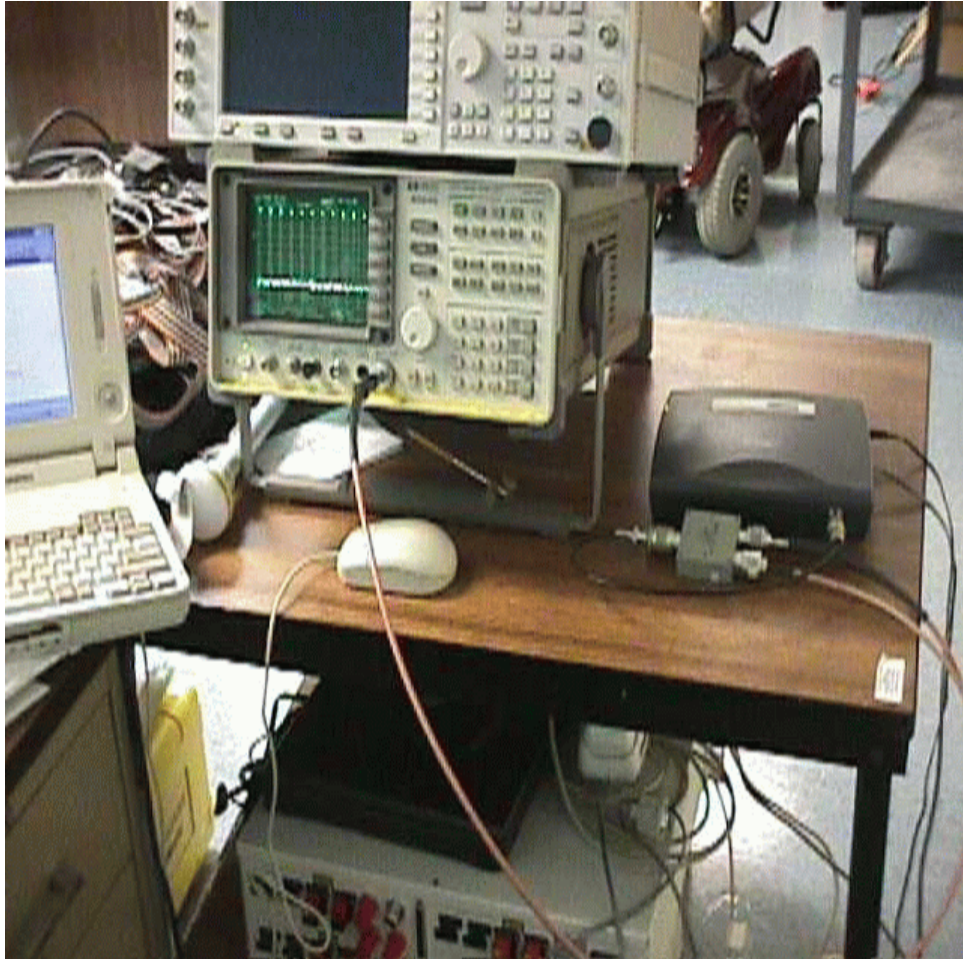

Figure 2. Photograph of Part 24 Tests Setup

Test Engineer: Liming Xu

Test Date: April 15, 2002



IV. Electromagnetic Compatibility Modulation Characteristics Requirements



IV. Electromagnetic Compatibility Modulation Characteristics Requirements

Test Type: Modulation Characteristics

Technical Specification: §2.1047(a)

Measurements Procedure: The Telular Corporation Phonocell SX5 uses GSM modulation. In GSM modulation, voice or data information is digitized and coded into a bit stream. The bits are conveyed through precise phase changes in the carrier.

Results: The following plots give a detailed explanation of the modulation scheme used in the mobile transceiver system.

Modulation Characteristics GSM1900 Met12089

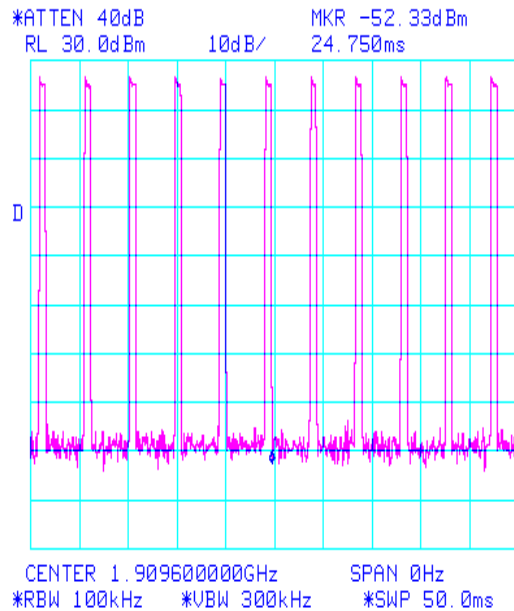



IV. Electromagnetic Compatibility Modulation Characteristics Requirements

Modulation Characteristics GSM1900 Met12089

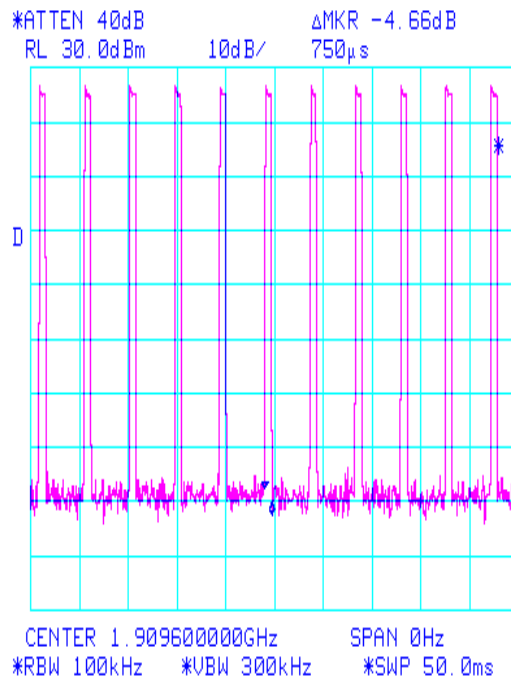

Test Engineer: Liming Xu

Test Date: April 15, 2002



V. Electromagnetic Compatibility Occupied Bandwidth Requirements



V. Electromagnetic Compatibility Occupied Bandwidth Requirements

Test Type: Occupied Bandwidth

Technical Specifications: §2.1049

Measurement Procedures: As required by 47 CFR 2.1049, *occupied bandwidth measurements* were made on the Phonocell SX5. The EUT was configured to transmit an GSM modulated carrier signal. Using an IF bandwidth of 10kHz, we determined the occupied bandwidth of the emission at the center of the selectable channel range.

Results: Equipment complies with Section 2.1049. Plots of the occupied bandwidth, as measured at the antenna RF output port follow:

Occupied B/W GSM1900 Met12089

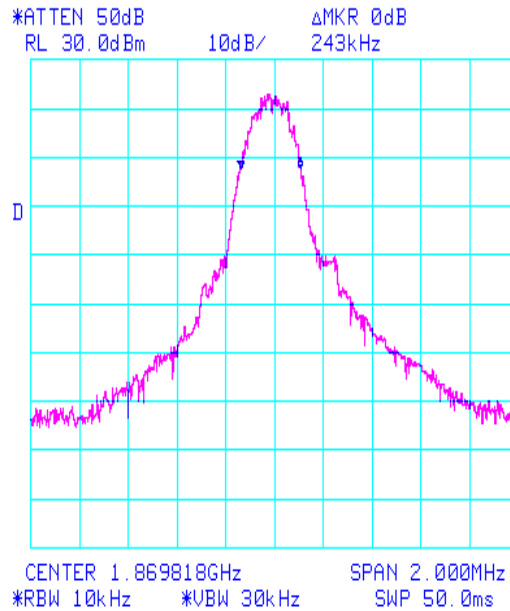

Test Engineer: Liming Xu

Test Date: April 15, 2002



VI. Electromagnetic Compatibility Spurious Emissions At Antenna Terminals Requirements



VI. Electromagnetic Compatibility Spurious Emissions at Antenna Terminals

Test Type: Spurious Emissions at Antenna Terminals

Technical Specifications: §2.1051 and §24.238(a)

Measurement Procedures: As required by §2.1051 of CFR 47, *spurious emissions at antenna terminal measurements* were made at the RF output terminals using a 50 S attenuator and spectrum analyzer set for a 100 kHz bandwidth. The RBW of 100 kHz was used to investigate and search for spurious emissions; any spurs found with this technique are to be re-measured with the appropriate 1MHz RBW. There were no detectable spurious emissions for this EUT. This test was performed with Digitally modulated carrier signals, and the EUT was adjusted for continuous transmission on frequencies across the operating band. The frequency spectrum was investigated from 9.0 KHz to 20.0 GHz.

Results: The following table and plots are included to illustrate compliance with the requirements of 47 CFR Part 24.238(a):

Frequency Range	Emission Frequency	Emission Level (dBm)	Limit (dBm)
0Hz - 3.0GHz	2.605GHz	-35.17 (noise floor)	-13.1
3.0GHz - 8.0GHz	7.283GHz	-40.67 (noise floor)	-13.1
8.0 GHz - 14.0 GHz	13.560GHz	-59.67 (noise floor)	-13.1
14.0 GHz - 20.0 GHz	16.690GHz	-60.83 (noise floor)	-13.1

Table 4. Spurious Emissions Measurements (antenna terminals)



VI. Electromagnetic Compatibility Spurious Emissions At Antenna Terminals Requirements

Conducted spur emissions at antenna port GSM1900 Met12089

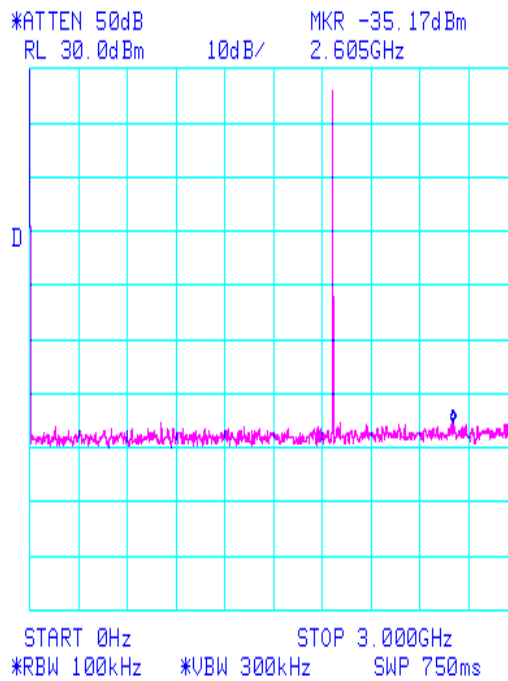



VI. Electromagnetic Compatibility Spurious Emissions At Antenna Terminals Requirements

Conducted spur emissions at antenna port GSM1900 Met12089

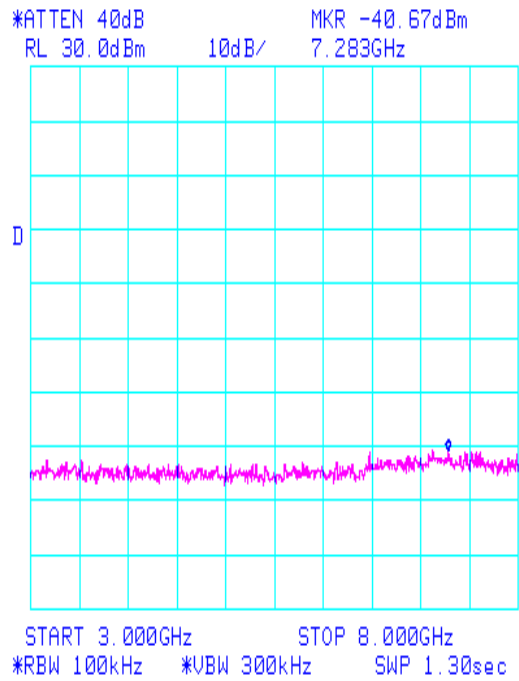



VI. Electromagnetic Compatibility Spurious Emissions At Antenna Terminals Requirements

Conducted spur emissions at antenna port GSM1900 Met12089

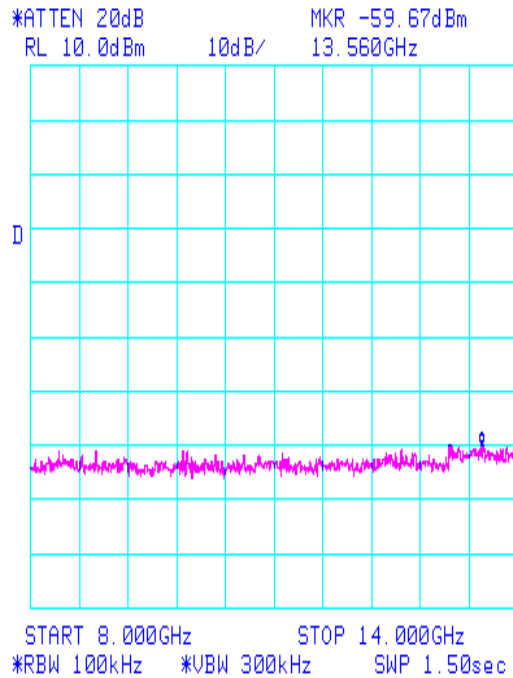



VI. Electromagnetic Compatibility Spurious Emissions At Antenna Terminals Requirements

Conducted spur emissions at antenna port GSM1900 Met12089

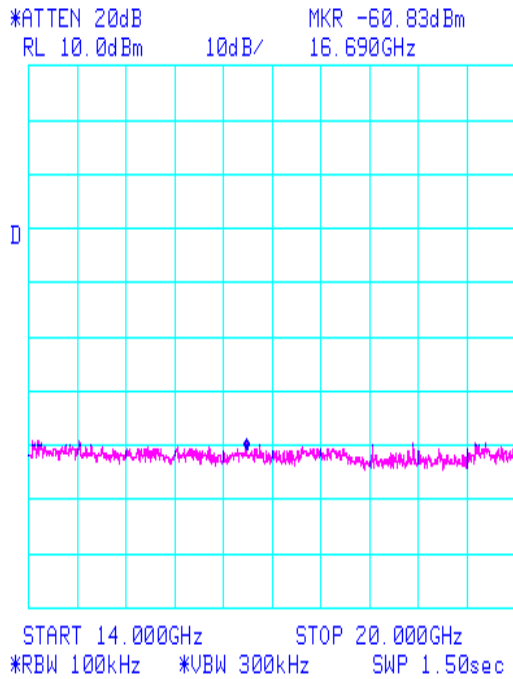

Test Engineer: Liming Xu

Test Date: April 15, 2002



**VII. Electromagnetic Compatibility Spurious Emissions At Antenna Terminals At Block Edges
+/- 1MHzRequirements**



VII. Electromagnetic Compatibility Spurious Emissions At Antenna Terminals At Block Edges +/- 1MHz Requirements

Test Type: Spurious Emissions at Antenna Terminals at Block Edges +/- 1MHz

Technical Specifications: §2.1051 and §24.238(b)

Measurement Procedures: As recommended in FCC Part 24, Great than or equal to 1% of emission spectrum bandwidth was chosen to measure the peak of any emission inside the 1.0 MHz frequency band adjacent to each frequency block edge. All other frequencies were measured using a 3 KHz RBW. The unit was exercised using signal types required by §2.1049.

Results: Modulation products outside of this band are attenuated at least $43 + 10 \text{ Log (P)}$ below the level of the modulated carrier. A Plot of the spurious emissions at +/- 1 MHz around the transmit frequency, as measured at the antenna port, appears on the following page.

SPURIOUS EMISSION FREQUENCY BLOCKS

Frequency Block (MHz)	Low Frequency (CH #)	Hi Frequency (CH #)
A (1850-1865)	1850.4 (513)	1863.75
B (1870-1885)	1871.25	1883.75
C (1895-1910)	1896.25	1909.6 (809)
D (1865-1870)	1866.25	1868.75
E (1885-1890)	1886.25	1888.75
F (1890-1895)	1891.25	1893.75

Table 5. Spurious Emissions (Block Edges)



VII. Electromagnetic Compatibility Spurious Emissions At Antenna Terminals At Block Edges +/- 1MHz Requirements Requirements

Spur emissions at high side of GSM1900 band Met12089

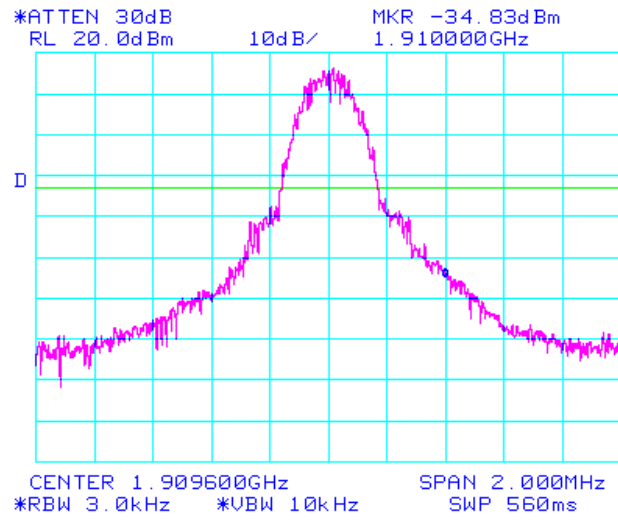



VII. Electromagnetic Compatibility Spurious Emissions At Antenna Terminals At Block Edges +/- 1MHz Requirements

Spur emissions at low side of GSM1900 band Met12089

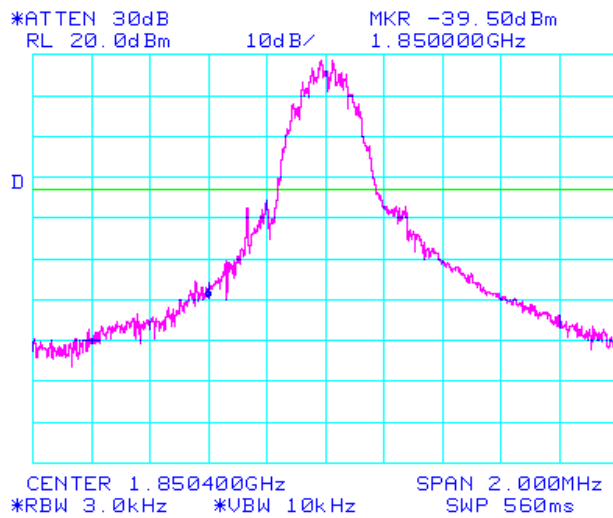

Test Engineer: Liming Xu

Test Date: April 15, 2002



VIII. Electromagnetic Compatibility Radiated Emissions Requirements



VIII. Electromagnetic Compatibility Radiated Emission Requirements

Test Type: Radiated Emissions

Technical Specifications: §2.1053 and §24.238(a)

Measurement Procedures: As required by §2.1053, *field strength of spurious radiation measurements* were made in accordance with the general procedures of ANSI C63.4-1992 "Methods of Measurement of Radio-Noise Emissions from Low-Voltage Electrical and Electronic Equipment in the Range of 9 kHz to 40 GHz". Preliminary radiated emission measurements were performed inside a shielded chamber with all digital signal generators on and terminated. The frequency list from the preliminary measurements was used as a guide for making final measurements in a 3 meter semi-anechoic chamber (equivalent to an Open Area Test Site). The unit was scanned over the frequency range of the lowest system oscillator value to 20 GHz.

The Radiated Spurious Emissions *Limit* is obtained by the following:

Based on an output power (as measured at the output of the Amplifier) of 1.6 watts:

$$P_o = 1.6 \text{ W}$$

the radiated power level of all spurious emissions must be attenuated by at least $43 + 10\log(P_o)$ below P_o , yielding:

$$P_o - [43 + 10\text{Log}(P_o)] = -13\text{dBm}$$

Results:

All of the measurable radiated emissions are related to the digital device portion of the EUT, and thus are compared to the 47CFR 15 Class B field strength limit. Mathematical calculations indicate that these field strengths yield radiated power levels greater than 30 dB below the -13 dBm limit for spurious emissions from the transmitter portion of the EUT calculated above. There were no observable radiated emissions from the transmitter portion of the EUT.

The Spurious Radiated Emissions were measured from 1GHz to 20GHz for the Phonecell SX5. There were no detectable spurious emissions in that frequency range.



VIII. Electromagnetic Compatibility Radiated Emission Requirements

Subject: Radiated Emissions - Substitution Equivalent Isotropic Radiated Power (E.I.R.P.)

Specification: FCC Part 24

Substitution Equivalent Isotropic Radiated Power (E.I.R.P)

Procedure: Radiated Measurements were made on a GSM Desktop 1900 Mhz phone. The EUT was placed on a 0.8-m high wooden table inside a shielded enclosure. An Antenna was placed 1 meter from the EUT and measurements were made for frequencies and amplitude of field strengths in three channel settings (Low, Mid and High). For EIRP Substitution method EUT was replaced with a horn antenna, which was driven by a signal generator whose level was adjusted to obtain the same level as received via the radiated method. EIRP is calculated by adding the gain of the horn antenna to the level on the signal generator. Measurements were made according to the Substitution Method of ANSI/TIA/EIA-603-A.

Configuration: Measurements were made with the Telular Corporation Phonocell SX5.

Results:

Frequency (MHz)	Conducted Level (dBm)	EIRP (dBm)	EIRP (W)
1850.7	29.33	32	1.6
1879.7	29.33	32	1.6
1910.0	29.00	31.5	1.4

Table 6. EIRP Measurements



IX. Electromagnetic Compatibility Frequency Stability Over Temperature Variations Requirements



IX. Electromagnetic Compatibility Frequency Stability Over Temperature Variations Requirements

Test Type: Frequency Stability over Temperature Variations

Technical Specifications: §2.1055(a)(1)

Measurement Procedures: As required by §2.1055(a)(1) of CFR 47, *frequency tolerance measurements* were made over the temperature range of -30EC to +50EC. The frequency measurements were made using direct input to a spectrum analyzer. Climatic control was accomplished using an environmental simulation chamber. The temperature was first lowered to -30EC and then raised hourly in 10E increments. The unit remained in the chamber during temperature transitions and during the measurement process.

Results: Frequency tolerance of carrier signal: +/- 0.005% for a temperature variation from - 30EC to + 50EC at normal supply voltage.

Temperature (EC)	Carrier Frequency (CH 661) (GHz)	Frequency Deviation (Hz)	Deviation Limit (Hz)
-30	1.879,788,9xx *	+/- 50	± 94
-20	1.879,788,9xx *	+/- 50	± 94
-10	1.879,788,9xx *	+/- 50	± 94
0	1.879,788,9xx *	+/- 50	± 94
+10	1.879,788,9xx *	+/- 50	± 94
+20	1.879,788,9xx *	+/- 50	± 94
+30	1.879,788,9xx *	+/- 50	± 94
+40	1.879,788,9xx *	+/- 50	± 94
+50	1.879,788,9xx *	+/- 50	± 94

Table 7. CARRIER FREQUENCY DEVIATIONS DUE TO TEMPERATURE INSTABILITY

***The frequency deviation (+/-50 Hz) can only affect the two least significant numbers of carrier frequency.**
The unit meets the requirements of 2.1055 (a)(1)

Test Engineer: Liming Xu
Test Date: April 17, 2002



X. Electromagnetic Compatibility Frequency Stability Over Voltage Variations Requirements



X Electromagnetic Compatibility Frequency Stability Over Voltage Variations Requirements

Test Type: Frequency Stability over Voltage Variations

Technical Specifications: §2.1055(d)(2)

Measurement Procedures: As required by §2.1055(d)(1) of CFR 47, *frequency tolerance measurements* were made over changes in the supply voltage to the EUT from 85% to 115% of the nominal supply voltage using a variac to vary the AC supply. The frequency measurements were made using direct input to a spectrum analyzer.

Results:

Frequency tolerance of carrier signal: ± 0.005% for a variation in primary voltage from 85% to 115% of the **rated supply**.

Results:

Percentage of Rated Supply	AC Voltage (VAC @ 60 Hz)	Carrier Frequency (GHz)	Deviation (Hz)	Deviation Limit (Hz)
85 %	178.5	1.879,788,9xx *	+/- 50	± 94
100 %	210	1.879,788,9xx *	+/- 50	± 94
115 %	241.5	1.879,788,9xx *	+/- 50	± 94

Table 8. Carrier Frequency Deviations Due to Voltage Variations

The unit meets the requirements of 2.1055 (d)(2)

***The frequency deviation (+/-50 Hz) can only affect the two least significant numbers of carrier frequency.**



XI. Test Equipment



XI. Test Equipment

Test Equipment	Manufacturer	Model #	Met Asset #	Cal Date	Cal Due
Receiver	HP	8546A	1T4302	08/11/01	08/11/02
Receiver	HP	8564E	1T4316	10/18/01	10/18/02
Antenna	Schaffner	CBL6140A	1T4303	03/27/02	03/27/03
Test Room	ETS	Chamber 10	1T4300	08/17/01	08/17/02

Table 9. Test Equipment List



XII. Certification Label & User's Manual Information



XII Certification Label & User's Manual Information

A. Certification Information

The following is extracted from Title 47 of the Code of Federal Regulations, Part 2, Subpart I — Marketing of Radio frequency devices:

§ 2.801 Radio-frequency device defined.

As used in this part, a radio-frequency device is any device which in its operation is capable of Emitting radio-frequency energy by radiation, conduction, or other means. Radio- frequency devices include, but are not limited to:

- (a) The various types of radio communication transmitting devices described throughout this chapter.
- (b) The incidental, unintentional and intentional radiators defined in Part 15 of this chapter.
- (c) The industrial, scientific, and medical equipment described in Part 18 of this chapter.
- (d) Any part or component thereof which in use emits radio-frequency energy by radiation, conduction, or other means.

§ 2.803 Marketing of radio frequency devices prior to equipment authorization.

- (a) Except as provided elsewhere in this chapter, no person shall sell or lease, or offer for sale or lease (including advertising for sale or lease), or import, ship or distribute for the purpose of selling or leasing or offering for sale or lease, any radio frequency device unless:
 - (1) In the case of a device subject to certification, such device has been authorized by the Commission in accordance with the rules in this chapter and is properly identified and labeled as required by §2.925 and other relevant sections in this chapter; or
 - (2) In the case of a device that is not required to have a grant of equipment authorization issued by the Commission, but which must comply with the specified technical standards prior to use, such device also complies with all applicable administrative (including verification of the equipment or authorization under a Declaration of Conformity, where required), technical, labeling and identification requirements specified in this chapter.
- (d) Notwithstanding the provisions of paragraph (a) of this section, the offer for sale solely to business, commercial, industrial, scientific or medical users (but not an offer for sale to other parties or to end users located in a residential environment) of a radio frequency device that is in the conceptual, developmental, design or pre-production stage is permitted prior to equipment authorization or, for devices not subject to the equipment authorization requirements, prior to a determination of compliance with the applicable technical requirements *provided* that the prospective buyer is advised in writing at the time of the offer for sale that the equipment is subject to the FCC rules and that the equipment will comply with the appropriate rules before delivery to the buyer or to centers of distribution.



XII Certification Label & User's Manual Information

- (e)(1) Notwithstanding the provisions of paragraph (a) of this section, prior to equipment authorization or determination of compliance with the applicable technical requirements any radio frequency device may be operated, but not marketed, for the following purposes and under the following conditions:
- (i) Compliance testing;
 - (ii) Demonstrations at a trade show provided the notice contained in paragraph (c) of this section is displayed in a conspicuous location on, or immediately adjacent to, the device;
 - (iii) Demonstrations at an exhibition conducted at a business, commercial, industrial, scientific or medical location, but excluding locations in a residential environment, provided the notice contained in paragraphs (c) or (d) of this section, as appropriate, is displayed in a conspicuous location on, or immediately adjacent to, the device;
 - (iv) Evaluation of product performance and determination of customer acceptability, provided such operation takes place at the manufacturer's facilities during developmental, design or pre-production stages; or
 - (v) Evaluation of product performance and determination of customer acceptability where customer acceptability of a radio frequency device cannot be determined at the manufacturer's facilities because of size or unique capability of the device, provided the device is operated at a business, commercial, industrial, scientific or medical user's site, but not at a residential site, during the development, design or pre-production stages.
- (e)(2) For the purpose of paragraphs (e)(1)(iv) and (e)(1)(v) of this section, the term *manufacturer's facilities* includes the facilities of the party responsible for compliance with the regulations and the manufacturer's premises, as well as the facilities of other entities working under the authorization of the responsible party in connection with the development and manufacture, but not the marketing, of the equipment.
- (f) For radio frequency devices subject to verification and sold solely to business, commercial, industrial, scientific and medical users (excluding products sold to other parties or for operation in a residential environment), parties responsible for verification of the devices shall have the option of ensuring compliance with the applicable technical specifications of this chapter at each end user's location after installation, provided that the purchase or lease agreement includes a proviso that such a determination of compliance be made and is the responsibility of the party responsible for verification of the equipment.

The following is extracted from Title 47 of the Code of Federal Regulations, Part 2, Subpart J — Equipment Authorization Procedures:

§ 2.901 Basis and Purpose

- (a) In order to carry out its responsibilities under the Communications Act and the various treaties and international regulations, and in order to promote efficient use of the radio spectrum, the Commission has developed technical standards for radio frequency equipment and parts or components thereof. The technical standards applicable to individual types of equipment are found in that part of the rules governing the service wherein the equipment is



XII. Certification Label & User's Manual Information

to be operated.¹ In addition to the technical standards provided, the rules governing the service may require that such equipment be verified by the manufacturer or importer, be authorized under a Declaration of Conformity, or receive an equipment authorization from the Commission by one of the following procedures: certification or registration.

- (b) The following sections describe the verification procedure, the procedure for a Declaration of Conformity, or the procedures to be followed in obtaining certification from the Commission and the conditions attendant to such a grant, whichever is applicable.

§ 2.907 Certification.

- II Certification is an equipment authorization issued by the Commission, based on representation and test data submitted by the applicant.
- (b) Certification attaches to all units subsequently marketed by the grantee which are identical (see Section 2.908) to the sample tested except for permissive changes or other variations authorized by the Commission pursuant to Section 2.1043.

§ 2.948 Description of measurement facilities.

- (a) Each party making measurements of equipment that is subject to an equipment authorization under Part 15 or Part 18 of this chapter, regardless of whether the measurements are filed with the Commission or kept on file by the party responsible for compliance of equipment marketed within the U.S. or its possessions, shall compile a description of the measurement facilities employed.
 - (1) If the measured equipment is subject to the verification procedure, the description of the measurement facilities shall be retained by the party responsible for verification of the equipment.
 - (i) If the equipment is verified through measurements performed by an independent laboratory, it is acceptable for the party responsible for verification of the equipment to rely upon the description of the measurement facilities retained by or placed on file with the Commission by that laboratory. In this situation, the party responsible for the verification of the equipment is not required to retain a duplicate copy of the description of the measurement facilities.
 - (ii) If the equipment is verified based on measurements performed at the installation site of the equipment, no specific site calibration data is required. It is acceptable to retain the description of the measurement facilities at the site at which the measurements were performed.

¹In this case, the equipment is subject to the rules of Part 15. More specifically, the equipment falls under Subpart C (of Part 15), which deals with intentional radiators.



XII. Certification Label & User's Manual Information

- (2) If the equipment is to be authorized by the Commission under the certification procedure, the description of the measurement facilities shall be filed with the Commission's Laboratory in Columbia, Maryland. The data describing the measurement facilities need only be filed once but must be updated as changes are made to the measurement facilities or as otherwise described in this section. At least every three years, the organization responsible for filing the data with the Commission shall certify that the data on file is current.

B. Label and User's Manual Information

The following is extracted from Title 47 of the Code of Federal Regulations, Part 15, Subpart A — General:

§ 15.19 Labeling requirements.

- (a) In addition to the requirements in Part 2 of this chapter, a device subject to certification or verification shall be labeled as follows:
- (ii) Receivers associated with the operation of a licensed radio service, e.g., FM broadcast under Part 73 of this chapter, land mobile operation under Part 90, etc., shall bear the following statement in a conspicuous location on the device:

This device complies with Part 15 of the FCC Rules. Operation is subject to the condition that this device does not cause harmful interference.

- (ii) A stand-alone cable input selector switch, shall bear the following statement in a conspicuous location on the device:

This device is verified to comply with Part 15 of the FCC Rules for use with cable television service.

- (ii) All other devices shall bear the following statement in a conspicuous location on the device:

This device complies with Part 15 of the FCC Rules. Operation is subject to the following two conditions: (1) This device may not cause harmful interference, and (2) this device must accept any interference received, including interference that may cause undesired operation.

- (4) Where a device is constructed in two or more sections connected by wires and marketed together, the statement specified under paragraph (a) of this section is required to be affixed only to the main control unit.
- (5) When the device is so small or for such use that it is not practicable to place the statement specified under paragraph (a) of this section on it, the information required by this paragraph shall be placed in a prominent



XII. Certification Label & User's Manual Information

location in the instruction manual or pamphlet supplied to the user or, alternatively, shall be placed on the container in which the device is marketed. However, the FCC identifier or the unique identifier, as appropriate, must be displayed on the device.

§ 15.21 Information to user.

The users manual or instruction manual for an intentional or unintentional radiator shall caution the user that changes or modifications not expressly approved by the party responsible for compliance could void the user's authority to operate the equipment.

The following is extracted from Title 47 of the Code of Federal Regulations, Part 15, Subpart B — Unintentional Radiators:

§ 15.105 Information to the user.

- (a) For a Class B digital device or peripheral, the instructions furnished the user shall include the following or similar statement, placed in a prominent location in the text of the manual:

Note: This equipment has been tested and found to comply with the limits for a Class B digital device, pursuant to Part 15 of the FCC Rules. These limits are designed to provide reasonable protection against harmful interference when the equipment is operated in a residential environment. This equipment generates, uses, and can radiate radio frequency energy and, if not installed and used in accordance with the instruction manual, may cause harmful interference to radio communications. However, there is no guarantee that interference will not occur in a particular installation. If this equipment does cause harmful interference to radio or television reception, which can be determined by turning the equipment off and on, the user is encouraged to try to correct the interference by one or more of the following measures:

- Reorient or relocate the receiving antenna.
- Increase the separation between the equipment and receiver.
- Connect the equipment into an outlet on a circuit different from that to which the receiver is connected.
- Consult the dealer or an experienced radio/TV technician for help.