



# **PHONECELL<sup>®</sup> SX5D GSM DESKTOP PHONE**

**900/1800 MHz GSM (DUAL BAND)  
1900 MHz GSM**

**VOICE COMMUNICATION AND COMPUTER FAX/DATA**

*TECHNICAL MANUAL*

## STANDARD CONNECTIONS

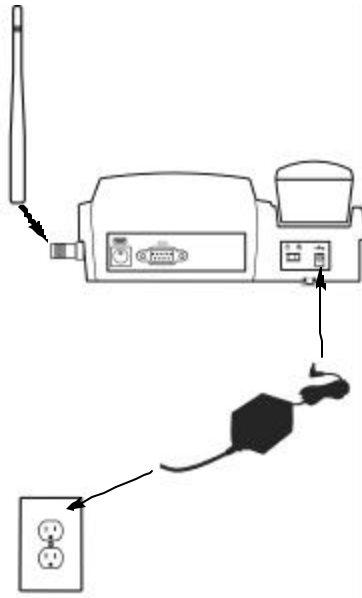

## DESKPHONE MODEL ONLY

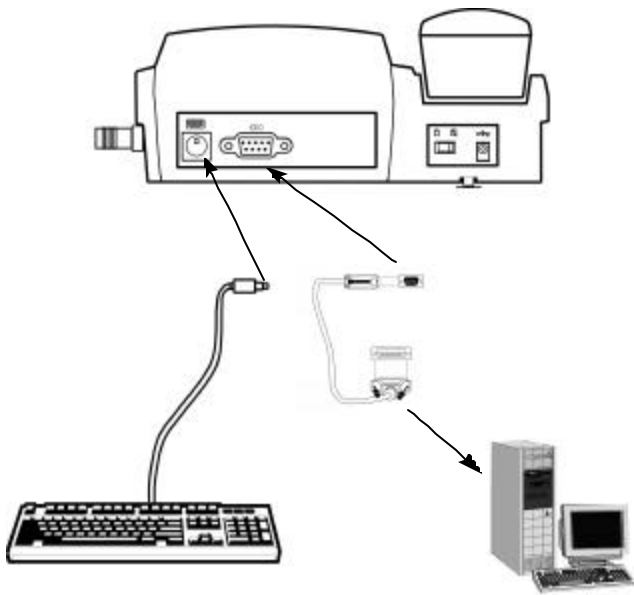

**FAX PHONE MODEL ONLY**

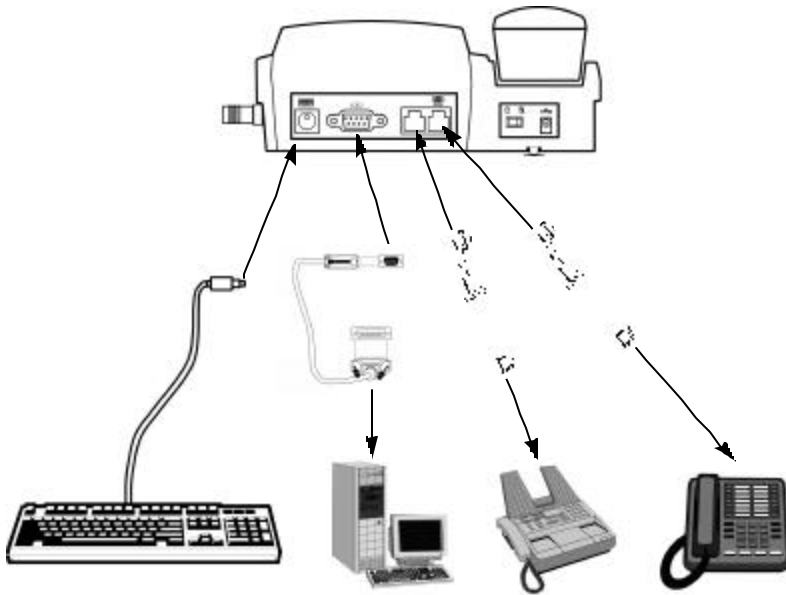

**PERSONAL LEAST COST ROUTING MODEL ONLY**

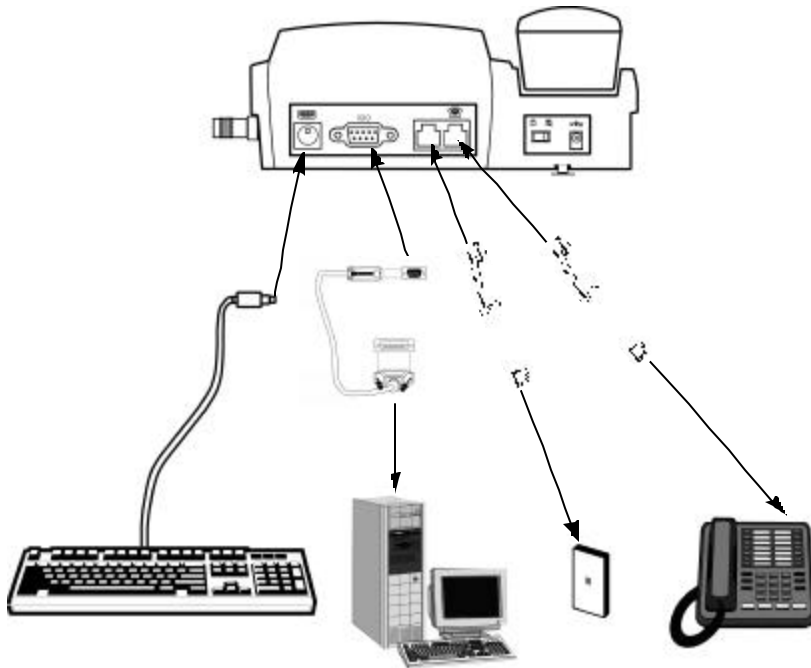

## **CONTENTS**



Phonecell® SX5D GSM Desktop Phone



Spike Antenna

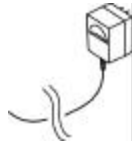

Power Supply

Before installing your **Phonecell® SX5D**, carefully remove the contents from the shipping carton and check for evidence of shipping damage. **If damage is found, contact your Authorized Telular Distributor or shipping agent immediately.**

### **SAFE OPERATION INSTRUCTIONS**

**IMPORTANT!** Before installing or operating this product, read the **SAFETY AND GENERAL INFORMATION** section of this manual.

- Install unit indoors.
- Install unit on hard, flat surface for proper ventilation.
- Do not expose unit to rain or moisture.
- Do not place unit on or close to sources of heat

**PLEASE SEE THE IMPORTANT NOTICES SECTION OF THIS MANUAL FOR IMPORTANT INFORMATION ON USE, WARRANTY AND INDEMNIFICATION**

### **IMPORTANT NOTICES**

#### **TERMS AND CONDITIONS FOR USE OF PHONECELL® PRODUCTS ("Product")**

These Terms and Conditions are a legal contract between you and Telular Corporation for the title to and use of the Product. BY RETAINING AND USING THE PRODUCT AFTER RECEIPT OF IT, YOU AGREE TO THE TERMS AND CONDITIONS INCLUDING WARRANTY DISCLAIMERS, LIMITATIONS OF LIABILITY AND INDEMNIFICATION PROVISIONS BELOW. IF YOU DO NOT AGREE TO THE TERMS AND CONDITIONS, DO NOT USE THE PRODUCT AND IMMEDIATELY RETURN THE UNUSED PRODUCT FOR A COMPLETE REFUND. You agree to accept sole responsibility for any misuse of the Product by you; and, in addition, any negligent or illegal act or omission of your or your agents, contractors, servants, employees, or other users of the Product so long as the Product was obtained from you, in the use and operation of the Product. Changes or modifications not expressly approved by Telular Corporation will void your authority to operate the equipment per FCC part 15 paragraph 15.21.

#### **INDEMNIFICATION OF TELULAR CORPORATION ("TELULAR")**

YOU SHALL INDEMNIFY, DEFEND AND HOLD HARMLESS TELULAR FOR ANY OF THE COST, INCLUDING REASONABLE ATTORNEYS' FEES, AND FROM CLAIMS ARISING OUT OF YOU, YOUR CLIENTS' OR OTHER THIRD PARTIES' USE OR OPERATION OF THE PRODUCT: (i) FOR MISUSE OR IN A MANNER NOT CONTEMPLATED BY YOU AND TELULAR OR INCONSISTENT WITH THE PROVISIONS OF THIS MANUAL; (ii) IN AN ILLEGAL MANNER OR AGAINST PUBLIC POLICY; (iii) IN A MANNER SPECIFICALLY UNAUTHORIZED IN THIS MANUAL; (iv) IN A MANNER HARMFUL OR DANGEROUS TO THIRD PARTIES; (v) FROM CLAIMS BY ANYONE RESPECTING PROBLEMS, ERRORS OR MISTAKES OF THE PRODUCT; OR (vi) COMBINATION OF THE PRODUCT WITH MATERIAL, MODIFICATION OF THE PRODUCT OR USE OF THE PRODUCT IN AN ENVIRONMENT NOT PROVIDED, OR PERMITTED, BY TELULAR IN WRITING. THE PARTIES SHALL GIVE EACH OTHER PROMPT NOTICE OF ANY SUCH COST OR CLAIMS AND COOPERATE, EACH WITH THE OTHER, TO EFFECTUATE THIS INDEMNIFICATION, DEFENSE AND HOLD HARMLESS.

#### **TELULAR CORPORATION**

**Corporate Headquarters**  
647 North Lakeview Parkway  
Vernon Hills, Illinois 60061, USA

#### **Technical Support**

Tel: 847-247-9400 · Fax: 847-247-0021

E-mail: [mainoffice@telular.com](mailto:mainoffice@telular.com) · <http://www.telular.com>

## **TABLE OF CONTENTS**

<b>IMPORTANT NOTICES</b> .....	2
Technical Support .....	2
<b>INSTALLATION</b> .....	5
Location and Setup .....	5
Connect the Handset .....	
Optional Wedge .....	
Wall Mounting .....	
Connect Your Phonecell® SX5D to AC Power .....	
Battery Backup .....	
External Connectors .....	
<b>OPERATION</b> .....	
Function Keys .....	
LCD Display .....	
SIM Card Installation .....	
SIM PIN Setup .....	
Service Indication .....	
Network Registration .....	
Call Functions .....	
Volume .....	
Alert Tones .....	
Speakerphone .....	
Internal Phone Book .....	
Speed Dial .....	
<b>FEATURES</b> .....	
Call Log .....	
Keypad Tones .....	
Warning Tones .....	
Date and Time .....	
Alarm .....	
Display Phone Number .....	
Greeting Message .....	
Screen Contrast .....	
Reset System Defaults .....	
Restrict Phone Use .....	
<b>SUPPLEMENTARY FEATURES (NETWORK DEPENDENT)</b> .....	
Call Forwarding .....	
Call Waiting .....	
Three-Way Calling .....	
Voicemail .....	
Short Message Service (SMS) .....	
Info Messages .....	
In-Call Options .....	

## **TABLE OF CONTENTS (CONTINUED)**

<b>DIGITAL DATA SERVICE</b> .....	
Standard Modem Setting .....	
Sending and Receiving Digital Fax.....	
<b>TECHNICIAN COMMANDS</b> .....	
<b>SAFETY INFORMATION</b> .....	
<b>WARRANTY</b> .....	
<b>Appendix A: How to Setup PC Serial Ports for Phonecell®</b>	
<b>Computer Digital Fax/Data</b> .....	

## **INSTALLATION**

### **SX5D Location and Setup**

The SX5D comes with a standard spike antenna (TNC).

- 1) Choose location that is above ground and as close to windows (or exterior walls) as possible to get the best signal - **see Figure**
- 2) Finger-tighten the antenna; do not over-tighten.

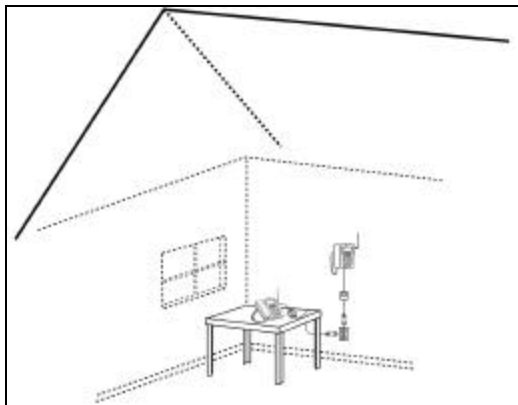

**Figure** – For optimal call clarity, the antenna should be pointed up and the SX5D located close to an exterior wall or window.

### **Connect the Handset**

Before you can use your Phonocell® SX5, you must connect the handset cable to the SX5D. Insert the cable into the phone jack - **see Figure**

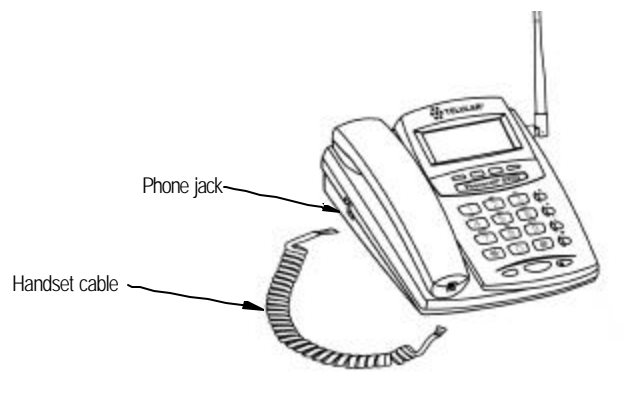

**Figure** – SX5D handset connection.

## SIM Card Installation

The SX5D requires a Subscriber Identification Module (SIM) for normal operation. The service provider supplies the SIM card, which carries the account information needed to operate the SX5D. The SIM compartment is on the back of the Phonecell® SX5.

**NOTE:** If you don't have a SIM card, contact your network service provider.

- 1) Remove the power supply if you have already connected it. You must remove the power supply whenever you install or remove a SIM Card.
- 2) Remove the SIM compartment cover by removing the screw. **See Figure.**
- 3) Open the SIM compartment holder.
- 4) Line up the SIM card with the arrow on the SIM card holder. **See Figure.**
- 5) Gently insert the SIM card in the slot of the SIM card holder.
- 6) Close the SIM card holder.

**NOTE:** If you insert the SIM card improperly, the holder will not close. Do not force the holder shut. Make sure the SIM card is aligned properly with the directional arrow on the holder.

- 7) Reattach the SIM compartment cover with the screw.
- 8) Attach the power supply.

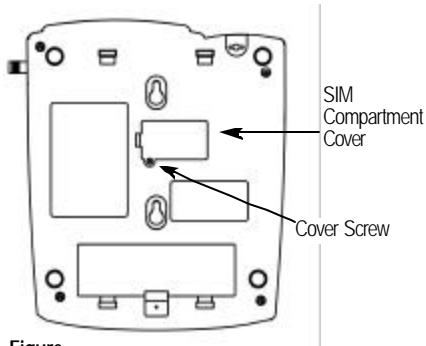

Figure -

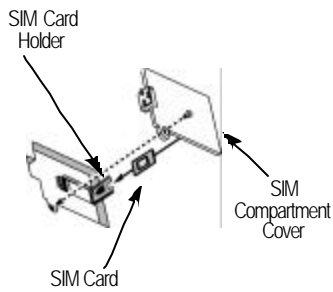

Figure -



### Attach the Optional Wedge

- 1) Slide the wedge tabs on one end of the wedge into the top wedge tab slots.
- 2) Snap the wedge tabs on the other end of the wedge into the bottom wedge tab slots.

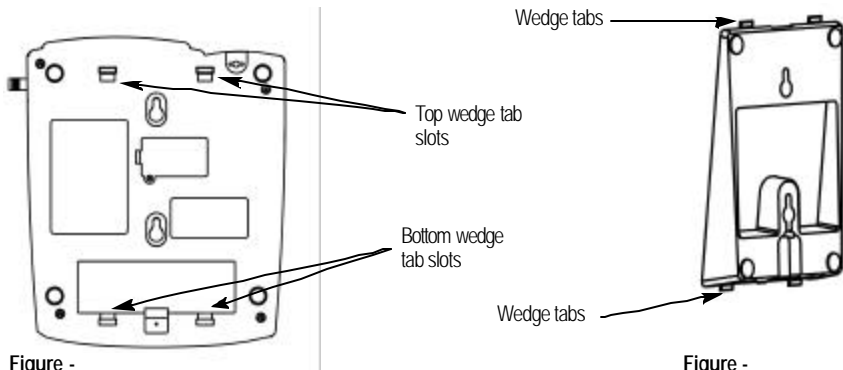

Figure -

Figure -

### Using the Optional Wedge

The wedge is used to put the SX5D on an angle that makes it easier to see the display screen if you are sitting at a desk. If you mount it on a wall, the wedge offsets the natural angle of the SX5D so that the keypad is parallel to the wall rather than angled down into the wall.

#### Attach for Wall Mounting

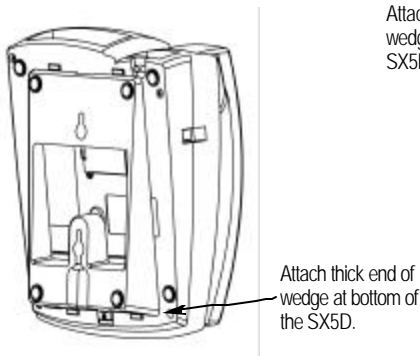

Figure -

#### Attach for Desk Mounting

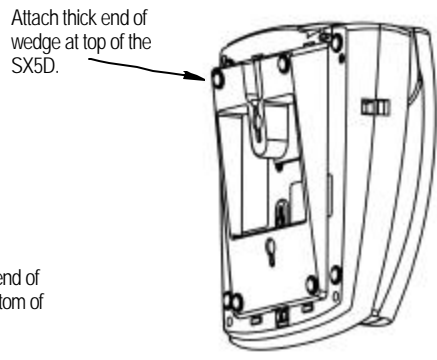

Figure -

## Wall-Mounting

- 1) Remove the mounting clip from the cradle and re-insert it with the tab pointing up - **see Figures and .**

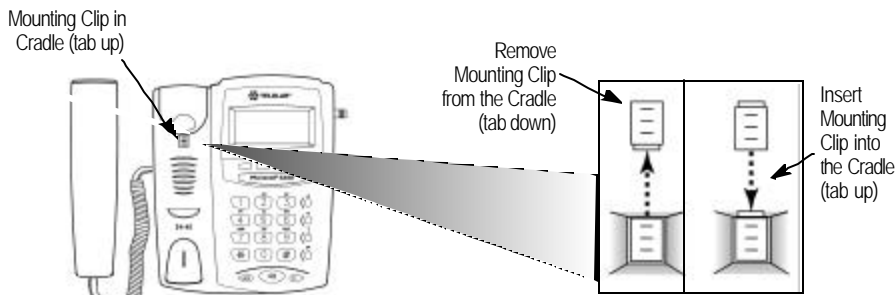

Figure - Handset mounting clip assembly.

Figure - Handset mounting clip assembly for wall-mount applications.

- 2) Mark two hole locations 83 mm (3-1/4 inches) vertically apart and drill two holes into the wall.
- 3) Install the screws (not supplied) into the wall, leaving a gap of approximately 3 mm (1/8 inches) between the screw head and the wall.
- 4) Align the mounting holes with the screws and mount the SX5D onto the screws - **see Figures and .**

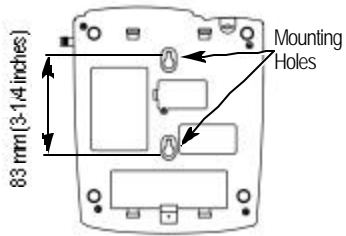

Figure - SX5D mounting hooks.

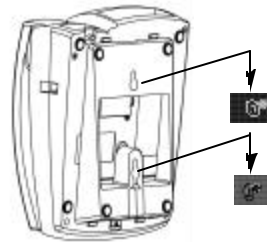

Figure - Mount the SX5D onto the screws.

## Battery Backup

### How to Install Battery

- 1) Remove the battery access door screw located on the bottom of the unit.
- 2) Press the battery access door tabs and remove the battery access door.
- 3) Install 4 AA batteries
- 4) Reinstall the battery access door using the screw
- 5) Turn the AC/Battery switch to battery operation

\*\*The SX5D does not support rechargeable batteries

### Battery Operation

The unit will automatically switch from AC to battery upon loss of AC power. A fully charged battery will provide up to two hours of talk time and 72 hours of standby. Total charging time is 15 hours.

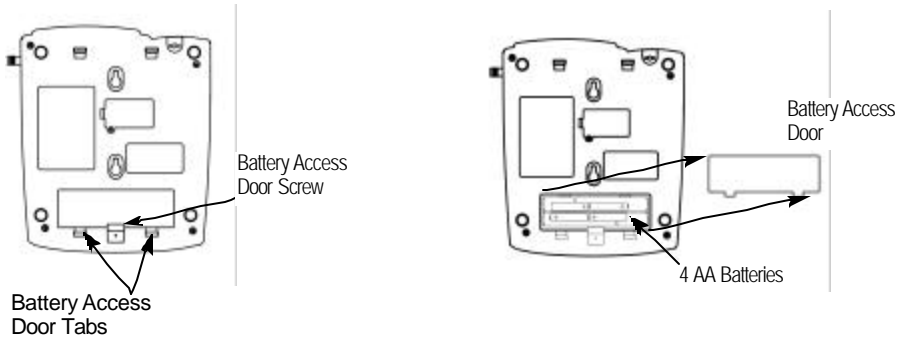

Figure - Battery Access Door.

Figure - Battery Installation

### Connect Your Phonecell® SX5 to AC Power

- 1) Connect the barrel connector of the power supply to the AC power input on the rear panel of the SX5D - **see Figure** .
- 2) Plug the power supply into the AC wall socket. The unit will power-up automatically.
- 3) Check the cellular signal strength and move the unit (or external antenna) until you achieve

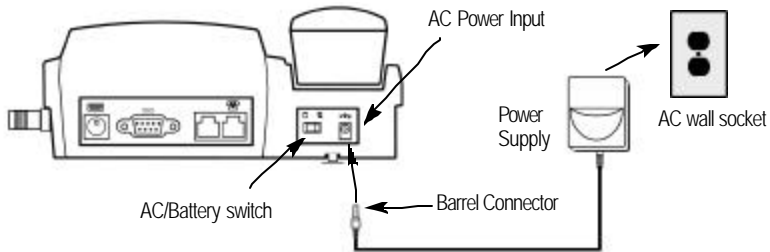
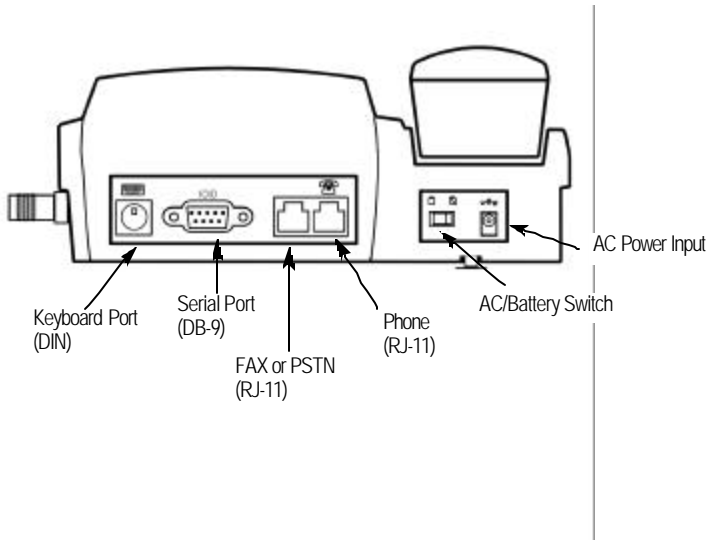

Figure - SX5D AC power input.

the best signal possible - see the *Received Signal Strength* section of this manual.

**Back View**

----UPDATE: THESE WILL CHANGE DEPENDING ON THE MODULE----



**Side View**

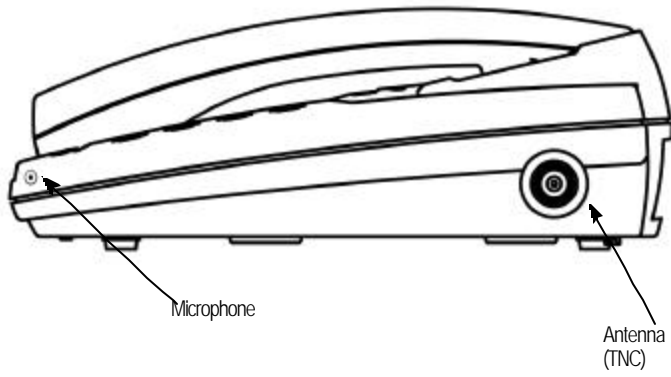

## OPERATION

### Function Keys

Operation of the Phonecell® SX5 is accomplished through the function keys on the keypad of the unit - see *Figure* .

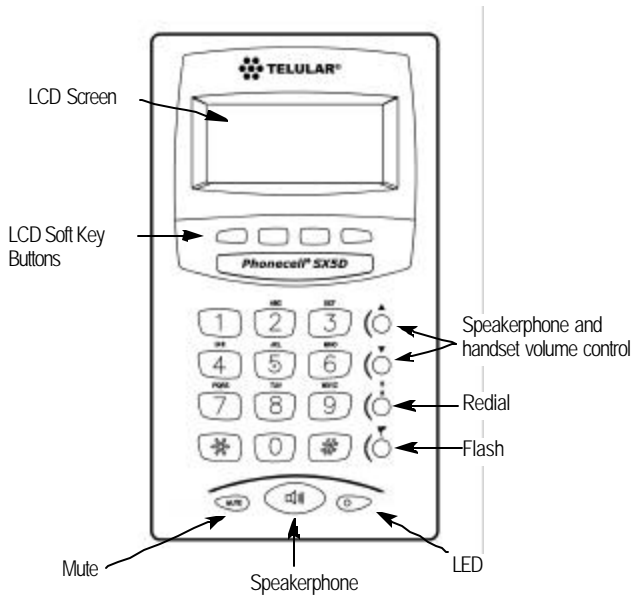

Figure - SX5D Keypad and Function Keys.

### LCD Display Icons

Icons displayed on the LCD display indicate the features in use, the status of the phone, signal strength and battery status - see *Figure* .

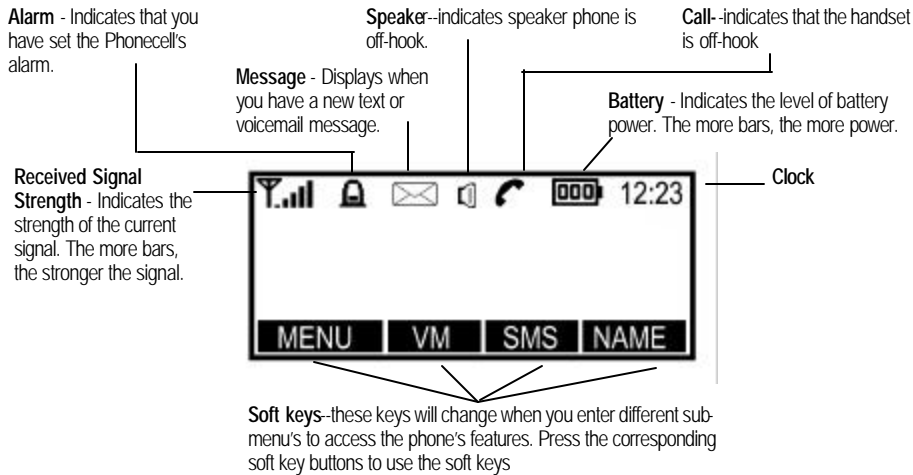

Figure - SX5D LCD display icons.

## Service Indication

### Full Service

When the power cord is connected properly, the SX5D will display the Telular logo, emit a power on tone, and the LED will light up. After a few seconds the greeting and mobile number will display. If you have service, the antenna icon will display indicator lines to show the signal strength.



Full Service

### No Service

When there is no service in your area, the antenna icon will have no indicator lines. Contact your service provider to make sure cellular service is activated. No calls can be made in this case.

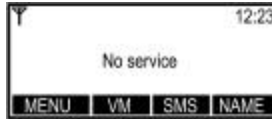

No Service

### Limited Service

If there is a signal, but full service with the system is blocked, only emergency calls will be allowed. Contact your service provider for more information.

## Network Settings

### Network Registration

If the home network is unavailable, but there is another network available (either another frequency or system), then the SX5D will prompt to register to that system. If there is more than one system, a list of available systems will display.

- 1) Use the arrow keys to highlight a network from the list.
- 2) Press SELECT. If the selected network cannot be accessed, the list of available networks will be updated and you will have to select a different one.

### Network Selection

- 1) Press MENU
- 2) Select Settings, then select Network Settings.
- 3) Select Select Network.
- 4) To use Automatic network selection, select Automatic.  
To use Manual network selection, select Manual and continue with Step 5.
- 5) Select a network from the list.



### Preferred Networks

#### To Insert New Entry

- 1) Press MENU
- 2) Select Settings, then select Network Settings.
- 3) Select Select Network.
- 4) Select Set Preferred.
- 4) Highlight the entry above which you want to insert a new preferred carrier.
- 5) Press SELECT.
- 6) Select Insert.
- 7) Select an entry from the list.

New entry will be inserted here



#### To Delete Entry

- 1) Press MENU
- 2) Select Settings, then select Network Settings.
- 3) Select Select Network.
- 4) Select Set Preferred.
- 5) Select the entry you want to delete.
- 6) Select Delete



### To Add New Network

- 1) Press MENU.
- 2) Select Settings, then select Network Settings.
- 3) Select Add New Network.  
If you have already added some networks, a list of those networks will display.
- 4) Select Add.  
If a list of networks displays, press the SELECT key, then select Add.
- 5) Enter the correct Country Code, Network Code, and Network Name as prompted.  
New networks will be added to the end of the list.

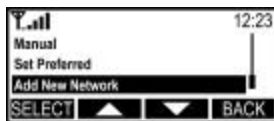

### To Edit or Delete an Added Network

Once you add a new network, you can edit the information you entered for that network, or delete it.

- 1) Press MENU.
- 2) Select Settings, then select Network Settings.
- 3) Select Add New Network.
- 4) Select the network you want to edit or delete.
- 5) Select the option you want to use.

### To Change Network Password

- 1) Press MENU.
- 2) Select Settings, then select Network Settings.
- 3) Select Change Network Password
- 4) **-NEED ADDITIONAL INFORMATION-**

### SIM PIN Setup

SIM PIN 1 controls access to SIM Card information. When On, it requires you to enter it each time the phone is turned on. When off it requires entry only when the SIM Card is put into a phone. Another user could still access your phone with a different SIM Card. To lock the phone even when a new SIM Card is inserted, see How to Lock the Phone. SIM PIN 2 accesses Network controlled features.

### To Turn On/Off SIM PIN 1

- 1) Press the MENU key.
- 2) Select Settings, then select Security Settings.
- 3) Select SIM PIN 1.
- 4) Select On or Off.

### To Change SIM PIN 2

- 1) Press the MENU key.
- 2) Select Settings, then select Security Settings.
- 3) Select SIM PIN 2.
- 4) Select Change PIN  
You will be prompted to enter the old PIN.
- 5) Enter the old PIN.
- 6) Enter the new PIN.  
It must be numerical and be between 4 and 8 digits long.
- 7) Press OK to save the new PIN, or use the CLEAR key to make changes.

### To Place a Call

- 1) Pick up the handset or press the Speaker phone button. The SX5D is now "off-hook."
- 2) Listen for dial tone.
- 3) Dial the phone number. The dialed number is displayed on the display, along with the name if it is stored in your phonebook.

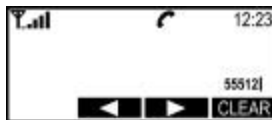

### To Correct Dialing Errors

- To erase one digit, press the CLEAR key once.
- To erase all digits, press and hold down the CLEAR key until all digits are erased.



Placing a call.

### To Redial the Last Telephone Number Dialed

- 1) Pick up the handset. The SX5D is now "off-hook".
- 2) Press the REDIAL key.

### To Receive a Call

When there is an incoming call, the SX5D rings, an incoming call notification displays and blinks, and the LED blinks.

- 1) Pick up the handset or press the Speaker phone button. Press the REJECT key to refuse the call. Your phone will stop ringing, and the calling party will be disconnected.
- 2) Begin talking.



Receiving a call

### To Receive a Call When Caller ID is Activated

The Caller ID feature displays the caller's number when the SX5D rings. If the caller's name and number are stored together in the phonebook of your SX5D, the caller's name and number will be displayed. Contact your service provider to activate this feature.

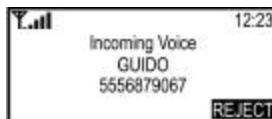

Receiving a call with Caller ID activated.

**NOTE:** If there is a missed call (call is not answered), "MISSED CALLS" will be displayed.

### To End a Call

Hang up the phone (place the handset back onto the SX5D cradle).

**NOTE:** If the call is ended by the other party, the SX5D will clear the line and re-establish a dial tone. The SX5D may be used for another call or may be hung up.

### To Mute a Call

- 1) While in a call, press the MUTE button. A message will notify you that the microphone is muted.
- 2) Press the MUTE button again to unmute the microphone.

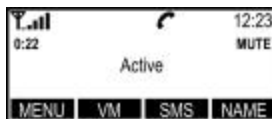

Muted call

### To Put a Call on Hold

- 1) While in a call, press the MENU key. The display will change from Active to Held.
- 2) Select Hold.
- 3) To activate the call, press the MENU key and select Retrieve.



Call on hold

### To Adjust Volumes

You can control the levels on your phone for the keypad tones and conversation volume (what you hear through the handset or speaker) and the ring volume of an incoming call. You can also turn the keypad tones on or off.

### To Adjust External Speaker Volume

- 1) Press the Speaker key.
- 2) Press the UP/DOWN arrow keys accordingly to adjust volume.

### To Adjust Handset Volume

- 1) Pick up the handset
- 2) Press UP/DOWN keys to adjust volume.

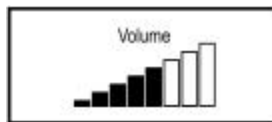

Handset/Speaker Volume



### To Adjust Phone Alert Volume (ringer)

- 1) Press the MENU key,
- 2) Select Settings, then Audio Settings.
- 3) Select Alert Volume and set desired volume level.

**NOTE:** If you choose "Silent", no alert will sound.



### To Change Alert Tones

You can set different alerts for different types of calls. This allows you to tell the difference between a voice call or an SMS message, for example, by the alert that sounds.

- 1) Press the MENU key
- 2) Select Settings, then Audio Settings.
- 3) Use the arrow keys to scroll through the alert types.
- 4) Select the alert you would like to change.
- 5) Select the alert sound you would like to use.



*Changing Alert Tones*

### To Use the Speaker Phone

- 1) Press the Speaker key.  
You will hear the dial tone through the speaker, and the Speaker icon will display.
- 2) Enter the telephone number.



*Speakerphone off-hook*

### Internal Phone Book

Your SX5D has an "Internal Phone Book" in which you can store up to 99 telephone numbers with corresponding names. You can set them up for convenient one-touch or two-touch dialing.

### To Change Phone Book Settings

You can save entries to the SIM card or to the phone memory. If you save to the SIM card, you can transfer that SIM card to another phone and keep all your phone book entries. You also have the option of selecting to choose where to save each entry as you enter it.



*Phonebook Settings*

- 1) Press the MENU key.
- 2) Select Phonebook, then Settings
- 3) Scroll to and select Save Entries To.  
When you scroll to Save Entries To, the current setting will display.
- 4) Select where you would like to save phone book entries.

### To Use Keypad Buttons

There are three or four letters assigned to each number on the telephone keypad. The letters on the keypad will display when you press the appropriate number. If you press the number 3, for example, a "D" will appear. If you press it twice, you will see the "E", and if you press it three times, the "F" will appear. The cursor will move on to the next space after a brief pause, so you must select the letter quickly.

### To Enter a Hard Pause

Hard pauses allow the SX5D to be used with automated phone systems used for pagers or automated banking. When you program a number into the phonebook, you can enter a pause by pressing and holding "#" for more than one second. The hard pause will be displayed as "P."

**NOTE:** This feature can only be used for phonebook entries.

### To Add a New Entry to the Phonebook

- 1) Press the MENU key,
- 2) Select Phonebook, then select Add Name
- 3) Enter a name by pressing the alphanumeric keys. You can only input 16 letters.



**NOTE:** To correct errors in the name, press the CLEAR key.

- 4) Press the OK key.
- 5) Enter the desired telephone number (maximum of 30 digits).
- 6) Press the OK key.  
You will be prompted to enter another number.
- 7) Press OK to save the entry and return to the Phonebook menu.



*Adding a phonebook entry*

If you have additional numbers (up to 2 more) follow steps 5 through 7 for each number.

### To Search for a Number in Memory

- 1) Press the NAME key.
- 2) Use the arrow keys to scroll through the entries, or use the keypad to view all entries that begin with a specific letter.

**NOTE:** If you use the arrow keys, the list will be in order of the most recently selected entries.

- 3) Press the SELECT key to view the phone number(s) listed for an entry that is highlighted.

### To Edit or Delete and Entry

- 1) Press the NAME key.
- 2) Use the arrow keys to scroll through the entries, or use the keypad to view all entries that begin with a specific letter.

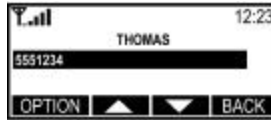

**NOTE:** If you use the arrow keys, the list will be in order of the most recently selected entries.

- 3) Press the SELECT key to view the phone number(s) listed for an entry that is highlighted.
- 4) Press the OPTIONS key and select the option you wish to use.

### Speed Dialing

Speed dialing permits one-touch dialing for up to 10 telephone numbers stored in the internal phone book.

### To Assign a Number to a Speed Dial Location

- 1) Press the NAME key.
- 2) Select the entry you wish to add to the speed dial list.
- 3) Press the OPTIONS key.
- 4) Select Add to Speed Dial.
- 5) Select the location (0 - 9).

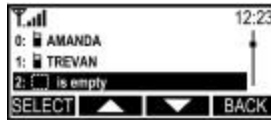

**NOTE:** The next available location will display automatically. You can select a specific location by pressing the desired number on the keypad. If that location is already in use, you can replace the phone number that was stored there with a new one.

### To Dial a Speed Dial Location

- 1) Pick up the handset or press the Speaker Phone key.
- 2) Press and hold the number of the location containing the number to be called.
- 3) The number is displayed and dials automatically.

**NOTE:** If you skip Step 1, the phone will automatically go off-hook in speaker phone mode when you press and hold a number.

### To View the Speed Dial List

- 1) Press the MENU key.
- 2) Select Phonebook, then select Settings.
- 3) Select Speed dial list.

## FEATURES

### Call Logs

The SX5D's memory stores the telephone numbers of the last ten outgoing calls and the last ten incoming calls along with the dates and times of the calls. You can display these numbers and the SX5D can dial them automatically from the call log.

#### To View the Call Log

- 1) Press the MENU key.
- 2) Select Call Log.
- 3) Select which calls you would like to view (All, Missed, Received, Dialed).

**NOTE:** Calls are denoted with the following icons:

Dialed calls      Missed calls      Received calls

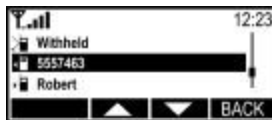

*View All Calls*

#### To Dial a number from the Call Log

- 1) View the Call Log.
- 2) Highlight the call with the number you wish to dial.
- 3) Pick up the handset or press the Speaker Phone button.
- 4) A dial tone will sound, then the number will be dialed.

**NOTE:** This feature will not work for unavailable or private calls (denoted as Withheld in the Log).

#### To Clear the Call Log

- 1) Press the MENU key.
- 2) Select Call Log, then select Clear Logs
- 3) A notification will appear to tell you that the Call Log has been cleared.

#### To Check the Last Call Time

- 1) Press the MENU key,
- 2) Select Call Log, then Times & Costs.
- 3) Select Last Call Time.

#### To Check Total Accumulated Air Time

- 1) Press the MENU key
- 2) Select Call Log, then Times & Costs.
- 3) Select All Calls Time.

#### To Reset Accumulated Air Time

- 1) Press the MENU key
- 2) Select Call Log, then Times & Costs.
- 3) Select Clear Logs.



*Total Accumulated Air Time*

#### To Turn On/Off the Keypad Tones

- 1) Press the MENU key.
- 2) Select Settings, then Audio Settings.
- 3) Select Keypad Tones.
- 4) Select On or Off.

#### To Turn On/Off the Warning Tones

- 1) Press the MENU key.
- 2) Select Settings, then Audio Settings.
- 3) Select Warning Tones
- 4) Select On or Off.

## Date and Time Settings

The SX5D allows you to set the date, time, time zone, and time format (12 or 24 hour), and customize how that information is displayed.

### To Set the Date

- 1) Press the MENU key.
- 2) Select Clock, then Clock Settings.
- 3) Scroll to Date Format.  
The current format will display.
- 4) Press the CHANGE key.
- 5) Select the way you want to view the date.  
Options are **Day:Month:Year**, **Month:Day:Year**, or **Year:Month:Day**
- 6) Press OK, then press the BACK key to return to the Clock menu.
- 7) Scroll to Set Date.
- 8) Press the CHANGE key.
- 9) Enter the desired date.
- 10) Press OK.

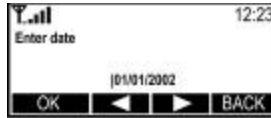

Setting the Date

### To Set the Time

- 1) Press the Menu key.
- 2) Select Clock, then Clock Settings.
- 3) Scroll to Time Format.  
The current format will display
- 4) Press the CHANGE key.
- 5) Select the time format you wish to use (12 hour or 24 hour)
- 6) Press OK, then the BACK key to return to the Clock menu.
- 7) Select Set Time.
- 8) Enter the desired time.
- 9) Press OK.



Setting the Time

### To Set the Time Zone

- 1) Press the Menu key.
- 2) Select Clock, then scroll to Set Time Zone.
- 3) Press the CHANGE key.  
Use the two middle soft keys to scroll left or right on the graphic to highlight the time zone you are in.
- 4) Press the far left soft key to select the highlighted time zone.

## Alarm Settings

You can set the alarm time and tone, and you can set it for daily use or for one time only.

### To Set Alarm Time and Tone

- 1) Press the MENU key.
- 2) Select Clock, then Set Alarm.
- 3) Select Set time, then enter the desired alarm time.
- 4) Press OK.
- 5) Select Set Tone, then select the desired alarm tone.
- 6) Press OK.

### To Set Alarm to Repeat Every day

- 1) Press the MENU key.
- 2) Select Clock, then Set Alarm.
- 3) Select Repeat Daily.

**To Turn Alarm On/Off**

- 1) Press the MENU key.
- 2) Select Clock, then Set alarm.
- 3) Select Alarm Status.
- 4) Select On or Off.
- 5) Press OK

**To Display Your Own Telephone Number**

You can have your phone number display when the SX5D is turned on.

- 1) Press the MENU key,
- 2) Select Settings, then Phone Settings.
- 3) Select My number.
- 4) Press the EDIT key.
- 5) Enter your phone number.
- 6) Press OK.

**To Change Greeting Message**

The Greeting Messages displays when the SX5D is turned on.

- 1) Press the MENU key,
- 2) Select Settings, then Phone Settings.
- 3) Select Set greeting.
- 4) Enter the desired greeting message.
- 5) Press OK.

**To Change the Display Screen Contrast**

- 1) Press the MENU key.
- 2) Select Settings, then Phone settings.
- 3) Select Screen contrast.
- 4) Use the arrow keys to adjust the display contrast.
- 5) Press OK.

**To Reset System Defaults**

You can reset all system features to the factory defaults.

- 1) Press the MENU key
- 2) Select Settings, then Restore Defaults.
- 3) Select Yes to restore all factory default settings.

**Phone Use Restrictions**

You can restrict the use of the phone by barring certain calls from being made or received. You can also create a Fixed Dialing list that will only allow numbers on that list to be dialed from your phone.

**Handset Call Bars**

Outgoing Calls: Does not allow any calls to be made from the phone.

Incoming Calls: Does not allow any incoming calls to be answered.

**Network Call Bars**

Foreign Calls: Does not allow international calls.

Only local and home country: Only allows local and home country calls.

Incoming Calls: Does not allow any incoming calls.

Incoming if abroad: Does not allow any incoming calls when outside the home country.

Outgoing: Does not allow any calls to be made.

All: Does not allow any calls to be made or received.

Cancel all: Deactivates any network call bars that are currently active.

**To Set Call Bar Modes**

- 1) Press the MENU key.
- 2) Select Settings, then Security settings.
- 3) Select Handset Call Barring, or Network Call Barring
- 4) Select the bars you wish to implement.

**To Use Fixed Dialing**

- 1) Press the MENU key.
- 2) Select Settings, then Security settings.
- 3) Select Fixed Dialing.
- 4) Select On.
- 5) Enter SIM PIN 2, then press OK.

**To Add to or Edit the Fixed Dialing List**

- 1) Press the MENU key
- 2) Select Settings, then Security settings.
- 3) Select Fixed Dialing.
- 4) Select Edit dial list
- 5) To add a new entry, select Add, enter the new number, then press OK.  
To Edit an existing entry, move on to Step 6.
- 6) Use the arrow keys to highlight the entry you wish to edit.
- 7) Press the OPTIONS key.
- 8) Select Edit to change the entry.  
Select Delete to erase the entry.

**To Lock the Phone**

You can lock your phone to keep unauthorized persons from using it or accessing any information stored in it. When the phone is locked, no keypad buttons will function until the lock code is entered. To receive incoming calls when your phone is locked, you must enter the lock code when the phone rings. Turning the phone off or inserting a new SIM Card does not disable this feature. The phone stays in lock mode until you unlock it.

- 1) Press the MENU key.
- 2) Select Settings, then Security settings.
- 3) Select Handset Lock PIN.
- 4) Select On.

**To Unlock the Phone**

- 1) Press the MENU key.
- 2) Select Settings, then Security settings.
- 3) Select Handset Lock PIN.
- 4) Select Off.

**To Change the Lock Code**

The lock code is preset at the factory to "0000." You can change the lock code to any 4-digit code.

- 1) Press the MENU key.
- 2) Select Settings, then Security settings.
- 3) Select Handset Lock PIN.
- 4) Select Change PIN
- 5) Enter your new lock code.

**NOTE:** The new lock code must be four numeric digits.

## SUPPLEMENTARY FEATURES (NETWORK DEPENDENT)

### Call Forwarding

Call Forwarding allows you to forward your incoming calls to another telephone number, even if your phone is turned off. You can specify the criteria for calls to be forwarded. Options are: all calls, calls that come in when your line is busy, calls that are not answered after a specified number of rings, or calls that come in when the SX5D is powered off or has lost the network signal (Not Found). You can also specify certain types of calls to forward, such as voice, data, fax, or text messages. Contact your service provider to activate Call Forwarding.

#### To Turn On Call Forwarding

- 1) Press the MENU key.
- 2) Scroll to and select Call Divert.
- 3) Select the criteria you wish to use for forwarding calls (All Calls, When Busy, No Answer, Not Found).
- 4) Select On
- 5) To choose which types of calls to forward, select By Service
- 6) Highlight the service you wish to forward, then press SELECT. The default is All Services.



Call Forwarding Step 2



Call Forwarding Step 4



Call Forwarding Step 6

### Call Waiting

Call Waiting alerts you to a second incoming call while you are on the phone. To respond to Call Waiting, press the Flash key or the hook switch. Contact your service provider to activate Call Waiting.

#### To Turn On Call Waiting

- 1) Press the MENU key.
- 2) Select Settings
- 3) Select Call Settings.
- 4) Select Call waiting.
- 5) Select On.

### Multiparty Calling

Multiparty Calling allows you to connect a three-way conversation, or transfer a call. Contact your service provider to activate Three-Way Calling.

#### To Engage a Multiparty Call

- 1) While in a call, put the call on hold.
- 2) Dial a second call, then press the Flash button to connect it.
- 3) When the second call is answered, press the MENU key and select Multiparty
- 5) Select the option you wish to use.

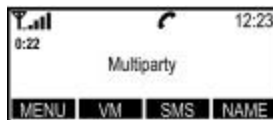

Multiparty call

**Join All:** Join the active call with the held multiparty call.

**Hold All:** Place multiparty call on hold.

**Next:** Display the next call party in a multiparty call.

**Transfer:** Connects one call party to another call party and allows the user to leave the call.

**Exclude:** Place the selected party of a multiparty call on hold

**Private:** Hold a private call with one party in a multiparty call. Other parties are put on hold.

**I am busy:** User defined user busy (UDUB) indicates BUSY to a waiting caller.

**End All:** End active and held calls.

**NOTE:** You will only see options available dependant on the status of the call or calls. For example, if you only have one other person in the call, you will only get the End All option, or if you have already joined all the calls, you will not see the Join All option.

## Voicemail

When there are new voicemail messages, the VM key will blink and the envelop icon will display. Contact your service provider to activate voicemail.

### How to Check Voicemail

- 1) Press the VM key.  
You will be connected to your voicemail system automatically.
- 2) Follow the the automated instructions.

### How to Turn Voicemail On/Off

- 1) Press the MENU key.
- 2) Select Messages, then select Voicemail.
- 3) Select Set Voicemail, then select On or Off.

### How to Change the Voicemail Alert Type

You can choose to be alerted to new voicemail by audio indication or by SMS. The default setting is for audio indication. Use the following instructions to set the voicemail alert to SMS.

- 1) Press the MENU key.
- 2) Select Messages, then select Voicemail.
- 3) Select Voicemail Settings.
- 4) To be alerted by a SMS indication, select Alert by SMS.
- 5) From a different phone, call your number and leave a voicemail message.  
The network will send you an SMS indication that you have new voicemail.
- 6) View the SMS message you receive from the network and write down the text.
- 7) Follow steps 1-3 above to return to Voicemail Settings.
- 8) Select Alert match.
- 9) Enter the text that you copied from the SMS message from the network.  
This text will display whenever you get a new voicemail message.

**NOTE:** If you do not specify the Alert match text, or if you enter incorrect text for the Alert match, the SMS message will not display when you receive new voicemail.

## Short Message Service (SMS)

SMS allows you to transmit and receive short text messages. If there are new messages that you have not checked, the message envelope icon will be displayed and the SMS key will blink. You can store up to ten text messages, each of which can be no more than 160 characters long. Contact your service provider to activate SMS.

To use a keyboard to type messages, connect a keyboard to the keyboard port on the back of the SX5. You still must use the soft keys to navigate through the menus, but you can use the keyboard to enter any text.

### How to View Text Messages

- 1) Press the SMS key.
- 2) Select Received Messages.
- 3) Scroll to the message you wish to view.
- 4) Press the READ key.

**NOTE:** Unread messages are denoted by the closed envelop icon, and message that have been read are denoted by the open envelop icon.



*New Message Notification*

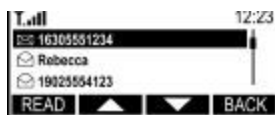

*Viewing Messages*



### To Reply to Received Messages

- 1) View the message you wish to reply to.
- 2) Press the OPTIONS key.
- 3) Select Text Reply to reply with a text message.  
Select Voice Reply to reply with a voicemail.
- 4) For a Text Reply, type your reply message, then press OK.  
Selecting Voice Reply will activate the speakerphone and connect to the person who sent the message.



View Received Message

### To Forward Text Messages

- 1) View the message you want to forward.
- 2) Press the OPTIONS key.
- 3) Select Forward.
- 4) Enter the number of the person you want to forward the message to, or press the NAME key to select a phonebook entry.
- 5) Press OK
- 6) Select Send Now.



Received Message Options

### To Delete Text Messages

- 1) View the message you wish to delete.
- 2) Press the OPTIONS key.
- 3) Select Delete



### To Create Text Messages

- 1) Press the SMS key.
- 2) Select New Message.
- 3) Enter the message text.

**NOTE:** Use the \* key on the keypad to change the type of text you enter to all capital letters (ABC), lower case letters (abc), or numbers (123). The current text type is displayed under the clock in the upper right corner of the display screen.

- 4) Press OK.
- 5) Enter the number of the person you wish to send the message to, or press the NAME key to select phonebook entry.
- 6) Press OK.
- 7) To send the message, select Send Now.  
To save it to send at a later time, select Send Later.



Creating Text Messages

### To View Saved Messages

- 1) Press the SMS key.
- 2) Select Saved Messages.
- 3) Select the message you wish to view.



Viewing Saved Messages

### To Send Saved Messages

- 1) Press the SMS key.
- 2) Select Saved Messages.
- 3) View the message you wish to send.
- 4) Press the OPTIONS key.
- 5) Select Forward.
- 6) Enter the number of the person you wish to send the message to or press the NAME key to search your phonebook.
- 7) Press OK
- 8) Select Send Now.



Forwarding Text Messages

## Info Messages

Info messages provide you with information such as phone numbers for taxi services, car rentals, or emergency services. If your service provider offers Info messages, you can select what subjects you would like to view and choose the language in which you would like to view it.

### To Set Info Subjects

- 1) Press the MENU key.
- 2) Select Messages, then select Info messages.
- 3) Select Settings, then select Subject.
- 4) Select Active.
- 5) Press the SELECT key.
- 5) Select Add.
- 6) From the list, select the subject you would like to view.

### To Set Languages

- 1) Press the MENU key.
- 2) Select Messages, then select Info messages.
- 3) Select Settings, the select Set languages.
- 4) From the list, select the language you would like to use.

## In-Call Options

The following options are available when you press the MENU key while in a call.

**Hold:** Puts active call on hold

**Retrieve:** Activates a call that is on hold.

**Swap:** Swaps between held call and active call.

**End & Next:** Releases active call and answers waiting call.

**End Current:** Ends the currently displayed call

**Multiparty:** Displays options for managing multiparty calls.

**Main Menu:** Allows access to the Phonebook, Messages, or Call Log features.

**NOTE:** Some options display depending on the call status. For example, if you have don't have any calls on hold, you will not see the Retrieve or Swap options.

## DIGITAL DATA SERVICE

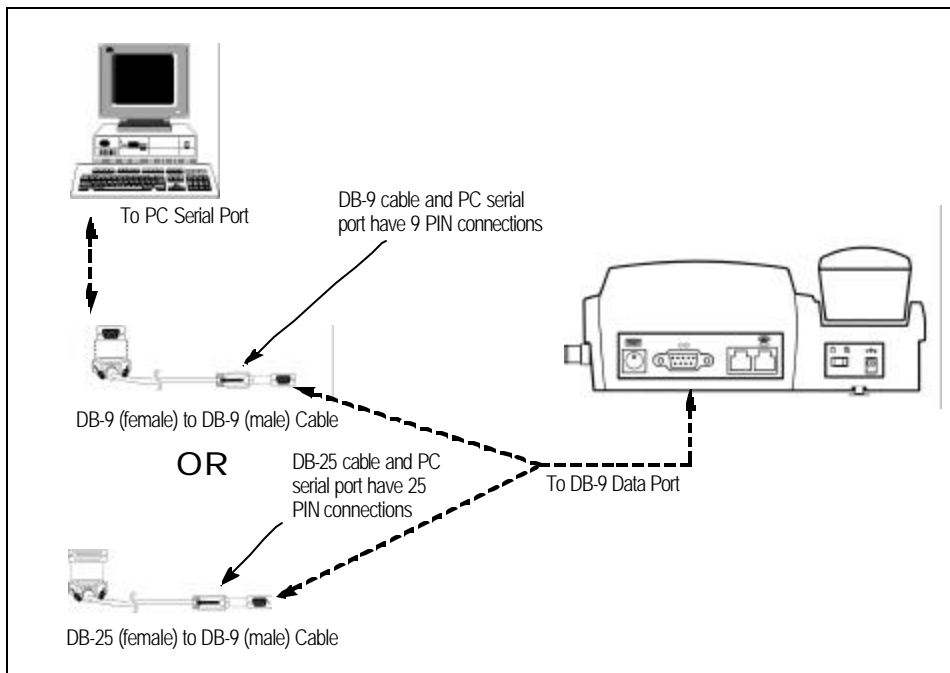

Figure - PC Data Connection

### Standard Modem Setting

The SX5D features a DB-9 digital computer fax/data port for connection to a personal computer (PC) - not supplied. When connected to a PC, the SX5D's PC interface is capable of sending and receiving digital fax transmissions, sending and receiving e-mail communications, and browsing the Internet. (Data speeds may vary depending upon your cellular network.)

### PC Data Connection

A data cable - *not included* - is required for data transmission. To determine the necessary cable, count the number of PIN connections in the serial port of your PC (see below). If there are 9 PIN connections in the PC serial port, a DB-9 (female) to DB-9 (male) cable is required. If there are 25 PIN connections in the PC serial port, a DB-25 (female) to DB-9 (male) cable is required - **see Figure -**

For specific digital fax/data setup procedures, **see Appendix A - How to Setup Your PC Serial Port for Phonecell®SX5 Digital Fax/Data.**

### Sending and Receiving Digital Fax

Your computer needs a standard 19,200 bps modem and a commercial PC fax emulator (Winfax, Netfax, etc.). To send a fax, no special settings are required. The computer will change the SX5D mode setting automatically and reset it to voice mode after sending a fax. To receive a fax, you must change the SX5D from voice to fax mode.

- 1) Set up a standard 19,200 bps modem.
- 2) Install a commercial PC fax emulator (Winfax, Netfax, etc.).

## **LEAST COST ROUTING (LCR) SETUP**

The personal LCR option for the SCX5D allows you to operate both a regular public switched telephone network (PSTN) landline phone account and a GSM wireless account through a single deskphone. This gives you two separate lines, and allows you to take advantage of lower calling costs, depending on whether you are connecting to someone via a PSTN or a wireless network. You can also connect additional phones to the SX5D, but these will only operate over the GSM network (they cannot access the PSTN). In order to make calls or receive calls over the PSTN, you must use the SCX5D deskphone.

### **How to Connect Your SX5 to the Landline PSTN**

- 1) Connect the wall jack to the unmarked jack on the SX5.

### **How to Connect Additional Phones to Your SX5**

- 1) Connect your additional telephone to the jack on the SX5 that is marked with a telephone icon.

**NOTE:** Be sure to connect to the appropriate RJ-11 jacks, because improper connections could cause damage your SX5.

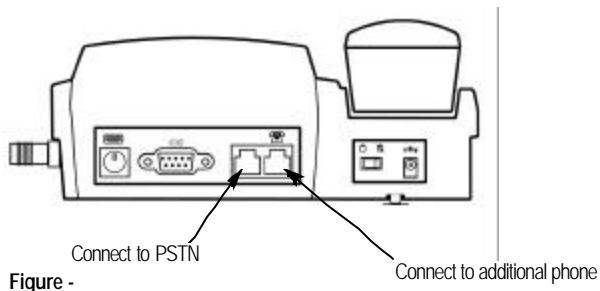

### **How to Set the LCR Default**

You can set the SX5D to operate on either the PSTN or the GSM network when you pick up the handset. You can then set a prefix to dial to access the other service. The factory default is GSM.

- 1) Press the MENU key.
- 2) Select Settings, then Extension Settings.
- 3) To set the system to operate over the PSTN when you pick up the phone, select Internal. To set the system to operate on the GSM wireless network, select External.
- 4) To set a prefix for accessing whichever system you did not select in Step 3, select Prefix.
- 5) Enter up to two digits for the prefix you wish to use. The factory default prefix is "#".
- 6) Press OK.

## **ANALOG FAX SETUP**

The Analog Fax option allows you to connect a fax machine and additional telephones to your SX5. Your SX5D can be set up to use one or both of its RJ-11 jacks. In Single Jack mode, only the jack designated with a telephone icon is operational. You can connect a fax machine or an additional telephone into that jack, but to receive faxes you must have fax machine connected. In Dual Jack mode, the unmarked jack is used for fax, and the jack marked with the telephone icon is used for any additional phones.

### **To Set Your SX5D for Analog Fax**

- 1) Press the MENU key.
- 2) Select Settings, then select Fax Settings.
- 3) Select RJ-11.
- 4) Select the mode you wish to use (Single or Dual Jack). The default is Dual Jack.

### **To Connect Your SX5D for Dual Jack Mode**

- 1) Connect your fax machine to the unmarked phone jack on your SX5D.
- 2) Connect a regular phone to the phone jack that is marked with a telephone icon.

### **To Connect Your SX5D for Single Jack Mode**

- 1) Connect your fax machine to the phone jack on your SX5D that is marked with a telephone icon.

**NOTE:** You will have to enter the fax by-pass to send a fax when you are in single jack mode, because the SX5D default setting is for voice calls. To send a fax, dial "# \* 19 \* 1 #" then dial the number for where you are sending the fax. After the fax is sent, the SX5D will reset itself for voice calls.

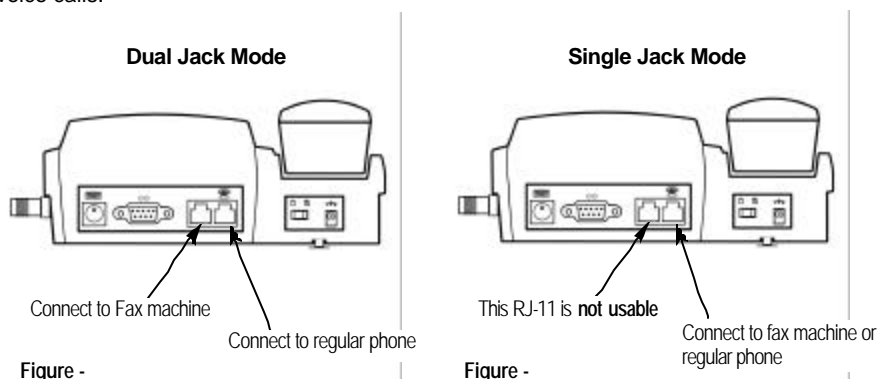

Figure -

Figure -

### **To Set Your SX5D for Digital Fax**

- 1) Press the MENU key.
- 2) Select Settings, then select Fax Settings.
- 3) Select Serial Port.

**NOTE:** You must have your SX5D connected to a computer, or other device that is set up for digital data, via the serial connector in order to send or receive digital faxes.



### WARNING!

The following commands may be used by a trained service technician to change the configuration of the Phonecel® SX5. **WARNING:** these commands are intended for use by trained service technicians only. Untrained users could damage the Phonecel® SX5, violate local regulations and breach the service agreement with the cellular provider. For further assistance, please contact your Authorized Telular Representative.

## TECHNICIAN COMMANDS

The following options are to be used by trained field technicians to set up the Phonecel® SX5 for operation in the network. To prevent casual access to these options, which can directly affect the proper operation of the unit, they are protected by a Service PIN.

To Access the Service menu, press the MENU key, then select Service. You will be prompted to enter the Service PIN before you can access any Service menu items. Each option is described below, along with the available settings and the system defaults

### Service Settings

**Mobile Equipment Personalization (MEP) Locks:** The five locks available are SIM, Network, Network Subset, Provider, and Corporate. With the correct password, you can activate, deactivate, disable, or check the status of any MEP lock. Once a lock is disabled, it cannot be reactivated.

**Dial Tone Type:** The available options are 425 Hz and Dual Frequency (default). This dial tone will be the air interface (GSM) dial tone presented to the user on the desk phone and any POTS phones connected to the SX5D.

**Audio In** changes the input impedance. Options are 600 Ohms (default) or 900 Ohms.

**Supervision Pulse** changes the pulse that is generated when the far end answers a call originated from the SX5D. Options are 12 kHz (default), 16 kHz., Off, Pulse Duration, and Pulse Level.

**Pulse Duration** options include any value between 10 and 65535 milliseconds.

**Pulse Level** options listed by dB ranges (default is -3dB).

**Line Reversal** enables line reversal on tip and ring for incoming calls.

**Line Reversal (MO)** can be turned On or Off (default).

**Line Reversal (MT)** can be turned On or Off (default).

**Line Ringing** controls the line ringer.

**Frequency** options are 20 Hz (default), 25 Hz, or 50Hz.

**Cadence** options range from .1 to 25.5 seconds (by 100 millisecond increments).

**Disconnect Pulse** sets pulse value. Options range from 10 to 65535 milliseconds.

**Dial Tone After Disconnect** determines if a dial tone is heard after far end disconnect. If On, then dial tone will start at some time after a far end disconnect is detected as long as the user is still off hook (Off is default).

**Receiver Off Hook (ROH) Setup** sets the parameters of the ROH tone that is heard when the SX5 goes off hook for an extended period of time without making a call. Options are Continuous or Non-continuous, Set Start Time, and Set Stop Time.

**Self Test Interval** sets the reset interval for periodic resetting or sanity checking. The range is 0 to 65536 minutes, where 0 means that there is no resetting.

**SERVICE PIN:** Options are On (default) or Off, and Change PIN. When the Service PIN is entered wrong three consecutive times, you will be returned to the Main Menu.

**RF:** Displays the quality and signal level of the received signal (for evaluation of SX5D placement, etc). The display will show a dB level for received signal strength and/or a decimal value representing the signal quality (BER, FER, etc.). The signal strength will be on row 2 and the signal quality value will be on row 3.

**Restore Service DEFAULTS:** Resets all service items to factory defaults separately from the user settings.

## **SAFETY INFORMATION**

### **IMPORTANT!**

*To ensure safe and efficient operation, please read the following information and observe these guidelines whenever using your Phonecell® SX5.*

Your Phonecell® SX5 Desktop Phone functions as both a radio transmitter and receiver. When it is ON, the SX5D receives and sends out radio frequency (RF) energy. The GSM 800 unit operates in the frequency range between 824 and 894 MHz, and the GSM 1900 between 1850 MHz and 1990 MHz. Both employ commonly used phase/frequency modulation techniques. When you use your Phonecell® SX5, the cellular system handling your call controls the power level at which your unit transmits.

### **Exposure to RF (Radio Frequency) Energy**

In 1991, the Institute of Electrical and Electronics Engineers (IEEE), and in 1992, the American National Standards Institute (ANSI), updated the 1982 ANSI Standard for safety levels with respect to human exposure to RF energy. After reviewing the available body of research, more than 120 scientists, engineers and physicians from universities, government health agencies and industry developed this updated Standard. In March, 1993, the U.S. Federal Communications Commission (FCC) proposed the adoption of this updated Standard.

The design of your Telular Phonecell® SX5 complies with this updated Standard. Of course, if you want to limit RF exposure even further than the updated ANSI Standard, you may choose to control the duration of your calls and operate your phone in the most power-efficient manner.

### **Safe Operation Requirement**

The Phonecell® SX5 must be either wall mounted or desk mounted and should not be operated when any person is within 8 inches (20 centimeters) of the antenna.

### **Temperature Environment**

**Operating Temperature:** From -20°C to +60°C ; Up to 95% relative humidity (non-condensing).

**Storage Temperature:** From -25°C to +75°C; Up to 95% relative humidity (non-condensing).

### **Antenna Care and Replacement**

Do not use the Phonecell® SX5 with a damaged antenna. If a damaged antenna comes into contact with the skin, a minor burn may result. Have your antenna replaced by a qualified technician immediately. Use only a manufacturer-approved antenna. Unauthorized antennas, modifications, or attachments could damage the Phonecell® SX5.

### **Driving**

Check the laws and regulations on the use of cellular products in the areas where you drive. Some jurisdictions prohibit your using a cellular device while driving a vehicle. Even if your jurisdiction does not have such a law, we strongly suggest that, for safety reasons, the driver use extreme caution when operating the cellular device while the vehicle is in motion. Always obey the law.

### **Electronic Devices**

Most modern electronic equipment is shielded from RF energy. However, RF energy from cellular devices may affect inadequately shielded electronic equipment.

RF energy may affect improperly installed or inadequately shielded electronic operating and entertainment systems in motor vehicles. Check with the manufacturer or its representative to determine if these systems are adequately shielded from external RF energy. You should also check with the manufacturer of any equipment that has been added to your vehicle.

Consult the manufacturer of any personal medical devices (such as pacemakers, hearing aids, etc.) to determine if they are adequately shielded from external RF energy.

Turn your Phonecell® SX5 OFF in health care facilities when any regulations posted in the areas instruct you to do so. Hospitals or health care facilities may be using equipment that could be sensitive to external RF energy.



### WARNING!

*Your Phonecell® SX5 is intended either to be wall mounted or desk mounted on a flat surface to allow proper ventilation. Do not block the space beneath your Phonecell® SX5 as this could cause the unit to overheat and fail.*

#### Aircraft

Turn OFF your Phonecell® SX5 before boarding any aircraft.

- Use it on the ground only with crew permission.
- Do not use it in the air.

To prevent possible interference with aircraft systems, U.S. Federal Aviation Administration (FAA) regulations require you to have permission from a crew member to use your cellular phone (or any other cellular product) while the plane is on the ground. To prevent interference with aircraft systems, FCC regulations prohibit using your cellular device while the plane is in the air.

#### Children

Do not allow children to play with your Phonecell® SX5 to prevent damage to the unit.

#### Blasting Areas

Construction crews often use remote control RF devices to set off explosives. Therefore, to avoid interfering with blasting operations, turn your Phonecell® SX5 OFF when in a "blasting area" or in areas posted: "Turn off two-way radio."

#### Potentially Explosive Atmospheres

Turn your Phonecell® SX5 OFF when in any area with a potentially explosive atmosphere. It is rare, but your Phonecell® SX5 or its accessories could generate sparks. Sparks in such areas could cause an explosion or fire resulting in bodily injury or even death.

Areas with a potentially explosive atmosphere are often, but not always, clearly marked. They include fueling areas such as gas stations; below deck on boats; fuel or chemical transfer or storage facilities; areas where the air contains chemicals or particles, such as grain, dust, or metal powders; and any other area where you would normally be advised to turn off your vehicle engine.

Do not transport or store flammable gas, liquid or explosives in the area of your Phonecell® SX5 or accessories.

Vehicles using liquefied petroleum gas (such as propane or butane) must comply with the National Fire Protection Standard (FPA-58). For a copy of this standard, contact the National Fire Protection Association, One Batterymarch Park, Quincy, MA 02269, Attn: Publications Sales Division.

#### FCC Part 15 Class B Compliance

This Phonecell® SX5 model has been tested and found to comply with the limits for a Class B digital device, pursuant to Part 15 of the FCC rules. These limits are designed to provide reasonable protection against harmful interference in a residential installation. This equipment generates, uses and can radiate radio frequency energy and, if not installed and used in accordance with the instructions, may cause harmful interference to radio communications. However, there is no guarantee that interference will not occur in a particular installation. If this equipment does cause harmful interference to radio or television reception, which can be determined by turning the equipment OFF and ON, the user is encouraged to try to correct the interference by one or more of the following measures:

Reorient or relocate the antenna.

Increase the separation between the equipment and the terminal.

Connect the equipment into an outlet on a circuit different from that to which the terminal is connected.

Consult your Authorized Telular Distributor or an experienced radio/TV technician for help.



## **IMPORTANT NOTICES**

### **Warranty**

#### **I. WHAT THIS WARRANTY COVERS AND FOR HOW LONG:**

TELULAR CORPORATION ("Telular") warrants to a distributor Buyer, or to a customer only if the customer is a Buyer directly from Telular, that the Products (including accessories) shall comply with the applicable Specifications and shall be free from defects in material and workmanship under normal use and service for a period of fifteen (15) months from date of shipment from Telular. Telular, at its option, shall at no charge either repair, replace or refund the purchase price of the Product during the warranty period, provided it is returned by Buyer in accordance with the terms of this warranty to the Telular designated repair center. Repair or replacement, at Telular's option, may include the replacement of parts, boards or Products with functionally equivalent reconditioned items. Repaired and replacement items are warranted for the balance of the original warranty period. All replaced items shall become the property of Telular. **SUCH ACTION ON THE PART OF TELULAR SHALL BE THE FULL EXTENT OF TELULAR'S LIABILITY HEREUNDER, AND BUYERS EXCLUSIVE REMEDY.** Buyer shall be responsible for all costs and expenses incurred by Buyer including without limitation any handling, labor or transportation charges. **OTHER THAN AFORESAID, THIS EXPRESS WARRANTY IS EXTENDED BY TELULAR TO BUYER ONLY AND NOT TO BUYER'S CUSTOMERS OR USERS OF BUYER'S PRODUCTS.**

#### **II. HOW TO OBTAIN WARRANTY SERVICE**

Product covered under this warranty shall only be accepted from and returned to Buyer's designated repair center. Buyer's dealers, distributors, agents, and end users cannot submit items to Telular under this warranty. To receive warranty service an RMA number must first be obtained from Telular Technical Support. The defective or non-compliant Product should be sent by Buyer freight pre-paid to: Telular Corporation, 647 North Lakeview Parkway, Vernon Hills, IL 60061, USA or other designated location. The product must be packaged in the original carton and packing material or an equivalent package and must have the assigned RMA number clearly marked on the carton. Returned Product received without an RMA number will be returned to the sender.

#### **III. WARRANTY CONDITIONS:**

This is the complete warranty for the Products manufactured by Telular and sold to Buyer. Telular assumes no obligation or liability for additions or modifications to this warranty unless made in writing and signed by an officer of Telular. Unless made in separate written agreement between Telular and Buyer, Telular does not warrant the installation, field maintenance or service of the Products or parts.

**TELULAR CANNOT BE RESPONSIBLE IN ANY WAY FOR ANY ANCILLARY EQUIPMENT NOT FURNISHED BY TELULAR WHICH IS ATTACHED TO OR USED IN CONNECTION WITH THE PRODUCTS OR FOR OPERATION OF THE PRODUCTS WITH ANY ANCILLARY EQUIPMENT AND ALL SUCH EQUIPMENT IS EXPRESSLY EXCLUDED FROM THIS WARRANTY. FURTHERMORE, TELULAR CANNOT BE RESPONSIBLE FOR ANY DAMAGE TO THE PRODUCTS RESULTING FROM THE USE OF ANCILLARY EQUIPMENT NOT FURNISHED BY TELULAR FOR USE WITH THE PRODUCTS.**

**WHEN THE PRODUCT IS USED IN CONJUNCTION WITH ANCILLARY OR PERIPHERAL EQUIPMENT NOT MANUFACTURED BY TELULAR, TELULAR DOES NOT WARRANT THE OPERATION OF THE PRODUCT/PERIPHERAL COMBINATION, AND TELULAR SHALL HONOR NO WARRANTY CLAIM WHERE THE PRODUCT IS USED IN SUCH A COMBINATION AND IT IS DETERMINED BY TELULAR THAT THERE IS NO FAULT WITH THE PRODUCT. TELULAR DISCLAIMS LIABILITY FOR RANGE, COVERAGE, AVAILABILITY, OR OPERATION OF THE CELLULAR SYSTEM WHICH IS PROVIDED BY THE CARRIER.**

**IV. WHAT THIS WARRANTY DOES NOT COVER:**

(a) Subsequent upgrades and enhancements to the Product. (b) Defects, non-compliance or damage resulting from use of the Product in other than its normal and customary manner or environment. (c) Defects, noncompliance or damage from misuse, lightening, accident or neglect. (d) Defects, noncompliance or damage from improper testing, operation, maintenance, installation, adjustment, or any alteration or modification of any kind. (e) Product disassembled or repaired in such a manner as to adversely affect performance or prevent adequate inspection and testing to verify any warranty claim. (f) Product which has had the serial number removed or made illegible. (g) Defects, non-compliance or damage due to spills of food or liquid. (h) All plastic surfaces and all other externally exposed parts that are scratched or damaged due to customer normal use. (i) Costs and expenses, including without limitation handling, labor and transportation, incurred in returning Product for warranty service to Telular's Repair Center. (j) Repair, programming or servicing by someone other than Telular.

**V. GENERAL PROVISIONS:**

**THIS WARRANTY IS GIVEN IN LIEU OF ALL OTHER EXPRESS OR STATUTORY WARRANTIES. IMPLIED WARRANTIES, INCLUDING WITHOUT LIMITATION IMPLIED WARRANTIES OF MERCHANTABILITY, FITNESS FOR A PARTICULAR PURPOSE, TITLE, INFRINGEMENT, DELIVERY, NEGLIGENCE AND PERSONAL INJURY, ARE DISCLAIMED. FURTHER, AS THE CELLULAR CARRIER IS NOT CONTROLLED BY TELULAR, NO WARRANTY IS MADE AS TO COVERAGE, AVAILABILITY OR GRADE OF SERVICE PROVIDED BY THE CELLULAR CARRIER. IN NO EVENT SHALL TELULAR BE LIABLE FOR DAMAGES IN EXCESS OF THE PURCHASE PRICE OF THE PRODUCT, FOR ANY LOSS OF USE, LOSS OF TIME, INCONVENIENCE, COMMERCIAL LOSS, LOST PROFITS OR SAVINGS OR OTHER INCIDENTAL, SPECIAL OR CONSEQUENTIAL DAMAGES ARISING OUT OF THE USE OR INABILITY TO USE SUCH PRODUCT TO THE FULL EXTENT SUCH MAY BE DISCLAIMED BY LAW. SOME JURISDICTIONS DO NOT ALLOW THE EXCLUSION OR LIMITATIONS OF INCIDENTAL OR CONSEQUENTIAL DAMAGES OR LIMITATION ON HOW LONG AN IMPLIED WARRANTY LASTS.**

**VI. SOFTWARE PROVISIONS:**

Laws in the United States and other countries preserve for Telular certain exclusive rights for copyrighted Telular software such as the exclusive rights to reproduce in copies and distribute copies of such Telular software. Telular software may be copied into, used in and redistributed with only the Product associated with such Telular software. No other use, including without limitation, disassembly of such Telular software or exercise of exclusive rights in such Telular software is permitted and Telular reserves all rights not expressly granted in this Limited Commercial Warranty.

**Patents:**

Telular Corporation products are protected and manufactured under one or more of the following U.S. patents and related international patents and patents pending relating thereto: 4,658,096; 4,737,975; 4,775,997; 4,868,519; 4,922,517; 5,134,651; 5,361,297; 5,469,494; 5,046,085; 5,715,296.

**Trademarks:**

Telular Corporation owns the following registered trademarks: TELULAR and design, TELULAR, CELJACK, MAXJACK, TELCEL, HEXAGON LOGO, PHONECELL, CELSERV, TELGUARD, CPX, and AXCELL.

## **APPENDIX A:**

### **TO SETUP PC SERIAL PORTS FOR PHONECELL DIGITAL FAX/DATA**

#### **Requirements**

- GSM account with your network service provider including a Data/Fax facility.
- PC/Laptop/ Notebook with Com Port.
- Windows 95/98

**NOTE:** When all of the above have been satisfied, you may proceed.

#### **Modem Setup**

- 1) Power on your PC/laptop and start Windows 95/98.
- 2) Using the PC pointing device, press the "START" button, select "SETTINGS" and then "CONTROL PANEL". Once the Control Panel window appears double click the MODEMS icon button. The modem properties window will appear.

**NOTE:** A data card modem device may appear in the list of installed modems.



- 3) Click the ADD button to install a new modem device for the Phonecell® SX5.

- 4) The install new modem window may appear asking for the type of modem to install. Click on "Other" followed by clicking the NEXT button. If this window does not appear, go to Step 5.

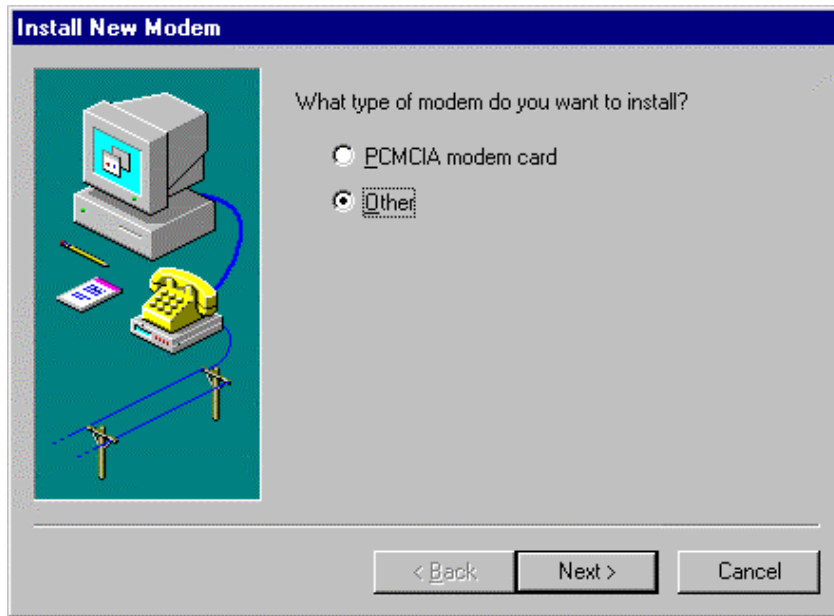

- 5) The install new modem window will appear. Then, click on the "Don't detect my modem option" followed by clicking the NEXT button.

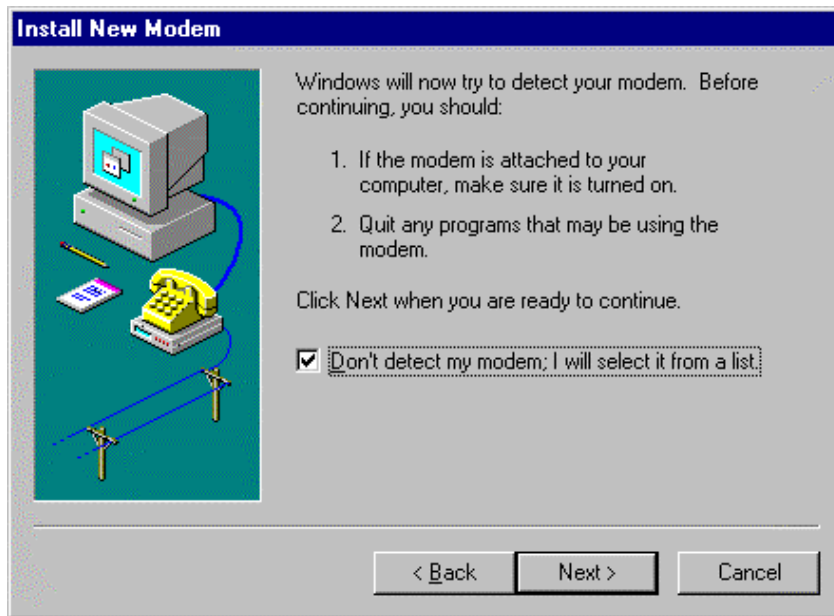

- 6) The install new modem will update again to select the manufacturer and modem model. Click on "Standard Modem Types" from the manufacturers list followed by "Standard 19200 bps Modem" from the model list. Then click on the NEXT button.

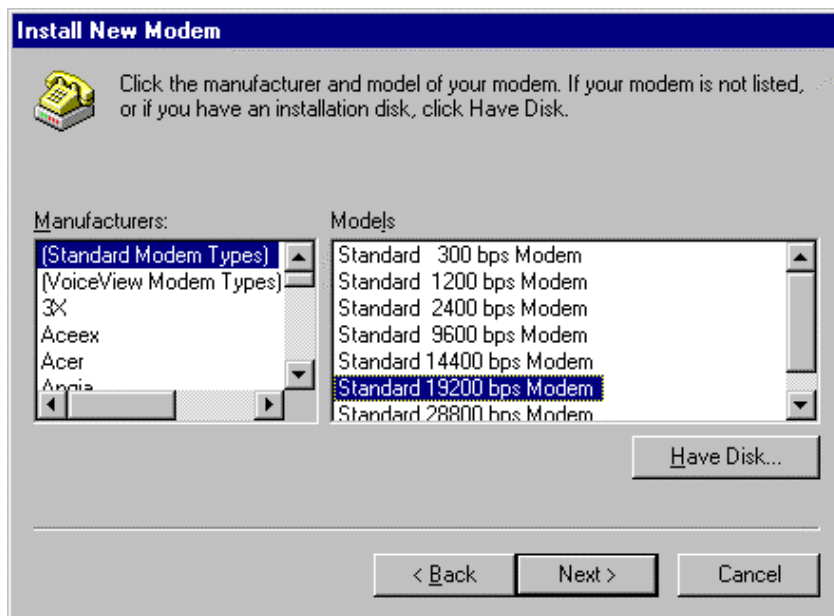

- 7) The install new modem will update to select the com port. Click on the available serial port and then click on the "Next" button. Windows 95 will create a modem configuration file for the Phonecell® SX5. This may take several minutes.

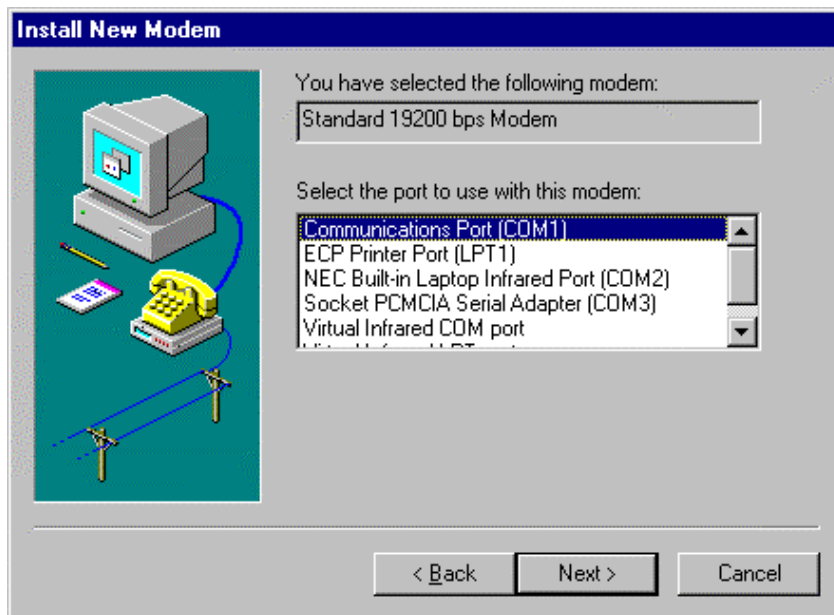

8) The Install New Modem window will update again. Click on Finish to proceed.

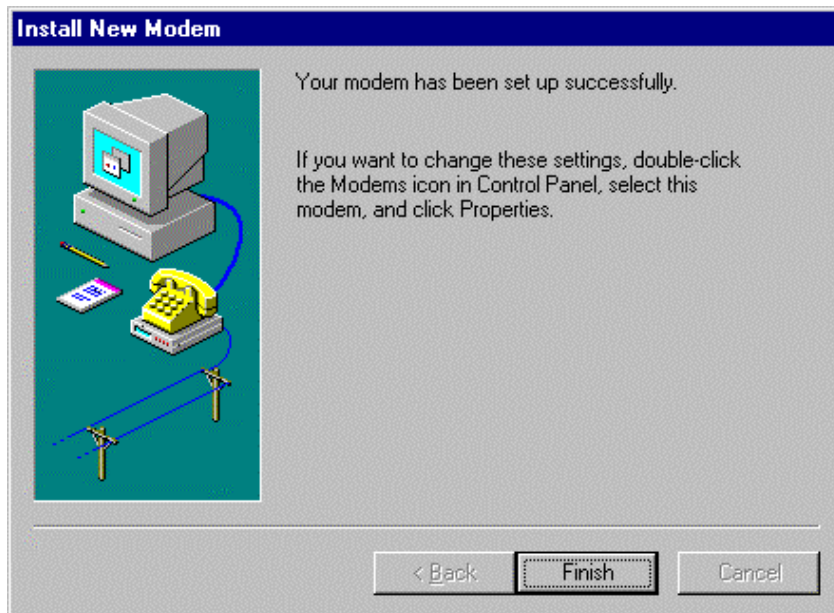

9) The Modems Properties window should appear. Click on the Properties button.



- 10) The Standard 19200 bps Modem Properties window will open in the General tab. Set as shown with the com port you have selected.

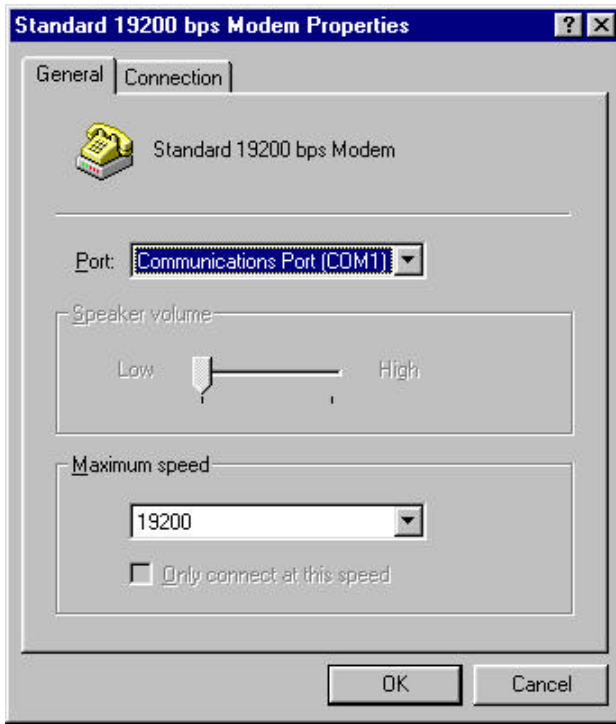

- 11) Click on the Connection tab. Set as shown below.

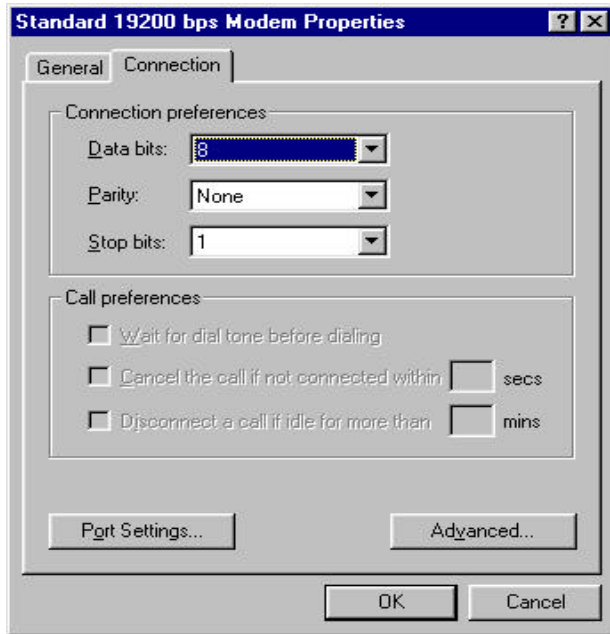

- 12) Click on the Advanced button. Set as shown.
- 13) Click on OK and Close to back out of each window. Your modem is now set up.

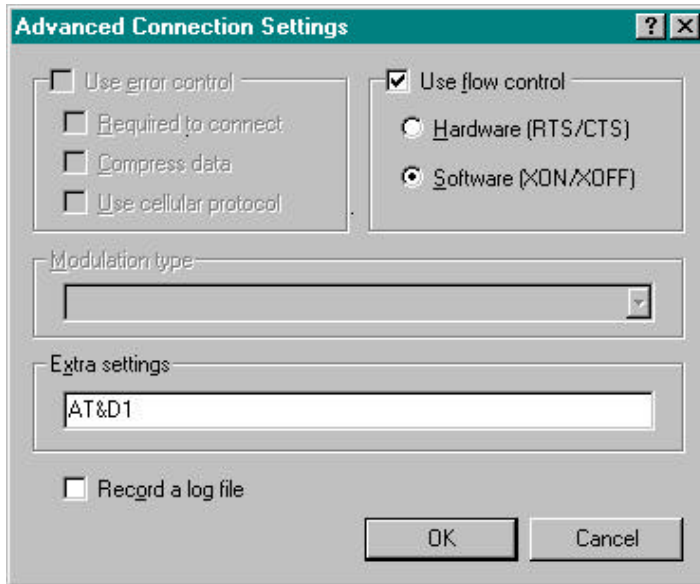

647 North Lakeview Parkway  
Vernon Hills, Illinois 60061, USA  
Tel: 847-247-9400 • Fax: 847-247-0021  
E-mail: [mainoffice@telular.com](mailto:mainoffice@telular.com)  
<http://www.telular.com>