

**TEST REPORT ON
PHONECELL SX4E**

PCS 1900 DEVICE OPERATING ON
1850.400 MHz to 1909.600 MHz
FCC Procedures
Part 24 and Part 15

**TEST REPORT NUMBER
CTMS 2001/1957b
August 2001**

Prepared for:

**Telular Corporation,
647 North Lakeview Parkway,
Vernon Hills,
IL 60061,
USA.**

The results in this report refer to the tested unit only

General Test Information

Date Test Sample Received : 06/07/2001

Date Testing Started : 06/07/2001

Date Testing Finished : 09/08/2001

Equipment Serial Number : 9

CTMS Project Number : 2001/1957b

Test Engineer : M. Billis

Technical Manager : D. Fisher

APPROVED BY:- _____ DATE _____

D. Fisher
Head of Laboratory

Report Copy No 1

Contents list and Information

2.1033 (b) (1)	Name of applicant	:	Telular Corporation
	Address of applicant	:	647 North Lakeview Parkway, Vernon Hills, IL 60061, USA.
			Contact: Jeff Hickey
2.1033 (b) (2)	FCC Identifier	:	MTF00701
	Model Type Number	:	Phonecell SX4E
2.1033 (b) (6)	Report of measurements	:	Page 7
2.1033 (7)	Photographs of equipment and identification plate / label	:	Page 53
15	Subpart A General		
15.31	Measurement standards (OATS)	:	Page 5
15.33	Frequency range of radiated measurements	:	Page 6
15.35	Measurement detector and bandwidths	:	Page 6
15	Subpart B unintentional Radiators (Unit in idle mode)		
15.109	Radiated Emission Limits	:	page 46
15.111	Antenna Power Conducted Limits	:	page 47
15.107	Conducted Limits (mains)	:	page 48

**15 Subpart C Intentional Radiators
(Unit in call)**

15.207 Conducted Limits (mains) : page 50

**24 Subpart E Broadband PCS
(Unit in call)**

24.232 Power Limits : page 7

24.235 Frequency Stability : page 19

24.238 Spurious Emission Limits : page 10

General Information and Attachments :

Company Accreditations & Credentials : Page 62

Test Instruments and ancillaries used : Page 71

15.31 Measurement standards

The measurement facilities at Cambridge Test and Measurement Services LTD, are in accordance with ANCI C63.4 and lodged with the FCC under rule 2.948, a letter from the FCC recognising compliance with the requirements was dated March 02,1999 with the registration number 93385.

Open Area Test Site (OATS)

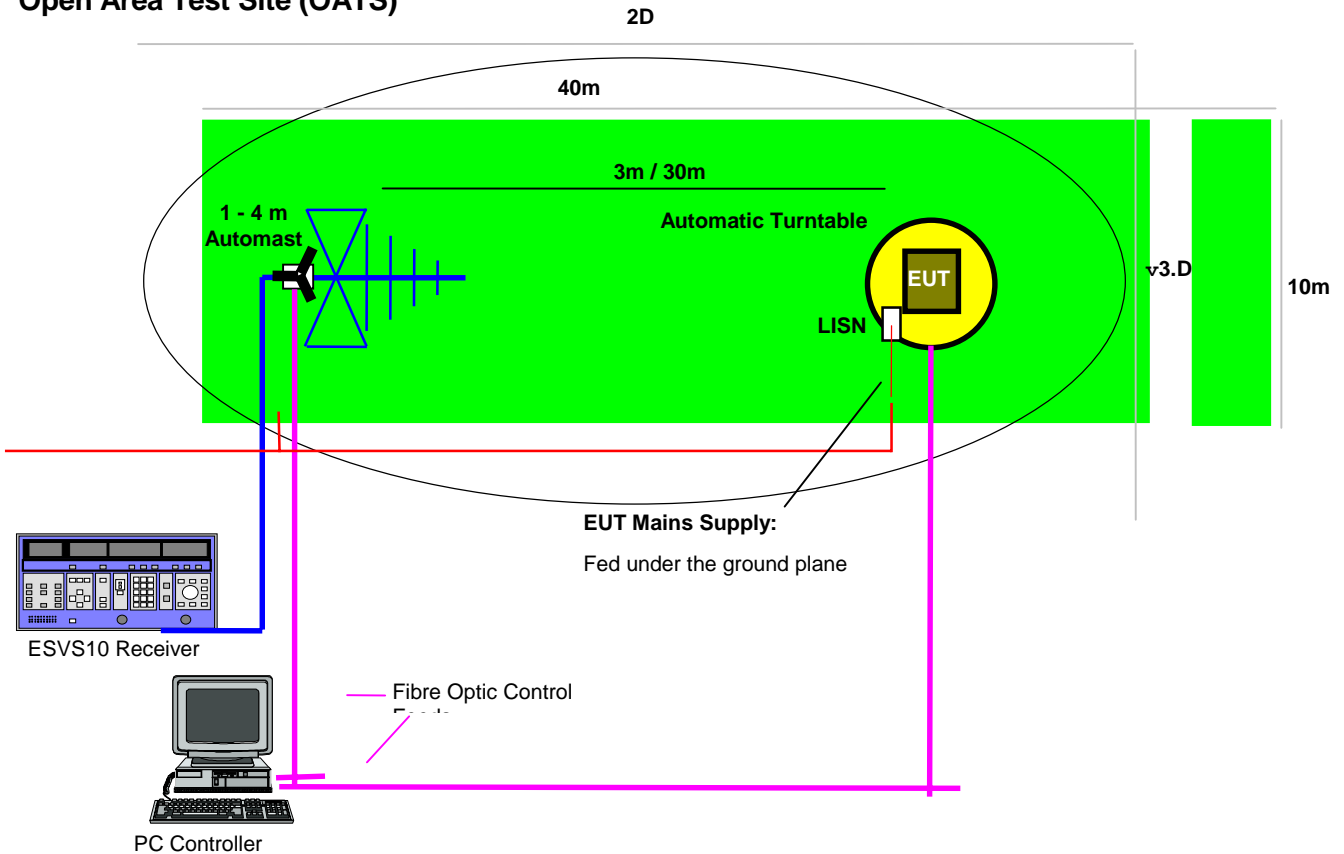

Equipment Test Set Up

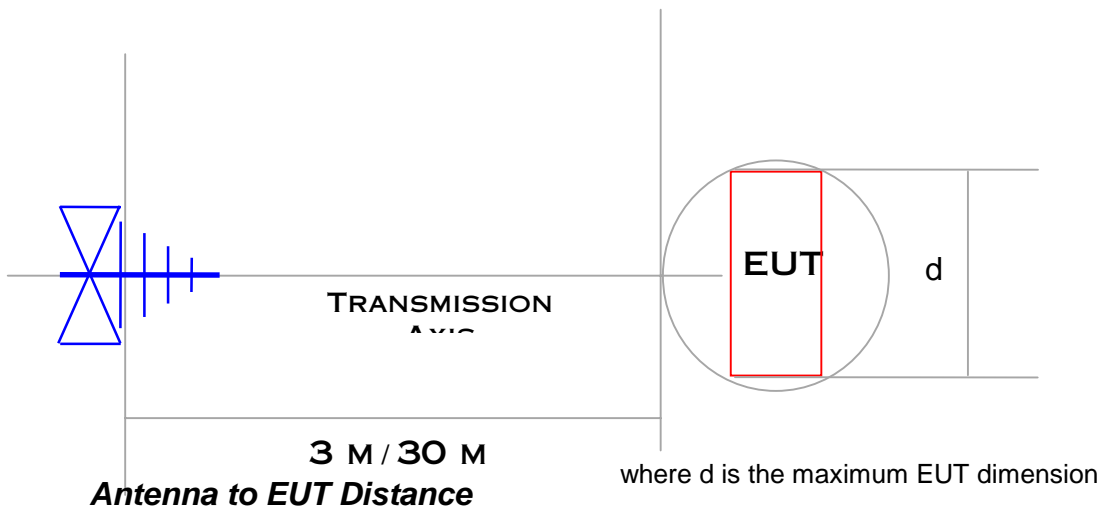

Frequency spectrum to be investigated - 47 CFR 15.33

The range of frequency search was from 9 kHz 20 GHz.

Measurement detector and bandwidths 47 CFR 15.35

Measurements below 1000 MHz are taken using a quasi-peak detector which has been calibrated to the requirements of CISPR 16-1.

General Test Conditions

Laboratory environment .

Ambient Temperature : 21 °C

Relative Humidity : 50 %

Open Area test Site : 23 °C

Test Instruments used

The complete list of laboratory instruments and ancillaries is included at the end of this report.

Transmitter emission limits- 47 CFR 24.232

The Transmitter (the EUT) was set to continuous transmit, and was placed on a wooden table at a distance of 3m from the receiving antenna.

For measurement of emissions above 1 GHz an absorber lined room was used, which is accepted in ANSI C63.4 in this frequency range.

The ETSI ETR 027 substitution method was used to measure the radiated peak power of the transmitter.

The calibrated Signal generator, cable and antenna were used to set up a field of 10dBm eirp at 3m as follows;

R & S Antenna item 904 gain = 8.3 dBi (= 6.15dB gain over a dipole)
Cables 128 + 129 loss = 5.4 dB
Signal Generator item 35 output = 7.1 dBm

The received level of the reference field was noted. Using the Spectrum analyser (item 69) with RBW and VBW set to 1 MHz and maximum hold.

With the EUT replacing the substitution antenna the increase in the received level was recorded using the maximum hold facility. The results were:-

Operating Frequency MHz	Increase from Reference dB	Tx Power eirp Watts	Tx power ERP Watts
1850.400	21.87	1.54	0.938
1880.000	20.08	1.02	0.621
1909.600	20.04	1.01	0.615

Measurement set up.

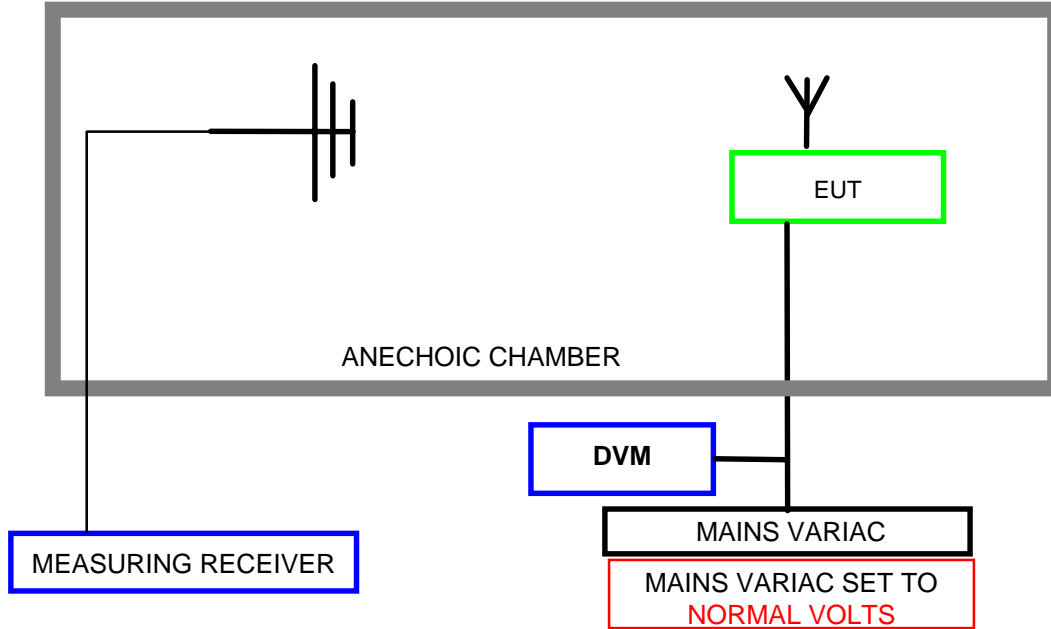

Substitution set up.

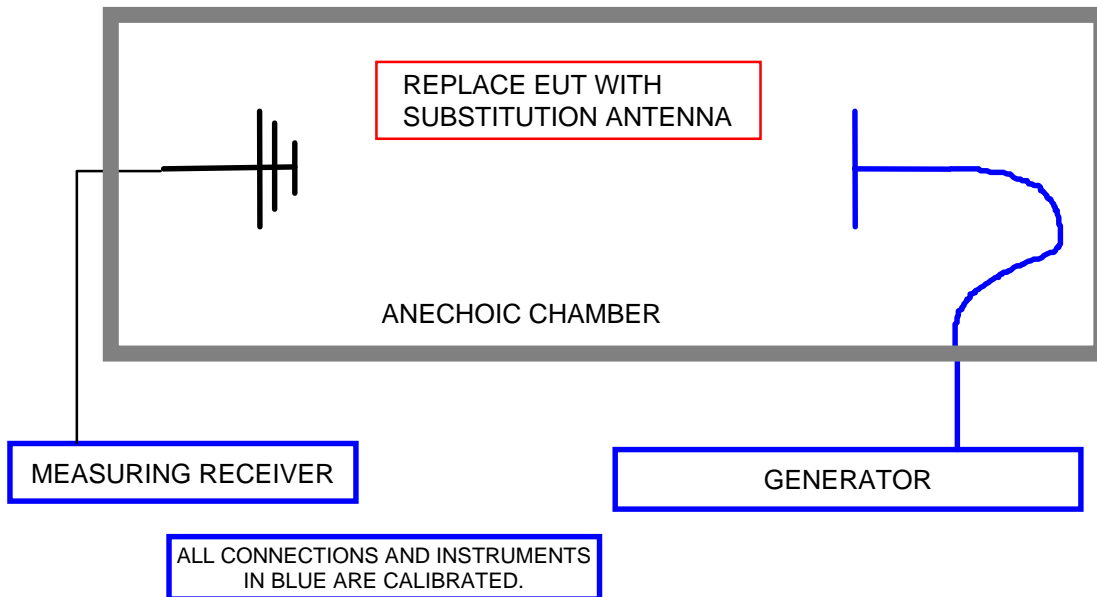

Test Instruments used (see general information).

69, 32, 57, 904, 922, 118, 813, 35, 128, 129, 907, Racal 6104/77 Test Set S/N 5010.

Results in accordance with Part 24.232(b) Radiated Power Limits - Mobile/portable stations.

Field Strength of Fundamental (with supplied 115V AC power supply)

Operating Frequency (MHz)	Identity	Result <u>e.i.r.p. (Watts)</u>	Spec limit <u>e.i.r.p. (Watts)</u>	Result ERP (Watts)
1850.400	Fundamental	1.54	2.00	0.938
1880.000	Fundamental	1.02	2.00	0.621
1909.600	Fundamental	1.01	2.00	0.615

Emission Limits 47CFR 24.238.

The Transmitter (the EUT) was set to continuous transmit, and was placed on a wooden table at a distance of 3m from the receiving antenna. The radiated field strength for each spurious emission was detected and measured on a calibrated receiver.

The antenna was orientated in the horizontal and vertical planes and was raised and lowered between a height of 1 and 4 metres so as to ensure the maximum level of any spurious emission was detected.

The EUT was rotated through 360° at each orthogonal axis, the emission levels for each spurious were observed on the receiver and recorded.

For each of the emissions detected the EUT was switched off to determine the emission was that of the EUT.

For measurement of emissions below 30 MHz a Calibrated shielded loop antenna was used.

For measurement of emissions above 1 GHz an absorber lined room was used, which is accepted in ANSI C63.4 in this frequency range.

The ETSI ETR 027 substitution method was used to measure the radiated power of the spurious emissions of the transmitter. The peak power of emissions outside the authorised frequency band used the above method with the reference level set to the -13 dBm limit. All emissions were less than -23 dBm as recorded on page 12.

Test Instruments used (see general information).

69, 32, 57, 904, 922, 118, 813, 35, 128, 129, 907, Racal 6104/77 Test Set S/N 5010.

In the 1 MHz frequency bands immediately outside and adjacent to the frequency block, the measurement of occupied bandwidth as described below was used. The emission 26dB bandwidth measured 4.06 MHz giving a minimum resolution bandwidth of 100 kHz specified in 24.238 (b).

To obtain an accurate plot of the occupied bandwidth a 100 kHz Resolution bandwidth was used with maximum hold facility on and a video bandwidth of 3 MHz. Maximum hold was used for at least ten scans to capture all the sidebands. To enable the system for transmission a directional coupler was connected between the EUT and the RACAL 6104/77 Test Set as shown.

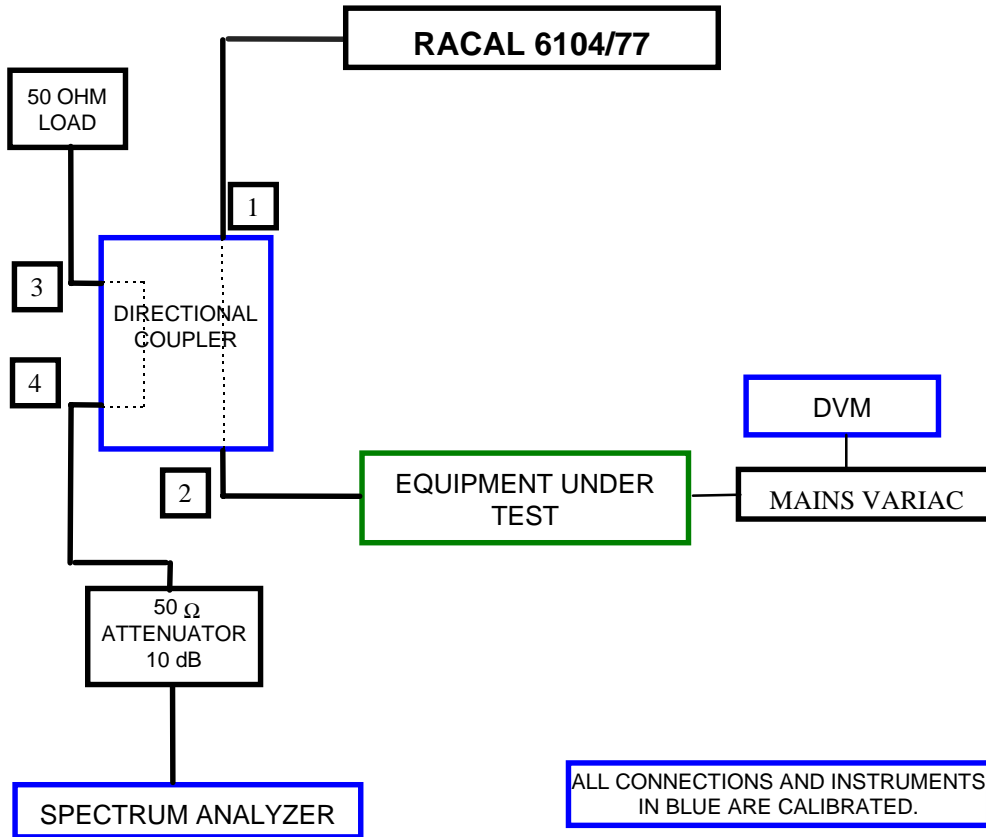

Test equipment used (listed in section 2):-

3, 69, 32, 57, 11, 44, 907, 112, 106, 7, 8, Racal 6104/77 Test Set S/N 5010

The results on pages 13 and 14 show the power at the band edge was attenuated much more than 43 dB below the carrier power.

Results in accordance with Part 24.238(a) Radiated Emission Limits

Emission Limits (with supplied 115V AC power supply)

Operating Frequency (MHz)	Identity	Result <u>dBm e.i.r.p.</u>	Spec limit - [43 + 10 log (P)] dBc
1850.400	All harmonics and spurious	All > 10 dB in spec.	- 13 dBm e.i.r.p.
1880.000	All harmonics and spurious	All > 10 dB in spec.	- 13 dBm e.i.r.p.
1909.600	All harmonics and spurious	All > 10 dB in spec.	- 13 dBm e.i.r.p.

Results in accordance with Part 24.238(b) Emission Limits

**PCS Bandwidth (-26 dBc)
(Lowest Frequency)**

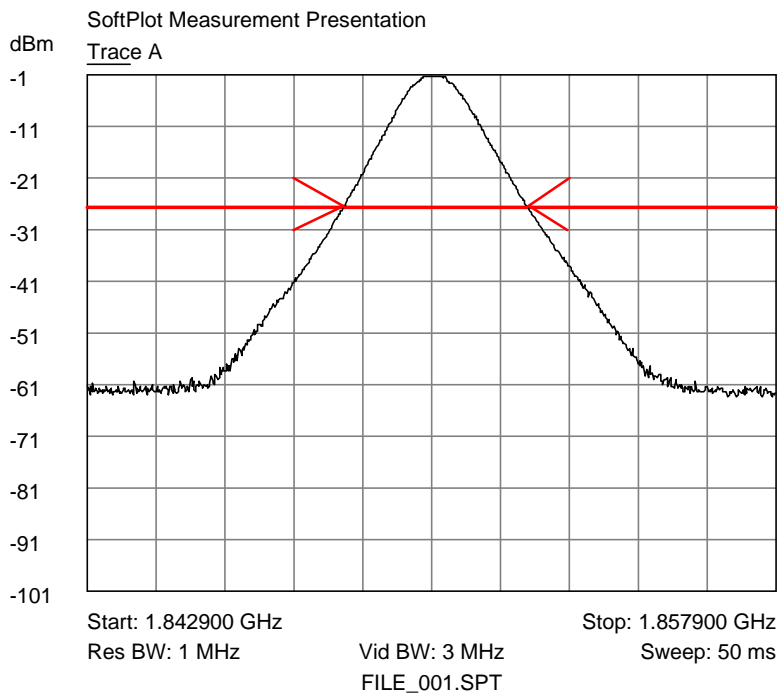

- 26 dBc bandwidth = 4.06 MHz

Results in accordance with Part 24.238(b) Emission Limits

PCS – Band Edge Emission Profile
(with supplied 115 V AC power supply)
(Lower band edge)

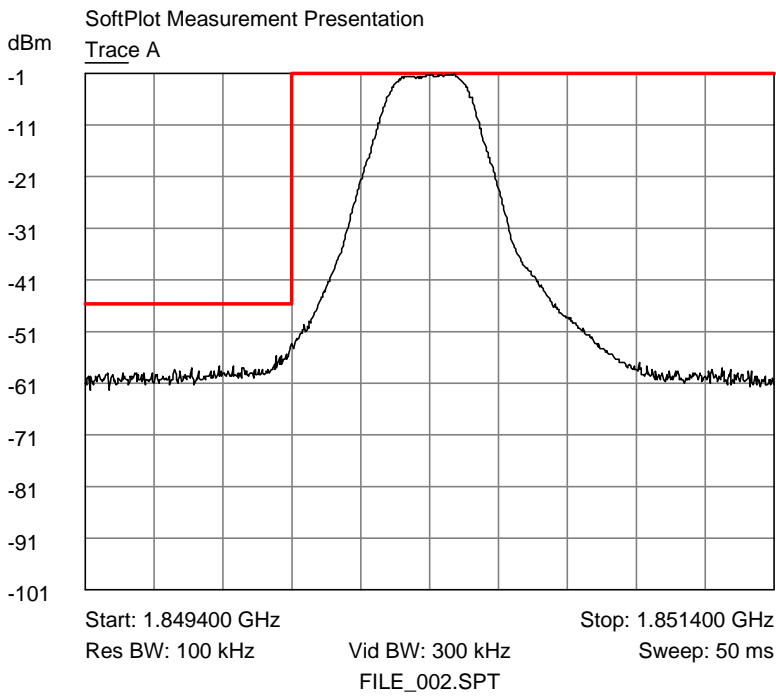

Mask showing compliance at the lower band edge (1850.000 MHz) based on an attenuation of $- [43 + 10 \log (P)]$ dBc, where P is 1.54 Watts E.I.R.P., which is the radiated output power with the unit under test set to the lowest declared operating frequency of 1850.400 MHz, at the highest available output power, fully modulated.

Results in accordance with Part 24.238(b) Emission Limits

**PCS Bandwidth
(Mid) Frequency**

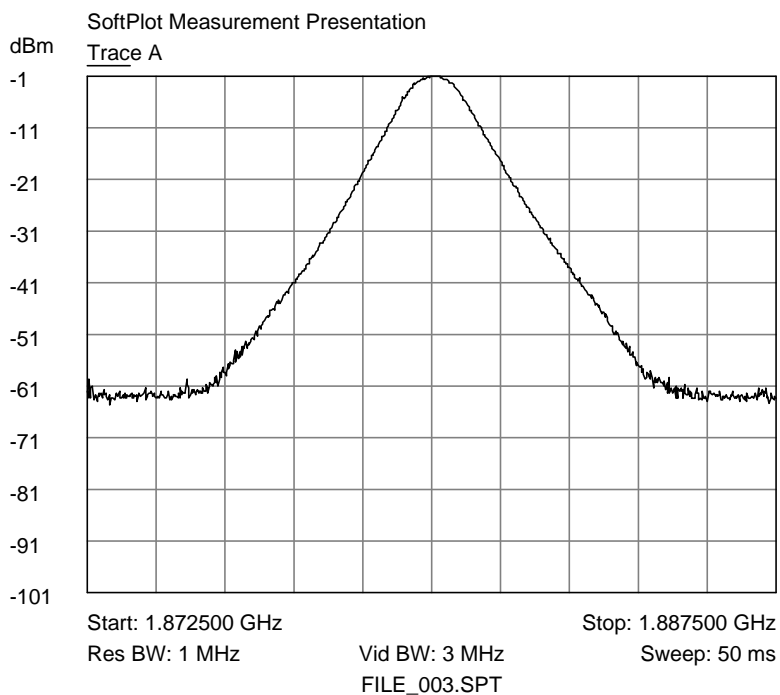

Results in accordance with Part 24.238(b) Emission Limits

PCS – Bandwidth
(with supplied 115 V AC power supply)
(Mid Frequency)

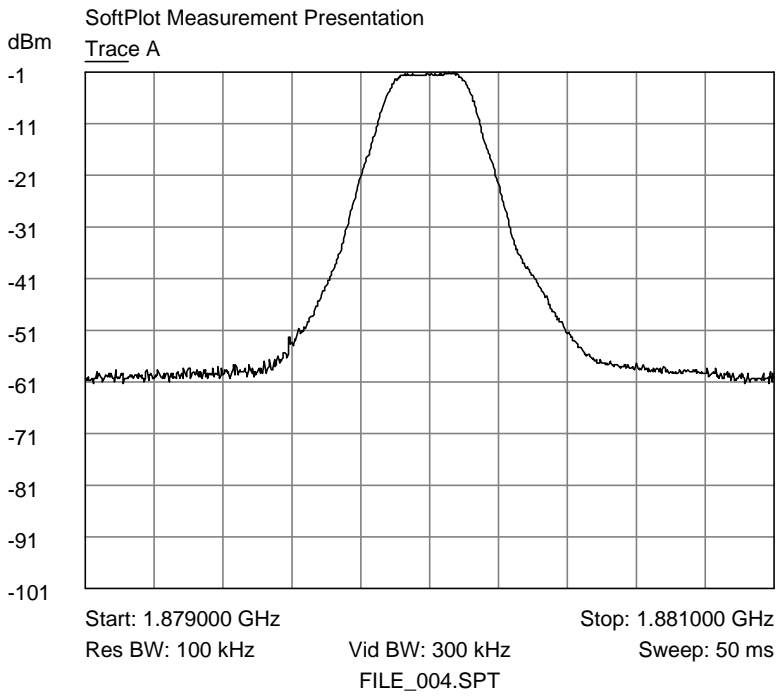

Results in accordance with Part 24.238(b) Emission Limits

**PCS Bandwidth (-26 dBC)
(Highest Frequency)**

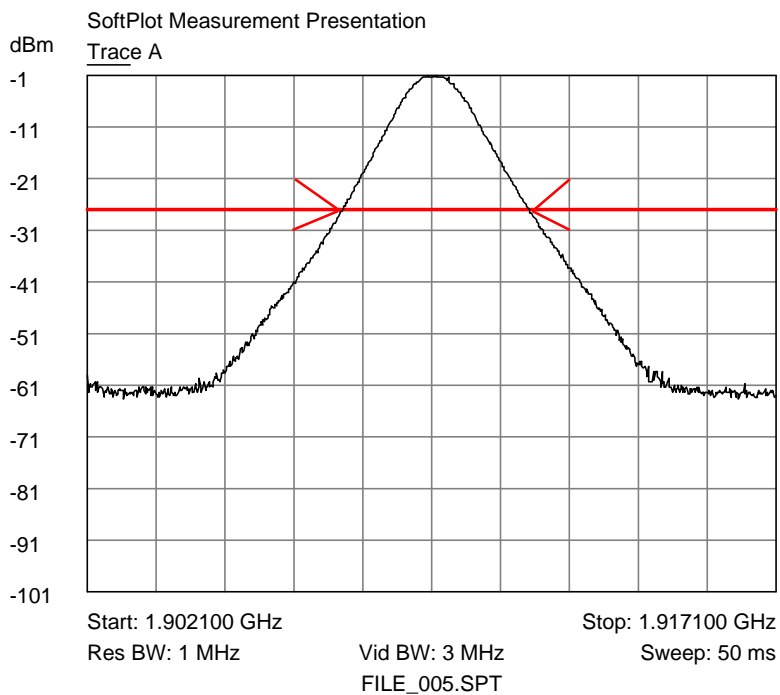

- 26 dBc bandwidth = 4.06 MHz

Results in accordance with Part 24.238(b) Emission Limits

PCS – Band Edge Emission Profile
(with supplied 115 V AC power supply)
(Upper band edge)

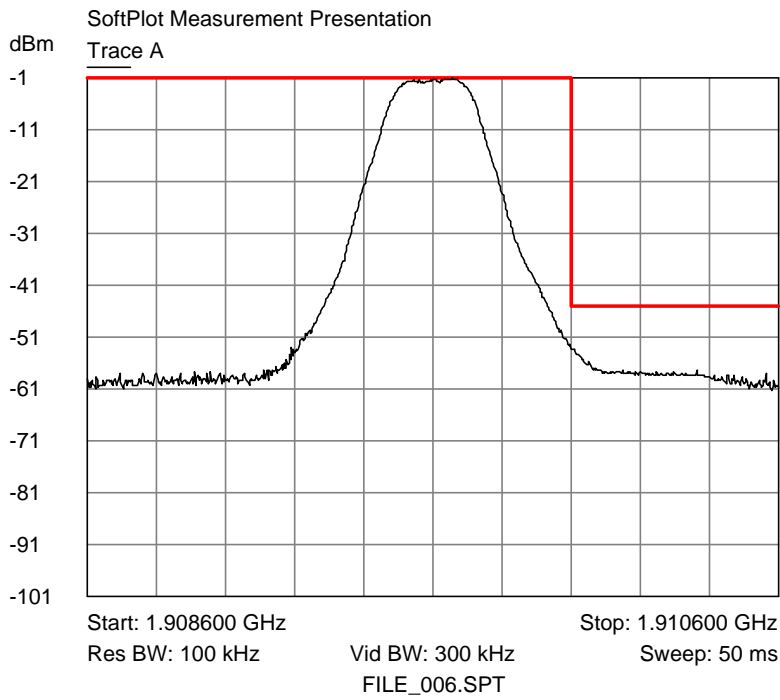

Mask showing compliance at the upper band edge (1910.000 MHz) based on an attenuation of $- [43 + 10 \log (P)]$ dBc, where P is 1.01 Watts E.I.R.P., which is the radiated output power with the unit under test set to the lowest declared operating frequency of 1909.600 MHz, at the highest available output power, fully modulated

Frequency Stability 47CFR 24.235.

The frequency drift with variation of ambient temperature and both mains and battery voltage were measured as occupied bandwidth plots (as required in 47CFR 2.1049) to ensure that the emission remained within the authorized frequency block.

The Frequency Drift in parts per million (ppm) is calculated for each condition from measurements of the bandwidth at two levels and averaged.

Temperature °C	Tx Frequency Drift from Nominal 1850.400 MHz	Tx Frequency Drift from Nominal 1909.600 MHz
-30	-5.6 ppm	-6.4 ppm
-20	-7.1 ppm	-6.9 ppm
-10	-7.6 ppm	-5.9 ppm
0	-5.1 ppm	-6.4 ppm
+10	-6.6 ppm	-6.4 ppm
+20	-6.6 ppm	-7.9 ppm
+30	-7.1 ppm	-5.5 ppm
+40	-5.6 ppm	-7.4 ppm
+50	-7.1 ppm	-5.9 ppm

VOLTAGE	Tx Frequency Drift from Nominal 1850.400 MHz	Tx Frequency Drift from Nominal 1909.600 MHz
97.75 V AC	-8.1 ppm	-7.4 ppm
115 V AC	-8.1 ppm	-7.4 ppm
132.25 V AC	-8.1 ppm	-6.9 ppm
5.95 V DC	-7.1 ppm	-8.4 ppm
7.0 V DC	-7.1 ppm	-6.9 ppm
7.7 V DC	-7.1 ppm	-7.4 ppm

Results in accordance with Part 24.235(b) Frequency Stability and part 2.1055(d)(1) Frequency Stability with Primary Voltage Variation

**PCS - Band Edge Emission Profile (with supplied 115V AC power supply)
(Lower band edge)**

Lower voltage extreme: 97.75 V AC

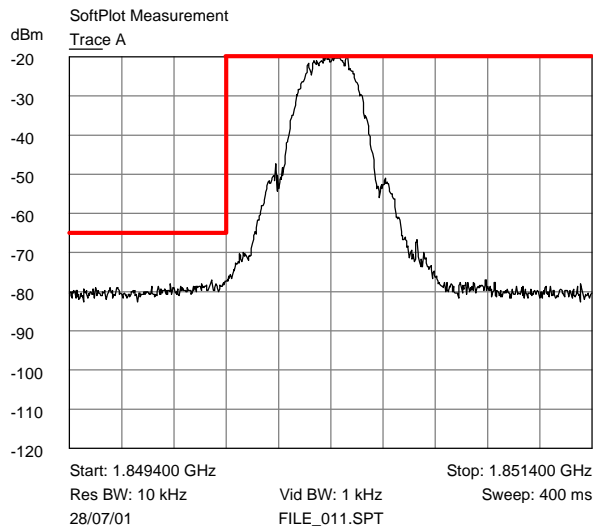

Mask Showing compliance at the lower band edge (1850.000 MHz) based on an attenuation of $- [43 + 10 \log (P)]$ dBc, where P is the radiated output power, with the unit under test set to the lowest declared operating frequency of 1850.400 MHz, at the highest available output power, fully modulated, **at 85 % of the declared AC primary voltage.**

Results in accordance with Part 24.235(b) Frequency Stability
and part 2.1055(d)(1) Frequency Stability with Primary Voltage Variation

**PCS - Band Edge Emission Profile (with supplied 115V AC power supply)
(Lower band edge)**

Upper voltage extreme: 132.25 V AC

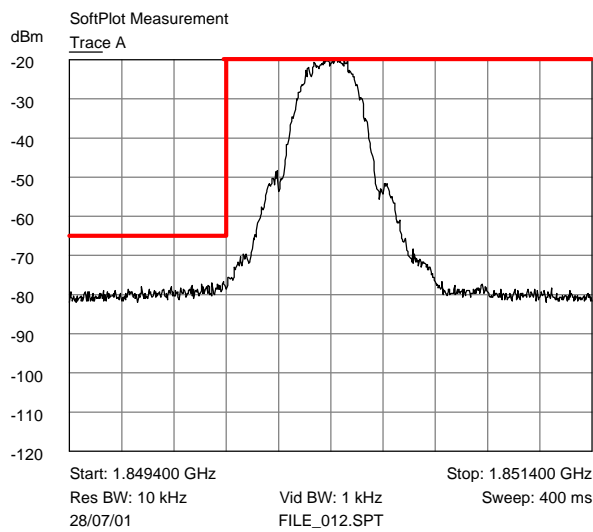

Mask Showing compliance at the lower band edge (1850.000 MHz) based on an attenuation of $- [43 + 10 \log (P)]$ dBc, where P is the radiated output power, with the unit under test set to the lowest declared operating frequency of 1850.400 MHz, at the highest available output power, fully modulated, **at 115 % of the declared AC primary voltage.**

Results in accordance with Part 24.235(b) Frequency Stability
and part 2.1055(d)(1) Frequency Stability with Primary Voltage Variation

**PCS - Band Edge Emission Profile (with Lab. DC supply)
(Lower band edge)**

Lower voltage extreme: 5.95 V DC

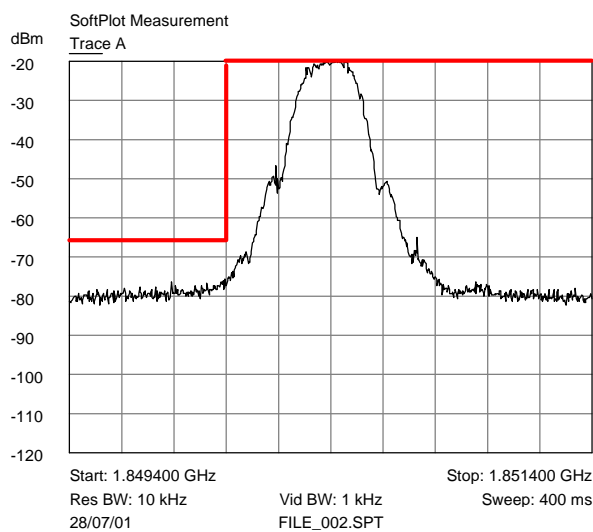

Mask Showing compliance at the lower band edge (1850.000 MHz) based on an attenuation of - [43 + 10 log (P)] dBc, where P is the radiated output power, with the unit under test set to the lowest declared operating frequency of 1850.400 MHz, at the highest available output power, fully modulated, **at 85 % of the declared DC input voltage.**

Results in accordance with Part 24.235(b) Frequency Stability
and part 2.1055(d)(1) Frequency Stability with Primary Voltage Variation

**PCS - Band Edge Emission Profile (with Lab. DC supply)
(Lower band edge)**

Upper voltage extreme: 7.70 V DC

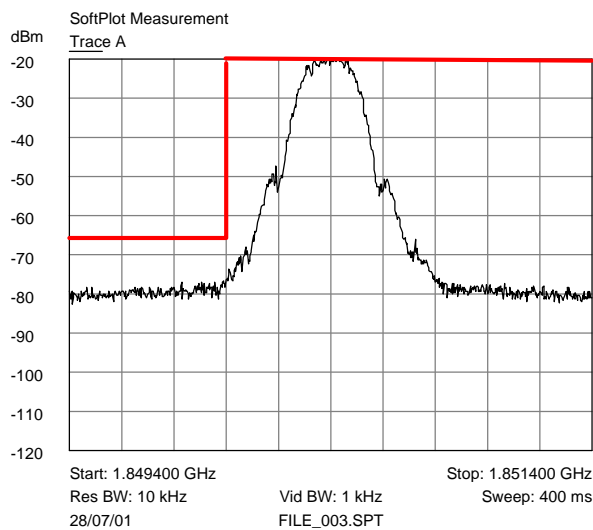

Mask Showing compliance at the lower band edge (1850.000 MHz) based on an attenuation of - [43 + 10 log (P)] dBc, where P is the radiated output power, with the unit under test set to the lowest declared operating frequency of 1850.400 MHz, at the highest available output power, fully modulated, **at 115 % of the declared DC input voltage.**

Results in accordance with Part 24.235(b) Frequency Stability
and part 2.1055(d)(1) Frequency Stability with Primary Voltage Variation

**PCS - Band Edge Emission Profile (with supplied 115V AC power supply)
(Upper band edge)**

Lower voltage extreme: 97.75 V AC

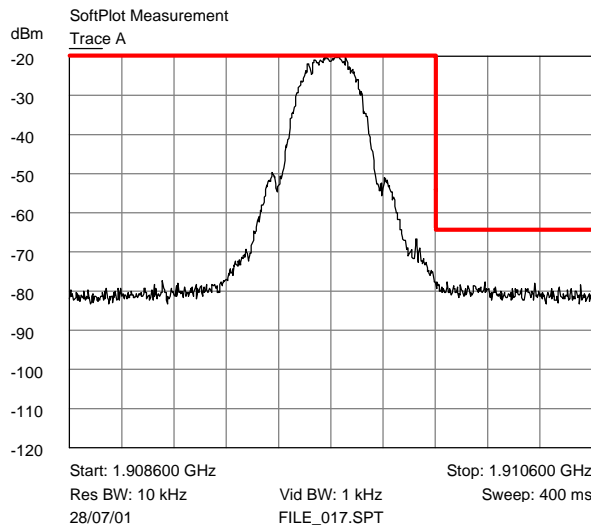

Mask Showing compliance at the upper band edge (1910.000 MHz) based on an attenuation of $- [43 + 10 \log (P)]$ dBc, where P is the radiated output power, with the unit under test set to the lowest declared operating frequency of 1909.600 MHz, at the highest available output power, fully modulated, **at 85 % of the declared AC primary voltage.**

Results in accordance with Part 24.235(b) Frequency Stability
and part 2.1055(d)(1) Frequency Stability with Primary Voltage Variation

**PCS - Band Edge Emission Profile (with supplied 115V AC power supply)
(Upper band edge)**

Upper voltage extreme: 132.25 V AC

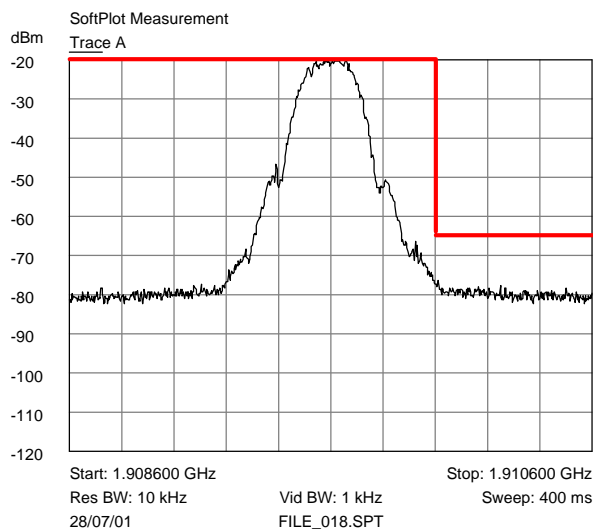

Mask Showing compliance at the upper band edge (1910.000 MHz) based on an attenuation of $- [43 + 10 \log (P)]$ dBc, where P is the radiated output power, with the unit under test set to the lowest declared operating frequency of 1909.600 MHz, at the highest available output power, fully modulated, **at 115 % of the declared AC primary voltage.**

Results in accordance with Part 24.235(b) Frequency Stability
and part 2.1055(d)(1) Frequency Stability with Primary Voltage Variation

**PCS - Band Edge Emission Profile (with lab DC power supply)
(Upper band edge)**

Lower voltage extreme: 5.95 V DC

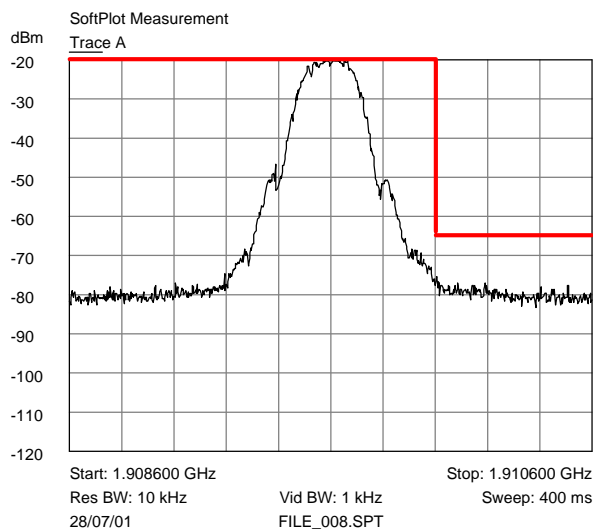

Mask Showing compliance at the upper band edge (1910.000 MHz) based on an attenuation of $- [43 + 10 \log (P)]$ dBc, where P is the radiated output power, with the unit under test set to the lowest declared operating frequency of 1909.600 MHz, at the highest available output power, fully modulated, **at 85 % of the declared DC input voltage.**

Results in accordance with Part 24.235(b) Frequency Stability
and part 2.1055(d)(1) Frequency Stability with Primary Voltage Variation

**PCS - Band Edge Emission Profile (with lab DC power supply)
(Upper band edge)**

Upper voltage extreme: 7.70 V DC

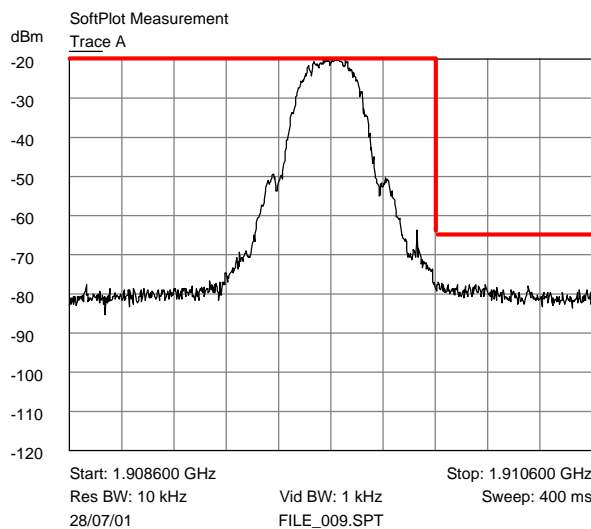

Mask Showing compliance at the upper band edge (1910.000 MHz) based on an attenuation of $- [43 + 10 \log (P)]$ dBc, where P is the radiated output power, with the unit under test set to the lowest declared operating frequency of 1909.600 MHz, at the highest available output power, fully modulated, **at 115 % of the declared DC input voltage.**

Results in accordance with Part 24.235(b) Frequency Stability
and part 2.1055(a)(1) Frequency Stability with Temperature Variation

**PCS - Band Edge Emission Profile (with supplied 115V AC power supply)
(Lower band edge)**

Unit at -30°C

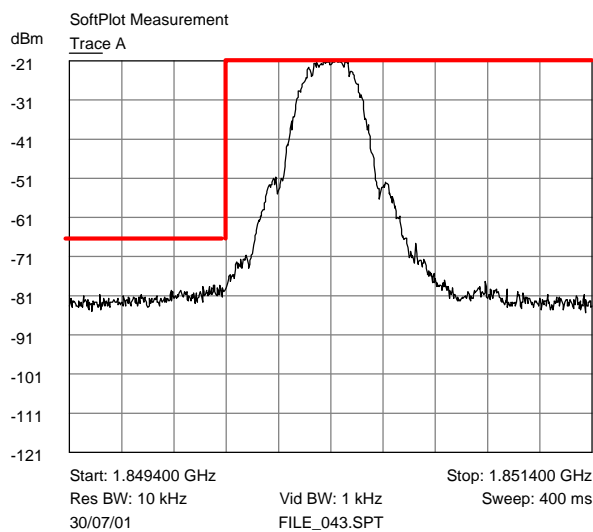

Mask Showing compliance at the lower band edge (1850.000 MHz) based on an attenuation of $- [43 + 10 \log (P)]$ dBc, where P is the radiated output power at room temperature, with the unit under test set to the lowest declared operating frequency of 1850.400 MHz, at the highest available output power, fully modulated.

Results in accordance with Part 24.235(b) Frequency Stability
and part 2.1055(a)(1) Frequency Stability with Temperature Variation

**PCS - Band Edge Emission Profile (with supplied 115V AC power supply)
(Lower band edge)**

Unit at -20°C

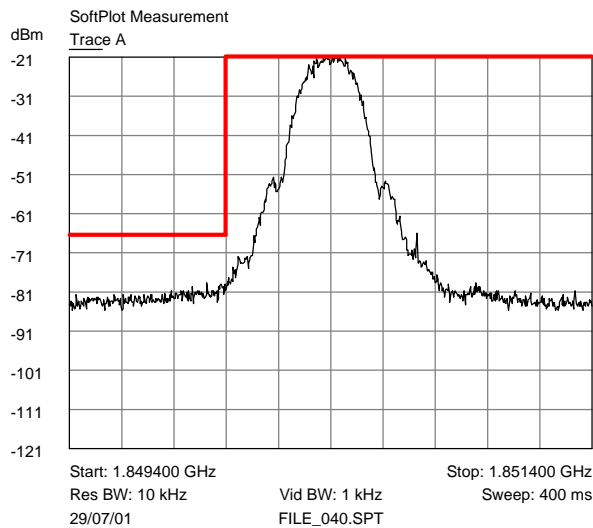

Mask Showing compliance at the lower band edge (1850.000 MHz) based on an attenuation of $- [43 + 10 \log (P)]$ dBc, where P is the radiated output power at room temperature, with the unit under test set to the lowest declared operating frequency of 1850.400 MHz, at the highest available output power, fully modulated.

Results in accordance with Part 24.235(b) Frequency Stability
and part 2.1055(a)(1) Frequency Stability with Temperature Variation

**PCS - Band Edge Emission Profile (with supplied 115V AC power supply)
(Lower band edge)**

Unit at -10°C

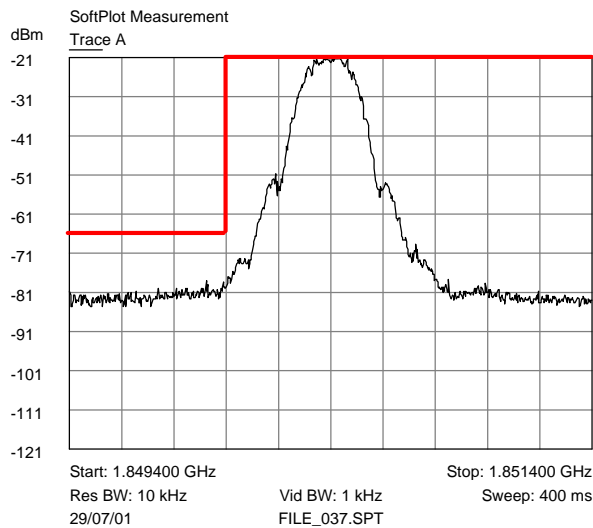

Mask Showing compliance at the lower band edge (1850.000 MHz) based on an attenuation of $- [43 + 10 \log (P)]$ dBc, where P is the radiated output power at room temperature, with the unit under test set to the lowest declared operating frequency of 1850.400 MHz, at the highest available output power, fully modulated.

Results in accordance with Part 24.235(b) Frequency Stability
and part 2.1055(a)(1) Frequency Stability with Temperature Variation

**PCS - Band Edge Emission Profile (with supplied 115V AC power supply)
(Lower band edge)**

Unit at 0°C

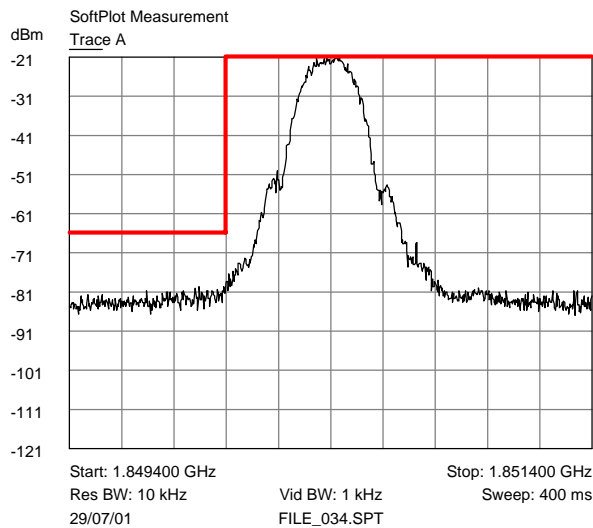

Mask Showing compliance at the lower band edge (1850.000 MHz) based on an attenuation of $- [43 + 10 \log (P)]$ dBc, where P is the radiated output power at room temperature, with the unit under test set to the lowest declared operating frequency of 1850.400 MHz, at the highest available output power, fully modulated.

Results in accordance with Part 24.235(b) Frequency Stability
and part 2.1055(a)(1) Frequency Stability with Temperature Variation

**PCS - Band Edge Emission Profile (with supplied 115V AC power supply)
(Lower band edge)**

Unit at + 10°C

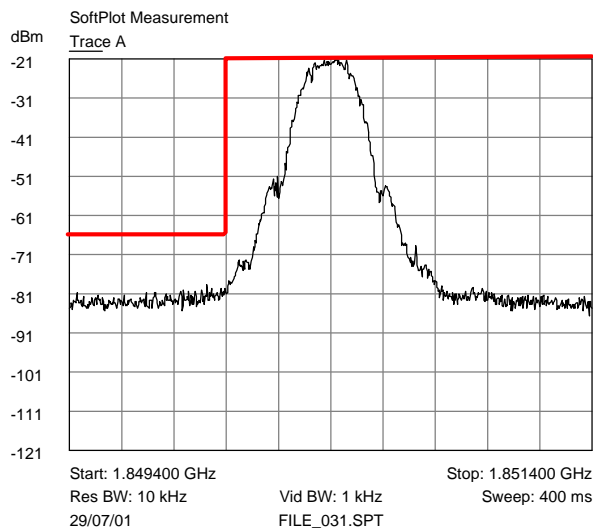

Mask Showing compliance at the lower band edge (1850.000 MHz) based on an attenuation of $- [43 + 10 \log (P)]$ dBc, where P is the radiated output power at room temperature, with the unit under test set to the lowest declared operating frequency of 1850.400 MHz, at the highest available output power, fully modulated.

Results in accordance with Part 24.235(b) Frequency Stability
and part 2.1055(a)(1) Frequency Stability with Temperature Variation

**PCS - Band Edge Emission Profile (with supplied 115V AC power supply)
(Lower band edge)**

Unit at + 20°C

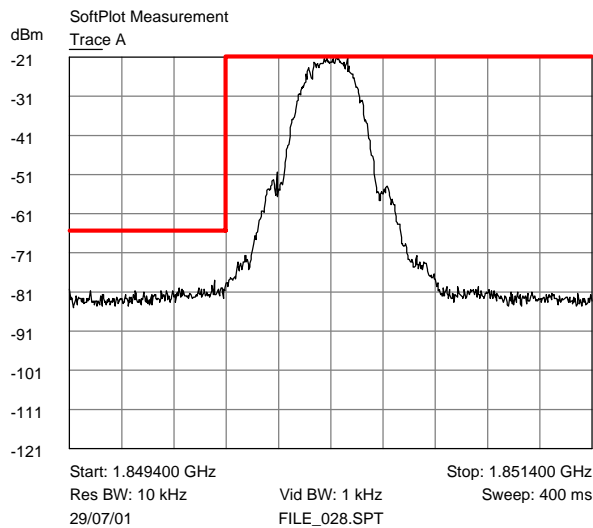

Mask

compliance at the lower band edge (1850.000 MHz) based on an attenuation of - [43 + 10 log (P)] dBc, where P is the radiated output power at room temperature, with the unit under test set to the lowest declared operating frequency of 1850.400 MHz, at the highest available output power, fully modulated.

Showing

Results in accordance with Part 24.235(b) Frequency Stability
and part 2.1055(a)(1) Frequency Stability with Temperature Variation

**PCS - Band Edge Emission Profile (with supplied 115V AC power supply)
(Lower band edge)**

Unit at + 30°C

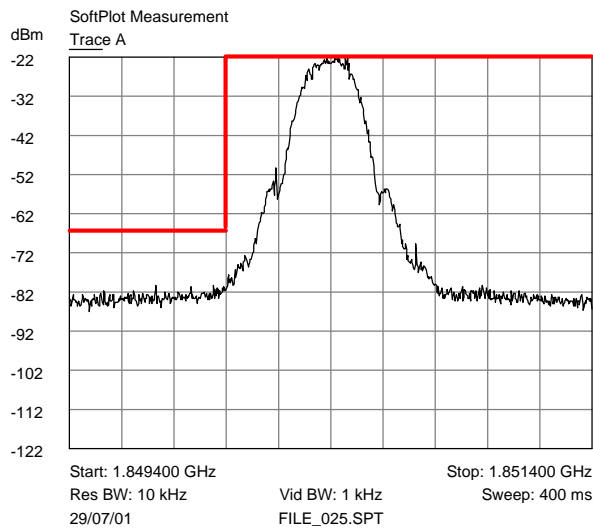

Mask Showing compliance at the lower band edge (1850.000 MHz) based on an attenuation of $- [43 + 10 \log (P)]$ dBc, where P is the radiated output power at room temperature, with the unit under test set to the lowest declared operating frequency of 1850.400 MHz, at the highest available output power, fully modulated.

Results in accordance with Part 24.235(b) Frequency Stability
and part 2.1055(a)(1) Frequency Stability with Temperature Variation

**PCS - Band Edge Emission Profile (with supplied 115V AC power supply)
(Lower band edge)**

Unit at + 40°C

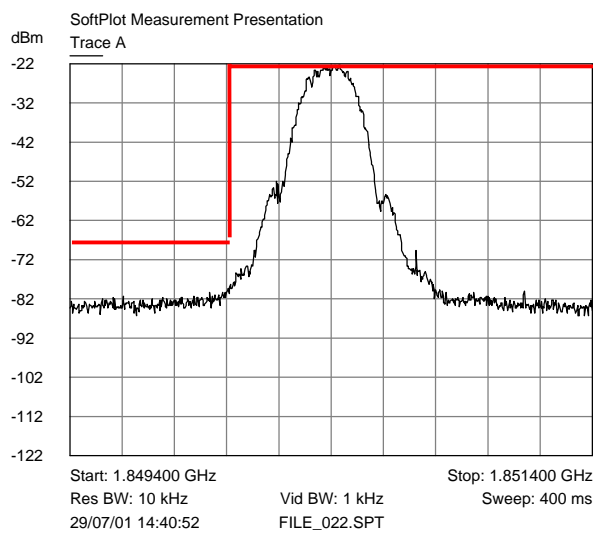

Mask Showing compliance at the lower band edge (1850.000 MHz) based on an attenuation of - [43 + 10 log (P)] dBc, where P is the radiated output power at room temperature, with the unit under test set to the lowest declared operating frequency of 1850.400 MHz, at the highest available output power, fully modulated.

Results in accordance with Part 24.235(b) Frequency Stability
and part 2.1055(a)(1) Frequency Stability with Temperature Variation

**PCS - Band Edge Emission Profile (with supplied 115V AC power supply)
(Lower band edge)**

Unit at + 50°C

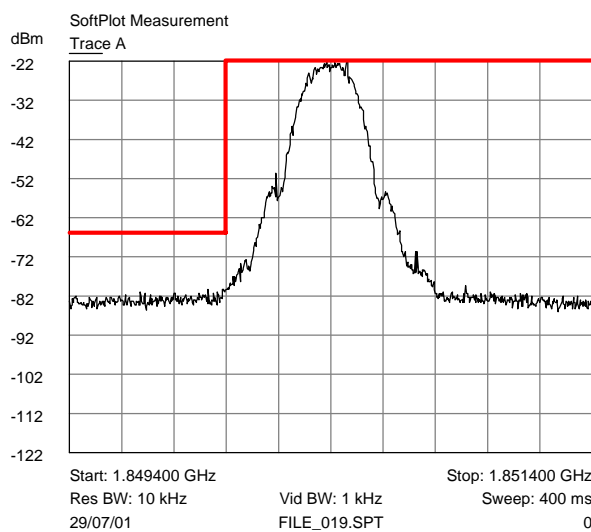

Mask Showing compliance at the lower band edge (1850.000 MHz) based on an attenuation of - [43 + 10 log (P)] dBc, where P is the radiated output power at room temperature, with the unit under test set to the lowest declared operating frequency of 1850.400 MHz, at the highest available output power, fully modulated.

Results in accordance with Part 24.235(b) Frequency Stability
and part 2.1055(a)(1) Frequency Stability with Temperature Variation

**PCS - Band Edge Emission Profile (with supplied 115V AC power supply)
(Upper band edge)**

Unit at -30°C

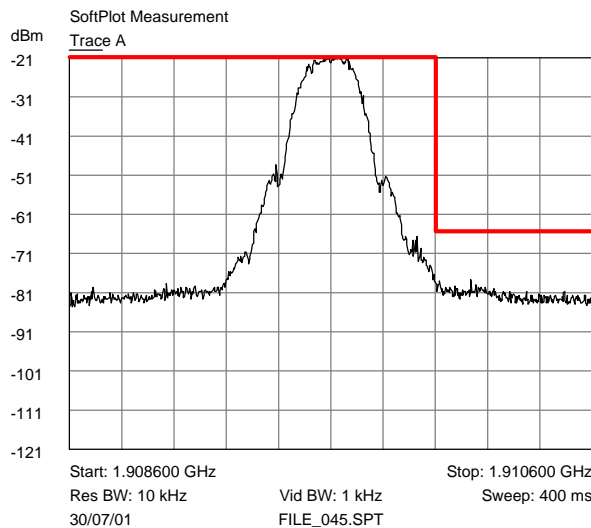

Mask Showing compliance at the upper band edge (1910.000 MHz) based on an attenuation of $- [43 + 10 \log (P)]$ dBc, where P is the radiated output power at room temperature, with the unit under test set to the lowest declared operating frequency of 1909.600 MHz, at the highest available output power, fully modulated.

Results in accordance with Part 24.235(b) Frequency Stability
and part 2.1055(a)(1) Frequency Stability with Temperature Variation

**PCS - Band Edge Emission Profile (with supplied 115V AC power supply)
(Upper band edge)**

Unit at -20°C

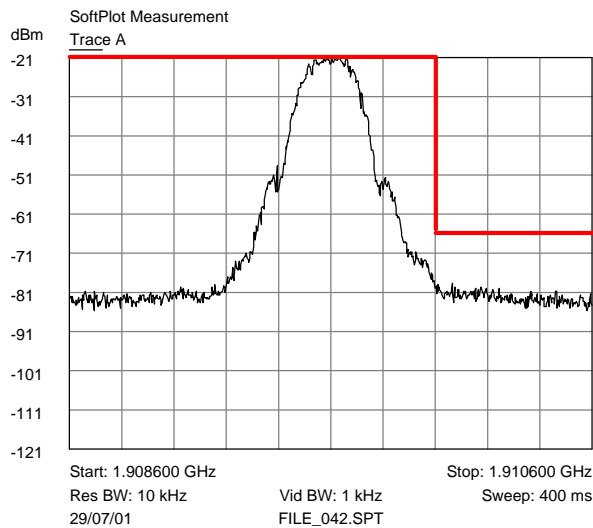

Mask Showing compliance at the upper band edge (1910.000 MHz) based on an attenuation of $- [43 + 10 \log (P)]$ dBc, where P is the radiated output power at room temperature, with the unit under test set to the lowest declared operating frequency of 1909.600 MHz, at the highest available output power, fully modulated.

Results in accordance with Part 24.235(b) Frequency Stability
and part 2.1055(a)(1) Frequency Stability with Temperature Variation

**PCS - Band Edge Emission Profile (with supplied 115V AC power supply)
(Upper band edge)**

Unit at -10°C

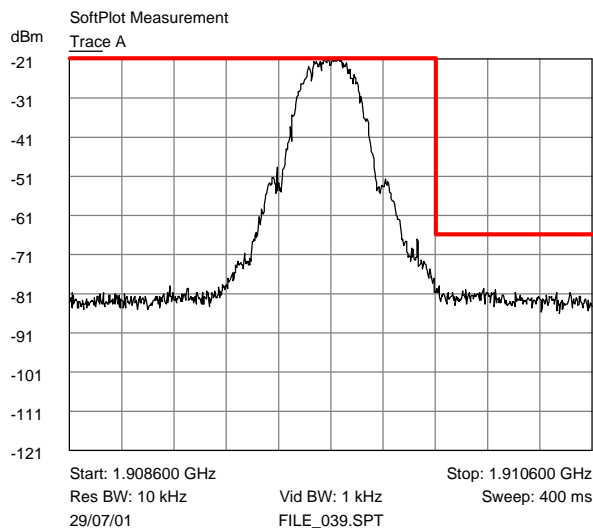

Mask Showing compliance at the upper band edge (1910.000 MHz) based on an attenuation of $- [43 + 10 \log (P)]$ dBc, where P is the radiated output power at room temperature, with the unit under test set to the lowest declared operating frequency of 1909.600 MHz, at the highest available output power, fully modulated.

Results in accordance with Part 24.235(b) Frequency Stability
and part 2.1055(a)(1) Frequency Stability with Temperature Variation

**PCS - Band Edge Emission Profile (with supplied 115V AC power supply)
(Upper band edge)**

Unit at 0°C

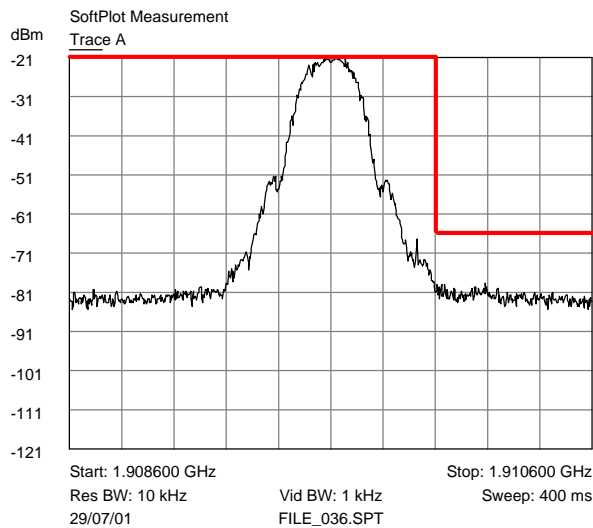

Mask Showing compliance at the upper band edge (1910.000 MHz) based on an attenuation of $- [43 + 10 \log (P)]$ dBc, where P is the radiated output power at room temperature, with the unit under test set to the lowest declared operating frequency of 1909.600 MHz, at the highest available output power, fully modulated.

Results in accordance with Part 24.235(b) Frequency Stability
and part 2.1055(a)(1) Frequency Stability with Temperature Variation

**PCS - Band Edge Emission Profile (with supplied 115V AC power supply)
(Upper band edge)**

Unit at + 10°C

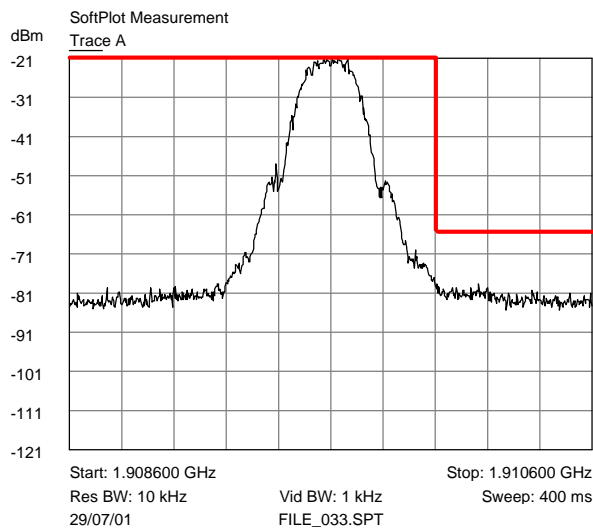

Mask Showing compliance at the upper band edge (1910.000 MHz) based on an attenuation of - [43 + 10 log (P)] dBc, where P is the radiated output power at room temperature, with the unit under test set to the lowest declared operating frequency of 1909.600 MHz, at the highest available output power, fully modulated.

Results in accordance with Part 24.235(b) Frequency Stability
and part 2.1055(a)(1) Frequency Stability with Temperature Variation

**PCS - Band Edge Emission Profile (with supplied 115V AC power supply)
(Upper band edge)**

Unit at + 20°C

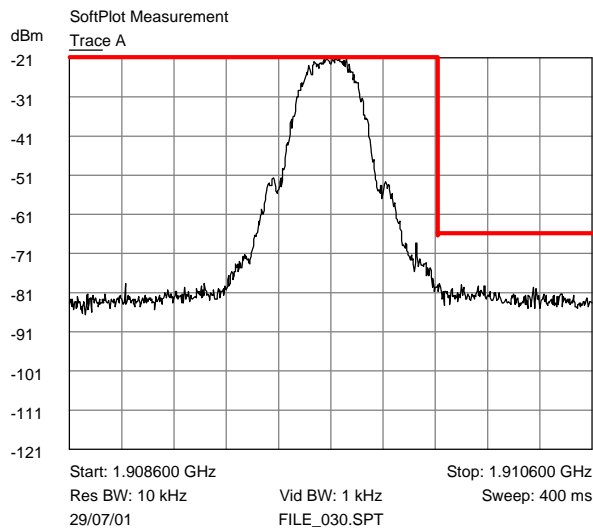

Mask Showing compliance at the upper band edge (1910.000 MHz) based on an attenuation of $- [43 + 10 \log (P)]$ dBc, where P is the radiated output power at room temperature, with the unit under test set to the lowest declared operating frequency of 1909.600 MHz, at the highest available output power, fully modulated.

Results in accordance with Part 24.235(b) Frequency Stability
and part 2.1055(a)(1) Frequency Stability with Temperature Variation

**PCS - Band Edge Emission Profile (with supplied 115V AC power supply)
(Upper band edge)**

Unit at + 30°C

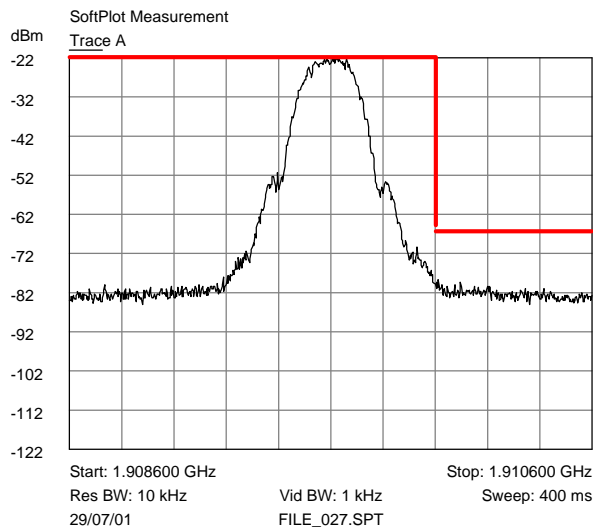

Mask Showing compliance at the upper band edge (1910.000 MHz) based on an attenuation of $- [43 + 10 \log (P)]$ dBc, where P is the radiated output power at room temperature, with the unit under test set to the lowest declared operating frequency of 1850.400 MHz, at the highest available output power, fully modulated.

Results in accordance with Part 24.235(b) Frequency Stability
and part 2.1055(a)(1) Frequency Stability with Temperature Variation

**PCS - Band Edge Emission Profile (with supplied 115V AC power supply)
(Upper band edge)**

Unit at + 40°C

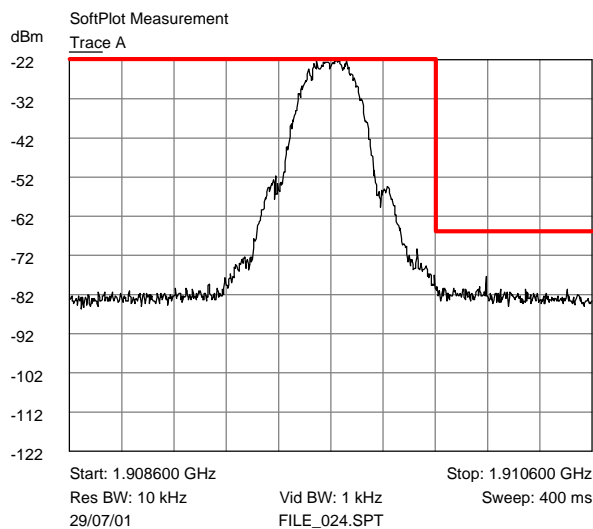

Mask Showing compliance at the upper band edge (1910.000 MHz) based on an attenuation of $- [43 + 10 \log (P)]$ dBc, where P is the radiated output power at room temperature, with the unit under test set to the lowest declared operating frequency of 1909.6 MHz, at the highest available output power, fully modulated.

Results in accordance with Part 24.235(b) Frequency Stability
and part 2.1055(a)(1) Frequency Stability with Temperature Variation

**PCS - Band Edge Emission Profile (with supplied 115V AC power supply)
(Upper band edge)**

Unit at + 50°C

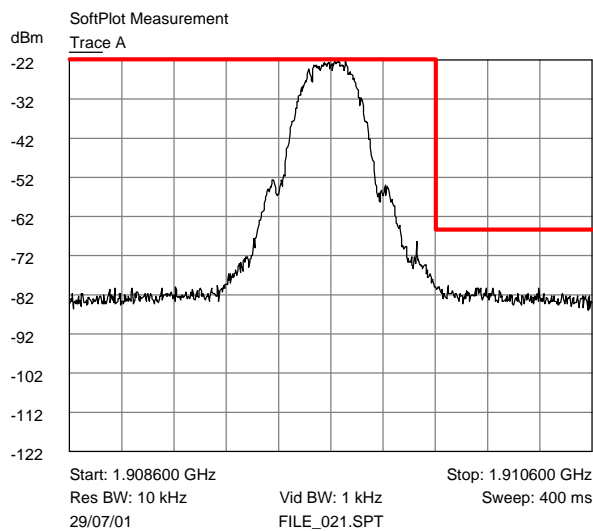

Mask Showing compliance at the upper band edge (1910.000 MHz) based on an attenuation of $- [43 + 10 \log (P)]$ dBc, where P is the radiated output power at room temperature, with the unit under test set to the lowest declared operating frequency of 1909.600 MHz, at the highest available output power, fully modulated.

Test Instruments used: TMS 57,32,69,39,80,907

Part 15.109(a) Radiated Emissions (Unit in Idle mode)

The EUT was set to operate in Idle mode (no transmission), and was placed on a wooden table at a distance of 3m from the receiving antenna.

The ETSI ETR 027 substitution method was used to measure the radiated peak power of the spurious emissions of the transmitter. The peak power of emissions outside the authorised frequency band was measured using the method described on page 10.

Results in accordance with Part 15.109(a) Radiated Emissions (Unit in Idle mode)

Emission Frequency (MHz)	Antenna Orientation	Identity	Result <u>µV/m</u> @ 3m	Spec limit at this frequency_ <u>µV/m</u> @ 3m
All emissions greater than 10 dB within Part 15.109(a) limits				

Conducted Emissions Part 15.111(a) ; (Antenna Port).

The EUT set to operate in Idle mode (no transmission) with the antenna port connected to a spectrum analyser as shown below.

The Spurious emissions of the EUT were measured over the specified frequency range with the following test configuration, using the test instruments listed with the spectrum analyser peak power detector and maximum hold facility on.

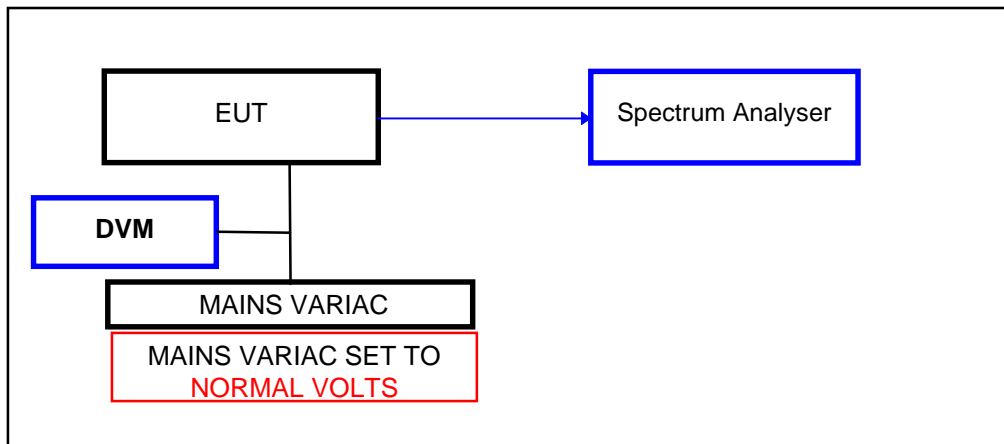

(Calibrated items are indicated in Blue)

Ambient Conditions. Temperature = 22°C Relative Humidity = 54 %

Test instruments used : 69, 57, 32, 113, 907.

Results in accordance with Part 15.111(a) Antenna Power Conducted Emissions
 (Unit in Idle mode)

Emission Frequency (MHz)	Antenna Orientation	Identity	Result dBm	Spec limit at this frequency_ 2nW (-57 dBm)
All emissions greater than 10 dB within Part 15.111(a) limits				

Mains Conducted Emissions (115 V AC Power lead)

The EUT was placed on the wooden table and connected to the Line Impedance Stabilising Network (LISN), as shown in the diagram below. Mains leads exceeding 1 m in length were reduced to an effective length of 1 m by coiling the excess lead length in a figure-of-eight.

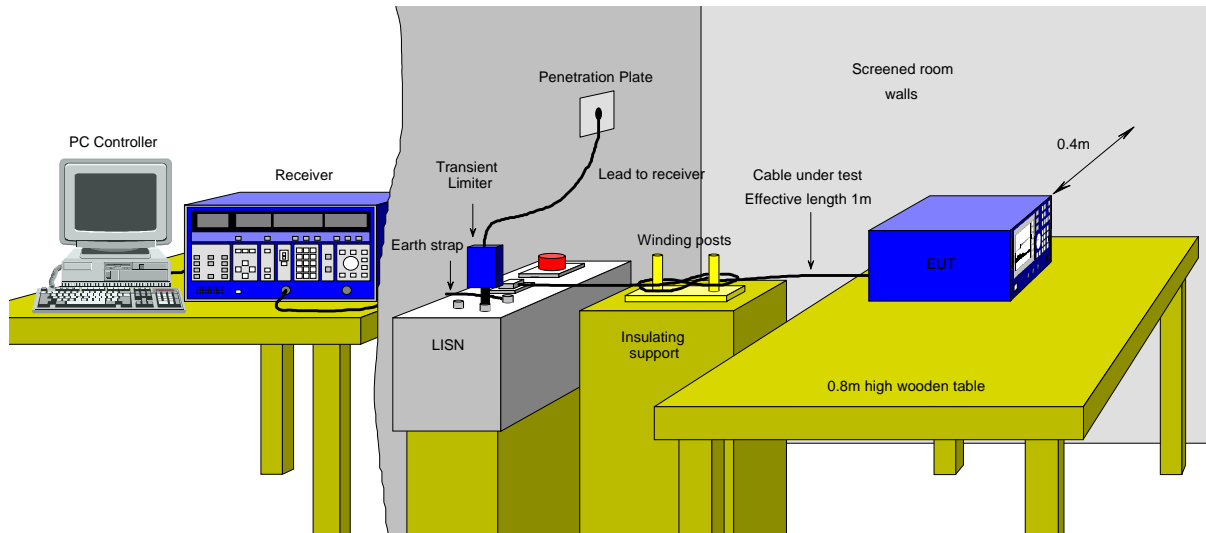

Equipment Test Set-up

Under software control the output from the LISN was measured using the receiver. A full incremental sweep was performed using the receiver. In cases where the emissions were close to the limit, the respective test frequencies were re-measured using the quasi-peak and average detectors. See attached results for the EUT configuration and set-up, test frequency range and limits.

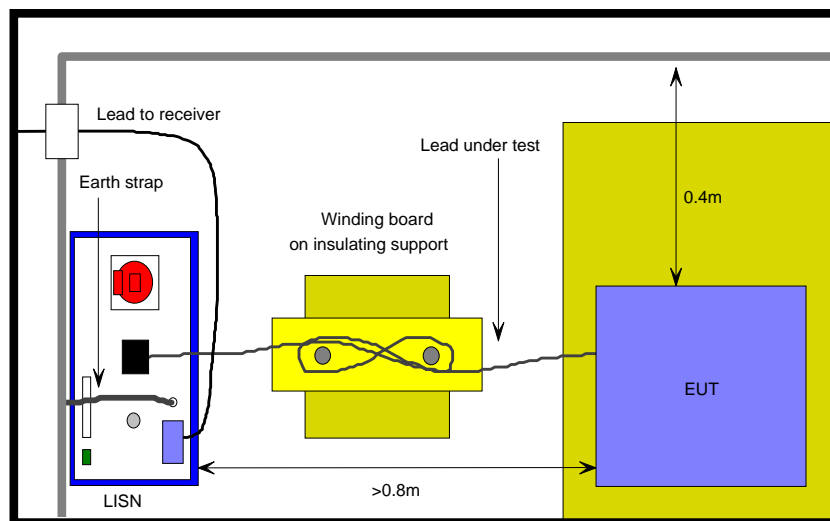

Arrangement of the EUT

Results in accordance with Part 15.107(a) (Mains Supply - Conducted limits)
 (Unit in Idle mode)

Level of Conducted Emissions (115 V AC Power line) **LIVE**

Operating Frequency (MHz)	Emission Frequency (MHz)	Identity	Result μV	Spec limit at this frequency_ μV
N.A. Idle mode	1.366	spurious	123.74	250
N.A. Idle mode	1.350	spurious	57.02	250
N.A. Idle mode	2.498	spurious	44.98	250
N.A. Idle mode	11.566	spurious	39.95	250
N.A. Idle mode	1.386	spurious	37.80	250
All others greater than 20 dB within Part 15.107(a) limits				

Level of Conducted Emissions (115 V AC Power line) **NEUTRAL**

Operating Frequency (MHz)	Emission Frequency (MHz)	Identity	Result μV	Spec limit at this frequency_ μV
N.A. Idle mode	0.854	spurious	97.39	250
N.A. Idle mode	1.186	spurious	96.16	250
N.A. Idle mode	0.678	spurious	95.61	250
N.A. Idle mode	1.198	spurious	93.54	250
N.A. Idle mode	0.966	spurious	87.20	250
All others greater than 20 dB within Part 15.107(a) limits				

Results in accordance with Part 15.107(a) (Mains Supply - Conducted limits)
 (Unit in call 1850.400 MHz)

Level of Conducted Emissions (115 V AC Power line) **LIVE**

Operating Frequency (MHz)	Emission Frequency (MHz)	Identity	Result μV	Spec limit at this frequency_ μV
1850.400	1.490	spurious	88.10	250
1850.400	1.526	spurious	82.41	250
1850.400	1.538	spurious	82.04	250
1850.400	1.550	spurious	81.66	250
1850.400	1.498	spurious	81.19	250
All others greater than 20 dB within Part 15.107(a) limits				

Level of Conducted Emissions (115 V AC Power line) **NEUTRAL**

Operating Frequency (MHz)	Emission Frequency (MHz)	Identity	Result μV	Spec limit at this frequency_ μV
1850.400	1.106	spurious	76.91	250
1850.400	1.086	spurious	70.23	250
1850.400	1.022	spurious	69.42	250
1850.400	1.074	spurious	68.79	250
1850.400	1.038	spurious	66.22	250
All others greater than 20 dB within Part 15.107(a) limits				

Results in accordance with Part 15.107(a) (Mains Supply - Conducted limits)
 (Unit in call 1880.000 MHz)

Level of Conducted Emissions (115 V AC Power line) **LIVE**

Operating Frequency (MHz)	Emission Frequency (MHz)	Identity	Result μV	Spec limit at this frequency_ μV
1880.000	1.474	spurious	109.52	250
1880.000	1.546	spurious	108.14	250
1880.000	1.558	spurious	107.15	250
1880.000	1.538	spurious	104.11	250
1880.000	1.582	spurious	103.16	250
All others greater than 20 dB within Part 15.107(a) limits				

Level of Conducted Emissions (115 V AC Power line) **NEUTRAL**

Operating Frequency (MHz)	Emission Frequency (MHz)	Identity	Result μV	Spec limit at this frequency_ μV
1880.000	1.102	spurious	89.33	250
1880.000	1.090	spurious	87.09	250
1880.000	1.082	spurious	85.90	250
1880.000	1.074	spurious	84.72	250
1880.000	1.066	spurious	82.89	250
All others greater than 20 dB within Part 15.107(a) limits				

Results in accordance with Part 15.107(a) (Mains Supply - Conducted limits)
 (Unit in call 1909.600 MHz)

Level of Conducted Emissions (115 V AC Power line) **LIVE**

Operating Frequency (MHz)	Emission Frequency (MHz)	Identity	Result μV	Spec limit at this frequency_ μV
1909.600	1.570	spurious	107.89	250
1909.600	1.578	spurious	106.65	250
1909.600	1.562	spurious	103.40	250
1909.600	1.546	spurious	98.51	250
1909.600	1.598	spurious	96.83	250
All others greater than 20 dB within Part 15.107(a) limits				

Level of Conducted Emissions (115 V AC Power line) **NEUTRAL**

Operating Frequency (MHz)	Emission Frequency (MHz)	Identity	Result μV	Spec limit at this frequency_ μV
1909.600	1.106	spurious	86.30	250
1909.600	1.090	spurious	85.70	250
1909.600	1.066	spurious	81.00	250
1909.600	1.074	spurious	80.08	250
1909.600	1.026	spurious	79.16	250
All others greater than 20 dB within Part 15.107(a) limits				

Test Instruments used: TMS 916,123,116,952,907

PHOTOGRAPHS OF EQUIPMENT

	Page No
Transceiver Front View	54
Transceiver Back View	55
Transceiver Antenna	56
Transceiver internal view 1	57
Transceiver Internal View 2	58
Transceiver Internal View 3	59
Transceiver label	60
Transceiver PSU	61

Transceiver Front View

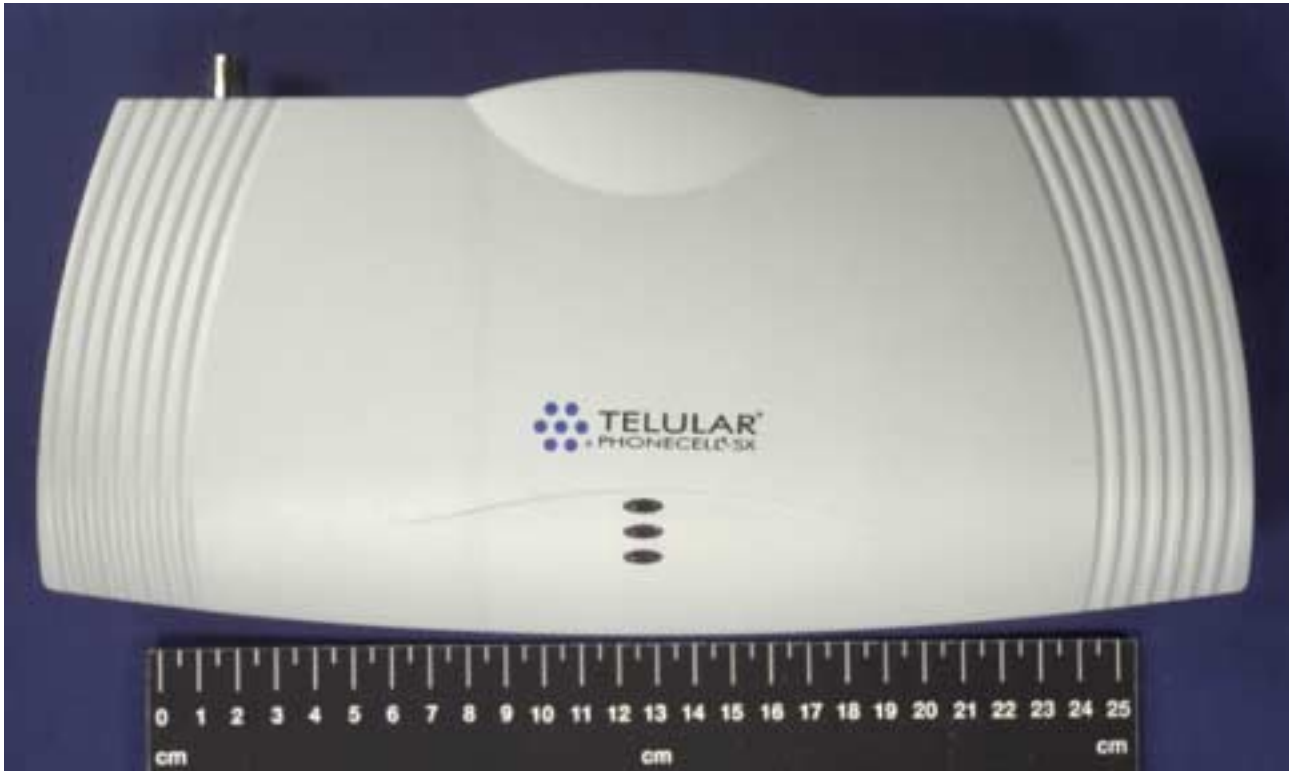

Transceiver Back View



Transceiver Antenna



Transceiver Inside View 1

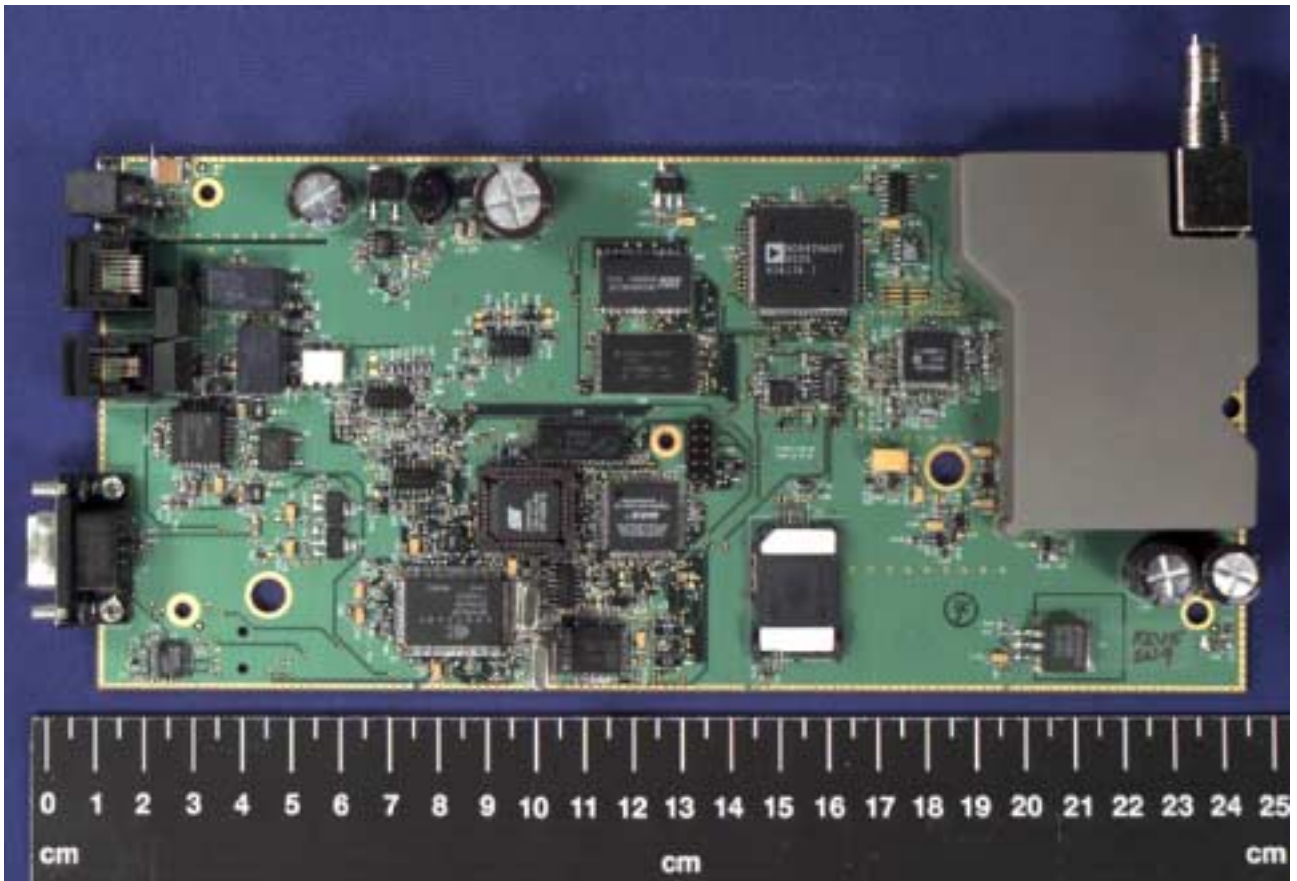

Transceiver Inside View 2

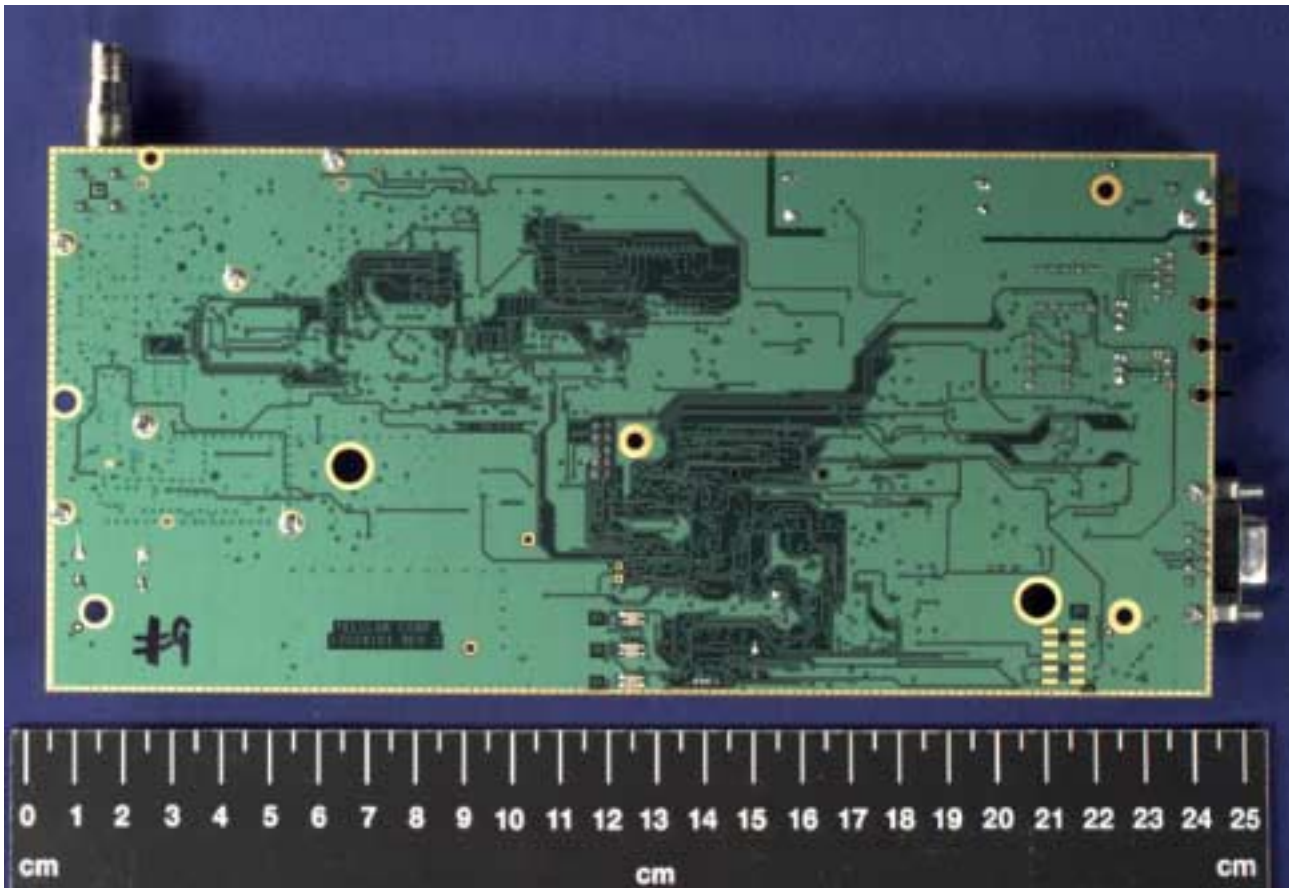

Transceiver Inside View 3

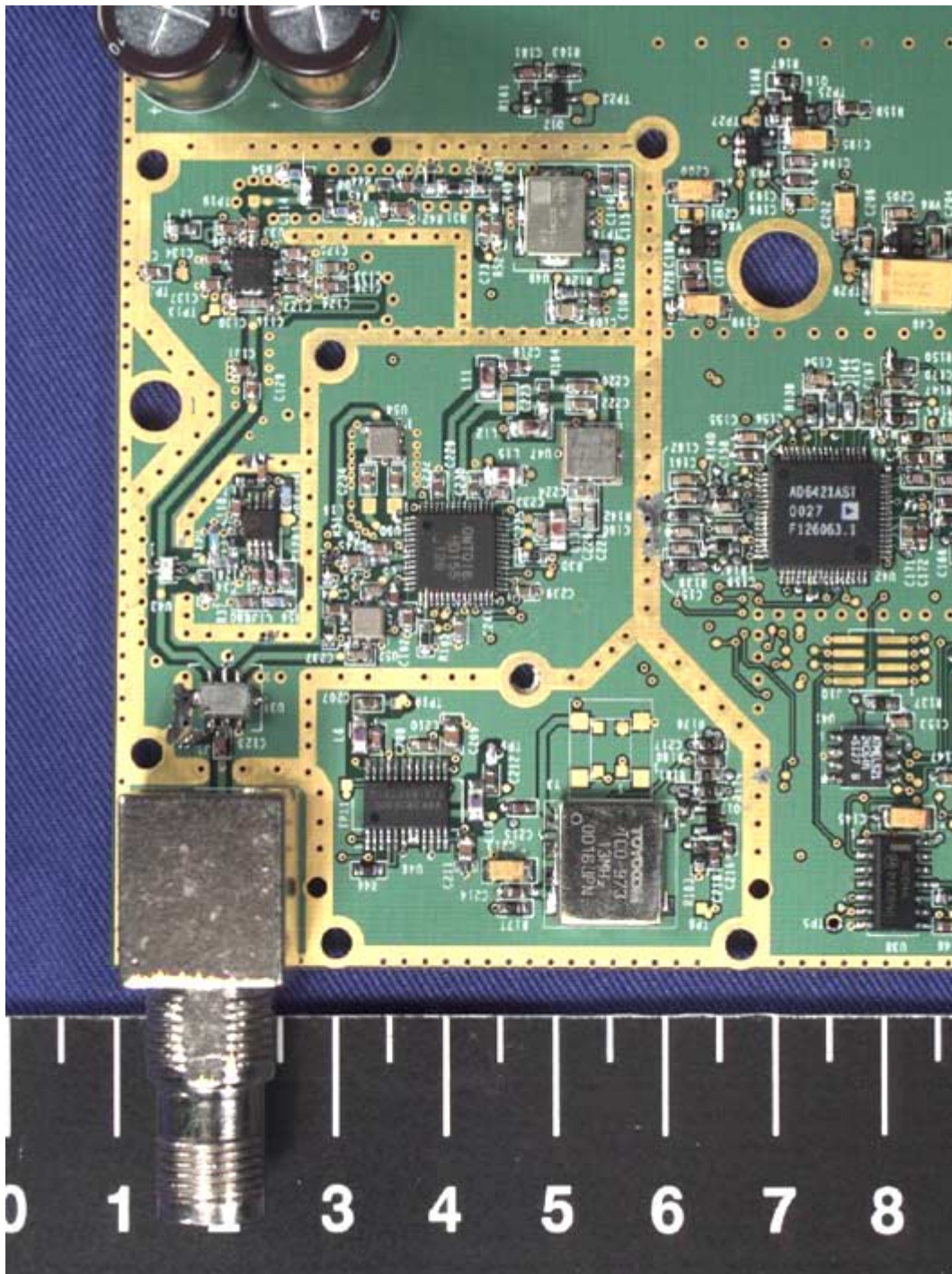

Transceiver Label



Transceiver Power Supply



CTMS LTD, Company Accreditations & Credentials

Appendix

UKAS Certificate	63
ISO 9002 Certification	64
UKAS Schedule	65

United Kingdom Accreditation Service

ACCREDITATION CERTIFICATE



TESTING LABORATORY
No. 1831

Cambridge Test and Measurement Services Ltd
PO Box 465
St Andrews Road
Cambridge
CB4 1ZJ

is accredited to undertake tests as detailed in the schedule bearing the accreditation number above. From time to time this schedule may be revised and reissued by the United Kingdom Accreditation Service.

This Accreditation shall remain in force until the expiry date printed below, subject to continuing compliance with United Kingdom Accreditation Service requirements. Accredited organisations meet the requirements of EN 45001, ISO/IEC Guide 25 and the relevant requirements of the BS EN ISO 9000 series of standards, including those of the model described in BS EN ISO 9002 when acting as suppliers producing test results.

Initial Accreditation 11 June 1997

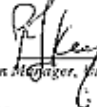

Accreditation Manager, United Kingdom Accreditation Service

This certificate issued on 16 June 2000

Expiry date 31 May 2001

The Department of Trade and Industry (DTI) has entered into a memorandum of understanding with the United Kingdom Accreditation Service (UKAS) through which UKAS is recognised as the national body responsible for assessing and accrediting the competence of organisations in the fields of measurement, testing, inspection and certification of systems, products and personnel.



SGS Yarsley
International Certification Services Limited

Certificate Number

Q10171

This is to certify that the
Quality Management systems of

***Cambridge Test and Measurement
Services Limited***

have been assessed and registered as meeting the
requirements of ISO 9002

The scope of registration is detailed on the Assessment
Schedule bearing this certificate number.

SGS Yarsley International Certification Services Ltd
Signed by

30 June 1997

This certificate remains valid subject to
satisfactory maintenance of the system



Registered Office:
SGS Yarsley
International Certification Services Limited
SGS House, 217/221 London Road,
Canterbury, Surrey GU15 3CY, United Kingdom

Where all the rules and regulations are observed, the certificate holder is entitled to the ISO 9002 award registration. The ISO 9002 award registration is not a guarantee of quality. The ISO 9002 award registration mark should not be used for advertising purposes. The certificate holder should be aware of the ISO 9002 award registration. The certificate holder should be aware of the ISO 9002 award registration.



Registration Number
005

United Kingdom Accreditation Service

TESTING LABORATORY
 No. 1831

SCHEDULE



Testing Performed at Permanent Laboratory

Address of permanent laboratory Cambridge Test & Measurement Services Ltd PO Box 465 St Andrews Road Cambridge CB4 1ZJ	Laboratory contact: Mr D Fisher Telephone: +44 (0) 1223 876876 Fax: +44 (0) 1223 876851 EMail: Issue No: 7 Date: 16 June 2000
---	--

Materials/Products Tested	Type of Test/Properties Measured Range of Measurement	Standard Specifications Equipment/Techniques Used
Computers and peripherals Domestic appliances Electrical/Electronic components Electrical/Electronic products Telecommunications equipment IT equipment Pager and pager devices Mobile/Portable radio - PMR PMR and ancillary equipment Fixed/Link PMR equipment Low power devices	1 EMC TESTS 1.1 Conducted Emissions 150 kHz to 30 MHz	EN 55011:1997 EN 55014:1993 Discontinuous emissions EN 55022:1994 CISPR 14-1:1997 Disturbance power CISPR 22:1993 FCC Part 15:1996 ANSI C63.4:1992
	1.2 Radiated Emissions - Electric Field 30 MHz to 1 GHz	EN 55011:1997 EN 55022:1994 CISPR 22:1993 FCC Part 15:1996 ANSI C63.4:1992
	1.3 Main Harmonics and Flicker	EN 61000-3-2:1995 EN 61000-3-3:1995
	1.4 Discontinuous Emissions (Clicks) 10 kHz to 30 MHz	EN 55014-1:1997
	1.5 Power Absorbing Emissions Measurements (Power Clamp) 30 MHz to 300 MHz	EN 55014-1:1997
	Continued on Sheet 2	

United Kingdom Accreditation Service

TESTING LABORATORY No. 1831 Testing Performed at Permanent Laboratory	SCHEDULE Issue No: 7 Date: 16 June 2000
--	---



Materials/Products Tested	Type of Test/Properties Measured Range of Measurement	Standard Specifications Equipment/Techniques Used
As listed on Sheet 1	1 EMC TESTS (cont'd)	
	1.6 Electrostatic Discharge Up to 15 kV	IEC 801-2:1991 IEC 1000-4-2:1995 EN 61000-4-2:1995
	1.7 Radiated Immunity 80 MHz to 1000 MHz, 1.4 GHz to 2.0 GHz up to 10 V/m	IEC 1000-4-3:1995 EN 61000-4-3:1996 Including Amendment 1:1998 ENV 50140:1995 ENV 50204:1995
	1.8 Fast Transient and Burst Immunity	IEC 801-4:1988 IEC 1000-4-4:1995 EN 61000-4-4:1995 ISO 7637:Part 1:1990
	1.9 Surge Immunity	IEC 1000-4-5:1995 EN 61000-4-5:1995 ENV 50142:1994
	1.10 Conducted Radio Frequency Disturbance	IEC 61000-4-6:1996 EN 61000-4-6:1996 ENV 50143:1993
	1.11 Mains Dips and Interruptions	IEC 1000-4-11:1994 EN 61000-4-11:1994
	1.12 Magnetic Field Immunity	EN 61000-4-8:1994
	Continued on Sheet 3	

United Kingdom Accreditation Service

TESTING LABORATORY No. 1831 Testing Performed at Permanent Laboratory	SCHEDULE Issue No: 7 Date: 16 June 2000
--	--



Materials/Products Tested	Type of Test/Properties Measured Range of Measurement	Standard Specifications Equipment/Techniques Used
As listed on Sheet 1	1 EMC TESTS (cont) 1.13 EMC Tests These generic and product specific tests are included in this Schedule, but limited to those basic standards that are explicitly listed in Sections 1.1 to 1.13.	Generic and Product Standards EN 50081-1:1992 EN 50081-2:1994 EN 50082-1:1996 EN 50082-2:1996 EN 50130-4:1995 EN 50199:1995 EN 55024:1996 EN 60601-1-2:1993 EN 60945:1997 EN 61000-6-2:1999 EN 61326:1997 ETS 300 279:1995 ETS 300 329:1997 ETS 300 339:1994 ETS 300 340:1994 ETS 300 342-1:1997 ETS 300 445:1996 ETS 300 446:1997 ETS 300 680-1:1997 ETS 300 682:1997 ETS 300 683:1997 ETS 300 684:1997 ETS 300 717:1997 ETS 300 741:1998 ETS 300 826:1997 ETS 300 827:1998 AS/NZS 2084:1997 AS/NZS 3548:1995 AS/NZS 4251.1:1994
Fixed, Mobile, Portable radio equipment PMR and auxiliary equipment Low power telemetry Low power telecommand Low power devices Maritime (VHF) Ship to shore Maritime (VHF) Shore stations.	2 RADIO TESTS Frequency range: 9 kHz to 4 GHz Power Output up to 150 W Tests on Radio Transmitters 2.1 Frequency 2.2 RF Power, conducted and radiated 2.3 Modulation 2.4 Adjacent channel power Continued on Sheet 4	MPT 1250:1978 MPT 1251:1973 MPT 1305:1996 MPT 1308:1978 MPT 1312:1993 MPT 1314:1994 MPT 1325:1988 MPT 1328:1997 MPT 1329:1994

United Kingdom Accreditation Service

TESTING LABORATORY No. 1831 Testing Performed at Permanent Laboratory	SCHEDULE Issue No: 7 Date: 16 June 2000
---	--



Materials/Products Tested	Type of Test/Properties Measured Range of Measurement	Standard Specifications Equipment/Techniques Used
As listed on Sheet 3	2 RADIO TESTS (cont'd) 2.5 Spurious Emissions - conducted and radiated 2.6 Transmitter intermodulation 2.7 Transmitter transient behaviour 2.8 Audio response 2.9 Audio distortion Tests on Radio Receivers 2.10 Sensitivity - SINAD 2.11 Adjacent channel selectivity 2.12 Receiver intermodulation 2.13 Co-channel rejection 2.14 Blocking performance 2.15 Spurious emissions - conducted and radiated 2.16 Audio response 2.17 Audio distortion	MPT 1330:1994 MPT 1335:1993 MPT 1336:1992 MPT 1338:1994 MPT 1340:1997 MPT 1344:1994 MPT 1345:1994 MPT 1350:1994 MPT 1357:1996 MPT 1360:1994 MPT 1361:1994 MPT 1365:1996 MPT 1374:1994 MPT 1382:1997 MPT 1411:1993 MPT 1601:1993 ETS 300 086:1991 ETS 300 113:1995 ETS 300 135:1991 ETS 300 162:1998 ETS 300 219:1993 I-ETS 300 220:1992 I-ETS 300 296:1994 ETS 300 328:1996 ETS 300 330:1990 ETS 300 390:1996 ETS 300 341:1995 I-ETS 300 422:1995 ETS 300 440:1999 ETS 300 454:1995 ETS 300 676:1997 ETS 300 719-1:1996 EN 300 220-1:1997 EN 300 220-2:1997 EN 300 422:V1.2.1:1999 EN 301 178:1999 EN 301 357:V1.1.1:1999 EN 301 688:1999 AS 4268.2:1995 AS 4295:1995
	Continued on Sheet 5	

United Kingdom Accreditation Service

TESTING LABORATORY No. 1831 Testing Performed at Permanent Laboratory	SCHEDULE Issue No: 7 Date: 16 June 2000
--	---



Materials/Products Tested	Type of Test/Properties Measured Range of Measurement	Standard Specifications Equipment/Techniques Used
	Facilities: Open area test site: 3, 10 and 30 m Screened Room (Partially Lined RF Absorber) 6.4 m x 4.9 m x 2.5 m Screened Room (anechoic) 3.7 m x 2.6 m x 2.5 m Screened Room (anechoic) 3.0 m x 2.4 m x 2.4 m Environmental Chambers (various)	
	END	

TEST INSTRUMENTS and ANCILLARIES USED FOR RADIO & EMC TESTING.

Each item of test equipment has a unique number allocated by Cambridge Test and Measurement Services. This number is listed on each page of the test report where this instrument was used in the test specified on that page.

NUMBER	DESCRIPTION	MANUFACTURER	TYPE	SERIAL No
1	Audio Analyzer	Hewlett Packard	HP 8903 B	3011A09130
2	Oscilloscope	Philips	PM 3375	DM546029
3	R.F. Generator	Rohde & Schwarz	SMPD	880627/003
4	Digital Multimeter	Philips	PM 2534	DY002910
5	R.F. Generator	Hewlett Packard	HP 8642A	2748A01501
6	Spectrum Analyzer	Anritsu	MS 2602A	MT88057
7	RF Power Meter	Hewlett Packard	435B	2449U01762
8	RF Power Sensor	Hewlett Packard	8481B	2350A03194
9	R.F. Generator	Hewlett Packard	HP 8640B	1415U00184
10	ThermoHygrometer	Radio Spares	TH200	0896/253
11	10dB Attenuator	Bird	8343-100	633
12	High Pass Filter	Anritsu	MP526D	M12524
13	High Pass Filter	Anritsu	MP526B	M15624
14	High Pass Filter	Anritsu	MP526A	M09521
15	Notch Filter	Telonic Altair	TTR 95-3EE	70063-1
16	Notch Filter	Telonic Altair	TTR 375-3EE	0004-1
17	Notch Filter	Telonic Altair	TTR 190-3EE	60435-5
18	Modulation Analyzer	Hewlett Packard	8901B	2642A01009
19	Audio Power Meter	Marconi	TF 893A	190134/050
20	Power Supply	Kingshill	18V10C	562
21	Power Supply	Kingshill	18V10C	561
22	Audio Power Meter	Marconi	TF 893A	58507/017
23	Receiver	Chase	UHR4000	6081
24	Attenuator 30 dB	Bird	8321	1058
25	Attenuator 10 dB	Bird	8343/100	623
26	Variable Attenuator	Telonic	8120A 50ohm	90789-4
27	50 Ohm Load 10W	Termaline	8053	7456
28	Attenuator 20 dB	Marconi	6535/4	625
29	50 Ohm Load 50W			
30	Dual Directional Coupler	Hewlett Packard	778D	16835
31	Adjacent Channel Power Meter	Rohde & Schwarz	NKS	879169/011
32	Mains Variac	TGDC	3kVA	
33	R.F. Generator	Rohde & Schwarz	SMH	894091-012
34	Audio Analyzer	Hewlett Packard	HP 8903 B	3011A09131
35	Signal Generator	Marconi	2032	119855-057
36	Environmental Oven	Heraeus Votsch	VMT 04/30	24558
37	Environmental Oven	Heraeus Votsch	VMT 04/240	27730
38	Environmental Oven	Heraeus Votsch	VMT 04/140	28785
39	Environmental Oven	Heraeus Votsch	VMT 04/16	24682
40	R.F. Generator	Hewlett Packard	8657A	2929A00908
41	Signal Generator	Marconi	2018	118421/001
42	RF Power Sensor	Hewlett Packard	8481A	2702A77623
43	Signal Generator	Hewlett Packard	8657A	2849U01043
44	Dual Directional Coupler	Hewlett Packard	777D	07041

NUMBER	DESCRIPTION	MANUFACTURER	TYPE	SERIAL No
45	Attenuator	Weinschel	Model 1	AX4024
46	Attenuator	Weinschel	Model 1	AX2978
47	50Ω Termination	Wiltron	28N50-3	600051
48	Modulation Analyzer	Hewlett Packard	8901B	2806A01910
49	Modulation Analyzer	Hewlett Packard	8901B	3028A03136
50	Modulation Analyzer	Hewlett Packard	8901B	2920A02137
51	Attenuator	Narda	766-3	
52	Signal Generator	Hewlett Packard	8656B	2838U05964
53	Audio Analyzer	Hewlett Packard	HP 8903 B	2836A05550
54	Signal Generator	Hewlett Packard	8656B	2838U05943
55	Audio Analyzer	Hewlett Packard	HP 8903 B	2836A05420
56	Signal Generator	Hewlett Packard	8656B	2703U03451
57	Digital Multimeter	Philips	PM 2534	DY002945
58	RF Power Meter	Hewlett Packard	435B	2005A03070
59	RF Power Sensor	Hewlett Packard	8481B	1801A01640
60	Audio Power Meter	Marconi	TF 893A	190102-006
61	R.F Generator	Rohde & Schwarz	SMH	883951-012
62	Audio Power Meter	Marconi	TF 893A	190113-081
63	Audio Power Meter	Marconi	TF 893A	58930-096
64	Signal Generator	Hewlett Packard	8656B	2838U05945
65	Modulation Analyzer	Hewlett Packard	8901A	2324A02929
66	Comms Test Set	Schlumberger	4040	0725122
67	Digital Multimeter	Hewlett Packard	HP 34401A	US36090783
69	Spectrum Analyzer	Advantest	R3271	15050051
70	Attenuator 30 dB	Bird 100W	8323	611
71	Attenuator 10 dB	Narda	765-10	8310
72	Attenuator 10 dB	Narda	765-10	8901
73	Off Air Standard	Quartzlock	2A	41125
74	Power Supply	Hewlett Packard	6632A	2851A-01862
75	Power Supply	Kingshill	18V10C	594
76	Com Test Set	Rohde & Schwarz	CMT	883398/071
77	Signal Generator	Hewlett Packard	8673B	2823A01376
78	Horn Antenna	ETS Systems	3160-08	9911-1109
79	Horn Antenna	ETS Systems	3160-09	9911-1186
80	Digital Thermometer	RS	206-3722	831016600
81	Loop antenna 9kHz-30MHz	EMCO	6502	9908-3306
82	1-26 GHz Pre-Amp	Hewlett Packard	HP 8449B	3008A01603
83	Oscilloscope	Phillips	PM 3375	DM0011431
84				
85				
86				
87				
101	R.F. Coax Cable 0.5 m	LOCAL		TMS RF 101
103	R.F. Coax Cable 0.5 m	LOCAL		TMS RF 103
104	R.F. Coax Cable 1.0 m	LOCAL		TMS RF 104
105	R.F. Coax Cable 1.0 m	LOCAL		TMS RF 105
106	R.F. Coax Cable 0.75 m	LOCAL		TMS RF 106
107	R.F. Coax Cable 1.0 m	LOCAL		TMS RF 107
110	R.F. Coax Cable 0.5 m	LOCAL		TMS RF 110
111	R.F. Coax Cable 0.75 m	LOCAL		TMS RF 111

NUMBER	DESCRIPTION	MANUFACTURER	TYPE	SERIAL No
112	R.F. Coax Cable 1.0 m	LOCAL		TMS RF 112
113	R.F. Coax Cable 1.0 m	LOCAL		TMS RF 113
115	R.F. Coax Cable 3 m	LOCAL		TMS RF 115
116	R.F. Coax Cable 10 m	LOCAL		TMS RF 116
117	R.F. Coax Cable	LOCAL		TMS RF 117
118	R.F. Coax Cable	LOCAL		TMS RF 118
119	R.F. Coax Cable 4.0 m	LOCAL		TMS RF 119
120	R.F. Coax Cable 6.0 m	LOCAL		TMS RF 120
121	R.F. Coax Cable 30 m	LOCAL		TMS RF 121
122	R.F. Coax Cable 40 m	LOCAL		TMS RF 122
123	R.F. Coax Cable 4.0 m	LOCAL		TMS RF 123
124	R.F. Coax Cable	LOCAL		TMS RF 124
125	R.F. Coax Cable	LOCAL		TMS RF 125
126	R.F. Coax Cable	LOCAL		TMS RF 126
127	R.F. Coax Cable	LOCAL		TMS RF 127
128	R.F. Coax Cable 3.0M	Midwest Microwave	CSY-3M3M-52-003-MA	9946-001
129	R.F. Coax Cable 3.0M	Midwest Microwave	CSY-3M3M-52-003-MA	9946-002
130	R.F. Coax Cable 3.0M	Midwest Microwave	CSY-3M3M-52-003-MA	9946-003
131	R.F. Coax Cable 1.0 m	LOCAL		TMS RF 131
132	R.F. Coax Cable 10 m	LOCAL		TMS RF 132
133	R.F. Coax Cable 0.5 m	LOCAL		TMS RF 133
134	R.F. Coax Cable 0.5 m	LOCAL		TMS RF 134
135	R.F. Coax Cable 1.0 m	LOCAL		TMS RF 135
136	R.F. Coax Cable 1.0 m	LOCAL		TMS RF 136
137	R.F. Coax Cable	LOCAL		TMS RF 137
138	R.F. Coax Cable	LOCAL		TMS RF 138
139	R.F. Coax Cable	LOCAL		TMS RF 139
140	R.F. Coax Cable 3.0 m	LOCAL		TMS RF 140
141	R.F Coax Cable 0.5 m	Gigaflex	326-8366	TMS RF 141
142	R.F Coax Cable 0.5 m	Gigaflex	326-8366	TMS RF 142
143	R.F. Coax Cable 2.0 m	LOCAL		TMS RF 143
144	R.F. Coax Cable 1.5 m	LOCAL		TMS RF 144
145	R.F. Coax Cable 1.0 m	LOCAL		TMS RF 145
146	R.F. Coax Cable 1.1 m	LOCAL		TMS RF 146
147				
148				
149				
150				
201	4 WAY COMBINER	ANZAC	DS 312	TMS COMB 201
202	4 WAY COMBINER	ANZAC	DS -4-4	TMS COMB 202
203	4 WAY COMBINER	ANZAC	DS -4-4	TMS COMB 203
204	4 WAY COMBINER	ANZAC	DS 312	TMS COMB 204
205	2 WAY COMBINER	SUHNER	4901.01B	TMS COMB 205
206	2 WAY COMBINER	SUHNER	4901.01B	TMS COMB 206
207				
208				
301	MIXER/FILTER 12.5 KHz	LOCAL		TMS FILT 301
302	MIXER/FILTER 25.0 KHz	LOCAL		TMS FILT 302
303	CCIR-559/2 Filter	LOCAL		TMS FILT 303

NUMBER	DESCRIPTION	MANUFACTURER	TYPE	SERIAL No
304				
305				
400				
401	High Voltage Tester	ET Systems	EHV10/SL	99/18/3425
403	Hybrid Recorder	Yokogawa	DR230	48JA0030
407	Scopemeter	Fluke	92B Series 2	DM7240229
410	Capacitance Meter	Isotech	9023	N058574
412	Dial Calliper	Mitutoyo	150mm	531099
419	Ball Pressure App	Unknown		
420	Test Probe	Unknown		
421	Test Pin	Unknown		
430	Clampmeter	Isotech	ICM36R	70308783
431	Scratch Pin	Nanson		0700/18
432	Test Finger	Nanson		0700/17
433	Test FingerJointed	Nanson		0700/16
434				
435				
436				
437				
438				
801	100 Watt Amplifier	Amplifier Research	100W1000M1	14195
802	Field Strength Meter	Holiday	HI-4400	60825
803	25 Watt Amplifier	Amplifier Research	25A250	6805
804	Power Supply	Kingshill	18V10C	686
805	Modulation Meter	Marconi	2305	169810-046
806	A.F. Oscillator	Marconi	TF2000	351220-02
807	Capacitive Coupling Clamp	Schaffner	CDN 125	62436
808	Current Probe	Chase	CIP9136	10500792
809	Screened Chamber	Rayproof		6366
810	Screened Chamber	Belling Lee		74152
812	Dipoles	Anritsu	MP534A, 34E3610, EP-0169	M08533,M22021, M22021
813	Dipoles	Anritsu	MP534A, 34E3610, EP-0169	M21921,M21921, M53022
814	Dipoles	Anritsu	MP534A, 34E3610, EP-0169	M11112,M11112, X0002
815	Dipoles	Anritsu	MP534A, 34E3610, EP-0169	X1992,M13832, X0003
816	Screened Chamber	Rayproof		
817	Screened Chamber	Rayproof		
818	30W 1-2GHz Amp	Milmega	AS0102-30R	992410
819	100W 0.2-1GHz Amp	Ophir	GRFS041	1007/9843
820	Directional Coupler 26-80MHz / 1500W	Werlatone	C5035	6910
821	Directional Coupler 80-1000MHz / 1500W	Werlatone	C3096	6912
822				
823				

NUMBER	DESCRIPTION	MANUFACTURER	TYPE	SERIAL No
824				
901	Spectrum Analyzer	Advantest	R3261C	51720046
902	Isotropic Field Probe	Holaday	HI-4421G	84838
903	Bilog Antenna 30MHz-1GHz	Chase	CBL6111A	1668
904	Log Periodic Antenna 1-15GHz	Rohde & Schwarz	HA226	321.312-30
905	Transient Limiter	Chase	CFL 9206	1067
906	ESD Gun	Keytek	MZ-15	9107193
907	ThermoHygrometer	Radio spares	TH200	0896-256
908	Manometer	Digitron	P200 AH	663
909	Signal Generator	Marconi	2030	119628-013
910	Interference test System	Schaffner	NSG600	3008
911	Double AC Supply Variator	Schaffner	NSG642	104
912	LISN	Chase	MN2053	5309
913	Isotropic Field Probe	Holaday	HI-4421G	16294
914	Biconical Antenna 30-300MHz	Schwarzbeck	VHBA9123	7440
915	Log Periodic Antenna 300MHz-GHz	Chase	UPA6108	1065
916	EMI Test Receiver 9KHz-30MHz	Rohde & Schwarz	ESHS10	835499/0016
917	EMI Test Receiver 20MHz-1GHz	Rohde & Schwarz	ESVS10	843207/0015
918	RF Power Meter	Bird	4421	3220
919	RF Power Sensor	Bird	4022	6840
920	LISN	Chase	MN20216	2544
921	Comb Generator	RN Electronics	RN 5102	235
922	Indoor Corner Reflector	Local		
923	Gaussmeter	Hirst	GM04	GM0327
924	Hall Probe	Hirst	TP002	PT1954
925	CDN Coupler	Local		
926	Mains CDN	Schaffner	MEB-M3	14415
927	Isotropic Field Probe	Schaffner	EMC20	M-0065
928	Sensor Probe	Schaffner	802	K-0095
929	Current Probe	Schaffner	CSP8441	223
930	RF Power Meter	Rohde & Schwarz	NRVS	826149/042
931	RF Power Sensor	Rohde & Schwarz	NRVS Z5	828.3818.03
932	Mains CDN Coupler	Schaffner	M3-16	9919
933	Bilog Antenna 30MHz-2GHz	York EMC	CBL6141A	4116
934	Matching Networks	Schaffner	TRA150	14066
935	Matching Networks	Schaffner	KAL	14050
936	Helmholtz Coil	Local		
937	Mains Flicker	Schaffner	CCN1000	X71748
938	3KV AC Power Source	Schaffner	CCN1007	
939	Signal Generator	Rohde & Schwarz	SMY01	826575/008
940	1Ω Load	Local		
941	110V Transformer	Carron & Meywell	CM7501	99PT8679
942	Burst Generator	Schaffner	Best EMC v2.3	199949-004SC
943	ESD Simulator	Schaffner	Best ESD	665
944	4.7Ω Load	Local		
945	Digital Multimeter	Fluke	77	48920928
946	Inrush Current Box	Local		
947	Absorbing Clamp (30-1000MHz)	Lüthi	MDS 21	01399
948	4 Line CDN	Schaffner	ISN T400	16009

NUMBER	DESCRIPTION	MANUFACTURER	TYPE	SERIAL No
949	2 Line CDN	Schaffner	ISN T200	15963
950	Copper Ground Plane	Local	1m x 0.4m	-
951	RF Pulse Modulator	Schaffner	CPM9830	1089
952	LISN	Schaffner Chase	MN2050D	1464
953	Signal Line Coupling Network	Schaffner	CDN 117	17372
954	6db/50Ω Attenuator	Schaffner	SL402-379	-
955	Coupling Accessory Gas Arrestor	Schaffner	INA 170	-
956	Coupling Accessory Gas Arrestor with 0.1μF Capacitor	Schaffner	INA 171	-
957	0.5μF Capacitor	Schaffner	INA 174	-
958	Current Injection Tester	Schaffner	NSG 420	9151/128
959				