

# FCC HAC (RF Emission) Test Report

Report No. : SA180207C11C R1  
Applicant : ASUSTek COMPUTER INC.  
Address : 4F, No. 150, LI-TE Rd., PEITOU, TAIPEI 112, TAIWAN  
Product : ASUS Phone  
FCC ID : MSQZ01RD  
Brand : ASUS  
Model No. : ASUS\_Z01RD / ASUS\_Z01RS  
Standards : FCC 47 CFR Part 20.19, ANSI C63.19-2011  
KDB 285076 D01 v05, KDB 285076 D02 v03  
Sample Received Date : Feb. 07, 2018  
Date of Testing : Apr. 12, 2018 ~ Jun. 26, 2018  
Summary M-Rating : M3  
Lab Address : No. 47-2, 14th Ling, Chia Pau Vil., Lin Kou Dist., New Taipei City, Taiwan, R.O.C.  
Test Location : No. 19, Hwa Ya 2nd Rd, Wen Hwa Vil, Kwei Shan Dist., Taoyuan City 33383, Taiwan (R.O.C)

**CERTIFICATION:** The above equipment have been tested by **Bureau Veritas Consumer Products Services (H.K.) Ltd., Taoyuan Branch – Lin Kou Laboratories**, and found compliance with the requirement of the above standards. The test record, data evaluation & Equipment Under Test (EUT) configurations represented herein are true and accurate accounts of the measurements of the sample's HAC characteristics under the conditions specified in this report. It should not be reproduced except in full, without the written approval of our laboratory. The client should not use it to claim product certification, approval, or endorsement by TAF or any government agencies.

Prepared By :

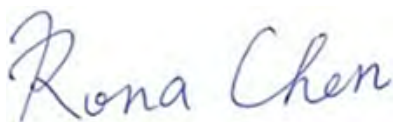

Rona Chen / Specialist

Approved By :



Eli Hsu / Senior Engineer



FCC Accredited No.: TW0003

This report is for your exclusive use. Any copying or replication of this report to or for any other person or entity, or use of our name or trademark, is permitted only with our prior written permission. This report sets forth our findings solely with respect to the test samples identified herein. The results set forth in this report are not indicative or representative of the quality or characteristics of the lot from which a test sample was taken or any similar or identical product unless specifically and expressly noted. Our report includes all of the tests requested by you and the results thereof based upon the information that you provided to us. You have 60 days from date of issuance of this report to notify us of any material error or omission caused by our negligence, provided, however, that such notice shall be in writing and shall specifically address the issue you wish to raise. A failure to raise such issue within the prescribed time shall constitute your unqualified acceptance of the completeness of this report, the tests conducted and the correctness of the report contents. Unless specific mention, the uncertainty of measurement has been explicitly taken into account to declare the compliance or non-compliance to the specification.



## Table of Contents

Release Control Record .....	3
1. Summary of Maximum M-Rating .....	4
2. Description of Equipment Under Test .....	5
3. HAC RF Emission Measurement System .....	7
3.1 SPEAG DASY System .....	7
3.1.1 Robot.....	8
3.1.2 Probes.....	8
3.1.3 Data Acquisition Electronics (DAE) .....	9
3.1.4 Phantoms.....	9
3.1.5 Device Holder.....	9
3.1.6 RF Emission Calibration Dipoles.....	9
3.2 DASY System Verification.....	10
3.3 EUT Measurements Reference and Plane.....	11
3.4 HAC RF Emission Measurement Procedure.....	12
3.5 Modulation Interference Factor .....	14
4. HAC Measurement Evaluation.....	16
4.1 M-Rating Category .....	16
4.2 EUT Configuration and Setting.....	16
4.3 System Verification.....	16
4.4 Maximum Target Conducted Power .....	17
4.5 Low Power Exemption Evaluation.....	19
4.6 Measured Conducted Power Results.....	21
4.7 HAC RF Emission Testing Results.....	22
5. Calibration of Test Equipment.....	24
6. Measurement Uncertainty.....	25
7. Information on the Testing Laboratories.....	26
Appendix A. Plots of System Verification	
Appendix B. Plots of HAC RF Emission Measurement	
Appendix C. Calibration Certificate for Probe and Dipole	
Appendix D. Photographs of EUT and Setup	



### Release Control Record

Report No.	Reason for Change	Date Issued
SA180207C11C	Initial release	Jun. 27, 2018
SA180207C11C R1	UID Summary updated on 2018.07.03	Jul. 13, 2018

## 1. Summary of Maximum M-Rating

Mode	Band	Maximum Audio Interference Level (dBV/m)	M-Rating
GSM	GSM850	43.30	M3
	GSM1900	33.25	M3
WCDMA	Band II	N/A	M4
	Band IV	N/A	M4
	Band V	N/A	M4
FDD-LTE	Band 2	N/A	M4
	Band 4	N/A	M4
	Band 5	N/A	M4
	Band 7	N/A	M4
	Band 12	N/A	M4
	Band 17	N/A	M4
	Band 26	N/A	M4
	Band 30	N/A	M4
TDD-LTE	Band 38	31.93	M3
	Band 41	32.00	M3
WLAN	2.4G	30.45	M3
	5.2G	N/A	N/A
	5.3G	N/A	N/A
	5.6G	N/A	N/A
	5.8G	N/A	N/A
Summary		M3	

**Note:**

1. The HAC RF emission limit (**M-rating Category M3**) is specified in FCC 47 CFR part 20.19 and ANSI C63.19.
2. The device RF emission rating is determined by the minimum rating.

# FCC HAC (RF Emission) Test Report

## 2. Description of Equipment Under Test

<b>EUT Type</b>	ASUS Phone
<b>FCC ID</b>	MSQZ01RD
<b>Brand Name</b>	ASUS
<b>Model Name</b>	ASUS_Z01RD / ASUS_Z01RS
<b>EUT Configuration</b>	EUT 1: EUT + CPU 1 + Rear Camera 1 + Front Camera 1 + UFS 3 + DDR 3 EUT 2: EUT + CPU 1 + Rear Camera 2 + Front Camera 2 + UFS 3 + DDR 3
<b>Tx Frequency Bands (Unit: MHz)</b>	<p><b>GSM</b> GSM850 : 824.2 ~ 848.8 GSM1900 : 1850.2 ~ 1909.8</p> <p><b>WCDMA</b> Band II : 1852.4 ~ 1907.6 Band IV : 1712.4 ~ 1752.6 Band V : 826.4 ~ 846.6</p> <p><b>FDD-LTE</b> Band 2 : 1850.7 ~ 1909.3 (BW: 1.4M, 3M, 5M, 10M, 15M, 20M) Band 4 : 1710.7 ~ 1754.3 (BW: 1.4M, 3M, 5M, 10M, 15M, 20M) Band 5 : 824.7 ~ 848.3 (BW: 1.4M, 3M, 5M, 10M) Band 7 : 2502.5 ~ 2567.5 (BW: 5M, 10M, 15M, 20M) Band 12 : 699.7 ~ 715.3 (BW: 1.4M, 3M, 5M, 10M) Band 17 : 706.5 ~ 713.5 (BW: 5M, 10M) Band 26 : 814.7 ~ 848.3 (BW: 1.4M, 3M, 5M, 10M, 15M) Band 30 : 2307.5 ~ 2312.5 (BW: 5M, 10M)</p> <p><b>TDD-LTE</b> LTE Band 38 : 2572.5 ~ 2617.5 (BW: 5M, 10M, 15M, 20M) LTE Band 41 : 2498.5 ~ 2687.5 (BW: 5M, 10M, 15M, 20M)</p> <p><b>WLAN</b> 2412 ~ 2462, 5180 ~ 5240, 5260 ~ 5320, 5500 ~ 5700, 5745 ~ 5825</p> <p><b>Bluetooth</b> 2402 ~ 2480</p>
<b>Modulations Supported in Uplink</b>	<p>GSM &amp; GPRS : GMSK EDGE : 8PSK WCDMA : QPSK LTE : QPSK, 16QAM, 64QAM 802.11b : DSSS 802.11a/g/n/ac : OFDM Bluetooth : GFSK, <math>\pi/4</math>-DQPSK, 8-DPSK</p>
<b>Antenna Type</b>	PIFA Antenna
<b>EUT Stage</b>	Production Unit

### Note:

- All models are listed as below.

Brand	Model	SKU	Difference
ASUS	ASUS_Z01RD	WW-5CA	Dual SIM
	ASUS_Z01RS	WW Operator-5CA	Single SIM

\*The models have the same layout, circuit, and components, but different SIM card slot, therefore Z01RD was chosen for final test.

- The above EUT information is declared by manufacturer and for more detailed features description please refers to the manufacturer's specifications or User's Manual.

# FCC HAC (RF Emission) Test Report

## Air Interface and Operational Mode:

Air Interface	Bands	Transport Type	HAC Tested	Simultaneous But Not Tested	Name of Voice Service	Power Reduction
GSM	850	VO	YES	WLAN or BT	CMRS Voice	No
	1900					No
	EGPRS	VD	YES	WLAN or BT	Google Duo	No
WCDMA	II	VO	No <sup>(1)</sup>	WLAN or BT	CMRS Voice	No
	IV					No
	V					No
	HSPA	VO	No <sup>(1)</sup>	WLAN or BT	Google Duo	No
FDD-LTE	2	VD	No <sup>(1)</sup>	WLAN or BT	VoLTE Google Duo	No
	4					No
	5					No
	7					No
	12					No
	17					No
	26					No
	30					No
TDD-LTE	38	VD	YES	WLAN or BT	VoLTE Google Duo	No
	41					No
WLAN	2.4G	VD	YES	WWAN	Google Duo	No
	5.2G	VD	No <sup>(1)</sup>		Google Duo	No
	5.3G					No
	5.6G					No
	5.8G					No
Bluetooth	2.4G	DT	No	WWAN	N/A	No
<b>Transport Type</b> VO = Legacy Cellular Voice Service DT = Digital Transport Only (No Voice) VD = IP Voice Service over Digital Transport			<b>Note</b> 1. It applies the low power exemption per ANSI C63.19-2011.			

### **3. HAC RF Emission Measurement System**

#### **3.1 SPEAG DASY System**

DASY system consists of high precision robot, probe alignment sensor, phantom, robot controller, controlled measurement server and near-field probe. The robot includes six axes that can move to the precision position of the DASY5 software defined. The DASY software can define the area that is detected by the probe. The robot is connected to controlled box. Controlled measurement server is connected to the controlled robot box. The DAE includes amplifier, signal multiplexing, AD converter, offset measurement and surface detection. It is connected to the Electro-optical coupler (ECO). The ECO performs the conversion from the optical into digital electric signal of the DAE and transfers data to the PC.

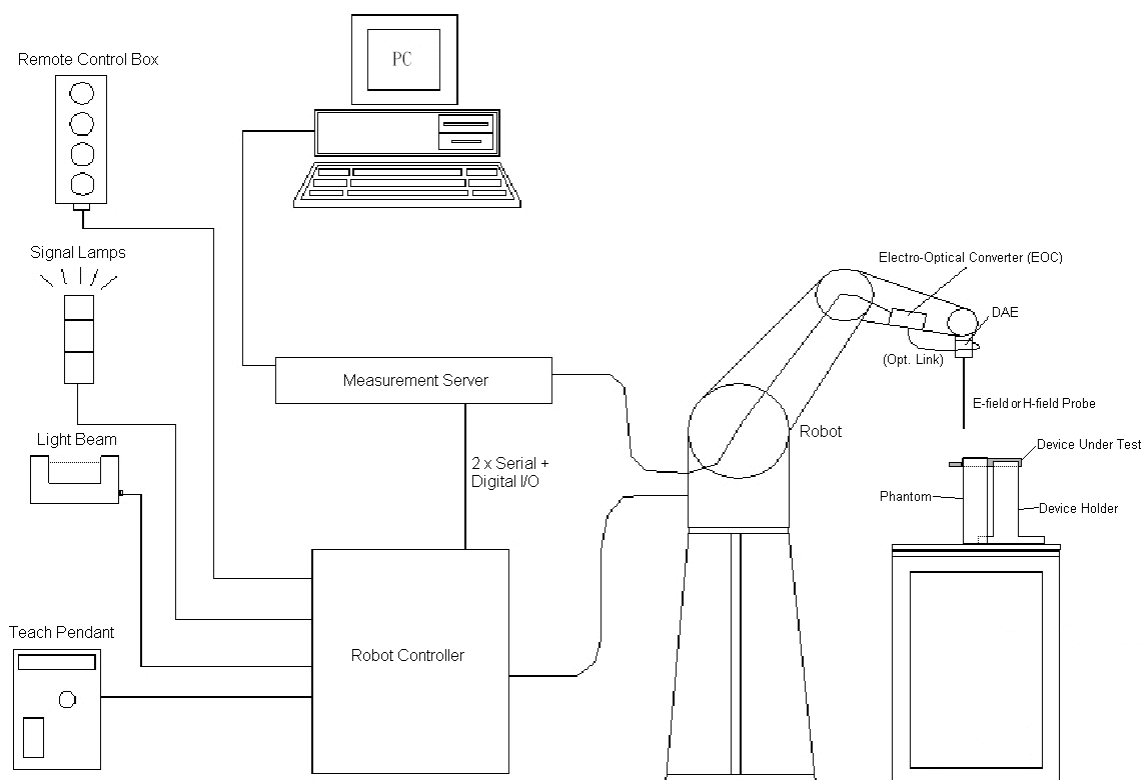

**Fig-3.1 DASY System Setup**

# FCC HAC (RF Emission) Test Report

## 3.1.1 Robot

The DASY system uses the high precision robots from Stäubli SA (France). For the 6-axis controller system, the robot controller version (DASY5: CS8c) from Stäubli is used. The Stäubli robot series have many features that are important for our application:

- High precision (repeatability  $\pm 0.035$  mm)
- High reliability (industrial design)
- Jerk-free straight movements
- Low ELF interference (the closed metallic construction shields against motor control fields)



**Fig-3.2 DASY5 Measurement System**

## 3.1.2 Probes

<b>Model</b>	ER3DV6	
<b>Construction</b>	One dipole parallel, two dipoles normal to probe axis Built-in shielding against static charges	
<b>Frequency</b>	40 MHz to 3 GHz Linearity: $\pm 0.2$ dB	
<b>Directivity</b>	$\pm 0.2$ dB in air (rotation around probe axis) $\pm 0.4$ dB in air (rotation normal to probe axis)	
<b>Dynamic Range</b>	2 V/m to 1000 V/m Linearity: $\pm 0.2$ dB	
<b>Dimensions</b>	Overall length: 337 mm (Tip: 16 mm) Tip diameter: 8 mm (Body: 12 mm) Distance from probe tip to dipole centers: 2.5 mm	

<b>Model</b>	EF3DV3	
<b>Construction</b>	One dipole parallel, two dipoles normal to probe axis Built-in shielding against static charges	
<b>Frequency</b>	40 MHz to 6 GHz Linearity: $\pm 0.2$ dB	
<b>Directivity</b>	$\pm 0.2$ dB in air (rotation around probe axis) $\pm 0.4$ dB in air (rotation normal to probe axis)	
<b>Dynamic Range</b>	2 V/m to 1000 V/m Linearity: $\pm 0.2$ dB	
<b>Dimensions</b>	Overall length: 337 mm (Tip: 20 mm) Tip diameter: 3.9 mm (Body: 12 mm) Distance from probe tip to dipole centers: 1.5 mm	



## FCC HAC (RF Emission) Test Report

### 3.1.3 Data Acquisition Electronics (DAE)

<b>Model</b>	DAE3, DAE4	
<b>Construction</b>	Signal amplifier, multiplexer, A/D converter and control logic. Serial optical link for communication with DASY embedded system (fully remote controlled). Two step probe touch detector for mechanical surface detection and emergency robot stop.	
<b>Measurement Range</b>	-100 to +300 mV (16 bit resolution and two range settings: 4mV, 400mV)	
<b>Input Offset Voltage</b>	< 5µV (with auto zero)	
<b>Input Bias Current</b>	< 50 fA	
<b>Dimensions</b>	60 x 60 x 68 mm	

### 3.1.4 Phantoms

<b>Model</b>	Test Arch	
<b>Construction</b>	Enables easy and well defined positioning of the phone and validation dipoles as well as simple teaching of the robot.	
<b>Dimensions</b>	Length : 370 mm Width : 370 mm Height : 370 mm	

### 3.1.5 Device Holder

<b>Model</b>	Mounting Device	
<b>Construction</b>	The Mounting Device enables the rotation of the mounted transmitter device in spherical coordinates. Rotation point is the ear opening point. Transmitter devices can be easily and accurately positioned according to ANSI C63.19.	
<b>Material</b>	POM	

### 3.1.6 RF Emission Calibration Dipoles

<b>Model</b>	CD-Serial	
<b>Construction</b>	Free space antenna Hearing Aid susceptibility measurements according to ANSI C63.19. Validation of Hearing Aid RF setup for wireless device emission measurements according to ANSI C63.19	
<b>Frequency</b>	CD700V3 : 698 ~ 806 MHz CD835V3 : 800 ~ 960 MHz CD1880V3 : 1710 ~ 2000 MHz CD2450V3 : 2250 ~ 2650 MHz CD2600V3 : 2450 ~ 2750 MHz CD3500V3 : 3300 ~ 3950 MHz CD5500V3 : 5000 ~ 5900 MHz	
<b>Return Loss</b>	CD700V3 : > 15 dB (750 MHz > 20 dB) CD835V3 : > 15 dB (835 MHz > 25 dB) CD1880V3 : > 18 dB (1880 MHz > 20 dB) CD2450V3 : > 18 dB (2450 MHz > 25 dB) CD2600V3 : > 18 dB (2600 MHz > 20 dB) CD3500V3 : > 16 dB (3500 MHz > 20 dB) CD5500V3 : > 18 dB (5500 MHz > 20 dB)	
<b>Power Capability</b>	> 40 W continuous	

**3.2 DASYS System Verification**

The system check verifies that the system operates within its specifications. It is performed before every E-field measurement. The system check uses normal measurements in the center section of the arch phantom with a matched dipole at a specified distance. The system verification setup is shown as below.

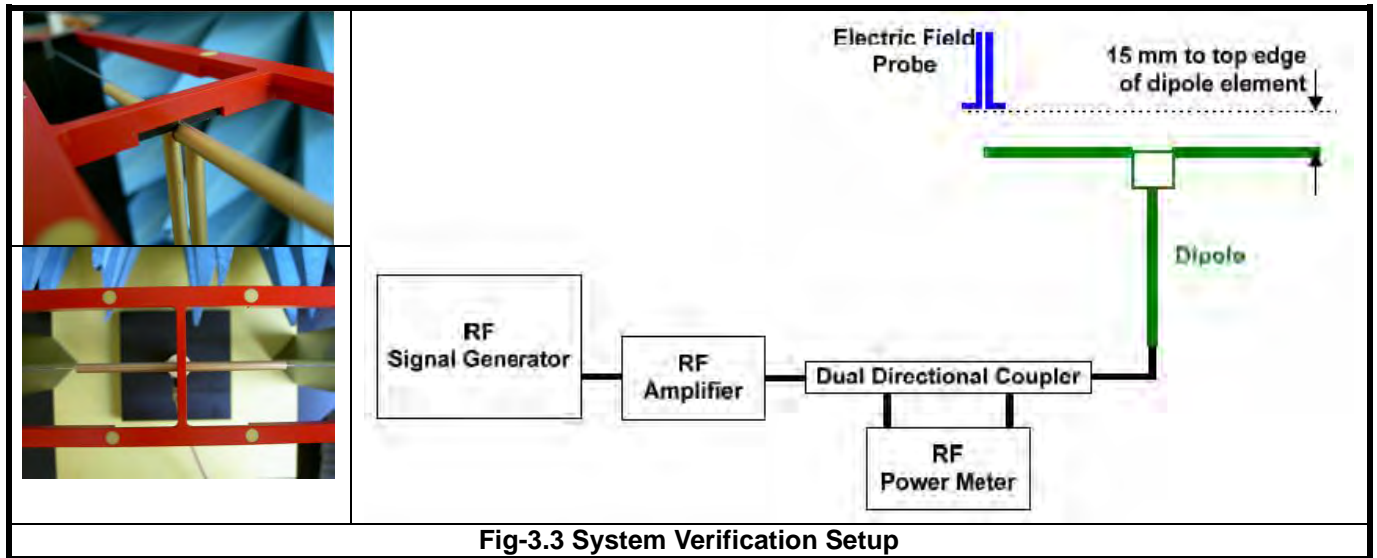

**Fig-3.3 System Verification Setup**

The validation dipole is placed beneath the center of arch phantom. The power meter measures the forward power at the location of the system check dipole connector. The signal generator is adjusted for the desired forward power, 100 mW (20 dBm) at the dipole connector and the RF power meter is read at that level. After connecting the cable to the dipole, the signal generator is readjusted for the same reading at RF power meter.

After system check testing, the E-field result will be compared with the reference value derived from validation dipole certificate report. The deviation of system check should be within 25 %.

The result of system verification is shown in section 4.3 of this report.

**3.3 EUT Measurements Reference and Plane**

The EUT is mounted in the device holder. The acoustic output of the EUT will coincide with the center point of the area formed by the dielectric wire and the middle bar of the arch's top frame. Then EUT will be moved vertically upwards until it touches the frame.

Fig-3.4 and Fig-3.5 illustrate the references and reference plane that is used in the RF emissions measurement.

- (a) The grid is 50 mm by 50 mm area that is divided into nine evenly sized blocks or sub-grids.
- (b) The grid is centered on the audio frequency output transducer of the EUT.
- (c) The grid is in a reference plane, which is defined as the planar area that contains the highest point in the area of the phone that normally rests against the user's ear. It is parallel to the centerline of the receiver area of the phone and is defined by the points of the receiver-end of the EUT handset, which in normal handset use rest against the ear.
- (d) The measurement plane is parallel to and 15 mm in front of the reference plane.



**Fig-3.4 EUT Reference and Plane**

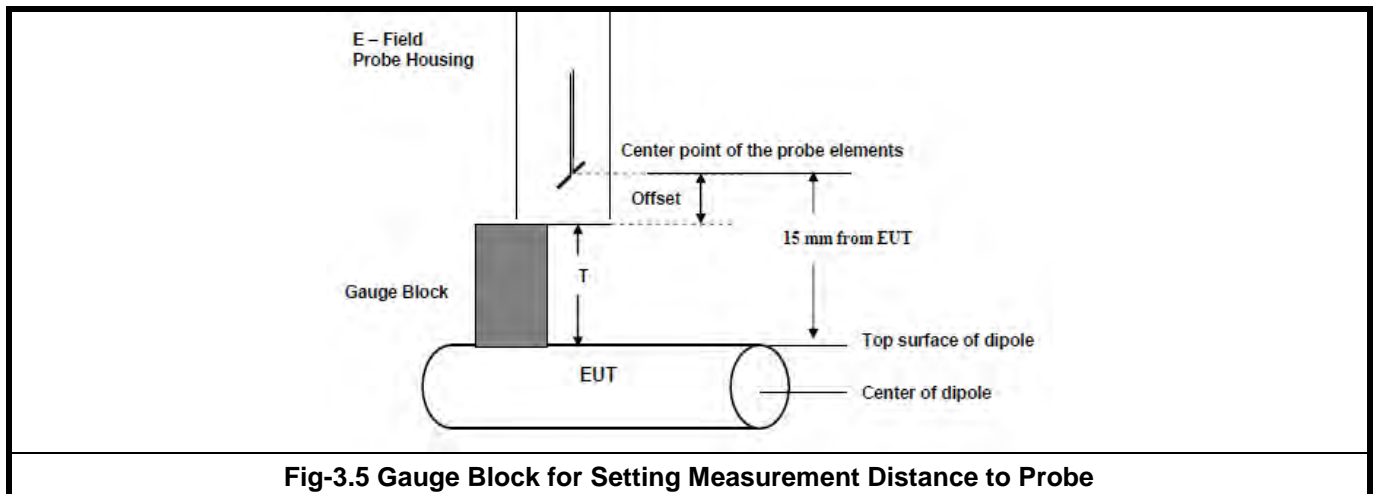

**Fig-3.5 Gauge Block for Setting Measurement Distance to Probe**

### **3.4 HAC RF Emission Measurement Procedure**

The RF emissions test procedure for wireless communications device is as below.

1. Confirm the proper operation of the field probe, probe measurement system, and other instrumentation and the positioning system.
2. Position the WD in its intended test position.
3. Set the WD to transmit a fixed and repeatable combination of signal power and modulation characteristic that is representative of the worst case (highest interference potential) encountered in normal use. Transiently occurring start-up, changeover, or termination conditions, or other operations likely to occur less than 1% of the time during normal operation, may be excluded from consideration.
4. The center sub-grid shall be centered on the T-Coil mode perpendicular measurement point or the acoustic output, as appropriate. Locate the field probe at the initial test position in the 50 mm by 50 mm grid, which is contained in the measurement plane, illustrated in Fig-3.4. If the field alignment method is used, align the probe for maximum field reception.
5. Record the reading at the output of the measurement system.
6. Scan the entire 50 mm by 50 mm region in equally spaced increments and record the reading at each measurement point. The distance between measurement points shall be sufficient to assure the identification of the maximum reading.
7. Identify the five contiguous sub-grids around the center sub-grid whose maximum reading is the lowest of all available choices. This eliminates the three sub-grids with the maximum readings. Thus, the six areas to be used to determine the WD's highest emissions are identified.
8. Identify the maximum reading within the non-excluded sub-grids identified in step 7.
9. Indirect Measurement Method: The RF audio interference level in dB(V/m) is obtained by adding the MIF (in dB) to the maximum steady-state rms field-strength reading, in dB(V/m), from step 8. Use this result to determine the category rating.

## FCC HAC (RF Emission) Test Report

10. Compare this RF audio interference level with the categories in section 4.1 and record the resulting WD category rating.
- 11 For the T-Coil mode M-rating assessment, determine whether the chosen perpendicular measurement point is contained in an included sub-grid of the first can. If so, then a second scan is not necessary. The first scan and resultant category rating may be used for the T-Coil mode M-rating. Otherwise, repeat step 1 through step 9, with the grid shifted so that it is centered on the perpendicular measurement point. Record the WD category rating.

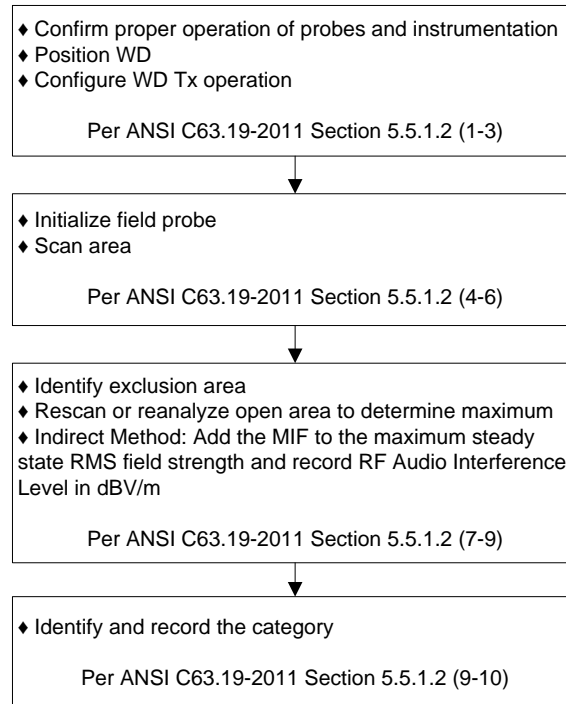

**Fig-3.6 WD Near-Field Emission Test Flowchart**

**3.5 Modulation Interference Factor**

The HAC Standard ANSI C63.19-2011 defines a new scaling using the Modulation Interference Factor (MIF) which replaces the need for the Articulation Weighting Factor (AWF) during the evaluation and is applicable to any modulation scheme.

The Modulation Interference Factor (MIF, in dB) is added to the measured average E-field (in dBV/m) and converts it to the RF audio interference potential (in dBV/m). This level considers the audible amplitude modulation components in the RF E-field. CW fields without amplitude modulation are assumed to not interfere with the hearing aid electronics. Modulations without time slots and low fluctuations at low frequencies have low MIF values, TDMA modulations with narrow transmission slots and repetition rates of few 100 Hz have high MIF values and give similar classification as ANSI C63.19-2007.

ER3D E-field probe have a bandwidth <10 kHz and can therefore not evaluate the RF envelope in the full audio band. DASY52 is therefore using the "indirect" measurement method according to ANSI C63.19-2011 which is the primary method. This near field probe read the averaged E-field. Especially for the new high peak-to-average (PAR) signal types, the probes shall be linearized by PMR calibration in order to not overestimate the field reading.

The evaluation method for the MIF is defined in ANSI C63.19-2011 section D.7. An RMS demodulated RF signal is fed to a spectral filter (similar to an A weighting filter) and forwarded to a temporal filter acting as a quasi-peak detector. The averaged output of these filtering is scaled to a 1 kHz 80% AM signal as reference. It may alternatively be determined through analysis and simulation, because it is constant and characteristic for a communication signal. DASY52 uses well-defined signals for PMR calibration. The MIF of these signals has been determined numerically. It allows a precise scaling and is therefore automatically applied.

The following table lists the MIF values evaluated by DASY manufacturer (SPEAG), and the test result will be calculated with the MIF parameter automatically. The detailed parameters for E-field probe can be found in the probe calibration report in appendix C.

UID	Reversion	Communication System Name	MIF (dB)
10021	DAC	GSM-FDD (TDMA, GMSK)	3.63
10025	DAC	EDGE-FDD (TDMA, 8PSK, TN 0)	3.75
10460	AAA	UMTS-FDD (WCDMA, AMR)	-25.43
10225	CAB	UMTS-FDD (HSPA+)	-20.39
10081	CAB	CDMA2000 (1xRTT, RC3)	-19.71
10295	AAB	CDMA2000, RC1, SO3, 1/8th Rate 25 fr.	3.26
10403	AAB	CDMA2000 (1xEV-DO, Rev. 0)	-17.67
10170	CAE	LTE-FDD (SC-FDMA, 1 RB, 20 MHz, 16-QAM)	-9.76
10172	CAF	LTE-TDD (SC-FDMA, 1 RB, 20 MHz, QPSK)	-1.62
10173	CAF	LTE-TDD (SC-FDMA, 1 RB, 20 MHz, 16-QAM)	-1.44
10174	CAF	LTE-TDD (SC-FDMA, 1 RB, 20 MHz, 64-QAM)	-1.54
10061	CAB	IEEE 802.11b WiFi 2.4 GHz (DSSS, 11 Mbps)	-2.02
10077	CAB	IEEE 802.11g WiFi 2.4 GHz (DSSS/OFDM, 54 Mbps)	0.12
10427	AAB	IEEE 802.11n (HT Greenfield, 150 Mbps, 64-QAM)	-13.44
10069	CAC	IEEE 802.11a/h WiFi 5 GHz (OFDM, 54 Mbps)	-3.15
10616	AAB	IEEE 802.11ac WiFi (40MHz, MCS0, 90pc duty cycle)	-5.57

## FCC HAC (RF Emission) Test Report

---

The MIF measurement uncertainty listed in following table is estimated by SPEAG.

MIF (dB)	MIF Measurement Uncertainty (dB)
-7 to +5	0.2
-13 to +11	0.5
> -20	1.0



**4. HAC Measurement Evaluation**

**4.1 M-Rating Category**

The HAC Standard ANSI C63.19-2011 represents performance requirements for acceptable interoperability of hearing aids with wireless communications devices. When these parameters are met, a hearing aid operates acceptably in close proximity to a wireless communications device.

Emission Categories	E-Field Emissions < 960 MHz (dB V/m)	E-Field Emissions > 960 MHz (dB V/m)
Category M1	50 - 55	40 - 45
Category M2	45 - 50	35 - 40
Category M3	40 - 45	30 - 35
Category M4	< 40	< 30

**4.2 EUT Configuration and Setting**

For HAC RF emission testing, the EUT was linked and controlled by base station emulator. Communication between the EUT and the emulator was established by air link. The distance between the EUT and the communicating antenna of the emulator is larger than 50 cm and the output power radiated from the emulator antenna is at least 30 dB smaller than the output power of EUT. The EUT was set from the emulator to radiate maximum output power during HAC testing.

**4.3 System Verification**

The measuring results for system check are shown as below.

Frequency (MHz)	Input Power (dBm)	Target Value (V/m)	E-Field 1 (V/m)	E-Field 2 (V/m)	Average E-Field (V/m)	Deviation (%)	Test Date
835	20.0	107.6	110.2	111.6	110.9	3.07	Apr. 12, 2018
1880	20.0	91.0	92.4	94.68	93.54	2.79	Apr. 12, 2018
2450	20.0	88.3	89.19	87.32	88.26	-0.05	Jun. 21, 2018
2450	20.0	88.3	87.31	85.2	86.255	-2.32	Jun. 26, 2018
2600	20.0	85.8	87.44	90.89	89.165	3.92	Jun. 15, 2018

**Note:**

1. Comparing to the reference target value provided by SPEAG, the validation data should be within its specification of 25 %. The result indicates the system check can meet the variation criterion and the plots can be referred to Appendix A of this report.
2. For E-Field, the deviation is  $[(E\text{-Field } 1 + E\text{-Field } 2) / 2 - \text{Target Value}] / \text{Target Value} \times 100\%$



# FCC HAC (RF Emission) Test Report

## 4.4 Maximum Target Conducted Power

The maximum conducted average power (Unit: dBm) including tune-up tolerance is shown as below.

Air Interface		Max. Tune-up Power		
		ANT 1	ANT 2	
GSM	GSM850	32.0	32.0	
	EDGE850	27.5	27.5	
	GSM1900	29.0	29.0	
	EDGE1900	25.0	25.0	
WCDMA	Band II	23.5	23.5	
	Band IV	24.0	24.0	
	Band V	24.0	24.0	
FDD-LTE	Band 2	23.5	23.5	
	Band 4	24.0	24.0	
	Band 5	24.0	24.0	
	Band 7	23.0	23.0	
	Band 12	23.0	23.0	
	Band 17	23.0	23.0	
	Band 26	24.0	24.0	
	Band 30	24.0	24.0	
TDD-LTE	Band 38	QPSK	24.0	24.0
		16QAM	23.0	23.0
		64QAM	22.0	22.0
	Band 41	QPSK	24.0	24.0
		16QAM	23.0	23.0
		64QAM	22.0	22.0

# FCC HAC (RF Emission) Test Report

Air Interface		Max. Tune-up Power		
		ANT 1	ANT 2	ANT 1+2
WLAN 2.4G	802.11b	Ch1-12: 18.5 Ch13: 17.5	Ch1-12: 18.5 Ch13: 17.5	Ch1-12: 18.5 Ch13: 17.5
	802.11g	Ch1-11: 18.5 Ch12: 16.5 Ch13: 5.5	Ch1-11: 18.5 Ch12: 16.5 Ch13: 5.5	Ch1-11: 18.5 Ch12: 16.5 Ch13: 5.5
	802.11n HT20	Ch1-11: 18.5 Ch12: 16.5 Ch13: 4.0	Ch1-11: 18.5 Ch12: 16.5 Ch13: 4.0	Ch1-11: 18.5 Ch12: 16.5 Ch13: 4.0
WLAN 5.2G	802.11a	18.0	18.0	18.0
	802.11ac VHT20	17.0	17.0	17.0
	802.11ac VHT40	15.5	15.5	15.5
	802.11ac VHT80	15.5	15.5	15.5
WLAN 5.3G	802.11a	18.0	18.0	18.0
	802.11ac VHT20	17.0	17.0	17.0
	802.11ac VHT40	15.5	15.5	15.5
	802.11ac VHT80	15.5	15.5	15.5
WLAN 5.6G	802.11a	18.0	18.0	18.0
	802.11ac VHT20	17.0	17.0	17.0
	802.11ac VHT40	15.5	15.5	15.5
	802.11ac VHT80	Ch106: 14.5 Ch122-138: 15.5	Ch106: 14.5 Ch122-138: 15.5	Ch106: 14.5 Ch122-138: 15.5
WLAN 5.8G	802.11a	18.0	18.0	18.0
	802.11ac VHT20	17.0	17.0	17.0
	802.11ac VHT40	15.5	15.5	15.5
	802.11ac VHT80	15.5	15.5	15.5

**4.5 Low Power Exemption Evaluation**

According to ANSI C63.19-2011 section 4, RF air interface technologies that have low power have been found to produce sufficiently low RF interference potential, so it is possible to exempt them from the product testing. An RF air interface technology of a device is exempt from testing when its average antenna input power plus its worst-case MIF is  $\leq 17$  dBm for any of its operating modes. If a device supports multiple RF air interfaces, each RF air interface shall be evaluated individually. An RF air interface technology that is exempted from testing by above method could be rated as M4.

The low power exemption for this device is analyzed in below.

Air Interface		Max. Tune-up Power (dBm)	Worst Case MIF (dB)	Power + MIF (dB)	C63.19 Testing Required	
GSM	GSM850	32.0	3.63	35.63	YES	
	EDGE850	27.5	3.75	31.25	No	
	GSM1900	29.0	3.63	32.63	YES	
	EDGE1900	25.0	3.75	28.75	No	
WCDMA	AMR	24.0	-25.43	-1.43	No	
	HSPA	24.0	-20.39	3.61	No	
FDD-LTE		24.0	-9.76	14.24	No	
TDD-LTE	QPSK	24.0	-1.62	22.38	YES	
	16QAM	23.0	-1.44	21.56	No	
	64QAM	22.0	-1.54	20.46	No	
WLAN 2.4G	802.11b	ANT 1	18.5	-2.02	16.48	No
		ANT 2	18.5	-2.02	16.48	No
		ANT 1+2	18.5	-2.02	16.48	No
	802.11g	ANT 1	18.5	0.12	18.62	YES
		ANT 2	18.5	0.12	18.62	YES
		ANT 1+2	18.5	0.12	18.62	YES
	802.11n HT20	ANT 1	18.5	-13.44	5.06	No
		ANT 2	18.5	-13.44	5.06	No
		ANT 1+2	18.5	-13.44	5.06	No

**Note:**

1. The EDGE data modes were considered but not tested because GSM voice mode was worst case for the GSM air interface.
2. The TDD-LTE 16QAM/64QAM data modes were considered but not tested because QPSK mode was worst case for the TDD-LTE air interface.
3. The 802.11b modes were considered but not tested because 802.11g mode was worst case for the WLAN 2.4G air interface.

# FCC HAC (RF Emission) Test Report

Air Interface		Max. Tune-up Power (dBm)	Worst Case MIF (dB)	Power + MIF (dB)	C63.19 Testing Required	
WLAN 5.2G	802.11a	ANT 1	18.0	-3.15	14.85	No
		ANT 2	18.0	-3.15	14.85	No
		ANT 1+2	18.0	-3.15	14.85	No
	802.11ac VHT20	ANT 1	17.0	-5.57	11.43	No
		ANT 2	17.0	-5.57	11.43	No
		ANT 1+2	17.0	-5.57	11.43	No
	802.11ac VHT40	ANT 1	15.5	-5.57	9.93	No
		ANT 2	15.5	-5.57	9.93	No
		ANT 1+2	15.5	-5.57	9.93	No
	802.11ac VHT80	ANT 1	15.5	-5.57	9.93	No
		ANT 2	15.5	-5.57	9.93	No
		ANT 1+2	15.5	-5.57	9.93	No
WLAN 5.3G	802.11a	ANT 1	18.0	-3.15	14.85	No
		ANT 2	18.0	-3.15	14.85	No
		ANT 1+2	18.0	-3.15	14.85	No
	802.11ac VHT20	ANT 1	17.0	-5.57	11.43	No
		ANT 2	17.0	-5.57	11.43	No
		ANT 1+2	17.0	-5.57	11.43	No
	802.11ac VHT40	ANT 1	15.5	-5.57	9.93	No
		ANT 2	15.5	-5.57	9.93	No
		ANT 1+2	15.5	-5.57	9.93	No
	802.11ac VHT80	ANT 1	15.5	-5.57	9.93	No
		ANT 2	15.5	-5.57	9.93	No
		ANT 1+2	15.5	-5.57	9.93	No
WLAN 5.6G	802.11a	ANT 1	18.0	-3.15	14.85	No
		ANT 2	18.0	-3.15	14.85	No
		ANT 1+2	18.0	-3.15	14.85	No
	802.11ac VHT20	ANT 1	17.0	-5.57	11.43	No
		ANT 2	17.0	-5.57	11.43	No
		ANT 1+2	17.0	-5.57	11.43	No
	802.11ac VHT40	ANT 1	15.5	-5.57	9.93	No
		ANT 2	15.5	-5.57	9.93	No
		ANT 1+2	15.5	-5.57	9.93	No
	802.11ac VHT80	ANT 1	15.5	-5.57	9.93	No
		ANT 2	15.5	-5.57	9.93	No
		ANT 1+2	15.5	-5.57	9.93	No
WLAN 5.8G	802.11a	ANT 1	18.0	-3.15	14.85	No
		ANT 2	18.0	-3.15	14.85	No
		ANT 1+2	18.0	-3.15	14.85	No
	802.11ac VHT20	ANT 1	17.0	-5.57	11.43	No
		ANT 2	17.0	-5.57	11.43	No
		ANT 1+2	17.0	-5.57	11.43	No
	802.11ac VHT40	ANT 1	15.5	-5.57	9.93	No
		ANT 2	15.5	-5.57	9.93	No
		ANT 1+2	15.5	-5.57	9.93	No
	802.11ac VHT80	ANT 1	15.5	-5.57	9.93	No
		ANT 2	15.5	-5.57	9.93	No
		ANT 1+2	15.5	-5.57	9.93	No

# FCC HAC (RF Emission) Test Report

## 4.6 Measured Conducted Power Results

The measuring conducted average power (Unit: dBm) are shown as below.

Band	GSM850			GSM1900		
Channel	128	189	251	512	661	810
Frequency (MHz)	824.2	836.4	848.8	1850.2	1880.0	1909.8
GSM (GMSK, 1 Tx Slot)	31.53	31.54	31.26	28.98	28.97	28.93

Band	LTE Band 38					
BW	Modulation	RB Size	RB Offset	Low	Mid	High
		Channel		37850	38000	38150
		Frequency (MHz)		2580	2595	2610
20M	QPSK	1	0	23.57	23.59	23.52
		1	50	23.54	23.52	23.29
		1	99	23.51	23.51	23.23
		50	0	22.56	22.64	22.51
		50	25	22.54	22.59	22.45
		50	50	22.51	22.51	22.33
		100	0	22.55	22.62	22.41

Band	LTE Band 41							
BW	Modulation	RB Size	RB Offset	Low	Low-Mid	Mid	High-Mid	High
		Channel		39750	40185	40620	41055	41490
		Frequency (MHz)		2506	2549.5	2593	2636.5	2680
20M	QPSK	1	0	23.85	23.72	23.67	23.61	23.44
		1	50	23.76	23.63	23.58	23.52	23.35
		1	99	23.74	23.61	23.56	23.50	23.33
		50	0	22.89	22.76	22.71	22.65	22.48
		50	25	22.76	22.63	22.58	22.52	22.35
		50	50	22.74	22.61	22.56	22.50	22.33
		100	0	22.85	22.72	22.67	22.61	22.44

Band	WLAN 2.4G					
Mode	Data Rate	Channel	Frequency (MHz)	Power ANT1	Power ANT2	Power ANT1+2
802.11g	6Mbps	1	2412	18.35	18.10	18.48
		6	2437	18.28	18.26	18.34
		11	2462	18.21	18.17	18.43
		12	2467	16.36	16.24	16.49
		13	2472	5.02	5.00	5.04

# FCC HAC (RF Emission) Test Report

## 4.7 HAC RF Emission Testing Results

Plot No.	Band	Mode	Channel	Transmit Antenna	EUT Config.	Audio Interference Level (dB V/m)	FCC Limit (dB V/m)	FCC Margin (dB)	M-Rating
	GSM850	GSM Voice	128	1	1	34.46	45	-10.54	M4
	GSM850	GSM Voice	189	1	1	34.52	45	-10.48	M4
	GSM850	GSM Voice	251	1	1	33.73	45	-11.27	M4
	GSM850	GSM Voice	128	2	1	42.54	45	-2.46	M3
	GSM850	GSM Voice	189	2	1	42.59	45	-2.41	M3
01	GSM850	GSM Voice	251	2	1	43.30	45	-1.70	M3
	GSM850	GSM Voice	251	2	2	43.18	45	-1.82	M3
	GSM1900	GSM Voice	512	1	1	23.68	35	-11.32	M4
	GSM1900	GSM Voice	661	1	1	20.82	35	-14.18	M4
	GSM1900	GSM Voice	810	1	1	21.48	35	-13.52	M4
	GSM1900	GSM Voice	512	2	1	31.75	35	-3.25	M3
02	GSM1900	GSM Voice	661	2	1	33.25	35	-1.75	M3
	GSM1900	GSM Voice	810	2	1	33.00	35	-2.00	M3
	GSM1900	GSM Voice	661	2	2	33.13	35	-1.87	M3
	LTE B38	20M, QPSK, 1RB, OS0	37850	1	1	20.23	35	-14.77	M4
	LTE B38	20M, QPSK, 1RB, OS0	38000	1	1	20.30	35	-14.7	M4
	LTE B38	20M, QPSK, 1RB, OS0	38150	1	1	20.40	35	-14.6	M4
	LTE B38	20M, QPSK, 1RB, OS0	37850	2	1	31.28	35	-3.72	M3
03	LTE B38	20M, QPSK, 1RB, OS0	38000	2	1	31.93	35	-3.07	M3
	LTE B38	20M, QPSK, 1RB, OS0	38150	2	1	31.63	35	-3.37	M3
	LTE B38	20M, QPSK, 1RB, OS0	38000	2	2	31.81	35	-3.19	M3
	LTE B41	20M, QPSK, 1RB, OS0	39750	1	1	22.98	35	-12.02	M4
	LTE B41	20M, QPSK, 1RB, OS0	40185	1	1	21.45	35	-13.55	M4
	LTE B41	20M, QPSK, 1RB, OS0	40620	1	1	20.35	35	-14.65	M4
	LTE B41	20M, QPSK, 1RB, OS0	41055	1	1	21.08	35	-13.92	M4
	LTE B41	20M, QPSK, 1RB, OS0	41490	1	1	20.64	35	-14.36	M4
	LTE B41	20M, QPSK, 1RB, OS0	39750	2	1	29.16	35	-5.84	M4
	LTE B41	20M, QPSK, 1RB, OS0	40185	2	1	30.84	35	-4.16	M3
04	LTE B41	20M, QPSK, 1RB, OS0	40620	2	1	32.00	35	-3	M3
	LTE B41	20M, QPSK, 1RB, OS0	41055	2	1	31.56	35	-3.44	M3
	LTE B41	20M, QPSK, 1RB, OS0	41490	2	1	30.64	35	-4.36	M3
	LTE B41	20M, QPSK, 1RB, OS0	40620	2	2	31.79	35	-3.21	M3

## FCC HAC (RF Emission) Test Report

Plot No.	Band	Mode	Channel	Transmit Antenna	EUT Config.	Audio Interference Level (dB V/m)	FCC Limit (dB V/m)	FCC Margin (dB)	M-Rating
05	WLAN 2.4G	802.11g 6Mbps	1	0	1	29.82	35	-5.18	M4
	WLAN 2.4G	802.11g 6Mbps	6	0	1	30.45	35	-4.55	M3
	WLAN 2.4G	802.11g 6Mbps	11	0	1	29.24	35	-5.76	M4
	WLAN 2.4G	802.11g 6Mbps	12	0	1	27.18	35	-7.82	M4
	WLAN 2.4G	802.11g 6Mbps	13	0	1	20.39	35	-14.61	M4
	WLAN 2.4G	802.11g 6Mbps	1	1	1	27.27	35	-7.73	M4
	WLAN 2.4G	802.11g 6Mbps	6	1	1	28.32	35	-6.68	M4
	WLAN 2.4G	802.11g 6Mbps	11	1	1	27.23	35	-7.77	M4
	WLAN 2.4G	802.11g 6Mbps	12	1	1	25.66	35	-9.34	M4
	WLAN 2.4G	802.11g 6Mbps	13	1	1	19.08	35	-15.92	M4
	WLAN 2.4G	802.11g 6Mbps	1	0+1	1	28.51	35	-6.49	M4
	WLAN 2.4G	802.11g 6Mbps	6	0+1	1	29.7	35	-5.3	M4
	WLAN 2.4G	802.11g 6Mbps	11	0+1	1	27.55	35	-7.45	M4
	WLAN 2.4G	802.11g 6Mbps	12	0+1	1	27.17	35	-7.83	M4
	WLAN 2.4G	802.11g 6Mbps	13	0+1	1	19.07	35	-15.93	M4
	WLAN 2.4G	802.11g 6Mbps	6	0	2	30.32	35	-4.68	M3

Test Engineer : Eric Wu, and Willy Chang

## FCC HAC (RF Emission) Test Report

### 5. Calibration of Test Equipment

Equipment	Manufacturer	Model	SN	Cal. Date	Cal. Interval
835MHz Calibration Dipole	SPEAG	CD835V3	1041	Mar. 20, 2017	2 Years
1880MHz Calibration Dipole	SPEAG	CD1880V3	1032	Apr. 25, 2017	2 Years
2450MHz Calibration Dipole	SPEAG	CD2450V3	1033	Apr. 25, 2017	2 Years
2600MHz Calibration Dipole	SPEAG	CD2600V3	1005	Mar. 14, 2018	2 Years
Isotropic E-Field Probe	SPEAG	EF3DV3	4049	Dec. 05, 2017	1 Year
Data Acquisition Electronics	SPEAG	DAE3	579	Aug. 17, 2017	1 Year
Wireless Communication Test Set	Agilent	E5515C	MY50266628	Dec. 06, 2017	1 Year
Power Meter	Anritsu	ML2495A	1218009	Jul. 12, 2017	1 Year
Power Sensor	Anritsu	MA2411B	1207252	Jul. 12, 2017	1 Year



## FCC HAC (RF Emission) Test Report

### 6. Measurement Uncertainty

Error Description	Uncertainty Value (±%)	Probability Distribution	Divisor	Ci (E)	Ci (H)	Standard Uncertainty (E)
<b>Measurement System</b>						
Probe Calibration	5.1	Normal	1	1	1	± 5.1 %
Axial Isotropy	4.7	Rectangular	√3	1	1	± 2.7 %
Sensor Displacement	16.5	Rectangular	√3	1	0.145	± 9.5 %
Boundary Effects	2.4	Rectangular	√3	1	1	± 1.4 %
Phantom Boundary Effect	7.2	Rectangular	√3	1	0	± 4.1 %
Linearity	4.7	Rectangular	√3	1	1	± 2.7 %
Scaling with PMR Calibration	10.0	Rectangular	√3	1	1	± 5.8 %
System Detection Limit	1.0	Rectangular	√3	1	1	± 0.6 %
Readout Electronics	0.3	Normal	1	1	1	± 0.3 %
Response Time	0.8	Rectangular	√3	1	1	± 0.5 %
Integration Time	2.6	Rectangular	√3	1	1	± 1.5 %
RF Ambient Conditions	3.0	Rectangular	√3	1	1	± 1.7 %
RF Reflections	12.0	Rectangular	√3	1	1	± 6.9 %
Probe Positioner	1.2	Rectangular	√3	1	0.67	± 0.7 %
Probe Positioning	4.7	Rectangular	√3	1	0.67	± 2.7 %
Extrap. and Interpolation	1.0	Rectangular	√3	1	1	± 0.6 %
<b>Test Sample Related</b>						
Device Positioning Vertical	4.7	Rectangular	√3	1	0.67	± 2.7 %
Device Positioning Lateral	1.0	Rectangular	√3	1	1	± 0.6 %
Device Holder and Phantom	2.4	Rectangular	√3	1	1	± 1.4 %
Power Drift	5.0	Rectangular	√3	1	1	± 2.9 %
<b>Phantom and Setup Related</b>						
Phantom Thickness	2.4	Rectangular	√3	1	0.67	± 1.4 %
<b>Combined Standard Uncertainty</b>						± 16.3 %
Coverage Factor for 95 %						K = 2
<b>Expanded Uncertainty</b>						<b>± 32.6 %</b>

#### Uncertainty budget for HAC RF Emission

## FCC HAC (RF Emission) Test Report

---

### 7. Information on the Testing Laboratories

We, Bureau Veritas Consumer Products Services (H.K.) Ltd., Taoyuan Branch, were founded in 1988 to provide our best service in EMC, Radio, Telecom and Safety consultation. Our laboratories are accredited and approved according to ISO/IEC 17025.

If you have any comments, please feel free to contact us at the following:

**Taiwan HwaYa EMC/RF/Safety Lab:**

Add: No.19, Hwa Ya 2nd Rd., Wen Hwa Vil., Kwei Shan Dist., Taoyuan City 33383, Taiwan, R.O.C.

Tel: 886-3-318-3232

Fax: 886-3-327-0892

**Taiwan LinKo EMC/RF Lab:**

Add: No. 47-2, 14th Ling, Chia Pau Vil., Linkou Dist., New Taipei City 244, Taiwan, R.O.C.

Tel: 886-2-2605-2180

Fax: 886-2-2605-1924

**Taiwan HsinChu EMC/RF/Telecom Lab:**

Add: E-2, No.1, Li Hsin 1<sup>st</sup> Road, Hsinchu Science Park, Hsinchu City 30078, Taiwan, R.O.C.

Tel: 886-3-666-8565

Fax: 886-3-666-8323

**Email:** [service.adt@tw.bureauveritas.com](mailto:service.adt@tw.bureauveritas.com)

**Web Site:** [www.bureauveritas-adt.com](http://www.bureauveritas-adt.com)

The road map of all our labs can be found in our web site also.

---END---

## Appendix A. Plots of System Verification

The plots for system verification are shown as follows.

### System Check\_E-Field\_835\_180412

**DUT: HAC Dipole 835 MHz; Type: CD835V3; SN: 1041**

Communication System: CW; Frequency: 835 MHz; Duty Cycle: 1:1

Medium: Air Medium parameters used:  $\sigma = 0 \text{ S/m}$ ,  $\epsilon_r = 1$ ;  $\rho = 1000 \text{ kg/m}^3$

Ambient Temperature : 23.7 °C

DASY5 Configuration:

- Probe: EF3DV3 - SN4049; ConvF(1, 1, 1); Calibrated: 2017/12/05;
- Sensor-Surface: (Fix Surface)
- Electronics: DAE3 Sn579; Calibrated: 2017/08/17
- Phantom: HAC Test Arch with AMCC; Type: SD HAC P01 BA;
- Measurement SW: DASY52, Version 52.8 (8); SEMCAD X Version 14.6.10 (7373)

**Hearing Aid Compatibility (41x361x1):** Interpolated grid: dx=0.5000 mm, dy=0.5000 mm

Device Reference Point: 0, 0, -6.3 mm

Reference Value = 129.9 V/m; Power Drift = -0.09 dB

E-field emissions = 111.6 V/m

Grid 1 M4 <b>109.1 V/m</b>	Grid 2 M4 <b>110.2 V/m</b>	Grid 3 M4 <b>106.4 V/m</b>
Grid 4 M4 <b>65.10 V/m</b>	Grid 5 M4 <b>65.76 V/m</b>	Grid 6 M4 <b>64.31 V/m</b>
Grid 7 M4 <b>110.8 V/m</b>	Grid 8 M4 <b>111.6 V/m</b>	Grid 9 M4 <b>107.7 V/m</b>

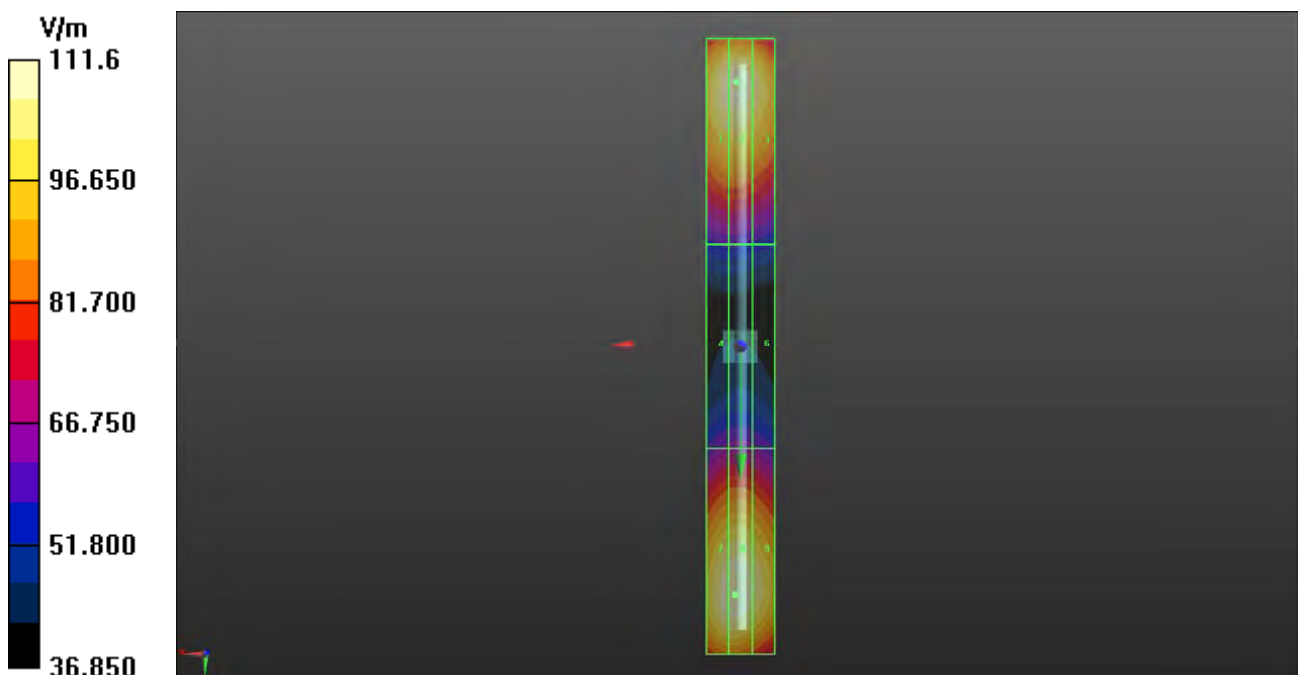

### System Check\_E-Field\_1880\_180412

**DUT: HAC Dipole 1880 MHz; Type: CD1880V3; SN: 1032**

Communication System: CW; Frequency: 1880 MHz;Duty Cycle: 1:1

Medium: Air Medium parameters used:  $\sigma = 0 \text{ S/m}$ ,  $\epsilon_r = 1$ ;  $\rho = 1000 \text{ kg/m}^3$

Ambient Temperature : 23.7 °C

DASY5 Configuration:

- Probe: EF3DV3 - SN4049; ConvF(1, 1, 1); Calibrated: 2017/12/05;
- Sensor-Surface: (Fix Surface)
- Electronics: DAE3 Sn579; Calibrated: 2017/08/17
- Phantom: HAC Test Arch with AMCC; Type: SD HAC P01 BA;
- Measurement SW: DASY52, Version 52.8 (8); SEMCAD X Version 14.6.10 (7373)

**Hearing Aid Compatibility (41x181x1):** Interpolated grid: dx=0.5000 mm, dy=0.5000 mm

Device Reference Point: 0, 0, -6.3 mm

Reference Value = 147.6 V/m; Power Drift = 0.05 dB

E-field emissions = 94.68 V/m

Grid 1 <b>M3</b> <b>92.22 V/m</b>	Grid 2 <b>M3</b> <b>92.40 V/m</b>	Grid 3 <b>M3</b> <b>87.63 V/m</b>
Grid 4 <b>M3</b> <b>71.53 V/m</b>	Grid 5 <b>M3</b> <b>72.92 V/m</b>	Grid 6 <b>M3</b> <b>72.15 V/m</b>
Grid 7 <b>M3</b> <b>93.66 V/m</b>	Grid 8 <b>M3</b> <b>94.68 V/m</b>	Grid 9 <b>M3</b> <b>92.20 V/m</b>

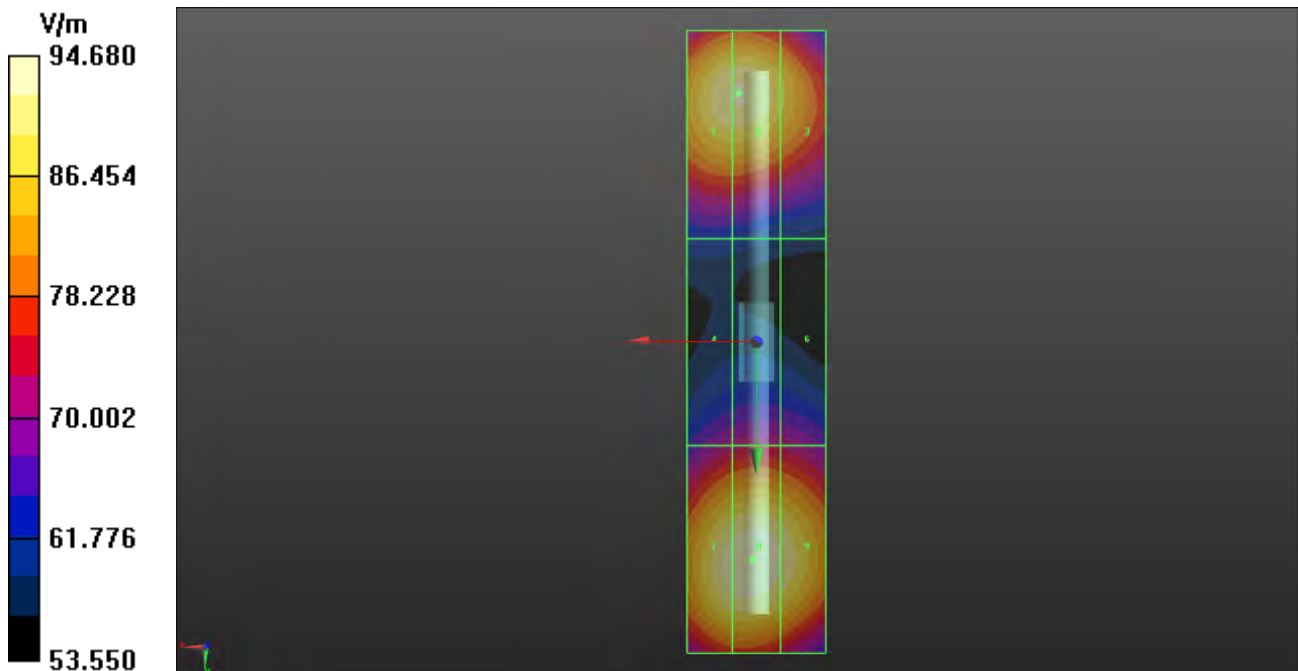

### System Check\_E-Field\_2450\_180626

**DUT: HAC Dipole 2450 MHz; Type: CD2450V3; SN: 1033**

Communication System: CW; Frequency: 2450 MHz; Duty Cycle: 1:1

Medium: Air Medium parameters used:  $\sigma = 0 \text{ S/m}$ ,  $\epsilon_r = 1$ ;  $\rho = 1000 \text{ kg/m}^3$

Ambient Temperature : 23.6 °C

DASY5 Configuration:

- Probe: EF3DV3 - SN4049; ConvF(1, 1, 1); Calibrated: 2017/12/05;
- Sensor-Surface: (Fix Surface)
- Electronics: DAE3 Sn579; Calibrated: 2017/08/17
- Phantom: HAC Test Arch with AMCC; Type: SD HAC P01 BA;
- Measurement SW: DASY52, Version 52.10 (0); SEMCAD X Version 14.6.10 (7373)

**Hearing Aid Compatibility (41x181x1):** Interpolated grid: dx=0.5000 mm, dy=0.5000 mm

Device Reference Point: 0, 0, -6.3 mm

Reference Value = 72.91 V/m; Power Drift = 0.06 dB

E-field emissions = 87.31 V/m

Grid 1 M3 <b>86.47 V/m</b>	Grid 2 M3 <b>87.31 V/m</b>	Grid 3 M3 <b>84.34 V/m</b>
Grid 4 M3 <b>75.55 V/m</b>	Grid 5 M3 <b>76.34 V/m</b>	Grid 6 M3 <b>74.61 V/m</b>
Grid 7 M3 <b>84.14 V/m</b>	Grid 8 M3 <b>85.20 V/m</b>	Grid 9 M3 <b>83.06 V/m</b>

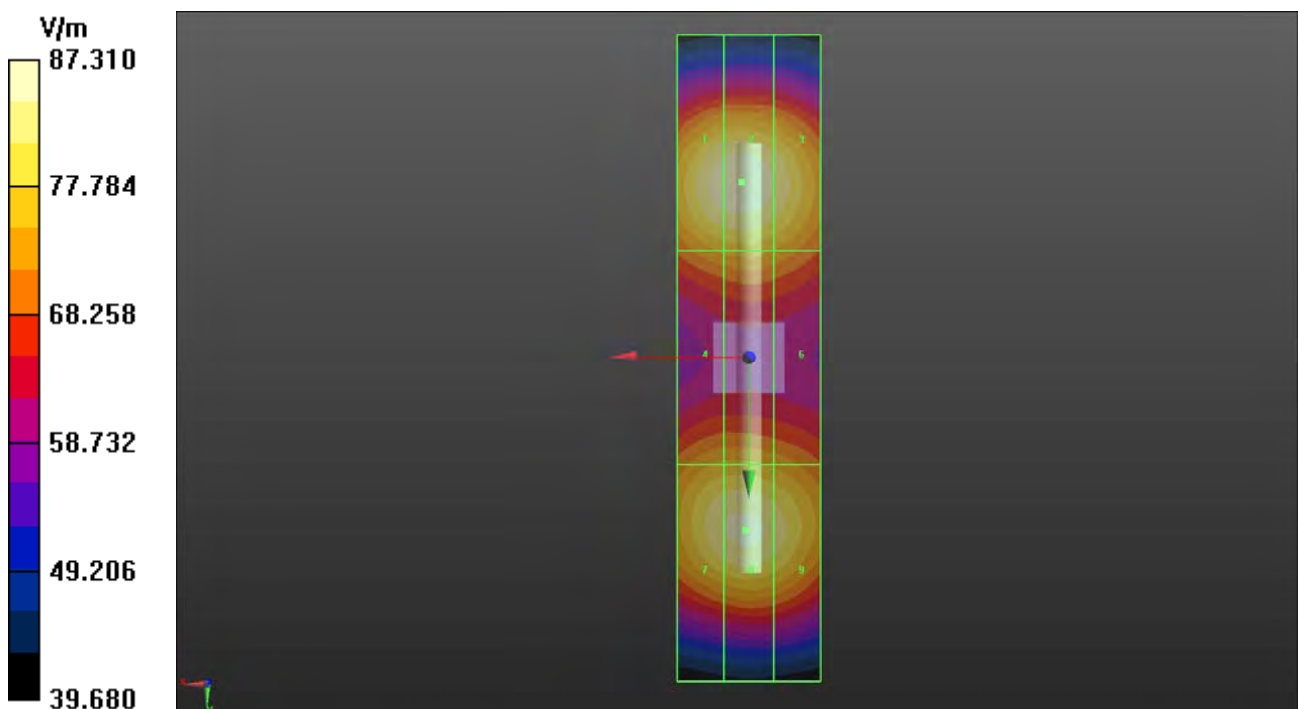

### System Check\_E-Field\_2600\_1: 0615

**DUT: HAC Dipole 2600 MHz; Type: CD2600V3; SN: 1005**

Communication System: CW; Frequency: 2600 MHz; Duty Cycle: 1:1

Medium: Air Medium parameters used:  $\sigma = 0 \text{ S/m}$ ,  $\epsilon_r = 1$ ;  $\rho = 0 \text{ kg/m}^3$

Ambient Temperature : 23.6 °C

DASY5 Configuration:

- Probe: EF3DV3 - SN4049; ConvF(1, 1, 1); Calibrated: 2017/12/05;
- Sensor-Surface: (Fix Surface)
- Electronics: DAE3 Sn579; Calibrated: 2017/08/17
- Phantom: HAC Test Arch with AMCC; Type: SD HAC P01 BA;
- Measurement SW: DASY52, Version 52.10 (0); SEMCAD X Version 14.6.10 (7373)

**Hearing Aid Compatibility (41x181x1):** Interpolated grid: dx=0.5000 mm, dy=0.5000 mm

Device Reference Point: 0, 0, -6.3 mm

Reference Value = 70.23 V/m; Power Drift = -0.01 dB

E-field emissions = 90.89 V/m

Grid 1 <b>M3</b> <b>87.10 V/m</b>	Grid 2 <b>M3</b> <b>87.44 V/m</b>	Grid 3 <b>M3</b> <b>83.81 V/m</b>
Grid 4 <b>M3</b> <b>86.36 V/m</b>	Grid 5 <b>M3</b> <b>87.53 V/m</b>	Grid 6 <b>M3</b> <b>85.47 V/m</b>
Grid 7 <b>M3</b> <b>90.30 V/m</b>	Grid 8 <b>M3</b> <b>90.89 V/m</b>	Grid 9 <b>M3</b> <b>87.98 V/m</b>

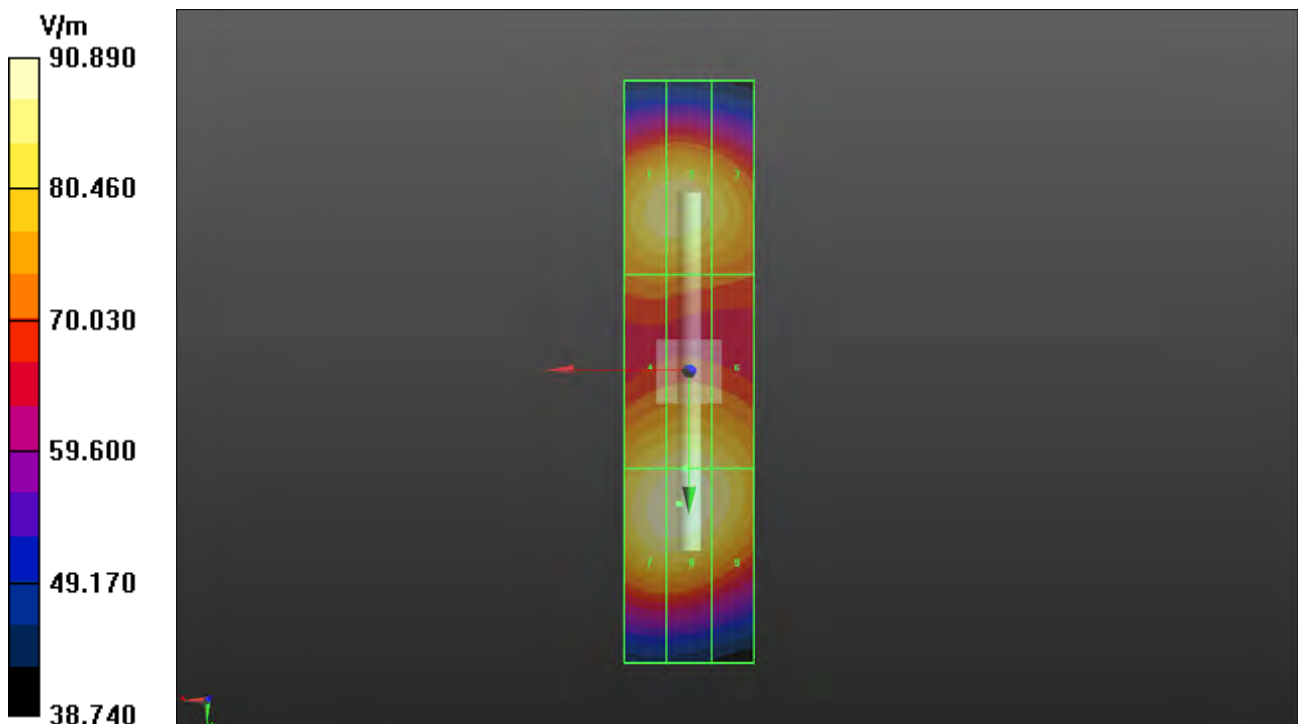



## **Appendix B. Plots of HAC RF Emission Measurement**

The plots for HAC measurement are shown as follows.



### P01 RF\_E-Field\_GSM850\_GSM\_Ch251\_Sample1\_Ant1

**DUT: 180207C11**

Communication System: GSM-FDD (TDMA, GMSK); Frequency: 848.8 MHz; Duty Cycle: 1:8.69

Medium: Air Medium parameters used:  $\sigma = 0 \text{ S/m}$ ,  $\epsilon_r = 1$ ;  $\rho = 1000 \text{ kg/m}^3$

Ambient Temperature : 23.7 °C

DASY5 Configuration:

- Probe: EF3DV3 - SN4049; ConvF(1, 1, 1); Calibrated: 2017/12/05;
- Sensor-Surface: (Fix Surface)
- Electronics: DAE3 Sn579; Calibrated: 2017/08/17
- Phantom: HAC Test Arch with AMCC; Type: SD HAC P01 BA;
- Measurement SW: DASY52, Version 52.8 (8); SEMCAD X Version 14.6.10 (7373)

**Hearing Aid Compatibility (101x101x1):** Interpolated grid: dx=0.5000 mm, dy=0.5000 mm

Device Reference Point: 0, 0, -6.3 mm

Reference Value = 176.2 V/m; Power Drift = -0.11 dB

MIF = 3.63 dB

RF audio interference level = 43.30 dBV/m

**Emission category: M3**

Grid 1 <b>M4</b> <b>35.29 dBV/m</b>	Grid 2 <b>M3</b> <b>40.51 dBV/m</b>	Grid 3 <b>M3</b> <b>40.28 dBV/m</b>
Grid 4 <b>M4</b> <b>38.66 dBV/m</b>	Grid 5 <b>M3</b> <b>43.3 dBV/m</b>	Grid 6 <b>M3</b> <b>42.8 dBV/m</b>
Grid 7 <b>M4</b> <b>38.67 dBV/m</b>	Grid 8 <b>M3</b> <b>43.24 dBV/m</b>	Grid 9 <b>M3</b> <b>42.77 dBV/m</b>

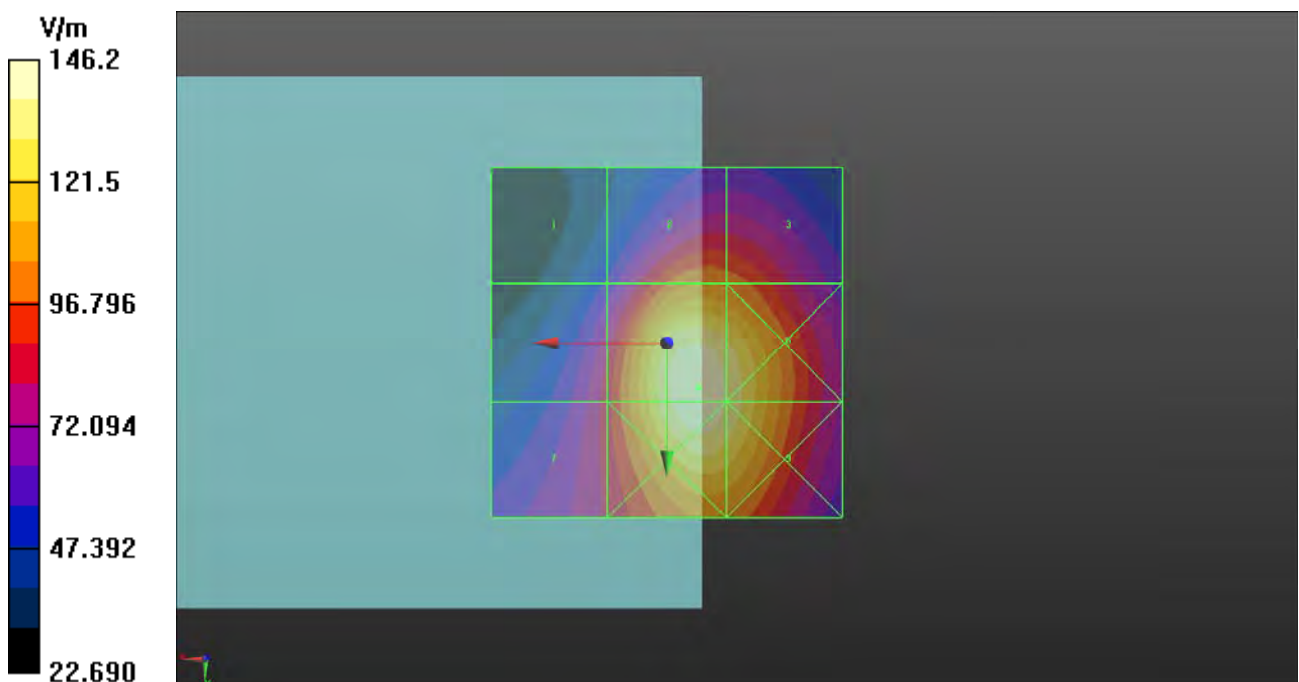

## P02 RF\_E-Field\_GSM1900\_GSM\_Ch661\_Sample1\_Ant1

**DUT: 180207C11**

Communication System: GSM-FDD (TDMA, GMSK); Frequency: 1880 MHz; Duty Cycle: 1:8.69

Medium: Air Medium parameters used:  $\sigma = 0 \text{ S/m}$ ,  $\epsilon_r = 1$ ;  $\rho = 1000 \text{ kg/m}^3$

Ambient Temperature : 23.7 °C

DASY5 Configuration:

- Probe: EF3DV3 - SN4049; ConvF(1, 1, 1); Calibrated: 2017/12/05;
- Sensor-Surface: (Fix Surface)
- Electronics: DAE3 Sn579; Calibrated: 2017/08/17
- Phantom: HAC Test Arch with AMCC; Type: SD HAC P01 BA;
- Measurement SW: DASY52, Version 52.8 (8); SEMCAD X Version 14.6.10 (7373)

**Hearing Aid Compatibility (101x101x1):** Interpolated grid: dx=0.5000 mm, dy=0.5000 mm

Device Reference Point: 0, 0, -6.3 mm

Reference Value = 20.17 V/m; Power Drift = -0.01 dB

MIF = 3.63 dB

RF audio interference level = 33.25 dBV/m

**Emission category: M3**

Grid 1 <b>M3</b> <b>30.92 dBV/m</b>	Grid 2 <b>M3</b> <b>33.25 dBV/m</b>	Grid 3 <b>M3</b> <b>33.09 dBV/m</b>
Grid 4 <b>M4</b> <b>28.36 dBV/m</b>	Grid 5 <b>M3</b> <b>32.02 dBV/m</b>	Grid 6 <b>M3</b> <b>32.05 dBV/m</b>
Grid 7 <b>M4</b> <b>29.85 dBV/m</b>	Grid 8 <b>M3</b> <b>33.25 dBV/m</b>	Grid 9 <b>M3</b> <b>33.24 dBV/m</b>

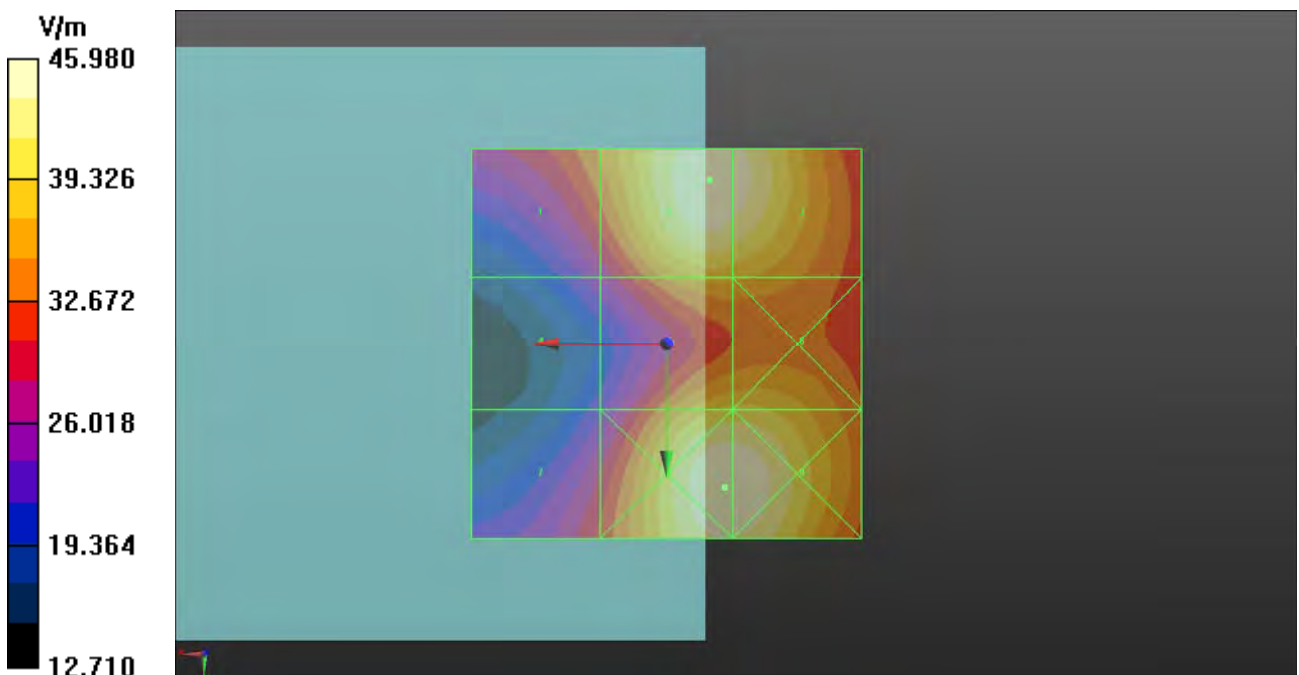

**P03 RF\_E-Field\_LTE 38\_QPSK20M\_Ch38000\_Sample1\_Ant1\_1RB\_OS0**

**DUT: 180207C11**

Communication System: LTE-TDD (SC-FDMA, 1 RB, 20 MHz, QPSK); Frequency: 2595 MHz; Duty Cycle: 1:8.34

Medium: Air Medium parameters used:  $\sigma = 0$  S/m,  $\epsilon_r = 1$ ;  $\rho = 1000$  kg/m<sup>3</sup>

Ambient Temperature : 23.6 °C

DASY5 Configuration:

- Probe: EF3DV3 - SN4049; ConvF(1, 1, 1); Calibrated: 2017/12/05;
- Sensor-Surface: (Fix Surface)
- Electronics: DAE3 Sn579; Calibrated: 2017/08/17
- Phantom: HAC Test Arch with AMCC; Type: SD HAC P01 BA;
- Measurement SW: DASY52, Version 52.8 (8); SEMCAD X Version 14.6.10 (7373)

**Hearing Aid Compatibility (101x101x1):** Interpolated grid: dx=0.5000 mm, dy=0.5000 mm

Device Reference Point: 0, 0, -6.3 mm

Reference Value = 75.23 V/m; Power Drift = -0.06 dB

MIF = -1.62 dB

RF audio interference level = 31.93 dBV/m

**Emission category: M3**

Grid 1 <b>M4</b> <b>28.27 dBV/m</b>	Grid 2 <b>M4</b> <b>29.93 dBV/m</b>	Grid 3 <b>M4</b> <b>29.44 dBV/m</b>
Grid 4 <b>M3</b> <b>30.33 dBV/m</b>	Grid 5 <b>M3</b> <b>31.93 dBV/m</b>	Grid 6 <b>M3</b> <b>31.26 dBV/m</b>
Grid 7 <b>M4</b> <b>29.45 dBV/m</b>	Grid 8 <b>M3</b> <b>31.36 dBV/m</b>	Grid 9 <b>M3</b> <b>31.01 dBV/m</b>

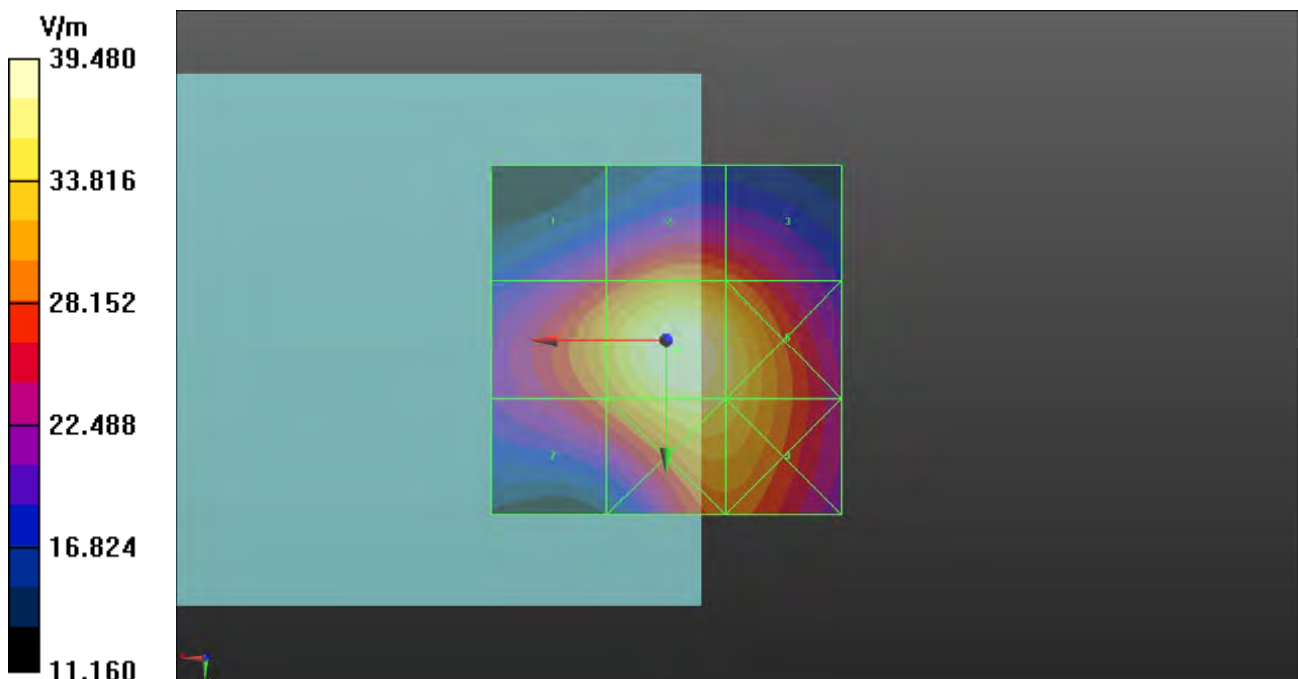

**P04 RF\_E-Field\_LTE 41\_QPSK20M\_Ch40620\_Sample1\_Ant1\_1RB\_OS0**

**DUT: 180207C11**

Communication System: LTE-TDD (SC-FDMA, 1 RB, 20 MHz, QPSK); Frequency: 2593 MHz; Duty Cycle: 1:8.34

Medium: Air Medium parameters used:  $\sigma = 0$  S/m,  $\epsilon_r = 1$ ;  $\rho = 1000$  kg/m<sup>3</sup>

Ambient Temperature : 23.6 °C

DASY5 Configuration:

- Probe: EF3DV3 - SN4049; ConvF(1, 1, 1); Calibrated: 2017/12/05;
- Sensor-Surface: (Fix Surface)
- Electronics: DAE3 Sn579; Calibrated: 2017/08/17
- Phantom: HAC Test Arch with AMCC; Type: SD HAC P01 BA;
- Measurement SW: DASY52, Version 52.8 (8); SEMCAD X Version 14.6.10 (7373)

**Hearing Aid Compatibility (101x101x1):** Interpolated grid: dx=0.5000 mm, dy=0.5000 mm

Device Reference Point: 0, 0, -6.3 mm

Reference Value = 75.49 V/m; Power Drift = -0.02 dB

MIF = -1.62 dB

RF audio interference level = 32.00 dBV/m

**Emission category: M3**

Grid 1 <b>M4</b> <b>28.26 dBV/m</b>	Grid 2 <b>M4</b> <b>29.94 dBV/m</b>	Grid 3 <b>M4</b> <b>29.43 dBV/m</b>
Grid 4 <b>M3</b> <b>30.38 dBV/m</b>	Grid 5 <b>M3</b> <b>32 dBV/m</b>	Grid 6 <b>M3</b> <b>31.35 dBV/m</b>
Grid 7 <b>M4</b> <b>29.53 dBV/m</b>	Grid 8 <b>M3</b> <b>31.47 dBV/m</b>	Grid 9 <b>M3</b> <b>31.12 dBV/m</b>

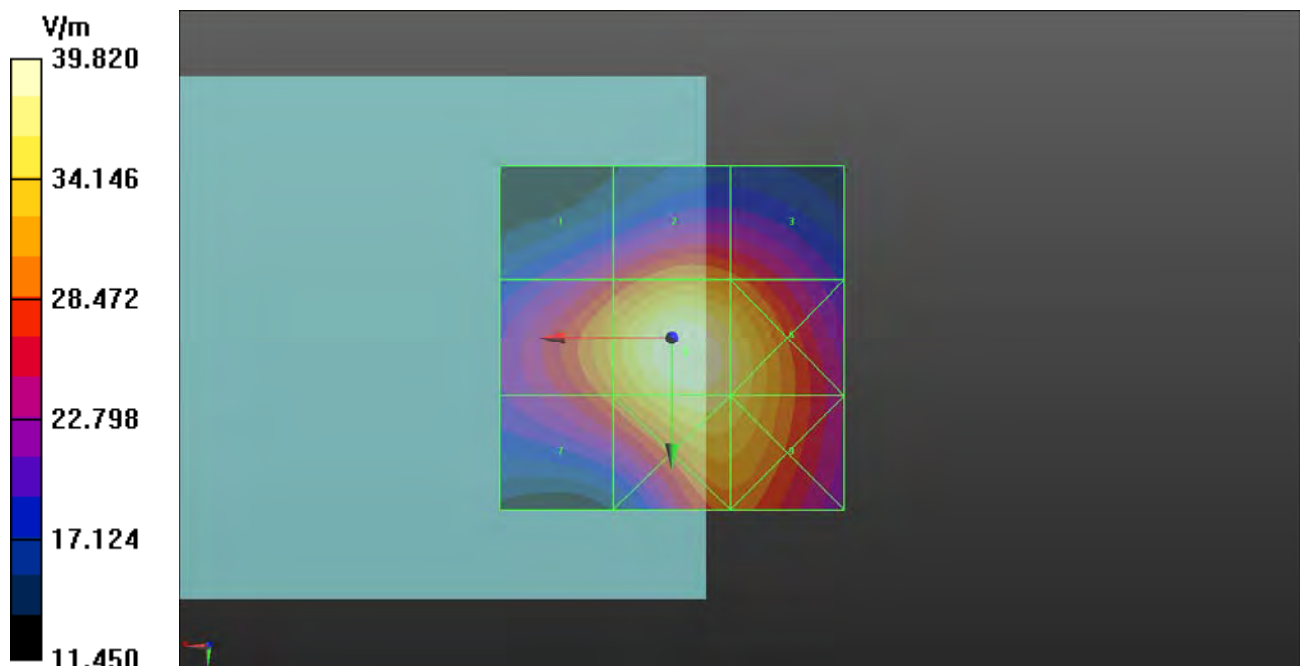

### P05 RF\_E-Field\_WLAN2.4G\_802.11g\_Ch6\_Ant0\_Sample1

**DUT: 180207C11**

Communication System: IEEE 802.11g WiFi 2.4 GHz (DSSS/OFDM, 54 Mbps); Frequency: 2437 MHz; Duty Cycle: 1:12.59

Medium: Air Medium parameters used:  $\sigma = 0 \text{ S/m}$ ,  $\epsilon_r = 1$ ;  $\rho = 1000 \text{ kg/m}^3$

Ambient Temperature : 23.8 °C

DASY5 Configuration:

- Probe: EF3DV3 - SN4049; ConvF(1, 1, 1); Calibrated: 2017/12/05;
- Sensor-Surface: (Fix Surface)
- Electronics: DAE3 Sn579; Calibrated: 2017/08/17
- Phantom: HAC Test Arch with AMCC; Type: SD HAC P01 BA;
- Measurement SW: DASY52, Version 52.10 (0); SEMCAD X Version 14.6.10 (7373)

**Hearing Aid Compatibility (101x101x1):** Interpolated grid: dx=0.5000 mm, dy=0.5000 mm

Device Reference Point: 0, 0, -6.3 mm

Reference Value = 39.55 V/m; Power Drift = -0.04 dB

MIF = 0.12 dB

RF audio interference level = 30.45 dBV/m

**Emission category: M3**

Grid 1 <b>M4</b> <b>27.39 dBV/m</b>	Grid 2 <b>M3</b> <b>30.53 dBV/m</b>	Grid 3 <b>M3</b> <b>30.53 dBV/m</b>
Grid 4 <b>M4</b> <b>27.43 dBV/m</b>	Grid 5 <b>M3</b> <b>30.45 dBV/m</b>	Grid 6 <b>M3</b> <b>30.45 dBV/m</b>
Grid 7 <b>M4</b> <b>25.52 dBV/m</b>	Grid 8 <b>M4</b> <b>27.91 dBV/m</b>	Grid 9 <b>M4</b> <b>27.92 dBV/m</b>

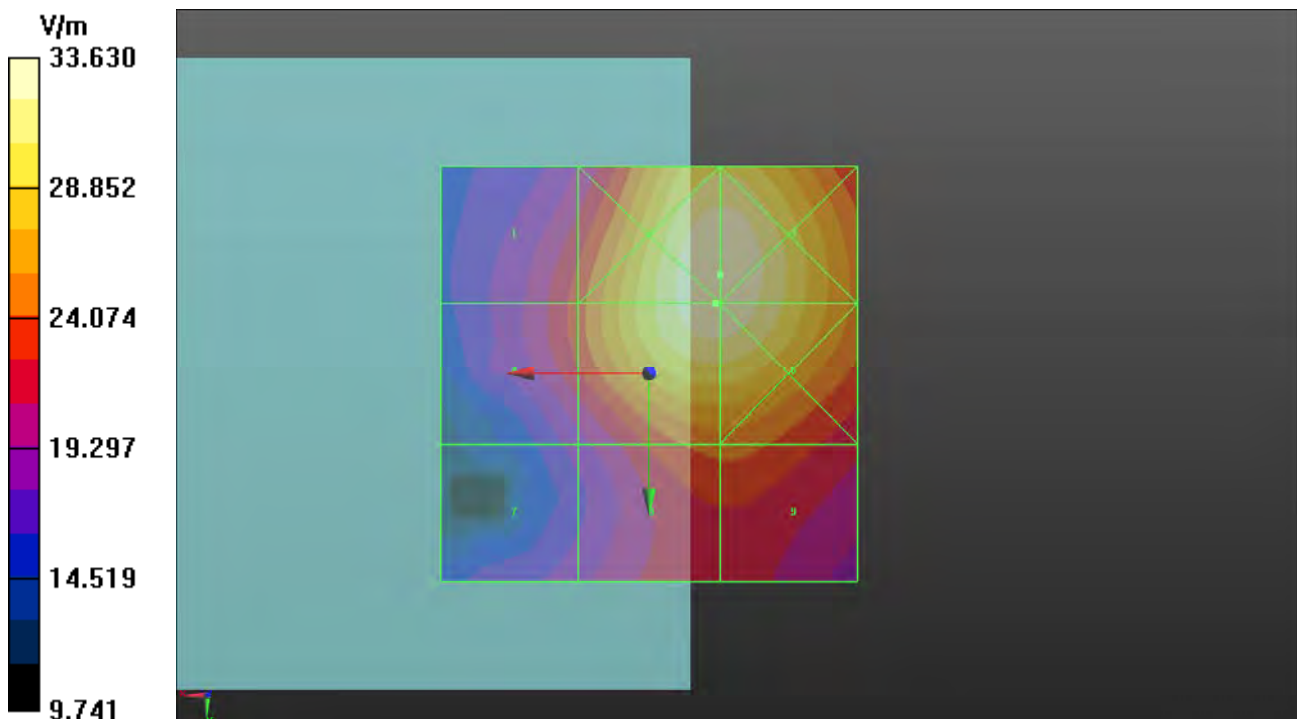



## **Appendix C. Calibration Certificate for Probe and Dipole**

The SPEAG calibration certificates are shown as follows.



Accredited by the Swiss Accreditation Service (SAS)  
The Swiss Accreditation Service is one of the signatories to the EA  
Multilateral Agreement for the recognition of calibration certificates

Accreditation No.: **SCS 0108**

Client **B.V. ADT (Auden)**

Certificate No: **CD835V3-1041\_Mar17**

## CALIBRATION CERTIFICATE

Object **CD835V3 - SN: 1041**

Calibration procedure(s) **QA CAL-20.v6  
Calibration procedure for dipoles in air**

Calibration date: **March 20, 2017**

This calibration certificate documents the traceability to national standards, which realize the physical units of measurements (SI).  
The measurements and the uncertainties with confidence probability are given on the following pages and are part of the certificate.

All calibrations have been conducted in the closed laboratory facility: environment temperature ( $22 \pm 3$ )°C and humidity < 70%.

Calibration Equipment used (M&TE critical for calibration)

Primary Standards	ID #	Cal Date (Certificate No.)	Scheduled Calibration
Power meter NRP	SN: 104778	06-Apr-16 (No. 217-02288/02289)	Apr-17
Power sensor NRP-Z91	SN: 103244	06-Apr-16 (No. 217-02288)	Apr-17
Power sensor NRP-Z91	SN: 103245	06-Apr-16 (No. 217-02289)	Apr-17
Reference 20 dB Attenuator	SN: 5058 (20k)	05-Apr-16 (No. 217-02292)	Apr-17
Type-N mismatch combination	SN: 5047.2 / 06327	05-Apr-16 (No. 217-02295)	Apr-17
Probe ER3DV6	SN: 2336	30-Dec-16 (No. ER3-2336_Dec16)	Dec-17
Probe H3DV6	SN: 6065	30-Dec-16 (No. H3-6065_Dec16)	Dec-17
DAE4	SN: 781	02-Sep-16 (No. DAE4-781_Sep16)	Sep-17
Secondary Standards	ID #	Check Date (in house)	Scheduled Check
Power meter Agilent 4419B	SN: GB42420191	09-Oct-09 (in house check Sep-14)	In house check: Oct-17
Power sensor HP E4412A	SN: US38485102	05-Jan-10 (in house check Sep-14)	In house check: Oct-17
Power sensor HP 8482A	SN: US37295597	09-Oct-09 (in house check Sep-14)	In house check: Oct-17
RF generator R&S SMT-06	SN: 832283/011	27-Aug-12 (in house check Oct-15)	In house check: Oct-17
Network Analyzer HP 8753E	SN: US37390585	18-Oct-01 (in house check Oct-16)	In house check: Oct-17

Calibrated by:	Name <b>Johannes Kurikka</b>	Function <b>Laboratory Technician</b>	Signature 
Approved by:	Name <b>Katja Pokovic</b>	Function <b>Technical Manager</b>	

Issued: March 20, 2017

This calibration certificate shall not be reproduced except in full without written approval of the laboratory.





Accredited by the Swiss Accreditation Service (SAS)  
**The Swiss Accreditation Service is one of the signatories to the EA  
Multilateral Agreement for the recognition of calibration certificates**

**Accreditation No.: SCS 0108**

## References

- [1] ANSI-C63.19-2007  
American National Standard for Methods of Measurement of Compatibility between Wireless Communications Devices and Hearing Aids.
- [2] ANSI-C63.19-2011  
American National Standard, Methods of Measurement of Compatibility between Wireless Communications Devices and Hearing Aids.

## Methods Applied and Interpretation of Parameters:

- **Coordinate System:** y-axis is in the direction of the dipole arms. z-axis is from the basis of the antenna (mounted on the table) towards its feed point between the two dipole arms. x-axis is normal to the other axes. In coincidence with the standards [1], the measurement planes (probe sensor center) are selected to be at a distance of 10 mm (15 mm for [2]) above the top metal edge of the dipole arms.
- **Measurement Conditions:** Further details are available from the hardcopies at the end of the certificate. All figures stated in the certificate are valid at the frequency indicated. The forward power to the dipole connector is set with a calibrated power meter connected and monitored with an auxiliary power meter connected to a directional coupler. While the dipole under test is connected, the forward power is adjusted to the same level.
- **Antenna Positioning:** The dipole is mounted on a HAC Test Arch phantom using the matching dipole positioner with the arms horizontal and the feeding cable coming from the floor. The measurements are performed in a shielded room with absorbers around the setup to reduce the reflections. It is verified before the mounting of the dipole under the Test Arch phantom, that its arms are perfectly in a line. It is installed on the HAC dipole positioner with its arms parallel below the dielectric reference wire and able to move elastically in vertical direction without changing its relative position to the top center of the Test Arch phantom. The vertical distance to the probe is adjusted after dipole mounting with a DASY5 Surface Check job. Before the measurement, the distance between phantom surface and probe tip is verified. The proper measurement distance is selected by choosing the matching section of the HAC Test Arch phantom with the proper device reference point (upper surface of the dipole) and the matching grid reference point (tip of the probe) considering the probe sensor offset. The vertical distance to the probe is essential for the accuracy.
- **Feed Point Impedance and Return Loss:** These parameters are measured using a HP 8753E Vector Network Analyzer. The impedance is specified at the SMA connector of the dipole. The influence of reflections was eliminating by applying the averaging function while moving the dipole in the air, at least 70cm away from any obstacles.
- **E-field distribution:** E field is measured in the x-y-plane with an isotropic ER3D-field probe with 100 mW forward power to the antenna feed point. In accordance with [1] and [2], the scan area is 20mm wide, its length exceeds the dipole arm length (180 or 90mm). The sensor center is 10 mm (15 mm for [2]) (in z) above the metal top of the dipole arms. Two 3D maxima are available near the end of the dipole arms. Assuming the dipole arms are perfectly in one line, the average of these two maxima (in subgrid 2 and subgrid 8) is determined to compensate for any non-parallelity to the measurement plane as well as the sensor displacement. The E-field value stated as calibration value represents the maximum of the interpolated 3D-E-field, in the plane above the dipole surface.
- **H-field distribution:** H-field is measured with an isotropic H-field probe with 100mW forward power to the antenna feed point, in the x-y-plane. The scan area and sensor distance is equivalent to the E-field scan. The maximum of the field is available at the center (subgrid 5) above the feed point. The H-field value stated as calibration value represents the maximum of the interpolated H-field, 10mm above the dipole surface at the feed point.

The reported uncertainty of measurement is stated as the standard uncertainty of measurement multiplied by the coverage factor  $k=2$ , which for a normal distribution corresponds to a coverage probability of approximately 95%.



## Measurement Conditions

DASY system configuration, as far as not given on page 1.

<b>DASY Version</b>	DASY5	V52.8.8
<b>Phantom</b>	HAC Test Arch	
<b>Distance Dipole Top - Probe Center</b>	10, 15 mm	
<b>Scan resolution</b>	dx, dy = 5 mm	
<b>Frequency</b>	835 MHz $\pm$ 1 MHz	
<b>Input power drift</b>	< 0.05 dB	

## Maximum Field values at 835 MHz

<b>H-field 10 mm above dipole surface</b>	condition	<b>interpolated maximum</b>
Maximum measured	100 mW input power	<b>0.464 A/m <math>\pm</math> 8.2 % (k=2)</b>

<b>E-field 10 mm above dipole surface</b>	condition	<b>Interpolated maximum</b>
Maximum measured above high end	100 mW input power	171.6 V/m = 44.69 dBV/m
Maximum measured above low end	100 mW input power	162.9 V/m = 44.24 dBV/m
Averaged maximum above arm	100 mW input power	<b>167.3 V/m <math>\pm</math> 12.8 % (k=2)</b>

<b>E-field 15 mm above dipole surface</b>	condition	<b>Interpolated maximum</b>
Maximum measured above high end	100 mW input power	108.9 V/m = 40.74 dBV/m
Maximum measured above low end	100 mW input power	106.2 V/m = 40.52 dBV/m
Averaged maximum above arm	100 mW input power	<b>107.6 V/m <math>\pm</math> 12.8 % (k=2)</b>

## Appendix (Additional assessments outside the scope of SCS 0108)

### Antenna Parameters

Frequency	Return Loss	Impedance
800 MHz	16.5 dB	41.0 $\Omega$ - 10.2 j $\Omega$
835 MHz	30.9 dB	50.4 $\Omega$ + 2.8 j $\Omega$
900 MHz	17.2 dB	51.7 $\Omega$ - 14.0 j $\Omega$
950 MHz	19.4 dB	51.5 $\Omega$ + 10.8 j $\Omega$
960 MHz	14.0 dB	64.9 $\Omega$ + 17.8 j $\Omega$

### 3.2 Antenna Design and Handling

The calibration dipole has a symmetric geometry with a built-in two stub matching network, which leads to the enhanced bandwidth.

The dipole is built of standard semirigid coaxial cable. The internal matching line is open ended. The antenna is therefore open for DC signals.

Do not apply force to dipole arms, as they are liable to bend. The soldered connections near the feedpoint may be damaged. After excessive mechanical stress or overheating, check the impedance characteristics to ensure that the internal matching network is not affected.

After long term use with 40W radiated power, only a slight warming of the dipole near the feedpoint can be measured.

# Impedance Measurement Plot

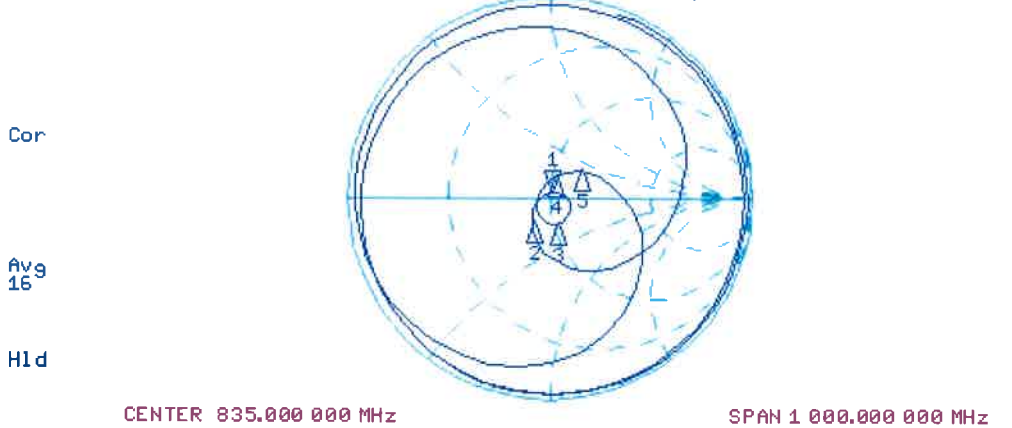
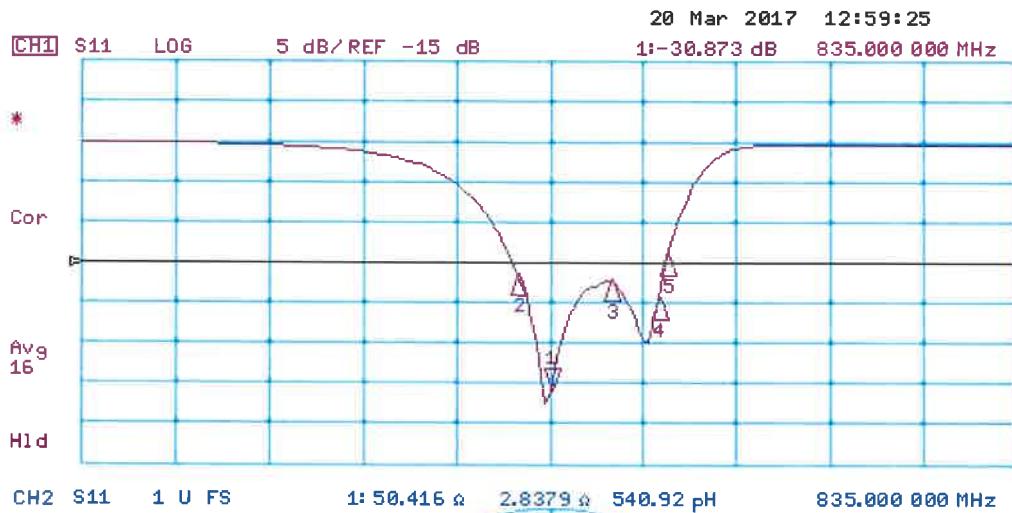

## DASY5 H-field Result

Date: 20.03.2017

Test Laboratory: SPEAG Lab 2

**DUT: HAC-Dipole 835 MHz; Type: CD835V3; Serial: CD835V3 - SN: 1041**

Communication System: UID 0 - CW ; Frequency: 835 MHz

Medium parameters used:  $\sigma = 0$  S/m,  $\epsilon_r = 1$ ;  $\rho = 1$  kg/m<sup>3</sup>

Phantom section: RF Section

Measurement Standard: DASY5 (IEEE/IEC/ANSI C63.19-2011)

DASY52 Configuration:

- Probe: H3DV6 - SN6065; ; Calibrated: 30.12.2016
- Sensor-Surface: (Fix Surface)
- Electronics: DAE4 Sn781; Calibrated: 02.09.2016
- Phantom: HAC Test Arch with AMCC; Type: SD HAC P01 BA; Serial: 1070
- DASY52 52.8.8(1222); SEMCAD X 14.6.10(7331)

**Dipole H-Field measurement @ 835MHz/H-Scan - 835MHz d=10mm/Hearing Aid Compatibility Test (41x361x1):**

Interpolated grid: dx=0.5000 mm, dy=0.5000 mm

Device Reference Point: 0, 0, -6.3 mm

Reference Value = 0.4830 A/m; Power Drift = 0.01 dB

PMR not calibrated. PMF = 1.000 is applied.

H-field emissions = 0.4635 A/m

**Near-field category: M4 (AWF 0 dB)**

PMF scaled H-field

Grid 1 M4 0.358 A/m	Grid 2 M4 0.410 A/m	Grid 3 M4 0.405 A/m
Grid 4 M4 0.406 A/m	Grid 5 M4 0.464 A/m	Grid 6 M4 0.460 A/m
Grid 7 M4 0.361 A/m	Grid 8 M4 0.408 A/m	Grid 9 M4 0.406 A/m

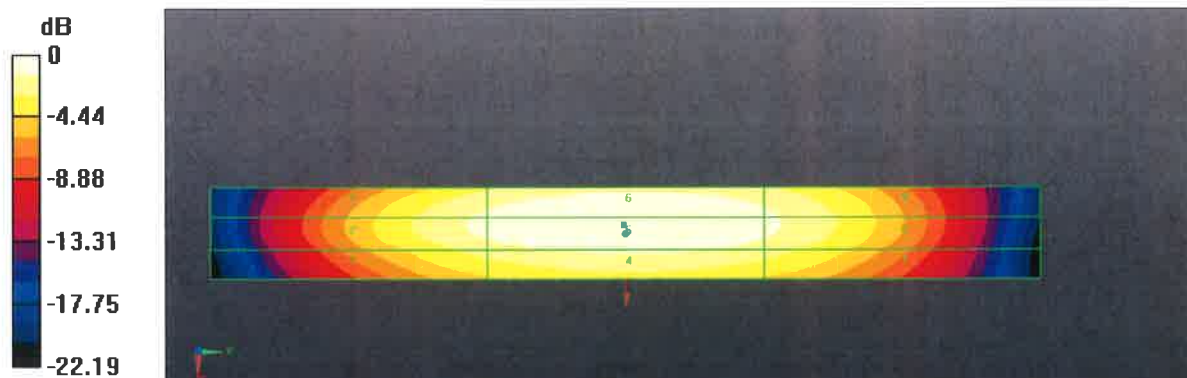

0 dB = 0.4635 A/m = -6.68 dBA/m

## DASY5 E-field Result

Date: 17.03.2017

Test Laboratory: SPEAG Lab 2

**DUT: HAC-Dipole 835 MHz; Type: CD835V3; Serial: CD835V3 - SN: 1041**

Communication System: UID 0 - CW ; Frequency: 835 MHz

Medium parameters used:  $\sigma = 0$  S/m,  $\epsilon_r = 1$ ;  $\rho = 1000$  kg/m<sup>3</sup>

Phantom section: RF Section

Measurement Standard: DASY5 (IEEE/IEC/ANSI C63.19-2011)

DASY52 Configuration:

- Probe: ER3DV6 - SN2336; ConvF(1, 1, 1); Calibrated: 30.12.2016;
- Sensor-Surface: (Fix Surface)
- Electronics: DAE4 Sn781; Calibrated: 02.09.2016
- Phantom: HAC Test Arch with AMCC; Type: SD HAC P01 BA; Serial: 1070
- DASY52 52.8.8(1222); SEMCAD X 14.6.10(7331)

**Dipole E-Field measurement @ 835MHz/E-Scan - 835MHz d=10mm/Hearing Aid Compatibility Test (41x361x1):**

Interpolated grid: dx=0.5000 mm, dy=0.5000 mm

Device Reference Point: 0, 0, -6.3 mm

Reference Value = 108.7 V/m; Power Drift = -0.04 dB

Applied MIF = 0.00 dB

RF audio interference level = 44.69 dBV/m

**Emission category: M3**

MIF scaled E-field

Grid 1 M3 43.88 dBV/m	Grid 2 M3 44.24 dBV/m	Grid 3 M3 44.09 dBV/m
Grid 4 M4 38.56 dBV/m	Grid 5 M4 38.94 dBV/m	Grid 6 M4 38.81 dBV/m
Grid 7 M3 43.89 dBV/m	Grid 8 M3 44.69 dBV/m	Grid 9 M3 44.68 dBV/m

**Dipole E-Field measurement @ 835MHz/E-Scan - 835MHz d=15mm/Hearing Aid Compatibility Test (41x361x1):**

Interpolated grid: dx=0.5000 mm, dy=0.5000 mm

Device Reference Point: 0, 0, -6.3 mm

Reference Value = 108.7 V/m; Power Drift = -0.03 dB

Applied MIF = 0.00 dB

RF audio interference level = 40.74 dBV/m

**Emission category: M3**

MIF scaled E-field

Grid 1 M3 40.31 dBV/m	Grid 2 M3 40.52 dBV/m	Grid 3 M3 40.45 dBV/m
Grid 4 M4 35.84 dBV/m	Grid 5 M4 36 dBV/m	Grid 6 M4 35.92 dBV/m
Grid 7 M3 40.41 dBV/m	Grid 8 M3 40.74 dBV/m	Grid 9 M3 40.71 dBV/m

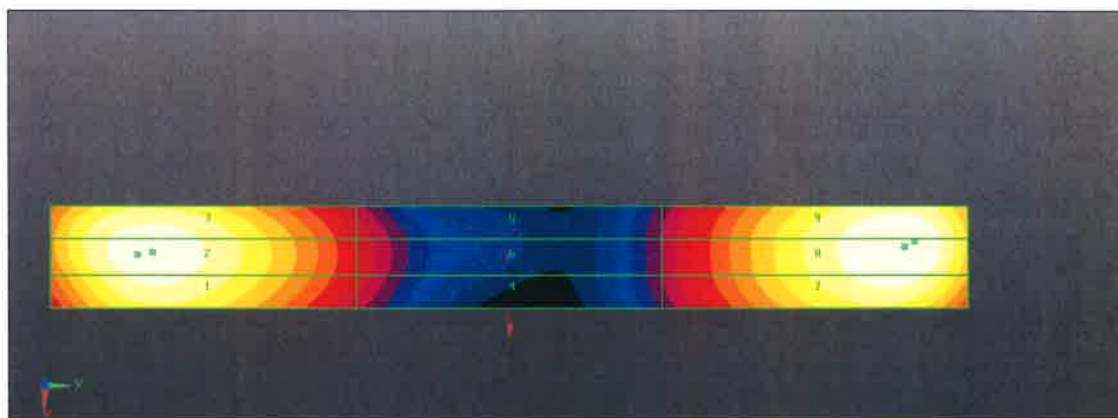
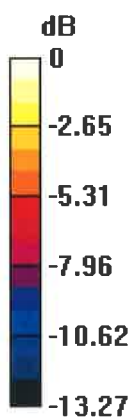

0 dB = 171.6 V/m = 44.69 dBV/m



Accredited by the Swiss Accreditation Service (SAS)  
The Swiss Accreditation Service is one of the signatories to the EA  
Multilateral Agreement for the recognition of calibration certificates

Accreditation No.: **SCS 0108**

Client **B.V. ADT (Auden)**

Certificate No: **CD1880V3-1032\_Apr17**

## CALIBRATION CERTIFICATE

Object **CD1880V3 - SN: 1032**

Calibration procedure(s) **QA CAL-20.v6  
Calibration procedure for dipoles in air**

Calibration date: **April 25, 2017**

This calibration certificate documents the traceability to national standards, which realize the physical units of measurements (SI).  
The measurements and the uncertainties with confidence probability are given on the following pages and are part of the certificate.

All calibrations have been conducted in the closed laboratory facility: environment temperature (22 ± 3)°C and humidity < 70%.

Calibration Equipment used (M&TE critical for calibration)

Primary Standards	ID #	Cal Date (Certificate No.)	Scheduled Calibration
Power meter NRP	SN: 104778	04-Apr-17 (No. 217-02521/02522)	Apr-18
Power sensor NRP-Z91	SN: 103244	04-Apr-17 (No. 217-02521)	Apr-18
Power sensor NRP-Z91	SN: 103245	04-Apr-17 (No. 217-02522)	Apr-18
Reference 20 dB Attenuator	SN: 5058 (20k)	07-Apr-17 (No. 217-02528)	Apr-18
Type-N mismatch combination	SN: 5047.2 / 06327	07-Apr-17 (No. 217-02529)	Apr-18
Probe ER3DV6	SN: 2336	30-Dec-16 (No. ER3-2336_Dec16)	Dec-17
Probe H3DV6	SN: 6065	30-Dec-16 (No. H3-6065_Dec16)	Dec-17
DAE4	SN: 781	02-Sep-16 (No. DAE4-781_Sep16)	Sep-17
Secondary Standards	ID #	Check Date (in house)	Scheduled Check
Power meter Agilent 4419B	SN: GB42420191	09-Oct-09 (in house check Sep-14)	In house check: Oct-17
Power sensor HP E4412A	SN: US38485102	05-Jan-10 (in house check Sep-14)	In house check: Oct-17
Power sensor HP 8482A	SN: US37295597	09-Oct-09 (in house check Sep-14)	In house check: Oct-17
RF generator R&S SMT-06	SN: 832283/011	27-Aug-12 (in house check Oct-15)	In house check: Oct-17
Network Analyzer HP 8753E	SN: US37390585	18-Oct-01 (in house check Oct-16)	In house check: Oct-17

Calibrated by:	Name <b>Johannes Kurikka</b>	Function <b>Laboratory Technician</b>	Signature 
Approved by:	Name <b>Katja Pokovic</b>	Function <b>Technical Manager</b>	Signature 

Issued: April 26, 2017

This calibration certificate shall not be reproduced except in full without written approval of the laboratory.





Accredited by the Swiss Accreditation Service (SAS)

The Swiss Accreditation Service is one of the signatories to the EA  
Multilateral Agreement for the recognition of calibration certificates

Accreditation No.: **SCS 0108**

## References

- [1] ANSI-C63.19-2007  
American National Standard for Methods of Measurement of Compatibility between Wireless Communications Devices and Hearing Aids.
- [2] ANSI-C63.19-2011  
American National Standard, Methods of Measurement of Compatibility between Wireless Communications Devices and Hearing Aids.

## Methods Applied and Interpretation of Parameters:

- **Coordinate System:** y-axis is in the direction of the dipole arms. z-axis is from the basis of the antenna (mounted on the table) towards its feed point between the two dipole arms. x-axis is normal to the other axes. In coincidence with the standards [1], the measurement planes (probe sensor center) are selected to be at a distance of 10 mm (15 mm for [2]) above the top metal edge of the dipole arms.
- **Measurement Conditions:** Further details are available from the hardcopies at the end of the certificate. All figures stated in the certificate are valid at the frequency indicated. The forward power to the dipole connector is set with a calibrated power meter connected and monitored with an auxiliary power meter connected to a directional coupler. While the dipole under test is connected, the forward power is adjusted to the same level.
- **Antenna Positioning:** The dipole is mounted on a HAC Test Arch phantom using the matching dipole positioner with the arms horizontal and the feeding cable coming from the floor. The measurements are performed in a shielded room with absorbers around the setup to reduce the reflections. It is verified before the mounting of the dipole under the Test Arch phantom, that its arms are perfectly in a line. It is installed on the HAC dipole positioner with its arms parallel below the dielectric reference wire and able to move elastically in vertical direction without changing its relative position to the top center of the Test Arch phantom. The vertical distance to the probe is adjusted after dipole mounting with a DASY5 Surface Check job. Before the measurement, the distance between phantom surface and probe tip is verified. The proper measurement distance is selected by choosing the matching section of the HAC Test Arch phantom with the proper device reference point (upper surface of the dipole) and the matching grid reference point (tip of the probe) considering the probe sensor offset. The vertical distance to the probe is essential for the accuracy.
- **Feed Point Impedance and Return Loss:** These parameters are measured using a HP 8753E Vector Network Analyzer. The impedance is specified at the SMA connector of the dipole. The influence of reflections was eliminated by applying the averaging function while moving the dipole in the air, at least 70cm away from any obstacles.
- **E-field distribution:** E field is measured in the x-y-plane with an isotropic ER3D-field probe with 100 mW forward power to the antenna feed point. In accordance with [1] and [2], the scan area is 20mm wide, its length exceeds the dipole arm length (180 or 90mm). The sensor center is 10 mm (15 mm for [2]) (in z) above the metal top of the dipole arms. Two 3D maxima are available near the end of the dipole arms. Assuming the dipole arms are perfectly in one line, the average of these two maxima (in subgrid 2 and subgrid 8) is determined to compensate for any non-parallelity to the measurement plane as well as the sensor displacement. The E-field value stated as calibration value represents the maximum of the interpolated 3D-E-field, in the plane above the dipole surface.
- **H-field distribution:** H-field is measured with an isotropic H-field probe with 100mW forward power to the antenna feed point, in the x-y-plane. The scan area and sensor distance is equivalent to the E-field scan. The maximum of the field is available at the center (subgrid 5) above the feed point. The H-field value stated as calibration value represents the maximum of the interpolated H-field, 10mm above the dipole surface at the feed point.

The reported uncertainty of measurement is stated as the standard uncertainty of measurement multiplied by the coverage factor  $k=2$ , which for a normal distribution corresponds to a coverage probability of approximately 95%.



## Measurement Conditions

DASY system configuration, as far as not given on page 1.

<b>DASY Version</b>	DASY5	V52.10.0
<b>Phantom</b>	HAC Test Arch	
<b>Distance Dipole Top - Probe Center</b>	10, 15 mm	
<b>Scan resolution</b>	dx, dy = 5 mm	
<b>Frequency</b>	1880 MHz $\pm$ 1 MHz	
<b>Input power drift</b>	< 0.05 dB	

## Maximum Field values at 1880 MHz

<b>H-field 10 mm above dipole surface</b>	condition	<b>interpolated maximum</b>
Maximum measured	100 mW input power	<b>0.464 A/m <math>\pm</math> 8.2 % (k=2)</b>

<b>E-field 10 mm above dipole surface</b>	condition	<b>Interpolated maximum</b>
Maximum measured above high end	100 mW input power	141.2 V/m = 43.00 dBV/m
Maximum measured above low end	100 mW input power	140.9 V/m = 42.98 dBV/m
Averaged maximum above arm	100 mW input power	<b>141.1 V/m <math>\pm</math> 12.8 % (k=2)</b>

<b>E-field 15 mm above dipole surface</b>	condition	<b>Interpolated maximum</b>
Maximum measured above high end	100 mW input power	92.5 V/m = 39.32 dBV/m
Maximum measured above low end	100 mW input power	89.5 V/m = 39.04 dBV/m
Averaged maximum above arm	100 mW input power	<b>91.0 V/m <math>\pm</math> 12.8 % (k=2)</b>

## Appendix (Additional assessments outside the scope of SCS 0108)

### Antenna Parameters

Frequency	Return Loss	Impedance
1730 MHz	24.9 dB	$54.8 \Omega + 3.5 j\Omega$
1880 MHz	20.5 dB	$58.8 \Omega + 5.3 j\Omega$
1900 MHz	21.4 dB	$59.1 \Omega + 1.8 j\Omega$
1950 MHz	26.6 dB	$53.4 \Omega - 3.5 j\Omega$
2000 MHz	22.4 dB	$47.0 \Omega + 6.7 j\Omega$

### 3.2 Antenna Design and Handling

The calibration dipole has a symmetric geometry with a built-in two stub matching network, which leads to the enhanced bandwidth.

The dipole is built of standard semirigid coaxial cable. The internal matching line is open ended. The antenna is therefore open for DC signals.

Do not apply force to dipole arms, as they are liable to bend. The soldered connections near the feedpoint may be damaged. After excessive mechanical stress or overheating, check the impedance characteristics to ensure that the internal matching network is not affected.

After long term use with 40W radiated power, only a slight warming of the dipole near the feedpoint can be measured.

# Impedance Measurement Plot

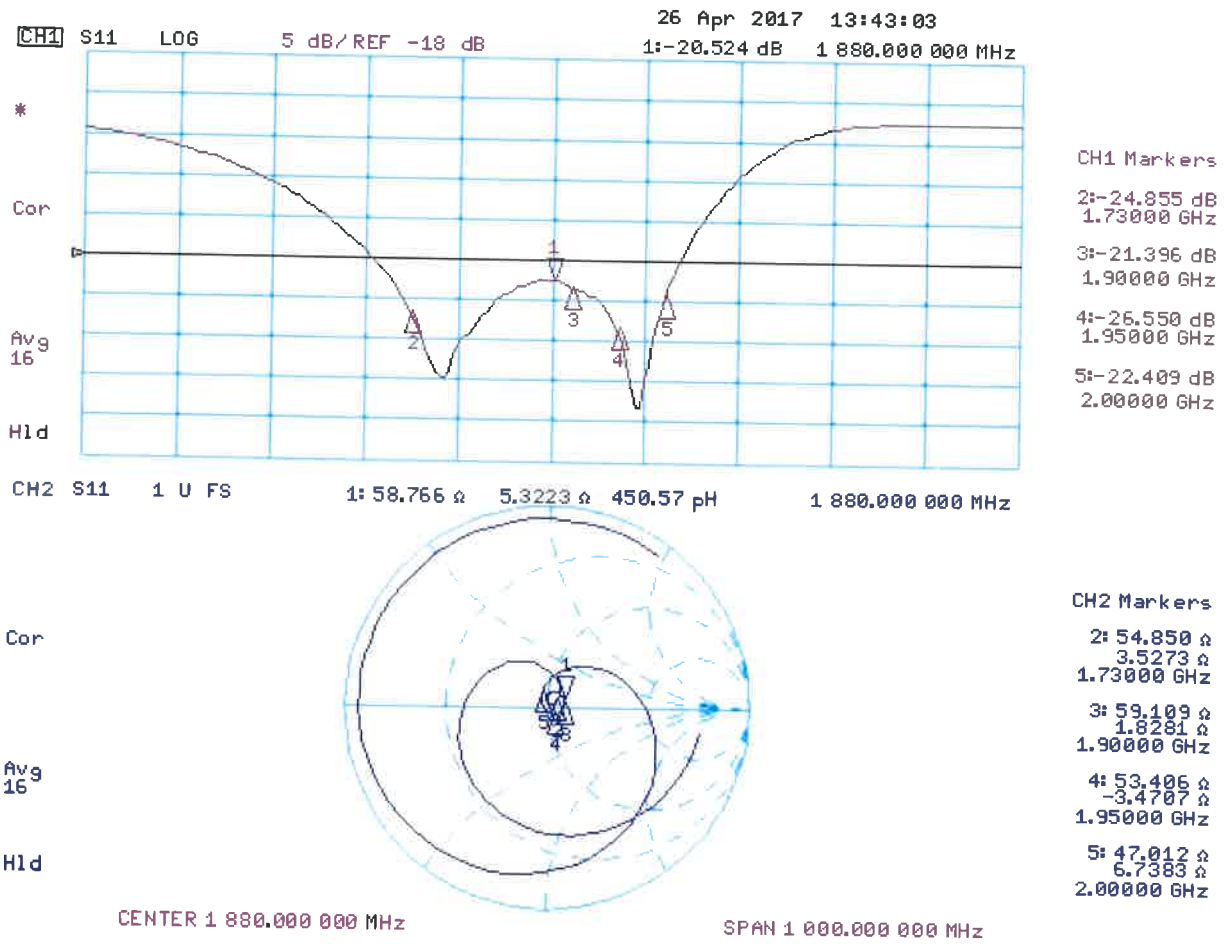

## DASY5 H-field Result

Date: 25.04.2017

Test Laboratory: SPEAG Lab2

**DUT: HAC Dipole 1880 MHz; Type: CD1880V3; Serial: CD1880V3 - SN: 1032**

Communication System: UID 0 - CW ; Frequency: 1880 MHz

Medium parameters used:  $\sigma = 0$  S/m,  $\epsilon_r = 1$ ;  $\rho = 1000$  kg/m<sup>3</sup>

Phantom section: RF Section

Measurement Standard: DASY5 (IEEE/IEC/ANSI C63.19-2011)

DASY52 Configuration:

- Probe: H3DV6 - SN6065; ; Calibrated: 30.12.2016
- Sensor-Surface: (Fix Surface)
- Electronics: DAE4 Sn781; Calibrated: 02.09.2016
- Phantom: HAC Test Arch with AMCC; Type: SD HAC P01 BA; Serial: 1070
- DASY52 52.10.0(1440); SEMCAD X 14.6.10(7413)

**Dipole H-Field measurement @ 1880MHz/H-Scan - 1880MHz d=10mm/Hearing Aid Compatibility Test (41x181x1):**

Interpolated grid: dx=0.5000 mm, dy=0.5000 mm

Device Reference Point: 0, 0, -6.3 mm

Reference Value = 0.4870 A/m; Power Drift = -0.00 dB

PMR not calibrated. PMF = 1.000 is applied.

H-field emissions = 0.4640 A/m

**Near-field category: M2 (AWF 0 dB)**

PMF scaled H-field

Grid 1 M2 0.390 A/m	Grid 2 M2 0.432 A/m	Grid 3 M2 0.422 A/m
Grid 4 M2 0.422 A/m	Grid 5 M2 0.464 A/m	Grid 6 M2 0.456 A/m
Grid 7 M2 0.384 A/m	Grid 8 M2 0.420 A/m	Grid 9 M2 0.413 A/m

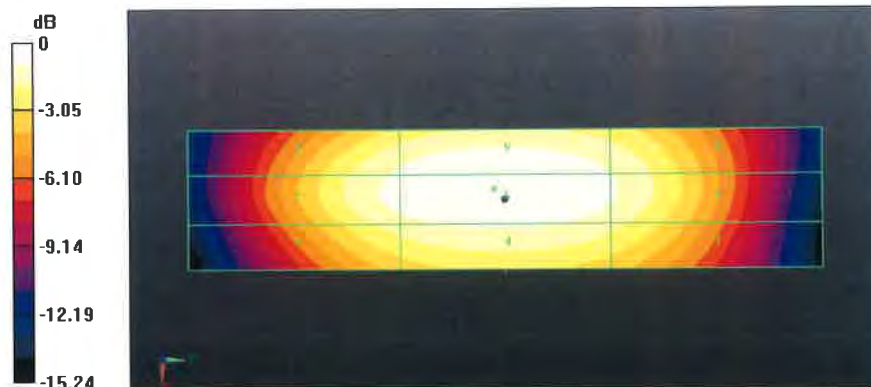

0 dB = 0.4640 A/m = -6.67 dBA/m

## DASY5 E-field Result

Date: 25.04.2017

Test Laboratory: SPEAG Lab2

**DUT: HAC Dipole 1880 MHz; Type: CD1880V3; Serial: CD1880V3 - SN: 1032**

Communication System: UID 0 - CW ; Frequency: 1880 MHz

Medium parameters used:  $\sigma = 0$  S/m,  $\epsilon_r = 1$ ;  $\rho = 1000$  kg/m<sup>3</sup>

Phantom section: RF Section

Measurement Standard: DASY5 (IEEE/IEC/ANSI C63.19-2011)

DASY52 Configuration:

- Probe: ER3DV6 - SN2336; ConvF(1, 1, 1); Calibrated: 30.12.2016;
- Sensor-Surface: (Fix Surface)
- Electronics: DAE4 Sn781; Calibrated: 02.09.2016
- Phantom: HAC Test Arch with AMCC; Type: SD HAC P01 BA; Serial: 1070
- DASY52 52.10.0(1440); SEMCAD X 14.6.10(7413)

**Dipole E-Field measurement @ 1880MHz/E-Scan - 1880MHz d=10mm/Hearing Aid Compatibility Test (41x181x1):**

Interpolated grid: dx=0.5000 mm, dy=0.5000 mm

Device Reference Point: 0, 0, -6.3 mm

Reference Value = 158.3 V/m; Power Drift = 0.02 dB

Applied MIF = 0.00 dB

RF audio interference level = 43.00 dBV/m

**Emission category: M1**

MIF scaled E-field

Grid 1 M1 42.53 dBV/m	Grid 2 M1 42.98 dBV/m	Grid 3 M1 42.86 dBV/m
Grid 4 M2 39.04 dBV/m	Grid 5 M2 39.41 dBV/m	Grid 6 M2 39.16 dBV/m
Grid 7 M1 42.42 dBV/m	Grid 8 M1 43 dBV/m	Grid 9 M1 42.92 dBV/m

**Dipole E-Field measurement @ 1880MHz/E-Scan - 1880MHz d=15mm/Hearing Aid Compatibility Test (41x181x1):**

Interpolated grid: dx=0.5000 mm, dy=0.5000 mm

Device Reference Point: 0, 0, -6.3 mm

Reference Value = 158.6 V/m; Power Drift = -0.02 dB

Applied MIF = 0.00 dB

RF audio interference level = 39.32 dBV/m

**Emission category: M2**

MIF scaled E-field

Grid 1 M2 39.06 dBV/m	Grid 2 M2 39.32 dBV/m	Grid 3 M2 39.25 dBV/m
Grid 4 M2 36.95 dBV/m	Grid 5 M2 37.13 dBV/m	Grid 6 M2 37.05 dBV/m
Grid 7 M2 38.76 dBV/m	Grid 8 M2 39.04 dBV/m	Grid 9 M2 38.99 dBV/m

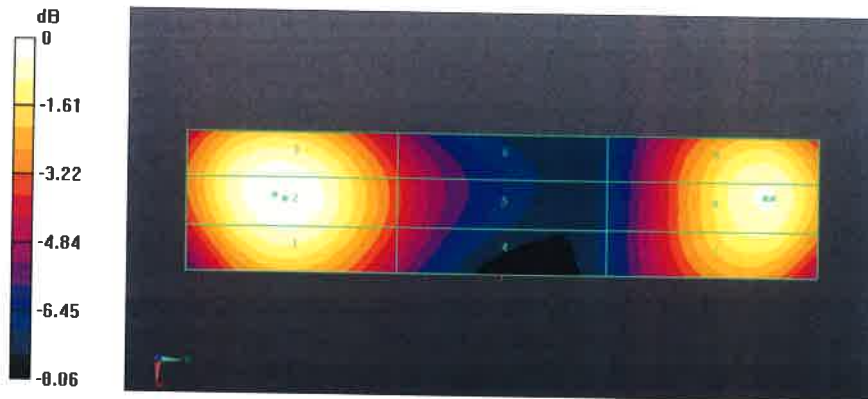

0 dB = 141.2 V/m = 43.00 dBV/m



Accredited by the Swiss Accreditation Service (SAS)  
The Swiss Accreditation Service is one of the signatories to the EA  
Multilateral Agreement for the recognition of calibration certificates

Accreditation No.: **SCS 0108**

Client **B.V. ADT (Auden)**

Certificate No: **CD2450V3-1033\_Apr17**

## CALIBRATION CERTIFICATE

Object **CD2450V3 - SN: 1033**

Calibration procedure(s) **QA CAL-20.v6  
Calibration procedure for dipoles in air**

Calibration date: **April 25, 2017**

This calibration certificate documents the traceability to national standards, which realize the physical units of measurements (SI).  
The measurements and the uncertainties with confidence probability are given on the following pages and are part of the certificate.

All calibrations have been conducted in the closed laboratory facility: environment temperature ( $22 \pm 3$ )°C and humidity < 70%.

Calibration Equipment used (M&TE critical for calibration)

Primary Standards	ID #	Cal Date (Certificate No.)	Scheduled Calibration
Power meter NRP	SN: 104778	04-Apr-17 (No. 217-02521/02522)	Apr-18
Power sensor NRP-Z91	SN: 103244	04-Apr-17 (No. 217-02521)	Apr-18
Power sensor NRP-Z91	SN: 103245	04-Apr-17 (No. 217-02522)	Apr-18
Reference 20 dB Attenuator	SN: 5058 (20k)	07-Apr-17 (No. 217-02528)	Apr-18
Type-N mismatch combination	SN: 5047.2 / 06327	07-Apr-17 (No. 217-02529)	Apr-18
Probe ER3DV6	SN: 2336	30-Dec-16 (No. ER3-2336_Dec16)	Dec-17
Probe H3DV6	SN: 6065	30-Dec-16 (No. H3-6065_Dec16)	Dec-17
DAE4	SN: 781	02-Sep-16 (No. DAE4-781_Sep16)	Sep-17
Secondary Standards	ID #	Check Date (in house)	Scheduled Check
Power meter Agilent 4419B	SN: GB42420191	09-Oct-09 (in house check Sep-14)	In house check: Oct-17
Power sensor HP E4412A	SN: US38485102	05-Jan-10 (in house check Sep-14)	In house check: Oct-17
Power sensor HP 8482A	SN: US37295597	09-Oct-09 (in house check Sep-14)	In house check: Oct-17
RF generator R&S SMT-06	SN: 832283/011	27-Aug-12 (in house check Oct-15)	In house check: Oct-17
Network Analyzer HP 8753E	SN: US37390585	18-Oct-01 (in house check Oct-16)	In house check: Oct-17

Calibrated by:	Name <b>Johannes Kurikka</b>	Function <b>Laboratory Technician</b>	Signature 
Approved by:	Name <b>Katja Pokovic</b>	Technical Manager	

Issued: April 27, 2017

This calibration certificate shall not be reproduced except in full without written approval of the laboratory.





Accredited by the Swiss Accreditation Service (SAS)  
The Swiss Accreditation Service is one of the signatories to the EA  
Multilateral Agreement for the recognition of calibration certificates

## References

- [1] ANSI-C63.19-2007  
American National Standard for Methods of Measurement of Compatibility between Wireless Communications Devices and Hearing Aids.
- [2] ANSI-C63.19-2011  
American National Standard, Methods of Measurement of Compatibility between Wireless Communications Devices and Hearing Aids.

## Methods Applied and Interpretation of Parameters:

- **Coordinate System:** y-axis is in the direction of the dipole arms. z-axis is from the basis of the antenna (mounted on the table) towards its feed point between the two dipole arms. x-axis is normal to the other axes. In coincidence with the standards [1], the measurement planes (probe sensor center) are selected to be at a distance of 10 mm (15 mm for [2]) above the top metal edge of the dipole arms.
- **Measurement Conditions:** Further details are available from the hardcopies at the end of the certificate. All figures stated in the certificate are valid at the frequency indicated. The forward power to the dipole connector is set with a calibrated power meter connected and monitored with an auxiliary power meter connected to a directional coupler. While the dipole under test is connected, the forward power is adjusted to the same level.
- **Antenna Positioning:** The dipole is mounted on a HAC Test Arch phantom using the matching dipole positioner with the arms horizontal and the feeding cable coming from the floor. The measurements are performed in a shielded room with absorbers around the setup to reduce the reflections. It is verified before the mounting of the dipole under the Test Arch phantom, that its arms are perfectly in a line. It is installed on the HAC dipole positioner with its arms parallel below the dielectric reference wire and able to move elastically in vertical direction without changing its relative position to the top center of the Test Arch phantom. The vertical distance to the probe is adjusted after dipole mounting with a DASY5 Surface Check job. Before the measurement, the distance between phantom surface and probe tip is verified. The proper measurement distance is selected by choosing the matching section of the HAC Test Arch phantom with the proper device reference point (upper surface of the dipole) and the matching grid reference point (tip of the probe) considering the probe sensor offset. The vertical distance to the probe is essential for the accuracy.
- **Feed Point Impedance and Return Loss:** These parameters are measured using a HP 8753E Vector Network Analyzer. The impedance is specified at the SMA connector of the dipole. The influence of reflections was eliminated by applying the averaging function while moving the dipole in the air, at least 70cm away from any obstacles.
- **E-field distribution:** E field is measured in the x-y-plane with an isotropic ER3D-field probe with 100 mW forward power to the antenna feed point. In accordance with [1] and [2], the scan area is 20mm wide, its length exceeds the dipole arm length (180 or 90mm). The sensor center is 10 mm (15 mm for [2]) (in z) above the metal top of the dipole arms. Two 3D maxima are available near the end of the dipole arms. Assuming the dipole arms are perfectly in one line, the average of these two maxima (in subgrid 2 and subgrid 8) is determined to compensate for any non-parallelity to the measurement plane as well as the sensor displacement. The E-field value stated as calibration value represents the maximum of the interpolated 3D-E-field, in the plane above the dipole surface.
- **H-field distribution:** H-field is measured with an isotropic H-field probe with 100mW forward power to the antenna feed point, in the x-y-plane. The scan area and sensor distance is equivalent to the E-field scan. The maximum of the field is available at the center (subgrid 5) above the feed point. The H-field value stated as calibration value represents the maximum of the interpolated H-field, 10mm above the dipole surface at the feed point.

The reported uncertainty of measurement is stated as the standard uncertainty of measurement multiplied by the coverage factor  $k=2$ , which for a normal distribution corresponds to a coverage probability of approximately 95%.



## Measurement Conditions

DASY system configuration, as far as not given on page 1.

<b>DASY Version</b>	DASY5	V52.10.0
<b>Phantom</b>	HAC Test Arch	
<b>Distance Dipole Top - Probe Center</b>	10, 15 mm	
<b>Scan resolution</b>	dx, dy = 5 mm	
<b>Frequency</b>	2450 MHz $\pm$ 1 MHz	
<b>Input power drift</b>	< 0.05 dB	

## Maximum Field values at 2450 MHz

<b>H-field 10 mm above dipole surface</b>	condition	<b>interpolated maximum</b>
Maximum measured	100 mW input power	<b>0.497 A/m <math>\pm</math> 8.2 % (k=2)</b>

<b>E-field 10 mm above dipole surface</b>	condition	<b>Interpolated maximum</b>
Maximum measured above high end	100 mW input power	136.8 V/m = 42.72 dBV/m
Maximum measured above low end	100 mW input power	134.5 V/m = 42.57 dBV/m
Averaged maximum above arm	100 mW input power	<b>135.7 V/m <math>\pm</math> 12.8 % (k=2)</b>

<b>E-field 15 mm above dipole surface</b>	condition	<b>Interpolated maximum</b>
Maximum measured above high end	100 mW input power	91.5 V/m = 39.23 dBV/m
Maximum measured above low end	100 mW input power	85.0 V/m = 38.59 dBV/m
Averaged maximum above arm	100 mW input power	<b>88.3 V/m <math>\pm</math> 12.8 % (k=2)</b>

## Appendix (Additional assessments outside the scope of SCS 0108)

### Antenna Parameters

Frequency	Return Loss	Impedance
2250 MHz	16.7 dB	67.1 $\Omega$ - 0.1 j $\Omega$
2350 MHz	27.3 dB	52.8 $\Omega$ - 3.4 j $\Omega$
2450 MHz	28.2 dB	53.2 $\Omega$ - 2.5 j $\Omega$
2550 MHz	33.2 dB	51.7 $\Omega$ - 1.4 j $\Omega$
2650 MHz	16.9 dB	60.4 $\Omega$ - 12.1 j $\Omega$

### 3.2 Antenna Design and Handling

The calibration dipole has a symmetric geometry with a built-in two stub matching network, which leads to the enhanced bandwidth.

The dipole is built of standard semirigid coaxial cable. The internal matching line is open ended. The antenna is therefore open for DC signals.

Do not apply force to dipole arms, as they are liable to bend. The soldered connections near the feedpoint may be damaged. After excessive mechanical stress or overheating, check the impedance characteristics to ensure that the internal matching network is not affected.

After long term use with 40W radiated power, only a slight warming of the dipole near the feedpoint can be measured.

# Impedance Measurement Plot

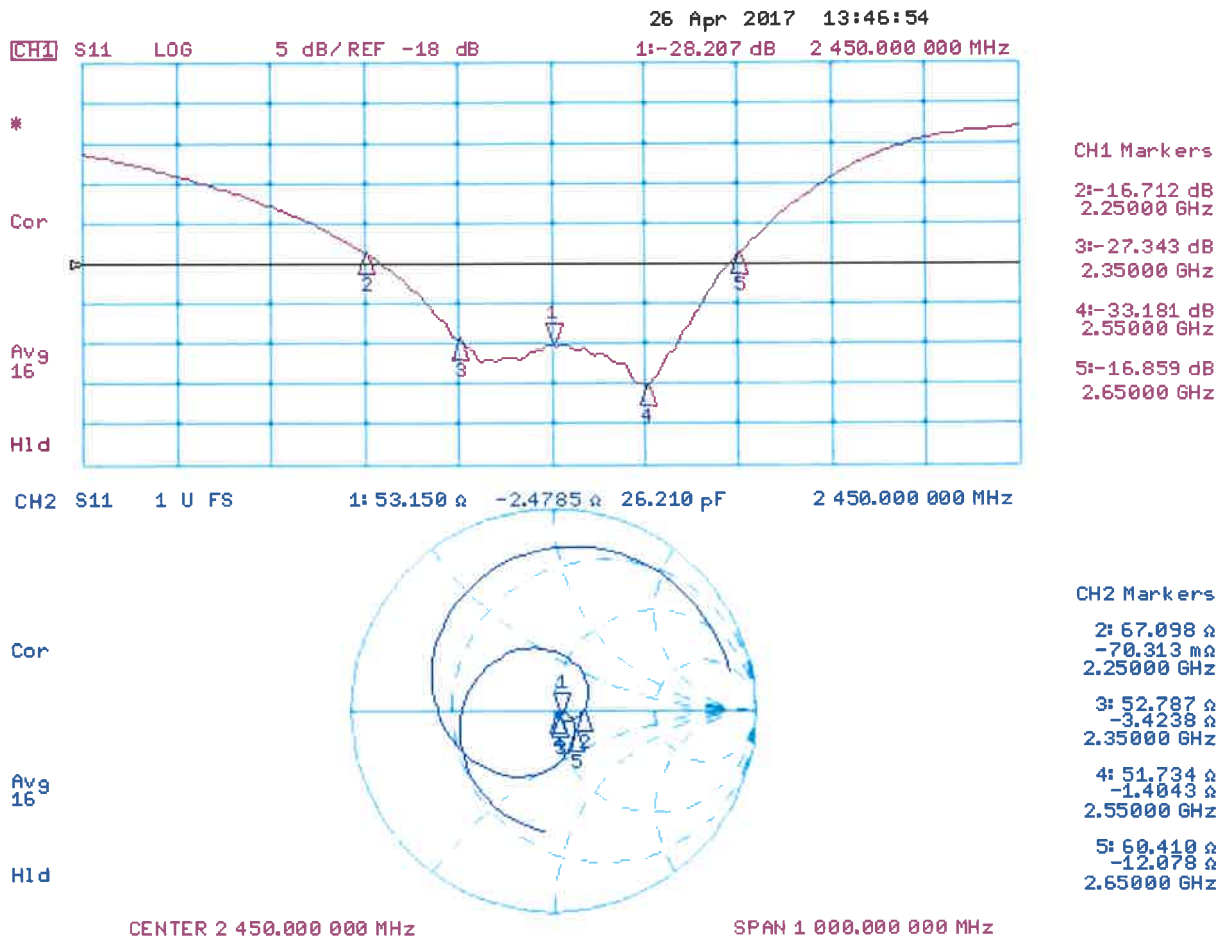

## DASY5 H-field Result

Date: 25.04.2017

Test Laboratory: SPEAG Lab2

**DUT: HAC Dipole 2450 MHz; Type: CD2450V3; Serial: CD2450V3 - SN: 1033**

Communication System: UID 0 - CW ; Frequency: 2450 MHz

Medium parameters used:  $\sigma = 0$  S/m,  $\epsilon_r = 1$ ;  $\rho = 1000$  kg/m<sup>3</sup>

Phantom section: RF Section

Measurement Standard: DASY5 (IEEE/IEC/ANSI C63.19-2011)

DASY52 Configuration:

- Probe: H3DV6 - SN6065; ; Calibrated: 30.12.2016
- Sensor-Surface: (Fix Surface)
- Electronics: DAE4 Sn781; Calibrated: 02.09.2016
- Phantom: HAC Test Arch with AMCC; Type: SD HAC P01 BA; Serial: 1070
- DASY52 52.10.0(1440); SEMCAD X 14.6.10(7413)

**Dipole H-Field measurement @ 2450MHz/H-Scan - 2450MHz d=10mm/Hearing Aid Compatibility Test (41x181x1):**

Interpolated grid: dx=0.5000 mm, dy=0.5000 mm

Device Reference Point: 0, 0, -6.3 mm

Reference Value = 0.5200 A/m; Power Drift = 0.02 dB

PMR not calibrated. PMF = 1.000 is applied.

H-field emissions = 0.4968 A/m

**Near-field category: M2 (AWF 0 dB)**

PMF scaled H-field

Grid 1 M2 0.371 A/m	Grid 2 M2 0.421 A/m	Grid 3 M2 0.415 A/m
Grid 4 M2 0.446 A/m	Grid 5 M2 0.497 A/m	Grid 6 M2 0.489 A/m
Grid 7 M2 0.370 A/m	Grid 8 M2 0.407 A/m	Grid 9 M2 0.403 A/m

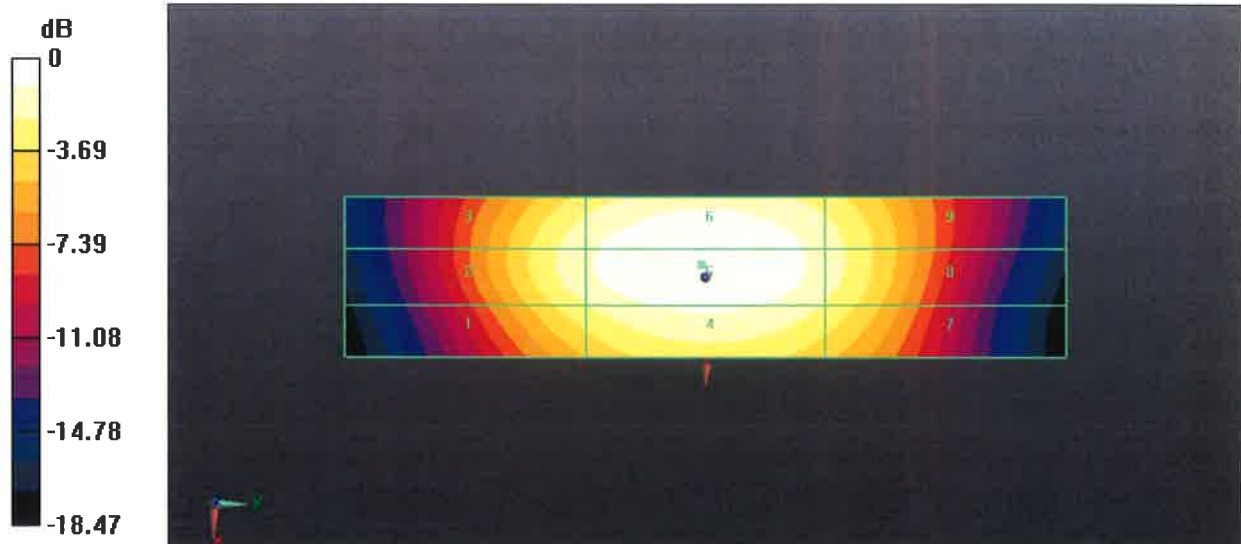

0 dB = 0.4968 A/m = -6.08 dBA/m

## DASY5 E-field Result

Date: 25.04.2017

Test Laboratory: SPEAG Lab2

**DUT: HAC Dipole 2450 MHz; Type: CD2450V3; Serial: CD2450V3 - SN: 1033**

Communication System: UID 0 - CW ; Frequency: 2450 MHz  
Medium parameters used:  $\sigma = 0$  S/m,  $\epsilon_r = 1$ ;  $\rho = 1000$  kg/m<sup>3</sup>  
Phantom section: RF Section  
Measurement Standard: DASY5 (IEEE/IEC/ANSI C63.19-2011)

DASY52 Configuration:

- Probe: ER3DV6 - SN2336; ConvF(1, 1, 1); Calibrated: 30.12.2016;
- Sensor-Surface: (Fix Surface)
- Electronics: DAE4 Sn781; Calibrated: 02.09.2016
- Phantom: HAC Test Arch with AMCC; Type: SD HAC P01 BA; Serial: 1070
- DASY52 52.10.0(1440); SEMCAD X 14.6.10(7413)

**Dipole E-Field measurement @ 2450MHz/E-Scan - 2450MHz d=10mm/Hearing Aid Compatibility Test (41x181x1):**

Interpolated grid: dx=0.5000 mm, dy=0.5000 mm  
Device Reference Point: 0, 0, -6.3 mm  
Reference Value = 85.56 V/m; Power Drift = -0.03 dB  
Applied MIF = 0.00 dB  
RF audio interference level = 42.72 dBV/m

**Emission category: M1**

MIF scaled E-field

Grid 1 M1 42.13 dBV/m	Grid 2 M1 42.72 dBV/m	Grid 3 M1 42.63 dBV/m
Grid 4 M1 41.03 dBV/m	Grid 5 M1 41.52 dBV/m	Grid 6 M1 41.32 dBV/m
Grid 7 M1 41.85 dBV/m	Grid 8 M1 42.57 dBV/m	Grid 9 M1 42.55 dBV/m

**Dipole E-Field measurement @ 2450MHz/E-Scan - 2450MHz d=15mm/Hearing Aid Compatibility Test (41x181x1):**

Interpolated grid: dx=0.5000 mm, dy=0.5000 mm

Device Reference Point: 0, 0, -6.3 mm

Reference Value = 85.08 V/m; Power Drift = 0.02 dB

Applied MIF = 0.00 dB

RF audio interference level = 39.23 dBV/m

**Emission category: M2**

MIF scaled E-field

Grid 1 M2 38.9 dBV/m	Grid 2 M2 39.23 dBV/m	Grid 3 M2 39.15 dBV/m
Grid 4 M2 38.48 dBV/m	Grid 5 M2 38.73 dBV/m	Grid 6 M2 38.63 dBV/m
Grid 7 M2 38.26 dBV/m	Grid 8 M2 38.59 dBV/m	Grid 9 M2 38.57 dBV/m

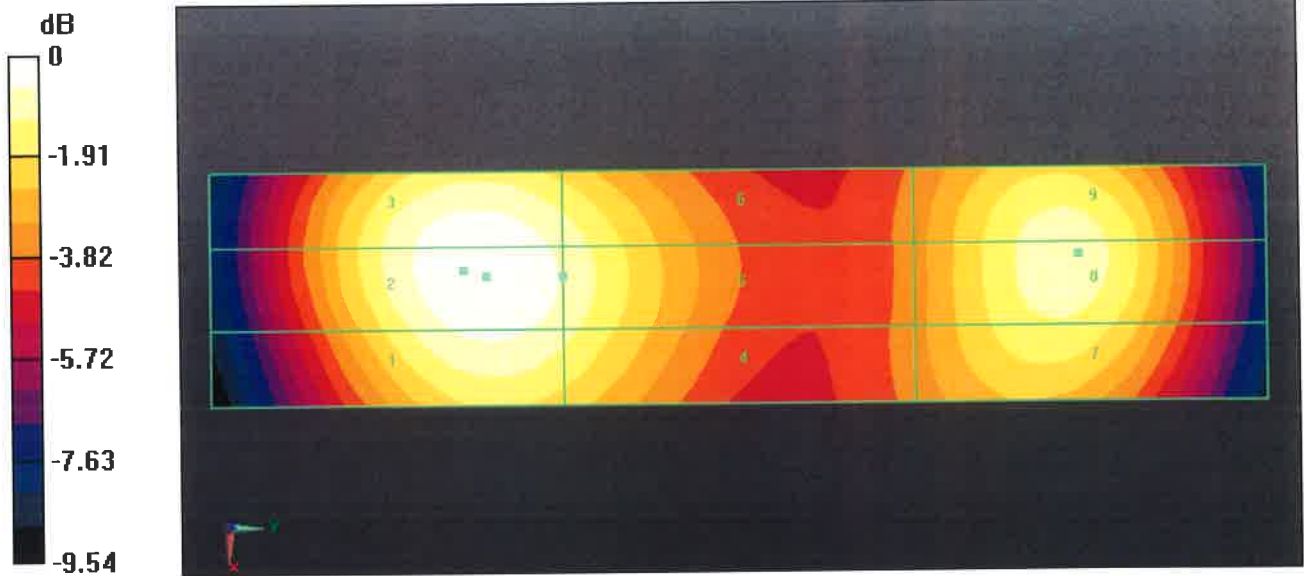

0 dB = 136.8 V/m = 42.72 dBV/m



# Annual Confirmation of HAC Reference Dipole

Model : CD2450V3

S/N : 1033

Measurement Date : 2018/4/24

Frequency (MHz)	Type	Item	Previous Measurement	Annual Check	Deviation	Accepted Tolerance	Result
2450	Free Space	Return Loss	-28.207	-28.602	1.40%	±20%	PASS
		Real Impedance	53.150	55.880	2.73	±5Ω	PASS
		Imaginary Impedance	-2.4785	-1.7202	0.76	±5Ω	PASS

2450 MHz · Free Space

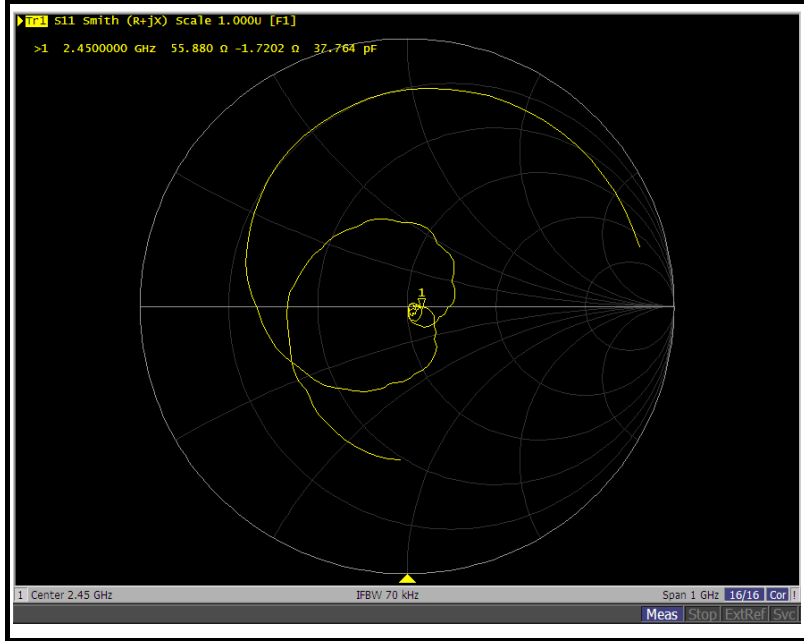
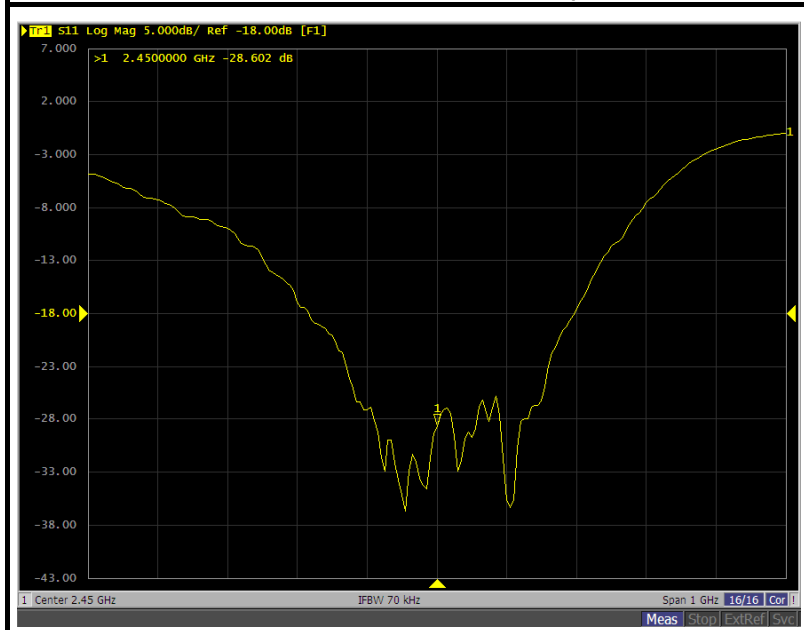



Accredited by the Swiss Accreditation Service (SAS)  
The Swiss Accreditation Service is one of the signatories to the EA  
Multilateral Agreement for the recognition of calibration certificates

Accreditation No.: **SCS 0108**

Client **B.V.ADT (Auden)**

Certificate No: **CD2600V3-1005\_Mar18**

## CALIBRATION CERTIFICATE

Object **CD2600V3 - SN: 1005**

Calibration procedure(s) **QA CAL-20.v6  
Calibration procedure for dipoles in air**

Calibration date: **March 14, 2018**

This calibration certificate documents the traceability to national standards, which realize the physical units of measurements (SI).  
The measurements and the uncertainties with confidence probability are given on the following pages and are part of the certificate.

All calibrations have been conducted in the closed laboratory facility: environment temperature ( $22 \pm 3$ )°C and humidity < 70%.

Calibration Equipment used (M&TE critical for calibration)

Primary Standards	ID #	Cal Date (Certificate No.)	Scheduled Calibration
Power meter NRP	SN: 104778	04-Apr-17 (No. 217-02521/02522)	Apr-18
Power sensor NRP-Z91	SN: 103244	04-Apr-17 (No. 217-02521)	Apr-18
Power sensor NRP-Z91	SN: 103245	04-Apr-17 (No. 217-02522)	Apr-18
Reference 20 dB Attenuator	SN: 5058 (20k)	07-Apr-17 (No. 217-02528)	Apr-18
Type-N mismatch combination	SN: 5047.2 / 06327	07-Apr-17 (No. 217-02529)	Apr-18
Probe EF3DV3	SN: 4013	05-Mar-18 (No. EF3-4013_Mar18)	Mar-19
DAE4	SN: 781	17-Jan-18 (No. DAE4-781_Jan18)	Jan-19

Secondary Standards	ID #	Check Date (in house)	Scheduled Check
Power meter Agilent 4419B	SN: GB42420191	09-Oct-09 (in house check Oct-17)	In house check: Oct-20
Power sensor HP E4412A	SN: US38485102	05-Jan-10 (in house check Oct-17)	In house check: Oct-20
Power sensor HP 8482A	SN: US37295597	09-Oct-09 (in house check Oct-17)	In house check: Oct-20
RF generator R&S SMT-06	SN: 832283/011	27-Aug-12 (in house check Oct-17)	In house check: Oct-20
Network Analyzer HP 8753E	SN: US37390585	18-Oct-01 (in house check Oct-17)	In house check: Oct-18

	Name	Function	Signature
Calibrated by:	Leif Klysner	Laboratory Technician	
Approved by:	Katja Pokovic	Technical Manager	

Issued: March 15, 2018

This calibration certificate shall not be reproduced except in full without written approval of the laboratory.





Accredited by the Swiss Accreditation Service (SAS)

The Swiss Accreditation Service is one of the signatories to the EA  
Multilateral Agreement for the recognition of calibration certificates

## References

- [1] ANSI-C63.19-2011  
American National Standard, Methods of Measurement of Compatibility between Wireless Communications Devices and Hearing Aids.

## Methods Applied and Interpretation of Parameters:

- *Coordinate System:* y-axis is in the direction of the dipole arms. z-axis is from the basis of the antenna (mounted on the table) towards its feed point between the two dipole arms. x-axis is normal to the other axes. In coincidence with the standards [1], the measurement planes (probe sensor center) are selected to be at a distance of 15 mm above the top metal edge of the dipole arms.
- *Measurement Conditions:* Further details are available from the hardcopies at the end of the certificate. All figures stated in the certificate are valid at the frequency indicated. The forward power to the dipole connector is set with a calibrated power meter connected and monitored with an auxiliary power meter connected to a directional coupler. While the dipole under test is connected, the forward power is adjusted to the same level.
- *Antenna Positioning:* The dipole is mounted on a HAC Test Arch phantom using the matching dipole positioner with the arms horizontal and the feeding cable coming from the floor. The measurements are performed in a shielded room with absorbers around the setup to reduce the reflections. It is verified before the mounting of the dipole under the Test Arch phantom, that its arms are perfectly in a line. It is installed on the HAC dipole positioner with its arms parallel below the dielectric reference wire and able to move elastically in vertical direction without changing its relative position to the top center of the Test Arch phantom. The vertical distance to the probe is adjusted after dipole mounting with a DASY5 Surface Check job. Before the measurement, the distance between phantom surface and probe tip is verified. The proper measurement distance is selected by choosing the matching section of the HAC Test Arch phantom with the proper device reference point (upper surface of the dipole) and the matching grid reference point (tip of the probe) considering the probe sensor offset. The vertical distance to the probe is essential for the accuracy.
- *Feed Point Impedance and Return Loss:* These parameters are measured using a HP 8753E Vector Network Analyzer. The impedance is specified at the SMA connector of the dipole. The influence of reflections was eliminated by applying the averaging function while moving the dipole in the air, at least 70cm away from any obstacles.
- *E-field distribution:* E field is measured in the x-y-plane with an isotropic ER3D-field probe with 100 mW forward power to the antenna feed point. In accordance with [1], the scan area is 20mm wide, its length exceeds the dipole arm length (180 or 90mm). The sensor center is 15 mm (in z) above the metal top of the dipole arms. Two 3D maxima are available near the end of the dipole arms. Assuming the dipole arms are perfectly in one line, the average of these two maxima (in subgrid 2 and subgrid 8) is determined to compensate for any non-parallelity to the measurement plane as well as the sensor displacement. The E-field value stated as calibration value represents the maximum of the interpolated 3D-E-field, in the plane above the dipole surface.

The reported uncertainty of measurement is stated as the standard uncertainty of measurement multiplied by the coverage factor  $k=2$ , which for a normal distribution corresponds to a coverage probability of approximately 95%.

## Measurement Conditions

DASY system configuration, as far as not given on page 1.

<b>DASY Version</b>	DASY5	V52.10.0
<b>Phantom</b>	HAC Test Arch	
<b>Distance Dipole Top - Probe Center</b>	15 mm	
<b>Scan resolution</b>	dx, dy = 5 mm	
<b>Frequency</b>	2600 MHz $\pm$ 1 MHz	
<b>Input power drift</b>	< 0.05 dB	

## Maximum Field values at 2600 MHz

<b>E-field 15 mm above dipole surface</b>	<b>condition</b>	<b>Interpolated maximum</b>
Maximum measured above high end	100 mW input power	86.5 V/m = 38.74 dBV/m
Maximum measured above low end	100 mW input power	85.1 V/m = 38.60 dBV/m
Averaged maximum above arm	100 mW input power	<b>85.8 V/m <math>\pm</math> 12.8 % (k=2)</b>

## Appendix (Additional assessments outside the scope of SCS 0108)

### Antenna Parameters

<b>Frequency</b>	<b>Return Loss</b>	<b>Impedance</b>
2450 MHz	22.4 dB	44.6 $\Omega$ - 4.8 j $\Omega$
2550 MHz	28.7 dB	51.4 $\Omega$ + 3.5 j $\Omega$
2600 MHz	26.8 dB	54.8 $\Omega$ + 0.6 j $\Omega$
2650 MHz	24.9 dB	54.9 $\Omega$ - 3.5 j $\Omega$
2750 MHz	18.8 dB	47.9 $\Omega$ - 11.1 j $\Omega$

### 3.2 Antenna Design and Handling

The calibration dipole has a symmetric geometry with a built-in two stub matching network, which leads to the enhanced bandwidth.

The dipole is built of standard semirigid coaxial cable. The internal matching line is open ended. The antenna is therefore open for DC signals.

Do not apply force to dipole arms, as they are liable to bend. The soldered connections near the feedpoint may be damaged. After excessive mechanical stress or overheating, check the impedance characteristics to ensure that the internal matching network is not affected.

After long term use with 40W radiated power, only a slight warming of the dipole near the feedpoint can be measured.

# Impedance Measurement Plot

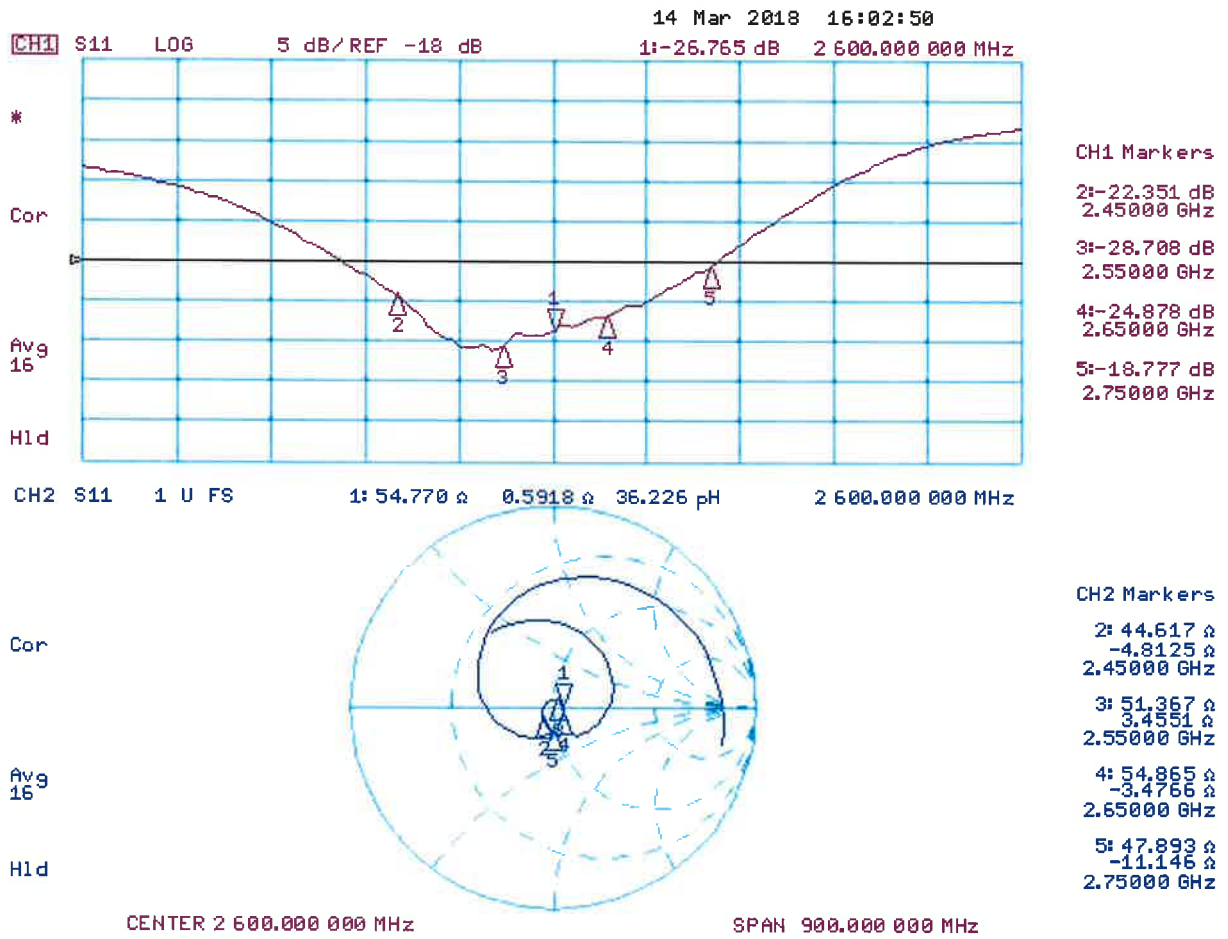

## DASY5 E-field Result

Date: 14.03.2018

Test Laboratory: SPEAG Lab2

**DUT: HAC Dipole 2600 MHz; Type: CD2600V3; Serial: CD2600V3 - SN: 1005**

Communication System: UID 0 - CW ; Frequency: 2600 MHz  
Medium parameters used:  $\sigma = 0$  S/m,  $\epsilon_r = 1$ ;  $\rho = 1000$  kg/m<sup>3</sup>  
Phantom section: RF Section  
Measurement Standard: DASY5 (IEEE/IEC/ANSI C63.19-2011)

DASY52 Configuration:

- Probe: EF3DV3 - SN4013; ConvF(1, 1, 1); Calibrated: 05.03.2018;
- Sensor-Surface: (Fix Surface)
- Electronics: DAE4 Sn781; Calibrated: 17.01.2018
- Phantom: HAC Test Arch with AMCC; Type: SD HAC P01 BA; Serial: 1070
- DASY52 52.10.0(1446); SEMCAD X 14.6.10(7417)

**Dipole E-Field measurement/E-Scan - 2600MHz d=15mm/Hearing Aid Compatibility Test (41x181x1): Interpolated grid:**

dx=0.5000 mm, dy=0.5000 mm

Device Reference Point: 0, 0, -6.3 mm

Reference Value = 63.21 V/m; Power Drift = -0.00 dB

Applied MIF = 0.00 dB

RF audio interference level = 38.74 dBV/m

**Emission category: M2**

MIF scaled E-field

Grid 1 M2 38.27 dBV/m	Grid 2 M2 38.6 dBV/m	Grid 3 M2 38.56 dBV/m
Grid 4 M2 37.94 dBV/m	Grid 5 M2 38.24 dBV/m	Grid 6 M2 38.22 dBV/m
Grid 7 M2 38.41 dBV/m	Grid 8 M2 38.74 dBV/m	Grid 9 M2 38.71 dBV/m

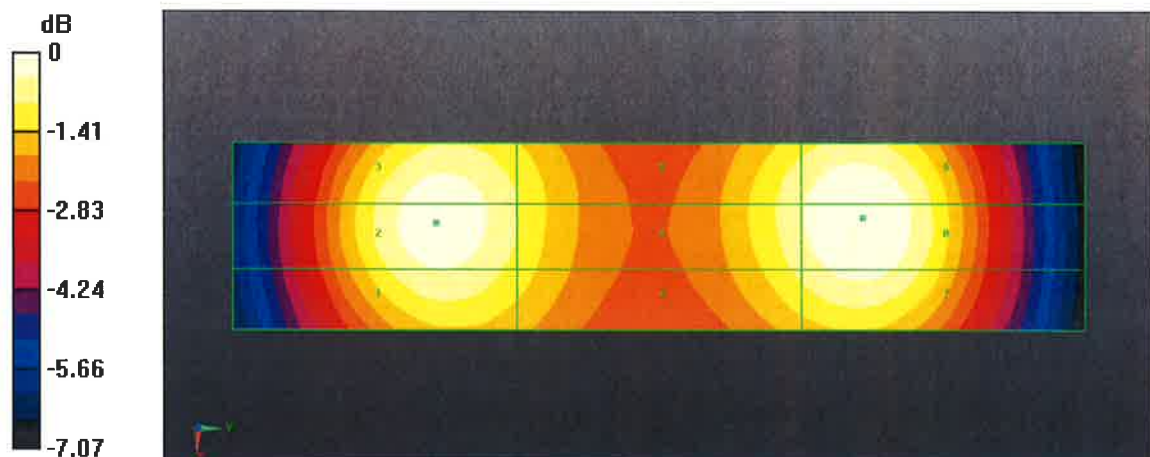



Accredited by the Swiss Accreditation Service (SAS)  
The Swiss Accreditation Service is one of the signatories to the EA  
Multilateral Agreement for the recognition of calibration certificates

Accreditation No.: **SCS 0108**

Client **BV ADT (Auden)**

Certificate No: **EF3-4049\_Dec17**

## CALIBRATION CERTIFICATE

Object **EF3DV3 - SN:4049**

Calibration procedure(s) **QA CAL-02.v8, QA CAL-25.v6  
Calibration procedure for E-field probes optimized for close near field  
evaluations in air**

Calibration date: **December 5, 2017**

This calibration certificate documents the traceability to national standards, which realize the physical units of measurements (SI).  
The measurements and the uncertainties with confidence probability are given on the following pages and are part of the certificate.

All calibrations have been conducted in the closed laboratory facility: environment temperature (22 ± 3)°C and humidity < 70%.

Calibration Equipment used (M&TE critical for calibration)

Primary Standards	ID	Cal Date (Certificate No.)	Scheduled Calibration
Power meter NRP	SN: 104778	04-Apr-17 (No. 217-02521/02522)	Apr-18
Power sensor NRP-Z91	SN: 103244	04-Apr-17 (No. 217-02521)	Apr-18
Power sensor NRP-Z91	SN: 103245	04-Apr-17 (No. 217-02525)	Apr-18
Reference 20 dB Attenuator	SN: S5277 (20x)	07-Apr-17 (No. 217-02528)	Apr-18
Reference Probe ER3DV6	SN: 2328	10-Oct-17 (No. ER3-2328_Oct17)	Oct-18
DAE4	SN: 789	2-Aug-17 (No. DAE4-789_Aug17)	Aug-18
Secondary Standards	ID	Check Date (in house)	Scheduled Check
Power meter E4419B	SN: GB41293874	06-Apr-16 (in house check Jun-16)	In house check: Jun-18
Power sensor E4412A	SN: MY41498087	06-Apr-16 (in house check Jun-16)	In house check: Jun-18
Power sensor E4412A	SN: 000110210	06-Apr-16 (in house check Jun-16)	In house check: Jun-18
RF generator HP 8648C	SN: US3642U01700	04-Aug-99 (in house check Jun-16)	In house check: Jun-18
Network Analyzer HP 8753E	SN: US37390585	18-Oct-01 (in house check Oct-17)	In house check: Oct-18

	Name	Function	Signature
Calibrated by:	Jeton Kastrati	Laboratory Technician	
Approved by:	Katja Pokovic	Technical Manager	

Issued: December 5, 2017

This calibration certificate shall not be reproduced except in full without written approval of the laboratory.





Accredited by the Swiss Accreditation Service (SAS)

Accreditation No.: **SCS 0108**

The Swiss Accreditation Service is one of the signatories to the EA  
Multilateral Agreement for the recognition of calibration certificates

**Glossary:**

NORM <sub>x,y,z</sub>	sensitivity in free space
DCP	diode compression point
CF	crest factor (1/duty_cycle) of the RF signal
A, B, C, D	modulation dependent linearization parameters
Polarization φ	φ rotation around probe axis
Polarization ϑ	ϑ rotation around an axis that is in the plane normal to probe axis (at measurement center), i.e., ϑ = 0 is normal to probe axis
Connector Angle	information used in DASY system to align probe sensor X to the robot coordinate system

**Calibration is Performed According to the Following Standards:**

- a) IEEE Std 1309-2005, " IEEE Standard for calibration of electromagnetic field sensors and probes, excluding antennas, from 9 kHz to 40 GHz", December 2005
- b) CTIA Test Plan for Hearing Aid Compatibility, Rev 3.0, November 2013

**Methods Applied and Interpretation of Parameters:**

- *NORM<sub>x,y,z</sub>*: Assessed for E-field polarization ϑ = 0 for XY sensors and ϑ = 90 for Z sensor (f ≤ 900 MHz in TEM-cell; f > 1800 MHz: R22 waveguide).
- *NORM(f)<sub>x,y,z</sub>* = *NORM<sub>x,y,z</sub>* \* *frequency\_response* (see Frequency Response Chart).
- *DCP<sub>x,y,z</sub>*: DCP are numerical linearization parameters assessed based on the data of power sweep with CW signal (no uncertainty required). DCP does not depend on frequency nor media.
- *PAR*: PAR is the Peak to Average Ratio that is not calibrated but determined based on the signal characteristics
- *A<sub>x,y,z</sub>*; *B<sub>x,y,z</sub>*; *C<sub>x,y,z</sub>*; *D<sub>x,y,z</sub>*; *VR<sub>x,y,z</sub>*: *A, B, C, D* are numerical linearization parameters assessed based on the data of power sweep for specific modulation signal. The parameters do not depend on frequency nor media. *VR* is the maximum calibration range expressed in RMS voltage across the diode.
- *Spherical isotropy (3D deviation from isotropy)*: in a locally homogeneous field realized using an open waveguide setup.
- *Sensor Offset*: The sensor offset corresponds to the offset of virtual measurement center from the probe tip (on probe axis). No tolerance required.
- *Connector Angle*: The angle is assessed using the information gained by determining the *NORM<sub>x</sub>* (no uncertainty required).

# Probe EF3DV3

## SN:4049

Manufactured: May 24, 2016  
Calibrated: December 5, 2017

**Calibrated for DASY/EASY Systems**  
(Note: non-compatible with DASY2 system!)

## DASY/EASY - Parameters of Probe: EF3DV3 - SN:4049

### Basic Calibration Parameters

	Sensor X	Sensor Y	Sensor Z	Unc (k=2)
Norm ( $\mu\text{V}/(\text{V}/\text{m})^2$ )	0.73	0.98	1.04	$\pm 10.1 \%$
DCP ( $\text{mV}$ ) <sup>B</sup>	99.8	94.7	86.2	

### Modulation Calibration Parameters

UID	Communication System Name		A dB	B dB $\sqrt{\mu\text{V}}$	C	D dB	VR mV	Unc <sup>E</sup> (k=2)
0	CW	X	0.0	0.0	1.0	0.00	175.0	$\pm 3.3 \%$
		Y	0.0	0.0	1.0		147.3	
		Z	0.0	0.0	1.0		144.9	

Note: For details on UID parameters see Appendix.

### Sensor Model Parameters

	C1 fF	C2 fF	$\alpha$ $\text{V}^{-1}$	T1 $\text{ms}\cdot\text{V}^{-2}$	T2 $\text{ms}\cdot\text{V}^{-1}$	T3 ms	T4 $\text{V}^{-2}$	T5 $\text{V}^{-1}$	T6
X	45.54	299.0	36.59	8.615	0.482	4.943	1.532	0.088	1.004
Y	81.02	554.1	39.26	25.84	1.781	5.100	0.000	0.725	1.016
Z	57.45	406.3	41.86	15.22	0.826	5.008	0.000	0.427	1.003

The reported uncertainty of measurement is stated as the standard uncertainty of measurement multiplied by the coverage factor  $k=2$ , which for a normal distribution corresponds to a coverage probability of approximately 95%.

<sup>B</sup> Numerical linearization parameter: uncertainty not required.

<sup>E</sup> Uncertainty is determined using the max. deviation from linear response applying rectangular distribution and is expressed for the square of the field value.



### Frequency Response of E-Field (TEM-Cell:ifi110 EXX, Waveguide: R22)

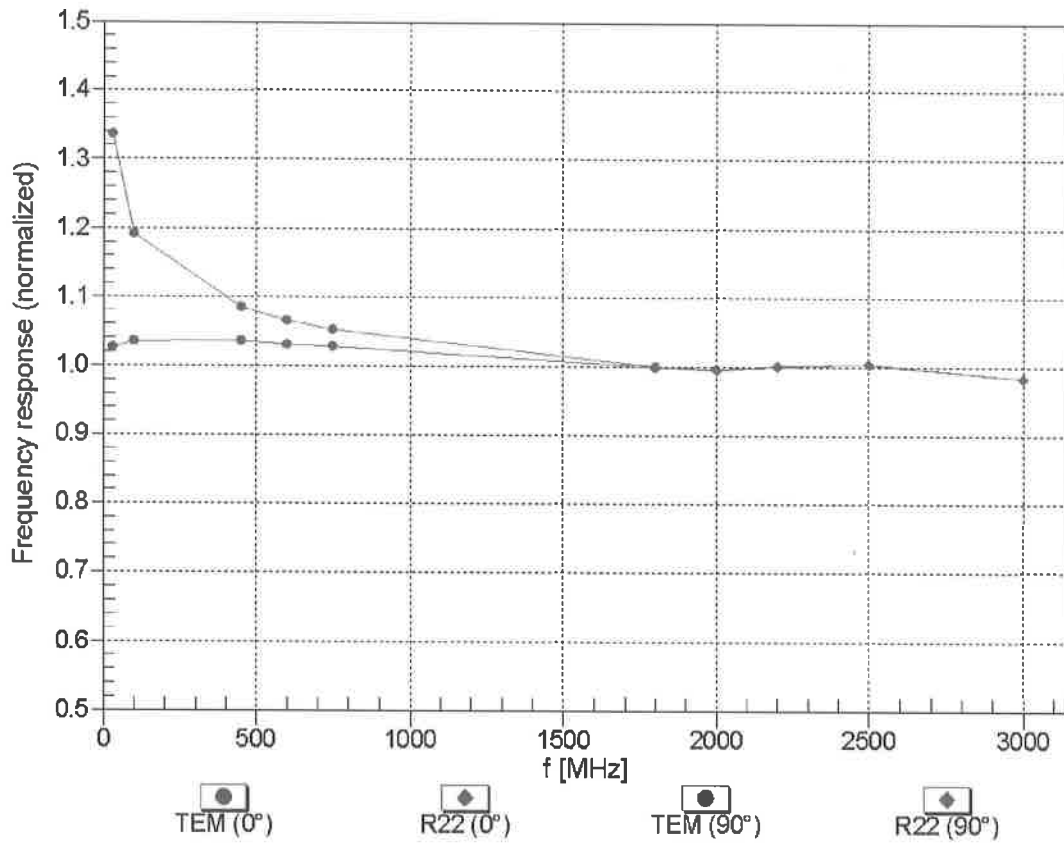

Uncertainty of Frequency Response of E-field:  $\pm 6.3\%$  (k=2)

### Receiving Pattern ( $\phi$ ), $\vartheta = 0^\circ$

f=600 MHz, TEM,  $0^\circ$

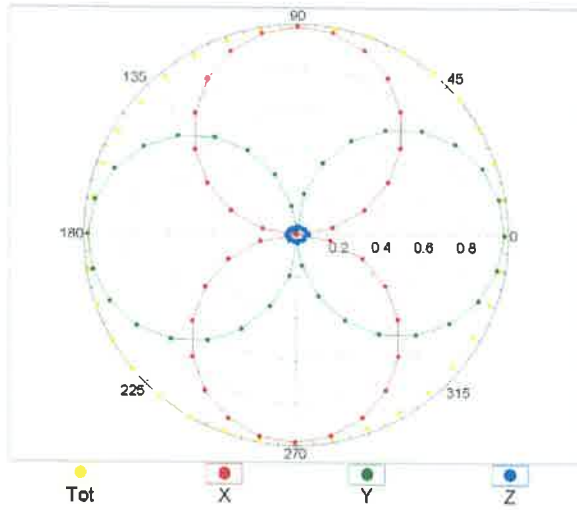

f=1800 MHz, R22,  $0^\circ$

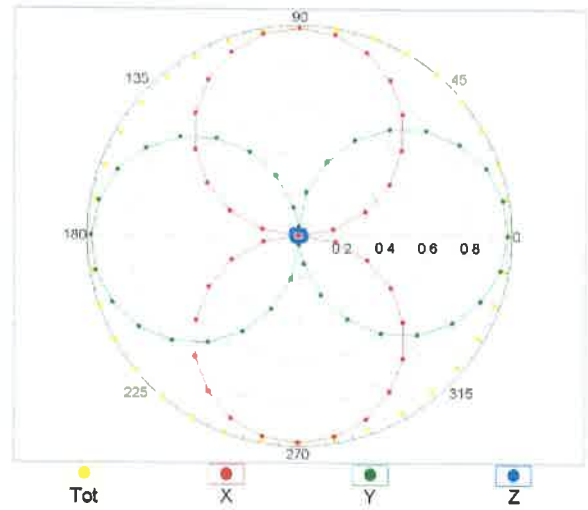

### Receiving Pattern ( $\phi$ ), $\vartheta = 90^\circ$

f=600 MHz, TEM,  $90^\circ$

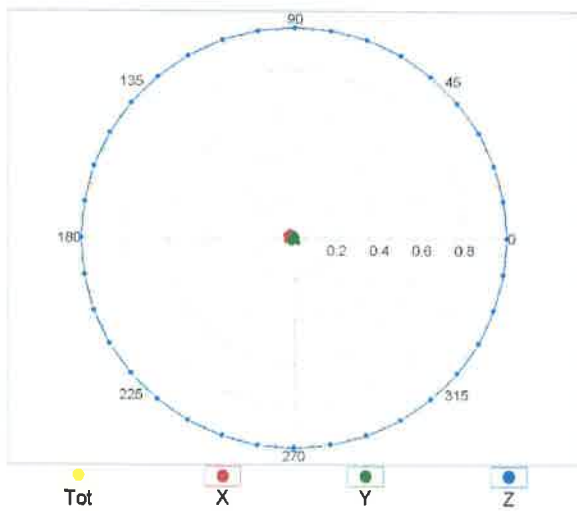

f=1800 MHz, R22,  $90^\circ$

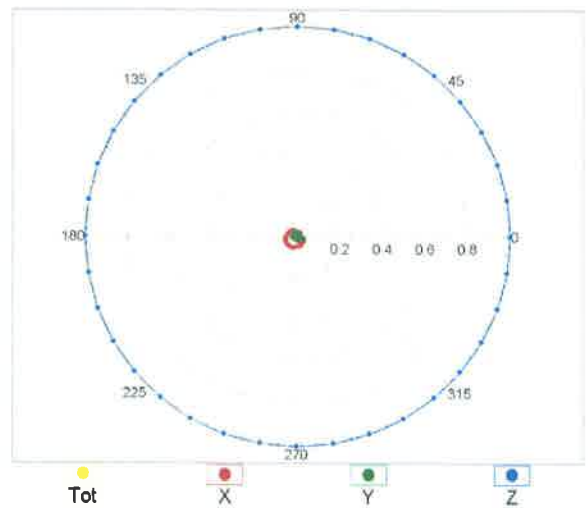

### Receiving Pattern ( $\phi$ ), $\vartheta = 0^\circ$

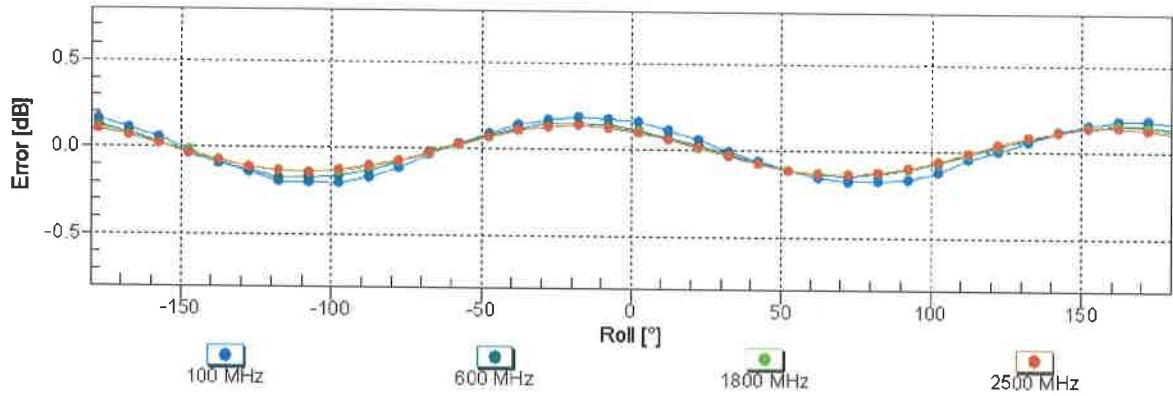

Uncertainty of Axial Isotropy Assessment:  $\pm 0.5\%$  (k=2)

### Receiving Pattern ( $\phi$ ), $\vartheta = 90^\circ$

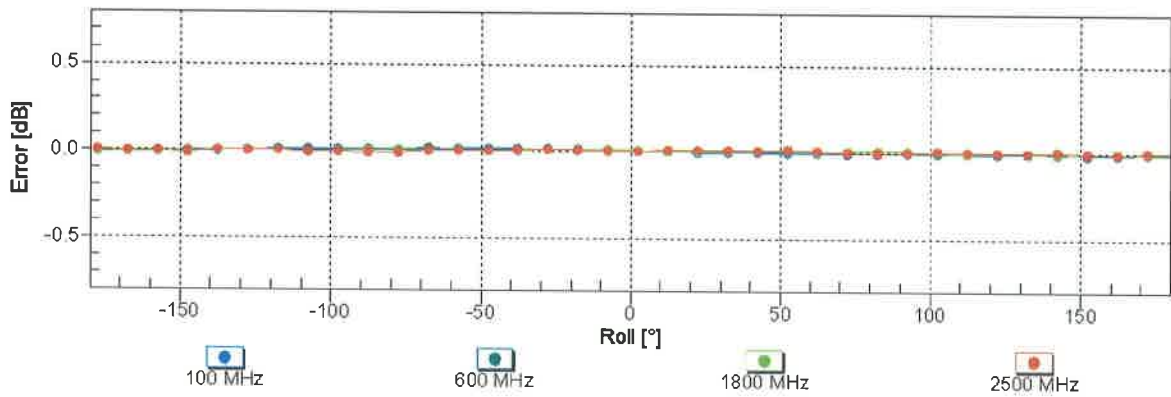

Uncertainty of Axial Isotropy Assessment:  $\pm 0.5\%$  (k=2)

### Dynamic Range f(E-field) (TEM cell , f = 900 MHz)

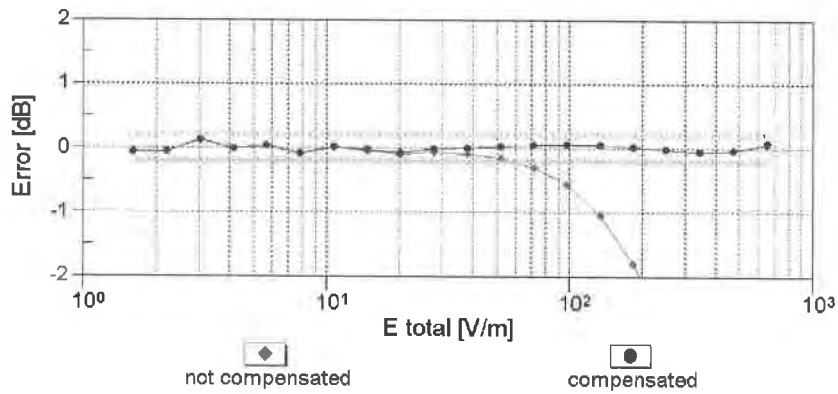
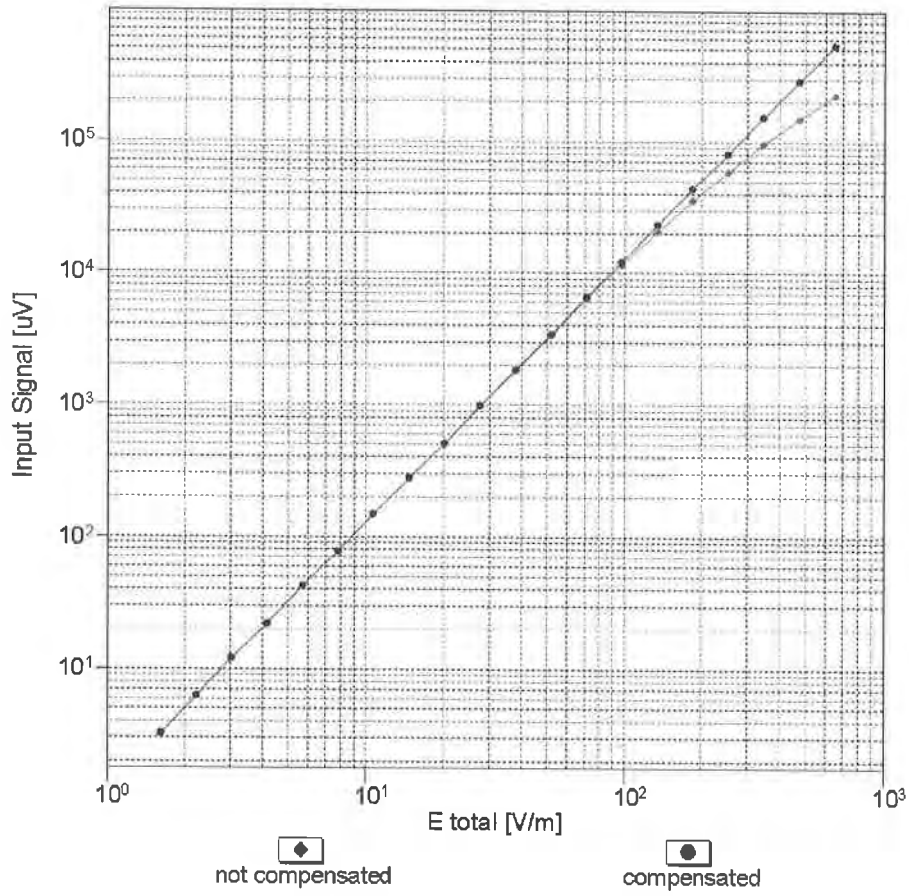

Uncertainty of Linearity Assessment: ± 0.6% (k=2)

# Deviation from Isotropy in Air

Error ( $\phi$ ,  $\theta$ ),  $f = 900$  MHz

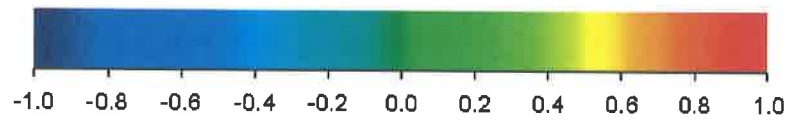
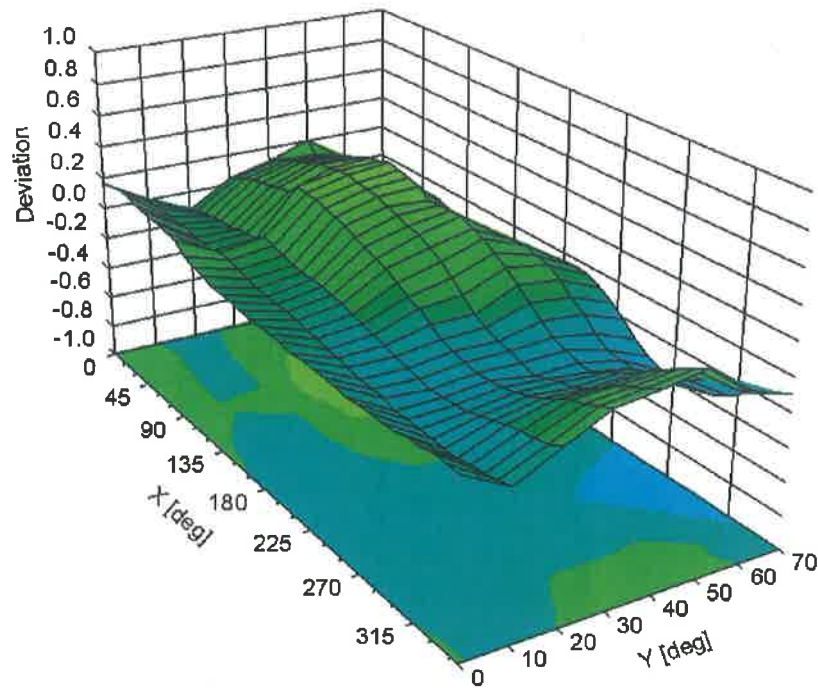

Uncertainty of Spherical Isotropy Assessment:  $\pm 2.6\%$  ( $k=2$ )

## DASY/EASY - Parameters of Probe: EF3DV3 - SN:4049

### Other Probe Parameters

Sensor Arrangement	Rectangular
Connector Angle (°)	112.4
Mechanical Surface Detection Mode	enabled
Optical Surface Detection Mode	disabled
Probe Overall Length	337 mm
Probe Body Diameter	12 mm
Tip Length	25 mm
Tip Diameter	4 mm
Probe Tip to Sensor X Calibration Point	1.5 mm
Probe Tip to Sensor Y Calibration Point	1.5 mm
Probe Tip to Sensor Z Calibration Point	1.5 mm

## Appendix (Additional assessments outside the scope of SCS 0108)

### Calibration Parameters for 3-4 GHz

	Sensor X	Sensor Y	Sensor Z	Unc (k=2)
Norm ( $\mu\text{V}/(\text{V}/\text{m})^2$ ) <sup>x</sup>	0.84	1.13	1.14	± 10.1 %
DCP (mV) <sup>b</sup>	99.8	94.7	86.2	

### Calibration Parameters for 5-6 GHz

	Sensor X	Sensor Y	Sensor Z	Unc (k=2)
Norm ( $\mu\text{V}/(\text{V}/\text{m})^2$ ) <sup>x</sup>	1.00	1.33	1.35	± 10.1 %
DCP (mV) <sup>b</sup>	99.8	94.7	86.2	

The reported uncertainty of measurement is stated as the standard uncertainty of measurement multiplied by the coverage factor  $k=2$ , which for a normal distribution corresponds to a coverage probability of approximately 95%.

<sup>b</sup> Numerical linearization parameter: uncertainty not required.

<sup>x</sup> Calibration procedure for frequencies above 3 GHz is pending accreditation.

**Appendix: Modulation Calibration Parameters**

UID	Communication System Name		A dB	B dB $\sqrt{\mu}$ V	C	D dB	VR mV	Max Unc <sup>E</sup> (k=2)
0	CW	X	0.00	0.00	1.00	0.00	175.0	± 3.3 %
		Y	0.00	0.00	1.00		147.3	
		Z	0.00	0.00	1.00		144.9	
10010- CAA	SAR Validation (Square, 100ms, 10ms)	X	2.13	64.04	8.34	10.00	20.0	± 9.6 %
		Y	6.99	77.76	17.22		20.0	
		Z	2.44	65.61	9.75		20.0	
10011- CAB	UMTS-FDD (WCDMA)	X	1.45	74.49	18.98	0.00	150.0	± 9.6 %
		Y	1.53	74.28	18.97		150.0	
		Z	2.66	86.27	24.38		150.0	
10012- CAB	IEEE 802.11b WiFi 2.4 GHz (DSSS, 1 Mbps)	X	1.21	65.55	16.51	0.41	150.0	± 9.6 %
		Y	1.34	66.80	17.47		150.0	
		Z	1.29	67.49	18.46		150.0	
10013- CAB	IEEE 802.11g WiFi 2.4 GHz (DSSS-OFDM, 6 Mbps)	X	4.88	67.45	17.49	1.46	150.0	± 9.6 %
		Y	5.34	67.66	18.09		150.0	
		Z	5.08	67.59	18.13		150.0	
10021- DAC	GSM-FDD (TDMA, GMSK)	X	3.55	69.17	11.61	9.39	50.0	± 9.6 %
		Y	58.34	112.03	29.77		50.0	
		Z	9.97	82.39	17.79		50.0	
10023- DAC	GPRS-FDD (TDMA, GMSK, TN 0)	X	3.53	68.89	11.52	9.57	50.0	± 9.6 %
		Y	44.80	107.92	28.75		50.0	
		Z	8.43	80.22	17.08		50.0	
10024- DAC	GPRS-FDD (TDMA, GMSK, TN 0-1)	X	2.10	66.83	9.63	6.56	60.0	± 9.6 %
		Y	100.00	117.13	29.18		60.0	
		Z	39.70	97.14	20.59		60.0	
10025- DAC	EDGE-FDD (TDMA, 8PSK, TN 0)	X	39.14	141.37	53.39	12.57	50.0	± 9.6 %
		Y	100.00	165.80	60.45		50.0	
		Z	22.52	124.82	49.21		50.0	
10026- DAC	EDGE-FDD (TDMA, 8PSK, TN 0-1)	X	15.82	107.71	38.10	9.56	60.0	± 9.6 %
		Y	47.91	129.94	44.88		60.0	
		Z	29.37	123.07	43.44		60.0	
10027- DAC	GPRS-FDD (TDMA, GMSK, TN 0-1-2)	X	1.50	66.06	8.73	4.80	80.0	± 9.6 %
		Y	100.00	115.86	27.74		80.0	
		Z	100.00	104.91	21.35		80.0	
10028- DAC	GPRS-FDD (TDMA, GMSK, TN 0-1-2-3)	X	1.19	66.13	8.36	3.55	100.0	± 9.6 %
		Y	100.00	115.65	26.88		100.0	
		Z	100.00	103.81	20.26		100.0	
10029- DAC	EDGE-FDD (TDMA, 8PSK, TN 0-1-2)	X	6.67	86.78	29.54	7.80	80.0	± 9.6 %
		Y	22.83	110.76	37.88		80.0	
		Z	11.35	98.82	34.51		80.0	
10030- CAA	IEEE 802.15.1 Bluetooth (GFSK, DH1)	X	1.54	65.21	8.43	5.30	70.0	± 9.6 %
		Y	100.00	115.69	28.00		70.0	
		Z	41.85	96.34	19.59		70.0	
10031- CAA	IEEE 802.15.1 Bluetooth (GFSK, DH3)	X	0.36	61.32	5.09	1.88	100.0	± 9.6 %
		Y	100.00	115.14	25.16		100.0	
		Z	100.00	97.14	16.31		100.0	



10032-CAA	IEEE 802.15.1 Bluetooth (GFSK, DH5)	X	0.20	60.44	4.23	1.17	100.0	± 9.6 %
		Y	100.00	117.18	24.92		100.0	
		Z	0.30	61.56	5.04		100.0	
10033-CAA	IEEE 802.15.1 Bluetooth (PI/4-DQPSK, DH1)	X	4.69	78.75	18.17	5.30	70.0	± 9.6 %
		Y	71.80	124.37	34.93		70.0	
		Z	34.00	110.07	29.36		70.0	
10034-CAA	IEEE 802.15.1 Bluetooth (PI/4-DQPSK, DH3)	X	2.18	72.88	15.21	1.88	100.0	± 9.6 %
		Y	13.02	99.46	27.07		100.0	
		Z	14.16	100.20	25.77		100.0	
10035-CAA	IEEE 802.15.1 Bluetooth (PI/4-DQPSK, DH5)	X	1.85	72.29	15.00	1.17	100.0	± 9.6 %
		Y	6.02	89.03	23.69		100.0	
		Z	8.95	95.35	24.38		100.0	
10036-CAA	IEEE 802.15.1 Bluetooth (8-DPSK, DH1)	X	5.44	80.93	18.99	5.30	70.0	± 9.6 %
		Y	100.00	130.29	36.41		70.0	
		Z	67.11	120.73	32.07		70.0	
10037-CAA	IEEE 802.15.1 Bluetooth (8-DPSK, DH3)	X	2.07	72.37	14.98	1.88	100.0	± 9.6 %
		Y	13.45	99.98	27.16		100.0	
		Z	13.25	99.28	25.46		100.0	
10038-CAA	IEEE 802.15.1 Bluetooth (8-DPSK, DH5)	X	1.90	72.90	15.38	1.17	100.0	± 9.6 %
		Y	6.57	90.70	24.32		100.0	
		Z	10.82	98.59	25.47		100.0	
10039-CAB	CDMA2000 (1xRTT, RC1)	X	3.31	81.15	18.65	0.00	150.0	± 9.6 %
		Y	2.63	76.57	18.92		150.0	
		Z	15.17	103.88	26.82		150.0	
10042-CAB	IS-54 / IS-136 FDD (TDMA/FDM, PI/4-DQPSK, Halfrate)	X	2.21	66.02	9.41	7.78	50.0	± 9.6 %
		Y	100.00	115.99	28.87		50.0	
		Z	4.67	73.84	13.63		50.0	
10044-CAA	IS-91/EIA/TIA-553 FDD (FDMA, FM)	X	0.00	122.81	7.50	0.00	150.0	± 9.6 %
		Y	0.01	122.43	0.60		150.0	
		Z	0.76	156.70	13.92		150.0	
10048-CAA	DECT (TDD, TDMA/FDM, GFSK, Full Slot, 24)	X	4.09	66.44	11.91	13.80	20.0	± 9.6 %
		Y	15.73	90.59	25.43		20.0	
		Z	6.01	73.33	15.97		20.0	
10049-CAA	DECT (TDD, TDMA/FDM, GFSK, Double Slot, 12)	X	3.91	68.66	11.66	10.79	40.0	± 9.6 %
		Y	19.84	94.97	25.45		40.0	
		Z	6.25	75.67	15.67		40.0	
10056-CAA	UMTS-TDD (TD-SCDMA, 1.28 Mcps)	X	7.99	80.56	18.81	9.03	50.0	± 9.6 %
		Y	20.34	98.21	28.30		50.0	
		Z	16.60	93.62	24.72		50.0	
10058-DAC	EDGE-FDD (TDMA, 8PSK, TN 0-1-2-3)	X	4.64	79.02	25.66	6.55	100.0	± 9.6 %
		Y	14.01	99.52	33.40		100.0	
		Z	7.17	88.34	29.96		100.0	
10059-CAB	IEEE 802.11b WiFi 2.4 GHz (DSSS, 2 Mbps)	X	1.24	66.68	17.02	0.61	110.0	± 9.6 %
		Y	1.55	69.66	18.86		110.0	
		Z	1.42	69.90	19.61		110.0	
10060-CAB	IEEE 802.11b WiFi 2.4 GHz (DSSS, 5.5 Mbps)	X	100.00	137.52	34.96	1.30	110.0	± 9.6 %
		Y	100.00	134.99	35.01		110.0	
		Z	100.00	141.19	36.91		110.0	

10061-CAB	IEEE 802.11b WiFi 2.4 GHz (DSSS, 11 Mbps)	X	3.00	82.37	22.53	2.04	110.0	± 9.6 %
		Y	56.21	129.85	36.87		110.0	
		Z	38.64	128.77	37.16		110.0	
10062-CAB	IEEE 802.11a/h WiFi 5 GHz (OFDM, 6 Mbps)	X	4.72	67.57	17.06	0.49	100.0	± 9.6 %
		Y	5.10	67.52	17.40		100.0	
		Z	4.91	67.65	17.63		100.0	
10063-CAB	IEEE 802.11a/h WiFi 5 GHz (OFDM, 9 Mbps)	X	4.73	67.62	17.12	0.72	100.0	± 9.6 %
		Y	5.14	67.69	17.55		100.0	
		Z	4.93	67.75	17.72		100.0	
10064-CAB	IEEE 802.11a/h WiFi 5 GHz (OFDM, 12 Mbps)	X	5.00	67.88	17.33	0.86	100.0	± 9.6 %
		Y	5.53	68.12	17.86		100.0	
		Z	5.24	68.08	17.97		100.0	
10065-CAB	IEEE 802.11a/h WiFi 5 GHz (OFDM, 18 Mbps)	X	4.85	67.69	17.36	1.21	100.0	± 9.6 %
		Y	5.39	68.09	18.00		100.0	
		Z	5.09	67.96	18.05		100.0	
10066-CAB	IEEE 802.11a/h WiFi 5 GHz (OFDM, 24 Mbps)	X	4.85	67.67	17.48	1.46	100.0	± 9.6 %
		Y	5.44	68.22	18.24		100.0	
		Z	5.11	68.00	18.22		100.0	
10067-CAB	IEEE 802.11a/h WiFi 5 GHz (OFDM, 36 Mbps)	X	5.13	67.86	17.90	2.04	100.0	± 9.6 %
		Y	5.76	68.40	18.74		100.0	
		Z	5.39	68.09	18.60		100.0	
10068-CAB	IEEE 802.11a/h WiFi 5 GHz (OFDM, 48 Mbps)	X	5.15	67.83	18.06	2.55	100.0	± 9.6 %
		Y	5.90	68.79	19.12		100.0	
		Z	5.46	68.28	18.89		100.0	
10069-CAB	IEEE 802.11a/h WiFi 5 GHz (OFDM, 54 Mbps)	X	5.23	67.89	18.28	2.67	100.0	± 9.6 %
		Y	5.96	68.66	19.29		100.0	
		Z	5.53	68.26	19.08		100.0	
10071-CAB	IEEE 802.11g WiFi 2.4 GHz (DSSS/OFDM, 9 Mbps)	X	4.95	67.48	17.73	1.99	100.0	± 9.6 %
		Y	5.46	67.87	18.47		100.0	
		Z	5.17	67.67	18.42		100.0	
10072-CAB	IEEE 802.11g WiFi 2.4 GHz (DSSS/OFDM, 12 Mbps)	X	4.91	67.74	17.89	2.30	100.0	± 9.6 %
		Y	5.52	68.42	18.78		100.0	
		Z	5.17	68.07	18.65		100.0	
10073-CAB	IEEE 802.11g WiFi 2.4 GHz (DSSS/OFDM, 18 Mbps)	X	4.95	67.85	18.16	2.83	100.0	± 9.6 %
		Y	5.62	68.72	19.19		100.0	
		Z	5.22	68.23	18.96		100.0	
10074-CAB	IEEE 802.11g WiFi 2.4 GHz (DSSS/OFDM, 24 Mbps)	X	4.93	67.71	18.25	3.30	100.0	± 9.6 %
		Y	5.61	68.77	19.46		100.0	
		Z	5.18	68.08	19.08		100.0	
10075-CAB	IEEE 802.11g WiFi 2.4 GHz (DSSS/OFDM, 36 Mbps)	X	4.95	67.80	18.53	3.82	90.0	± 9.6 %
		Y	5.77	69.38	20.05		90.0	
		Z	5.24	68.32	19.44		90.0	
10076-CAB	IEEE 802.11g WiFi 2.4 GHz (DSSS/OFDM, 48 Mbps)	X	4.96	67.60	18.65	4.15	90.0	± 9.6 %
		Y	5.72	69.03	20.11		90.0	
		Z	5.22	67.99	19.50		90.0	
10077-CAB	IEEE 802.11g WiFi 2.4 GHz (DSSS/OFDM, 54 Mbps)	X	4.99	67.66	18.73	4.30	90.0	± 9.6 %
		Y	5.74	69.07	20.19		90.0	
		Z	5.24	68.03	19.58		90.0	

10081-CAB	CDMA2000 (1xRTT, RC3)	X	1.21	72.08	14.79	0.00	150.0	± 9.6 %
		Y	1.40	72.78	17.00		150.0	
		Z	5.25	93.26	23.37		150.0	
10082-CAB	IS-54 / IS-136 FDD (TDMA/FDM, PI/4-DQPSK, Fullrate)	X	0.58	59.47	3.18	4.77	80.0	± 9.6 %
		Y	1.78	63.29	7.58		80.0	
		Z	0.81	60.00	4.09		80.0	
10090-DAC	GPRS-FDD (TDMA, GMSK, TN 0-4)	X	2.11	66.82	9.63	6.56	60.0	± 9.6 %
		Y	100.00	117.22	29.24		60.0	
		Z	39.34	97.09	20.60		60.0	
10097-CAB	UMTS-FDD (HSDPA)	X	2.09	71.02	17.41	0.00	150.0	± 9.6 %
		Y	2.05	69.37	17.17		150.0	
		Z	2.31	72.86	19.02		150.0	
10098-CAB	UMTS-FDD (HSUPA, Subtest 2)	X	2.06	71.05	17.43	0.00	150.0	± 9.6 %
		Y	2.01	69.43	17.19		150.0	
		Z	2.29	73.01	19.09		150.0	
10099-DAC	EDGE-FDD (TDMA, 8PSK, TN 0-4)	X	15.96	107.87	38.14	9.56	60.0	± 9.6 %
		Y	47.48	129.65	44.79		60.0	
		Z	29.59	123.18	43.45		60.0	
10100-CAD	LTE-FDD (SC-FDMA, 100% RB, 20 MHz, QPSK)	X	3.38	72.36	17.96	0.00	150.0	± 9.6 %
		Y	3.64	72.28	17.76		150.0	
		Z	3.75	73.87	19.00		150.0	
10101-CAD	LTE-FDD (SC-FDMA, 100% RB, 20 MHz, 16-QAM)	X	3.38	68.90	16.87	0.00	150.0	± 9.6 %
		Y	3.64	69.00	16.95		150.0	
		Z	3.58	69.51	17.60		150.0	
10102-CAD	LTE-FDD (SC-FDMA, 100% RB, 20 MHz, 64-QAM)	X	3.47	68.79	16.91	0.00	150.0	± 9.6 %
		Y	3.73	68.80	16.97		150.0	
		Z	3.66	69.31	17.61		150.0	
10103-CAD	LTE-TDD (SC-FDMA, 100% RB, 20 MHz, QPSK)	X	5.81	75.12	19.98	3.98	65.0	± 9.6 %
		Y	8.80	79.51	22.13		65.0	
		Z	7.08	77.96	21.70		65.0	
10104-CAD	LTE-TDD (SC-FDMA, 100% RB, 20 MHz, 16-QAM)	X	6.16	74.45	20.63	3.98	65.0	± 9.6 %
		Y	9.03	79.01	22.98		65.0	
		Z	7.29	77.04	22.33		65.0	
10105-CAD	LTE-TDD (SC-FDMA, 100% RB, 20 MHz, 64-QAM)	X	5.78	73.04	20.32	3.98	65.0	± 9.6 %
		Y	7.94	76.37	22.16		65.0	
		Z	6.72	75.27	21.88		65.0	
10108-CAE	LTE-FDD (SC-FDMA, 100% RB, 10 MHz, QPSK)	X	2.98	72.04	18.00	0.00	150.0	± 9.6 %
		Y	3.28	71.78	17.76		150.0	
		Z	3.38	73.83	19.22		150.0	
10109-CAE	LTE-FDD (SC-FDMA, 100% RB, 10 MHz, 16-QAM)	X	3.03	69.01	16.86	0.00	150.0	± 9.6 %
		Y	3.32	68.92	16.97		150.0	
		Z	3.25	69.78	17.73		150.0	
10110-CAE	LTE-FDD (SC-FDMA, 100% RB, 5 MHz, QPSK)	X	2.48	71.83	17.87	0.00	150.0	± 9.6 %
		Y	2.76	71.28	17.72		150.0	
		Z	2.90	74.16	19.46		150.0	
10111-CAE	LTE-FDD (SC-FDMA, 100% RB, 5 MHz, 16-QAM)	X	2.77	70.29	17.22	0.00	150.0	± 9.6 %
		Y	2.97	69.30	17.23		150.0	
		Z	3.00	71.24	18.33		150.0	

10112-CAE	LTE-FDD (SC-FDMA, 100% RB, 10 MHz, 64-QAM)	X	3.15	68.93	16.86	0.00	150.0	± 9.6 %
		Y	3.42	68.69	16.94		150.0	
		Z	3.35	69.54	17.67		150.0	
10113-CAE	LTE-FDD (SC-FDMA, 100% RB, 5 MHz, 64-QAM)	X	2.91	70.33	17.29	0.00	150.0	± 9.6 %
		Y	3.12	69.24	17.26		150.0	
		Z	3.14	71.11	18.31		150.0	
10114-CAB	IEEE 802.11n (HT Greenfield, 13.5 Mbps, BPSK)	X	5.37	68.66	17.41	0.00	150.0	± 9.6 %
		Y	5.57	68.23	17.31		150.0	
		Z	5.61	68.94	17.97		150.0	
10115-CAB	IEEE 802.11n (HT Greenfield, 81 Mbps, 16-QAM)	X	5.61	68.60	17.39	0.00	150.0	± 9.6 %
		Y	6.16	69.19	17.81		150.0	
		Z	5.90	69.01	18.02		150.0	
10116-CAB	IEEE 802.11n (HT Greenfield, 135 Mbps, 64-QAM)	X	5.45	68.78	17.40	0.00	150.0	± 9.6 %
		Y	5.75	68.62	17.42		150.0	
		Z	5.77	69.35	18.10		150.0	
10117-CAB	IEEE 802.11n (HT Mixed, 13.5 Mbps, BPSK)	X	5.28	68.29	17.24	0.00	150.0	± 9.6 %
		Y	5.61	68.36	17.40		150.0	
		Z	5.47	68.44	17.74		150.0	
10118-CAB	IEEE 802.11n (HT Mixed, 81 Mbps, 16-QAM)	X	6.02	69.96	18.09	0.00	150.0	± 9.6 %
		Y	6.09	68.83	17.62		150.0	
		Z	6.15	69.79	18.42		150.0	
10119-CAB	IEEE 802.11n (HT Mixed, 135 Mbps, 64-QAM)	X	5.50	68.98	17.51	0.00	150.0	± 9.6 %
		Y	5.83	68.96	17.62		150.0	
		Z	5.87	69.72	18.30		150.0	
10140-CAD	LTE-FDD (SC-FDMA, 100% RB, 15 MHz, 16-QAM)	X	3.50	68.81	16.83	0.00	150.0	± 9.6 %
		Y	3.78	68.77	16.89		150.0	
		Z	3.70	69.29	17.51		150.0	
10141-CAD	LTE-FDD (SC-FDMA, 100% RB, 15 MHz, 64-QAM)	X	3.62	68.86	16.97	0.00	150.0	± 9.6 %
		Y	3.89	68.72	16.99		150.0	
		Z	3.80	69.26	17.61		150.0	
10142-CAD	LTE-FDD (SC-FDMA, 100% RB, 3 MHz, QPSK)	X	2.30	72.41	17.61	0.00	150.0	± 9.6 %
		Y	2.54	71.38	17.67		150.0	
		Z	2.82	75.49	19.66		150.0	
10143-CAD	LTE-FDD (SC-FDMA, 100% RB, 3 MHz, 16-QAM)	X	2.67	71.39	16.84	0.00	150.0	± 9.6 %
		Y	2.85	69.98	17.18		150.0	
		Z	3.02	72.95	18.39		150.0	
10144-CAD	LTE-FDD (SC-FDMA, 100% RB, 3 MHz, 64-QAM)	X	2.36	68.53	14.93	0.00	150.0	± 9.6 %
		Y	2.72	68.39	16.01		150.0	
		Z	2.67	69.92	16.43		150.0	
10145-CAE	LTE-FDD (SC-FDMA, 100% RB, 1.4 MHz, QPSK)	X	1.19	65.81	11.31	0.00	150.0	± 9.6 %
		Y	1.90	70.32	16.00		150.0	
		Z	1.86	71.57	15.27		150.0	
10146-CAE	LTE-FDD (SC-FDMA, 100% RB, 1.4 MHz, 16-QAM)	X	1.56	64.35	9.33	0.00	150.0	± 9.6 %
		Y	4.28	77.21	19.05		150.0	
		Z	1.96	66.95	12.09		150.0	
10147-CAE	LTE-FDD (SC-FDMA, 100% RB, 1.4 MHz, 64-QAM)	X	1.68	65.11	9.82	0.00	150.0	± 9.6 %
		Y	5.11	80.15	20.40		150.0	
		Z	2.22	68.58	13.02		150.0	

10149-CAD	LTE-FDD (SC-FDMA, 50% RB, 20 MHz, 16-QAM)	X	3.04	69.07	16.90	0.00	150.0	± 9.6 %
		Y	3.33	68.97	17.01		150.0	
		Z	3.26	69.84	17.78		150.0	
10150-CAD	LTE-FDD (SC-FDMA, 50% RB, 20 MHz, 64-QAM)	X	3.15	68.98	16.90	0.00	150.0	± 9.6 %
		Y	3.43	68.73	16.97		150.0	
		Z	3.36	69.59	17.71		150.0	
10151-CAD	LTE-TDD (SC-FDMA, 50% RB, 20 MHz, QPSK)	X	6.29	78.18	21.22	3.98	65.0	± 9.6 %
		Y	9.52	82.30	23.35		65.0	
		Z	8.05	81.99	23.36		65.0	
10152-CAD	LTE-TDD (SC-FDMA, 50% RB, 20 MHz, 16-QAM)	X	5.68	74.38	20.17	3.98	65.0	± 9.6 %
		Y	8.79	79.62	23.05		65.0	
		Z	6.92	77.43	22.15		65.0	
10153-CAD	LTE-TDD (SC-FDMA, 50% RB, 20 MHz, 64-QAM)	X	6.04	75.32	20.95	3.98	65.0	± 9.6 %
		Y	9.04	80.07	23.59		65.0	
		Z	7.26	78.21	22.86		65.0	
10154-CAE	LTE-FDD (SC-FDMA, 50% RB, 10 MHz, QPSK)	X	2.53	72.24	18.11	0.00	150.0	± 9.6 %
		Y	2.82	71.71	17.99		150.0	
		Z	2.98	74.73	19.77		150.0	
10155-CAE	LTE-FDD (SC-FDMA, 50% RB, 10 MHz, 16-QAM)	X	2.77	70.31	17.24	0.00	150.0	± 9.6 %
		Y	2.97	69.30	17.23		150.0	
		Z	3.01	71.25	18.34		150.0	
10156-CAE	LTE-FDD (SC-FDMA, 50% RB, 5 MHz, QPSK)	X	2.18	72.88	17.44	0.00	150.0	± 9.6 %
		Y	2.44	72.00	17.85		150.0	
		Z	2.86	77.14	20.07		150.0	
10157-CAE	LTE-FDD (SC-FDMA, 50% RB, 5 MHz, 16-QAM)	X	2.28	69.64	15.08	0.00	150.0	± 9.6 %
		Y	2.68	69.82	16.54		150.0	
		Z	2.91	72.91	17.46		150.0	
10158-CAE	LTE-FDD (SC-FDMA, 50% RB, 10 MHz, 64-QAM)	X	2.92	70.39	17.34	0.00	150.0	± 9.6 %
		Y	3.12	69.27	17.29		150.0	
		Z	3.15	71.17	18.36		150.0	
10159-CAE	LTE-FDD (SC-FDMA, 50% RB, 5 MHz, 64-QAM)	X	2.31	69.64	15.15	0.00	150.0	± 9.6 %
		Y	2.66	69.40	16.44		150.0	
		Z	2.75	71.84	17.11		150.0	
10160-CAD	LTE-FDD (SC-FDMA, 50% RB, 15 MHz, QPSK)	X	3.30	72.69	18.39	0.00	150.0	± 9.6 %
		Y	3.63	72.51	18.39		150.0	
		Z	4.46	77.40	20.81		150.0	
10161-CAD	LTE-FDD (SC-FDMA, 50% RB, 15 MHz, 16-QAM)	X	3.05	68.99	16.83	0.00	150.0	± 9.6 %
		Y	3.30	68.56	16.91		150.0	
		Z	3.25	69.60	17.68		150.0	
10162-CAD	LTE-FDD (SC-FDMA, 50% RB, 15 MHz, 64-QAM)	X	3.16	69.14	16.93	0.00	150.0	± 9.6 %
		Y	3.40	68.51	16.92		150.0	
		Z	3.36	69.64	17.73		150.0	
10166-CAE	LTE-FDD (SC-FDMA, 50% RB, 1.4 MHz, QPSK)	X	3.70	72.05	20.56	3.01	150.0	± 9.6 %
		Y	4.32	71.73	20.84		150.0	
		Z	3.69	71.03	20.46		150.0	
10167-CAE	LTE-FDD (SC-FDMA, 50% RB, 1.4 MHz, 16-QAM)	X	4.99	77.08	21.74	3.01	150.0	± 9.6 %
		Y	5.61	75.13	21.47		150.0	
		Z	4.54	74.16	20.93		150.0	



10168-CAE	LTE-FDD (SC-FDMA, 50% RB, 1.4 MHz, 64-QAM)	X	5.73	80.18	23.37	3.01	150.0	± 9.6 %
		Y	5.98	76.55	22.35		150.0	
		Z	4.99	76.34	22.22		150.0	
10169-CAD	LTE-FDD (SC-FDMA, 1 RB, 20 MHz, QPSK)	X	3.07	71.78	20.59	3.01	150.0	± 9.6 %
		Y	4.28	75.07	22.33		150.0	
		Z	2.96	70.47	20.41		150.0	
10170-CAD	LTE-FDD (SC-FDMA, 1 RB, 20 MHz, 16-QAM)	X	5.12	82.36	24.61	3.01	150.0	± 9.6 %
		Y	6.45	82.05	24.66		150.0	
		Z	4.01	76.82	22.89		150.0	
10171-AAD	LTE-FDD (SC-FDMA, 1 RB, 20 MHz, 64-QAM)	X	3.90	76.30	21.08	3.01	150.0	± 9.6 %
		Y	5.42	78.00	22.20		150.0	
		Z	3.36	72.78	20.10		150.0	
10172-CAD	LTE-TDD (SC-FDMA, 1 RB, 20 MHz, QPSK)	X	8.97	95.29	29.40	6.02	65.0	± 9.6 %
		Y	66.42	129.30	40.05		65.0	
		Z	19.22	109.06	34.25		65.0	
10173-CAD	LTE-TDD (SC-FDMA, 1 RB, 20 MHz, 16-QAM)	X	22.53	105.50	29.61	6.02	65.0	± 9.6 %
		Y	46.79	115.50	34.39		65.0	
		Z	31.65	111.56	32.40		65.0	
10174-CAD	LTE-TDD (SC-FDMA, 1 RB, 20 MHz, 64-QAM)	X	11.11	92.49	25.14	6.02	65.0	± 9.6 %
		Y	33.29	107.45	31.61		65.0	
		Z	17.82	99.64	28.32		65.0	
10175-CAE	LTE-FDD (SC-FDMA, 1 RB, 10 MHz, QPSK)	X	3.04	71.53	20.36	3.01	150.0	± 9.6 %
		Y	4.24	74.80	22.12		150.0	
		Z	2.96	70.37	20.26		150.0	
10176-CAE	LTE-FDD (SC-FDMA, 1 RB, 10 MHz, 16-QAM)	X	5.13	82.40	24.62	3.01	150.0	± 9.6 %
		Y	6.46	82.07	24.66		150.0	
		Z	4.02	76.85	22.90		150.0	
10177-CAG	LTE-FDD (SC-FDMA, 1 RB, 5 MHz, QPSK)	X	3.05	71.61	20.42	3.01	150.0	± 9.6 %
		Y	4.26	74.86	22.17		150.0	
		Z	2.95	70.32	20.25		150.0	
10178-CAE	LTE-FDD (SC-FDMA, 1 RB, 5 MHz, 16-QAM)	X	5.07	82.12	24.49	3.01	150.0	± 9.6 %
		Y	6.36	81.75	24.51		150.0	
		Z	3.98	76.61	22.77		150.0	
10179-CAE	LTE-FDD (SC-FDMA, 1 RB, 10 MHz, 64-QAM)	X	4.46	79.19	22.69	3.01	150.0	± 9.6 %
		Y	5.89	79.84	23.26		150.0	
		Z	3.67	74.75	21.38		150.0	
10180-CAE	LTE-FDD (SC-FDMA, 1 RB, 5 MHz, 64-QAM)	X	3.89	76.23	21.04	3.01	150.0	± 9.6 %
		Y	5.40	77.91	22.14		150.0	
		Z	3.35	72.73	20.06		150.0	
10181-CAD	LTE-FDD (SC-FDMA, 1 RB, 15 MHz, QPSK)	X	3.05	71.60	20.42	3.01	150.0	± 9.6 %
		Y	4.25	74.86	22.17		150.0	
		Z	2.95	70.31	20.25		150.0	
10182-CAD	LTE-FDD (SC-FDMA, 1 RB, 15 MHz, 16-QAM)	X	5.06	82.09	24.48	3.01	150.0	± 9.6 %
		Y	6.35	81.72	24.50		150.0	
		Z	3.97	76.58	22.76		150.0	
10183-AAC	LTE-FDD (SC-FDMA, 1 RB, 15 MHz, 64-QAM)	X	3.88	76.20	21.02	3.01	150.0	± 9.6 %
		Y	5.39	77.88	22.13		150.0	
		Z	3.35	72.70	20.05		150.0	

10184-CAD	LTE-FDD (SC-FDMA, 1 RB, 3 MHz, QPSK)	X	3.06	71.64	20.43	3.01	150.0	± 9.6 %
		Y	4.27	74.89	22.18		150.0	
		Z	2.96	70.35	20.27		150.0	
10185-CAD	LTE-FDD (SC-FDMA, 1 RB, 3 MHz, 16-QAM)	X	5.09	82.20	24.53	3.01	150.0	± 9.6 %
		Y	6.39	81.80	24.54		150.0	
		Z	3.99	76.66	22.80		150.0	
10186-AAD	LTE-FDD (SC-FDMA, 1 RB, 3 MHz, 64-QAM)	X	3.91	76.30	21.06	3.01	150.0	± 9.6 %
		Y	5.42	77.96	22.16		150.0	
		Z	3.37	72.78	20.09		150.0	
10187-CAE	LTE-FDD (SC-FDMA, 1 RB, 1.4 MHz, QPSK)	X	3.07	71.73	20.52	3.01	150.0	± 9.6 %
		Y	4.28	74.96	22.24		150.0	
		Z	2.98	70.47	20.37		150.0	
10188-CAE	LTE-FDD (SC-FDMA, 1 RB, 1.4 MHz, 16-QAM)	X	5.32	83.14	25.00	3.01	150.0	± 9.6 %
		Y	6.60	82.51	24.90		150.0	
		Z	4.12	77.33	23.18		150.0	
10189-AAE	LTE-FDD (SC-FDMA, 1 RB, 1.4 MHz, 64-QAM)	X	4.02	76.88	21.40	3.01	150.0	± 9.6 %
		Y	5.54	78.42	22.43		150.0	
		Z	3.44	73.20	20.37		150.0	
10193-CAB	IEEE 802.11n (HT Greenfield, 6.5 Mbps, BPSK)	X	4.62	67.69	16.85	0.00	150.0	± 9.6 %
		Y	4.90	67.32	16.95		150.0	
		Z	4.77	67.64	17.31		150.0	
10194-CAB	IEEE 802.11n (HT Greenfield, 39 Mbps, 16-QAM)	X	4.78	68.00	16.99	0.00	150.0	± 9.6 %
		Y	5.13	67.74	17.06		150.0	
		Z	4.96	68.01	17.45		150.0	
10195-CAB	IEEE 802.11n (HT Greenfield, 65 Mbps, 64-QAM)	X	4.83	68.03	17.01	0.00	150.0	± 9.6 %
		Y	5.17	67.72	17.06		150.0	
		Z	5.01	68.03	17.47		150.0	
10196-CAB	IEEE 802.11n (HT Mixed, 6.5 Mbps, BPSK)	X	4.61	67.75	16.86	0.00	150.0	± 9.6 %
		Y	4.94	67.47	17.01		150.0	
		Z	4.78	67.75	17.35		150.0	
10197-CAB	IEEE 802.11n (HT Mixed, 39 Mbps, 16-QAM)	X	4.80	68.02	17.01	0.00	150.0	± 9.6 %
		Y	5.15	67.75	17.07		150.0	
		Z	4.98	68.03	17.47		150.0	
10198-CAB	IEEE 802.11n (HT Mixed, 65 Mbps, 64-QAM)	X	4.83	68.05	17.03	0.00	150.0	± 9.6 %
		Y	5.17	67.74	17.07		150.0	
		Z	5.01	68.06	17.48		150.0	
10219-CAB	IEEE 802.11n (HT Mixed, 7.2 Mbps, BPSK)	X	4.57	67.78	16.83	0.00	150.0	± 9.6 %
		Y	4.89	67.49	16.98		150.0	
		Z	4.73	67.78	17.32		150.0	
10220-CAB	IEEE 802.11n (HT Mixed, 43.3 Mbps, 16-QAM)	X	4.79	67.99	17.00	0.00	150.0	± 9.6 %
		Y	5.15	67.78	17.08		150.0	
		Z	4.98	68.02	17.47		150.0	
10221-CAB	IEEE 802.11n (HT Mixed, 72.2 Mbps, 64-QAM)	X	4.83	67.98	17.01	0.00	150.0	± 9.6 %
		Y	5.18	67.69	17.07		150.0	
		Z	5.02	67.97	17.46		150.0	
10222-CAB	IEEE 802.11n (HT Mixed, 15 Mbps, BPSK)	X	5.26	68.32	17.25	0.00	150.0	± 9.6 %
		Y	5.60	68.44	17.43		150.0	
		Z	5.46	68.52	17.77		150.0	

10223-CAB	IEEE 802.11n (HT Mixed, 90 Mbps, 16-QAM)	X	5.65	68.86	17.55	0.00	150.0	± 9.6 %
		Y	6.05	68.91	17.69		150.0	
		Z	5.93	69.26	18.17		150.0	
10224-CAB	IEEE 802.11n (HT Mixed, 150 Mbps, 64-QAM)	X	5.30	68.41	17.22	0.00	150.0	± 9.6 %
		Y	5.64	68.44	17.34		150.0	
		Z	5.54	68.72	17.79		150.0	
10225-CAB	UMTS-FDD (HSPA+)	X	2.88	67.59	16.05	0.00	150.0	± 9.6 %
		Y	3.12	67.05	16.47		150.0	
		Z	3.04	67.95	16.94		150.0	
10226-CAA	LTE-TDD (SC-FDMA, 1 RB, 1.4 MHz, 16-QAM)	X	25.41	107.72	30.34	6.02	65.0	± 9.6 %
		Y	49.22	116.62	34.78		65.0	
		Z	35.21	113.68	33.08		65.0	
10227-CAA	LTE-TDD (SC-FDMA, 1 RB, 1.4 MHz, 64-QAM)	X	18.82	100.46	27.45	6.02	65.0	± 9.6 %
		Y	33.58	107.81	31.81		65.0	
		Z	24.46	105.02	29.92		65.0	
10228-CAA	LTE-TDD (SC-FDMA, 1 RB, 1.4 MHz, QPSK)	X	11.96	100.80	31.13	6.02	65.0	± 9.6 %
		Y	71.95	131.69	40.81		65.0	
		Z	28.76	117.44	36.67		65.0	
10229-CAB	LTE-TDD (SC-FDMA, 1 RB, 3 MHz, 16-QAM)	X	22.58	105.52	29.63	6.02	65.0	± 9.6 %
		Y	46.42	115.33	34.35		65.0	
		Z	31.51	111.47	32.38		65.0	
10230-CAB	LTE-TDD (SC-FDMA, 1 RB, 3 MHz, 64-QAM)	X	17.04	98.77	26.88	6.02	65.0	± 9.6 %
		Y	32.08	106.86	31.47		65.0	
		Z	22.49	103.46	29.40		65.0	
10231-CAB	LTE-TDD (SC-FDMA, 1 RB, 3 MHz, QPSK)	X	11.19	99.38	30.60	6.02	65.0	± 9.6 %
		Y	67.39	130.16	40.34		65.0	
		Z	26.15	115.36	36.00		65.0	
10232-CAD	LTE-TDD (SC-FDMA, 1 RB, 5 MHz, 16-QAM)	X	22.57	105.53	29.63	6.02	65.0	± 9.6 %
		Y	46.52	115.38	34.37		65.0	
		Z	31.52	111.49	32.39		65.0	
10233-CAD	LTE-TDD (SC-FDMA, 1 RB, 5 MHz, 64-QAM)	X	17.03	98.78	26.89	6.02	65.0	± 9.6 %
		Y	32.16	106.92	31.49		65.0	
		Z	22.52	103.49	29.41		65.0	
10234-CAD	LTE-TDD (SC-FDMA, 1 RB, 5 MHz, QPSK)	X	10.58	98.09	30.06	6.02	65.0	± 9.6 %
		Y	62.54	128.33	39.76		65.0	
		Z	24.15	113.46	35.33		65.0	
10235-CAD	LTE-TDD (SC-FDMA, 1 RB, 10 MHz, 16-QAM)	X	22.80	105.71	29.68	6.02	65.0	± 9.6 %
		Y	46.92	115.56	34.42		65.0	
		Z	31.95	111.75	32.46		65.0	
10236-CAD	LTE-TDD (SC-FDMA, 1 RB, 10 MHz, 64-QAM)	X	17.36	99.03	26.95	6.02	65.0	± 9.6 %
		Y	32.60	107.14	31.54		65.0	
		Z	22.98	103.78	29.48		65.0	
10237-CAD	LTE-TDD (SC-FDMA, 1 RB, 10 MHz, QPSK)	X	11.29	99.61	30.68	6.02	65.0	± 9.6 %
		Y	69.42	130.80	40.50		65.0	
		Z	26.77	115.87	36.14		65.0	
10238-CAD	LTE-TDD (SC-FDMA, 1 RB, 15 MHz, 16-QAM)	X	22.53	105.52	29.63	6.02	65.0	± 9.6 %
		Y	46.68	115.46	34.39		65.0	
		Z	31.55	111.52	32.40		65.0	



10239-CAD	LTE-TDD (SC-FDMA, 1 RB, 15 MHz, 64-QAM)	X	17.00	98.77	26.89	6.02	65.0	± 9.6 %
		Y	32.28	107.01	31.51		65.0	
		Z	22.55	103.54	29.42		65.0	
10240-CAD	LTE-TDD (SC-FDMA, 1 RB, 15 MHz, QPSK)	X	11.21	99.48	30.64	6.02	65.0	± 9.6 %
		Y	68.62	130.57	40.44		65.0	
		Z	26.41	115.62	36.07		65.0	
10241-CAA	LTE-TDD (SC-FDMA, 50% RB, 1.4 MHz, 16-QAM)	X	8.70	85.06	26.61	6.98	65.0	± 9.6 %
		Y	13.14	89.29	29.40		65.0	
		Z	9.11	84.48	26.99		65.0	
10242-CAA	LTE-TDD (SC-FDMA, 50% RB, 1.4 MHz, 64-QAM)	X	7.68	82.49	25.53	6.98	65.0	± 9.6 %
		Y	12.34	87.74	28.72		65.0	
		Z	8.26	82.28	26.01		65.0	
10243-CAA	LTE-TDD (SC-FDMA, 50% RB, 1.4 MHz, QPSK)	X	5.98	78.21	24.85	6.98	65.0	± 9.6 %
		Y	10.25	85.93	29.07		65.0	
		Z	6.72	79.26	25.82		65.0	
10244-CAB	LTE-TDD (SC-FDMA, 50% RB, 3 MHz, 16-QAM)	X	4.18	70.70	14.72	3.98	65.0	± 9.6 %
		Y	11.11	85.28	23.99		65.0	
		Z	5.92	75.67	18.27		65.0	
10245-CAB	LTE-TDD (SC-FDMA, 50% RB, 3 MHz, 64-QAM)	X	4.14	70.31	14.51	3.98	65.0	± 9.6 %
		Y	10.90	84.67	23.71		65.0	
		Z	5.85	75.20	18.03		65.0	
10246-CAB	LTE-TDD (SC-FDMA, 50% RB, 3 MHz, QPSK)	X	3.95	73.32	16.38	3.98	65.0	± 9.6 %
		Y	11.36	88.36	24.59		65.0	
		Z	7.56	83.18	21.52		65.0	
10247-CAD	LTE-TDD (SC-FDMA, 50% RB, 5 MHz, 16-QAM)	X	4.30	71.88	16.68	3.98	65.0	± 9.6 %
		Y	8.48	81.03	22.61		65.0	
		Z	6.01	76.97	20.04		65.0	
10248-CAD	LTE-TDD (SC-FDMA, 50% RB, 5 MHz, 64-QAM)	X	4.36	71.63	16.58	3.98	65.0	± 9.6 %
		Y	8.49	80.50	22.40		65.0	
		Z	6.02	76.49	19.83		65.0	
10249-CAD	LTE-TDD (SC-FDMA, 50% RB, 5 MHz, QPSK)	X	5.48	78.62	19.76	3.98	65.0	± 9.6 %
		Y	11.91	89.26	25.44		65.0	
		Z	9.74	88.10	24.34		65.0	
10250-CAD	LTE-TDD (SC-FDMA, 50% RB, 10 MHz, 16-QAM)	X	5.56	76.05	20.60	3.98	65.0	± 9.6 %
		Y	9.11	82.25	24.20		65.0	
		Z	7.15	80.22	23.18		65.0	
10251-CAD	LTE-TDD (SC-FDMA, 50% RB, 10 MHz, 64-QAM)	X	5.38	74.28	19.50	3.98	65.0	± 9.6 %
		Y	8.60	79.92	23.03		65.0	
		Z	6.76	77.81	21.85		65.0	
10252-CAD	LTE-TDD (SC-FDMA, 50% RB, 10 MHz, QPSK)	X	6.39	80.70	21.97	3.98	65.0	± 9.6 %
		Y	10.77	86.61	25.05		65.0	
		Z	9.33	87.04	25.13		65.0	
10253-CAD	LTE-TDD (SC-FDMA, 50% RB, 15 MHz, 16-QAM)	X	5.56	73.85	19.87	3.98	65.0	± 9.6 %
		Y	8.46	78.85	22.84		65.0	
		Z	6.68	76.61	21.80		65.0	
10254-CAD	LTE-TDD (SC-FDMA, 50% RB, 15 MHz, 64-QAM)	X	5.89	74.73	20.57	3.98	65.0	± 9.6 %
		Y	8.78	79.42	23.37		65.0	
		Z	7.04	77.46	22.48		65.0	

10255-CAD	LTE-TDD (SC-FDMA, 50% RB, 15 MHz, QPSK)	X	6.08	77.82	21.28	3.98	65.0	± 9.6 %
		Y	9.29	82.20	23.62		65.0	
		Z	7.72	81.56	23.45		65.0	
10256-CAA	LTE-TDD (SC-FDMA, 100% RB, 1.4 MHz, 16-QAM)	X	3.09	66.64	11.58	3.98	65.0	± 9.6 %
		Y	10.58	84.19	22.85		65.0	
		Z	4.52	71.30	15.24		65.0	
10257-CAA	LTE-TDD (SC-FDMA, 100% RB, 1.4 MHz, 64-QAM)	X	3.08	66.30	11.34	3.98	65.0	± 9.6 %
		Y	10.39	83.45	22.50		65.0	
		Z	4.47	70.78	14.91		65.0	
10258-CAA	LTE-TDD (SC-FDMA, 100% RB, 1.4 MHz, QPSK)	X	2.80	68.20	13.02	3.98	65.0	± 9.6 %
		Y	10.48	86.71	23.49		65.0	
		Z	5.13	76.47	17.99		65.0	
10259-CAB	LTE-TDD (SC-FDMA, 100% RB, 3 MHz, 16-QAM)	X	4.81	73.55	18.16	3.98	65.0	± 9.6 %
		Y	8.71	81.36	23.12		65.0	
		Z	6.50	78.30	21.22		65.0	
10260-CAB	LTE-TDD (SC-FDMA, 100% RB, 3 MHz, 64-QAM)	X	4.84	73.31	18.07	3.98	65.0	± 9.6 %
		Y	8.73	81.06	23.04		65.0	
		Z	6.49	77.91	21.08		65.0	
10261-CAB	LTE-TDD (SC-FDMA, 100% RB, 3 MHz, QPSK)	X	5.63	78.88	20.45	3.98	65.0	± 9.6 %
		Y	11.03	87.66	25.18		65.0	
		Z	9.02	86.72	24.38		65.0	
10262-CAD	LTE-TDD (SC-FDMA, 100% RB, 5 MHz, 16-QAM)	X	5.55	76.00	20.56	3.98	65.0	± 9.6 %
		Y	9.12	82.24	24.18		65.0	
		Z	7.14	80.17	23.14		65.0	
10263-CAD	LTE-TDD (SC-FDMA, 100% RB, 5 MHz, 64-QAM)	X	5.37	74.26	19.49	3.98	65.0	± 9.6 %
		Y	8.61	79.95	23.04		65.0	
		Z	6.75	77.80	21.85		65.0	
10264-CAD	LTE-TDD (SC-FDMA, 100% RB, 5 MHz, QPSK)	X	6.33	80.51	21.87	3.98	65.0	± 9.6 %
		Y	10.72	86.51	25.00		65.0	
		Z	9.24	86.83	25.03		65.0	
10265-CAD	LTE-TDD (SC-FDMA, 100% RB, 10 MHz, 16-QAM)	X	5.68	74.39	20.17	3.98	65.0	± 9.6 %
		Y	8.78	79.62	23.06		65.0	
		Z	6.92	77.42	22.15		65.0	
10266-CAD	LTE-TDD (SC-FDMA, 100% RB, 10 MHz, 64-QAM)	X	6.03	75.30	20.94	3.98	65.0	± 9.6 %
		Y	9.04	80.07	23.58		65.0	
		Z	7.26	78.20	22.85		65.0	
10267-CAD	LTE-TDD (SC-FDMA, 100% RB, 10 MHz, QPSK)	X	6.28	78.15	21.21	3.98	65.0	± 9.6 %
		Y	9.51	82.26	23.34		65.0	
		Z	8.03	81.94	23.34		65.0	
10268-CAD	LTE-TDD (SC-FDMA, 100% RB, 15 MHz, 16-QAM)	X	6.31	74.34	20.69	3.98	65.0	± 9.6 %
		Y	9.03	78.48	22.93		65.0	
		Z	7.36	76.63	22.28		65.0	
10269-CAD	LTE-TDD (SC-FDMA, 100% RB, 15 MHz, 64-QAM)	X	6.30	73.95	20.59	3.98	65.0	± 9.6 %
		Y	8.91	78.00	22.83		65.0	
		Z	7.28	76.10	22.13		65.0	
10270-CAD	LTE-TDD (SC-FDMA, 100% RB, 15 MHz, QPSK)	X	6.21	75.67	20.46	3.98	65.0	± 9.6 %
		Y	8.86	79.17	22.30		65.0	
		Z	7.38	78.17	22.07		65.0	

10274-CAB	UMTS-FDD (HSUPA, Subtest 5, 3GPP Rel8.10)	X	2.73	68.32	16.17	0.00	150.0	± 9.6 %
		Y	2.80	67.19	16.24		150.0	
		Z	2.85	68.60	17.01		150.0	
10275-CAB	UMTS-FDD (HSUPA, Subtest 5, 3GPP Rel8.4)	X	1.93	72.13	17.78	0.00	150.0	± 9.6 %
		Y	2.00	71.23	17.64		150.0	
		Z	2.38	75.89	20.10		150.0	
10277-CAA	PHS (QPSK)	X	2.25	61.91	6.25	9.03	50.0	± 9.6 %
		Y	5.08	69.66	13.52		50.0	
		Z	2.71	63.31	7.90		50.0	
10278-CAA	PHS (QPSK, BW 884MHz, Rolloff 0.5)	X	3.40	66.90	11.20	9.03	50.0	± 9.6 %
		Y	12.34	87.20	23.50		50.0	
		Z	4.84	72.04	14.93		50.0	
10279-CAA	PHS (QPSK, BW 884MHz, Rolloff 0.38)	X	3.49	67.14	11.38	9.03	50.0	± 9.6 %
		Y	12.67	87.51	23.63		50.0	
		Z	5.00	72.41	15.15		50.0	
10290-AAB	CDMA2000, RC1, SO55, Full Rate	X	1.93	73.74	15.52	0.00	150.0	± 9.6 %
		Y	2.16	73.43	17.37		150.0	
		Z	4.78	86.57	21.32		150.0	
10291-AAB	CDMA2000, RC3, SO55, Full Rate	X	1.16	71.55	14.54	0.00	150.0	± 9.6 %
		Y	1.35	72.31	16.79		150.0	
		Z	4.50	91.12	22.70		150.0	
10292-AAB	CDMA2000, RC3, SO32, Full Rate	X	3.97	89.02	21.33	0.00	150.0	± 9.6 %
		Y	1.91	78.88	19.96		150.0	
		Z	100.00	139.13	35.40		150.0	
10293-AAB	CDMA2000, RC3, SO3, Full Rate	X	100.00	135.11	33.53	0.00	150.0	± 9.6 %
		Y	2.87	85.80	23.06		150.0	
		Z	100.00	143.61	37.54		150.0	
10295-AAB	CDMA2000, RC1, SO3, 1/8th Rate 25 fr.	X	21.98	95.18	24.82	9.03	50.0	± 9.6 %
		Y	19.01	98.51	30.07		50.0	
		Z	100.00	123.75	34.34		50.0	
10297-AAC	LTE-FDD (SC-FDMA, 50% RB, 20 MHz, QPSK)	X	3.00	72.15	18.07	0.00	150.0	± 9.6 %
		Y	3.29	71.87	17.82		150.0	
		Z	3.40	73.95	19.30		150.0	
10298-AAC	LTE-FDD (SC-FDMA, 50% RB, 3 MHz, QPSK)	X	1.77	70.74	15.07	0.00	150.0	± 9.6 %
		Y	2.21	71.63	17.13		150.0	
		Z	2.71	76.99	18.79		150.0	
10299-AAC	LTE-FDD (SC-FDMA, 50% RB, 3 MHz, 16-QAM)	X	2.44	69.25	13.00	0.00	150.0	± 9.6 %
		Y	4.39	76.92	19.51		150.0	
		Z	2.79	71.34	15.31		150.0	
10300-AAC	LTE-FDD (SC-FDMA, 50% RB, 3 MHz, 64-QAM)	X	1.81	65.03	10.23	0.00	150.0	± 9.6 %
		Y	3.51	72.23	16.79		150.0	
		Z	2.09	66.45	12.20		150.0	
10301-AAA	IEEE 802.16e WiMAX (29:18, 5ms, 10MHz, QPSK, PUSC)	X	4.61	66.13	17.96	4.17	80.0	± 9.6 %
		Y	5.70	67.79	19.17		80.0	
		Z	5.05	66.94	18.85		80.0	
10302-AAA	IEEE 802.16e WiMAX (29:18, 5ms, 10MHz, QPSK, PUSC, 3 CTRL symbols)	X	5.07	66.65	18.63	4.96	80.0	± 9.6 %
		Y	6.07	67.88	19.58		80.0	
		Z	5.50	67.45	19.51		80.0	

10303-AAA	IEEE 802.16e WiMAX (31:15, 5ms, 10MHz, 64QAM, PUSC)	X	4.79	66.20	18.41	4.96	80.0	± 9.6 %
		Y	6.11	69.19	20.48		80.0	
		Z	5.24	67.15	19.40		80.0	
10304-AAA	IEEE 802.16e WiMAX (29:18, 5ms, 10MHz, 64QAM, PUSC)	X	4.62	66.12	17.92	4.17	80.0	± 9.6 %
		Y	5.56	67.23	18.82		80.0	
		Z	5.03	66.92	18.82		80.0	
10305-AAA	IEEE 802.16e WiMAX (31:15, 10ms, 10MHz, 64QAM, PUSC, 15 symbols)	X	4.12	67.23	19.31	6.02	50.0	± 9.6 %
		Y	6.46	74.67	24.03		50.0	
		Z	4.78	70.08	21.63		50.0	
10306-AAA	IEEE 802.16e WiMAX (29:18, 10ms, 10MHz, 64QAM, PUSC, 18 symbols)	X	4.49	66.55	19.14	6.02	50.0	± 9.6 %
		Y	6.22	71.46	22.52		50.0	
		Z	4.99	67.86	20.42		50.0	
10307-AAA	IEEE 802.16e WiMAX (29:18, 10ms, 10MHz, QPSK, PUSC, 18 symbols)	X	4.37	66.62	19.06	6.02	50.0	± 9.6 %
		Y	6.25	72.11	22.66		50.0	
		Z	4.91	68.15	20.44		50.0	
10308-AAA	IEEE 802.16e WiMAX (29:18, 10ms, 10MHz, 16QAM, PUSC)	X	4.34	66.80	19.20	6.02	50.0	± 9.6 %
		Y	6.25	72.43	22.84		50.0	
		Z	4.88	68.32	20.56		50.0	
10309-AAA	IEEE 802.16e WiMAX (29:18, 10ms, 10MHz, 16QAM, AMC 2x3, 18 symbols)	X	4.54	66.77	19.30	6.02	50.0	± 9.6 %
		Y	6.35	71.80	22.69		50.0	
		Z	5.07	68.22	20.63		50.0	
10310-AAA	IEEE 802.16e WiMAX (29:18, 10ms, 10MHz, QPSK, AMC 2x3, 18 symbols)	X	4.43	66.59	19.11	6.02	50.0	± 9.6 %
		Y	6.19	71.60	22.50		50.0	
		Z	4.94	67.94	20.40		50.0	
10311-AAC	LTE-FDD (SC-FDMA, 100% RB, 15 MHz, QPSK)	X	3.34	70.93	17.47	0.00	150.0	± 9.6 %
		Y	3.61	70.78	17.28		150.0	
		Z	3.70	72.27	18.47		150.0	
10313-AAA	iDEN 1:3	X	2.86	70.73	14.24	6.99	70.0	± 9.6 %
		Y	8.80	82.44	19.98		70.0	
		Z	4.99	77.10	17.28		70.0	
10314-AAA	iDEN 1:6	X	4.06	76.54	19.24	10.00	30.0	± 9.6 %
		Y	12.97	91.87	25.76		30.0	
		Z	8.31	87.65	23.80		30.0	
10315-AAB	IEEE 802.11b WiFi 2.4 GHz (DSSS, 1 Mbps, 96pc duty cycle)	X	1.13	65.67	16.64	0.17	150.0	± 9.6 %
		Y	1.20	66.24	17.20		150.0	
		Z	1.19	67.54	18.59		150.0	
10316-AAB	IEEE 802.11g WiFi 2.4 GHz (ERP-OFDM, 6 Mbps, 96pc duty cycle)	X	4.64	67.62	16.88	0.17	150.0	± 9.6 %
		Y	5.00	67.51	17.15		150.0	
		Z	4.83	67.71	17.44		150.0	
10317-AAB	IEEE 802.11a WiFi 5 GHz (OFDM, 6 Mbps, 96pc duty cycle)	X	4.64	67.62	16.88	0.17	150.0	± 9.6 %
		Y	5.00	67.51	17.15		150.0	
		Z	4.83	67.71	17.44		150.0	
10400-AAC	IEEE 802.11ac WiFi (20MHz, 64-QAM, 99pc duty cycle)	X	4.78	68.12	17.03	0.00	150.0	± 9.6 %
		Y	5.17	67.86	17.09		150.0	
		Z	4.98	68.17	17.50		150.0	
10401-AAC	IEEE 802.11ac WiFi (40MHz, 64-QAM, 99pc duty cycle)	X	5.68	68.82	17.51	0.00	150.0	± 9.6 %
		Y	5.83	68.09	17.27		150.0	
		Z	5.74	68.39	17.70		150.0	

10402-AAC	IEEE 802.11ac WiFi (80MHz, 64-QAM, 99pc duty cycle)	X	5.80	68.48	17.18	0.00	150.0	± 9.6 %
		Y	6.16	68.66	17.36		150.0	
		Z	5.99	68.57	17.62		150.0	
10403-AAB	CDMA2000 (1xEV-DO, Rev. 0)	X	1.93	73.74	15.52	0.00	115.0	± 9.6 %
		Y	2.16	73.43	17.37		115.0	
		Z	4.78	86.57	21.32		115.0	
10404-AAB	CDMA2000 (1xEV-DO, Rev. A)	X	1.93	73.74	15.52	0.00	115.0	± 9.6 %
		Y	2.16	73.43	17.37		115.0	
		Z	4.78	86.57	21.32		115.0	
10406-AAB	CDMA2000, RC3, SO32, SCH0, Full Rate	X	100.00	115.47	26.70	0.00	100.0	± 9.6 %
		Y	63.68	123.62	33.90		100.0	
		Z	100.00	129.65	33.53		100.0	
10410-AAC	LTE-TDD (SC-FDMA, 1 RB, 10 MHz, QPSK, UL Subframe=2,3,4,7,8,9)	X	14.25	93.10	20.84	3.23	80.0	± 9.6 %
		Y	100.00	124.42	32.78		80.0	
		Z	100.00	120.24	29.11		80.0	
10415-AAA	IEEE 802.11b WiFi 2.4 GHz (DSSS, 1 Mbps, 99pc duty cycle)	X	1.07	65.07	16.30	0.00	150.0	± 9.6 %
		Y	1.05	64.53	16.21		150.0	
		Z	1.09	66.29	17.90		150.0	
10416-AAA	IEEE 802.11g WiFi 2.4 GHz (ERP-OFDM, 6 Mbps, 99pc duty cycle)	X	4.62	67.74	16.94	0.00	150.0	± 9.6 %
		Y	4.90	67.35	16.98		150.0	
		Z	4.78	67.71	17.40		150.0	
10417-AAA	IEEE 802.11a/h WiFi 5 GHz (OFDM, 6 Mbps, 99pc duty cycle)	X	4.62	67.74	16.94	0.00	150.0	± 9.6 %
		Y	4.90	67.35	16.98		150.0	
		Z	4.78	67.71	17.40		150.0	
10418-AAA	IEEE 802.11g WiFi 2.4 GHz (DSSS-OFDM, 6 Mbps, 99pc duty cycle, Long preamble)	X	4.62	67.93	16.98	0.00	150.0	± 9.6 %
		Y	4.88	67.45	16.96		150.0	
		Z	4.77	67.87	17.41		150.0	
10419-AAA	IEEE 802.11g WiFi 2.4 GHz (DSSS-OFDM, 6 Mbps, 99pc duty cycle, Short preamble)	X	4.63	67.87	16.97	0.00	150.0	± 9.6 %
		Y	4.91	67.43	16.98		150.0	
		Z	4.79	67.82	17.41		150.0	
10422-AAA	IEEE 802.11n (HT Greenfield, 7.2 Mbps, BPSK)	X	4.75	67.85	16.98	0.00	150.0	± 9.6 %
		Y	5.05	67.45	17.00		150.0	
		Z	4.91	67.81	17.42		150.0	
10423-AAA	IEEE 802.11n (HT Greenfield, 43.3 Mbps, 16-QAM)	X	4.90	68.16	17.09	0.00	150.0	± 9.6 %
		Y	5.30	67.92	17.18		150.0	
		Z	5.10	68.19	17.56		150.0	
10424-AAA	IEEE 802.11n (HT Greenfield, 72.2 Mbps, 64-QAM)	X	4.83	68.11	17.07	0.00	150.0	± 9.6 %
		Y	5.19	67.83	17.13		150.0	
		Z	5.02	68.13	17.53		150.0	
10425-AAA	IEEE 802.11n (HT Greenfield, 15 Mbps, BPSK)	X	5.59	68.80	17.49	0.00	150.0	± 9.6 %
		Y	6.07	69.27	17.86		150.0	
		Z	5.97	69.54	18.29		150.0	
10426-AAA	IEEE 802.11n (HT Greenfield, 90 Mbps, 16-QAM)	X	5.74	69.36	17.77	0.00	150.0	± 9.6 %
		Y	6.08	69.24	17.84		150.0	
		Z	6.20	70.35	18.70		150.0	



10427-AAA	IEEE 802.11n (HT Greenfield, 150 Mbps, 64-QAM)	X	5.65	68.96	17.57	0.00	150.0	± 9.6 %
		Y	5.97	68.82	17.61		150.0	
		Z	6.07	69.84	18.44		150.0	
10430-AAB	LTE-FDD (OFDMA, 5 MHz, E-TM 3.1)	X	4.29	72.17	18.72	0.00	150.0	± 9.6 %
		Y	4.51	70.21	18.49		150.0	
		Z	4.50	72.18	19.43		150.0	
10431-AAB	LTE-FDD (OFDMA, 10 MHz, E-TM 3.1)	X	4.28	68.47	16.93	0.00	150.0	± 9.6 %
		Y	4.69	68.01	17.11		150.0	
		Z	4.49	68.55	17.51		150.0	
10432-AAB	LTE-FDD (OFDMA, 15 MHz, E-TM 3.1)	X	4.59	68.23	17.02	0.00	150.0	± 9.6 %
		Y	4.97	67.90	17.12		150.0	
		Z	4.79	68.26	17.52		150.0	
10433-AAB	LTE-FDD (OFDMA, 20 MHz, E-TM 3.1)	X	4.84	68.14	17.08	0.00	150.0	± 9.6 %
		Y	5.21	67.90	17.16		150.0	
		Z	5.03	68.16	17.55		150.0	
10434-AAA	W-CDMA (BS Test Model 1, 64 DPCH)	X	4.39	73.04	18.58	0.00	150.0	± 9.6 %
		Y	4.56	70.70	18.41		150.0	
		Z	4.63	73.14	19.39		150.0	
10435-AAC	LTE-TDD (SC-FDMA, 1 RB, 20 MHz, QPSK, UL Subframe=2,3,4,7,8,9)	X	3.20	77.29	16.38	3.23	80.0	± 9.6 %
		Y	100.00	125.64	33.32		80.0	
		Z	100.00	120.71	29.30		80.0	
10447-AAB	LTE-FDD (OFDMA, 5 MHz, E-TM 3.1, Clipping 44%)	X	3.56	68.58	16.08	0.00	150.0	± 9.6 %
		Y	4.00	68.12	16.72		150.0	
		Z	3.81	68.94	16.97		150.0	
10448-AAB	LTE-FDD (OFDMA, 10 MHz, E-TM 3.1, Clipping 44%)	X	4.13	68.24	16.79	0.00	150.0	± 9.6 %
		Y	4.48	67.74	16.95		150.0	
		Z	4.32	68.31	17.37		150.0	
10449-AAB	LTE-FDD (OFDMA, 15 MHz, E-TM 3.1, Clipping 44%)	X	4.41	68.04	16.91	0.00	150.0	± 9.6 %
		Y	4.72	67.66	16.98		150.0	
		Z	4.58	68.06	17.41		150.0	
10450-AAB	LTE-FDD (OFDMA, 20 MHz, E-TM 3.1, Clipping 44%)	X	4.61	67.89	16.93	0.00	150.0	± 9.6 %
		Y	4.89	67.58	16.98		150.0	
		Z	4.77	67.88	17.39		150.0	
10451-AAA	W-CDMA (BS Test Model 1, 64 DPCH, Clipping 44%)	X	3.43	68.68	15.54	0.00	150.0	± 9.6 %
		Y	3.95	68.43	16.51		150.0	
		Z	3.75	69.28	16.61		150.0	
10456-AAA	IEEE 802.11ac WiFi (160MHz, 64-QAM, 99pc duty cycle)	X	6.67	69.75	17.86	0.00	150.0	± 9.6 %
		Y	6.91	69.64	17.90		150.0	
		Z	7.26	71.06	18.93		150.0	
10457-AAA	UMTS-FDD (DC-HSDPA)	X	3.88	66.35	16.64	0.00	150.0	± 9.6 %
		Y	4.00	65.98	16.76		150.0	
		Z	3.96	66.24	17.12		150.0	
10458-AAA	CDMA2000 (1xEV-DO, Rev. B, 2 carriers)	X	4.00	72.18	17.76	0.00	150.0	± 9.6 %
		Y	4.06	69.37	17.72		150.0	
		Z	4.24	72.39	18.76		150.0	
10459-AAA	CDMA2000 (1xEV-DO, Rev. B, 3 carriers)	X	4.99	69.15	18.30	0.00	150.0	± 9.6 %
		Y	5.22	66.98	18.07		150.0	
		Z	5.25	69.07	19.00		150.0	

10460-AAA	UMTS-FDD (WCDMA, AMR)	X	1.41	77.68	20.95	0.00	150.0	± 9.6 %
		Y	1.38	76.56	20.56		150.0	
		Z	4.12	99.68	29.80		150.0	
10461-AAA	LTE-TDD (SC-FDMA, 1 RB, 1.4 MHz, QPSK, UL Subframe=2,3,4,7,8,9)	X	5.32	84.77	19.68	3.29	80.0	± 9.6 %
		Y	100.00	128.02	34.53		80.0	
		Z	100.00	124.98	31.37		80.0	
10462-AAA	LTE-TDD (SC-FDMA, 1 RB, 1.4 MHz, 16-QAM, UL Subframe=2,3,4,7,8,9)	X	0.75	60.00	6.20	3.23	80.0	± 9.6 %
		Y	100.00	114.30	27.97		80.0	
		Z	1.34	63.49	9.41		80.0	
10463-AAA	LTE-TDD (SC-FDMA, 1 RB, 1.4 MHz, 64-QAM, UL Subframe=2,3,4,7,8,9)	X	0.76	60.00	5.71	3.23	80.0	± 9.6 %
		Y	100.00	111.60	26.67		80.0	
		Z	1.05	60.90	7.63		80.0	
10464-AAA	LTE-TDD (SC-FDMA, 1 RB, 3 MHz, QPSK, UL Subframe=2,3,4,7,8,9)	X	2.95	76.76	16.28	3.23	80.0	± 9.6 %
		Y	100.00	126.29	33.56		80.0	
		Z	100.00	121.26	29.49		80.0	
10465-AAA	LTE-TDD (SC-FDMA, 1 RB, 3 MHz, 16-QAM, UL Subframe=2,3,4,7,8,9)	X	0.75	60.00	6.15	3.23	80.0	± 9.6 %
		Y	100.00	113.92	27.77		80.0	
		Z	1.26	62.89	9.06		80.0	
10466-AAA	LTE-TDD (SC-FDMA, 1 RB, 3 MHz, 64-QAM, UL Subframe=2,3,4,7,8,9)	X	0.76	60.00	5.68	3.23	80.0	± 9.6 %
		Y	100.00	111.22	26.48		80.0	
		Z	1.02	60.66	7.46		80.0	
10467-AAC	LTE-TDD (SC-FDMA, 1 RB, 5 MHz, QPSK, UL Subframe=2,3,4,7,8,9)	X	3.24	77.89	16.70	3.23	80.0	± 9.6 %
		Y	100.00	126.47	33.64		80.0	
		Z	100.00	121.56	29.62		80.0	
10468-AAC	LTE-TDD (SC-FDMA, 1 RB, 5 MHz, 16-QAM, UL Subframe=2,3,4,7,8,9)	X	0.74	60.00	6.16	3.23	80.0	± 9.6 %
		Y	100.00	114.04	27.82		80.0	
		Z	1.27	63.04	9.14		80.0	
10469-AAC	LTE-TDD (SC-FDMA, 1 RB, 5 MHz, 64-QAM, UL Subframe=2,3,4,7,8,9)	X	0.76	60.00	5.68	3.23	80.0	± 9.6 %
		Y	100.00	111.23	26.48		80.0	
		Z	1.02	60.66	7.46		80.0	
10470-AAC	LTE-TDD (SC-FDMA, 1 RB, 10 MHz, QPSK, UL Subframe=2,3,4,7,8,9)	X	3.23	77.88	16.68	3.23	80.0	± 9.6 %
		Y	100.00	126.51	33.65		80.0	
		Z	100.00	121.56	29.61		80.0	
10471-AAC	LTE-TDD (SC-FDMA, 1 RB, 10 MHz, 16-QAM, UL Subframe=2,3,4,7,8,9)	X	0.74	60.00	6.14	3.23	80.0	± 9.6 %
		Y	100.00	113.99	27.79		80.0	
		Z	1.27	62.98	9.10		80.0	
10472-AAC	LTE-TDD (SC-FDMA, 1 RB, 10 MHz, 64-QAM, UL Subframe=2,3,4,7,8,9)	X	0.76	60.00	5.66	3.23	80.0	± 9.6 %
		Y	100.00	111.19	26.46		80.0	
		Z	1.02	60.62	7.42		80.0	
10473-AAC	LTE-TDD (SC-FDMA, 1 RB, 15 MHz, QPSK, UL Subframe=2,3,4,7,8,9)	X	3.22	77.81	16.65	3.23	80.0	± 9.6 %
		Y	100.00	126.48	33.64		80.0	
		Z	100.00	121.51	29.59		80.0	
10474-AAC	LTE-TDD (SC-FDMA, 1 RB, 15 MHz, 16-QAM, UL Subframe=2,3,4,7,8,9)	X	0.74	60.00	6.14	3.23	80.0	± 9.6 %
		Y	100.00	114.01	27.80		80.0	
		Z	1.26	62.95	9.09		80.0	
10475-AAC	LTE-TDD (SC-FDMA, 1 RB, 15 MHz, 64-QAM, UL Subframe=2,3,4,7,8,9)	X	0.76	60.00	5.66	3.23	80.0	± 9.6 %
		Y	100.00	111.21	26.46		80.0	
		Z	1.01	60.61	7.42		80.0	

10477-AAC	LTE-TDD (SC-FDMA, 1 RB, 20 MHz, 16-QAM, UL Subframe=2,3,4,7,8,9)	X	0.74	60.00	6.12	3.23	80.0	± 9.6 %
		Y	100.00	113.87	27.73		80.0	
		Z	1.24	62.81	9.00		80.0	
10478-AAC	LTE-TDD (SC-FDMA, 1 RB, 20 MHz, 64-QAM, UL Subframe=2,3,4,7,8,9)	X	0.76	60.00	5.65	3.23	80.0	± 9.6 %
		Y	100.00	111.16	26.44		80.0	
		Z	1.01	60.58	7.39		80.0	
10479-AAA	LTE-TDD (SC-FDMA, 50% RB, 1.4 MHz, QPSK, UL Subframe=2,3,4,7,8,9)	X	4.99	80.61	19.92	3.23	80.0	± 9.6 %
		Y	14.87	97.31	28.43		80.0	
		Z	11.06	92.78	25.14		80.0	
10480-AAA	LTE-TDD (SC-FDMA, 50% RB, 1.4 MHz, 16-QAM, UL Subframe=2,3,4,7,8,9)	X	2.77	68.92	13.30	3.23	80.0	± 9.6 %
		Y	14.98	91.74	25.09		80.0	
		Z	6.02	78.44	18.39		80.0	
10481-AAA	LTE-TDD (SC-FDMA, 50% RB, 1.4 MHz, 64-QAM, UL Subframe=2,3,4,7,8,9)	X	2.24	66.13	11.70	3.23	80.0	± 9.6 %
		Y	13.75	89.64	24.12		80.0	
		Z	4.60	74.25	16.46		80.0	
10482-AAA	LTE-TDD (SC-FDMA, 50% RB, 3 MHz, QPSK, UL Subframe=2,3,4,7,8,9)	X	1.99	67.29	13.59	2.23	80.0	± 9.6 %
		Y	7.00	83.19	22.17		80.0	
		Z	5.48	81.09	20.34		80.0	
10483-AAA	LTE-TDD (SC-FDMA, 50% RB, 3 MHz, 16-QAM, UL Subframe=2,3,4,7,8,9)	X	2.15	64.86	11.63	2.23	80.0	± 9.6 %
		Y	9.60	85.15	23.22		80.0	
		Z	4.00	72.37	16.33		80.0	
10484-AAA	LTE-TDD (SC-FDMA, 50% RB, 3 MHz, 64-QAM, UL Subframe=2,3,4,7,8,9)	X	2.13	64.51	11.48	2.23	80.0	± 9.6 %
		Y	9.13	84.04	22.84		80.0	
		Z	3.83	71.53	16.00		80.0	
10485-AAC	LTE-TDD (SC-FDMA, 50% RB, 5 MHz, QPSK, UL Subframe=2,3,4,7,8,9)	X	2.70	71.30	16.67	2.23	80.0	± 9.6 %
		Y	7.14	83.57	22.88		80.0	
		Z	6.03	83.39	22.38		80.0	
10486-AAC	LTE-TDD (SC-FDMA, 50% RB, 5 MHz, 16-QAM, UL Subframe=2,3,4,7,8,9)	X	2.55	67.05	14.17	2.23	80.0	± 9.6 %
		Y	5.06	74.83	19.46		80.0	
		Z	3.99	73.10	17.98		80.0	
10487-AAC	LTE-TDD (SC-FDMA, 50% RB, 5 MHz, 64-QAM, UL Subframe=2,3,4,7,8,9)	X	2.56	66.73	14.01	2.23	80.0	± 9.6 %
		Y	5.04	74.37	19.28		80.0	
		Z	3.92	72.42	17.68		80.0	
10488-AAC	LTE-TDD (SC-FDMA, 50% RB, 10 MHz, QPSK, UL Subframe=2,3,4,7,8,9)	X	3.23	72.04	18.13	2.23	80.0	± 9.6 %
		Y	6.55	80.43	22.10		80.0	
		Z	5.24	79.48	21.88		80.0	
10489-AAC	LTE-TDD (SC-FDMA, 50% RB, 10 MHz, 16-QAM, UL Subframe=2,3,4,7,8,9)	X	3.18	68.67	16.66	2.23	80.0	± 9.6 %
		Y	5.07	73.63	19.77		80.0	
		Z	4.12	72.33	19.12		80.0	
10490-AAC	LTE-TDD (SC-FDMA, 50% RB, 10 MHz, 64-QAM, UL Subframe=2,3,4,7,8,9)	X	3.28	68.57	16.63	2.23	80.0	± 9.6 %
		Y	5.11	73.14	19.60		80.0	
		Z	4.19	71.97	18.98		80.0	
10491-AAC	LTE-TDD (SC-FDMA, 50% RB, 15 MHz, QPSK, UL Subframe=2,3,4,7,8,9)	X	3.51	70.77	17.88	2.23	80.0	± 9.6 %
		Y	5.93	76.64	20.75		80.0	
		Z	4.80	75.40	20.49		80.0	
10492-AAC	LTE-TDD (SC-FDMA, 50% RB, 15 MHz, 16-QAM, UL Subframe=2,3,4,7,8,9)	X	3.60	68.31	16.99	2.23	80.0	± 9.6 %
		Y	5.24	72.17	19.37		80.0	
		Z	4.35	70.87	18.86		80.0	



10493-AAC	LTE-TDD (SC-FDMA, 50% RB, 15 MHz, 64-QAM, UL Subframe=2,3,4,7,8,9)	X	3.67	68.22	16.96	2.23	80.0	± 9.6 %
		Y	5.30	71.93	19.29		80.0	
		Z	4.41	70.65	18.78		80.0	
10494-AAC	LTE-TDD (SC-FDMA, 50% RB, 20 MHz, QPSK, UL Subframe=2,3,4,7,8,9)	X	3.74	71.90	18.21	2.23	80.0	± 9.6 %
		Y	6.75	78.85	21.35		80.0	
		Z	5.37	77.38	21.06		80.0	
10495-AAC	LTE-TDD (SC-FDMA, 50% RB, 20 MHz, 16-QAM, UL Subframe=2,3,4,7,8,9)	X	3.63	68.61	17.19	2.23	80.0	± 9.6 %
		Y	5.39	72.93	19.64		80.0	
		Z	4.42	71.39	19.11		80.0	
10496-AAC	LTE-TDD (SC-FDMA, 50% RB, 20 MHz, 64-QAM, UL Subframe=2,3,4,7,8,9)	X	3.71	68.42	17.15	2.23	80.0	± 9.6 %
		Y	5.40	72.39	19.47		80.0	
		Z	4.47	70.94	18.96		80.0	
10497-AAA	LTE-TDD (SC-FDMA, 100% RB, 1.4 MHz, QPSK, UL Subframe=2,3,4,7,8,9)	X	1.28	62.18	9.83	2.23	80.0	± 9.6 %
		Y	5.79	80.39	20.61		80.0	
		Z	2.99	72.07	15.77		80.0	
10498-AAA	LTE-TDD (SC-FDMA, 100% RB, 1.4 MHz, 16-QAM, UL Subframe=2,3,4,7,8,9)	X	1.24	60.00	7.60	2.23	80.0	± 9.6 %
		Y	4.14	72.25	16.69		80.0	
		Z	1.91	63.49	10.81		80.0	
10499-AAA	LTE-TDD (SC-FDMA, 100% RB, 1.4 MHz, 64-QAM, UL Subframe=2,3,4,7,8,9)	X	1.25	60.00	7.47	2.23	80.0	± 9.6 %
		Y	4.11	71.72	16.36		80.0	
		Z	1.86	62.92	10.36		80.0	
10500-AAA	LTE-TDD (SC-FDMA, 100% RB, 3 MHz, QPSK, UL Subframe=2,3,4,7,8,9)	X	2.92	71.59	17.27	2.23	80.0	± 9.6 %
		Y	6.52	81.33	22.27		80.0	
		Z	5.41	81.01	21.94		80.0	
10501-AAA	LTE-TDD (SC-FDMA, 100% RB, 3 MHz, 16-QAM, UL Subframe=2,3,4,7,8,9)	X	2.85	67.95	15.25	2.23	80.0	± 9.6 %
		Y	5.03	74.14	19.50		80.0	
		Z	4.07	72.85	18.44		80.0	
10502-AAA	LTE-TDD (SC-FDMA, 100% RB, 3 MHz, 64-QAM, UL Subframe=2,3,4,7,8,9)	X	2.90	67.79	15.11	2.23	80.0	± 9.6 %
		Y	5.04	73.73	19.30		80.0	
		Z	4.09	72.48	18.22		80.0	
10503-AAC	LTE-TDD (SC-FDMA, 100% RB, 5 MHz, QPSK, UL Subframe=2,3,4,7,8,9)	X	3.20	71.87	18.04	2.23	80.0	± 9.6 %
		Y	6.47	80.23	22.02		80.0	
		Z	5.16	79.22	21.77		80.0	
10504-AAC	LTE-TDD (SC-FDMA, 100% RB, 5 MHz, 16-QAM, UL Subframe=2,3,4,7,8,9)	X	3.17	68.59	16.61	2.23	80.0	± 9.6 %
		Y	5.06	73.57	19.73		80.0	
		Z	4.10	72.24	19.07		80.0	
10505-AAC	LTE-TDD (SC-FDMA, 100% RB, 5 MHz, 64-QAM, UL Subframe=2,3,4,7,8,9)	X	3.26	68.50	16.58	2.23	80.0	± 9.6 %
		Y	5.09	73.07	19.56		80.0	
		Z	4.17	71.87	18.93		80.0	
10506-AAC	LTE-TDD (SC-FDMA, 100% RB, 10 MHz, QPSK, UL Subframe=2,3,4,7,8,9)	X	3.71	71.78	18.14	2.23	80.0	± 9.6 %
		Y	6.69	78.71	21.29		80.0	
		Z	5.32	77.21	20.98		80.0	
10507-AAC	LTE-TDD (SC-FDMA, 100% RB, 10 MHz, 16-QAM, UL Subframe=2,3,4,7,8,9)	X	3.61	68.56	17.16	2.23	80.0	± 9.6 %
		Y	5.37	72.88	19.61		80.0	
		Z	4.40	71.33	19.08		80.0	

10508-AAC	LTE-TDD (SC-FDMA, 100% RB, 10 MHz, 64-QAM, UL Subframe=2,3,4,7,8,9)	X	3.70	68.36	17.11	2.23	80.0	± 9.6 %
		Y	5.39	72.34	19.44		80.0	
		Z	4.45	70.88	18.92		80.0	
10509-AAC	LTE-TDD (SC-FDMA, 100% RB, 15 MHz, QPSK, UL Subframe=2,3,4,7,8,9)	X	4.06	70.55	17.70	2.23	80.0	± 9.6 %
		Y	6.29	75.48	20.05		80.0	
		Z	5.14	73.96	19.72		80.0	
10510-AAC	LTE-TDD (SC-FDMA, 100% RB, 15 MHz, 16-QAM, UL Subframe=2,3,4,7,8,9)	X	4.12	68.36	17.27	2.23	80.0	± 9.6 %
		Y	5.76	72.02	19.29		80.0	
		Z	4.81	70.46	18.80		80.0	
10511-AAC	LTE-TDD (SC-FDMA, 100% RB, 15 MHz, 64-QAM, UL Subframe=2,3,4,7,8,9)	X	4.18	68.16	17.23	2.23	80.0	± 9.6 %
		Y	5.74	71.58	19.17		80.0	
		Z	4.84	70.08	18.69		80.0	
10512-AAC	LTE-TDD (SC-FDMA, 100% RB, 20 MHz, QPSK, UL Subframe=2,3,4,7,8,9)	X	4.14	71.67	18.00	2.23	80.0	± 9.6 %
		Y	6.96	77.89	20.79		80.0	
		Z	5.57	76.08	20.37		80.0	
10513-AAC	LTE-TDD (SC-FDMA, 100% RB, 20 MHz, 16-QAM, UL Subframe=2,3,4,7,8,9)	X	4.00	68.53	17.33	2.23	80.0	± 9.6 %
		Y	5.75	72.74	19.55		80.0	
		Z	4.73	70.92	18.99		80.0	
10514-AAC	LTE-TDD (SC-FDMA, 100% RB, 20 MHz, 64-QAM, UL Subframe=2,3,4,7,8,9)	X	4.04	68.19	17.25	2.23	80.0	± 9.6 %
		Y	5.65	72.02	19.34		80.0	
		Z	4.71	70.33	18.81		80.0	
10515-AAA	IEEE 802.11b WiFi 2.4 GHz (DSSS, 2 Mbps, 99pc duty cycle)	X	1.04	65.45	16.49	0.00	150.0	± 9.6 %
		Y	1.02	64.92	16.39		150.0	
		Z	1.06	66.95	18.26		150.0	
10516-AAA	IEEE 802.11b WiFi 2.4 GHz (DSSS, 5.5 Mbps, 99pc duty cycle)	X	4.54	109.46	32.14	0.00	150.0	± 9.6 %
		Y	10.15	122.16	34.85		150.0	
		Z	100.00	178.99	50.51		150.0	
10517-AAA	IEEE 802.11b WiFi 2.4 GHz (DSSS, 11 Mbps, 99pc duty cycle)	X	0.97	69.67	18.34	0.00	150.0	± 9.6 %
		Y	0.98	69.46	18.28		150.0	
		Z	1.21	75.75	22.26		150.0	
10518-AAA	IEEE 802.11a/h WiFi 5 GHz (OFDM, 9 Mbps, 99pc duty cycle)	X	4.61	67.84	16.93	0.00	150.0	± 9.6 %
		Y	4.91	67.45	16.97		150.0	
		Z	4.77	67.80	17.38		150.0	
10519-AAA	IEEE 802.11a/h WiFi 5 GHz (OFDM, 12 Mbps, 99pc duty cycle)	X	4.79	68.06	17.04	0.00	150.0	± 9.6 %
		Y	5.17	67.83	17.15		150.0	
		Z	4.98	68.10	17.53		150.0	
10520-AAA	IEEE 802.11a/h WiFi 5 GHz (OFDM, 18 Mbps, 99pc duty cycle)	X	4.64	68.02	16.97	0.00	150.0	± 9.6 %
		Y	5.01	67.80	17.06		150.0	
		Z	4.83	68.09	17.46		150.0	
10521-AAA	IEEE 802.11a/h WiFi 5 GHz (OFDM, 24 Mbps, 99pc duty cycle)	X	4.57	67.99	16.95	0.00	150.0	± 9.6 %
		Y	4.93	67.79	17.04		150.0	
		Z	4.76	68.08	17.45		150.0	
10522-AAA	IEEE 802.11a/h WiFi 5 GHz (OFDM, 36 Mbps, 99pc duty cycle)	X	4.64	68.16	17.07	0.00	150.0	± 9.6 %
		Y	4.96	67.68	17.04		150.0	
		Z	4.82	68.15	17.52		150.0	

10523-AAA	IEEE 802.11a/h WiFi 5 GHz (OFDM, 48 Mbps, 99pc duty cycle)	X	4.52	68.00	16.90	0.00	150.0	± 9.6 %
		Y	4.83	67.61	16.90		150.0	
		Z	4.68	67.97	17.35		150.0	
10524-AAA	IEEE 802.11a/h WiFi 5 GHz (OFDM, 54 Mbps, 99pc duty cycle)	X	4.58	68.08	17.04	0.00	150.0	± 9.6 %
		Y	4.92	67.67	17.04		150.0	
		Z	4.76	68.11	17.51		150.0	
10525-AAA	IEEE 802.11ac WiFi (20MHz, MCS0, 99pc duty cycle)	X	4.59	67.07	16.60	0.00	150.0	± 9.6 %
		Y	4.86	66.66	16.60		150.0	
		Z	4.74	67.03	17.04		150.0	
10526-AAA	IEEE 802.11ac WiFi (20MHz, MCS1, 99pc duty cycle)	X	4.74	67.44	16.74	0.00	150.0	± 9.6 %
		Y	5.10	67.10	16.75		150.0	
		Z	4.94	67.46	17.20		150.0	
10527-AAA	IEEE 802.11ac WiFi (20MHz, MCS2, 99pc duty cycle)	X	4.67	67.40	16.68	0.00	150.0	± 9.6 %
		Y	5.01	67.09	16.72		150.0	
		Z	4.86	67.43	17.15		150.0	
10528-AAA	IEEE 802.11ac WiFi (20MHz, MCS3, 99pc duty cycle)	X	4.68	67.41	16.71	0.00	150.0	± 9.6 %
		Y	5.03	67.12	16.75		150.0	
		Z	4.87	67.45	17.18		150.0	
10529-AAA	IEEE 802.11ac WiFi (20MHz, MCS4, 99pc duty cycle)	X	4.68	67.41	16.71	0.00	150.0	± 9.6 %
		Y	5.03	67.12	16.75		150.0	
		Z	4.87	67.45	17.18		150.0	
10531-AAA	IEEE 802.11ac WiFi (20MHz, MCS6, 99pc duty cycle)	X	4.67	67.51	16.73	0.00	150.0	± 9.6 %
		Y	5.06	67.30	16.79		150.0	
		Z	4.88	67.63	17.23		150.0	
10532-AAA	IEEE 802.11ac WiFi (20MHz, MCS7, 99pc duty cycle)	X	4.53	67.35	16.65	0.00	150.0	± 9.6 %
		Y	4.91	67.22	16.77		150.0	
		Z	4.73	67.46	17.16		150.0	
10533-AAA	IEEE 802.11ac WiFi (20MHz, MCS8, 99pc duty cycle)	X	4.69	67.49	16.71	0.00	150.0	± 9.6 %
		Y	5.05	67.13	16.72		150.0	
		Z	4.88	67.49	17.17		150.0	
10534-AAA	IEEE 802.11ac WiFi (40MHz, MCS0, 99pc duty cycle)	X	5.29	67.55	16.83	0.00	150.0	± 9.6 %
		Y	5.62	67.53	16.93		150.0	
		Z	5.52	67.79	17.36		150.0	
10535-AAA	IEEE 802.11ac WiFi (40MHz, MCS1, 99pc duty cycle)	X	5.42	67.99	17.04	0.00	150.0	± 9.6 %
		Y	5.72	67.74	17.02		150.0	
		Z	5.72	68.40	17.66		150.0	
10536-AAA	IEEE 802.11ac WiFi (40MHz, MCS2, 99pc duty cycle)	X	5.26	67.81	16.93	0.00	150.0	± 9.6 %
		Y	5.56	67.67	16.96		150.0	
		Z	5.50	68.07	17.47		150.0	
10537-AAA	IEEE 802.11ac WiFi (40MHz, MCS3, 99pc duty cycle)	X	5.32	67.81	16.93	0.00	150.0	± 9.6 %
		Y	5.62	67.59	16.93		150.0	
		Z	5.57	68.08	17.48		150.0	
10538-AAA	IEEE 802.11ac WiFi (40MHz, MCS4, 99pc duty cycle)	X	5.40	67.81	16.98	0.00	150.0	± 9.6 %
		Y	5.82	67.94	17.15		150.0	
		Z	5.62	67.93	17.45		150.0	
10540-AAA	IEEE 802.11ac WiFi (40MHz, MCS6, 99pc duty cycle)	X	5.32	67.77	16.97	0.00	150.0	± 9.6 %
		Y	5.68	67.78	17.08		150.0	
		Z	5.62	68.23	17.62		150.0	

10541-AAA	IEEE 802.11ac WiFi (40MHz, MCS7, 99pc duty cycle)	X	5.26	67.49	16.82	0.00	150.0	± 9.6 %
		Y	5.64	67.61	17.00		150.0	
		Z	5.52	67.85	17.42		150.0	
10542-AAA	IEEE 802.11ac WiFi (40MHz, MCS8, 99pc duty cycle)	X	5.44	67.66	16.92	0.00	150.0	± 9.6 %
		Y	5.79	67.62	17.02		150.0	
		Z	5.72	68.02	17.52		150.0	
10543-AAA	IEEE 802.11ac WiFi (40MHz, MCS9, 99pc duty cycle)	X	5.50	67.67	16.95	0.00	150.0	± 9.6 %
		Y	5.85	67.53	16.98		150.0	
		Z	5.94	68.55	17.81		150.0	
10544-AAA	IEEE 802.11ac WiFi (80MHz, MCS0, 99pc duty cycle)	X	5.62	67.56	16.77	0.00	150.0	± 9.6 %
		Y	5.83	67.38	16.77		150.0	
		Z	5.81	67.68	17.24		150.0	
10545-AAA	IEEE 802.11ac WiFi (80MHz, MCS1, 99pc duty cycle)	X	5.97	68.53	17.22	0.00	150.0	± 9.6 %
		Y	6.20	68.27	17.16		150.0	
		Z	6.38	69.30	18.00		150.0	
10546-AAA	IEEE 802.11ac WiFi (80MHz, MCS2, 99pc duty cycle)	X	5.69	67.82	16.87	0.00	150.0	± 9.6 %
		Y	6.00	67.87	16.97		150.0	
		Z	5.96	68.18	17.45		150.0	
10547-AAA	IEEE 802.11ac WiFi (80MHz, MCS3, 99pc duty cycle)	X	5.82	68.08	17.00	0.00	150.0	± 9.6 %
		Y	6.14	68.09	17.08		150.0	
		Z	6.08	68.38	17.55		150.0	
10548-AAA	IEEE 802.11ac WiFi (80MHz, MCS4, 99pc duty cycle)	X	6.52	70.35	18.09	0.00	150.0	± 9.6 %
		Y	8.07	73.52	19.69		150.0	
		Z	7.99	73.81	20.09		150.0	
10550-AAA	IEEE 802.11ac WiFi (80MHz, MCS6, 99pc duty cycle)	X	5.88	68.41	17.19	0.00	150.0	± 9.6 %
		Y	6.05	67.90	17.00		150.0	
		Z	6.20	68.90	17.83		150.0	
10551-AAA	IEEE 802.11ac WiFi (80MHz, MCS7, 99pc duty cycle)	X	5.68	67.74	16.81	0.00	150.0	± 9.6 %
		Y	6.15	68.29	17.16		150.0	
		Z	5.91	67.96	17.31		150.0	
10552-AAA	IEEE 802.11ac WiFi (80MHz, MCS8, 99pc duty cycle)	X	5.60	67.56	16.71	0.00	150.0	± 9.6 %
		Y	5.97	67.79	16.93		150.0	
		Z	5.79	67.64	17.15		150.0	
10553-AAA	IEEE 802.11ac WiFi (80MHz, MCS9, 99pc duty cycle)	X	5.67	67.54	16.73	0.00	150.0	± 9.6 %
		Y	5.97	67.52	16.81		150.0	
		Z	5.86	67.61	17.16		150.0	
10554-AAB	IEEE 802.11ac WiFi (160MHz, MCS0, 99pc duty cycle)	X	6.09	68.02	16.91	0.00	150.0	± 9.6 %
		Y	6.31	67.99	16.99		150.0	
		Z	6.33	68.30	17.45		150.0	
10555-AAB	IEEE 802.11ac WiFi (160MHz, MCS1, 99pc duty cycle)	X	6.30	68.59	17.18	0.00	150.0	± 9.6 %
		Y	6.59	68.69	17.31		150.0	
		Z	6.67	69.23	17.89		150.0	
10556-AAB	IEEE 802.11ac WiFi (160MHz, MCS2, 99pc duty cycle)	X	6.32	68.62	17.19	0.00	150.0	± 9.6 %
		Y	6.56	68.55	17.23		150.0	
		Z	6.68	69.24	17.89		150.0	
10557-AAB	IEEE 802.11ac WiFi (160MHz, MCS3, 99pc duty cycle)	X	6.20	68.26	17.02	0.00	150.0	± 9.6 %
		Y	6.53	68.49	17.22		150.0	
		Z	6.45	68.55	17.56		150.0	

10558-AAB	IEEE 802.11ac WiFi (160MHz, MCS4, 99pc duty cycle)	X	6.27	68.50	17.16	0.00	150.0	± 9.6 %
		Y	6.73	69.07	17.53		150.0	
		Z	6.56	68.88	17.74		150.0	
10560-AAB	IEEE 802.11ac WiFi (160MHz, MCS6, 99pc duty cycle)	X	6.25	68.31	17.10	0.00	150.0	± 9.6 %
		Y	6.54	68.34	17.20		150.0	
		Z	6.54	68.70	17.69		150.0	
10561-AAB	IEEE 802.11ac WiFi (160MHz, MCS7, 99pc duty cycle)	X	6.21	68.41	17.19	0.00	150.0	± 9.6 %
		Y	6.49	68.46	17.30		150.0	
		Z	6.45	68.66	17.71		150.0	
10562-AAB	IEEE 802.11ac WiFi (160MHz, MCS8, 99pc duty cycle)	X	6.28	68.61	17.29	0.00	150.0	± 9.6 %
		Y	7.02	70.01	18.09		150.0	
		Z	6.68	69.35	18.05		150.0	
10563-AAB	IEEE 802.11ac WiFi (160MHz, MCS9, 99pc duty cycle)	X	6.76	69.69	17.81	0.00	150.0	± 9.6 %
		Y	7.18	69.96	18.00		150.0	
		Z	8.10	72.83	19.71		150.0	
10564-AAA	IEEE 802.11g WiFi 2.4 GHz (DSSS-OFDM, 9 Mbps, 99pc duty cycle)	X	4.94	67.87	17.05	0.46	150.0	± 9.6 %
		Y	5.27	67.63	17.19		150.0	
		Z	5.11	67.86	17.51		150.0	
10565-AAA	IEEE 802.11g WiFi 2.4 GHz (DSSS-OFDM, 12 Mbps, 99pc duty cycle)	X	5.15	68.28	17.36	0.46	150.0	± 9.6 %
		Y	5.56	68.15	17.52		150.0	
		Z	5.36	68.33	17.84		150.0	
10566-AAA	IEEE 802.11g WiFi 2.4 GHz (DSSS-OFDM, 18 Mbps, 99pc duty cycle)	X	4.99	68.13	17.18	0.46	150.0	± 9.6 %
		Y	5.38	68.02	17.35		150.0	
		Z	5.19	68.20	17.67		150.0	
10567-AAA	IEEE 802.11g WiFi 2.4 GHz (DSSS-OFDM, 24 Mbps, 99pc duty cycle)	X	5.00	68.45	17.50	0.46	150.0	± 9.6 %
		Y	5.39	68.30	17.61		150.0	
		Z	5.20	68.54	17.99		150.0	
10568-AAA	IEEE 802.11g WiFi 2.4 GHz (DSSS-OFDM, 36 Mbps, 99pc duty cycle)	X	4.91	67.97	16.98	0.46	150.0	± 9.6 %
		Y	5.29	67.76	17.12		150.0	
		Z	5.11	68.02	17.46		150.0	
10569-AAA	IEEE 802.11g WiFi 2.4 GHz (DSSS-OFDM, 48 Mbps, 99pc duty cycle)	X	4.96	68.56	17.56	0.46	150.0	± 9.6 %
		Y	5.31	68.26	17.59		150.0	
		Z	5.14	68.55	18.01		150.0	
10570-AAA	IEEE 802.11g WiFi 2.4 GHz (DSSS-OFDM, 54 Mbps, 99pc duty cycle)	X	5.00	68.48	17.54	0.46	150.0	± 9.6 %
		Y	5.37	68.13	17.57		150.0	
		Z	5.20	68.50	18.00		150.0	
10571-AAA	IEEE 802.11b WiFi 2.4 GHz (DSSS, 1 Mbps, 90pc duty cycle)	X	1.19	65.99	16.68	0.46	130.0	± 9.6 %
		Y	1.39	68.00	18.05		130.0	
		Z	1.31	68.54	18.96		130.0	
10572-AAA	IEEE 802.11b WiFi 2.4 GHz (DSSS, 2 Mbps, 90pc duty cycle)	X	1.20	66.66	17.09	0.46	130.0	± 9.6 %
		Y	1.43	68.87	18.52		130.0	
		Z	1.35	69.62	19.57		130.0	
10573-AAA	IEEE 802.11b WiFi 2.4 GHz (DSSS, 5.5 Mbps, 90pc duty cycle)	X	57.34	144.97	39.50	0.46	130.0	± 9.6 %
		Y	100.00	149.30	39.89		130.0	
		Z	100.00	161.71	44.64		130.0	
10574-AAA	IEEE 802.11b WiFi 2.4 GHz (DSSS, 11 Mbps, 90pc duty cycle)	X	1.44	74.62	21.04	0.46	130.0	± 9.6 %
		Y	2.12	80.28	23.49		130.0	
		Z	2.54	87.54	27.35		130.0	



10575-AAA	IEEE 802.11g WiFi 2.4 GHz (DSSS-OFDM, 6 Mbps, 90pc duty cycle)	X	4.68	67.54	16.98	0.46	130.0	± 9.6 %
		Y	5.05	67.44	17.28		130.0	
		Z	4.87	67.61	17.53		130.0	
10576-AAA	IEEE 802.11g WiFi 2.4 GHz (DSSS-OFDM, 9 Mbps, 90pc duty cycle)	X	4.71	67.71	17.05	0.46	130.0	± 9.6 %
		Y	5.08	67.59	17.32		130.0	
		Z	4.89	67.76	17.58		130.0	
10577-AAA	IEEE 802.11g WiFi 2.4 GHz (DSSS-OFDM, 12 Mbps, 90pc duty cycle)	X	4.90	67.99	17.22	0.46	130.0	± 9.6 %
		Y	5.35	67.99	17.53		130.0	
		Z	5.12	68.12	17.78		130.0	
10578-AAA	IEEE 802.11g WiFi 2.4 GHz (DSSS-OFDM, 18 Mbps, 90pc duty cycle)	X	4.79	68.11	17.30	0.46	130.0	± 9.6 %
		Y	5.23	68.12	17.59		130.0	
		Z	5.01	68.26	17.87		130.0	
10579-AAA	IEEE 802.11g WiFi 2.4 GHz (DSSS-OFDM, 24 Mbps, 90pc duty cycle)	X	4.56	67.44	16.64	0.46	130.0	± 9.6 %
		Y	5.03	67.67	17.08		130.0	
		Z	4.79	67.65	17.25		130.0	
10580-AAA	IEEE 802.11g WiFi 2.4 GHz (DSSS-OFDM, 36 Mbps, 90pc duty cycle)	X	4.62	67.55	16.69	0.46	130.0	± 9.6 %
		Y	5.09	67.64	17.09		130.0	
		Z	4.84	67.72	17.28		130.0	
10581-AAA	IEEE 802.11g WiFi 2.4 GHz (DSSS-OFDM, 48 Mbps, 90pc duty cycle)	X	4.69	68.15	17.25	0.46	130.0	± 9.6 %
		Y	5.15	68.27	17.58		130.0	
		Z	4.91	68.32	17.82		130.0	
10582-AAA	IEEE 802.11g WiFi 2.4 GHz (DSSS-OFDM, 54 Mbps, 90pc duty cycle)	X	4.52	67.29	16.48	0.46	130.0	± 9.6 %
		Y	5.01	67.50	16.94		130.0	
		Z	4.75	67.51	17.09		130.0	
10583-AAA	IEEE 802.11a/h WiFi 5 GHz (OFDM, 6 Mbps, 90pc duty cycle)	X	4.68	67.54	16.98	0.46	130.0	± 9.6 %
		Y	5.05	67.44	17.28		130.0	
		Z	4.87	67.61	17.53		130.0	
10584-AAA	IEEE 802.11a/h WiFi 5 GHz (OFDM, 9 Mbps, 90pc duty cycle)	X	4.71	67.71	17.05	0.46	130.0	± 9.6 %
		Y	5.08	67.59	17.32		130.0	
		Z	4.89	67.76	17.58		130.0	
10585-AAA	IEEE 802.11a/h WiFi 5 GHz (OFDM, 12 Mbps, 90pc duty cycle)	X	4.90	67.99	17.22	0.46	130.0	± 9.6 %
		Y	5.35	67.99	17.53		130.0	
		Z	5.12	68.12	17.78		130.0	
10586-AAA	IEEE 802.11a/h WiFi 5 GHz (OFDM, 18 Mbps, 90pc duty cycle)	X	4.79	68.11	17.30	0.46	130.0	± 9.6 %
		Y	5.23	68.12	17.59		130.0	
		Z	5.01	68.26	17.87		130.0	
10587-AAA	IEEE 802.11a/h WiFi 5 GHz (OFDM, 24 Mbps, 90pc duty cycle)	X	4.56	67.44	16.64	0.46	130.0	± 9.6 %
		Y	5.03	67.67	17.08		130.0	
		Z	4.79	67.65	17.25		130.0	
10588-AAA	IEEE 802.11a/h WiFi 5 GHz (OFDM, 36 Mbps, 90pc duty cycle)	X	4.62	67.55	16.69	0.46	130.0	± 9.6 %
		Y	5.09	67.64	17.09		130.0	
		Z	4.84	67.72	17.28		130.0	
10589-AAA	IEEE 802.11a/h WiFi 5 GHz (OFDM, 48 Mbps, 90pc duty cycle)	X	4.69	68.15	17.25	0.46	130.0	± 9.6 %
		Y	5.15	68.27	17.58		130.0	
		Z	4.91	68.32	17.82		130.0	
10590-AAA	IEEE 802.11a/h WiFi 5 GHz (OFDM, 54 Mbps, 90pc duty cycle)	X	4.52	67.29	16.48	0.46	130.0	± 9.6 %
		Y	5.01	67.50	16.94		130.0	
		Z	4.75	67.51	17.09		130.0	

10591-AAA	IEEE 802.11n (HT Mixed, 20MHz, MCS0, 90pc duty cycle)	X	4.84	67.58	17.08	0.46	130.0	± 9.6 %
		Y	5.20	67.48	17.36		130.0	
		Z	5.02	67.62	17.61		130.0	
10592-AAA	IEEE 802.11n (HT Mixed, 20MHz, MCS1, 90pc duty cycle)	X	4.98	67.92	17.22	0.46	130.0	± 9.6 %
		Y	5.40	67.84	17.47		130.0	
		Z	5.18	67.99	17.74		130.0	
10593-AAA	IEEE 802.11n (HT Mixed, 20MHz, MCS2, 90pc duty cycle)	X	4.90	67.82	17.09	0.46	130.0	± 9.6 %
		Y	5.34	67.86	17.42		130.0	
		Z	5.11	67.94	17.65		130.0	
10594-AAA	IEEE 802.11n (HT Mixed, 20MHz, MCS3, 90pc duty cycle)	X	4.95	67.97	17.24	0.46	130.0	± 9.6 %
		Y	5.38	67.94	17.52		130.0	
		Z	5.16	68.07	17.78		130.0	
10595-AAA	IEEE 802.11n (HT Mixed, 20MHz, MCS4, 90pc duty cycle)	X	4.92	67.95	17.15	0.46	130.0	± 9.6 %
		Y	5.38	68.00	17.47		130.0	
		Z	5.14	68.06	17.70		130.0	
10596-AAA	IEEE 802.11n (HT Mixed, 20MHz, MCS5, 90pc duty cycle)	X	4.85	67.95	17.16	0.46	130.0	± 9.6 %
		Y	5.31	67.97	17.45		130.0	
		Z	5.07	68.09	17.71		130.0	
10597-AAA	IEEE 802.11n (HT Mixed, 20MHz, MCS6, 90pc duty cycle)	X	4.80	67.83	17.02	0.46	130.0	± 9.6 %
		Y	5.27	67.95	17.39		130.0	
		Z	5.03	68.00	17.60		130.0	
10598-AAA	IEEE 802.11n (HT Mixed, 20MHz, MCS7, 90pc duty cycle)	X	4.78	68.00	17.25	0.46	130.0	± 9.6 %
		Y	5.24	68.18	17.63		130.0	
		Z	5.00	68.20	17.85		130.0	
10599-AAA	IEEE 802.11n (HT Mixed, 40MHz, MCS0, 90pc duty cycle)	X	5.70	68.70	17.66	0.46	130.0	± 9.6 %
		Y	6.10	68.87	17.95		130.0	
		Z	6.00	69.16	18.35		130.0	
10600-AAA	IEEE 802.11n (HT Mixed, 40MHz, MCS1, 90pc duty cycle)	X	6.16	70.24	18.41	0.46	130.0	± 9.6 %
		Y	7.13	72.02	19.53		130.0	
		Z	7.28	73.18	20.31		130.0	
10601-AAA	IEEE 802.11n (HT Mixed, 40MHz, MCS2, 90pc duty cycle)	X	5.79	69.11	17.85	0.46	130.0	± 9.6 %
		Y	6.40	69.89	18.47		130.0	
		Z	6.30	70.28	18.91		130.0	
10602-AAA	IEEE 802.11n (HT Mixed, 40MHz, MCS3, 90pc duty cycle)	X	5.94	69.31	17.88	0.46	130.0	± 9.6 %
		Y	6.60	70.23	18.57		130.0	
		Z	6.45	70.46	18.91		130.0	
10603-AAA	IEEE 802.11n (HT Mixed, 40MHz, MCS4, 90pc duty cycle)	X	6.01	69.59	18.15	0.46	130.0	± 9.6 %
		Y	6.40	69.51	18.29		130.0	
		Z	6.40	70.30	18.95		130.0	
10604-AAA	IEEE 802.11n (HT Mixed, 40MHz, MCS5, 90pc duty cycle)	X	5.66	68.47	17.56	0.46	130.0	± 9.6 %
		Y	6.09	68.77	17.92		130.0	
		Z	6.00	69.11	18.34		130.0	
10605-AAA	IEEE 802.11n (HT Mixed, 40MHz, MCS6, 90pc duty cycle)	X	6.05	69.80	18.25	0.46	130.0	± 9.6 %
		Y	6.32	69.44	18.28		130.0	
		Z	6.65	71.24	19.42		130.0	
10606-AAA	IEEE 802.11n (HT Mixed, 40MHz, MCS7, 90pc duty cycle)	X	5.59	68.43	17.41	0.46	130.0	± 9.6 %
		Y	5.87	68.18	17.50		130.0	
		Z	5.81	68.66	17.98		130.0	

10607-AAA	IEEE 802.11ac WiFi (20MHz, MCS0, 90pc duty cycle)	X	4.68	66.90	16.70	0.46	130.0	± 9.6 %
		Y	5.03	66.74	16.93		130.0	
		Z	4.87	66.94	17.22		130.0	
10608-AAA	IEEE 802.11ac WiFi (20MHz, MCS1, 90pc duty cycle)	X	4.85	67.30	16.87	0.46	130.0	± 9.6 %
		Y	5.28	67.19	17.09		130.0	
		Z	5.07	67.40	17.40		130.0	
10609-AAA	IEEE 802.11ac WiFi (20MHz, MCS2, 90pc duty cycle)	X	4.75	67.15	16.70	0.46	130.0	± 9.6 %
		Y	5.17	67.12	16.98		130.0	
		Z	4.96	67.27	17.25		130.0	
10610-AAA	IEEE 802.11ac WiFi (20MHz, MCS3, 90pc duty cycle)	X	4.79	67.29	16.85	0.46	130.0	± 9.6 %
		Y	5.22	67.25	17.12		130.0	
		Z	5.01	67.41	17.40		130.0	
10611-AAA	IEEE 802.11ac WiFi (20MHz, MCS4, 90pc duty cycle)	X	4.71	67.11	16.71	0.46	130.0	± 9.6 %
		Y	5.16	67.18	17.03		130.0	
		Z	4.93	67.26	17.28		130.0	
10612-AAA	IEEE 802.11ac WiFi (20MHz, MCS5, 90pc duty cycle)	X	4.72	67.31	16.78	0.46	130.0	± 9.6 %
		Y	5.18	67.31	17.05		130.0	
		Z	4.96	67.48	17.35		130.0	
10613-AAA	IEEE 802.11ac WiFi (20MHz, MCS6, 90pc duty cycle)	X	4.72	67.16	16.65	0.46	130.0	± 9.6 %
		Y	5.20	67.27	16.98		130.0	
		Z	4.96	67.37	17.24		130.0	
10614-AAA	IEEE 802.11ac WiFi (20MHz, MCS7, 90pc duty cycle)	X	4.66	67.28	16.84	0.46	130.0	± 9.6 %
		Y	5.12	67.42	17.19		130.0	
		Z	4.88	67.48	17.43		130.0	
10615-AAA	IEEE 802.11ac WiFi (20MHz, MCS8, 90pc duty cycle)	X	4.72	66.99	16.50	0.46	130.0	± 9.6 %
		Y	5.17	66.99	16.82		130.0	
		Z	4.94	67.11	17.06		130.0	
10616-AAA	IEEE 802.11ac WiFi (40MHz, MCS0, 90pc duty cycle)	X	5.43	67.55	17.03	0.46	130.0	± 9.6 %
		Y	5.82	67.72	17.32		130.0	
		Z	5.71	67.97	17.70		130.0	
10617-AAA	IEEE 802.11ac WiFi (40MHz, MCS1, 90pc duty cycle)	X	5.61	68.15	17.32	0.46	130.0	± 9.6 %
		Y	5.94	68.01	17.43		130.0	
		Z	5.92	68.61	17.99		130.0	
10618-AAA	IEEE 802.11ac WiFi (40MHz, MCS2, 90pc duty cycle)	X	5.42	67.89	17.19	0.46	130.0	± 9.6 %
		Y	5.80	67.97	17.42		130.0	
		Z	5.71	68.31	17.85		130.0	
10619-AAA	IEEE 802.11ac WiFi (40MHz, MCS3, 90pc duty cycle)	X	5.44	67.73	17.05	0.46	130.0	± 9.6 %
		Y	5.82	67.78	17.27		130.0	
		Z	5.76	68.22	17.75		130.0	
10620-AAA	IEEE 802.11ac WiFi (40MHz, MCS4, 90pc duty cycle)	X	5.52	67.75	17.11	0.46	130.0	± 9.6 %
		Y	6.02	68.15	17.52		130.0	
		Z	5.77	67.99	17.68		130.0	
10621-AAA	IEEE 802.11ac WiFi (40MHz, MCS5, 90pc duty cycle)	X	5.50	67.74	17.22	0.46	130.0	± 9.6 %
		Y	5.86	67.74	17.40		130.0	
		Z	5.70	67.85	17.72		130.0	
10622-AAA	IEEE 802.11ac WiFi (40MHz, MCS6, 90pc duty cycle)	X	5.53	67.98	17.34	0.46	130.0	± 9.6 %
		Y	5.94	68.17	17.61		130.0	
		Z	5.86	68.56	18.08		130.0	



10623-AAA	IEEE 802.11ac WiFi (40MHz, MCS7, 90pc duty cycle)	X	5.37	67.38	16.91	0.46	130.0	± 9.6 %
		Y	5.83	67.79	17.33		130.0	
		Z	5.67	67.86	17.61		130.0	
10624-AAA	IEEE 802.11ac WiFi (40MHz, MCS8, 90pc duty cycle)	X	5.59	67.67	17.12	0.46	130.0	± 9.6 %
		Y	6.01	67.88	17.43		130.0	
		Z	5.91	68.19	17.83		130.0	
10625-AAA	IEEE 802.11ac WiFi (40MHz, MCS9, 90pc duty cycle)	X	5.93	68.66	17.68	0.46	130.0	± 9.6 %
		Y	6.68	69.69	18.39		130.0	
		Z	7.12	71.68	19.60		130.0	
10626-AAA	IEEE 802.11ac WiFi (80MHz, MCS0, 90pc duty cycle)	X	5.74	67.49	16.94	0.46	130.0	± 9.6 %
		Y	5.99	67.43	17.08		130.0	
		Z	5.97	67.76	17.51		130.0	
10627-AAA	IEEE 802.11ac WiFi (80MHz, MCS1, 90pc duty cycle)	X	6.22	68.90	17.62	0.46	130.0	± 9.6 %
		Y	6.47	68.64	17.65		130.0	
		Z	6.82	70.21	18.71		130.0	
10628-AAA	IEEE 802.11ac WiFi (80MHz, MCS2, 90pc duty cycle)	X	5.80	67.72	16.96	0.46	130.0	± 9.6 %
		Y	6.13	67.85	17.18		130.0	
		Z	6.11	68.20	17.64		130.0	
10629-AAA	IEEE 802.11ac WiFi (80MHz, MCS3, 90pc duty cycle)	X	5.95	68.04	17.12	0.46	130.0	± 9.6 %
		Y	6.32	68.22	17.37		130.0	
		Z	6.24	68.44	17.75		130.0	
10630-AAA	IEEE 802.11ac WiFi (80MHz, MCS4, 90pc duty cycle)	X	7.01	71.32	18.73	0.46	130.0	± 9.6 %
		Y	10.01	77.42	21.69		130.0	
		Z	9.69	77.23	21.81		130.0	
10631-AAA	IEEE 802.11ac WiFi (80MHz, MCS5, 90pc duty cycle)	X	6.26	69.22	17.88	0.46	130.0	± 9.6 %
		Y	7.54	71.90	19.35		130.0	
		Z	6.74	70.17	18.77		130.0	
10632-AAA	IEEE 802.11ac WiFi (80MHz, MCS6, 90pc duty cycle)	X	6.21	69.05	17.84	0.46	130.0	± 9.6 %
		Y	6.42	68.63	17.76		130.0	
		Z	6.64	69.85	18.67		130.0	
10633-AAA	IEEE 802.11ac WiFi (80MHz, MCS7, 90pc duty cycle)	X	5.77	67.56	16.91	0.46	130.0	± 9.6 %
		Y	6.46	68.81	17.70		130.0	
		Z	6.09	68.08	17.59		130.0	
10634-AAA	IEEE 802.11ac WiFi (80MHz, MCS8, 90pc duty cycle)	X	5.78	67.67	17.01	0.46	130.0	± 9.6 %
		Y	6.31	68.40	17.54		130.0	
		Z	6.03	67.97	17.59		130.0	
10635-AAA	IEEE 802.11ac WiFi (80MHz, MCS9, 90pc duty cycle)	X	5.65	67.03	16.44	0.46	130.0	± 9.6 %
		Y	6.10	67.45	16.83		130.0	
		Z	5.91	67.29	17.00		130.0	
10636-AAB	IEEE 802.11ac WiFi (160MHz, MCS0, 90pc duty cycle)	X	6.25	68.05	17.13	0.46	130.0	± 9.6 %
		Y	6.52	68.18	17.37		130.0	
		Z	6.54	68.51	17.79		130.0	
10637-AAB	IEEE 802.11ac WiFi (160MHz, MCS1, 90pc duty cycle)	X	6.52	68.82	17.51	0.46	130.0	± 9.6 %
		Y	6.87	69.07	17.79		130.0	
		Z	7.01	69.82	18.44		130.0	
10638-AAB	IEEE 802.11ac WiFi (160MHz, MCS2, 90pc duty cycle)	X	6.54	68.85	17.50	0.46	130.0	± 9.6 %
		Y	6.79	68.82	17.64		130.0	
		Z	7.01	69.79	18.39		130.0	

10639-AAB	IEEE 802.11ac WiFi (160MHz, MCS3, 90pc duty cycle)	X	6.36	68.30	17.26	0.46	130.0	± 9.6 %
		Y	6.77	68.75	17.65		130.0	
		Z	6.65	68.70	17.88		130.0	
10640-AAB	IEEE 802.11ac WiFi (160MHz, MCS4, 90pc duty cycle)	X	6.39	68.42	17.27	0.46	130.0	± 9.6 %
		Y	7.00	69.46	17.96		130.0	
		Z	6.74	68.98	17.97		130.0	
10641-AAB	IEEE 802.11ac WiFi (160MHz, MCS5, 90pc duty cycle)	X	6.50	68.52	17.35	0.46	130.0	± 9.6 %
		Y	6.76	68.48	17.48		130.0	
		Z	6.79	68.92	17.96		130.0	
10642-AAB	IEEE 802.11ac WiFi (160MHz, MCS6, 90pc duty cycle)	X	6.47	68.57	17.52	0.46	130.0	± 9.6 %
		Y	6.77	68.60	17.68		130.0	
		Z	6.87	69.28	18.30		130.0	
10643-AAB	IEEE 802.11ac WiFi (160MHz, MCS7, 90pc duty cycle)	X	6.36	68.42	17.36	0.46	130.0	± 9.6 %
		Y	6.67	68.57	17.59		130.0	
		Z	6.61	68.72	17.93		130.0	
10644-AAB	IEEE 802.11ac WiFi (160MHz, MCS8, 90pc duty cycle)	X	6.42	68.61	17.46	0.46	130.0	± 9.6 %
		Y	7.44	70.79	18.74		130.0	
		Z	6.91	69.60	18.38		130.0	
10645-AAB	IEEE 802.11ac WiFi (160MHz, MCS9, 90pc duty cycle)	X	7.29	70.79	18.54	0.46	130.0	± 9.6 %
		Y	7.57	70.62	18.59		130.0	
		Z	9.67	76.04	21.40		130.0	
10646-AAD	LTE-TDD (SC-FDMA, 1 RB, 5 MHz, QPSK, UL Subframe=2,7)	X	37.96	127.69	41.83	9.30	60.0	± 9.6 %
		Y	62.72	133.42	44.28		60.0	
		Z	72.33	141.37	45.90		60.0	
10647-AAC	LTE-TDD (SC-FDMA, 1 RB, 20 MHz, QPSK, UL Subframe=2,7)	X	28.82	122.45	40.60	9.30	60.0	± 9.6 %
		Y	66.21	135.68	45.06		60.0	
		Z	63.53	139.41	45.60		60.0	
10648-AAA	CDMA2000 (1x Advanced)	X	0.77	66.28	11.46	0.00	150.0	± 9.6 %
		Y	1.08	68.86	14.63		150.0	
		Z	1.39	74.06	15.93		150.0	
10652-AAB	LTE-TDD (OFDMA, 5 MHz, E-TM 3.1, Clipping 44%)	X	3.50	67.26	16.46	2.23	80.0	± 9.6 %
		Y	4.54	69.41	18.31		80.0	
		Z	3.99	68.83	17.95		80.0	
10653-AAB	LTE-TDD (OFDMA, 10 MHz, E-TM 3.1, Clipping 44%)	X	4.07	66.74	16.84	2.23	80.0	± 9.6 %
		Y	5.03	68.66	18.31		80.0	
		Z	4.48	67.80	17.97		80.0	
10654-AAB	LTE-TDD (OFDMA, 15 MHz, E-TM 3.1, Clipping 44%)	X	4.07	66.36	16.88	2.23	80.0	± 9.6 %
		Y	4.92	68.27	18.27		80.0	
		Z	4.42	67.33	17.95		80.0	
10655-AAB	LTE-TDD (OFDMA, 20 MHz, E-TM 3.1, Clipping 44%)	X	4.15	66.34	16.94	2.23	80.0	± 9.6 %
		Y	4.99	68.40	18.35		80.0	
		Z	4.49	67.33	18.00		80.0	

<sup>E</sup> Uncertainty is determined using the max. deviation from linear response applying rectangular distribution and is expressed for the square of the field value.