

# B Simulated Power Density Distributions

---

NOTE: Antenna configuration is noted as a sector

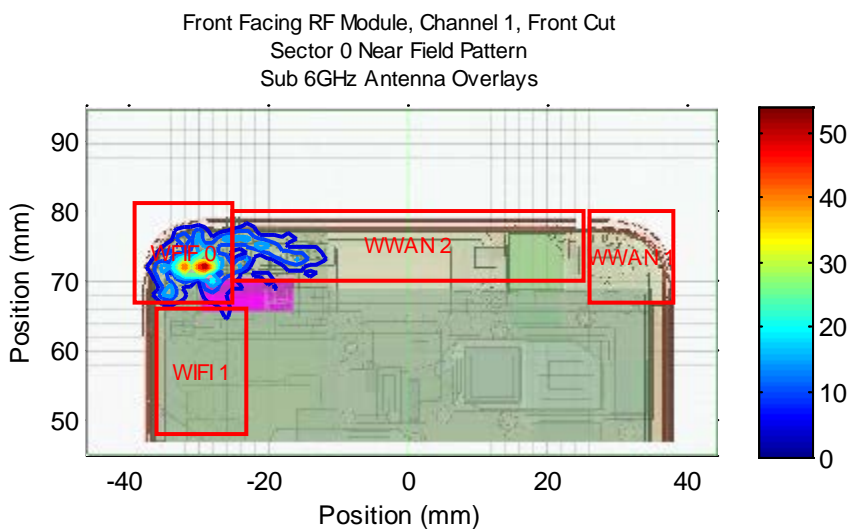
This appendix shows the point power density distribution over the 45 mm x 45 mm area for all antenna configurations at the worst exposure plane.

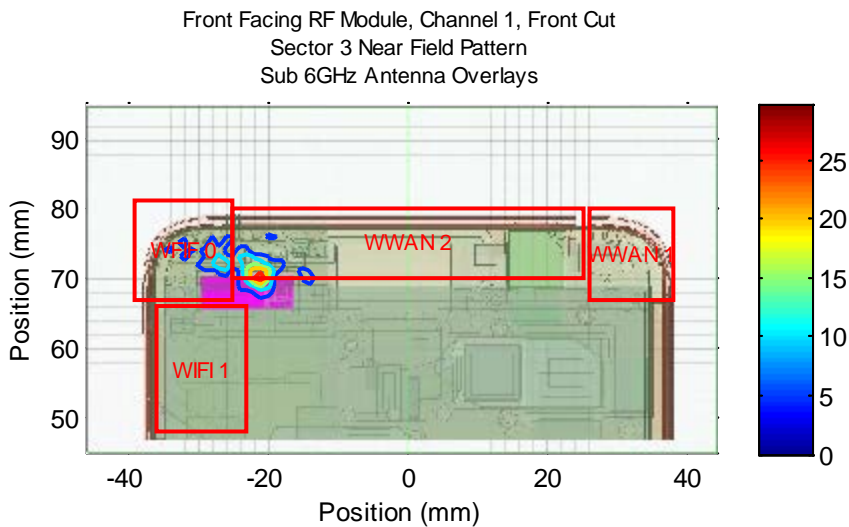
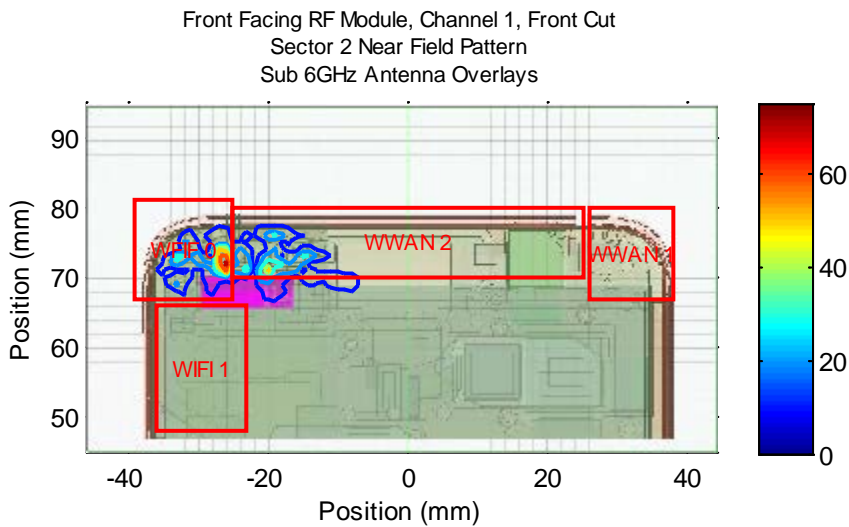
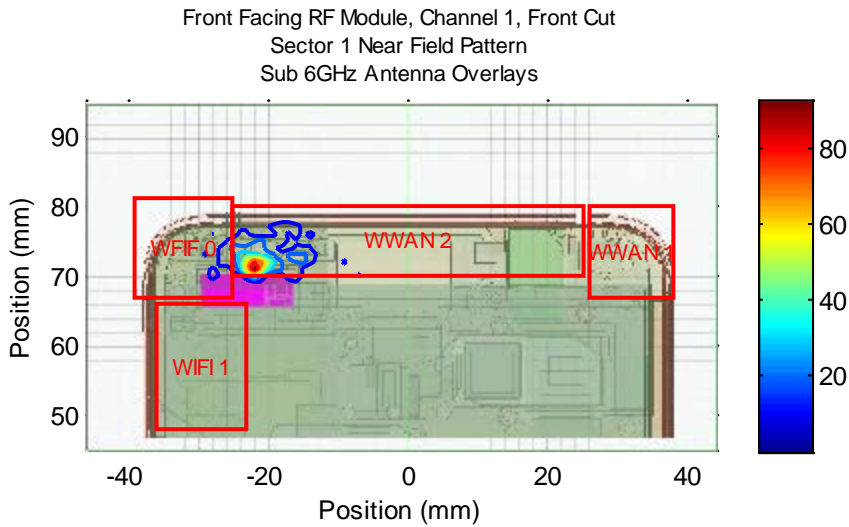
- Top array – The worst-case exposure plane is the front of the device.
- Bottom array – The worst-case exposure plane is the rear of device.

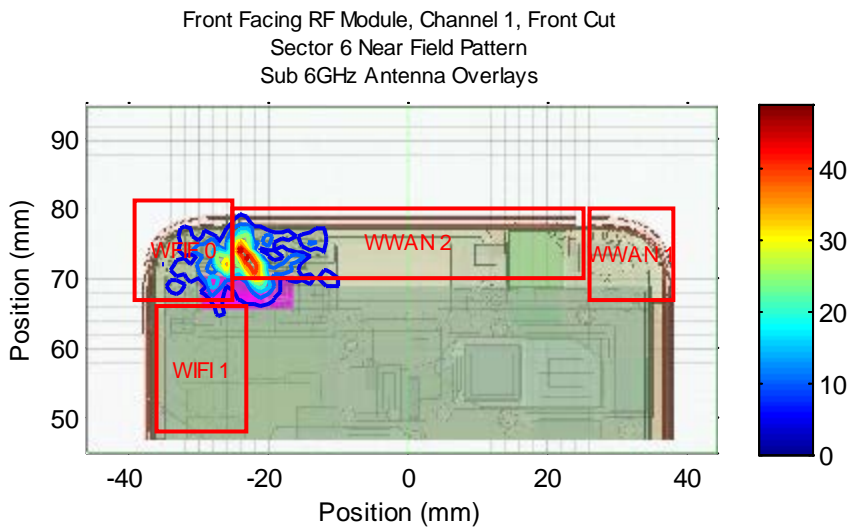
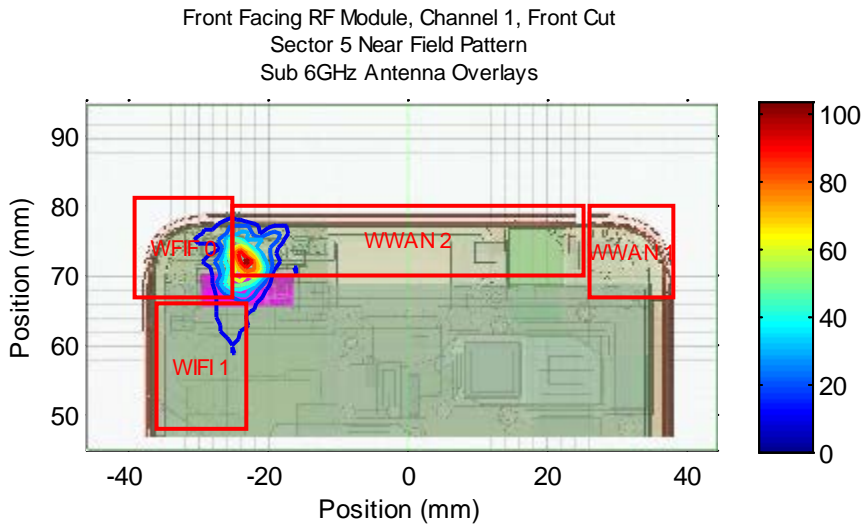
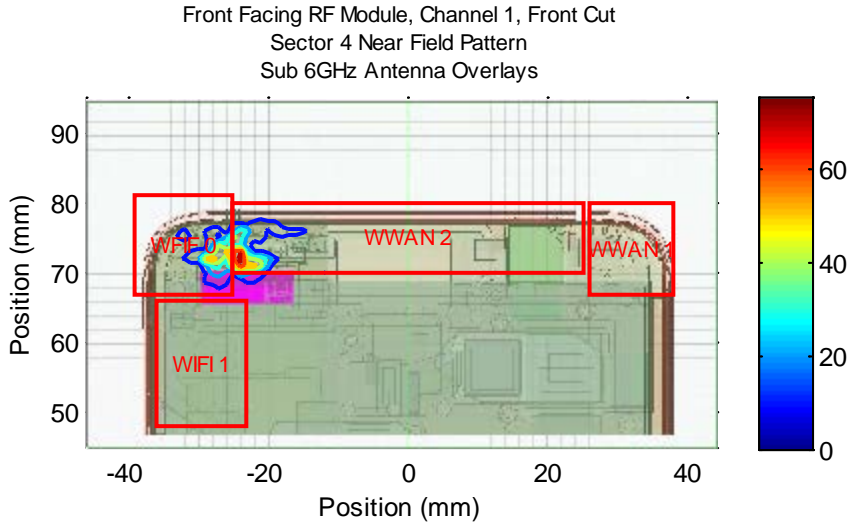
All plots showed the point power density.

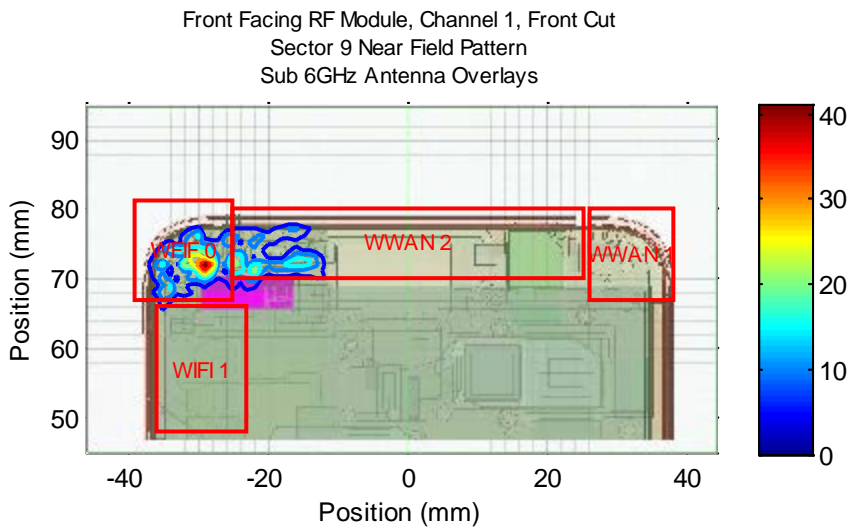
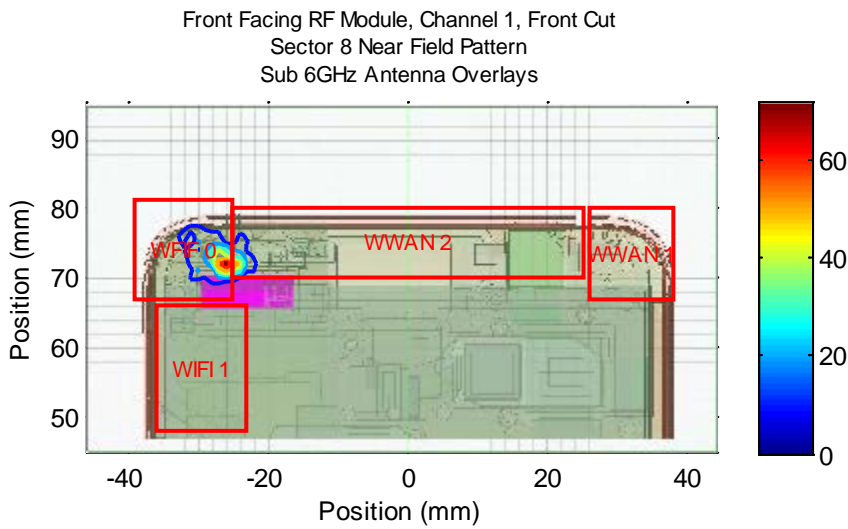
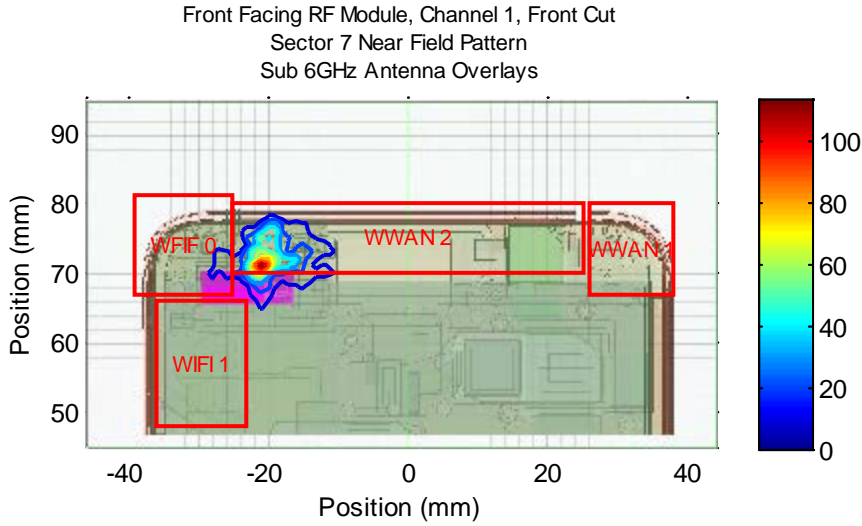
The plots do not show the power density averaged over a 1cm<sup>2</sup> or 4cm<sup>2</sup> area.

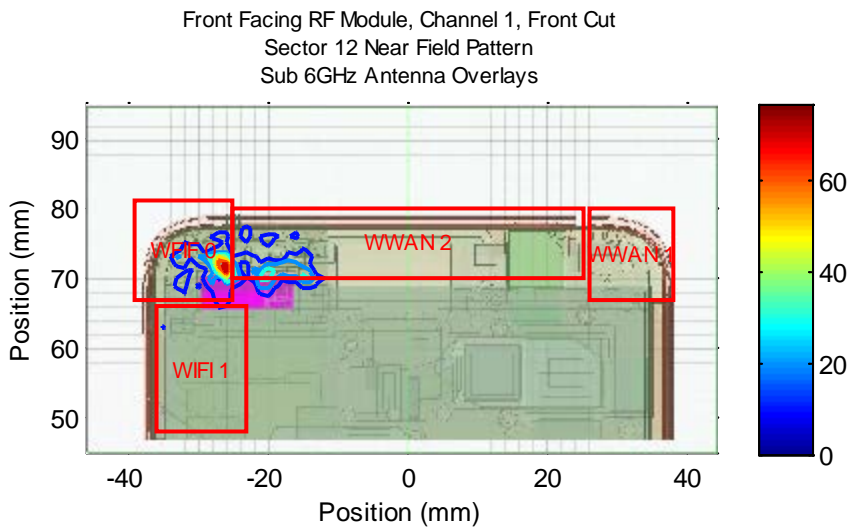
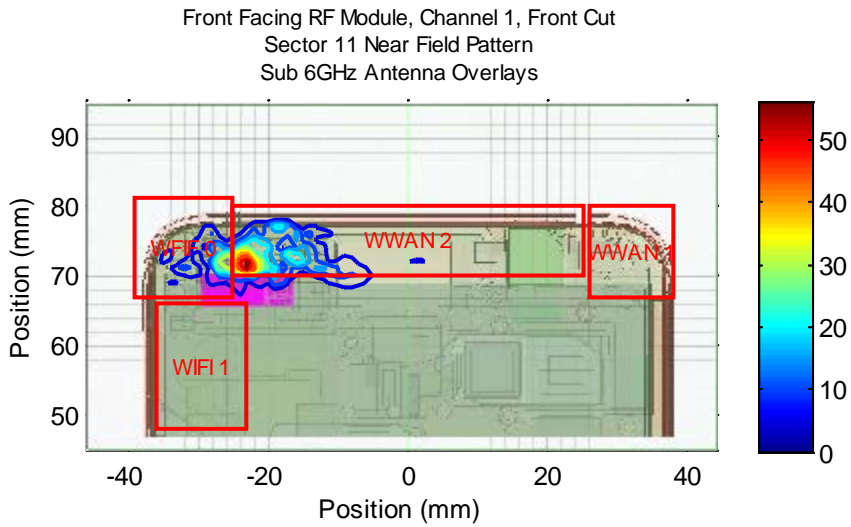
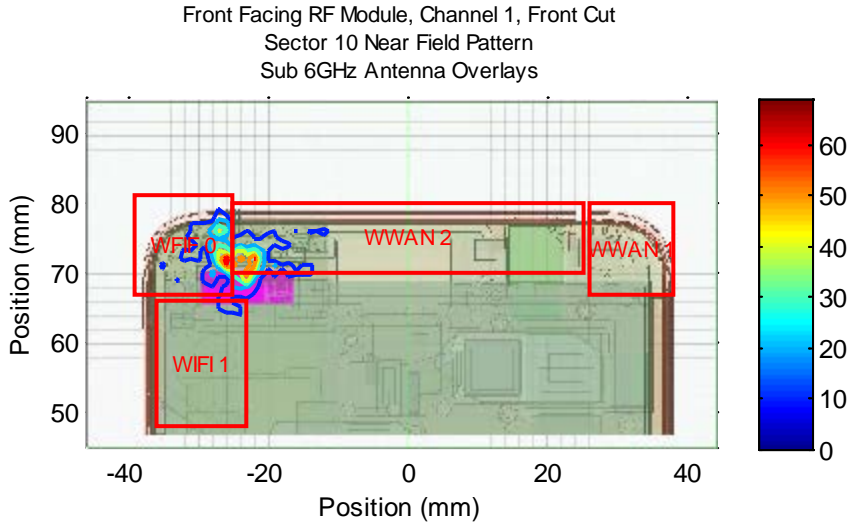
See [Figure C-4](#) for the orientation of all the power distributions relative to ASUS\_Z01QD.

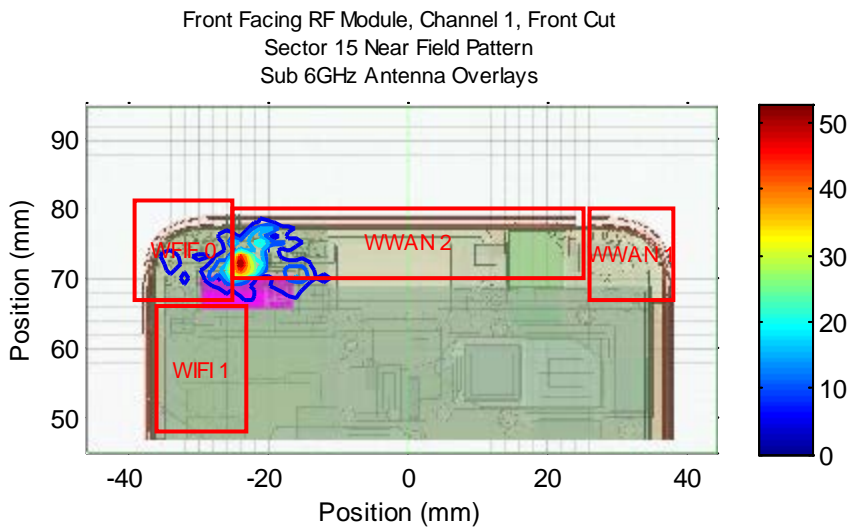
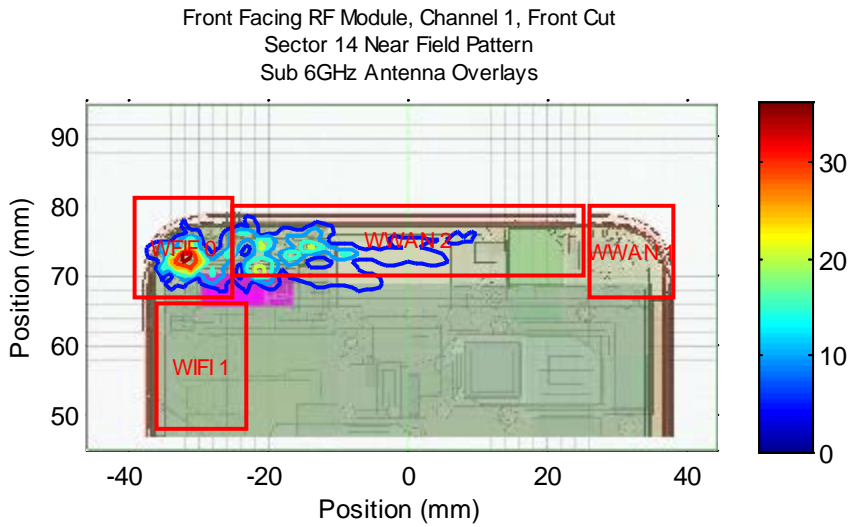
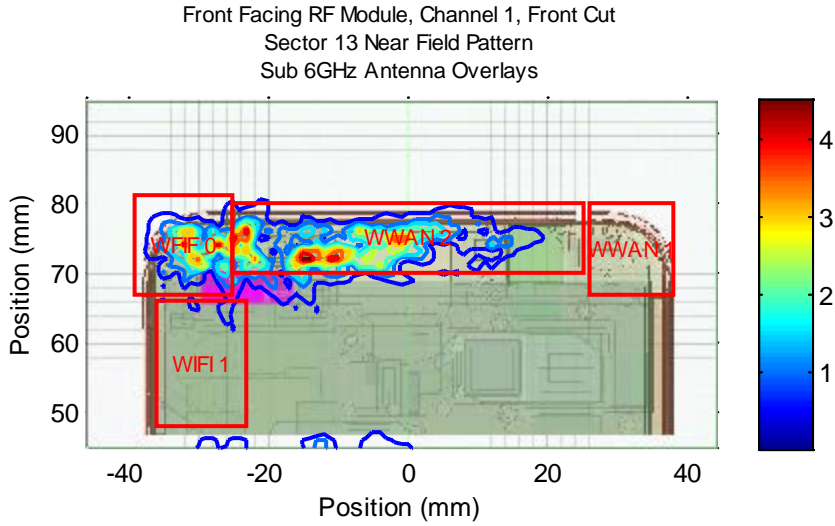




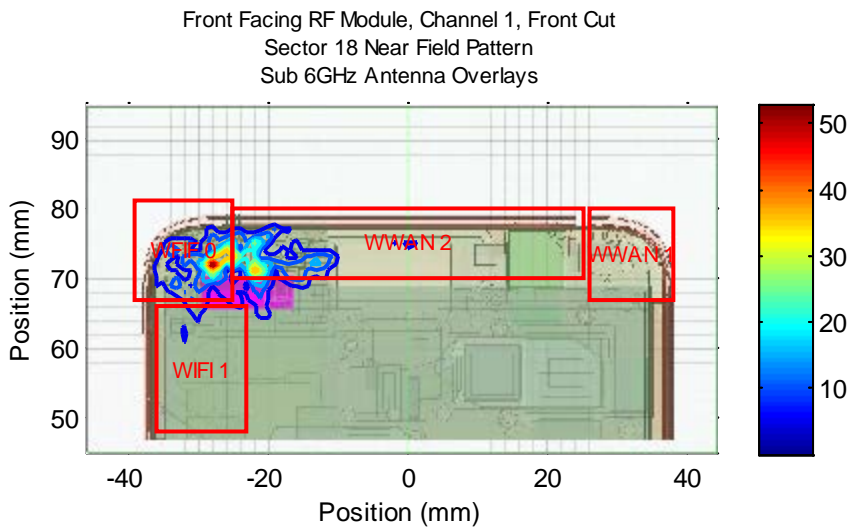
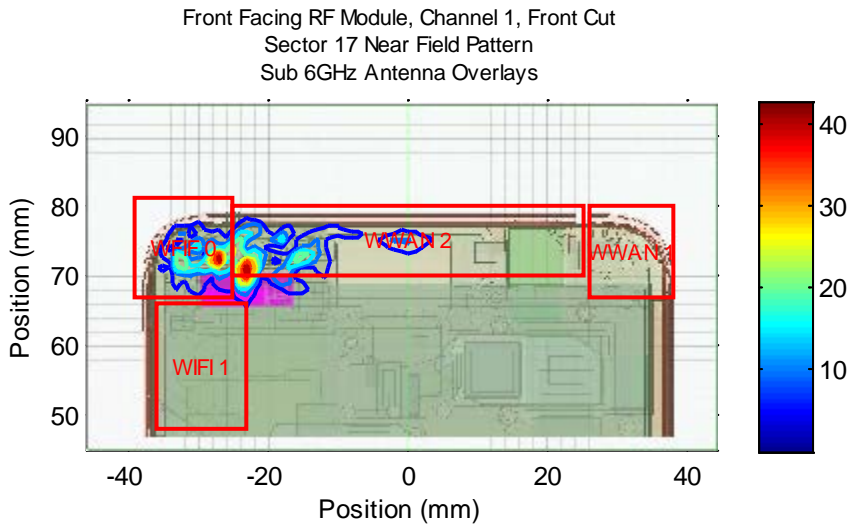
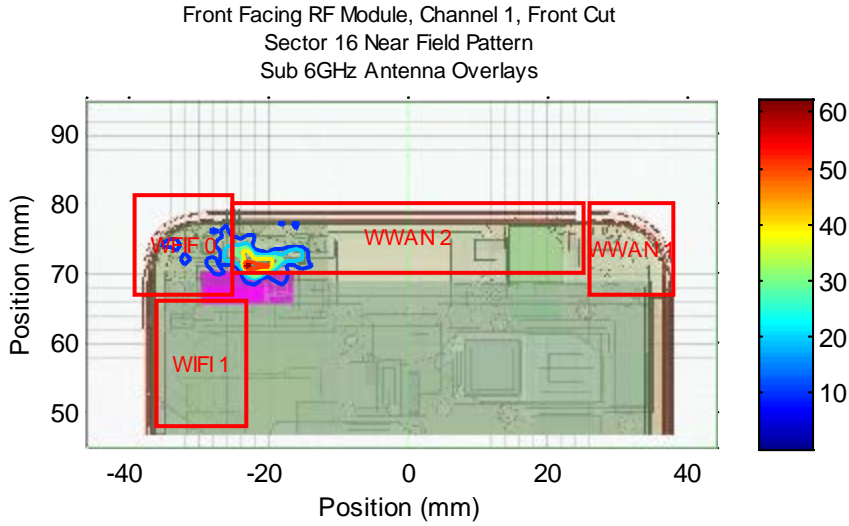


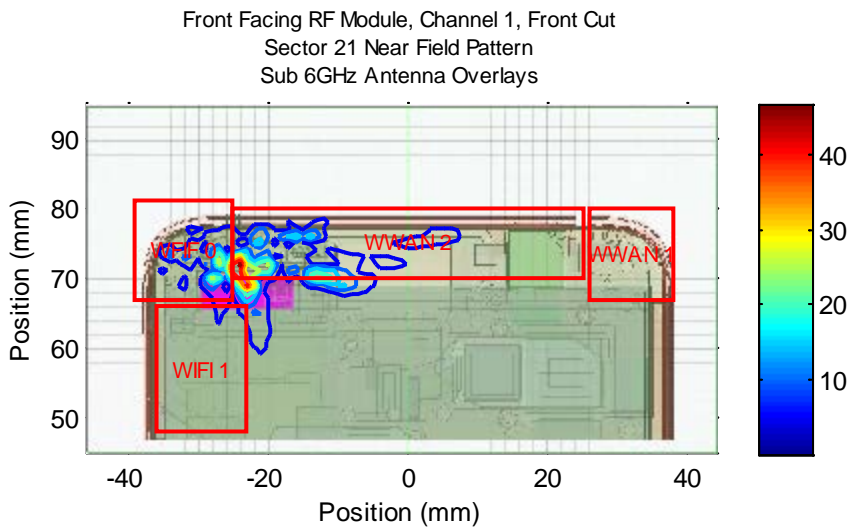
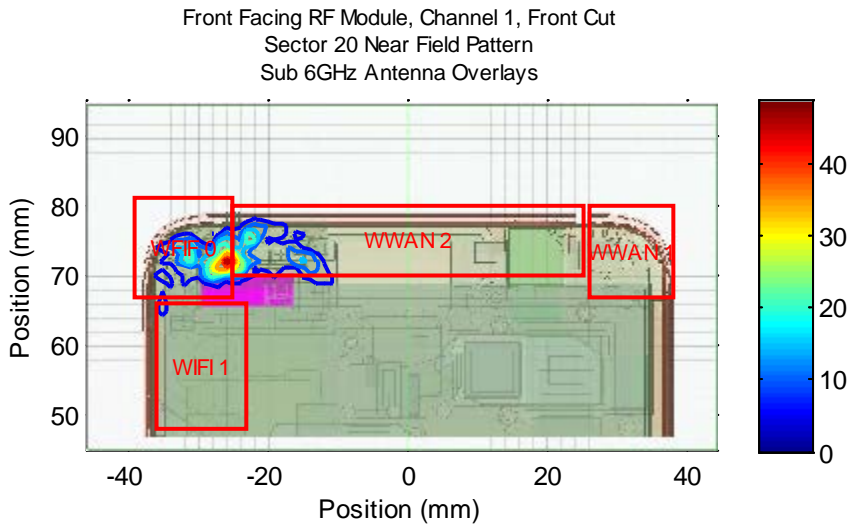
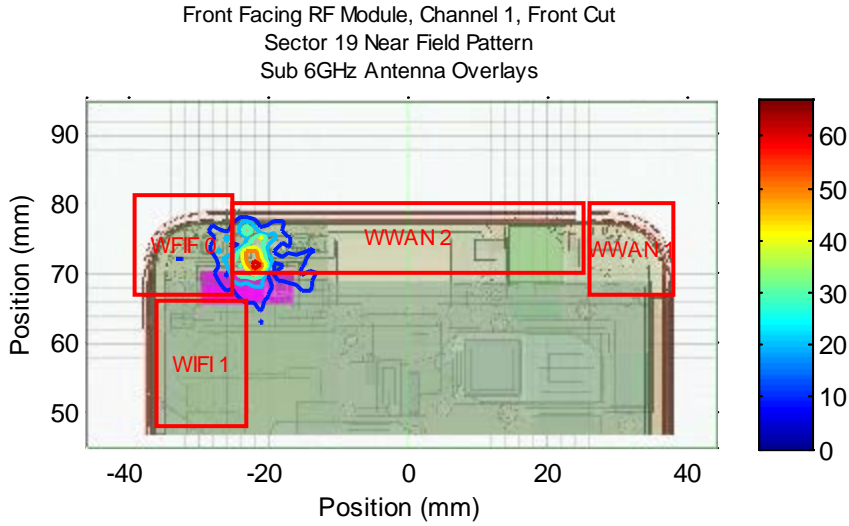




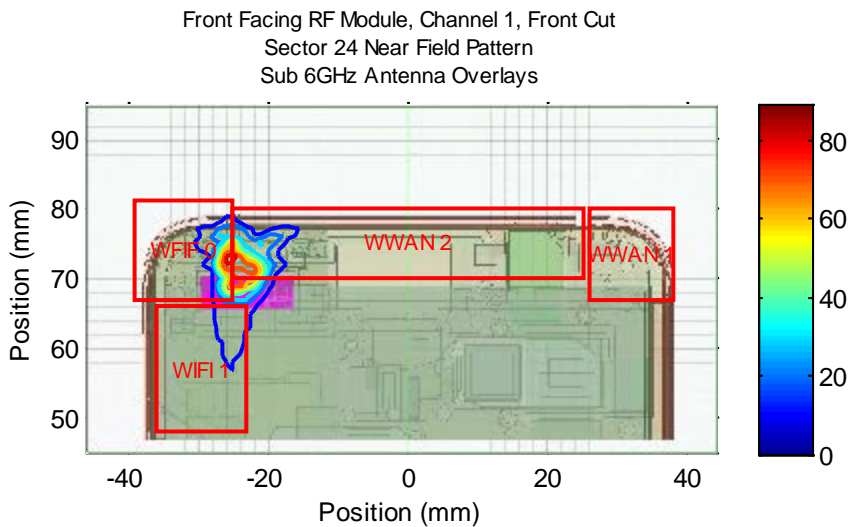
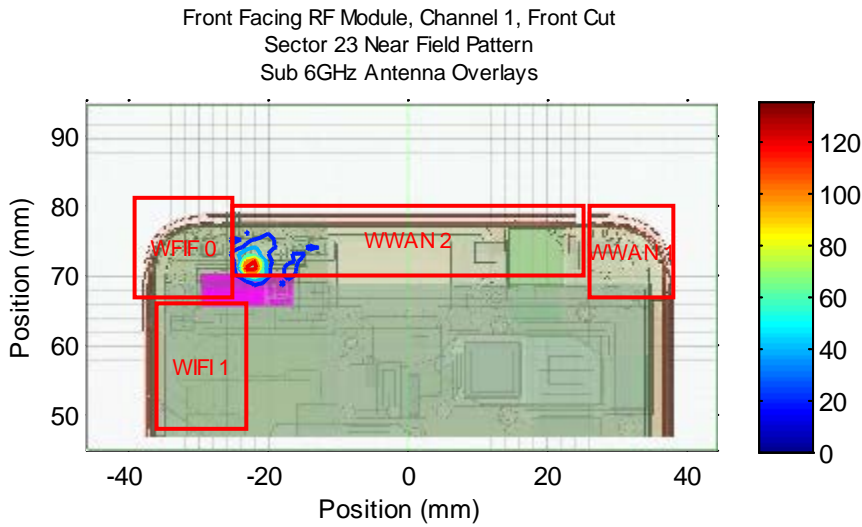
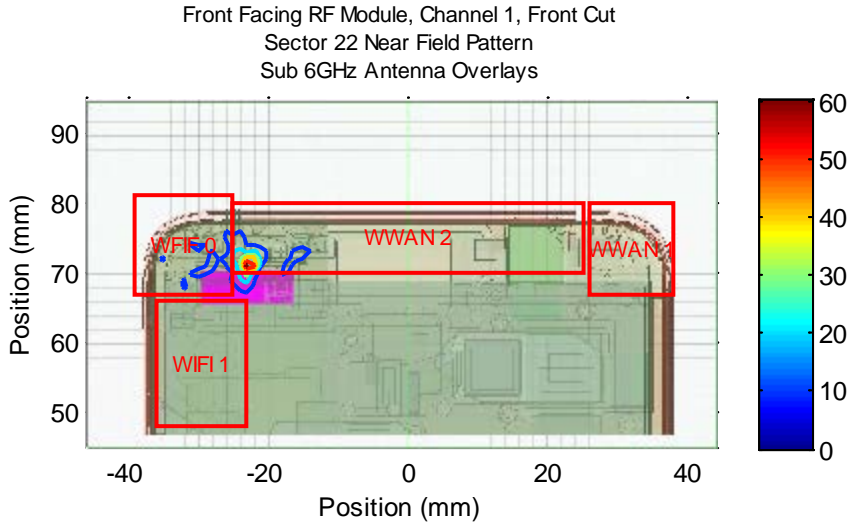


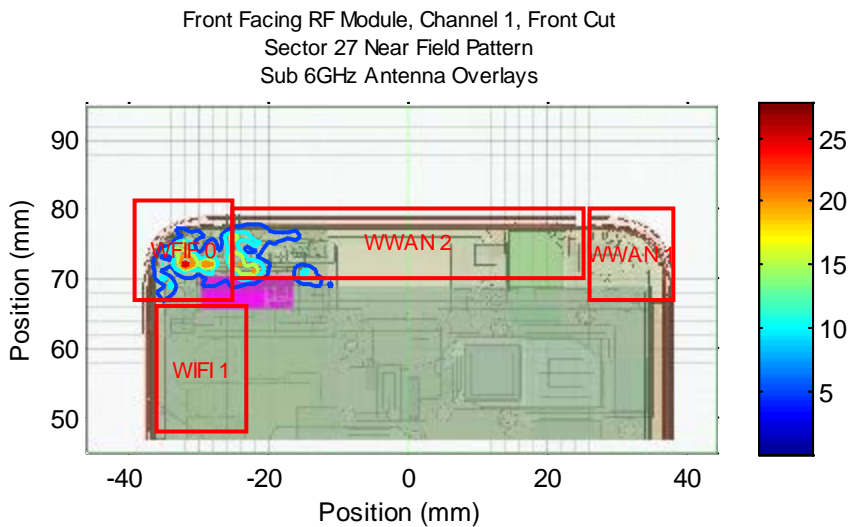
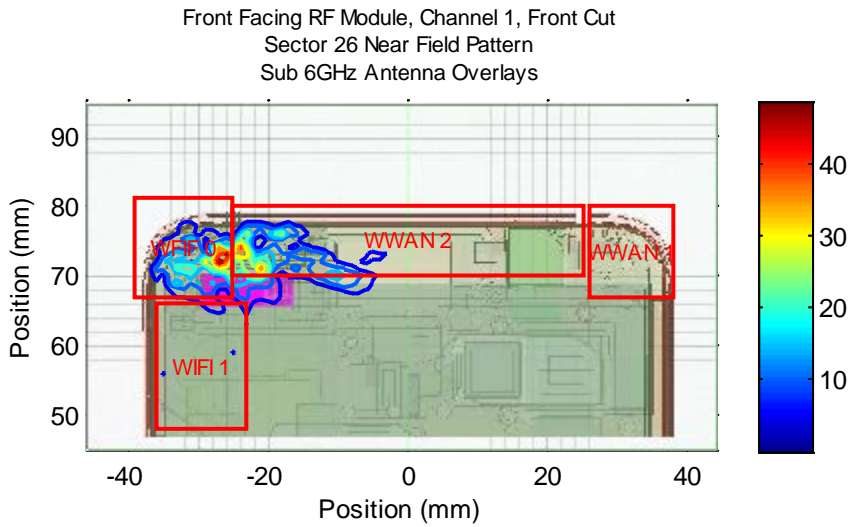
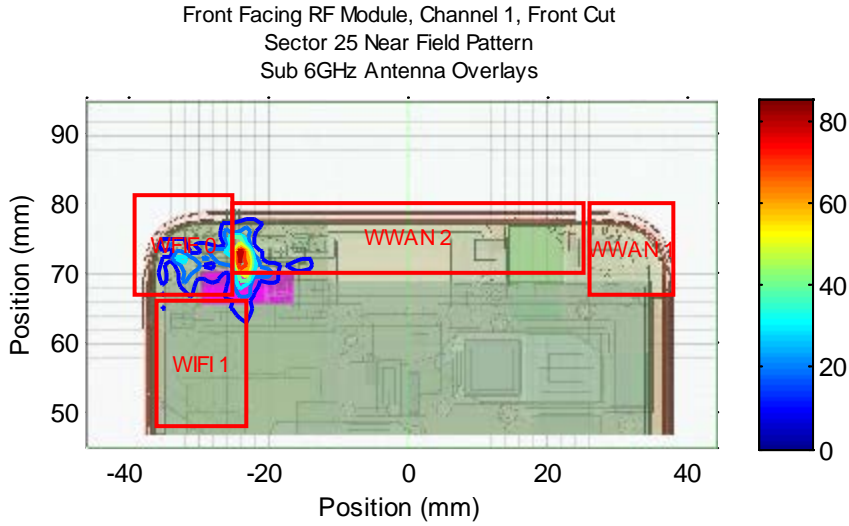


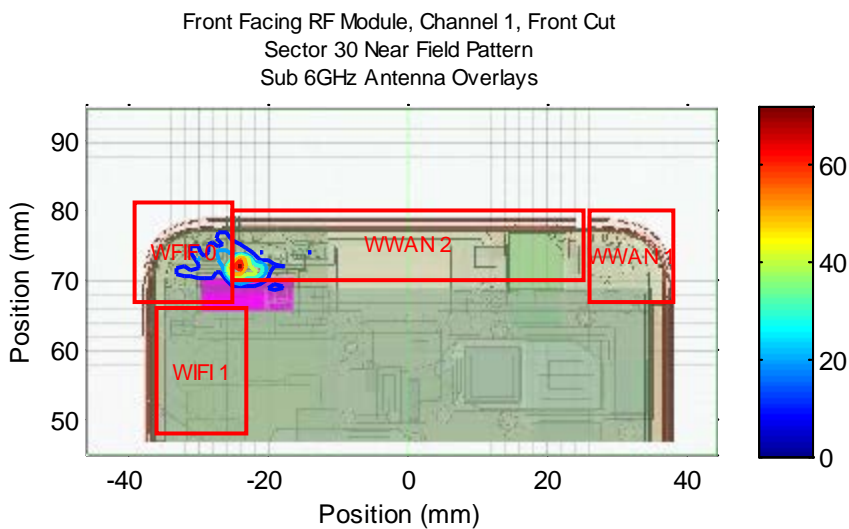
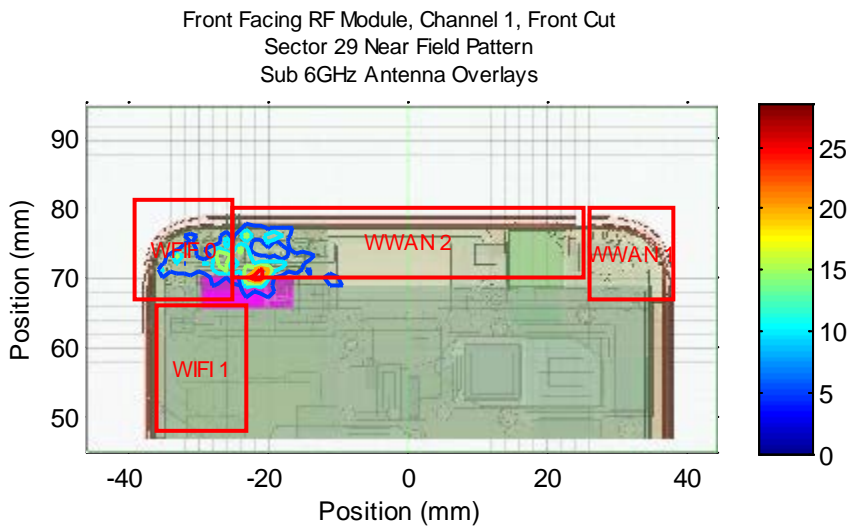
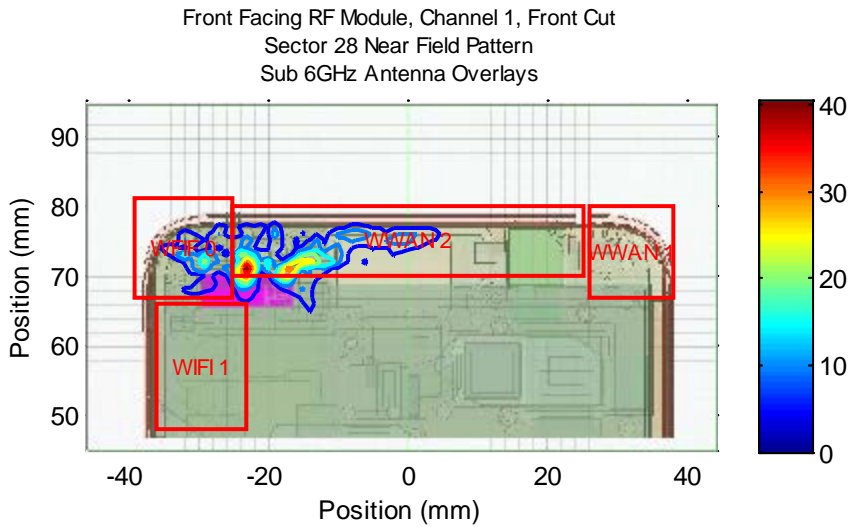


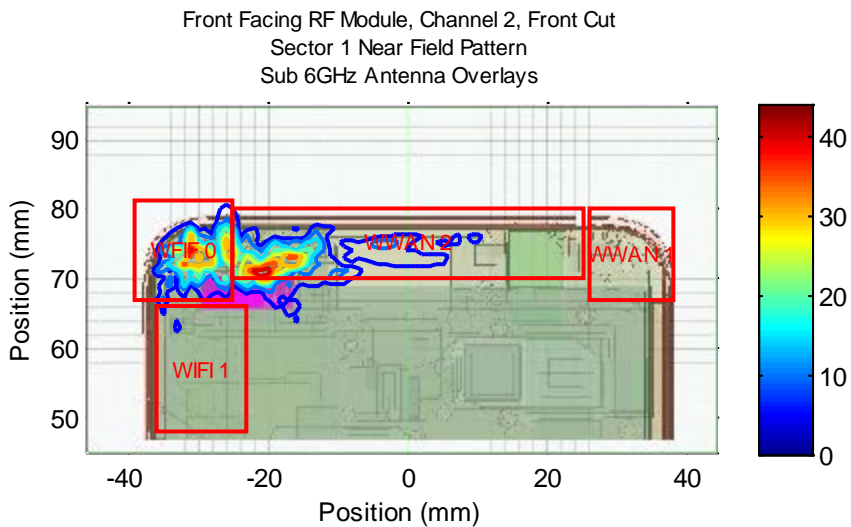
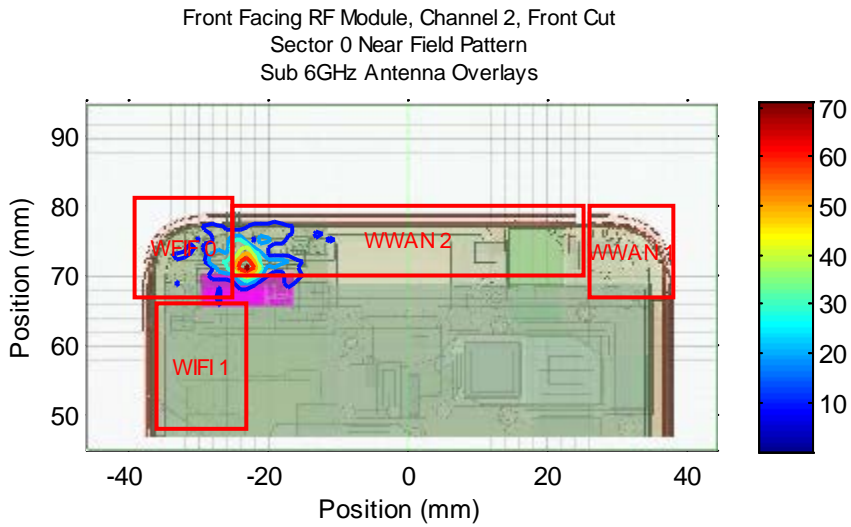
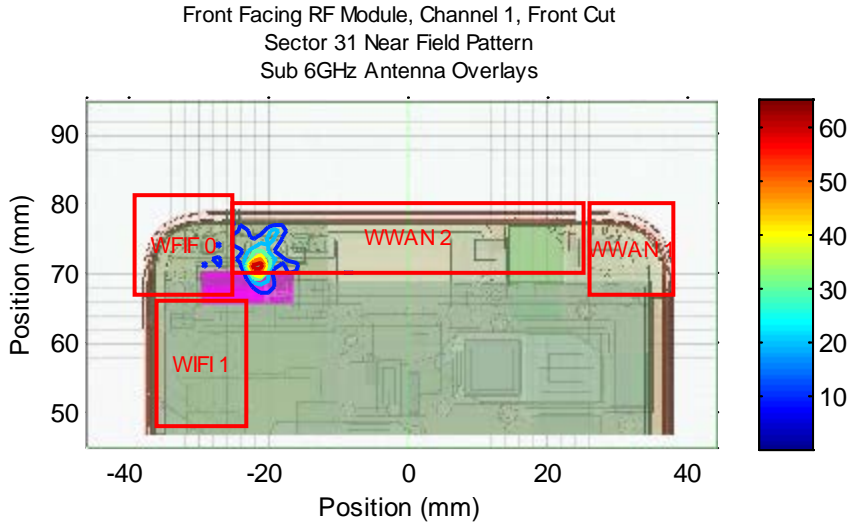


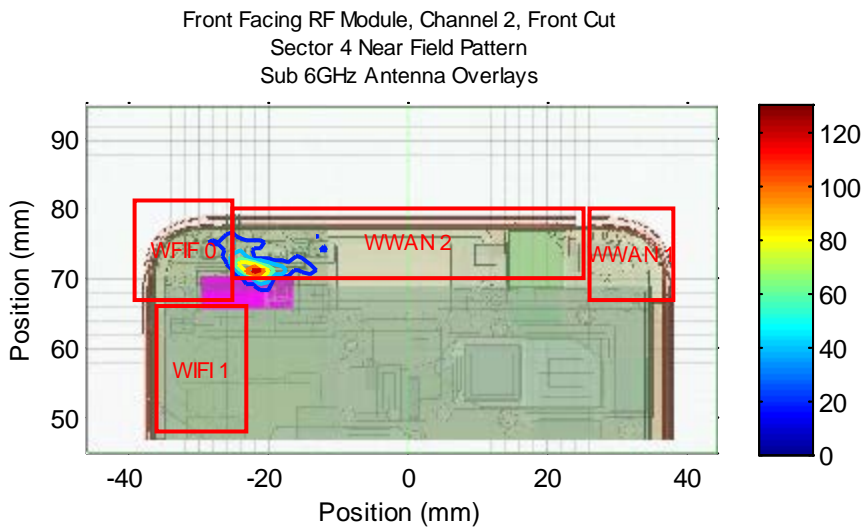
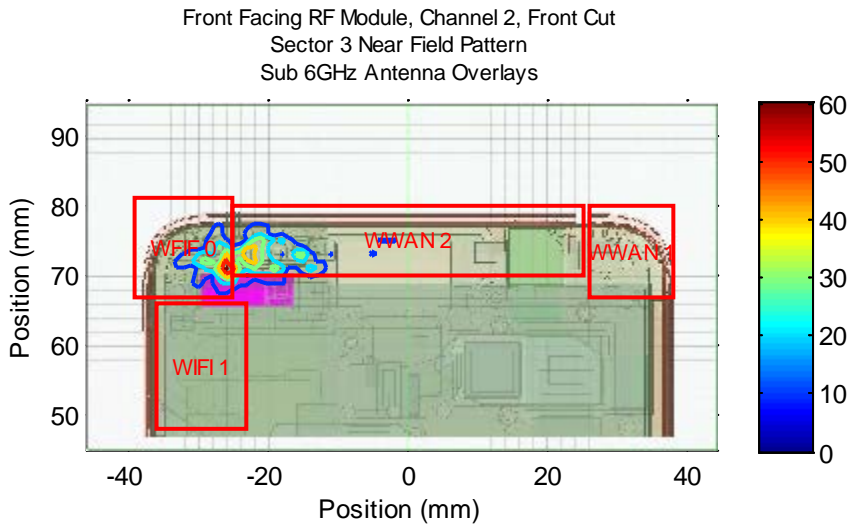




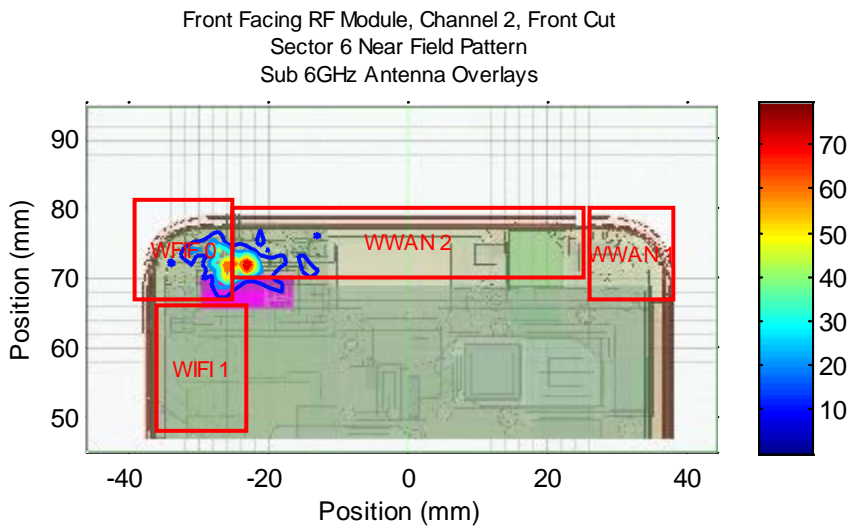
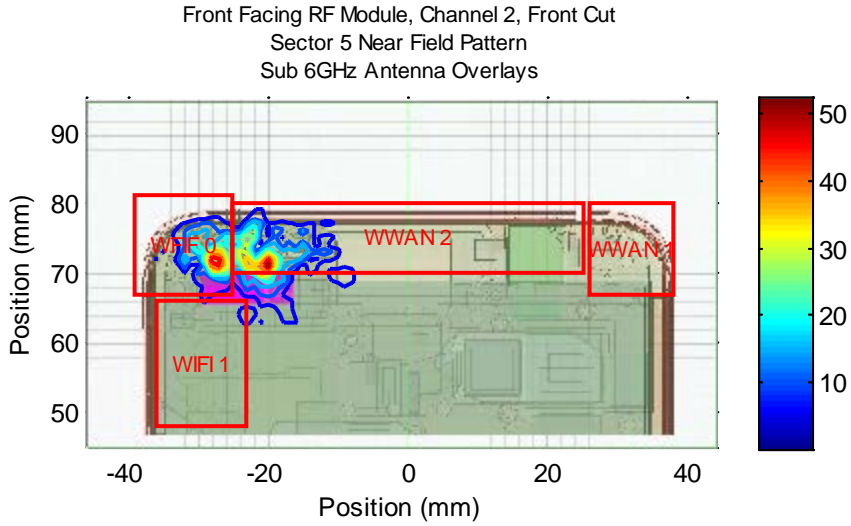




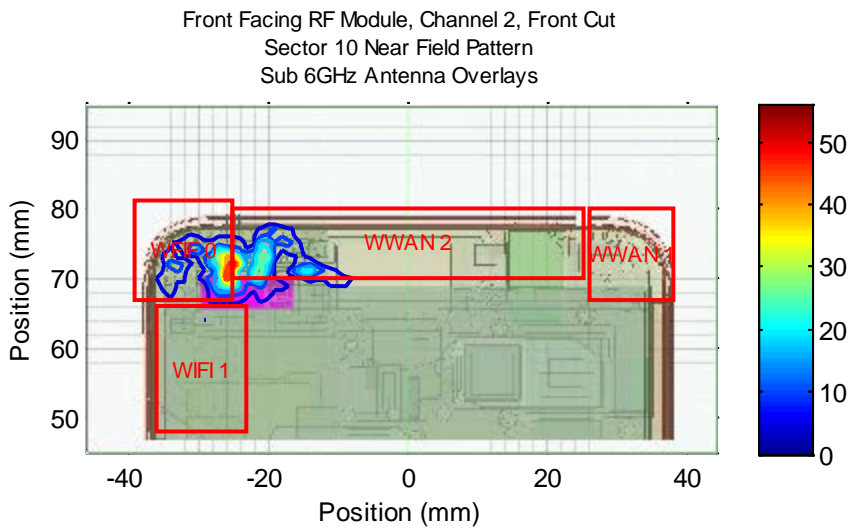
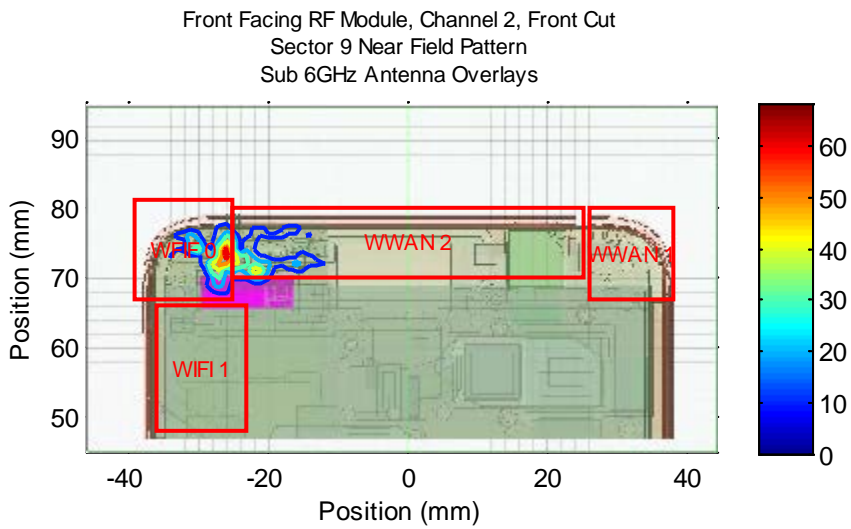
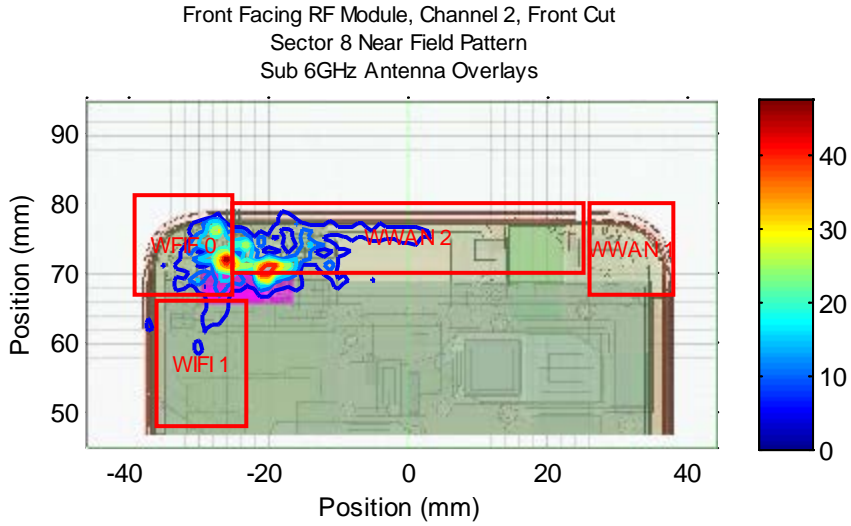


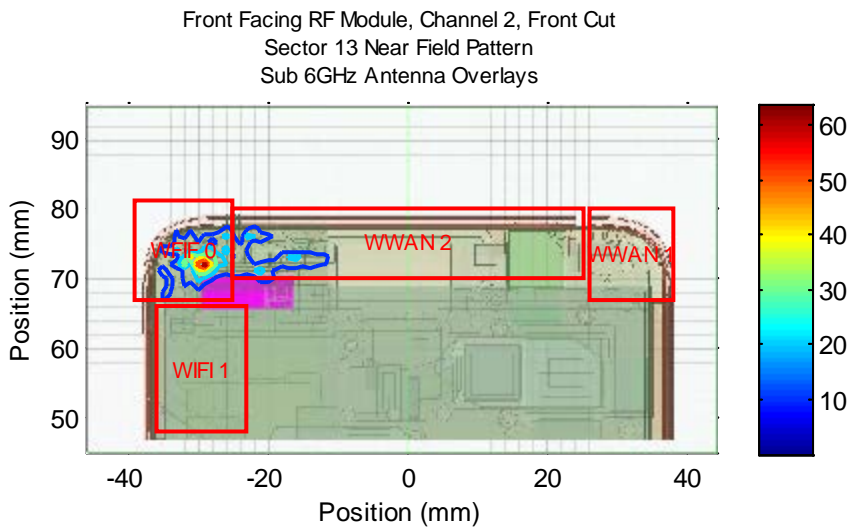
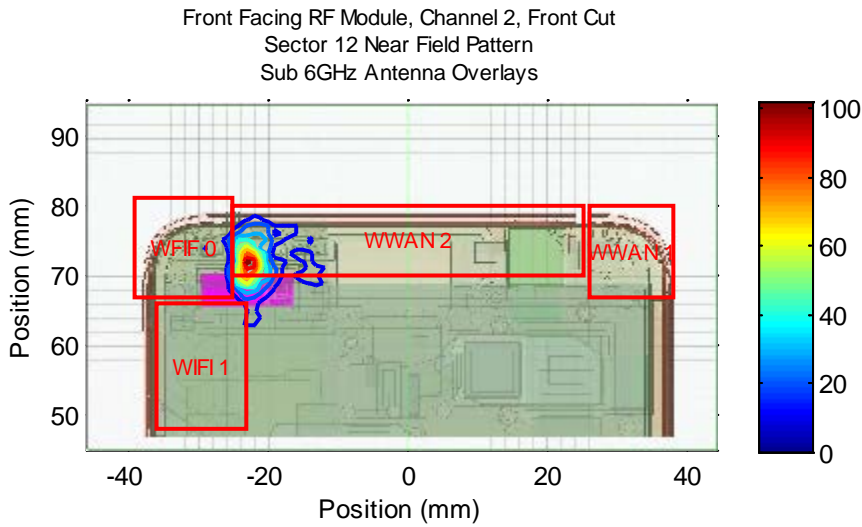
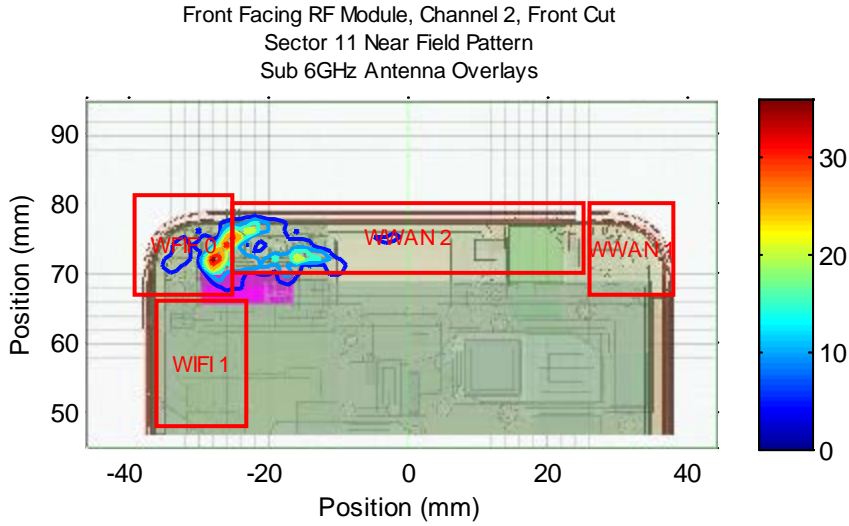


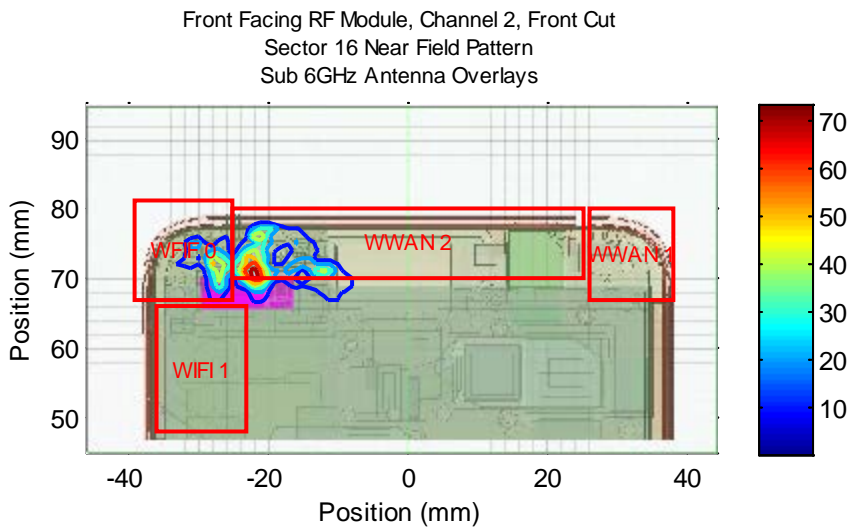
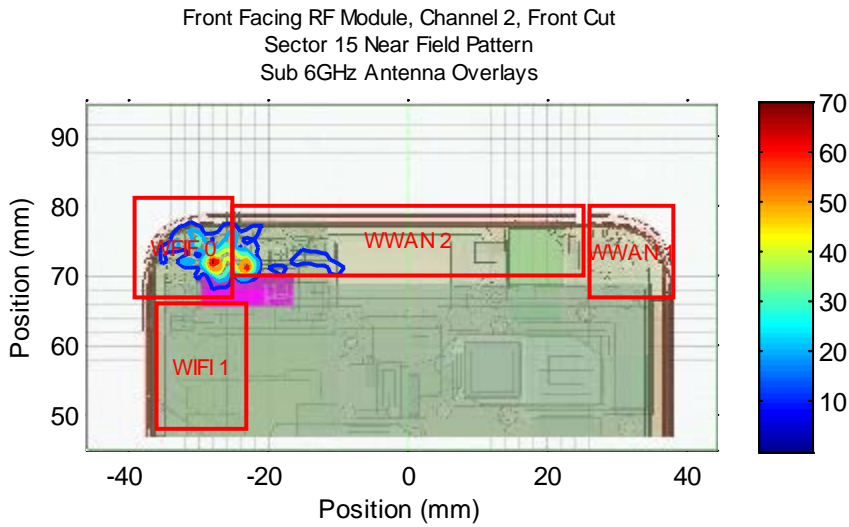
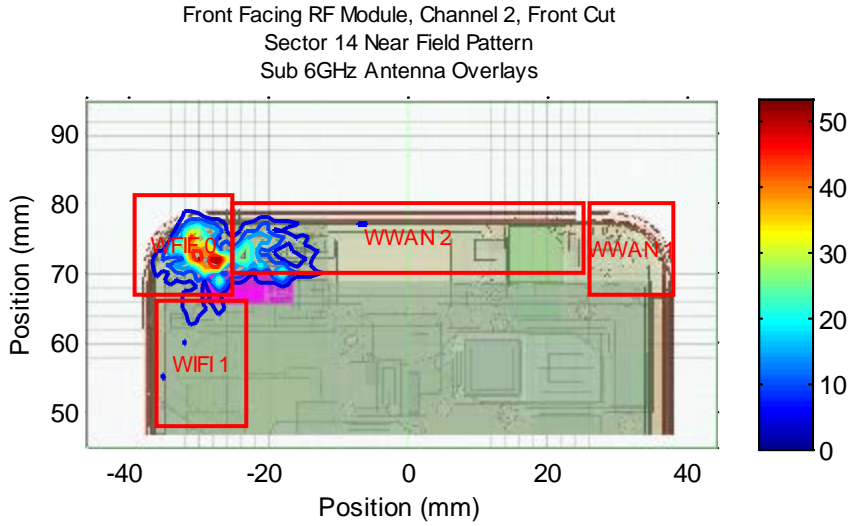


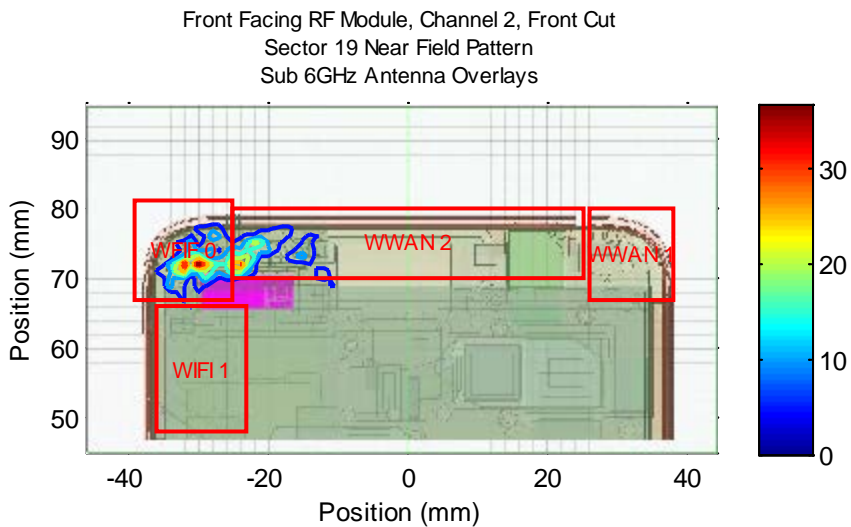
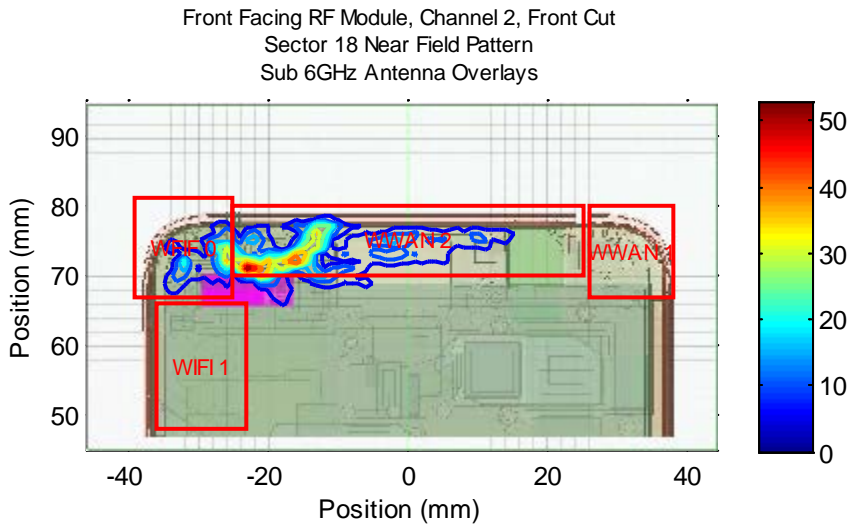
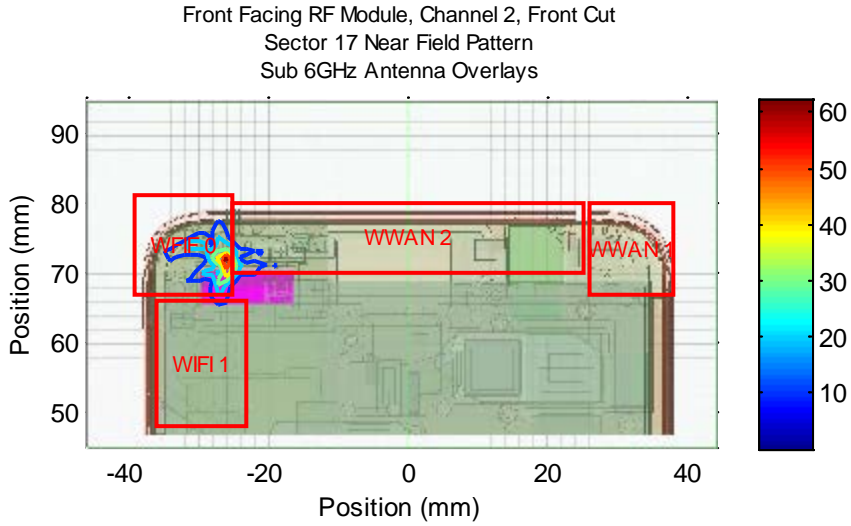


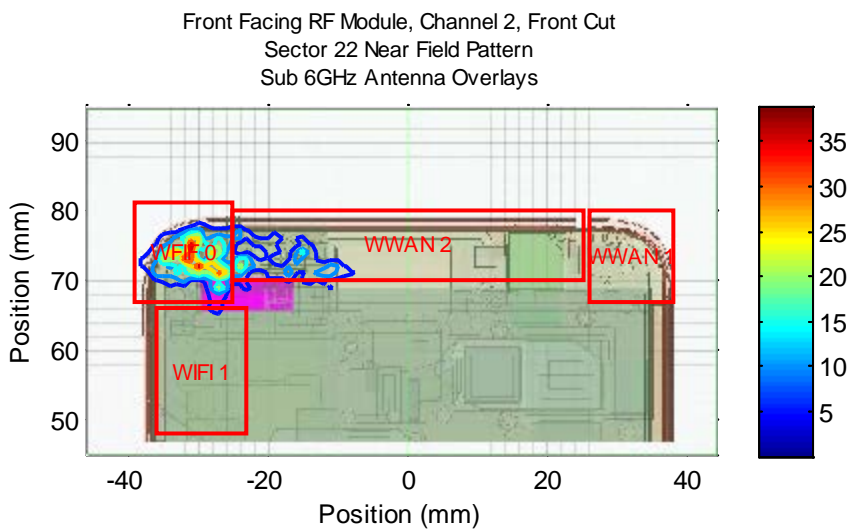
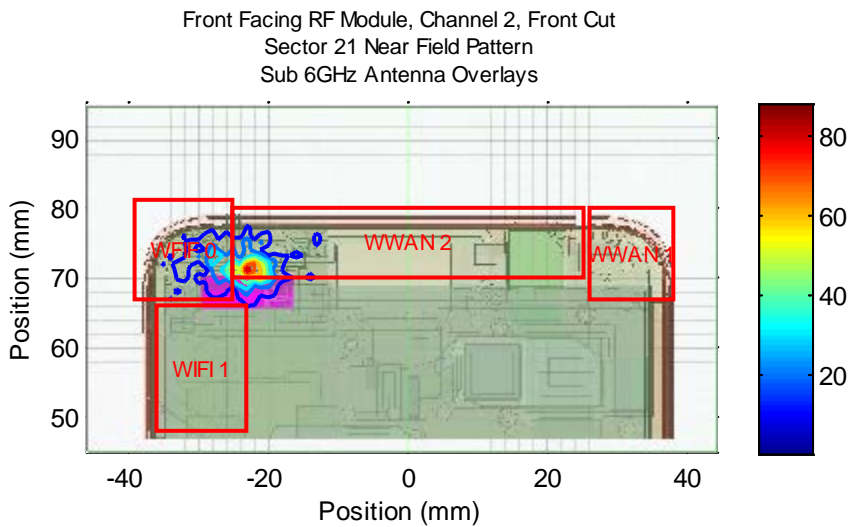
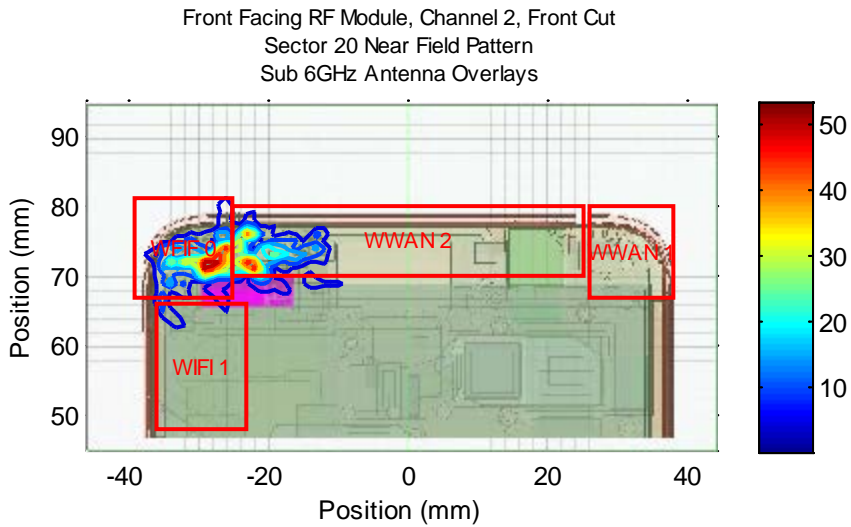




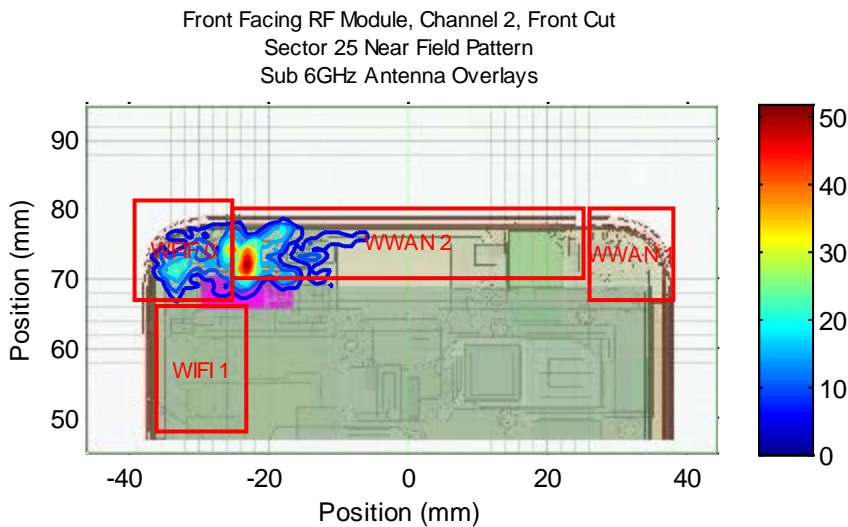
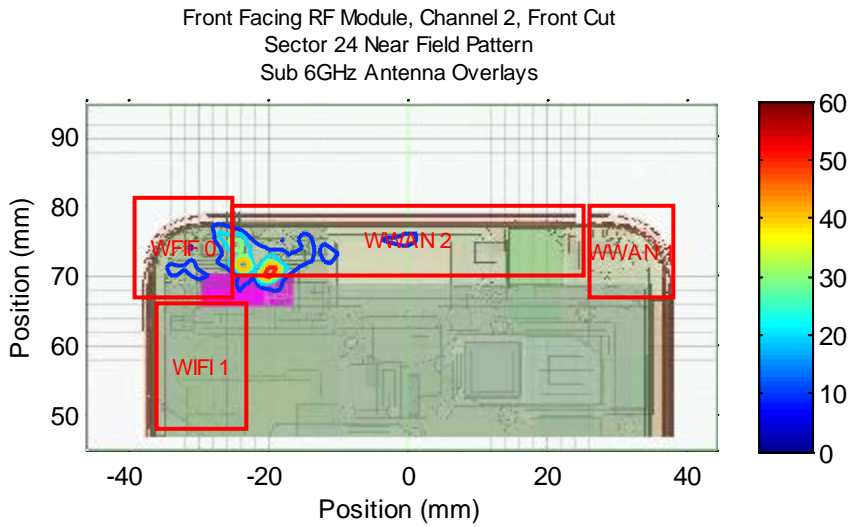




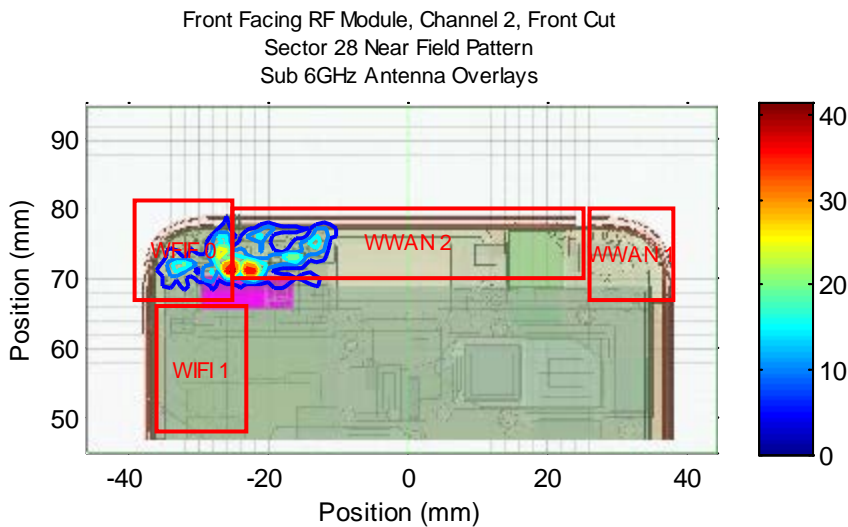
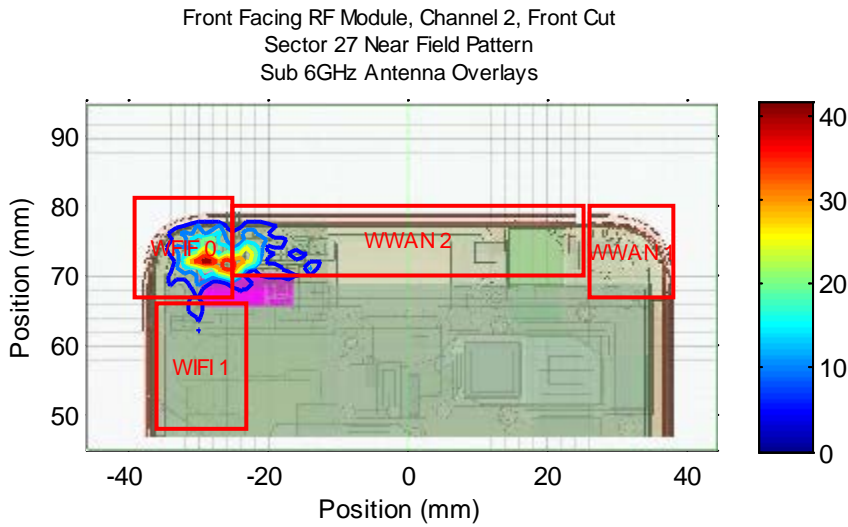
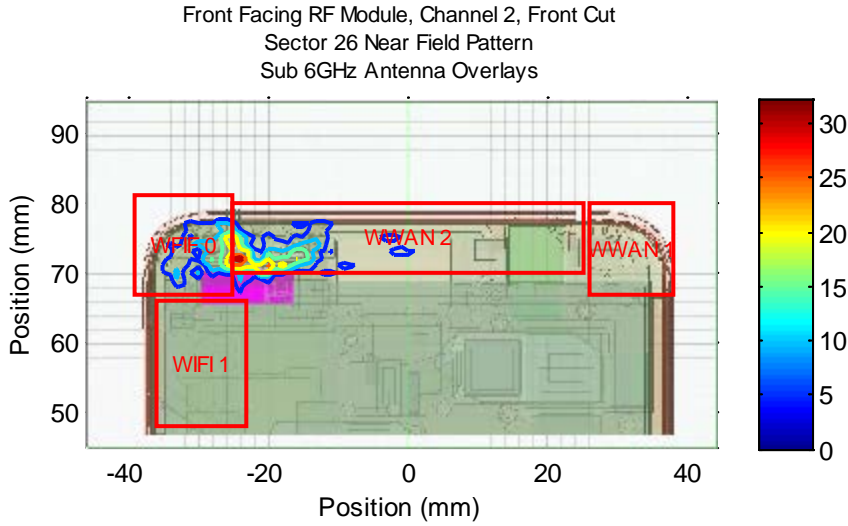


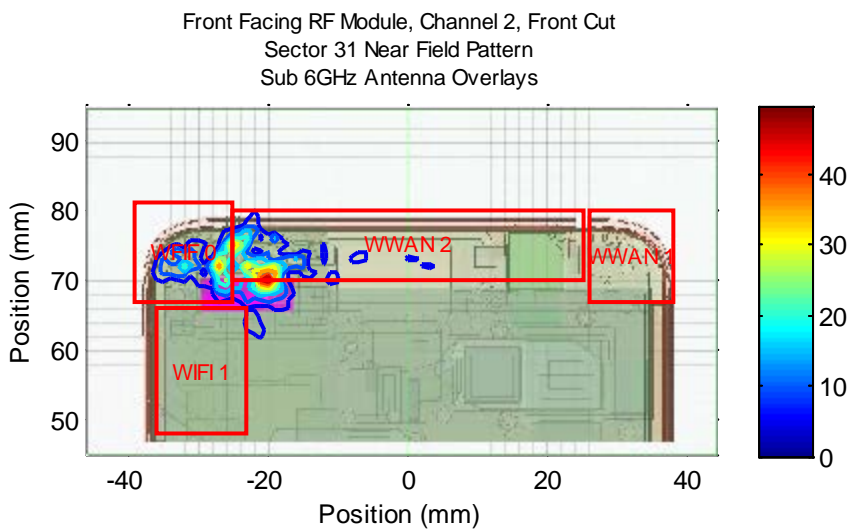
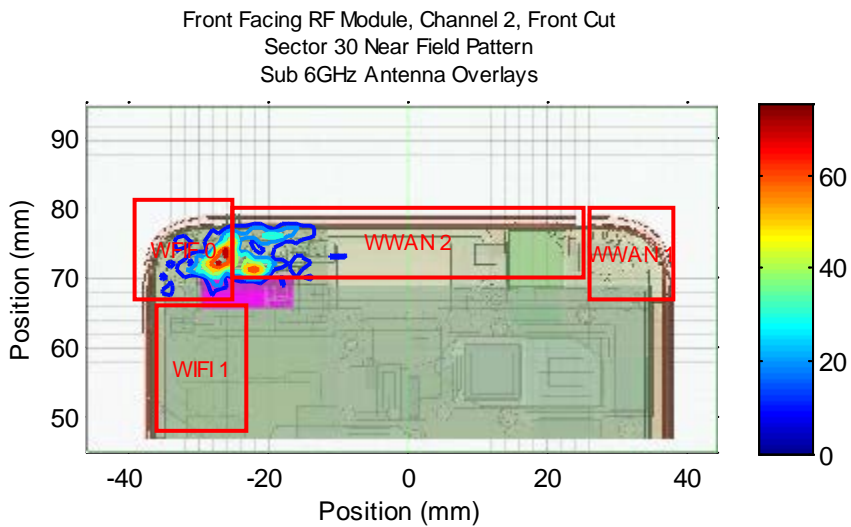
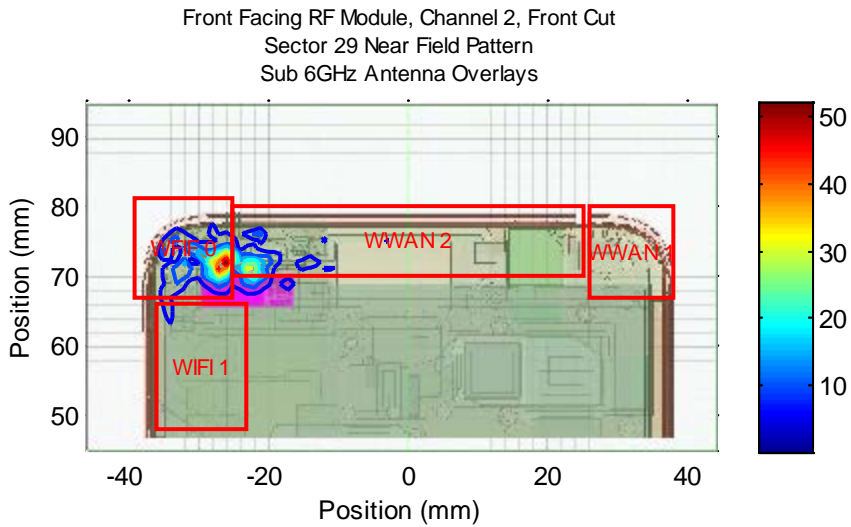




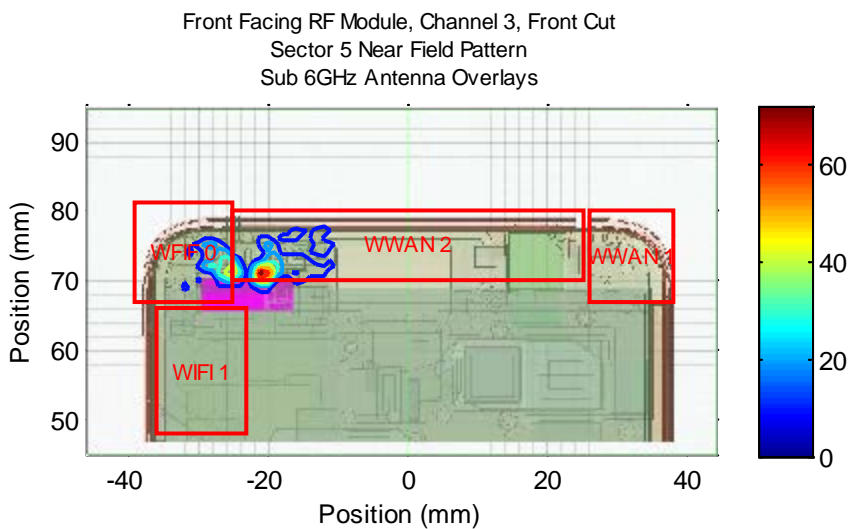
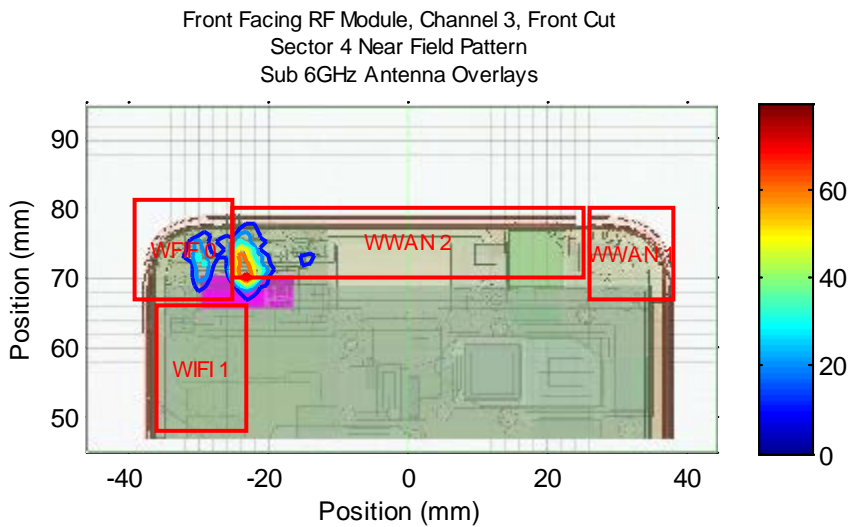
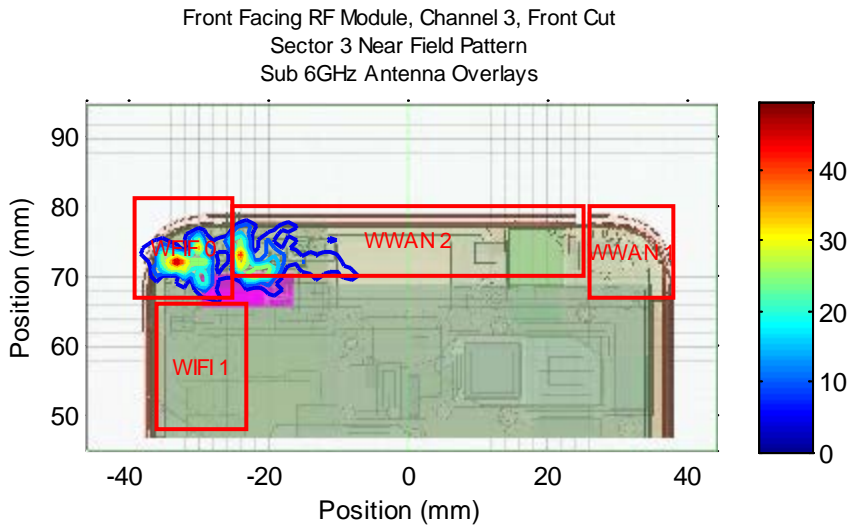


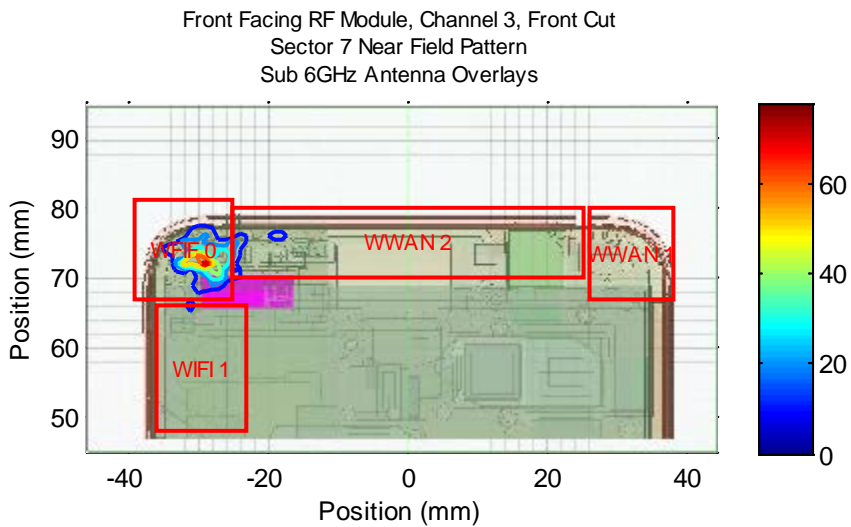
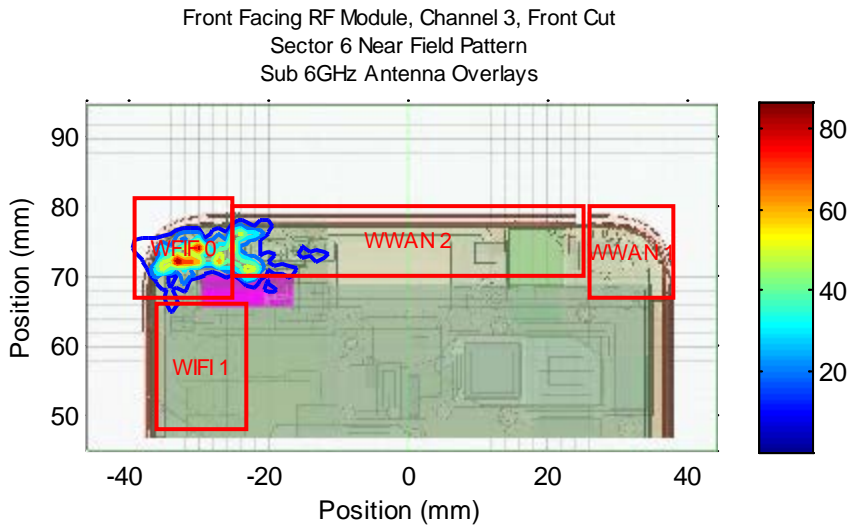




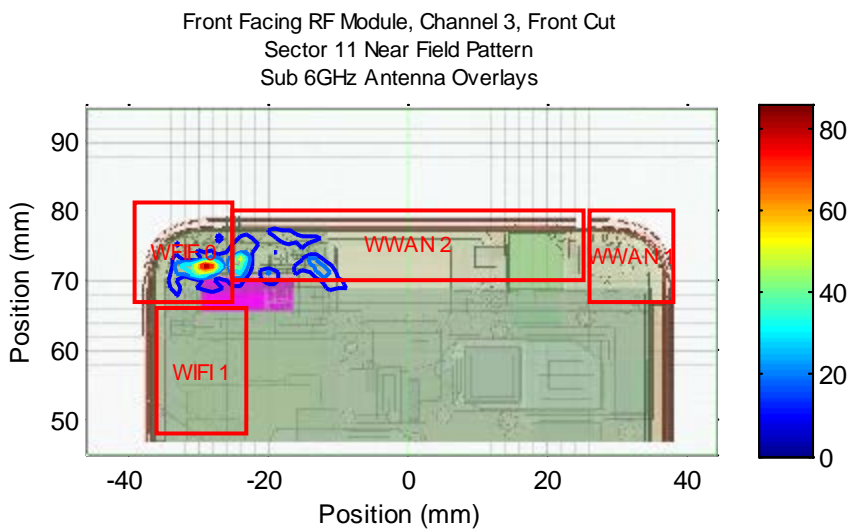
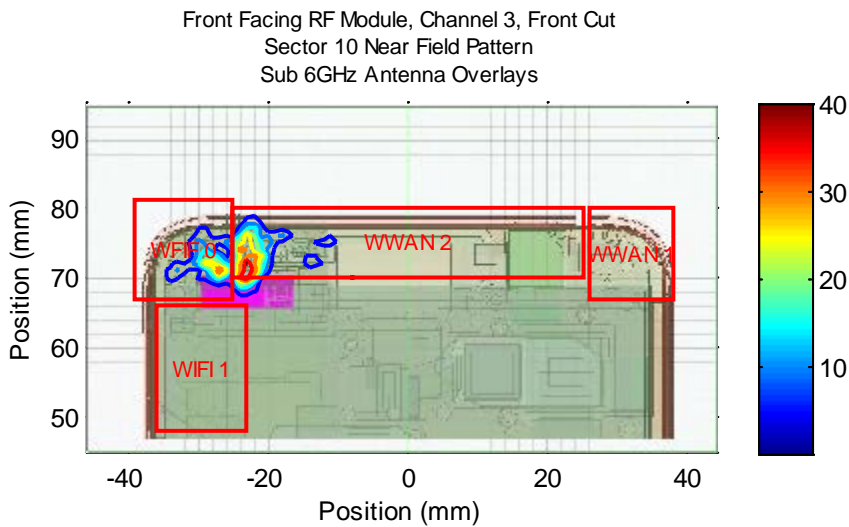
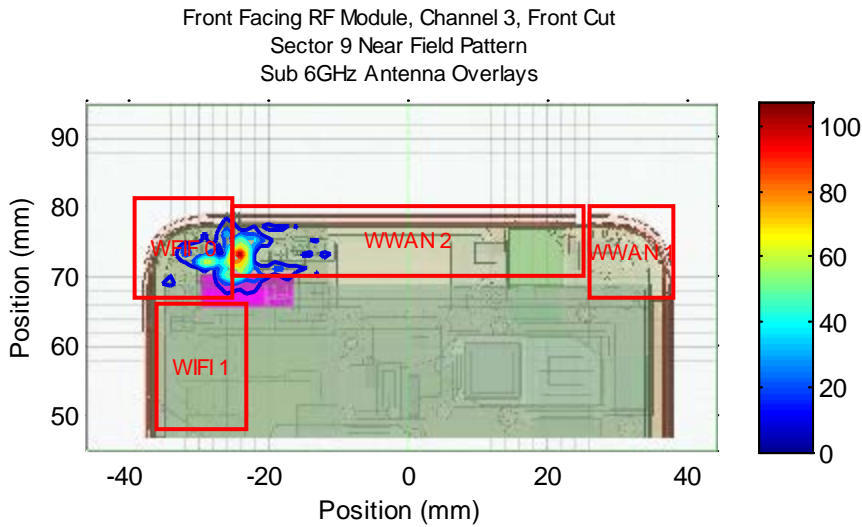




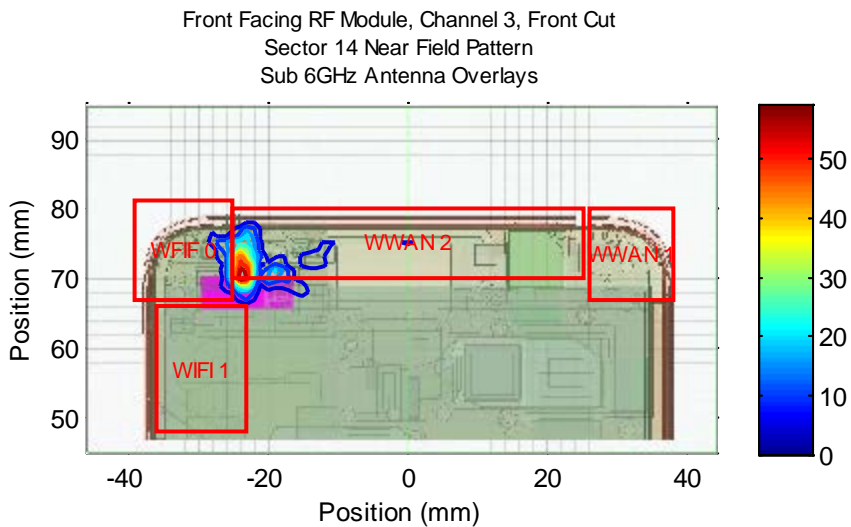
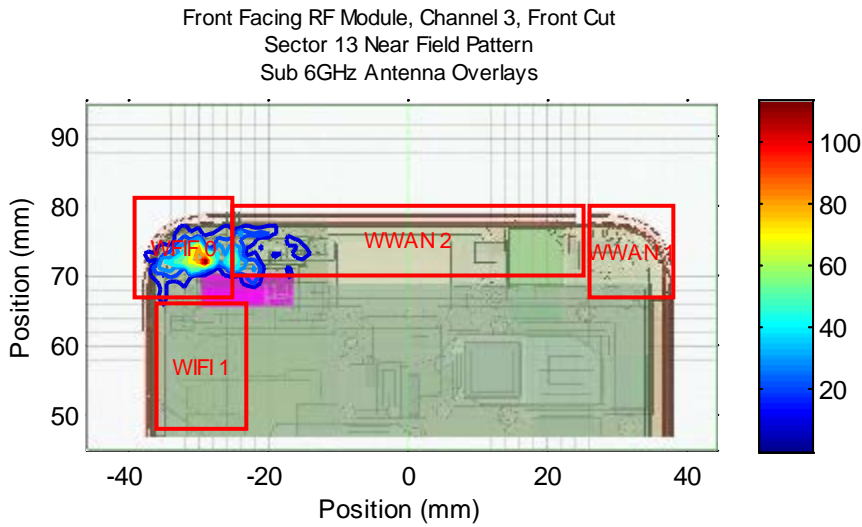
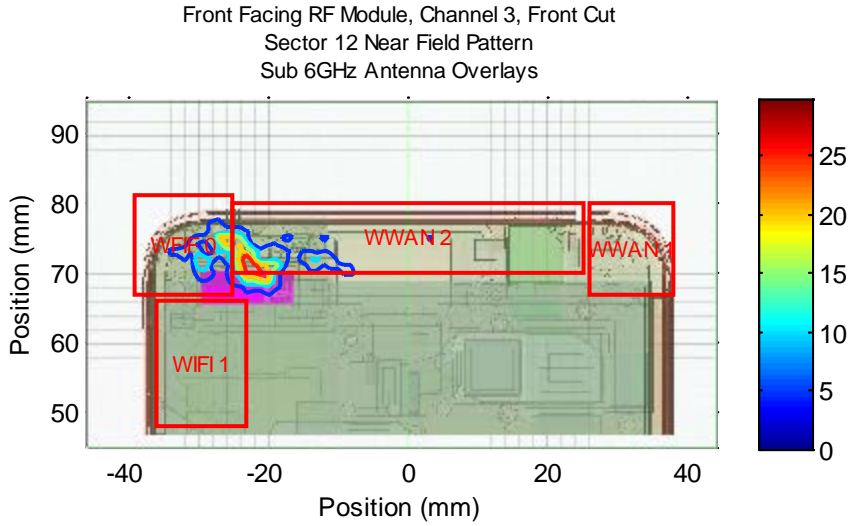


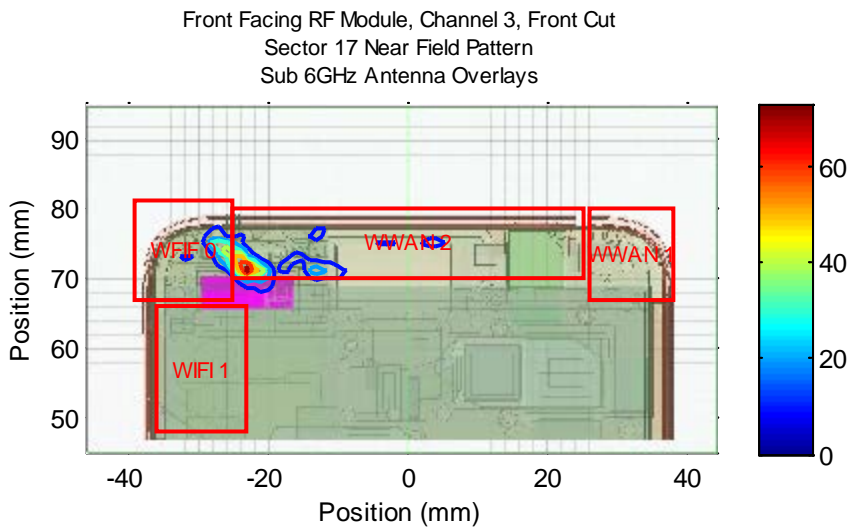
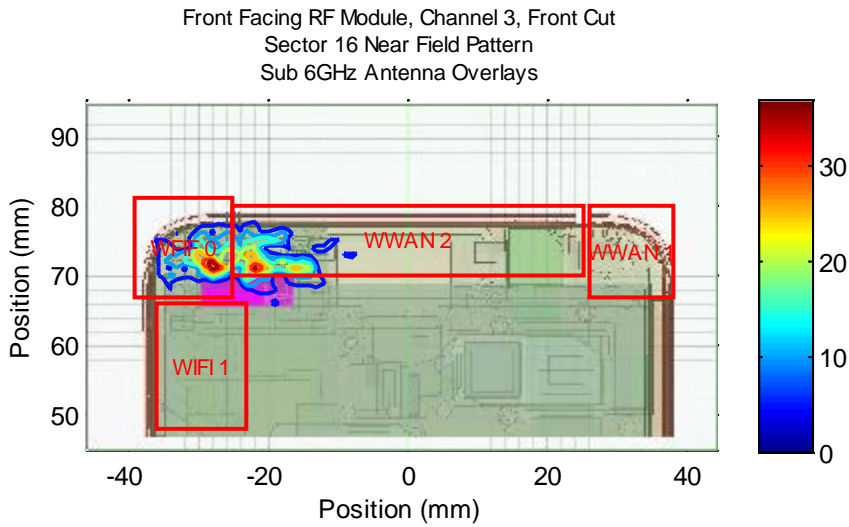
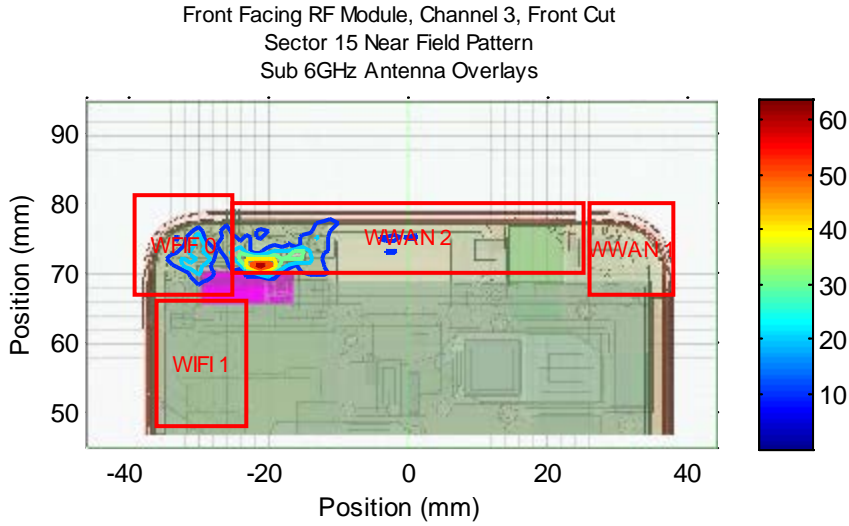


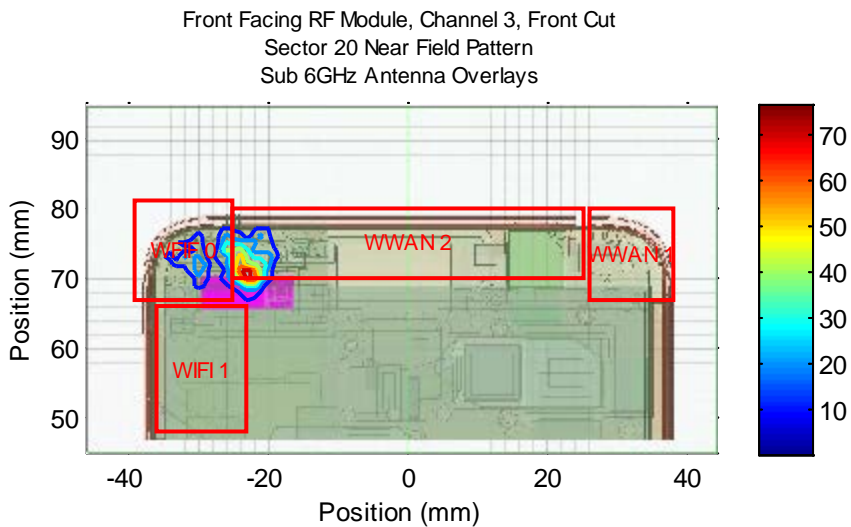
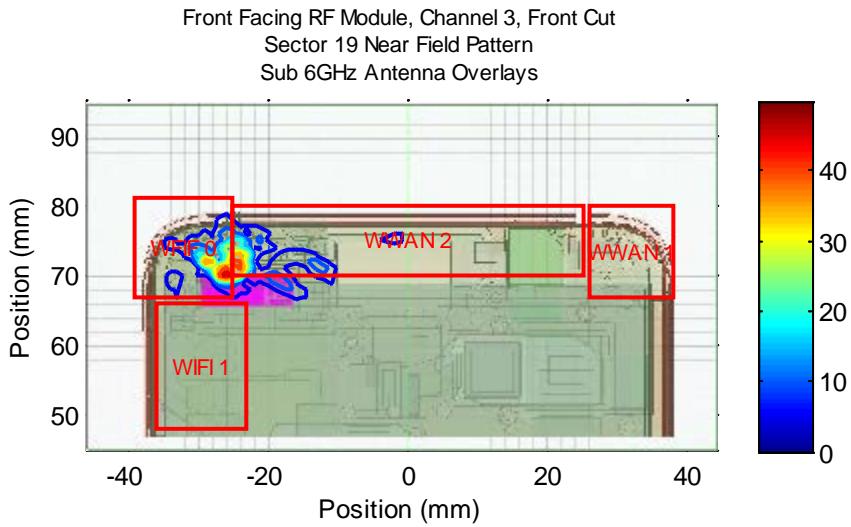
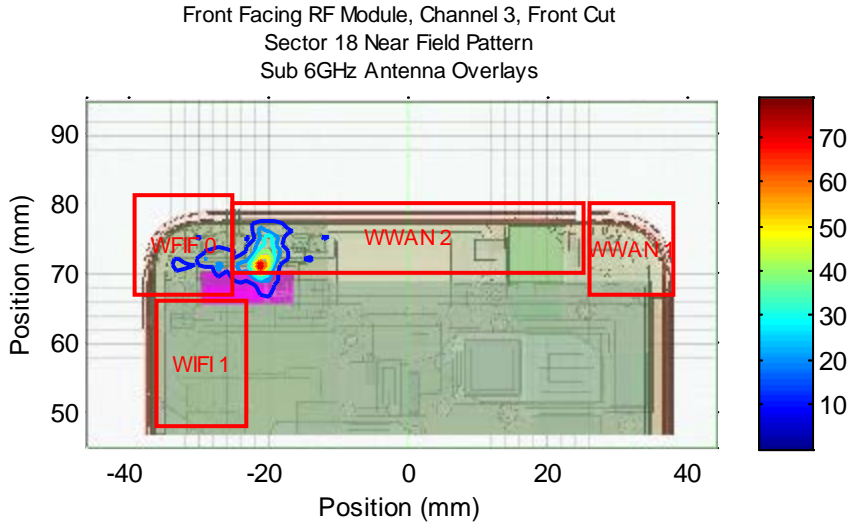


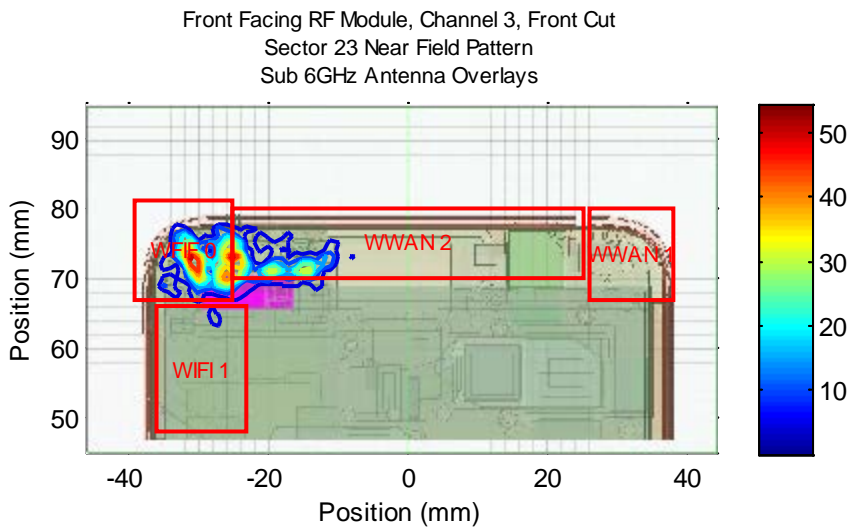
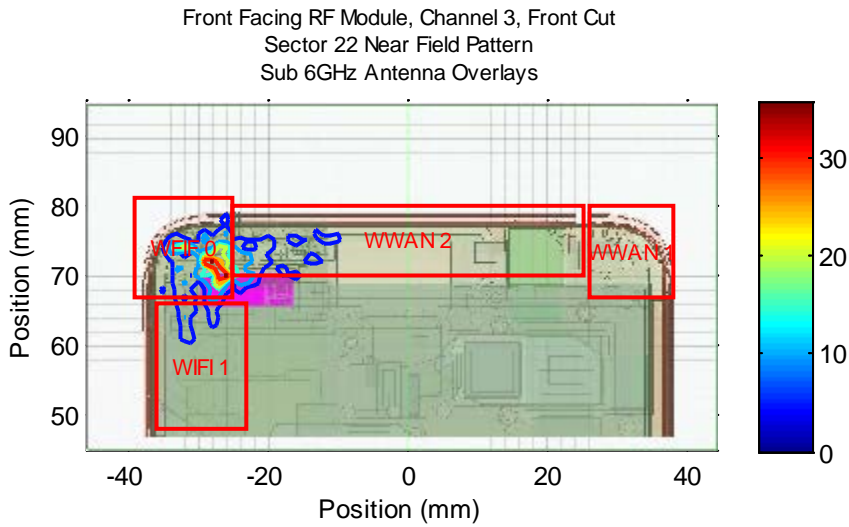
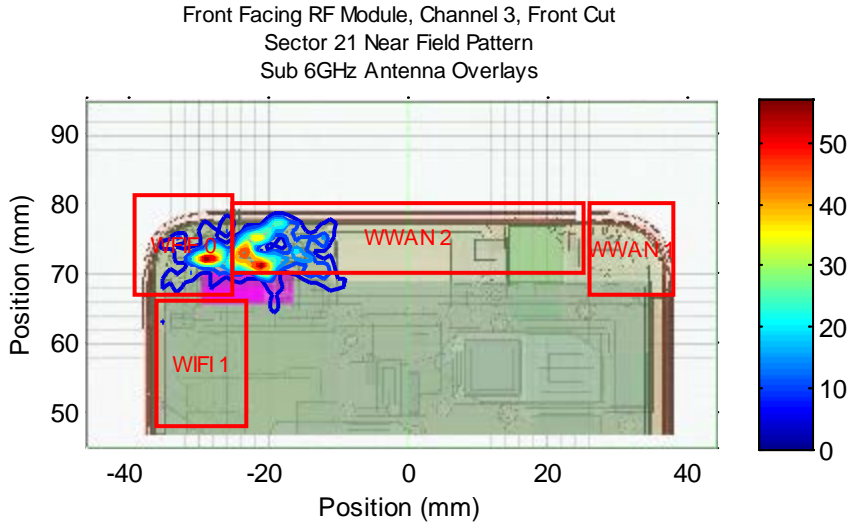


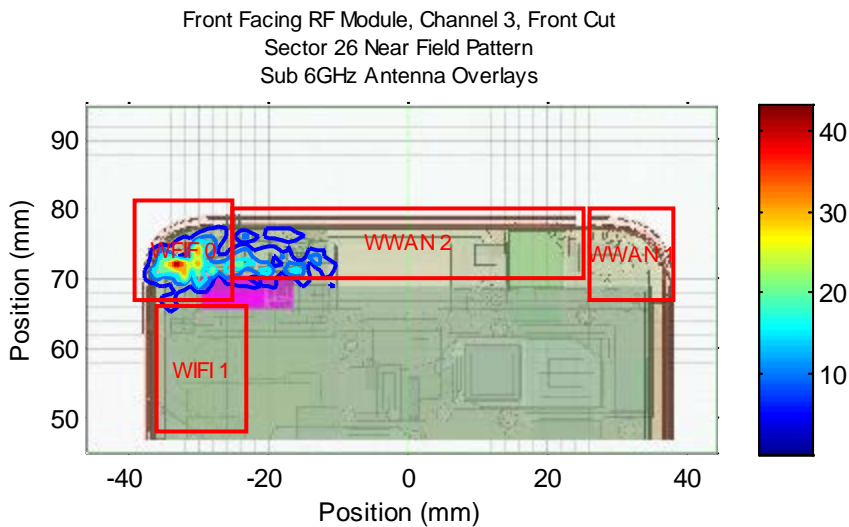
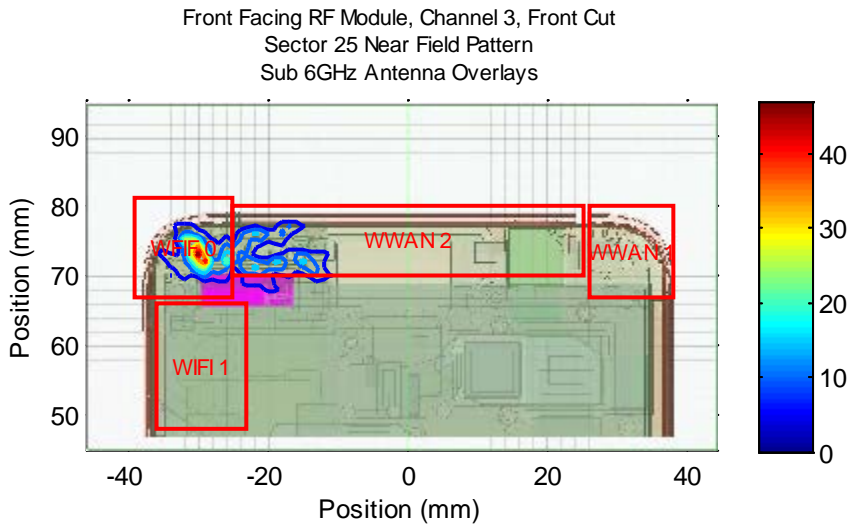
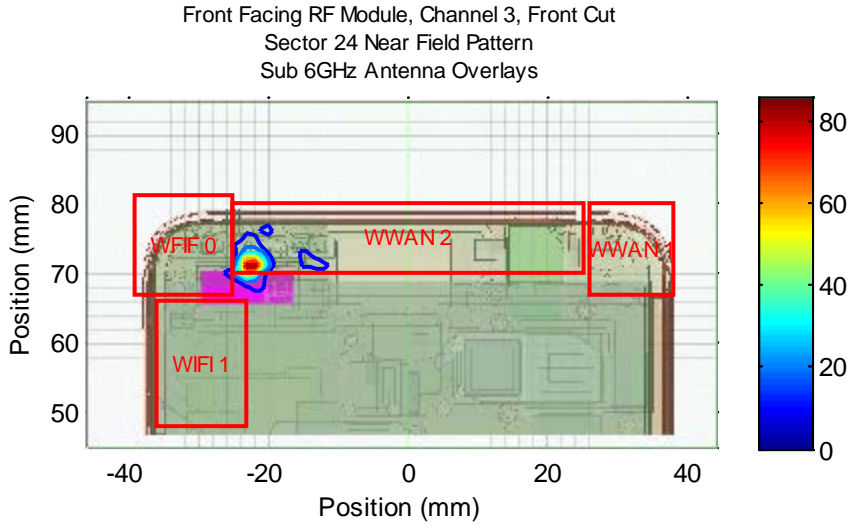




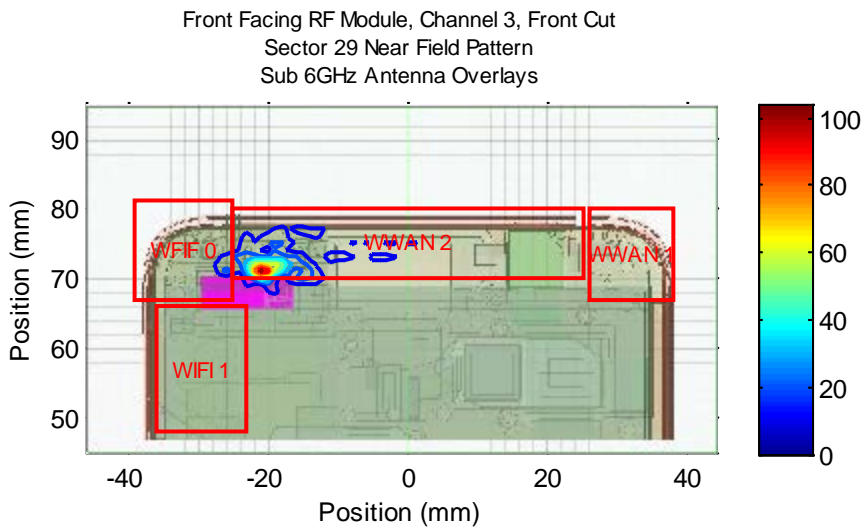
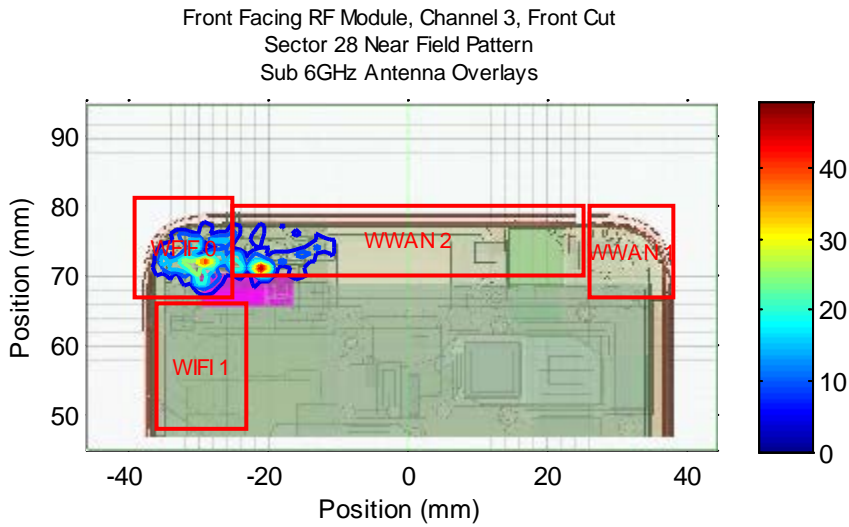
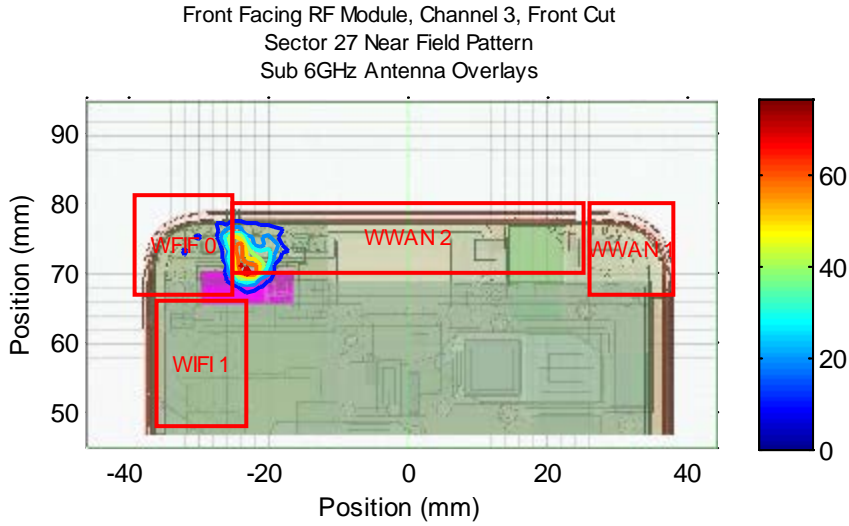




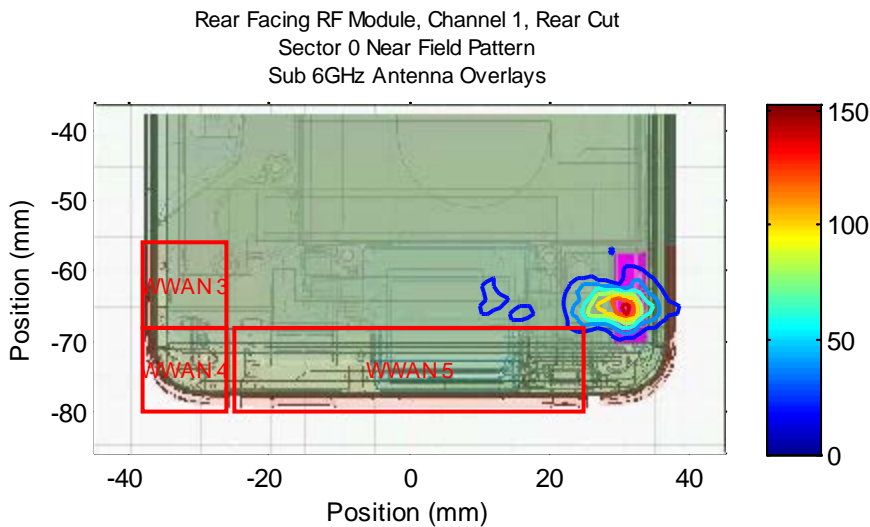
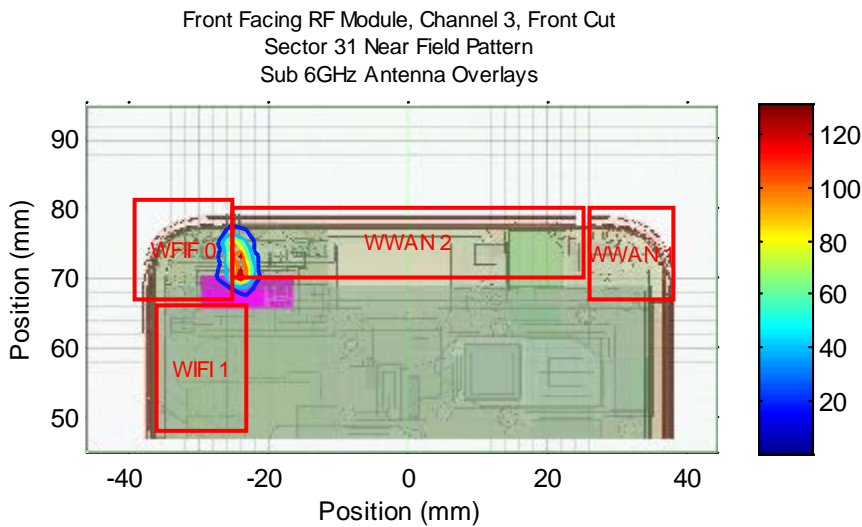
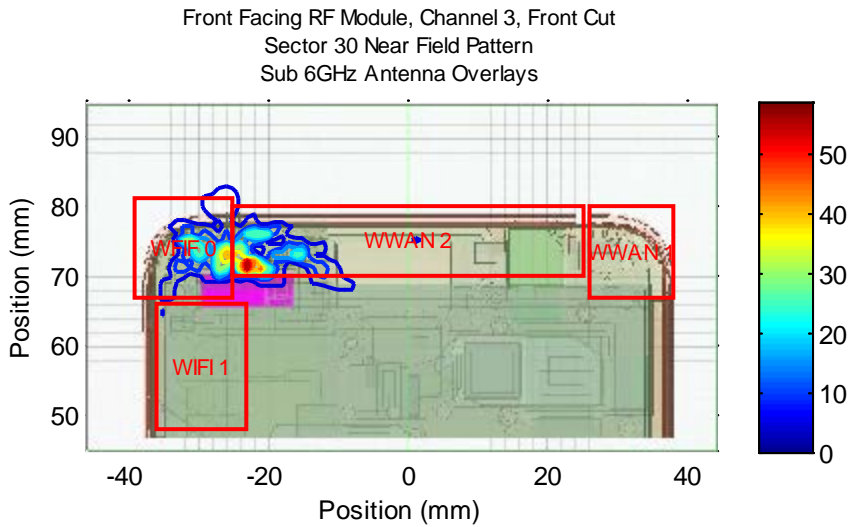


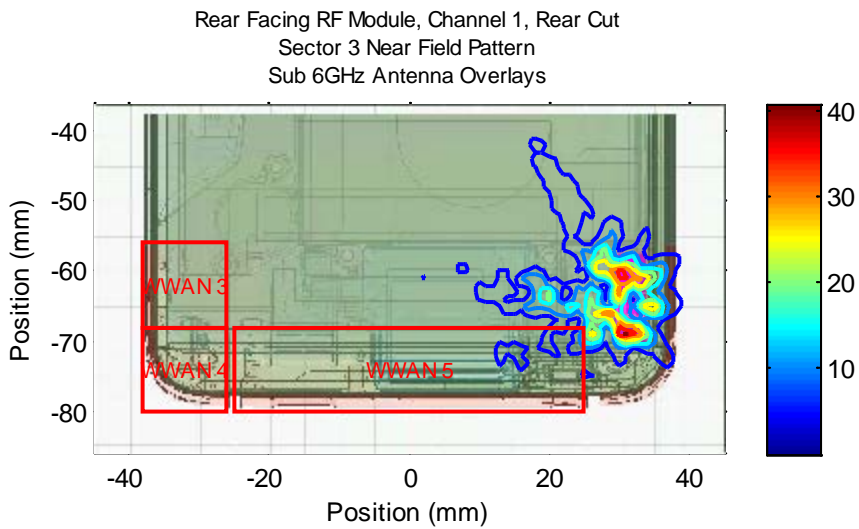
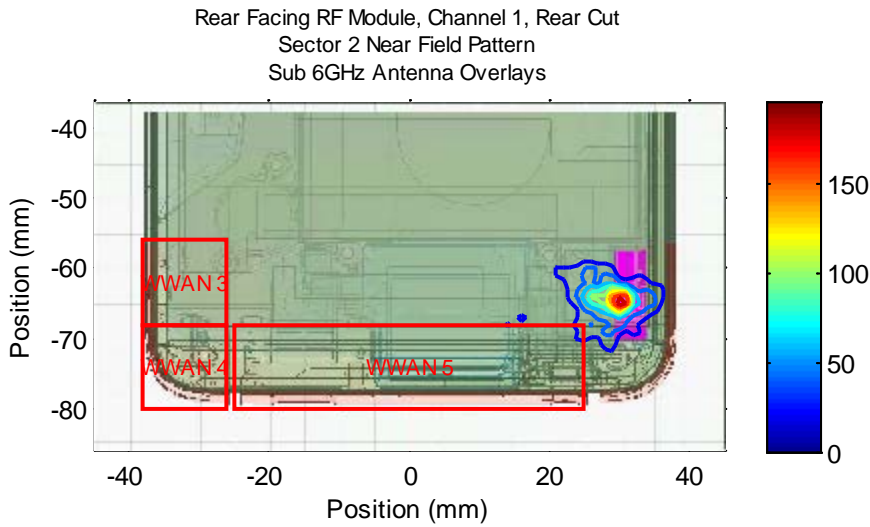
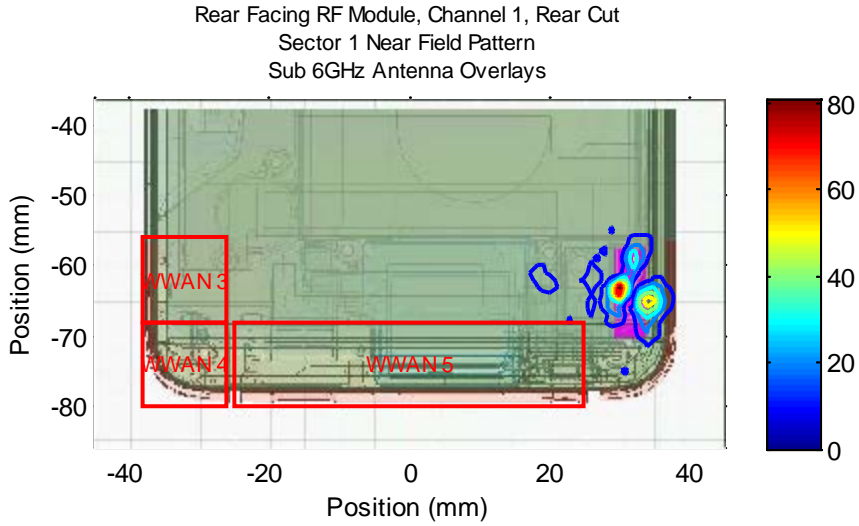


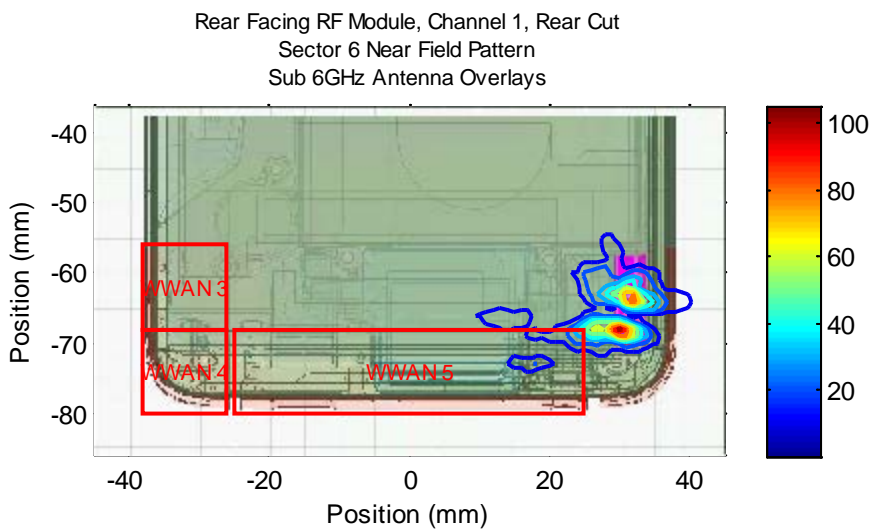
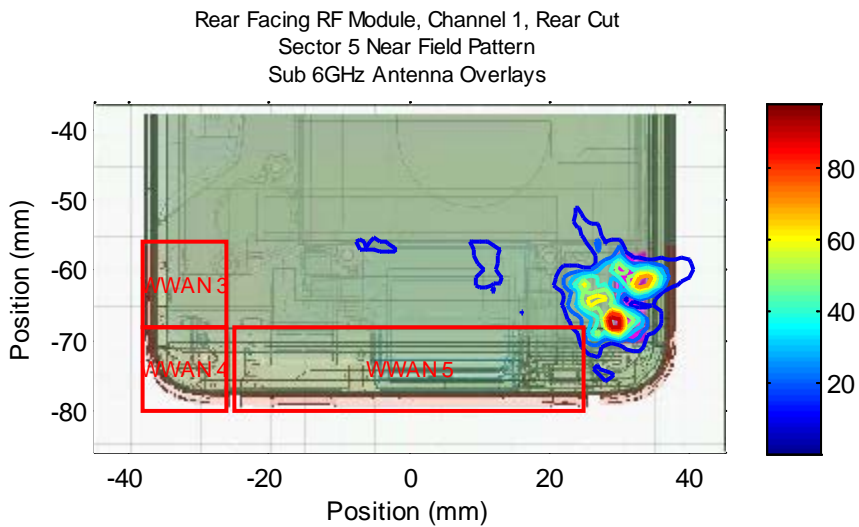
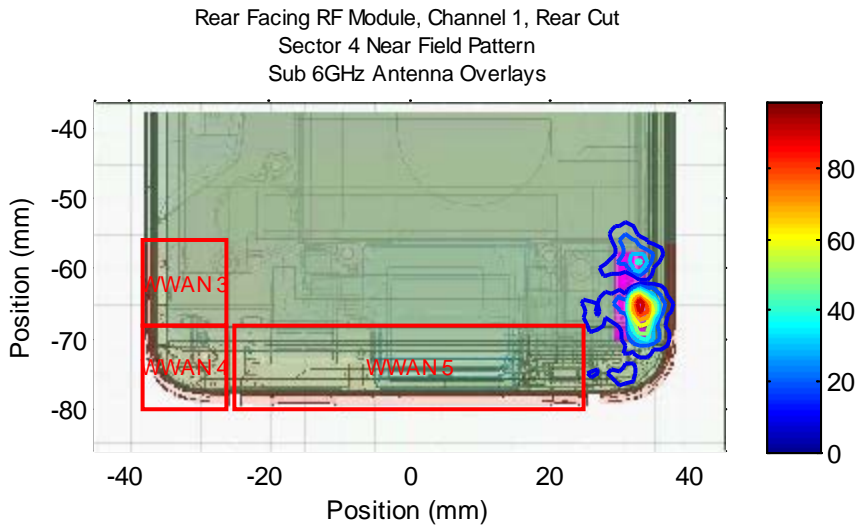


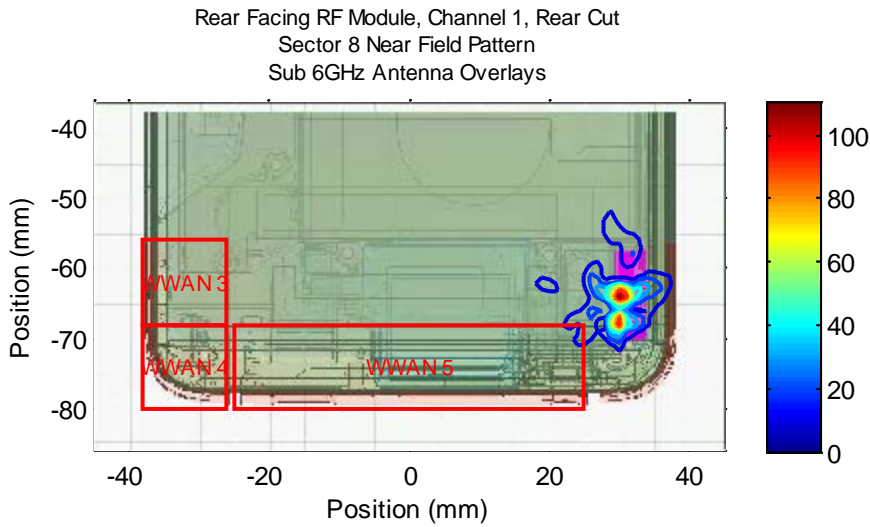
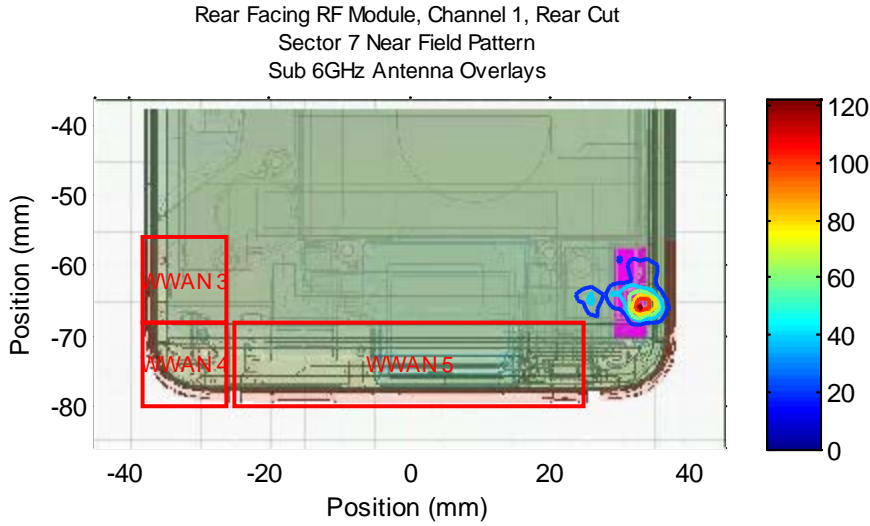


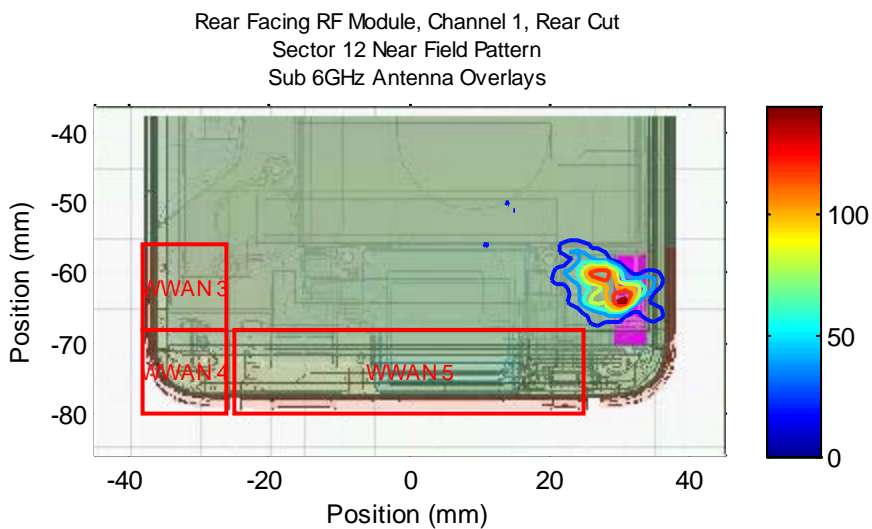
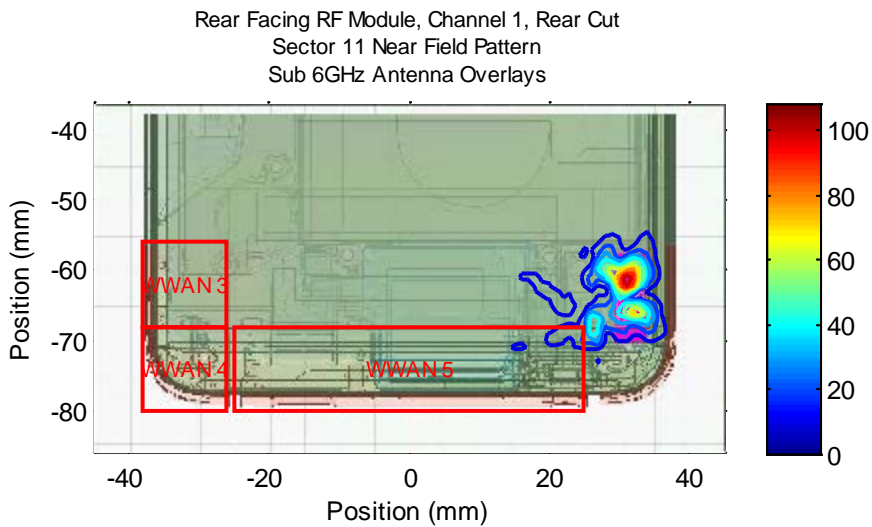
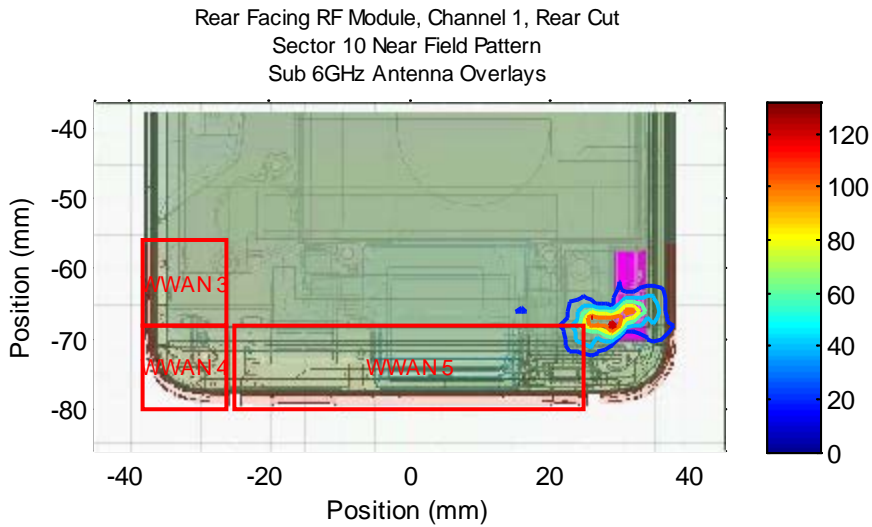




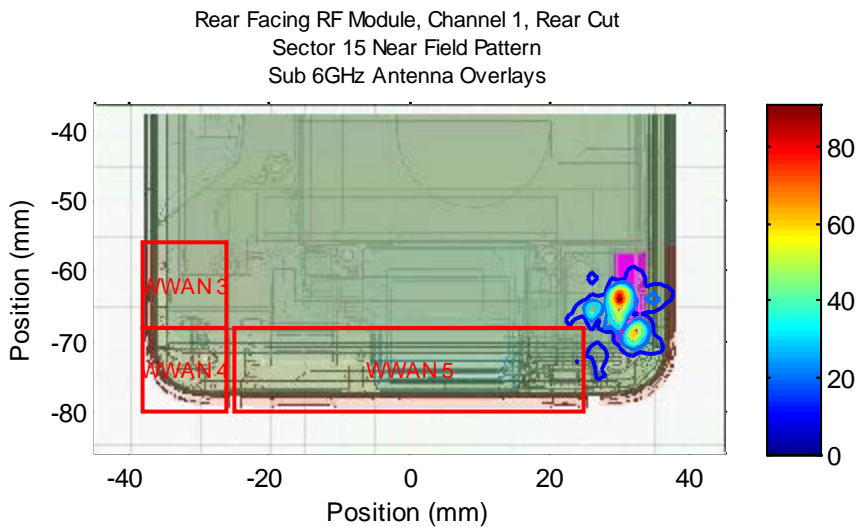
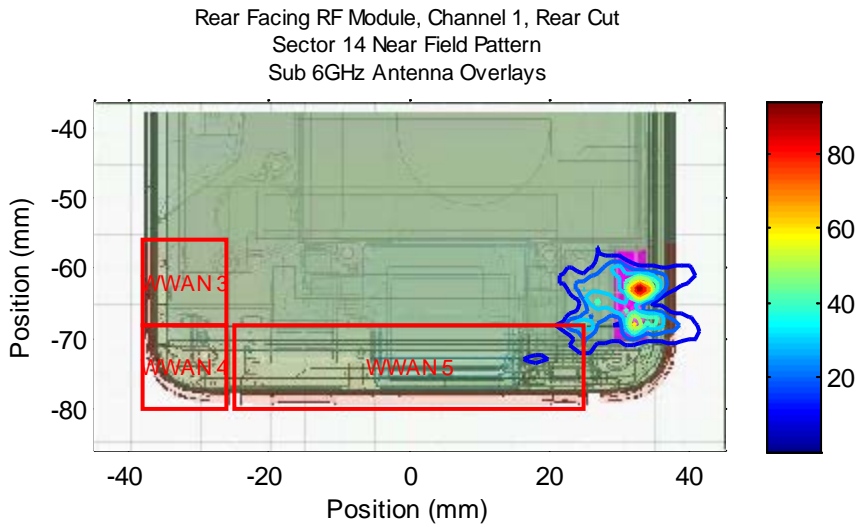
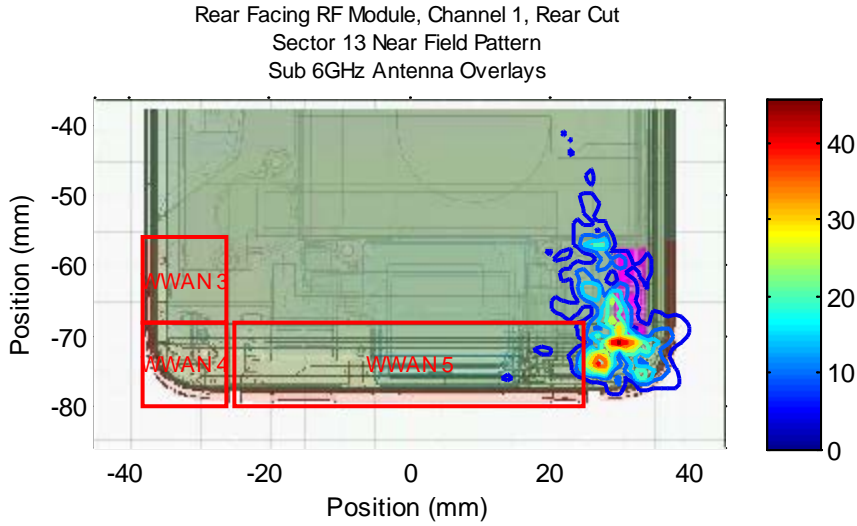


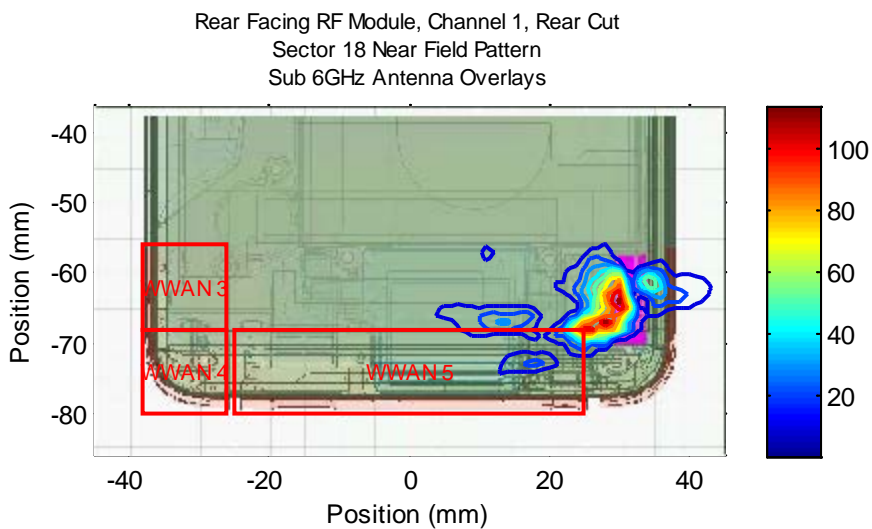
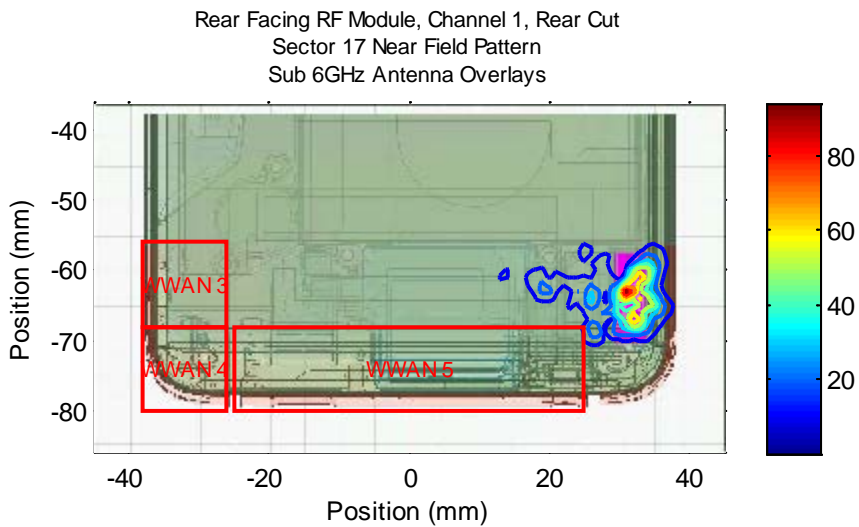
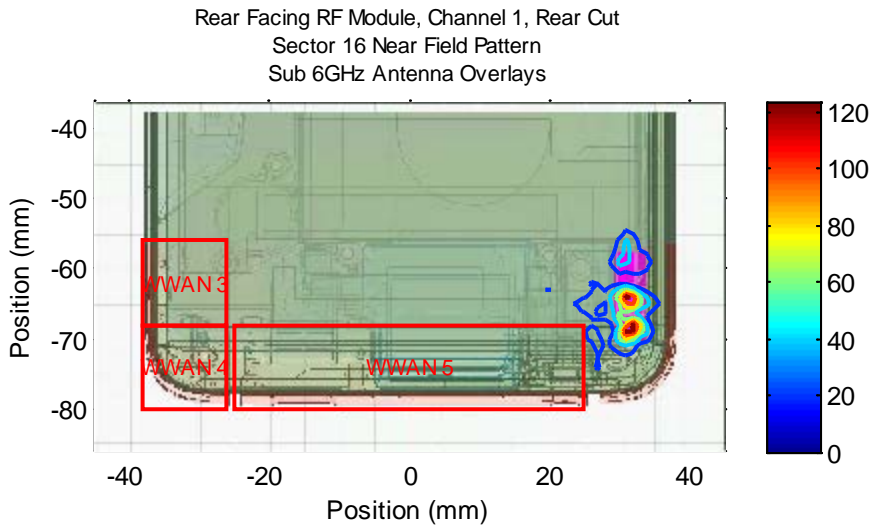


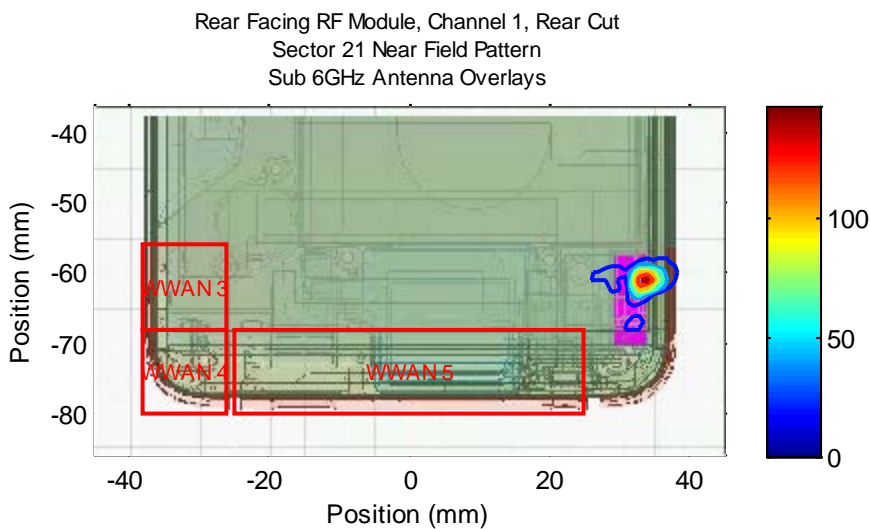
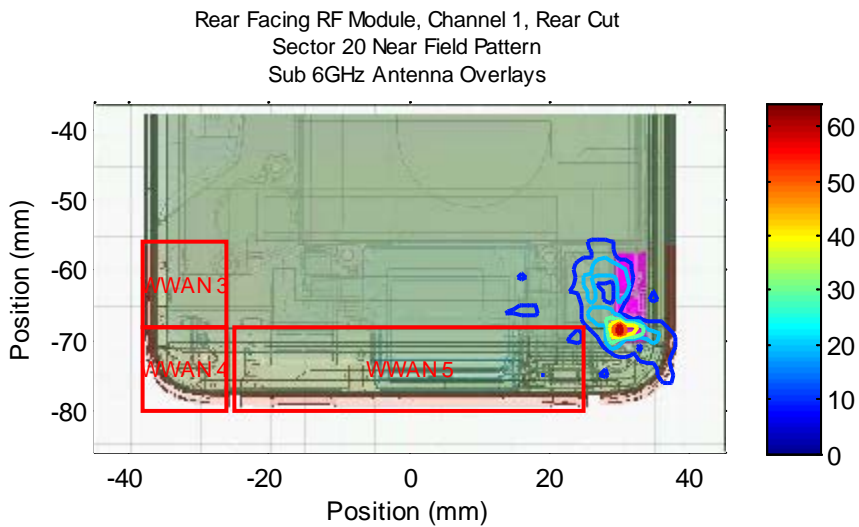
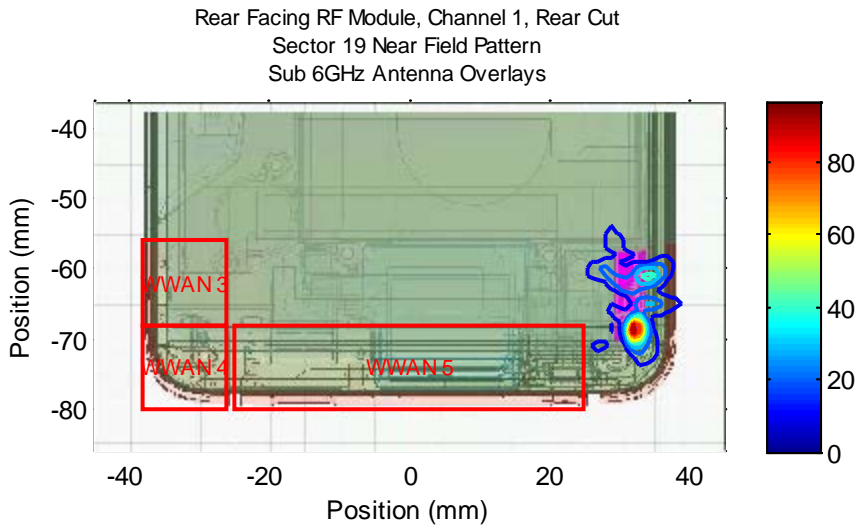


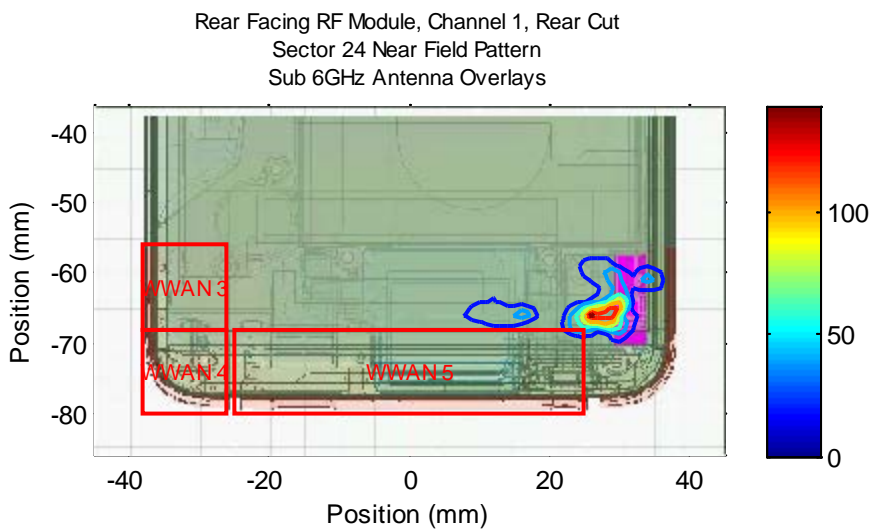
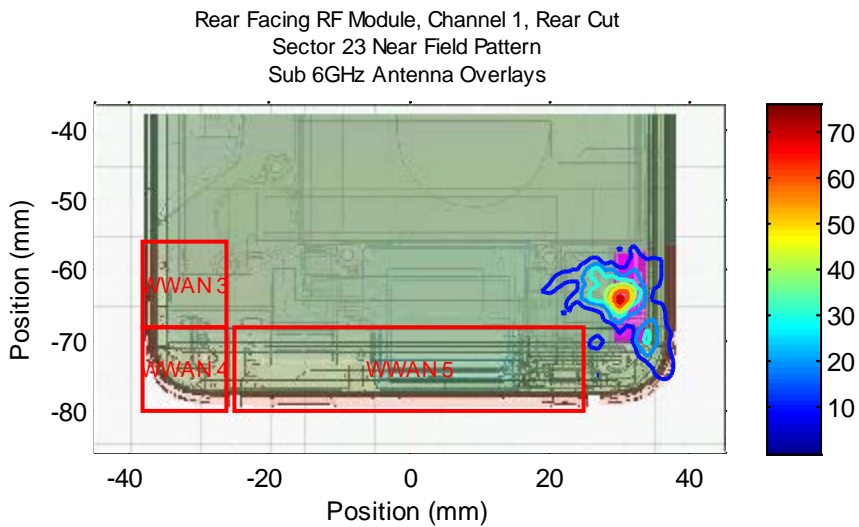
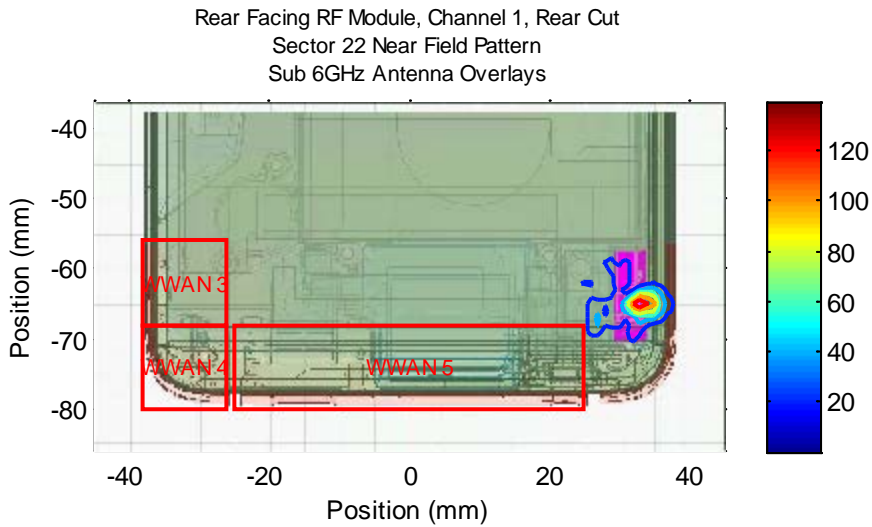


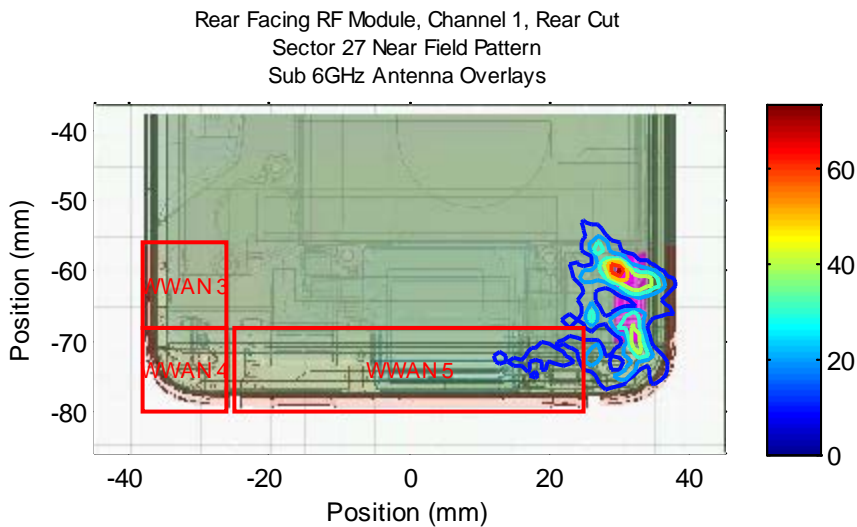
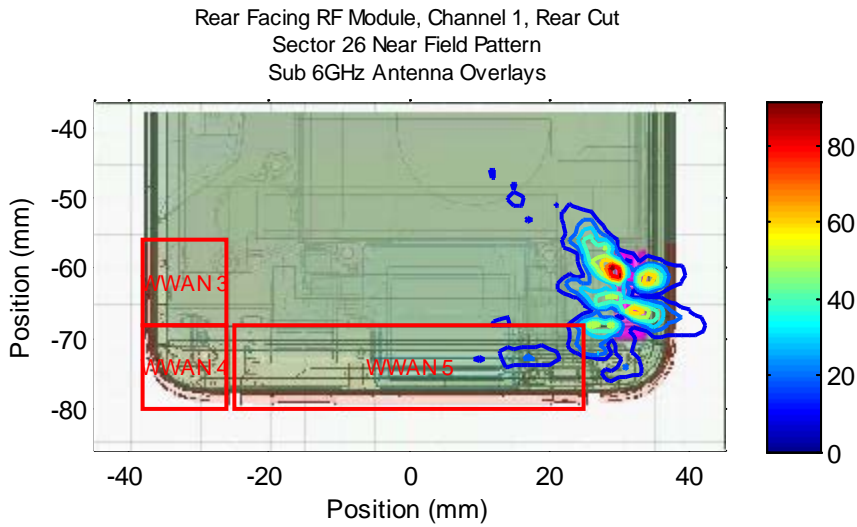
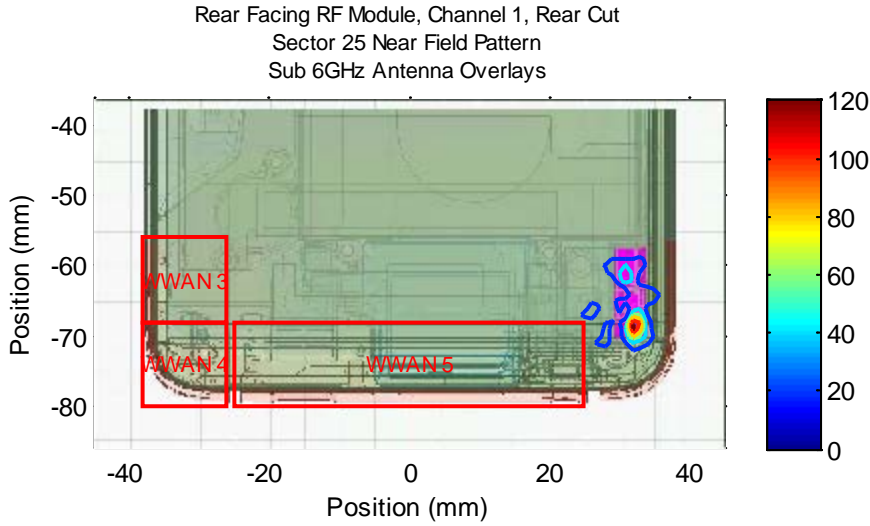




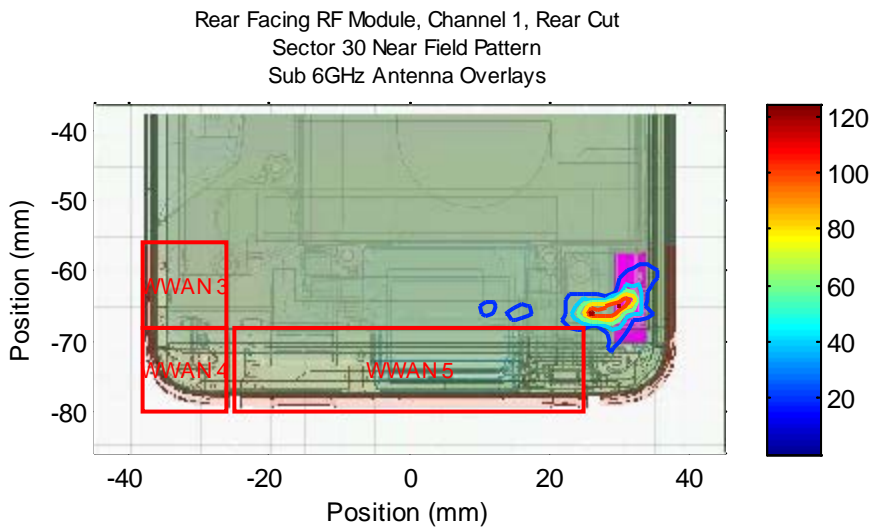
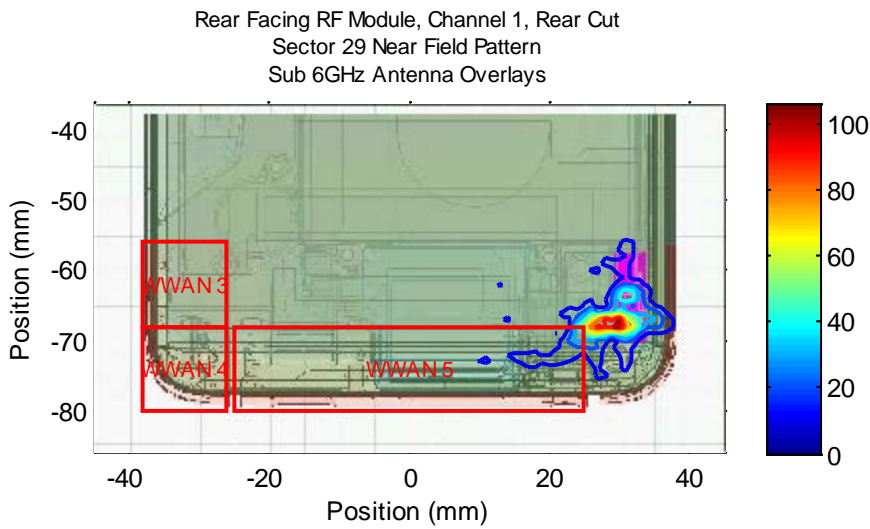
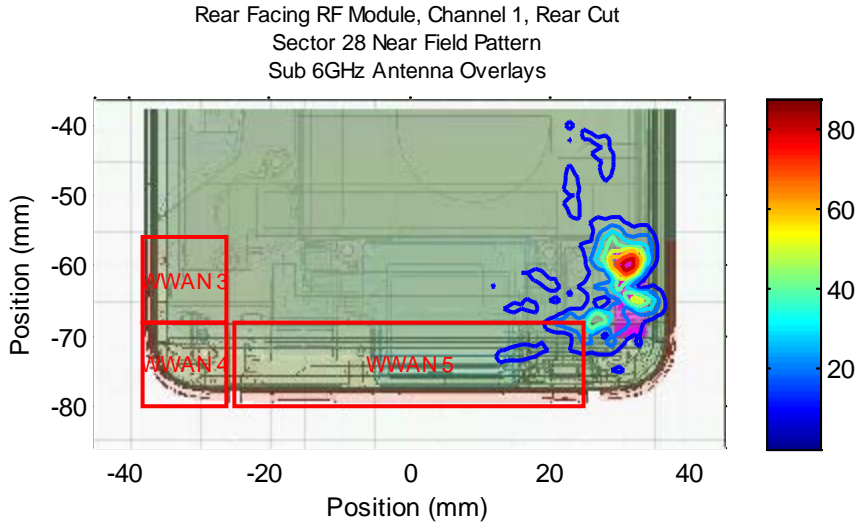


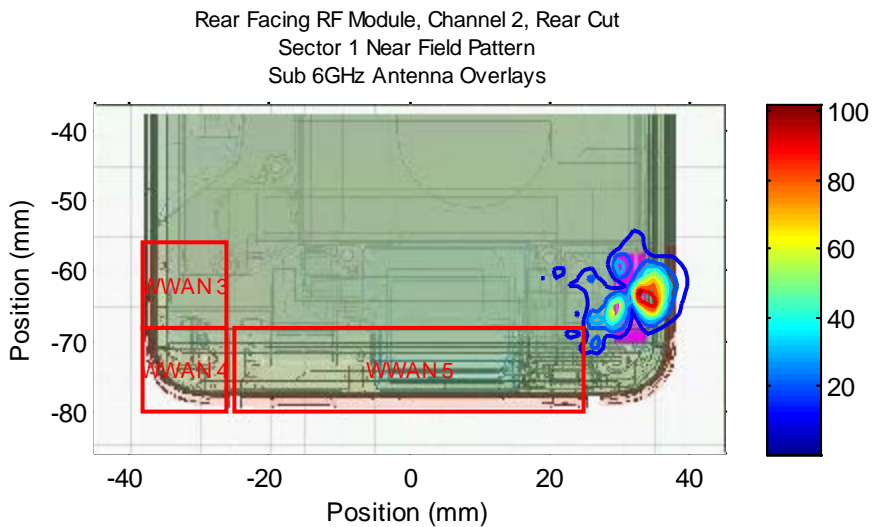
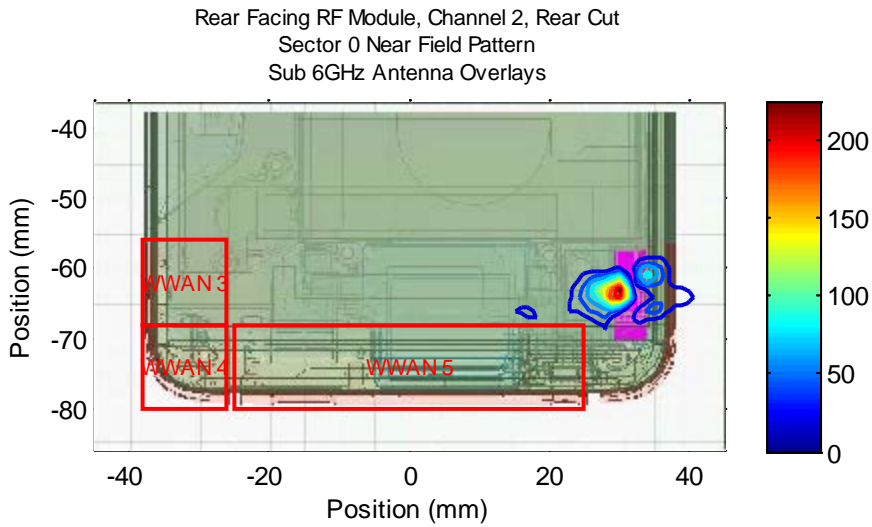
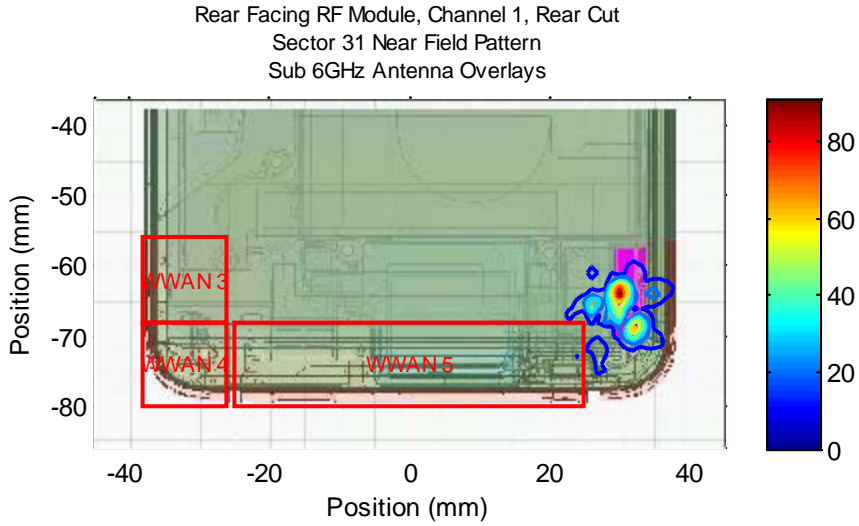


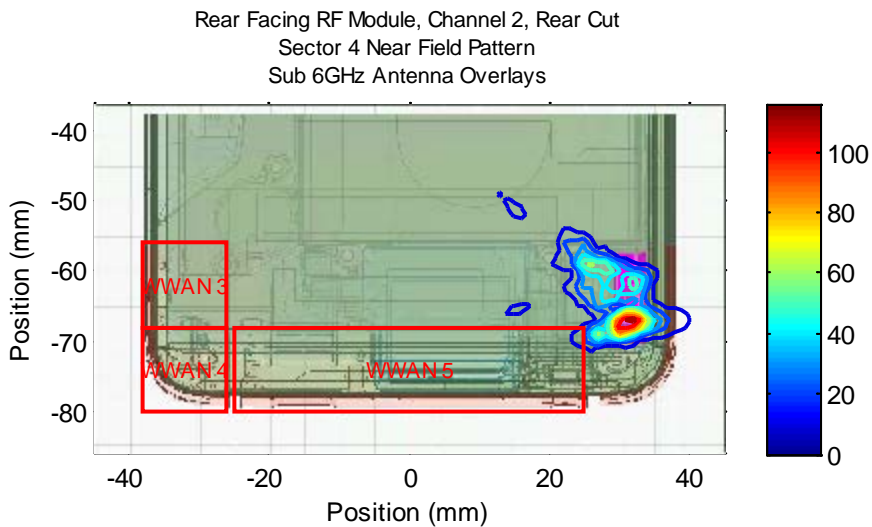
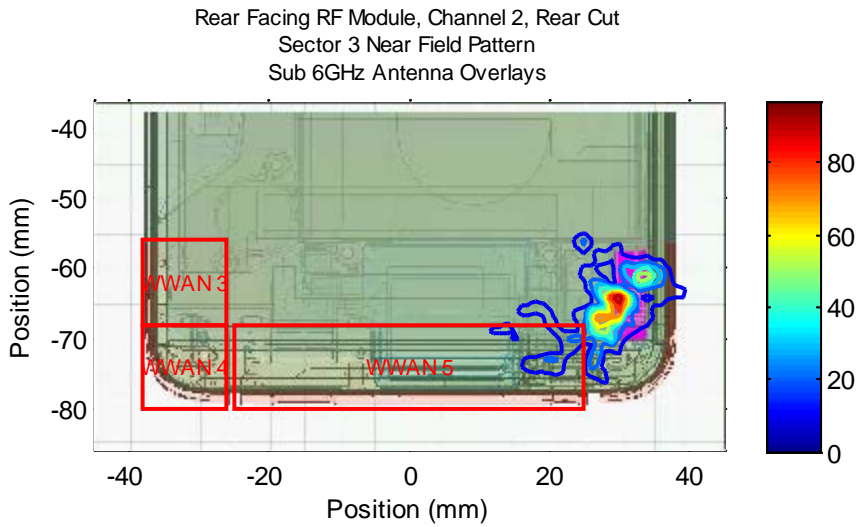
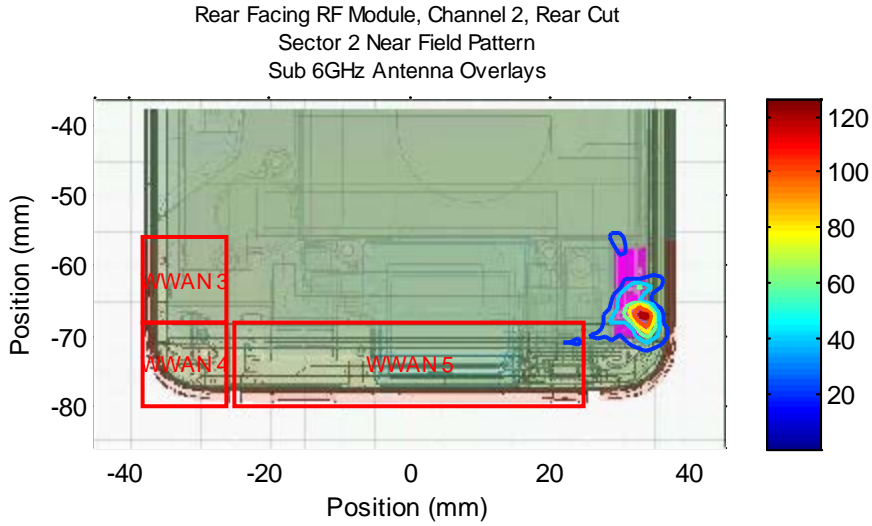


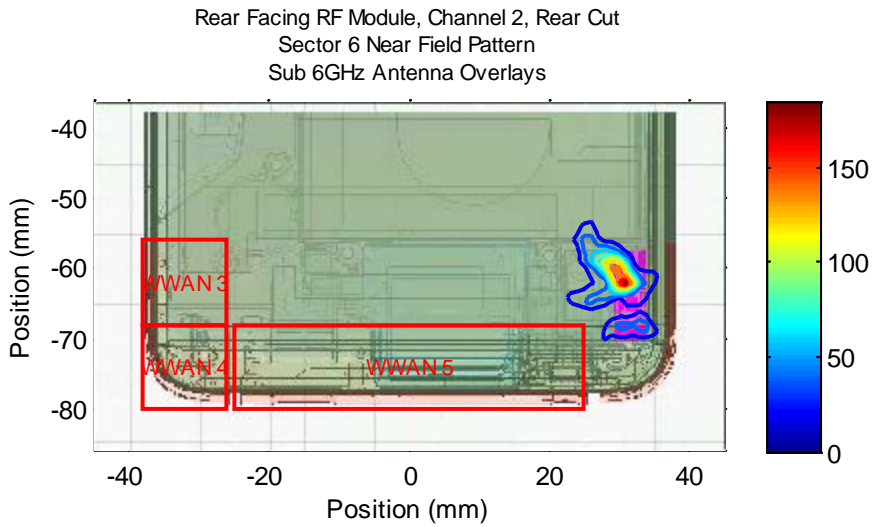


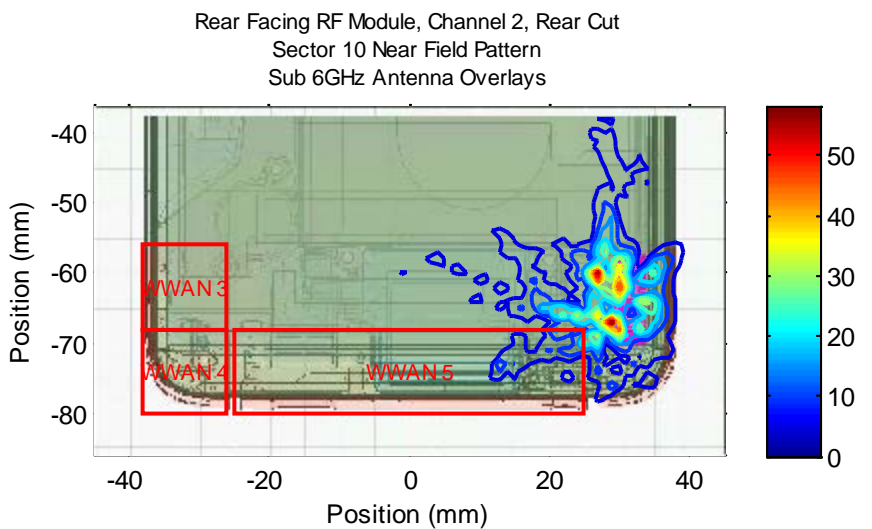
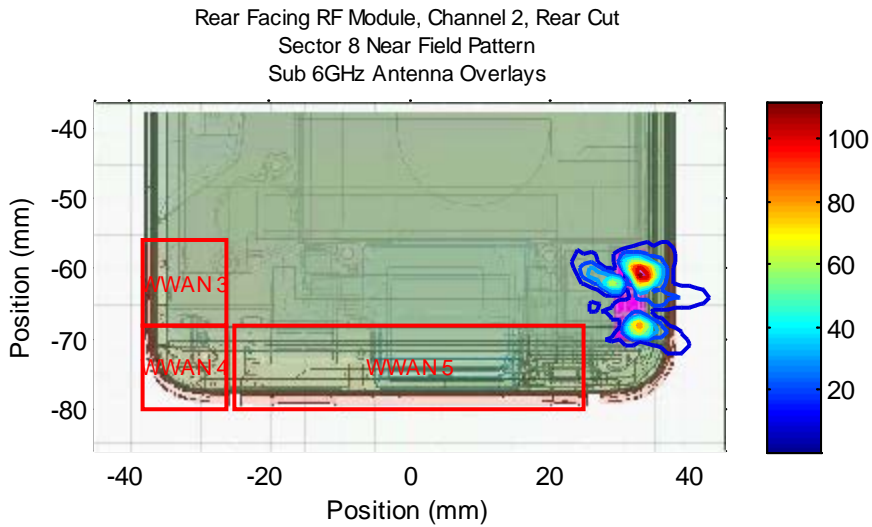




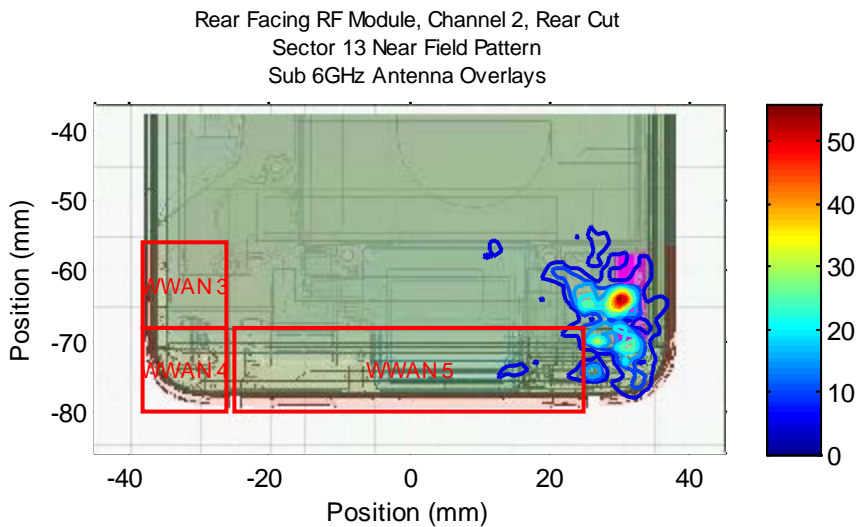
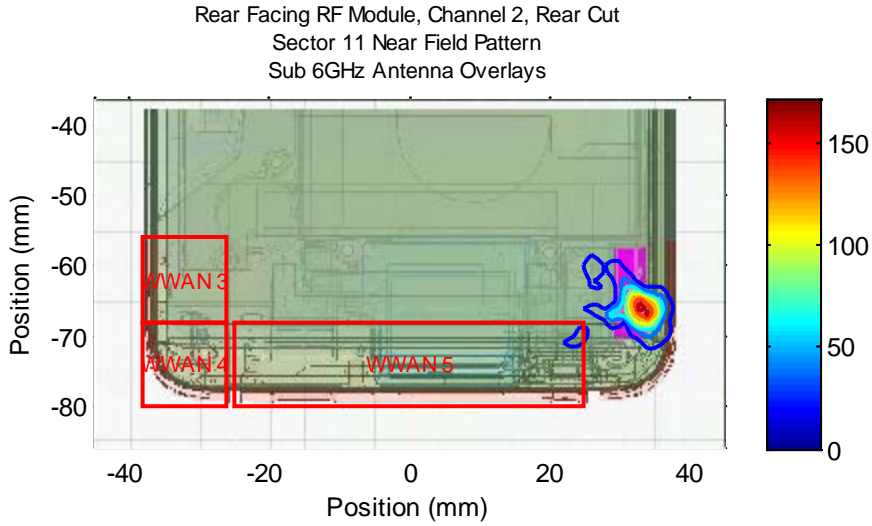


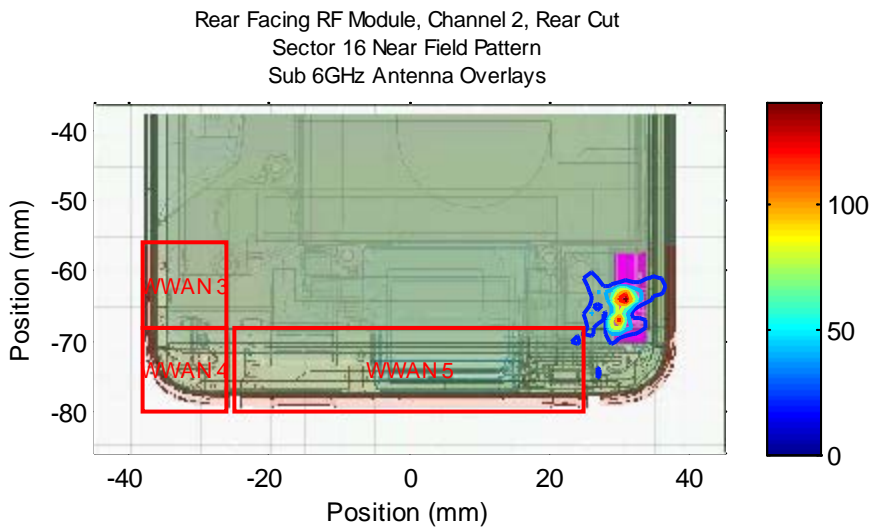
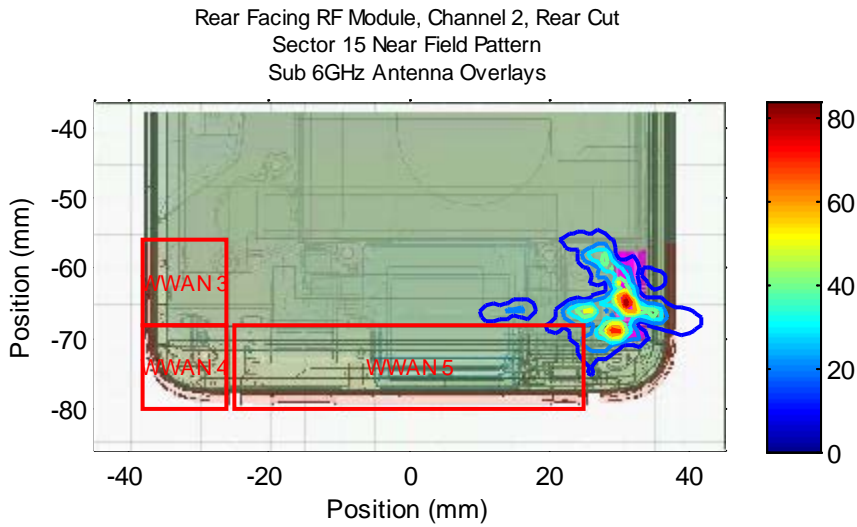
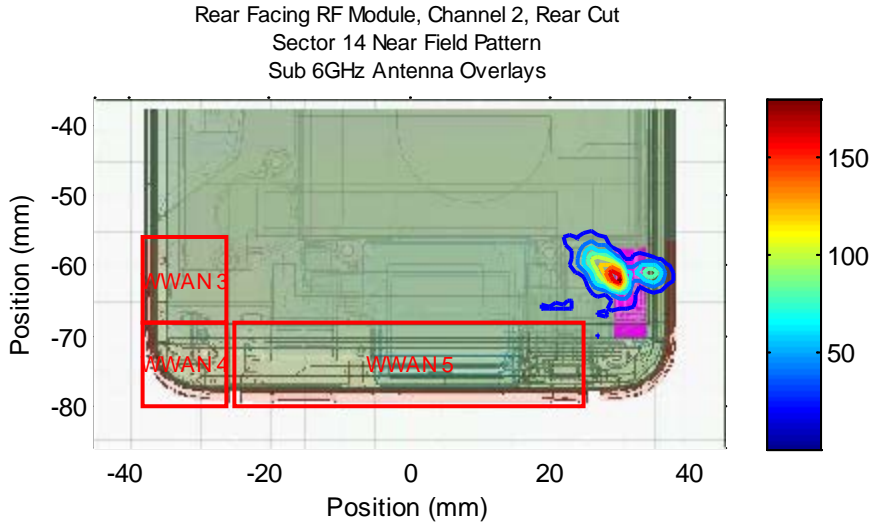


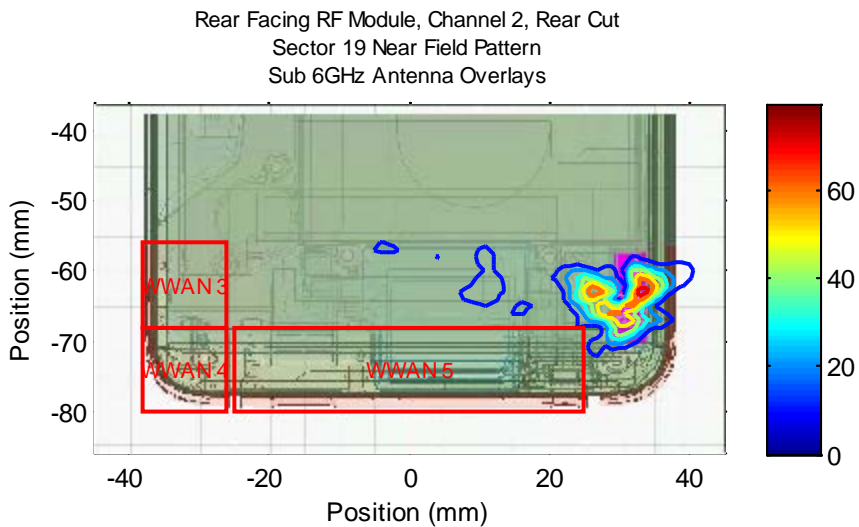
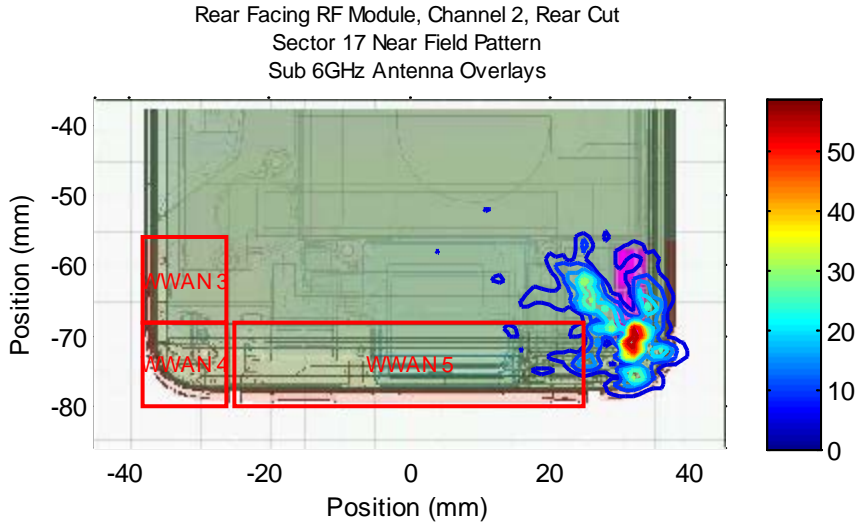


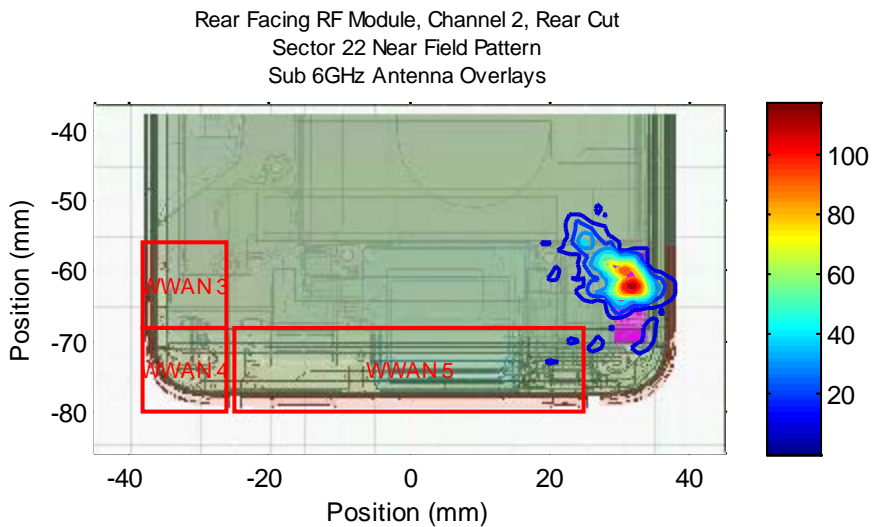
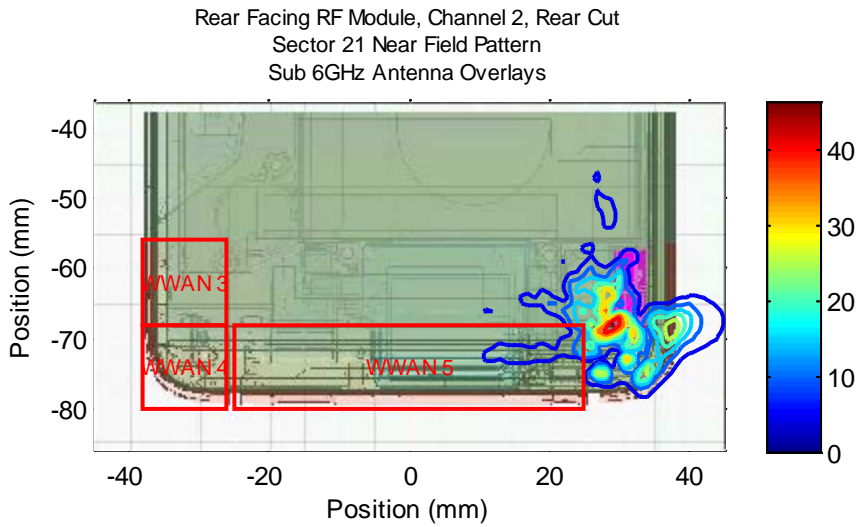
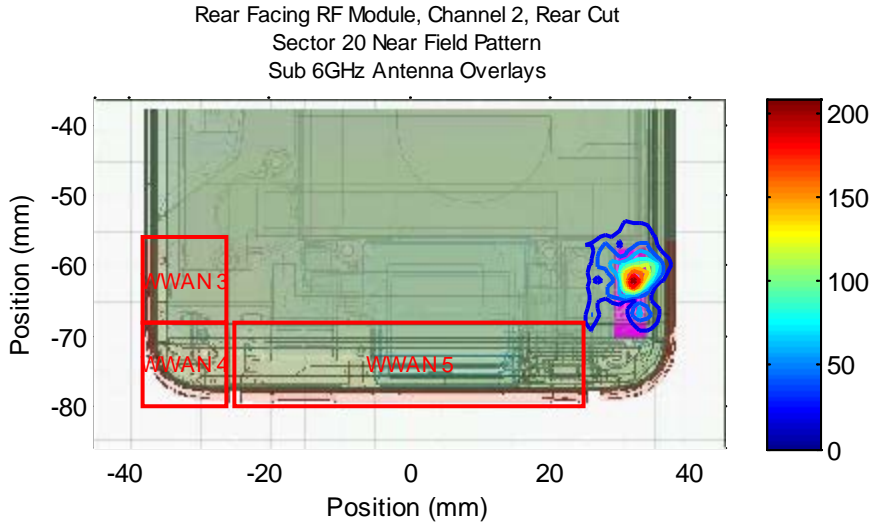


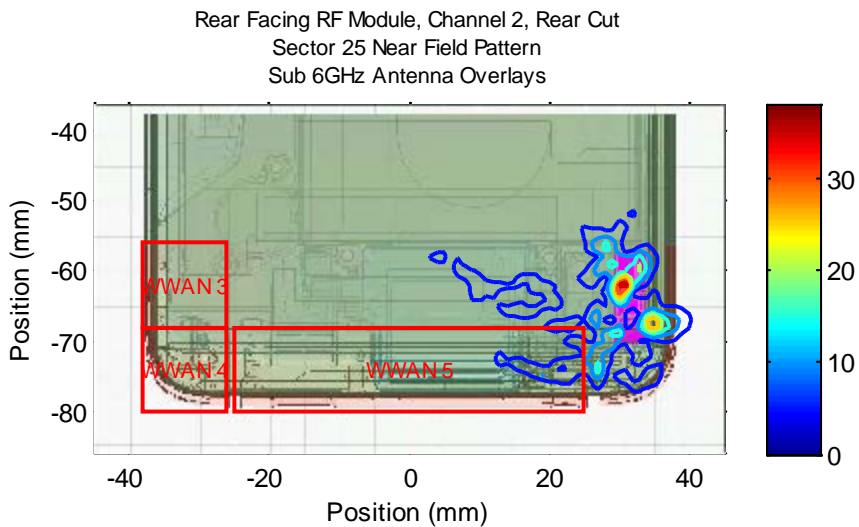
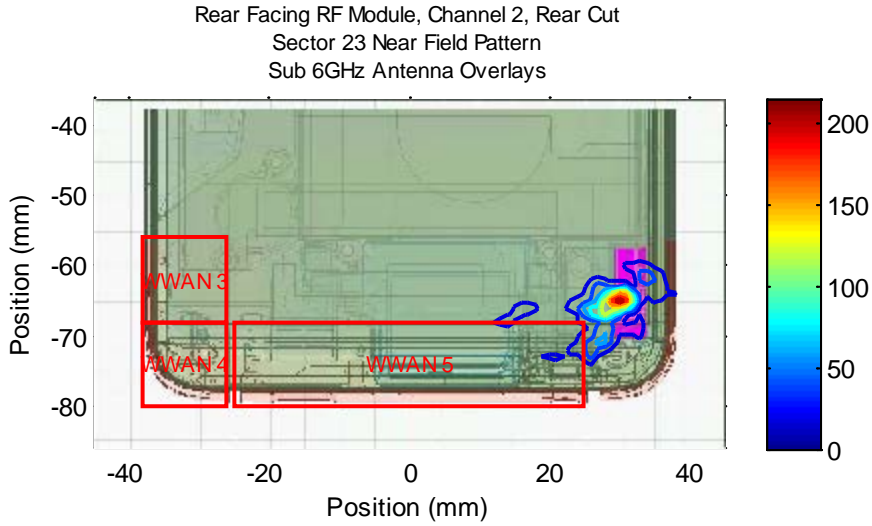




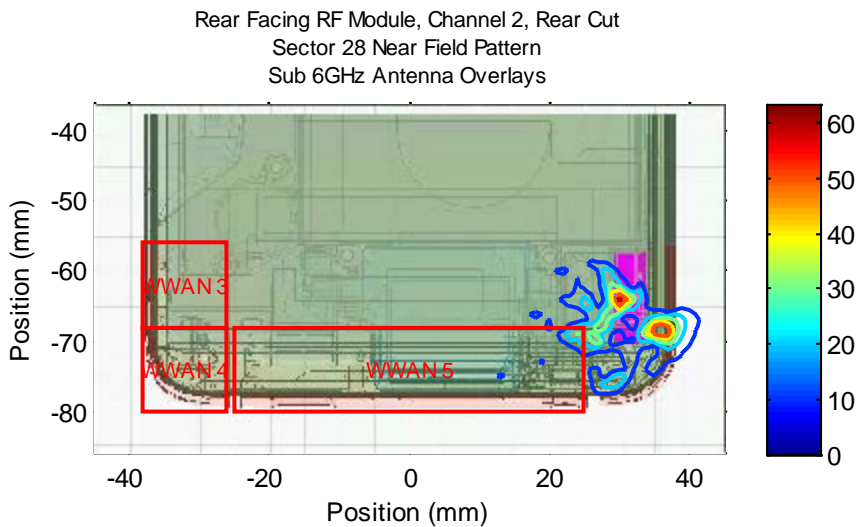
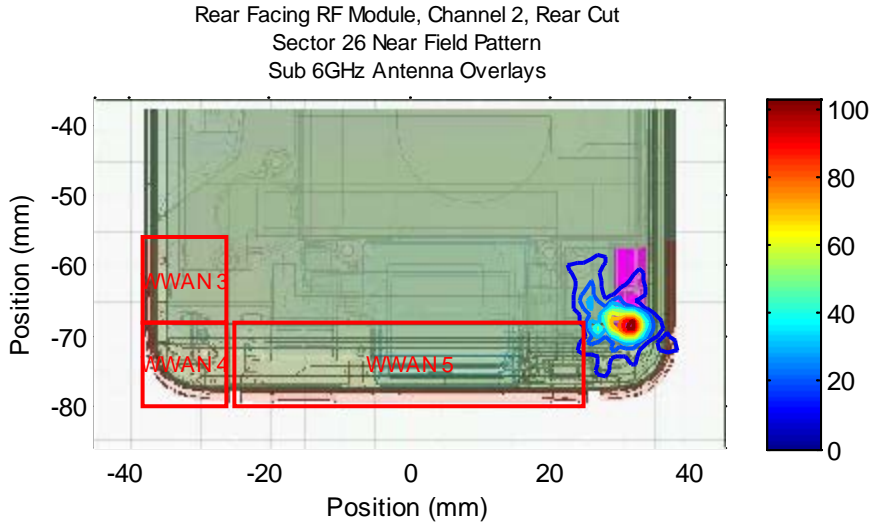


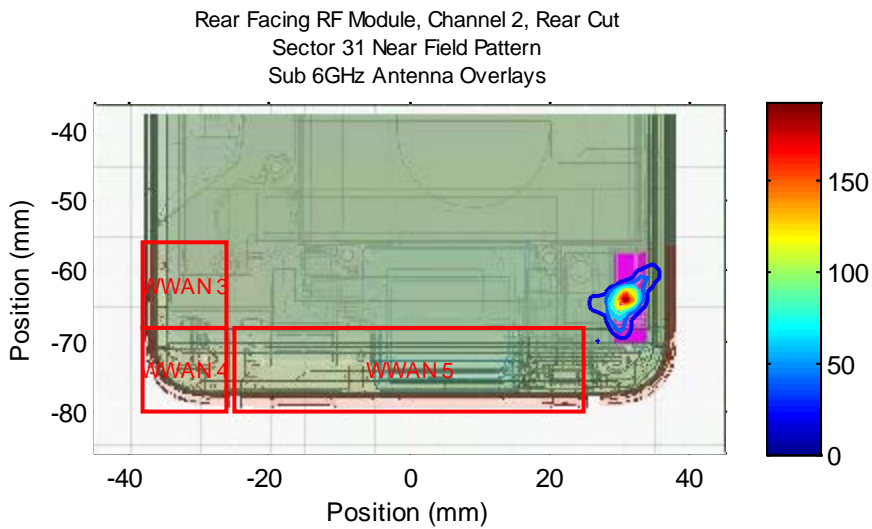
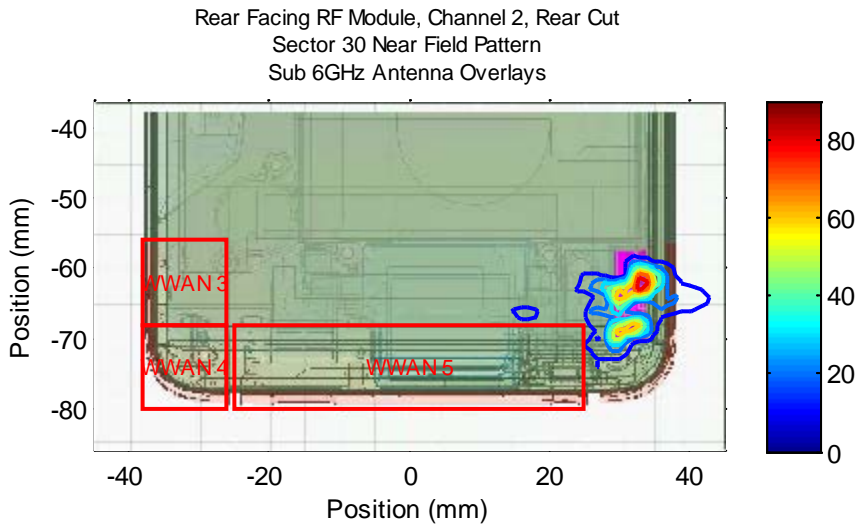
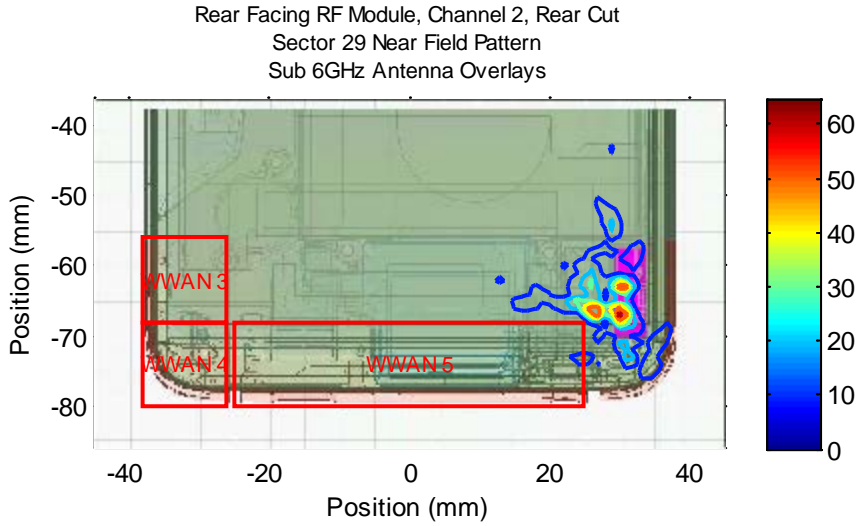


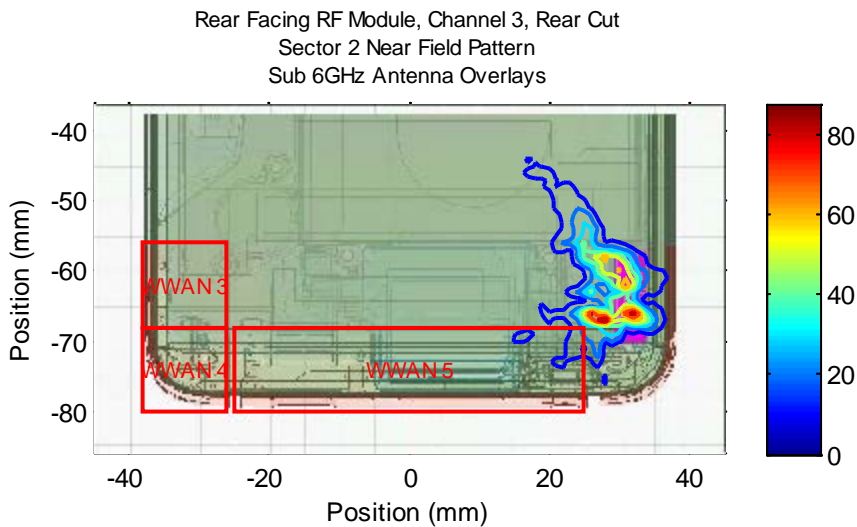
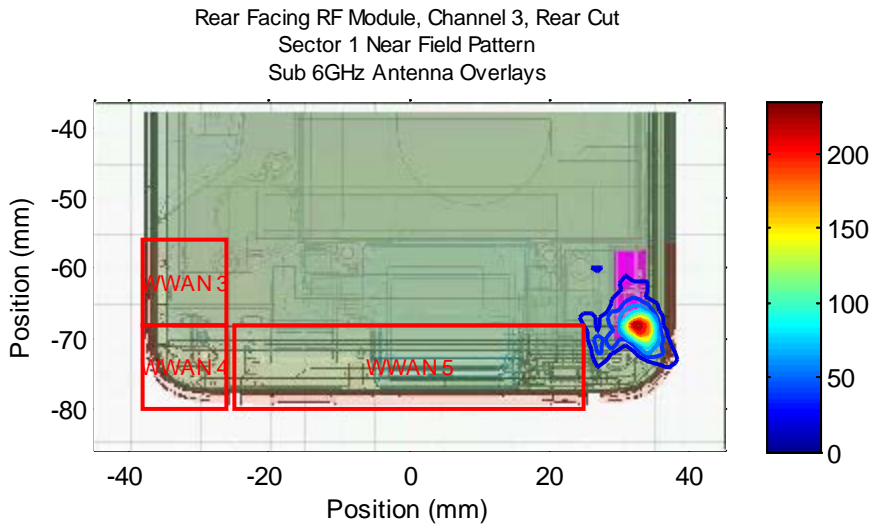


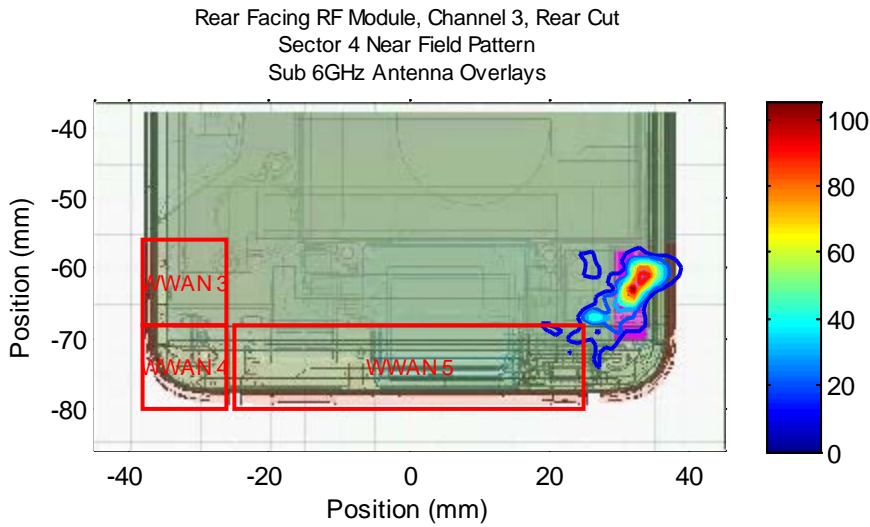
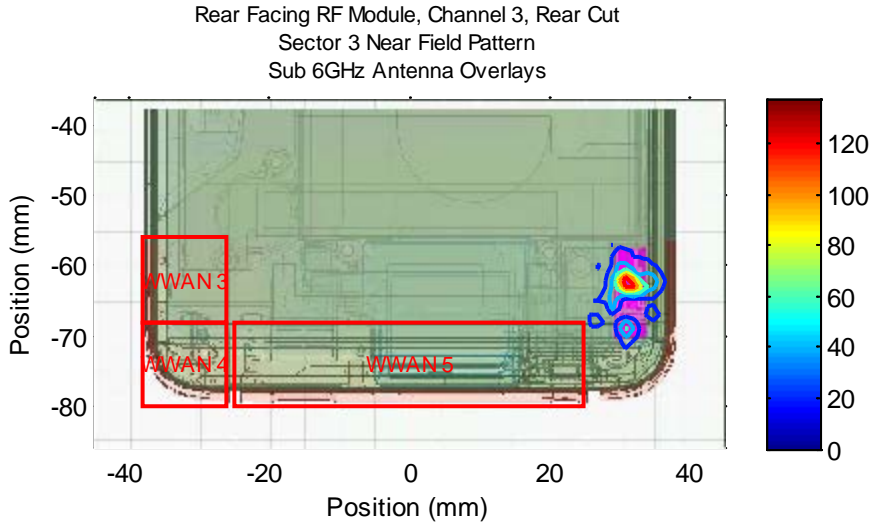


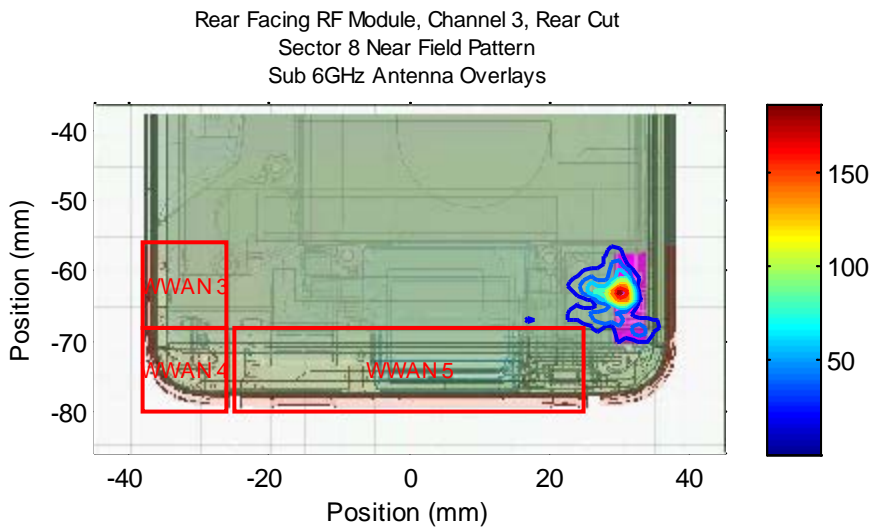
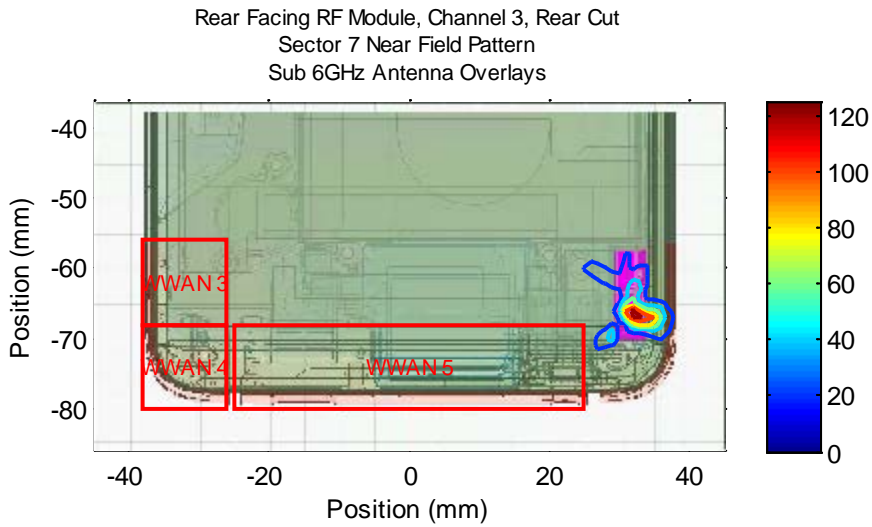
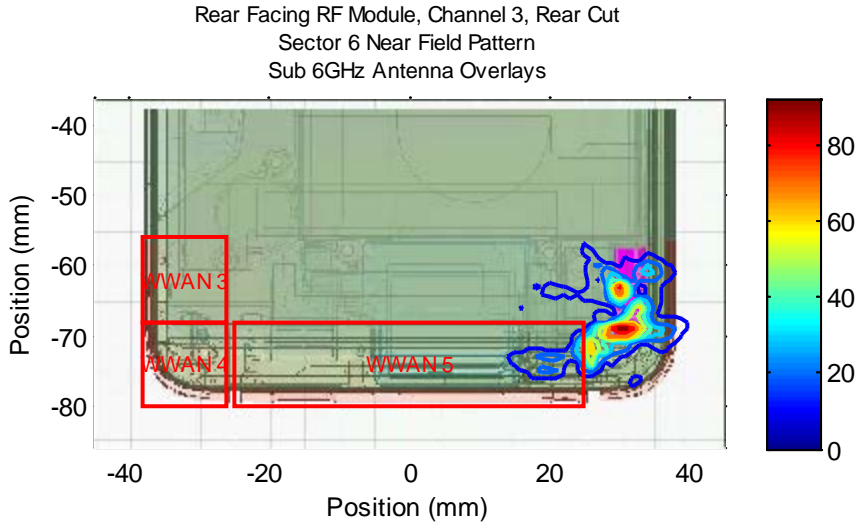




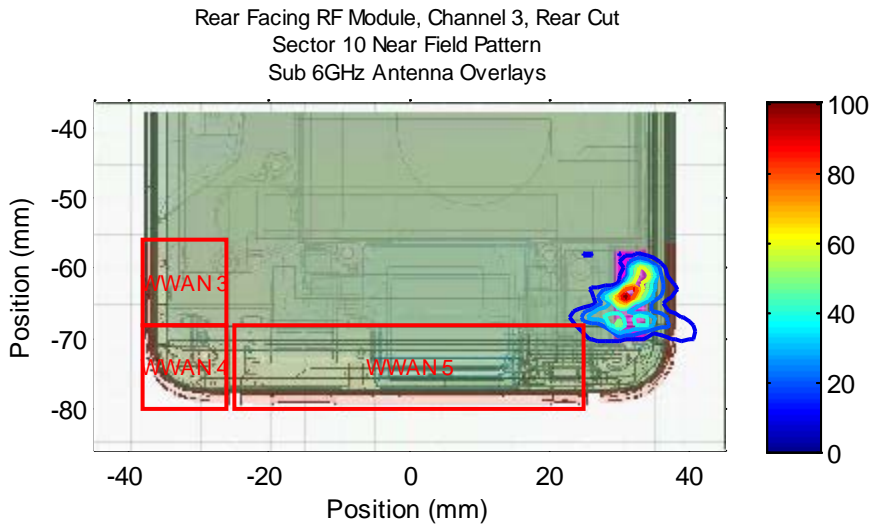
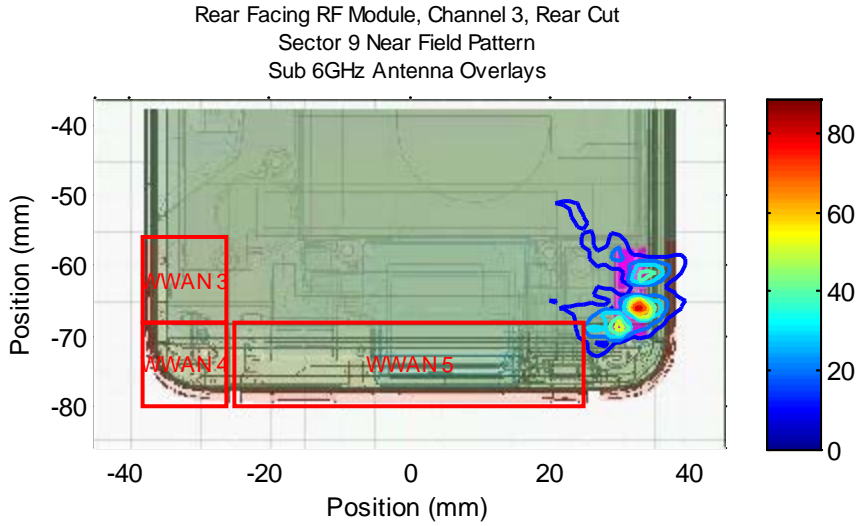


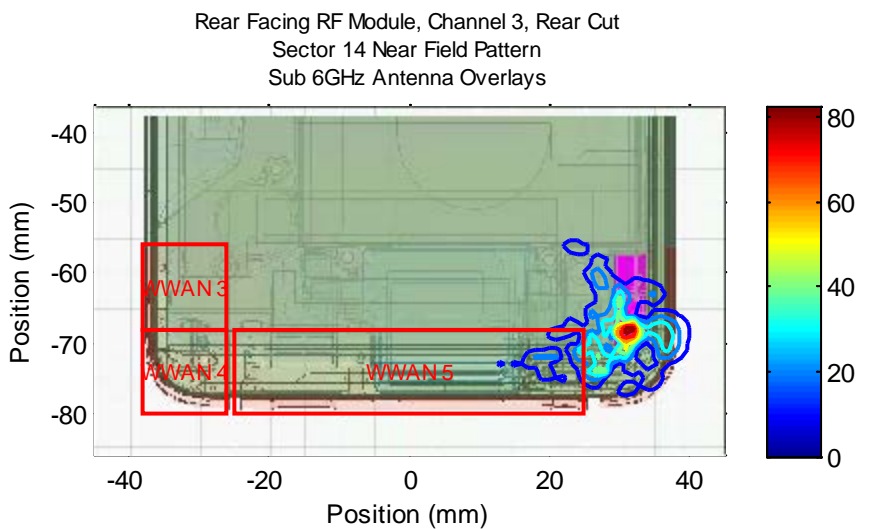
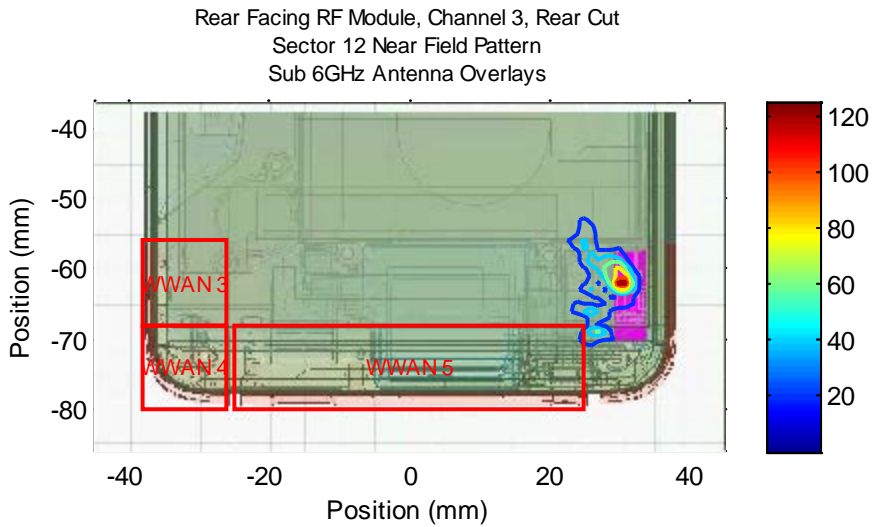


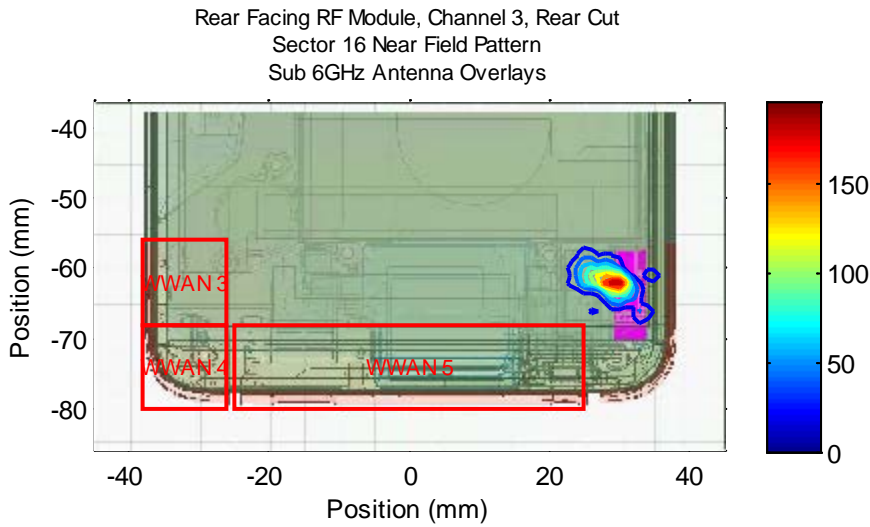
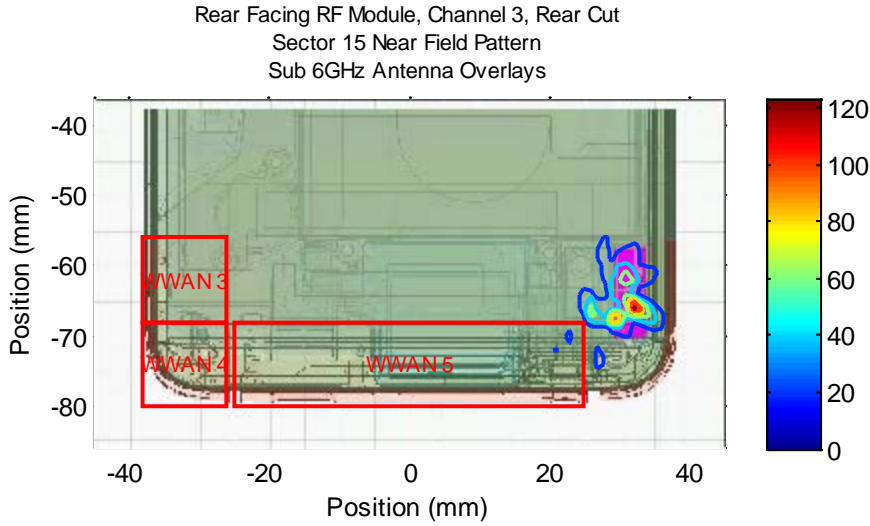


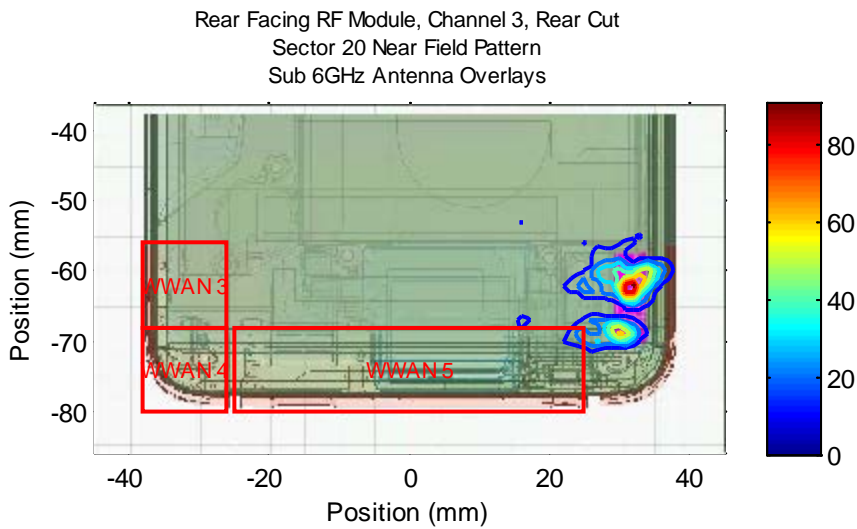
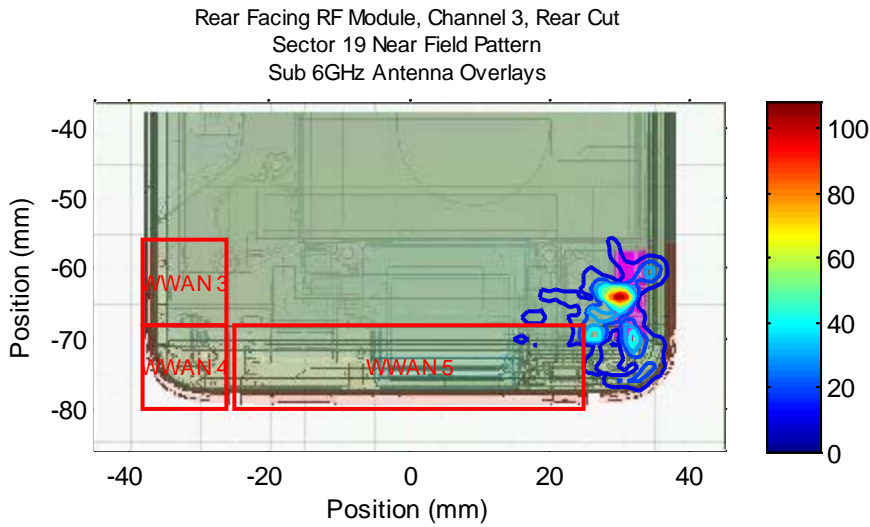
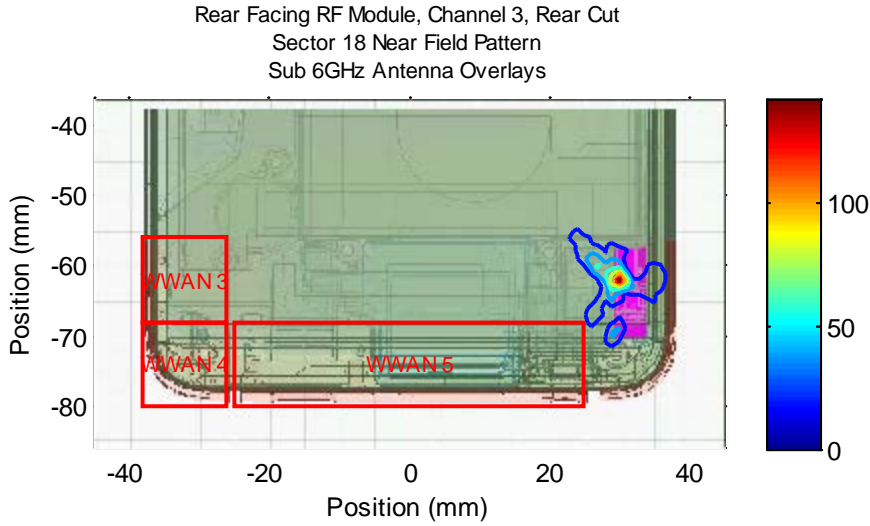


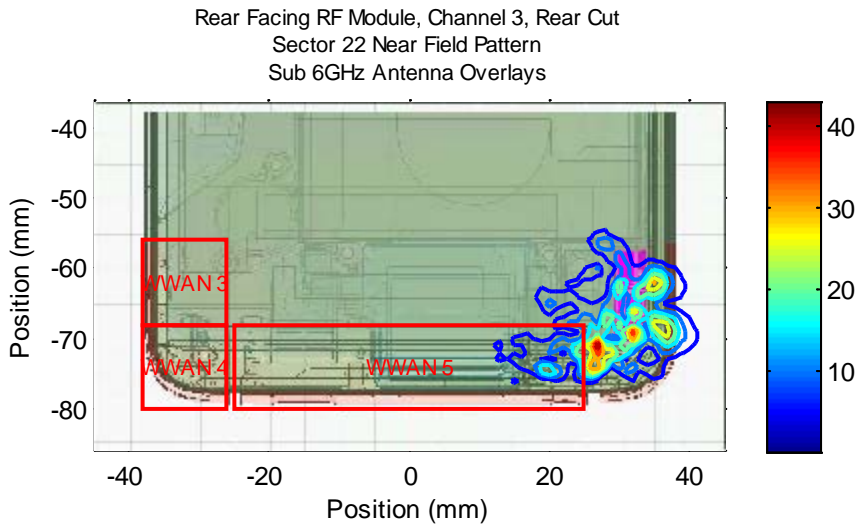
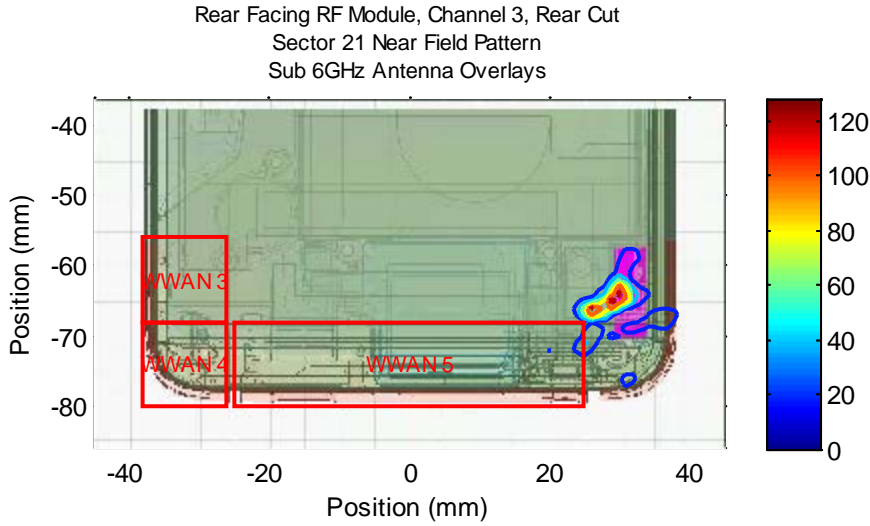




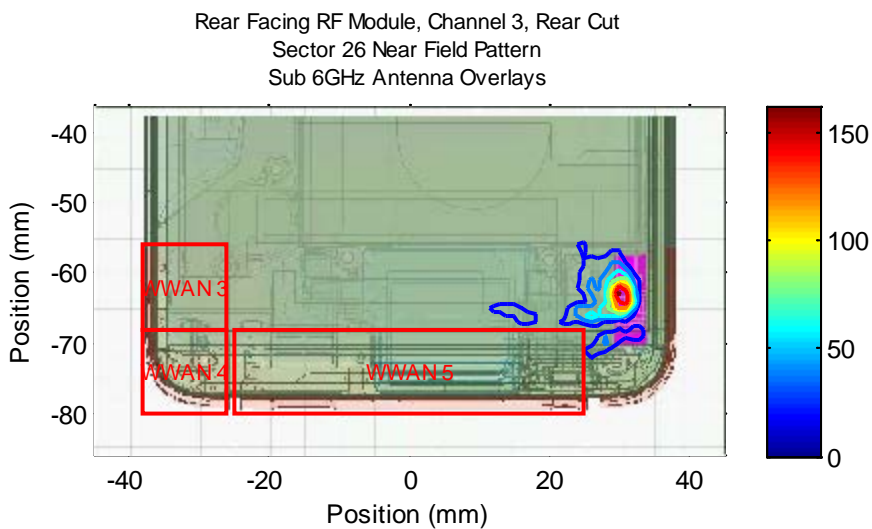
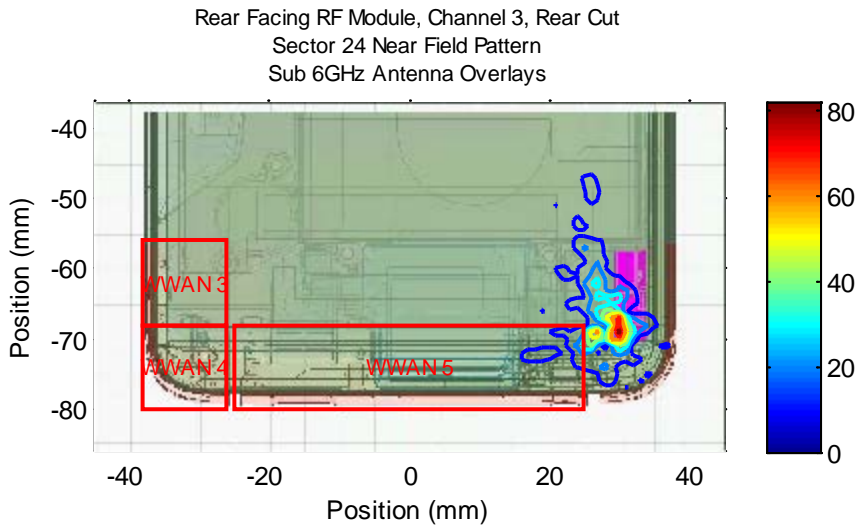


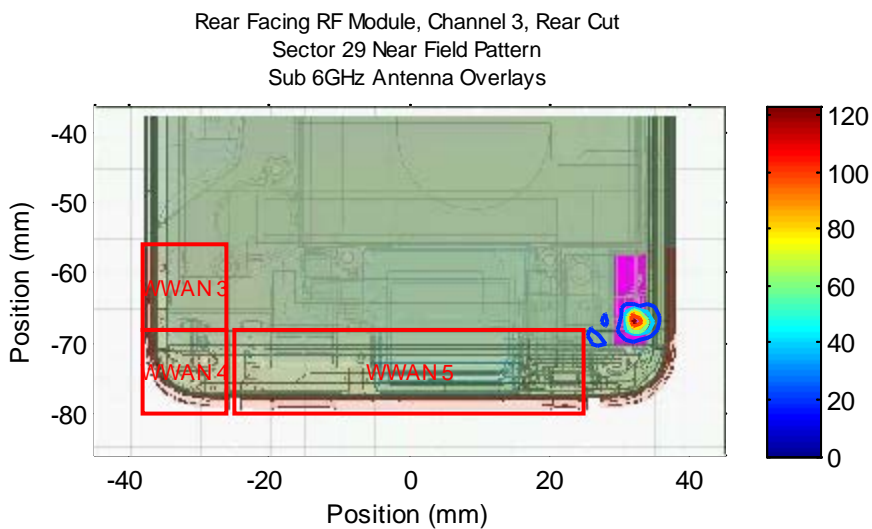
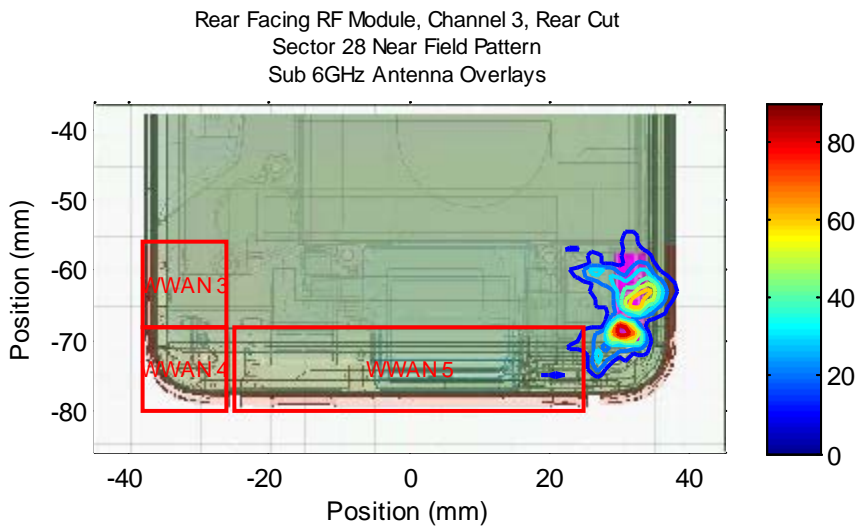
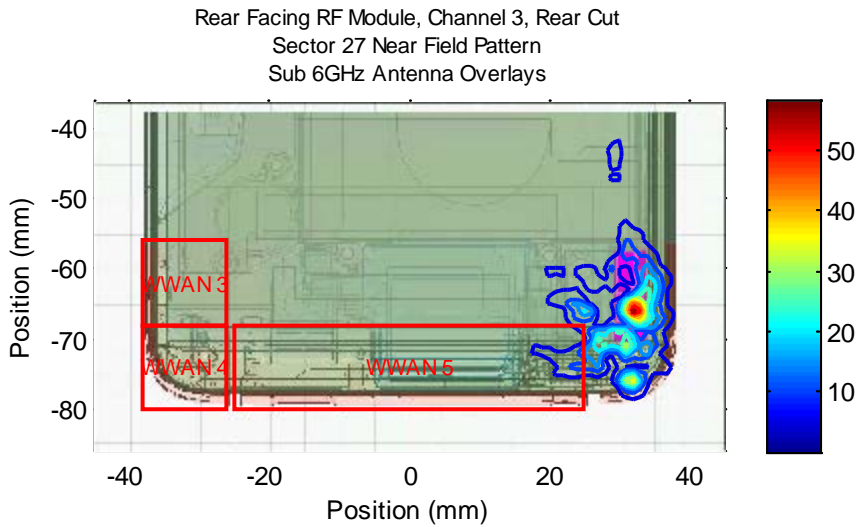


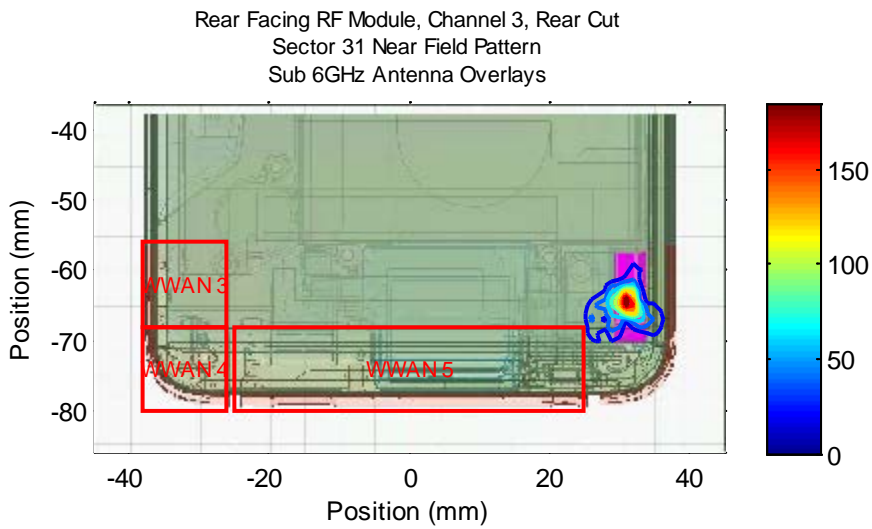
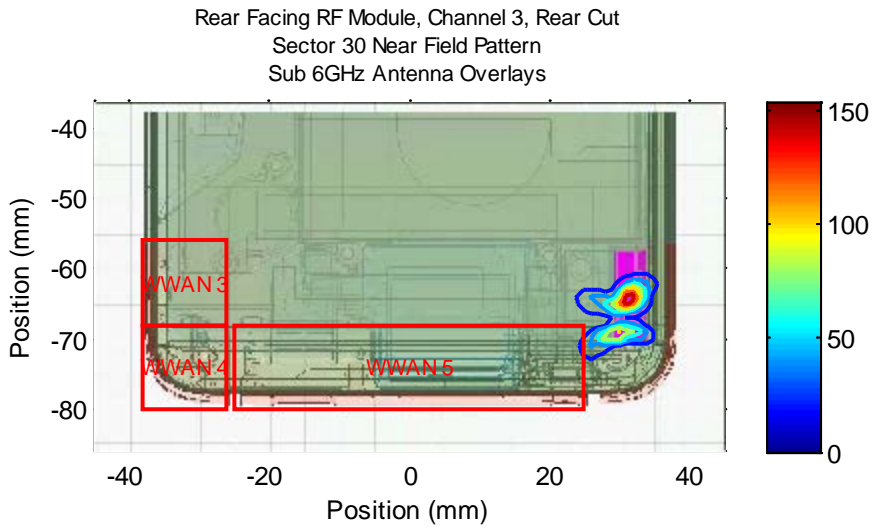












# C 802.11ad Antenna Modules Images and Drawings

---

## C.1 802.11ad antenna module images inside ASUS\_Z01QD

Figure C-1 and Figure C-2 show the top (Side A) and bottom (Side B) of the 802.11ad antenna module.

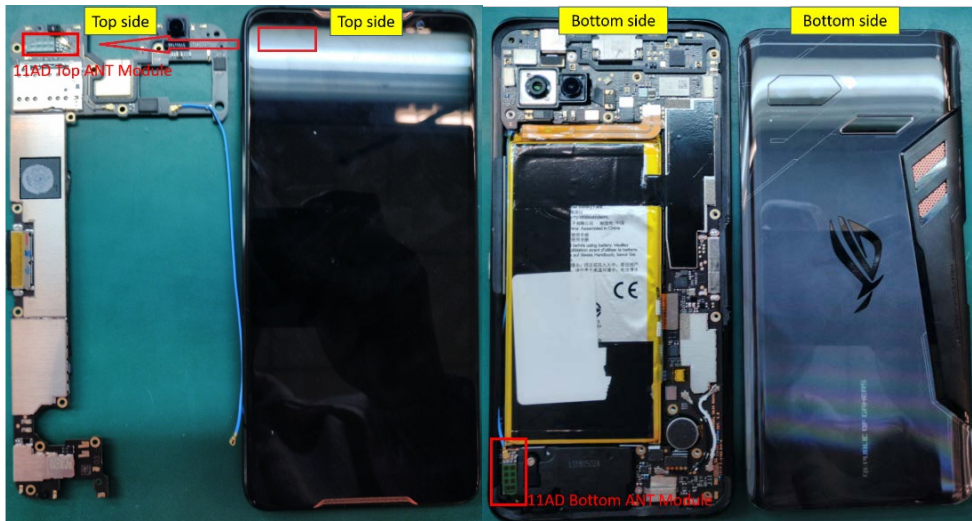


Figure C-1 802.11ad antenna module inside ASUS\_Z01QD

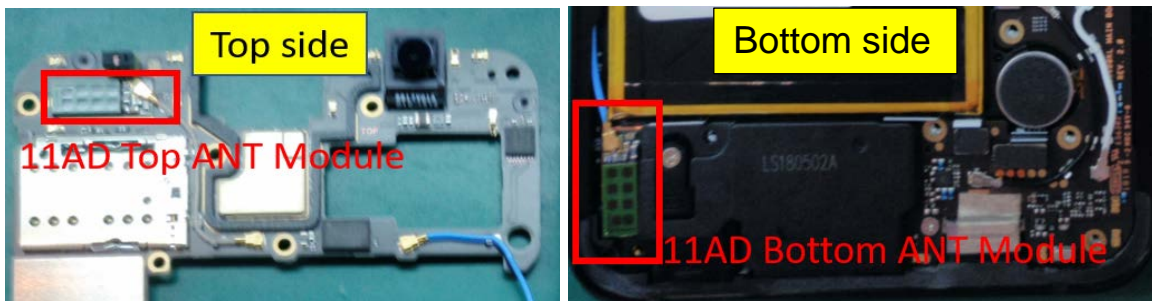


Figure C-2 Relative position and orientation of top and bottom antenna modules

## C.2 Antenna module array elements drawing

In [Figure C-3](#), the antenna configuration or sector is a given combination of amplitude and phase of array elements.

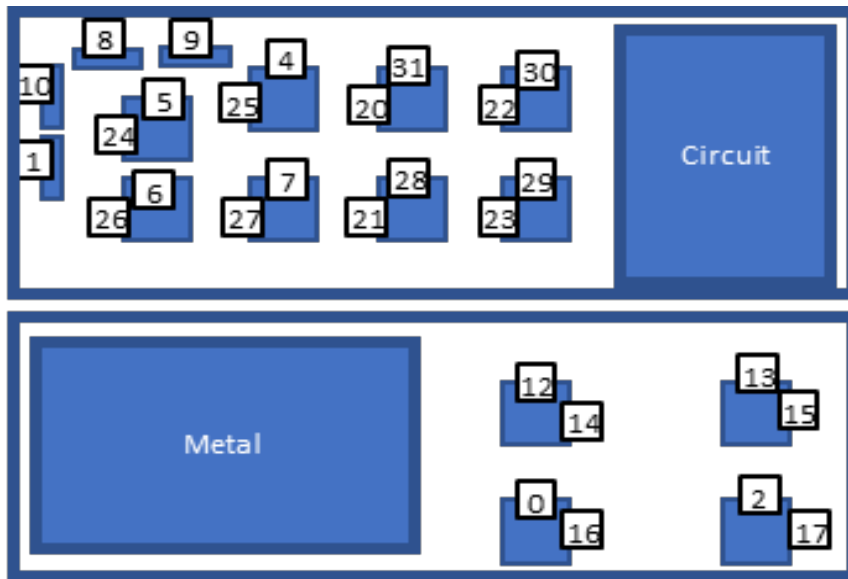


Figure C-3 Antenna module array elements view

## C.3 Simulation modeling drawings

NOTE: Simulation modeling drawings are based on the array model provided by Murata and the 3D platform provided by ASUS.

[Figure C-4](#) shows the placement of the 802.11ad antenna modules configurations: front, back, bottom, and side and the orientation of all the power distributions relative to ASUS\_Z01QD.

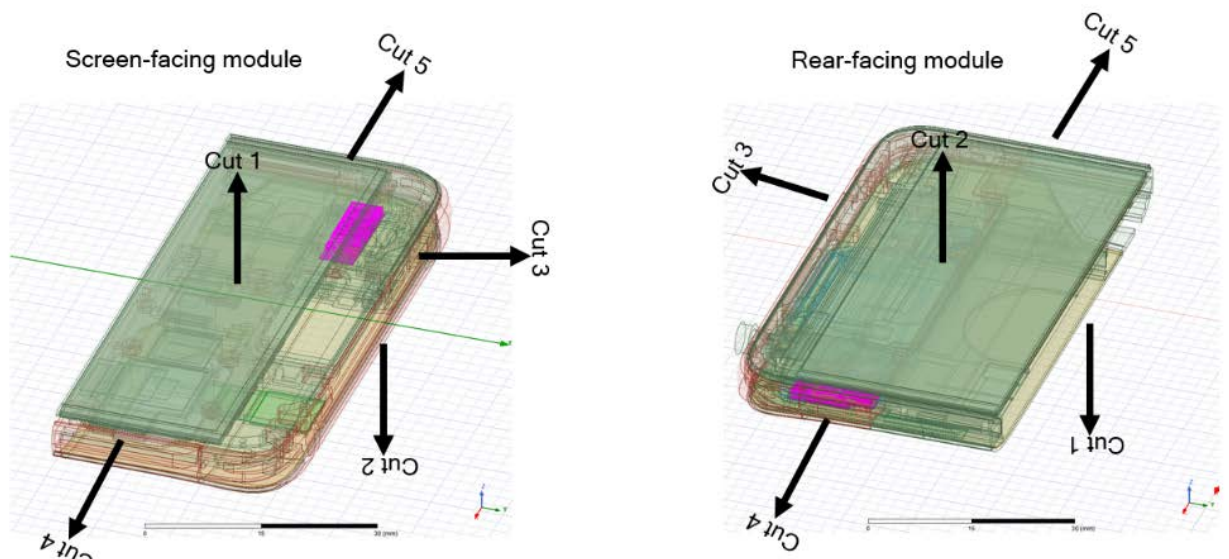
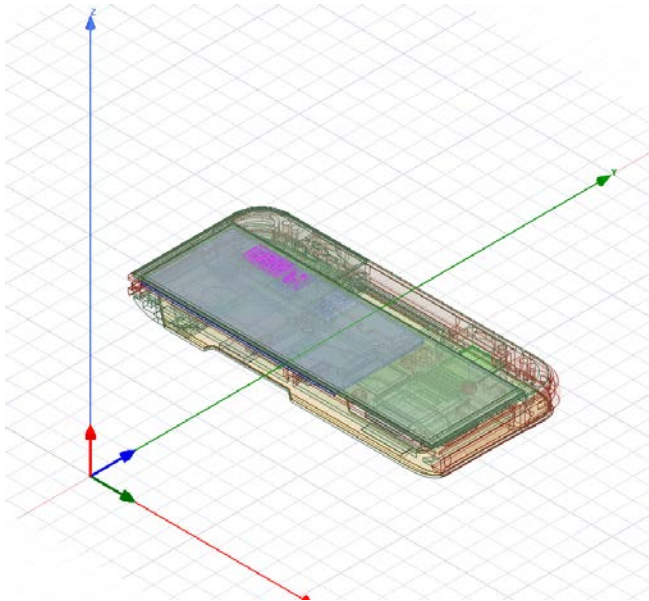


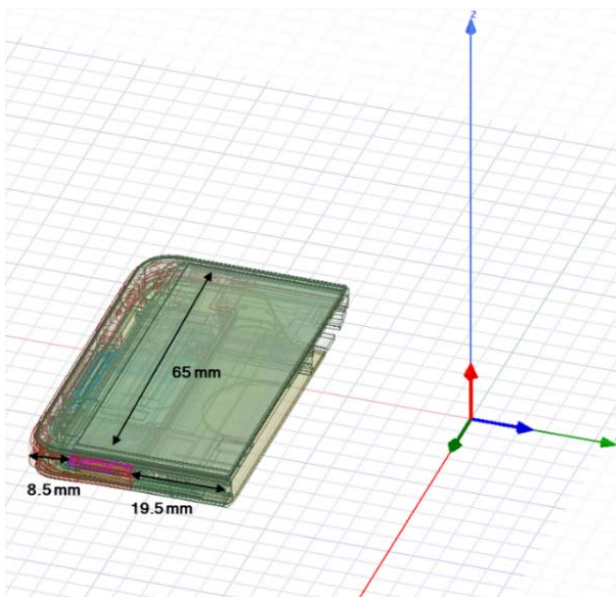
Figure C-4 Orientation of the simulated power distribution relative to the ASUS\_Z01QD device



Figure C-5 and Figure C-6 completely models the top and bottom of the 802.11ad modules from the antenna manufacturer Murata, respectively.

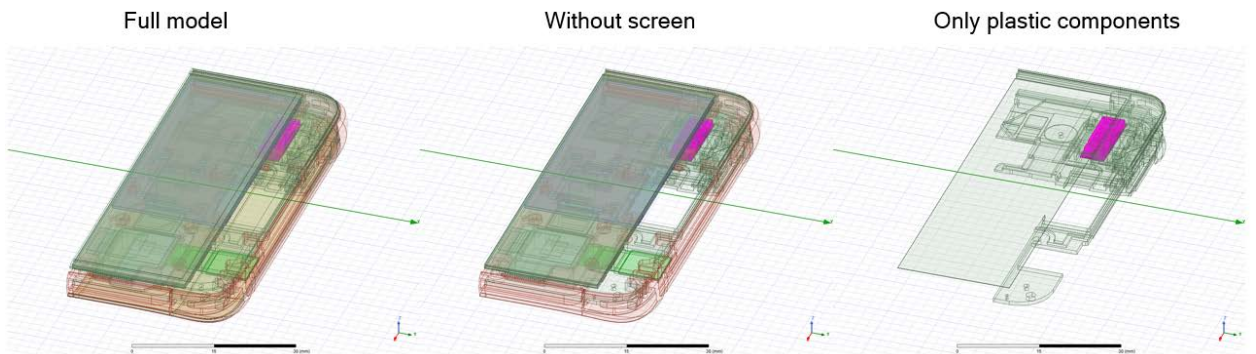


**Figure C-5 Top module**

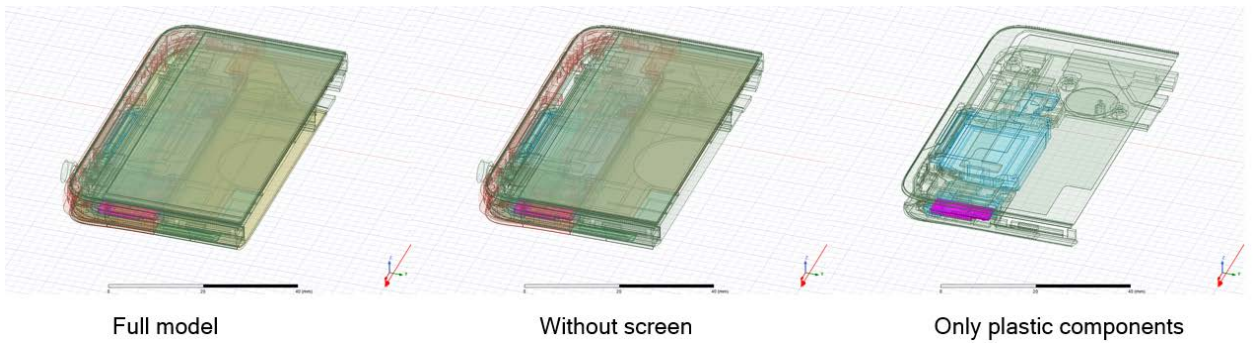


**Figure C-6 Bottom module**

Figure C-7 and Figure C-8 show a layered breakdown of the 802.11ad top and bottom module simulation model mechanical structure.



**Figure C-7 Simulation model structure – Top module**



**Figure C-8 Simulation model structure – Bottom module**