

#01_GSM850_GPRS (4 Tx slots)_Right Cheek_Ch189

Communication System: GSM850; Frequency: 836.4 MHz; Duty Cycle: 1:2.08

Medium: HSL_850_170905 Medium parameters used : $f = 836.4$ MHz; $\sigma = 0.888$ S/m; $\epsilon_r = 40.918$; $\rho = 1000$ kg/m³

Ambient Temperature : 23.2 °C ; Liquid Temperature : 22.2 °C

DASY5 Configuration

- Probe: ES3DV3 - SN3071; ConvF(5.61, 5.61, 5.61); Calibrated: 2016/12/8;
- Sensor-Surface: 3mm (Mechanical Surface Detection)
- Electronics: DAE4 Sn778; Calibrated: 2017/5/22
- Phantom: SAM_RIGHT; Type: QD000P40CD; Serial: 1719
- Measurement SW: DASY52, Version 52.8 (8); SEMCAD X Version 14.6.10 (7373)

Area Scan (61x121x1): Interpolated grid: dx=1.500 mm, dy=1.500 mm

Maximum value of SAR (interpolated) = 1.33 W/kg

Zoom Scan (5x5x7)/Cube 0: Measurement grid: dx=8mm, dy=8mm, dz=5mm

Reference Value = 31.71 V/m; Power Drift = 0.03 dB

Peak SAR (extrapolated) = 2.07 W/kg

SAR(1 g) = 0.991 W/kg; SAR(10 g) = 0.586 W/kg

Maximum value of SAR (measured) = 1.34 W/kg

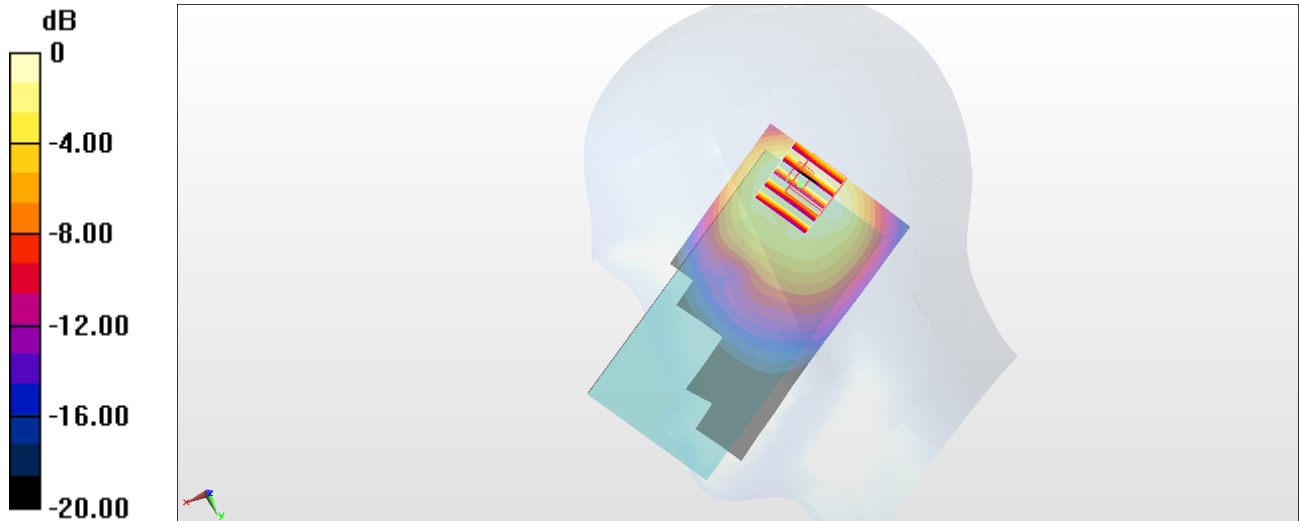

0 dB = 1.34 W/kg = 1.27 dBW/kg

#02_GSM1900_GPRS (4 Tx slots)_Right Cheek_Ch810

Communication System: PCS; Frequency: 1909.8 MHz; Duty Cycle: 1:2.08

Medium: HSL_1900_170904 Medium parameters used: $f = 1910$ MHz; $\sigma = 1.396$ S/m; $\epsilon_r = 40.344$;

$\rho = 1000$ kg/m³

Ambient Temperature : 23.6 °C; Liquid Temperature : 22.6 °C

DASY5 Configuration:

- Probe: EX3DV4 - SN7306; ConvF(8.34, 8.34, 8.34); Calibrated: 2017/7/24;
- Sensor-Surface: 1.4mm (Mechanical Surface Detection)
- Electronics: DAE4 Sn854; Calibrated: 2017/5/2
- Phantom: SAM_Left; Type: QD000P40CD; Serial: TP:1431
- Measurement SW: DASY52, Version 52.8 (8); SEMCAD X Version 14.6.10 (7373)

Area Scan (61x121x1): Interpolated grid: dx=1.500 mm, dy=1.500 mm

Maximum value of SAR (interpolated) = 0.00744 W/kg

Zoom Scan (5x5x7)/Cube 0: Measurement grid: dx=8mm, dy=8mm, dz=5mm

Reference Value = 0 V/m; Power Drift = 0.00 dB

Peak SAR (extrapolated) = 0.0320 W/kg

SAR(1 g) = 0.00688 W/kg; SAR(10 g) = 0.0019 W/kg

Maximum value of SAR (measured) = 0.0203 W/kg

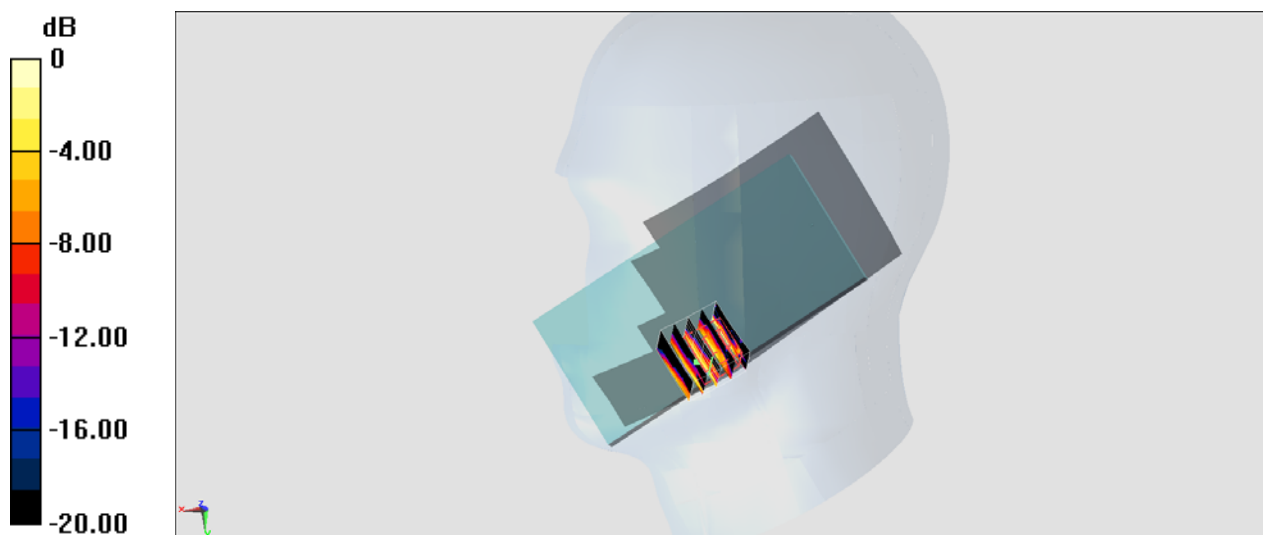

0 dB = 0.0203 W/kg = -16.93 dBW/kg

#03_WCDMA II_RMC 12.2Kbps_Right Cheek_Ch9262

Communication System: WCDMA; Frequency: 1852.4 MHz; Duty Cycle: 1:1

Medium: HSL_1900_170913 Medium parameters used: $f = 1852.4$ MHz; $\sigma = 1.397$ S/m; $\epsilon_r = 41.285$; $\rho = 1000$ kg/m³

Ambient Temperature : 23.5 °C ; Liquid Temperature : 22.5 °C

DASY5 Configuration

- Probe: EX3DV4 - SN7346; ConvF(8.53, 8.53, 8.53); Calibrated: 2017/6/27;
- Sensor-Surface: 1.4mm (Mechanical Surface Detection)
- Electronics: DAE4 Sn916; Calibrated: 2016/12/15
- Phantom: SAM_RIGHT; Type: QD000P40CD; Serial: 1719
- Measurement SW: DASY52, Version 52.8 (8); SEMCAD X Version 14.6.10 (7373)

Area Scan (71x121x1): Interpolated grid: dx=1.500 mm, dy=1.500 mm

Maximum value of SAR (interpolated) = 0.0883 W/kg

Zoom Scan (5x5x7)/Cube 0: Measurement grid: dx=8mm, dy=8mm, dz=5mm

Reference Value = 0.7310 V/m; Power Drift = 0.10 dB

Peak SAR (extrapolated) = 0.0960 W/kg

SAR(1 g) = 0.050 W/kg; SAR(10 g) = 0.029 W/kg

Maximum value of SAR (measured) = 0.0606 W/kg

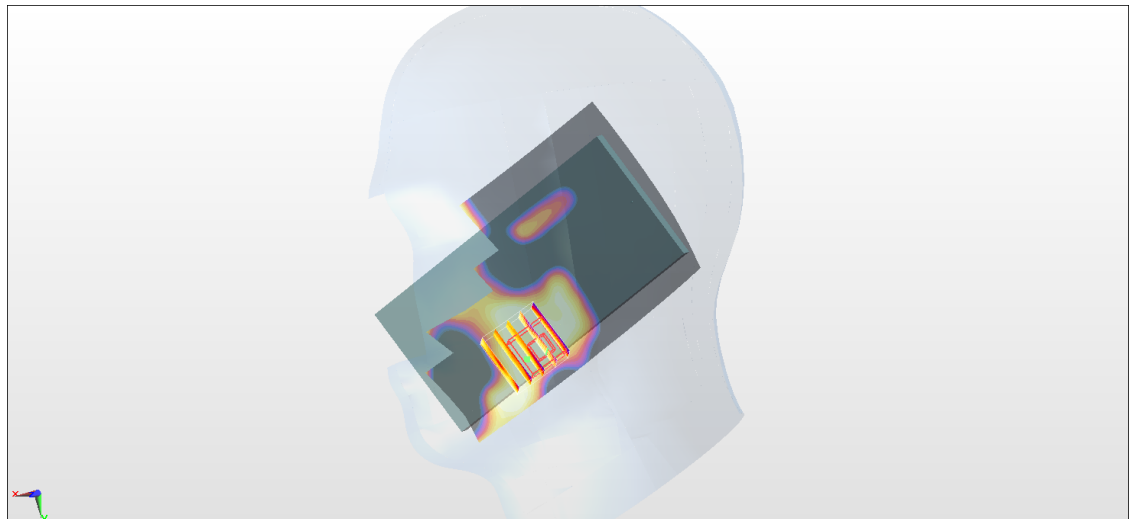
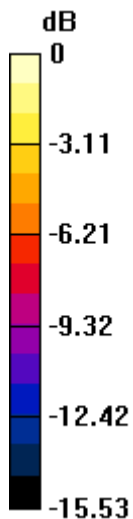

#04_WCDMA IV_RMC 12.2Kbps_Right Cheek_Ch1413

Communication System: WCDMA; Frequency: 1732.6 MHz; Duty Cycle: 1:1

Medium: HSL_1750_170913 Medium parameters used: $f = 1733$ MHz; $\sigma = 1.333$ S/m; $\epsilon_r = 41.727$; $\rho = 1000$ kg/m³

Ambient Temperature : 23.5 °C ; Liquid Temperature : 22.5 °C

DASY5 Configuration

- Probe: EX3DV4 - SN7346; ConvF(8.75, 8.75, 8.75); Calibrated: 2017/6/27;
- Sensor-Surface: 1.4mm (Mechanical Surface Detection)
- Electronics: DAE4 Sn916; Calibrated: 2016/12/15
- Phantom: SAM_RIGHT; Type: QD000P40CD; Serial: 1719
- Measurement SW: DASY52, Version 52.8 (8); SEMCAD X Version 14.6.10 (7373)

Area Scan (71x121x1): Interpolated grid: dx=1.500 mm, dy=1.500 mm

Maximum value of SAR (interpolated) = 0.126 W/kg

Zoom Scan (5x5x7)/Cube 0: Measurement grid: dx=8mm, dy=8mm, dz=5mm

Reference Value = 1.796 V/m; Power Drift = 0.16 dB

Peak SAR (extrapolated) = 0.109 W/kg

SAR(1 g) = 0.040 W/kg; SAR(10 g) = 0.017 W/kg

Maximum value of SAR (measured) = 0.104 W/kg

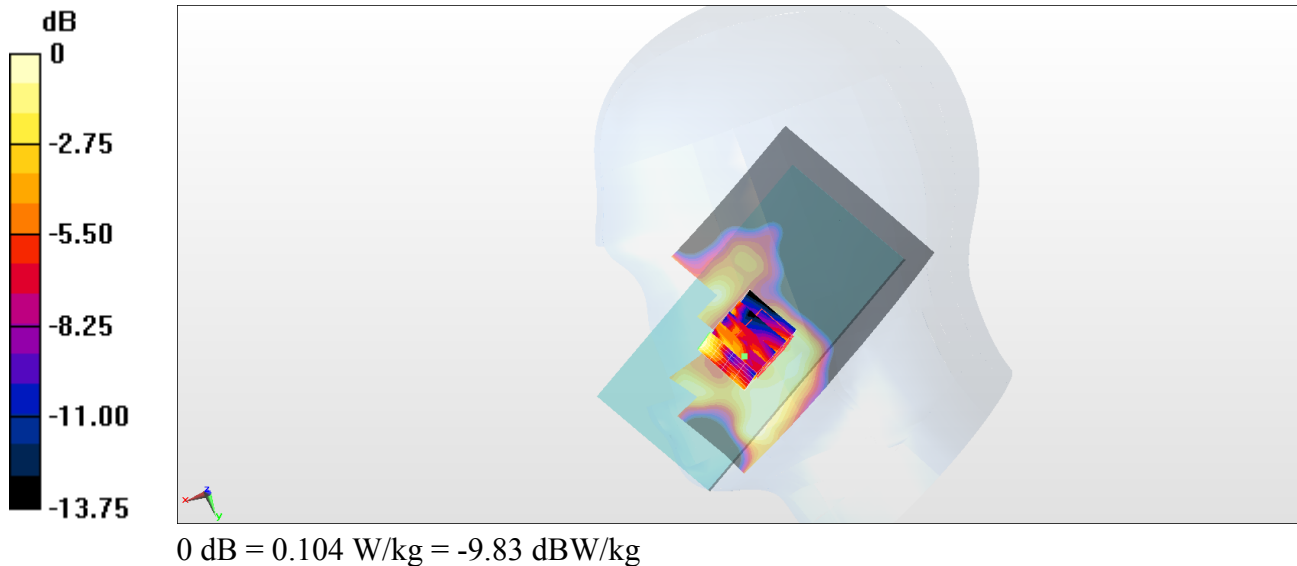

#05_WCDMA V_RMC 12.2Kbps_Right Cheek_Ch4233

Communication System: WCDMA; Frequency: 846.6 MHz; Duty Cycle: 1:1

Medium: HSL_850_170913 Medium parameters used: $f = 847$ MHz; $\sigma = 0.909$ S/m; $\epsilon_r = 41.633$; $\rho = 1000$ kg/m³

Ambient Temperature : 23.4 °C ; Liquid Temperature : 22.4 °C

DASY5 Configuration

- Probe: EX3DV4 - SN3931; ConvF(10.35, 10.35, 10.35); Calibrated: 2016/10/3;
- Sensor-Surface: 1.4mm (Mechanical Surface Detection)
- Electronics: DAE4 Sn916; Calibrated: 2016/12/15
- Phantom: SAM_RIGHT; Type: QD000P40CD; Serial: 1719
- Measurement SW: DASY52, Version 52.8 (8); SEMCAD X Version 14.6.10 (7373)

Area Scan (71x121x1): Interpolated grid: dx=1.500 mm, dy=1.500 mm

Maximum value of SAR (interpolated) = 1.03 W/kg

Zoom Scan (5x5x7)/Cube 0: Measurement grid: dx=8mm, dy=8mm, dz=5mm

Reference Value = 25.50 V/m; Power Drift = 0.12 dB

Peak SAR (extrapolated) = 1.39 W/kg

SAR(1 g) = 0.722 W/kg; SAR(10 g) = 0.398 W/kg

Maximum value of SAR (measured) = 1.13 W/kg

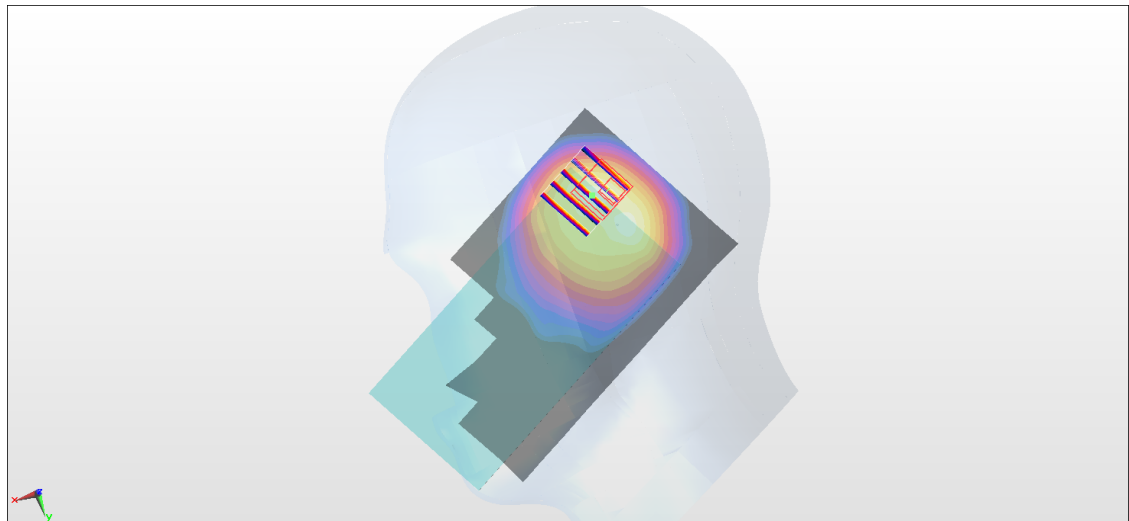
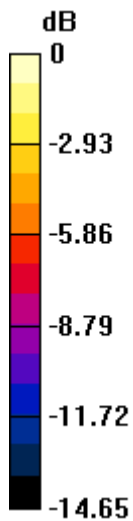

#06_LTE Band 2_20M_QPSK_1_0_Left Cheek_Ch18700

Communication System: LTE; Frequency: 1860 MHz; Duty Cycle: 1:1

Medium: HSL_1900_170914 Medium parameters used: $f = 1860$ MHz; $\sigma = 1.402$ S/m; $\epsilon_r = 41.328$; $\rho = 1000$ kg/m³

Ambient Temperature : 23.6 °C ; Liquid Temperature : 22.6 °C

DASY5 Configuration

- Probe: EX3DV4 - SN3931; ConvF(8.42, 8.42, 8.42); Calibrated: 2016/10/3;
- Sensor-Surface: 1.4mm (Mechanical Surface Detection)
- Electronics: DAE4 Sn916; Calibrated: 2016/12/15
- Phantom: SAM_RIGHT; Type: QD000P40CD; Serial: 1719
- Measurement SW: DASY52, Version 52.8 (8); SEMCAD X Version 14.6.10 (7373)

Area Scan (71x121x1): Interpolated grid: dx=1.500 mm, dy=1.500 mm

Maximum value of SAR (interpolated) = 0.343 W/kg

Zoom Scan (5x5x7)/Cube 0: Measurement grid: dx=8mm, dy=8mm, dz=5mm

Reference Value = 5.421 V/m; Power Drift = -0.05 dB

Peak SAR (extrapolated) = 0.183 W/kg

SAR(1 g) = 0.089 W/kg; SAR(10 g) = 0.035 W/kg

Maximum value of SAR (measured) = 0.100 W/kg

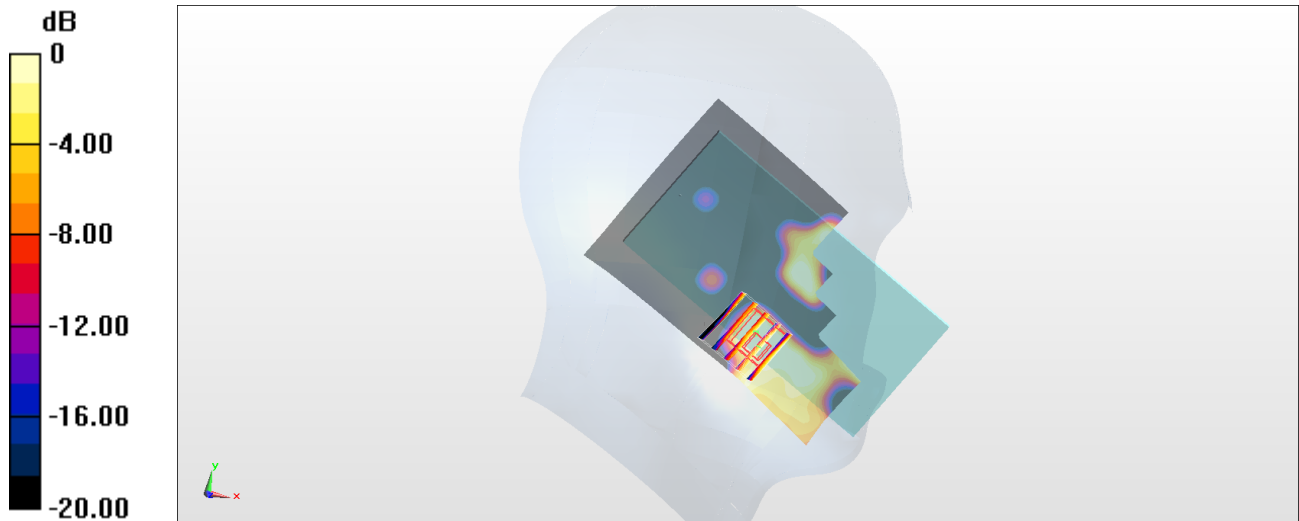

0 dB = 0.100 W/kg = -10.00 dBW/kg

#07_LTE Band 4_20M_QPSK_1_0_Right Cheek_Ch20175

Communication System: LTE ; Frequency: 1732.5 MHz;Duty Cycle: 1:1
 Medium: HSL_1750_170904 Medium parameters used : $f = 1732.5$ MHz; $\sigma = 1.362$ S/m; $\epsilon_r = 38.859$; $\rho = 1000$ kg/m³
 Ambient Temperature : 23.6 °C ; Liquid Temperature : 22.6 °C

DASY5 Configuration:

- Probe: EX3DV4 - SN7306; ConvF(8.64, 8.64, 8.64); Calibrated: 2017/7/24;
- Sensor-Surface: 1.4mm (Mechanical Surface Detection)
- Electronics: DAE4 Sn854; Calibrated: 2017/5/2
- Phantom: SAM_Left; Type: QD000P40CD; Serial: TP:1431
- Measurement SW: DASY52, Version 52.8 (8);SEMCAD X Version 14.6.10 (7373)

Area Scan (61x121x1): Interpolated grid: dx=1.500 mm, dy=1.500 mm
 Maximum value of SAR (interpolated) = 0.0959 W/kg

Zoom Scan (5x5x7)/Cube 0: Measurement grid: dx=8mm, dy=8mm, dz=5mm
 Reference Value = 5.702 V/m; Power Drift = 0.11 dB
 Peak SAR (extrapolated) = 0.113 W/kg
SAR(1 g) = 0.074 W/kg; SAR(10 g) = 0.049 W/kg
 Maximum value of SAR (measured) = 0.101 W/kg

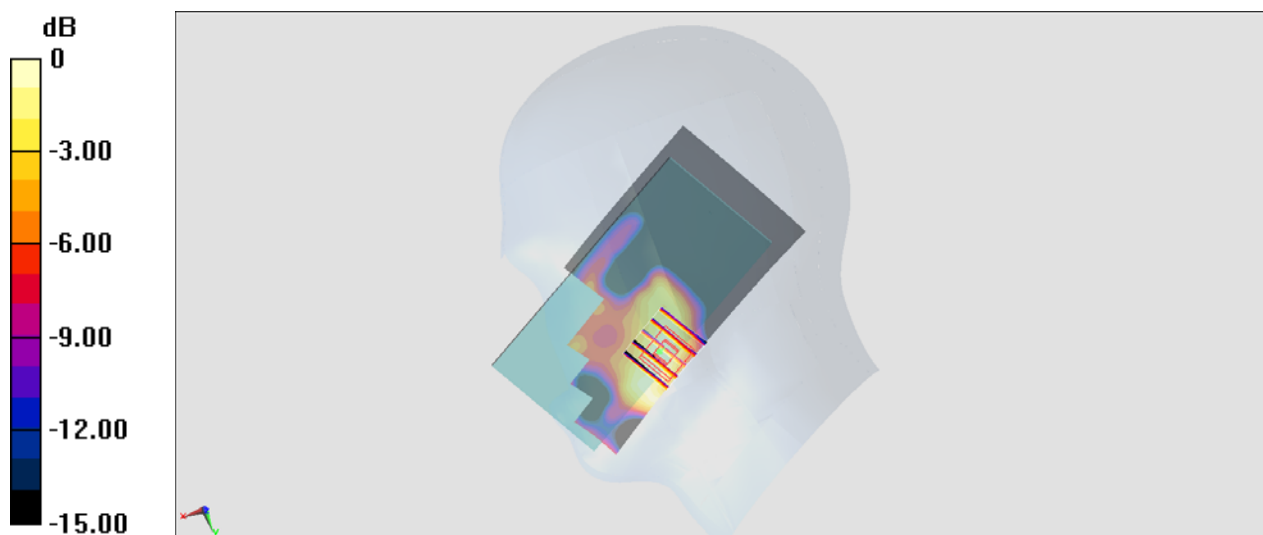

0 dB = 0.101 W/kg = -9.96 dBW/kg

#08_LTE Band 7_20M_QPSK_1_49_Right Tilted_Ch21100

Communication System: LTE ; Frequency: 2535 MHz; Duty Cycle: 1:1

Medium: HSL_2600_170830 Medium parameters used : $f = 2535 \text{ MHz}$; $\sigma = 1.911 \text{ S/m}$; $\epsilon_r = 40.408$; $\rho = 1000 \text{ kg/m}^3$

Ambient Temperature : $23.4 \text{ }^\circ\text{C}$; Liquid Temperature : $22.4 \text{ }^\circ\text{C}$

DASY5 Configuration

- Probe: ES3DV3 - SN3071; ConvF(4.18, 4.18, 4.18); Calibrated: 2016/12/8;
- Sensor-Surface: 3mm (Mechanical Surface Detection)
- Electronics: DAE4 Sn778; Calibrated: 2017/5/22
- Phantom: SAM_Right; Type: QD000P40CD; Serial: S/N:1801
- Measurement SW: DASY52, Version 52.8 (8); SEMCAD X Version 14.6.10 (7373)

Area Scan (91x151x1): Interpolated grid: $dx=1.200 \text{ mm}$, $dy=1.200 \text{ mm}$

Maximum value of SAR (interpolated) = 0.0989 W/kg

Zoom Scan (7x7x7)/Cube 0: Measurement grid: $dx=5\text{mm}$, $dy=5\text{mm}$, $dz=5\text{mm}$

Reference Value = 5.626 V/m ; Power Drift = -0.04 dB

Peak SAR (extrapolated) = 0.131 W/kg

SAR(1 g) = 0.075 W/kg ; SAR(10 g) = 0.039 W/kg

Maximum value of SAR (measured) = 0.0925 W/kg

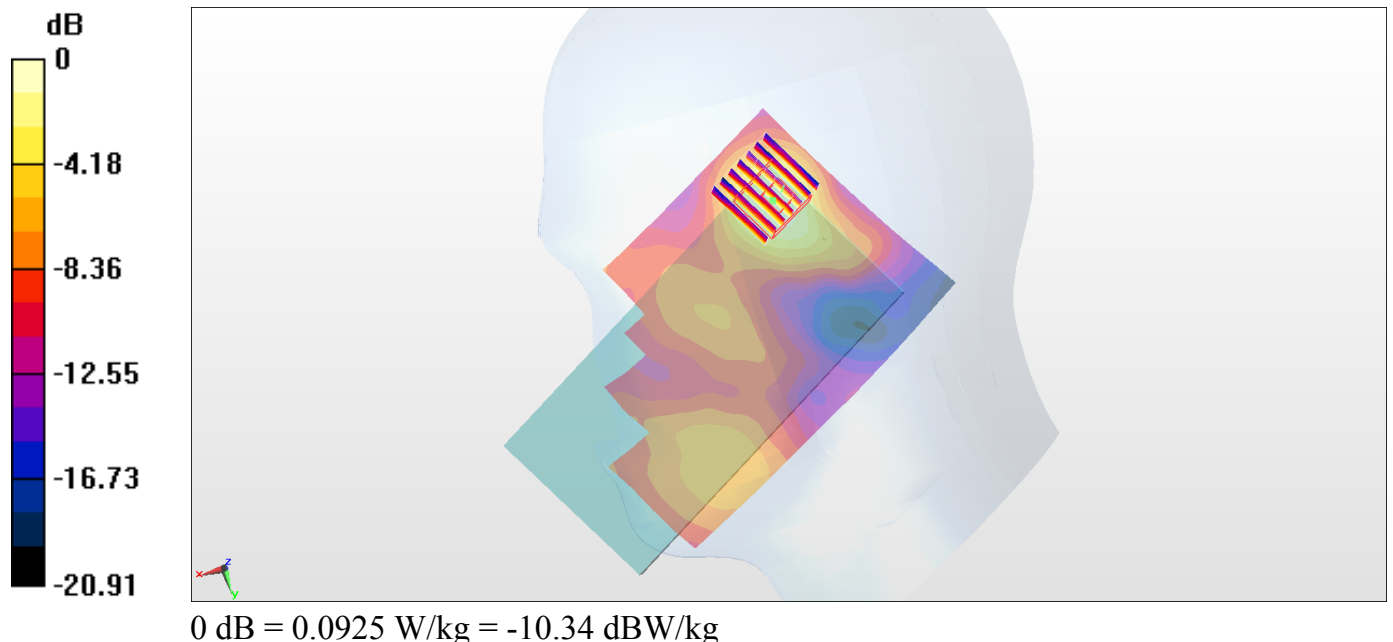

#09_LTE Band 12_10M_QPSK_25_0_Right Cheek_Ch23095

Communication System: LTE; Frequency: 707.5 MHz; Duty Cycle: 1:1

Medium: HSL_750_170905 Medium parameters used : $f = 707.5$ MHz; $\sigma = 0.855$ S/m; $\epsilon_r = 43.772$; $\rho = 1000$ kg/m³

Ambient Temperature : 23.2 °C ; Liquid Temperature : 22.2 °C

DASY5 Configuration

- Probe: ES3DV3 - SN3071; ConvF(5.73, 5.73, 5.73); Calibrated: 2016/12/8;
- Sensor-Surface: 3mm (Mechanical Surface Detection)
- Electronics: DAE4 Sn778; Calibrated: 2017/5/22
- Phantom: SAM_RIGHT; Type: QD000P40CD; Serial: 1719
- Measurement SW: DASY52, Version 52.8 (8); SEMCAD X Version 14.6.10 (7373)

Area Scan (61x121x1): Interpolated grid: dx=1.500 mm, dy=1.500 mm

Maximum value of SAR (interpolated) = 0.821 W/kg

Zoom Scan (5x5x7)/Cube 0: Measurement grid: dx=8mm, dy=8mm, dz=5mm

Reference Value = 23.07 V/m; Power Drift = -0.04 dB

Peak SAR (extrapolated) = 1.22 W/kg

SAR(1 g) = 0.576 W/kg; SAR(10 g) = 0.320 W/kg

Maximum value of SAR (measured) = 0.764 W/kg

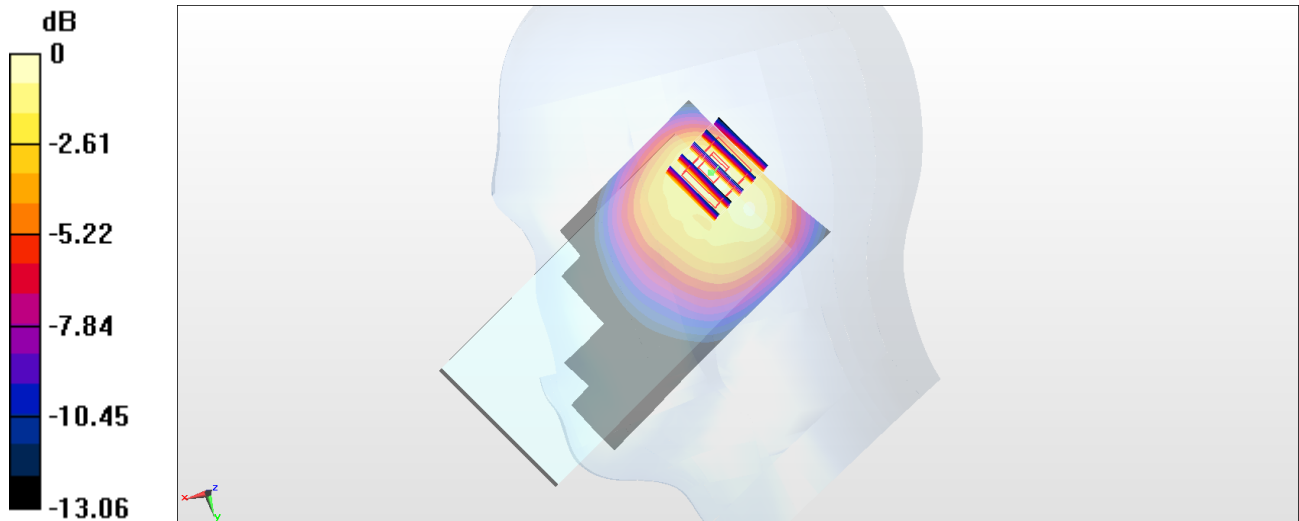

0 dB = 0.764 W/kg = -1.17 dBW/kg

#10_LTE Band 26_15M_QPSK_1_0_Left Cheek_Ch26865

Communication System: LTE; Frequency: 831.5 MHz; Duty Cycle: 1:1

Medium: HSL_850_170913 Medium parameters used: $f = 831.5$ MHz; $\sigma = 0.894$ S/m; $\epsilon_r = 41.836$; $\rho = 1000$ kg/m³

Ambient Temperature : 23.4 °C ; Liquid Temperature : 22.4 °C

DASY5 Configuration

- Probe: EX3DV4 - SN7346; ConvF(10.48, 10.48, 10.48); Calibrated: 2017/6/27;
- Sensor-Surface: 1.4mm (Mechanical Surface Detection)
- Electronics: DAE4 Sn916; Calibrated: 2016/12/15
- Phantom: SAM_RIGHT; Type: QD000P40CD; Serial: 1719
- Measurement SW: DASY52, Version 52.8 (8); SEMCAD X Version 14.6.10 (7373)

Area Scan (71x121x1): Interpolated grid: dx=1.500 mm, dy=1.500 mm

Maximum value of SAR (interpolated) = 0.924 W/kg

Zoom Scan (5x5x7)/Cube 0: Measurement grid: dx=8mm, dy=8mm, dz=5mm

Reference Value = 29.85 V/m; Power Drift = -0.07 dB

Peak SAR (extrapolated) = 1.25 W/kg

SAR(1 g) = 0.628 W/kg; SAR(10 g) = 0.322 W/kg

Maximum value of SAR (measured) = 0.963 W/kg

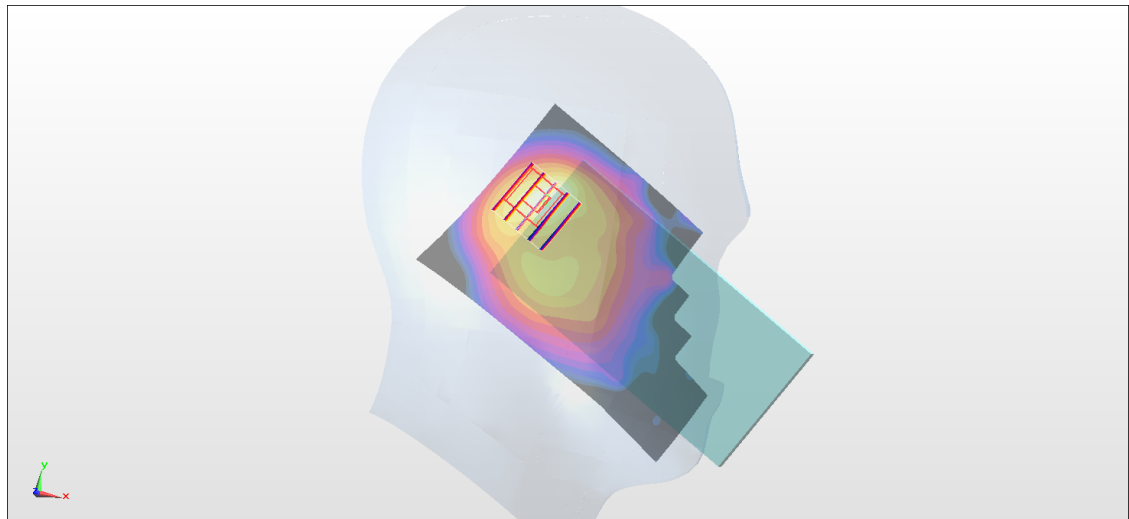
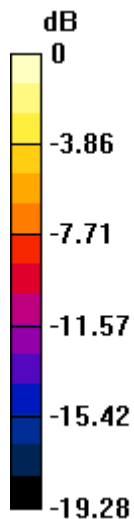

0 dB = 0.963 W/kg = -0.16 dBW/kg

#11_LTE Band 30_10M_QPSK_1_0_Right Tilted_Ch27710

Communication System: LTE; Frequency: 2310 MHz; Duty Cycle: 1:1

Medium: HSL_2300_170830 Medium parameters used: $f = 2310$ MHz; $\sigma = 1.656$ S/m; $\epsilon_r = 41.212$; $\rho = 1000$ kg/m³

Ambient Temperature : 23.4 °C ; Liquid Temperature : 22.4 °C

DASY5 Configuration

- Probe: EX3DV4 - SN3931; ConvF(7.94, 7.94, 7.94); Calibrated: 2016/10/3;
- Sensor-Surface: 1.4mm (Mechanical Surface Detection)
- Electronics: DAE3 Sn577; Calibrated: 2016/9/28
- Phantom: SAM_RIGHT; Type: QD000P40CD; Serial: 1719
- Measurement SW: DASY52, Version 52.8 (8); SEMCAD X Version 14.6.10 (7373)

Area Scan (91x151x1): Interpolated grid: dx=1.200 mm, dy=1.200 mm

Maximum value of SAR (interpolated) = 0.102 W/kg

Zoom Scan (7x7x7)/Cube 0: Measurement grid: dx=5mm, dy=5mm, dz=5mm

Reference Value = 6.570 V/m; Power Drift = 0.13 dB

Peak SAR (extrapolated) = 0.116 W/kg

SAR(1 g) = 0.069 W/kg; SAR(10 g) = 0.038 W/kg

Maximum value of SAR (measured) = 0.0988 W/kg

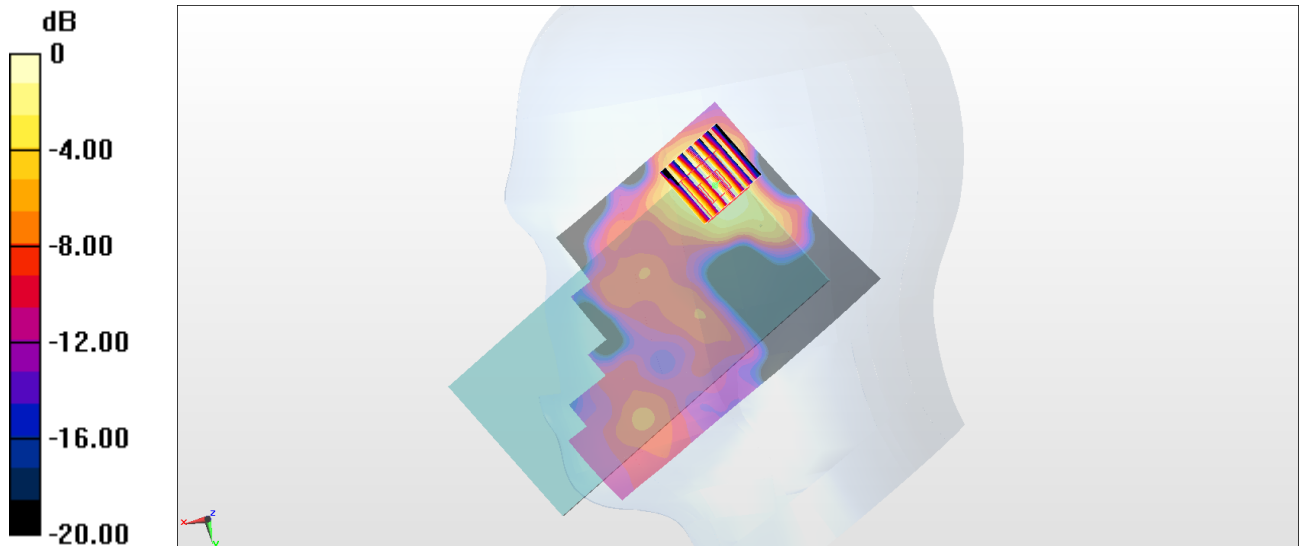

0 dB = 0.0988 W/kg = -10.05 dBW/kg

#12_LTE Band 41_20M_QPSK_1_0_Left Cheek_Ch40240

Communication System: LTE TDD; Frequency: 2555 MHz; Duty Cycle: 1:1.59

Medium: HSL_2600_170905 Medium parameters used: $f = 2555$ MHz; $\sigma = 1.948$ S/m; $\epsilon_r = 39.626$; $\rho = 1000$ kg/m³

Ambient Temperature : 23.6 °C ; Liquid Temperature : 22.6 °C

DASY5 Configuration

- Probe: ES3DV3 - SN3071; ConvF(4.06, 4.06, 4.06); Calibrated: 2016/12/8;
- Sensor-Surface: 3mm (Mechanical Surface Detection)
- Electronics: DAE4 Sn778; Calibrated: 2017/5/22
- Phantom: SAM_RIGHT; Type: QD000P40CD; Serial: 1719
- Measurement SW: DASY52, Version 52.8 (8); SEMCAD X Version 14.6.10 (7373)

Area Scan (81x151x1): Interpolated grid: dx=1.200 mm, dy=1.200 mm

Maximum value of SAR (interpolated) = 0.0713 W/kg

Zoom Scan (7x7x7)/Cube 0: Measurement grid: dx=5mm, dy=5mm, dz=5mm

Reference Value = 1.617 V/m; Power Drift = 0.06 dB

Peak SAR (extrapolated) = 0.0960 W/kg

SAR(1 g) = 0.056 W/kg; SAR(10 g) = 0.031 W/kg

Maximum value of SAR (measured) = 0.0688 W/kg

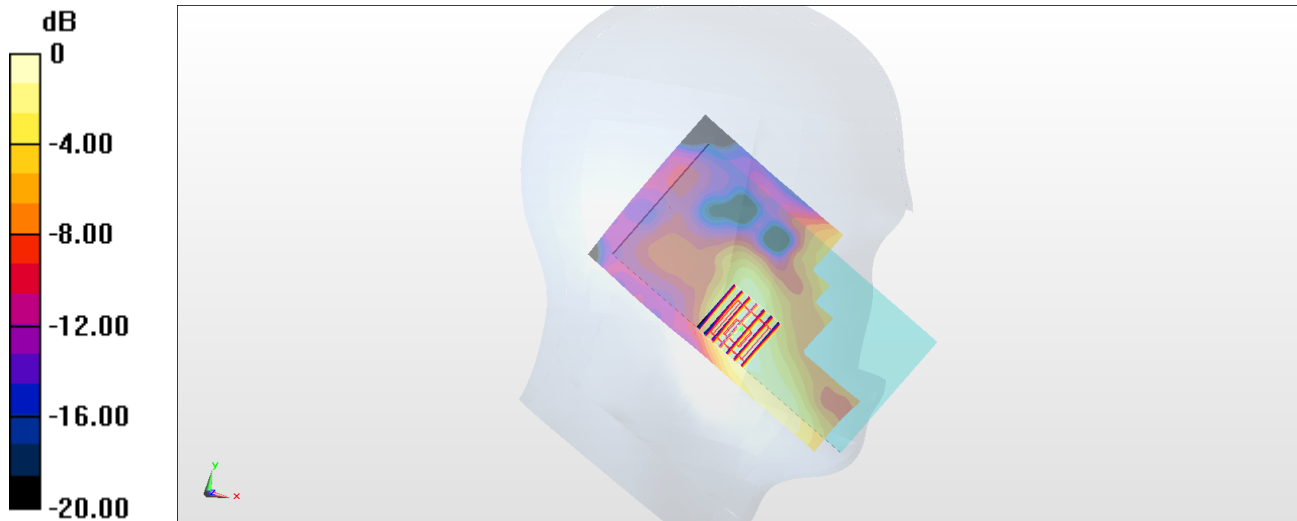

0 dB = 0.0688 W/kg = -11.62 dBW/kg

#13_WLAN2.4GHz_802.11b 1Mbps_Left Tilted_Ch1;Ant 2

Communication System: 802.11b ; Frequency: 2412 MHz;Duty Cycle: 1:1.019

Medium: HSL_2450_170911 Medium parameters used: $f = 2412$ MHz; $\sigma = 1.754$ S/m; $\epsilon_r = 40.376$; $\rho = 1000$ kg/m³

Ambient Temperature : 23.3 °C ; Liquid Temperature : 22.3 °C

DASY5 Configuration

- Probe: EX3DV4 - SN3931; ConvF(7.6, 7.6, 7.6); Calibrated: 2016/10/3;
- Sensor-Surface: 1.4mm (Mechanical Surface Detection)
- Electronics: DAE3 Sn577; Calibrated: 2016/9/28
- Phantom: SAM LEFT; Type: QD000P40CD; Serial: TP:1718
- Measurement SW: DASY52, Version 52.8 (8); SEMCAD X Version 14.6.10 (7373)

Area Scan (91x151x1): Interpolated grid: dx=1.200 mm, dy=1.200 mm

Maximum value of SAR (interpolated) = 0.440 W/kg

Zoom Scan (7x7x7)/Cube 0: Measurement grid: dx=5mm, dy=5mm, dz=5mm

Reference Value = 8.885 V/m; Power Drift = -0.16 dB

Peak SAR (extrapolated) = 0.506 W/kg

SAR(1 g) = 0.198 W/kg; SAR(10 g) = 0.092 W/kg

Maximum value of SAR (measured) = 0.388 W/kg

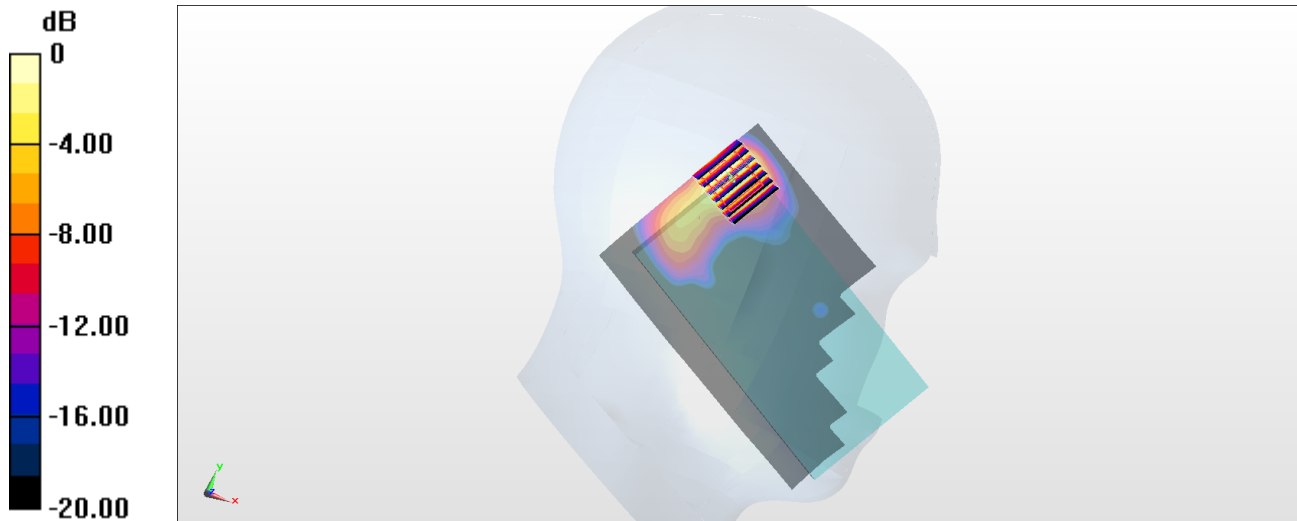

0 dB = 0.388 W/kg = -4.11 dBW/kg

#14_WLAN5GHz_802.11ac-VHT80 MCS0_Right Cheek_Ch58;Ant 1

Communication System: 802.11ac; Frequency: 5290 MHz; Duty Cycle: 1:1.078

Medium: HSL_5G_170911 Medium parameters used: $f = 5290$ MHz; $\sigma = 4.629$ S/m; $\epsilon_r = 36.839$; $\rho = 1000$ kg/m³

Ambient Temperature : 23.2 °C ; Liquid Temperature : 22.2 °C

DASY5 Configuration

- Probe: EX3DV4 - SN3931; ConvF(5.38, 5.38, 5.38); Calibrated: 2016/10/3;
- Sensor-Surface: 1.4mm (Mechanical Surface Detection)
- Electronics: DAE3 Sn577; Calibrated: 2016/9/28
- Phantom: SAM LEFT; Type: QD000P40CD; Serial: TP:1718
- Measurement SW: DASY52, Version 52.8 (8); SEMCAD X Version 14.6.10 (7373)

Area Scan (101x91x1): Interpolated grid: dx=1.000 mm, dy=1.000 mm

Maximum value of SAR (interpolated) = 0.724 W/kg

Zoom Scan (7x7x7)/Cube 0: Measurement grid: dx=4mm, dy=4mm, dz=1.4mm

Reference Value = 2.866 V/m; Power Drift = 0.10 dB

Peak SAR (extrapolated) = 2.78 W/kg

SAR(1 g) = 0.219 W/kg; SAR(10 g) = 0.041 W/kg

Maximum value of SAR (measured) = 0.651 W/kg

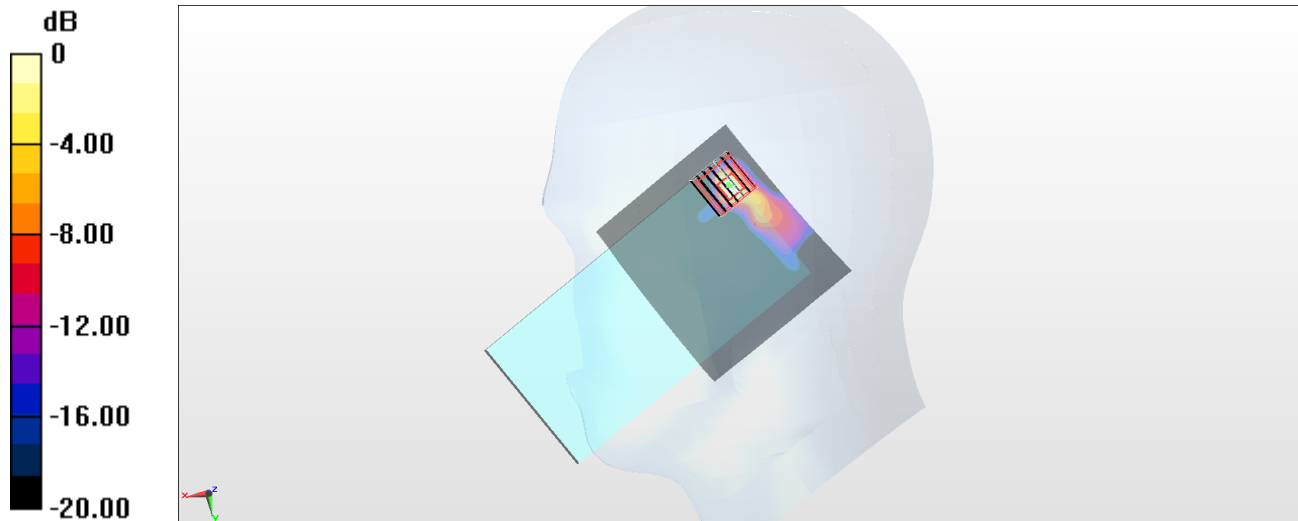

0 dB = 0.651 W/kg = -1.86 dBW/kg

#15_WLAN5GHz_802.11ac-VHT80 MCS0_Right Cheek_Ch106;Ant 1

Communication System: 802.11ac; Frequency: 5530 MHz; Duty Cycle: 1:1.078

Medium: HSL_5G_170911 Medium parameters used: $f = 5530$ MHz; $\sigma = 4.867$ S/m; $\epsilon_r = 36.499$; $\rho = 1000$ kg/m³

Ambient Temperature : 23.2 °C ; Liquid Temperature : 22.2 °C

DASY5 Configuration

- Probe: EX3DV4 - SN3931; ConvF(4.68, 4.68, 4.68); Calibrated: 2016/10/3;
- Sensor-Surface: 1.4mm (Mechanical Surface Detection)
- Electronics: DAE3 Sn577; Calibrated: 2016/9/28
- Phantom: SAM LEFT; Type: QD000P40CD; Serial: TP:1718
- Measurement SW: DASY52, Version 52.8 (8); SEMCAD X Version 14.6.10 (7373)

Area Scan (101x91x1): Interpolated grid: dx=1.000 mm, dy=1.000 mm

Maximum value of SAR (interpolated) = 0.382 W/kg

Zoom Scan (7x7x7)/Cube 0: Measurement grid: dx=4mm, dy=4mm, dz=1.4mm

Reference Value = 0 V/m; Power Drift = 0.00 dB

Peak SAR (extrapolated) = 0.466 W/kg

SAR(1 g) = 0.093 W/kg; SAR(10 g) = 0.019 W/kg

Maximum value of SAR (measured) = 0.282 W/kg

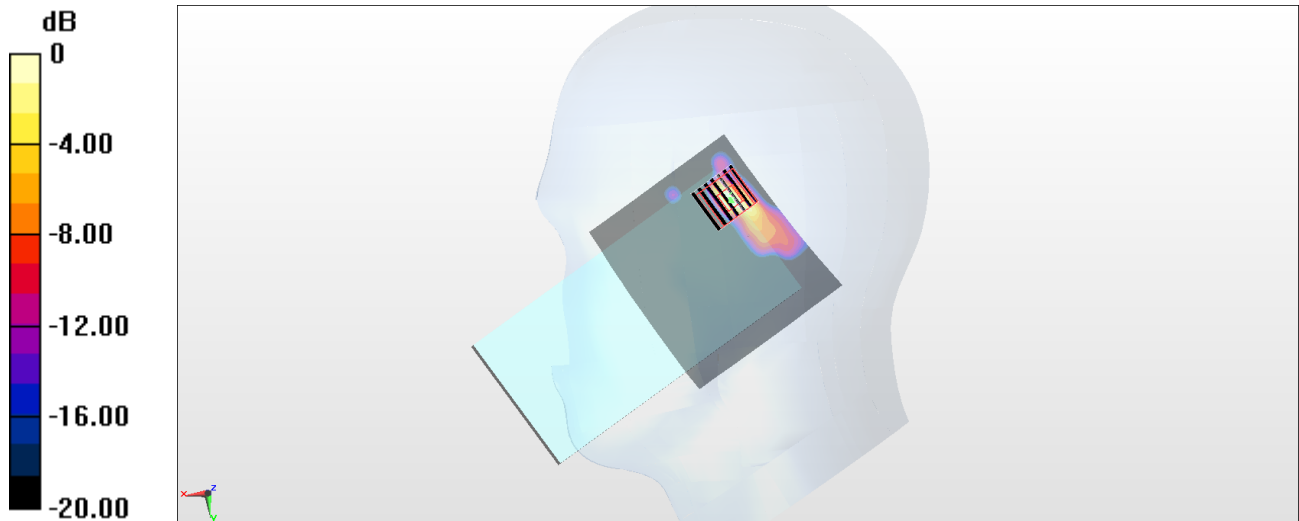

#16_WLAN5GHz_802.11ac-VHT80 MCS0_Right Tilted_Ch155;Ant 1

Communication System: 802.11ac; Frequency: 5775 MHz; Duty Cycle: 1:1.078

Medium: HSL_5G_170911 Medium parameters used: $f = 5775$ MHz; $\sigma = 5.134$ S/m; $\epsilon_r = 36.145$; $\rho = 1000$ kg/m³

Ambient Temperature : 23.2 °C ; Liquid Temperature : 22.2 °C

DASY5 Configuration

- Probe: EX3DV4 - SN7346; ConvF(4.9, 4.9, 4.9); Calibrated: 2017/6/27;
- Sensor-Surface: 1.4mm (Mechanical Surface Detection)
- Electronics: DAE4 Sn916; Calibrated: 2016/12/15
- Phantom: SAM LEFT; Type: QD000P40CD; Serial: TP:1718
- Measurement SW: DASY52, Version 52.8 (8); SEMCAD X Version 14.6.10 (7373)

Area Scan (101x91x1): Interpolated grid: dx=1.000 mm, dy=1.000 mm

Maximum value of SAR (interpolated) = 0.136 W/kg

Zoom Scan (7x7x7)/Cube 0: Measurement grid: dx=4mm, dy=4mm, dz=1.4mm

Reference Value = 2.728 V/m; Power Drift = 0.14 dB

Peak SAR (extrapolated) = 0.378 W/kg

SAR(1 g) = 0.081 W/kg; SAR(10 g) = 0.040 W/kg

Maximum value of SAR (measured) = 0.187 W/kg

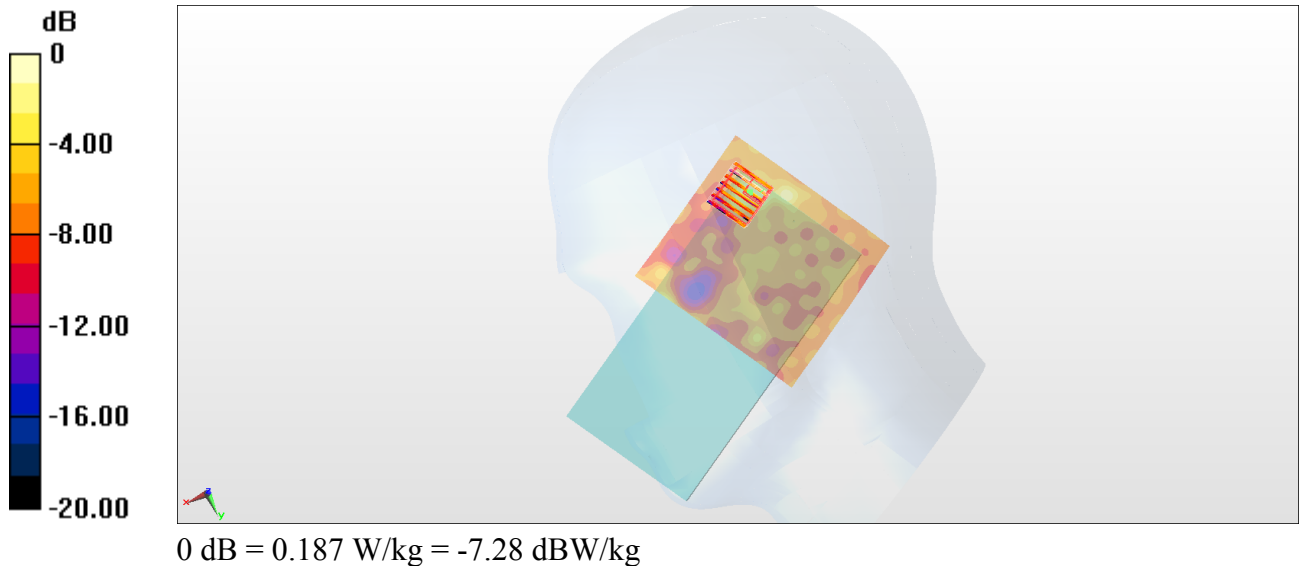

#17_Bluetooth_1Mbps_Right Cheek_Ch78

Communication System: Bluetooth; Frequency: 2480 MHz; Duty Cycle: 1:1.297

Medium: HSL_2450_170916 Medium parameters used: $f = 2480$ MHz; $\sigma = 1.827$ S/m; $\epsilon_r = 39.691$; $\rho = 1000$ kg/m³

Ambient Temperature : 23.7 °C ; Liquid Temperature : 22.7 °C

DASY5 Configuration:

- Probe: EX3DV4 - SN3925; ConvF(7.85, 7.85, 7.85); Calibrated: 2017/5/24;
- Sensor-Surface: 1.4mm (Mechanical Surface Detection)
- Electronics: DAE3 Sn495; Calibrated: 2017/5/22
- Phantom: SAM_Left; Type: QD000P40CD; Serial: TP:1815
- Measurement SW: DASY52, Version 52.8 (8); SEMCAD X Version 14.6.10 (7373)

Area Scan (81x71x1): Interpolated grid: dx=1.200 mm, dy=1.200 mm

Maximum value of SAR (interpolated) = 0.185 W/kg

Zoom Scan (7x7x7)/Cube 0: Measurement grid: dx=5mm, dy=5mm, dz=5mm

Reference Value = 6.574 V/m; Power Drift = 0.06 dB

Peak SAR (extrapolated) = 0.199 W/kg

SAR(1 g) = 0.096 W/kg; SAR(10 g) = 0.043 W/kg

Maximum value of SAR (measured) = 0.163 W/kg

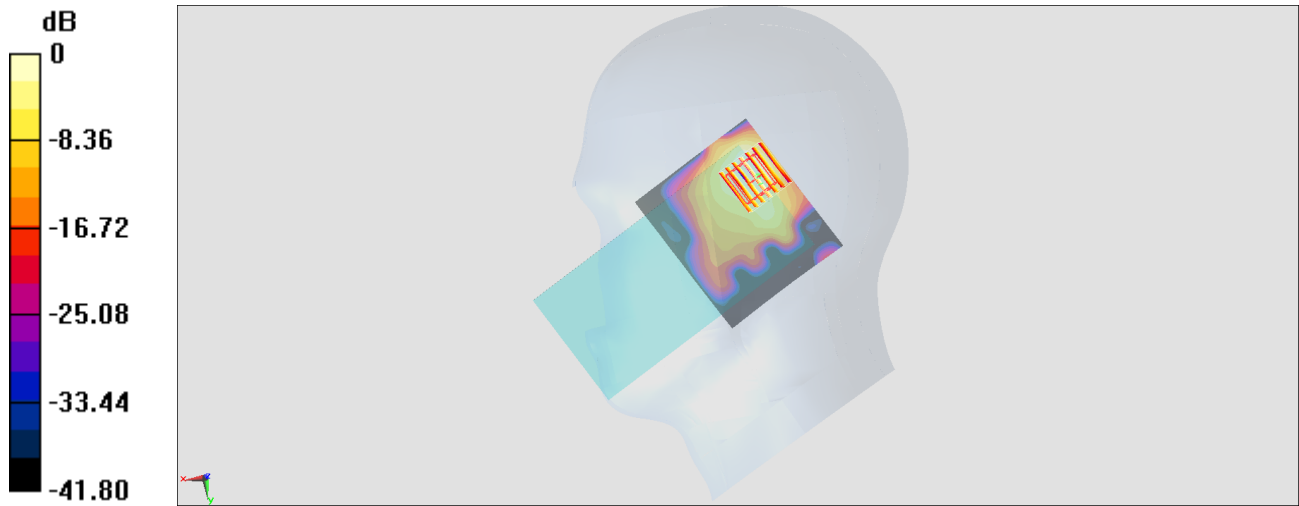

0 dB = 0.163 W/kg = -7.88 dBW/kg

#18_GSM850_GPRS (4 Tx slots)_Front_10mm_Ch251

Communication System: GSM850; Frequency: 848.8 MHz; Duty Cycle: 1:2.08
Medium: MSL_850_170829 Medium parameters used: $f = 849$ MHz; $\sigma = 0.972$ S/m; $\epsilon_r = 55.368$; $\rho = 1000$ kg/m³
Ambient Temperature : 23.5 °C; Liquid Temperature : 22.5 °C

DASY5 Configuration:

- Probe: EX3DV4 - SN3976; ConvF(10.41, 10.41, 10.41); Calibrated: 2017/2/21;
- Sensor-Surface: 1.4mm (Mechanical Surface Detection)
- Electronics: DAE4 Sn1424; Calibrated: 2017/2/16
- Phantom: SAM_Left; Type: QD000P40CD; Serial: TP:1477
- Measurement SW: DASY52, Version 52.8 (8); SEMCAD X Version 14.6.10 (7373)

Area Scan (61x61x1): Interpolated grid: dx=1.500 mm, dy=1.500 mm
Maximum value of SAR (interpolated) = 0.646 W/kg

Zoom Scan (5x5x7)/Cube 0: Measurement grid: dx=8mm, dy=8mm, dz=5mm
Reference Value = 11.15 V/m; Power Drift = 0.14 dB
Peak SAR (extrapolated) = 0.767 W/kg
SAR(1 g) = 0.441 W/kg; SAR(10 g) = 0.253 W/kg
Maximum value of SAR (measured) = 0.622 W/kg

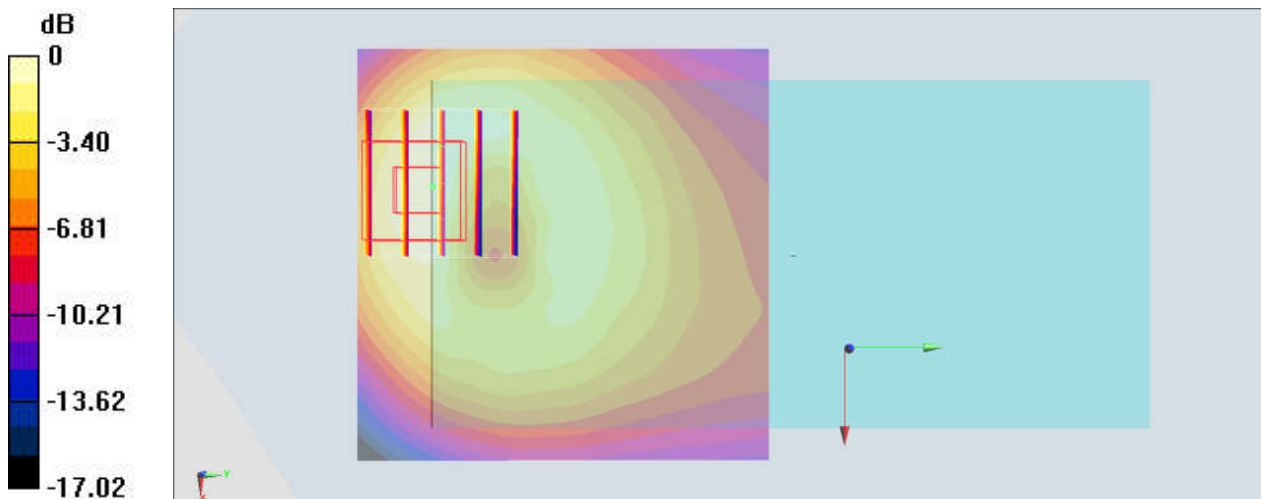

0 dB = 0.622 W/kg = -2.06 dBW/kg

#19_GSM1900_GPRS (4 Tx slots)_Bottom Side_10mm_Ch810

Communication System: PCS; Frequency: 1909.8 MHz; Duty Cycle: 1:2.08

Medium: MSL_1900_170907 Medium parameters used: $f = 1910$ MHz; $\sigma = 1.564$ S/m; $\epsilon_r = 54.248$; $\rho = 1000$ kg/m³

Ambient Temperature : 23.6 °C ; Liquid Temperature : 22.6 °C

DASY5 Configuration

- Probe: EX3DV4 - SN7306; ConvF(7.98, 7.98, 7.98); Calibrated: 2017/7/24;
- Sensor-Surface: 1.4mm (Mechanical Surface Detection)
- Electronics: DAE3 Sn577; Calibrated: 2016/9/28
- Phantom: SAM_RIGHT; Type: QD000P40CD; Serial: 1719
- Measurement SW: DASY52, Version 52.8 (8); SEMCAD X Version 14.6.10 (7373)

Area Scan (41x61x1): Interpolated grid: dx=1.500 mm, dy=1.500 mm

Maximum value of SAR (interpolated) = 0.652 W/kg

Zoom Scan (5x5x7)/Cube 0: Measurement grid: dx=8mm, dy=8mm, dz=5mm

Reference Value = 18.76 V/m; Power Drift = -0.01 dB

Peak SAR (extrapolated) = 0.801 W/kg

SAR(1 g) = 0.434 W/kg; SAR(10 g) = 0.217 W/kg

Maximum value of SAR (measured) = 0.680 W/kg

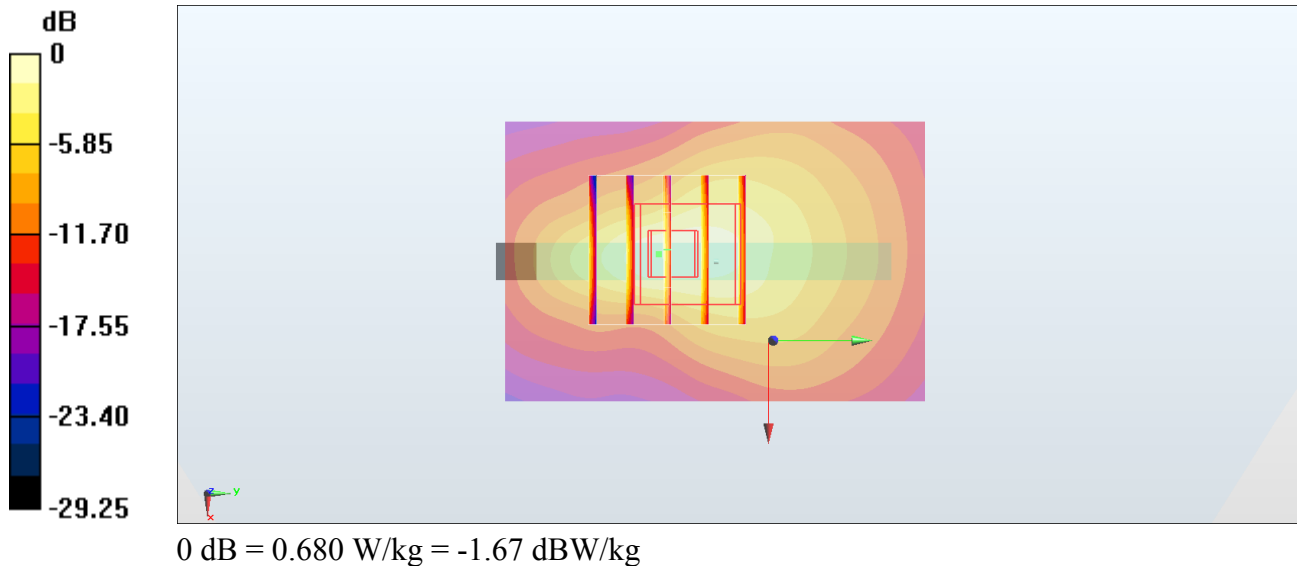

#20_WCDMA II_RMC 12.2Kbps_Front_10mm_Ch9538

Communication System: WCDMA; Frequency: 1907.6 MHz; Duty Cycle: 1:1

Medium: MSL_1900_170913 Medium parameters used: $f = 1908$ MHz; $\sigma = 1.572$ S/m; $\epsilon_r = 54.411$; $\rho = 1000$ kg/m³

Ambient Temperature : 23.5 °C ; Liquid Temperature : 22.5 °C

DASY5 Configuration

- Probe: EX3DV4 - SN3931; ConvF(8.14, 8.14, 8.14); Calibrated: 2016/10/3;
- Sensor-Surface: 1.4mm (Mechanical Surface Detection)
- Electronics: DAE4 Sn916; Calibrated: 2016/12/15
- Phantom: SAM LEFT; Type: QD000P40CD; Serial: TP:1718
- Measurement SW: DASY52, Version 52.8 (8); SEMCAD X Version 14.6.10 (7373)

Area Scan (71x61x1): Interpolated grid: dx=1.500 mm, dy=1.500 mm

Maximum value of SAR (interpolated) = 0.830 W/kg

Zoom Scan (5x5x7)/Cube 0: Measurement grid: dx=8mm, dy=8mm, dz=5mm

Reference Value = 5.326 V/m; Power Drift = 0.15 dB

Peak SAR (extrapolated) = 1.17 W/kg

SAR(1 g) = 0.659 W/kg; SAR(10 g) = 0.336 W/kg

Maximum value of SAR (measured) = 0.923 W/kg

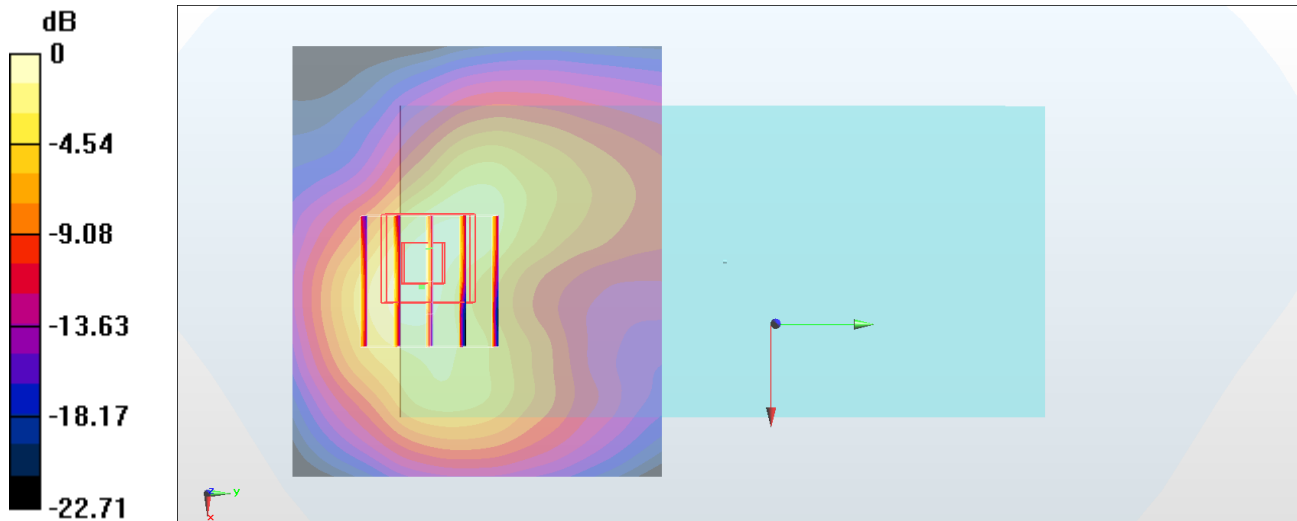

0 dB = 0.923 W/kg = -0.35 dBW/kg

#21_WCDMA IV_RMC 12.2Kbps_Front_10mm_Ch1413

Communication System: WCDMA; Frequency: 1732.6 MHz; Duty Cycle: 1:1

Medium: MSL_1750_170914 Medium parameters used: $f = 1733$ MHz; $\sigma = 1.434$ S/m; $\epsilon_r = 54.986$; $\rho = 1000$ kg/m³

Ambient Temperature : 23.5 °C ; Liquid Temperature : 22.5 °C

DASY5 Configuration

- Probe: EX3DV4 - SN3931; ConvF(8.45, 8.45, 8.45); Calibrated: 2016/10/3;
- Sensor-Surface: 1.4mm (Mechanical Surface Detection)
- Electronics: DAE4 Sn916; Calibrated: 2016/12/15
- Phantom: SAM LEFT; Type: QD000P40CD; Serial: TP:1718
- Measurement SW: DASY52, Version 52.8 (8); SEMCAD X Version 14.6.10 (7373)

Area Scan (71x61x1): Interpolated grid: dx=1.500 mm, dy=1.500 mm

Maximum value of SAR (interpolated) = 0.943 W/kg

Zoom Scan (5x5x7)/Cube 0: Measurement grid: dx=8mm, dy=8mm, dz=5mm

Reference Value = 5.251 V/m; Power Drift = 0.01 dB

Peak SAR (extrapolated) = 1.17 W/kg

SAR(1 g) = 0.694 W/kg; SAR(10 g) = 0.375 W/kg

Maximum value of SAR (measured) = 0.972 W/kg

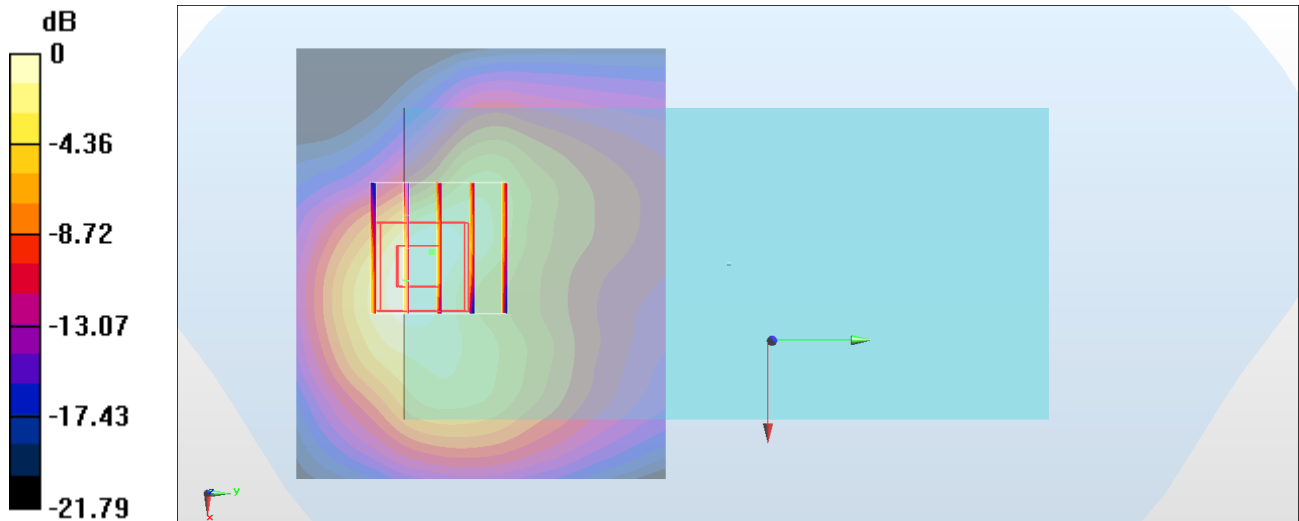

0 dB = 0.972 W/kg = -0.12 dBW/kg

#22_WCDMA V_RMC 12.2Kbps_Front_10mm_Ch4132

Communication System: WCDMA; Frequency: 826.4 MHz; Duty Cycle: 1:1
Medium: MSL_850_170829 Medium parameters used : $f = 826.4$ MHz; $\sigma = 0.951$ S/m; $\epsilon_r = 55.585$;
 $\rho = 1000$ kg/m³
Ambient Temperature : 23.5 °C; Liquid Temperature : 22.5 °C

DASY5 Configuration:

- Probe: EX3DV4 - SN3976; ConvF(10.41, 10.41, 10.41); Calibrated: 2017/2/21;
- Sensor-Surface: 1.4mm (Mechanical Surface Detection)
- Electronics: DAE4 Sn1424; Calibrated: 2017/2/16
- Phantom: SAM_Left; Type: QD000P40CD; Serial: TP:1477
- Measurement SW: DASY52, Version 52.8 (8); SEMCAD X Version 14.6.10 (7373)

Area Scan (61x61x1): Interpolated grid: dx=1.500 mm, dy=1.500 mm
Maximum value of SAR (interpolated) = 0.608 W/kg

Zoom Scan (5x5x7)/Cube 0: Measurement grid: dx=8mm, dy=8mm, dz=5mm
Reference Value = 11.17 V/m; Power Drift = -0.01 dB
Peak SAR (extrapolated) = 0.700 W/kg
SAR(1 g) = 0.405 W/kg; SAR(10 g) = 0.233 W/kg
Maximum value of SAR (measured) = 0.566 W/kg

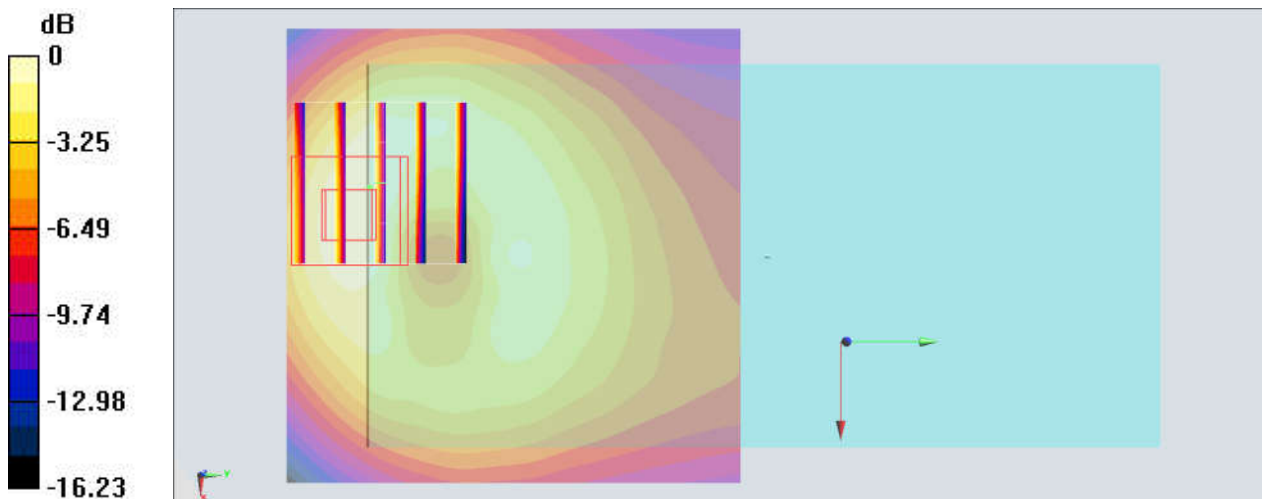

0 dB = 0.566 W/kg = -2.47 dBW/kg

#23_LTE Band 2_20M_QPSK_1_0_Front_10mm_Ch18700

Communication System: LTE; Frequency: 1860 MHz; Duty Cycle: 1:1

Medium: MSL_1900_170913 Medium parameters used: $f = 1860$ MHz; $\sigma = 1.521$ S/m; $\epsilon_r = 54.588$; $\rho = 1000$ kg/m³

Ambient Temperature : 23.5 °C ; Liquid Temperature : 22.5 °C

DASY5 Configuration

- Probe: EX3DV4 - SN3931; ConvF(8.14, 8.14, 8.14); Calibrated: 2016/10/3;
- Sensor-Surface: 1.4mm (Mechanical Surface Detection)
- Electronics: DAE4 Sn916; Calibrated: 2016/12/15
- Phantom: SAM LEFT; Type: QD000P40CD; Serial: TP:1718
- Measurement SW: DASY52, Version 52.8 (8); SEMCAD X Version 14.6.10 (7373)

Area Scan (61x51x1): Interpolated grid: dx=1.500 mm, dy=1.500 mm

Maximum value of SAR (interpolated) = 1.22 W/kg

Zoom Scan (5x5x7)/Cube 0: Measurement grid: dx=8mm, dy=8mm, dz=5mm

Reference Value = 5.198 V/m; Power Drift = 0.01 dB

Peak SAR (extrapolated) = 1.57 W/kg

SAR(1 g) = 0.905 W/kg; SAR(10 g) = 0.477 W/kg

Maximum value of SAR (measured) = 1.31 W/kg

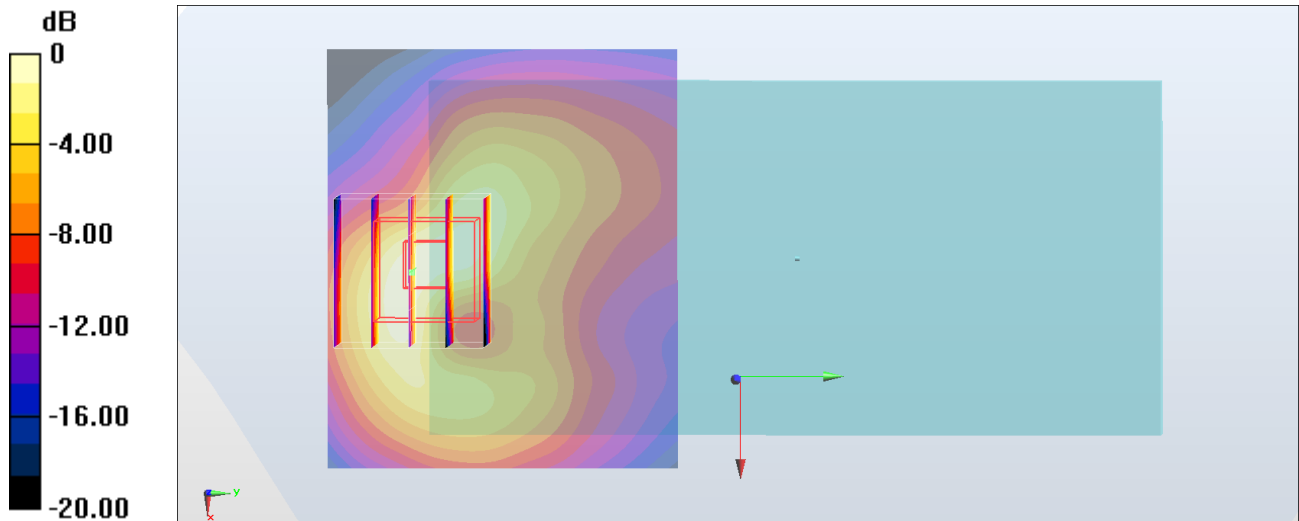

0 dB = 1.31 W/kg = 1.17 dBW/kg

#24_LTE Band 4_20M_QPSK_1_0_Front_10mm_Ch20175

Communication System: LTE; Frequency: 1732.5 MHz; Duty Cycle: 1:1

Medium: MSL_1750_170914 Medium parameters used : $f = 1732.5$ MHz; $\sigma = 1.433$ S/m; $\epsilon_r = 54.986$; $\rho = 1000$ kg/m³

Ambient Temperature : 23.5 °C ; Liquid Temperature : 22.5 °C

DASY5 Configuration

- Probe: EX3DV4 - SN3931; ConvF(8.45, 8.45, 8.45); Calibrated: 2016/10/3;
- Sensor-Surface: 1.4mm (Mechanical Surface Detection)
- Electronics: DAE4 Sn916; Calibrated: 2016/12/15
- Phantom: SAM LEFT; Type: QD000P40CD; Serial: TP:1718
- Measurement SW: DASY52, Version 52.8 (8); SEMCAD X Version 14.6.10 (7373)

Area Scan (61x51x1): Interpolated grid: dx=1.500 mm, dy=1.500 mm

Maximum value of SAR (interpolated) = 1.23 W/kg

Zoom Scan (5x5x7)/Cube 0: Measurement grid: dx=8mm, dy=8mm, dz=5mm

Reference Value = 6.028 V/m; Power Drift = 0.12 dB

Peak SAR (extrapolated) = 1.63 W/kg

SAR(1 g) = 0.973 W/kg; SAR(10 g) = 0.527 W/kg

Maximum value of SAR (measured) = 1.38 W/kg

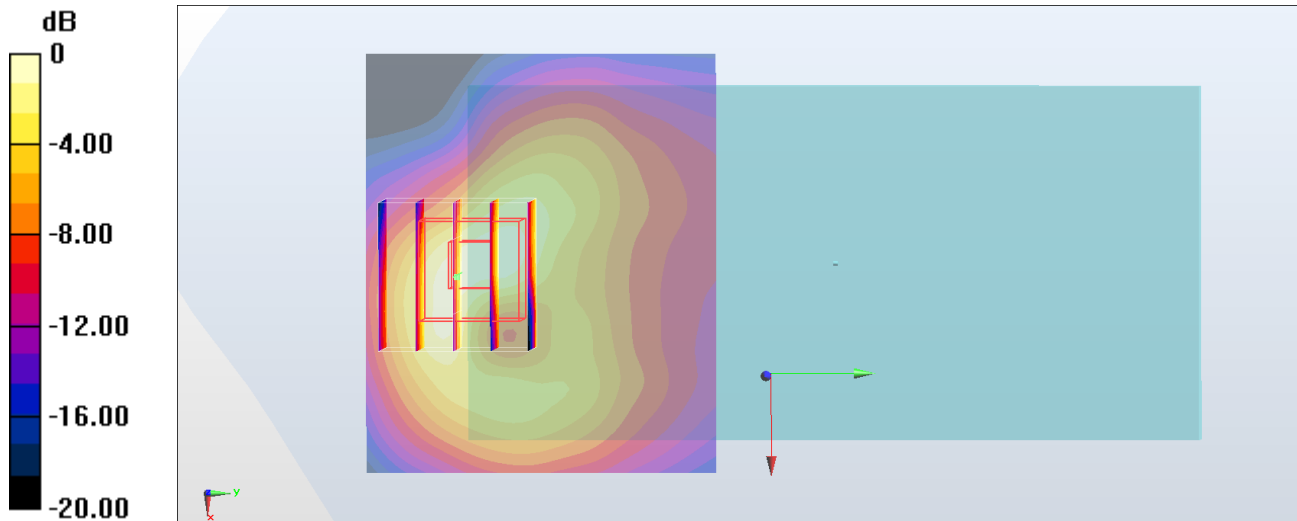

0 dB = 1.38 W/kg = 1.40 dBW/kg

#25_LTE Band 7_20M_QPSK_1_49_Bottom Side_10mm_Ch20850

Communication System: LTE ; Frequency: 2510 MHz;Duty Cycle: 1:1

Medium: MSL_2600_170906 Medium parameters used: $f = 2510$ MHz; $\sigma = 2.082$ S/m; $\epsilon_r = 54.45$; $\rho = 1000$ kg/m³

Ambient Temperature : 23.7 °C ; Liquid Temperature : 22.7 °C

DASY5 Configuration

- Probe: ES3DV3 - SN3071; ConvF(3.88, 3.88, 3.88); Calibrated: 2016/12/8;
- Sensor-Surface: 3mm (Mechanical Surface Detection)
- Electronics: DAE4 Sn778; Calibrated: 2017/5/22
- Phantom: SAM_RIGHT; Type: QD000P40CD; Serial: 1719
- Measurement SW: DASY52, Version 52.8 (8); SEMCAD X Version 14.6.10 (7373)

Area Scan (51x101x1): Interpolated grid: dx=1.200 mm, dy=1.200 mm

Maximum value of SAR (interpolated) = 1.15 W/kg

Zoom Scan (7x7x7)/Cube 0: Measurement grid: dx=5mm, dy=5mm, dz=5mm

Reference Value = 22.28 V/m; Power Drift = -0.02 dB

Peak SAR (extrapolated) = 1.56 W/kg

SAR(1 g) = 0.845 W/kg; SAR(10 g) = 0.423 W/kg

Maximum value of SAR (measured) = 1.08 W/kg

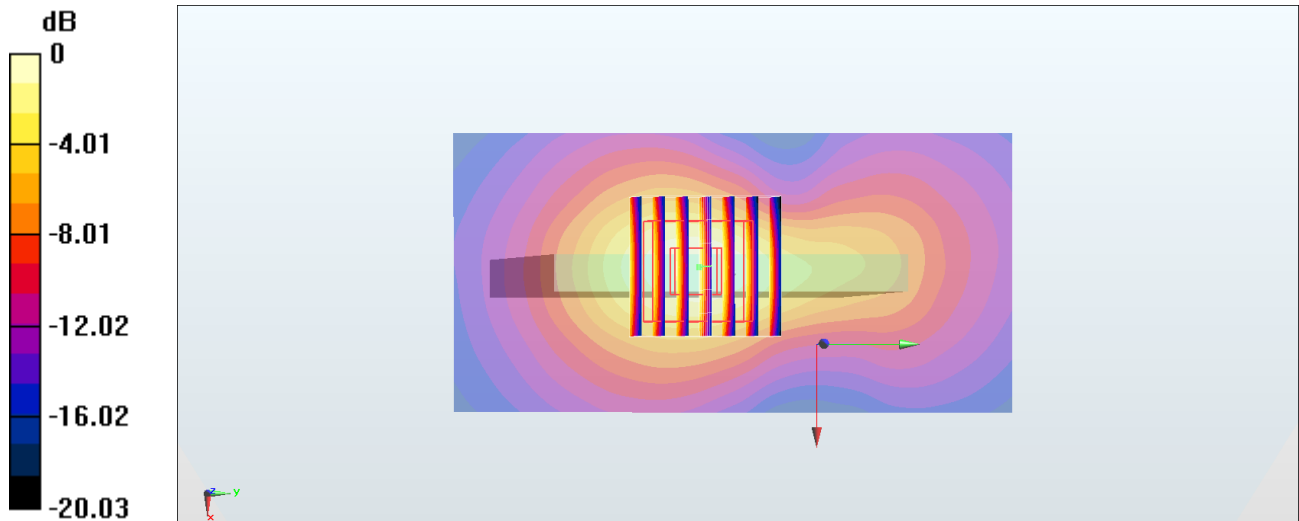

0 dB = 1.08 W/kg = 0.33 dBW/kg

#26_LTE Band 12_10M_QPSK_1_0_Front_10mm_Ch23095

Communication System: LTE; Frequency: 707.5 MHz; Duty Cycle: 1:1
Medium: MSL_750_170830 Medium parameters used : $f = 707.5$ MHz; $\sigma = 0.932$ S/m; $\epsilon_r = 54.955$;
 $\rho = 1000$ kg/m³
Ambient Temperature : 23.5 °C; Liquid Temperature : 22.5 °C

DASY5 Configuration:

- Probe: EX3DV4 - SN3976; ConvF(10.68, 10.68, 10.68); Calibrated: 2017/2/21;
- Sensor-Surface: 1.4mm (Mechanical Surface Detection)
- Electronics: DAE4 Sn1424; Calibrated: 2017/2/16
- Phantom: SAM_Left; Type: QD000P40CD; Serial: TP:1477
- Measurement SW: DASY52, Version 52.8 (8); SEMCAD X Version 14.6.10 (7373)

Area Scan (61x61x1): Interpolated grid: dx=1.500 mm, dy=1.500 mm
Maximum value of SAR (interpolated) = 0.550 W/kg

Zoom Scan (5x5x7)/Cube 0: Measurement grid: dx=8mm, dy=8mm, dz=5mm
Reference Value = 12.07 V/m; Power Drift = -0.08 dB
Peak SAR (extrapolated) = 0.679 W/kg
SAR(1 g) = 0.364 W/kg; SAR(10 g) = 0.211 W/kg
Maximum value of SAR (measured) = 0.547 W/kg

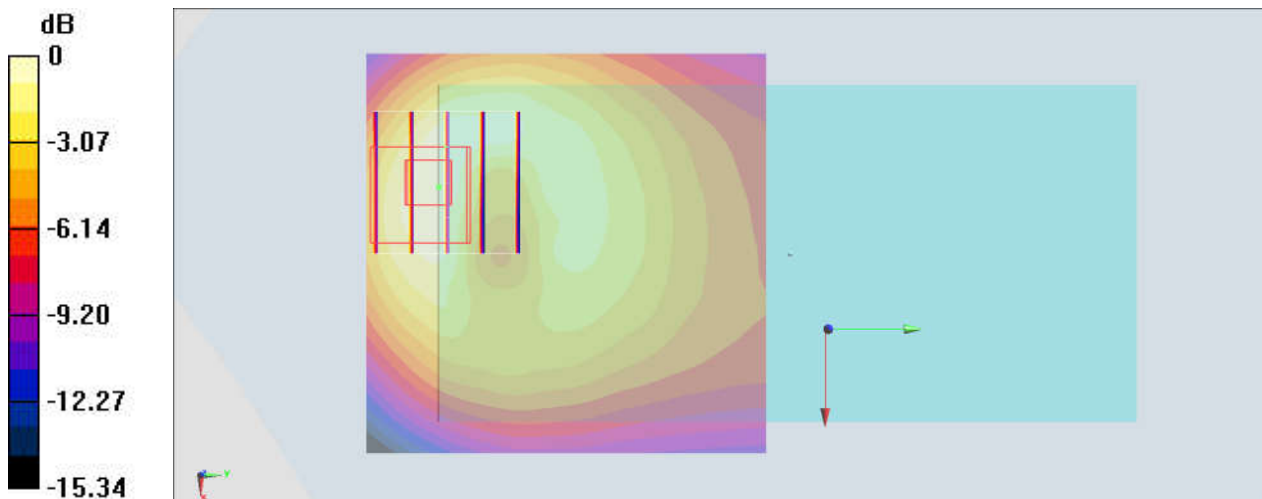

0 dB = 0.547 W/kg = -2.62 dBW/kg

#27_LTE Band 26_15M_QPSK_1_0_Front_10mm_Ch26865

Communication System: LTE; Frequency: 831.5 MHz; Duty Cycle: 1:1
Medium: MSL_850_170829 Medium parameters used : $f = 831.5$ MHz; $\sigma = 0.956$ S/m; $\epsilon_r = 55.533$;
 $\rho = 1000$ kg/m³
Ambient Temperature : 23.5 °C; Liquid Temperature : 22.5 °C

DASY5 Configuration:

- Probe: EX3DV4 - SN3976; ConvF(10.41, 10.41, 10.41); Calibrated: 2017/2/21;
- Sensor-Surface: 1.4mm (Mechanical Surface Detection)
- Electronics: DAE4 Sn1424; Calibrated: 2017/2/16
- Phantom: SAM_Left; Type: QD000P40CD; Serial: TP:1477
- Measurement SW: DASY52, Version 52.8 (8); SEMCAD X Version 14.6.10 (7373)

Area Scan (61x61x1): Interpolated grid: dx=1.500 mm, dy=1.500 mm
Maximum value of SAR (interpolated) = 0.654 W/kg

Zoom Scan (5x5x7)/Cube 0: Measurement grid: dx=8mm, dy=8mm, dz=5mm
Reference Value = 11.88 V/m; Power Drift = 0.01 dB
Peak SAR (extrapolated) = 0.774 W/kg
SAR(1 g) = 0.446 W/kg; SAR(10 g) = 0.257 W/kg
Maximum value of SAR (measured) = 0.645 W/kg

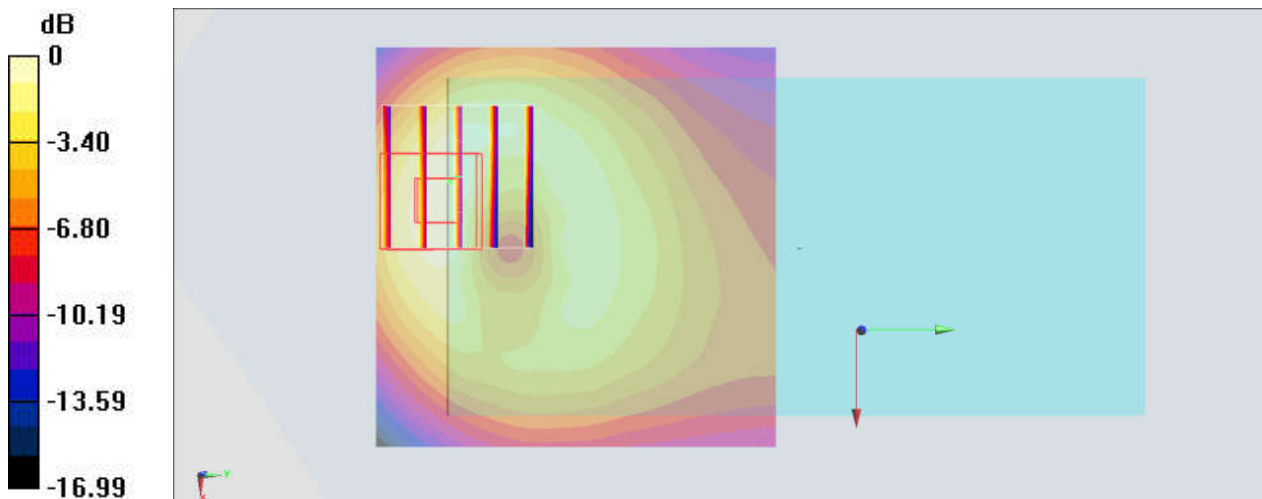

0 dB = 0.645 W/kg = -1.90 dBW/kg

#28_LTE Band 30_10M_QPSK_1_0_Bottom Side_10mm_Ch27710

Communication System: LTE; Frequency: 2310 MHz; Duty Cycle: 1:1

Medium: MSL_2300_170915 Medium parameters used: $f = 2310$ MHz; $\sigma = 1.839$ S/m; $\epsilon_r = 53.88$; $\rho = 1000$ kg/m³

Ambient Temperature : 23.7 °C ; Liquid Temperature : 22.7 °C

DASY5 Configuration

- Probe: EX3DV4 - SN3931; ConvF(7.96, 7.96, 7.96); Calibrated: 2016/10/3;
- Sensor-Surface: 1.4mm (Mechanical Surface Detection)
- Electronics: DAE4 Sn916; Calibrated: 2016/12/15
- Phantom: SAM LEFT; Type: QD000P40CD; Serial: TP:1718
- Measurement SW: DASY52, Version 52.8 (8); SEMCAD X Version 14.6.10 (7373)

Area Scan (41x81x1): Interpolated grid: dx=1.200 mm, dy=1.200 mm

Maximum value of SAR (interpolated) = 0.977 W/kg

Zoom Scan (7x7x7)/Cube 0: Measurement grid: dx=5mm, dy=5mm, dz=5mm

Reference Value = 22.77 V/m; Power Drift = 0.06 dB

Peak SAR (extrapolated) = 1.15 W/kg

SAR(1 g) = 0.619 W/kg; SAR(10 g) = 0.321 W/kg

Maximum value of SAR (measured) = 0.955 W/kg

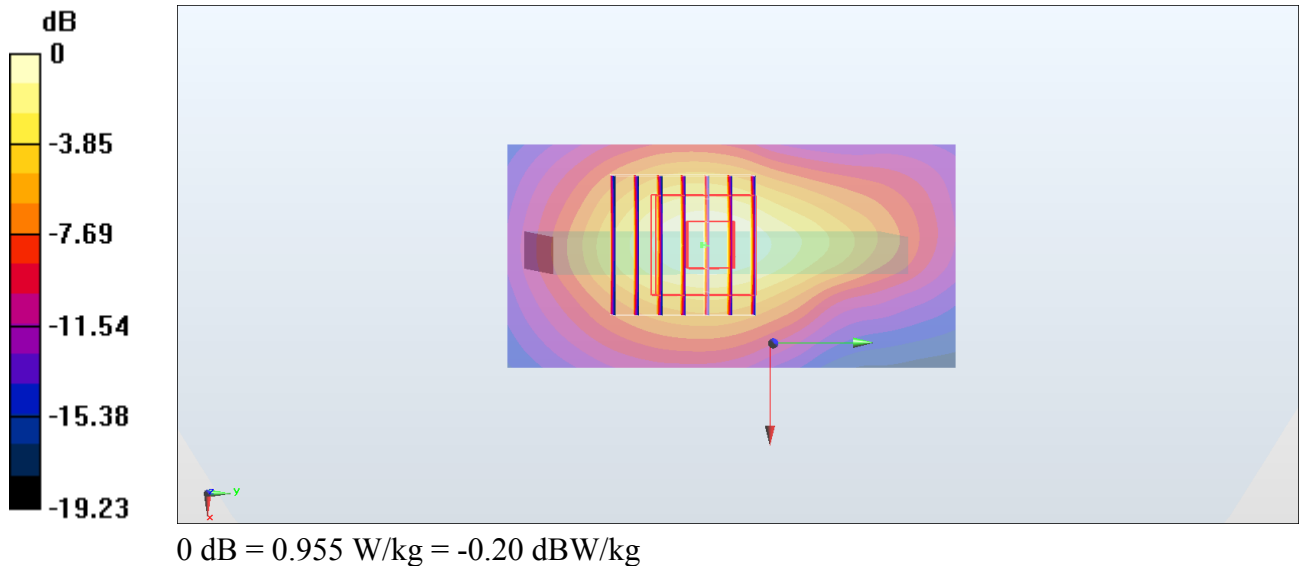

#29_LTE Band 41_20M_QPSK_1_0_Bottom Side_10mm_Ch40240

Communication System: LTE TDD; Frequency: 2555 MHz; Duty Cycle: 1:1.59

Medium: MSL_2600_170906 Medium parameters used: $f = 2555$ MHz; $\sigma = 2.146$ S/m; $\epsilon_r = 54.265$; $\rho = 1000$ kg/m³

Ambient Temperature : 23.7 °C ; Liquid Temperature : 22.7 °C

DASY5 Configuration

- Probe: ES3DV3 - SN3071; ConvF(3.74, 3.74, 3.74); Calibrated: 2016/12/8;
- Sensor-Surface: 3mm (Mechanical Surface Detection)
- Electronics: DAE4 Sn778; Calibrated: 2017/5/22
- Phantom: SAM_RIGHT; Type: QD000P40CD; Serial: 1719
- Measurement SW: DASY52, Version 52.8 (8); SEMCAD X Version 14.6.10 (7373)

Area Scan (51x101x1): Interpolated grid: dx=1.200 mm, dy=1.200 mm

Maximum value of SAR (interpolated) = 0.821 W/kg

Zoom Scan (7x7x7)/Cube 0: Measurement grid: dx=5mm, dy=5mm, dz=5mm

Reference Value = 17.33 V/m; Power Drift = -0.11 dB

Peak SAR (extrapolated) = 1.15 W/kg

SAR(1 g) = 0.605 W/kg; SAR(10 g) = 0.298 W/kg

Maximum value of SAR (measured) = 0.779 W/kg

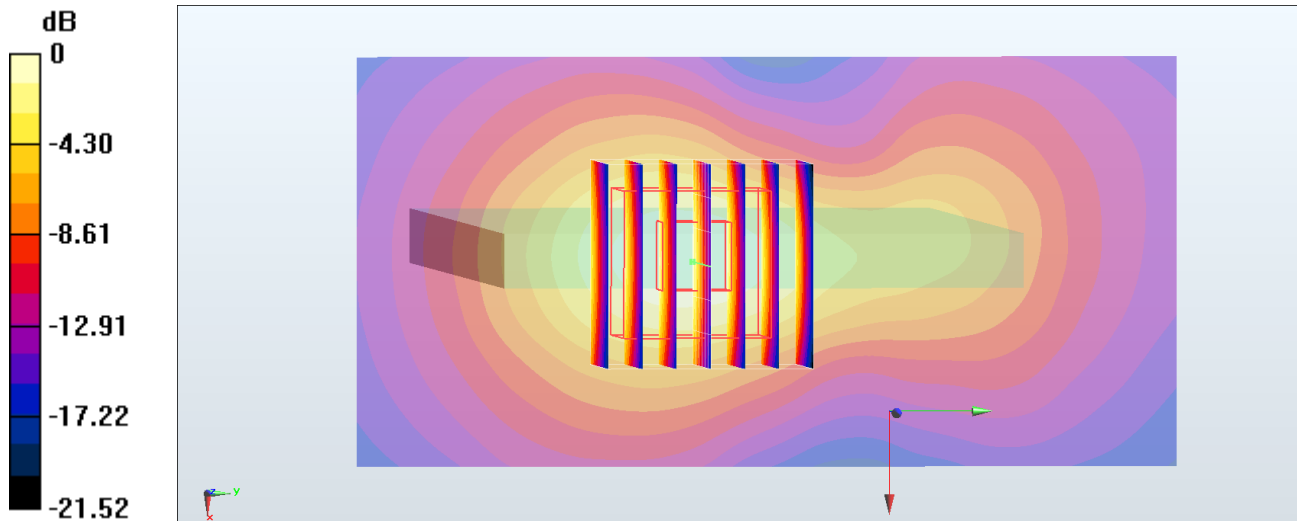

0 dB = 0.779 W/kg = -1.08 dBW/kg

#30_WLAN2.4GHz_802.11b 1Mbps_Top Side_10mm_Ch6;Ant 2

Communication System: 802.11b; Frequency: 2437 MHz; Duty Cycle: 1:1.019

Medium: MSL_2450_170908 Medium parameters used : $f = 2437$ MHz; $\sigma = 1.972$ S/m; $\epsilon_r = 54.528$; $\rho = 1000$ kg/m³

Ambient Temperature : 23.5 °C ; Liquid Temperature : 22.5 °C

DASY5 Configuration

- Probe: ES3DV3 - SN3169; ConvF(4.28, 4.28, 4.28); Calibrated: 2017/5/11;
- Sensor-Surface: 3mm (Mechanical Surface Detection)
- Electronics: DAE4 Sn1399; Calibrated: 2016/11/17
- Phantom: SAM_RIGHT; Type: QD000P40CD; Serial: 1719
- Measurement SW: DASY52, Version 52.8 (8); SEMCAD X Version 14.6.10 (7373)

Area Scan (51x101x1): Interpolated grid: dx=1.200 mm, dy=1.200 mm

Maximum value of SAR (interpolated) = 0.321 W/kg

Zoom Scan (7x7x7)/Cube 0: Measurement grid: dx=5mm, dy=5mm, dz=5mm

Reference Value = 13.24 V/m; Power Drift = -0.11 dB

Peak SAR (extrapolated) = 0.460 W/kg

SAR(1 g) = 0.253 W/kg; SAR(10 g) = 0.135 W/kg

Maximum value of SAR (measured) = 0.315 W/kg

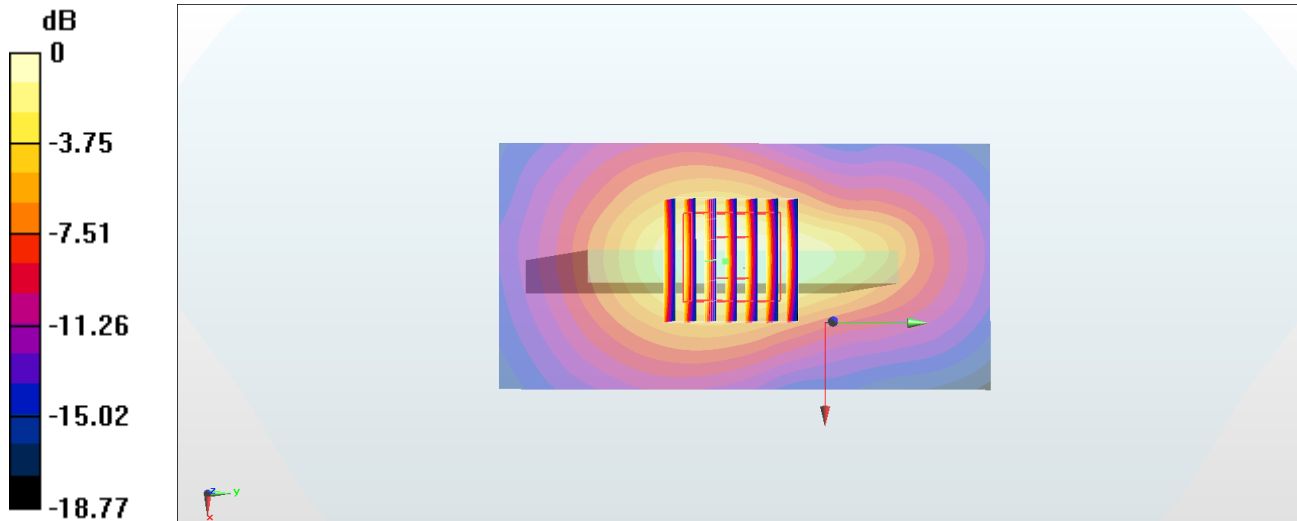

0 dB = 0.315 W/kg = -5.02 dBW/kg

#31_WLAN5GHz_802.11a 6Mbps_Front_10mm_Ch44

Communication System: 802.11a; Frequency: 5220 MHz; Duty Cycle: 1:1.019

Medium: MSL_5G_170914 Medium parameters used: $f = 5220$ MHz; $\sigma = 5.395$ S/m; $\epsilon_r = 47.488$; $\rho = 1000$ kg/m³

Ambient Temperature : 23.5 °C ; Liquid Temperature : 22.5 °C

DASY5 Configuration

- Probe: EX3DV4 - SN3925; ConvF(4.59, 4.59, 4.59); Calibrated: 2017/5/24;
- Sensor-Surface: 1.4mm (Mechanical Surface Detection)
- Electronics: DAE3 Sn495; Calibrated: 2017/5/22
- Phantom: SAM_Left; Type: QD000P40CD; Serial: TP:1815
- Measurement SW: DASY52, Version 52.8 (8); SEMCAD X Version 14.6.10 (7373)

Area Scan (71x71x1): Interpolated grid: dx=1.000 mm, dy=1.000 mm

Maximum value of SAR (interpolated) = 0.377 W/kg

Zoom Scan (7x7x7)/Cube 0: Measurement grid: dx=4mm, dy=4mm, dz=1.4mm

Reference Value = 6.240 V/m; Power Drift = -0.01 dB

Peak SAR (extrapolated) = 0.967 W/kg

SAR(1 g) = 0.149 W/kg; SAR(10 g) = 0.038 W/kg

Maximum value of SAR (measured) = 0.390 W/kg

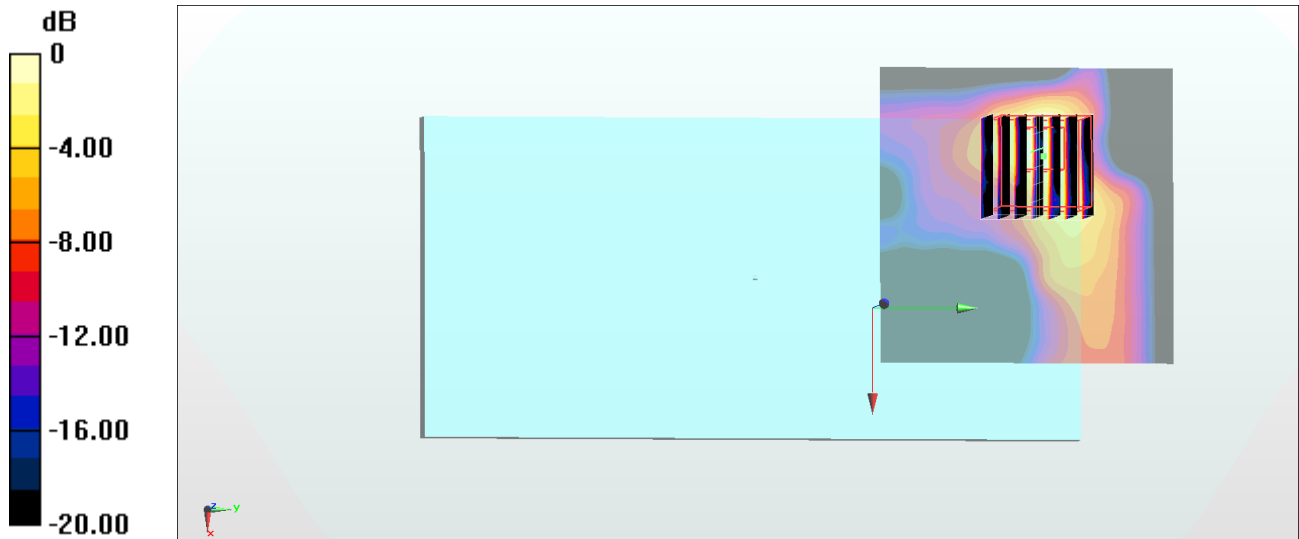

0 dB = 0.390 W/kg = -4.09 dBW/kg

#32_WLAN5GHz_802.11n-HT40 MCS0_Back_10mm_Ch151

Communication System: 802.11n ; Frequency: 5755 MHz; Duty Cycle: 1:1.042

Medium: MSL_5G_170914 Medium parameters used: $f = 5755$ MHz; $\sigma = 6.111$ S/m; $\epsilon_r = 46.602$; $\rho = 1000$ kg/m³

Ambient Temperature : 23.5 °C ; Liquid Temperature : 22.5 °C

DASY5 Configuration

- Probe: EX3DV4 - SN3925; ConvF(4.14, 4.14, 4.14); Calibrated: 2017/5/24;
- Sensor-Surface: 1.4mm (Mechanical Surface Detection)
- Electronics: DAE3 Sn495; Calibrated: 2017/5/22
- Phantom: SAM_Left; Type: QD000P40CD; Serial: TP:1815
- Measurement SW: DASY52, Version 52.8 (8); SEMCAD X Version 14.6.10 (7373)

Area Scan (71x71x1): Interpolated grid: dx=1.000 mm, dy=1.000 mm

Maximum value of SAR (interpolated) = 0.715 W/kg

Zoom Scan (7x7x7)/Cube 0: Measurement grid: dx=4mm, dy=4mm, dz=1.4mm

Reference Value = 10.52 V/m; Power Drift = -0.13 dB

Peak SAR (extrapolated) = 1.34 W/kg

SAR(1 g) = 0.293 W/kg; SAR(10 g) = 0.101 W/kg

Maximum value of SAR (measured) = 0.747 W/kg

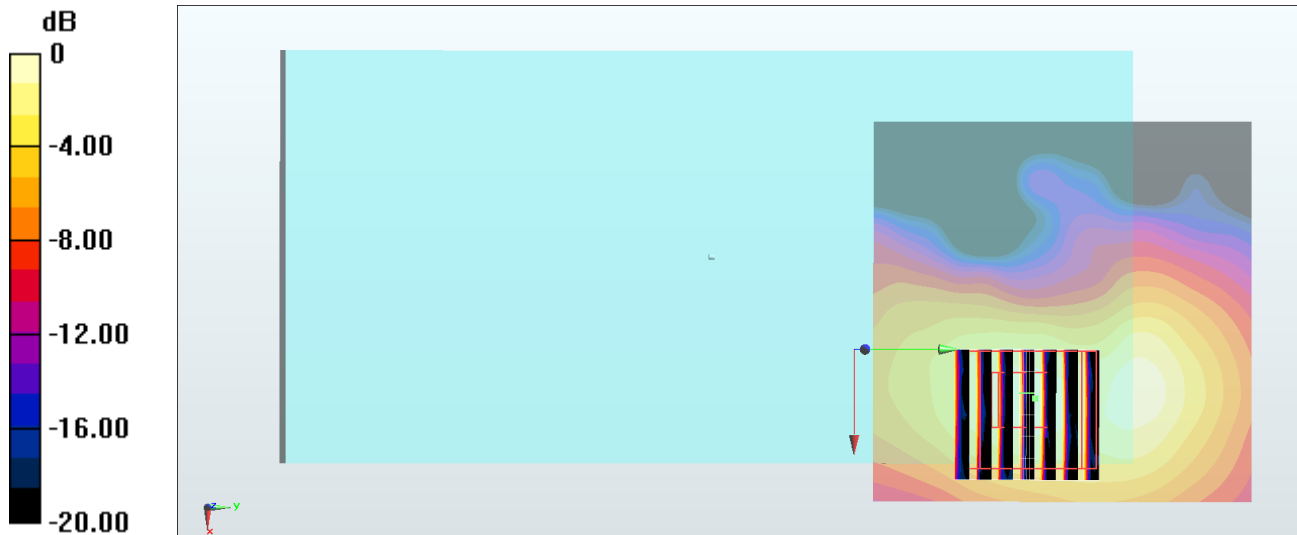

0 dB = 0.747 W/kg = -1.27 dBW/kg

#33_Bluetooth_1Mbps_Back_10mm_Ch78

Communication System: Bluetooth; Frequency: 2480 MHz; Duty Cycle: 1:1.297

Medium: MSL_2450_170916 Medium parameters used: $f = 2480$ MHz; $\sigma = 2.011$ S/m; $\epsilon_r = 53.932$; $\rho = 1000$ kg/m³

Ambient Temperature : 23.7 °C ; Liquid Temperature : 22.7 °C

DASY5 Configuration:

- Probe: EX3DV4 - SN3925; ConvF(7.94, 7.94, 7.94); Calibrated: 2017/5/24;
- Sensor-Surface: 1.4mm (Mechanical Surface Detection)
- Electronics: DAE3 Sn495; Calibrated: 2017/5/22
- Phantom: SAM_Left; Type: QD000P40CD; Serial: TP:1815
- Measurement SW: DASY52, Version 52.8 (8); SEMCAD X Version 14.6.10 (7373)

Area Scan (61x61x1): Interpolated grid: dx=1.200 mm, dy=1.200 mm

Maximum value of SAR (interpolated) = 0.0266 W/kg

Zoom Scan (7x7x7)/Cube 0: Measurement grid: dx=5mm, dy=5mm, dz=5mm

Reference Value = 0.8180 V/m; Power Drift = -0.01 dB

Peak SAR (extrapolated) = 0.0340 W/kg

SAR(1 g) = 0.019 W/kg; SAR(10 g) = 0.00805 W/kg

Maximum value of SAR (measured) = 0.0250 W/kg

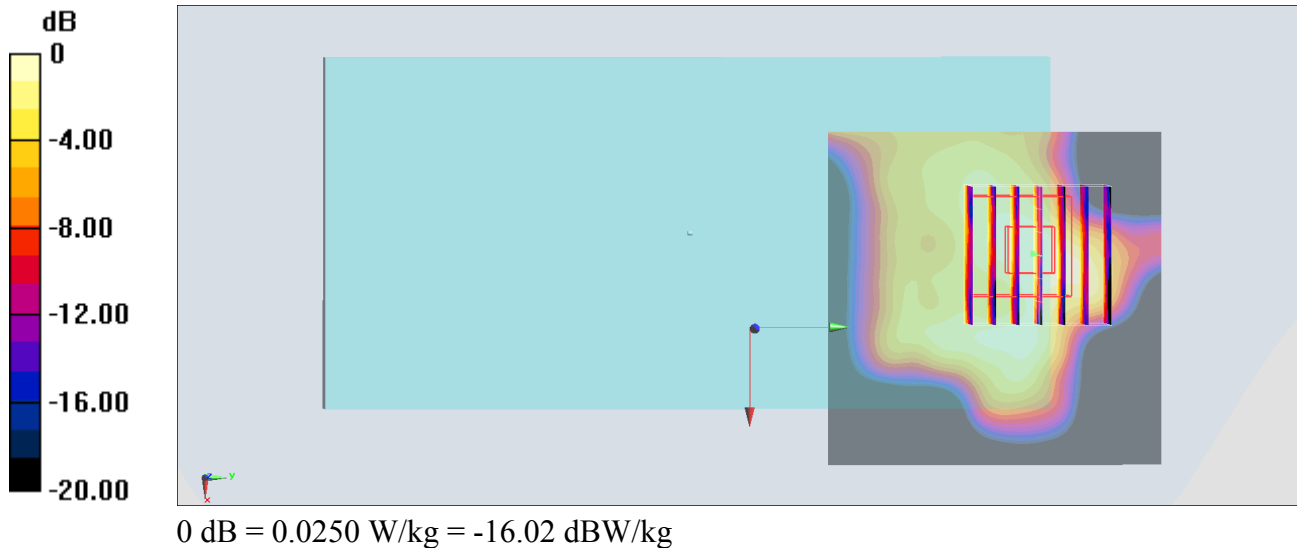

#34_GSM850_GPRS (4 Tx slots)_Front_15mm_Ch251

Communication System: GSM850; Frequency: 848.8 MHz; Duty Cycle: 1:2.08
Medium: MSL_850_170831 Medium parameters used: $f = 849$ MHz; $\sigma = 0.974$ S/m; $\epsilon_r = 55.483$; $\rho = 1000$ kg/m³
Ambient Temperature : 23.3 °C; Liquid Temperature : 22.3 °C

DASY5 Configuration:

- Probe: EX3DV4 - SN3976; ConvF(10.41, 10.41, 10.41); Calibrated: 2017/2/21;
- Sensor-Surface: 1.4mm (Mechanical Surface Detection)
- Electronics: DAE4 Sn1424; Calibrated: 2017/2/16
- Phantom: SAM_Left; Type: QD000P40CD; Serial: TP:1477
- Measurement SW: DASY52, Version 52.8 (8); SEMCAD X Version 14.6.10 (7373)

Area Scan (61x61x1): Interpolated grid: dx=1.500 mm, dy=1.500 mm
Maximum value of SAR (interpolated) = 0.324 W/kg

Zoom Scan (5x5x7)/Cube 0: Measurement grid: dx=8mm, dy=8mm, dz=5mm
Reference Value = 9.560 V/m; Power Drift = 0.13 dB
Peak SAR (extrapolated) = 0.384 W/kg
SAR(1 g) = 0.269 W/kg; SAR(10 g) = 0.184 W/kg
Maximum value of SAR (measured) = 0.339 W/kg

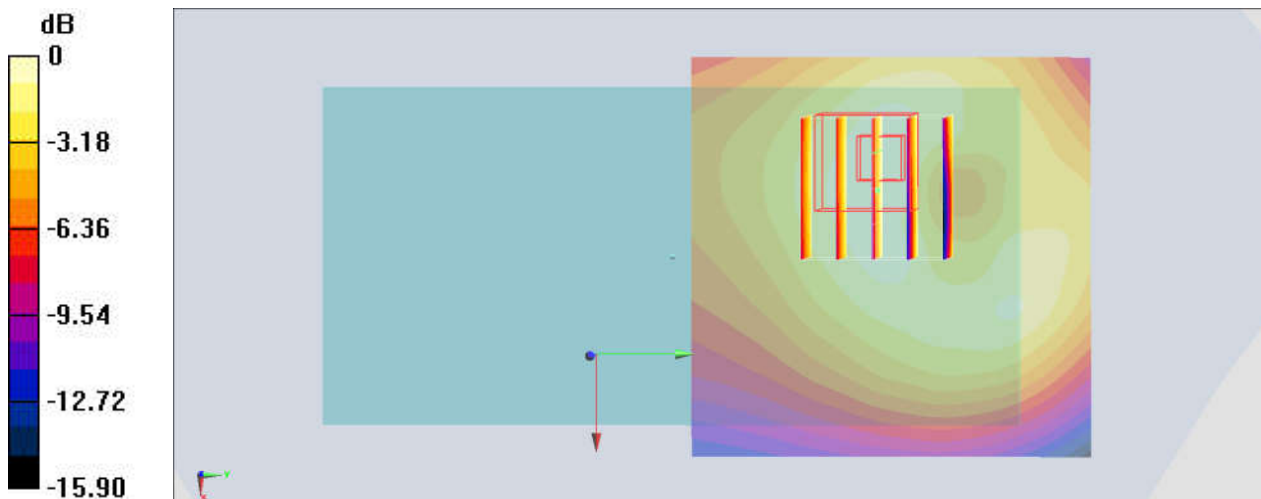

0 dB = 0.339 W/kg = -4.70 dBW/kg

#35_GSM1900_GPRS (4 Tx slots)_Front_15mm_Ch810

Communication System: PCS; Frequency: 1909.8 MHz; Duty Cycle: 1:2.08

Medium: MSL_1900_170907 Medium parameters used: $f = 1910$ MHz; $\sigma = 1.564$ S/m; $\epsilon_r = 54.248$; $\rho = 1000$ kg/m³

Ambient Temperature : 23.6 °C ; Liquid Temperature : 22.6 °C

DASY5 Configuration

- Probe: EX3DV4 - SN7306; ConvF(7.98, 7.98, 7.98); Calibrated: 2017/7/24;
- Sensor-Surface: 1.4mm (Mechanical Surface Detection)
- Electronics: DAE3 Sn577; Calibrated: 2016/9/28
- Phantom: SAM_RIGHT; Type: QD000P40CD; Serial: 1719
- Measurement SW: DASY52, Version 52.8 (8); SEMCAD X Version 14.6.10 (7373)

Area Scan (71x61x1): Interpolated grid: dx=1.500 mm, dy=1.500 mm

Maximum value of SAR (interpolated) = 0.223 W/kg

Zoom Scan (5x5x7)/Cube 0: Measurement grid: dx=8mm, dy=8mm, dz=5mm

Reference Value = 3.764 V/m; Power Drift = 0.07 dB

Peak SAR (extrapolated) = 0.291 W/kg

SAR(1 g) = 0.172 W/kg; SAR(10 g) = 0.095 W/kg

Maximum value of SAR (measured) = 0.242 W/kg

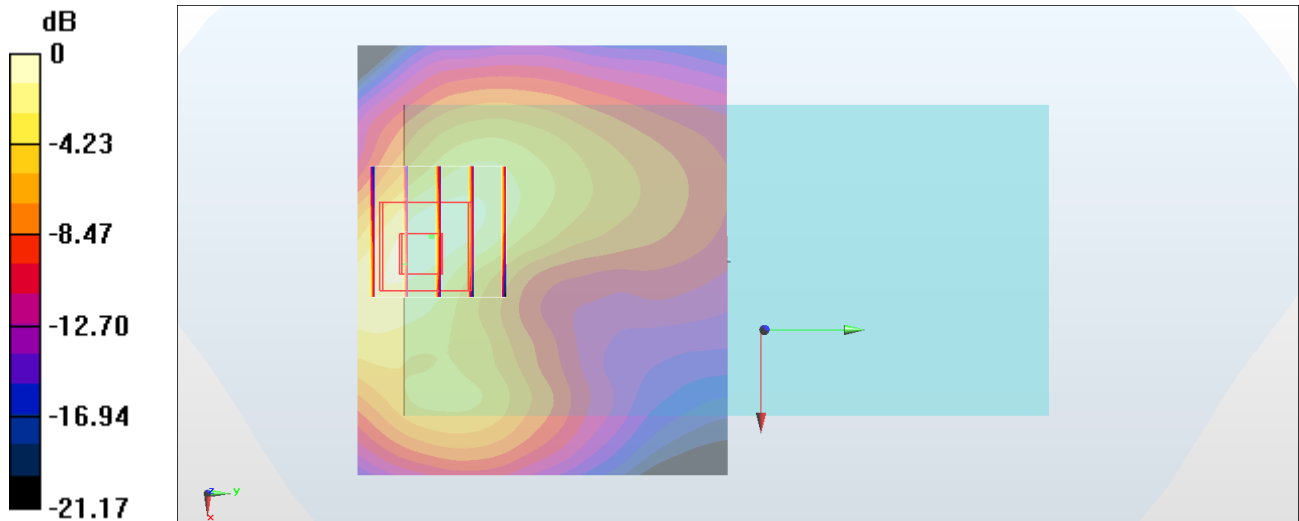

0 dB = 0.242 W/kg = -6.16 dBW/kg

#36_WCDMA II_RMC 12.23Kbps_Front_15mm_Ch9262

Communication System: WCDMA; Frequency: 1852.4 MHz; Duty Cycle: 1:1

Medium: MSL_1900_170913 Medium parameters used: $f = 1852.4$ MHz; $\sigma = 1.512$ S/m; $\epsilon_r = 54.61$; $\rho = 1000$ kg/m³

Ambient Temperature : 23.5 °C ; Liquid Temperature : 22.5 °C

DASY5 Configuration

- Probe: EX3DV4 - SN3931; ConvF(8.14, 8.14, 8.14); Calibrated: 2016/10/3;
- Sensor-Surface: 1.4mm (Mechanical Surface Detection)
- Electronics: DAE4 Sn916; Calibrated: 2016/12/15
- Phantom: SAM LEFT; Type: QD000P40CD; Serial: TP:1718
- Measurement SW: DASY52, Version 52.8 (8); SEMCAD X Version 14.6.10 (7373)

Area Scan (71x61x1): Interpolated grid: dx=1.500 mm, dy=1.500 mm

Maximum value of SAR (interpolated) = 0.550 W/kg

Zoom Scan (5x5x7)/Cube 0: Measurement grid: dx=8mm, dy=8mm, dz=5mm

Reference Value = 4.971 V/m; Power Drift = 0.10 dB

Peak SAR (extrapolated) = 0.711 W/kg

SAR(1 g) = 0.433 W/kg; SAR(10 g) = 0.243 W/kg

Maximum value of SAR (measured) = 0.590 W/kg

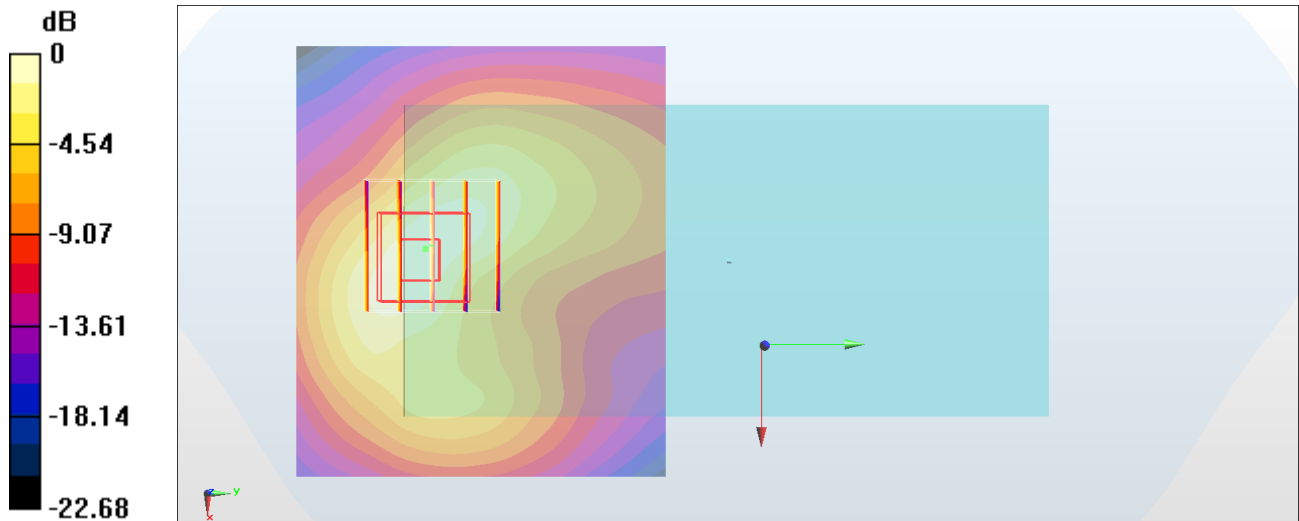

0 dB = 0.590 W/kg = -2.29 dBW/kg

#37_WCDMA IV_RMC 12.23Kbps_Front_15mm_Ch1413

Communication System: WCDMA; Frequency: 1732.6 MHz; Duty Cycle: 1:1

Medium: MSL_1750_170914 Medium parameters used: $f = 1733 \text{ MHz}$; $\sigma = 1.434 \text{ S/m}$; $\epsilon_r = 54.986$; $\rho = 1000 \text{ kg/m}^3$

Ambient Temperature : $23.5 \text{ }^\circ\text{C}$; Liquid Temperature : $22.5 \text{ }^\circ\text{C}$

DASY5 Configuration

- Probe: EX3DV4 - SN3931; ConvF(8.45, 8.45, 8.45); Calibrated: 2016/10/3;
- Sensor-Surface: 1.4mm (Mechanical Surface Detection)
- Electronics: DAE4 Sn916; Calibrated: 2016/12/15
- Phantom: SAM LEFT; Type: QD000P40CD; Serial: TP:1718
- Measurement SW: DASY52, Version 52.8 (8); SEMCAD X Version 14.6.10 (7373)

Area Scan (71x61x1): Interpolated grid: $dx=1.500 \text{ mm}$, $dy=1.500 \text{ mm}$

Maximum value of SAR (interpolated) = 0.519 W/kg

Zoom Scan (5x5x7)/Cube 0: Measurement grid: $dx=8\text{mm}$, $dy=8\text{mm}$, $dz=5\text{mm}$

Reference Value = 4.942 V/m ; Power Drift = 0.14 dB

Peak SAR (extrapolated) = 0.609 W/kg

SAR(1 g) = 0.381 W/kg ; SAR(10 g) = 0.220 W/kg

Maximum value of SAR (measured) = 0.513 W/kg

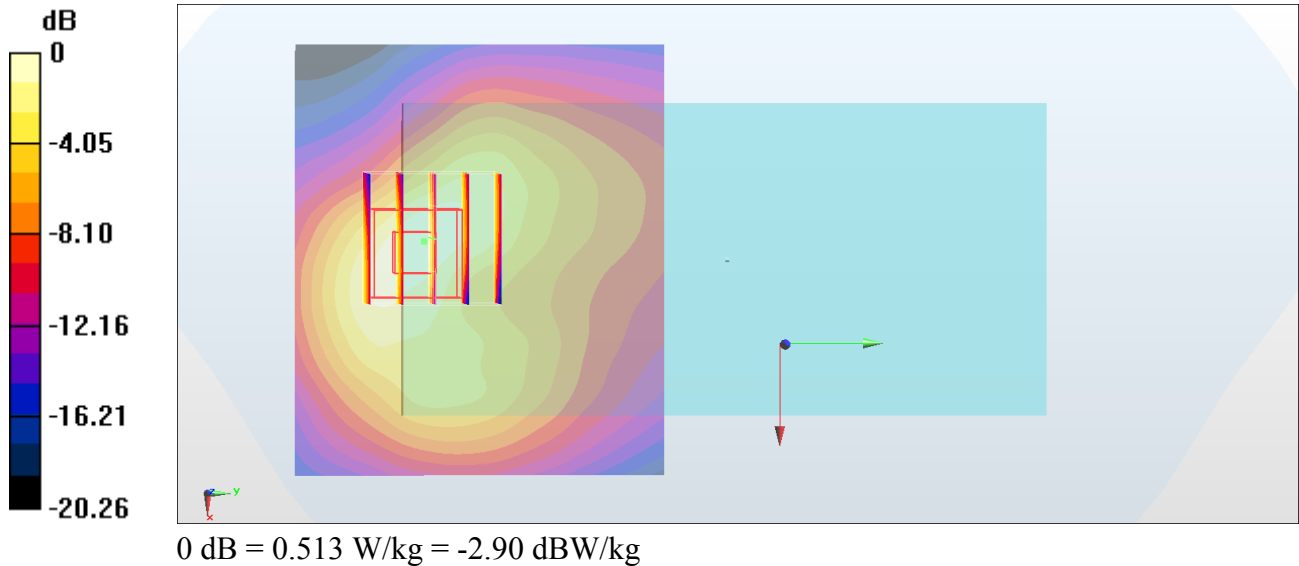

#38_WCDMA V_RMC 12.2Kbps_Front_15mm_Ch4132

Communication System: WCDMA; Frequency: 826.4 MHz; Duty Cycle: 1:1
Medium: MSL_850_170829 Medium parameters used: $f = 826.4$ MHz; $\sigma = 0.951$ S/m; $\epsilon_r = 55.585$;
 $\rho = 1000$ kg/m³
Ambient Temperature : 23.5 °C; Liquid Temperature : 22.5 °C

DASY5 Configuration:

- Probe: EX3DV4 - SN3976; ConvF(10.41, 10.41, 10.41); Calibrated: 2017/2/21;
- Sensor-Surface: 1.4mm (Mechanical Surface Detection)
- Electronics: DAE4 Sn1424; Calibrated: 2017/2/16
- Phantom: SAM_Left; Type: QD000P40CD; Serial: TP:1477
- Measurement SW: DASY52, Version 52.8 (8); SEMCAD X Version 14.6.10 (7373)

Area Scan (61x61x1): Interpolated grid: dx=1.500 mm, dy=1.500 mm
Maximum value of SAR (interpolated) = 0.277 W/kg

Zoom Scan (5x5x7)/Cube 0: Measurement grid: dx=8mm, dy=8mm, dz=5mm
Reference Value = 10.73 V/m; Power Drift = 0.10 dB
Peak SAR (extrapolated) = 0.319 W/kg
SAR(1 g) = 0.226 W/kg; SAR(10 g) = 0.158 W/kg
Maximum value of SAR (measured) = 0.284 W/kg

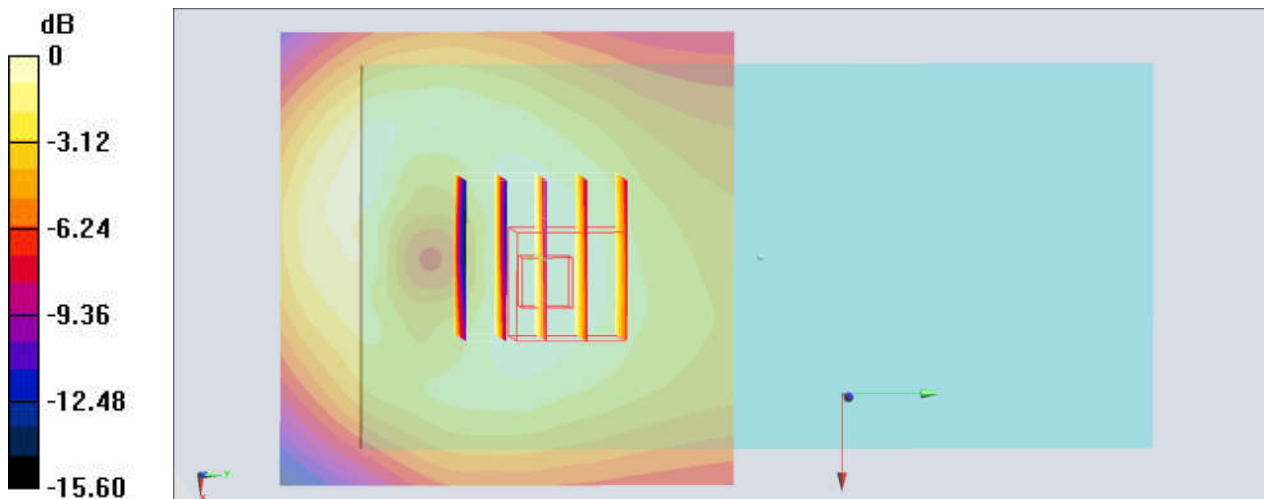

0 dB = 0.284 W/kg = -5.47 dBW/kg

#39_LTE Band 2_20M_QPSK_1_0_Front_15mm_Ch18700

Communication System: LTE; Frequency: 1860 MHz; Duty Cycle: 1:1

Medium: MSL_1900_170913 Medium parameters used: $f = 1860$ MHz; $\sigma = 1.521$ S/m; $\epsilon_r = 54.588$; $\rho = 1000$ kg/m³

Ambient Temperature : 23.5 °C ; Liquid Temperature : 22.5 °C

DASY5 Configuration

- Probe: EX3DV4 - SN3931; ConvF(8.14, 8.14, 8.14); Calibrated: 2016/10/3;
- Sensor-Surface: 1.4mm (Mechanical Surface Detection)
- Electronics: DAE4 Sn916; Calibrated: 2016/12/15
- Phantom: SAM LEFT; Type: QD000P40CD; Serial: TP:1718
- Measurement SW: DASY52, Version 52.8 (8); SEMCAD X Version 14.6.10 (7373)

Area Scan (71x61x1): Interpolated grid: dx=1.500 mm, dy=1.500 mm

Maximum value of SAR (interpolated) = 0.569 W/kg

Zoom Scan (5x5x7)/Cube 0: Measurement grid: dx=8mm, dy=8mm, dz=5mm

Reference Value = 4.931 V/m; Power Drift = 0.05 dB

Peak SAR (extrapolated) = 0.743 W/kg

SAR(1 g) = 0.452 W/kg; SAR(10 g) = 0.255 W/kg

Maximum value of SAR (measured) = 0.615 W/kg

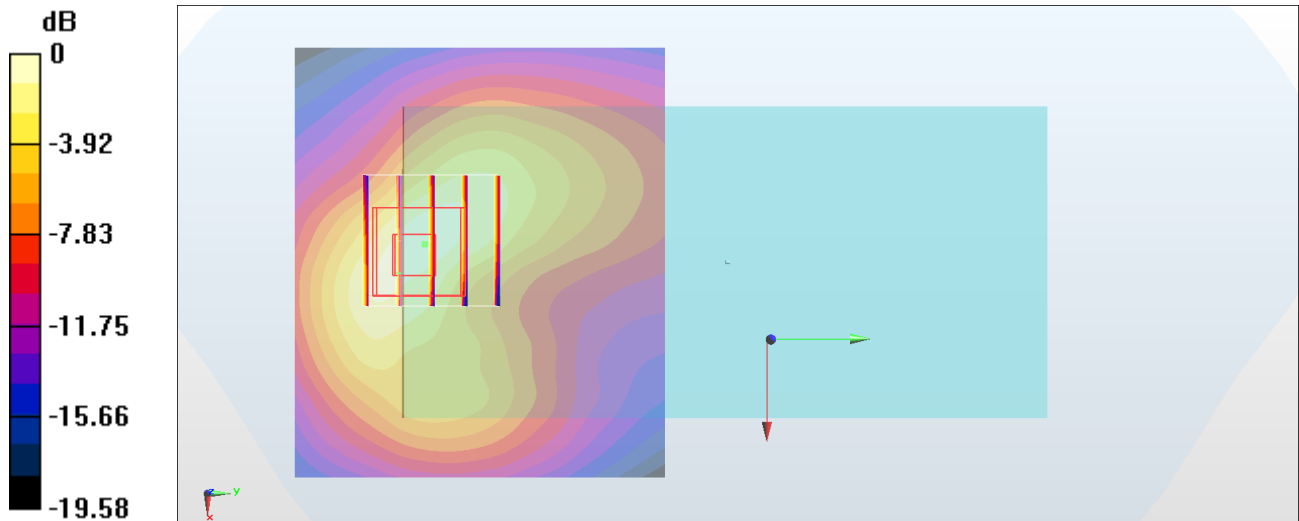

0 dB = 0.615 W/kg = -2.11 dBW/kg

#40_LTE Band 4_20M_QPSK_1_0_Front_15mm_Ch20175

Communication System: LTE ; Frequency: 1732.5 MHz;Duty Cycle: 1:1

Medium: MSL_1750_170907 Medium parameters used : $f = 1732.5$ MHz; $\sigma = 1.453$ S/m; $\epsilon_r = 54.732$; $\rho = 1000$ kg/m³

Ambient Temperature : 23.6 °C ; Liquid Temperature : 22.6 °C

DASY5 Configuration

- Probe: EX3DV4 - SN7306; ConvF(8.29, 8.29, 8.29); Calibrated: 2017/7/24;
- Sensor-Surface: 1.4mm (Mechanical Surface Detection)
- Electronics: DAE3 Sn577; Calibrated: 2016/9/28
- Phantom: SAM_RIGHT; Type: QD000P40CD; Serial: 1719
- Measurement SW: DASY52, Version 52.8 (8); SEMCAD X Version 14.6.10 (7373)

Area Scan (71x71x1): Interpolated grid: dx=1.500 mm, dy=1.500 mm

Maximum value of SAR (interpolated) = 0.542 W/kg

Zoom Scan (5x5x7)/Cube 0: Measurement grid: dx=8mm, dy=8mm, dz=5mm

Reference Value = 4.697 V/m; Power Drift = -0.15 dB

Peak SAR (extrapolated) = 0.700 W/kg

SAR(1 g) = 0.444 W/kg; SAR(10 g) = 0.257 W/kg

Maximum value of SAR (measured) = 0.601 W/kg

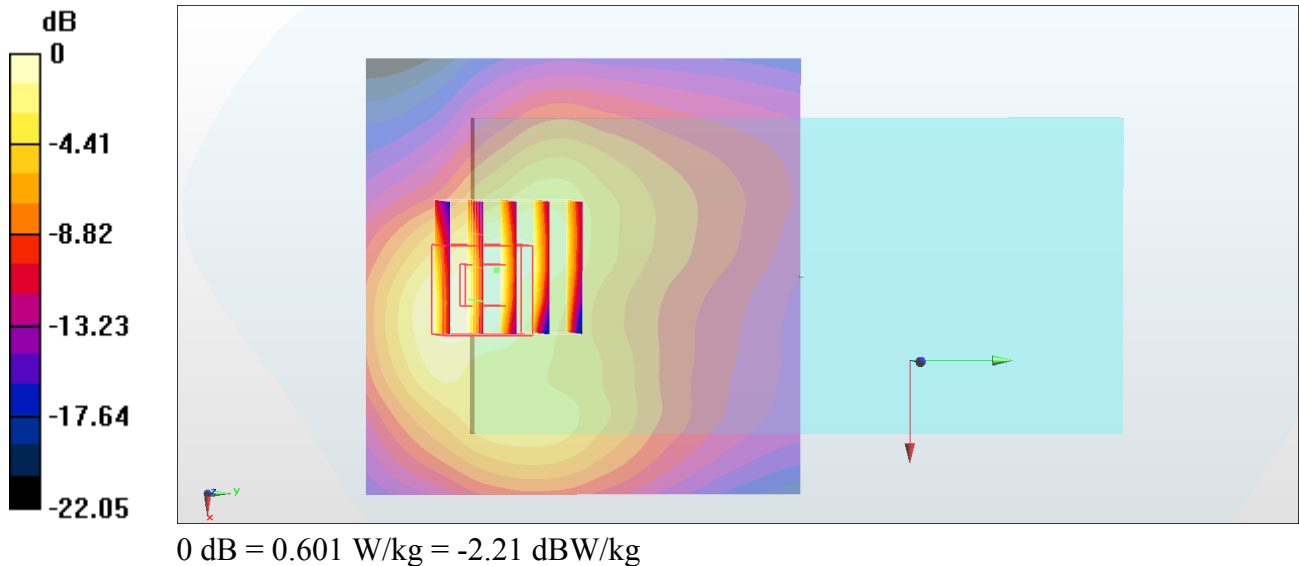

#41_LTE Band 7_20M_QPSK_1_49_Back_15mm_Ch21100

Communication System: LTE; Frequency: 2535 MHz; Duty Cycle: 1:1

Medium: MSL_2600_170906 Medium parameters used : $f = 2535$ MHz; $\sigma = 2.118$ S/m; $\epsilon_r = 54.343$; $\rho = 1000$ kg/m³

Ambient Temperature : 23.7 °C ; Liquid Temperature : 22.7 °C

DASY5 Configuration

- Probe: ES3DV3 - SN3071; ConvF(3.88, 3.88, 3.88); Calibrated: 2016/12/8;
- Sensor-Surface: 3mm (Mechanical Surface Detection)
- Electronics: DAE4 Sn778; Calibrated: 2017/5/22
- Phantom: SAM_RIGHT; Type: QD000P40CD; Serial: 1719
- Measurement SW: DASY52, Version 52.8 (8); SEMCAD X Version 14.6.10 (7373)

Area Scan (81x71x1): Interpolated grid: dx=1.200 mm, dy=1.200 mm

Maximum value of SAR (interpolated) = 0.311 W/kg

Zoom Scan (7x7x7)/Cube 0: Measurement grid: dx=5mm, dy=5mm, dz=5mm

Reference Value = 4.487 V/m; Power Drift = 0.02 dB

Peak SAR (extrapolated) = 0.472 W/kg

SAR(1 g) = 0.253 W/kg; SAR(10 g) = 0.128 W/kg

Maximum value of SAR (measured) = 0.323 W/kg

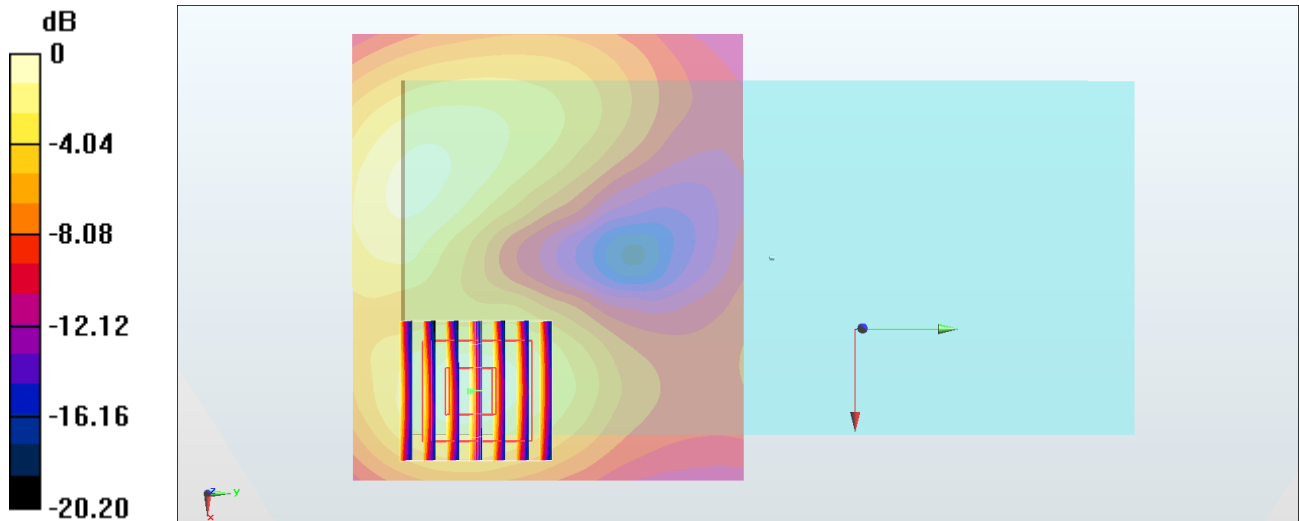

0 dB = 0.323 W/kg = -4.91 dBW/kg

#42_LTE Band 12_10M_QPSK_1_0_Back_15mm_Ch23095

Communication System: LTE; Frequency: 707.5 MHz; Duty Cycle: 1:1
Medium: MSL_750_170830 Medium parameters used : $f = 707.5$ MHz; $\sigma = 0.932$ S/m; $\epsilon_r = 54.955$;
 $\rho = 1000$ kg/m³
Ambient Temperature : 23.5 °C; Liquid Temperature : 22.5 °C

DASY5 Configuration:

- Probe: EX3DV4 - SN3976; ConvF(10.68, 10.68, 10.68); Calibrated: 2017/2/21;
- Sensor-Surface: 1.4mm (Mechanical Surface Detection)
- Electronics: DAE4 Sn1424; Calibrated: 2017/2/16
- Phantom: SAM_Left; Type: QD000P40CD; Serial: TP:1477
- Measurement SW: DASY52, Version 52.8 (8); SEMCAD X Version 14.6.10 (7373)

Area Scan (61x61x1): Interpolated grid: dx=1.500 mm, dy=1.500 mm
Maximum value of SAR (interpolated) = 0.232 W/kg

Zoom Scan (5x5x7)/Cube 0: Measurement grid: dx=8mm, dy=8mm, dz=5mm
Reference Value = 12.34 V/m; Power Drift = -0.03 dB
Peak SAR (extrapolated) = 0.260 W/kg
SAR(1 g) = 0.190 W/kg; SAR(10 g) = 0.141 W/kg
Maximum value of SAR (measured) = 0.236 W/kg

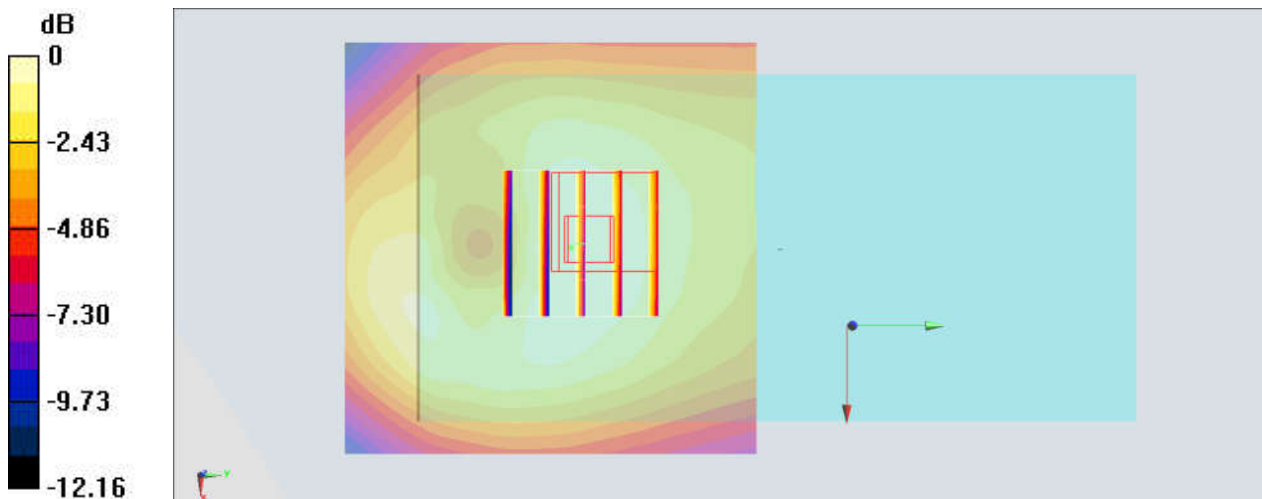

0 dB = 0.236 W/kg = -6.27 dBW/kg

#43_LTE Band 26_15M_QPSK_1_0_Front_15mm_Ch26865

Communication System: LTE; Frequency: 831.5 MHz; Duty Cycle: 1:1
Medium: MSL_850_170829 Medium parameters used: $f = 831.5$ MHz; $\sigma = 0.956$ S/m; $\epsilon_r = 55.533$;
 $\rho = 1000$ kg/m³
Ambient Temperature : 23.5 °C; Liquid Temperature : 22.5 °C

DASY5 Configuration:

- Probe: EX3DV4 - SN3976; ConvF(10.41, 10.41, 10.41); Calibrated: 2017/2/21;
- Sensor-Surface: 1.4mm (Mechanical Surface Detection)
- Electronics: DAE4 Sn1424; Calibrated: 2017/2/16
- Phantom: SAM_Left; Type: QD000P40CD; Serial: TP:1477
- Measurement SW: DASY52, Version 52.8 (8); SEMCAD X Version 14.6.10 (7373)

Area Scan (61x61x1): Interpolated grid: dx=1.500 mm, dy=1.500 mm
Maximum value of SAR (interpolated) = 0.279 W/kg

Zoom Scan (5x5x7)/Cube 0: Measurement grid: dx=8mm, dy=8mm, dz=5mm
Reference Value = 11.90 V/m; Power Drift = -0.01 dB
Peak SAR (extrapolated) = 0.316 W/kg
SAR(1 g) = 0.228 W/kg; SAR(10 g) = 0.161 W/kg
Maximum value of SAR (measured) = 0.282 W/kg

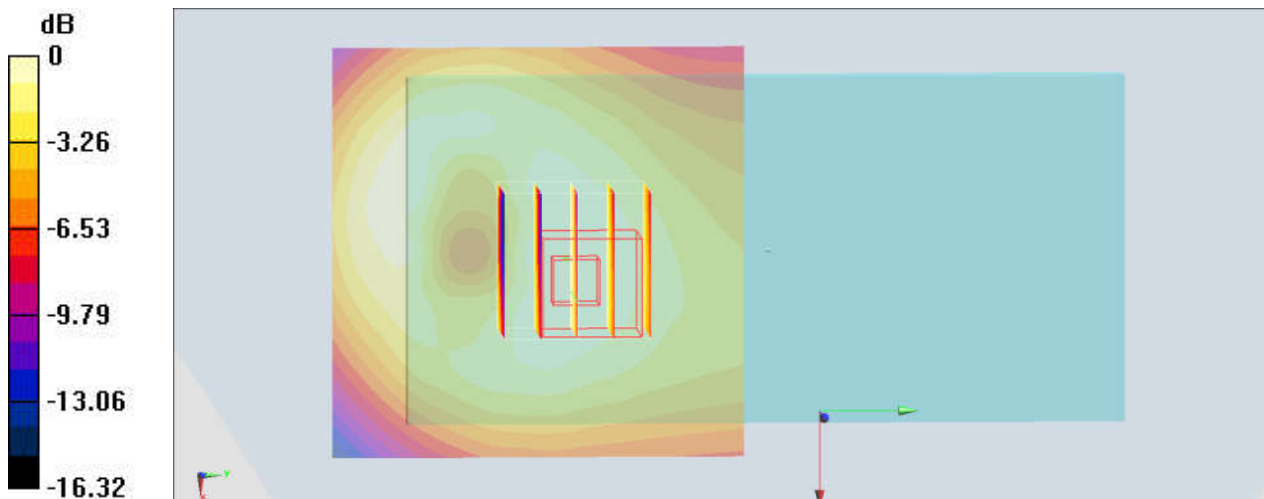

0 dB = 0.282 W/kg = -5.50 dBW/kg

#44_LTE Band 30_10M_QPSK_1_0_Front_15mm_Ch27710

Communication System: LTE ; Frequency: 2310 MHz;Duty Cycle: 1:1

Medium: MSL_2300_170908 Medium parameters used: $f = 2310$ MHz; $\sigma = 1.797$ S/m; $\epsilon_r = 54.937$; $\rho = 1000$ kg/m³

Ambient Temperature : 23.2 °C ; Liquid Temperature : 22.2 °C

DASY5 Configuration

- Probe: EX3DV4 - SN3931; ConvF(7.96, 7.96, 7.96); Calibrated: 2016/10/3;
- Sensor-Surface: 1.4mm (Mechanical Surface Detection)
- Electronics: DAE3 Sn577; Calibrated: 2016/9/28
- Phantom: SAM_RIGHT; Type: QD000P40CD; Serial: 1719
- Measurement SW: DASY52, Version 52.8 (8); SEMCAD X Version 14.6.10 (7373)

Area Scan (81x81x1): Interpolated grid: dx=1.200 mm, dy=1.200 mm

Maximum value of SAR (interpolated) = 0.261 W/kg

Zoom Scan (7x7x7)/Cube 0: Measurement grid: dx=5mm, dy=5mm, dz=5mm

Reference Value = 4.229 V/m; Power Drift = -0.15 dB

Peak SAR (extrapolated) = 0.317 W/kg

SAR(1 g) = 0.188 W/kg; SAR(10 g) = 0.112 W/kg

Maximum value of SAR (measured) = 0.268 W/kg

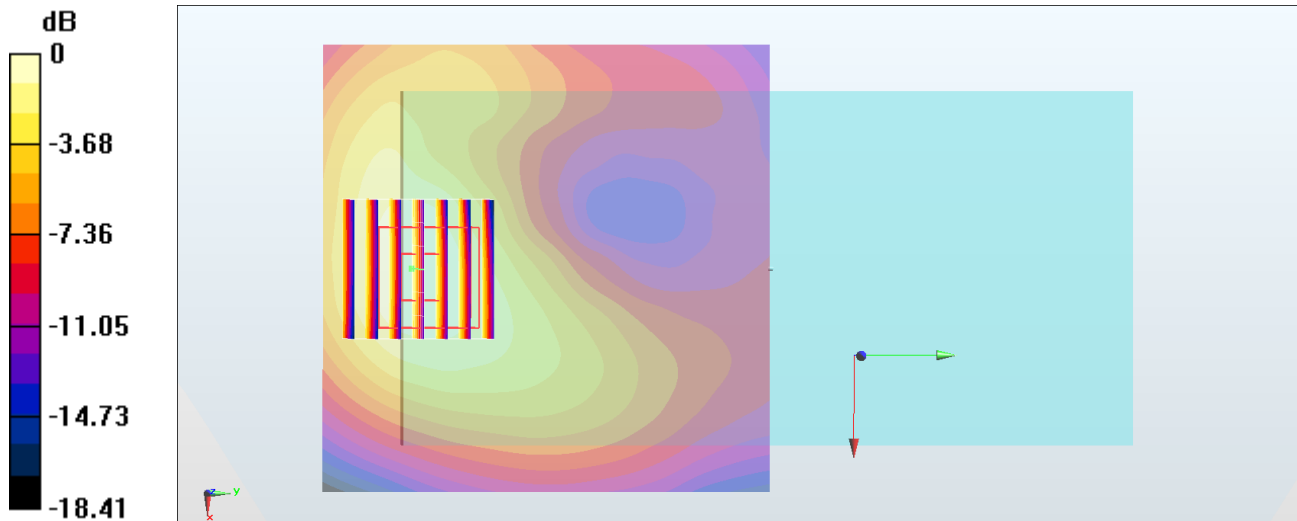

0 dB = 0.268 W/kg = -5.72 dBW/kg

#45_LTE Band 41_20M_QPSK_1_0_Back_15mm_Ch40240

Communication System: LTE TDD; Frequency: 2555 MHz; Duty Cycle: 1:1.59

Medium: MSL_2600_170906 Medium parameters used : $f = 2555$ MHz; $\sigma = 2.146$ S/m; $\epsilon_r = 54.265$; $\rho = 1000$ kg/m³

Ambient Temperature : 23.7 °C ; Liquid Temperature : 22.7 °C

DASY5 Configuration

- Probe: ES3DV3 - SN3071; ConvF(3.74, 3.74, 3.74); Calibrated: 2016/12/8;
- Sensor-Surface: 3mm (Mechanical Surface Detection)
- Electronics: DAE4 Sn778; Calibrated: 2017/5/22
- Phantom: SAM_RIGHT; Type: QD000P40CD; Serial: 1719
- Measurement SW: DASY52, Version 52.8 (8); SEMCAD X Version 14.6.10 (7373)

Area Scan (81x71x1): Interpolated grid: dx=1.200 mm, dy=1.200 mm

Maximum value of SAR (interpolated) = 0.196 W/kg

Zoom Scan (7x7x7)/Cube 0: Measurement grid: dx=5mm, dy=5mm, dz=5mm

Reference Value = 3.417 V/m; Power Drift = -0.17 dB

Peak SAR (extrapolated) = 0.293 W/kg

SAR(1 g) = 0.155 W/kg; SAR(10 g) = 0.079 W/kg

Maximum value of SAR (measured) = 0.197 W/kg

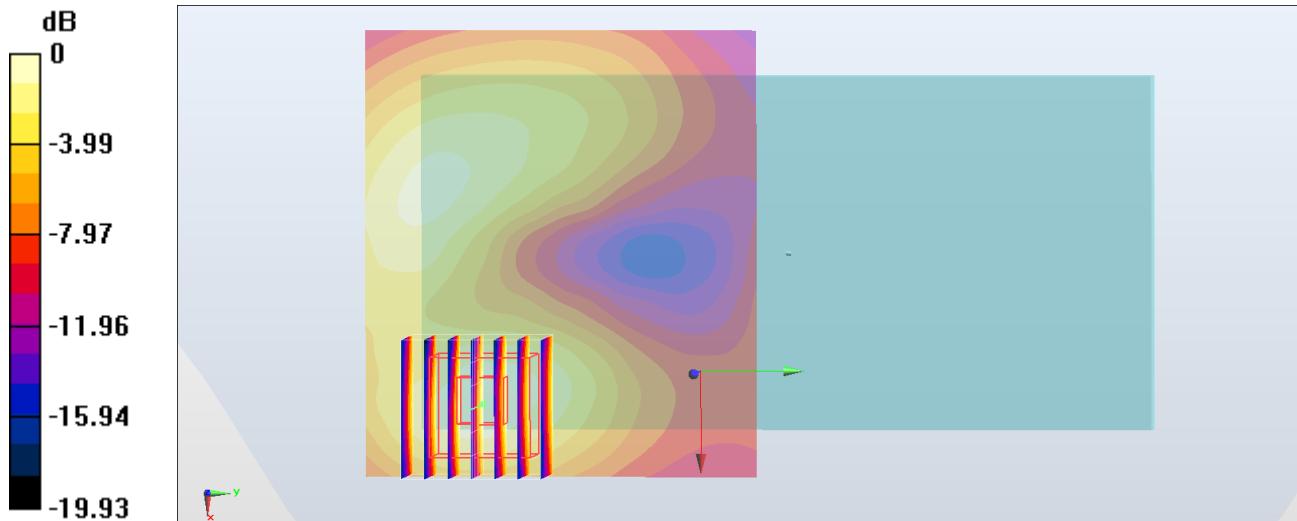

0 dB = 0.197 W/kg = -7.06 dBW/kg

#46_WLAN2.4GHz_802.11b 1Mbps_Front_15mm_Ch6;Ant 1

Communication System: 802.11b; Frequency: 2437 MHz; Duty Cycle: 1:1.01

Medium: MSL_2450_170908 Medium parameters used: $f = 2437$ MHz; $\sigma = 1.972$ S/m; $\epsilon_r = 54.528$; $\rho = 1000$ kg/m³

Ambient Temperature : 23.5 °C ; Liquid Temperature : 22.5 °C

DASY5 Configuration

- Probe: ES3DV3 - SN3169; ConvF(4.28, 4.28, 4.28); Calibrated: 2017/5/11;
- Sensor-Surface: 3mm (Mechanical Surface Detection)
- Electronics: DAE4 Sn1399; Calibrated: 2016/11/17
- Phantom: SAM_RIGHT; Type: QD000P40CD; Serial: 1719
- Measurement SW: DASY52, Version 52.8 (8); SEMCAD X Version 14.6.10 (7373)

Area Scan (81x71x1): Interpolated grid: dx=1.200 mm, dy=1.200 mm

Maximum value of SAR (interpolated) = 0.0931 W/kg

Zoom Scan (7x7x7)/Cube 0: Measurement grid: dx=5mm, dy=5mm, dz=5mm

Reference Value = 2.279 V/m; Power Drift = 0.03 dB

Peak SAR (extrapolated) = 0.143 W/kg

SAR(1 g) = 0.081 W/kg; SAR(10 g) = 0.044 W/kg

Maximum value of SAR (measured) = 0.101 W/kg

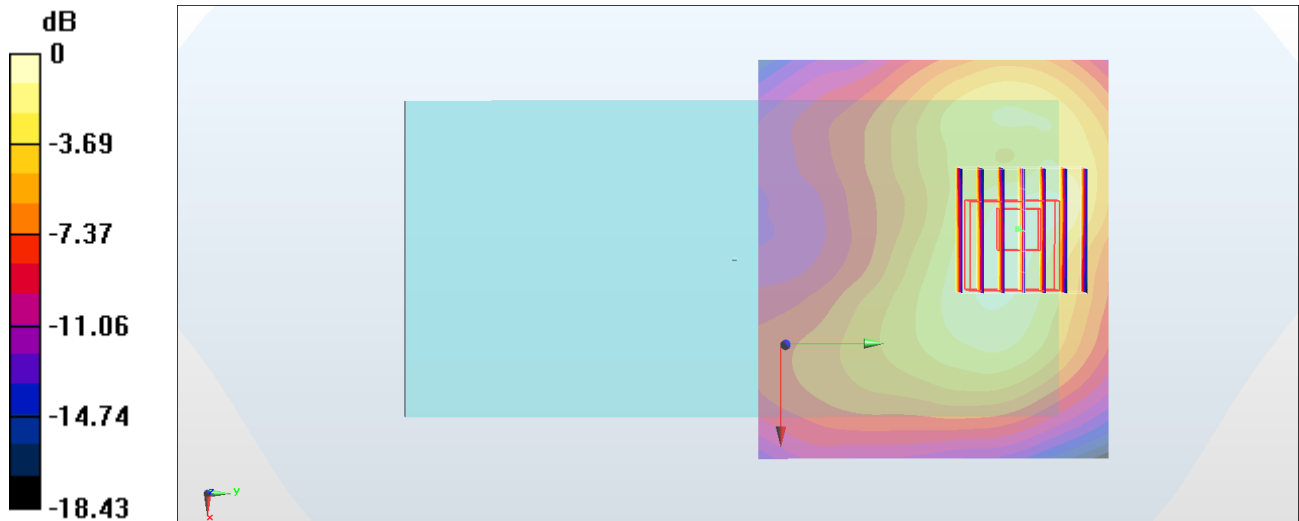

0 dB = 0.101 W/kg = -9.96 dBW/kg

#47_WLAN5GHz_802.11n-HT40 MCS0_Back_15mm_Ch54

Communication System: 802.11n; Frequency: 5270 MHz; Duty Cycle: 1:1.042

Medium: MSL_5G_170914 Medium parameters used: $f = 5270$ MHz; $\sigma = 5.472$ S/m; $\epsilon_r = 47.434$; $\rho = 1000$ kg/m³

Ambient Temperature : 23.5 °C ; Liquid Temperature : 22.5 °C

DASY5 Configuration

- Probe: EX3DV4 - SN3925; ConvF(4.59, 4.59, 4.59); Calibrated: 2017/5/24;
- Sensor-Surface: 1.4mm (Mechanical Surface Detection)
- Electronics: DAE3 Sn495; Calibrated: 2017/5/22
- Phantom: SAM_Left; Type: QD000P40CD; Serial: TP:1815
- Measurement SW: DASY52, Version 52.8 (8); SEMCAD X Version 14.6.10 (7373)

Area Scan (71x71x1): Interpolated grid: dx=1.000 mm, dy=1.000 mm

Maximum value of SAR (interpolated) = 0.171 W/kg

Zoom Scan (8x9x7)/Cube 0: Measurement grid: dx=4mm, dy=4mm, dz=1.4mm

Reference Value = 5.101 V/m; Power Drift = -0.01 dB

Peak SAR (extrapolated) = 0.247 W/kg

SAR(1 g) = 0.070 W/kg; SAR(10 g) = 0.027 W/kg

Maximum value of SAR (measured) = 0.162 W/kg

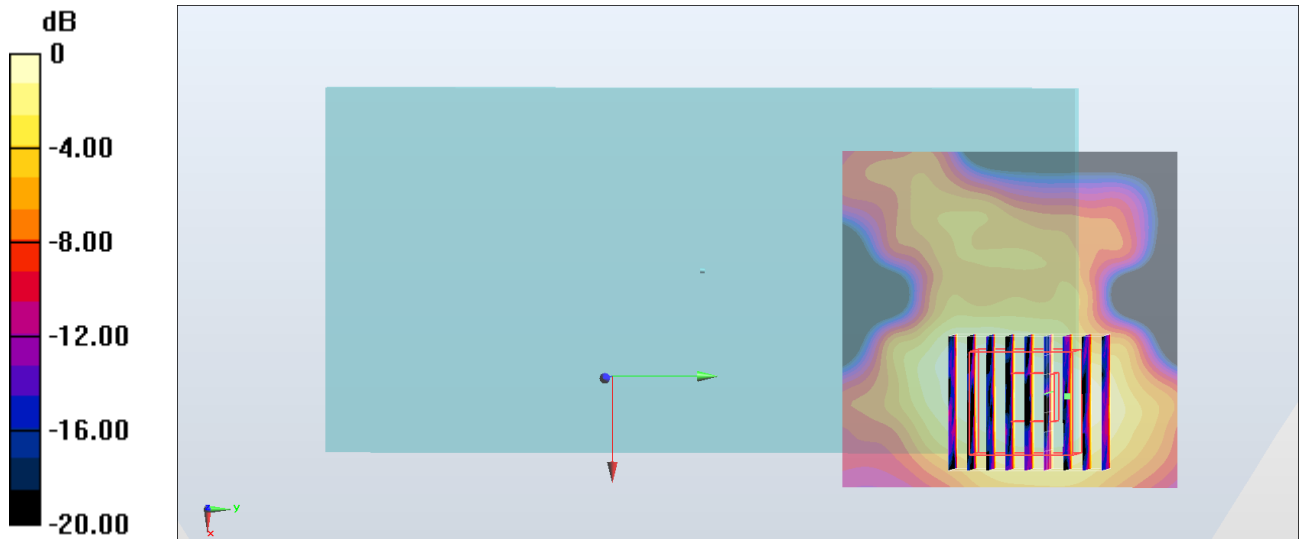

0 dB = 0.162 W/kg = -7.90 dBW/kg

#48_WLAN5GHz_802.11ac-VHT80 MCS0_Back_15mm_Ch138

Communication System: 802.11ac; Frequency: 5690 MHz; Duty Cycle: 1:1.078

Medium: MSL_5G_170914 Medium parameters used: $f = 5690$ MHz; $\sigma = 6.031$ S/m; $\epsilon_r = 46.73$; $\rho = 1000$ kg/m³

Ambient Temperature : 23.5 °C ; Liquid Temperature : 22.5 °C

DASY5 Configuration:

- Probe: EX3DV4 - SN3925; ConvF(4.14, 4.14, 4.14); Calibrated: 2017/5/24;
- Sensor-Surface: 1.4mm (Mechanical Surface Detection)
- Electronics: DAE3 Sn495; Calibrated: 2017/5/22
- Phantom: SAM_Left; Type: QD000P40CD; Serial: TP:1815
- Measurement SW: DASY52, Version 52.8 (8); SEMCAD X Version 14.6.10 (7373)

Area Scan (71x71x1): Interpolated grid: dx=1.000 mm, dy=1.000 mm

Maximum value of SAR (interpolated) = 0.574 W/kg

Zoom Scan (8x8x7)/Cube 0: Measurement grid: dx=4mm, dy=4mm, dz=1.4mm

Reference Value = 6.671 V/m; Power Drift = -0.12 dB

Peak SAR (extrapolated) = 0.976 W/kg

SAR(1 g) = 0.238 W/kg; SAR(10 g) = 0.090 W/kg

Maximum value of SAR (measured) = 0.562 W/kg

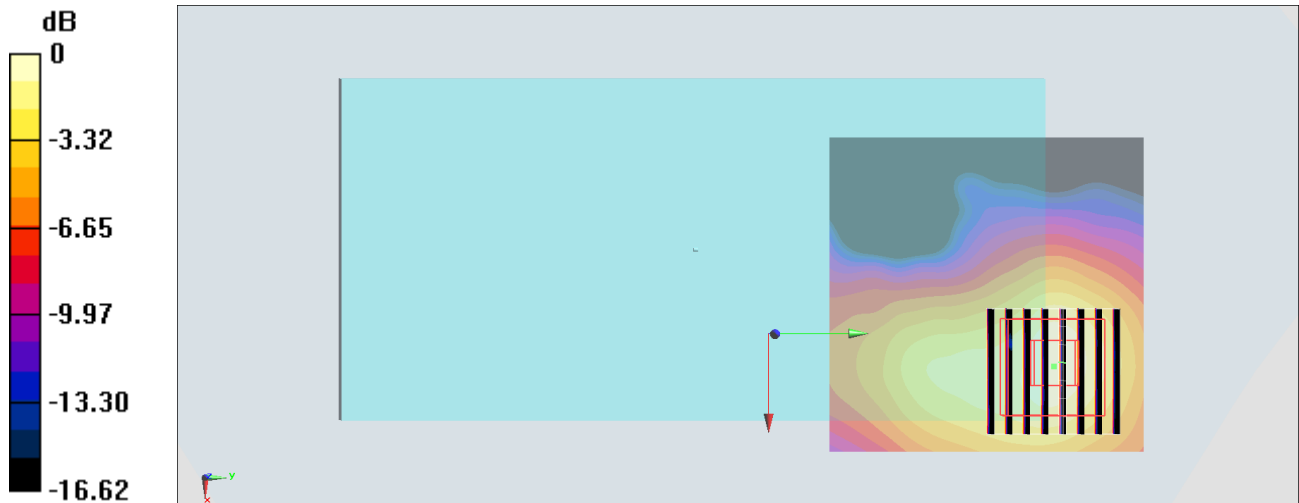

0 dB = 0.562 W/kg = -2.50 dBW/kg

#49_WLAN5GHz_802.11n-HT40 MCS0_Back_15mm_Ch151

Communication System: 802.11n ; Frequency: 5755 MHz; Duty Cycle: 1:1.042

Medium: MSL_5G_170914 Medium parameters used: $f = 5755$ MHz; $\sigma = 6.111$ S/m; $\epsilon_r = 46.602$; $\rho = 1000$ kg/m³

Ambient Temperature : 23.5 °C ; Liquid Temperature : 22.5 °C

DASY5 Configuration

- Probe: EX3DV4 - SN3925; ConvF(4.14, 4.14, 4.14); Calibrated: 2017/5/24;
- Sensor-Surface: 1.4mm (Mechanical Surface Detection)
- Electronics: DAE3 Sn495; Calibrated: 2017/5/22
- Phantom: SAM_Left; Type: QD000P40CD; Serial: TP:1815
- Measurement SW: DASY52, Version 52.8 (8); SEMCAD X Version 14.6.10 (7373)

Area Scan (71x71x1): Interpolated grid: dx=1.000 mm, dy=1.000 mm

Maximum value of SAR (interpolated) = 0.595 W/kg

Zoom Scan (8x8x7)/Cube 0: Measurement grid: dx=4mm, dy=4mm, dz=1.4mm

Reference Value = 6.743 V/m; Power Drift = -0.12 dB

Peak SAR (extrapolated) = 1.01 W/kg

SAR(1 g) = 0.246 W/kg; SAR(10 g) = 0.093 W/kg

Maximum value of SAR (measured) = 0.582 W/kg

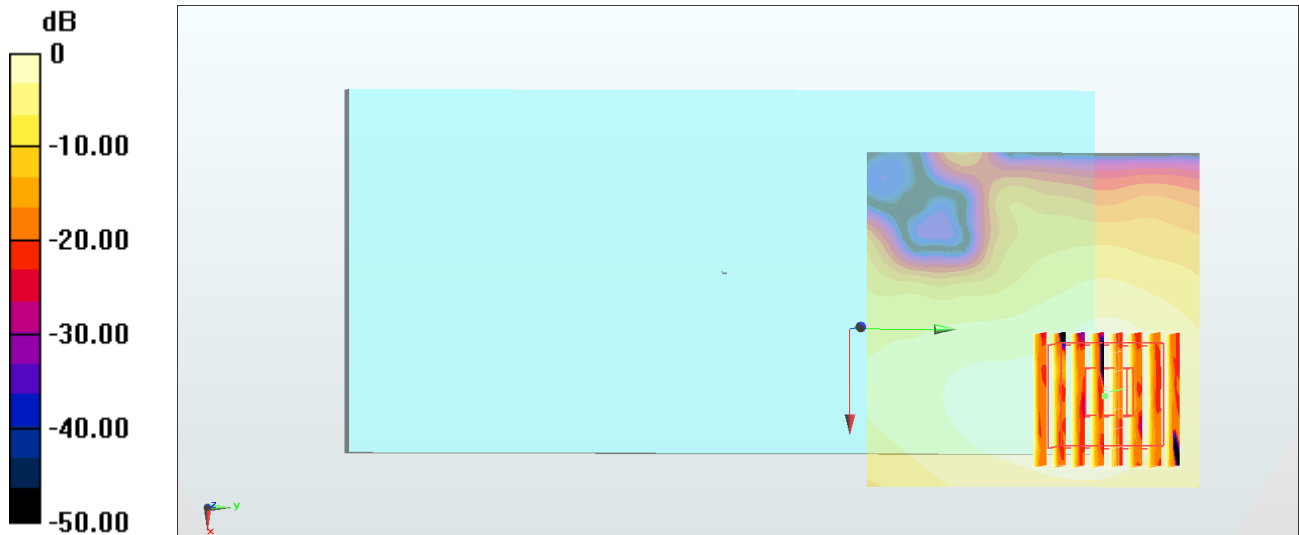

0 dB = 0.582 W/kg = -2.35 dBW/kg

#50_Bluetooth_1Mbps_Back_15mm_Ch78

Communication System: Bluetooth; Frequency: 2480 MHz; Duty Cycle: 1:1.297

Medium: MSL_2450_170916 Medium parameters used: $f = 2480$ MHz; $\sigma = 2.011$ S/m; $\epsilon_r = 53.932$; $\rho = 1000$ kg/m³

Ambient Temperature : 23.7 °C; Liquid Temperature : 22.7 °C

DASY5 Configuration:

- Probe: EX3DV4 - SN3925; ConvF(7.94, 7.94, 7.94); Calibrated: 2017/5/24;
- Sensor-Surface: 1.4mm (Mechanical Surface Detection)
- Electronics: DAE3 Sn495; Calibrated: 2017/5/22
- Phantom: SAM_Left; Type: QD000P40CD; Serial: TP:1815
- Measurement SW: DASY52, Version 52.8 (8); SEMCAD X Version 14.6.10 (7373)

Area Scan (61x61x1): Interpolated grid: dx=1.200 mm, dy=1.200 mm

Maximum value of SAR (interpolated) = 0.0154 W/kg

Zoom Scan (7x7x7)/Cube 0: Measurement grid: dx=5mm, dy=5mm, dz=5mm

Reference Value = 0.4560 V/m; Power Drift = -0.00 dB

Peak SAR (extrapolated) = 0.0270 W/kg

SAR(1 g) = 0.00721 W/kg; SAR(10 g) = 0.00283 W/kg

Maximum value of SAR (measured) = 0.00949 W/kg

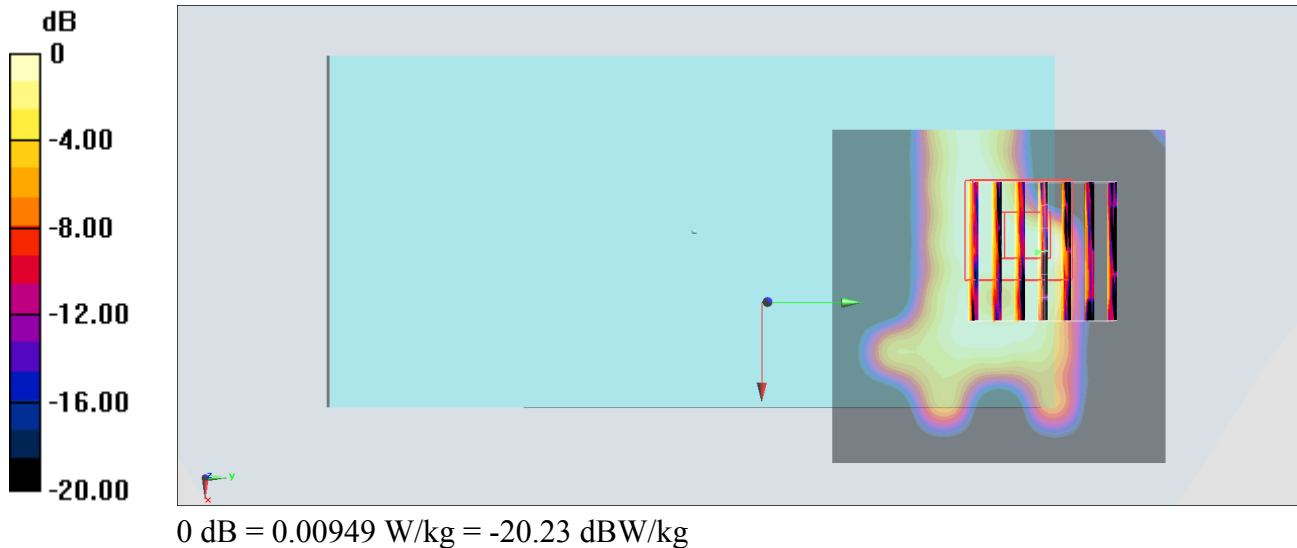

#51_LTE Band 2_20M_QPSK_1_0_Front_0mm_Ch19100

Communication System: LTE; Frequency: 1900 MHz; Duty Cycle: 1:1

Medium: MSL_1900_170913 Medium parameters used: $f = 1900$ MHz; $\sigma = 1.563$ S/m; $\epsilon_r = 54.437$; $\rho = 1000$ kg/m³

Ambient Temperature : 23.5 °C ; Liquid Temperature : 22.5 °C

DASY5 Configuration

- Probe: EX3DV4 - SN3931; ConvF(8.14, 8.14, 8.14); Calibrated: 2016/10/3;
- Sensor-Surface: 1.4mm (Mechanical Surface Detection)
- Electronics: DAE4 Sn916; Calibrated: 2016/12/15
- Phantom: SAM LEFT; Type: QD000P40CD; Serial: TP:1718
- Measurement SW: DASY52, Version 52.8 (8); SEMCAD X Version 14.6.10 (7373)

Area Scan (71x61x1): Interpolated grid: dx=1.500 mm, dy=1.500 mm

Maximum value of SAR (interpolated) = 9.22 W/kg

Zoom Scan (5x5x7)/Cube 0: Measurement grid: dx=8mm, dy=8mm, dz=5mm

Reference Value = 1.418 V/m; Power Drift = 0.08 dB

Peak SAR (extrapolated) = 11.4 W/kg

SAR(1 g) = 5.42 W/kg; SAR(10 g) = 2.47 W/kg

Maximum value of SAR (measured) = 9.75 W/kg

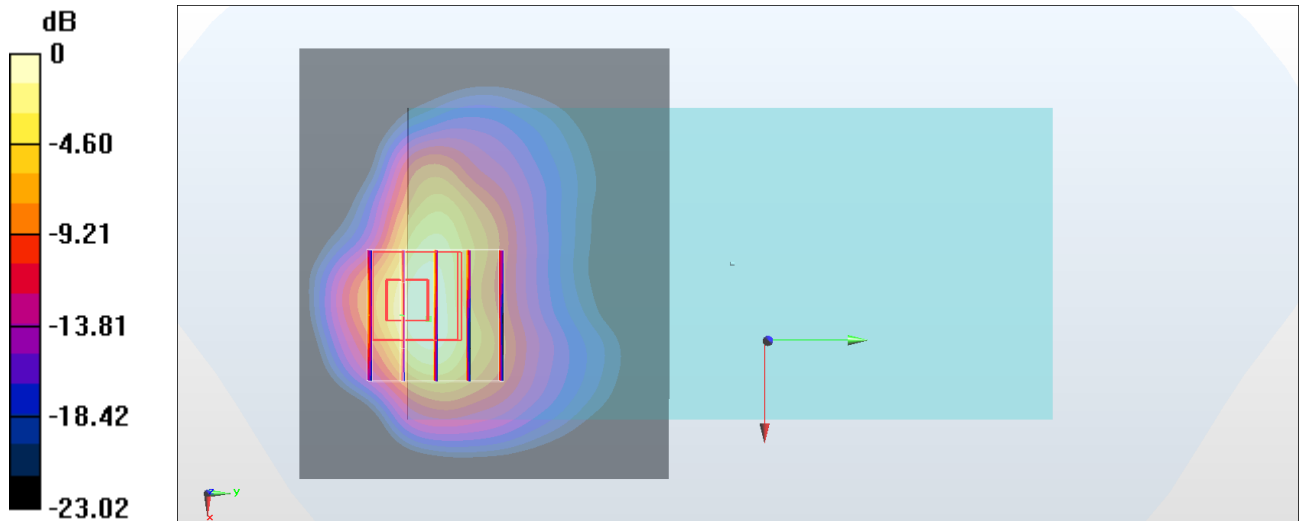

0 dB = 9.75 W/kg = 9.89 dBW/kg

#52_LTE Band 4_20M_QPSK_1_0_Front_0mm_Ch20175

Communication System: LTE ; Frequency: 1732.5 MHz;Duty Cycle: 1:1

Medium: MSL_1750_170907 Medium parameters used : $f = 1732.5$ MHz; $\sigma = 1.453$ S/m; $\epsilon_r = 54.732$; $\rho = 1000$ kg/m³

Ambient Temperature : 23.6 °C ; Liquid Temperature : 22.6 °C

DASY5 Configuration

- Probe: EX3DV4 - SN7306; ConvF(8.29, 8.29, 8.29); Calibrated: 2017/7/24;
- Sensor-Surface: 1.4mm (Mechanical Surface Detection)
- Electronics: DAE3 Sn577; Calibrated: 2016/9/28
- Phantom: SAM_RIGHT; Type: QD000P40CD; Serial: 1719
- Measurement SW: DASY52, Version 52.8 (8); SEMCAD X Version 14.6.10 (7373)

Area Scan (71x71x1): Interpolated grid: dx=1.500 mm, dy=1.500 mm

Maximum value of SAR (interpolated) = 8.89 W/kg

Zoom Scan (5x5x7)/Cube 0: Measurement grid: dx=8mm, dy=8mm, dz=5mm

Reference Value = 1.880 V/m; Power Drift = -0.11 dB

Peak SAR (extrapolated) = 12.6 W/kg

SAR(1 g) = 6.03 W/kg; SAR(10 g) = 2.61 W/kg

Maximum value of SAR (measured) = 10.3 W/kg

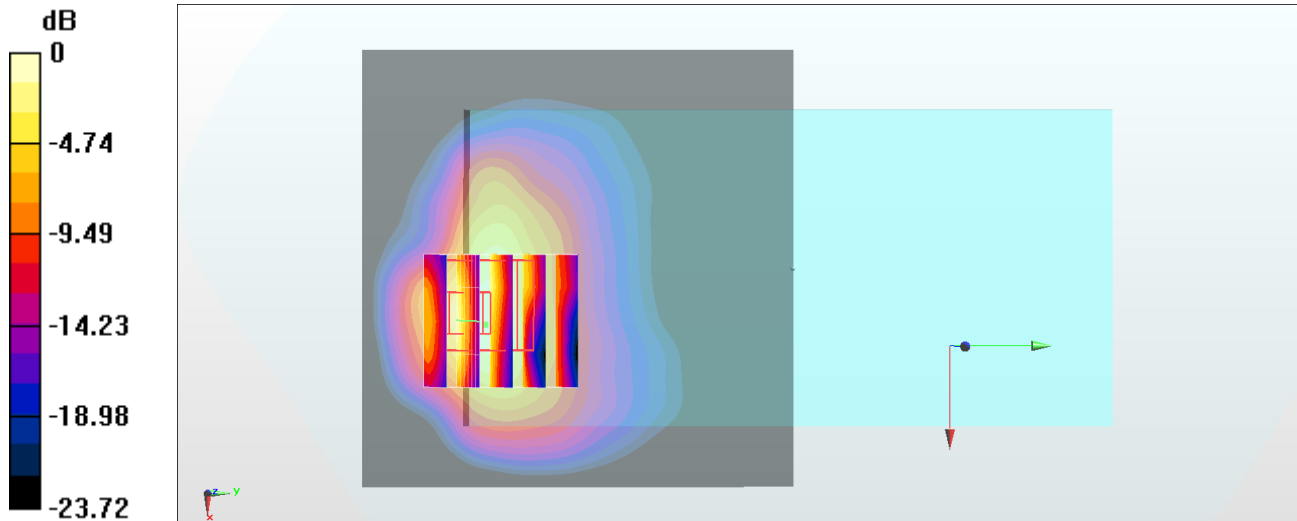

0 dB = 10.3 W/kg = 10.13 dBW/kg

#53_WLAN5GHz_802.11n-HT40 MCS0_Back_0mm_Ch54

Communication System: 802.11n; Frequency: 5270 MHz; Duty Cycle: 1:1.042

Medium: MSL_5G_170914 Medium parameters used: $f = 5270$ MHz; $\sigma = 5.472$ S/m; $\epsilon_r = 47.434$; $\rho = 1000$ kg/m³

Ambient Temperature : 23.5 °C ; Liquid Temperature : 22.5 °C

DASY5 Configuration

- Probe: EX3DV4 - SN3925; ConvF(4.59, 4.59, 4.59); Calibrated: 2017/5/24;
- Sensor-Surface: 1.4mm (Mechanical Surface Detection)
- Electronics: DAE3 Sn495; Calibrated: 2017/5/22
- Phantom: SAM_Left; Type: QD000P40CD; Serial: TP:1815
- Measurement SW: DASY52, Version 52.8 (8); SEMCAD X Version 14.6.10 (7373)

Area Scan (71x71x1): Interpolated grid: dx=1.000 mm, dy=1.000 mm

Maximum value of SAR (interpolated) = 13.2 W/kg

Zoom Scan (7x7x7)/Cube 0: Measurement grid: dx=4mm, dy=4mm, dz=1.4mm

Reference Value = 29.37 V/m; Power Drift = -0.14 dB

Peak SAR (extrapolated) = 25.9 W/kg

SAR(1 g) = 4.78 W/kg; SAR(10 g) = 1.41 W/kg

Maximum value of SAR (measured) = 13.0 W/kg

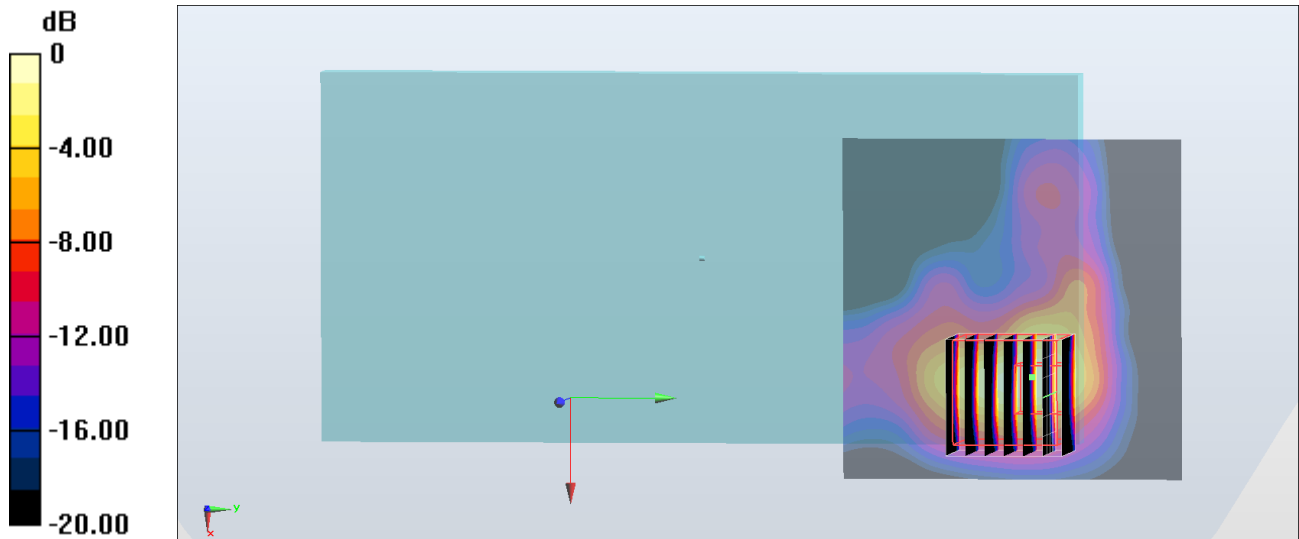

0 dB = 13.0 W/kg = 11.14 dBW/kg

#54_WLAN5GHz_802.11ac-VHT80 MCS0_Back_0mm_Ch122

Communication System: 802.11ac; Frequency: 5610 MHz; Duty Cycle: 1:1.078

Medium: MSL_5G_170914 Medium parameters used: $f = 5610$ MHz; $\sigma = 5.916$ S/m; $\epsilon_r = 46.873$; $\rho = 1000$ kg/m³

Ambient Temperature : 23.5 °C ; Liquid Temperature : 22.5 °C

DASY5 Configuration:

- Probe: EX3DV4 - SN3925; ConvF(4.17, 4.17, 4.17); Calibrated: 2017/5/24;
- Sensor-Surface: 1.4mm (Mechanical Surface Detection)
- Electronics: DAE3 Sn495; Calibrated: 2017/5/22
- Phantom: SAM_Left; Type: QD000P40CD; Serial: TP:1815
- Measurement SW: DASY52, Version 52.8 (8); SEMCAD X Version 14.6.10 (7373)

Area Scan (71x71x1): Interpolated grid: dx=1.000 mm, dy=1.000 mm

Maximum value of SAR (interpolated) = 26.3 W/kg

Zoom Scan (8x8x7)/Cube 0: Measurement grid: dx=4mm, dy=4mm, dz=1.4mm

Reference Value = 39.61 V/m; Power Drift = -0.02 dB

Peak SAR (extrapolated) = 56.9 W/kg

SAR(1 g) = 9 W/kg; SAR(10 g) = 2.54 W/kg

Maximum value of SAR (measured) = 25.7 W/kg

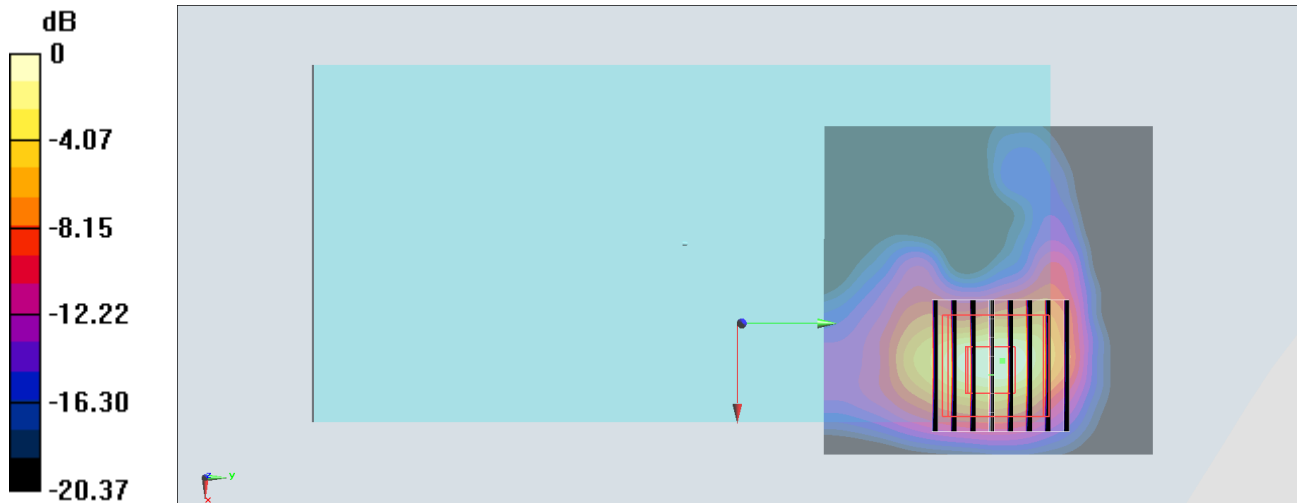

0 dB = 25.7 W/kg = 14.10 dBW/kg