



FCC RF Test Report

APPLICANT : ASUSTeK COMPUTER INC.
EQUIPMENT : ASUS Phone
BRAND NAME : ASUS
MODEL NAME : ASUS_Z016D
FCC ID : MSQZ016D
STANDARD : FCC Part 15 Subpart C §15.225

CLASSIFICATION : (DXX) Low Power Communication Device Transmitter

The testing was completed on Aug. 16, 2016. We, SPORTON INTERNATIONAL INC., would like to declare that the tested sample has been evaluated in accordance with the test procedures and has been in compliance with the applicable technical standards.

The test results in this report apply exclusively to the tested model / sample. Without written approval of SPORTON INTERNATIONAL INC., the test report shall not be reproduced except in full.

Reviewed by: Joseph Lin / Supervisor

Approved by: Jones Tsai / Manager



SPORTON INTERNATIONAL INC.

No. 52, Hwa Ya 1st Rd., Hwa Ya Technology Park, Kwei-Shan District, Tao Yuan City, Taiwan, R.O.C.



Table of Contents

SUMMARY OF THE TEST RESULT4

1. GENERAL INFORMATION.....5

1.1 Applicant 5

1.2 Manufacturer..... 5

1.3 Product Details..... 5

1.4 Modification of EUT..... 5

1.5 Testing Location 6

1.6 Applicable Standards 6

1.7 Test Modes..... 7

1.8 Test Configurations..... 8

1.9 Table for Supporting Units 9

2. CONDUCTED EMISSION TEST.....10

2.1 Measuring Instruments 10

2.2 Test setup 10

2.3 Test Result of Conducted Emission Test..... 10

2.4 AC Power Line Conducted Emissions Measurement 11

3. CONDUCTED TEST ITEMS12

3.1 Measuring Instruments 12

3.2 Test Setup 12

3.3 Test Result of Conducted Test Items..... 12

3.4 20dB and 99% OBW Spectrum Bandwidth Measurement..... 13

3.5 Frequency Stability Measurement 13

4. RADIATED TEST ITEMS.....14

4.1 Measuring Instruments 14

4.2 Test Setup 14

4.3 Test Result of Radiated Test Items 14

4.4 Field Strength of Fundamental Emissions and Mask Measurement 15

4.5 Radiated Emissions Measurement 16

5. LIST OF MEASURING EQUIPMENT18

APPENDIX A. SETUP PHOTOGRAPHS OF EUT

APPENDIX B. TEST RESULTS OF CONDUCTED EMISSION TEST

APPENDIX C. TEST RESULTS OF CONDUCTED TEST ITEMS

C.1. Test Result of 20dB Spectrum Bandwidth

C.2 Test Result of Frequency Stability

APPENDIX D. TEST RESULTS OF RADIATED TEST ITEMS

D.1 Test Result of Field Strength of Fundamental Emissions

D.2 Results of Radiated Emissions (9 kHz~30MHz)

D.3 Results of Radiated Emissions (30MHz~1GHz)

APPENDIX E. VERIFICATION OF RADIATED SPURIOUS EMISSIONS AT OPEN-AREA TEST SITE

E.1 Results of Radiated Emissions (9 kHz~30MHz)

E.2 LIST OF MEASURING EQUIPMENT



SUMMARY OF THE TEST RESULT

Applied Standard: 47 CFR FCC Part 15 Subpart C				
Part	FCC Rule	Description of Test	Result	Under Limit
3.1	15.207	AC Power Line Conducted Emissions	Complies	15.50 dB at 0.166MHz
3.2	15.225(a)(b)(c)	Field Strength of Fundamental Emissions	Complies	64.25 dB at 13.560 MHz
3.3	2.1049	20dB Spectrum Bandwidth	Complies	-
3.3	-	99% OBW Spectrum Bandwidth	Complies	-
3.4	15.225(d) 15.209	Radiated Emissions	Complies	4.88 dB at 40.800 MHz for Peak
3.5	15.225(e)	Frequency Stability	Complies	-
3.6	15.203	Antenna Requirements	Complies	-

Test Items	Uncertainty	Remark
AC Power Line Conducted Emissions	±2.26dB	Confidence levels of 95%
Radiated Emissions (30MHz~1000MHz)	±4.80dB	Confidence levels of 95%



1. GENERAL INFORMATION

1.1 Applicant

ASUSTeK COMPUTER INC.
4F, No. 150, LI-TE RD., PEITOU, TAIPEI, TAIWAN

1.2 Manufacturer

COTEK ELECTRONICS (SUZHOU) CO., LTD.
No.288, Mayun Road, Suzhou New District, Jiangsu, PRC

1.3 Product Details

Items	Description
Tx/Rx Frequency Range	13.553 ~ 13.567MHz
Channel Number	1
20dBW	2.64 KHz
99%OBW	2.24 KHz
Antenna Type	Loop Antenna
Type of Modulation	ASK

Remark: The above EUT's information was declared by manufacturer. Please refer to the specifications or user's manual for more detailed description.

1.4 Modification of EUT

No modifications are made to the EUT during all test items.

1.5 Testing Location

Sporton Lab is accredited to ISO 17025 by Taiwan Accreditation Foundation (TAF code : 1190) and the FCC designation No. TW1022 under the FCC 2.948(e) by Mutual Recognition Agreement (MRA) in FCC Test.

Test Site	SPORTON INTERNATIONAL INC.		
Test Site Location	No. 52, Hwa Ya 1 st Rd., Hwa Ya Technology Park, Kwei-Shan District, Tao Yuan City, Taiwan, R.O.C. TEL: +886-3-3273456 / FAX: +886-3-3284978		
Test Site No.	Sporton Site No.		
	TH03-HY	CO05-HY	03CH07-HY
Test Engineer	Tommy Lee	Arthur Hsieh	Derreck Chen
Temperature	22~24	24~25	21~23
Relative Humidity	53~55	49~50	57~61

Note: The test site complies with ANSI C63.4 2014 requirement.

Test Site	SPORTON INTERNATIONAL INC.		
Test Site Location	No. 30-2, Dingfu Tsuen, Linkou District, New Taipei City, Taiwan 244, R.O.C. TEL: +886-2-2603-5367 / +886-2-2601-1640 FAX: +886-2-2601-1695		
Test Site No.	Sporton Site No.		
	OS03-LK		
Test Engineer	Eric Jeng		
Temperature	23~25°C		
Relative Humidity	55~59%		

Note: The test site complies with ANSI C63.4 2014 requirement.

1.6 Applicable Standards

According to the specifications of the manufacturer, the EUT must comply with the requirements of the following standards:

- ♦ FCC Part 15 Subpart C §15.225
- ♦ ANSI C63.10-2013



1.7 Test Modes

Investigation has been done on all the possible configurations for searching the worst cases. The following table is a list of the test modes shown in this test report.

Test Items	
AC Power Line Conducted Emissions	Field Strength of Fundamental Emissions
20dB Spectrum Bandwidth	Frequency Stability
Radiated Emissions 9kHz~30MHz	Radiated Emissions 30MHz~1GHz
Note: 1. The EUT was programmed to be in continuously transmitting mode. 2. The ancillary equipment, NFC card, is used to make the EUT (NFC) continuously transmit at 13.56MHz and is placed around 3 cm gap to the EUT. 3. The EUT pre-scanned in four NFC type, A, B, F, V. The worst type (type V) was recorded in this report.	

1.8 Test Configurations

<AC Conducted Emissions>

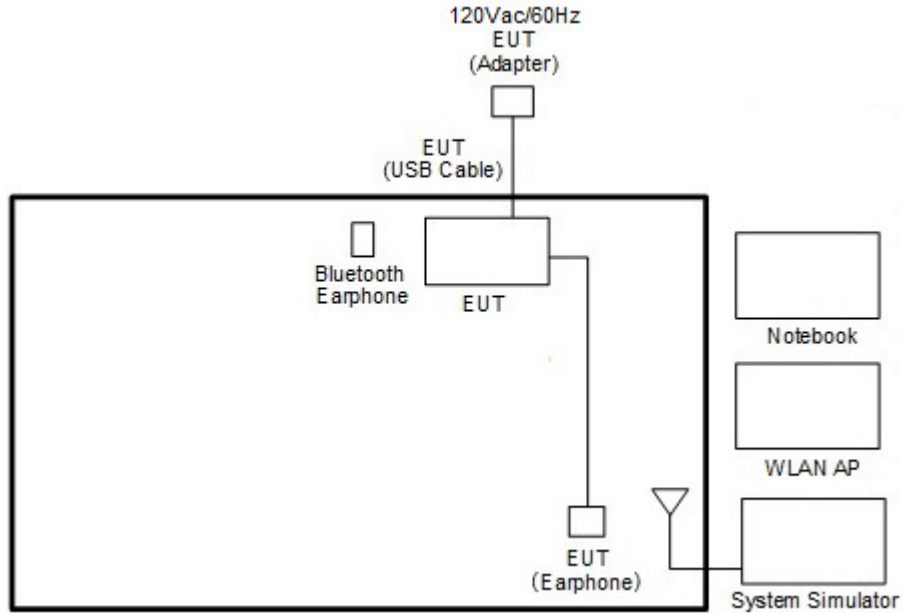

< For Fundamental Emissions and Mask and Radiated Emissions Measurement >

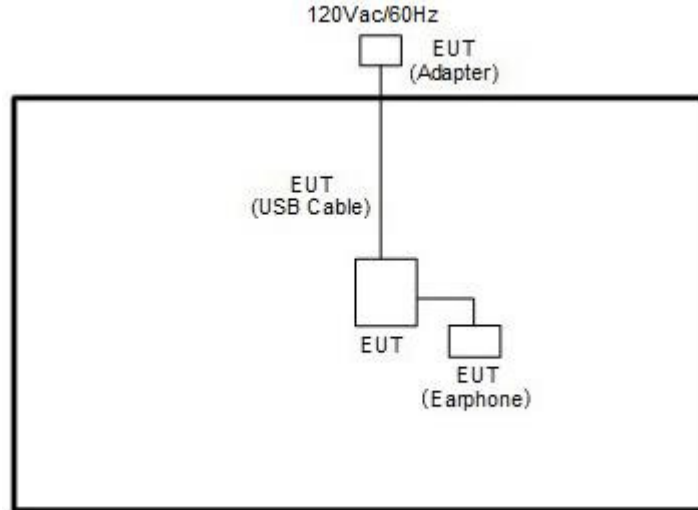



1.9 Table for Supporting Units

Support Unit	Manufacturer	Model	FCC ID
System Simulator	Anritsu	MT8820C	N/A
Bluetooth Earphone	Sony Ericsson	MW600	PY7DDA-2029
WLAN AP	Asus	RT-AC66U	MSQ-ETAC66U
Notebook	DELL	Latitude E6320	FCC DoC/ Contains FCC ID: QDS-BRCM1054
SD Card	SanDisk	MicroSD HC	FCC DoC

2. CONDUCTED EMISSION TEST

2.1 Measuring Instruments

See list of measuring instruments of this test report.

2.2 Test setup

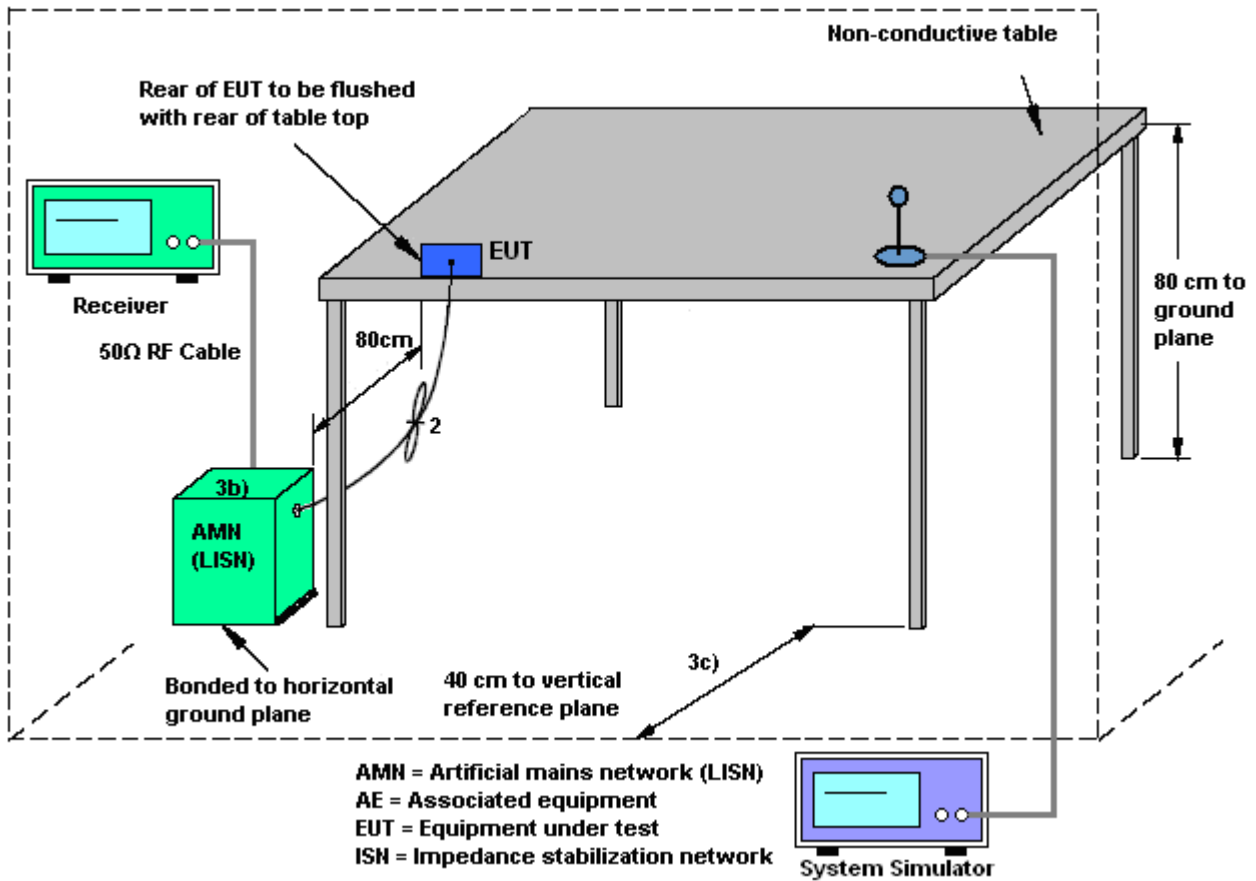

2.3 Test Result of Conducted Emission Test

Please refer to Appendix B.



2.4 AC Power Line Conducted Emissions Measurement

2.4.1 Limit

For equipment that is designed to be connected to the public utility (AC) power line, the radio frequency voltage that is conducted back onto the AC power line on any frequency or frequencies within the band 150 kHz to 30 MHz shall not exceed the limits in the following table.

Frequency of Emission (MHz)	Conducted Limit (dB μ V)	
	Quasi-Peak	Average
0.15-0.5	66 to 56*	56 to 46*
0.5-5	56	46
5-30	60	50

*Decreases with the logarithm of the frequency.

2.4.2 Test Procedures

1. The EUT was placed 0.4 meter from the conducting wall of the shielding room, and it was kept at least 80 centimeters from any other grounded conducting surface.
2. Connect EUT to the power mains through a line impedance stabilization network (LISN).
3. All the support units are connecting to the other LISN.
4. The LISN provides 50 ohm coupling impedance for the measuring instrument.
5. The FCC states that a 50 ohm, 50 microhenry LISN should be used.
6. Both sides of AC line were checked for maximum conducted interference.
7. The frequency range from 150 kHz to 30 MHz was searched.
8. Set the test-receiver system to Peak Detect Function and specified bandwidth (IF Bandwidth = 9kHz) with Maximum Hold Mode. Then measurement is also conducted by Average Detector and Quasi-Peak Detector Function respectively.

3. CONDUCTED TEST ITEMS

3.1 Measuring Instruments

See list of measuring instruments of this test report.

3.2 Test Setup

3.2.1 20dB and 99% OBW Spectrum Bandwidth

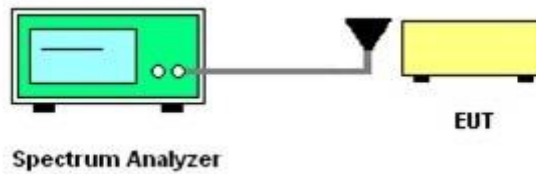

3.2.2 Frequency Stability

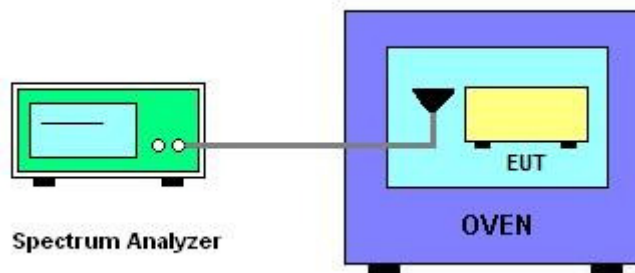

3.3 Test Result of Conducted Test Items

Please refer to Appendix C.



3.4 20dB and 99% OBW Spectrum Bandwidth Measurement

3.4.1 Limit

Intentional radiators must be designed to ensure that the 20dB and 99% emission bandwidth in the specific band 13.553~13.567MHz.

3.4.2 Test Procedures

1. The spectrum analyzer connected via a receive antenna placed near the EUT in peak Max hold mode.
2. The resolution bandwidth of 1 kHz and the video bandwidth of 3 kHz were used.
3. Measured the spectrum width with power higher than 20dB below carrier.
4. Measured the 99% OBW.

3.5 Frequency Stability Measurement

3.5.1 Limit

The frequency tolerance of the carrier signal shall be maintained within +/- 0.01% (100ppm) of the operating frequency over a temperature variation of -20 degrees to +50 degrees C at normal supply voltage, and for a variation in the primary supply voltage from 85% to 115% of the rated supply voltage at a temperature of 20 degrees C. For battery operated equipment, the equipment tests shall be performed using a new battery.

3.5.2 Test Procedures

1. The spectrum analyzer connected via a receive antenna placed near the EUT.
2. EUT have transmitted signal and fixed channelize.
3. Set the spectrum analyzer span to view the entire emissions bandwidth.
4. Set RBW = 1 kHz, VBW = 3 kHz with peak detector and maxhold settings.
5. The f_c is declaring of channel frequency. Then the frequency error formula is $(f_c - f) / f_c \times 10^6$ ppm and the limit is less than ± 100 ppm.
6. Extreme temperature rule is -20°C~50°C.

4. RADIATED TEST ITEMS

4.1 Measuring Instruments

See list of measuring instruments of this test report.

4.2 Test Setup

4.2.1 For radiated emissions below 30MHz

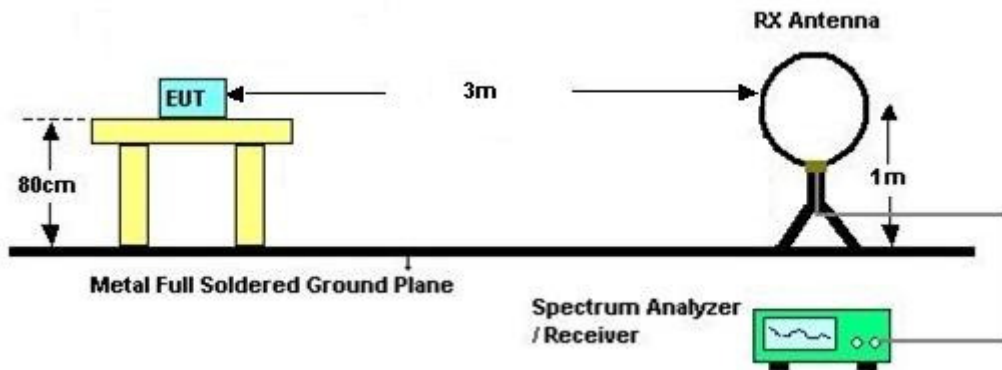

4.2.2 For radiated emissions above 30MHz

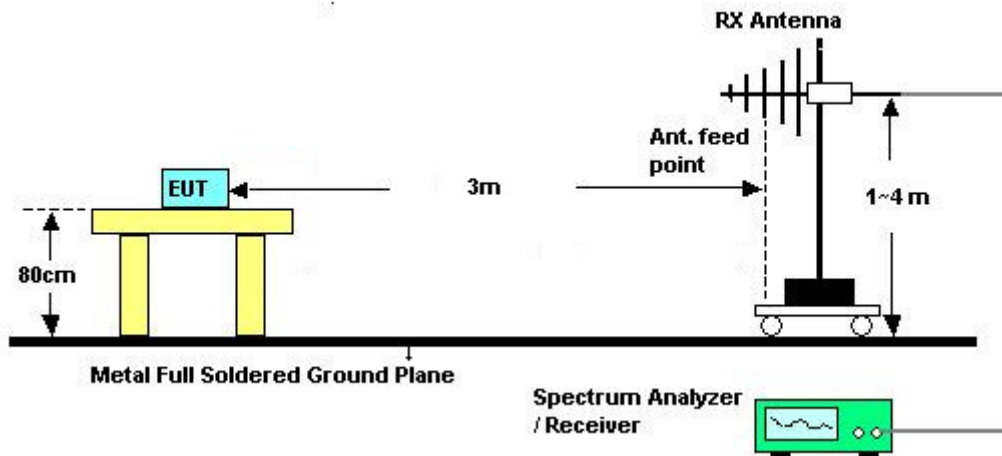

4.3 Test Result of Radiated Test Items

Please refer to Appendix D.



4.4 Field Strength of Fundamental Emissions and Mask Measurement

4.4.1 Limit

Rules and specifications	FCC CFR 47 Part 15 section 15.225 IC RSS-210 A2.6			
	Description	Compliance with the spectrum mask is tested with RBW set to 9kHz.		
Freq. of Emission (MHz)	Field Strength (μV/m) at 30m	Field Strength (dBμV/m) at 30m	Field Strength (dBμV/m) at 10m	Field Strength (dBμV/m) at 3m
1.705~13.110	30	29.5	48.58	69.5
13.110~13.410	106	40.5	59.58	80.5
13.410~13.553	334	50.5	69.58	90.5
13.553~13.567	15848	84.0	103.08	124.0
13.567~13.710	334	50.5	69.58	90.5
13.710~14.010	106	40.5	59.58	80.5
14.010~30.000	30	29.5	48.58	69.5

4.4.2 Test Procedures

1. Configure the EUT according to ANSI C63.10. The EUT was placed on the top of the turntable 0.8 meter above ground. The phase center of the loop receiving antenna mounted antenna tower was placed 3 meters far away from the turntable.
2. Power on the EUT and all the supporting units. The turntable was rotated by 360 degrees to determine the position of the highest radiation.
3. The height of the receiving antenna was fixed at one meter above ground to find the maximum emissions field strength.
4. For Fundamental emissions, use the receiver to measure QP reading.
5. When the radiated emissions limits are expressed in terms of the average value of the emissions, and pulsed operation is employed, the measurement field strength shall be determined by averaging over one complete pulse train, including blanking intervals, as long as the pulse train does not exceed 0.1 seconds. As an alternative (provided the transmitter operates for longer than 0.1 seconds) or in cases where the pulse train exceeds 0.1 seconds, the measured field strength shall be determined from the average absolute voltage during a 0.1 second interval during which the field strength is at its maximum value.
6. Compliance with the spectrum mask is tested with RBW set to 9kHz.

Note: Emission level (dBμV/m) = 20 log Emission level (μV/m).



4.5 Radiated Emissions Measurement

4.5.1 Limit

The field strength of any emissions which appear outside of 13.110 ~14.010MHz band shall not exceed the general radiated emissions limits.

Frequencies (MHz)	Field Strength (µV/m)	Measurement Distance (meters)
0.009~0.490	2400/F(kHz)	300
0.490~1.705	24000/F(kHz)	30
1.705~30.0	30	30
30~88	100	3
88~216	150	3
216~960	200	3
Above 960	500	3

4.5.2 Measuring Instrument Setting

The following table is the setting of receiver.

Receiver Parameter	Setting
Attenuation	Auto
Frequency Range: 9kHz~150kHz	RBW 200Hz for QP
Frequency Range: 150kHz~30MHz	RBW 9kHz for QP
Frequency Range: 30MHz~1000MHz	RBW 120kHz for Peak

Note: The emission limits shown in the above table are based on measurements employing a CISPR quasi-peak detector except for the frequency bands 9-90 kHz, 110-490 kHz. Radiated emission limits in these two bands are based on measurements employing an average detector.



4.5.3 Test Procedures

1. Configure the EUT according to ANSI C63.10. The EUT was placed on the top of the turntable 0.8 meter above ground. The phase center of the receiving antenna mounted on the top of a height-variable antenna tower was placed 3 meters far away from the turntable.
1. Power on the EUT and all the supporting units. The turntable was rotated by 360 degrees to determine the position of the highest radiation.
2. The height of the broadband receiving antenna was varied between one meter and four meters above ground to find the maximum emissions field strength of both horizontal and vertical polarization.
3. For each suspected emissions, the antenna tower was scan (from 1 M to 4 M) and then the turntable was rotated (from 0 degree to 360 degrees) to find the maximum reading.
4. Set the test-receiver system to Peak or CISPR quasi-peak Detect Function with specified bandwidth under Maximum Hold Mode.
5. When the radiated emissions limits are expressed in terms of the average value of the emissions, and pulsed operation is employed, the measurement field strength shall be determined by averaging over one complete pulse train, including blanking intervals, as long as the pulse train does not exceed 0.1 seconds. As an alternative (provided the transmitter operates for longer than 0.1 seconds) or in cases where the pulse train exceeds 0.1 seconds, the measured field strength shall be determined from the average absolute voltage during a 0.1 second interval during which the field strength is at its maximum value.
6. In case the emission is lower than 30MHz, loop antenna has to be used for measurement and the recorded data should be QP measured by receiver. Antenna Requirements

4.5.4 Limit

Except for special regulations, the Low-power Radio-frequency Devices must not be equipped with any jacket for installing an antenna with extension cable. An intentional radiator shall be designed to ensure that no antenna other than that furnished by the responsible party shall be used with the device. The use of a permanently attached antenna or of an antenna that uses a unique coupling to the intentional radiator shall be considered sufficient to comply with the provisions of this Section. The manufacturer may design the unit so that the user can replace a broken antenna, but the use of a standard antenna jack or electrical connector is prohibited.

4.5.5 Antenna Anti-Replacement Construction

An embedded-in antenna design is used.



5. LIST OF MEASURING EQUIPMENT

Instrument	Manufacturer	Model No.	Serial No.	Characteristics	Calibration Date	Test Date	Due Date	Remark
AC Power Source	AC POWER	AFC-500W	F104070011	50Hz~60Hz	Dec. 02, 2015	Jun. 21, 2016	Dec. 01, 2016	Conducted (TH03-HY)
Spectrum Analyzer	Rohde & Schwarz	FSP30	101329	9kHz~30GHz	Jun. 24, 2015	Jun. 21, 2016	Jun. 23, 2016	Conducted (TH03-HY)
Temperature Chamber	ESPEC	SU-641	92013721	-30℃ ~70℃	Nov. 20, 2015	Jun. 21, 2016	Nov. 19, 2016	Conducted (TH03-HY)
AC Power Source	ChainTek	APC-1000W	N/A	N/A	N/A	Jun. 28, 2016	N/A	Conduction (CO05-HY)
EMI Test Receiver	Rohde & Schwarz	ESCI 7	100724	9kHz~7GHz	Aug. 26, 2015	Jun. 28, 2016	Aug. 25, 2016	Conduction (CO05-HY)
LISN	Rohde & Schwarz	ENV216	100080	9kHz~30MHz	Dec. 02, 2015	Jun. 28, 2016	Dec. 01, 2016	Conduction (CO05-HY)
Bilog Antenna	TESEQ	CBL 6111D	35419	30MHz to 1GHz	Jan. 13, 2016	Jun. 21, 2016	Jan. 12, 2017	Radiation (03CH07-HY)
EMI Test Receiver	Keysight	N9038A(MXE)	MY54130085	20Hz ~ 8.4GHz	Nov. 04, 2015	Jun. 21, 2016	Nov. 03, 2016	Radiation (03CH07-HY)
Loop Antenna	Rohde & Schwarz	HFH2-Z2	100315	9 kHz~30 MHz	Sep. 02, 2015	Jun. 21, 2016	Sep. 01, 2016	Radiation (03CH07-HY)
Preamplifier	MITEQ	AMF-7D-00101800-30-10P	1590075	1GHz ~ 18GHz	Apr. 15, 2016	Jun. 21, 2016	Apr. 14, 2017	Radiation (03CH07-HY)
Spectrum Analyzer	Agilent	N9010A	MY53470118	10Hz~44GHz	Feb. 27, 2016	Jun. 21, 2016	Feb. 26, 2017	Radiation (03CH07-HY)
RF Cable	HUBER + SUHNER	SUCOFLEX 104	MY84209521	1GHz~26GHz	Dec. 03, 2015	Jun. 21, 2016	Dec. 02, 2016	Radiation (03CH07-HY)
Antenna Mast	Max-Full	MFA520BS	N/A	1m~4m	N/A	Jun. 21, 2016	N/A	Radiation (03CH07-HY)
Turn Table	ChainTek	Chaintek 3000	N/A	0~360 Degree	N/A	Jun. 21, 2016	N/A	Radiation (03CH07-HY)
Loop Cable	Rohde & Schwarz	N/A	N/A	9KHz~30MHz	Dec. 03, 2015	Jun. 21, 2016	Dec. 02, 2016	Radiation (03CH07-HY)
Preamplifier	COM-POWER	PA-103A	161241	10MHz~1GHz	Mar. 18, 2016	Jun. 21, 2016	Mar. 17, 2017	Radiation (03CH07-HY)

Appendix B. Test Results of Conducted Emission Test

<Original Test Result>

Test Mode :	NFC Tx	Test Voltage :	120Vac / 60Hz
Function Type :	LTE Band 30 Idle + Bluetooth Link + WLAN (2.4GHz) link + NFC Link + MP3 + Earphone + USB Cable 5 (Charging from Adapter 2)		

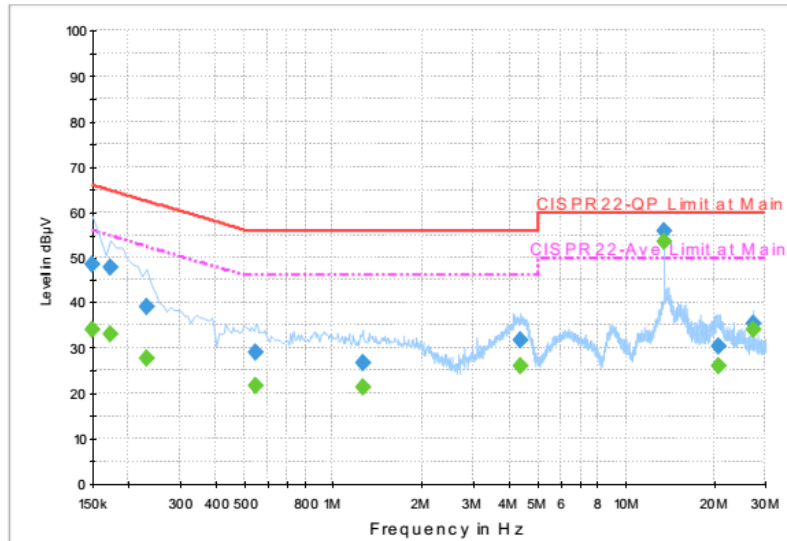

Final Result : Quasi-Peak

Frequency (MHz)	Quasi-Peak (dBµV)	Filter	Line	Corr. (dB)	Margin (dB)	Limit (dBµV)
0.150000	48.4	Off	L1	19.6	17.6	66.0
0.174000	47.9	Off	L1	19.6	16.9	64.8
0.230000	39.2	Off	L1	19.6	23.2	62.4
0.542000	29.1	Off	L1	19.6	26.9	56.0
1.262000	26.8	Off	L1	19.7	29.2	56.0
4.366000	31.9	Off	L1	19.8	24.1	56.0
13.558000	55.8	Off	L1	20.3	4.2	60.0
20.846000	30.5	Off	L1	20.7	29.5	60.0
27.118000	35.3	Off	L1	21.0	24.7	60.0

Final Result : Average

Frequency (MHz)	Average (dBµV)	Filter	Line	Corr. (dB)	Margin (dB)	Limit (dBµV)
0.150000	34.1	Off	L1	19.6	21.9	56.0
0.174000	33.2	Off	L1	19.6	21.6	54.8
0.230000	27.7	Off	L1	19.6	24.7	52.4
0.542000	21.9	Off	L1	19.6	24.1	46.0
1.262000	21.5	Off	L1	19.7	24.5	46.0
4.366000	26.2	Off	L1	19.8	19.8	46.0
13.558000	53.5	Off	L1	20.3	-3.5	50.0
20.846000	26.0	Off	L1	20.7	24.0	50.0
27.118000	34.2	Off	L1	21.0	15.8	50.0



Test Mode :	NFC Tx	Test Voltage :	120Vac / 60Hz
Function Type :	LTE Band 30 Idle + Bluetooth Link + WLAN (2.4GHz) link + NFC Link + MP3 + Earphone + USB Cable 5 (Charging from Adapter 2)		

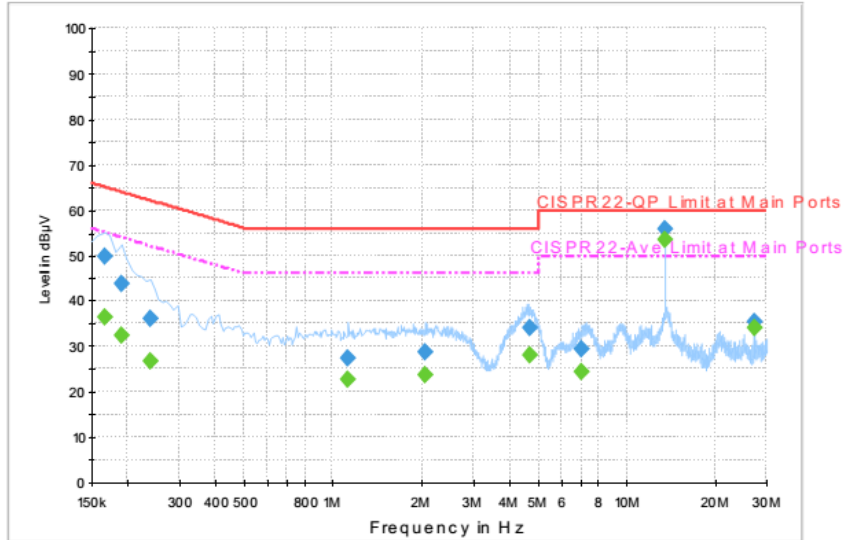

Final Result : Quasi-Peak

Frequency (MHz)	Quasi-Peak (dBµV)	Filter	Line	Corr. (dB)	Margin (dB)	Limit (dBµV)
0.166000	49.7	Off	N	19.6	15.5	65.2
0.190000	43.8	Off	N	19.6	20.2	64.0
0.238000	36.0	Off	N	19.6	26.2	62.2
1.126000	27.4	Off	N	19.6	28.6	56.0
2.070000	28.7	Off	N	19.6	27.3	56.0
4.694000	34.2	Off	N	19.8	21.8	56.0
7.054000	29.3	Off	N	19.9	30.7	60.0
13.558000	55.8	Off	N	20.3	4.2	60.0
27.118000	35.3	Off	N	21.2	24.7	60.0

Final Result : Average

Frequency (MHz)	Average (dBµV)	Filter	Line	Corr. (dB)	Margin (dB)	Limit (dBµV)
0.166000	36.5	Off	N	19.6	18.7	55.2
0.190000	32.5	Off	N	19.6	21.5	54.0
0.238000	26.6	Off	N	19.6	25.6	52.2
1.126000	22.7	Off	N	19.6	23.3	46.0
2.070000	23.7	Off	N	19.6	22.3	46.0
4.694000	28.2	Off	N	19.8	17.8	46.0
7.054000	24.3	Off	N	19.9	25.7	50.0
13.558000	53.7	Off	N	20.3	-3.7	50.0
27.118000	34.1	Off	N	21.2	15.9	50.0



<Terminal Test Result>

Test Mode :	NFC Tx	Test Voltage :	120Vac / 60Hz
Function Type :	LTE Band 30 Idle + Bluetooth Link + WLAN (2.4GHz) link + NFC Link + MP3 + Earphone + USB Cable 5 (Charging from Adapter 2)		

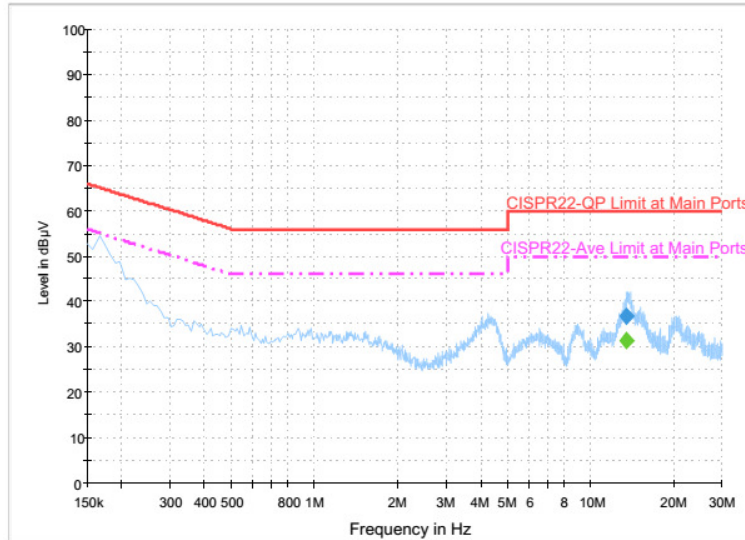

Final Result : Quasi-Peak

Frequency (MHz)	Quasi-Peak (dBµV)	Filter	Line	Corr. (dB)	Margin (dB)	Limit (dBµV)
13.558000	36.9	Off	L1	20.3	23.1	60.0

Final Result : Average

Frequency (MHz)	Average (dBµV)	Filter	Line	Corr. (dB)	Margin (dB)	Limit (dBµV)
13.558000	31.6	Off	L1	20.3	18.4	50.0



Test Mode :	NFC Tx	Test Voltage :	120Vac / 60Hz
Function Type :	LTE Band 30 Idle + Bluetooth Link + WLAN (2.4GHz) link + NFC Link + MP3 + Earphone + USB Cable 5 (Charging from Adapter 2)		

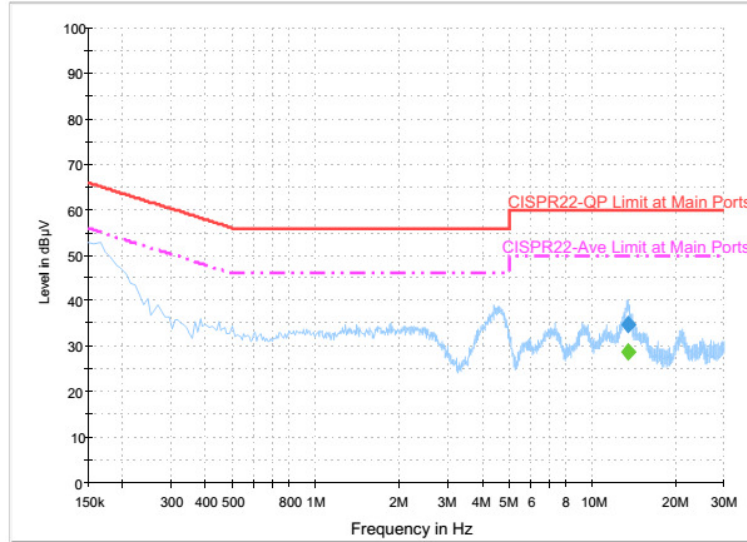

Final Result : Quasi-Peak

Frequency (MHz)	Quasi-Peak (dBµV)	Filter	Line	Corr. (dB)	Margin (dB)	Limit (dBµV)
13.558000	34.7	Off	N	20.3	25.3	60.0

Final Result : Average

Frequency (MHz)	Average (dBµV)	Filter	Line	Corr. (dB)	Margin (dB)	Limit (dBµV)
13.558000	28.8	Off	N	20.3	21.2	50.0

(1) with antenna

Remark: 13.558MHz is the NFC RF fundamental signal.

(2) with dummy load

Remark: Only the fundamental NFC signal needs to be retested per C63.4.



Appendix C. Test Results of Conducted Test Items

C.1 Test Result of 20dB Spectrum Bandwidth

Test mode	NFC Tx	Test Frequency (MHz)	13.56
Date: 21.JUN.2016 09:12:04		Date: 21.JUN.2016 09:47:32	
20dB Bandwidth (kHz)	2.64	99% OccupiedBW(kHz)	2.24
Frequency range (MHz)	$f_L > 13.553$	13.55798	Test Result
	$f_H < 13.567$	13.56062	Complies



C.2 Test Result of Frequency Stability

Voltage vs. Frequency Stability		Temperature vs. Frequency Stability		
Voltage (Vac)	Measurement Frequency (MHz)	Temperature (°C)	Time	Measurement Frequency (MHz)
120	13.559280	-20	0	13.559360
102	13.559280		2	13.559360
138	13.559300		5	13.559350
			10	13.559340
		-10	0	13.559350
			2	13.559340
			5	13.559340
			10	13.559340
		0	0	13.559340
			2	13.559340
			5	13.559340
			10	13.559330
		10	0	13.559340
			2	13.559340
			5	13.559330
			10	13.559320
		20	0	13.559300
			2	13.559300
			5	13.559300
			10	13.559300
		30	0	13.559300
			2	13.559300
			5	13.559280
			10	13.559280
		40	0	13.559260
			2	13.559260
			5	13.559260
			10	13.559260



Voltage vs. Frequency Stability		Temperature vs. Frequency Stability		
Voltage (Vac)	Measurement Frequency (MHz)	Temperature (°C)	Time	Measurement Frequency (MHz)
		50	0	13.559240
			2	13.559240
			5	13.559240
			10	13.559260
Max.Deviation (MHz)	-0.000720	Max.Deviation (MHz)		-0.000760
Max.Deviation (ppm)	-53.0973	Max.Deviation (ppm)		-56.0472
Limit	FS < ±100 ppm	Limit		FS < ±100 ppm
Test Result	PASS	Test Result		PASS



Appendix D. Test Results of Radiated Test Items

D.1 Test Result of Field Strength of Fundamental Emissions

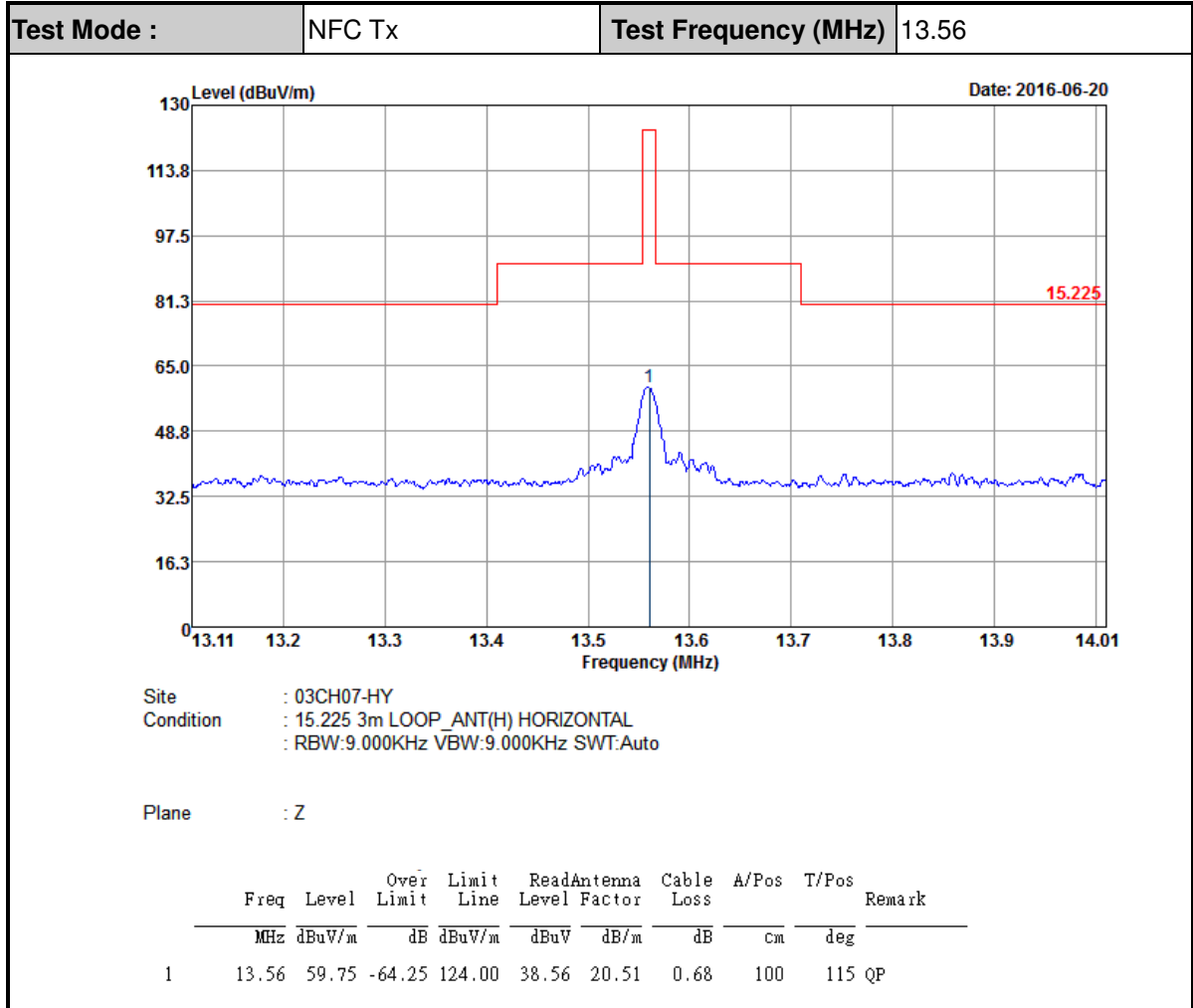

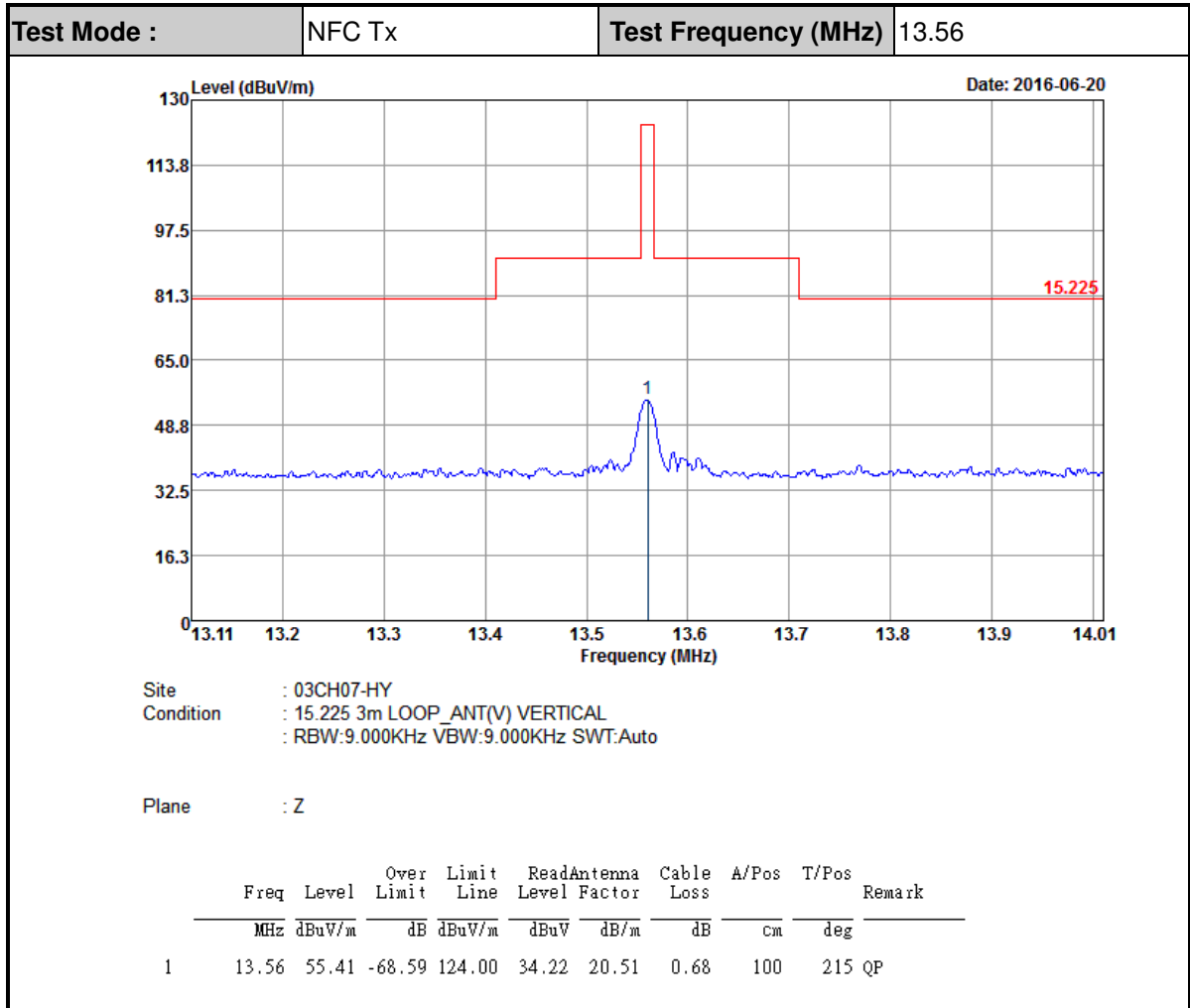

Note: All NFC's spurious emissions are below 20dB of limits.



D.2 Results of Radiated Emissions (9 kHz~30MHz)

Test Mode :	NFC Tx	Polarization :	Horizontal
-------------	--------	----------------	------------

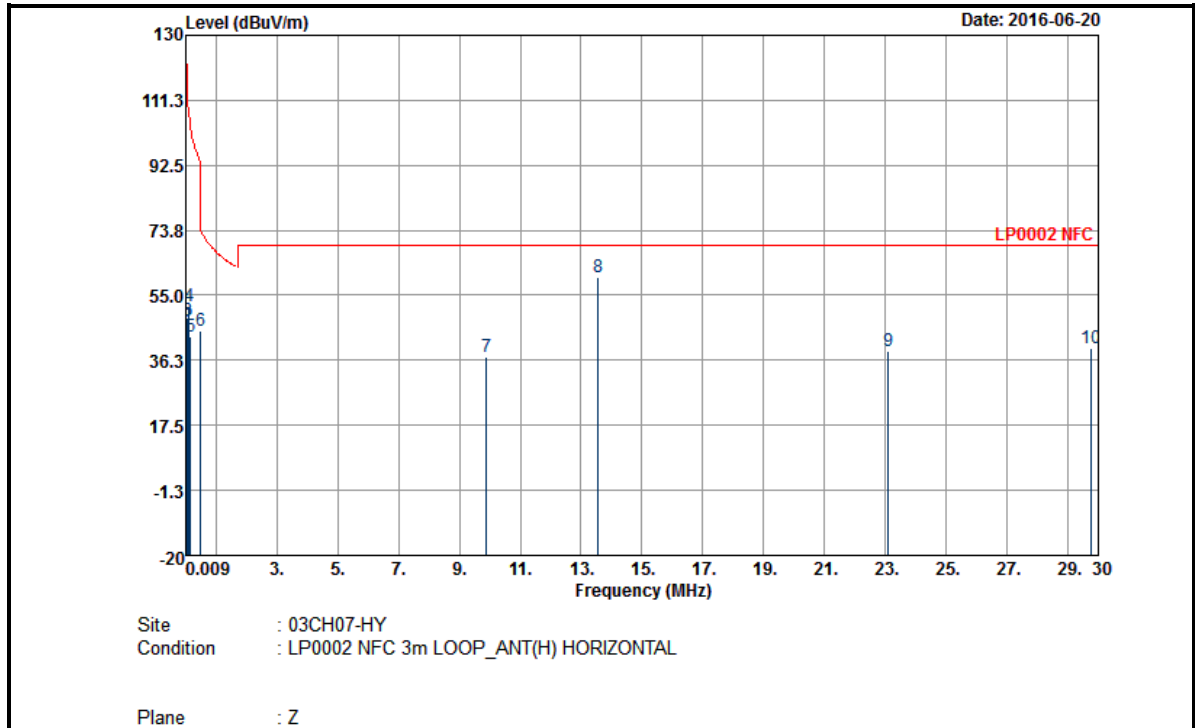

Frequency (MHz)	Level (dB μ V/m)	Over Limit (dB)	Limit Line (dB μ V/m)	Read Level (dB μ V)	Antenna Factor (dB)	Cable Loss (dB)	Ant Pos (cm)	Table Pos (deg)	Remark
0.01573	42.98	-80.69	123.67	19.4	22.9	0.68	-	-	Average
0.07875	46.41	-63.27	109.68	26.73	19	0.68	-	-	Average
0.10282	47.72	-59.64	107.36	28.24	18.8	0.68	-	-	QP
0.11024	51.71	-55.05	106.76	32.23	18.8	0.68	-	-	Average
0.17312	43.16	-59.68	102.84	23.71	18.77	0.68	-	-	Average
0.49	44.86	-28.94	73.8	25.58	18.6	0.68	100	0	QP
9.888	37.16	-32.34	69.5	16.7	19.78	0.68	-	-	QP
13.56	60.02	-	-	38.83	20.51	0.68	-	-	QP
23.092	38.91	-30.59	69.5	15.85	21.99	1.07	-	-	QP
29.745	39.61	-29.89	69.5	16.16	22.38	1.07	-	-	QP



Test Mode :	NFC Tx	Polarization :	Vertical
-------------	--------	----------------	----------

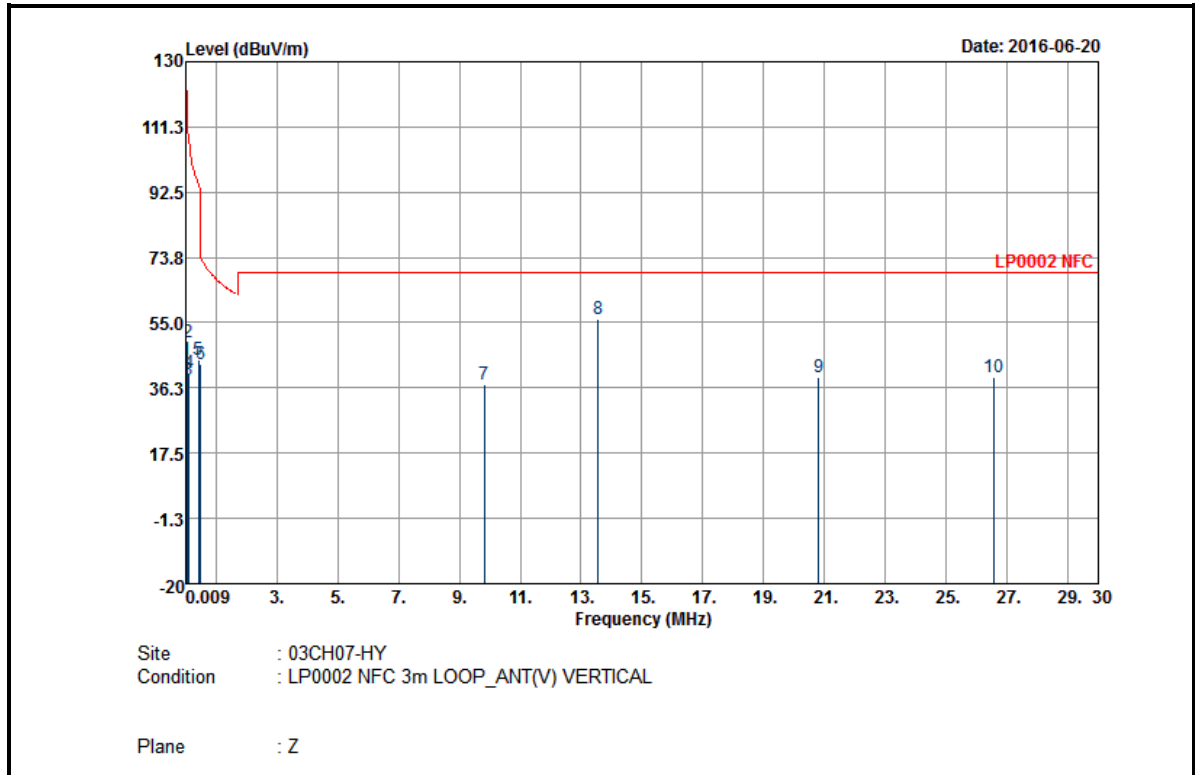

Frequency (MHz)	Level (dBμV/m)	Over Limit (dB)	Limit Line (dBμV/m)	Read Level (dBμV)	Antenna Factor (dB)	Cable Loss (dB)	Ant Pos (cm)	Table Pos (deg)	Remark
0.01349	44.21	-80.8	125.01	20.63	22.9	0.68	-	-	Average
0.07581	49.37	-60.64	110.01	29.69	19	0.68	-	-	Average
0.10282	38.34	-69.02	107.36	18.86	18.8	0.68	-	-	QP
0.12212	40.53	-65.34	105.87	21.06	18.79	0.68	-	-	Average
0.42438	44.52	-50.53	95.05	25.21	18.63	0.68	-	-	Average
0.49751	43.03	-30.64	73.67	23.75	18.6	0.68	-	-	QP
9.808	37.33	-32.17	69.5	16.88	19.77	0.68	-	-	QP
13.56	56.25	-	-	35.06	20.51	0.68	-	-	QP
20.815	39.26	-30.24	69.5	16.34	21.85	1.07	-	-	QP
26.55	39.43	-30.07	69.5	16.17	22.19	1.07	100	0	QP

Note:

1. The test was performed with adapter 1, USB cable 1, and earphone 1.
2. 13.56 MHz is fundamental signal which can be ignored.
3. The amplitude of spurious emissions which are attenuated by more than 20dB below the permissible value has no need to be reported.



4. Distance extrapolation factor = $40 \log (\text{specific distance} / \text{test distance})$ (dB);
5. Limit line = specific limits (dB μ V) + distance extrapolation factor.



D.3 Results of Radiated Emissions (30MHz~1GHz)

Test Mode :	NFC Tx	Polarization :	Horizontal
-------------	--------	----------------	------------

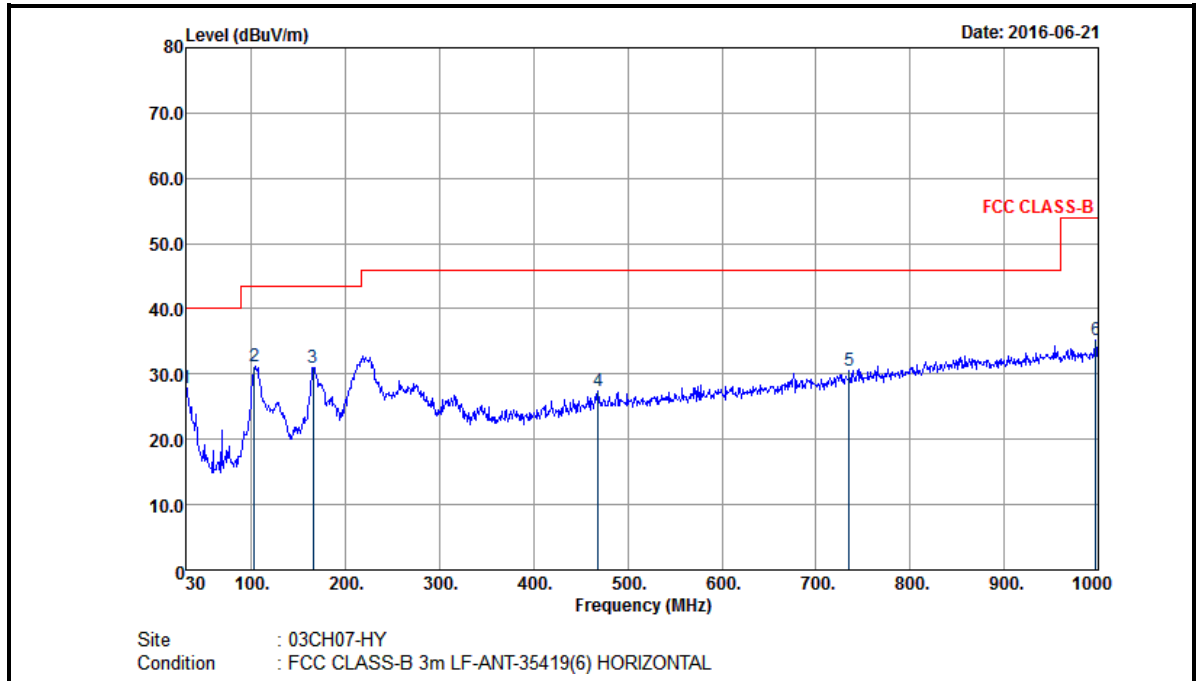

Frequency (MHz)	Level (dB μ V/m)	Over Limit (dB)	Limit Line (dB μ V/m)	Read Level (dB μ V)	Antenna Factor (dB)	Cable Loss (dB)	Preamp Factor (dB)	Ant Pos (cm)	Table Pos (deg)	Remark
30	27.88	-12.12	40	32.16	26	1.07	31.35	100	0	Peak
102.9	31.23	-12.27	43.5	44.53	16.67	1.55	31.52	-	-	Peak
165.54	30.97	-12.53	43.5	44.28	16.4	1.78	31.49	-	-	Peak
468	27.52	-18.48	46	32.05	23.5	3.04	31.07	-	-	Peak
735.4	30.54	-15.46	46	30.51	26.96	3.74	30.67	-	-	Peak
997.2	35.12	-18.88	54	31.37	30.29	3.98	30.52	-	-	Peak



Test Mode :	NFC Tx	Polarization :	Vertical
-------------	--------	----------------	----------

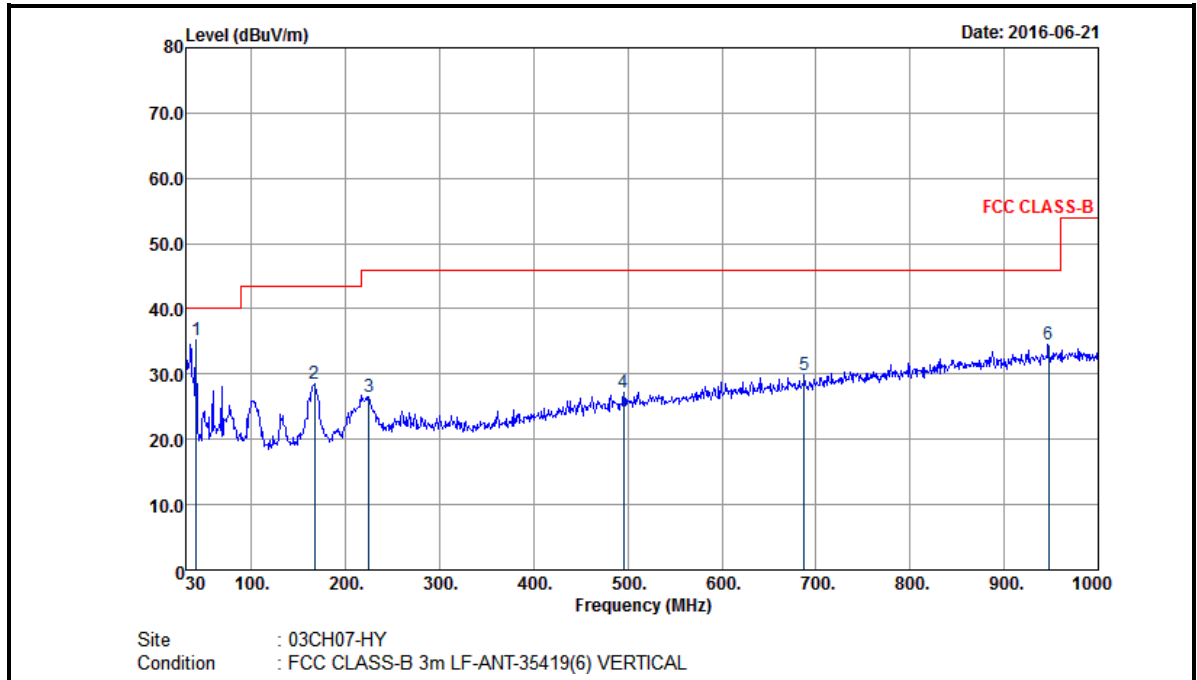

Frequency (MHz)	Level (dBμV/m)	Over Limit (dB)	Limit Line (dBμV/m)	Read Level (dBμV)	Antenna Factor (dB)	Cable Loss (dB)	Preamp Factor (dB)	Ant Pos (cm)	Table Pos (deg)	Remark
40.8	35.12	-4.88	40	45.7	19.84	1.07	31.49	100	0	Peak
167.16	28.55	-14.95	43.5	41.96	16.3	1.78	31.49	-	-	Peak
224.67	26.53	-19.47	46	39.09	16.8	2.07	31.43	-	-	Peak
495.3	27.1	-18.9	46	31	24.09	3.04	31.03	-	-	Peak
687.1	29.88	-16.12	46	30.69	26.27	3.65	30.73	-	-	Peak
946.8	34.48	-11.52	46	30.81	30.13	4.07	30.53	-	-	Peak

Note:

1. The test was performed with adapter 1, USB cable 1, and earphone 1.
2. The amplitude of spurious emissions which are attenuated by more than 20dB below the permissible value has no need to be reported.
3. Emission level (dBμV/m) = 20 log Emission level (μV/m).
4. Corrected Reading: Antenna Factor + Cable Loss + Read Level - Preamp Factor= Level.



Appendix E. Verification of Radiated Spurious Emissions at open-area test site

E.1 Results of Radiated Emissions (9 kHz~30MHz)

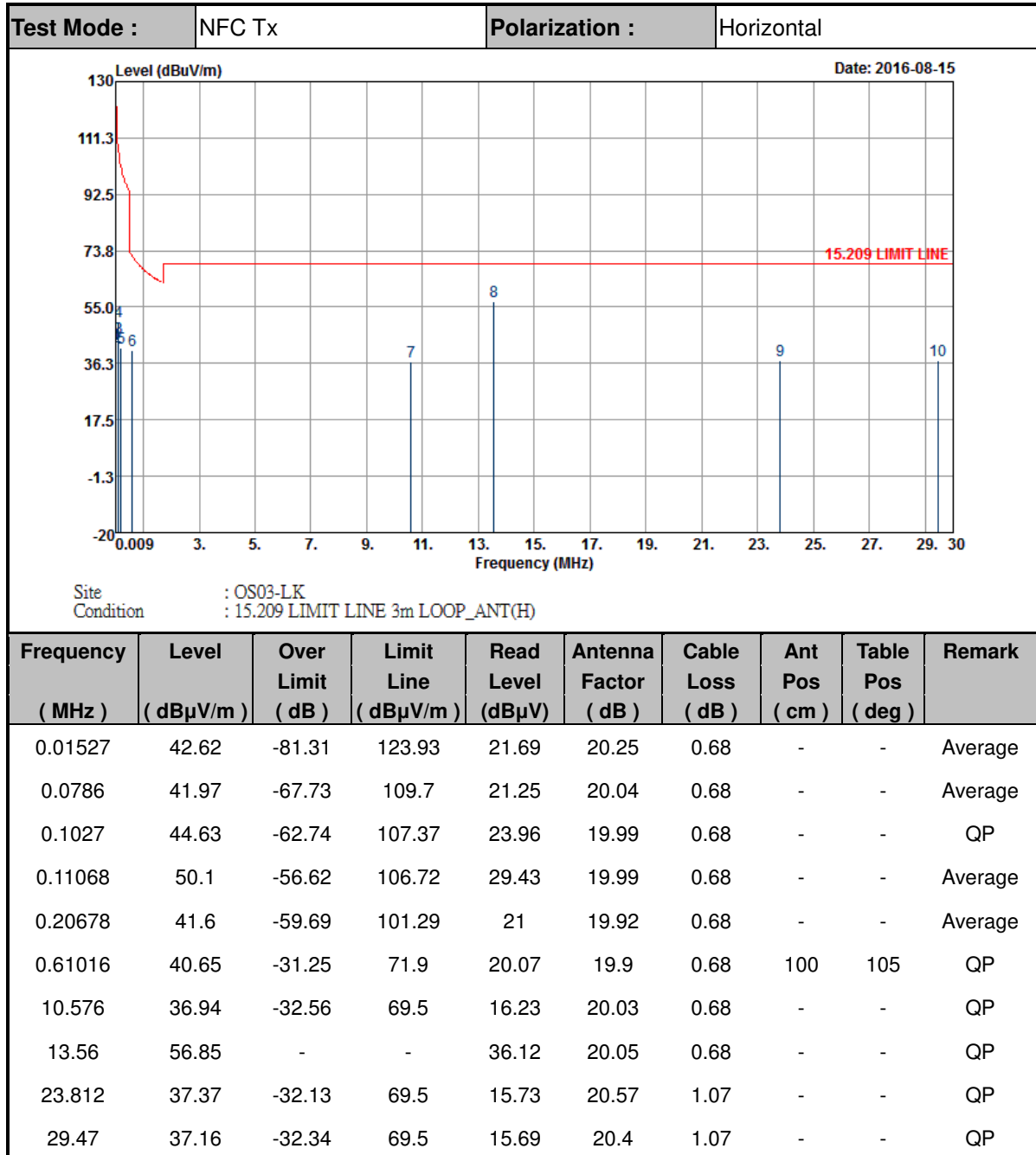

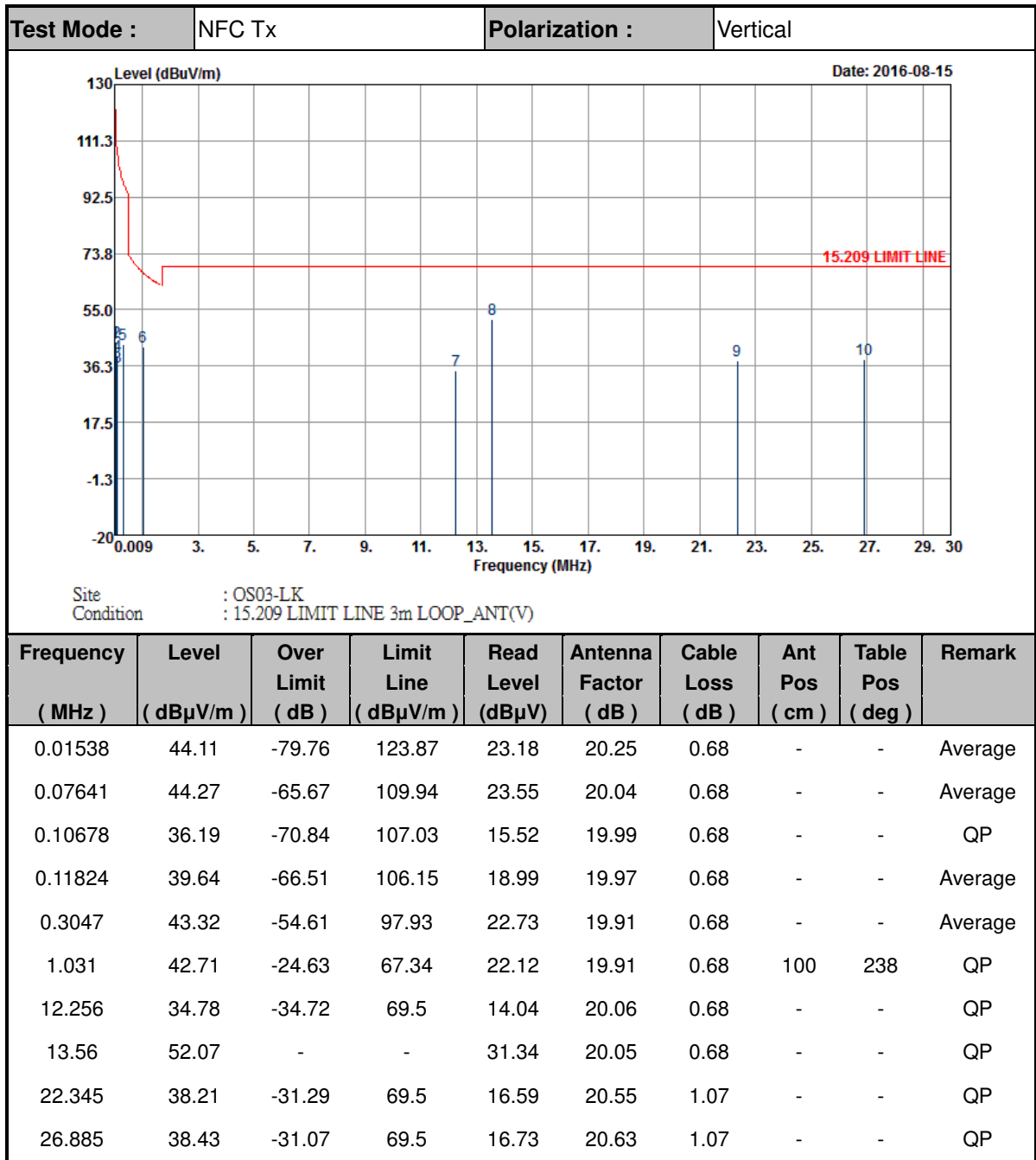

Note:

1. The test was performed with adapter 1, USB cable 1, and earphone 1.
2. 13.56 MHz are fundamental signal which can be ignored.
3. The amplitude of spurious emissions which are attenuated by more than 20dB below the permissible value has no need to be reported.
4. Distance extrapolation factor = 40 log (specific distance / test distance) (dB);
5. Limit line = specific limits (dBμV) + distance extrapolation factor.
6. The test distance between the receiving antenna and the EUT is 3meter.



E.2 List of Measuring Equipment

Instrument	Manufacturer	Model No.	Serial No.	Characteristics	Calibration Date	Test Date	Due Date	Remark
Test Receiver	R&S	ESCS 30	836858/024	9 kHz ~ 2.75 GHz	Jun. 24, 2016	Aug. 15, 2016 ~ Aug. 16, 2016	Jun. 23, 2017	Radiation (OS03-LK)
Loop Antenna	R&S	HFH2-Z2	25236	9 kHz ~ 30MHz	Sep. 02, 2015	Aug. 15, 2016 ~ Aug. 16, 2016	Sep. 01, 2016	Radiation (OS03-LK)
Turn Table	EMCO	2080	9711-2021	0 ~ 360 degree	N/A	Aug. 15, 2016 ~ Aug. 16, 2016	N/A	Radiation (OS03-LK)
Antenna Mast	EMCO	2075	9711-2115	1 m ~ 4 m	N/A	Aug. 15, 2016 ~ Aug. 16, 2016	N/A	Radiation (OS03-LK)