



# FCC RF Test Report

APPLICANT : ASUSTeK COMPUTER INC.  
EQUIPMENT : ASUS Phone  
BRAND NAME : ASUS  
MODEL NAME : ASUS\_X00ID  
FCC ID : MSQX00ID  
STANDARD : FCC 47 CFR Part 2, and 90(S)  
CLASSIFICATION : PCS Licensed Transmitter Held to Ear (PCE)

The product was received on Mar. 22, 2017 and testing was completed on Jun. 14, 2017. We, Sporton International (KunShan) INC., would like to declare that the tested sample has been evaluated in accordance with the procedures given in ANSI / TIA / EIA-603-D-2010 and shown compliance with the applicable technical standards.

The test results in this report apply exclusively to the tested model / sample. Without written approval of Sporton International (KunShan) INC., the test report shall not be reproduced except in full.

Prepared by: James Huang / Manager

Approved by: Jones Tsai / Manager



**Sporton International (KunShan) INC.**  
**No.3-2, Pingxiang Road, Kunshan Development Zone, Jiangsu, China**



# TABLE OF CONTENTS

**REVISION HISTORY..... 3**

**SUMMARY OF TEST RESULT ..... 4**

**1 GENERAL DESCRIPTION ..... 5**

    1.1 Applicant..... 5

    1.2 Manufacturer ..... 5

    1.3 Feature of Equipment Under Test..... 5

    1.4 Product Specification of Equipment Under Test ..... 6

    1.5 Modification of EUT ..... 6

    1.6 Maximum Frequency Tolerance, Emission Designator and Conducted Power..... 7

    1.7 Testing Site..... 8

    1.8 Applied Standards ..... 8

**2 TEST CONFIGURATION OF EQUIPMENT UNDER TEST..... 9**

    2.1 Test Mode..... 9

    2.2 Connection Diagram of Test System ..... 10

    2.3 Support Unit used in test configuration and system..... 10

    2.4 Measurement Results Explanation Example ..... 10

    2.5 Frequency List of Low/Middle/High Channels..... 11

**3 TEST RESULT..... 12**

    3.1 Conducted Output Power Measurement..... 12

    3.2 99% Occupied Bandwidth and 26dB Bandwidth Measurement..... 13

    3.3 Emissions Mask Measurement ..... 14

    3.4 Emissions Mask – Out Of Band Emissions Measurement..... 16

    3.5 Field Strength of Spurious Radiation Measurement ..... 18

    3.6 Frequency Stability Measurement..... 20

**4 LIST OF MEASURING EQUIPMENT ..... 22**

**5 UNCERTAINTY OF EVALUATION ..... 23**

**APPENDIX A. TEST RESULTS OF CONDUCTED TEST**

**APPENDIX B. TEST RESULTS OF RADIATED TEST**

**APPENDIX C. SETUP PHOTOGRAPHS**



### REVISION HISTORY

REPORT NO.	VERSION	DESCRIPTION	ISSUED DATE
FW732212	Rev. 01	Initial issue of report	Jul. 10, 2017



### SUMMARY OF TEST RESULT

Report Section	FCC Rule	Description	Limit	Result	Remark
3.1	§2.1046	Conducted Output Power	Reporting only	PASS	-
3.2	§2.1049 §90.209	Occupied Bandwidth and 26dB Bandwidth	Reporting only	PASS	-
3.3	§2.1051 §90.691	Emission masks – In-band emissions	$< 50+10\log_{10}(P[\text{Watts}])$	PASS	-
3.4	§2.1051 §90.691	Emission masks – Out of band emissions	$< 43+10\log_{10}(P[\text{Watts}])$	PASS	-
3.5	§2.1053 §90.691	Field Strength of Spurious Radiation	$< 43+10\log_{10}(P[\text{Watts}])$	PASS	Under limit 36.00 dB at 2456.000 MHz
3.6	§2.1055 §90.213	Frequency Stability for Temperature & Voltage	$< 2.5 \text{ ppm}$	PASS	-



# 1 General Description

## 1.1 Applicant

ASUSTeK COMPUTER INC.

4F, No.150, Li-Te Rd., Peitou, Taipei 112, Taiwan

## 1.2 Manufacturer

ASUSTeK COMPUTER INC.

4F, No.150, Li-Te Rd., Peitou, Taipei 112, Taiwan

## 1.3 Feature of Equipment Under Test

Product Feature & Specification	
Equipment	ASUS Phone
Brand Name	ASUS
Model Name	ASUS_X00ID
FCC ID	MSQX00ID
EUT supports Radios application	GSM/GPRS/EGPRS/WCDMA/HSPA/HSPA+(16QAM uplink is not supported)/LTE/ WLAN 2.4GHz 802.11b/g/n HT20/HT40/ Bluetooth v3.0+EDR/Bluetooth v4.0 LE/ Bluetooth v4.1 LE/ Bluetooth v4.2 LE
IMEI Code	Conducted: 357911080064220/357911080064238 Radiation: 357911080063487/357911080063495
HW Version	QL1516_MB_PCB_V3.0
SW Version	NMF26F.WW_Phone-14.2016.1703.111-20170511 071001011_201705030213
EUT Stage	Identical Prototype

**Remark:** The above EUT's information was declared by manufacturer. Please refer to the specifications or user's manual for more detailed description.



### 1.4 Product Specification of Equipment Under Test

Product Specification subjective to this standard	
Tx Frequency	LTE Band 26 : 814.7 ~ 823.3 MHz
Rx Frequency	LTE Band 26 : 859.7 ~ 868.3 MHz
Bandwidth	1.4MHz / 3MHz / 5MHz / 10MHz / 15MHz
Maximum Output Power to Antenna	23.11 dBm
Antenna Type	PIFA Antenna
Type of Modulation	QPSK / 16QAM

Remark: This test report recorded only product characteristics and test results of PCS Licensed Transmitter Held to Ear (PCE).

### 1.5 Modification of EUT

No modifications are made to the EUT during all test items.



### 1.6 Maximum Frequency Tolerance, Emission Designator and Conducted Power

FCC Rule	System	Type of Modulation	BW	Frequency Tolerance (ppm)	Emission Designator	Maximum Conducted power(W)
Part 90S	LTE Band 26	QPSK	1.4 MHz	-	1M09G7D	0.2046
Part 90S	LTE Band 26	16QAM	1.4 MHz	-	1M09W7D	0.1663
Part 90S	LTE Band 26	QPSK	3 MHz	-	2M72G7D	0.2000
Part 90S	LTE Band 26	16QAM	3 MHz	-	2M72W7D	0.1660
Part 90S	LTE Band 26	QPSK	5 MHz	-	4M51G7D	0.1995
Part 90S	LTE Band 26	16QAM	5 MHz	-	4M49W7D	0.1663
Part 90S	LTE Band 26	QPSK	10 MHz	0.0050 ppm	8M97G7D	0.1875
Part 90S	LTE Band 26	16QAM	10 MHz	-	8M95W7D	0.1419
Part 90S	LTE Band 26	QPSK	15 MHz	-	13M3G7D	0.1977
Part 90S	LTE Band 26	16QAM	15 MHz	-	13M4W7D	0.1578



### 1.7 Testing Site

<b>Test Site</b>	Sporton International (KunShan) INC.		
<b>Test Site Location</b>	No.3-2, Pingxiang Road, Kunshan Development Zone, Jiangsu, China TEL: +86-0512-5790-0158 FAX: +86-0512-5790-0958		
<b>Test Site No.</b>	<b>Sporton Site No.</b>		<b>FCC Registration No.</b>
	TH01-KS	03CH03-KS	306251

**Note:** The test site complies with ANSI C63.4 2014 requirement.

### 1.8 Applied Standards

According to the specifications of the manufacturer, the EUT must comply with the requirements of the following standards:

- ♦ FCC 47 CFR Part 2, 90
- ♦ ANSI / TIA / EIA-603-D-2010
- ♦ FCC KDB 971168 D01 Power Meas. License Digital Systems v02r02
- ♦ Interim Guidance for Equipment Authorization of Devices with Channel Bandwidths Combined Across Two Contiguous Service Rule Allocations OET/Lab/EACB, June 6, 2013

**Remark:**

1. All test items were verified and recorded according to the standards and without any deviation during the test.
2. This EUT has also been tested and complied with the requirements of FCC Part 15, Subpart B, recorded in a separate test report.





## 2 Test Configuration of Equipment Under Test

### 2.1 Test Mode

During all testing, EUT is in link mode with base station emulator at maximum power level. The spurious emission measurements were carried out in semi-anechoic chamber with 3-meter test range, and EUT is rotated on three test planes to find out the worst emission.

Frequency range investigated for radiated emission is 30 MHz to 10th harmonic.

Test Items	Band	Bandwidth (MHz)						Modulation		RB #			Test Channel		
		1.4	3	5	10	15	20	QPSK	16QAM	1	Half	Full	L	M	H
Max. Output Power	26	v	v	v	v	v	-	v	v	v	v	v	v	v	v
26dB and 99% Bandwidth	26	v	v	v	v	v	-	v	v			v	v	v	v
Emission masks In-band emissions	26	v	v	v	v	v	-	v	v	v		v	v		v
Emission masks – Out of band emissions	26	v	v	v	v	v	-	v	v	v			v	v	v
Frequency Stability	26				v		-	v				v		v	
Radiated Spurious Emission	26	v	v	v	v		-	v		v				v	
Note	1. The mark “v” means that this configuration is chosen for testing 2. The mark “-“ means that this bandwidth is not supported. 3. LTE Band26 transmit frequency for part22 rule is 824MHz-849MHz, for part90 rule is 814MHz-824MHz. ERP over 15MHz bandwidth complies the ERP limit line of part22 rule, therefore ERP of the partial frequency spectrum which falls within part 22 also complies.														

## 2.2 Connection Diagram of Test System

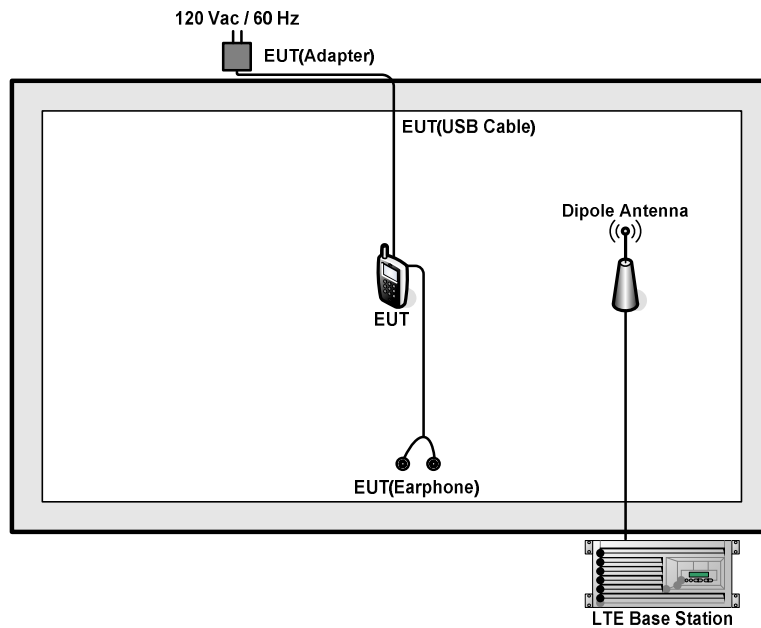

## 2.3 Support Unit used in test configuration and system

Item	Equipment	Trade Name	Model No.	FCC ID	Data Cable	Power Cord
1.	LTE Base Station	Anritsu	MT8820C	N/A	N/A	Unshielded, 1.8 m
2.	DC Power Supply	GWINSTEK	GPS-3030D	N/A	N/A	Unshielded, 1.8 m

## 2.4 Measurement Results Explanation Example

### For all conducted test items:

The offset level is set in the spectrum analyzer to compensate the RF cable loss and attenuator factor between EUT conducted output port and spectrum analyzer. With the offset compensation, the spectrum analyzer reading level is exactly the EUT RF output level.

Example:

The spectrum analyzer offset is derived from RF cable loss.

*Offset = RF cable loss*

Following shows an offset computation example with cable loss 4.8 dB

$$\begin{aligned} \text{Offset (dB)} &= \text{RF cable loss (dB)}. \\ &= 4.8 \text{ (dB)} \end{aligned}$$



## 2.5 Frequency List of Low/Middle/High Channels

LTE Band 26 Channel and Frequency List				
BW [MHz]	Channel/Frequency(MHz)	Lowest	Middle	Highest
15	Channel	26765	-	-
	Frequency	821.5	-	-
10	Channel	-	26740	-
	Frequency	-	819	-
5	Channel	26715	26740	26765
	Frequency	816.5	819	821.5
3	Channel	26705	26740	26775
	Frequency	815.5	819	822.5
1.4	Channel	26697	26740	26783
	Frequency	814.7	819	823.3

### 3 Test Result

#### 3.1 Conducted Output Power Measurement

##### 3.1.1 Description of the Conducted Output Power Measurement

A system simulator was used to establish communication with the EUT. Its parameters were set to enforce EUT transmitting at the maximum power. The measured power in the radio frequency on the transmitter output terminals shall be reported.

##### 3.1.2 Measuring Instruments

The measuring equipment is listed in the section 4 of this test report.

##### 3.1.3 Test Procedures

1. The transmitter output port was connected to the system simulator.
2. Set EUT at maximum power through system simulator.
3. Select lowest, middle, and highest channels for each band and different modulation.
4. Measure and record the power level from the system simulator.

##### 3.1.4 Test Setup

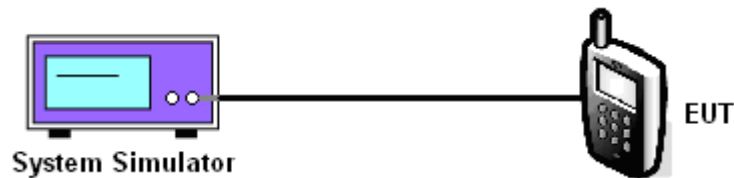

##### 3.1.5 Test Result of Conducted Output Power

Please refer to Appendix A.

## 3.2 99% Occupied Bandwidth and 26dB Bandwidth Measurement

### 3.2.1 Description of (Occupied) Bandwidth Limitations Measurement

The 99% occupied bandwidth is the width of a frequency band such that, below the lower and above the upper frequency limits, the mean powers emitted are each equal to a specified percentage 0.5% of the total mean transmitted power.

The emission bandwidth is defined as the width of the signal between two points, located at the 2 sides of the carrier frequency, outside of which all emissions are attenuated at least 26 dB below the transmitter power.

### 3.2.2 Measuring Instruments

The measuring equipment is listed in the section 4 of this test report.

### 3.2.3 Test Procedures

1. The EUT was connected to spectrum analyzer and system simulator via a power divider.
2. The 26dB and 99% occupied bandwidth (BW) of the middle channel for the highest RF power with full RB sizes were measured.

### 3.2.4 Test Setup

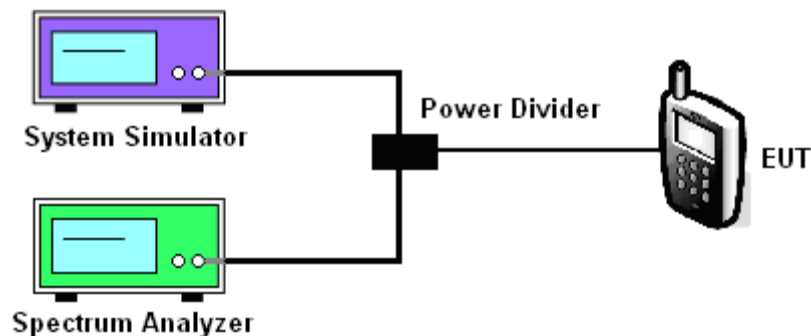

### 3.2.5 Test Result of 99% Occupied Bandwidth and 26dB Bandwidth

Please refer to Appendix A.



### 3.3 Emissions Mask Measurement

#### 3.3.1 Description of Emissions Mask Measurement

Equipment used in this licensed to EA or non-EA systems shall comply with the emission mask provisions of FCC Part 90.691.(a)

(a) Out-of-band emission requirement shall apply only to the "outer" channels included in an EA license and to spectrum adjacent to interior channels used by incumbent licensees. The emission limits are as follows:

(1) For any frequency removed from the EA licensee's frequency block by up to and including 37.5 kHz, the power of any emission shall be attenuated below the transmitter power (P) in watts by at least  $116 \text{ Log}_{10}(f/6.1)$  decibels or  $50 + 10 \text{ Log}_{10}(P)$  decibels or 80 decibels, whichever is the lesser attenuation, where f is the frequency removed from the center of the outer channel in the block in kilohertz and where f is greater than 12.5 kHz.

(2) For any frequency removed from the EA licensee's frequency block greater than 37.5 kHz, the power of any emission shall be attenuated below the transmitter power (P) in watts by at least  $43 + 10 \text{ Log}_{10}(P)$  decibels or 80 decibels, whichever is the lesser attenuation, where f is the frequency removed from the center of the outer channel in the block in kilohertz and where f is greater than 37.5 kHz.

#### 3.3.2 Measuring Instruments

The measuring equipment is listed in the section 4 of this test report.

#### 3.3.3 Test Procedures

1. The EUT was connected to spectrum analyzer and base station via power divider.
2. The emissions mask of low and high channels for the highest RF powers were measured.
3. The measured RBW and the VBW set 3 times of RBW are then set in spectrum analyzer, and the RBW correction factor  $10 \text{ log } (1\% \text{ of OBW/measured RBW})(\text{dB})$  was compensated, if required.
4. The test results were shown below plots with a correction offset factor including cable loss, insertion loss of power divider.

### 3.3.4 Test Setup

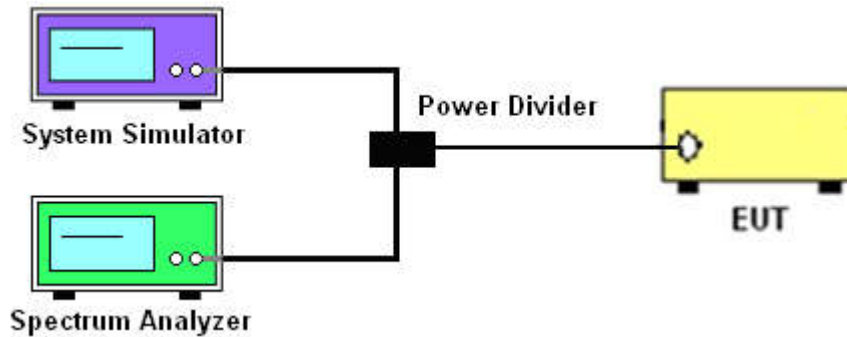

### 3.3.5 Test Result (Plots) of Conducted Emissions Mask

Please refer to Appendix A.



### 3.4 Emissions Mask – Out Of Band Emissions Measurement

#### 3.4.1 Description of Conducted Emissions Out of band emissions measurement

The power of any emission FCC Part 90.691 (a)(2) on any frequency removed from the assigned frequency by out of the authorized bandwidth at least  $43 + 10 \log (P)$  dB. It is measured by means of a calibrated spectrum analyzer and scanned from 30MHz up to a frequency including its 10<sup>th</sup> harmonic.

#### 3.4.2 Measuring Instruments

The measuring equipment is listed in the section 4 of this test report.

#### 3.4.3 Test Procedures

1. The EUT was connected to spectrum analyzer and system simulator via a power divider.
2. The RF output of EUT was connected to the spectrum analyzer by RF cable and attenuator. The path loss was compensated to the results for each measurement.
3. The middle channel for the highest RF power within the transmitting frequency was measured.
4. The conducted spurious emission for the whole frequency range was taken.
5. Make the measurement with the spectrum analyzer's RBW = 1MHz, VBW = 3MHz, taking the record of maximum spurious emission.
6. The RF fundamental frequency should be excluded against the limit line in the operating frequency band.
7. The limit line is derived from  $43 + 10\log(P)$ dB below the transmitter power P(Watts)  
= P(W)- [43 + 10log(P)] (dB)  
= [30 + 10log(P)] (dBm) - [43 + 10log(P)] (dB)  
= -13dBm.



### 3.4.4 Test Setup

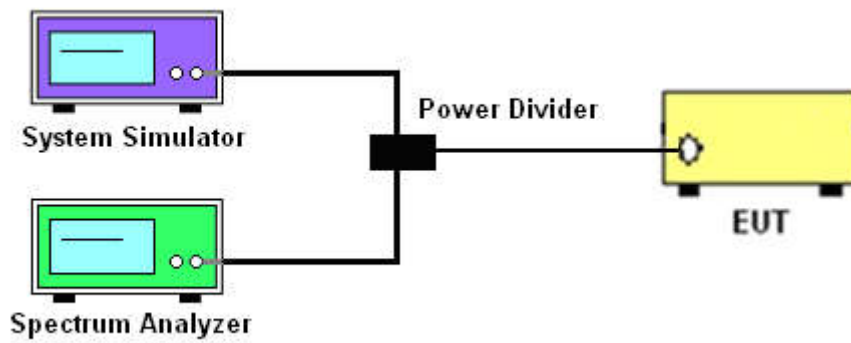

### 3.4.5 Test Result (Plots) of Conducted Emission

Please refer to Appendix A.



### 3.5 Field Strength of Spurious Radiation Measurement

#### 3.5.1 Description of Field Strength of Spurious Radiated Measurement

The radiated spurious emission was measured by substitution method according to ANSI / TIA / EIA-603-D-2010. The power of any emission FCC Part 90.691 on any frequency removed from the assigned frequency by more than 250 percent of the authorized bandwidth at least  $43 + 10 \log (P)$  dB. The spectrum is scanned from 30 MHz up to a frequency including its 10th harmonic.

The power of any emission outside of the authorized operating frequency ranges must be attenuated below the transmitter power (P) by a factor of at least  $43 + 10 \log_{10}(P[\text{Watts}])$  dB. The spectrum is scanned from 30 MHz up to a frequency including its 10th harmonic.

#### 3.5.2 Measuring Instruments

The measuring equipment is listed in the section 4 of this test report.

#### 3.5.3 Test Procedures

1. The EUT was placed on a turntable with 0.8 meter for frequency below 1GHz and 1.5 meter for frequency above 1GHz respectively above ground.
2. The EUT was set 3 meters from the receiving antenna, which was mounted on the antenna tower.
3. The table was rotated 360 degrees to determine the position of the highest spurious emission.
4. The height of the receiving antenna is varied between one meter and four meters to search the maximum spurious emission for both horizontal and vertical polarizations.
5. Make the measurement with the spectrum analyzer's RBW = 1MHz, VBW = 3MHz, Sweep = 500ms, Taking the record of maximum spurious emission.
6. A horn antenna was substituted in place of the EUT and was driven by a signal generator.
7. Tune the output power of signal generator to the same emission level with EUT maximum spurious emission.
8. Taking the record of output power at antenna port.
9. Repeat step 7 to step 8 for another polarization.
10.  $\text{EIRP (dBm)} = \text{S.G. Power} - \text{Tx Cable Loss} + \text{Tx Antenna Gain}$
11.  $\text{ERP (dBm)} = \text{EIRP} - 2.15$
12. The RF fundamental frequency should be excluded against the limit line in the operating frequency band.
13. The limit line is derived from  $43 + 10 \log(P)$  dB below the transmitter power P(Watts)  
 $= P(W) - [43 + 10 \log(P)]$  (dB)  
 $= [30 + 10 \log(P)]$  (dBm) -  $[43 + 10 \log(P)]$  (dB)  
 $= -13\text{dBm}$ .

### 3.5.4 Test Setup

For radiated test from 30MHz to 1GHz

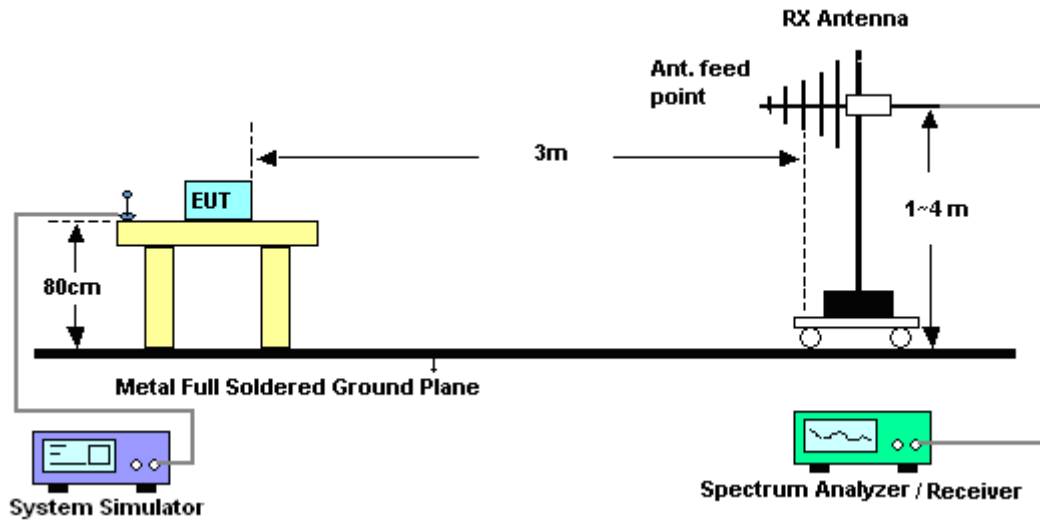

For radiated test above 1GHz

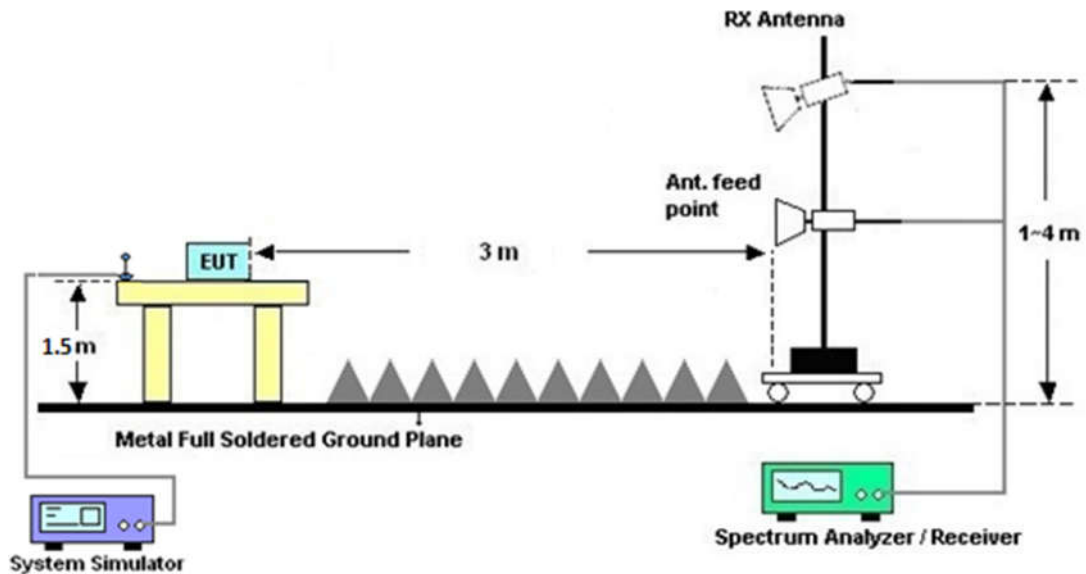

### 3.5.5 Test Result of Field Strength of Spurious Radiated

Please refer to Appendix B.



## **3.6 Frequency Stability Measurement**

### **3.6.1 Description of Frequency Stability Measurement**

The frequency stability shall be measured by variation of ambient temperature and variation of primary supply voltage to ensure that the fundamental emission stays within the authorized frequency block. The frequency stability of the transmitter shall be maintained within  $\pm 0.00025\%$  ( $\pm 2.5\text{ppm}$ ) of the center frequency according to FCC Part 90.213.

### **3.6.2 Measuring Instruments**

The measuring equipment is listed in the section 4 of this test report.

### **3.6.3 Test Procedures for Temperature Variation**

1. The EUT was set up in the thermal chamber and connected with the base station.
2. With power OFF, the temperature was decreased to  $-30^{\circ}\text{C}$  and the EUT was stabilized for three hours. Power was applied and the maximum change in frequency was recorded within one minute.
3. With power OFF, the temperature was raised in  $10^{\circ}\text{C}$  step up to  $50^{\circ}\text{C}$ . The EUT was stabilized at each step for at least half an hour. Power was applied and the maximum frequency change was recorded within one minute.

### **3.6.4 Test Procedures for Voltage Variation**

1. The EUT was placed in a temperature chamber at  $20\pm 5^{\circ}\text{C}$  and connected with the base station.
2. The power supply voltage to the EUT was varied from BEP to 115% of the nominal value measured at the input to the EUT.
3. The variation in frequency was measured for the worst case.

### 3.6.5 Test Setup

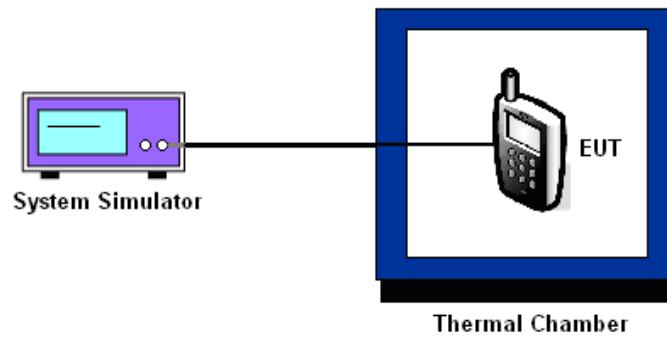

### 3.6.6 Test Result of Temperature Variation

Please refer to Appendix A.



## 4 List of Measuring Equipment

Instrument	Manufacturer	Model No.	Serial No.	Characteristics	Calibration Date	Test Date	Due Date	Remark
Spectrum Analyzer	R&S	FSV40	101040	10Hz~40GHz	Aug. 09, 2016	Jun. 02, 2017~ Jun. 14, 2017	Aug. 08, 2017	Conducted (TH01-KS)
Thermal Chamber	Ten Billion	TTC-B3S	TBN-960502	-40~+150°C	Oct. 13, 2016	Jun. 02, 2017~ Jun. 14, 2017	Oct. 12, 2017	Conducted (TH01-KS)
EXA Spectrum Analyzer	Keysight	N9010A	MY55150244	10Hz~44GHz	Apr. 18, 2017	Jun. 09, 2017	Apr. 17, 2018	Radiation (03CH03-KS)
Bilog Antenna	TeseQ	CBL6112D	35406	25MHz~2GHz	Apr. 22, 2017	Jun. 09, 2017	Apr. 21, 2018	Radiation (03CH03-KS)
Horn Antenna	Schwarzbeck	BBHA9120D	9120D-1356	1GHz~18GHz	Apr. 22, 2017	Jun. 09, 2017	Apr. 21, 2018	Radiation (03CH03-KS)
Amplifier	SONOMA	310N	187289	9kHz~1GHz	Aug. 09, 2016	Jun. 09, 2017	Aug. 08, 2017	Radiation (03CH03-KS)
Amplifier	Agilent	8449B	3008A02370	1GHz~26.5GHz	Oct. 13, 2016	Jun. 09, 2017	Oct. 12, 2017	Radiation (03CH03-KS)
AC Power Source	Chroma	61601	F104090004	N/A	NCR	Jun. 09, 2017	NCR	Radiation (03CH03-KS)
Turn Table	ChamPro	EM 1000-T	060762-T	0~360 degree	NCR	Jun. 09, 2017	NCR	Radiation (03CH03-KS)
Antenna Mast	ChamPro	EM 1000-A	060762-A	1 m~4 m	NCR	Jun. 09, 2017	NCR	Radiation (03CH03-KS)

NCR: No Calibration Required



## 5 Uncertainty of Evaluation

### Uncertainty of Radiated Emission Measurement (30 MHz ~ 1000 MHz)

Measuring Uncertainty for a Level of Confidence of 95% ( $U = 2Uc(y)$ )	2.8dB
---	-------

### Uncertainty of Radiated Emission Measurement (1 GHz ~ 18 GHz)

Measuring Uncertainty for a Level of Confidence of 95% ( $U = 2Uc(y)$ )	3.3dB
---	-------



### Appendix A. Test Results of Conducted Test

#### Conducted Output Power (Average power)

LTE Band 26 Maximum Average Power [dBm]						
BW [MHz]	RB Size	RB Offset	Mod	Lowest	Middle	Highest
15	1	0	QPSK	22.44	-	-
15	1	37		22.96		
15	1	74		22.49		
15	36	0		21.84		
15	36	20		21.78		
15	36	39		21.84		
15	75	0		21.85		
15	1	0	16-QAM	21.38		
15	1	37		21.98		
15	1	74		21.58		
15	36	0		20.78		
15	36	20		20.78		
15	36	39		20.78		
15	75	0		20.99		





LTE Band 26 Maximum Average Power [dBm]						
BW [MHz]	RB Size	RB Offset	Mod	Lowest	Middle	Highest
10	1	0	QPSK		22.57	
10	1	25			22.73	
10	1	49			22.63	
10	25	0			21.77	
10	25	12			21.95	
10	25	25			21.91	
10	50	0			21.75	
10	1	0	16-QAM		21.51	
10	1	25			21.52	
10	1	49			21.44	
10	25	0			20.91	
10	25	12			20.97	
10	25	25			20.88	
10	50	0			20.97	
5	1	0	QPSK	22.34	22.53	22.67
5	1	12		22.93	23.00	22.94
5	1	24		22.82	22.51	22.50
5	12	0		21.82	21.83	21.84
5	12	7		21.95	22.06	21.99
5	12	13		21.83	21.96	21.94
5	25	0		21.72	21.89	21.85
5	1	0	16-QAM	21.67	21.31	21.91
5	1	12		22.09	21.52	22.21
5	1	24		21.29	21.23	21.66
5	12	0		20.73	20.75	20.63
5	12	7		20.78	20.87	20.70
5	12	13		20.87	20.88	20.73
5	25	0		20.74	20.89	20.78



LTE Band 26 Maximum Average Power [dBm]						
BW [MHz]	RB Size	RB Offset	Mod	Lowest	Middle	Highest
3	1	0	QPSK	22.69	22.65	22.70
3	1	8		22.80	22.79	23.01
3	1	14		22.81	22.77	22.99
3	8	0		21.82	22.00	21.97
3	8	4		21.86	21.93	21.91
3	8	7		21.86	21.96	21.96
3	15	0		21.78	21.87	21.94
3	1	0	16-QAM	21.55	21.28	21.92
3	1	8		21.41	21.47	22.20
3	1	14		21.32	21.91	21.45
3	8	0		20.75	20.97	21.03
3	8	4		20.76	20.90	20.99
3	8	7		20.83	20.92	21.02
3	15	0		20.62	20.90	21.01
1.4	1	0	QPSK	22.49	22.80	22.78
1.4	1	3		22.62	22.86	22.93
1.4	1	5		22.71	22.77	22.89
1.4	3	0		22.82	22.91	23.02
1.4	3	1		22.82	23.05	23.03
1.4	3	3		22.79	22.85	23.11
1.4	6	0		21.79	21.85	21.90
1.4	1	0	16-QAM	21.97	21.94	22.17
1.4	1	3		21.98	22.12	22.20
1.4	1	5		21.95	22.03	22.21
1.4	3	0		21.64	22.06	21.90
1.4	3	1		21.72	22.12	21.92
1.4	3	3		21.65	21.72	22.13
1.4	6	0		20.83	20.83	20.95



**26dB Bandwidth**

Mode	LTE Band 26 : 26dB BW(MHz)											
	1.4MHz		3MHz		5MHz		10MHz		15MHz		20MHz	
BW												
Mod.	QPSK	16QAM	QPSK	16QAM	QPSK	16QAM	QPSK	16QAM	QPSK	16QAM	QPSK	16QAM
Lowest CH	1.28	1.28	3.02	2.99	4.97	4.92	-	-	14.45	14.36	-	-
Middle CH	1.27	1.27	3.01	2.99	4.89	5.05	9.73	9.61	-	-	-	-
Highest CH	1.28	1.28	2.99	2.97	4.97	4.95	-	-	-	-	-	-



LTE Band 26

Lowest Channel / 1.4MHz / QPSK

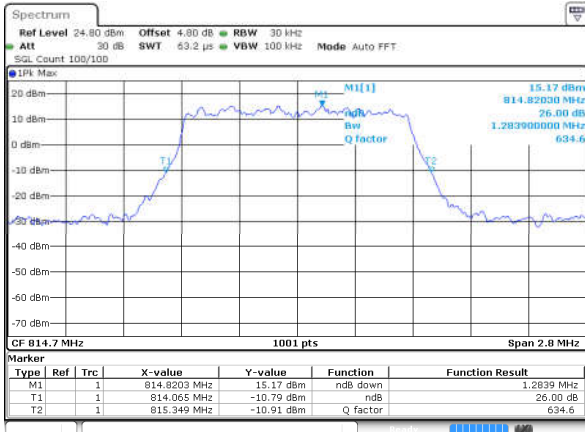

Date: 2 JUN 2017 20:30:33

Lowest Channel / 1.4MHz / 16QAM

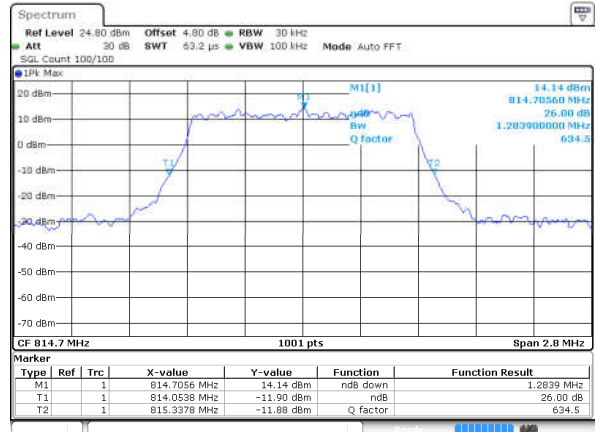

Date: 2 JUN 2017 20:31:01

Middle Channel / 1.4MHz / QPSK

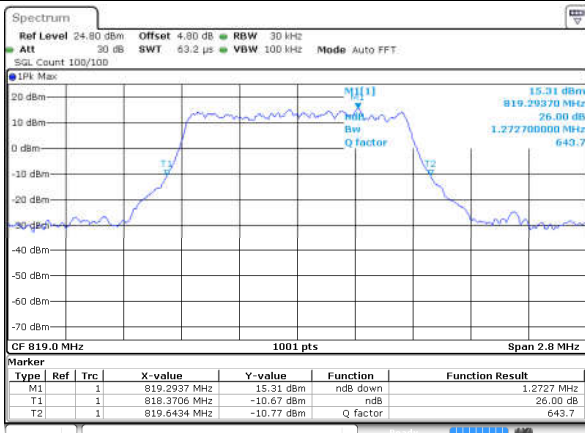

Date: 2 JUN 2017 20:33:20

Middle Channel / 1.4MHz / 16QAM

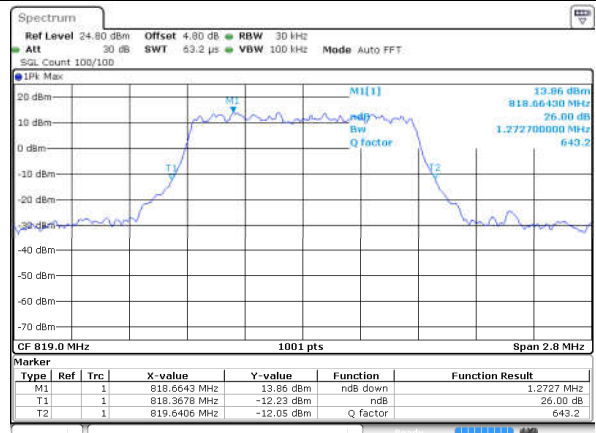

Date: 2 JUN 2017 20:32:53

Highest Channel / 1.4MHz / QPSK

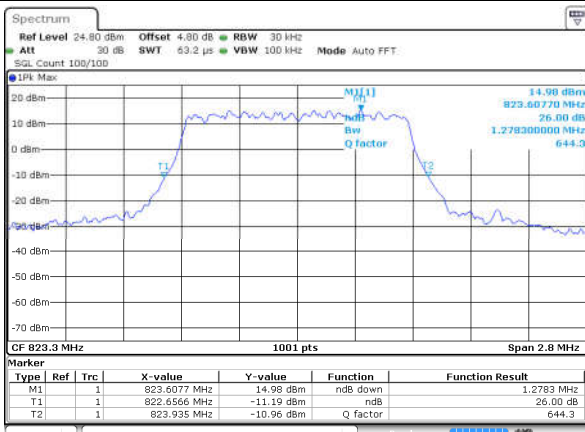

Date: 2 JUN 2017 20:33:56

Highest Channel / 1.4MHz / 16QAM

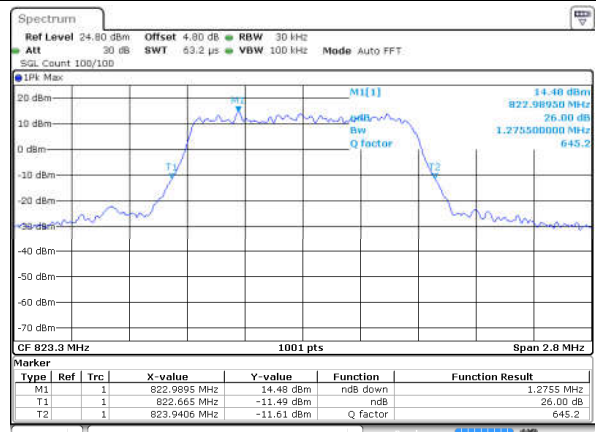

Date: 2 JUN 2017 20:34:29



LTE Band 26

Lowest Channel / 3MHz / QPSK

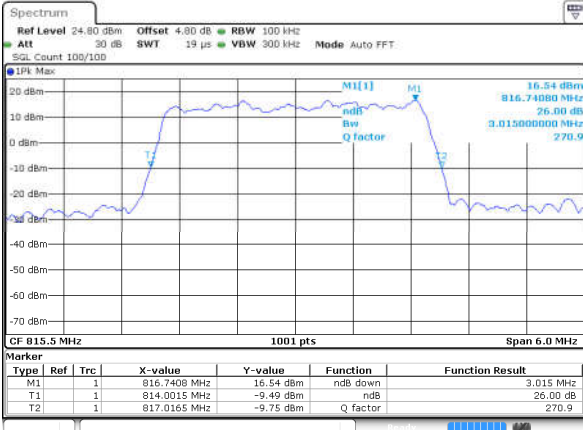

Date: 2 JUN 2017 20:40:47

Lowest Channel / 3MHz / 16QAM

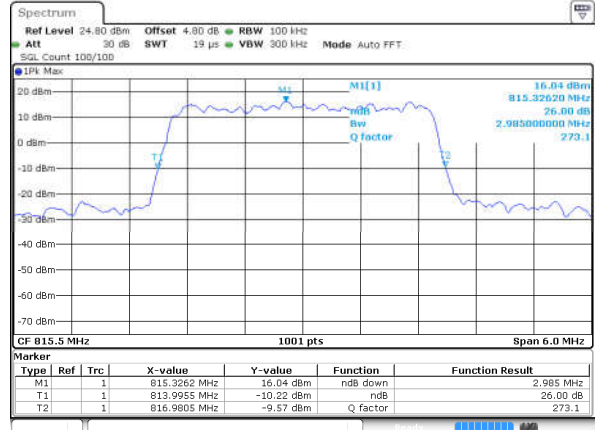

Date: 2 JUN 2017 20:41:20

Middle Channel / 3MHz / QPSK

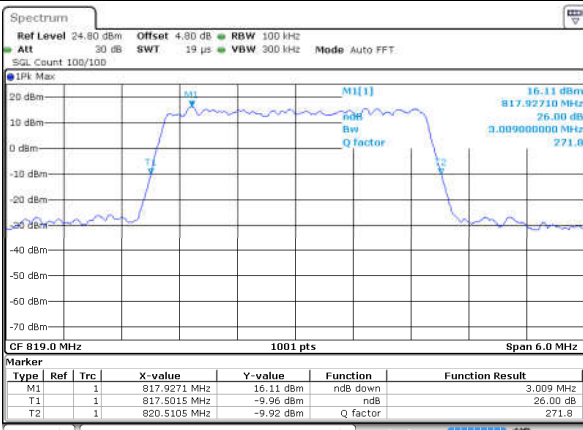

Date: 2 JUN 2017 20:44:14

Middle Channel / 3MHz / 16QAM

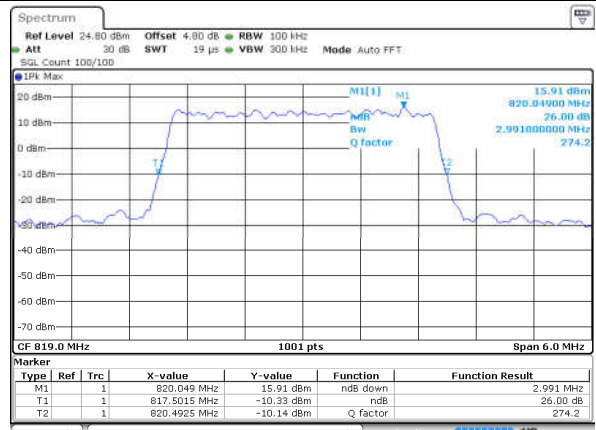

Date: 2 JUN 2017 20:43:08

Highest Channel / 3MHz / QPSK

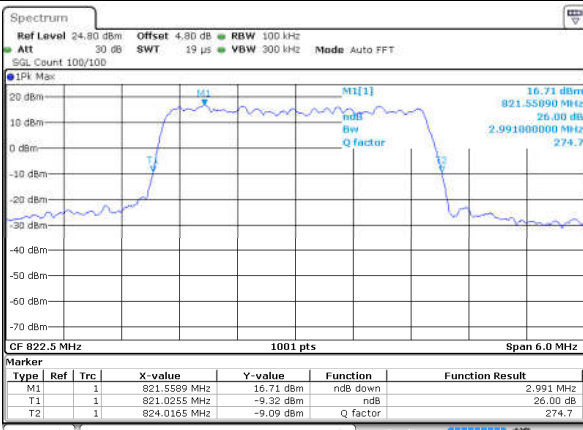

Date: 2 JUN 2017 20:45:00

Highest Channel / 3MHz / 16QAM

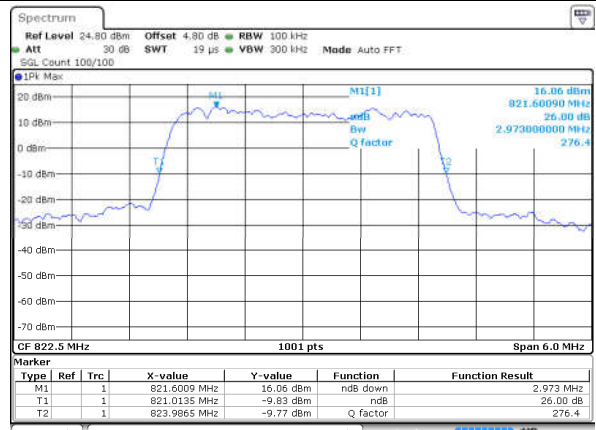

Date: 2 JUN 2017 20:45:38



LTE Band 26

Lowest Channel / 5MHz / QPSK

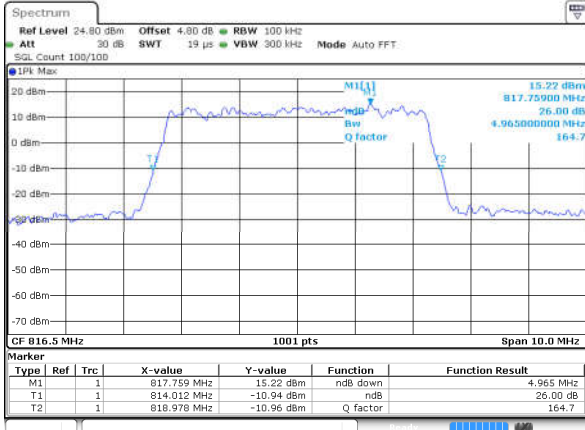

Date: 2 JUN 2017 20:53:07

Lowest Channel / 5MHz / 16QAM

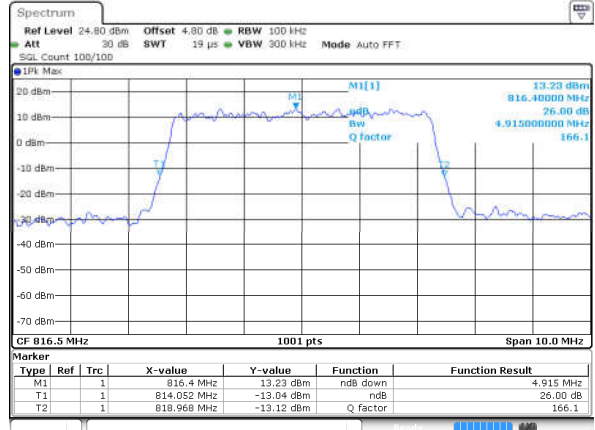

Date: 2 JUN 2017 20:53:38

Middle Channel / 5MHz / QPSK

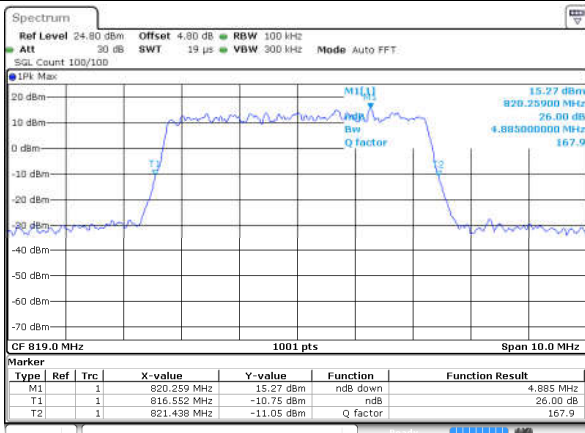

Date: 2 JUN 2017 20:55:50

Middle Channel / 5MHz / 16QAM

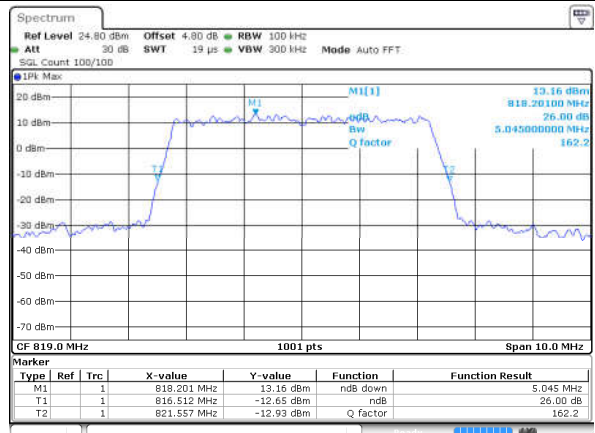

Date: 2 JUN 2017 20:55:04

Highest Channel / 5MHz / QPSK

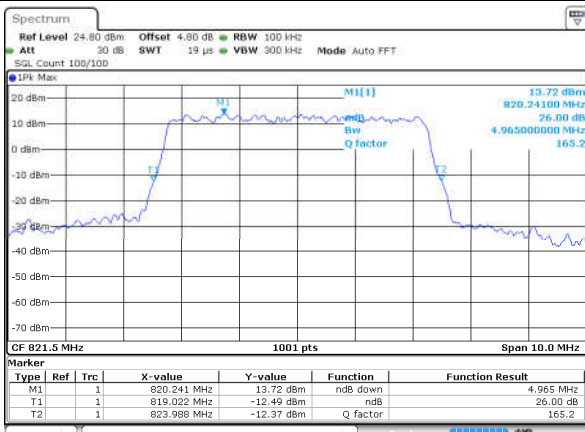

Date: 2 JUN 2017 20:56:26

Highest Channel / 5MHz / 16QAM

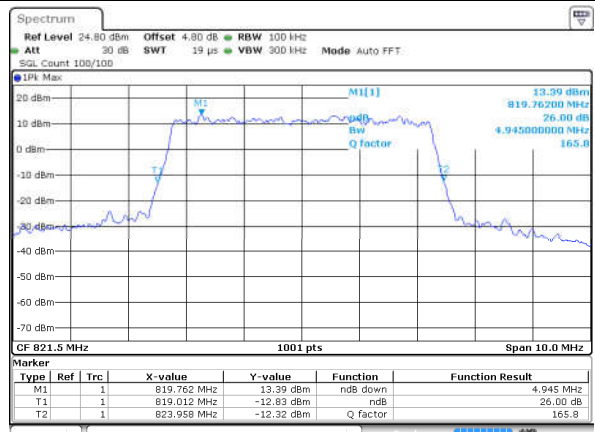

Date: 2 JUN 2017 20:57:43



LTE Band 26

Middle Channel / 10MHz / QPSK

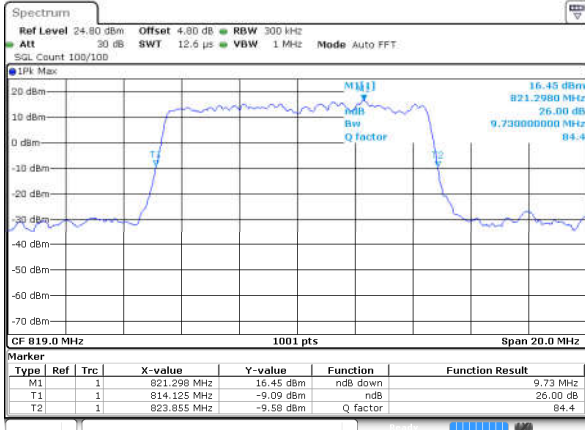

Date: 2 JUN 2017 21:04:58

Middle Channel / 10MHz / 16QAM

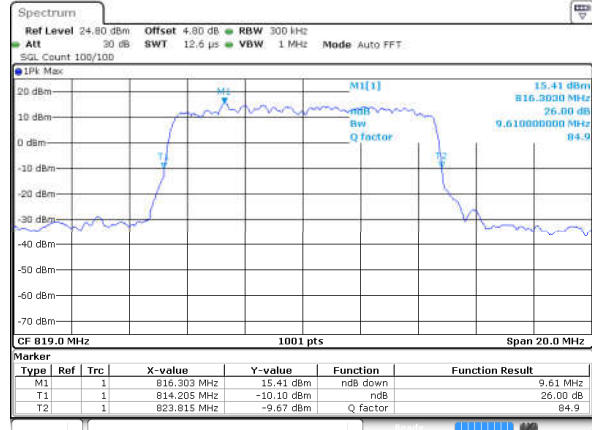

Date: 2 JUN 2017 21:05:51

Lowest Channel / 15MHz / QPSK

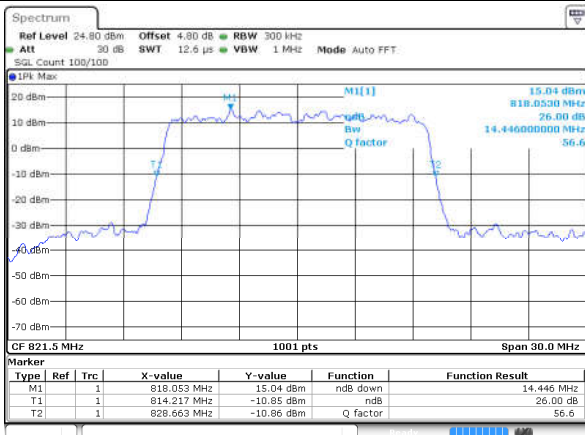

Date: 2 JUN 2017 21:10:29

Lowest Channel / 15MHz / 16QAM

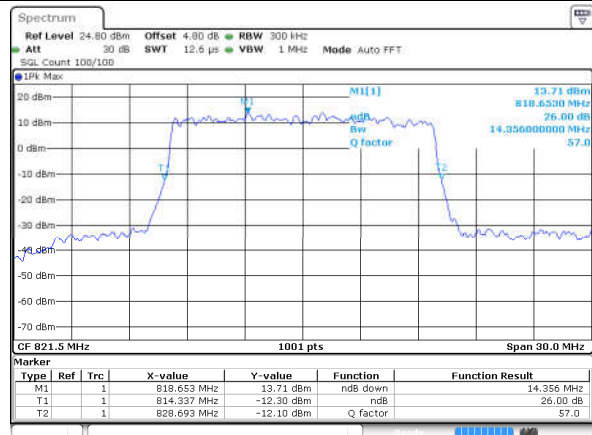

Date: 2 JUN 2017 21:09:48



## Occupied Bandwidth

Mode	LTE Band 26 : 99%OBW(MHz)											
	1.4MHz		3MHz		5MHz		10MHz		15MHz		20MHz	
BW	QPSK	16QAM	QPSK	16QAM	QPSK	16QAM	QPSK	16QAM	QPSK	16QAM	QPSK	16QAM
Lowest CH	1.09	1.09	2.70	2.71	4.50	4.49	-	-	13.34	13.37	-	-
Middle CH	1.09	1.09	2.72	2.71	4.48	4.49	8.97	8.95	-	-	-	-
Highest CH	1.09	1.09	2.71	2.72	4.51	4.49	-	-	-	-	-	-





LTE Band 26

Lowest Channel / 1.4MHz / QPSK

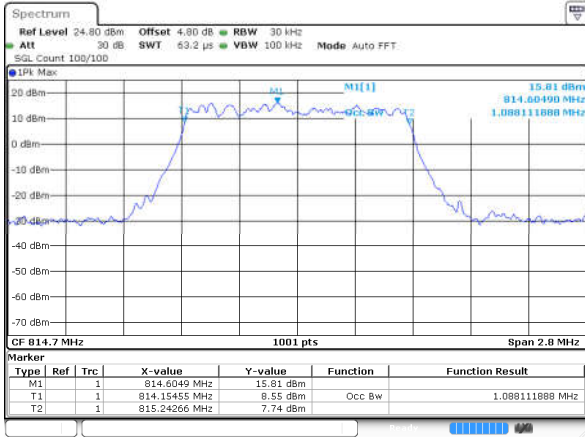

Date: 2 JUN 2017 20:29:59

Lowest Channel / 1.4MHz / 16QAM

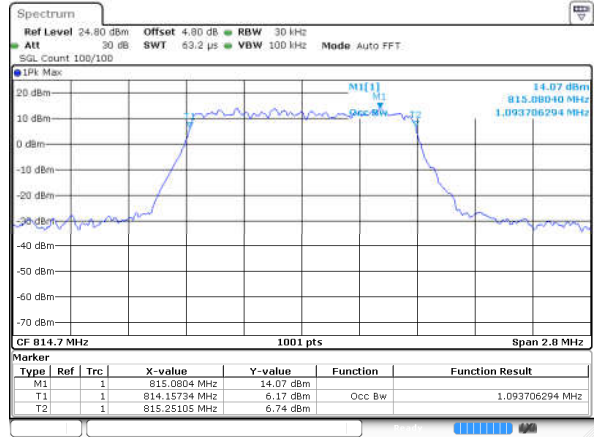

Date: 2 JUN 2017 20:31:41

Middle Channel / 1.4MHz / QPSK

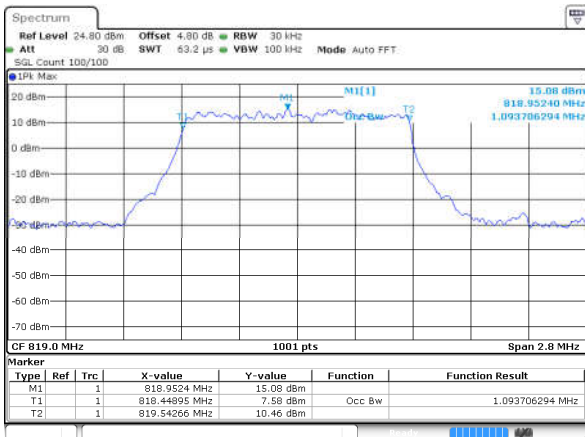

Date: 2 JUN 2017 20:33:07

Middle Channel / 1.4MHz / 16QAM

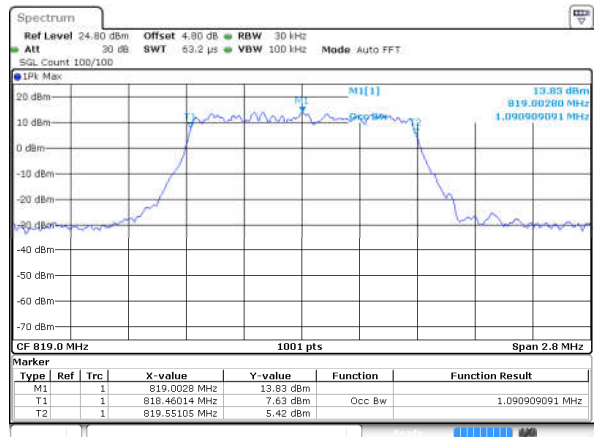

Date: 2 JUN 2017 20:32:42

Highest Channel / 1.4MHz / QPSK

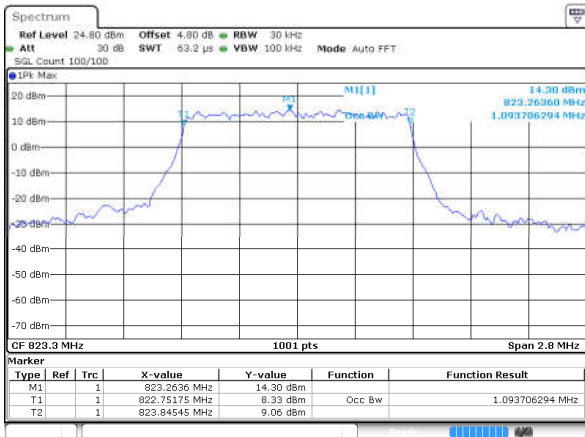

Date: 2 JUN 2017 20:34:08

Highest Channel / 1.4MHz / 16QAM

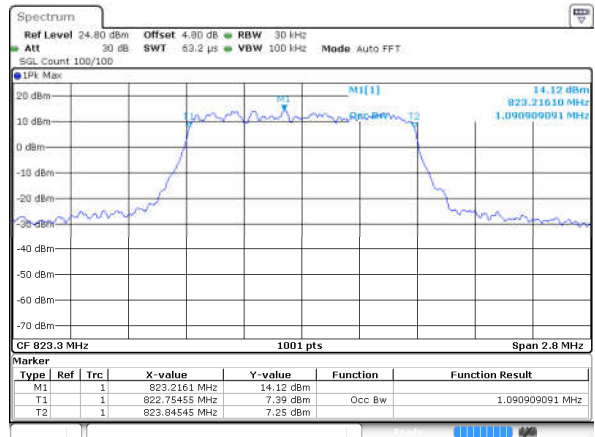

Date: 2 JUN 2017 20:34:51



LTE Band 26

Lowest Channel / 3MHz / QPSK

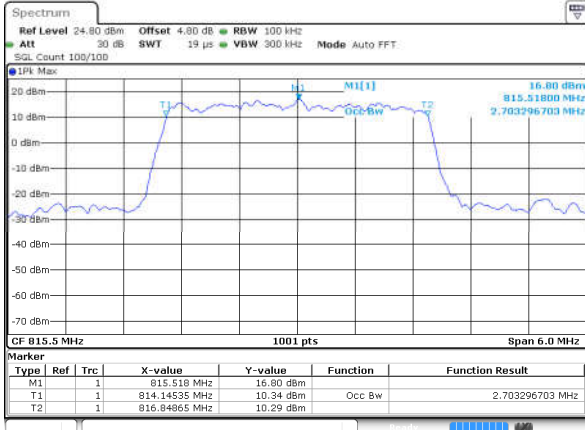

Date: 2 JUN 2017 20:40:37

Lowest Channel / 3MHz / 16QAM

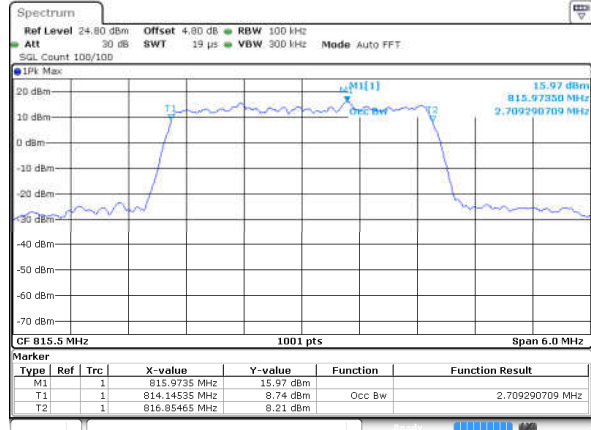

Date: 2 JUN 2017 20:41:04

Middle Channel / 3MHz / QPSK

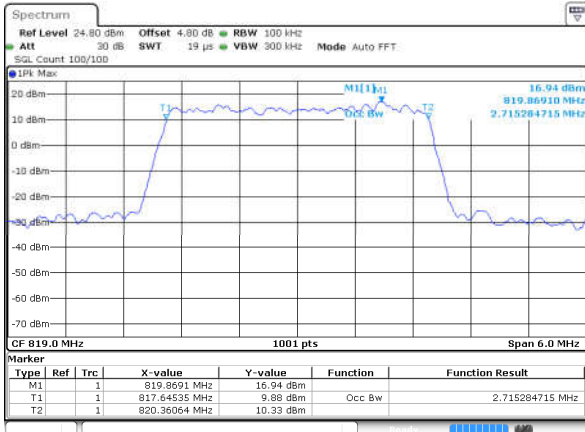

Date: 2 JUN 2017 20:44:04

Middle Channel / 3MHz / 16QAM

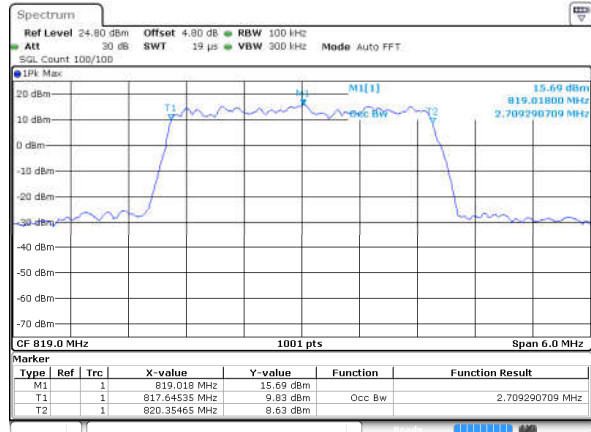

Date: 2 JUN 2017 20:42:27

Highest Channel / 3MHz / QPSK

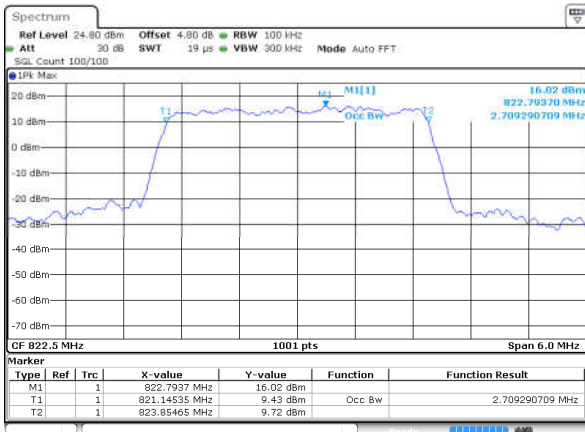

Date: 2 JUN 2017 20:44:26

Highest Channel / 3MHz / 16QAM

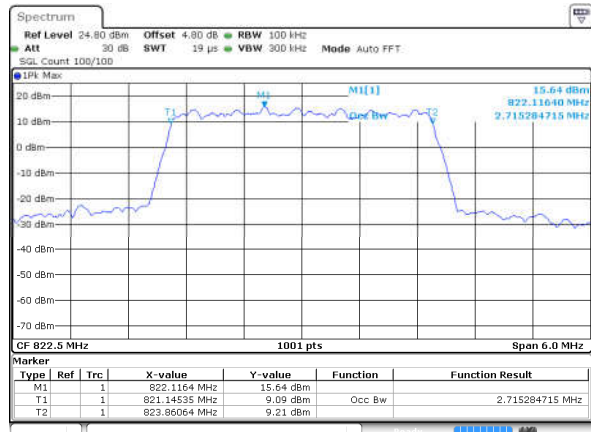

Date: 2 JUN 2017 20:45:21



LTE Band 26

Lowest Channel / 5MHz / QPSK

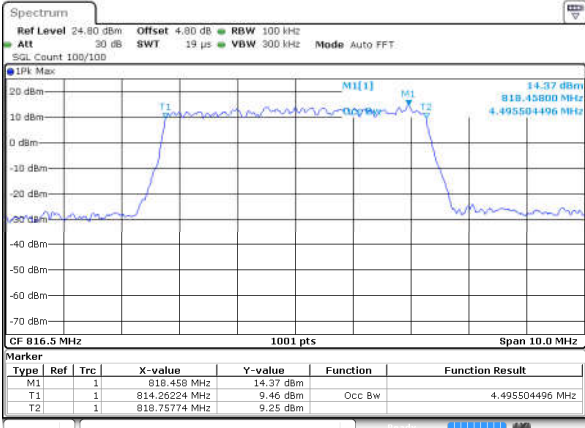

Date: 2 JUN 2017 20:51:46

Lowest Channel / 5MHz / 16QAM

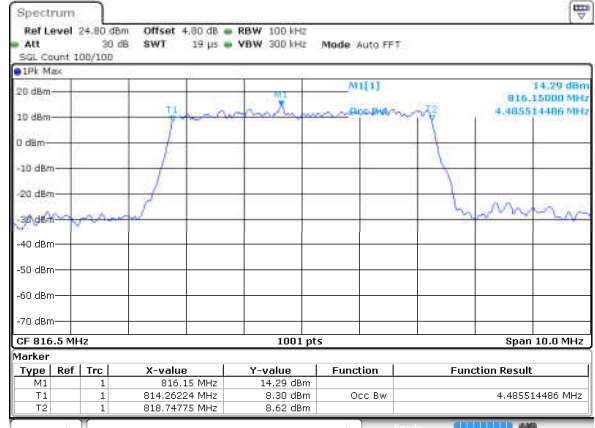

Date: 2 JUN 2017 20:52:29

Middle Channel / 5MHz / QPSK

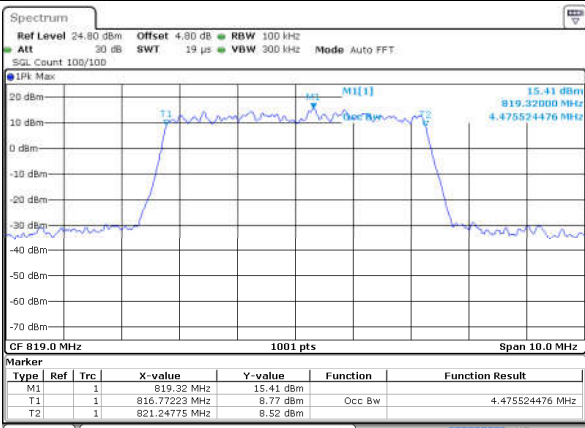

Date: 2 JUN 2017 20:55:25

Middle Channel / 5MHz / 16QAM

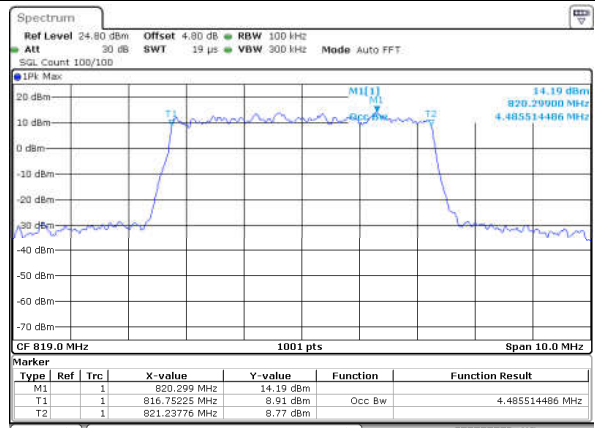

Date: 2 JUN 2017 20:54:22

Highest Channel / 5MHz / QPSK

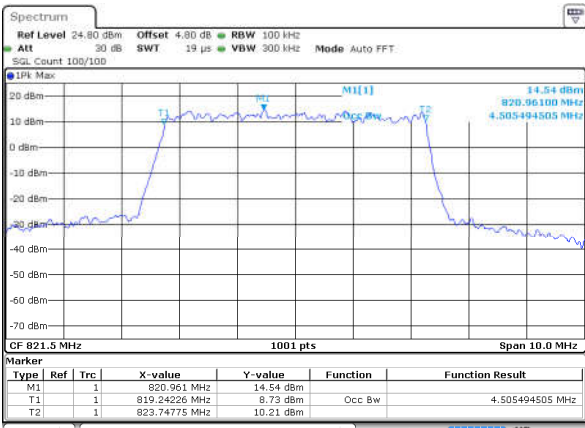

Date: 2 JUN 2017 20:56:06

Highest Channel / 5MHz / 16QAM

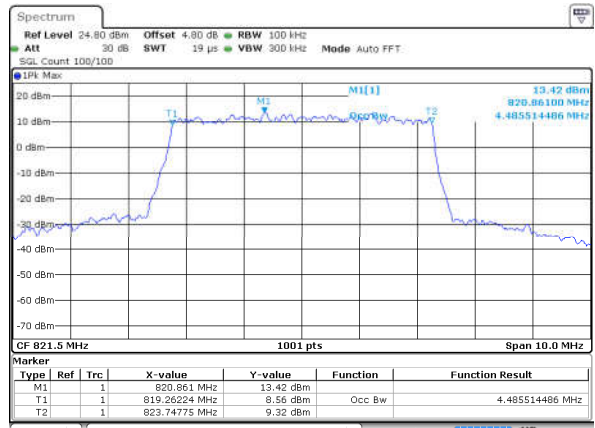

Date: 2 JUN 2017 20:57:12



LTE Band 26

Middle Channel / 10MHz / QPSK

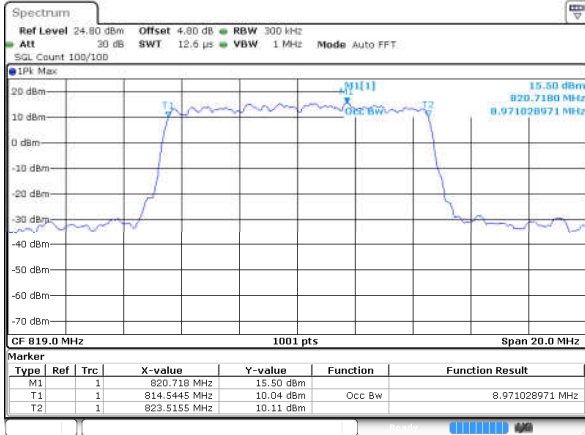

Date: 2 JUN 2017 21:04:46

Middle Channel / 10MHz / 16QAM

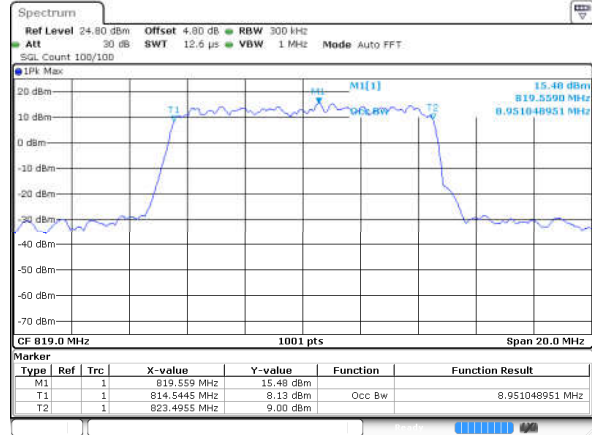

Date: 2 JUN 2017 21:05:11

LTE Band 26

Lowest Channel / 15MHz / QPSK

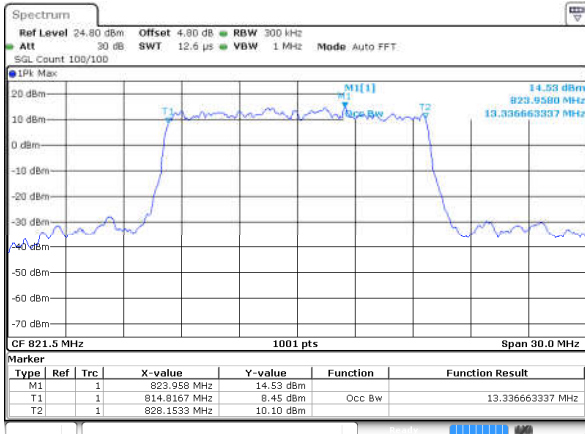

Date: 2 JUN 2017 21:10:15

Lowest Channel / 15MHz / 16QAM

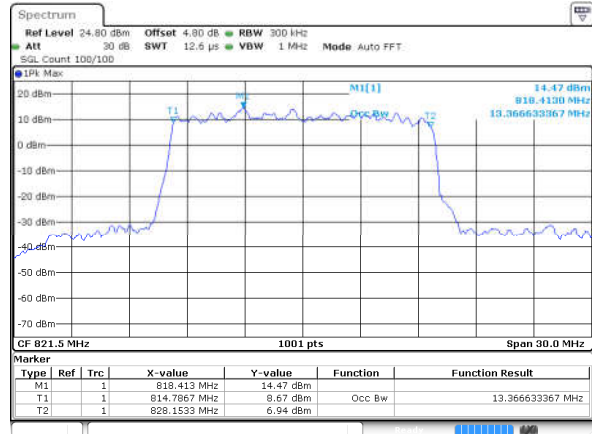

Date: 2 JUN 2017 21:09:31



# Conducted Band Edge

## LTE Band 26 / 1.4MHz / QPSK

### Lowest Band Edge / 1RB

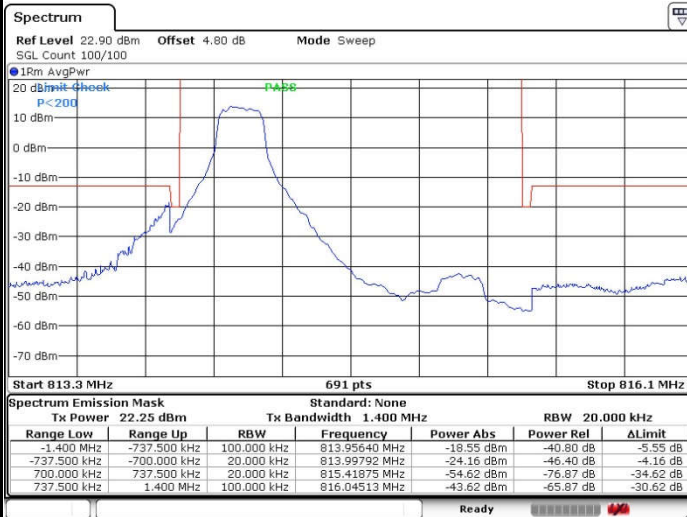

### Highest Band Edge / 1RB

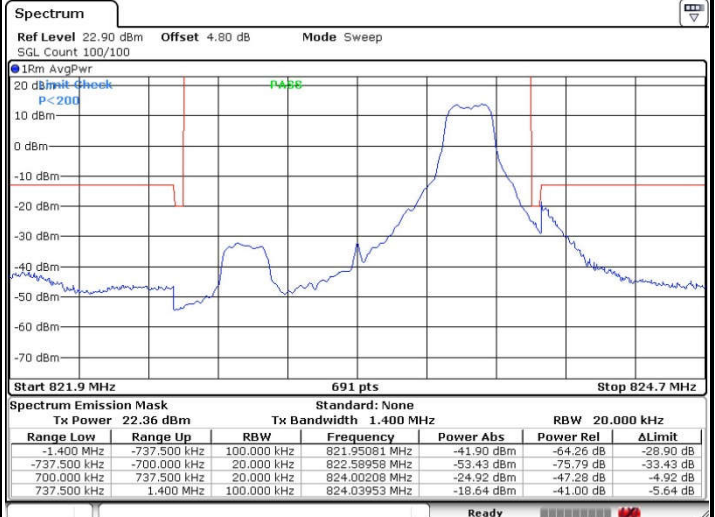

### Lowest Band Edge / Full RB

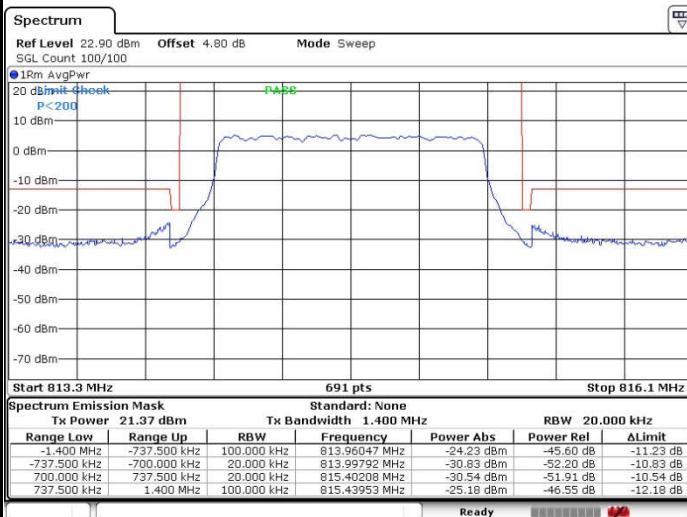

### Highest Band Edge / Full RB

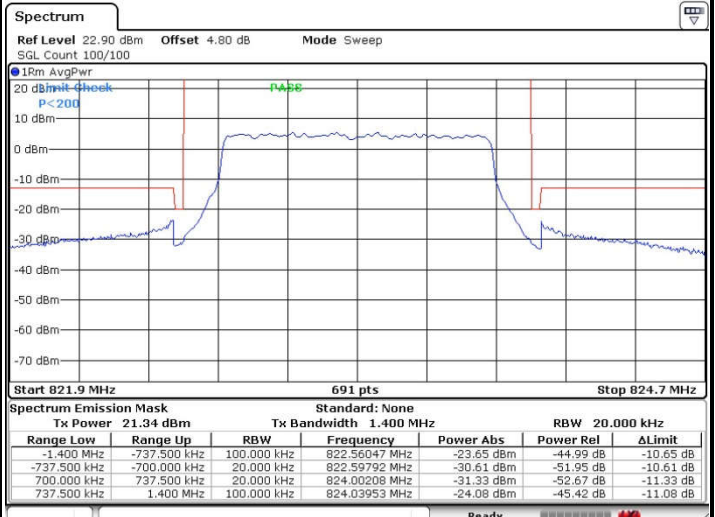





LTE Band 26 / 1.4MHz / 16QAM

Lowest Band Edge / 1 RB

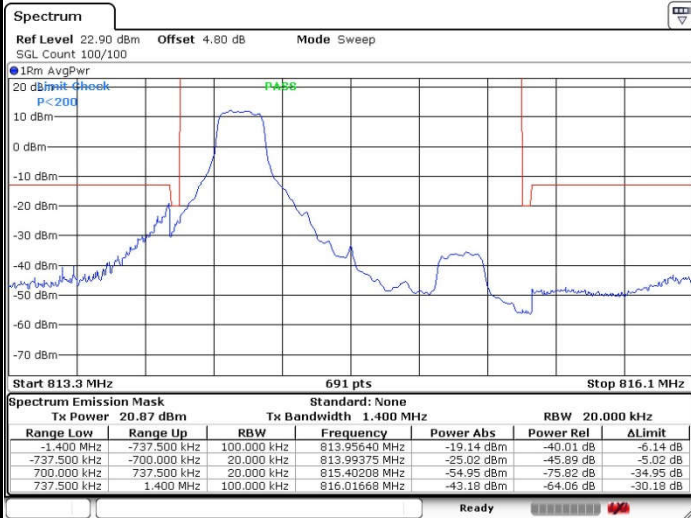

Date: 2 JUN 2017 21:23:18

Highest Band Edge / 1 RB

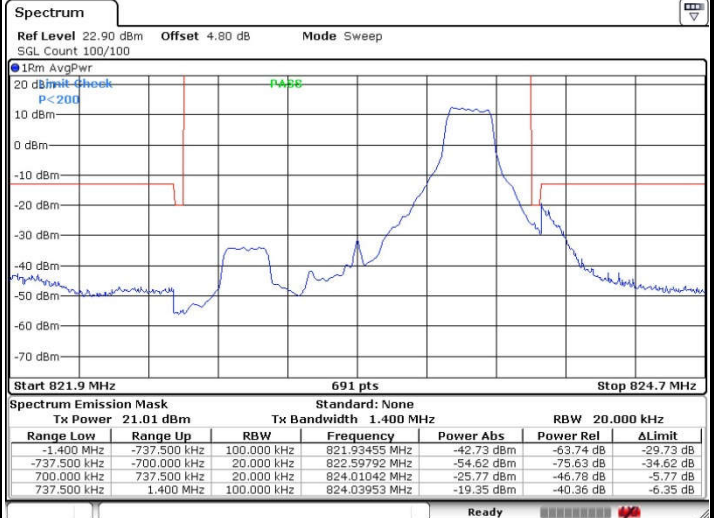

Date: 2 JUN 2017 22:09:16

Lowest Band Edge / Full RB

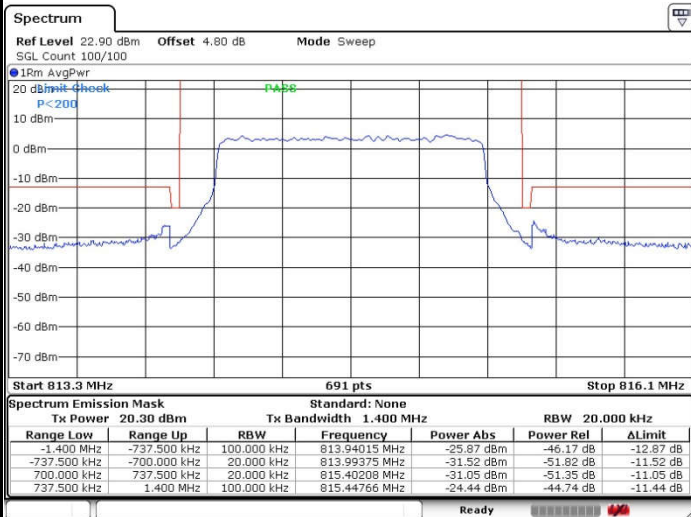

Date: 2 JUN 2017 21:23:33

Highest Band Edge / Full RB

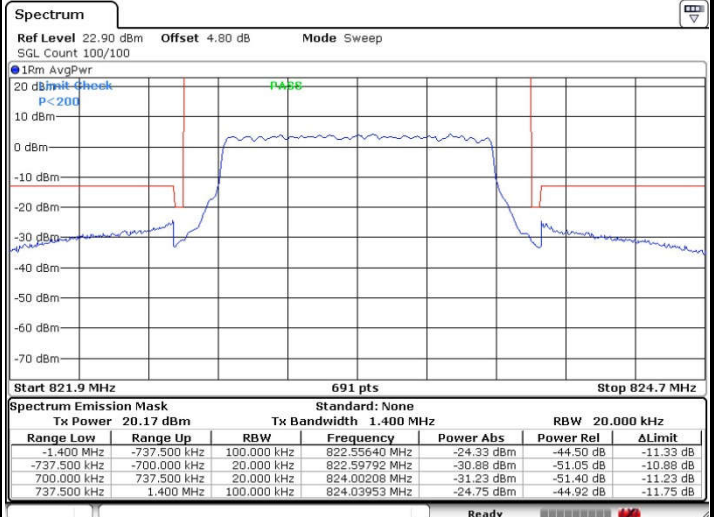

Date: 2 JUN 2017 21:21:01



LTE Band 26 / 3MHz / QPSK

Lowest Band Edge / 1RB

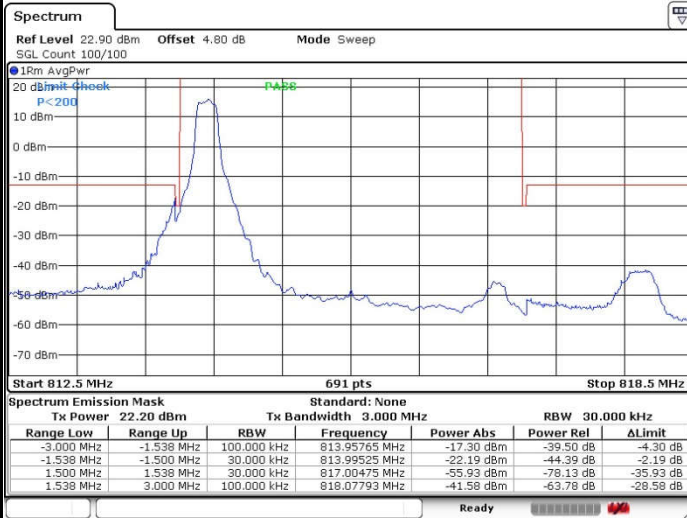

Date: 2 JUN 2017 21:26:31

Highest Band Edge / 1 RB

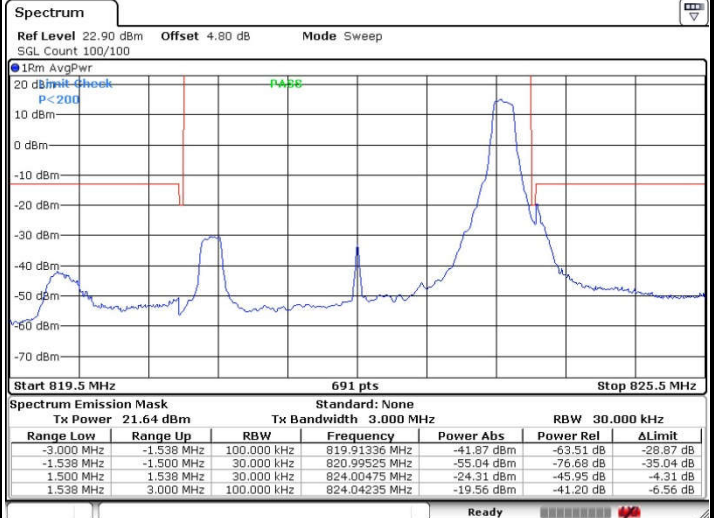

Date: 2 JUN 2017 21:30:21

Lowest Band Edge / Full RB

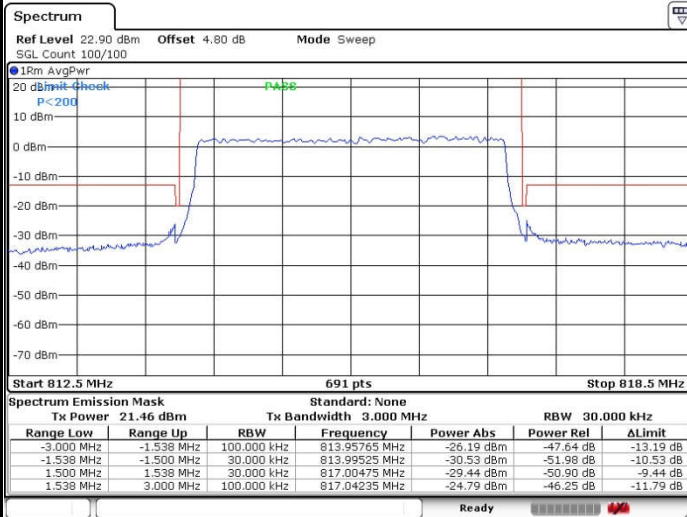

Date: 2 JUN 2017 21:28:07

Highest Band Edge / Full RB

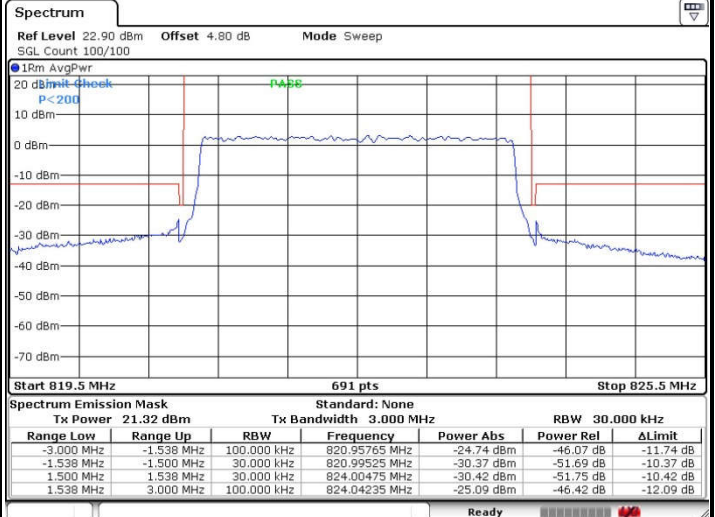

Date: 2 JUN 2017 21:28:56



LTE Band 26 / 3MHz / 16QAM

Lowest Band Edge / 1 RB

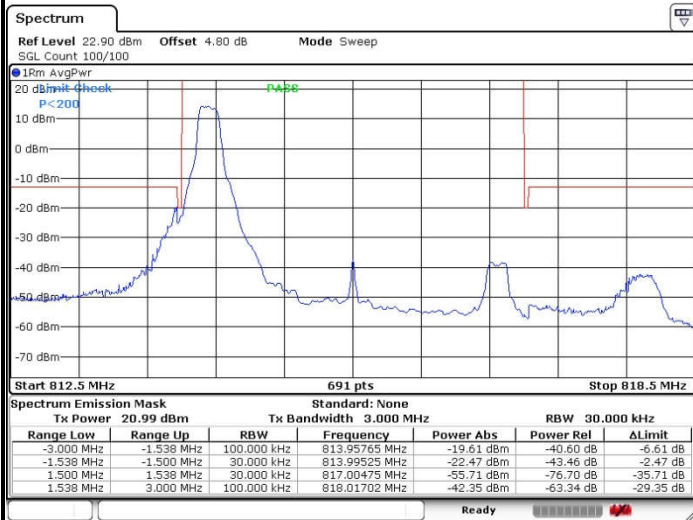

Date: 2 JUN 2017 21:27:20

Highest Band Edge / 1 RB

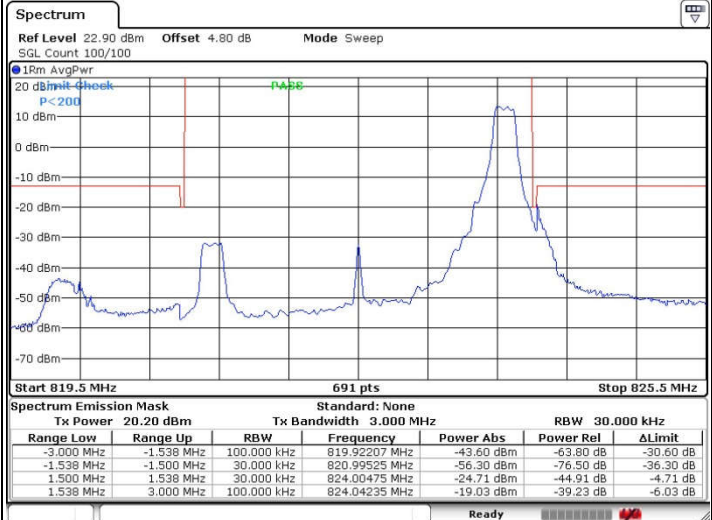

Date: 2 JUN 2017 21:30:01

Lowest Band Edge / Full RB

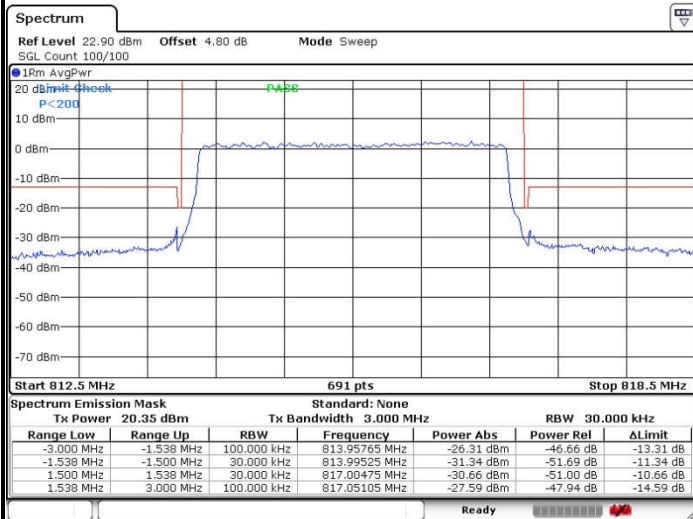

Date: 2 JUN 2017 21:27:48

Highest Band Edge / Full RB

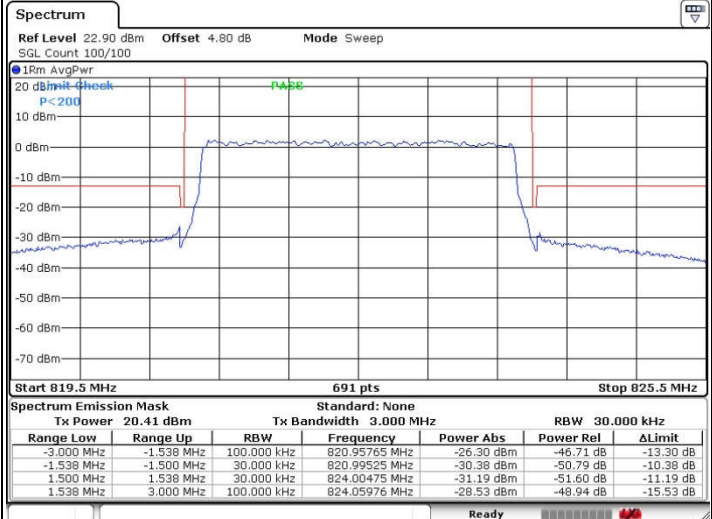

Date: 2 JUN 2017 21:29:20





LTE Band 26 / 5MHz / QPSK

Lowest Band Edge / 1 RB

Highest Band Edge / 1 RB

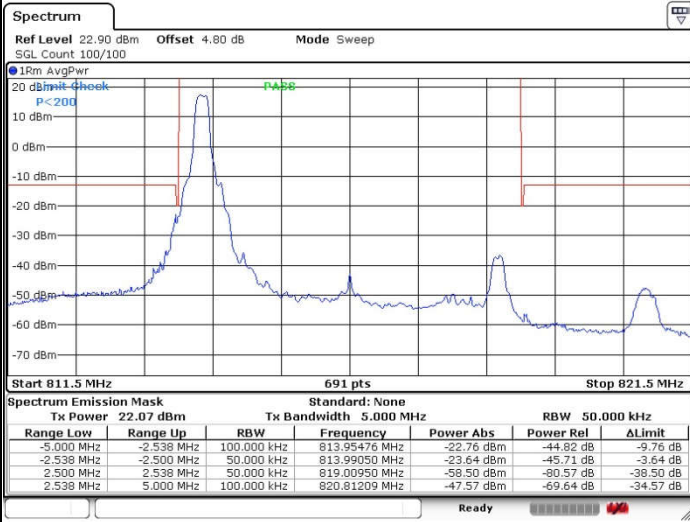

Date: 2 JUN 2017 21:57:00

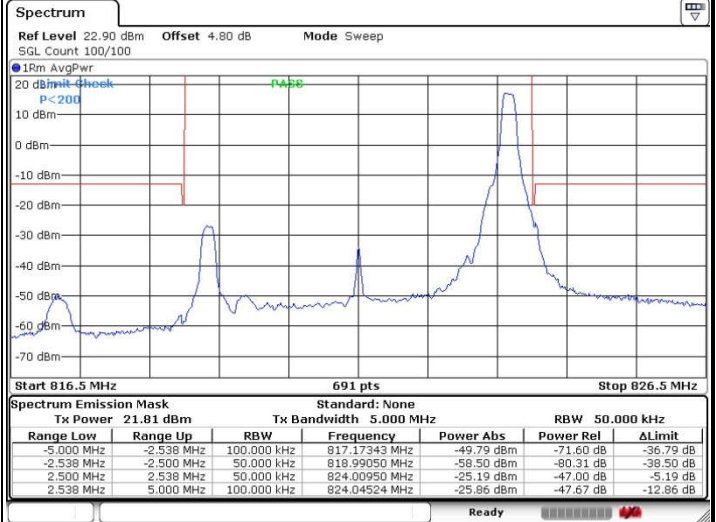

Date: 2 JUN 2017 22:00:15

Lowest Band Edge / Full RB

Highest Band Edge / Full RB

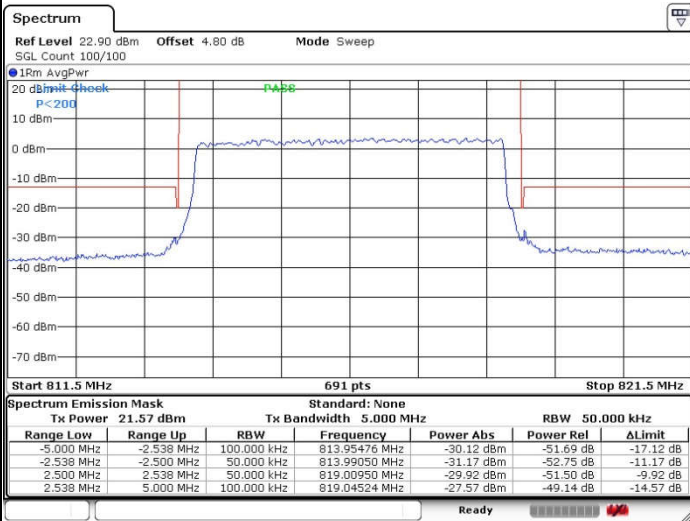

Date: 2 JUN 2017 21:58:13

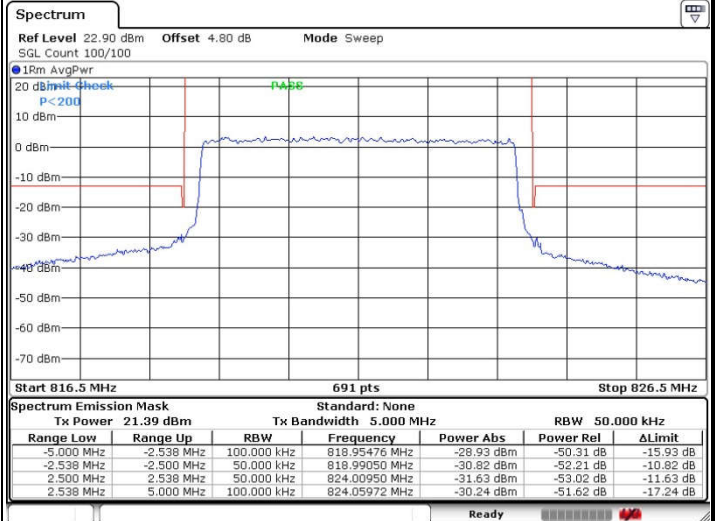

Date: 2 JUN 2017 21:59:12



LTE Band 26 / 5MHz / 16QAM

Lowest Band Edge / 1RB

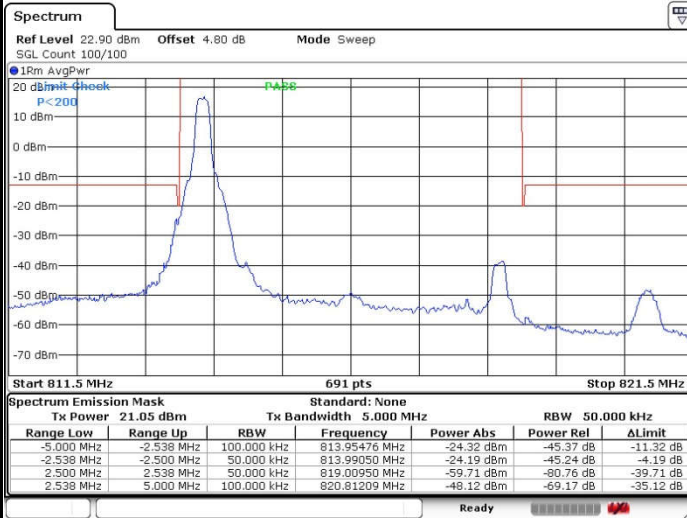

Date: 2 JUN 2017 21:57:24

Highest Band Edge / 1 RB

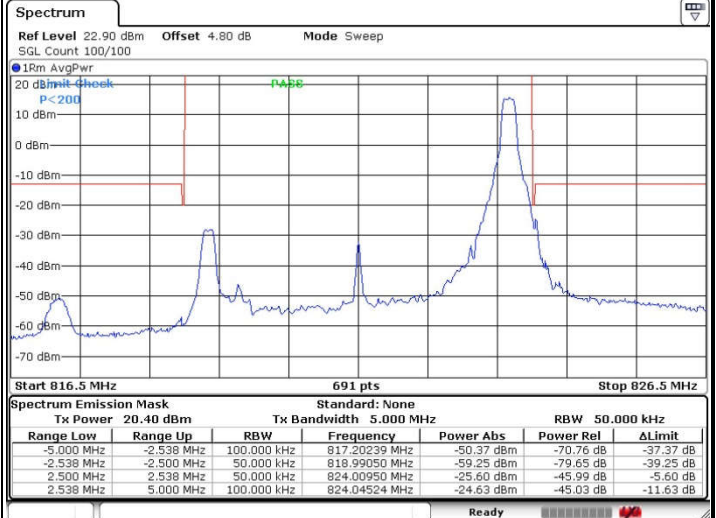

Date: 2 JUN 2017 21:59:54

Lowest Band Edge / Full RB

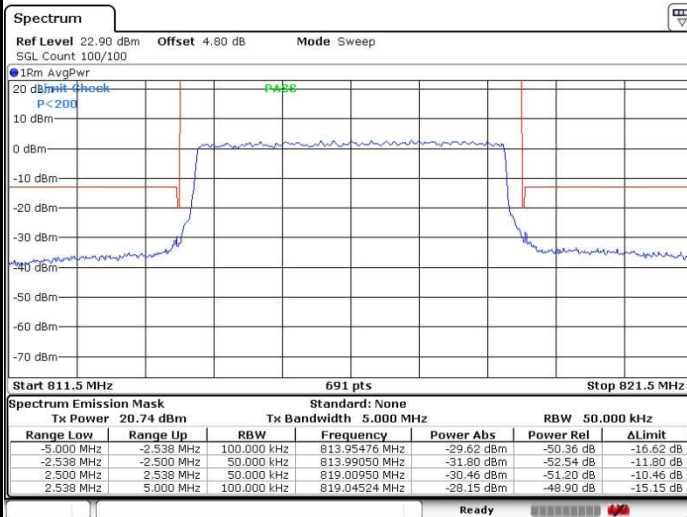

Date: 2 JUN 2017 21:57:56

Highest Band Edge / Full RB

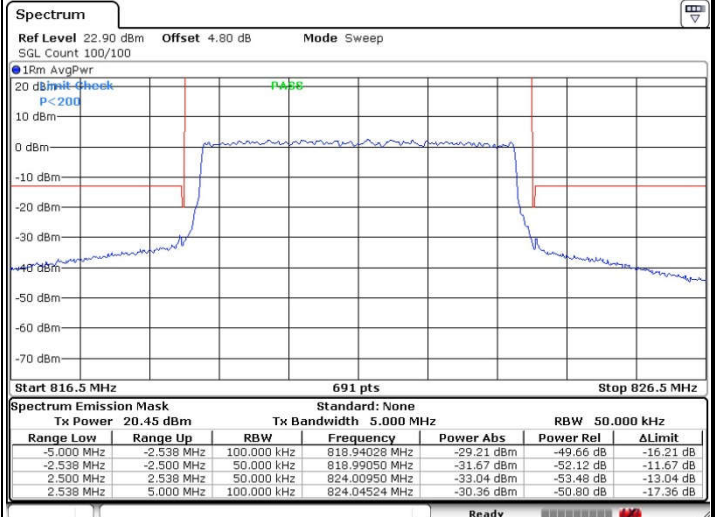

Date: 2 JUN 2017 21:59:32



LTE Band 26 / 10MHz / QPSK

Lowest Band Edge / 1 RB

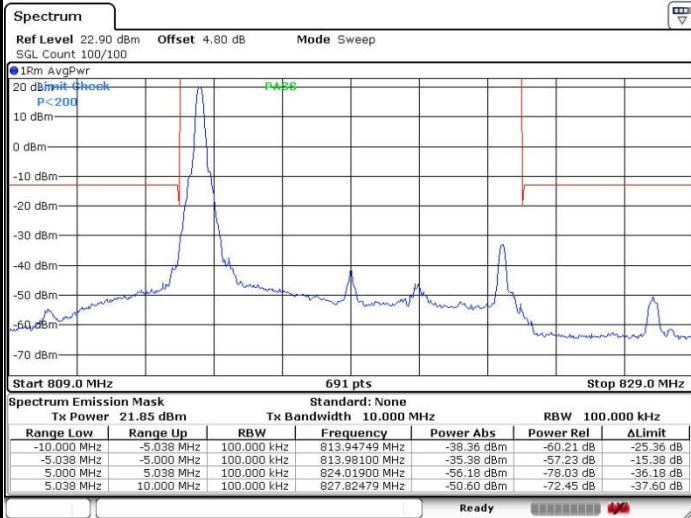

Date: 2 JUN 2017 22:02:15

Highest Band Edge / 1 RB

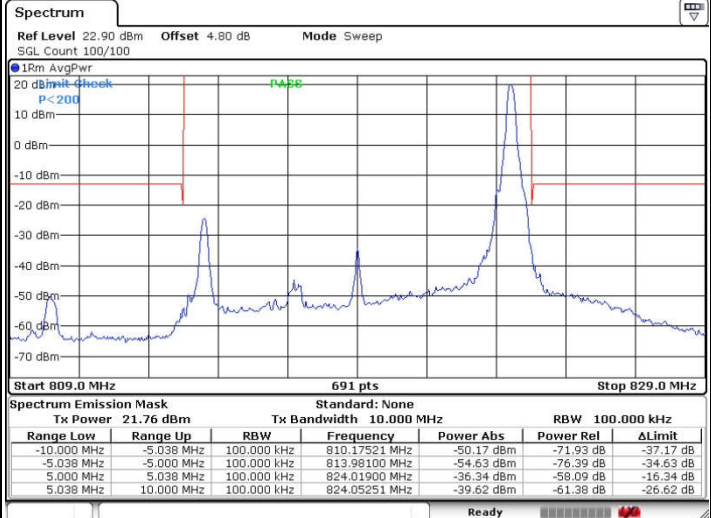

Date: 2 JUN 2017 22:03:34

Band Edge / Full RB

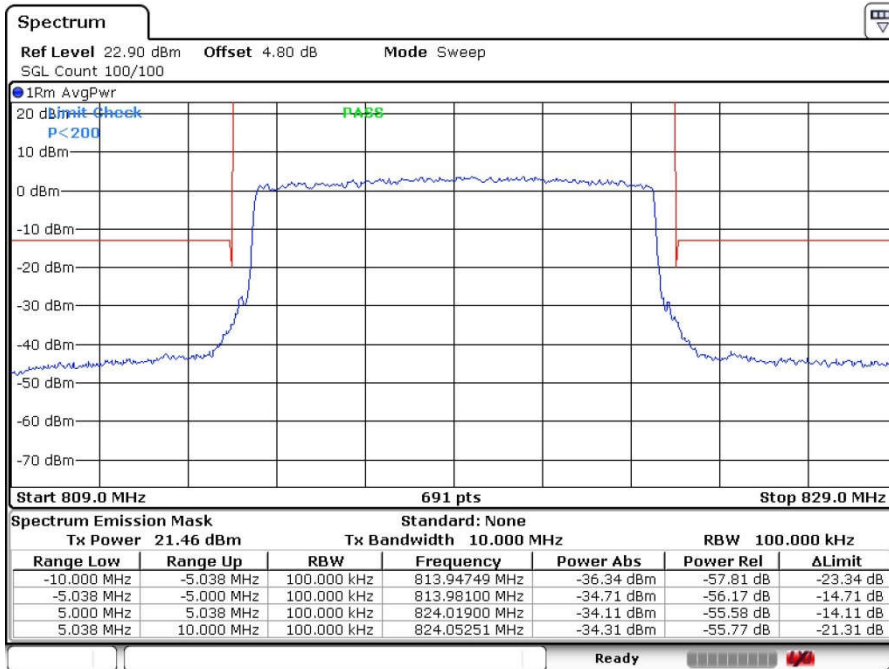

Date: 2 JUN 2017 22:03:51



LTE Band 26 / 10MHz / 16QAM

Lowest Band Edge / 1 RB

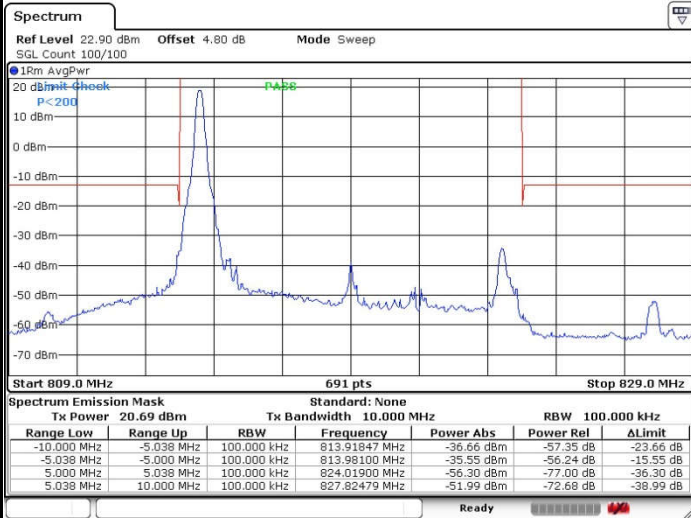

Date: 2 JUN 2017 22:02:45

Highest Band Edge / 1 RB

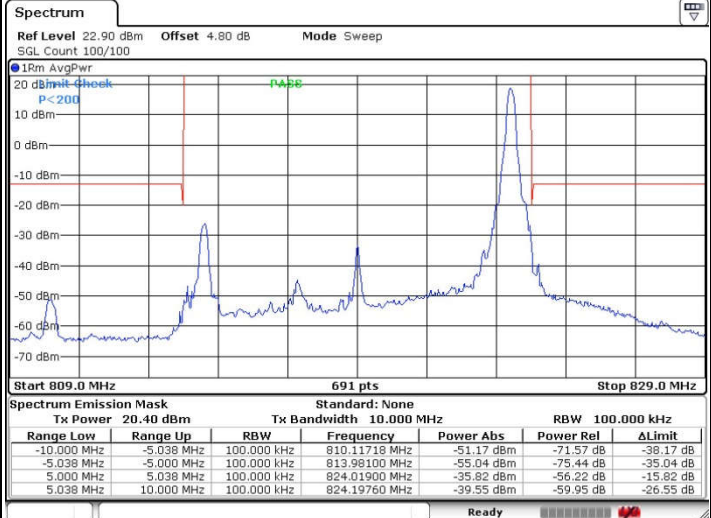

Date: 2 JUN 2017 22:03:16

Band Edge / Full RB

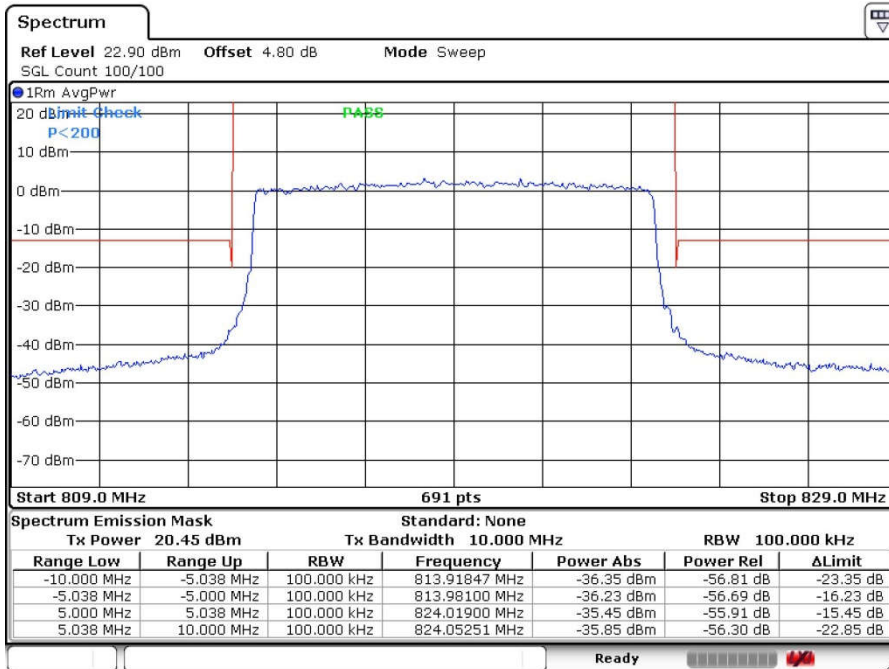

Date: 2 JUN 2017 22:04:14





LTE Band 26 / 15MHz QPSK

Lowest Band Edge / 1 RB

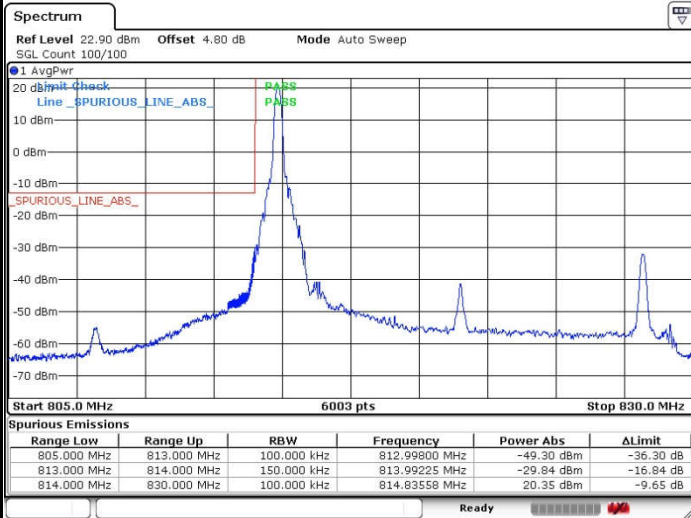

Lowest Band Edge / Full RB

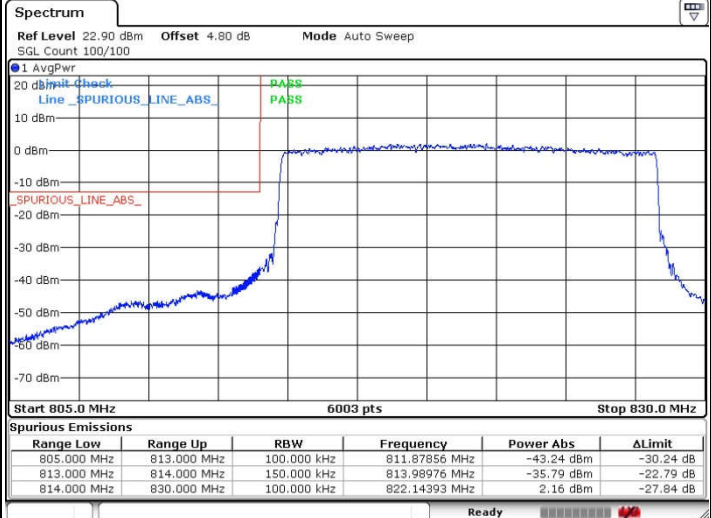

LTE Band 26 / 15MHz 16QAM

Lowest Band Edge / 1 RB

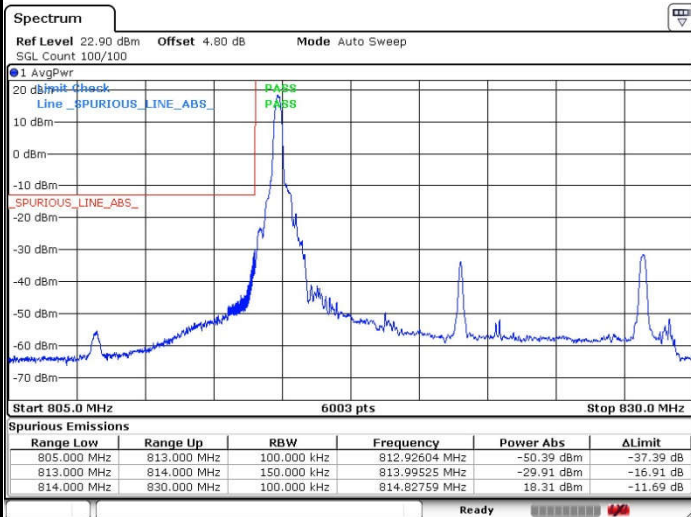

Lowest Band Edge / Full RB

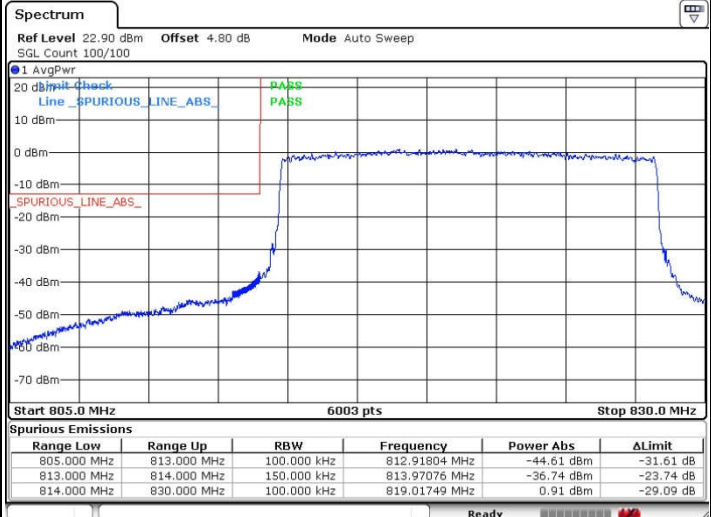



# Conducted Spurious Emission

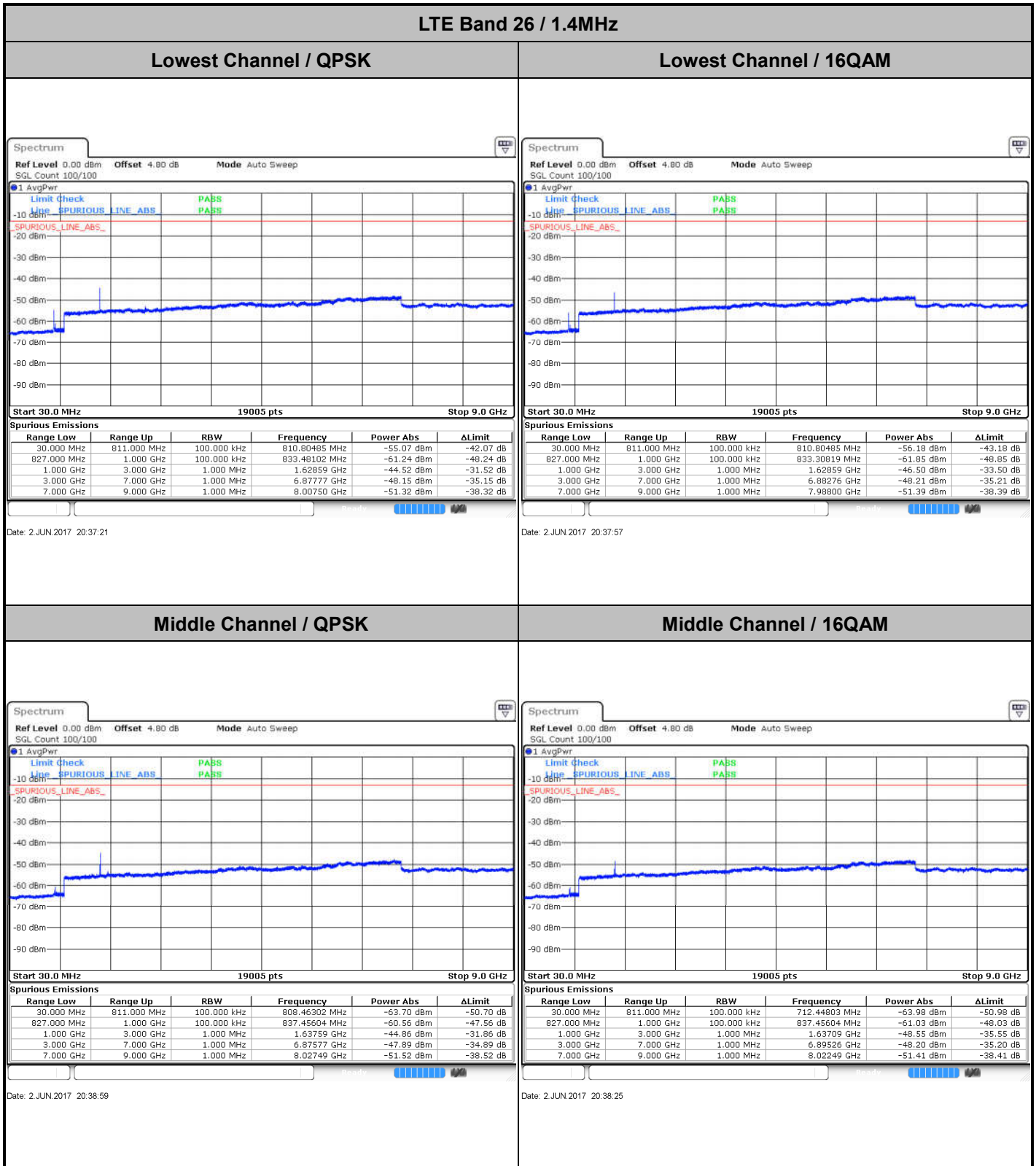



LTE Band 26 / 1.4MHz

Highest Channel / QPSK

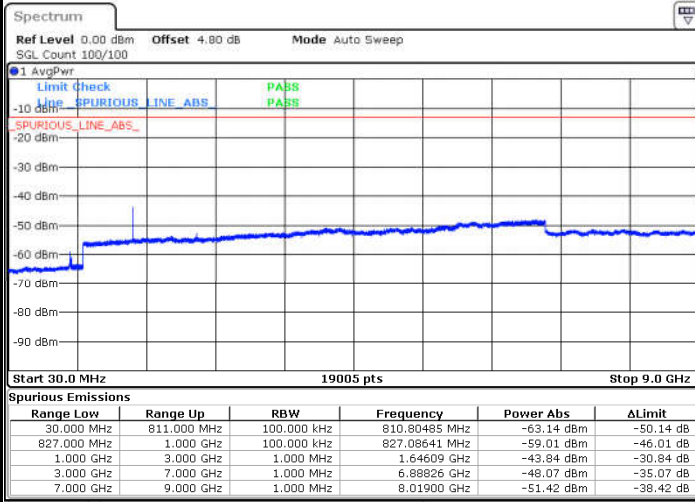

Date: 2 JUN 2017 20:39:54

Highest Channel / 16QAM

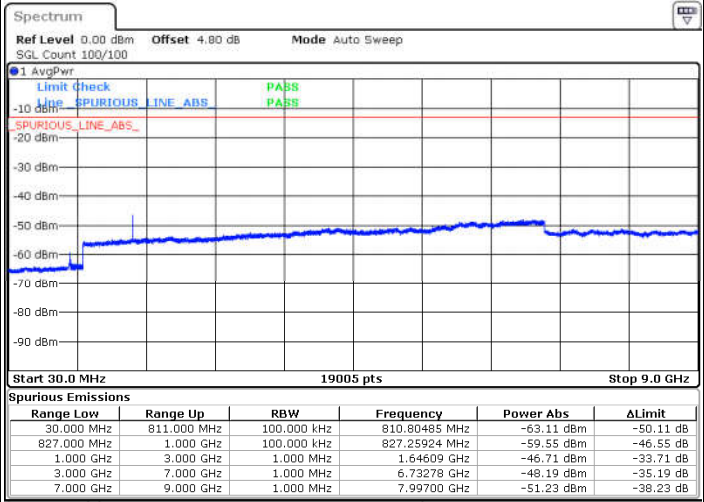

Date: 2 JUN 2017 20:35:24

LTE Band 26 / 3MHz

Lowest Channel / QPSK

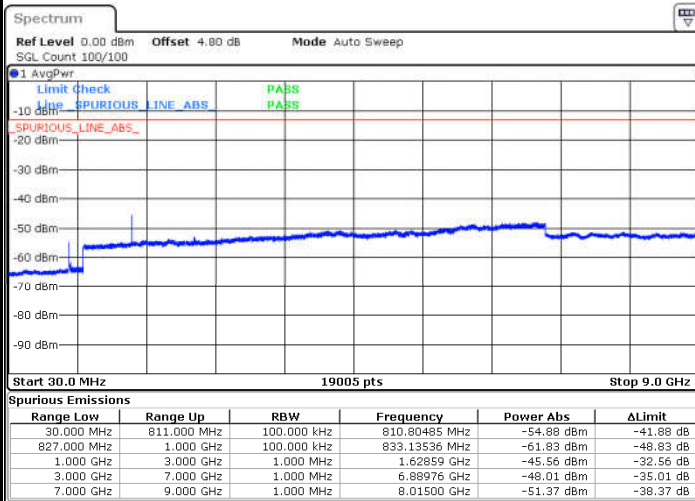

Date: 2 JUN 2017 20:48:36

Lowest Channel / 16QAM

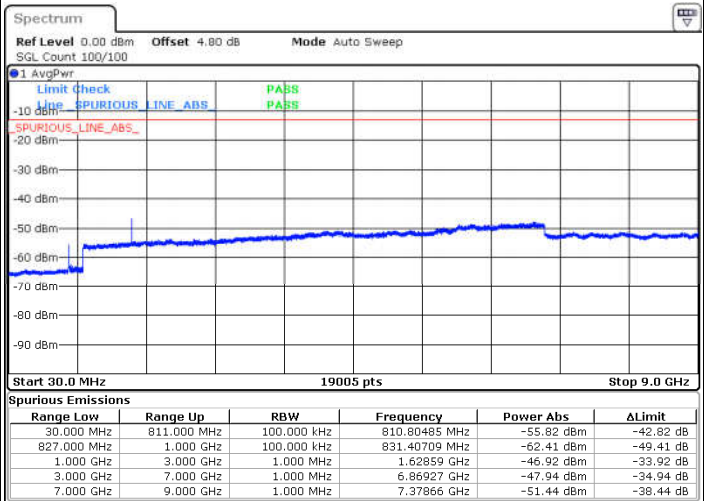

Date: 2 JUN 2017 20:46:32



LTE Band 26 / 3MHz

Middle Channel / QPSK

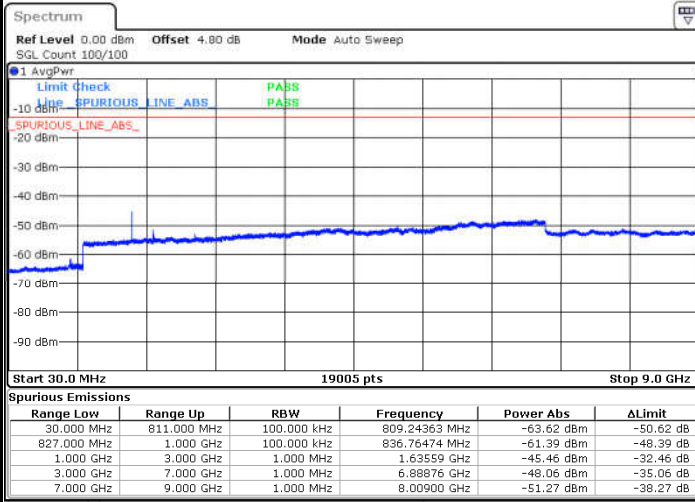

Date: 2 JUN 2017 20:49:16

Middle Channel / 16QAM

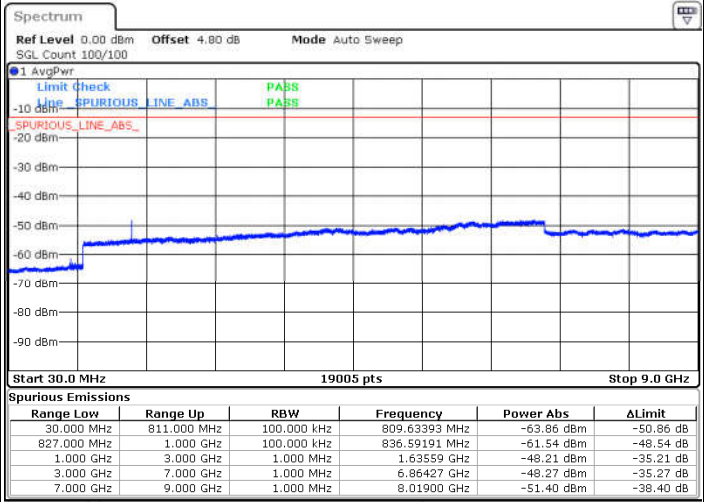

Date: 2 JUN 2017 20:49:47

Highest Channel / QPSK

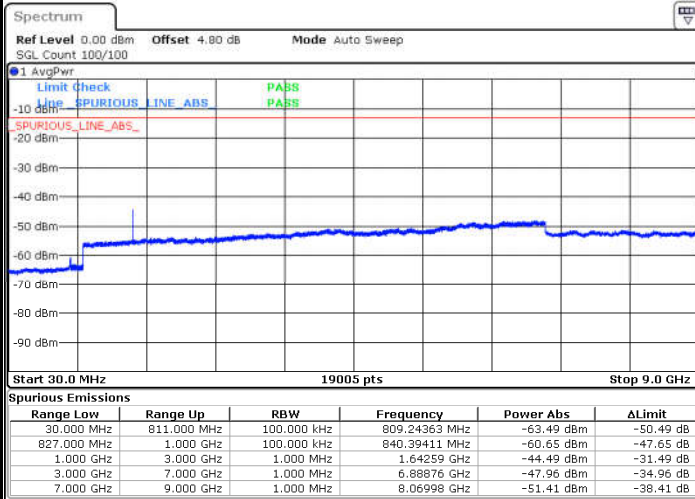

Date: 2 JUN 2017 20:51:03

Highest Channel / 16QAM

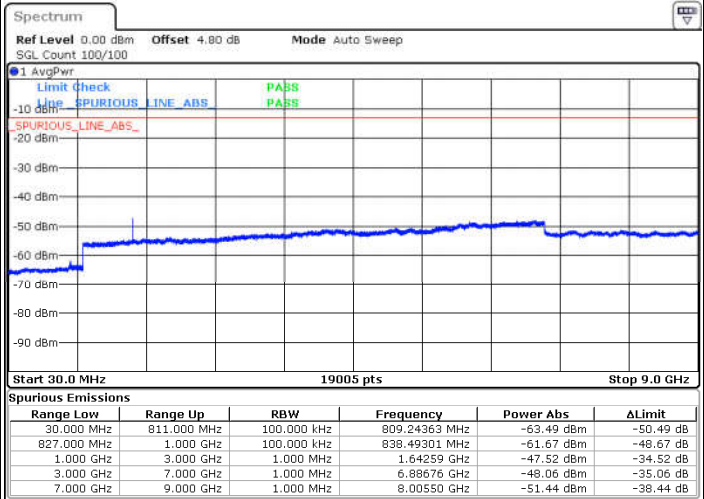

Date: 2 JUN 2017 20:50:30





LTE Band 26 / 5MHz

Lowest Channel / QPSK

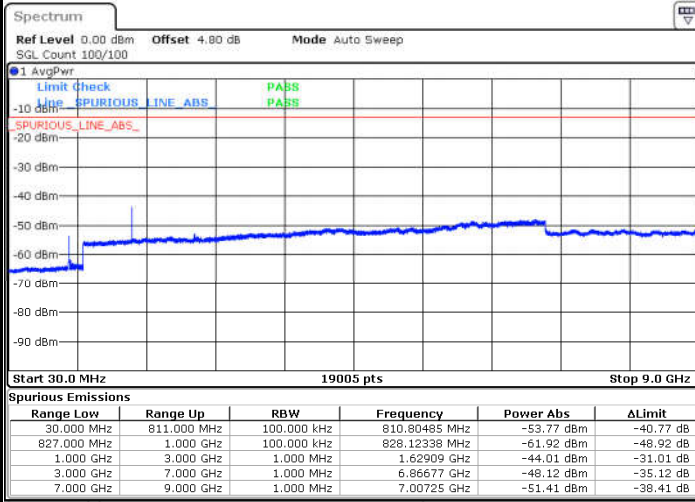

Date: 2 JUN 2017 20:58:36

Lowest Channel / 16QAM

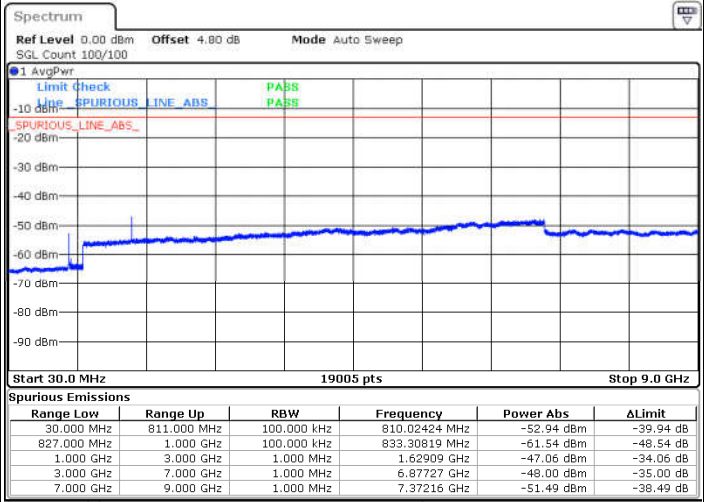

Date: 2 JUN 2017 20:58:12

Middle Channel / QPSK

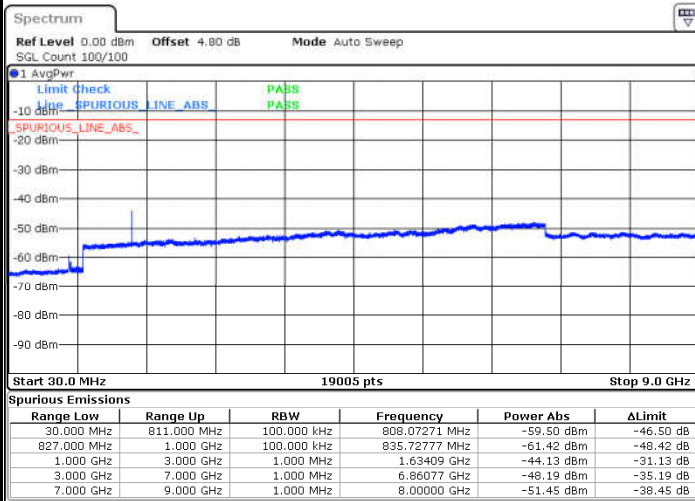

Date: 2 JUN 2017 20:59:15

Middle Channel / 16QAM

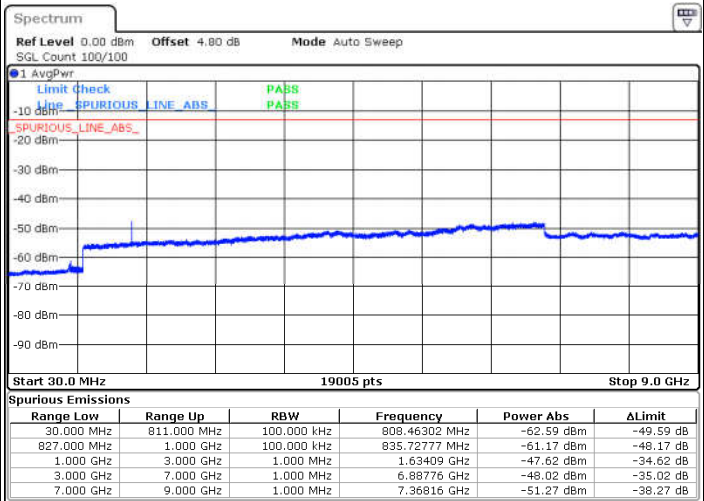

Date: 2 JUN 2017 21:01:25



LTE Band 26 / 5MHz

Highest Channel / QPSK

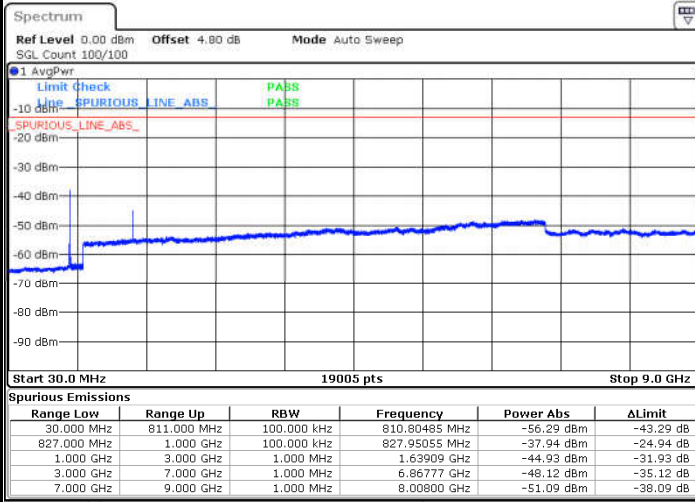

Date: 2 JUN 2017 21:04:18

Highest Channel / 16QAM

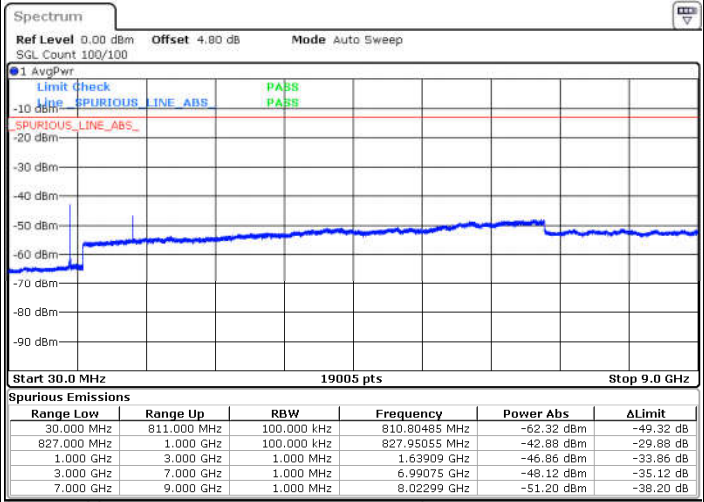

Date: 2 JUN 2017 21:03:02

LTE Band 26 / 10MHz

Middle Channel / QPSK

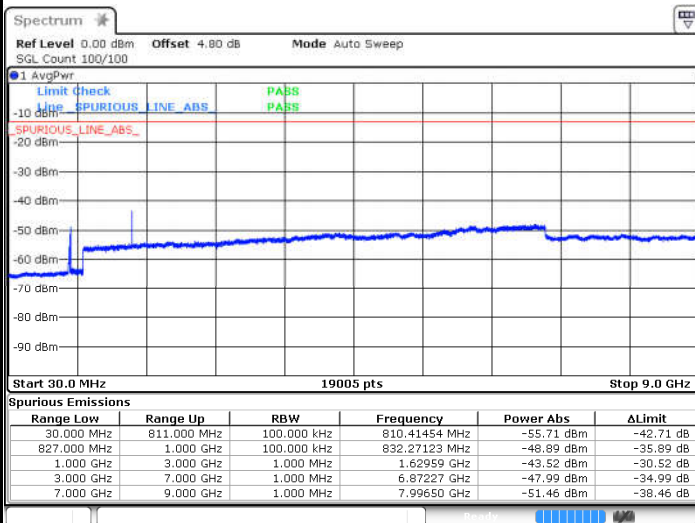

Date: 2 JUN 2017 21:07:42

Middle Channel / 16QAM

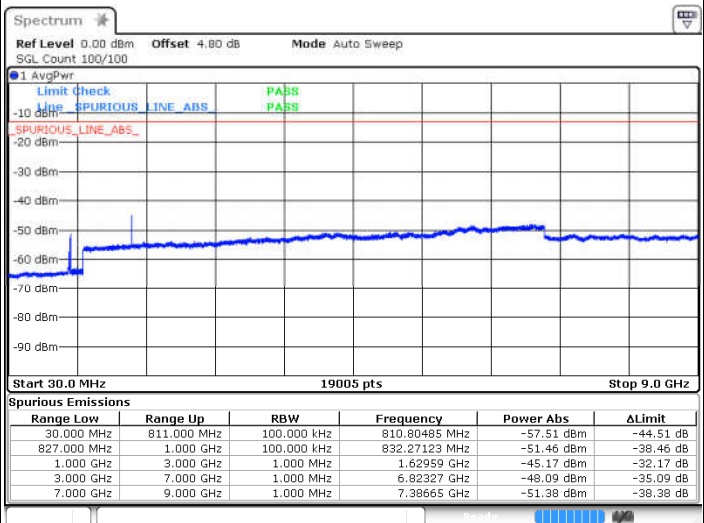

Date: 2 JUN 2017 21:07:03

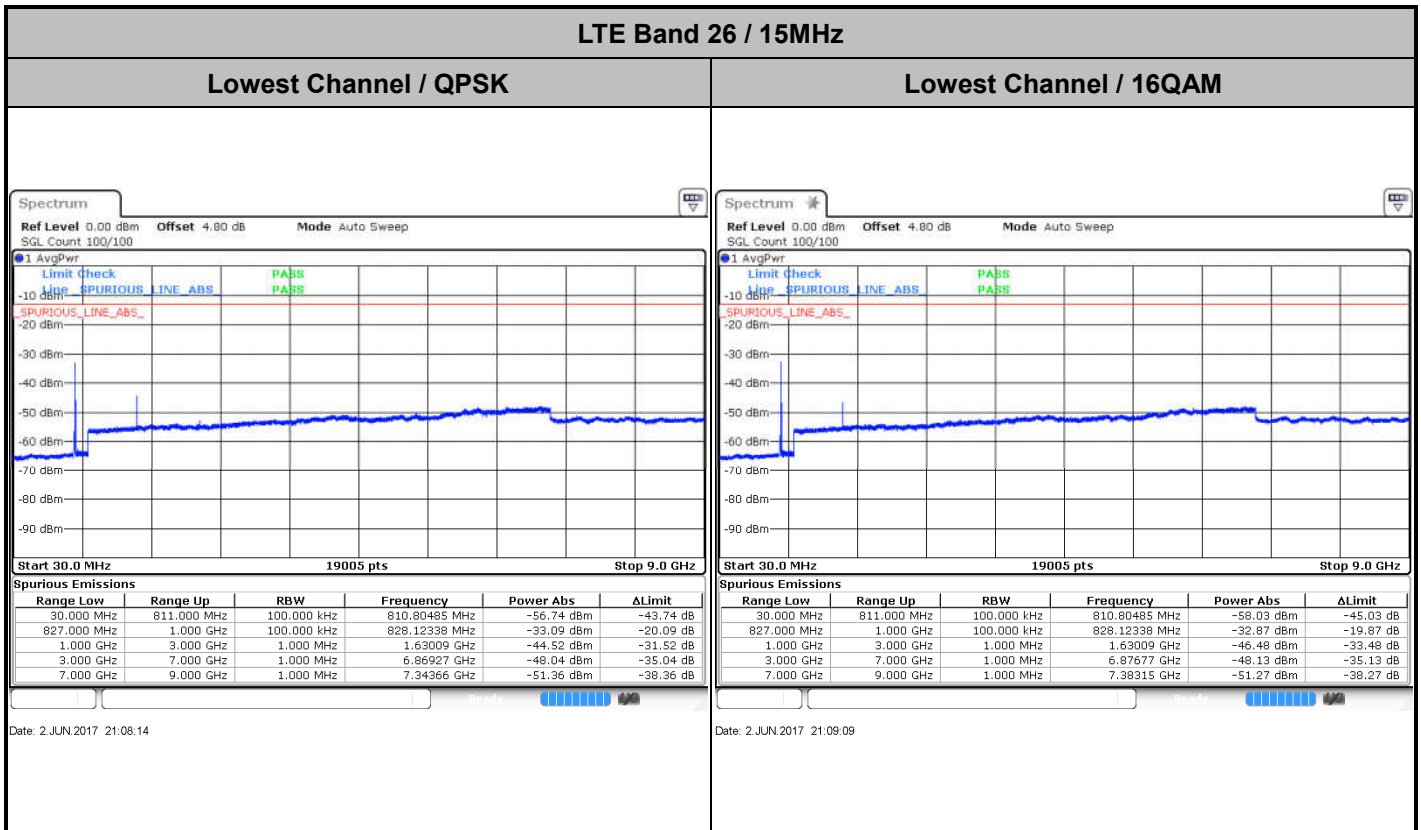



**Frequency Stability**

Test Conditions		LTE Band 26 (QPSK) / Middle Channel	Limit
Temperature (°C)	Voltage (Volt)	BW 10MHz	2.5ppm
		Deviation (ppm)	Result
50	Normal Voltage	0.0001	PASS
40	Normal Voltage	0.0016	
30	Normal Voltage	0.0042	
20(Ref.)	Normal Voltage	0.0000	
10	Normal Voltage	0.0005	
0	Normal Voltage	0.0044	
-10	Normal Voltage	0.0037	
-20	Normal Voltage	0.0045	
-30	Normal Voltage	0.0050	
20	Maximum Voltage	0.0049	
20	Normal Voltage	0.0012	
20	Battery End Point	0.0044	

**Note:** Normal Voltage =3.85 V. ; Battery End Point (BEP) =3.45 V. ; Maximum Voltage =4.4 V.



### Appendix B. Test Results of Radiated Test

LTE Band 26 / 1.4MHz / QPSK / RB Size 1 Offset 0									
Channel	Frequency ( MHz )	ERP ( dBm )	Limit ( dBm )	Over Limit ( dB )	SPA Reading (dBm)	S.G. Power ( dBm )	TX Cable loss ( dB )	TX Antenna Gain (dBi)	Polarization (H/V)
Middle	1636	-67.95	-13	-54.95	-66.58	-69.81	1.19	5.20	H
	2456	-49.00	-13	-36.00	-53.09	-51.22	1.53	5.90	H
	3273	-67.12	-13	-54.12	-71.07	-69.91	1.76	6.70	H
	1637	-67.79	-13	-54.79	-65.75	-69.65	1.19	5.20	V
	2456	-59.96	-13	-46.96	-61.94	-62.18	1.53	5.90	V
	3273	-67.31	-13	-54.31	-70.63	-70.10	1.76	6.70	V

Remark: Spurious emissions within 30-1000MHz were found more than 20dB below limit line.

LTE Band 26 / 3MHz / QPSK / RB Size 1 Offset 0									
Channel	Frequency ( MHz )	ERP ( dBm )	Limit ( dBm )	Over Limit ( dB )	SPA Reading (dBm)	S.G. Power ( dBm )	TX Cable loss ( dB )	TX Antenna Gain (dBi)	Polarization (H/V)
Middle	1635	-67.93	-13	-54.93	-66.56	-69.79	1.19	5.20	H
	2452	-60.11	-13	-47.11	-63.10	-62.33	1.53	5.90	H
	3270	-66.87	-13	-53.87	-70.82	-69.66	1.76	6.70	H
	1636	-67.25	-13	-54.25	-65.21	-69.11	1.19	5.20	V
	2453	-65.43	-13	-52.43	-67.41	-67.65	1.53	5.90	V
	3270	-67.15	-13	-54.15	-70.47	-69.94	1.76	6.70	V

Remark: Spurious emissions within 30-1000MHz were found more than 20dB below limit line.



LTE Band 26 / 5MHz / QPSK / RB Size 1 Offset 0									
Channel	Frequency ( MHz )	ERP ( dBm )	Limit ( dBm )	Over Limit ( dB )	SPA Reading (dBm)	S.G. Power ( dBm )	TX Cable loss ( dB )	TX Antenna Gain (dBi)	Polarization (H/V)
Middle	1634	-67.35	-13	-54.35	-65.98	-69.21	1.19	5.20	H
	2450	-61.02	-13	-48.02	-64.01	-63.24	1.53	5.90	H
	3267	-66.85	-13	-53.85	-70.80	-69.64	1.76	6.70	H
	1634	-68.15	-13	-55.15	-66.11	-70.01	1.19	5.20	V
	2450	-64.60	-13	-51.60	-66.58	-66.82	1.53	5.90	V
	3267	-67.53	-13	-54.53	-70.85	-70.32	1.76	6.70	V

Remark: Spurious emissions within 30-1000MHz were found more than 20dB below limit line.

LTE Band 26 / 10MHz / QPSK / RB Size 1 Offset 0									
Channel	Frequency ( MHz )	ERP ( dBm )	Limit ( dBm )	Over Limit ( dB )	SPA Reading (dBm)	S.G. Power ( dBm )	TX Cable loss ( dB )	TX Antenna Gain (dBi)	Polarization (H/V)
Middle	1628	-67.63	-13	-54.63	-66.26	-69.49	1.19	5.20	H
	2444	-63.56	-13	-50.56	-66.55	-65.78	1.53	5.90	H
	3258	-66.55	-13	-53.55	-70.50	-69.34	1.76	6.70	H
	1628	-68.81	-13	-55.81	-66.77	-70.67	1.19	5.20	V
	2444	-65.06	-13	-52.06	-67.04	-67.28	1.53	5.90	V
	3258	-66.89	-13	-53.89	-70.21	-69.68	1.76	6.70	V

Remark: Spurious emissions within 30-1000MHz were found more than 20dB below limit line.