



In Collaboration with
s p e a g
 CALIBRATION LABORATORY



中国认可
 国际互认
 校准
 CALIBRATION
 CNAS L0570

Add: No.51 Xueyuan Road, Haidian District, Beijing, 100191, China
 Tel: +86-10-62304633-2079 Fax: +86-10-62304633-2504
 E-mail: cttl@chinattl.com http://www.chinattl.cn

Client

Sporton_SZ

Certificate No:

Z17-97044

CALIBRATION CERTIFICATE

Object

D2450V2 - SN: 924

Calibration Procedure(s)

FD-Z11-003-01

Calibration Procedures for dipole validation kits

Calibration date:

March 21, 2017

This calibration Certificate documents the traceability to national standards, which realize the physical units of measurements(SI). The measurements and the uncertainties with confidence probability are given on the following pages and are part of the certificate.

All calibrations have been conducted in the closed laboratory facility: environment temperature(22±3)°C and humidity<70%.

Calibration Equipment used (M&TE critical for calibration)

| Primary Standards | ID # | Cal Date(Calibrated by, Certificate No.) | Scheduled Calibration |
|-------------------------|------------|--|-----------------------|
| Power Meter NRP2 | 101919 | 27-Jun-16 (CTTL, No.J16X04777) | Jun-17 |
| Power sensor NRP-Z91 | 101547 | 27-Jun-16 (CTTL, No.J16X04777) | Jun-17 |
| Reference Probe EX3DV4 | SN 3617 | 23-Jan-17(SPEAG,No.EX3-3617_Jan17) | Jan-18 |
| DAE4 | SN 777 | 22-Aug-16(CTTL-SPEAG,No.Z16-97138) | Aug-17 |
| Secondary Standards | ID # | Cal Date(Calibrated by, Certificate No.) | Scheduled Calibration |
| Signal Generator E4438C | MY49071430 | 13-Jan-17 (CTTL, No.J17X00286) | Jan-18 |
| Network Analyzer E5071C | MY46110673 | 13-Jan-17 (CTTL, No.J17X00285) | Jan-18 |

| | Name | Function | Signature |
|----------------|-------------|-----------------------------------|-----------|
| Calibrated by: | Zhao Jing | SAR Test Engineer | |
| Reviewed by: | Qi Dianyuan | SAR Project Leader | |
| Approved by: | Lu Bingsong | Deputy Director of the laboratory | |

Issued: March 25, 2017

This calibration certificate shall not be reproduced except in full without written approval of the laboratory.



In Collaboration with
s p e a g
CALIBRATION LABORATORY

Add: No.51 Xueyuan Road, Haidian District, Beijing, 100191, China
Tel: +86-10-62304633-2079 Fax: +86-10-62304633-2504
E-mail: cttl@chinattl.com http://www.chinattl.cn

Glossary:

| | |
|-------|--|
| TSL | tissue simulating liquid |
| ConvF | sensitivity in TSL / NORM _{x,y,z} |
| N/A | not applicable or not measured |

Calibration is Performed According to the Following Standards:

- IEEE Std 1528-2013, "IEEE Recommended Practice for Determining the Peak Spatial-Averaged Specific Absorption Rate (SAR) in the Human Head from Wireless Communications Devices: Measurement Techniques", June 2013
- IEC 62209-1, "Procedure to measure the Specific Absorption Rate (SAR) For hand-held devices used in close proximity to the ear (frequency range of 300MHz to 3GHz)", February 2005
- IEC 62209-2, "Procedure to measure the Specific Absorption Rate (SAR) For wireless communication devices used in close proximity to the human body (frequency range of 30MHz to 6GHz)", March 2010
- KDB865664, SAR Measurement Requirements for 100 MHz to 6 GHz

Additional Documentation:

- DASY4/5 System Handbook

Methods Applied and Interpretation of Parameters:

- Measurement Conditions:* Further details are available from the Validation Report at the end of the certificate. All figures stated in the certificate are valid at the frequency indicated.
- Antenna Parameters with TSL:* The dipole is mounted with the spacer to position its feed point exactly below the center marking of the flat phantom section, with the arms oriented parallel to the body axis.
- Feed Point Impedance and Return Loss:* These parameters are measured with the dipole positioned under the liquid filled phantom. The impedance stated is transformed from the measurement at the SMA connector to the feed point. The Return Loss ensures low reflected power. No uncertainty required.
- Electrical Delay:* One-way delay between the SMA connector and the antenna feed point. No uncertainty required.
- SAR measured:* SAR measured at the stated antenna input power.
- SAR normalized:* SAR as measured, normalized to an input power of 1 W at the antenna connector.
- SAR for nominal TSL parameters:* The measured TSL parameters are used to calculate the nominal SAR result.

The reported uncertainty of measurement is stated as the standard uncertainty of Measurement multiplied by the coverage factor $k=2$, which for a normal distribution Corresponds to a coverage probability of approximately 95%.



Measurement Conditions

DASY system configuration, as far as not given on page 1.

| | | |
|-------------------------------------|--------------------------|-------------|
| DASY Version | DASY52 | 52.8.8.1258 |
| Extrapolation | Advanced Extrapolation | |
| Phantom | Triple Flat Phantom 5.1C | |
| Distance Dipole Center - TSL | 10 mm | with Spacer |
| Zoom Scan Resolution | dx, dy, dz = 5 mm | |
| Frequency | 2450 MHz ± 1 MHz | |

Head TSL parameters

The following parameters and calculations were applied.

| | Temperature | Permittivity | Conductivity |
|--|-----------------|--------------|------------------|
| Nominal Head TSL parameters | 22.0 °C | 39.2 | 1.80 mho/m |
| Measured Head TSL parameters | (22.0 ± 0.2) °C | 39.0 ± 6 % | 1.77 mho/m ± 6 % |
| Head TSL temperature change during test | <1.0 °C | ---- | ---- |

SAR result with Head TSL

| | | |
|---|--------------------|-----------------------------------|
| SAR averaged over 1 cm³ (1 g) of Head TSL | Condition | |
| SAR measured | 250 mW input power | 13.0 mW / g |
| SAR for nominal Head TSL parameters | normalized to 1W | 52.4 mW / g ± 20.8 % (k=2) |
| SAR averaged over 10 cm³ (10 g) of Head TSL | Condition | |
| SAR measured | 250 mW input power | 6.04 mW / g |
| SAR for nominal Head TSL parameters | normalized to 1W | 24.3 mW / g ± 20.4 % (k=2) |

Body TSL parameters

The following parameters and calculations were applied.

| | Temperature | Permittivity | Conductivity |
|--|-----------------|--------------|------------------|
| Nominal Body TSL parameters | 22.0 °C | 52.7 | 1.95 mho/m |
| Measured Body TSL parameters | (22.0 ± 0.2) °C | 52.3 ± 6 % | 1.93 mho/m ± 6 % |
| Body TSL temperature change during test | <1.0 °C | ---- | ---- |

SAR result with Body TSL

| | | |
|---|--------------------|-----------------------------------|
| SAR averaged over 1 cm³ (1 g) of Body TSL | Condition | |
| SAR measured | 250 mW input power | 12.6 mW / g |
| SAR for nominal Body TSL parameters | normalized to 1W | 50.5 mW / g ± 20.8 % (k=2) |
| SAR averaged over 10 cm³ (10 g) of Body TSL | Condition | |
| SAR measured | 250 mW input power | 5.86 mW / g |
| SAR for nominal Body TSL parameters | normalized to 1W | 23.5 mW / g ± 20.4 % (k=2) |



Add: No.51 Xueyuan Road, Haidian District, Beijing, 100191, China
Tel: +86-10-62304633-2079 Fax: +86-10-62304633-2504
E-mail: cttl@chinattl.com http://www.chinattl.cn

Appendix (Additional assessments outside the scope of CNAS L0570)

Antenna Parameters with Head TSL

| | |
|--------------------------------------|---------------|
| Impedance, transformed to feed point | 50.9Ω+ 3.77jΩ |
| Return Loss | - 28.3dB |

Antenna Parameters with Body TSL

| | |
|--------------------------------------|---------------|
| Impedance, transformed to feed point | 48.3Ω+ 4.18jΩ |
| Return Loss | - 26.8dB |

General Antenna Parameters and Design

| | |
|----------------------------------|----------|
| Electrical Delay (one direction) | 1.260 ns |
|----------------------------------|----------|

After long term use with 100W radiated power, only a slight warming of the dipole near the feedpoint can be measured.

The dipole is made of standard semirigid coaxial cable. The center conductor of the feeding line is directly connected to the second arm of the dipole. The antenna is therefore short-circuited for DC-signals. On some of the dipoles, small end caps are added to the dipole arms in order to improve matching when loaded according to the position as explained in the "Measurement Conditions" paragraph. The SAR data are not affected by this change. The overall dipole length is still according to the Standard.

No excessive force must be applied to the dipole arms, because they might bend or the soldered connections near the feedpoint may be damaged.

Additional EUT Data

| | |
|-----------------|-------|
| Manufactured by | SPEAG |
|-----------------|-------|



Add: No.51 Xueyuan Road, Haidian District, Beijing, 100191, China
Tel: +86-10-62304633-2079 Fax: +86-10-62304633-2504
E-mail: cttl@chinattl.com http://www.chinattl.cn

DASY5 Validation Report for Head TSL

Date: 03.21.2017

Test Laboratory: CTTL, Beijing, China

DUT: Dipole 2450 MHz; Type: D2450V2; Serial: D2450V2 - SN: 924

Communication System: UID 0, CW; Frequency: 2450 MHz; Duty Cycle: 1:1

Medium parameters used: $f = 2450$ MHz; $\sigma = 1.768$ S/m; $\epsilon_r = 39.02$; $\rho = 1000$ kg/m³

Phantom section: Right Section

Measurement Standard: DASY5 (IEEE/IEC/ANSI C63.19-2007)

DASY5 Configuration:

- Probe: EX3DV4 - SN3617; ConvF(7.74, 7.74, 7.74); Calibrated: 1/23/2017;
- Sensor-Surface: 1.4mm (Mechanical Surface Detection)
- Electronics: DAE4 Sn777; Calibrated: 8/22/2016
- Phantom: Triple Flat Phantom 5.1C; Type: QD 000 P51 CA; Serial: 1161/1
- Measurement SW: DASY52, Version 52.8 (8); SEMCAD X Version 14.6.10 (7372)

Dipole Calibration/Zoom Scan (7x7x7) (7x7x7)/Cube 0: Measurement grid: dx=5mm, dy=5mm, dz=5mm

Reference Value = 103.8 V/m; Power Drift = 0.02 dB

Peak SAR (extrapolated) = 27.0 W/kg

SAR(1 g) = 13 W/kg; SAR(10 g) = 6.04 W/kg

Maximum value of SAR (measured) = 21.7 W/kg

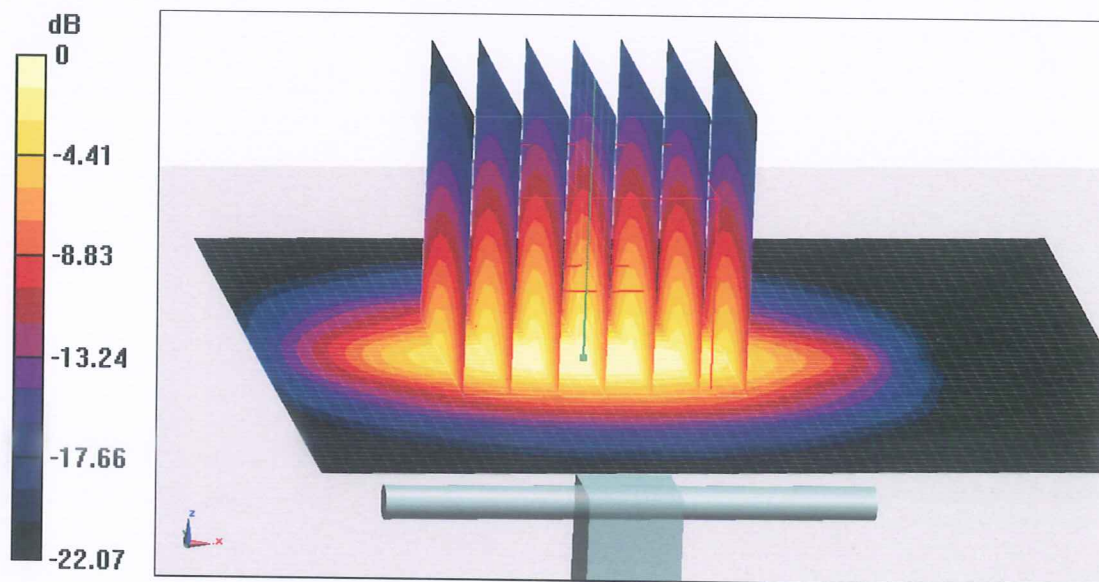

0 dB = 21.7 W/kg = 13.36 dBW/kg



Add: No.51 Xueyuan Road, Haidian District, Beijing, 100191, China
Tel: +86-10-62304633-2079 Fax: +86-10-62304633-2504
E-mail: cttl@chinattl.com http://www.chinattl.cn

Impedance Measurement Plot for Head TSL

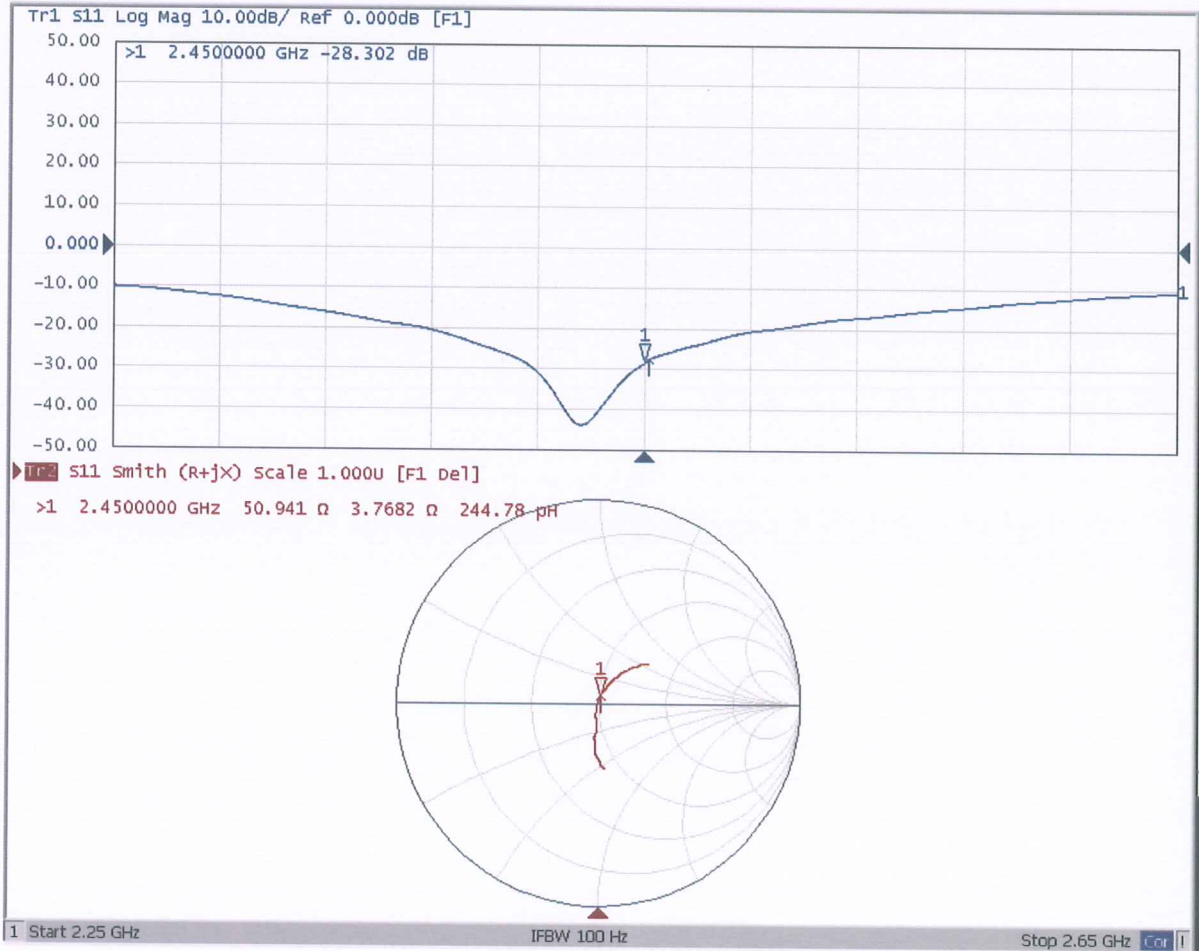



Add: No.51 Xueyuan Road, Haidian District, Beijing, 100191, China
Tel: +86-10-62304633-2079 Fax: +86-10-62304633-2504
E-mail: cttl@chinattl.com http://www.chinattl.cn

DASY5 Validation Report for Body TSL

Date: 03.21.2017

Test Laboratory: CTTL, Beijing, China

DUT: Dipole 2450 MHz; Type: D2450V2; Serial: D2450V2 - SN: 924

Communication System: UID 0, CW; Frequency: 2450 MHz; Duty Cycle: 1:1

Medium parameters used: $f = 2450$ MHz; $\sigma = 1.931$ S/m; $\epsilon_r = 52.27$; $\rho = 1000$ kg/m³

Phantom section: Center Section

Measurement Standard: DASY5 (IEEE/IEC/ANSI C63.19-2007)

DASY5 Configuration:

- Probe: EX3DV4 - SN3617; ConvF(7.8, 7.8, 7.8); Calibrated: 1/23/2017;
- Sensor-Surface: 1.4mm (Mechanical Surface Detection)
- Electronics: DAE4 Sn777; Calibrated: 8/22/2016
- Phantom: Triple Flat Phantom 5.1C; Type: QD 000 P51 CA; Serial: 1161/1
- Measurement SW: DASY52, Version 52.8 (8); SEMCAD X Version 14.6.10 (7372)

Dipole Calibration/Zoom Scan (7x7x7) (7x7x7)/Cube 0: Measurement grid: dx=5mm, dy=5mm, dz=5mm

Reference Value = 97.48 V/m; Power Drift = -0.01 dB

Peak SAR (extrapolated) = 26.4 W/kg

SAR(1 g) = 12.6 W/kg; SAR(10 g) = 5.86 W/kg

Maximum value of SAR (measured) = 20.9 W/kg

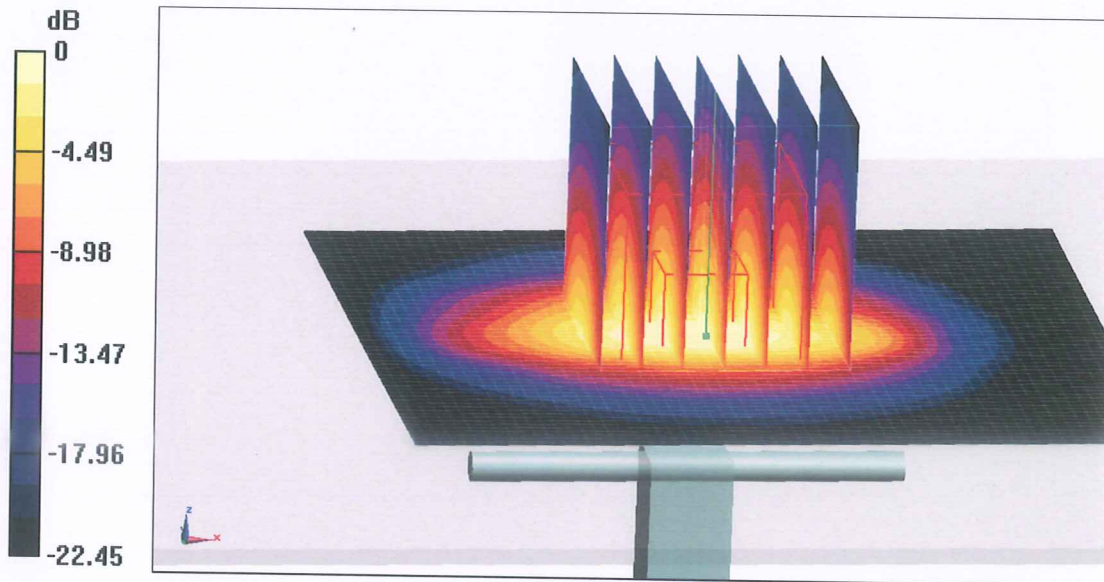

0 dB = 20.9 W/kg = 13.20 dBW/kg



Add: No.51 Xueyuan Road, Haidian District, Beijing, 100191, China
Tel: +86-10-62304633-2079 Fax: +86-10-62304633-2504
E-mail: cttl@chinattl.com http://www.chinattl.cn

Impedance Measurement Plot for Body TSL

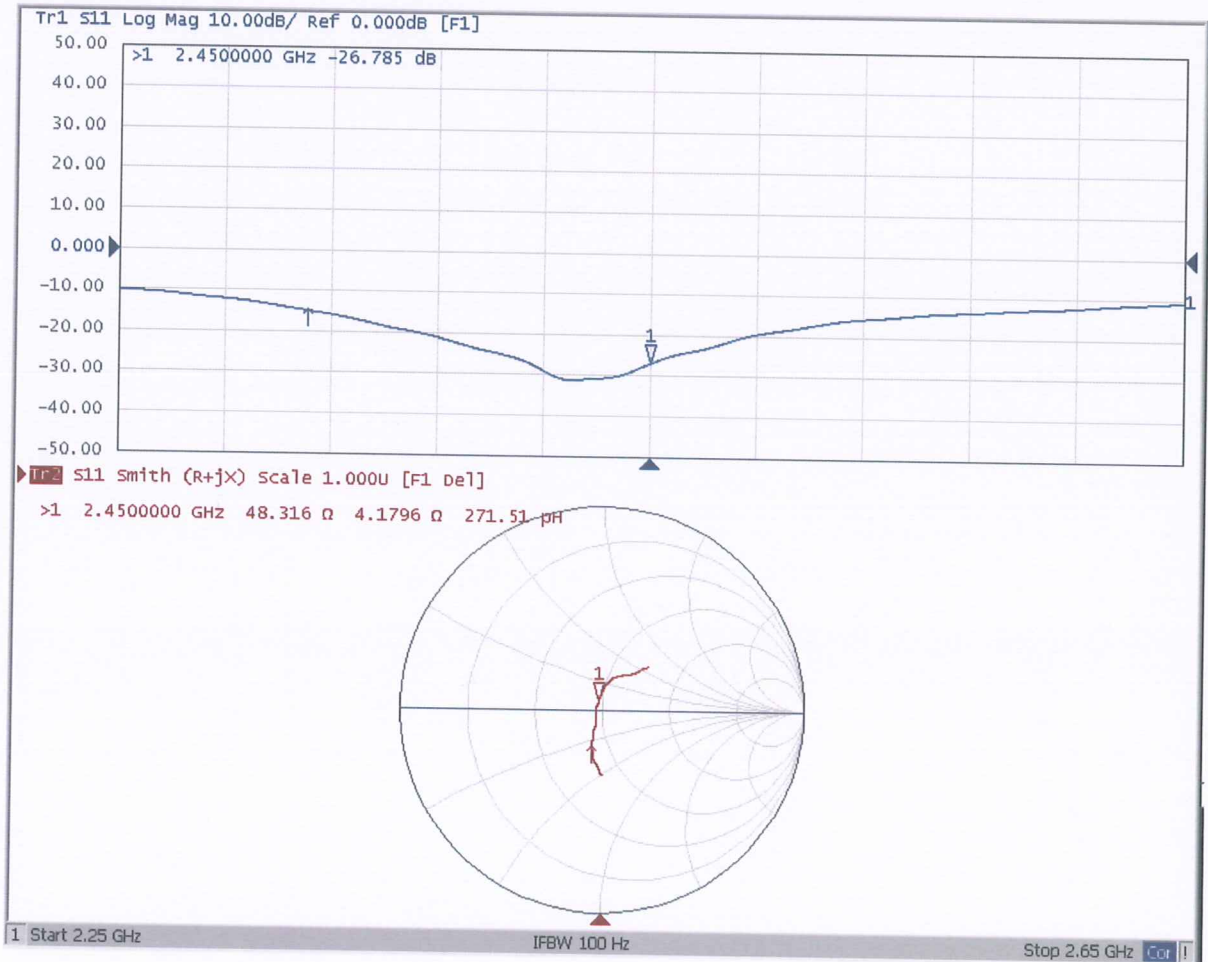



In Collaboration with
s p e a g
 CALIBRATION LABORATORY



中国认可
 国际互认
 校准
 CALIBRATION
 CNAS L0570

Add: No.51 Xueyuan Road, Haidian District, Beijing, 100191, China
 Tel: +86-10-62304633-2079 Fax: +86-10-62304633-2504
 E-mail: cttl@chinattl.com [Http://www.chinattl.cn](http://www.chinattl.cn)

Client **Sporton-CN**

Certificate No: **Z16-97233**

CALIBRATION CERTIFICATE

Object: **D2600V2 - SN: 1070**

Calibration Procedure(s): **FD-Z11-003-01**
Calibration Procedures for dipole validation kits

Calibration date: **November 24, 2016**

This calibration Certificate documents the traceability to national standards, which realize the physical units of measurements(SI). The measurements and the uncertainties with confidence probability are given on the following pages and are part of the certificate.

All calibrations have been conducted in the closed laboratory facility; environment temperature(22±3)°C and humidity<70%.

Calibration Equipment used (M&TE critical for calibration)

| Primary Standards | ID # | Cal Date(Calibrated by, Certificate No.) | Scheduled Calibration |
|-------------------------|------------|--|-----------------------|
| Power Meter NRP2 | 101919 | 01-Jul-15 (CTTL, No.J15X04256) | Jun-16 |
| Power sensor NRP-Z91 | 101547 | 01-Jul-15 (CTTL, No.J15X04256) | Jun-16 |
| Reference Probe EX3DV4 | SN 7433 | 26-Sep-16(SPEAG,No.EX3-7433_Sep16) | Sep-17 |
| DAE4 | SN 771 | 02-Feb-16(CTTL-SPEAG,No.Z16-97011) | Feb-17 |
| Secondary Standards | ID # | Cal Date(Calibrated by, Certificate No.) | Scheduled Calibration |
| Signal Generator E4438C | MY49071430 | 01-Feb-16 (CTTL, No.J16X00893) | Jan-17 |
| Network Analyzer E5071C | MY46110673 | 26-Jan-16 (CTTL, No.J16X00894) | Jan-17 |

| | Name | Function | Signature |
|----------------|-------------|-----------------------------------|-----------|
| Calibrated by: | Zhao Jing | SAR Test Engineer | |
| Reviewed by: | Qi Dianyuan | SAR Project Leader | |
| Approved by: | Lu Bingsong | Deputy Director of the laboratory | |

Issued: November 27, 2016

This calibration certificate shall not be reproduced except in full without written approval of the laboratory.



In Collaboration with

s p e a g
CALIBRATION LABORATORY

Add: No.51 Xueyuan Road, Haidian District, Beijing, 100191, China
Tel: +86-10-62304633-2079 Fax: +86-10-62304633-2504
E-mail: cttl@chinattl.com Http://www.chinattl.cn

Glossary:

| | |
|-------|--|
| TSL | tissue simulating liquid |
| ConvF | sensitivity in TSL / NORM _{x,y,z} |
| N/A | not applicable or not measured |

Calibration is Performed According to the Following Standards:

- IEEE Std 1528-2013, "IEEE Recommended Practice for Determining the Peak Spatial-Averaged Specific Absorption Rate (SAR) in the Human Head from Wireless Communications Devices: Measurement Techniques", June 2013
- IEC 62209-1, "Procedure to measure the Specific Absorption Rate (SAR) For hand-held devices used in close proximity to the ear (frequency range of 300MHz to 3GHz)", February 2005
- IEC 62209-2, "Procedure to measure the Specific Absorption Rate (SAR) For wireless communication devices used in close proximity to the human body (frequency range of 30MHz to 6GHz)", March 2010
- KDB865664, SAR Measurement Requirements for 100 MHz to 6 GHz

Additional Documentation:

- DASY4/5 System Handbook

Methods Applied and Interpretation of Parameters:

- Measurement Conditions:** Further details are available from the Validation Report at the end of the certificate. All figures stated in the certificate are valid at the frequency indicated.
- Antenna Parameters with TSL:** The dipole is mounted with the spacer to position its feed point exactly below the center marking of the flat phantom section, with the arms oriented parallel to the body axis.
- Feed Point Impedance and Return Loss:** These parameters are measured with the dipole positioned under the liquid filled phantom. The impedance stated is transformed from the measurement at the SMA connector to the feed point. The Return Loss ensures low reflected power. No uncertainty required.
- Electrical Delay:** One-way delay between the SMA connector and the antenna feed point. No uncertainty required.
- SAR measured:** SAR measured at the stated antenna input power.
- SAR normalized:** SAR as measured, normalized to an input power of 1 W at the antenna connector.
- SAR for nominal TSL parameters:** The measured TSL parameters are used to calculate the nominal SAR result.

The reported uncertainty of measurement is stated as the standard uncertainty of Measurement multiplied by the coverage factor $k=2$, which for a normal distribution Corresponds to a coverage probability of approximately 95%.



Add: No.51 Xueyuan Road, Haidian District, Beijing, 100191, China
Tel: +86-10-62304633-2079 Fax: +86-10-62304633-2504
E-mail: cttl@chinattl.com Http://www.chinattl.cn

Measurement Conditions

DASY system configuration, as far as not given on page 1.

| | | |
|------------------------------|--------------------------|-------------|
| DASY Version | DASY52 | 52.8.8.1258 |
| Extrapolation | Advanced Extrapolation | |
| Phantom | Triple Flat Phantom 5.1C | |
| Distance Dipole Center - TSL | 10 mm | with Spacer |
| Zoom Scan Resolution | dx, dy, dz = 5 mm | |
| Frequency | 2600 MHz \pm 1 MHz | |

Head TSL parameters

The following parameters and calculations were applied.

| | Temperature | Permittivity | Conductivity |
|---|---------------------|----------------|----------------------|
| Nominal Head TSL parameters | 22.0 °C | 39.0 | 1.96 mho/m |
| Measured Head TSL parameters | (22.0 \pm 0.2) °C | 38.3 \pm 6 % | 1.94 mho/m \pm 6 % |
| Head TSL temperature change during test | <1.0 °C | --- | --- |

SAR result with Head TSL

| | | |
|--|--------------------|--------------------------------|
| SAR averaged over 1 cm^3 (1 g) of Head TSL | Condition | |
| SAR measured | 250 mW input power | 14.2 mW / g |
| SAR for nominal Head TSL parameters | normalized to 1W | 56.8 mW / g \pm 20.8 % (k=2) |
| SAR averaged over 10 cm^3 (10 g) of Head TSL | Condition | |
| SAR measured | 250 mW input power | 6.47 mW / g |
| SAR for nominal Head TSL parameters | normalized to 1W | 25.9 mW / g \pm 20.4 % (k=2) |

Body TSL parameters

The following parameters and calculations were applied.

| | Temperature | Permittivity | Conductivity |
|---|---------------------|----------------|----------------------|
| Nominal Body TSL parameters | 22.0 °C | 52.5 | 2.16 mho/m |
| Measured Body TSL parameters | (22.0 \pm 0.2) °C | 52.1 \pm 6 % | 2.17 mho/m \pm 6 % |
| Body TSL temperature change during test | <1.0 °C | --- | --- |

SAR result with Body TSL

| | | |
|--|--------------------|--------------------------------|
| SAR averaged over 1 cm^3 (1 g) of Body TSL | Condition | |
| SAR measured | 250 mW input power | 13.9 mW / g |
| SAR for nominal Body TSL parameters | normalized to 1W | 55.4 mW / g \pm 20.8 % (k=2) |
| SAR averaged over 10 cm^3 (10 g) of Body TSL | Condition | |
| SAR measured | 250 mW input power | 6.36 mW / g |
| SAR for nominal Body TSL parameters | normalized to 1W | 25.4 mW / g \pm 20.4 % (k=2) |



Add: No.51 Xueyuan Road, Haidian District, Beijing, 100191, China
Tel: +86-10-62304633-2079 Fax: +86-10-62304633-2504
E-mail: cttl@chinattl.com Http://www.chinattl.cn

Appendix

Antenna Parameters with Head TSL

| | |
|--------------------------------------|---------------|
| Impedance, transformed to feed point | 47.8Ω- 5.22jΩ |
| Return Loss | - 24.7dB |

Antenna Parameters with Body TSL

| | |
|--------------------------------------|---------------|
| Impedance, transformed to feed point | 45.1Ω- 4.05jΩ |
| Return Loss | - 23.6dB |

General Antenna Parameters and Design

| | |
|----------------------------------|----------|
| Electrical Delay (one direction) | 1.029 ns |
|----------------------------------|----------|

After long term use with 100W radiated power, only a slight warming of the dipole near the feedpoint can be measured.

The dipole is made of standard semirigid coaxial cable. The center conductor of the feeding line is directly connected to the second arm of the dipole. The antenna is therefore short-circuited for DC-signals. On some of the dipoles, small end caps are added to the dipole arms in order to improve matching when loaded according to the position as explained in the "Measurement Conditions" paragraph. The SAR data are not affected by this change. The overall dipole length is still according to the Standard.

No excessive force must be applied to the dipole arms, because they might bend or the soldered connections near the feedpoint may be damaged.

Additional EUT Data

| | |
|-----------------|-------|
| Manufactured by | SPEAG |
|-----------------|-------|



Add: No.51 Xueyuan Road, Haidian District, Beijing, 100191, China
Tel: +86-10-62304633-2079 Fax: +86-10-62304633-2504
E-mail: cttl@chinattl.com Http://www.chinattl.cn

DASY5 Validation Report for Head TSL

Date: 11.24.2016

Test Laboratory: CTTL, Beijing, China

DUT: Dipole 2600 MHz; Type: D2600V2; Serial: D2600V2 - SN: 1070

Communication System: UID 0, CW; Frequency: 2600 MHz; Duty Cycle: 1:1

Medium parameters used: $f = 2600$ MHz; $\sigma = 1.941$ S/m; $\epsilon_r = 38.28$; $\rho = 1000$ kg/m³

Phantom section: Center Section

Measurement Standard: DASY5 (IEEE/IEC/ANSI C63.19-2007)

DASY5 Configuration:

- Probe: EX3DV4 - SN7433; ConvF(7.19, 7.19, 7.19); Calibrated: 9/26/2016;
- Sensor-Surface: 2mm (Mechanical Surface Detection)
- Electronics: DAE4 Sn771; Calibrated: 2/2/2016
- Phantom: Triple Flat Phantom 5.1C; Type: QD 000 P51 CA; Serial: 1161/1
- Measurement SW: DASY52, Version 52.8 (8); SEMCAD X Version 14.6.10 (7372)

Dipole Calibration/Zoom Scan (7x7x7) (7x7x7)/Cube 0: Measurement grid: dx=5mm, dy=5mm, dz=5mm

Reference Value = 107.7 V/m; Power Drift = -0.04 dB

Peak SAR (extrapolated) = 29.0 W/kg

SAR(1 g) = 14.2 W/kg; SAR(10 g) = 6.47 W/kg

Maximum value of SAR (measured) = 21.7 W/kg

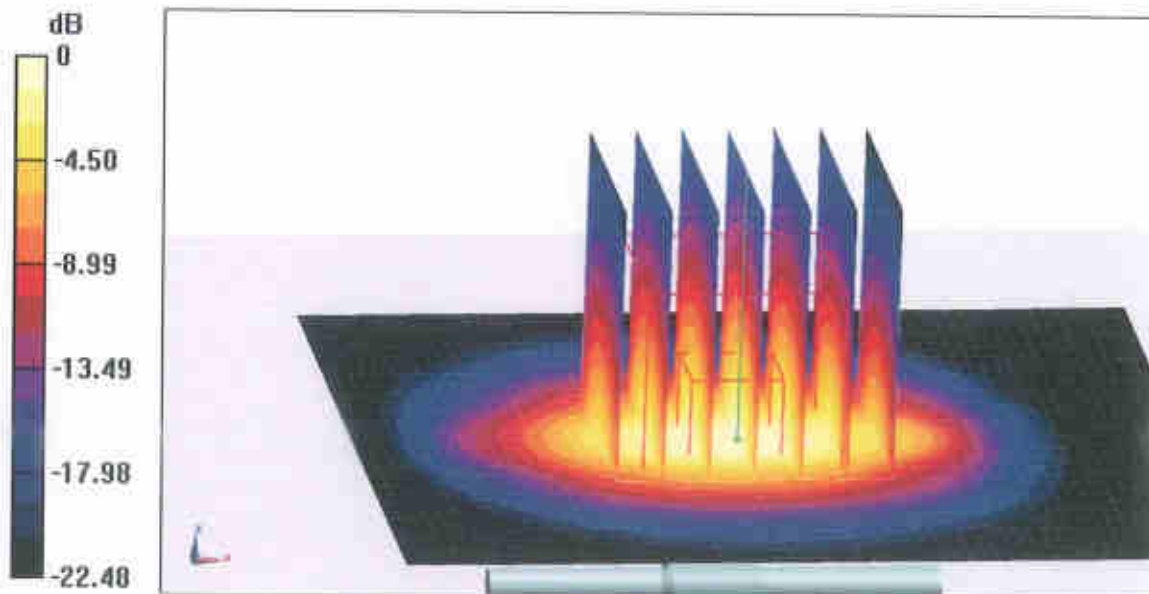

0 dB = 21.7 W/kg = 13.36 dBW/kg



Add: No.51 Xueyuan Road, Haidian District, Beijing, 100191, China
Tel: +86-10-62304633-2079 Fax: +86-10-62304633-2504
E-mail: cttl@chinattl.com Http://www.chinattl.cn

Impedance Measurement Plot for Head TSL

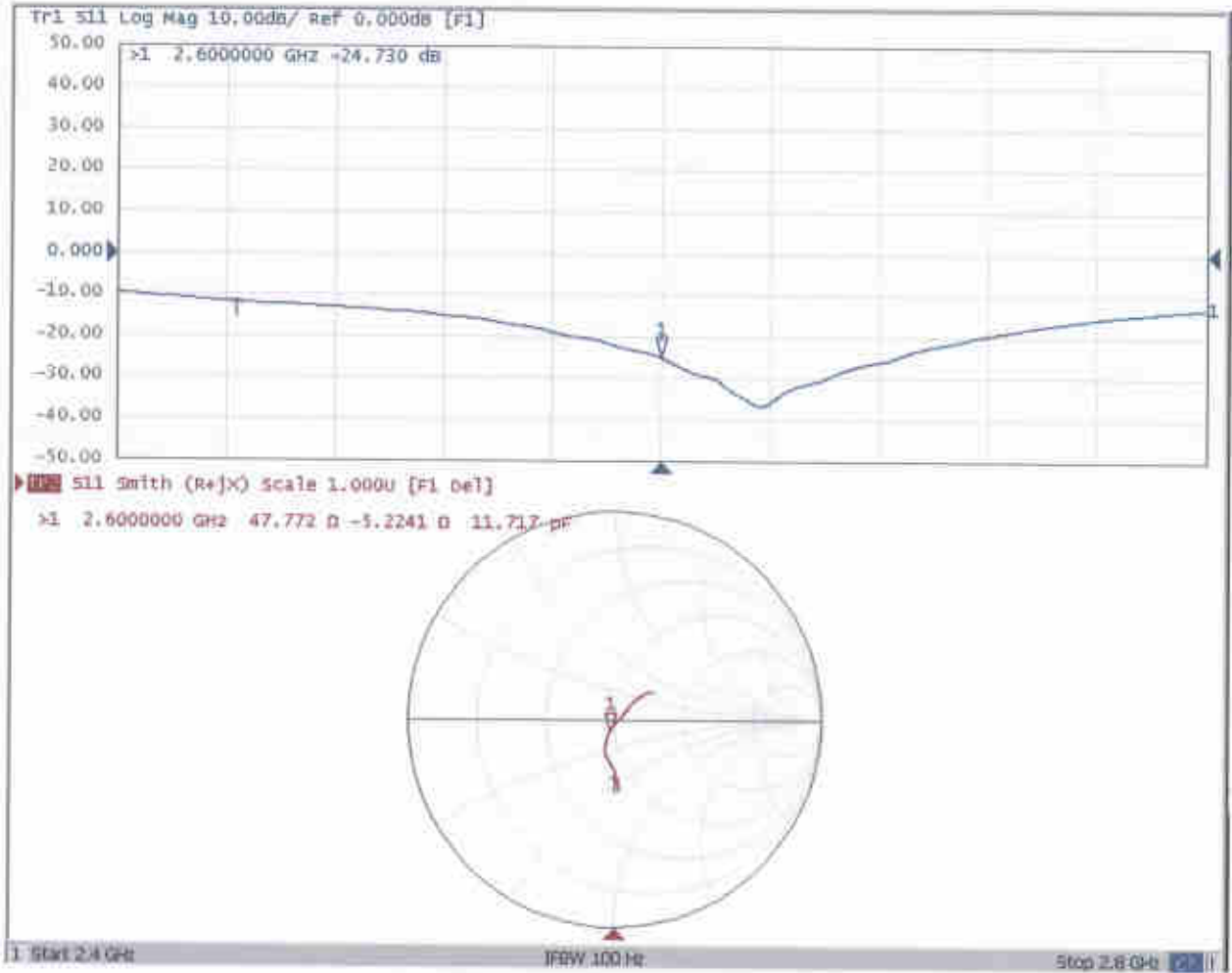



Add: No.51 Xueyuan Road, Haidian District, Beijing, 100191, China
Tel: +86-10-62304633-2079 Fax: +86-10-62304633-2504
E-mail: cttl@chinattl.com Http://www.chinattl.cn

DASY5 Validation Report for Body TSL

Date: 11.24.2016

Test Laboratory: CTTL, Beijing, China

DUT: Dipole 2600 MHz; Type: D2600V2; Serial: D2600V2 - SN: 1070

Communication System: UID 0, CW; Frequency: 2600 MHz; Duty Cycle: 1:1

Medium parameters used: $f = 2600$ MHz; $\sigma = 2.173$ S/m; $\epsilon_r = 52.13$; $\rho = 1000$ kg/m³

Phantom section: Left Section

Measurement Standard: DASY5 (IEEE/IEC/ANSI C63.19-2007)

DASY5 Configuration:

- Probe: EX3DV4 - SN7433; ConvF(7.22, 7.22,7.22); Calibrated: 9/26/2016;
- Sensor-Surface: 2mm (Mechanical Surface Detection)
- Electronics: DAE4 Sn771; Calibrated: 2/2/2016
- Phantom: Triple Flat Phantom 5.1C; Type: QD 000 P51 CA; Serial: 1161/1
- Measurement SW: DASY52, Version 52.8 (8); SEMCAD X Version 14.6.10 (7372)

Dipole Calibration/Zoom Scan (7x7x7) (7x7x7)/Cube 0: Measurement grid: dx=5mm, dy=5mm, dz=5mm

Reference Value = 100.5 V/m; Power Drift = -0.03 dB

Peak SAR (extrapolated) = 28.1 W/kg

SAR(1 g) = 13.9 W/kg; SAR(10 g) = 6.36 W/kg

Maximum value of SAR (measured) = 21.3 W/kg



0 dB = 21.3 W/kg = 13.28 dBW/kg



Add: No.51 Xueyuan Road, Haidian District, Beijing, 100191, China
Tel: +86-10-62304633-2079 Fax: +86-10-62304633-2504
E-mail: cttl@chinattl.com Http://www.chinattl.cn

Impedance Measurement Plot for Body TSL

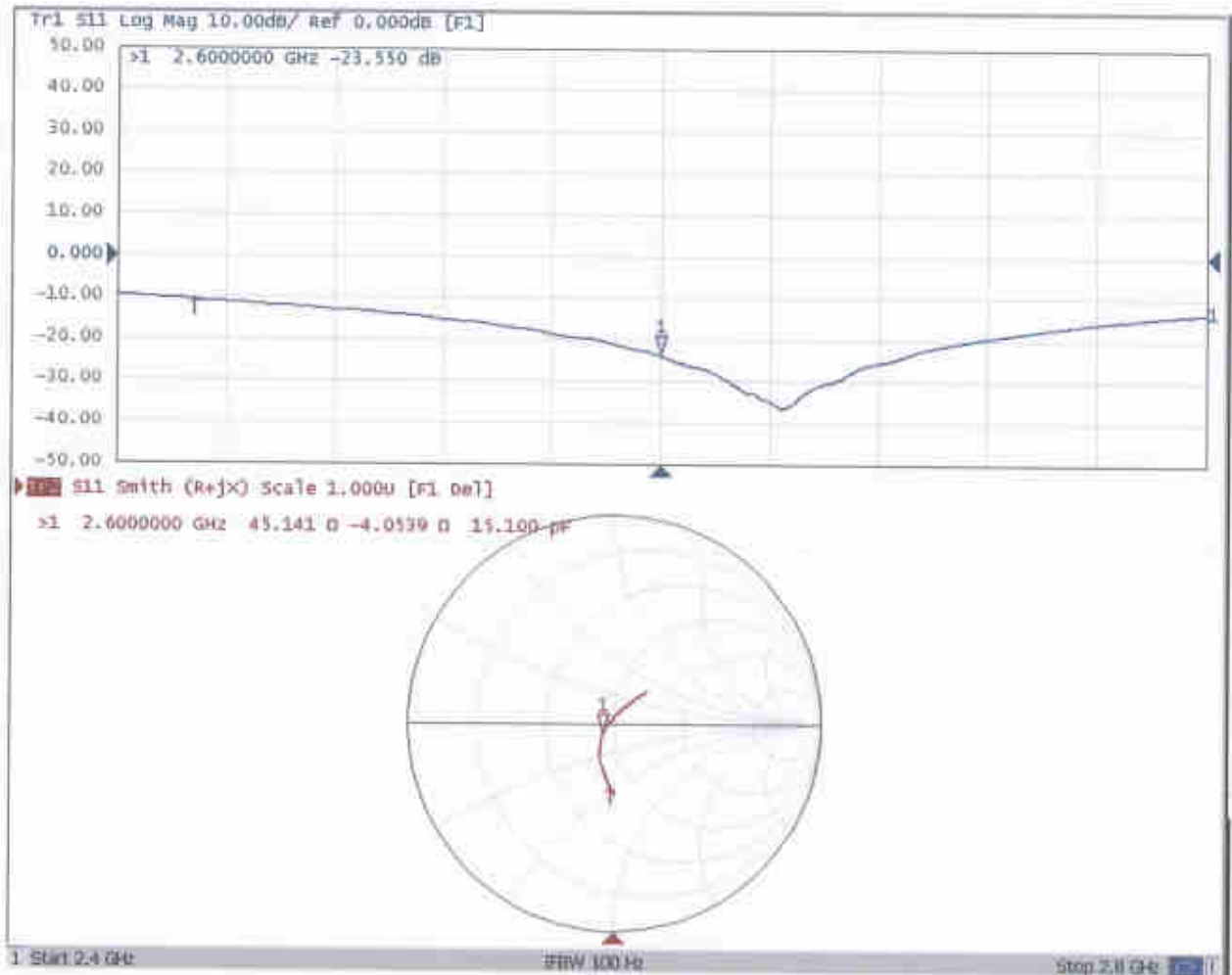

1338

IMPORTANT NOTICE

USAGE OF THE DAE 4

The DAE unit is a delicate, high precision instrument and requires careful treatment by the user. There are no serviceable parts inside the DAE. Special attention shall be given to the following points:

Battery Exchange: The battery cover of the DAE4 unit is closed using a screw, over tightening the screw may cause the threads inside the DAE to wear out.

Shipping of the DAE: Before shipping the DAE to SPEAG for calibration, remove the batteries and pack the DAE in an antistatic bag. This antistatic bag shall then be packed into a larger box or container which protects the DAE from impacts during transportation. The package shall be marked to indicate that a fragile instrument is inside.

E-Stop Failures: Touch detection may be malfunctioning due to broken magnets in the E-stop. Rough handling of the E-stop may lead to damage of these magnets. Touch and collision errors are often caused by dust and dirt accumulated in the E-stop. To prevent E-stop failure, the customer shall always mount the probe to the DAE carefully and keep the DAE unit in a non-dusty environment if not used for measurements.

Repair: Minor repairs are performed at no extra cost during the annual calibration. However, SPEAG reserves the right to charge for any repair especially if rough unprofessional handling caused the defect.

DASY Configuration Files: Since the exact values of the DAE input resistances, as measured during the calibration procedure of a DAE unit, are not used by the DASY software, a nominal value of 200 MOhm is given in the corresponding configuration file.

Important Note:

Warranty and calibration is void if the DAE unit is disassembled partly or fully by the Customer.

Important Note:

Never attempt to grease or oil the E-stop assembly. Cleaning and readjusting of the E-stop assembly is allowed by certified SPEAG personnel only and is part of the annual calibration procedure.

Important Note:

To prevent damage of the DAE probe connector pins, use great care when installing the probe to the DAE. Carefully connect the probe with the connector notch oriented in the mating position. Avoid any rotational movement of the probe body versus the DAE while turning the locking nut of the connector. The same care shall be used when disconnecting the probe from the DAE.



Accredited by the Swiss Accreditation Service (SAS)
The Swiss Accreditation Service is one of the signatories to the EA
Multilateral Agreement for the recognition of calibration certificates

Accreditation No.: **SCS 0108**

Client **Sporton - SZ (Auden)**

Certificate No: **DAE4-1338_Nov16**

CALIBRATION CERTIFICATE

Object **DAE4 - SD 000 D04 BM - SN: 1338**

Calibration procedure(s) **QA CAL-06.v29
Calibration procedure for the data acquisition electronics (DAE)**

Calibration date: **November 22, 2016**

This calibration certificate documents the traceability to national standards, which realize the physical units of measurements (SI).
The measurements and the uncertainties with confidence probability are given on the following pages and are part of the certificate.

All calibrations have been conducted in the closed laboratory facility: environment temperature $(22 \pm 3)^{\circ}\text{C}$ and humidity $< 70\%$.

Calibration Equipment used (M&TE critical for calibration)

| Primary Standards | ID # | Cal Date (Certificate No.) | Scheduled Calibration |
|-------------------------------|--------------------|----------------------------|------------------------|
| Keithley Multimeter Type 2001 | SN: 0810278 | 09-Sep-16 (No:19065) | Sep-17 |
| Secondary Standards: | ID # | Check Date (in house) | Scheduled Check |
| Auto DAE Calibration Unit | SE UWS 053 AA 1001 | 05-Jan-16 (in house check) | In house check: Jan-17 |
| Calibrator Box V2.1 | SE UMS 006 AA 1002 | 05-Jan-16 (in house check) | In house check: Jan-17 |

| | | | |
|----------------|-------------------------------|--------------------------------------|---------------|
| Calibrated by: | Name Adrian Gehring | Function Technician | Signature |
| Approved by: | Name Fin Bomholt | Function Deputy Technical Manager | Signature |

Issued: November 22, 2016

This calibration certificate shall not be reproduced except in full without written approval of the laboratory.



Accredited by the Swiss Accreditation Service (SAS)

The Swiss Accreditation Service is one of the signatories to the EA
Multilateral Agreement for the recognition of calibration certificates

Accreditation No.: **SCS 0108**

Glossary

| | |
|-----------------|---|
| DAE | data acquisition electronics |
| Connector angle | information used in DASY system to align probe sensor X to the robot coordinate system. |

Methods Applied and Interpretation of Parameters

- *DC Voltage Measurement:* Calibration Factor assessed for use in DASY system by comparison with a calibrated instrument traceable to national standards. The figure given corresponds to the full scale range of the voltmeter in the respective range.
- *Connector angle:* The angle of the connector is assessed measuring the angle mechanically by a tool inserted. Uncertainty is not required.
- The following parameters as documented in the Appendix contain technical information as a result from the performance test and require no uncertainty.
 - *DC Voltage Measurement Linearity:* Verification of the Linearity at +10% and -10% of the nominal calibration voltage. Influence of offset voltage is included in this measurement.
 - *Common mode sensitivity:* Influence of a positive or negative common mode voltage on the differential measurement.
 - *Channel separation:* Influence of a voltage on the neighbor channels not subject to an input voltage.
 - *AD Converter Values with inputs shorted:* Values on the internal AD converter corresponding to zero input voltage
 - *Input Offset Measurement:* Output voltage and statistical results over a large number of zero voltage measurements.
 - *Input Offset Current:* Typical value for information; Maximum channel input offset current, not considering the input resistance.
 - *Input resistance:* Typical value for information; DAE input resistance at the connector, during internal auto-zeroing and during measurement.
 - *Low Battery Alarm Voltage:* Typical value for information. Below this voltage, a battery alarm signal is generated.
 - *Power consumption:* Typical value for information. Supply currents in various operating modes.

DC Voltage Measurement

A/D - Converter Resolution nominal

High Range: 1LSB = 6.1 μ V, full range = -100...+300 mV
Low Range: 1LSB = 61nV, full range = -1.....+3mV

DASY measurement parameters: Auto Zero Time: 3 sec; Measuring time: 3 sec

| Calibration Factors | X | Y | Z |
|---------------------|---------------------------|---------------------------|---------------------------|
| High Range | 403.674 \pm 0.02% (k=2) | 404.250 \pm 0.02% (k=2) | 404.207 \pm 0.02% (k=2) |
| Low Range | 3.97238 \pm 1.50% (k=2) | 3.97905 \pm 1.50% (k=2) | 3.97471 \pm 1.50% (k=2) |

Connector Angle

| | |
|---|------------------------------------|
| Connector Angle to be used in DASY system | 62.0 $^{\circ}$ \pm 1 $^{\circ}$ |
|---|------------------------------------|

Appendix (Additional assessments outside the scope of SCS0108)

1. DC Voltage Linearity

| High Range | | Reading (μV) | Difference (μV) | Error (%) |
|------------|---------|---------------------------|------------------------------|-----------|
| Channel X | + Input | 199996.77 | 0.71 | 0.00 |
| Channel X | + Input | 20002.26 | 0.91 | 0.00 |
| Channel X | - Input | -20000.38 | 0.70 | -0.00 |
| Channel Y | + Input | 199996.98 | 1.32 | 0.00 |
| Channel Y | + Input | 19999.89 | -1.32 | -0.01 |
| Channel Y | - Input | -20003.36 | -2.29 | 0.01 |
| Channel Z | + Input | 199997.81 | 1.86 | 0.00 |
| Channel Z | + Input | 20001.76 | 0.52 | 0.00 |
| Channel Z | - Input | -20002.73 | -1.59 | 0.01 |

| Low Range | | Reading (μV) | Difference (μV) | Error (%) |
|-----------|---------|---------------------------|------------------------------|-----------|
| Channel X | + Input | 2001.72 | 0.37 | 0.02 |
| Channel X | + Input | 201.83 | 0.23 | 0.11 |
| Channel X | - Input | -197.67 | 0.66 | -0.33 |
| Channel Y | + Input | 2001.35 | -0.07 | -0.00 |
| Channel Y | + Input | 200.56 | -1.07 | -0.53 |
| Channel Y | - Input | -199.76 | -1.41 | 0.71 |
| Channel Z | + Input | 2001.21 | -0.12 | -0.01 |
| Channel Z | + Input | 200.89 | -0.61 | -0.30 |
| Channel Z | - Input | -199.38 | -0.88 | 0.44 |

2. Common mode sensitivity

DASY measurement parameters: Auto Zero Time: 3 sec; Measuring time: 3 sec

| | Common mode Input Voltage (mV) | High Range Average Reading (μV) | Low Range Average Reading (μV) |
|-----------|--------------------------------|--|---|
| Channel X | 200 | 7.57 | 6.75 |
| | - 200 | -5.52 | -6.95 |
| Channel Y | 200 | -21.81 | -21.79 |
| | - 200 | 20.05 | 19.45 |
| Channel Z | 200 | -2.35 | -2.47 |
| | - 200 | 0.80 | 0.82 |

3. Channel separation

DASY measurement parameters: Auto Zero Time: 3 sec; Measuring time: 3 sec

| | Input Voltage (mV) | Channel X (μV) | Channel Y (μV) | Channel Z (μV) |
|-----------|--------------------|-----------------------------|-----------------------------|-----------------------------|
| Channel X | 200 | - | 2.79 | -3.02 |
| Channel Y | 200 | 8.38 | - | 5.71 |
| Channel Z | 200 | 9.27 | 5.72 | - |

4. AD-Converter Values with inputs shorted

DASY measurement parameters: Auto Zero Time: 3 sec; Measuring time: 3 sec

| | High Range (LSB) | Low Range (LSB) |
|-----------|------------------|-----------------|
| Channel X | 16201 | 15043 |
| Channel Y | 16281 | 15799 |
| Channel Z | 16108 | 15449 |

5. Input Offset Measurement

DASY measurement parameters: Auto Zero Time: 3 sec; Measuring time: 3 sec

Input 10M Ω

| | Average (μ V) | min. Offset (μ V) | max. Offset (μ V) | Std. Deviation (μ V) |
|-----------|--------------------|------------------------|------------------------|---------------------------|
| Channel X | 1.34 | 0.13 | 2.66 | 0.51 |
| Channel Y | -0.17 | -1.21 | 1.45 | 0.49 |
| Channel Z | -0.51 | -1.57 | 0.55 | 0.45 |

6. Input Offset Current

Nominal Input circuitry offset current on all channels: <25fA

7. Input Resistance (Typical values for information)

| | Zeroing (kOhm) | Measuring (MOhm) |
|-----------|----------------|------------------|
| Channel X | 200 | 200 |
| Channel Y | 200 | 200 |
| Channel Z | 200 | 200 |

8. Low Battery Alarm Voltage (Typical values for information)

| Typical values | Alarm Level (VDC) |
|----------------|-------------------|
| Supply (+ Vcc) | +7.9 |
| Supply (- Vcc) | -7.6 |

9. Power Consumption (Typical values for information)

| Typical values | Switched off (mA) | Stand by (mA) | Transmitting (mA) |
|----------------|-------------------|---------------|-------------------|
| Supply (+ Vcc) | +0.01 | +6 | +14 |
| Supply (- Vcc) | -0.01 | -8 | -9 |



Add: No.51 Xueyuan Road, Haidian District, Beijing, 100191, China
Tel: +86-10-62304633-2218 Fax: +86-10-62304633-2209
E-mail: cttl@chinattl.com Http://www.chinattl.cn

Client

Sporton International INC

Certificate No: **Z17-97151**

CALIBRATION CERTIFICATE

Object **EX3DV4 - SN:3642**

Calibration Procedure(s) **FF-Z11-004-01**
Calibration Procedures for Dosimetric E-field Probes

Calibration date: **September 25, 2017**

This calibration Certificate documents the traceability to national standards, which realize the physical units of measurements(SI). The measurements and the uncertainties with confidence probability are given on the following pages and are part of the certificate.

All calibrations have been conducted in the closed laboratory facility: environment temperature(22±3)°C and humidity<70%.

Calibration Equipment used (M&TE critical for calibration)

| Primary Standards | ID # | Cal Date(Calibrated by, Certificate No.) | Scheduled Calibration |
|-------------------------|-------------|--|-----------------------|
| Power Meter NRP2 | 101919 | 27-Jun-17 (CTTL, No.J17X05857) | Jun-18 |
| Power sensor NRP-Z91 | 101547 | 27-Jun-17 (CTTL, No.J17X05857) | Jun-18 |
| Power sensor NRP-Z91 | 101548 | 27-Jun-17 (CTTL, No.J17X05857) | Jun-18 |
| Reference10dBAttenuator | 18N50W-10dB | 13-Mar-16(CTTL, No.J16X01547) | Mar-18 |
| Reference20dBAttenuator | 18N50W-20dB | 13-Mar-16(CTTL, No.J16X01548) | Mar-18 |
| Reference Probe EX3DV4 | SN 7433 | 26-Sep-16(SPEAG, No.EX3-7433_Sep16) | Sep-17 |
| DAE4 | SN 549 | 13-Dec-16(SPEAG, No.DAE4-549_Dec16) | Dec -17 |
| Secondary Standards | ID # | Cal Date(Calibrated by, Certificate No.) | Scheduled Calibration |
| SignalGeneratorMG3700A | 6201052605 | 27-Jun-17 (CTTL, No.J17X05858) | Jun-18 |
| Network Analyzer E5071C | MY46110673 | 13-Jan-17 (CTTL, No.J17X00285) | Jan -18 |

| | Name | Function | Signature |
|----------------|-------------|--------------------|-----------|
| Calibrated by: | Yu Zongying | SAR Test Engineer | |
| Reviewed by: | Zhao Jing | SAR Test Engineer | |
| Approved by: | Qi Dianyuan | SAR Project Leader | |

Issued: September 27, 2017

This calibration certificate shall not be reproduced except in full without written approval of the laboratory.



Glossary:

| | |
|-----------------------|---|
| TSL | tissue simulating liquid |
| NORM _{x,y,z} | sensitivity in free space |
| ConvF | sensitivity in TSL / NORM _{x,y,z} |
| DCP | diode compression point |
| CF | crest factor (1/duty_cycle) of the RF signal |
| A,B,C,D | modulation dependent linearization parameters |
| Polarization Φ | Φ rotation around probe axis |
| Polarization θ | θ rotation around an axis that is in the plane normal to probe axis (at measurement center), $\theta=0$ is normal to probe axis |

Connector Angle information used in DASY system to align probe sensor X to the robot coordinate system

Calibration is Performed According to the Following Standards:

- IEEE Std 1528-2013, "IEEE Recommended Practice for Determining the Peak Spatial-Averaged Specific Absorption Rate (SAR) in the Human Head from Wireless Communications Devices: Measurement Techniques", June 2013
- IEC 62209-1, "Measurement procedure for the assessment of Specific Absorption Rate (SAR) from hand-held and body-mounted devices used next to the ear (frequency range of 300 MHz to 6 GHz)", July 2016
- IEC 62209-2, "Procedure to determine the Specific Absorption Rate (SAR) for wireless communication devices used in close proximity to the human body (frequency range of 30 MHz to 6 GHz)", March 2010
- KDB 865664, "SAR Measurement Requirements for 100 MHz to 6 GHz"

Methods Applied and Interpretation of Parameters:

- NORM_{x,y,z}**: Assessed for E-field polarization $\theta=0$ ($f \leq 900\text{MHz}$ in TEM-cell; $f > 1800\text{MHz}$: waveguide). NORM_{x,y,z} are only intermediate values, i.e., the uncertainties of NORM_{x,y,z} does not effect the E^2 -field uncertainty inside TSL (see below ConvF).
- NORM(f)_{x,y,z}** = NORM_{x,y,z} * frequency_response (see Frequency Response Chart). This linearization is implemented in DASY4 software versions later than 4.2. The uncertainty of the frequency response is included in the stated uncertainty of ConvF.
- DCP_{x,y,z}**: DCP are numerical linearization parameters assessed based on the data of power sweep (no uncertainty required). DCP does not depend on frequency nor media.
- PAR**: PAR is the Peak to Average Ratio that is not calibrated but determined based on the signal characteristics.
- A_{x,y,z}; B_{x,y,z}; C_{x,y,z}; VR_{x,y,z}**: A,B,C are numerical linearization parameters assessed based on the data of power sweep for specific modulation signal. The parameters do not depend on frequency nor media. VR is the maximum calibration range expressed in RMS voltage across the diode.
- ConvF and Boundary Effect Parameters**: Assessed in flat phantom using E-field (or Temperature Transfer Standard for $f \leq 800\text{MHz}$) and inside waveguide using analytical field distributions based on power measurements for $f > 800\text{MHz}$. The same setups are used for assessment of the parameters applied for boundary compensation (alpha, depth) of which typical uncertainty valued are given. These parameters are used in DASY4 software to improve probe accuracy close to the boundary. The sensitivity in TSL corresponds to NORM_{x,y,z} * ConvF whereby the uncertainty corresponds to that given for ConvF. A frequency dependent ConvF is used in DASY version 4.4 and higher which allows extending the validity from $\pm 50\text{MHz}$ to $\pm 100\text{MHz}$.
- Spherical isotropy (3D deviation from isotropy)**: in a field of low gradients realized using a flat phantom exposed by a patch antenna.
- Sensor Offset**: The sensor offset corresponds to the offset of virtual measurement center from the probe tip (on probe axis). No tolerance required.
- Connector Angle**: The angle is assessed using the information gained by determining the NORM_x (no uncertainty required).



In Collaboration with

s p e a g

CALIBRATION LABORATORY

Add: No.51 Xueyuan Road, Haidian District, Beijing, 100191, China

Tel: +86-10-62304633-2218

Fax: +86-10-62304633-2209

E-mail: ctl@chinattl.com

[Http://www.chinattl.cn](http://www.chinattl.cn)

Probe EX3DV4

SN: 3642

Calibrated: September 25, 2017

Calibrated for DASY/EASY Systems

(Note: non-compatible with DASY2 system!)



DASY/EASY – Parameters of Probe: EX3DV4 – SN: 3642

Basic Calibration Parameters

| | Sensor X | Sensor Y | Sensor Z | Unc (k=2) |
|--|----------|----------|----------|--------------|
| Norm($\mu\text{V}/(\text{V}/\text{m})^2$) ^A | 0.31 | 0.34 | 0.36 | $\pm 10.0\%$ |
| DCP(mV) ^B | 98.8 | 100.9 | 103.4 | |

Modulation Calibration Parameters

| UID | Communication System Name | | A dB | B dB $\sqrt{\mu\text{V}}$ | C | D dB | VR mV | Unc ^E (k=2) |
|-----|---------------------------|---|------|---------------------------|-----|------|-------|------------------------|
| 0 | CW | X | 0.0 | 0.0 | 1.0 | 0.00 | 135.1 | $\pm 2.3\%$ |
| | | Y | 0.0 | 0.0 | 1.0 | | 142.2 | |
| | | Z | 0.0 | 0.0 | 1.0 | | 152.2 | |

The reported uncertainty of measurement is stated as the standard uncertainty of Measurement multiplied by the coverage factor k=2, which for a normal distribution Corresponds to a coverage probability of approximately 95%.

^A The uncertainties of Norm X, Y, Z do not affect the E²-field uncertainty inside TSL (see Page 5 and Page 6).

^B Numerical linearization parameter: uncertainty not required.

^E Uncertainty is determined using the max. deviation from linear response applying rectangular distribution and is expressed for the square of the field value.



In Collaboration with

s p e a g
CALIBRATION LABORATORY

Add: No.51 Xueyuan Road, Haidian District, Beijing, 100191, China
 Tel: +86-10-62304633-2218 Fax: +86-10-62304633-2209
 E-mail: cttl@chinattl.com [Http://www.chinattl.cn](http://www.chinattl.cn)

DASY/EASY – Parameters of Probe: EX3DV4 – SN: 3642

Calibration Parameter Determined in Head Tissue Simulating Media

| f [MHz] ^C | Relative Permittivity ^F | Conductivity (S/m) ^F | ConvF X | ConvF Y | ConvF Z | Alpha ^G | Depth ^G (mm) | Unct. (k=2) |
|----------------------|------------------------------------|---------------------------------|---------|---------|---------|--------------------|-------------------------|-------------|
| 750 | 41.9 | 0.89 | 9.20 | 9.20 | 9.20 | 0.32 | 0.80 | ± 12.1% |
| 835 | 41.5 | 0.90 | 9.04 | 9.04 | 9.04 | 0.29 | 0.93 | ± 12.1% |
| 900 | 41.5 | 0.97 | 9.00 | 9.00 | 9.00 | 0.18 | 1.23 | ± 12.1% |
| 1750 | 40.1 | 1.37 | 7.75 | 7.75 | 7.75 | 0.20 | 1.17 | ± 12.1% |
| 1900 | 40.0 | 1.40 | 7.59 | 7.59 | 7.59 | 0.21 | 1.17 | ± 12.1% |
| 2000 | 40.0 | 1.40 | 7.40 | 7.40 | 7.40 | 0.15 | 1.48 | ± 12.1% |
| 2300 | 39.5 | 1.67 | 7.35 | 7.35 | 7.35 | 0.46 | 0.77 | ± 12.1% |
| 2450 | 39.2 | 1.80 | 7.25 | 7.25 | 7.25 | 0.49 | 0.76 | ± 12.1% |
| 2600 | 39.0 | 1.96 | 6.90 | 6.90 | 6.90 | 0.60 | 0.70 | ± 12.1% |

^C Frequency validity above 300 MHz of ±100MHz only applies for DASY v4.4 and higher (Page 2), else it is restricted to ±50MHz. The uncertainty is the RSS of ConvF uncertainty at calibration frequency and the uncertainty for the indicated frequency band. Frequency validity below 300 MHz is ± 10, 25, 40, 50 and 70 MHz for ConvF assessments at 30, 64, 128, 150 and 220 MHz respectively. Above 5 GHz frequency validity can be extended to ± 110 MHz.

^F At frequency below 3 GHz, the validity of tissue parameters (ϵ and σ) can be relaxed to ±10% if liquid compensation formula is applied to measured SAR values. At frequencies above 3 GHz, the validity of tissue parameters (ϵ and σ) is restricted to ±5%. The uncertainty is the RSS of the ConvF uncertainty for indicated target tissue parameters.

^G Alpha/Depth are determined during calibration. SPEAG warrants that the remaining deviation due to the boundary effect after compensation is always less than ± 1% for frequencies below 3 GHz and below ± 2% for the frequencies between 3-6 GHz at any distance larger than half the probe tip diameter from the boundary.



DASY/EASY – Parameters of Probe: EX3DV4 – SN: 3642

Calibration Parameter Determined in Body Tissue Simulating Media

| f [MHz] ^C | Relative Permittivity ^F | Conductivity (S/m) ^F | ConvF X | ConvF Y | ConvF Z | Alpha ^G | Depth ^G (mm) | Unct. (k=2) |
|----------------------|------------------------------------|---------------------------------|---------|---------|---------|--------------------|-------------------------|-------------|
| 750 | 55.5 | 0.96 | 9.35 | 9.35 | 9.35 | 0.40 | 0.85 | ± 12.1% |
| 835 | 55.2 | 0.97 | 9.06 | 9.06 | 9.06 | 0.23 | 1.18 | ± 12.1% |
| 1750 | 53.4 | 1.49 | 7.55 | 7.55 | 7.55 | 0.22 | 1.16 | ± 12.1% |
| 1900 | 53.3 | 1.52 | 7.58 | 7.58 | 7.58 | 0.16 | 1.00 | ± 12.1% |
| 2300 | 52.9 | 1.81 | 7.19 | 7.19 | 7.19 | 0.51 | 0.81 | ± 12.1% |
| 2450 | 52.7 | 1.95 | 7.09 | 7.09 | 7.09 | 0.38 | 1.02 | ± 12.1% |
| 2600 | 52.5 | 2.16 | 6.80 | 6.80 | 6.80 | 0.46 | 0.82 | ± 12.1% |

^C Frequency validity above 300 MHz of ±100MHz only applies for DASY v4.4 and higher (Page 2), else it is restricted to ±50MHz. The uncertainty is the RSS of ConvF uncertainty at calibration frequency and the uncertainty for the indicated frequency band. Frequency validity below 300 MHz is ± 10, 25, 40, 50 and 70 MHz for ConvF assessments at 30, 64, 128, 150 and 220 MHz respectively. Above 5 GHz frequency validity can be extended to ± 110 MHz.

^F At frequency below 3 GHz, the validity of tissue parameters (ϵ and σ) can be relaxed to ±10% if liquid compensation formula is applied to measured SAR values. At frequencies above 3 GHz, the validity of tissue parameters (ϵ and σ) is restricted to ±5%. The uncertainty is the RSS of the ConvF uncertainty for indicated target tissue parameters.

^G Alpha/Depth are determined during calibration. SPEAG warrants that the remaining deviation due to the boundary effect after compensation is always less than ± 1% for frequencies below 3 GHz and below ± 2% for the frequencies between 3-6 GHz at any distance larger than half the probe tip diameter from the boundary.



Add: No.51 Xueyuan Road, Haidian District, Beijing, 100191, China
Tel: +86-10-62304633-2218 Fax: +86-10-62304633-2209
E-mail: cttl@chinattl.com [Http://www.chinattl.cn](http://www.chinattl.cn)

Frequency Response of E-Field (TEM-Cell: ifi110 EXX, Waveguide: R22)

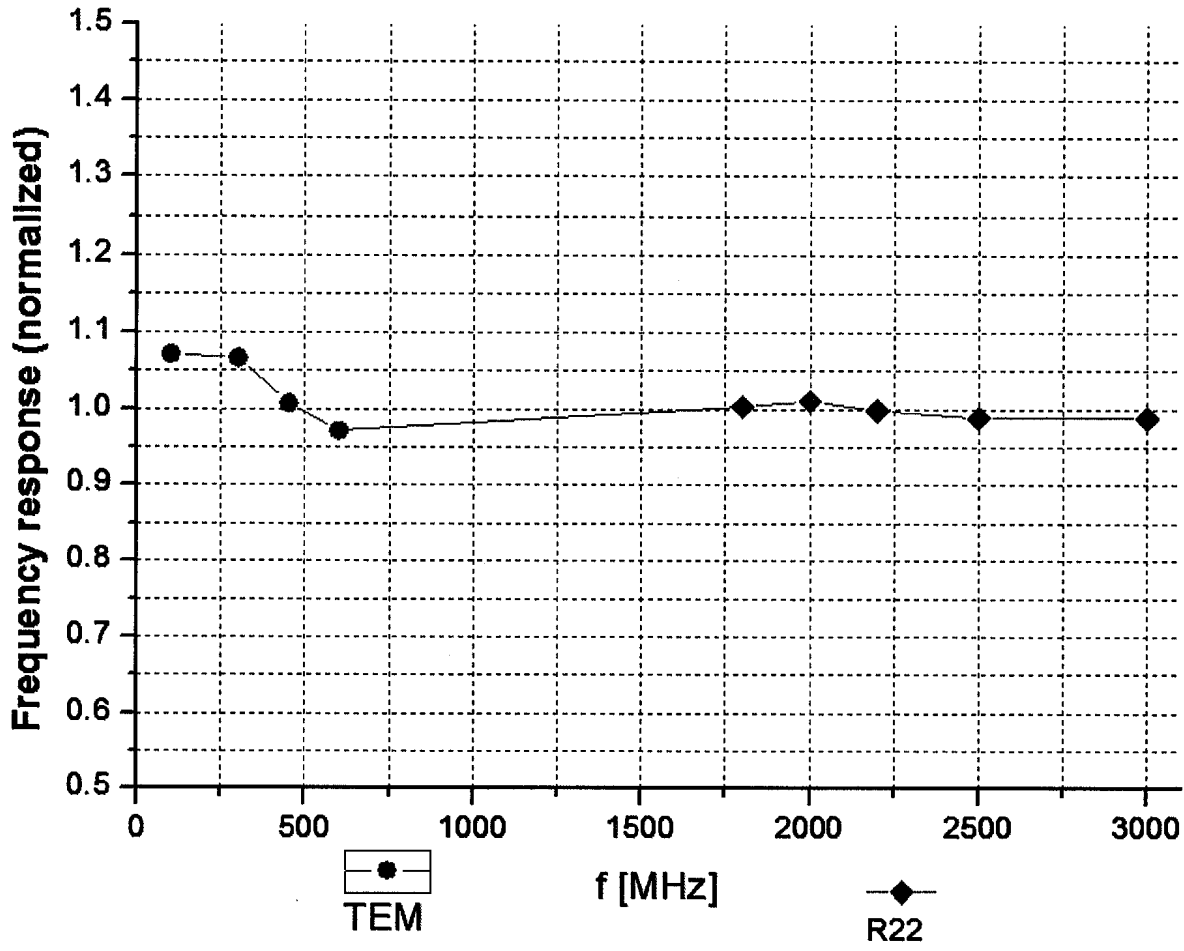

Uncertainty of Frequency Response of E-field: $\pm 7.4\%$ (k=2)



Add: No.51 Xueyuan Road, Haidian District, Beijing, 100191, China
 Tel: +86-10-62304633-2218 Fax: +86-10-62304633-2209
 E-mail: cttl@chinattl.com [Http://www.chinattl.cn](http://www.chinattl.cn)

Receiving Pattern (Φ), $\theta=0^\circ$

f=600 MHz, TEM

f=1800 MHz, R22

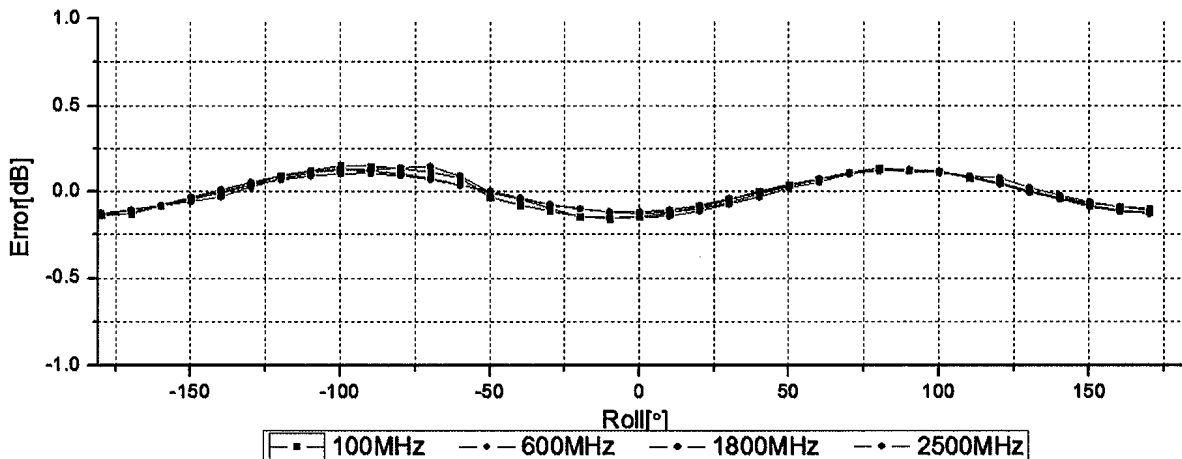
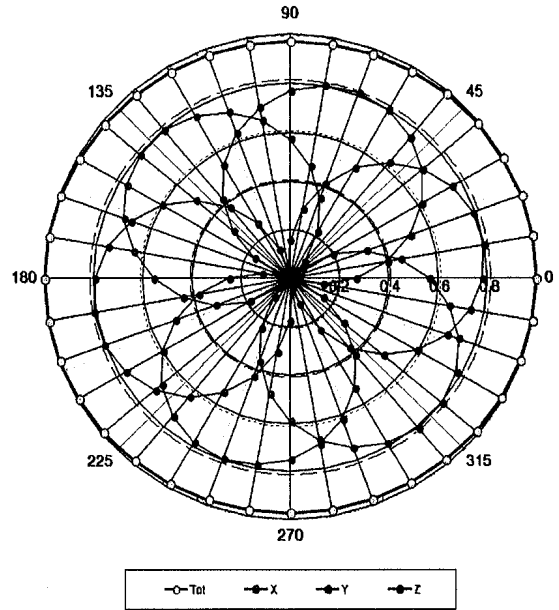
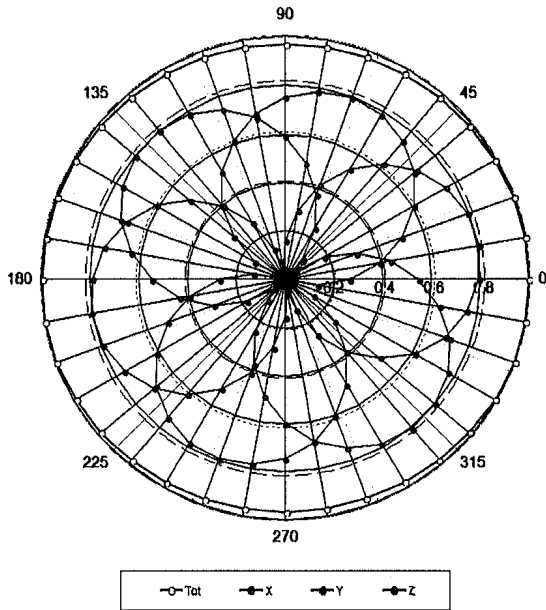

Uncertainty of Axial Isotropy Assessment: $\pm 1.2\%$ (k=2)



Dynamic Range f(SAR_{head}) (TEM cell, f = 900 MHz)

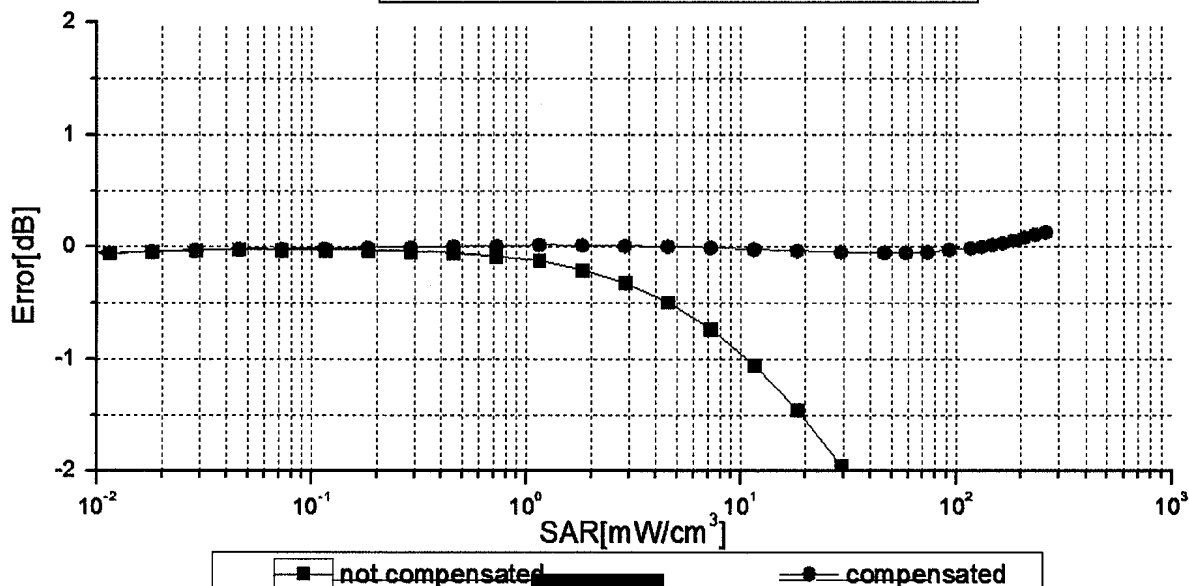
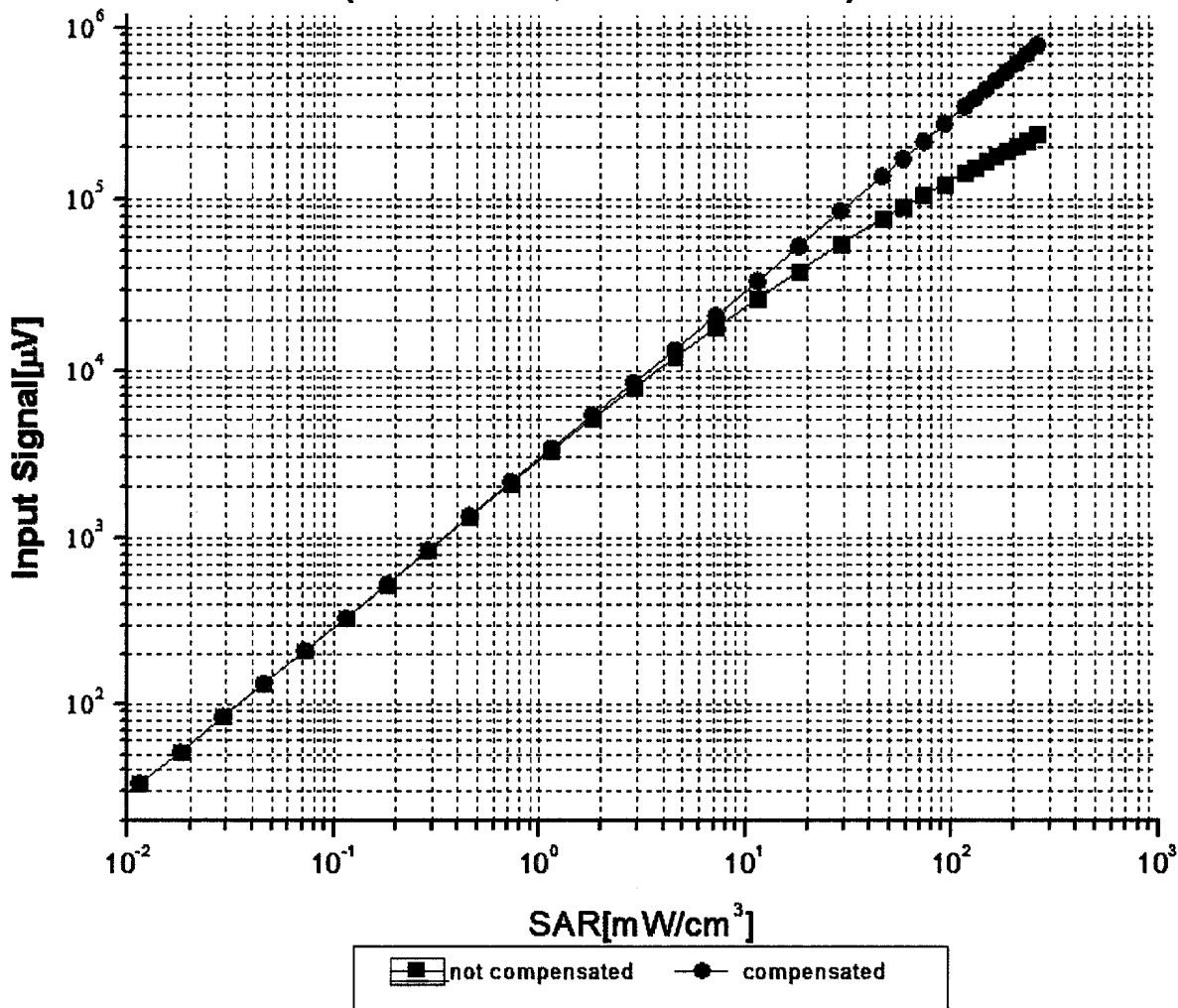

Uncertainty of Linearity Assessment: ±0.9% (k=2)



Conversion Factor Assessment

f=835 MHz, WGLS R9(H_convF)

f=1750 MHz, WGLS R22(H_convF)

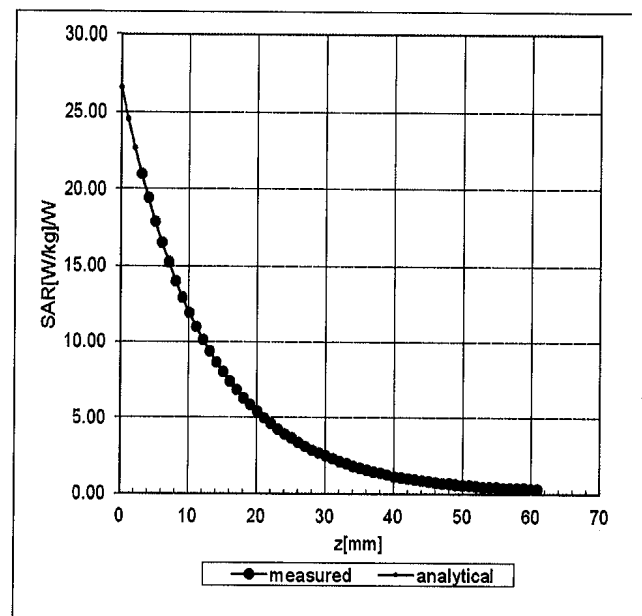
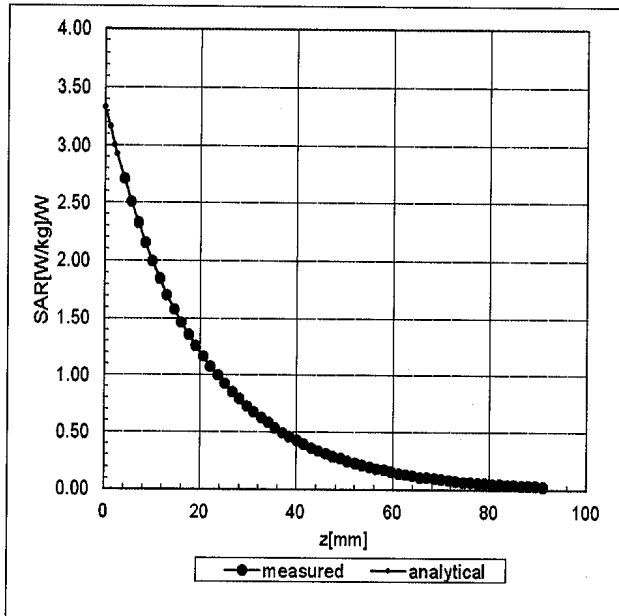

Deviation from Isotropy in Liquid

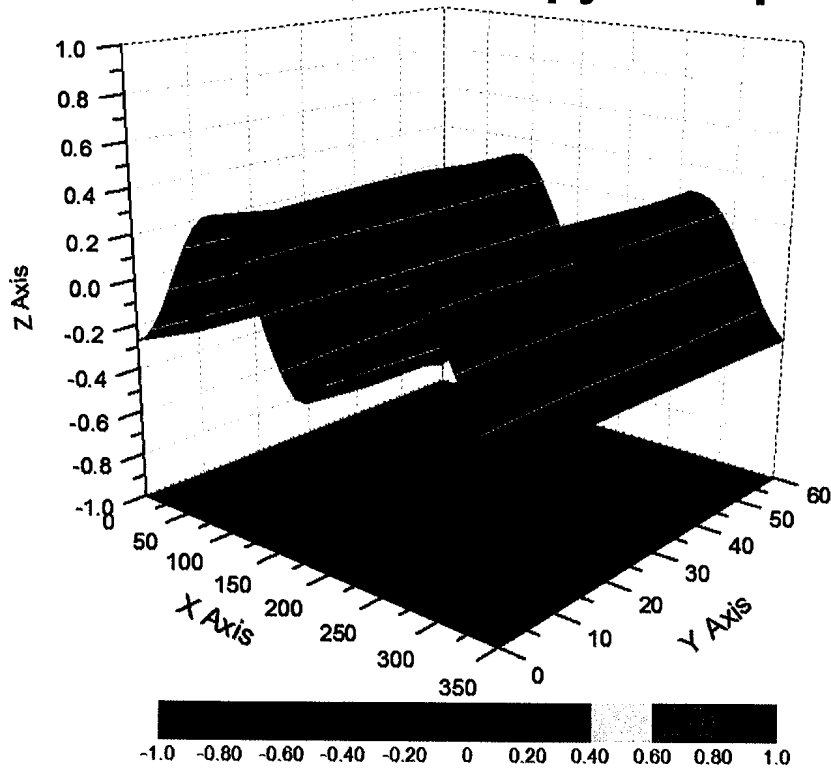

Uncertainty of Spherical Isotropy Assessment: $\pm 3.2\%$ (K=2)



Add: No.51 Xueyuan Road, Haidian District, Beijing, 100191, China
Tel: +86-10-62304633-2218 Fax: +86-10-62304633-2209
E-mail: cttl@chinattl.com [Http://www.chinattl.cn](http://www.chinattl.cn)

DASY/EASY – Parameters of Probe: EX3DV4 – SN: 3642

Other Probe Parameters

| | |
|--|-------------------|
| Sensor Arrangement | Triangular |
| Connector Angle (°) | 110 |
| Mechanical Surface Detection Mode | enabled |
| Optical Surface Detection Mode | disable |
| Probe Overall Length | 337mm |
| Probe Body Diameter | 10mm |
| Tip Length | 9mm |
| Tip Diameter | 2.5mm |
| Probe Tip to Sensor X Calibration Point | 1mm |
| Probe Tip to Sensor Y Calibration Point | 1mm |
| Probe Tip to Sensor Z Calibration Point | 1mm |
| Recommended Measurement Distance from Surface | 1.4mm |