

FCC SAR Test Report

APPLICANT : ASUSTeK COMPUTER INC.
EQUIPMENT : ASUS Phone (Mobile Phone)
BRAND NAME : ASUS
MODEL NAME : ASUS_X00HD
MARKETING NAME : ZC520KL
FCC ID : MSQX00HD
STANDARD : FCC 47 CFR Part 2 (2.1093)
ANSI/IEEE C95.1-1992
IEEE 1528-2013

We, Sporton International (Shenzhen) Inc., would like to declare that the tested sample has been evaluated in accordance with the procedures and had been in compliance with the applicable technical standards.

The test results in this report apply exclusively to the tested model / sample. Without written approval of Sporton International (Shenzhen) Inc., the test report shall not be reproduced except in full.



Approved by: Mark Qu / Manager



Sporton International (Shenzhen) Inc.

1/F, 2/F, Bldg 5, Shiling Industrial Zone, Xinwei Village, Xili, Nanshan Shenzhen City
Guangdong Province 518055 China



Table of Contents

1. Statement of Compliance 4
2. Administration Data 5
3. Guidance Applied..... 5
4. Equipment Under Test (EUT) Information 6
4.1 General Information 6
4.2 General LTE SAR Test and Reporting Considerations 7
5. RF Exposure Limits.....10
5.1 Uncontrolled Environment.....10
5.2 Controlled Environment.....10
6. Specific Absorption Rate (SAR).....11
6.1 Introduction 11
6.2 SAR Definition..... 11
7. System Description and Setup12
7.1 E-Field Probe13
7.2 Data Acquisition Electronics (DAE)13
7.3 Phantom.....14
7.4 Device Holder.....15
8. Measurement Procedures16
8.1 Spatial Peak SAR Evaluation16
8.2 Power Reference Measurement.....17
8.3 Area Scan17
8.4 Zoom Scan.....18
8.5 Volume Scan Procedures.....18
8.6 Power Drift Monitoring.....18
9. Test Equipment List19
10. System Verification20
10.1 Tissue Simulating Liquids.....20
10.2 Tissue Verification21
10.3 System Performance Check Results.....22
11. RF Exposure Positions23
11.1 Ear and handset reference point23
11.2 Definition of the cheek position.....24
11.3 Definition of the tilt position.....25
11.4 Body Worn Accessory26
11.5 Wireless Router.....26
12. Conducted RF Output Power (Unit: dBm).....27
13. Antenna Location57
14. SAR Test Results58
14.1 Head SAR60
14.2 Hotspot SAR64
14.3 Body Worn Accessory SAR.....68
14.4 Repeated SAR Measurement71
15. Simultaneous Transmission Analysis72
15.1 Head Exposure Conditions73
15.2 Hotspot Exposure Conditions.....75
15.3 Body-Worn Accessory Exposure Conditions77
16. Uncertainty Assessment79
17. References.....81
Appendix A. Plots of System Performance Check
Appendix B. Plots of High SAR Measurement
Appendix C. DASy Calibration Certificate
Appendix D. Test Setup Photos



Revision History

REPORT NO.	VERSION	DESCRIPTION	ISSUED DATE
FA752406	Rev. 01	Initial issue of report.	Aug. 28, 2017



1. Statement of Compliance

The maximum results of Specific Absorption Rate (SAR) found during testing for **ASUSTeK COMPUTER INC., ASUS Phone (Mobile Phone), ASUS_X00HD**, are as follows.

Equipment Class	Frequency Band		Highest SAR Summary			Highest Simultaneous Transmission 1g SAR (W/kg)
			Head (Separation 0mm)	Hotspot (Separation 10mm)	Body-worn (Separation 10mm)	
			1g SAR (W/kg)			
Licensed	GSM	GSM850	0.32	0.52	0.52	1.57
		GSM1900	0.33	0.66	0.66	
	WCDMA	Band V	0.44	0.64	0.64	
		Band II	0.38	0.67	0.67	
	LTE	Band 12/Band 17	0.18	0.41	0.41	
		Band 26	0.31	0.51	0.51	
		Band 5	0.39	0.55	0.55	
		Band 4	0.15	0.96	0.96	
		Band 2	0.44	0.88	0.88	
		Band 7	<0.10	0.72	0.38	
		Band 38	<0.10	0.31	0.25	
	Band 41	<0.10	0.39	0.29		
DTS	WLAN	2.4GHz WLAN	1.19	0.34	0.34	1.57
DSS	Bluetooth	2.4GHz BT				1.07
Date of Testing:			2017/8/11 ~ 2017/8/18			
Remark: This device supports both LTE B12 and LTE B17. Since the supported frequency span for LTE B17 falls completely within the supports frequency span for LTE B12, both LTE bands have the same target power, and both LTE bands share the same transmission path; therefore, SAR was only assessed for LTE B12.						

This device is in compliance with Specific Absorption Rate (SAR) for general population/uncontrolled exposure limits (1.6W/kg as averaged over any 1 gram of tissue) specified in FCC 47 CFR part 2 (2.1093) and ANSI/IEEE C95.1-1992, and had been tested in accordance with the measurement methods and procedures specified in IEEE 1528-2013 and FCC KDB publications.

2. Administration Data

Testing Laboratory	
Test Site	Sporton International (Shenzhen) Inc.
Test Site Location	1/F, 2/F, Bldg 5, Shiling Industrial Zone, Xinwei Village, Xili, Nanshan Shenzhen City Guangdong Province 518055 China TEL: +86-755-8637-9589 FAX: +86-755-8637-9595

Applicant	
Company Name	ASUSTeK COMPUTER INC.
Address	4F, No.150, Li-Te Rd., Peitou, Taipei 112, Taiwan

Manufacturer	
Company Name	ASUSTeK COMPUTER INC.
Address	4F, No.150, Li-Te Rd., Peitou, Taipei 112, Taiwan

3. Guidance Applied

The Specific Absorption Rate (SAR) testing specification, method, and procedure for this device is in accordance with the following standards:

- FCC 47 CFR Part 2 (2.1093)
- ANSI/IEEE C95.1-1992
- IEEE 1528-2013
- FCC KDB 865664 D01 SAR Measurement 100 MHz to 6 GHz v01r04
- FCC KDB 865664 D02 SAR Reporting v01r02
- FCC KDB 447498 D01 General RF Exposure Guidance v06
- FCC KDB 648474 D04 SAR Evaluation Considerations for Wireless Handsets v01r03
- FCC KDB 248227 D01 802.11 Wi-Fi SAR v02r02
- FCC KDB 941225 D01 3G SAR Procedures v03r01
- FCC KDB 941225 D05 SAR for LTE Devices v02r05
- FCC KDB 941225 D06 Hotspot Mode SAR v02r01

4. Equipment Under Test (EUT) Information

4.1 General Information

Product Feature & Specification	
Equipment Name	ASUS Phone (Mobile Phone)
Brand Name	ASUS
Model Name	ASUS_X00HD
Marketing Name	ZC520KL
FCC ID	MSQX00HD
IMEI Code	SIM1: 358410080034100 SIM2: 358410080034118
Wireless Technology and Frequency Range	GSM850: 824.2 MHz ~ 848.8 MHz GSM1900: 1850.2 MHz ~ 1909.8 MHz WCDMA Band II: 1852.4 MHz ~ 1907.6 MHz WCDMA Band V: 826.4 MHz ~ 846.6 MHz LTE Band 2: 1850.7 MHz ~ 1909.3 MHz LTE Band 4: 1710.7 MHz ~ 1754.3 MHz LTE Band 5: 824.7 MHz ~ 848.3 MHz LTE Band 7: 2502.5 MHz ~ 2567.5 MHz LTE Band 12: 699.7 MHz ~ 715.3 MHz LTE Band 17: 706.5 MHz ~ 713.5 MHz LTE Band 26: 814.7 MHz ~ 848.3 MHz LTE Band 38: 2572.5 MHz ~ 2617.5 MHz LTE Band 41: 2547.5 MHz ~ 2652.5 MHz WLAN 2.4GHz Band: 2412 MHz ~ 2462 MHz Bluetooth: 2402 MHz ~ 2480 MHz
Mode	GSM/GPRS/EGPRS RMC/AMR 12.2Kbps HSDPA HSUPA HSPA+ DC-HSDPA LTE: QPSK, 16QAM 802.11b/g/n HT20/HT40 Bluetooth v3.0 + EDR, Bluetooth v4.0 LE, Bluetooth v4.1 LE Bluetooth v4.2 LE
HW Version	QL1526_MB_PCB_v2.0
SW Version	NMF26F.WW_Phone-14.2016.1705.135
GSM / (E)GPRS Transfer mode	Class B – EUT cannot support Packet Switched and Circuit Switched Network simultaneously but can automatically switch between Packet and Circuit Switched Network.
EUT Stage	Identical Prototype
Remark:	
<ol style="list-style-type: none"> 1. This device supports VoIP in GPRS, EGPRS, WCDMA and LTE (e.g. for 3rd-party VoIP), LTE supports VoLTE operation. 2. This device 2.4GHz WLAN supports hotspot operation and Bluetooth support tethering applications. 3. This device does not support DTM operation and supports GRPS/EGRPS mode up to multi-slot class 12. 4. The dual SIM card mobile has 2 SIM slots and supports dual SIM dual standby. The WWAN radio transmission will be enabled by either one SIM at a time (single active). After pre-scan two SIM cards power, we found test result of the SIM1 was the worse, so we chose dual SIM1 card to perform all tests. 	



4.2 General LTE SAR Test and Reporting Considerations

Summarized necessary items addressed in KDB 941225 D05 v02r05																																															
FCC ID	MSQX00HD																																														
Equipment Name	ASUS Phone (Mobile Phone)																																														
Operating Frequency Range of each LTE transmission band	LTE Band 2: 1850.7 MHz ~ 1909.3 MHz LTE Band 4: 1710.7 MHz ~ 1754.3 MHz LTE Band 5: 824.7 MHz ~ 848.3 MHz LTE Band 7: 2502.5 MHz ~ 2567.5 MHz LTE Band 12: 699.7 MHz ~ 715.3 MHz LTE Band 17: 706.5 MHz ~ 713.5 MHz LTE Band 26: 814.7 MHz ~ 848.3 MHz LTE Band 38: 2572.5 MHz ~ 2617.5 MHz LTE Band 41: 2547.5 MHz ~ 2652.5 MHz																																														
Channel Bandwidth	LTE Band 2: 1.4MHz, 3MHz, 5MHz, 10MHz, 15MHz, 20MHz LTE Band 4: 1.4MHz, 3MHz, 5MHz, 10MHz, 15MHz, 20MHz LTE Band 5: 1.4MHz, 3MHz, 5MHz, 10MHz LTE Band 7: 5MHz, 10MHz, 15MHz, 20MHz LTE Band 12: 1.4MHz, 3MHz, 5MHz, 10MHz LTE Band 17: 5MHz, 10MHz LTE Band 26: 1.4MHz, 3MHz, 5MHz, 10MHz, 15MHz LTE Band 38: 5MHz, 10MHz, 15MHz, 20MHz LTE Band 41: 5MHz, 10MHz, 15MHz, 20MHz																																														
uplink modulations used	QPSK, and 16QAM																																														
LTE Voice / Data requirements	Voice and Data																																														
LTE Release Version	R10, Cat 4																																														
CA Support	Not Supported																																														
LTE MPR permanently built-in by design	<table border="1"> <thead> <tr> <th colspan="8">Table 6.2.3-1: Maximum Power Reduction (MPR) for Power Class 3</th> </tr> <tr> <th rowspan="2">Modulation</th> <th colspan="6">Channel bandwidth / Transmission bandwidth (RB)</th> <th rowspan="2">MPR (dB)</th> </tr> <tr> <th>1.4 MHz</th> <th>3.0 MHz</th> <th>5 MHz</th> <th>10 MHz</th> <th>15 MHz</th> <th>20 MHz</th> </tr> </thead> <tbody> <tr> <td>QPSK</td> <td>> 5</td> <td>> 4</td> <td>> 8</td> <td>> 12</td> <td>> 16</td> <td>> 18</td> <td>≤ 1</td> </tr> <tr> <td>16 QAM</td> <td>≤ 5</td> <td>≤ 4</td> <td>≤ 8</td> <td>≤ 12</td> <td>≤ 16</td> <td>≤ 18</td> <td>≤ 1</td> </tr> <tr> <td>16 QAM</td> <td>> 5</td> <td>> 4</td> <td>> 8</td> <td>> 12</td> <td>> 16</td> <td>> 18</td> <td>≤ 2</td> </tr> </tbody> </table>	Table 6.2.3-1: Maximum Power Reduction (MPR) for Power Class 3								Modulation	Channel bandwidth / Transmission bandwidth (RB)						MPR (dB)	1.4 MHz	3.0 MHz	5 MHz	10 MHz	15 MHz	20 MHz	QPSK	> 5	> 4	> 8	> 12	> 16	> 18	≤ 1	16 QAM	≤ 5	≤ 4	≤ 8	≤ 12	≤ 16	≤ 18	≤ 1	16 QAM	> 5	> 4	> 8	> 12	> 16	> 18	≤ 2
Table 6.2.3-1: Maximum Power Reduction (MPR) for Power Class 3																																															
Modulation	Channel bandwidth / Transmission bandwidth (RB)						MPR (dB)																																								
	1.4 MHz	3.0 MHz	5 MHz	10 MHz	15 MHz	20 MHz																																									
QPSK	> 5	> 4	> 8	> 12	> 16	> 18	≤ 1																																								
16 QAM	≤ 5	≤ 4	≤ 8	≤ 12	≤ 16	≤ 18	≤ 1																																								
16 QAM	> 5	> 4	> 8	> 12	> 16	> 18	≤ 2																																								
LTE A-MPR	In the base station simulator configuration, Network Setting value is set to NS_01 to disable A-MPR during SAR testing and the LTE SAR tests was transmitting on all TTI frames (Maximum TTI)																																														
Spectrum plots for RB configuration	A properly configured base station simulator was used for the SAR and power measurement; therefore, spectrum plots for each RB allocation and offset configuration are not included in the SAR report.																																														



Transmission (H, M, L) channel numbers and frequencies in each LTE band												
LTE Band 2												
	Bandwidth 1.4 MHz		Bandwidth 3 MHz		Bandwidth 5 MHz		Bandwidth 10 MHz		Bandwidth 15 MHz		Bandwidth 20 MHz	
	Ch. #	Freq. (MHz)	Ch. #	Freq. (MHz)	Ch. #	Freq. (MHz)	Ch. #	Freq. (MHz)	Ch. #	Freq. (MHz)	Ch. #	Freq. (MHz)
L	18607	1850.7	18615	1851.5	18625	1852.5	18650	1855	18675	1857.5	18700	1860
M	18900	1880	18900	1880	18900	1880	18900	1880	18900	1880	18900	1880
H	19193	1909.3	19185	1908.5	19175	1907.5	19150	1905	19125	1902.5	19100	1900
LTE Band 4												
	Bandwidth 1.4 MHz		Bandwidth 3 MHz		Bandwidth 5 MHz		Bandwidth 10 MHz		Bandwidth 15 MHz		Bandwidth 20 MHz	
	Ch. #	Freq. (MHz)	Ch. #	Freq. (MHz)	Ch. #	Freq. (MHz)	Ch. #	Freq. (MHz)	Ch. #	Freq. (MHz)	Ch. #	Freq. (MHz)
L	19957	1710.7	19965	1711.5	19975	1712.5	20000	1715	20025	1717.5	20050	1720
M	20175	1732.5	20175	1732.5	20175	1732.5	20175	1732.5	20175	1732.5	20175	1732.5
H	20393	1754.3	20385	1753.5	20375	1752.5	20350	1750	20325	1747.5	20300	1745
LTE Band 5												
	Bandwidth 1.4 MHz		Bandwidth 3 MHz		Bandwidth 5 MHz		Bandwidth 10 MHz					
	Ch. #	Freq. (MHz)	Ch. #	Freq. (MHz)	Ch. #	Freq. (MHz)	Ch. #	Freq. (MHz)	Ch. #	Freq. (MHz)	Ch. #	Freq. (MHz)
L	20407	824.7	20415	825.5	20425	826.5	20450	829				
M	20525	836.5	20525	836.5	20525	836.5	20525	836.5				
H	20643	848.3	20635	847.5	20625	846.5	20600	844				
LTE Band 7												
	Bandwidth 5 MHz		Bandwidth 10 MHz		Bandwidth 15 MHz		Bandwidth 20 MHz					
	Ch. #	Freq. (MHz)	Ch. #	Freq. (MHz)	Ch. #	Freq. (MHz)	Ch. #	Freq. (MHz)	Ch. #	Freq. (MHz)	Ch. #	Freq. (MHz)
L	20775	2502.5	20800	2505	20825	2507.5	20850	2510				
M	21100	2535	21100	2535	21100	2535	21100	2535				
H	21425	2567.5	21400	2565	21375	2562.5	21350	2560				
LTE Band 12												
	Bandwidth 1.4 MHz		Bandwidth 3 MHz		Bandwidth 5 MHz		Bandwidth 10 MHz					
	Ch. #	Freq. (MHz)	Ch. #	Freq. (MHz)	Ch. #	Freq. (MHz)	Ch. #	Freq. (MHz)	Ch. #	Freq. (MHz)	Ch. #	Freq. (MHz)
L	23017	699.7	23025	700.5	23035	701.5	23060	704				
M	23095	707.5	23095	707.5	23095	707.5	23095	707.5				
H	23173	715.3	23165	714.5	23155	713.5	23130	711				
LTE Band 17												
	Bandwidth 5 MHz				Bandwidth 10 MHz							
	Channel #		Freq.(MHz)		Channel #		Freq. (MHz)					
L	23755		706.5		23780		709					
M	23790		710		23790		710					
H	23825		713.5		23800		711					



LTE Band 26										
	Bandwidth 1.4 MHz		Bandwidth 3 MHz		Bandwidth 5 MHz		Bandwidth 10 MHz		Bandwidth 15 MHz	
	Ch. #	Freq. (MHz)	Ch. #	Freq. (MHz)	Ch. #	Freq. (MHz)	Ch. #	Freq. (MHz)	Ch. #	Freq. (MHz)
L	26697	814.7	26705	815.5	26715	816.5	26740	819	26765	821.5
M	26865	831.5	26865	831.5	26865	831.5	26865	831.5	26865	831.5
H	27033	848.3	27025	847.5	27015	846.5	26990	844	26965	841.5
LTE Band 38										
	Bandwidth 5 MHz		Bandwidth 10 MHz		Bandwidth 15 MHz		Bandwidth 20 MHz			
	Ch. #	Freq. (MHz)	Ch. #	Freq. (MHz)	Ch. #	Freq. (MHz)	Ch. #	Freq. (MHz)	Ch. #	Freq. (MHz)
L	37775	2572.5	37800	2575	37825	2577.5	37850	2580		
M	38000	2595	38000	2595	38000	2595	38000	2595		
H	38225	2617.5	38200	2615	38175	2612.5	38150	2610		
LTE Band 41										
	Bandwidth 5 MHz		Bandwidth 10 MHz		Bandwidth 15 MHz		Bandwidth 20 MHz			
	Ch. #	Freq. (MHz)	Ch. #	Freq. (MHz)	Ch. #	Freq. (MHz)	Ch. #	Freq. (MHz)	Ch. #	Freq. (MHz)
L	40165	2547.5	40190	2550	40215	2552.5	40240	2555		
L M	40185	2579.5	40490	2580	40495	2580.5	40500	2581		
H M	40805	2611.5	40790	2610	40785	2609.5	40770	2608		
H	41215	2652.5	41190	2650	41165	2647.5	41140	2645		

5. RF Exposure Limits

5.1 Uncontrolled Environment

Uncontrolled Environments are defined as locations where there is the exposure of individuals who have no knowledge or control of their exposure. The general population/uncontrolled exposure limits are applicable to situations in which the general public may be exposed or in which persons who are exposed as a consequence of their employment may not be made fully aware of the potential for exposure or cannot exercise control over their exposure. Members of the general public would come under this category when exposure is not employment-related; for example, in the case of a wireless transmitter that exposes persons in its vicinity.

5.2 Controlled Environment

Controlled Environments are defined as locations where there is exposure that may be incurred by persons who are aware of the potential for exposure, (i.e. as a result of employment or occupation). In general, occupational/controlled exposure limits are applicable to situations in which persons are exposed as a consequence of their employment, who have been made fully aware of the potential for exposure and can exercise control over their exposure. The exposure category is also applicable when the exposure is of a transient nature due to incidental passage through a location where the exposure levels may be higher than the general population/uncontrolled limits, but the exposed person is fully aware of the potential for exposure and can exercise control over his or her exposure by leaving the area or by some other appropriate means.

Limits for Occupational/Controlled Exposure (W/kg)

Whole-Body	Partial-Body	Hands, Wrists, Feet and Ankles
0.4	8.0	20.0

Limits for General Population/Uncontrolled Exposure (W/kg)

Whole-Body	Partial-Body	Hands, Wrists, Feet and Ankles
0.08	1.6	4.0

Whole-Body SAR is averaged over the entire body, partial-body SAR is averaged over any 1gram of tissue defined as a tissue volume in the shape of a cube. SAR for hands, wrists, feet and ankles is averaged over any 10 grams of tissue defined as a tissue volume in the shape of a cube.

6. Specific Absorption Rate (SAR)

6.1 Introduction

SAR is related to the rate at which energy is absorbed per unit mass in an object exposed to a radio field. The SAR distribution in a biological body is complicated and is usually carried out by experimental techniques or numerical modeling. The standard recommends limits for two tiers of groups, occupational/controlled and general population/uncontrolled, based on a person's awareness and ability to exercise control over his or her exposure. In general, occupational/controlled exposure limits are higher than the limits for general population/uncontrolled.

6.2 SAR Definition

The SAR definition is the time derivative (rate) of the incremental energy (dW) absorbed by (dissipated in) an incremental mass (dm) contained in a volume element (dv) of a given density (ρ). The equation description is as below:

$$SAR = \frac{d}{dt} \left(\frac{dW}{dm} \right) = \frac{d}{dt} \left(\frac{dW}{\rho dv} \right)$$

SAR is expressed in units of Watts per kilogram (W/kg)

$$SAR = \frac{\sigma |E|^2}{\rho}$$

Where: σ is the conductivity of the tissue, ρ is the mass density of the tissue and E is the RMS electrical field strength.

7. System Description and Setup

The DASY system used for performing compliance tests consists of the following items:

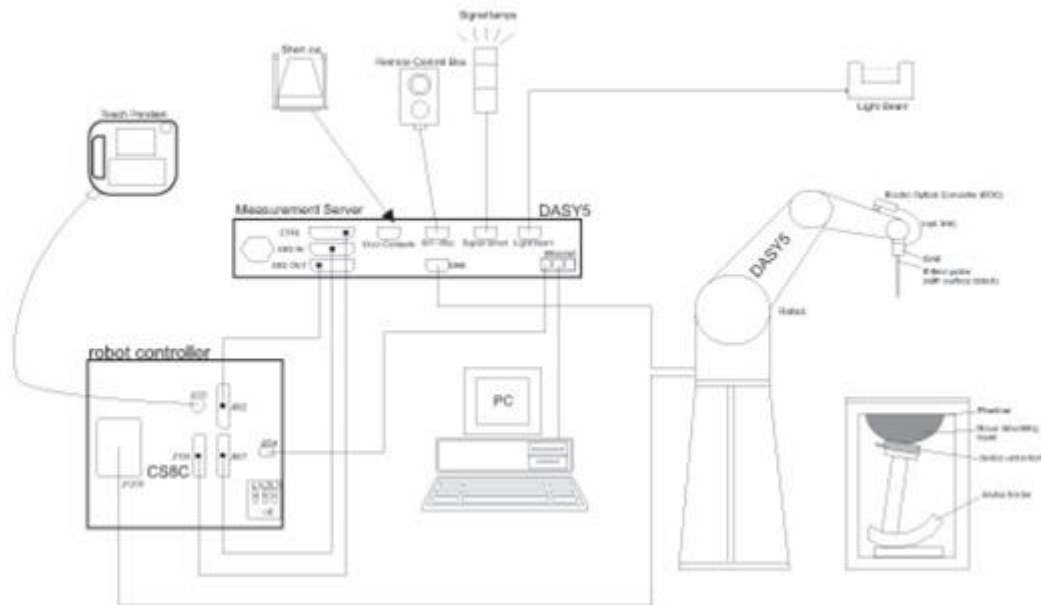

- A standard high precision 6-axis robot with controller, teach pendant and software. An arm extension for accommodating the data acquisition electronics (DAE).
- An isotropic Field probe optimized and calibrated for the targeted measurement.
- A data acquisition electronics (DAE) which performs the signal amplification, signal multiplexing, AD-conversion, offset measurements, mechanical surface detection, collision detection, etc. The unit is battery powered with standard or rechargeable batteries. The signal is optically transmitted to the EOC.
- The Electro-optical converter (EOC) performs the conversion from optical to electrical signals for the digital communication to the DAE. To use optical surface detection, a special version of the EOC is required. The EOC signal is transmitted to the measurement server.
- The function of the measurement server is to perform the time critical tasks such as signal filtering, control of the robot operation and fast movement interrupts.
- The Light Beam used is for probe alignment. This improves the (absolute) accuracy of the probe positioning.
- A computer running WinXP or Win7 and the DASY5 software.
- Remote control and teach pendant as well as additional circuitry for robot safety such as warning lamps, etc.
- The phantom, the device holder and other accessories according to the targeted measurement.

7.1 E-Field Probe

The SAR measurement is conducted with the dosimetric probe (manufactured by SPEAG).The probe is specially designed and calibrated for use in liquid with high permittivity. The dosimetric probe has special calibration in liquid at different frequency. This probe has a built in optical surface detection system to prevent from collision with phantom.

<EX3DV4 Probe>

Construction	Symmetric design with triangular core Built-in shielding against static charges PEEK enclosure material (resistant to organic solvents, e.g., DGBE)	
Frequency	10 MHz – >6 GHz Linearity: ±0.2 dB (30 MHz – 6 GHz)	
Directivity	±0.3 dB in TSL (rotation around probe axis) ±0.5 dB in TSL (rotation normal to probe axis)	
Dynamic Range	10 µW/g – >100 mW/g Linearity: ±0.2 dB (noise: typically <1 µW/g)	
Dimensions	Overall length: 337 mm (tip: 20 mm) Tip diameter: 2.5 mm (body: 12 mm) Typical distance from probe tip to dipole centers: 1 mm	

7.2 Data Acquisition Electronics (DAE)

The data acquisition electronics (DAE) consists of a highly sensitive electrometer-grade preamplifier with auto-zeroing, a channel and gain-switching multiplexer, a fast 16 bit AD-converter and a command decoder and control logic unit. Transmission to the measurement server is accomplished through an optical downlink for data and status information as well as an optical uplink for commands and the clock.

The input impedance of the DAE is 200 MOhm; the inputs are symmetrical and floating. Common mode rejection is above 80 dB.



Fig 5.1 Photo of DAE

7.3 Phantom

<SAM Twin Phantom>

Shell Thickness	2 ± 0.2 mm; Center ear point: 6 ± 0.2 mm
Filling Volume	Approx. 25 liters
Dimensions	Length: 1000 mm; Width: 500 mm; Height: adjustable feet
Measurement Areas	Left Hand, Right Hand, Flat Phantom



The bottom plate contains three pair of bolts for locking the device holder. The device holder positions are adjusted to the standard measurement positions in the three sections. A white cover is provided to tap the phantom during off-periods to prevent water evaporation and changes in the liquid parameters. On the phantom top, three reference markers are provided to identify the phantom position with respect to the robot.

<ELI Phantom>

Shell Thickness	2 ± 0.2 mm (sagging: <1%)
Filling Volume	Approx. 30 liters
Dimensions	Major ellipse axis: 600 mm Minor axis: 400 mm



The ELI phantom is intended for compliance testing of handheld and body-mounted wireless devices in the frequency range of 30 MHz to 6 GHz. ELI4 is fully compatible with standard and all known tissue simulating liquids.

7.4 Device Holder

<Mounting Device for Hand-Held Transmitter>

In combination with the Twin SAM V5.0/V5.0c or ELI phantoms, the Mounting Device for Hand-Held Transmitters enables rotation of the mounted transmitter device to specified spherical coordinates. At the heads, the rotation axis is at the ear opening. Transmitter devices can be easily and accurately positioned according to IEC 62209-1, IEEE 1528, FCC, or other specifications. The device holder can be locked for positioning at different phantom sections (left head, right head, flat). And upgrade kit to Mounting Device to enable easy mounting of wider devices like big smart-phones, e-books, small tablets, etc. It holds devices with width up to 140 mm.



Mounting Device for Hand-Held Transmitters



Mounting Device Adaptor for Wide-Phones

<Mounting Device for Laptops and other Body-Worn Transmitters>

The extension is lightweight and made of POM, acrylic glass and foam. It fits easily on the upper part of the mounting device in place of the phone positioned. The extension is fully compatible with the SAM Twin and ELI phantoms.



Mounting Device for Laptops

8. Measurement Procedures

The measurement procedures are as follows:

<Conducted power measurement>

- (a) For WWAN power measurement, use base station simulator to configure EUT WWAN transmission in conducted connection with RF cable, at maximum power in each supported wireless interface and frequency band.
- (b) Read the WWAN RF power level from the base station simulator.
- (c) For WLAN/BT power measurement, use engineering software to configure EUT WLAN/BT continuously transmission, at maximum RF power in each supported wireless interface and frequency band
- (d) Connect EUT RF port through RF cable to the power meter, and measure WLAN/BT output power

<SAR measurement>

- (a) Use base station simulator to configure EUT WWAN transmission in radiated connection, and engineering software to configure EUT WLAN/BT continuously transmission, at maximum RF power, in the highest power channel.
- (b) Place the EUT in the positions as Appendix D demonstrates.
- (c) Set scan area, grid size and other setting on the DASY software.
- (d) Measure SAR results for the highest power channel on each testing position.
- (e) Find out the largest SAR result on these testing positions of each band
- (f) Measure SAR results for other channels in worst SAR testing position if the reported SAR of highest power channel is larger than 0.8 W/kg

According to the test standard, the recommended procedure for assessing the peak spatial-average SAR value consists of the following steps:

- (a) Power reference measurement
- (b) Area scan
- (c) Zoom scan
- (d) Power drift measurement

8.1 Spatial Peak SAR Evaluation

The procedure for spatial peak SAR evaluation has been implemented according to the test standard. It can be conducted for 1g and 10g, as well as for user-specific masses. The DASY software includes all numerical procedures necessary to evaluate the spatial peak SAR value.

The base for the evaluation is a "cube" measurement. The measured volume must include the 1g and 10g cubes with the highest averaged SAR values. For that purpose, the center of the measured volume is aligned to the interpolated peak SAR value of a previously performed area scan.

The entire evaluation of the spatial peak values is performed within the post-processing engine (SEMCAD). The system always gives the maximum values for the 1g and 10g cubes. The algorithm to find the cube with highest averaged SAR is divided into the following stages:

- (a) Extraction of the measured data (grid and values) from the Zoom Scan
- (b) Calculation of the SAR value at every measurement point based on all stored data (A/D values and measurement parameters)
- (c) Generation of a high-resolution mesh within the measured volume
- (d) Interpolation of all measured values from the measurement grid to the high-resolution grid
- (e) Extrapolation of the entire 3-D field distribution to the phantom surface over the distance from sensor to surface
- (f) Calculation of the averaged SAR within masses of 1g and 10g

8.2 Power Reference Measurement

The Power Reference Measurement and Power Drift Measurements are for monitoring the power drift of the device under test in the batch process. The minimum distance of probe sensors to surface determines the closest measurement point to phantom surface. This distance cannot be smaller than the distance of sensor calibration points to probe tip as defined in the probe properties.

8.3 Area Scan

The area scan is used as a fast scan in two dimensions to find the area of high field values, before doing a fine measurement around the hot spot. The sophisticated interpolation routines implemented in DASY software can find the maximum found in the scanned area, within a range of the global maximum. The range (in dB0) is specified in the standards for compliance testing. For example, a 2 dB range is required in IEEE standard 1528 and IEC 62209 standards, whereby 3 dB is a requirement when compliance is assessed in accordance with the ARIB standard (Japan), if only one zoom scan follows the area scan, then only the absolute maximum will be taken as reference. For cases where multiple maximums are detected, the number of zoom scans has to be increased accordingly.

Area scan parameters extracted from FCC KDB 865664 D01v01r04 SAR measurement 100 MHz to 6 GHz.

	≤ 3 GHz	> 3 GHz
Maximum distance from closest measurement point (geometric center of probe sensors) to phantom surface	5 ± 1 mm	$\frac{1}{2} \cdot \delta \cdot \ln(2) \pm 0.5$ mm
Maximum probe angle from probe axis to phantom surface normal at the measurement location	30° ± 1°	20° ± 1°
Maximum area scan spatial resolution: $\Delta x_{Area}, \Delta y_{Area}$	≤ 2 GHz: ≤ 15 mm 2 – 3 GHz: ≤ 12 mm	3 – 4 GHz: ≤ 12 mm 4 – 6 GHz: ≤ 10 mm
	When the x or y dimension of the test device, in the measurement plane orientation, is smaller than the above, the measurement resolution must be ≤ the corresponding x or y dimension of the test device with at least one measurement point on the test device.	

8.4 Zoom Scan

Zoom scans are used assess the peak spatial SAR values within a cubic averaging volume containing 1 gram and 10 gram of simulated tissue. The zoom scan measures points (refer to table below) within a cube shoes base faces are centered on the maxima found in a preceding area scan job within the same procedure. When the measurement is done, the zoom scan evaluates the averaged SAR for 1 gram and 10 gram and displays these values next to the job's label.

Zoom scan parameters extracted from FCC KDB 865664 D01v01r04 SAR measurement 100 MHz to 6 GHz.

		≤ 3 GHz	> 3 GHz	
Maximum zoom scan spatial resolution: $\Delta x_{Zoom}, \Delta y_{Zoom}$		≤ 2 GHz: ≤ 8 mm 2 – 3 GHz: ≤ 5 mm*	3 – 4 GHz: ≤ 5 mm* 4 – 6 GHz: ≤ 4 mm*	
Maximum zoom scan spatial resolution, normal to phantom surface	uniform grid: $\Delta z_{Zoom}(n)$	≤ 5 mm	3 – 4 GHz: ≤ 4 mm 4 – 5 GHz: ≤ 3 mm 5 – 6 GHz: ≤ 2 mm	
	graded grid	$\Delta z_{Zoom}(1)$: between 1 st two points closest to phantom surface	≤ 4 mm	3 – 4 GHz: ≤ 3 mm 4 – 5 GHz: ≤ 2.5 mm 5 – 6 GHz: ≤ 2 mm
		$\Delta z_{Zoom}(n>1)$: between subsequent points	$\leq 1.5 \cdot \Delta z_{Zoom}(n-1)$	
Minimum zoom scan volume	x, y, z	≥ 30 mm	3 – 4 GHz: ≥ 28 mm 4 – 5 GHz: ≥ 25 mm 5 – 6 GHz: ≥ 22 mm	
Note: δ is the penetration depth of a plane-wave at normal incidence to the tissue medium; see draft standard IEEE P1528-2011 for details. * When zoom scan is required and the <i>reported</i> SAR from the <i>area scan based 1-g SAR estimation</i> procedures of KDB 447498 is ≤ 1.4 W/kg, ≤ 8 mm, ≤ 7 mm and ≤ 5 mm zoom scan resolution may be applied, respectively, for 2 GHz to 3 GHz, 3 GHz to 4 GHz and 4 GHz to 6 GHz.				

8.5 Volume Scan Procedures

The volume scan is used for assess overlapping SAR distributions for antennas transmitting in different frequency bands. It is equivalent to an oversized zoom scan used in standalone measurements. The measurement volume will be used to enclose all the simultaneous transmitting antennas. For antennas transmitting simultaneously in different frequency bands, the volume scan is measured separately in each frequency band. In order to sum correctly to compute the 1g aggregate SAR, the EUT remain in the same test position for all measurements and all volume scan use the same spatial resolution and grid spacing. When all volume scan were completed, the software, SEMCAD postprocessor can combine and subsequently superpose these measurement data to calculating the multiband SAR.

8.6 Power Drift Monitoring

All SAR testing is under the EUT install full charged battery and transmit maximum output power. In DASy measurement software, the power reference measurement and power drift measurement procedures are used for monitoring the power drift of EUT during SAR test. Both these procedures measure the field at a specified reference position before and after the SAR testing. The software will calculate the field difference in dB. If the power drifts more than 5%, the SAR will be retested.



9. Test Equipment List

Manufacturer	Name of Equipment	Type/Model	Serial Number	Calibration	
				Last Cal.	Due Date
SPEAG	750MHz System Validation Kit	D750V3	1099	2016/11/21	2017/11/20
SPEAG	835MHz System Validation Kit	D835V2	4d162	2016/11/22	2017/11/21
SPEAG	1750MHz System Validation Kit	D1750V2	1137	2017/6/5	2018/6/4
SPEAG	1900MHz System Validation Kit	D1900V2	5d182	2016/11/24	2017/11/23
SPEAG	2450MHz System Validation Kit	D2450V2	924	2017/3/21	2018/3/20
SPEAG	2600MHz System Validation Kit	D2600V2	1070	2016/11/24	2017/11/23
SPEAG	Data Acquisition Electronics	DAE4	1338	2016/11/22	2017/11/21
SPEAG	Dosimetric E-Field Probe	EX3DV4	3911	2016/9/29	2017/9/28
SPEAG	SAM Twin Phantom	QD 000 P40 CD	TP-1795	NCR	NCR
SPEAG	Phone Positioner	N/A	N/A	NCR	NCR
Anritsu	Radio communication analyzer	MT8820C	6201300653	2017/7/19	2018/7/18
Agilent	Network Analyzer	E5071C	MY46523671	2016/10/11	2017/10/10
SPEAG	Dielectric Assessment KIT	DAK-3.5	1071	2016/11/23	2017/11/22
Agilent	Signal Generator	N5181A	MY50145381	2017/1/3	2018/1/2
Anritsu	Power Sensor	MA2411B	1306099	2017/7/19	2018/7/18
Anritsu	Power Meter	ML2495A	1349001	2017/7/19	2018/7/18
Anritsu	Power Sensor	MA2411B	1207253	2017/1/3	2018/1/2
Anritsu	Power Meter	ML2495A	1218010	2017/1/3	2018/1/2
LKM electronic	Hygrometer	DTM3000	3241	2017/7/21	2018/7/20
Anymetre	Thermo-Hygrometer	JR593	2015102801	2017/1/6	2018/1/5
R&S	Spectrum Analyzer	FSP7	100818	2017/7/19	2018/7/18
ARRA	Power Divider	A3200-2	N/A	Note	
PASTERNAK	Dual Directional Coupler	PE2214-10	N/A	Note	
Agilent	Dual Directional Coupler	778D	N/A	Note	
MCL	Attenuation1	BW-S10W5	N/A	Note	
Weinschel	Attenuation2	3M-20	N/A	Note	
Zhongjilianhe	Attenuation3	MVE2214-03	N/A	Note	
mini-circuits	Amplifier	ZHL-42W+	QA1341002	Note	
mini-circuits	Amplifier	ZVE-3W-83+	599201528	Note	

Note:

Prior to system verification and validation, the path loss from the signal generator to the system check source and the power meter, which includes the amplifier, cable, attenuator and directional coupler, was measured by the network analyzer. The reading of the power meter was offset by the path loss difference between the path to the power meter and the path to the system check source to monitor the actual power level fed to the system check.

10. System Verification

10.1 Tissue Simulating Liquids

For the measurement of the field distribution inside the SAM phantom with DASY, the phantom must be filled with around 25 liters of homogeneous body tissue simulating liquid. For head SAR testing, the liquid height from the ear reference point (ERP) of the phantom to the liquid top surface is larger than 15 cm, which is shown in Fig. 10.1. For body SAR testing, the liquid height from the center of the flat phantom to the liquid top surface is larger than 15 cm, which is shown in Fig. 10.2.

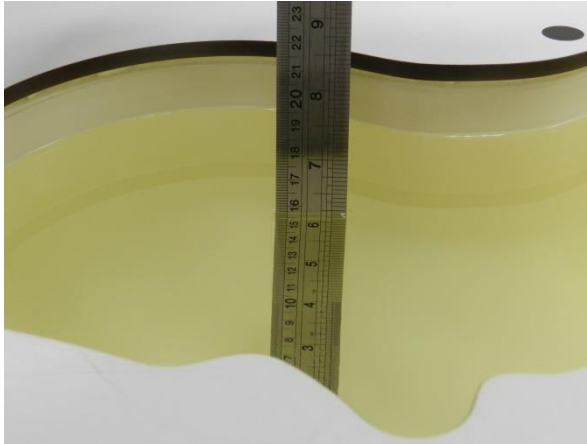

Fig 10.1 Photo of Liquid Height for Head SAR

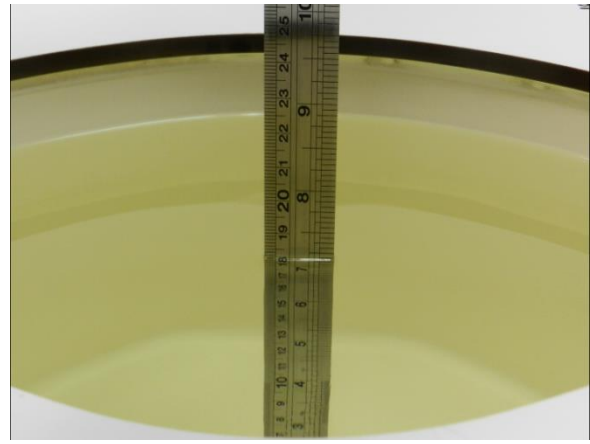

Fig 10.2 Photo of Liquid Height for Body SAR

10.2 Tissue Verification

The following tissue formulations are provided for reference only as some of the parameters have not been thoroughly verified. The composition of ingredients may be modified accordingly to achieve the desired target tissue parameters required for routine SAR evaluation.

Frequency (MHz)	Water (%)	Sugar (%)	Cellulose (%)	Salt (%)	Preventol (%)	DGBE (%)	Conductivity (σ)	Permittivity (ϵ_r)
For Head								
750	41.1	57.0	0.2	1.4	0.2	0	0.89	41.9
835	40.3	57.9	0.2	1.4	0.2	0	0.90	41.5
1800, 1900, 2000	55.2	0	0	0.3	0	44.5	1.40	40.0
2450	55.0	0	0	0	0	45.0	1.80	39.2
2600	54.8	0	0	0.1	0	45.1	1.96	39.0
For Body								
750	51.7	47.2	0	0.9	0.1	0	0.96	55.5
835	50.8	48.2	0	0.9	0.1	0	0.97	55.2
1800, 1900, 2000	70.2	0	0	0.4	0	29.4	1.52	53.3
2450	68.6	0	0	0	0	31.4	1.95	52.7
2600	68.1	0	0	0.1	0	31.8	2.16	52.5

<Tissue Dielectric Parameter Check Results>

Frequency (MHz)	Tissue Type	Liquid Temp. (°C)	Conductivity (σ)	Permittivity (ϵ_r)	Conductivity Target (σ)	Permittivity Target (ϵ_r)	Delta (σ) (%)	Delta (ϵ_r) (%)	Limit (%)	Date
750	Head	22.7	0.879	40.711	0.89	41.90	-1.24	-2.84	±5	2017/8/15
835	Head	22.8	0.910	42.910	0.90	41.50	1.11	3.40	±5	2017/8/15
1750	Head	22.7	1.352	38.776	1.37	40.10	-1.31	-3.30	±5	2017/8/12
1900	Head	22.5	1.445	40.021	1.40	40.00	3.21	0.05	±5	2017/8/12
2450	Head	22.6	1.829	40.081	1.80	39.20	1.61	2.25	±5	2017/8/16
2600	Head	22.6	2.050	38.344	1.96	39.00	4.59	-1.68	±5	2017/8/16
750	Body	22.5	0.961	53.914	0.96	55.50	0.10	-2.86	±5	2017/8/14
835	Body	22.8	1.011	56.243	0.97	55.20	4.23	1.89	±5	2017/8/14
1750	Body	22.6	1.524	52.564	1.49	53.40	2.28	-1.57	±5	2017/8/11
1900	Body	22.7	1.545	53.535	1.52	53.30	1.64	0.44	±5	2017/8/11
2450	Body	22.4	1.913	50.974	1.95	52.70	-1.90	-3.28	±5	2017/8/17
2600	Body	22.9	2.209	51.123	2.16	52.50	2.27	-2.62	±5	2017/8/18

10.3 System Performance Check Results

Comparing to the original SAR value provided by SPEAG, the verification data should be within its specification of 10 %. Below table shows the target SAR and measured SAR after normalized to 1W input power. The table below indicates the system performance check can meet the variation criterion and the plots can be referred to Appendix A of this report.

Date	Frequency (MHz)	Tissue Type	Input Power (mW)	Dipole S/N	Probe S/N	DAE S/N	Measured 1g SAR (W/kg)	Targeted 1g SAR (W/kg)	Normalized 1g SAR (W/kg)	Deviation (%)
2017/8/15	750	Head	250	1099	3911	1338	1.99	8.28	7.96	-3.86
2017/8/15	835	Head	250	4d162	3911	1338	2.20	9.31	8.80	-5.48
2017/8/12	1750	Head	250	1137	3911	1338	8.82	36.60	35.28	-3.61
2017/8/12	1900	Head	250	5d182	3911	1338	9.60	40.00	38.40	-4.00
2017/8/16	2450	Head	250	924	3911	1338	13.20	52.40	52.80	0.76
2017/8/16	2600	Head	250	1070	3911	1338	14.50	56.80	58.00	2.11
2017/8/14	750	Body	250	1099	3911	1338	2.08	8.71	8.32	-4.48
2017/8/14	835	Body	250	4d162	3911	1338	2.32	9.64	9.28	-3.73
2017/8/11	1750	Body	250	1137	3911	1338	8.87	37.00	35.48	-4.11
2017/8/11	1900	Body	250	5d182	3911	1338	9.98	40.80	39.92	-2.16
2017/8/17	2450	Body	250	924	3911	1338	12.30	50.50	49.20	-2.57
2017/8/18	2600	Body	250	1070	3911	1338	14.50	55.40	58.00	4.69

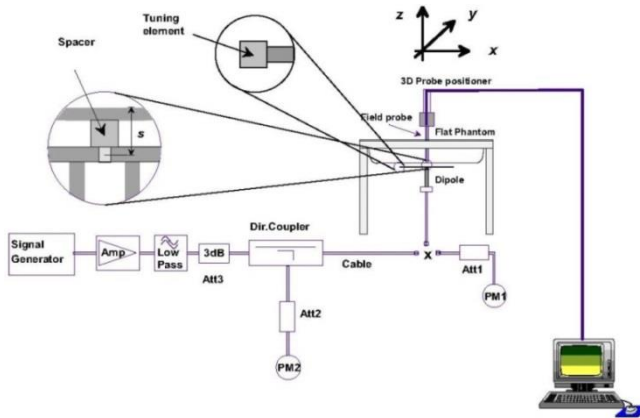

Fig 8.3.1 System Performance Check Setup



Fig 8.3.2 Setup Photo

11. RF Exposure Positions

11.1 Ear and handset reference point

Figure 9.1.1 shows the front, back, and side views of the SAM phantom. The center-of-mouth reference point is labeled “M,” the left ear reference point (ERP) is marked “LE,” and the right ERP is marked “RE.” Each ERP is 15 mm along the B-M (back-mouth) line behind the entrance-to-ear-canal (EEC) point, as shown in Figure 9.1.2 The Reference Plane is defined as passing through the two ear reference points and point M. The line N-F (neck-front), also called the reference pivoting line, is normal to the Reference Plane and perpendicular to both a line passing through RE and LE and the B-M line (see Figure 9.1.3). Both N-F and B-M lines should be marked on the exterior of the phantom shell to facilitate handset positioning. Posterior to the N-F line the ear shape is a flat surface with 6 mm thickness at each ERP, and forward of the N-F line the ear is truncated, as illustrated in Figure 9.1.2. The ear truncation is introduced to preclude the ear lobe from interfering with handset tilt, which could lead to unstable positioning at the cheek.

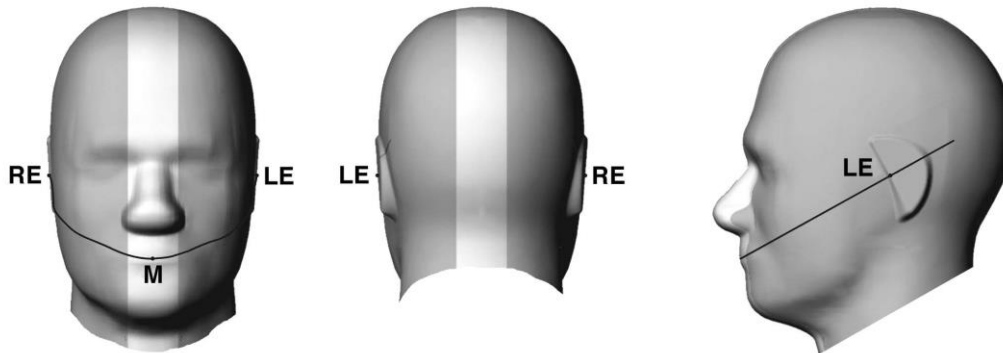

Fig 9.1.1 Front, back, and side views of SAM twin phantom

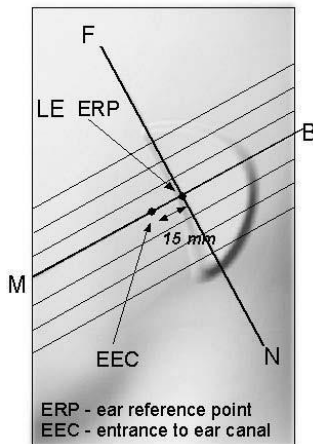

Fig 9.1.2 Close-up side view of phantom showing the ear region.

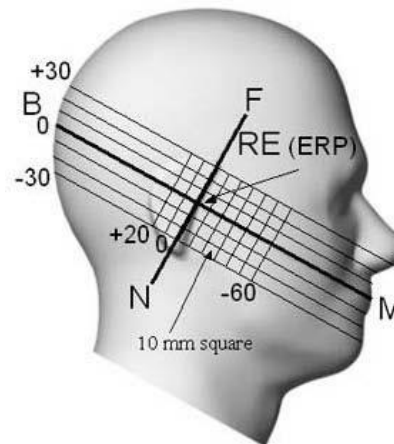

Fig 9.1.3 Side view of the phantom showing relevant markings and seven cross-sectional plane locations

11.2 Definition of the cheek position

1. Ready the handset for talk operation, if necessary. For example, for handsets with a cover piece (flip cover), open the cover. If the handset can transmit with the cover closed, both configurations must be tested.
2. Define two imaginary lines on the handset—the vertical centerline and the horizontal line. The vertical centerline passes through two points on the front side of the handset—the midpoint of the width w_t of the handset at the level of the acoustic output (point A in Figure 9.2.1 and Figure 9.2.2), and the midpoint of the width w_b of the bottom of the handset (point B). The horizontal line is perpendicular to the vertical centerline and passes through the center of the acoustic output (see Figure 9.2.1). The two lines intersect at point A. Note that for many handsets, point A coincides with the center of the acoustic output; however, the acoustic output may be located elsewhere on the horizontal line. Also note that the vertical centerline is not necessarily parallel to the front face of the handset (see Figure 9.2.2), especially for clamshell handsets, handsets with flip covers, and other irregularly-shaped handsets.
3. Position the handset close to the surface of the phantom such that point A is on the (virtual) extension of the line passing through points RE and LE on the phantom (see Figure 9.2.3), such that the plane defined by the vertical centerline and the horizontal line of the handset is approximately parallel to the sagittal plane of the phantom.
4. Translate the handset towards the phantom along the line passing through RE and LE until handset point A touches the pinna at the ERP.
5. While maintaining the handset in this plane, rotate it around the LE-RE line until the vertical centerline is in the plane normal to the plane containing B-M and N-F lines, i.e., the Reference Plane.
6. Rotate the handset around the vertical centerline until the handset (horizontal line) is parallel to the N-F line.
7. While maintaining the vertical centerline in the Reference Plane, keeping point A on the line passing through RE and LE, and maintaining the handset contact with the pinna, rotate the handset about the N-F line until any point on the handset is in contact with a phantom point below the pinna on the cheek. See Figure 9.2.3. The actual rotation angles should be documented in the test report.

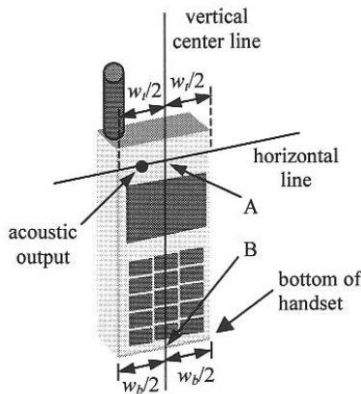

Fig 9.2.1 Handset vertical and horizontal reference lines—“fixed case”

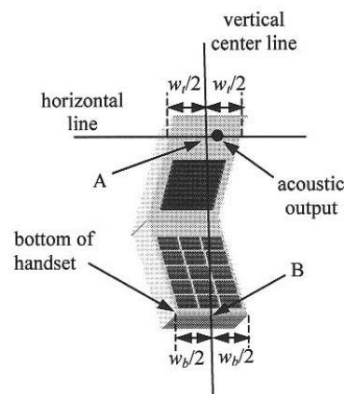

Fig 9.2.2 Handset vertical and horizontal reference lines—“clam-shell case”

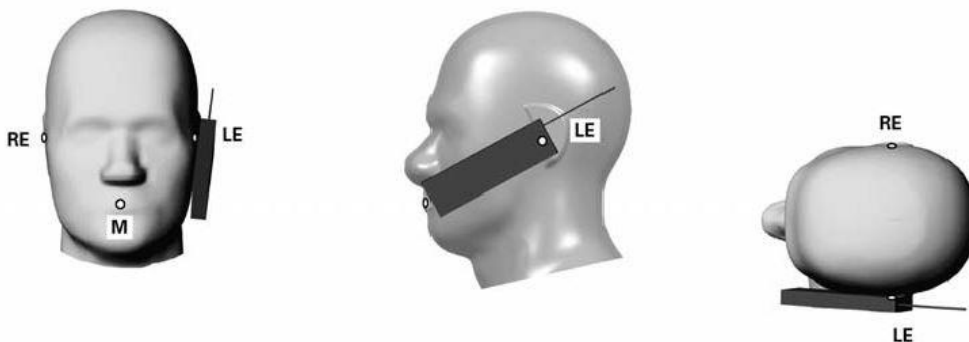

Fig 9.2.3 cheek or touch position. The reference points for the right ear (RE), left ear (LE), and mouth (M), which establish the Reference Plane for handset positioning, are indicated.

11.3 Definition of the tilt position

1. Ready the handset for talk operation, if necessary. For example, for handsets with a cover piece (flip cover), open the cover. If the handset can transmit with the cover closed, both configurations must be tested.
2. While maintaining the orientation of the handset, move the handset away from the pinna along the line passing through RE and LE far enough to allow a rotation of the handset away from the cheek by 15°.
3. Rotate the handset around the horizontal line by 15°.
4. While maintaining the orientation of the handset, move the handset towards the phantom on the line passing through RE and LE until any part of the handset touches the ear. The tilt position is obtained when the contact point is on the pinna. See Figure 9.3.1. If contact occurs at any location other than the pinna, e.g., the antenna at the back of the phantom head, the angle of the handset should be reduced. In this case, the tilt position is obtained if any point on the handset is in contact with the pinna and a second point

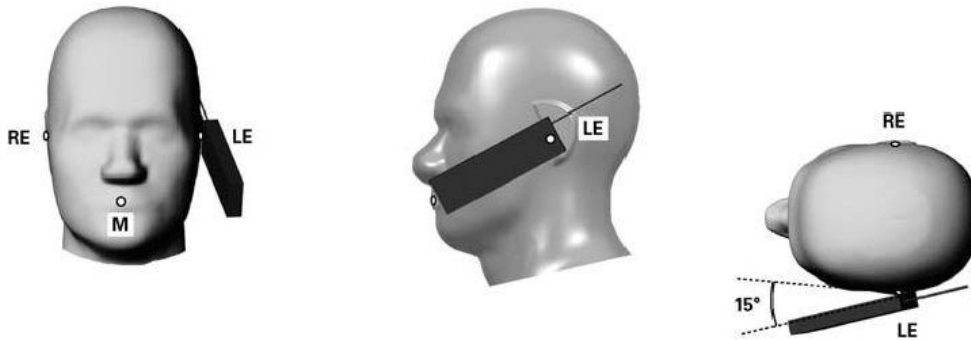

Fig 9.3.1 Tilt position. The reference points for the right ear (RE), left ear (LE), and mouth (M), which define the Reference Plane for handset positioning, are indicated.

11.4 Body Worn Accessory

Body-worn operating configurations are tested with the belt-clips and holsters attached to the device and positioned against a flat phantom in a normal use configuration (see Figure 9.4). Per KDB648474 D04v01r03, body-worn accessory exposure is typically related to voice mode operations when handsets are carried in body-worn accessories. The body-worn accessory procedures in FCC KDB 447498 D01v06 should be used to test for body-worn accessory SAR compliance, without a headset connected to it. This enables the test results for such configuration to be compatible with that required for hotspot mode when the body-worn accessory test separation distance is greater than or equal to that required for hotspot mode, when applicable. When the reported SAR for body-worn accessory, measured without a headset connected to the handset is > 1.2 W/kg, the highest reported SAR configuration for that wireless mode and frequency band should be repeated for that body-worn accessory with a headset attached to the handset.

Accessories for body-worn operation configurations are divided into two categories: those that do not contain metallic components and those that do contain metallic components. When multiple accessories that do not contain metallic components are supplied with the device, the device is tested with only the accessory that dictates the closest spacing to the body. Then multiple accessories that contain metallic components are tested with the device with each accessory. If multiple accessories share an identical metallic component (i.e. the same metallic belt-clip used with different holsters with no other metallic components) only the accessory that dictates the closest spacing to the body is tested.

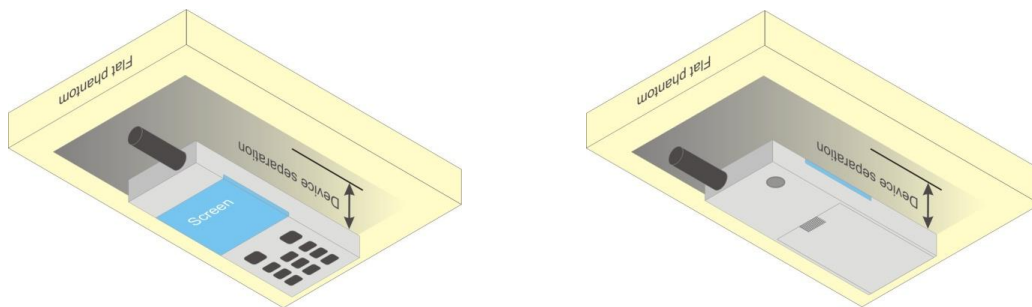

Fig 9.4 Body Worn Position

11.5 Wireless Router

Some battery-operated handsets have the capability to transmit and receive user through simultaneous transmission of WIFI simultaneously with a separate licensed transmitter. The FCC has provided guidance in FCC KDB Publication 941225 D06 v02r01 where SAR test considerations for handsets ($L \times W \geq 9 \text{ cm} \times 5 \text{ cm}$) are based on a composite test separation distance of 10mm from the front, back and edges of the device containing transmitting antennas within 2.5cm of their edges, determined from general mixed use conditions for this type of devices. Since the hotspot SAR results may overlap with the body-worn accessory SAR requirements, the more conservative configurations can be considered, thus excluding some body-worn accessory SAR tests.

When the user enables the personal wireless router functions for the handset, actual operations include simultaneous transmission of both the WIFI transmitter and another licensed transmitter. Both transmitters often do not transmit at the same transmitting frequency and thus cannot be evaluated for SAR under actual use conditions due to the limitations of the SAR assessment probes. Therefore, SAR must be evaluated for each frequency transmission and mode separately and spatially summed with the WIFI transmitter according to FCC KDB Publication 447498 D01v06 publication procedures. The "Portable Hotspot" feature on the handset was NOT activated during SAR assessments, to ensure the SAR measurements were evaluated for a single transmission frequency RF signal at a time.



12. Conducted RF Output Power (Unit: dBm)

<GSM Conducted Power>

- Per KDB 447498 D01v06, the maximum output power channel is used for SAR testing and for further SAR test reduction.
- Per KDB 941225 D01v03r01, for SAR test reduction for GSM / GPRS / EDGE modes is determined by the source-based time-averaged output power including tune-up tolerance. The mode with highest specified time-averaged output power should be tested for SAR compliance in the applicable exposure conditions. For modes with the same specified maximum output power and tolerance, the higher number time-slot configuration should be tested. Therefore, the GPRS (4Tx slots) for GSM850/GSM1900 is considered as the primary mode.
- Other configurations of GSM / GPRS / EDGE are considered as secondary modes. The 3G SAR test reduction procedure is applied, when the maximum output power and tune-up tolerance specified for production units in a secondary mode is $\leq \frac{1}{4}$ dB higher than the primary mode, SAR measurement is not required for the secondary mode.

GSM850	Burst Average Power (dBm)			Tune-up Limit (dBm)	Frame-Average Power (dBm)			Tune-up Limit (dBm)
	Tx Channel	128	189		251	128	189	
Frequency (MHz)	824.2	836.4	848.8		824.2	836.4	848.8	
GSM 1 Tx slot	32.23	32.40	32.51	33.00	23.23	23.40	23.51	24.00
GPRS 1 Tx slot	32.20	32.39	32.48	33.00	23.20	23.39	23.48	24.00
GPRS 2 Tx slots	30.18	30.43	30.64	31.00	24.18	24.43	24.64	25.00
GPRS 3 Tx slots	28.96	29.17	29.33	29.50	24.70	24.91	25.07	25.24
GPRS 4 Tx slots	28.00	28.13	28.34	28.50	25.00	25.13	25.34	25.50
EDGE 1 Tx slot	26.52	26.50	26.60	27.00	17.52	17.50	17.60	18.00
EDGE 2 Tx slots	23.90	23.86	23.89	24.50	17.90	17.86	17.89	18.50
EDGE 3 Tx slots	22.59	22.56	22.69	23.00	18.33	18.30	18.43	18.74
EDGE 4 Tx slots	22.45	22.44	22.56	23.00	19.45	19.44	19.56	20.00
GSM1900	Burst Average Power (dBm)			Tune-up Limit (dBm)	Frame-Average Power (dBm)			Tune-up Limit (dBm)
Tx Channel	512	661	810		512	661	810	
Frequency (MHz)	1850.2	1880	1909.8		1850.2	1880	1909.8	
GSM 1 Tx slot	30.04	30.06	30.13	30.50	21.04	21.06	21.13	21.50
GPRS 1 Tx slot	30.02	30.05	30.11	30.50	21.02	21.05	21.11	21.50
GPRS 2 Tx slots	27.72	27.76	27.83	28.00	21.72	21.76	21.83	22.00
GPRS 3 Tx slots	26.42	26.45	26.58	27.00	22.16	22.19	22.32	22.74
GPRS 4 Tx slots	26.16	26.18	26.23	26.50	23.16	23.18	23.23	23.50
EDGE 1 Tx slot	26.37	26.39	26.02	26.50	17.37	17.39	17.02	17.50
EDGE 2 Tx slots	23.64	23.68	23.32	24.00	17.64	17.68	17.32	18.00
EDGE 3 Tx slots	23.26	23.25	23.03	23.50	19.00	18.99	18.77	19.24
EDGE 4 Tx slots	22.90	22.94	22.56	23.50	19.90	19.94	19.56	20.50

Remark: The frame-averaged power is linearly scaled the maximum burst averaged power over 8 time slots.

The calculated method are shown as below:

- Frame-averaged power = Maximum burst averaged power (1 Tx Slot) - 9 dB
- Frame-averaged power = Maximum burst averaged power (2 Tx Slots) - 6 dB
- Frame-averaged power = Maximum burst averaged power (3 Tx Slots) - 4.26 dB
- Frame-averaged power = Maximum burst averaged power (4 Tx Slots) - 3 dB

<WCDMA Conducted Power>

1. The following tests were conducted according to the test requirements outlines in 3GPP TS 34.121 specification.
2. The procedures in KDB 941225 D01v03r01 are applied for 3GPP Rel. 6 HSPA to configure the device in the required sub-test mode(s) to determine SAR test exclusion.
3. For HSPA+ devices supporting 16 QAM in the uplink, power measurements procedure is according to the configurations in Table C.11.1.4 of 3GPP TS 34.121-1.
4. For DC-HSDPA, the device was configured according to the H-Set 12, Fixed Reference Channel (FRC) configuration in Table C.8.1.12 of 3GPP TS 34.121-1, with the primary and the secondary serving HS-DSCH Cell enabled during the power measurement.

A summary of these settings are illustrated below:

HSDPA Setup Configuration:

- a. The EUT was connected to Base Station Agilent E5515C referred to the Setup Configuration.
- b. The RF path losses were compensated into the measurements.
- c. A call was established between EUT and Base Station with following setting:
 - i. Set Gain Factors (β_c and β_d) and parameters were set according to each
 - ii. Specific sub-test in the following table, C10.1.4, quoted from the TS 34.121
 - iii. Set RMC 12.2Kbps + HSDPA mode.
 - iv. Set Cell Power = -86 dBm
 - v. Set HS-DSCH Configuration Type to FRC (H-set 1, QPSK)
 - vi. Select HSDPA Uplink Parameters
 - vii. Set Delta ACK, Delta NACK and Delta CQI = 8
 - viii. Set Ack-Nack Repetition Factor to 3
 - ix. Set CQI Feedback Cycle (k) to 4 ms
 - x. Set CQI Repetition Factor to 2
 - xi. Power Ctrl Mode = All Up bits
- d. The transmitted maximum output power was recorded.

Table C.10.1.4: β values for transmitter characteristics tests with HS-DPCCH

Sub-test	β_c	β_d	β_d (SF)	β_c/β_d	β_{HS} (Note 1, Note 2)	CM (dB) (Note 3)	MPR (dB) (Note 3)
1	2/15	15/15	64	2/15	4/15	0.0	0.0
2	12/15 (Note 4)	15/15 (Note 4)	64	12/15 (Note 4)	24/15	1.0	0.0
3	15/15	8/15	64	15/8	30/15	1.5	0.5
4	15/15	4/15	64	15/4	30/15	1.5	0.5

Note 1: $\Delta_{ACK}, \Delta_{NACK}$ and $\Delta_{CQI} = 30/15$ with $\beta_{HS} = 30/15 * \beta_c$.

Note 2: For the HS-DPCCH power mask requirement test in clause 5.2C, 5.7A, and the Error Vector Magnitude (EVM) with HS-DPCCH test in clause 5.13.1A, and HSDPA EVM with phase discontinuity in clause 5.13.1AA, Δ_{ACK} and $\Delta_{NACK} = 30/15$ with $\beta_{HS} = 30/15 * \beta_c$, and $\Delta_{CQI} = 24/15$ with $\beta_{HS} = 24/15 * \beta_c$.

Note 3: CM = 1 for $\beta_c/\beta_d = 12/15, \beta_{HS}/\beta_c = 24/15$. For all other combinations of DPDCH, DPCCH and HS-DPCCH the MPR is based on the relative CM difference. This is applicable for only UEs that support HSDPA in release 6 and later releases.

Note 4: For subtest 2 the β_c/β_d ratio of 12/15 for the TFC during the measurement period (TF1, TF0) is achieved by setting the signalled gain factors for the reference TFC (TF1, TF1) to $\beta_c = 11/15$ and $\beta_d = 15/15$.

Setup Configuration

HSUPA Setup Configuration:

- a. The EUT was connected to Base Station Agilent E5515C referred to the Setup Configuration.
- b. The RF path losses were compensated into the measurements.
- c. A call was established between EUT and Base Station with following setting * :
 - i. Call Configs = 5.2B, 5.9B, 5.10B, and 5.13.2B with QPSK
 - ii. Set the Gain Factors (β_c and β_d) and parameters (AG Index) were set according to each specific sub-test in the following table, C11.1.3, quoted from the TS 34.121
 - iii. Set Cell Power = -86 dBm
 - iv. Set Channel Type = 12.2k + HSPA
 - v. Set UE Target Power
 - vi. Power Ctrl Mode= Alternating bits
 - vii. Set and observe the E-TFCl
 - viii. Confirm that E-TFCl is equal to the target E-TFCl of 75 for sub-test 1, and other subtest's E-TFCl
- d. The transmitted maximum output power was recorded.

Table C.11.1.3: β values for transmitter characteristics tests with HS-DPCCH and E-DCH

Sub-test	β_c	β_d	β_d (SF)	β_c/β_d	β_{HS} (Note1)	β_{ec}	β_{ed} (Note 4) (Note 5)	β_{ed} (SF)	β_{ed} (Codes)	CM (dB) (Note 2)	MPR (dB) (Note 2) (Note 6)	AG Index (Note 5)	E-TFCl
1	11/15 (Note 3)	15/15 (Note 3)	64	11/15 (Note 3)	22/15	209/25	1309/225	4	1	1.0	0.0	20	75
2	6/15	15/15	64	6/15	12/15	12/15	94/75	4	1	3.0	2.0	12	67
3	15/15	9/15	64	15/9	30/15	30/15	$\beta_{ed1}: 47/15$ $\beta_{ed2}: 47/15$	4 4	2	2.0	1.0	15	92
4	2/15	15/15	64	2/15	4/15	2/15	56/75	4	1	3.0	2.0	17	71
5	15/15	0	-	-	5/15	5/15	47/15	4	1	1.0	0.0	12	67

Note 1: For sub-test 1 to 4, Δ_{ACK} , Δ_{NACK} and $\Delta_{CQI} = 30/15$ with $\beta_{hs} = 30/15 * \beta_c$. For sub-test 5, Δ_{ACK} , Δ_{NACK} and $\Delta_{CQI} = 5/15$ with $\beta_{hs} = 5/15 * \beta_c$.

Note 2: CM = 1 for $\beta_c/\beta_d = 12/15$, $\beta_{hs}/\beta_c = 24/15$. For all other combinations of DPDCH, DPCCH, HS-DPCCH, E-DPDCH and E-DPCCH the MPR is based on the relative CM difference.

Note 3: For subtest 1 the β_c/β_d ratio of 11/15 for the TFC during the measurement period (TF1, TF0) is achieved by setting the signalled gain factors for the reference TFC (TF1, TF1) to $\beta_c = 10/15$ and $\beta_d = 15/15$.

Note 4: In case of testing by UE using E-DPDCH Physical Layer category 1, Sub-test 3 is omitted according to TS25.306 Table 5.1g.

Note 5: β_{ed} can not be set directly; it is set by Absolute Grant Value.

Note 6: For subtests 2, 3 and 4, UE may perform E-DPDCH power scaling at max power which could results in slightly smaller MPR values.

Setup Configuration

DC-HSDPA 3GPP release 8 Setup Configuration:

- a. The EUT was connected to Base Station Agilent E5515C referred to the Setup Configuration below
- b. The RF path losses were compensated into the measurements.
- c. A call was established between EUT and Base Station with following setting:
 - i. Set RMC 12.2Kbps + HSDPA mode.
 - ii. Set Cell Power = -25 dBm
 - iii. Set HS-DSCH Configuration Type to FRC (H-set 12, QPSK)
 - iv. Select HSDPA Uplink Parameters
 - v. Set Gain Factors (β_c and β_d) and parameters were set according to each Specific sub-test in the following table, C10.1.4, quoted from the TS 34.121
 - a). Subtest 1: $\beta_c/\beta_d=2/15$
 - b). Subtest 2: $\beta_c/\beta_d=12/15$
 - c). Subtest 3: $\beta_c/\beta_d=15/8$
 - d). Subtest 4: $\beta_c/\beta_d=15/4$
 - vi. Set Delta ACK, Delta NACK and Delta CQI = 8
 - vii. Set Ack-Nack Repetition Factor to 3
 - viii. Set CQI Feedback Cycle (k) to 4 ms
 - ix. Set CQI Repetition Factor to 2
 - x. Power Ctrl Mode = All Up bits
- d. The transmitted maximum output power was recorded.

The following tests were conducted according to the test requirements outlines in 3GPP TS 34.121 specification. A summary of these settings are illustrated below:

C.8.1.12 Fixed Reference Channel Definition H-Set 12

Table C.8.1.12: Fixed Reference Channel H-Set 12

Parameter	Unit	Value
Nominal Avg. Inf. Bit Rate	kbps	60
Inter-TTI Distance	TTI's	1
Number of HARQ Processes	Processes	6
Information Bit Payload (N_{INF})	Bits	120
Number Code Blocks	Blocks	1
Binary Channel Bits Per TTI	Bits	960
Total Available SML's in UE	SML's	19200
Number of SML's per HARQ Proc.	SML's	3200
Coding Rate		0.15
Number of Physical Channel Codes	Codes	1
Modulation		QPSK
Note 1: The RMC is intended to be used for DC-HSDPA mode and both cells shall transmit with identical parameters as listed in the table. Note 2: Maximum number of transmission is limited to 1, i.e., retransmission is not allowed. The redundancy and constellation version 0 shall be used.		

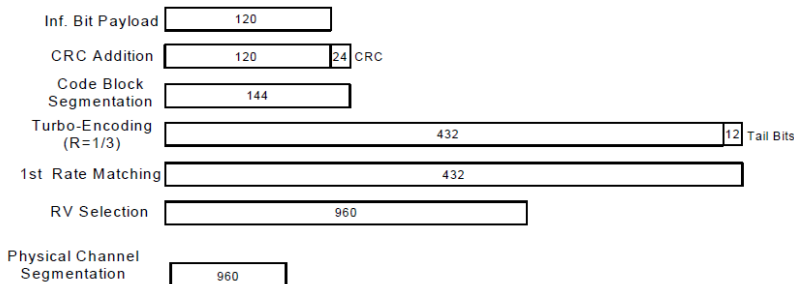

Figure C.8.19: Coding rate for Fixed reference Channel H-Set 12 (QPSK)

Setup Configuration

HSPA+ 3GPP release 7 (uplink category 7) 16QAM, Setup Configuration:

- a. The EUT was connected to Base Station Agilent E5515C referred to the Setup Configuration.
- b. The RF path losses were compensated into the measurements.
- c. A call was established between EUT and Base Station with following setting * :
 - i. Call Configs = 5.2E:HSPA+:UL with 16QAM
 - ii. Set the Gain Factors (β_c and β_d) and parameters (AG Index) were set according to each specific sub-test in the following table, C11.1.4, quoted from the TS 34.121-1 s5.2E
 - iii. Set Channel Parmes
 - iv. Set Cell Power = -86 dBm
 - v. Set Channel Type = HSPA
 - vi. Set UE Target Power =21 dBm
 - vii. Power Ctrl Mode= All Up Bits
 - viii. Set Manual Uplink DPCH Bc/Bd = Manual
 - ix. Set Manual Uplink DPCH Bc and Bd=15,15(for 34.121-1 v8.10.0 table C11.1.4 sub-test 1)
 - x. Set HSPA Conn DL Channel Levels
 - xi. Set HS-SCCH Configs
 - xii. Set RB Test Mode Setup
 - xiii. Set Common HSUPA Parameters
 - xiv. Set Serving Grant
 - xv. Confirm that E-TFCI is equal to the target E-TFCI of 105 for sub-test 1, and other subtest's E-TFCI
- d. The transmitted maximum output power was recorded.

Table C.11.1.4: β values for transmitter characteristics tests with HS-DPCCH and E-DCH with 16QAM

Sub-test	β_c (Note 3)	β_d	β_{HS} (Note 1)	β_{ec}	β_{ed} (2xSF2) (Note 4)	β_{ed} (2xSF4) (Note 4)	CM (dB) (Note 2)	MPR (dB) (Note 2)	AG Index (Note 4)	E-TFCI (Note 5)	E-TFCI (boost)
1	1	0	30/15	30/15	β_{ed1} : 30/15 β_{ed2} : 30/15	β_{ed3} : 24/15 β_{ed4} : 24/15	3.5	2.5	14	105	105

Note 1: $\Delta_{ACK}, \Delta_{NACK}$ and $\Delta_{CQI} = 30/15$ with $\beta_{HS} = 30/15 * \beta_c$.

Note 2: CM = 3.5 and the MPR is based on the relative CM difference, MPR = MAX(CM-1,0).

Note 3: DPDCH is not configured, therefore the β_c is set to 1 and $\beta_d = 0$ by default.

Note 4: β_{ed} can not be set directly; it is set by Absolute Grant Value.

Note 5: All the sub-tests require the UE to transmit 2SF2+2SF4 16QAM EDCH and they apply for UE using E-DPDCH category 7. E-DCH TTI is set to 2ms TTI and E-DCH table index = 2. To support these E-DCH configurations DPDCH is not allocated. The UE is signaled to use the extrapolation algorithm.

Setup Configuration

<WCDMA Conducted Power>
General Note:

1. Per KDB 941225 D01v03r01, for SAR testing is measured using a 12.2 kbps RMC with TPC bits configured to all "1's".
2. Per KDB 941225 D01v03r01, RMC 12.2kbps setting is used to evaluate SAR. If the maximum output power and tune-up tolerance specified for production units in HSDPA / HSUPA / DC-HSUPA / HSPA+ is $\leq \frac{1}{4}$ dB higher than RMC 12.2Kbps or when the highest reported SAR of the RMC12.2Kbps is scaled by the ratio of specified maximum output power and tune-up tolerance of HSDPA / HSUPA / DC-HSUPA / HSPA+ to RMC12.2Kbps and the adjusted SAR is ≤ 1.2 W/kg, SAR measurement is not required for HSDPA / HSUPA / DC-HSUPA / HSPA+.

Band		WCDMA Band II			Tune-up Limit (dBm)	WCDMA Band V			Tune-up Limit (dBm)
Tx Channel		9262	9400	9538		4132	4182	4233	
Rx Channel		9662	9800	9938		4357	4407	4458	
Frequency (MHz)		1852.4	1880	1907.6		826.4	836.4	846.6	
3GPP Rel 99	AMR 12.2Kbps	22.75	22.70	22.53	23.00	23.33	23.18	23.04	23.50
3GPP Rel 99	RMC 12.2Kbps	22.79	22.72	22.55	23.00	23.35	23.19	23.05	23.50
3GPP Rel 6	HSDPA Subtest-1	22.01	22.00	21.74	22.50	22.07	22.03	21.80	22.50
3GPP Rel 6	HSDPA Subtest-2	22.04	22.04	21.82	22.50	22.13	22.17	21.91	22.50
3GPP Rel 6	HSDPA Subtest-3	21.53	21.62	21.33	22.00	21.63	21.67	21.06	22.00
3GPP Rel 6	HSDPA Subtest-4	21.53	21.64	21.33	22.00	21.63	21.68	21.42	22.00
3GPP Rel 8	DC-HSDPA Subtest-1	21.85	21.88	21.77	22.50	22.01	21.95	21.77	22.50
3GPP Rel 8	DC-HSDPA Subtest-2	21.80	21.85	21.75	22.50	22.00	21.92	21.72	22.50
3GPP Rel 8	DC-HSDPA Subtest-3	21.38	21.42	21.38	22.00	21.60	21.55	21.28	22.00
3GPP Rel 8	DC-HSDPA Subtest-4	21.32	21.45	21.32	22.00	21.58	21.52	21.32	22.00
3GPP Rel 6	HSUPA Subtest-1	21.90	22.00	21.69	22.50	22.03	22.16	21.70	22.50
3GPP Rel 6	HSUPA Subtest-2	21.07	21.16	20.35	21.50	20.63	20.73	20.38	21.50
3GPP Rel 6	HSUPA Subtest-3	20.75	20.87	20.47	21.50	19.48	20.75	20.49	21.50
3GPP Rel 6	HSUPA Subtest-4	21.35	21.06	21.08	21.50	21.31	21.04	20.77	21.50
3GPP Rel 6	HSUPA Subtest-5	22.10	22.20	21.90	22.50	22.10	22.10	21.80	22.50
3GPP Rel 7	HSPA+ (16QAM) Subtest-1	21.08	20.78	20.80	21.50	21.11	20.77	20.56	21.50



<LTE Conducted Power>

General Note:

1. Anritsu MT8820C base station simulator was used to setup the connection with EUT; the frequency band, channel bandwidth, RB allocation configuration, modulation type are set in the base station simulator to configure EUT transmitting at maximum power and at different configurations which are requested to be reported to FCC, for conducted power measurement and SAR testing.
2. Per KDB 941225 D05v02r05, when a properly configured base station simulator is used for the SAR and power measurements, spectrum plots for each RB allocation and offset configuration is not required.
3. Per KDB 941225 D05v02r05, start with the largest channel bandwidth and measure SAR for QPSK with 1 RB allocation, using the RB offset and required test channel combination with the highest maximum output power for RB offsets at the upper edge, middle and lower edge of each required test channel.
4. Per KDB 941225 D05v02r05, 50% RB allocation for QPSK SAR testing follows 1RB QPSK allocation procedure.
5. Per KDB 941225 D05v02r05, For QPSK with 100% RB allocation, SAR is not required when the highest maximum output power for 100 % RB allocation is less than the highest maximum output power in 50% and 1 RB allocations and the highest reported SAR for 1 RB and 50% RB allocation are ≤ 0.8 W/kg. Otherwise, SAR is measured for the highest output power channel; and if the reported SAR is > 1.45 W/kg, the remaining required test channels must also be tested.
6. Per KDB 941225 D05v02r05, 16QAM output power for each RB allocation configuration is $>$ not $\frac{1}{2}$ dB higher than the same configuration in QPSK and the reported SAR for the QPSK configuration is ≤ 1.45 W/kg; Per KDB 941225 D05v02r05, 16QAM SAR testing is not required.
7. Per KDB 941225 D05v02r05, Smaller bandwidth output power for each RB allocation configuration is $>$ not $\frac{1}{2}$ dB higher than the same configuration in the largest supported bandwidth, and the reported SAR for the largest supported bandwidth is ≤ 1.45 W/kg; Per KDB 941225 D05v02r05, smaller bandwidth SAR testing is not required.
8. For LTE B4 / B5 / B12 / B17 the maximum bandwidth does not support three non-overlapping channels, per KDB 941225 D05v02r05, when a device supports overlapping channel assignment in a channel bandwidth configuration, the middle channel of the group of overlapping channels should be selected for testing.
9. LTE band 17 SAR test was covered by Band 12; according to April 2015 TCB workshop, SAR test for overlapping LTE bands can be reduced if
 - a. The maximum output power, including tolerance, for the smaller band is \leq the larger band to qualify for the SAR test exclusion.
 - b. The channel bandwidth and other operating parameters for the smaller band are fully supported by the larger band.



<FDD LTE Conducted Power>

<LTE Band 2>

BW [MHz]	Modulation	RB Size	RB Offset	Power Low Ch. / Freq.	Power Middle Ch. / Freq.	Power High Ch. / Freq.	Tune-up limit (dBm)	MPR (dB)
Channel				18700	18900	19100		
Frequency (MHz)				1860	1880	1900		
20	QPSK	1	0	22.78	22.48	22.39	23.5	0
20	QPSK	1	49	22.95	22.91	22.85		
20	QPSK	1	99	22.86	22.34	22.31		
20	QPSK	50	0	21.90	21.89	21.87	22.5	1
20	QPSK	50	24	21.79	21.85	21.82		
20	QPSK	50	50	21.69	21.63	21.68		
20	QPSK	100	0	21.89	21.84	21.88	22.5	1
20	16QAM	1	0	21.28	21.43	21.11		
20	16QAM	1	49	21.32	21.52	21.65		
20	16QAM	1	99	20.79	20.69	21.00	21.5	2
20	16QAM	50	0	20.84	20.98	20.90		
20	16QAM	50	24	20.85	20.62	20.65		
20	16QAM	50	50	20.87	20.67	20.70	21.5	2
20	16QAM	100	0	20.88	20.85	20.95		
Channel				18675	18900	19125		
Frequency (MHz)				1857.5	1880	1902.5		
15	QPSK	1	0	22.67	22.73	22.65	23.5	0
15	QPSK	1	37	22.89	22.69	22.84		
15	QPSK	1	74	22.85	22.61	22.70		
15	QPSK	36	0	21.92	21.92	21.85	22.5	1
15	QPSK	36	20	21.90	21.85	21.90		
15	QPSK	36	39	21.87	21.67	21.64		
15	QPSK	75	0	21.87	21.88	21.87	22.5	1
15	16QAM	1	0	20.93	21.84	20.98		
15	16QAM	1	37	21.82	21.81	21.39		
15	16QAM	1	74	20.99	20.95	21.48	21.5	2
15	16QAM	36	0	20.89	20.81	20.85		
15	16QAM	36	20	20.87	20.86	20.84		
15	16QAM	36	39	20.85	20.80	20.66	21.5	2
15	16QAM	75	0	20.98	20.70	20.82		



Channel				18650	18900	19150	Tune-up limit (dBm)	MPR (dB)
Frequency (MHz)				1855	1880	1905		
10	QPSK	1	0	22.76	22.64	22.47	23.5	0
10	QPSK	1	25	22.90	22.72	22.77		
10	QPSK	1	49	22.46	22.72	22.41		
10	QPSK	25	0	21.91	21.93	21.89	22.5	1
10	QPSK	25	12	21.90	21.86	21.78		
10	QPSK	25	25	21.88	21.77	21.62		
10	QPSK	50	0	21.92	21.87	21.80	22.5	1
10	16QAM	1	0	21.68	21.25	21.30		
10	16QAM	1	25	21.91	21.86	21.95		
10	16QAM	1	49	21.39	21.15	21.08	21.5	2
10	16QAM	25	0	20.72	20.73	20.78		
10	16QAM	25	12	20.93	20.85	20.86		
10	16QAM	25	25	20.94	20.65	20.73	21.5	2
10	16QAM	50	0	20.95	20.76	20.94		
Channel				18625	18900	19175	Tune-up limit (dBm)	MPR (dB)
Frequency (MHz)				1852.5	1880	1907.5		
5	QPSK	1	0	22.81	22.74	22.39	23.5	0
5	QPSK	1	12	22.74	22.72	22.61		
5	QPSK	1	24	22.60	22.45	22.43		
5	QPSK	12	0	21.92	21.84	21.75	22.5	1
5	QPSK	12	7	21.97	21.77	21.66		
5	QPSK	12	13	21.85	21.70	21.57		
5	QPSK	25	0	21.90	21.85	21.70	22.5	1
5	16QAM	1	0	21.85	21.95	21.91		
5	16QAM	1	12	21.91	21.24	21.74		
5	16QAM	1	24	21.79	21.15	21.17	21.5	2
5	16QAM	12	0	20.84	20.89	20.74		
5	16QAM	12	7	20.84	20.96	20.70		
5	16QAM	12	13	20.81	20.75	20.75	21.5	2
5	16QAM	25	0	20.85	20.94	20.78		



Channel				18615	18900	19185	Tune-up limit (dBm)	MPR (dB)
Frequency (MHz)				1851.5	1880	1908.5		
3	QPSK	1	0	22.73	22.53	22.50	23.5	0
3	QPSK	1	8	22.52	22.48	22.28		
3	QPSK	1	14	22.51	22.51	22.29		
3	QPSK	8	0	21.99	21.82	21.67	22.5	1
3	QPSK	8	4	21.85	21.79	21.62		
3	QPSK	8	7	21.79	21.73	21.53		
3	QPSK	15	0	21.79	21.76	21.69	22.5	1
3	16QAM	1	0	21.20	21.93	21.00		
3	16QAM	1	8	21.99	21.48	21.99		
3	16QAM	1	14	21.41	21.72	21.55	21.5	2
3	16QAM	8	0	20.81	20.88	20.74		
3	16QAM	8	4	20.70	20.78	20.67		
3	16QAM	8	7	20.85	20.89	20.62	21.5	2
3	16QAM	15	0	20.94	20.68	20.43		
Channel				18607	18900	19193	Tune-up limit (dBm)	MPR (dB)
Frequency (MHz)				1850.7	1880	1909.3		
1.4	QPSK	1	0	22.64	22.73	22.60	23.5	0
1.4	QPSK	1	3	22.68	22.86	22.76		
1.4	QPSK	1	5	22.49	22.75	22.68		
1.4	QPSK	3	0	22.94	22.86	22.66		
1.4	QPSK	3	1	22.93	22.85	22.68		
1.4	QPSK	3	3	22.92	22.92	22.77	22.5	1
1.4	QPSK	6	0	21.84	21.87	21.61		
1.4	16QAM	1	0	21.92	21.26	21.50	22.5	1
1.4	16QAM	1	3	21.38	21.98	21.78		
1.4	16QAM	1	5	21.17	21.47	21.27		
1.4	16QAM	3	0	21.58	21.66	21.46		
1.4	16QAM	3	1	21.65	21.72	21.59		
1.4	16QAM	3	3	21.89	21.73	21.36	21.5	2
1.4	16QAM	6	0	20.96	20.94	20.44		



<LTE Band 4>

BW [MHz]	Modulation	RB Size	RB Offset	Power Low Ch. / Freq.	Power Middle Ch. / Freq.	Power High Ch. / Freq.	Tune-up limit (dBm)	MPR (dB)
Channel				20050	20175	20300		
Frequency (MHz)				1720	1732.5	1745		
20	QPSK	1	0	20.66	20.83	20.89	21.5	0
20	QPSK	1	49	21.14	21.13	21.40		
20	QPSK	1	99	20.58	20.72	20.93		
20	QPSK	50	0	20.07	20.03	20.13	20.5	1
20	QPSK	50	24	20.12	20.08	20.19		
20	QPSK	50	50	19.98	19.96	20.15		
20	QPSK	100	0	20.06	19.94	20.18	20.5	1
20	16QAM	1	0	19.53	19.70	19.30		
20	16QAM	1	49	19.68	19.95	19.83		
20	16QAM	1	99	19.43	19.63	19.30	19.5	2
20	16QAM	50	0	19.07	19.08	19.19		
20	16QAM	50	24	19.34	19.03	19.44		
20	16QAM	50	50	19.20	19.11	19.10	19.5	2
20	16QAM	100	0	19.16	19.06	19.24		
Channel				20025	20175	20325		
Frequency (MHz)				1717.5	1732.5	1747.5		
15	QPSK	1	0	21.08	21.03	21.10	21.5	0
15	QPSK	1	37	21.24	21.00	21.22		
15	QPSK	1	74	21.05	20.95	21.21		
15	QPSK	36	0	20.11	20.05	20.15	20.5	1
15	QPSK	36	20	20.07	19.98	20.25		
15	QPSK	36	39	20.07	20.01	20.11		
15	QPSK	75	0	20.03	19.98	20.12	20.5	1
15	16QAM	1	0	19.76	19.51	19.76		
15	16QAM	1	37	19.89	19.75	20.00		
15	16QAM	1	74	19.58	19.40	19.33	19.5	2
15	16QAM	36	0	19.01	19.09	19.19		
15	16QAM	36	20	19.10	19.14	19.21		
15	16QAM	36	39	19.10	19.05	19.25	19.5	2
15	16QAM	75	0	19.15	18.91	19.39		



Channel				20000	20175	20350	Tune-up limit (dBm)	MPR (dB)
Frequency (MHz)				1715	1732.5	1750		
10	QPSK	1	0	20.89	20.86	21.04	21.5	0
10	QPSK	1	25	21.26	21.17	21.27		
10	QPSK	1	49	20.82	20.80	20.99		
10	QPSK	25	0	20.06	20.06	20.20	20.5	1
10	QPSK	25	12	20.09	19.97	20.27		
10	QPSK	25	25	19.97	19.96	20.11		
10	QPSK	50	0	20.10	19.99	20.21	20.5	1
10	16QAM	1	0	19.50	19.54	19.76		
10	16QAM	1	25	19.84	19.82	20.41		
10	16QAM	1	49	19.61	19.56	19.58	19.5	2
10	16QAM	25	0	19.19	19.12	19.30		
10	16QAM	25	12	19.23	19.15	19.32		
10	16QAM	25	25	19.22	19.03	19.07	19.5	2
10	16QAM	50	0	19.22	18.95	19.17		
Channel				19975	20175	20375	Tune-up limit (dBm)	MPR (dB)
Frequency (MHz)				1712.5	1732.5	1752.5		
5	QPSK	1	0	20.87	20.95	21.14	21.5	0
5	QPSK	1	12	21.18	21.27	21.24		
5	QPSK	1	24	20.94	20.90	21.15		
5	QPSK	12	0	20.00	20.06	20.20	20.5	1
5	QPSK	12	7	20.08	20.10	20.25		
5	QPSK	12	13	20.12	20.05	20.19		
5	QPSK	25	0	20.02	20.02	20.28	20.5	1
5	16QAM	1	0	19.62	19.52	19.65		
5	16QAM	1	12	19.92	19.78	19.94		
5	16QAM	1	24	19.43	19.44	19.68	19.5	2
5	16QAM	12	0	18.94	18.94	19.26		
5	16QAM	12	7	19.03	19.29	19.32		
5	16QAM	12	13	18.94	19.24	19.18	19.5	2
5	16QAM	25	0	19.07	18.98	19.25		



Channel				19965	20175	20385	Tune-up limit (dBm)	MPR (dB)
Frequency (MHz)				1711.5	1732.5	1753.5		
3	QPSK	1	0	20.80	20.88	21.20	21.5	0
3	QPSK	1	8	20.88	20.92	21.24		
3	QPSK	1	14	21.04	20.91	21.20		
3	QPSK	8	0	20.05	20.00	20.12	20.5	1
3	QPSK	8	4	20.08	20.05	20.09		
3	QPSK	8	7	19.94	20.01	20.10		
3	QPSK	15	0	20.02	19.98	20.04	20.5	1
3	16QAM	1	0	19.55	20.13	19.53		
3	16QAM	1	8	19.56	20.15	19.52		
3	16QAM	1	14	19.50	20.23	19.49	19.5	2
3	16QAM	8	0	19.19	19.05	19.25		
3	16QAM	8	4	19.06	18.99	19.11		
3	16QAM	8	7	19.14	19.03	19.12	19.5	2
3	16QAM	15	0	18.85	18.96	18.91		
Channel				19957	20175	20393	Tune-up limit (dBm)	MPR (dB)
Frequency (MHz)				1710.7	1732.5	1754.3		
1.4	QPSK	1	0	21.02	20.91	21.13	21.5	0
1.4	QPSK	1	3	21.11	21.17	21.20		
1.4	QPSK	1	5	21.05	21.09	21.18		
1.4	QPSK	3	0	21.24	21.26	21.27		
1.4	QPSK	3	1	21.22	21.13	21.28		
1.4	QPSK	3	3	21.19	21.25	21.20		
1.4	QPSK	6	0	20.03	20.01	20.10	20.5	1
1.4	16QAM	1	0	19.88	19.60	19.60	20.5	1
1.4	16QAM	1	3	19.56	20.03	19.80		
1.4	16QAM	1	5	19.65	19.47	19.57		
1.4	16QAM	3	0	19.78	19.85	19.88		
1.4	16QAM	3	1	19.83	20.30	20.12		
1.4	16QAM	3	3	19.72	20.27	20.05		
1.4	16QAM	6	0	18.99	19.04	19.06	19.5	2



<LTE Band 5>

BW [MHz]	Modulation	RB Size	RB Offset	Power Low Ch. / Freq.	Power Middle Ch. / Freq.	Power High Ch. / Freq.	Tune-up limit (dBm)	MPR (dB)
Channel				20450	20525	20600		
Frequency (MHz)				829	836.5	844		
10	QPSK	1	0	23.09	22.92	22.78	23.5	0
10	QPSK	1	25	23.41	23.42	23.31		
10	QPSK	1	49	23.11	23.06	23.12		
10	QPSK	25	0	22.35	22.36	22.27	22.5	1
10	QPSK	25	12	22.30	22.30	22.27		
10	QPSK	25	25	22.30	22.21	22.07		
10	QPSK	50	0	22.32	22.32	22.19	22.5	1
10	16QAM	1	0	21.75	21.88	21.87		
10	16QAM	1	25	22.00	22.33	21.87		
10	16QAM	1	49	21.80	21.75	21.74	21.5	2
10	16QAM	25	0	21.38	21.19	21.12		
10	16QAM	25	12	21.17	21.21	21.16		
10	16QAM	25	25	21.26	21.13	21.09	21.5	2
10	16QAM	25	25	21.26	21.13	21.09		
10	16QAM	50	0	21.34	21.21	21.11		
Channel				20425	20525	20625		
Frequency (MHz)				826.5	836.5	846.5		
5	QPSK	1	0	23.05	22.96	22.96	23.5	0
5	QPSK	1	12	23.20	23.25	23.18		
5	QPSK	1	24	23.12	22.98	22.95		
5	QPSK	12	0	22.38	22.15	22.22	22.5	1
5	QPSK	12	7	22.46	22.33	22.20		
5	QPSK	12	13	22.32	22.18	22.17		
5	QPSK	25	0	22.37	22.11	22.15	22.5	1
5	16QAM	1	0	22.31	22.35	21.61		
5	16QAM	1	12	22.08	22.36	21.90		
5	16QAM	1	24	21.67	22.31	21.97	21.5	2
5	16QAM	12	0	21.21	21.00	21.07		
5	16QAM	12	7	21.21	21.15	21.01		
5	16QAM	12	13	21.37	21.02	21.03	21.5	2
5	16QAM	12	13	21.37	21.02	21.03		
5	16QAM	25	0	21.40	21.14	20.97		



Channel				20415	20525	20635	Tune-up limit (dBm)	MPR (dB)
Frequency (MHz)				825.5	836.5	847.5		
3	QPSK	1	0	22.81	22.90	22.95	23.5	0
3	QPSK	1	8	22.91	22.93	23.00		
3	QPSK	1	14	23.06	22.95	23.25		
3	QPSK	8	0	22.10	22.09	22.06	22.5	1
3	QPSK	8	4	22.22	22.08	22.00		
3	QPSK	8	7	22.20	22.14	22.03		
3	QPSK	15	0	22.13	22.11	22.00	22.5	1
3	16QAM	1	0	22.05	21.86	22.42		
3	16QAM	1	8	21.88	21.87	21.55		
3	16QAM	1	14	22.00	21.65	21.66	21.5	2
3	16QAM	8	0	20.79	20.93	20.76		
3	16QAM	8	4	21.28	20.78	20.83		
3	16QAM	8	7	21.26	20.79	20.84	21.5	2
3	16QAM	15	0	20.96	21.04	21.06		
Channel				20407	20525	20643	Tune-up limit (dBm)	MPR (dB)
Frequency (MHz)				824.7	836.5	848.3		
1.4	QPSK	1	0	22.94	22.93	23.02	23.5	0
1.4	QPSK	1	3	22.99	23.04	23.00		
1.4	QPSK	1	5	23.02	22.92	22.81		
1.4	QPSK	3	0	23.14	23.12	23.06		
1.4	QPSK	3	1	23.23	23.14	23.03		
1.4	QPSK	3	3	23.20	23.05	23.11		
1.4	QPSK	6	0	22.12	22.09	22.02	22.5	1
1.4	16QAM	1	0	21.67	22.28	22.20	22.5	1
1.4	16QAM	1	3	21.95	21.67	21.83		
1.4	16QAM	1	5	21.68	21.58	21.84		
1.4	16QAM	3	0	21.99	21.83	22.04		
1.4	16QAM	3	1	22.17	21.82	21.76		
1.4	16QAM	3	3	21.58	21.85	21.69		
1.4	16QAM	6	0	20.99	20.93	21.05	21.5	2



<LTE Band 7>

BW [MHz]	Modulation	RB Size	RB Offset	Power Low Ch. / Freq.	Power Middle Ch. / Freq.	Power High Ch. / Freq.	Tune-up limit (dBm)	MPR (dB)
Channel				20850	21100	21350		
Frequency (MHz)				2510	2535	2560		
20	QPSK	1	0	21.63	21.25	21.36	22.5	0
20	QPSK	1	49	22.09	22.15	22.23		
20	QPSK	1	99	21.51	21.28	21.75		
20	QPSK	50	0	20.60	20.72	20.74	21.5	1
20	QPSK	50	24	20.55	20.76	20.93		
20	QPSK	50	50	20.70	20.86	21.04		
20	QPSK	100	0	20.63	20.79	20.94	21.5	1
20	16QAM	1	0	20.07	20.13	20.27		
20	16QAM	1	49	20.20	20.28	20.88		
20	16QAM	1	99	20.01	19.98	20.53	20.5	2
20	16QAM	50	0	19.39	19.77	19.72		
20	16QAM	50	24	19.39	19.81	19.81		
20	16QAM	50	50	19.36	19.82	19.94	20.5	2
20	16QAM	100	0	19.66	19.75	19.74		
Channel				20825	21100	21375		
Frequency (MHz)				2507.5	2535	2562.5		
15	QPSK	1	0	21.87	21.40	21.57	22.5	0
15	QPSK	1	37	21.89	21.93	21.88		
15	QPSK	1	74	21.71	21.58	21.73		
15	QPSK	36	0	20.74	20.74	20.93	21.5	1
15	QPSK	36	20	20.82	20.79	20.87		
15	QPSK	36	39	20.78	20.75	21.00		
15	QPSK	75	0	20.77	20.81	20.94	21.5	1
15	16QAM	1	0	20.40	20.43	20.51		
15	16QAM	1	37	20.41	21.10	21.17		
15	16QAM	1	74	20.25	20.54	20.82	20.5	2
15	16QAM	36	0	19.81	19.62	19.90		
15	16QAM	36	20	19.67	19.77	19.64		
15	16QAM	36	39	19.85	19.61	20.00	20.5	2
15	16QAM	75	0	19.84	19.87	19.84		



Channel				20800	21100	21400	Tune-up limit (dBm)	MPR (dB)
Frequency (MHz)				2505	2535	2565		
10	QPSK	1	0	21.77	21.57	21.38	22.5	0
10	QPSK	1	25	21.92	21.62	22.18		
10	QPSK	1	49	21.43	21.40	21.73		
10	QPSK	25	0	20.88	20.75	20.86	21.5	1
10	QPSK	25	12	20.88	20.85	21.07		
10	QPSK	25	25	20.82	20.71	21.07		
10	QPSK	50	0	20.81	20.79	20.93	21.5	1
10	16QAM	1	0	20.48	20.30	20.28		
10	16QAM	1	25	20.55	20.57	21.24		
10	16QAM	1	49	20.25	20.25	20.60	20.5	2
10	16QAM	25	0	19.77	19.63	19.85		
10	16QAM	25	12	19.87	19.74	20.15		
10	16QAM	25	25	19.79	19.49	20.07	20.5	2
10	16QAM	50	0	19.88	19.66	20.01		
Channel				20775	21100	21425	Tune-up limit (dBm)	MPR (dB)
Frequency (MHz)				2502.5	2535	2567.5		
5	QPSK	1	0	21.80	21.58	21.82	22.5	0
5	QPSK	1	12	22.04	21.93	22.04		
5	QPSK	1	24	21.68	21.64	21.69		
5	QPSK	12	0	20.86	20.71	21.08	21.5	1
5	QPSK	12	7	20.95	20.74	21.08		
5	QPSK	12	13	20.80	20.77	20.94		
5	QPSK	25	0	20.85	20.72	20.98	21.5	1
5	16QAM	1	0	20.86	20.79	20.48		
5	16QAM	1	12	21.05	20.42	20.73		
5	16QAM	1	24	20.44	20.69	20.49	20.5	2
5	16QAM	12	0	19.97	19.79	20.00		
5	16QAM	12	7	20.03	19.82	20.09		
5	16QAM	12	13	19.88	19.65	19.98	20.5	2
5	16QAM	25	0	19.84	19.61	19.99		



<LTE Band 12>

BW [MHz]	Modulation	RB Size	RB Offset	Power Low Ch. / Freq.	Power Middle Ch. / Freq.	Power High Ch. / Freq.	Tune-up limit (dBm)	MPR (dB)
Channel				23060	23095	23130		
Frequency (MHz)				704	707.5	711		
10	QPSK	1	0	21.98	22.35	22.46	23	0
10	QPSK	1	25	22.83	22.66	22.63		
10	QPSK	1	49	22.39	22.42	22.27		
10	QPSK	25	0	21.66	21.67	21.74	22	1
10	QPSK	25	12	21.78	21.75	21.72		
10	QPSK	25	25	21.56	21.67	21.64		
10	QPSK	50	0	21.70	21.61	21.75	22	1
10	16QAM	1	0	21.16	20.91	20.93		
10	16QAM	1	25	21.76	21.24	21.32		
10	16QAM	1	49	21.26	21.11	21.22	21	2
10	16QAM	25	0	20.64	20.67	20.84		
10	16QAM	25	12	20.82	20.72	20.77		
10	16QAM	25	25	20.55	20.67	20.72	21	2
10	16QAM	25	0	20.61	20.50	20.81		
10	16QAM	50	0	20.61	20.50	20.81		
Channel				23035	23095	23155	Tune-up limit (dBm)	MPR (dB)
Frequency (MHz)				701.5	707.5	713.5		
5	QPSK	1	0	22.29	22.33	22.43	23	0
5	QPSK	1	12	22.76	22.72	22.58		
5	QPSK	1	24	22.75	22.44	22.20		
5	QPSK	12	0	21.52	21.65	21.69	22	1
5	QPSK	12	7	21.78	21.62	21.71		
5	QPSK	12	13	21.62	21.59	21.66		
5	QPSK	25	0	21.52	21.57	21.70	22	1
5	16QAM	1	0	21.05	21.01	21.91		
5	16QAM	1	12	21.23	22.00	21.92		
5	16QAM	1	24	21.20	21.25	21.86	21	2
5	16QAM	12	0	20.43	20.34	20.56		
5	16QAM	12	7	20.79	20.53	20.84		
5	16QAM	12	13	20.74	20.51	20.67	21	2
5	16QAM	12	0	20.73	20.79	20.70		



Channel				23025	23095	23165	Tune-up limit (dBm)	MPR (dB)
Frequency (MHz)				700.5	707.5	714.5		
3	QPSK	1	0	22.30	22.43	22.30	23	0
3	QPSK	1	8	22.48	22.54	22.33		
3	QPSK	1	14	22.48	22.62	22.50		
3	QPSK	8	0	21.46	21.61	21.69	22	1
3	QPSK	8	4	21.70	21.65	21.66		
3	QPSK	8	7	21.61	21.55	21.63		
3	QPSK	15	0	21.62	21.71	21.70		
3	16QAM	1	0	21.26	21.74	21.14	22	1
3	16QAM	1	8	21.68	21.65	21.07		
3	16QAM	1	14	21.80	21.67	21.11		
3	16QAM	8	0	20.54	20.65	20.74	21	2
3	16QAM	8	4	20.58	20.61	20.71		
3	16QAM	8	7	20.72	20.63	20.77		
3	16QAM	15	0	20.37	20.61	20.64		
Channel				23017	23095	23173	Tune-up limit (dBm)	MPR (dB)
Frequency (MHz)				699.7	707.5	715.3		
1.4	QPSK	1	0	22.17	22.59	22.55	23	0
1.4	QPSK	1	3	22.35	22.40	22.57		
1.4	QPSK	1	5	22.51	22.30	22.57		
1.4	QPSK	3	0	22.52	22.62	22.70		
1.4	QPSK	3	1	22.51	22.67	22.67		
1.4	QPSK	3	3	22.67	22.63	22.75		
1.4	QPSK	6	0	21.56	21.61	21.60	22	1
1.4	16QAM	1	0	21.62	21.15	21.13	22	1
1.4	16QAM	1	3	21.61	21.80	21.39		
1.4	16QAM	1	5	21.49	21.70	21.16		
1.4	16QAM	3	0	21.35	21.32	21.32		
1.4	16QAM	3	1	21.48	21.33	21.58		
1.4	16QAM	3	3	21.33	21.55	21.42		
1.4	16QAM	6	0	20.41	20.48	20.46	21	2



<LTE Band 17>

BW [MHz]	Modulation	RB Size	RB Offset	Power Low Ch. / Freq.	Power Middle Ch. / Freq.	Power High Ch. / Freq.	Tune-up limit (dBm)	MPR (dB)
Channel				23780	23790	23800		
Frequency (MHz)				709	710	711		
10	QPSK	1	0	21.85	22.26	22.19	23	0
10	QPSK	1	25	22.61	22.75	22.67		
10	QPSK	1	49	22.32	22.32	22.42		
10	QPSK	25	0	21.64	21.64	21.68	22	1
10	QPSK	25	12	21.79	21.84	21.71		
10	QPSK	25	25	21.74	21.78	21.77		
10	QPSK	50	0	21.73	21.71	21.69	22	1
10	16QAM	1	0	21.41	21.06	21.26		
10	16QAM	1	25	21.98	21.40	21.70		
10	16QAM	1	49	21.41	21.31	21.32	21	2
10	16QAM	25	0	20.56	20.71	20.66		
10	16QAM	25	12	20.58	20.74	20.69		
10	16QAM	25	25	20.78	20.55	20.66	21	2
10	16QAM	25	0	20.65	20.69	20.67		
10	16QAM	50	0	20.65	20.69	20.67		
Channel				23755	23790	23825	Tune-up limit (dBm)	MPR (dB)
Frequency (MHz)				706.5	710	713.5		
5	QPSK	1	0	22.44	22.22	22.48	23	0
5	QPSK	1	12	22.61	22.70	22.60		
5	QPSK	1	24	22.46	22.41	22.30		
5	QPSK	12	0	21.63	21.55	21.58	22	1
5	QPSK	12	7	21.68	21.63	21.73		
5	QPSK	12	13	21.58	21.70	21.59		
5	QPSK	25	0	21.63	21.72	21.71	22	1
5	16QAM	1	0	21.67	21.08	21.44		
5	16QAM	1	12	21.41	21.85	21.86		
5	16QAM	1	24	21.56	21.58	21.48	21	2
5	16QAM	12	0	20.47	20.44	20.58		
5	16QAM	12	7	20.47	20.62	20.63		
5	16QAM	12	13	20.37	20.57	20.59	21	2
5	16QAM	12	0	20.59	20.81	20.71		



<LTE Band 26>

BW [MHz]	Modulation	RB Size	RB Offset	Power Low Ch. / Freq.	Power Middle Ch. / Freq.	Power High Ch. / Freq.	Tune-up limit (dBm)	MPR (dB)
Channel				26765	26865	26965		
Frequency (MHz)				821.5	831.5	841.5		
15	QPSK	1	0	21.87	22.02	21.90	22.5	0
15	QPSK	1	37	22.27	22.38	22.37		
15	QPSK	1	74	22.05	22.02	21.89		
15	QPSK	36	0	21.16	21.25	21.15	21.5	1
15	QPSK	36	20	21.17	21.24	21.13		
15	QPSK	36	39	21.29	21.15	21.16		
15	16QAM	1	0	20.81	20.78	20.66	21.5	1
15	16QAM	1	37	21.39	21.48	21.49		
15	16QAM	1	74	21.01	20.85	20.69		
15	16QAM	36	0	20.00	20.35	20.05	20.5	2
15	16QAM	36	20	20.08	20.31	20.24		
15	16QAM	36	39	20.21	20.05	20.13		
15	16QAM	75	0	20.16	20.28	20.06		
Channel				26740	26865	26990	Tune-up limit (dBm)	MPR (dB)
Frequency (MHz)				819	831.5	844		
10	QPSK	1	0	21.69	22.05	21.84	22.5	0
10	QPSK	1	25	22.24	22.16	22.35		
10	QPSK	1	49	22.09	21.93	22.01		
10	QPSK	25	0	21.05	21.17	21.11	21.5	1
10	QPSK	25	12	21.13	21.25	21.15		
10	QPSK	25	25	21.23	21.20	21.05		
10	QPSK	50	0	21.15	21.25	21.09	21.5	1
10	16QAM	1	0	20.52	20.88	20.72		
10	16QAM	1	25	20.84	21.47	20.82		
10	16QAM	1	49	20.70	20.48	20.63	20.5	2
10	16QAM	25	0	19.96	20.19	20.35		
10	16QAM	25	12	20.14	20.28	20.35		
10	16QAM	25	25	20.11	20.11	19.98		
10	16QAM	50	0	20.04	20.26	20.09		



Channel				26715	26865	27015	Tune-up limit (dBm)	MPR (dB)
Frequency (MHz)				816.5	831.5	846.5		
5	QPSK	1	0	21.70	22.09	22.01	22.5	0
5	QPSK	1	12	22.03	22.30	21.93		
5	QPSK	1	24	21.84	22.00	21.86		
5	QPSK	12	0	21.04	21.17	21.12	21.5	1
5	QPSK	12	7	21.07	21.18	21.11		
5	QPSK	12	13	21.09	21.12	21.05		
5	QPSK	25	0	21.01	21.14	21.04	21.5	1
5	16QAM	1	0	21.14	20.68	20.63		
5	16QAM	1	12	21.29	20.90	20.81		
5	16QAM	1	24	20.88	20.60	20.48	20.5	2
5	16QAM	12	0	19.96	20.12	19.94		
5	16QAM	12	7	19.99	20.15	19.98		
5	16QAM	12	13	20.01	20.04	19.80	20.5	2
5	16QAM	25	0	19.94	20.07	19.97		
Channel				26705	26865	27025	Tune-up limit (dBm)	MPR (dB)
Frequency (MHz)				815.5	831.5	847.5		
3	QPSK	1	0	22.00	22.03	21.94	22.5	0
3	QPSK	1	8	21.86	22.19	21.83		
3	QPSK	1	14	21.92	22.08	21.78		
3	QPSK	8	0	21.14	21.24	21.07	21.5	1
3	QPSK	8	4	21.09	21.20	21.17		
3	QPSK	8	7	21.01	21.23	21.05		
3	QPSK	15	0	21.12	21.13	21.12	21.5	1
3	16QAM	1	0	20.55	20.71	21.15		
3	16QAM	1	8	20.57	20.66	21.12		
3	16QAM	1	14	20.63	20.67	20.44	20.5	2
3	16QAM	8	0	20.12	20.21	20.04		
3	16QAM	8	4	20.06	20.08	19.97		
3	16QAM	8	7	20.08	20.30	20.01	20.5	2
3	16QAM	15	0	19.86	20.16	19.79		
Channel				26697	26865	27033	Tune-up limit (dBm)	MPR (dB)
Frequency (MHz)				814.7	831.5	848.3		
1.4	QPSK	1	0	21.89	22.10	22.09	22.5	0
1.4	QPSK	1	3	22.02	22.14	22.22		
1.4	QPSK	1	5	21.94	22.05	21.86		
1.4	QPSK	3	0	21.93	22.13	22.11		
1.4	QPSK	3	1	22.09	22.30	22.15		
1.4	QPSK	3	3	22.10	22.31	22.17	21.5	1
1.4	QPSK	6	0	21.08	21.19	21.10		
1.4	16QAM	1	0	21.21	21.38	20.93	21.5	1
1.4	16QAM	1	3	21.35	21.18	20.75		
1.4	16QAM	1	5	21.24	20.86	20.69		
1.4	16QAM	3	0	20.89	21.10	21.24		
1.4	16QAM	3	1	20.92	21.18	21.11		
1.4	16QAM	3	3	20.88	21.02	20.91	20.5	2
1.4	16QAM	6	0	19.73	20.07	20.06		

<TDD LTE SAR Measurement>

TDD LTE configuration setup for SAR measurement

SAR was tested with a fixed periodic duty factor according to the highest transmission duty factor implemented for the device and supported by 3GPP.

- a. 3GPP TS 36.211 section 4.2 for Type 2 Frame Structure and Table 4.2-2 for uplink-downlink configurations
- b. "special subframe S" contains both uplink and downlink transmissions, it has been taken into consideration to determine the transmission duty factor according to the worst case uplink and downlink cyclic prefix requirements for UpPTS
- c. Establishing connections with base station simulators ensure a consistent means for testing SAR and recommended for evaluating SAR. The Anritsu MT8820C (firmware: #22.52#004) was used for LTE output power measurements and SAR testing.

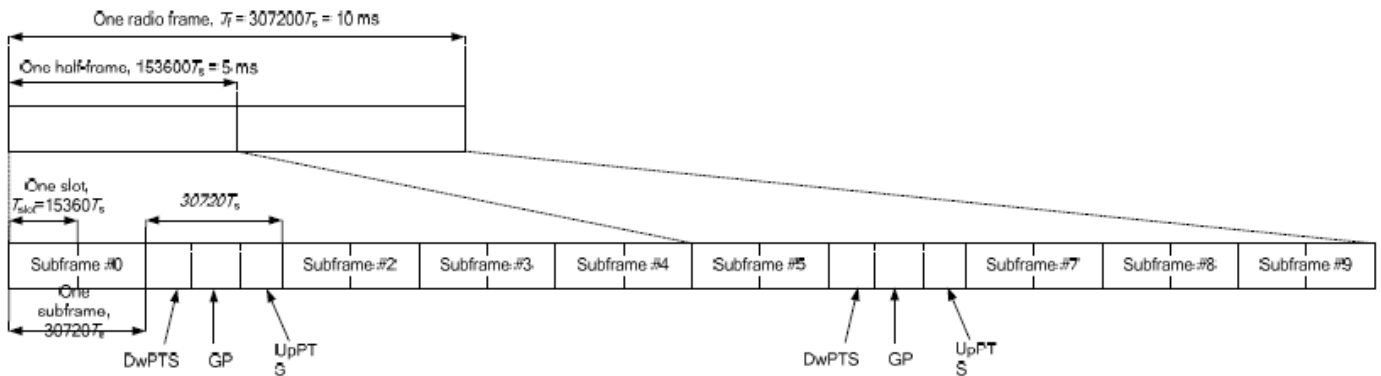

Figure 4.2-1: Frame structure type 2 (for 5 ms switch-point periodicity).

Table 4.2-2: Uplink-downlink configurations.

Uplink-downlink configuration	Downlink-to-Uplink Switch-point periodicity	Subframe number									
		0	1	2	3	4	5	6	7	8	9
0	5 ms	D	S	U	U	U	D	S	U	U	U
1	5 ms	D	S	U	U	D	D	S	U	U	D
2	5 ms	D	S	U	D	D	D	S	U	D	D
3	10 ms	D	S	U	U	U	D	D	D	D	D
4	10 ms	D	S	U	U	D	D	D	D	D	D
5	10 ms	D	S	U	D	D	D	D	D	D	D
6	5 ms	D	S	U	U	U	D	S	U	U	D

Table 4.2-1: Configuration of special subframe (lengths of DwPTS/GP/UpPTS).

Special subframe configuration	Normal cyclic prefix in downlink			Extended cyclic prefix in downlink		
	DwPTS	UpPTS		DwPTS	UpPTS	
		Normal cyclic prefix in uplink	Extended cyclic prefix in uplink		Normal cyclic prefix in uplink	Extended cyclic prefix in uplink
0	6592 · Ts	2192 · Ts	2560 · Ts	7680 · Ts	2192 · Ts	2560 · Ts
1	19760 · Ts			20480 · Ts		
2	21952 · Ts			23040 · Ts		
3	24144 · Ts			25600 · Ts		
4	26336 · Ts	4384 · Ts	5120 · Ts	7680 · Ts	4384 · Ts	5120 · Ts
5	6592 · Ts			20480 · Ts		
6	19760 · Ts			23040 · Ts		
7	21952 · Ts			12800 · Ts		
8	24144 · Ts			-		
9	13168 · Ts	-	-	-	-	-

Special subframe (30720·T_s): Normal cyclic prefix in downlink (UpPTS)			
	Special subframe configuration	Normal cyclic prefix in uplink	Extended cyclic prefix in uplink
Uplink duty factor in one special subframe	0~4	7.13%	8.33%
	5~9	14.3%	16.7%

Special subframe(30720·T_s): Extended cyclic prefix in downlink (UpPTS)			
	Special subframe configuration	Normal cyclic prefix in uplink	Extended cyclic prefix in uplink
Uplink duty factor in one special subframe	0~3	7.13%	8.33%
	4~7	14.3%	16.7%

The highest duty factor is resulted from:

- i. Uplink-downlink configuration: 0. In a half-frame consisted of 5 subframes, uplink operation is in 3 uplink subframes and 1 special subframe.
- ii. special subframe configuration: 5-9 for normal cyclic prefix in downlink, 4-7 for extended cyclic prefix in downlink
- iii. for special subframe with extended cyclic prefix in uplink, the total uplink duty factor in one half-frame is: $(3+0.167)/5 = 63.3\%$
- iv. for special subframe with normal cyclic prefix in uplink, the total uplink duty factor in one half-frame is: $(3+0.143)/5 = 62.9\%$
- v. For TDD LTE SAR measurement, the duty cycle 1:1.59 (62.9 %) was used perform testing and considering the theoretical duty cycle of 63.3% for extended cyclic prefix in the uplink, and the theoretical duty cycle of 62.9% for normal cyclic prefix in uplink, a scaling factor of extended cyclic prefix $63.3\%/62.9\% = 1.006$ is applied to scale-up the measured SAR result. The scaled TDD LTE SAR = measured SAR (W/kg)* Tune-up Scaling Factor* scaling factor for extended cyclic prefix.



<LTE Band 38>

BW [MHz]	Modulation	RB Size	RB Offset	Power Low Ch. / Freq.	Power Middle Ch. / Freq.	Power High Ch. / Freq.	Tune-up limit (dBm)	MPR (dB)
Channel				37850	38000	38150		
Frequency (MHz)				2580	2595	2610		
20	QPSK	1	0	22.80	22.69	22.70		
20	QPSK	1	49	22.87	22.81	22.82	23	0
20	QPSK	1	99	22.60	22.44	22.40		
20	QPSK	50	0	22.02	21.91	21.84		
20	QPSK	50	24	22.04	21.79	21.85	22.5	0.5
20	QPSK	50	50	22.02	21.71	21.70		
20	QPSK	100	0	22.05	21.82	21.80		
20	16QAM	1	0	21.58	21.55	21.60	22	1
20	16QAM	1	49	21.87	21.63	21.64		
20	16QAM	1	99	21.42	21.42	21.42		
20	16QAM	50	0	21.02	20.84	20.87	21.5	1.5
20	16QAM	50	24	21.04	20.84	20.73		
20	16QAM	50	50	21.04	20.82	20.80		
20	16QAM	100	0	20.90	20.75	20.66		
Channel				37825	38000	38175	Tune-up limit (dBm)	MPR (dB)
Frequency (MHz)				2577.5	2595	2612.5		
15	QPSK	1	0	22.77	22.85	22.77	23	0
15	QPSK	1	37	22.80	22.79	22.79		
15	QPSK	1	74	22.85	22.74	22.62		
15	QPSK	36	0	22.05	21.74	21.74	22.5	0.5
15	QPSK	36	20	22.08	21.81	21.81		
15	QPSK	36	39	22.01	21.73	21.73		
15	QPSK	75	0	22.01	21.82	21.82	22	1
15	16QAM	1	0	21.67	21.58	21.58		
15	16QAM	1	37	21.74	21.63	21.60		
15	16QAM	1	74	21.65	21.38	21.38	21.5	1.5
15	16QAM	36	0	20.93	20.73	20.73		
15	16QAM	36	20	20.95	20.77	20.77		
15	16QAM	36	39	20.93	20.61	20.69		
15	16QAM	75	0	21.04	20.73	20.74		



Channel				37800	38000	38200	Tune-up limit (dBm)	MPR (dB)
Frequency (MHz)				2575	2595	2615		
10	QPSK	1	0	22.80	22.69	22.60	23	0
10	QPSK	1	25	22.83	22.70	22.61		
10	QPSK	1	49	22.79	22.53	22.53		
10	QPSK	25	0	22.01	21.85	21.85	22.5	0.5
10	QPSK	25	12	22.10	21.79	21.79		
10	QPSK	25	25	22.02	21.80	21.80		
10	QPSK	50	0	22.06	21.84	21.84		
10	16QAM	1	0	21.57	21.48	21.47	22	1
10	16QAM	1	25	21.94	21.55	21.70		
10	16QAM	1	49	21.66	21.33	21.42		
10	16QAM	25	0	21.14	21.08	20.99	21.5	1.5
10	16QAM	25	12	21.14	21.04	20.93		
10	16QAM	25	25	21.20	20.93	21.01		
10	16QAM	50	0	21.00	20.78	20.77		
Channel				37775	38000	38225	Tune-up limit (dBm)	MPR (dB)
Frequency (MHz)				2572.5	2595	2617.5		
5	QPSK	1	0	22.85	22.54	22.55	23	0
5	QPSK	1	12	22.77	22.73	22.83		
5	QPSK	1	24	22.81	22.44	22.54		
5	QPSK	12	0	22.10	21.83	21.83	22.5	0.5
5	QPSK	12	7	22.03	21.93	21.82		
5	QPSK	12	13	22.03	21.82	21.70		
5	QPSK	25	0	22.02	21.84	21.84		
5	16QAM	1	0	21.61	21.29	21.29	22	1
5	16QAM	1	12	21.92	21.54	21.54		
5	16QAM	1	24	21.61	21.33	21.33		
5	16QAM	12	0	21.01	20.66	20.66	21.5	1.5
5	16QAM	12	7	21.10	20.67	20.67		
5	16QAM	12	13	21.02	20.56	20.56		
5	16QAM	25	0	21.15	20.69	20.69		

<LTE Band 41>

BW [MHz]	Modulation	RB Size	RB Offset	Power Low Ch. / Freq.	Power Middle Low Ch. / Freq.	Power Middle High Ch. / Freq.	Power High Ch. / Freq.	Tune-up limit (dBm)	MPR (dB)
Channel				40240	40500	40770	41140		
Frequency (MHz)				2555	2581	2608	2645		
20	QPSK	1	0	22.66	22.85	22.53	22.87	23.5	0
20	QPSK	1	49	22.94	22.96	22.88	23.37		
20	QPSK	1	99	22.54	22.56	22.45	23.14		
20	QPSK	50	0	21.96	22.12	21.86	22.28	22.5	1
20	QPSK	50	24	22.14	21.99	21.80	22.39		
20	QPSK	50	50	21.86	22.01	21.78	22.28		
20	QPSK	100	0	21.95	22.10	21.88	22.40	22.5	1
20	16QAM	1	0	21.52	21.61	21.49	21.78		
20	16QAM	1	49	21.89	21.89	21.59	22.23		
20	16QAM	1	99	21.33	21.49	21.35	21.94	22	1.5
20	16QAM	50	0	20.95	21.15	20.87	21.31		
20	16QAM	50	24	21.00	20.92	20.62	21.32		
20	16QAM	50	50	20.70	20.93	20.91	21.39	22	1.5
20	16QAM	50	0	20.88	20.95	20.91	21.38		
20	16QAM	100	0	20.88	20.95	20.91	21.38		
Channel				40215	40495	40785	41165	Tune-up limit (dBm)	MPR (dB)
Frequency (MHz)				2552.5	2580.5	2609.5	2647.5		
15	QPSK	1	0	22.87	22.91	22.59	22.98	23.5	0
15	QPSK	1	37	23.28	23.17	23.00	23.33		
15	QPSK	1	74	22.78	22.96	22.65	23.28		
15	QPSK	36	0	21.96	22.19	21.78	22.27	22.5	1
15	QPSK	36	20	22.11	21.93	21.95	22.42		
15	QPSK	36	39	21.94	22.02	21.79	22.36		
15	QPSK	75	0	21.98	22.01	21.85	22.41	22.5	1
15	16QAM	1	0	21.59	21.65	21.46	21.93		
15	16QAM	1	37	21.98	21.77	21.40	22.18		
15	16QAM	1	74	21.44	21.57	21.56	22.02	22	1.5
15	16QAM	36	0	20.92	21.02	20.73	21.29		
15	16QAM	36	20	21.08	20.91	20.79	21.45		
15	16QAM	36	39	20.93	20.90	20.80	21.46	22	1.5
15	16QAM	75	0	20.98	21.00	20.88	21.40		



Channel				40190	40490	40790	41190	Tune-up limit (dBm)	MPR (dB)
Frequency (MHz)				2550	2580	2610	2650		
10	QPSK	1	0	22.68	22.48	22.51	22.94	23.5	0
10	QPSK	1	25	22.88	22.78	22.77	23.31		
10	QPSK	1	49	22.81	22.82	22.55	23.02		
10	QPSK	25	0	21.92	21.93	21.85	22.32	22.5	1
10	QPSK	25	12	22.07	22.08	21.88	22.41		
10	QPSK	25	25	21.91	21.92	21.84	22.40		
10	QPSK	50	0	21.99	21.99	21.90	22.38	22.5	1
10	16QAM	1	0	21.55	21.56	21.47	21.78		
10	16QAM	1	25	21.94	21.86	21.70	22.40		
10	16QAM	1	49	21.52	21.51	21.46	22.06	22	1.5
10	16QAM	25	0	21.14	20.95	20.98	21.48		
10	16QAM	25	12	21.20	21.02	20.88	21.56		
10	16QAM	25	25	21.03	20.93	20.98	21.55	22	1.5
10	16QAM	50	0	20.99	21.01	20.84	21.43		
10	16QAM	50	0	20.99	21.01	20.84	21.43		
Channel				40165	40485	40805	41215	Tune-up limit (dBm)	MPR (dB)
Frequency (MHz)				2547.5	2579.5	2611.5	2652.5		
5	QPSK	1	0	22.65	22.88	22.46	23.14	23.5	0
5	QPSK	1	12	22.85	23.17	22.66	23.32		
5	QPSK	1	24	22.74	22.80	22.67	23.16		
5	QPSK	12	0	21.94	22.05	21.90	22.50	22.5	1
5	QPSK	12	7	22.02	22.16	21.81	22.43		
5	QPSK	12	13	21.91	21.98	21.85	22.48		
5	QPSK	25	0	22.03	22.07	21.84	22.50	22.5	1
5	16QAM	1	0	21.47	21.51	21.27	21.95		
5	16QAM	1	12	21.88	21.71	21.53	22.12		
5	16QAM	1	24	21.57	21.50	21.39	22.07	22	1.5
5	16QAM	12	0	20.83	21.09	20.66	21.39		
5	16QAM	12	7	21.05	21.19	20.92	21.59		
5	16QAM	12	13	20.79	20.91	20.65	21.57	22	1.5
5	16QAM	25	0	20.84	21.12	20.72	21.60		



<WLAN Conducted Power>

General Note:

1. Per KDB 248227 D01v02r02, SAR test reduction is determined according to 802.11 transmission mode configurations and certain exposure conditions with multiple test positions. In the 2.4 GHz band, separate SAR procedures are applied to DSSS and OFDM configurations to simplify DSSS test requirements. For OFDM, in both 2.4 and 5 GHz bands, an initial test configuration must be determined for each standalone and aggregated frequency band, according to the transmission mode configuration with the highest maximum output power specified for production units to perform SAR measurements. If the same highest maximum output power applies to different combinations of channel bandwidths, modulations and data rates, additional procedures are applied to determine which test configurations require SAR measurement. When applicable, an initial test position may be applied to reduce the number of SAR measurements required for next to the ear, UMPC mini-tablet or hotspot mode configurations with multiple test positions.
2. For 2.4 GHz 802.11b DSSS, either the initial test position procedure for multiple exposure test positions or the DSSS procedure for fixed exposure position is applied; these are mutually exclusive. For 2.4 GHz and 5 GHz OFDM configurations, the initial test configuration is applied to measure SAR using either the initial test position procedure for multiple exposure test position configurations or the initial test configuration procedures for fixed exposure test conditions. Based on the reported SAR of the measured configurations and maximum output power of the transmission mode configurations that are not included in the initial test configuration, the subsequent test configuration and initial test position procedures are applied to determine if SAR measurements are required for the remaining OFDM transmission configurations. In general, the number of test channels that require SAR measurement is minimized based on maximum output power measured for the test sample(s).
3. For OFDM transmission configurations in the 2.4 GHz and 5 GHz bands, When the same maximum power is specified for multiple transmission modes in a frequency band, the largest channel bandwidth, lowest order modulation, lowest data rate and lowest order 802.11a/g/n/ac mode is used for SAR measurement, on the highest measured output power channel for each frequency band.
4. DSSS and OFDM configurations are considered separately according to the required SAR procedures. SAR is measured in the initial test position using the 802.11 transmission mode configuration required by the DSSS procedure or initial test configuration and subsequent test configuration(s) according to the OFDM procedures.18 The initial test position procedure is described in the following:
 - a. When the reported SAR of the initial test position is ≤ 0.4 W/kg, further SAR measurement is not required for the other test positions in that exposure configuration and 802.11 transmission mode combinations within the frequency band or aggregated band.
 - b. When the reported SAR of the test position is > 0.4 W/kg, SAR is repeated for the 802.11 transmission mode configuration tested in the initial test position to measure the subsequent next closet/smallest test separation distance and maximum coupling test position on the highest maximum output power channel, until the report SAR is ≤ 0.8 W/kg or all required test position are tested.
 - c. For all positions/configurations, when the reported SAR is > 0.8 W/kg, SAR is measured for these test positions/configurations on the subsequent next highest measured output power channel(s) until the reported SAR is ≤ 1.2 W/kg or all required channels are tested.

<2.4GHz WLAN>

	Mode	Channel	Frequency (MHz)	Average power (dBm)	Tune-Up Limit	Duty Cycle %
2.4GHz WLAN	802.11b 1Mbps	1	2412	15.94	16.50	97.59
		6	2437	16.29	16.50	
		11	2462	16.58	17.00	
	802.11g 6Mbps	1	2412	12.12	12.50	87.41
		6	2437	14.68	15.00	
		11	2462	14.63	15.00	
	802.11n-HT20 MCS0	1	2412	11.68	12.00	86.44
		6	2437	13.86	14.50	
		11	2462	13.79	14.00	
	802.11n-HT40 MCS0	3	2422	9.62	10.00	76.04
		6	2437	12.51	13.00	
		9	2452	13.85	14.00	

13. Bluetooth Exclusions Applied

Mode Band	Average power(dBm)	
	Bluetooth v3.0+EDR	Bluetooth v4.0/4.1/4.2 LE
2.4GHz Bluetooth	7.00	1.00

Note:

Per KDB 447498 D01v06, the 1-g and 10-g SAR test exclusion thresholds for 100 MHz to 6 GHz at *test separation distances* ≤ 50 mm are determined by:

$[(\text{max. power of channel, including tune-up tolerance, mW}) / (\text{min. test separation distance, mm})] \cdot [\sqrt{f(\text{GHz})}] \leq 3.0$ for 1-g SAR and ≤ 7.5 for 10-g extremity SAR

- f(GHz) is the RF channel transmit frequency in GHz
- Power and distance are rounded to the nearest mW and mm before calculation
- The result is rounded to one decimal place for comparison

Bluetooth Max Power (dBm)	Separation Distance (mm)	Frequency (GHz)	Exclusion Thresholds
7.00	10	2.48	0.8

Note:

Per KDB 447498 D01v06, a distance of 10 mm is applied to determine 1g SAR test exclusion. The test exclusion threshold is 0.8 which is ≤ 3, SAR testing is not required.

14. Antenna Location

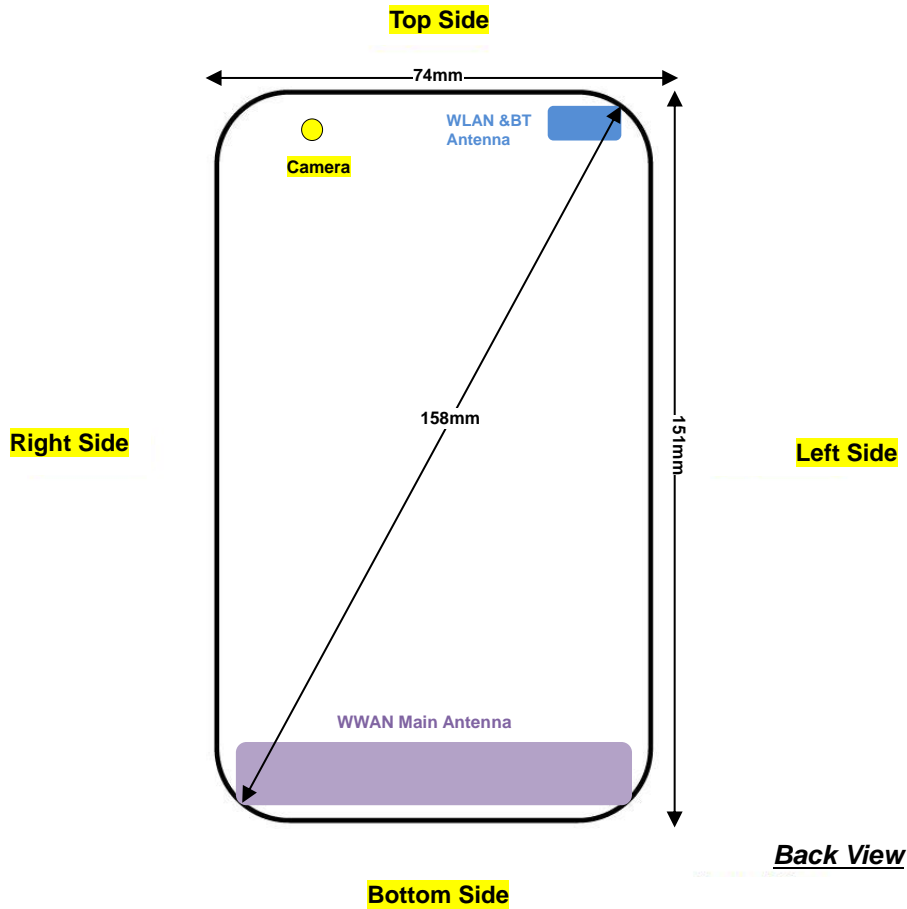

Distance of the Antenna to the EUT surface/edge						
Antennas	Back	Front	Top Side	Bottom Side	Right Side	Left Side
WWAN Main Antenna	≤ 25mm	≤ 25mm	>25mm	≤ 25mm	≤ 25mm	≤ 25mm
WLAN & BT	≤ 25mm	≤ 25mm	≤ 25mm	>25mm	>25mm	≤ 25mm

Positions for SAR tests; Hotspot mode						
Antennas	Back	Front	Top Side	Bottom Side	Right Side	Left Side
WWAN Main Antenna	Yes	Yes	No	Yes	Yes	Yes
WLAN & BT	Yes	Yes	Yes	No	No	Yes

General Note:

Referring to KDB 941225 D06 v02r01, when the overall device length and width are ≥ 9cm*5cm, the test distance is 10 mm. SAR must be measured for all sides and surfaces with a transmitting antenna located within 25mm from that surface or edge.



15. SAR Test Results

General Note:

1. Per KDB 447498 D01v06, the reported SAR is the measured SAR value adjusted for maximum tune-up tolerance.
 - a. Tune-up scaling Factor = tune-up limit power (mW) / EUT RF power (mW), where tune-up limit is the maximum rated power among all production units.
 - b. For SAR testing of WLAN signal with non-100% duty cycle, the measured SAR is scaled-up by the duty cycle scaling factor which is equal to "1/(duty cycle)"
 - c. For WWAN: Reported SAR(W/kg)= Measured SAR(W/kg)*Tune-up Scaling Factor
 - d. For WLAN: Reported SAR(W/kg)= Measured SAR(W/kg)* Duty Cycle scaling factor * Tune-up scaling factor
 - e. For TDD LTE SAR measurement, the duty cycle 1:1.59 (62.9 %) was used perform testing and considering the theoretical duty cycle of 63.3% for extended cyclic prefix in the uplink, and the theoretical duty cycle of 62.9% for normal cyclic prefix in uplink, a scaling factor of extended cyclic prefix 63.3%/62.9% = 1.006 is applied to scale-up the measured SAR result. The Reported TDD LTE SAR = measured SAR (W/kg) * Tune-up Scaling Factor * scaling factor for extended cyclic prefix.
2. Per KDB 447498 D01v06, for each exposure position, testing of other required channels within the operating mode of a frequency band is not required when the *reported* 1-g or 10-g SAR for the mid-band or highest output power channel is:
 - ≤ 0.8 W/kg or 2.0 W/kg, for 1-g or 10-g respectively, when the transmission band is ≤ 100 MHz
 - ≤ 0.6 W/kg or 1.5 W/kg, for 1-g or 10-g respectively, when the transmission band is between 100 MHz and 200 MHz
 - ≤ 0.4 W/kg or 1.0 W/kg, for 1-g or 10-g respectively, when the transmission band is ≥ 200 MHz
3. Per KDB 865664 D01v01r04, for each frequency band, repeated SAR measurement is required only when the measured SAR is ≥ 0.8 W/kg.
4. Per KDB 648474 D04v01r03, when the reported SAR for a body-worn accessory measured without a headset connected to the handset is ≤ 1.2 W/kg, SAR testing with a headset connected to the handset is not required.

GSM Note:

1. Per KDB 941225 D01v03r01, for SAR test reduction for GSM / GPRS / EDGE modes is determined by the source-based time-averaged output power including tune-up tolerance. The mode with highest specified time-averaged output power should be tested for SAR compliance in the applicable exposure conditions. For modes with the same specified maximum output power and tolerance, the higher number time-slot configuration should be tested. Therefore, the GPRS (4Tx slots) for GSM850/GSM1900 is considered as the primary mode.
2. Other configurations of GSM / GPRS / EDGE are considered as secondary modes. The 3G SAR test reduction procedure is applied, when the maximum output power and tune-up tolerance specified for production units in a secondary mode is $\leq \frac{1}{4}$ dB higher than the primary mode, SAR measurement is not required for the secondary mode.

UMTS Note:

1. Per KDB 941225 D01v03r01, for SAR testing is measured using a 12.2 kbps RMC with TPC bits configured to all "1's".
2. Per KDB 941225 D01v03r01, RMC 12.2kbps setting is used to evaluate SAR. The maximum output power and tune-up tolerance specified for production units in HSDPA / HSUPA / DC-HSDPA / HSPA+ is $\leq \frac{1}{4}$ dB higher than RMC 12.2Kbps or when the highest reported SAR of the RMC12.2Kbps is scaled by the ratio of specified maximum output power and tune-up tolerance of HSDPA / HSUPA / DC-HSDPA / HSPA+ to RMC12.2Kbps and the adjusted SAR is ≤ 1.2 W/kg, SAR measurement is not required for HSDPA / HSUPA, and according to the following RF output power, the output power results of the secondary modes (HSDPA / HSUPA / DC-HSDPA / HSPA+) are less than $\frac{1}{4}$ dB higher than the primary modes; therefore, SAR measurement is not required for HSDPA / HSUPA / DC-HSDPA / HSPA+.

LTE Note:

1. Per KDB 941225 D05v02r05, start with the largest channel bandwidth and measure SAR for QPSK with 1 RB allocation, using the RB offset and required test channel combination with the highest maximum output power for RB offsets at the upper edge, middle and lower edge of each required test channel.
2. Per KDB 941225 D05v02r05, 50% RB allocation for QPSK SAR testing follows 1RB QPSK allocation procedure.
3. Per KDB 941225 D05v02r05, For QPSK with 100% RB allocation, SAR is not required when the highest maximum output power for 100 % RB allocation is less than the highest maximum output power in 50% and 1 RB allocations and the highest reported SAR for 1 RB and 50% RB allocation are ≤ 0.8 W/kg. Otherwise, SAR is measured for the highest output power channel; and if the reported SAR is > 1.45 W/kg, the remaining required test channels must also be tested.
4. Per KDB 941225 D05v02r05, 16QAM output power for each RB allocation configuration is $>$ not $\frac{1}{2}$ dB higher than the same configuration in QPSK and the reported SAR for the QPSK configuration is ≤ 1.45 W/kg; Per KDB 941225 D05v02r05, 16QAM SAR testing is not required.
5. Per KDB 941225 D05v02r05, smaller bandwidth output power for each RB allocation configuration is $>$ not $\frac{1}{2}$ dB higher than the same configuration in the largest supported bandwidth, and the reported SAR for the largest supported bandwidth is ≤ 1.45 W/kg; Per KDB 941225 D05v02r05, smaller bandwidth SAR testing is not required.
6. For LTE B4 / B5 / B12 / B17 the maximum bandwidth does not support three non-overlapping channels, per KDB 941225 D05v02r05, when a device supports overlapping channel assignment in a channel bandwidth configuration, the middle channel of the group of overlapping channels should be selected for testing.
7. LTE band 17 SAR test was covered by Band 12; according to April 2015 TCB workshop, SAR test for overlapping LTE bands can be reduced if
 - a. The maximum output power, including tolerance, for the smaller band is \leq the larger band to qualify for the SAR test exclusion.
 - b. The channel bandwidth and other operating parameters for the smaller band are fully supported by the larger band.

WLAN Note:

1. Per KDB 248227 D01v02r02, for 2.4GHz 802.11g/n SAR testing is not required when the highest reported SAR for DSSS is adjusted by the ratio of OFDM to DSSS specified maximum output power and the adjusted SAR is ≤ 1.2 W/kg.
2. When the reported SAR of the test position is > 0.4 W/kg, SAR is repeated for the 802.11 transmission mode configuration tested in the initial test position to measure the subsequent next closet/smallest test separation distance and maximum coupling test position on the highest maximum output power channel, until the report SAR is ≤ 0.8 W/kg or all required test position are tested.
3. For all positions / configurations, when the reported SAR is > 0.8 W/kg, SAR is measured for these test positions / configurations on the subsequent next highest measured output power channel(s) until the reported SAR is ≤ 1.2 W/kg or all required channels are tested.
4. During SAR testing the WLAN transmission was verified using a spectrum analyzer.



15.1 Head SAR

<GSM SAR>

Table with 12 columns: Plot No., Band, Mode, Test Position, Ch., Freq. (MHz), Average Power (dBm), Tune-Up Limit (dBm), Tune-up Scaling Factor, Power Drift (dB), Measured 1g SAR (W/kg), Reported 1g SAR (W/kg). Rows include GSM850 and GSM1900 configurations for various test positions like Right Cheek, Left Cheek, Right Tilted, and Left Tilted.

<WCDMA SAR>

Table with 12 columns: Plot No., Band, Mode, Test Position, Ch., Freq. (MHz), Average Power (dBm), Tune-Up Limit (dBm), Tune-up Scaling Factor, Power Drift (dB), Measured 1g SAR (W/kg), Reported 1g SAR (W/kg). Rows include WCDMA Band V and WCDMA Band II configurations for various test positions like Right Cheek, Left Cheek, Right Tilted, and Left Tilted.



<FDD LTE SAR>

Plot No.	Band	BW (MHz)	Modulation	RB Size	RB Offset	Test Position	Ch.	Freq. (MHz)	Average Power (dBm)	Tune-Up Limit (dBm)	Tune-up Scaling Factor	Power Drift (dB)	Measured 1g SAR (W/kg)	Reported 1g SAR (W/kg)	
05	LTE Band 12	10M	QPSK	1	25	Right Cheek	23095	707.5	22.66	23.00	1.081	0.05	0.167	0.181	
	LTE Band 12	10M	QPSK	25	12	Right Cheek	23095	707.5	21.75	22.00	1.059	0.09	0.138	0.146	
	LTE Band 12	10M	QPSK	1	25	Right Tilted	23095	707.5	22.66	23.00	1.081	0.03	0.118	0.128	
	LTE Band 12	10M	QPSK	25	12	Right Tilted	23095	707.5	21.75	22.00	1.059	0.01	0.092	0.097	
	LTE Band 12	10M	QPSK	1	25	Left Cheek	23095	707.5	22.66	23.00	1.081	0.06	0.160	0.173	
	LTE Band 12	10M	QPSK	25	12	Left Cheek	23095	707.5	21.75	22.00	1.059	0.07	0.131	0.139	
	LTE Band 12	10M	QPSK	1	25	Left Tilted	23095	707.5	22.66	23.00	1.081	0.07	0.100	0.108	
	LTE Band 12	10M	QPSK	25	12	Left Tilted	23095	707.5	21.75	22.00	1.059	0.01	0.080	0.085	
	LTE Band 26	15M	QPSK	1	37	Right Cheek	26865	831.5	22.38	22.50	1.028	0.06	0.296	0.304	
	LTE Band 26	15M	QPSK	1	37	Right Cheek	26765	821.5	22.27	22.50	1.054	0.02	0.267	0.282	
	06	LTE Band 26	15M	QPSK	1	37	Right Cheek	26965	841.5	22.37	22.50	1.030	0.06	0.297	0.306
		LTE Band 26	15M	QPSK	36	0	Right Cheek	26865	831.5	21.25	21.50	1.059	0.05	0.219	0.232
		LTE Band 26	15M	QPSK	1	37	Right Tilted	26865	831.5	22.38	22.50	1.028	0.03	0.178	0.183
		LTE Band 26	15M	QPSK	36	0	Right Tilted	26865	831.5	21.25	21.50	1.059	0.14	0.136	0.144
		LTE Band 26	15M	QPSK	1	37	Left Cheek	26865	831.5	22.38	22.50	1.028	0.04	0.269	0.277
		LTE Band 26	15M	QPSK	36	0	Left Cheek	26865	831.5	21.25	21.50	1.059	0.09	0.210	0.222
LTE Band 26		15M	QPSK	1	37	Left Tilted	26865	831.5	22.38	22.50	1.028	0.03	0.179	0.184	
LTE Band 26		15M	QPSK	36	0	Left Tilted	26865	831.5	21.25	21.50	1.059	0.01	0.132	0.140	
07	LTE Band 5	10M	QPSK	1	25	Right Cheek	20525	836.5	23.42	23.50	1.019	0.07	0.379	0.386	
	LTE Band 5	10M	QPSK	25	0	Right Cheek	20525	836.5	22.36	22.50	1.033	0.09	0.302	0.312	
	LTE Band 5	10M	QPSK	1	25	Right Tilted	20525	836.5	23.42	23.50	1.019	0.07	0.197	0.201	
	LTE Band 5	10M	QPSK	25	0	Right Tilted	20525	836.5	22.36	22.50	1.033	0.07	0.177	0.183	
	LTE Band 5	10M	QPSK	1	25	Left Cheek	20525	836.5	23.42	23.50	1.019	0.16	0.313	0.319	
	LTE Band 5	10M	QPSK	25	0	Left Cheek	20525	836.5	22.36	22.50	1.033	0.04	0.272	0.281	
	LTE Band 5	10M	QPSK	1	25	Left Tilted	20525	836.5	23.42	23.50	1.019	0.08	0.200	0.204	
	LTE Band 5	10M	QPSK	25	0	Left Tilted	20525	836.5	22.36	22.50	1.033	0.06	0.170	0.176	
	LTE Band 4	20M	QPSK	1	49	Right Cheek	20175	1732.5	21.13	21.50	1.089	-0.09	0.098	0.107	
	LTE Band 4	20M	QPSK	50	24	Right Cheek	20175	1732.5	20.08	20.50	1.102	0.05	0.075	0.083	
	LTE Band 4	20M	QPSK	1	49	Right Tilted	20175	1732.5	21.13	21.50	1.089	0.14	0.082	0.089	
	LTE Band 4	20M	QPSK	50	24	Right Tilted	20175	1732.5	20.08	20.50	1.102	0.07	0.065	0.072	
08	LTE Band 4	20M	QPSK	1	49	Left Cheek	20175	1732.5	21.13	21.50	1.089	0.04	0.141	0.154	
	LTE Band 4	20M	QPSK	50	24	Left Cheek	20175	1732.5	20.08	20.50	1.102	0.01	0.106	0.117	
	LTE Band 4	20M	QPSK	1	49	Left Tilted	20175	1732.5	21.13	21.50	1.089	0.06	0.073	0.079	
	LTE Band 4	20M	QPSK	50	24	Left Tilted	20175	1732.5	20.08	20.50	1.102	0.04	0.056	0.062	



Plot No.	Band	BW (MHz)	Modulation	RB Size	RB Offset	Test Position	Ch.	Freq. (MHz)	Average Power (dBm)	Tune-Up Limit (dBm)	Tune-up Scaling Factor	Power Drift (dB)	Measured 1g SAR (W/kg)	Reported 1g SAR (W/kg)
	LTE Band 2	20M	QPSK	1	49	Right Cheek	18700	1860	22.95	23.50	1.135	0.07	0.239	0.271
	LTE Band 2	20M	QPSK	50	0	Right Cheek	18700	1860	21.90	22.50	1.148	0.11	0.164	0.188
	LTE Band 2	20M	QPSK	1	49	Right Tilted	18700	1860	22.95	23.50	1.135	0.04	0.194	0.220
	LTE Band 2	20M	QPSK	50	0	Right Tilted	18700	1860	21.90	22.50	1.148	0.03	0.151	0.173
	LTE Band 2	20M	QPSK	1	49	Left Cheek	18700	1860	22.95	23.50	1.135	0.08	0.383	0.435
09	LTE Band 2	20M	QPSK	1	49	Left Cheek	18900	1880	22.91	23.50	1.146	0.02	0.387	0.443
	LTE Band 2	20M	QPSK	1	49	Left Cheek	19100	1900	22.85	23.50	1.161	0.02	0.354	0.411
	LTE Band 2	20M	QPSK	50	0	Left Cheek	18700	1860	21.90	22.50	1.148	0.07	0.304	0.349
	LTE Band 2	20M	QPSK	1	49	Left Tilted	18700	1860	22.95	23.50	1.135	0.07	0.203	0.230
	LTE Band 2	20M	QPSK	50	0	Left Tilted	18700	1860	21.90	22.50	1.148	0.06	0.160	0.184
10	LTE Band 7	20M	QPSK	1	49	Right Cheek	21350	2560	22.23	22.50	1.064	0.08	0.073	0.078
	LTE Band 7	20M	QPSK	1	49	Right Cheek	20850	2510	22.09	22.50	1.099	0.06	0.066	0.073
	LTE Band 7	20M	QPSK	1	49	Right Cheek	21100	2535	22.15	22.50	1.084	0.07	0.061	0.066
	LTE Band 7	20M	QPSK	50	50	Right Cheek	21350	2560	21.04	21.50	1.112	0.07	0.058	0.064
	LTE Band 7	20M	QPSK	1	49	Right Tilted	21350	2560	22.23	22.50	1.064	0.05	0.027	0.029
	LTE Band 7	20M	QPSK	50	50	Right Tilted	21350	2560	21.04	21.50	1.112	0.04	0.019	0.021
	LTE Band 7	20M	QPSK	1	49	Left Cheek	21350	2560	22.23	22.50	1.064	0.05	0.049	0.052
	LTE Band 7	20M	QPSK	50	50	Left Cheek	21350	2560	21.04	21.50	1.112	0.01	0.041	0.046
	LTE Band 7	20M	QPSK	1	49	Left Tilted	21350	2560	22.23	22.50	1.064	0.05	0.050	0.053
	LTE Band 7	20M	QPSK	50	50	Left Tilted	21350	2560	21.04	21.50	1.112	0.07	0.037	0.041

<TDD LTE SAR>

Plot No.	Band	BW (MHz)	Modulation	RB Size	RB Offset	Test Position	Ch.	Freq. (MHz)	Average Power (dBm)	Tune-Up Limit (dBm)	Tune-up Scaling Factor	Duty Cycle %	Duty Cycle Scaling Factor	Power Drift (dB)	Measured 1g SAR (W/kg)	Reported 1g SAR (W/kg)
11	LTE Band 38	20M	QPSK	1	49	Right Cheek	37850	2580	22.87	23.00	1.030	62.9	1.006	0.09	0.060	0.062
	LTE Band 38	20M	QPSK	1	49	Right Cheek	38000	2595	22.81	23.00	1.045	62.9	1.006	0.04	0.050	0.053
	LTE Band 38	20M	QPSK	1	49	Right Cheek	38150	2610	22.82	23.00	1.042	62.9	1.006	0.05	0.049	0.051
	LTE Band 38	20M	QPSK	50	24	Right Cheek	37850	2580	22.04	22.50	1.112	62.9	1.006	0.02	0.046	0.051
	LTE Band 38	20M	QPSK	1	49	Right Tilted	37850	2580	22.87	23.00	1.030	62.9	1.006	0.03	0.022	0.023
	LTE Band 38	20M	QPSK	50	24	Right Tilted	37850	2580	22.04	22.50	1.112	62.9	1.006	0.06	0.015	0.017
	LTE Band 38	20M	QPSK	1	49	Left Cheek	37850	2580	22.87	23.00	1.030	62.9	1.006	0.04	0.041	0.042
	LTE Band 38	20M	QPSK	50	24	Left Cheek	37850	2580	22.04	22.50	1.112	62.9	1.006	0.07	0.029	0.032
	LTE Band 38	20M	QPSK	1	49	Left Tilted	37850	2580	22.87	23.00	1.030	62.9	1.006	-0.06	0.042	0.044
	LTE Band 38	20M	QPSK	50	24	Left Tilted	37850	2580	22.04	22.50	1.112	62.9	1.006	0.03	0.025	0.028
12	LTE Band 41	20M	QPSK	1	49	Right Cheek	41140	2645	23.37	23.50	1.030	62.9	1.006	0.01	0.071	0.074
	LTE Band 41	20M	QPSK	1	49	Right Cheek	40240	2555	22.94	23.50	1.138	62.9	1.006	0.01	0.049	0.056
	LTE Band 41	20M	QPSK	1	49	Right Cheek	40500	2581	22.96	23.50	1.132	62.9	1.006	0.09	0.046	0.052
	LTE Band 41	20M	QPSK	1	49	Right Cheek	40770	2608	22.88	23.50	1.153	62.9	1.006	0.01	0.054	0.063
	LTE Band 41	20M	QPSK	50	24	Right Cheek	41140	2645	22.39	22.50	1.026	62.9	1.006	0.06	0.053	0.055
	LTE Band 41	20M	QPSK	1	49	Right Tilted	41140	2645	23.37	23.50	1.030	62.9	1.006	0.05	0.033	0.034
	LTE Band 41	20M	QPSK	50	24	Right Tilted	41140	2645	22.39	22.50	1.026	62.9	1.006	0.04	0.025	0.026
	LTE Band 41	20M	QPSK	1	49	Left Cheek	41140	2645	23.37	23.50	1.030	62.9	1.006	0.04	0.045	0.047
	LTE Band 41	20M	QPSK	50	24	Left Cheek	41140	2645	22.39	22.50	1.026	62.9	1.006	0.06	0.036	0.037
	LTE Band 41	20M	QPSK	1	49	Left Tilted	41140	2645	23.37	23.50	1.030	62.9	1.006	0.02	0.054	0.056
	LTE Band 41	20M	QPSK	50	24	Left Tilted	41140	2645	22.39	22.50	1.026	62.9	1.006	0.09	0.037	0.038

<WLAN SAR>

Plot No.	Band	Mode	Test Position	Ch.	Freq. (MHz)	Average Power (dBm)	Tune-Up Limit (dBm)	Tune-up Scaling Factor	Duty Cycle %	Duty Cycle Scaling Factor	Power Drift (dB)	Measured 1g SAR (W/kg)	Reported 1g SAR (W/kg)
	WLAN2.4GHz	802.11b 1Mbps	Right Cheek	11	2462	16.58	17.00	1.103	97.59	1.025	0.09	0.610	0.689
	WLAN2.4GHz	802.11b 1Mbps	Right Tilted	11	2462	16.58	17.00	1.103	97.59	1.025	0.09	0.491	0.555
	WLAN2.4GHz	802.11b 1Mbps	Left Cheek	11	2462	16.58	17.00	1.103	97.59	1.025	0.01	0.191	0.216
	WLAN2.4GHz	802.11b 1Mbps	Left Tilted	11	2462	16.58	17.00	1.103	97.59	1.025	0.01	0.188	0.212
	WLAN2.4GHz	802.11b 1Mbps	Right Cheek	1	2412	15.94	16.50	1.139	97.59	1.025	0.01	0.597	0.697
13	WLAN2.4GHz	802.11b 1Mbps	Right Cheek	6	2437	16.29	16.50	1.051	97.59	1.025	0.06	1.100	1.185



15.2 Hotspot SAR

<GSM SAR>

Plot No.	Band	Mode	Test Position	Gap (mm)	Ch.	Freq. (MHz)	Average Power (dBm)	Tune-Up Limit (dBm)	Tune-up Scaling Factor	Power Drift (dB)	Measured 1g SAR (W/kg)	Reported 1g SAR (W/kg)
	GSM850	GPRS(4 Tx slots)	Front	10	251	848.8	28.34	28.50	1.038	0.05	0.287	0.298
14	GSM850	GPRS(4 Tx slots)	Back	10	251	848.8	28.34	28.50	1.038	0.02	0.504	0.523
	GSM850	GPRS(4 Tx slots)	Left Side	10	251	848.8	28.34	28.50	1.038	0.06	0.398	0.413
	GSM850	GPRS(4 Tx slots)	Right Side	10	251	848.8	28.34	28.50	1.038	0.02	0.319	0.331
	GSM850	GPRS(4 Tx slots)	Bottom Side	10	251	848.8	28.34	28.50	1.038	0.05	0.041	0.043
	GSM850	GPRS(4 Tx slots)	Back	10	128	824.2	28.00	28.50	1.122	0.08	0.431	0.484
	GSM850	GPRS(4 Tx slots)	Back	10	189	836.4	28.13	28.50	1.089	0.04	0.455	0.495
	GSM1900	GPRS(4 Tx slots)	Front	10	810	1909.8	26.23	26.50	1.064	0.01	0.298	0.317
	GSM1900	GPRS(4 Tx slots)	Back	10	810	1909.8	26.23	26.50	1.064	0.04	0.445	0.474
	GSM1900	GPRS(4 Tx slots)	Left Side	10	810	1909.8	26.23	26.50	1.064	0.06	0.181	0.193
	GSM1900	GPRS(4 Tx slots)	Right Side	10	810	1909.8	26.23	26.50	1.064	0.05	0.138	0.147
	GSM1900	GPRS(4 Tx slots)	Bottom Side	10	810	1909.8	26.23	26.50	1.064	0.02	0.089	0.095
15	GSM1900	GPRS(4 Tx slots)	Back	10	512	1850.2	26.16	26.50	1.081	0.09	0.613	0.663
	GSM1900	GPRS(4 Tx slots)	Back	10	661	1880	26.18	26.50	1.076	0.06	0.561	0.604

<WCDMA SAR>

Plot No.	Band	Mode	Test Position	Gap (mm)	Ch.	Freq. (MHz)	Average Power (dBm)	Tune-Up Limit (dBm)	Tune-up Scaling Factor	Power Drift (dB)	Measured 1g SAR (W/kg)	Reported 1g SAR (W/kg)
	WCDMA Band V	RMC 12.2Kbps	Front	10	4132	826.4	23.35	23.50	1.035	0.08	0.404	0.418
	WCDMA Band V	RMC 12.2Kbps	Back	10	4132	826.4	23.35	23.50	1.035	0.05	0.587	0.608
	WCDMA Band V	RMC 12.2Kbps	Left Side	10	4132	826.4	23.35	23.50	1.035	0.01	0.553	0.572
	WCDMA Band V	RMC 12.2Kbps	Right Side	10	4132	826.4	23.35	23.50	1.035	0.04	0.430	0.445
	WCDMA Band V	RMC 12.2Kbps	Bottom Side	10	4132	826.4	23.35	23.50	1.035	-0.16	0.051	0.053
16	WCDMA Band V	RMC 12.2Kbps	Back	10	4182	836.4	23.19	23.50	1.074	0.07	0.596	0.640
	WCDMA Band V	RMC 12.2Kbps	Back	10	4233	846.6	23.05	23.50	1.109	0.02	0.563	0.624
	WCDMA Band II	RMC 12.2Kbps	Front	10	9262	1852.4	22.79	23.00	1.050	0.09	0.382	0.401
17	WCDMA Band II	RMC 12.2Kbps	Back	10	9262	1852.4	22.79	23.00	1.050	0.09	0.637	0.669
	WCDMA Band II	RMC 12.2Kbps	Left Side	10	9262	1852.4	22.79	23.00	1.050	0.02	0.227	0.238
	WCDMA Band II	RMC 12.2Kbps	Right Side	10	9262	1852.4	22.79	23.00	1.050	0.02	0.147	0.154
	WCDMA Band II	RMC 12.2Kbps	Bottom Side	10	9262	1852.4	22.79	23.00	1.050	0.05	0.150	0.157
	WCDMA Band II	RMC 12.2Kbps	Back	10	9400	1880	22.72	23.00	1.067	0.05	0.496	0.529
	WCDMA Band II	RMC 12.2Kbps	Back	10	9538	1907.6	22.55	23.00	1.109	0.04	0.509	0.565

<FDD LTE SAR>

Plot No.	Band	BW (MHz)	Modulation	RB Size	RB Offset	Test Position	Gap (mm)	Ch.	Freq. (MHz)	Average Power (dBm)	Tune-Up Limit (dBm)	Tune-up Scaling Factor	Power Drift (dB)	Measured 1g SAR (W/kg)	Reported 1g SAR (W/kg)
	LTE Band 12	10M	QPSK	1	25	Front	10	23095	707.5	22.66	23.00	1.081	0.03	0.219	0.237
	LTE Band 12	10M	QPSK	25	12	Front	10	23095	707.5	21.75	22.00	1.059	0.08	0.180	0.191
18	LTE Band 12	10M	QPSK	1	25	Back	10	23095	707.5	22.66	23.00	1.081	0.04	0.377	0.408
	LTE Band 12	10M	QPSK	25	12	Back	10	23095	707.5	21.75	22.00	1.059	0.02	0.309	0.327
	LTE Band 12	10M	QPSK	1	25	Left Side	10	23095	707.5	22.66	23.00	1.081	0.01	0.240	0.260
	LTE Band 12	10M	QPSK	25	12	Left Side	10	23095	707.5	21.75	22.00	1.059	0.07	0.191	0.202
	LTE Band 12	10M	QPSK	1	25	Right Side	10	23095	707.5	22.66	23.00	1.081	0.01	0.214	0.231
	LTE Band 12	10M	QPSK	25	12	Right Side	10	23095	707.5	21.75	22.00	1.059	0.17	0.175	0.185
	LTE Band 12	10M	QPSK	1	25	Bottom Side	10	23095	707.5	22.66	23.00	1.081	-0.06	0.023	0.025
	LTE Band 12	10M	QPSK	25	12	Bottom Side	10	23095	707.5	21.75	22.00	1.059	-0.05	0.018	0.019
	LTE Band 26	15M	QPSK	1	37	Front	10	26865	831.5	22.38	22.50	1.028	0.06	0.316	0.325
	LTE Band 26	15M	QPSK	36	0	Front	10	26865	831.5	21.25	21.50	1.059	0.05	0.243	0.257
	LTE Band 26	15M	QPSK	1	37	Back	10	26865	831.5	22.38	22.50	1.028	0.02	0.432	0.444
19	LTE Band 26	15M	QPSK	1	37	Back	10	26765	821.5	22.27	22.50	1.054	0.04	0.486	0.512
	LTE Band 26	15M	QPSK	1	37	Back	10	26965	841.5	22.37	22.50	1.030	0.09	0.476	0.490
	LTE Band 26	15M	QPSK	36	0	Back	10	26865	831.5	21.25	21.50	1.059	0.04	0.346	0.367
	LTE Band 26	15M	QPSK	1	37	Left Side	10	26865	831.5	22.38	22.50	1.028	0.07	0.403	0.414
	LTE Band 26	15M	QPSK	36	0	Left Side	10	26865	831.5	21.25	21.50	1.059	0.06	0.316	0.335
	LTE Band 26	15M	QPSK	1	37	Right Side	10	26865	831.5	22.38	22.50	1.028	0.03	0.300	0.308
	LTE Band 26	15M	QPSK	36	0	Right Side	10	26865	831.5	21.25	21.50	1.059	0.02	0.240	0.254
	LTE Band 26	15M	QPSK	1	37	Bottom Side	10	26865	831.5	22.38	22.50	1.028	0.08	0.040	0.041
	LTE Band 26	15M	QPSK	36	0	Bottom Side	10	26865	831.5	21.25	21.50	1.059	-0.04	0.037	0.039
	LTE Band 5	10M	QPSK	1	25	Front	10	20525	836.5	23.42	23.50	1.019	0.08	0.381	0.388
	LTE Band 5	10M	QPSK	25	0	Front	10	20525	836.5	22.36	22.50	1.033	0.07	0.352	0.364
20	LTE Band 5	10M	QPSK	1	25	Back	10	20525	836.5	23.42	23.50	1.019	0.01	0.543	0.553
	LTE Band 5	10M	QPSK	25	0	Back	10	20525	836.5	22.36	22.50	1.033	0.07	0.433	0.447
	LTE Band 5	10M	QPSK	1	25	Left Side	10	20525	836.5	23.42	23.50	1.019	0.07	0.497	0.506
	LTE Band 5	10M	QPSK	25	0	Left Side	10	20525	836.5	22.36	22.50	1.033	0.04	0.406	0.419
	LTE Band 5	10M	QPSK	1	25	Right Side	10	20525	836.5	23.42	23.50	1.019	0.08	0.347	0.353
	LTE Band 5	10M	QPSK	25	0	Right Side	10	20525	836.5	22.36	22.50	1.033	0.06	0.301	0.311
	LTE Band 5	10M	QPSK	1	25	Bottom Side	10	20525	836.5	23.42	23.50	1.019	0.05	0.048	0.049
	LTE Band 5	10M	QPSK	25	0	Bottom Side	10	20525	836.5	22.36	22.50	1.033	0.01	0.042	0.043



Plot No.	Band	BW (MHz)	Modulation	RB Size	RB Offset	Test Position	Gap (mm)	Ch.	Freq. (MHz)	Average Power (dBm)	Tune-Up Limit (dBm)	Tune-up Scaling Factor	Power Drift (dB)	Measured 1g SAR (W/kg)	Reported 1g SAR (W/kg)
	LTE Band 4	20M	QPSK	1	49	Front	10	20175	1732.5	21.13	21.50	1.089	0.06	0.344	0.375
	LTE Band 4	20M	QPSK	50	24	Front	10	20175	1732.5	20.08	20.50	1.102	0.05	0.266	0.293
21	LTE Band 4	20M	QPSK	1	49	Back	10	20175	1732.5	21.13	21.50	1.089	0.16	0.884	0.963
	LTE Band 4	20M	QPSK	50	24	Back	10	20175	1732.5	20.08	20.50	1.102	0.05	0.695	0.766
	LTE Band 4	20M	QPSK	100	0	Back	10	20175	1732.5	19.94	20.50	1.138	0.03	0.672	0.764
	LTE Band 4	20M	QPSK	1	49	Left Side	10	20175	1732.5	21.13	21.50	1.089	0.06	0.116	0.126
	LTE Band 4	20M	QPSK	50	24	Left Side	10	20175	1732.5	20.08	20.50	1.102	0.04	0.090	0.099
	LTE Band 4	20M	QPSK	1	49	Right Side	10	20175	1732.5	21.13	21.50	1.089	0.03	0.103	0.112
	LTE Band 4	20M	QPSK	50	24	Right Side	10	20175	1732.5	20.08	20.50	1.102	0.07	0.083	0.091
	LTE Band 4	20M	QPSK	1	49	Bottom Side	10	20175	1732.5	21.13	21.50	1.089	0.01	0.450	0.490
	LTE Band 4	20M	QPSK	50	24	Bottom Side	10	20175	1732.5	20.08	20.50	1.102	0.06	0.349	0.384
	LTE Band 2	20M	QPSK	1	49	Front	10	18700	1860	22.95	23.50	1.135	0.04	0.425	0.482
	LTE Band 2	20M	QPSK	50	0	Front	10	18700	1860	21.90	22.50	1.148	0.09	0.339	0.389
22	LTE Band 2	20M	QPSK	1	49	Back	10	18700	1860	22.95	23.50	1.135	0.06	0.771	0.875
	LTE Band 2	20M	QPSK	1	49	Back	10	18900	1880	22.91	23.50	1.146	0.08	0.648	0.742
	LTE Band 2	20M	QPSK	1	49	Back	10	19100	1900	22.85	23.50	1.161	0.11	0.611	0.710
	LTE Band 2	20M	QPSK	50	0	Back	10	18700	1860	21.90	22.50	1.148	0.03	0.618	0.710
	LTE Band 2	20M	QPSK	100	0	Back	10	18700	1860	21.89	22.50	1.151	-0.02	0.585	0.673
	LTE Band 2	20M	QPSK	1	49	Left Side	10	18700	1860	22.95	23.50	1.135	0.06	0.275	0.312
	LTE Band 2	20M	QPSK	50	0	Left Side	10	18700	1860	21.90	22.50	1.148	0.08	0.217	0.249
	LTE Band 2	20M	QPSK	1	49	Right Side	10	18700	1860	22.95	23.50	1.135	0.01	0.174	0.197
	LTE Band 2	20M	QPSK	50	0	Right Side	10	18700	1860	21.90	22.50	1.148	0.06	0.137	0.157
	LTE Band 2	20M	QPSK	1	49	Bottom Side	10	18700	1860	22.95	23.50	1.135	0.08	0.204	0.232
	LTE Band 2	20M	QPSK	50	0	Bottom Side	10	18700	1860	21.90	22.50	1.148	0.06	0.171	0.196
	LTE Band 7	20M	QPSK	1	49	Front	10	21350	2560	22.23	22.50	1.064	0.04	0.318	0.338
	LTE Band 7	20M	QPSK	1	49	Front	10	20850	2510	22.09	22.50	1.099	0.06	0.347	0.381
	LTE Band 7	20M	QPSK	1	49	Front	10	21100	2535	22.15	22.50	1.084	0.04	0.312	0.338
	LTE Band 7	20M	QPSK	50	50	Front	10	21350	2560	21.04	21.50	1.112	0.01	0.253	0.281
	LTE Band 7	20M	QPSK	1	49	Back	10	21350	2560	22.23	22.50	1.064	0.06	0.290	0.309
	LTE Band 7	20M	QPSK	50	50	Back	10	21350	2560	21.04	21.50	1.112	0.07	0.232	0.258
	LTE Band 7	20M	QPSK	1	49	Left Side	10	21350	2560	22.23	22.50	1.064	0.06	0.053	0.056
	LTE Band 7	20M	QPSK	50	50	Left Side	10	21350	2560	21.04	21.50	1.112	0.05	0.040	0.044
	LTE Band 7	20M	QPSK	1	49	Right Side	10	21350	2560	22.23	22.50	1.064	-0.08	0.082	0.087
	LTE Band 7	20M	QPSK	50	50	Right Side	10	21350	2560	21.04	21.50	1.112	-0.01	0.063	0.070
	LTE Band 7	20M	QPSK	1	49	Bottom Side	10	21350	2560	22.23	22.50	1.064	0.07	0.474	0.504
23	LTE Band 7	20M	QPSK	1	49	Bottom Side	10	20850	2510	22.09	22.50	1.099	0.05	0.657	0.722
	LTE Band 7	20M	QPSK	1	49	Bottom Side	10	21100	2535	22.15	22.50	1.084	0.04	0.523	0.567
	LTE Band 7	20M	QPSK	50	50	Bottom Side	10	21350	2560	21.04	21.50	1.112	0.08	0.354	0.394



<TDD LTE SAR>

Plot No.	Band	BW (MHz)	Modulation	RB Size	RB Offset	Test Position	Gap (mm)	Ch.	Freq. (MHz)	Average Power (dBm)	Tune-Up Limit (dBm)	Tune-up Scaling Factor	Duty Cycle %	Duty Cycle Scaling Factor	Power Drift (dB)	Measured 1g SAR (W/kg)	Reported 1g SAR (W/kg)
	LTE Band 38	20M	QPSK	1	49	Front	10	37850	2580	22.87	23.00	1.030	62.9	1.006	0.07	0.244	0.253
	LTE Band 38	20M	QPSK	1	49	Front	10	38000	2595	22.81	23.00	1.045	62.9	1.006	0.07	0.213	0.224
	LTE Band 38	20M	QPSK	1	49	Front	10	38150	2610	22.82	23.00	1.042	62.9	1.006	0.03	0.211	0.221
	LTE Band 38	20M	QPSK	50	24	Front	10	37850	2580	22.04	22.50	1.112	62.9	1.006	0.05	0.184	0.206
	LTE Band 38	20M	QPSK	1	49	Back	10	37850	2580	22.87	23.00	1.030	62.9	1.006	0.07	0.213	0.221
	LTE Band 38	20M	QPSK	50	24	Back	10	37850	2580	22.04	22.50	1.112	62.9	1.006	0.06	0.166	0.186
	LTE Band 38	20M	QPSK	1	49	Left Side	10	37850	2580	22.87	23.00	1.030	62.9	1.006	0.05	0.051	0.053
	LTE Band 38	20M	QPSK	50	24	Left Side	10	37850	2580	22.04	22.50	1.112	62.9	1.006	0.04	0.038	0.042
	LTE Band 38	20M	QPSK	1	49	Right Side	10	37850	2580	22.87	23.00	1.030	62.9	1.006	-0.02	0.037	0.038
	LTE Band 38	20M	QPSK	50	24	Right Side	10	37850	2580	22.04	22.50	1.112	62.9	1.006	-0.03	0.027	0.030
24	LTE Band 38	20M	QPSK	1	49	Bottom Side	10	37850	2580	22.87	23.00	1.030	62.9	1.006	0.01	0.296	0.307
	LTE Band 38	20M	QPSK	1	49	Bottom Side	10	38000	2595	22.81	23.00	1.045	62.9	1.006	0.08	0.285	0.300
	LTE Band 38	20M	QPSK	1	49	Bottom Side	10	38150	2610	22.82	23.00	1.042	62.9	1.006	0.07	0.271	0.284
	LTE Band 38	20M	QPSK	50	24	Bottom Side	10	37850	2580	22.04	22.50	1.112	62.9	1.006	0.03	0.211	0.236
	LTE Band 41	20M	QPSK	1	49	Front	10	41140	2645	23.37	23.50	1.030	62.9	1.006	0.02	0.281	0.291
	LTE Band 41	20M	QPSK	1	49	Front	10	40240	2555	22.94	23.50	1.138	62.9	1.006	0.05	0.235	0.269
	LTE Band 41	20M	QPSK	1	49	Front	10	40500	2581	22.96	23.50	1.132	62.9	1.006	0.02	0.216	0.246
	LTE Band 41	20M	QPSK	1	49	Front	10	40770	2608	22.88	23.50	1.153	62.9	1.006	0.05	0.213	0.247
	LTE Band 41	20M	QPSK	50	24	Front	10	41140	2645	22.39	22.50	1.026	62.9	1.006	0.01	0.216	0.223
	LTE Band 41	20M	QPSK	1	49	Back	10	41140	2645	23.37	23.50	1.030	62.9	1.006	0.03	0.277	0.287
	LTE Band 41	20M	QPSK	50	24	Back	10	41140	2645	22.39	22.50	1.026	62.9	1.006	0.01	0.210	0.217
	LTE Band 41	20M	QPSK	1	49	Left Side	10	41140	2645	23.37	23.50	1.030	62.9	1.006	0.06	0.100	0.104
	LTE Band 41	20M	QPSK	50	24	Left Side	10	41140	2645	22.39	22.50	1.026	62.9	1.006	0.04	0.068	0.070
	LTE Band 41	20M	QPSK	1	49	Right Side	10	41140	2645	23.37	23.50	1.030	62.9	1.006	-0.09	0.085	0.088
	LTE Band 41	20M	QPSK	50	24	Right Side	10	41140	2645	22.39	22.50	1.026	62.9	1.006	-0.09	0.035	0.036
	LTE Band 41	20M	QPSK	1	49	Bottom Side	10	41140	2645	23.37	23.50	1.030	62.9	1.006	-0.03	0.287	0.297
25	LTE Band 41	20M	QPSK	1	49	Bottom Side	10	40240	2555	22.94	23.50	1.138	62.9	1.006	0.09	0.341	0.390
	LTE Band 41	20M	QPSK	1	49	Bottom Side	10	40500	2581	22.96	23.50	1.132	62.9	1.006	-0.15	0.281	0.320
	LTE Band 41	20M	QPSK	1	49	Bottom Side	10	40770	2608	22.88	23.50	1.153	62.9	1.006	-0.02	0.282	0.327
	LTE Band 41	20M	QPSK	50	24	Bottom Side	10	41140	2645	22.39	22.50	1.026	62.9	1.006	-0.02	0.235	0.242

<WLAN SAR>

Plot No.	Band	Mode	Test Position	Gap (mm)	Ch.	Freq. (MHz)	Average Power (dBm)	Tune-Up Limit (dBm)	Tune-up Scaling Factor	Duty Cycle %	Duty Cycle Scaling Factor	Power Drift (dB)	Measured 1g SAR (W/kg)	Reported 1g SAR (W/kg)
	WLAN2.4GHz	802.11b 1Mbps	Front	10	11	2462	16.58	17.00	1.103	97.59	1.025	0.07	0.118	0.133
	WLAN2.4GHz	802.11b 1Mbps	Back	10	11	2462	16.58	17.00	1.103	97.59	1.025	0.02	0.149	0.168
	WLAN2.4GHz	802.11b 1Mbps	Left Side	10	11	2462	16.58	17.00	1.103	97.59	1.025	0.06	0.138	0.156
	WLAN2.4GHz	802.11b 1Mbps	Top Side	10	11	2462	16.58	17.00	1.103	97.59	1.025	0.06	0.073	0.083
	WLAN2.4GHz	802.11b 1Mbps	Back	10	1	2412	15.94	16.50	1.139	97.59	1.025	0.04	0.145	0.169
26	WLAN2.4GHz	802.11b 1Mbps	Back	10	6	2437	16.29	16.50	1.051	97.59	1.025	0.07	0.318	0.342



15.3 Body Worn Accessory SAR

<GSM SAR>

Plot No.	Band	Mode	Test Position	Gap (mm)	Ch.	Freq. (MHz)	Average Power (dBm)	Tune-Up Limit (dBm)	Tune-up Scaling Factor	Power Drift (dB)	Measured 1g SAR (W/kg)	Reported 1g SAR (W/kg)
	GSM850	GPRS(4 Tx slots)	Front	10	251	848.8	28.34	28.50	1.038	0.05	0.287	0.298
27	GSM850	GPRS(4 Tx slots)	Back	10	251	848.8	28.34	28.50	1.038	0.02	0.504	0.523
	GSM850	GPRS(4 Tx slots)	Back	10	128	824.2	28.00	28.50	1.122	0.08	0.431	0.484
	GSM850	GPRS(4 Tx slots)	Back	10	189	836.4	28.13	28.50	1.089	0.04	0.455	0.495
	GSM1900	GPRS(4 Tx slots)	Front	10	810	1909.8	26.23	26.50	1.064	0.01	0.298	0.317
	GSM1900	GPRS(4 Tx slots)	Back	10	810	1909.8	26.23	26.50	1.064	0.04	0.445	0.474
28	GSM1900	GPRS(4 Tx slots)	Back	10	512	1850.2	26.16	26.50	1.081	0.09	0.613	0.663
	GSM1900	GPRS(4 Tx slots)	Back	10	661	1880	26.18	26.50	1.076	0.06	0.561	0.604

<WCDMA SAR>

Plot No.	Band	Mode	Test Position	Gap (mm)	Ch.	Freq. (MHz)	Average Power (dBm)	Tune-Up Limit (dBm)	Tune-up Scaling Factor	Power Drift (dB)	Measured 1g SAR (W/kg)	Reported 1g SAR (W/kg)
	WCDMA Band V	RMC 12.2Kbps	Front	10	4132	826.4	23.35	23.50	1.035	0.08	0.404	0.418
	WCDMA Band V	RMC 12.2Kbps	Back	10	4132	826.4	23.35	23.50	1.035	0.05	0.587	0.608
29	WCDMA Band V	RMC 12.2Kbps	Back	10	4182	836.4	23.19	23.50	1.074	0.07	0.596	0.640
	WCDMA Band V	RMC 12.2Kbps	Back	10	4233	846.6	23.05	23.50	1.109	0.02	0.563	0.624
	WCDMA Band II	RMC 12.2Kbps	Front	10	9262	1852.4	22.79	23.00	1.050	0.09	0.382	0.401
30	WCDMA Band II	RMC 12.2Kbps	Back	10	9262	1852.4	22.79	23.00	1.050	0.09	0.637	0.669
	WCDMA Band II	RMC 12.2Kbps	Back	10	9400	1880	22.72	23.00	1.067	0.05	0.496	0.529
	WCDMA Band II	RMC 12.2Kbps	Back	10	9538	1907.6	22.55	23.00	1.109	0.04	0.509	0.565



<FDD LTE SAR>

Plot No.	Band	BW (MHz)	Modulation	RB Size	RB Offset	Test Position	Gap (mm)	Ch.	Freq. (MHz)	Average Power (dBm)	Tune-Up Limit (dBm)	Tune-up Scaling Factor	Power Drift (dB)	Measured 1g SAR (W/kg)	Reported 1g SAR (W/kg)
	LTE Band 12	10M	QPSK	1	25	Front	10	23095	707.5	22.66	23.00	1.081	0.03	0.219	0.237
	LTE Band 12	10M	QPSK	25	12	Front	10	23095	707.5	21.75	22.00	1.059	0.08	0.180	0.191
31	LTE Band 12	10M	QPSK	1	25	Back	10	23095	707.5	22.66	23.00	1.081	0.04	0.377	0.408
	LTE Band 12	10M	QPSK	25	12	Back	10	23095	707.5	21.75	22.00	1.059	0.02	0.309	0.327
	LTE Band 26	15M	QPSK	1	37	Front	10	26865	831.5	22.38	22.50	1.028	0.06	0.316	0.325
	LTE Band 26	15M	QPSK	36	0	Front	10	26865	831.5	21.25	21.50	1.059	0.05	0.243	0.257
	LTE Band 26	15M	QPSK	1	37	Back	10	26865	831.5	22.38	22.50	1.028	0.02	0.432	0.444
32	LTE Band 26	15M	QPSK	1	37	Back	10	26765	821.5	22.27	22.50	1.054	0.04	0.486	0.512
	LTE Band 26	15M	QPSK	1	37	Back	10	26965	841.5	22.37	22.50	1.030	0.09	0.476	0.490
	LTE Band 26	15M	QPSK	36	0	Back	10	26865	831.5	21.25	21.50	1.059	0.04	0.346	0.367
	LTE Band 5	10M	QPSK	1	25	Front	10	20525	836.5	23.42	23.50	1.019	0.08	0.381	0.388
	LTE Band 5	10M	QPSK	25	0	Front	10	20525	836.5	22.36	22.50	1.033	0.07	0.352	0.364
33	LTE Band 5	10M	QPSK	1	25	Back	10	20525	836.5	23.42	23.50	1.019	0.01	0.543	0.553
	LTE Band 5	10M	QPSK	25	0	Back	10	20525	836.5	22.36	22.50	1.033	0.07	0.433	0.447
	LTE Band 4	20M	QPSK	1	49	Front	10	20175	1732.5	21.13	21.50	1.089	0.06	0.344	0.375
	LTE Band 4	20M	QPSK	50	24	Front	10	20175	1732.5	20.08	20.50	1.102	0.05	0.266	0.293
34	LTE Band 4	20M	QPSK	1	49	Back	10	20175	1732.5	21.13	21.50	1.089	0.16	0.884	0.963
	LTE Band 4	20M	QPSK	50	24	Back	10	20175	1732.5	20.08	20.50	1.102	0.05	0.695	0.766
	LTE Band 4	20M	QPSK	100	0	Back	10	20175	1732.5	19.94	20.50	1.138	0.03	0.672	0.764
	LTE Band 2	20M	QPSK	1	49	Front	10	18700	1860	22.95	23.50	1.135	0.04	0.425	0.482
	LTE Band 2	20M	QPSK	50	0	Front	10	18700	1860	21.90	22.50	1.148	0.09	0.339	0.389
35	LTE Band 2	20M	QPSK	1	49	Back	10	18700	1860	22.95	23.50	1.135	0.06	0.771	0.875
	LTE Band 2	20M	QPSK	1	49	Back	10	18900	1880	22.91	23.50	1.146	0.08	0.648	0.742
	LTE Band 2	20M	QPSK	1	49	Back	10	19100	1900	22.85	23.50	1.161	0.11	0.611	0.710
	LTE Band 2	20M	QPSK	50	0	Back	10	18700	1860	21.90	22.50	1.148	0.03	0.618	0.710
	LTE Band 2	20M	QPSK	100	0	Back	10	18700	1860	21.89	22.50	1.151	-0.02	0.585	0.673
	LTE Band 7	20M	QPSK	1	49	Front	10	21350	2560	22.23	22.50	1.064	0.04	0.318	0.338
36	LTE Band 7	20M	QPSK	1	49	Front	10	20850	2510	22.09	22.50	1.099	0.06	0.347	0.381
	LTE Band 7	20M	QPSK	1	49	Front	10	21100	2535	22.15	22.50	1.084	0.04	0.312	0.338
	LTE Band 7	20M	QPSK	50	50	Front	10	21350	2560	21.04	21.50	1.112	0.01	0.253	0.281
	LTE Band 7	20M	QPSK	1	49	Back	10	21350	2560	22.23	22.50	1.064	0.06	0.290	0.309
	LTE Band 7	20M	QPSK	50	50	Back	10	21350	2560	21.04	21.50	1.112	0.07	0.232	0.258



<TDD LTE SAR>

Plot No.	Band	BW (MHz)	Modulation	RB Size	RB Offset	Test Position	Gap (mm)	Ch.	Freq. (MHz)	Average Power (dBm)	Tune-Up Limit (dBm)	Tune-up Scaling Factor	Duty Cycle %	Duty Cycle Scaling Factor	Power Drift (dB)	Measured 1g SAR (W/kg)	Reported 1g SAR (W/kg)
37	LTE Band 38	20M	QPSK	1	49	Front	10	37850	2580	22.87	23.00	1.030	62.9	1.006	0.07	0.244	0.253
	LTE Band 38	20M	QPSK	1	49	Front	10	38000	2595	22.81	23.00	1.045	62.9	1.006	0.07	0.213	0.224
	LTE Band 38	20M	QPSK	1	49	Front	10	38150	2610	22.82	23.00	1.042	62.9	1.006	0.03	0.211	0.221
	LTE Band 38	20M	QPSK	50	24	Front	10	37850	2580	22.04	22.50	1.112	62.9	1.006	0.05	0.184	0.206
	LTE Band 38	20M	QPSK	1	49	Back	10	37850	2580	22.87	23.00	1.030	62.9	1.006	0.07	0.213	0.221
	LTE Band 38	20M	QPSK	50	24	Back	10	37850	2580	22.04	22.50	1.112	62.9	1.006	0.06	0.166	0.186
38	LTE Band 41	20M	QPSK	1	49	Front	10	41140	2645	23.37	23.50	1.030	62.9	1.006	0.02	0.281	0.291
	LTE Band 41	20M	QPSK	1	49	Front	10	40240	2555	22.94	23.50	1.138	62.9	1.006	0.05	0.235	0.269
	LTE Band 41	20M	QPSK	1	49	Front	10	40500	2581	22.96	23.50	1.132	62.9	1.006	0.02	0.216	0.246
	LTE Band 41	20M	QPSK	1	49	Front	10	40770	2608	22.88	23.50	1.153	62.9	1.006	0.05	0.213	0.247
	LTE Band 41	20M	QPSK	50	24	Front	10	41140	2645	22.39	22.50	1.026	62.9	1.006	0.01	0.216	0.223
	LTE Band 41	20M	QPSK	1	49	Back	10	41140	2645	23.37	23.50	1.030	62.9	1.006	0.03	0.277	0.287
	LTE Band 41	20M	QPSK	50	24	Back	10	41140	2645	22.39	22.50	1.026	62.9	1.006	0.01	0.210	0.217

<WLAN SAR>

Plot No.	Band	Mode	Test Position	Gap (mm)	Ch.	Freq. (MHz)	Average Power (dBm)	Tune-Up Limit (dBm)	Tune-up Scaling Factor	Duty Cycle %	Duty Cycle Scaling Factor	Power Drift (dB)	Measured 1g SAR (W/kg)	Reported 1g SAR (W/kg)
	WLAN2.4GHz	802.11b 1Mbps	Front	10	11	2462	16.58	17.00	1.103	97.59	1.025	0.07	0.118	0.133
	WLAN2.4GHz	802.11b 1Mbps	Back	10	11	2462	16.58	17.00	1.103	97.59	1.025	0.02	0.149	0.168
	WLAN2.4GHz	802.11b 1Mbps	Back	10	1	2412	15.94	16.50	1.139	97.59	1.025	0.04	0.145	0.169
39	WLAN2.4GHz	802.11b 1Mbps	Back	10	6	2437	16.29	16.50	1.051	97.59	1.025	0.07	0.318	0.342

15.4 Repeated SAR Measurement

No.	Band	Mode	BW (MHz)	Modulation	RB Size	RB Offset	Test Position	Gap (mm)	Ch.	Freq. (MHz)	Average Power (dBm)	Tune-Up Limit (dBm)	Tune-up Scaling Factor	Duty Cycle %	Duty Cycle Scaling Factor	Power Drift (dB)	Measured 1g SAR (W/kg)	Ratio	Reported 1g SAR (W/kg)
1st	LTE Band 4	-	20M	QPSK	1	49	Back	10	20175	1732.5	21.13	21.50	1.089	-	-	0.16	0.884	1	0.963
2nd	LTE Band 4	-	20M	QPSK	1	49	Back	10	20175	1732.5	21.13	21.50	1.089	-	-	0.06	0.874	1.011	0.952
1st	WLAN2.4GHz	802.11b 1Mbps	-	-	-	-	Right Cheek	-	6	2437	16.29	16.50	1.051	97.59	1.025	0.06	1.100	1	1.185
2nd	WLAN2.4GHz	802.11b 1Mbps	-	-	-	-	Right Cheek	-	6	2437	16.29	16.50	1.051	97.59	1.025	0.02	1.090	1.009	1.174

General Note:

1. Per KDB 865664 D01v01r04, for each frequency band, repeated SAR measurement is required only when the measured SAR is ≥ 0.8 W/kg.
2. Per KDB 865664 D01v01r04, if the ratio among the repeated measurement is ≤ 1.2 and the measured SAR < 1.45 W/kg, only one repeated measurement is required.
3. The ratio is the difference in percentage between original and repeated *measured SAR*.
4. All measurement SAR result is scaled-up to account for tune-up tolerance and is compliant.

16. Simultaneous Transmission Analysis

No.	Simultaneous Transmission Configurations	Portable Handset			Note
		Head	Body-worn	Hotspot	
1.	GSM Voice + WLAN2.4GHz	Yes	Yes		
2.	GPRS/EDGE + WLAN2.4GHz	Yes	Yes	Yes	WLAN Hotspot
3.	WCDMA + WLAN2.4GHz	Yes	Yes	Yes	WLAN Hotspot
4.	LTE + WLAN2.4GHz	Yes	Yes	Yes	WLAN Hotspot
5.	GSM Voice + Bluetooth		Yes		
6.	GPRS/EDGE + Bluetooth		Yes	Yes	BT Tethering
7.	WCDMA + Bluetooth		Yes	Yes	BT Tethering
8.	LTE + Bluetooth		Yes	Yes	BT Tethering

General Note:

1. This device supports VoIP in GPRS, EGPRS, WCDMA and LTE (e.g. for 3rd-party VoIP), LTE supports VoLTE operation.
2. EUT will choose each GSM, WCDMA, and LTE according to the network signal condition; therefore, they will not operate simultaneously at any moment.
3. WLAN 2.4GHz and Bluetooth share the same antenna so can't transmit simultaneously.
4. This device 2.4GHz WLAN supports hotspot operation and Bluetooth support tethering applications.
5. The reported SAR summation is calculated based on the same configuration and test position.
6. Per KDB 447498 D01v06, simultaneous transmission SAR is compliant if,
 - i) Scalar SAR summation < 1.6W/kg.
 - ii) $SPLSR = (SAR1 + SAR2)^{1.5} / (\text{min. separation distance, mm})$, and the peak separation distance is determined from the square root of $[(x1-x2)^2 + (y1-y2)^2 + (z1-z2)^2]$, where (x1, y1, z1) and (x2, y2, z2) are the coordinates of the extrapolated peak SAR locations in the zoom scan.
 - iii) If $SPLSR \leq 0.04$, simultaneously transmission SAR measurement is not necessary.
 - iv) Simultaneously transmission SAR measurement, and the reported multi-band SAR < 1.6W/kg.
 - v) The SPLSR calculated results please refer to section 16.4.
7. For simultaneous transmission analysis, Bluetooth SAR is estimated per KDB 447498 D01v06 based on the formula below.
 - i) $(\text{max. power of channel, including tune-up tolerance, mW}) / (\text{min. test separation distance, mm}) \cdot [\sqrt{f(\text{GHz})} / x] \text{ W/kg}$ for test separation distances $\leq 50 \text{ mm}$; where $x = 7.5$ for 1-g SAR, and $x = 18.75$ for 10-g SAR.
 - ii) When the minimum separation distance is < 5mm, the distance is used 5mm to determine SAR test exclusion.
 - iii) 0.4 W/kg for 1-g SAR and 1.0 W/kg for 10-g SAR, when the test separation distances is > 50 mm.

Bluetooth Max Power (dBm)	Exposure Position	Hotspot & Body worn
	Test separation	10 mm
7.00	Estimated 1g SAR (W/kg)	0.105

16.1 Head Exposure Conditions

WWAN Band		Exposure Position	1	2	1+2 Summed 1g SAR (W/kg)	SPLSR	Case No
			WWAN	2.4GHz WLAN			
			1g SAR (W/kg)	1g SAR (W/kg)			
GSM	GSM850	Right Cheek	0.322	1.185	1.51		
		Right Tilted	0.187	0.555	0.74		
		Left Cheek	0.300	0.216	0.52		
		Left Tilted	0.162	0.212	0.37		
	GSM1900	Right Cheek	0.227	1.185	1.41		
		Right Tilted	0.085	0.555	0.64		
		Left Cheek	0.326	0.216	0.54		
		Left Tilted	0.179	0.212	0.39		
WCDMA	Band V	Right Cheek	0.441	1.185	1.63	0.03	#1
		Right Tilted	0.248	0.555	0.80		
		Left Cheek	0.353	0.216	0.57		
		Left Tilted	0.201	0.212	0.41		
	Band II	Right Cheek	0.200	1.185	1.39		
		Right Tilted	0.168	0.555	0.72		
		Left Cheek	0.380	0.216	0.60		
		Left Tilted	0.182	0.212	0.39		



WWAN Band		Exposure Position	1	2	1+2 Summed 1g SAR (W/kg)	SPLSR	Case No
			WWAN	2.4GHz WLAN			
			1g SAR (W/kg)	1g SAR (W/kg)			
LTE	Band 12	Right Cheek	0.181	1.185	1.37		
		Right Tilted	0.128	0.555	0.68		
		Left Cheek	0.173	0.216	0.39		
		Left Tilted	0.108	0.212	0.32		
	Band 26	Right Cheek	0.306	1.185	1.49		
		Right Tilted	0.183	0.555	0.74		
		Left Cheek	0.277	0.216	0.49		
		Left Tilted	0.184	0.212	0.40		
	Band 5	Right Cheek	0.386	1.185	1.57		
		Right Tilted	0.201	0.555	0.76		
		Left Cheek	0.319	0.216	0.54		
		Left Tilted	0.204	0.212	0.42		
	Band 4	Right Cheek	0.107	1.185	1.29		
		Right Tilted	0.089	0.555	0.64		
		Left Cheek	0.154	0.216	0.37		
		Left Tilted	0.079	0.212	0.29		
	Band 2	Right Cheek	0.271	1.185	1.46		
		Right Tilted	0.220	0.555	0.78		
		Left Cheek	0.443	0.216	0.66		
		Left Tilted	0.230	0.212	0.44		
	Band 7	Right Cheek	0.078	1.185	1.26		
		Right Tilted	0.029	0.555	0.58		
		Left Cheek	0.052	0.216	0.27		
		Left Tilted	0.053	0.212	0.27		
	Band 38	Right Cheek	0.062	1.185	1.25		
		Right Tilted	0.023	0.555	0.58		
		Left Cheek	0.042	0.216	0.26		
		Left Tilted	0.044	0.212	0.26		
	Band 41	Right Cheek	0.074	1.185	1.26		
		Right Tilted	0.034	0.555	0.59		
		Left Cheek	0.047	0.216	0.26		
		Left Tilted	0.056	0.212	0.27		

16.2 Hotspot Exposure Conditions

WWAN Band		Exposure Position	1	2	3	1+2 Summed 1g SAR (W/kg)	1+3 Summed 1g SAR (W/kg)
			WWAN	2.4GHz WLAN	Bluetooth		
			1g SAR (W/kg)	1g SAR (W/kg)	1g SAR (W/kg)		
GSM	GSM850	Front	0.298	0.133	0.105	0.43	0.40
		Back	0.523	0.342	0.105	0.87	0.63
		Left side	0.413	0.156	0.105	0.57	0.52
		Right side	0.331			0.33	0.33
		Top side		0.083	0.105	0.08	0.11
		Bottom side	0.043			0.04	0.04
	GSM1900	Front	0.317	0.133	0.105	0.45	0.42
		Back	0.663	0.342	0.105	1.01	0.77
		Left side	0.193	0.156	0.105	0.35	0.30
		Right side	0.147			0.15	0.15
		Top side		0.083	0.105	0.08	0.11
		Bottom side	0.095			0.10	0.10
WCDMA	Band V	Front	0.418	0.133	0.105	0.55	0.52
		Back	0.640	0.342	0.105	0.98	0.75
		Left side	0.572	0.156	0.105	0.73	0.68
		Right side	0.445			0.45	0.45
		Top side		0.083	0.105	0.08	0.11
		Bottom side	0.053			0.05	0.05
	Band II	Front	0.401	0.133	0.105	0.53	0.51
		Back	0.669	0.342	0.105	1.01	0.77
		Left side	0.238	0.156	0.105	0.39	0.34
		Right side	0.154			0.15	0.15
		Top side		0.083	0.105	0.08	0.11
		Bottom side	0.157			0.16	0.16



WWAN Band		Exposure Position	1	2	3	1+2 Summed 1g SAR (W/kg)	1+3 Summed 1g SAR (W/kg)
			WWAN	2.4GHz WLAN	Bluetooth		
			1g SAR (W/kg)	1g SAR (W/kg)	1g SAR (W/kg)		
LTE	Band 12	Front	0.237	0.133	0.105	0.37	0.34
		Back	0.408	0.342	0.105	0.75	0.51
		Left side	0.260	0.156	0.105	0.42	0.37
		Right side	0.231			0.23	0.23
		Top side		0.083	0.105	0.08	0.11
		Bottom side	0.025			0.03	0.03
	Band 26	Front	0.325	0.133	0.105	0.46	0.43
		Back	0.512	0.342	0.105	0.85	0.62
		Left side	0.414	0.156	0.105	0.57	0.52
		Right side	0.308			0.31	0.31
		Top side		0.083	0.105	0.08	0.11
		Bottom side	0.041			0.04	0.04
	Band 5	Front	0.388	0.133	0.105	0.52	0.49
		Back	0.553	0.342	0.105	0.90	0.66
		Left side	0.506	0.156	0.105	0.66	0.61
		Right side	0.353			0.35	0.35
		Top side		0.083	0.105	0.08	0.11
		Bottom side	0.049			0.05	0.05
	Band 4	Front	0.375	0.133	0.105	0.51	0.48
		Back	0.963	0.342	0.105	1.31	1.07
		Left side	0.126	0.156	0.105	0.28	0.23
		Right side	0.112			0.11	0.11
		Top side		0.083	0.105	0.08	0.11
		Bottom side	0.490			0.49	0.49
	Band 2	Front	0.482	0.133	0.105	0.62	0.59
		Back	0.875	0.342	0.105	1.22	0.98
		Left side	0.312	0.156	0.105	0.47	0.42
		Right side	0.197			0.20	0.20
		Top side		0.083	0.105	0.08	0.11
		Bottom side	0.232			0.23	0.23
	Band 7	Front	0.381	0.133	0.105	0.51	0.49
		Back	0.309	0.342	0.105	0.65	0.41
		Left side	0.056	0.156	0.105	0.21	0.16
		Right side	0.087			0.09	0.09
		Top side		0.083	0.105	0.08	0.11
		Bottom side	0.722			0.72	0.72
	Band 38	Front	0.253	0.133	0.105	0.39	0.36
		Back	0.221	0.342	0.105	0.56	0.33
		Left side	0.053	0.156	0.105	0.21	0.16
		Right side	0.038			0.04	0.04
		Top side		0.083	0.105	0.08	0.11
		Bottom side	0.307			0.31	0.31
Band 41	Front	0.291	0.133	0.105	0.42	0.40	
	Back	0.287	0.342	0.105	0.63	0.39	
	Left side	0.104	0.156	0.105	0.26	0.21	
	Right side	0.088			0.09	0.09	
	Top side		0.083	0.105	0.08	0.11	
	Bottom side	0.390			0.39	0.39	



16.3 Body-Worn Accessory Exposure Conditions

WWAN Band		Exposure Position	1	2	3	1+2 Summed 1g SAR (W/kg)	1+3 Summed 1g SAR (W/kg)
			WWAN	2.4GHz WLAN	Bluetooth		
			1g SAR (W/kg)	1g SAR (W/kg)	1g SAR (W/kg)		
GSM	GSM850	Front	0.298	0.133	0.105	0.43	0.40
		Back	0.523	0.342	0.105	0.87	0.63
	GSM1900	Front	0.317	0.133	0.105	0.45	0.42
		Back	0.663	0.342	0.105	1.01	0.77
WCDMA	Band V	Front	0.418	0.133	0.105	0.55	0.52
		Back	0.640	0.342	0.105	0.98	0.75
	Band II	Front	0.401	0.133	0.105	0.53	0.51
		Back	0.669	0.342	0.105	1.01	0.77
LTE	Band 12	Front	0.237	0.133	0.105	0.37	0.34
		Back	0.408	0.342	0.105	0.75	0.51
	Band 26	Front	0.325	0.133	0.105	0.46	0.43
		Back	0.512	0.342	0.105	0.85	0.62
	Band 5	Front	0.388	0.133	0.105	0.52	0.49
		Back	0.553	0.342	0.105	0.90	0.66
	Band 4	Front	0.375	0.133	0.105	0.51	0.48
		Back	0.963	0.342	0.105	1.31	1.07
	Band 2	Front	0.482	0.133	0.105	0.62	0.59
		Back	0.875	0.342	0.105	1.22	0.98
	Band 7	Front	0.381	0.133	0.105	0.51	0.49
		Back	0.309	0.342	0.105	0.65	0.41
	Band 38	Front	0.253	0.133	0.105	0.39	0.36
		Back	0.221	0.342	0.105	0.56	0.33
	Band 41	Front	0.291	0.133	0.105	0.42	0.40
		Back	0.287	0.342	0.105	0.63	0.39

16.4 SPLSR Evaluation and Analysis

General Note:

- When standalone SAR is measured for both antennas in the pair, the peak location separation distance is computed by the square root of $[(x1-x2)^2 + (y1-y2)^2 + (z1-z2)^2]$, where $(x1, y1, z1)$ and $(x2, y2, z2)$ are the coordinates in the area scans or extrapolated peak SAR locations in the zoom scans, as appropriate.
- $SPLSR = (SAR_1 + SAR_2)^{1.5} / (min. \text{ separation distance, mm})$. If $SPLSR \leq 0.04$, simultaneously transmission SAR measurement is not necessary.

Case #1	Band	Position	SAR (W/kg)	Gap (mm)	SAR peak location (m)			3D distance (mm)	Summed SAR (W/kg)	SPLSR Results	Simultaneous SAR
					X	Y	Z				
	WCDMA Band V	Right Cheek	0.441	0	0.0655	-0.275	-0.175	70.6	1.63	0.03	Not required
	WLAN2.4GHz		1.185	0	0.0267	-0.334	-0.173				



Test Engineer: Weilong Chen

17. Uncertainty Assessment

The component of uncertainty may generally be categorized according to the methods used to evaluate them. The evaluation of uncertainty by the statistical analysis of a series of observations is termed a Type A evaluation of uncertainty. The evaluation of uncertainty by means other than the statistical analysis of a series of observation is termed a Type B evaluation of uncertainty. Each component of uncertainty, however evaluated, is represented by an estimated standard deviation, termed standard uncertainty, which is determined by the positive square root of the estimated variance.

A Type A evaluation of standard uncertainty may be based on any valid statistical method for treating data. This includes calculating the standard deviation of the mean of a series of independent observations; using the method of least squares to fit a curve to the data in order to estimate the parameter of the curve and their standard deviations; or carrying out an analysis of variance in order to identify and quantify random effects in certain kinds of measurement.

A type B evaluation of standard uncertainty is typically based on scientific judgment using all of the relevant information available. These may include previous measurement data, experience, and knowledge of the behavior and properties of relevant materials and instruments, manufacture’s specification, data provided in calibration reports and uncertainties assigned to reference data taken from handbooks. Broadly speaking, the uncertainty is either obtained from an outdoor source or obtained from an assumed distribution, such as the normal distribution, rectangular or triangular distributions indicated in table below.

Uncertainty Distributions	Normal	Rectangular	Triangular	U-Shape
Multi-plying Factor ^(a)	1/k ^(b)	1/√3	1/√6	1/√2

(a) standard uncertainty is determined as the product of the multiplying factor and the estimated range of variations in the measured quantity

(b) κ is the coverage factor

Table 17.1. Standard Uncertainty for Assumed Distribution

The combined standard uncertainty of the measurement result represents the estimated standard deviation of the result. It is obtained by combining the individual standard uncertainties of both Type A and Type B evaluation using the usual “root-sum-squares” (RSS) methods of combining standard deviations by taking the positive square root of the estimated variances.

Expanded uncertainty is a measure of uncertainty that defines an interval about the measurement result within which the measured value is confidently believed to lie. It is obtained by multiplying the combined standard uncertainty by a coverage factor. Typically, the coverage factor ranges from 2 to 3. Using a coverage factor allows the true value of a measured quantity to be specified with a defined probability within the specified uncertainty range. For purpose of this document, a coverage factor two is used, which corresponds to confidence interval of about 95 %. The DASY uncertainty Budget is shown in the following tables.

Error Description	Uncertainty Value (±%)	Probability	Divisor	(Ci) 1g	(Ci) 10g	Standard Uncertainty (1g) (±%)	Standard Uncertainty (10g) (±%)
Measurement System							
Probe Calibration	6.0	N	1	1	1	6.0	6.0
Axial Isotropy	4.7	R	1.732	0.7	0.7	1.9	1.9
Hemispherical Isotropy	9.6	R	1.732	0.7	0.7	3.9	3.9
Boundary Effects	1.0	R	1.732	1	1	0.6	0.6
Linearity	4.7	R	1.732	1	1	2.7	2.7
System Detection Limits	1.0	R	1.732	1	1	0.6	0.6
Modulation Response	3.2	R	1.732	1	1	1.8	1.8
Readout Electronics	0.3	N	1	1	1	0.3	0.3
Response Time	0.0	R	1.732	1	1	0.0	0.0
Integration Time	2.6	R	1.732	1	1	1.5	1.5
RF Ambient Noise	3.0	R	1.732	1	1	1.7	1.7
RF Ambient Reflections	3.0	R	1.732	1	1	1.7	1.7
Probe Positioner	0.4	R	1.732	1	1	0.2	0.2
Probe Positioning	2.9	R	1.732	1	1	1.7	1.7
Max. SAR Eval.	2.0	R	1.732	1	1	1.2	1.2
Test Sample Related							
Device Positioning	3.0	N	1	1	1	3.0	3.0
Device Holder	3.6	N	1	1	1	3.6	3.6
Power Drift	5.0	R	1.732	1	1	2.9	2.9
Power Scaling	0.0	R	1.732	1	1	0.0	0.0
Phantom and Setup							
Phantom Uncertainty	6.1	R	1.732	1	1	3.5	3.5
SAR correction	0.0	R	1.732	1	0.84	0.0	0.0
Liquid Conductivity Repeatability	0.2	N	1	0.78	0.71	0.1	0.1
Liquid Conductivity (target)	5.0	R	1.732	0.78	0.71	2.3	2.0
Liquid Conductivity (mea.)	2.5	R	1.732	0.78	0.71	1.1	1.0
Temp. unc. - Conductivity	3.4	R	1.732	0.78	0.71	1.5	1.4
Liquid Permittivity Repeatability	0.15	N	1	0.23	0.26	0.0	0.0
Liquid Permittivity (target)	5.0	R	1.732	0.23	0.26	0.7	0.8
Liquid Permittivity (mea.)	2.5	R	1.732	0.23	0.26	0.3	0.4
Temp. unc. - Permittivity	0.83	R	1.732	0.23	0.26	0.1	0.1
Combined Std. Uncertainty						11.4%	11.4%
Coverage Factor for 95 %						K=2	K=2
Expanded STD Uncertainty						22.9%	22.7%

Table 17.2. Uncertainty Budget for frequency range 300 MHz to 3 GHz



18. References

- [1] FCC 47 CFR Part 2 "Frequency Allocations and Radio Treaty Matters; General Rules and Regulations"
- [2] ANSI/IEEE Std. C95.1-1992, "IEEE Standard for Safety Levels with Respect to Human Exposure to Radio Frequency Electromagnetic Fields, 3 kHz to 300 GHz", September 1992
- [3] IEEE Std. 1528-2013, "IEEE Recommended Practice for Determining the Peak Spatial-Average Specific Absorption Rate (SAR) in the Human Head from Wireless Communications Devices: Measurement Techniques", Sep 2013
- [4] SPEAG DASY System Handbook
- [5] FCC KDB 248227 D01 v02r02, "SAR Guidance for IEEE 802.11 (WiFi) Transmitters", Oct 2015.
- [6] FCC KDB 447498 D01 v06, "Mobile and Portable Device RF Exposure Procedures and Equipment Authorization Policies", Oct 2015
- [7] FCC KDB 648474 D04 v01r03, "SAR Evaluation Considerations for Wireless Handsets", Oct 2015.
- [8] FCC KDB 941225 D01 v03r01, "3G SAR MEAUREMENT PROCEDURES", Oct 2015
- [9] FCC KDB 941225 D05 v02r05, "SAR Evaluation Considerations for LTE Devices", Dec 2015
- [10] FCC KDB 941225 D06 v02r01, "SAR Evaluation Procedures for Portable Devices with Wireless Router Capabilities", Oct 2015.
- [11] FCC KDB 865664 D01 v01r04, "SAR Measurement Requirements for 100 MHz to 6 GHz", Aug 2015.
- [12] FCC KDB 865664 D02 v01r02, "RF Exposure Compliance Reporting and Documentation Considerations" Oct 2015.



Appendix A. Plots of System Performance Check

The plots are shown as follows.

System Check_Head_750MHz_170815

DUT: D750V3-SN:1099

Communication System: UID 0, CW (0); Frequency: 750 MHz; Duty Cycle: 1:1
Medium: HSL_750_170815 Medium parameters used: $f = 750 \text{ MHz}$; $\sigma = 0.879 \text{ S/m}$; $\epsilon_r = 40.711$; $\rho = 1000 \text{ kg/m}^3$
Ambient Temperature : $23.6 \text{ }^\circ\text{C}$; Liquid Temperature : $22.7 \text{ }^\circ\text{C}$

DASY5 Configuration:

- Probe: EX3DV4 - SN3911; ConvF(10.99, 10.99, 10.99); Calibrated: 2016.09.29;
- Sensor-Surface: 2mm (Mechanical Surface Detection)
- Electronics: DAE4 Sn1338; Calibrated: 2016.11.22
- Phantom: SAM (Front) with CRP v5.0; Type: QD000P40CD; Serial: TP:1795
- Measurement SW: DASY52, Version 52.8 (8); SEMCAD X Version 14.6.10 (7331)

Pin=250mW/Area Scan (61x61x1): Interpolated grid: $dx=15\text{mm}$, $dy=15\text{mm}$
Maximum value of SAR (interpolated) = 2.37 W/kg

Pin=250mW/Zoom Scan (5x5x7)/Cube 0: Measurement grid: $dx=8\text{mm}$, $dy=8\text{mm}$, $dz=5\text{mm}$
Reference Value = 53.28 V/m ; Power Drift = -0.08 dB
Peak SAR (extrapolated) = 2.74 W/kg
SAR(1 g) = 1.99 W/kg ; SAR(10 g) = 1.36 W/kg
Maximum value of SAR (measured) = 2.37 W/kg

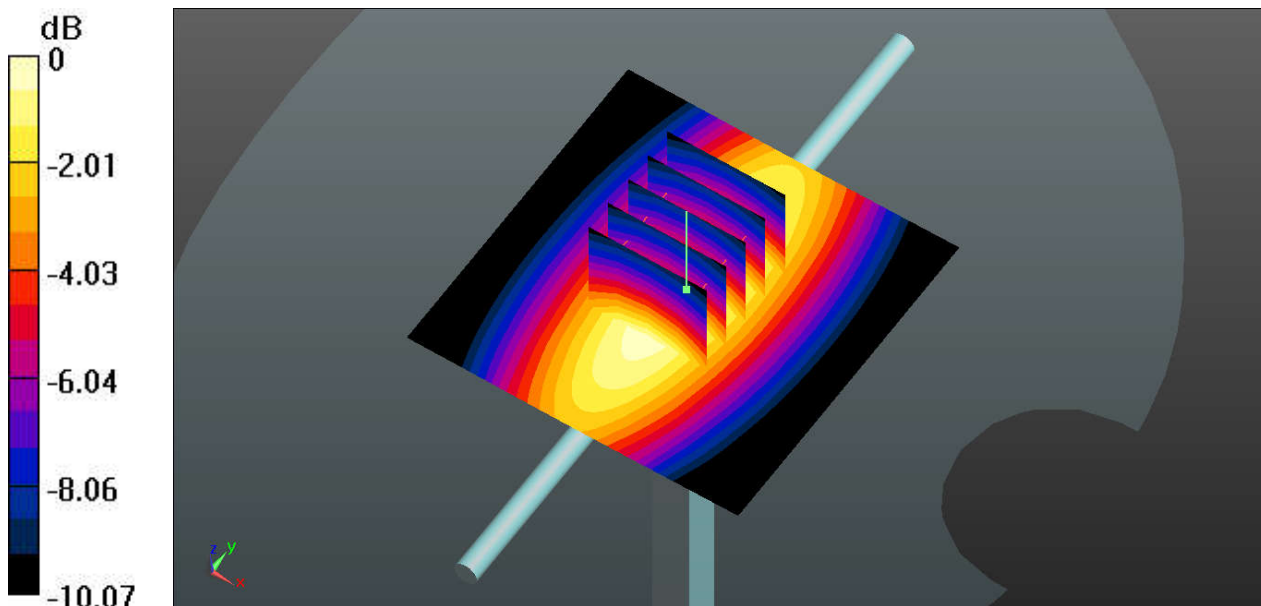

0 dB = 2.37 W/kg

System Check_Head_835MHz_170815

DUT: D835V2-SN:4d162

Communication System: UID 0, CW; Frequency: 835 MHz; Duty Cycle: 1:1

Medium: HSL_835_170815 Medium parameters used: $f = 835 \text{ MHz}$; $\sigma = 0.91 \text{ S/m}$; $\epsilon_r = 42.91$; $\rho = 1000 \text{ kg/m}^3$

Ambient Temperature : $23.6 \text{ }^\circ\text{C}$; Liquid Temperature : $22.8 \text{ }^\circ\text{C}$

DASY5 Configuration:

- Probe: EX3DV4 - SN3911; ConvF(10.54, 10.54, 10.54); Calibrated: 2016.09.29;
- Sensor-Surface: 2mm (Mechanical Surface Detection)
- Electronics: DAE4 Sn1338; Calibrated: 2016.11.22
- Phantom: SAM (Front) with CRP v5.0; Type: QD000P40CD; Serial: TP:1795
- Measurement SW: DASY52, Version 52.8 (8); SEMCAD X Version 14.6.10 (7331)

Pin=250mW/Area Scan (61x61x1): Interpolated grid: $dx=15\text{mm}$, $dy=15\text{mm}$

Maximum value of SAR (interpolated) = 2.80 W/kg

Pin=250mW/Zoom Scan (5x5x7)/Cube 0: Measurement grid: $dx=8\text{mm}$, $dy=8\text{mm}$, $dz=5\text{mm}$

Reference Value = 56.17 V/m ; Power Drift = 0.01 dB

Peak SAR (extrapolated) = 3.19 W/kg

SAR(1 g) = 2.2 W/kg ; SAR(10 g) = 1.49 W/kg

Maximum value of SAR (measured) = 2.75 W/kg

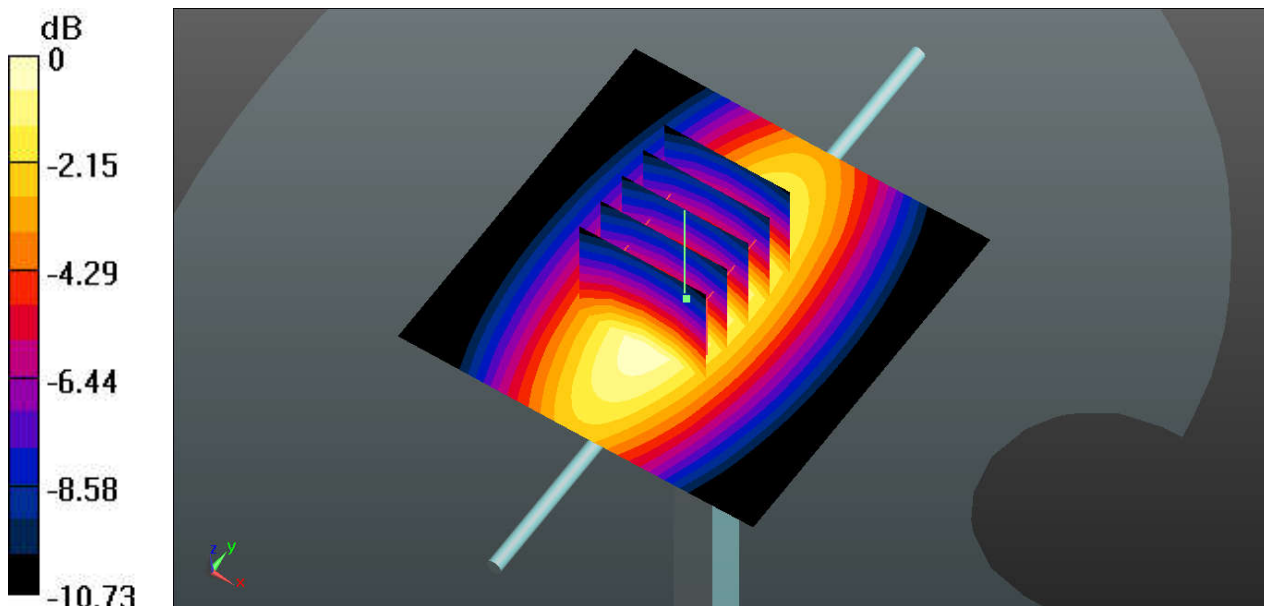

0 dB = 2.75 W/kg

System Check_Head_1750MHz_170812

DUT: D1750V2-SN:1137

Communication System: UID 0, CW; Frequency: 1750 MHz; Duty Cycle: 1:1
Medium: HSL_1750_170812 Medium parameters used: $f = 1750$ MHz; $\sigma = 1.352$ S/m; $\epsilon_r = 38.776$;
 $\rho = 1000$ kg/m³
Ambient Temperature : 23.3 °C; Liquid Temperature : 22.7 °C

DASY5 Configuration:

- Probe: EX3DV4 - SN3911; ConvF(8.88, 8.88, 8.88); Calibrated: 2016.09.29;
- Sensor-Surface: 2mm (Mechanical Surface Detection)
- Electronics: DAE4 Sn1338; Calibrated: 2016.11.22
- Phantom: SAM (Front) with CRP v5.0; Type: QD000P40CD; Serial: TP:1795
- Measurement SW: DASY52, Version 52.8 (8); SEMCAD X Version 14.6.10 (7331)

Pin=250mW/Area Scan (61x61x1): Interpolated grid: dx=15mm, dy=15mm
Maximum value of SAR (interpolated) = 12.3 W/kg

Pin=250mW/Zoom Scan (5x5x7)/Cube 0: Measurement grid: dx=8mm, dy=8mm, dz=5mm
Reference Value = 97.20 V/m; Power Drift = 0.01 dB
Peak SAR (extrapolated) = 15.4 W/kg
SAR(1 g) = 8.82 W/kg; SAR(10 g) = 4.79 W/kg
Maximum value of SAR (measured) = 12.4 W/kg

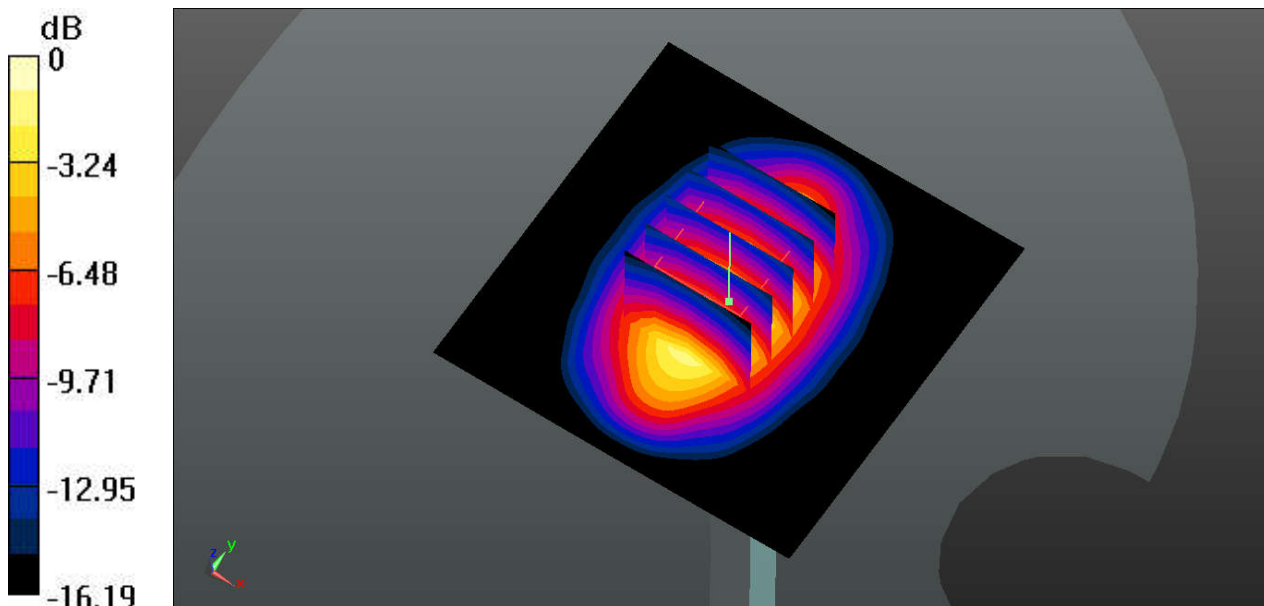

0 dB = 12.4 W/kg

System Check_Head_1900MHz_170812

DUT: D1900V2-SN:5d182

Communication System: UID 0, CW; Frequency: 1900 MHz; Duty Cycle: 1:1

Medium: HSL_1900_170812 Medium parameters used: $f = 1900$ MHz; $\sigma = 1.445$ S/m; $\epsilon_r = 40.021$;
 $\rho = 1000$ kg/m³

Ambient Temperature : 23.3 °C; Liquid Temperature : 22.5 °C

DASY5 Configuration:

- Probe: EX3DV4 - SN3911; ConvF(8.5, 8.5, 8.5); Calibrated: 2016.09.29;
- Sensor-Surface: 2mm (Mechanical Surface Detection)
- Electronics: DAE4 Sn1338; Calibrated: 2016.11.22
- Phantom: SAM (Front) with CRP v5.0; Type: QD000P40CD; Serial: TP:1795
- Measurement SW: DASY52, Version 52.8 (8); SEMCAD X Version 14.6.10 (7331)

Pin=250mW/Area Scan (61x61x1): Interpolated grid: dx=15mm, dy=15mm

Maximum value of SAR (interpolated) = 13.6 W/kg

Pin=250mW/Zoom Scan (5x5x7)/Cube 0: Measurement grid: dx=8mm, dy=8mm, dz=5mm

Reference Value = 99.03 V/m; Power Drift = 0.00 dB

Peak SAR (extrapolated) = 17.1 W/kg

SAR(1 g) = 9.6 W/kg; SAR(10 g) = 5.05 W/kg

Maximum value of SAR (measured) = 13.6 W/kg

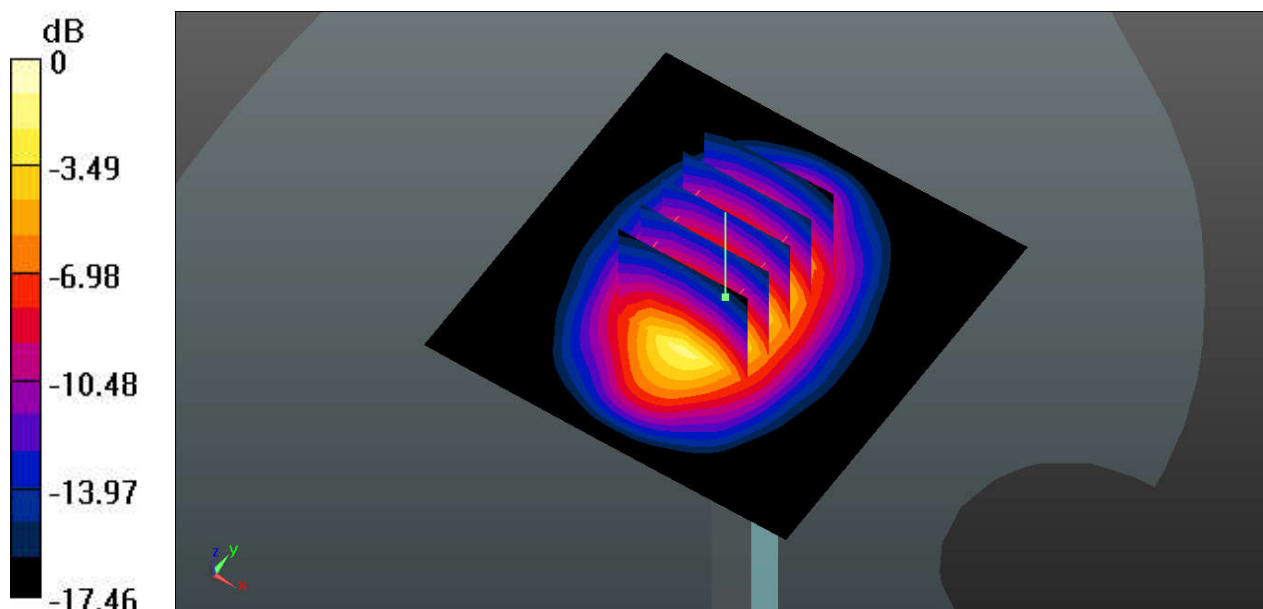

0 dB = 13.6 W/kg

System Check_Head_2450MHz_170816

DUT: D2450V2-SN:924

Communication System: UID 0, CW; Frequency: 2450 MHz; Duty Cycle: 1:1
 Medium: HSL_2450_170816 Medium parameters used: $f = 2450$ MHz; $\sigma = 1.829$ S/m; $\epsilon_r = 40.081$;
 $\rho = 1000$ kg/m³
 Ambient Temperature : 23.5 °C; Liquid Temperature : 22.6 °C

DASY5 Configuration:

- Probe: EX3DV4 - SN3911; ConvF(7.43, 7.43, 7.43); Calibrated: 2016.09.29;
- Sensor-Surface: 2mm (Mechanical Surface Detection)
- Electronics: DAE4 Sn1338; Calibrated: 2016.11.22
- Phantom: SAM (Front) with CRP v5.0; Type: QD000P40CD; Serial: TP:1795
- Measurement SW: DASY52, Version 52.8 (8); SEMCAD X Version 14.6.10 (7331)

Pin=250mW/Area Scan (81x81x1): Interpolated grid: dx=12mm, dy=12mm
 Maximum value of SAR (interpolated) = 20.2 W/kg

Pin=250mW/Zoom Scan (7x7x7)/Cube 0: Measurement grid: dx=5mm, dy=5mm, dz=5mm
 Reference Value = 92.88 V/m; Power Drift = -0.03 dB
 Peak SAR (extrapolated) = 26.8 W/kg
SAR(1 g) = 13.2 W/kg; SAR(10 g) = 6.15 W/kg
 Maximum value of SAR (measured) = 20.1 W/kg

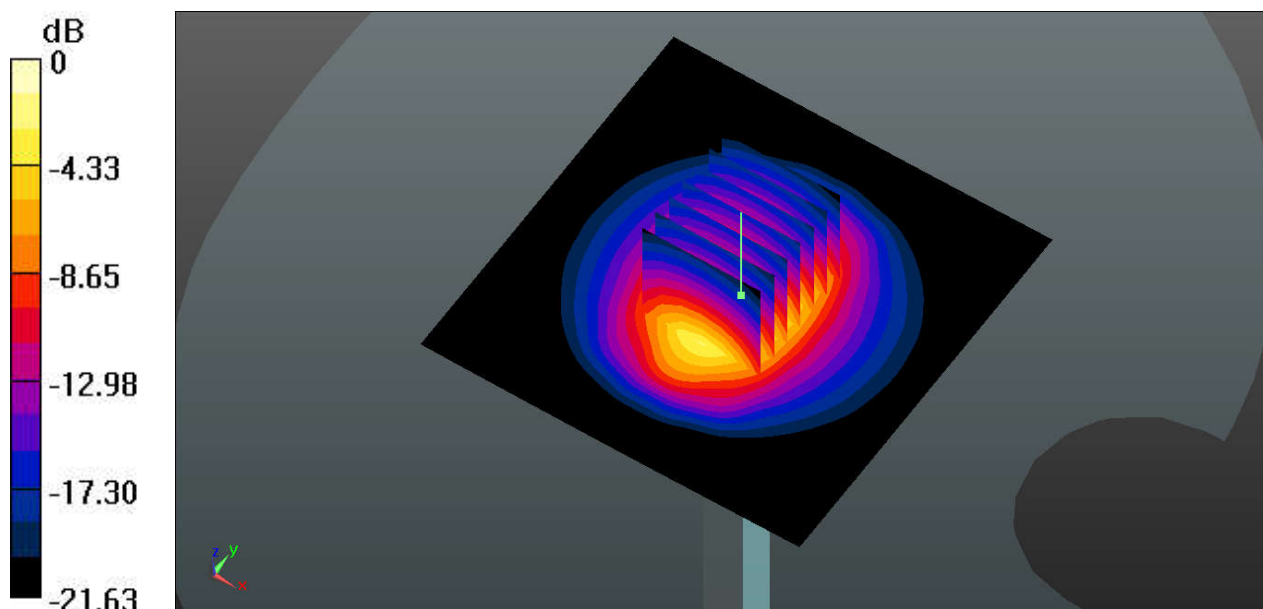

0 dB = 20.2 W/kg

System Check_Head_2600MHz_170816

DUT: D2600V2-SN:1070

Communication System: UID 0, CW (0); Frequency: 2600 MHz; Duty Cycle: 1:1
Medium: HSL_2600_170816 Medium parameters used: $f = 2600$ MHz; $\sigma = 2.05$ S/m; $\epsilon_r = 38.344$; $\rho = 1000$ kg/m³
Ambient Temperature : 23.3 °C; Liquid Temperature : 22.6 °C

DASY5 Configuration:

- Probe: EX3DV4 - SN3911; ConvF(7.39, 7.39, 7.39); Calibrated: 2016.09.29;
- Sensor-Surface: 2mm (Mechanical Surface Detection)
- Electronics: DAE4 Sn1338; Calibrated: 2016.11.22
- Phantom: SAM (Front) with CRP v5.0; Type: QD000P40CD; Serial: TP:1795
- Measurement SW: DASY52, Version 52.8 (8); SEMCAD X Version 14.6.10 (7331)

Pin=250mW/Area Scan (71x71x1): Interpolated grid: dx=12mm, dy=12mm
Maximum value of SAR (interpolated) = 22.6 W/kg

Pin=250mW/Zoom Scan (7x7x7)/Cube 0: Measurement grid: dx=5mm, dy=5mm, dz=5mm
Reference Value = 104.8 V/m; Power Drift = -0.17 dB
Peak SAR (extrapolated) = 30.8 W/kg
SAR(1 g) = 14.5 W/kg; SAR(10 g) = 6.52 W/kg
Maximum value of SAR (measured) = 22.7 W/kg

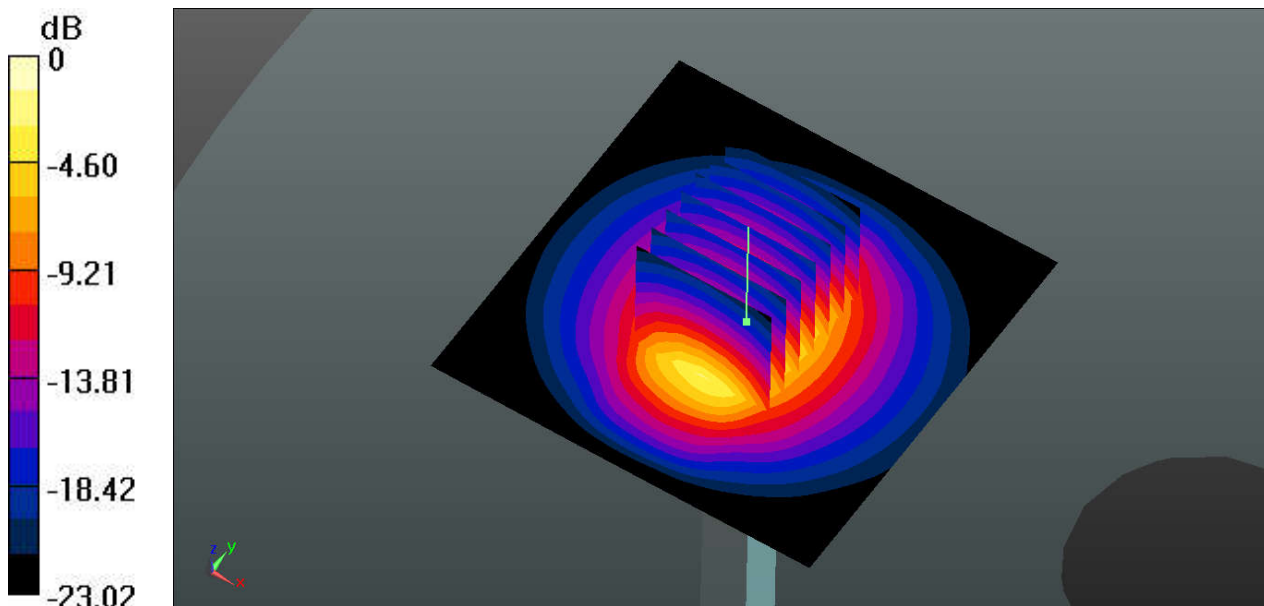

0 dB = 22.6 W/kg

System Check_Body_750MHz_170814

DUT: D750V3-SN:1099

Communication System: UID 0, CW (0); Frequency: 750 MHz; Duty Cycle: 1:1
Medium: MSL_750_170814 Medium parameters used: $f = 750$ MHz; $\sigma = 0.961$ S/m; $\epsilon_r = 53.914$; $\rho = 1000$ kg/m³
Ambient Temperature : 23.4 °C; Liquid Temperature : 22.5 °C

DASY5 Configuration:

- Probe: EX3DV4 - SN3911; ConvF(10.43, 10.43, 10.43); Calibrated: 2016.09.29;
- Sensor-Surface: 2mm (Mechanical Surface Detection)
- Electronics: DAE4 Sn1338; Calibrated: 2016.11.22
- Phantom: SAM (Front) with CRP v5.0; Type: QD000P40CD; Serial: TP:1795
- Measurement SW: DASY52, Version 52.8 (8); SEMCAD X Version 14.6.10 (7331)

Pin=250mW/Area Scan (61x61x1): Interpolated grid: dx=15mm, dy=15mm
Maximum value of SAR (interpolated) = 2.61 W/kg

Pin=250mW/Zoom Scan (5x5x7)/Cube 0: Measurement grid: dx=8mm, dy=8mm, dz=5mm
Reference Value = 51.98 V/m; Power Drift = -0.03 dB
Peak SAR (extrapolated) = 3.02 W/kg
SAR(1 g) = 2.08 W/kg; SAR(10 g) = 1.39 W/kg
Maximum value of SAR (measured) = 2.63 W/kg

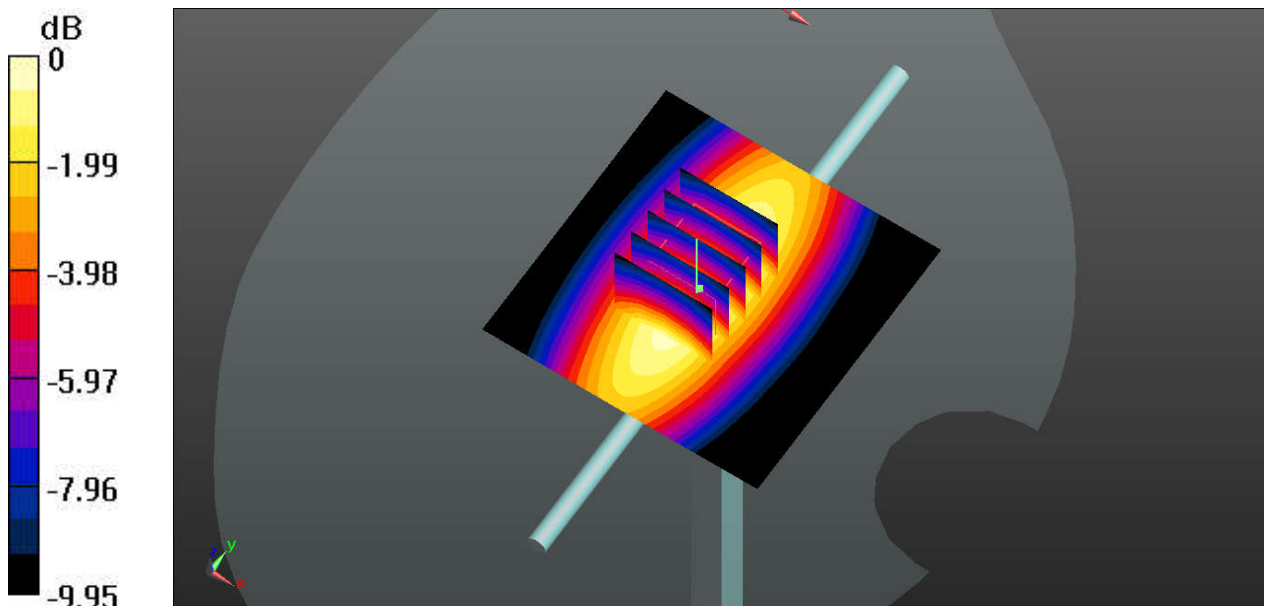

0 dB = 2.61 W/kg

System Check_Body_835MHz_170814

DUT: D835V2-SN:4d162

Communication System: UID 0, CW; Frequency: 835 MHz; Duty Cycle: 1:1
Medium: MSL_835_170814 Medium parameters used: $f = 835 \text{ MHz}$; $\sigma = 1.011 \text{ S/m}$; $\epsilon_r = 56.243$; $\rho = 1000 \text{ kg/m}^3$
Ambient Temperature : $23.4 \text{ }^\circ\text{C}$; Liquid Temperature : $22.8 \text{ }^\circ\text{C}$

DASY5 Configuration:

- Probe: EX3DV4 - SN3911; ConvF(10.19, 10.19, 10.19); Calibrated: 2016.09.29;
- Sensor-Surface: 2mm (Mechanical Surface Detection)
- Electronics: DAE4 Sn1338; Calibrated: 2016.11.22
- Phantom: SAM (Front) with CRP v5.0; Type: QD000P40CD; Serial: TP:1795
- Measurement SW: DASY52, Version 52.8 (8); SEMCAD X Version 14.6.10 (7331)

Pin=250mW/Area Scan (61x61x1): Interpolated grid: $dx=15\text{mm}$, $dy=15\text{mm}$
Maximum value of SAR (interpolated) = 2.96 W/kg

Pin=250mW/Zoom Scan (5x5x7)/Cube 0: Measurement grid: $dx=8\text{mm}$, $dy=8\text{mm}$, $dz=5\text{mm}$
Reference Value = 49.93 V/m ; Power Drift = -0.12 dB
Peak SAR (extrapolated) = 3.33 W/kg
SAR(1 g) = 2.32 W/kg ; SAR(10 g) = 1.54 W/kg
Maximum value of SAR (measured) = 2.90 W/kg

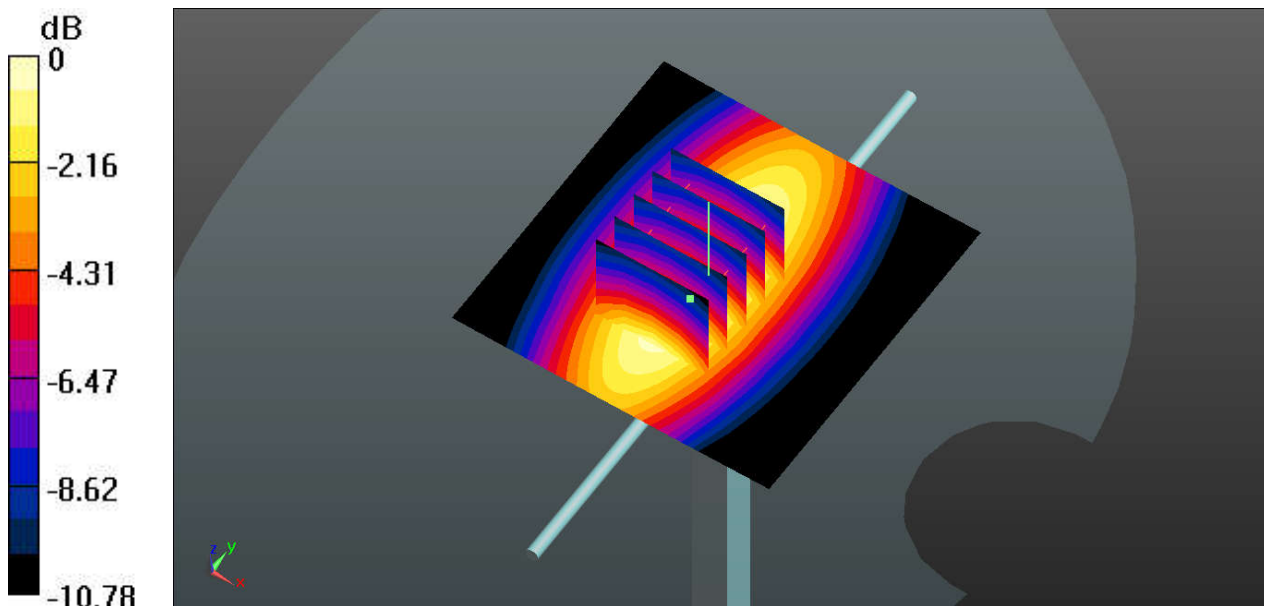

0 dB = 2.90 W/kg

System Check_Body_1750MHz_170811

DUT: D1750V2-SN:1137

Communication System: UID 0, CW; Frequency: 1750 MHz; Duty Cycle: 1:1
Medium: MSL_1750_170811 Medium parameters used: $f = 1750$ MHz; $\sigma = 1.524$ S/m; $\epsilon_r = 52.564$;
 $\rho = 1000$ kg/m³
Ambient Temperature : 23.4 °C ; Liquid Temperature : 22.6 °C

DASY5 Configuration:

- Probe: EX3DV4 - SN3911; ConvF(8.46, 8.46, 8.46); Calibrated: 2016.09.29;
- Sensor-Surface: 2mm (Mechanical Surface Detection)
- Electronics: DAE4 Sn1338; Calibrated: 2016.11.22
- Phantom: SAM (Front) with CRP v5.0; Type: QD000P40CD; Serial: TP:1795
- Measurement SW: DASY52, Version 52.8 (8); SEMCAD X Version 14.6.10 (7331)

Pin=250mW/Area Scan (61x61x1): Interpolated grid: dx=15mm, dy=15mm
Maximum value of SAR (interpolated) = 14.2 W/kg

Pin=250mW/Zoom Scan (5x5x7)/Cube 0: Measurement grid: dx=8mm, dy=8mm, dz=5mm
Reference Value = 97.55 V/m; Power Drift = 0.03 dB
Peak SAR (extrapolated) = 17.7 W/kg
SAR(1 g) = 8.87 W/kg; SAR(10 g) = 5.01 W/kg
Maximum value of SAR (measured) = 14.0 W/kg

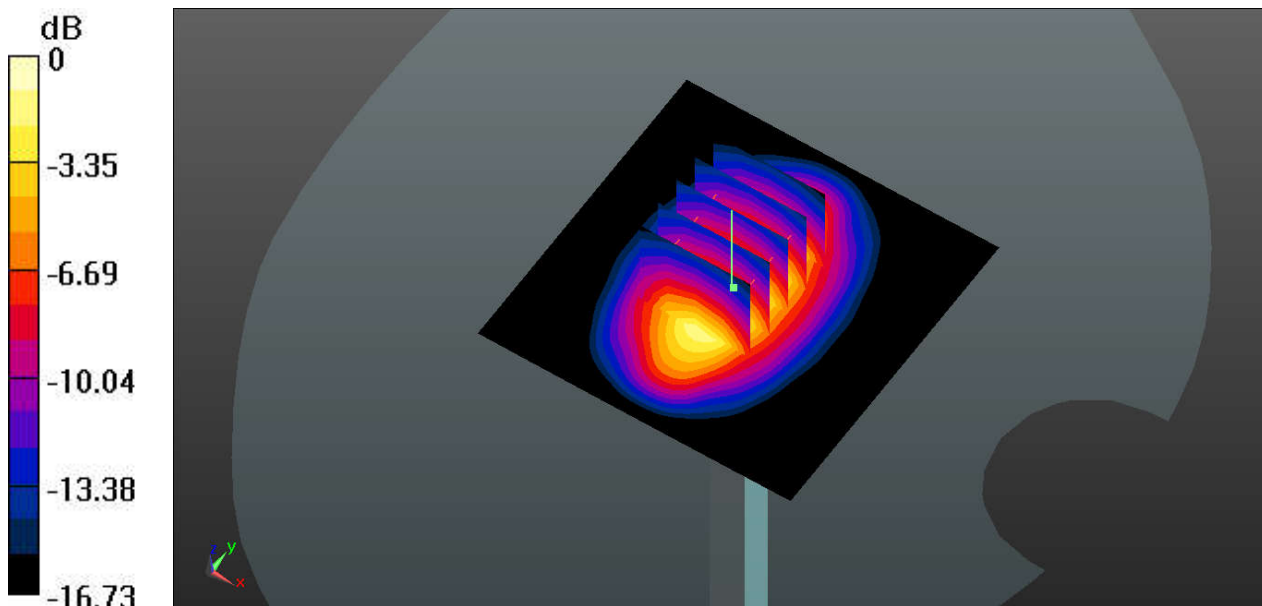

0 dB = 14.2 W/kg

System Check_Body_1900MHz_170811

DUT: D1900V2-SN:5d182

Communication System: UID 0, CW; Frequency: 1900 MHz; Duty Cycle: 1:1
Medium: MSL_1900_170811 Medium parameters used: $f = 1900$ MHz; $\sigma = 1.545$ S/m; $\epsilon_r = 53.535$;
 $\rho = 1000$ kg/m³
Ambient Temperature : 23.4 °C; Liquid Temperature : 22.7 °C

DASY5 Configuration:

- Probe: EX3DV4 - SN3911; ConvF(8.17, 8.17, 8.17); Calibrated: 2016.09.29;
- Sensor-Surface: 2mm (Mechanical Surface Detection)
- Electronics: DAE4 Sn1338; Calibrated: 2016.11.22
- Phantom: SAM (Front) with CRP v5.0; Type: QD000P40CD; Serial: TP:1795
- Measurement SW: DASY52, Version 52.8 (8); SEMCAD X Version 14.6.10 (7331)

Pin=250mW/Area Scan (61x61x1): Interpolated grid: dx=15mm, dy=15mm
Maximum value of SAR (interpolated) = 13.8 W/kg

Pin=250mW/Zoom Scan (5x5x7)/Cube 0: Measurement grid: dx=8mm, dy=8mm, dz=5mm
Reference Value = 93.81 V/m; Power Drift = 0.16 dB
Peak SAR (extrapolated) = 17.5 W/kg
SAR(1 g) = 9.98 W/kg; SAR(10 g) = 5.26 W/kg
Maximum value of SAR (measured) = 14.1 W/kg

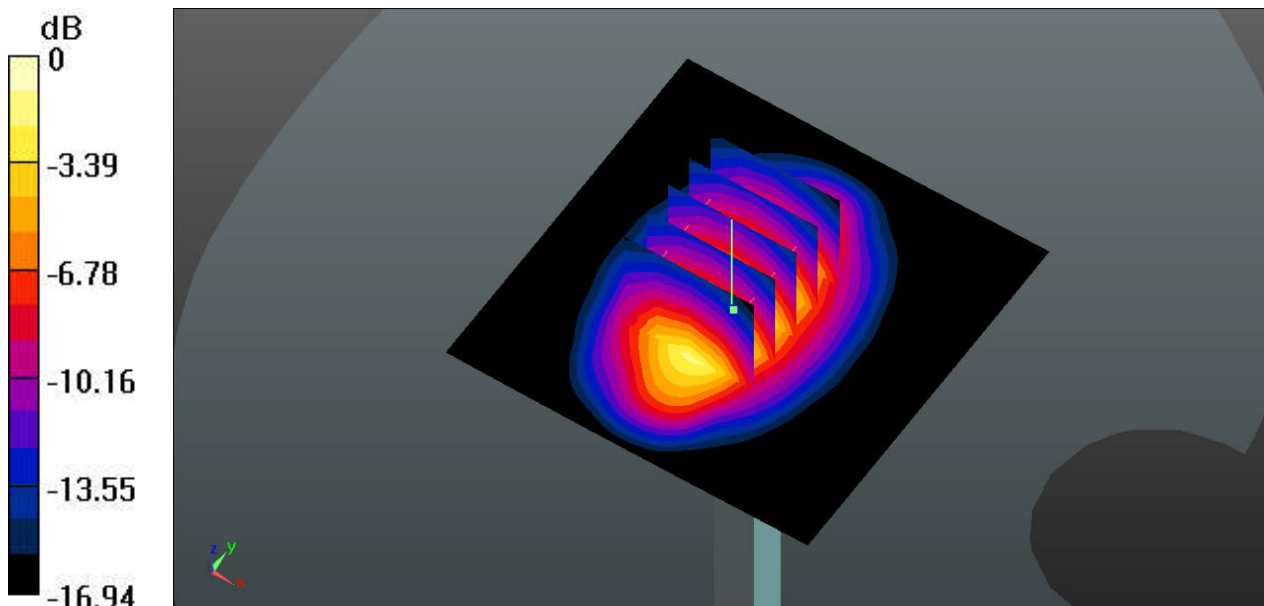

0 dB = 13.8 W/kg

System Check_Body_2450MHz_170817

DUT: D2450V2-SN:924

Communication System: UID 0, CW; Frequency: 2450 MHz; Duty Cycle: 1:1
Medium: MSL_2450_170817 Medium parameters used: $f = 2450$ MHz; $\sigma = 1.913$ S/m; $\epsilon_r = 50.974$;
 $\rho = 1000$ kg/m³
Ambient Temperature : 23.5 °C; Liquid Temperature : 22.4 °C

DASY5 Configuration:

- Probe: EX3DV4 - SN3911; ConvF(7.66, 7.66, 7.66); Calibrated: 2016.09.29;
- Sensor-Surface: 2mm (Mechanical Surface Detection)
- Electronics: DAE4 Sn1338; Calibrated: 2016.11.22
- Phantom: SAM (Front) with CRP v5.0; Type: QD000P40CD; Serial: TP:1795
- Measurement SW: DASY52, Version 52.8 (8); SEMCAD X Version 14.6.10 (7331)

Pin=250mW/Area Scan (81x81x1): Interpolated grid: dx=12mm, dy=12mm
Maximum value of SAR (interpolated) = 23.6 W/kg

Pin=250mW/Zoom Scan (7x7x7)/Cube 0: Measurement grid: dx=5mm, dy=5mm, dz=5mm
Reference Value = 95.20 V/m; Power Drift = -0.11 dB
Peak SAR (extrapolated) = 31.6 W/kg
SAR(1 g) = 12.3 W/kg; SAR(10 g) = 6.04 W/kg
Maximum value of SAR (measured) = 23.4 W/kg

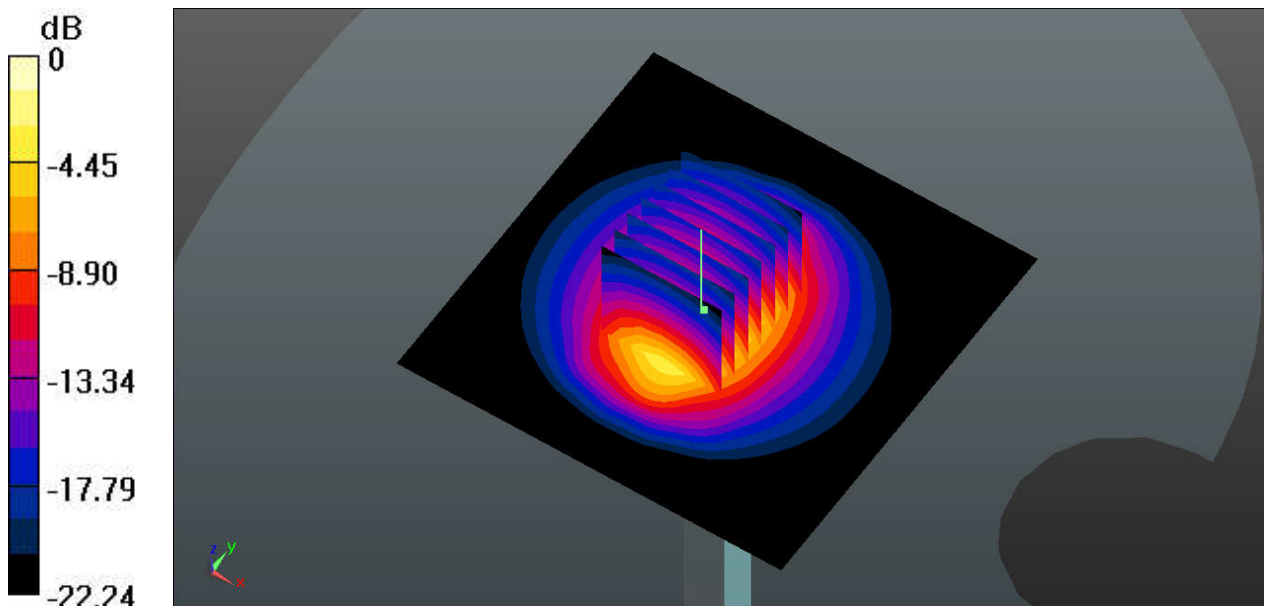

System Check_Body_2600MHz_170818

DUT: D2600V2-SN:1070

Communication System: UID 0, CW; Frequency: 2600 MHz; Duty Cycle: 1:1
Medium: MSL_2600_170818 Medium parameters used: $f = 2600$ MHz; $\sigma = 2.209$ S/m; $\epsilon_r = 51.123$;
 $\rho = 1000$ kg/m³
Ambient Temperature : 23.5 °C ; Liquid Temperature : 22.9 °C

DASY5 Configuration:

- Probe: EX3DV4 - SN3911; ConvF(7.38, 7.38, 7.38); Calibrated: 2016.09.29;
- Sensor-Surface: 2mm (Mechanical Surface Detection)
- Electronics: DAE4 Sn1338; Calibrated: 2016.11.22
- Phantom: SAM (Front) with CRP v5.0; Type: QD000P40CD; Serial: TP:1795
- Measurement SW: DASY52, Version 52.8 (8); SEMCAD X Version 14.6.10 (7331)

Pin=250mW/Area Scan (71x71x1): Interpolated grid: dx=12mm, dy=12mm
Maximum value of SAR (interpolated) = 29.5 W/kg

Pin=250mW/Zoom Scan (7x7x7)/Cube 0: Measurement grid: dx=5mm, dy=5mm, dz=5mm
Reference Value = 114.3 V/m; Power Drift = 0.02 dB
Peak SAR (extrapolated) = 40.5 W/kg
SAR(1 g) = 14.5 W/kg; SAR(10 g) = 6.56 W/kg
Maximum value of SAR (measured) = 29.2 W/kg

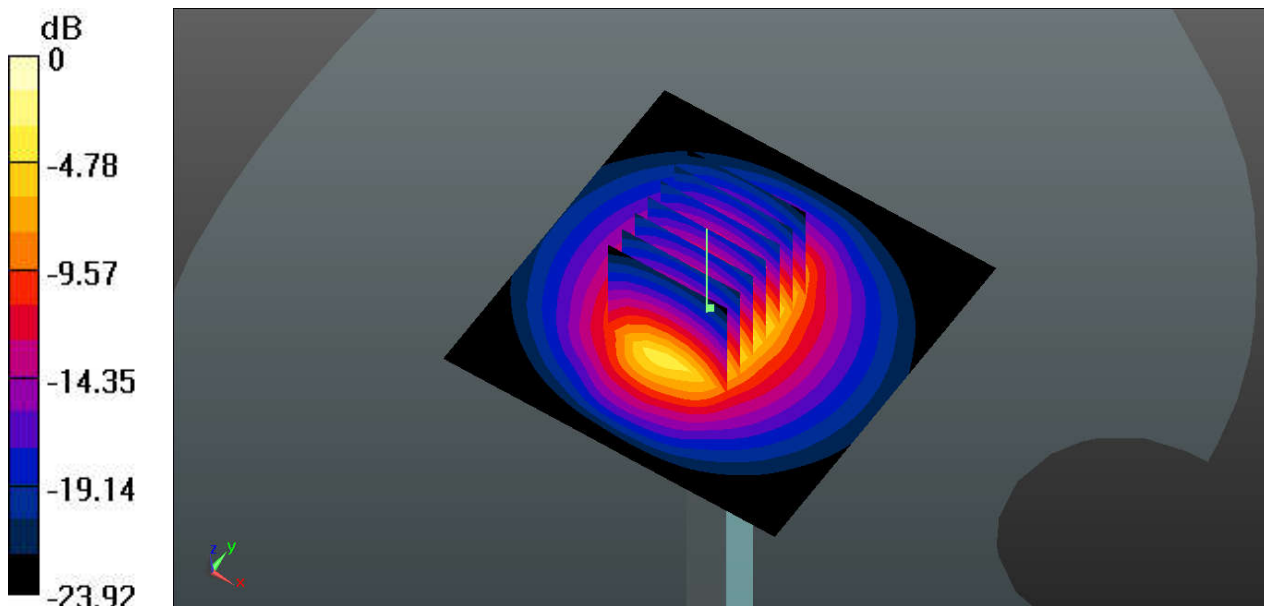

0 dB = 29.2 W/kg



Appendix B. Plots of High SAR Measurement

The plots are shown as follows.

01_GSM850_GPRS(4 Tx slots)_Right Cheek_Ch251

Communication System: UID 0, GPRS/EDGE12 (0); Frequency: 848.8 MHz; Duty Cycle: 1:2.08
Medium: HSL_835_170815 Medium parameters used: $f = 848.8$ MHz; $\sigma = 0.925$ S/m; $\epsilon_r = 42.729$;
 $\rho = 1000$ kg/m³
Ambient Temperature : 23.6 °C; Liquid Temperature : 22.8 °C

DASY5 Configuration:

- Probe: EX3DV4 - SN3911; ConvF(10.54, 10.54, 10.54); Calibrated: 2016.09.29;
- Sensor-Surface: 2mm (Mechanical Surface Detection)
- Electronics: DAE4 Sn1338; Calibrated: 2016.11.22
- Phantom: SAM (Front) with CRP v5.0; Type: QD000P40CD; Serial: TP:1795
- Measurement SW: DASY52, Version 52.8 (8); SEMCAD X Version 14.6.10 (7331)

Ch251/Area Scan (71x121x1): Interpolated grid: dx=15mm, dy=15mm
Maximum value of SAR (interpolated) = 0.344 W/kg

Ch251/Zoom Scan (5x5x7)/Cube 0: Measurement grid: dx=8mm, dy=8mm, dz=5mm
Reference Value = 1.167 V/m; Power Drift = 0.07 dB
Peak SAR (extrapolated) = 0.358 W/kg
SAR(1 g) = 0.310 W/kg; SAR(10 g) = 0.244 W/kg
Maximum value of SAR (measured) = 0.340 W/kg

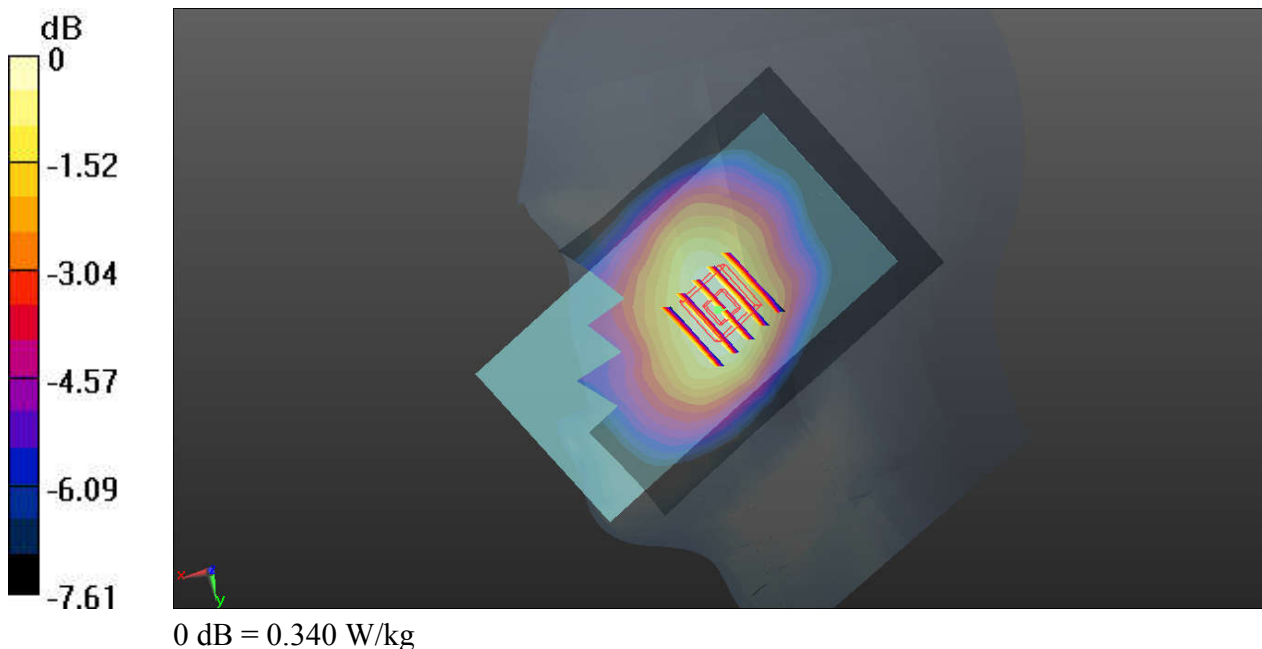

02_GSM1900_GPRS(4 Tx slots)_Left Cheek_Ch810

Communication System: UID 0, GPRS/EDGE12 (0); Frequency: 1909.8 MHz; Duty Cycle: 1:2.08
Medium: HSL_1900_170812 Medium parameters used: $f = 1909.8$ MHz; $\sigma = 1.455$ S/m; $\epsilon_r = 39.979$;
 $\rho = 1000$ kg/m³
Ambient Temperature : 23.3 °C; Liquid Temperature : 22.5 °C

DASY5 Configuration:

- Probe: EX3DV4 - SN3911; ConvF(8.5, 8.5, 8.5); Calibrated: 2016.09.29;
- Sensor-Surface: 2mm (Mechanical Surface Detection)
- Electronics: DAE4 Sn1338; Calibrated: 2016.11.22
- Phantom: SAM (Front) with CRP v5.0; Type: QD000P40CD; Serial: TP:1795
- Measurement SW: DASY52, Version 52.8 (8); SEMCAD X Version 14.6.10 (7331)

Ch810/Area Scan (71x121x1): Interpolated grid: dx=15mm, dy=15mm
Maximum value of SAR (interpolated) = 0.370 W/kg

Ch810/Zoom Scan (5x5x7)/Cube 0: Measurement grid: dx=8mm, dy=8mm, dz=5mm
Reference Value = 0 V/m; Power Drift = 0.01 dB
Peak SAR (extrapolated) = 0.396 W/kg
SAR(1 g) = 0.306 W/kg; SAR(10 g) = 0.213 W/kg
Maximum value of SAR (measured) = 0.351 W/kg

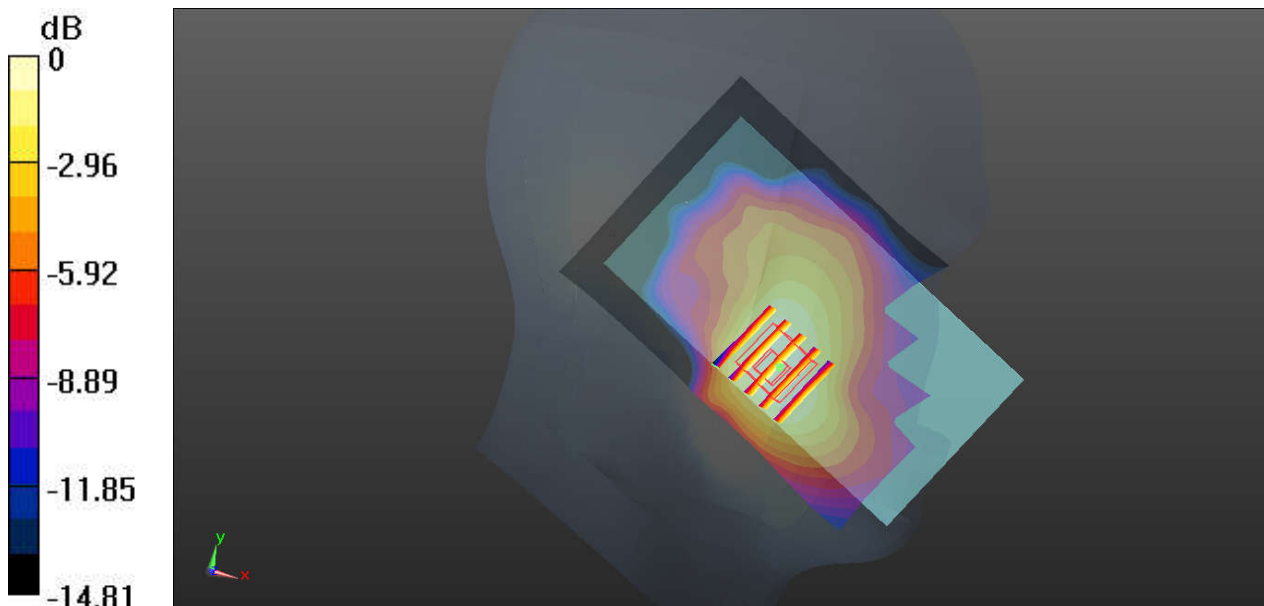

0 dB = 0.351 W/kg

03_WCDMA Band V_RMC 12.2Kbps_Right Cheek_Ch4233

Communication System: UID 0, UMTS (0); Frequency: 846.6 MHz; Duty Cycle: 1:1
Medium: HSL_835_170815 Medium parameters used: $f = 846.6$ MHz; $\sigma = 0.923$ S/m; $\epsilon_r = 42.747$;
 $\rho = 1000$ kg/m³
Ambient Temperature : 23.6 °C; Liquid Temperature : 22.8 °C

DASY5 Configuration:

- Probe: EX3DV4 - SN3911; ConvF(10.54, 10.54, 10.54); Calibrated: 2016.09.29;
- Sensor-Surface: 2mm (Mechanical Surface Detection)
- Electronics: DAE4 Sn1338; Calibrated: 2016.11.22
- Phantom: SAM (Front) with CRP v5.0; Type: QD000P40CD; Serial: TP:1795
- Measurement SW: DASY52, Version 52.8 (8); SEMCAD X Version 14.6.10 (7331)

Ch4233/Area Scan (71x121x1): Interpolated grid: dx=15mm, dy=15mm
Maximum value of SAR (interpolated) = 0.436 W/kg

Ch4233/Zoom Scan (5x5x7)/Cube 0: Measurement grid: dx=8mm, dy=8mm, dz=5mm
Reference Value = 1.387 V/m; Power Drift = 0.05 dB
Peak SAR (extrapolated) = 0.456 W/kg
SAR(1 g) = 0.398 W/kg; SAR(10 g) = 0.317 W/kg
Maximum value of SAR (measured) = 0.434 W/kg

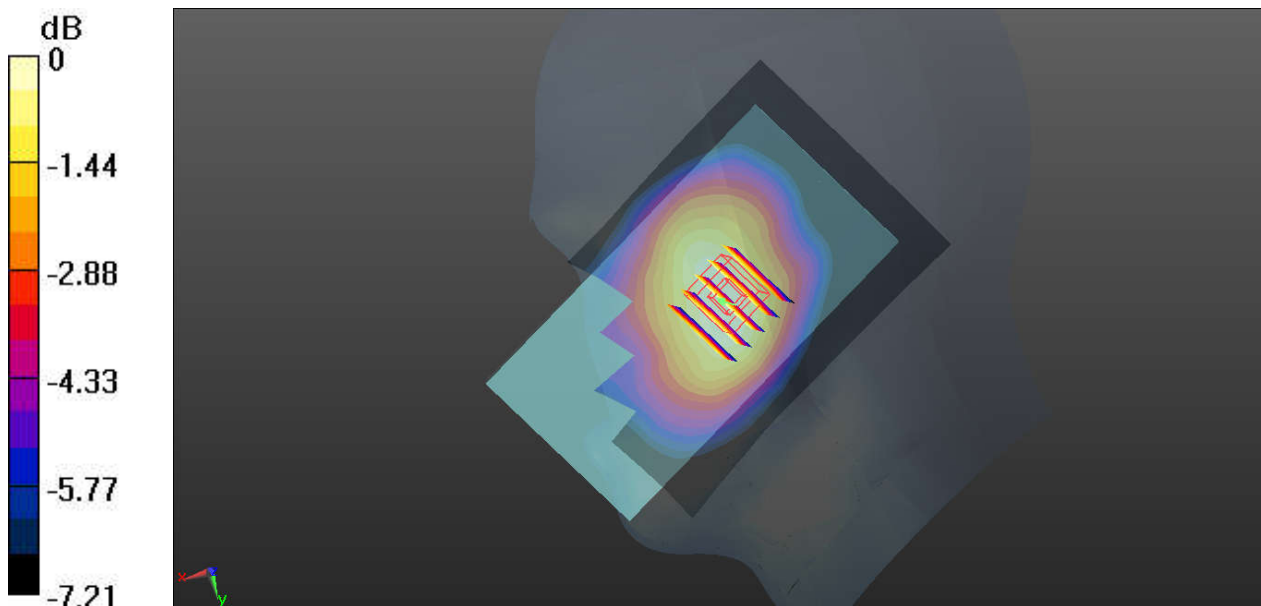

0 dB = 0.436 W/kg

04_WCDMA Band II_RMC 12.2Kbps_Left Cheek_Ch9262

Communication System: UID 0, UMTS (0); Frequency: 1852.4 MHz; Duty Cycle: 1:1
Medium: HSL_1900_170812 Medium parameters used: $f = 1852.4 \text{ MHz}$; $\sigma = 1.396 \text{ S/m}$; $\epsilon_r = 40.237$;
 $\rho = 1000 \text{ kg/m}^3$
Ambient Temperature : $23.3 \text{ }^\circ\text{C}$; Liquid Temperature : $22.5 \text{ }^\circ\text{C}$

DASY5 Configuration:

- Probe: EX3DV4 - SN3911; ConvF(8.5, 8.5, 8.5); Calibrated: 2016.09.29;
- Sensor-Surface: 2mm (Mechanical Surface Detection)
- Electronics: DAE4 Sn1338; Calibrated: 2016.11.22
- Phantom: SAM (Front) with CRP v5.0; Type: QD000P40CD; Serial: TP:1795
- Measurement SW: DASY52, Version 52.8 (8); SEMCAD X Version 14.6.10 (7331)

Ch9262/Area Scan (71x121x1): Interpolated grid: $dx=15\text{mm}$, $dy=15\text{mm}$
Maximum value of SAR (interpolated) = 0.438 W/kg

Ch9262/Zoom Scan (5x5x7)/Cube 0: Measurement grid: $dx=8\text{mm}$, $dy=8\text{mm}$, $dz=5\text{mm}$
Reference Value = 0 V/m ; Power Drift = 0.01 dB
Peak SAR (extrapolated) = 0.484 W/kg
SAR(1 g) = 0.362 W/kg ; SAR(10 g) = 0.248 W/kg
Maximum value of SAR (measured) = 0.423 W/kg

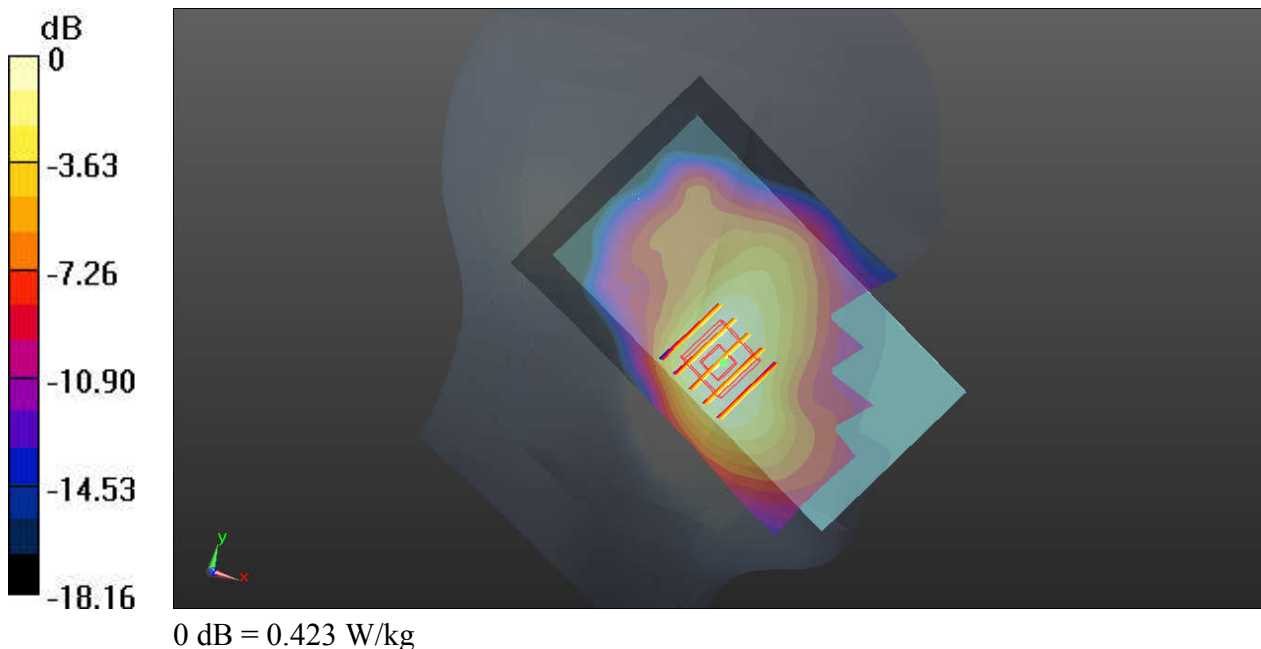

05_LTE Band 12_10M_QPSK_1RB_25Offset_Right Cheek_Ch23095

Communication System: UID 0, LTE (0); Frequency: 707.5 MHz; Duty Cycle: 1:1
Medium: HSL_750_170815 Medium parameters used: $f = 707.5$ MHz; $\sigma = 0.857$ S/m; $\epsilon_r = 41.645$;
 $\rho = 1000$ kg/m³
Ambient Temperature : 23.6 °C; Liquid Temperature : 22.7 °C

DASY5 Configuration:

- Probe: EX3DV4 - SN3911; ConvF(10.99, 10.99, 10.99); Calibrated: 2016.09.29;
- Sensor-Surface: 2mm (Mechanical Surface Detection)
- Electronics: DAE4 Sn1338; Calibrated: 2016.11.22
- Phantom: SAM (Front) with CRP v5.0; Type: QD000P40CD; Serial: TP:1795
- Measurement SW: DASY52, Version 52.8 (8); SEMCAD X Version 14.6.10 (7331)

Ch23095/Area Scan (71x121x1): Interpolated grid: dx=15mm, dy=15mm
Maximum value of SAR (interpolated) = 0.192 W/kg

Ch23095/Zoom Scan (5x5x7)/Cube 0: Measurement grid: dx=8mm, dy=8mm, dz=5mm
Reference Value = 1.060 V/m; Power Drift = 0.05 dB
Peak SAR (extrapolated) = 0.185 W/kg
SAR(1 g) = 0.167 W/kg; SAR(10 g) = 0.139 W/kg
Maximum value of SAR (measured) = 0.180 W/kg

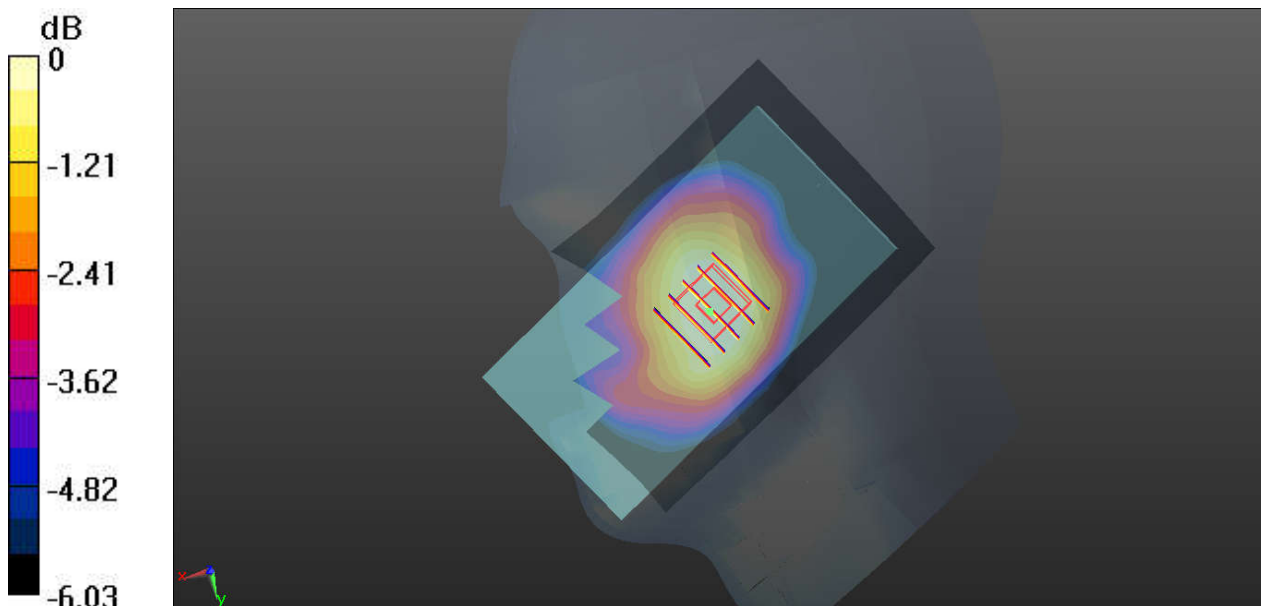

06_LTE Band 26_15M_QPSK_1RB_37Offset_Right Cheek_Ch26965

Communication System: UID 0, LTE (0); Frequency: 841.5 MHz; Duty Cycle: 1:1
Medium: HSL_835_170815 Medium parameters used: $f = 841.5$ MHz; $\sigma = 0.917$ S/m; $\epsilon_r = 42.819$;
 $\rho = 1000$ kg/m³
Ambient Temperature : 23.6 °C; Liquid Temperature : 22.8 °C

DASY5 Configuration:

- Probe: EX3DV4 - SN3911; ConvF(10.54, 10.54, 10.54); Calibrated: 2016.09.29;
- Sensor-Surface: 2mm (Mechanical Surface Detection)
- Electronics: DAE4 Sn1338; Calibrated: 2016.11.22
- Phantom: SAM (Front) with CRP v5.0; Type: QD000P40CD; Serial: TP:1795
- Measurement SW: DASY52, Version 52.8 (8); SEMCAD X Version 14.6.10 (7331)

Ch26965/Area Scan (71x121x1): Interpolated grid: dx=15mm, dy=15mm
Maximum value of SAR (interpolated) = 0.346 W/kg

Ch26965/Zoom Scan (5x5x7)/Cube 0: Measurement grid: dx=8mm, dy=8mm, dz=5mm
Reference Value = 1.121 V/m; Power Drift = 0.06 dB
Peak SAR (extrapolated) = 0.341 W/kg
SAR(1 g) = 0.297 W/kg; SAR(10 g) = 0.239 W/kg
Maximum value of SAR (measured) = 0.324 W/kg

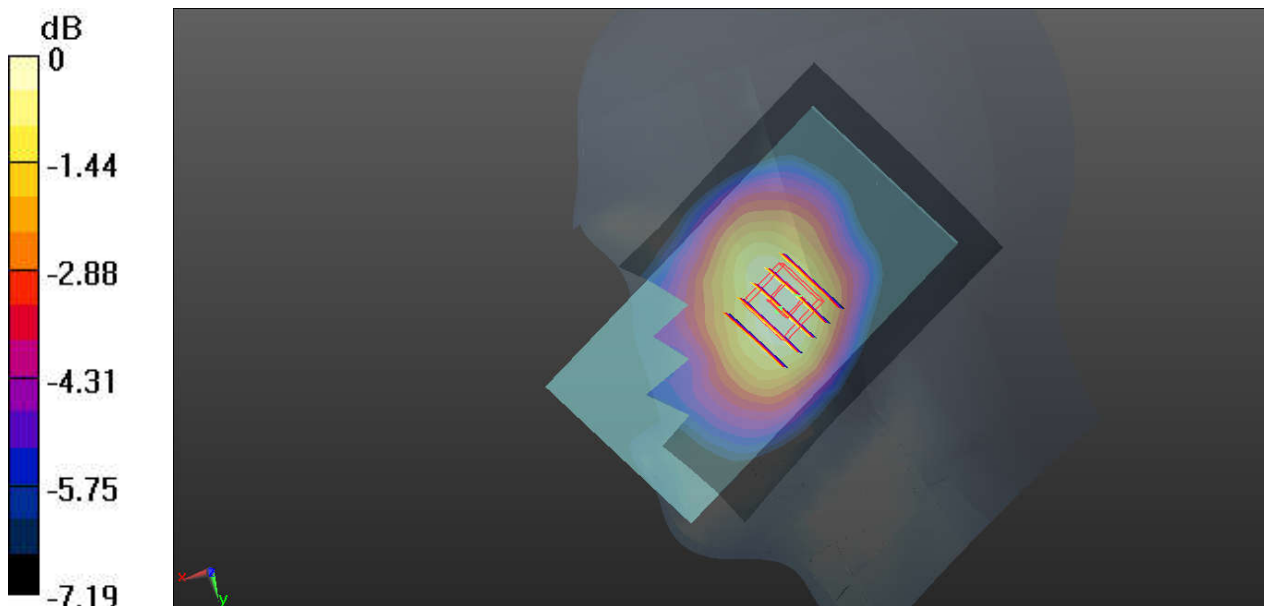

0 dB = 0.346 W/kg

07_LTE Band 5_10M_QPSK_1RB_25Offset_Right Cheek_Ch20525

Communication System: UID 0, LTE (0); Frequency: 836.5 MHz; Duty Cycle: 1:1
Medium: HSL_835_170815 Medium parameters used: $f = 836.5$ MHz; $\sigma = 0.912$ S/m; $\epsilon_r = 42.892$;
 $\rho = 1000$ kg/m³
Ambient Temperature : 23.6 °C; Liquid Temperature : 22.8 °C

DASY5 Configuration:

- Probe: EX3DV4 - SN3911; ConvF(10.54, 10.54, 10.54); Calibrated: 2016.09.29;
- Sensor-Surface: 2mm (Mechanical Surface Detection)
- Electronics: DAE4 Sn1338; Calibrated: 2016.11.22
- Phantom: SAM (Front) with CRP v5.0; Type: QD000P40CD; Serial: TP:1795
- Measurement SW: DASY52, Version 52.8 (8); SEMCAD X Version 14.6.10 (7331)

Ch20525/Area Scan (71x121x1): Interpolated grid: dx=15mm, dy=15mm
Maximum value of SAR (interpolated) = 0.420 W/kg

Ch20525/Zoom Scan (5x5x7)/Cube 0: Measurement grid: dx=8mm, dy=8mm, dz=5mm
Reference Value = 1.418 V/m; Power Drift = 0.07 dB
Peak SAR (extrapolated) = 0.437 W/kg
SAR(1 g) = 0.379 W/kg; SAR(10 g) = 0.301 W/kg
Maximum value of SAR (measured) = 0.416 W/kg

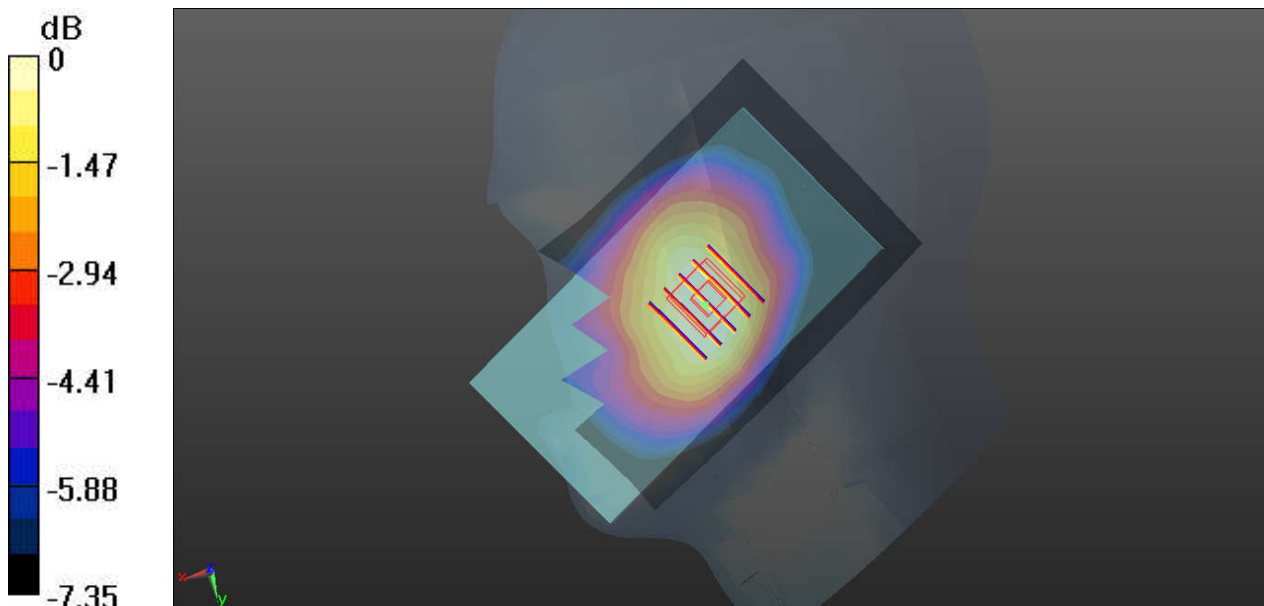

0 dB = 0.416 W/kg

08_LTE Band 4_20M_QPSK_1RB_49Offset_Left Cheek_Ch20175

Communication System: UID 0, LTE (0); Frequency: 1732.5 MHz; Duty Cycle: 1:1
Medium: HSL_1750_170812 Medium parameters used: $f = 1732.5$ MHz; $\sigma = 1.336$ S/m; $\epsilon_r = 38.865$;
 $\rho = 1000$ kg/m³
Ambient Temperature : 23.3 °C; Liquid Temperature : 22.7 °C

DASY5 Configuration:

- Probe: EX3DV4 - SN3911; ConvF(8.88, 8.88, 8.88); Calibrated: 2016.09.29;
- Sensor-Surface: 2mm (Mechanical Surface Detection)
- Electronics: DAE4 Sn1338; Calibrated: 2016.11.22
- Phantom: SAM (Front) with CRP v5.0; Type: QD000P40CD; Serial: TP:1795
- Measurement SW: DASY52, Version 52.8 (8); SEMCAD X Version 14.6.10 (7331)

Ch20175/Area Scan (71x121x1): Interpolated grid: dx=15mm, dy=15mm
Maximum value of SAR (interpolated) = 0.165 W/kg

Ch20175/Zoom Scan (5x5x7)/Cube 0: Measurement grid: dx=8mm, dy=8mm, dz=5mm
Reference Value = 0.4000 V/m; Power Drift = 0.04 dB
Peak SAR (extrapolated) = 0.183 W/kg
SAR(1 g) = 0.141 W/kg; SAR(10 g) = 0.099 W/kg
Maximum value of SAR (measured) = 0.164 W/kg

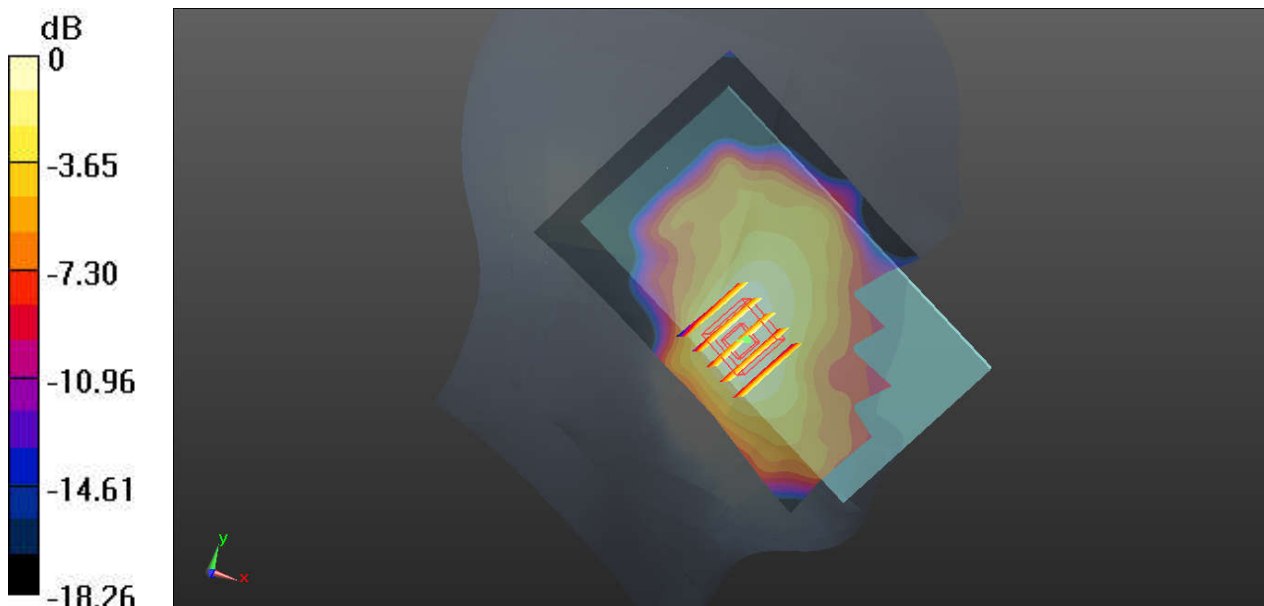

0 dB = 0.164 W/kg

09_LTE Band 2_20M_QPSK_1RB_49Offset_Left Cheek_Ch18900

Communication System: UID 0, LTE (0); Frequency: 1880 MHz; Duty Cycle: 1:1
Medium: HSL_1900_170812 Medium parameters used: $f = 1880$ MHz; $\sigma = 1.425$ S/m; $\epsilon_r = 40.114$;
 $\rho = 1000$ kg/m³
Ambient Temperature : 23.3 °C; Liquid Temperature : 22.5 °C

DASY5 Configuration:

- Probe: EX3DV4 - SN3911; ConvF(8.5, 8.5, 8.5); Calibrated: 2016.09.29;
- Sensor-Surface: 2mm (Mechanical Surface Detection)
- Electronics: DAE4 Sn1338; Calibrated: 2016.11.22
- Phantom: SAM (Front) with CRP v5.0; Type: QD000P40CD; Serial: TP:1795
- Measurement SW: DASY52, Version 52.8 (8); SEMCAD X Version 14.6.10 (7331)

Ch18900/Area Scan (71x121x1): Interpolated grid: dx=15mm, dy=15mm
Maximum value of SAR (interpolated) = 0.475 W/kg

Ch18900/Zoom Scan (5x5x7)/Cube 0: Measurement grid: dx=8mm, dy=8mm, dz=5mm
Reference Value = 0.6160 V/m; Power Drift = 0.02 dB
Peak SAR (extrapolated) = 0.510 W/kg
SAR(1 g) = 0.387 W/kg; SAR(10 g) = 0.268 W/kg
Maximum value of SAR (measured) = 0.449 W/kg

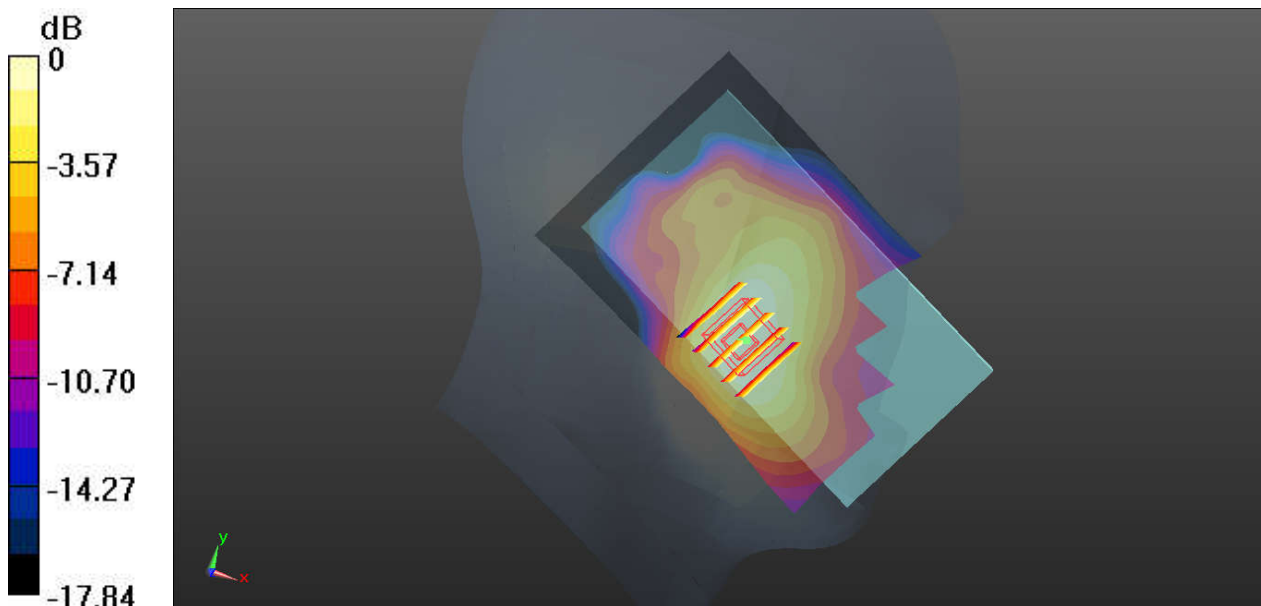

0 dB = 0.449 W/kg

10_LTE Band 7_20M_QPSK_1RB_49Offset_Right Cheek_Ch21350

Communication System: UID 0, LTE (0); Frequency: 2560 MHz; Duty Cycle: 1:1
Medium: HSL_2600_170816 Medium parameters used: $f = 2560$ MHz; $\sigma = 2.003$ S/m; $\epsilon_r = 38.557$;
 $\rho = 1000$ kg/m³
Ambient Temperature : 23.3 °C; Liquid Temperature : 22.6 °C

DASY5 Configuration:

- Probe: EX3DV4 - SN3911; ConvF(7.39, 7.39, 7.39); Calibrated: 2016.09.29;
- Sensor-Surface: 2mm (Mechanical Surface Detection)
- Electronics: DAE4 Sn1338; Calibrated: 2016.11.22
- Phantom: SAM (Front) with CRP v5.0; Type: QD000P40CD; Serial: TP:1795
- Measurement SW: DASY52, Version 52.8 (8); SEMCAD X Version 14.6.10 (7331)

Ch21350/Area Scan (91x151x1): Interpolated grid: dx=12mm, dy=12mm
Maximum value of SAR (interpolated) = 0.146 W/kg

Ch21350/Zoom Scan (7x7x7)/Cube 0: Measurement grid: dx=5mm, dy=5mm, dz=5mm
Reference Value = 0 V/m; Power Drift = 0.08 dB
Peak SAR (extrapolated) = 0.124 W/kg
SAR(1 g) = 0.073 W/kg; SAR(10 g) = 0.039 W/kg
Maximum value of SAR (measured) = 0.0995 W/kg

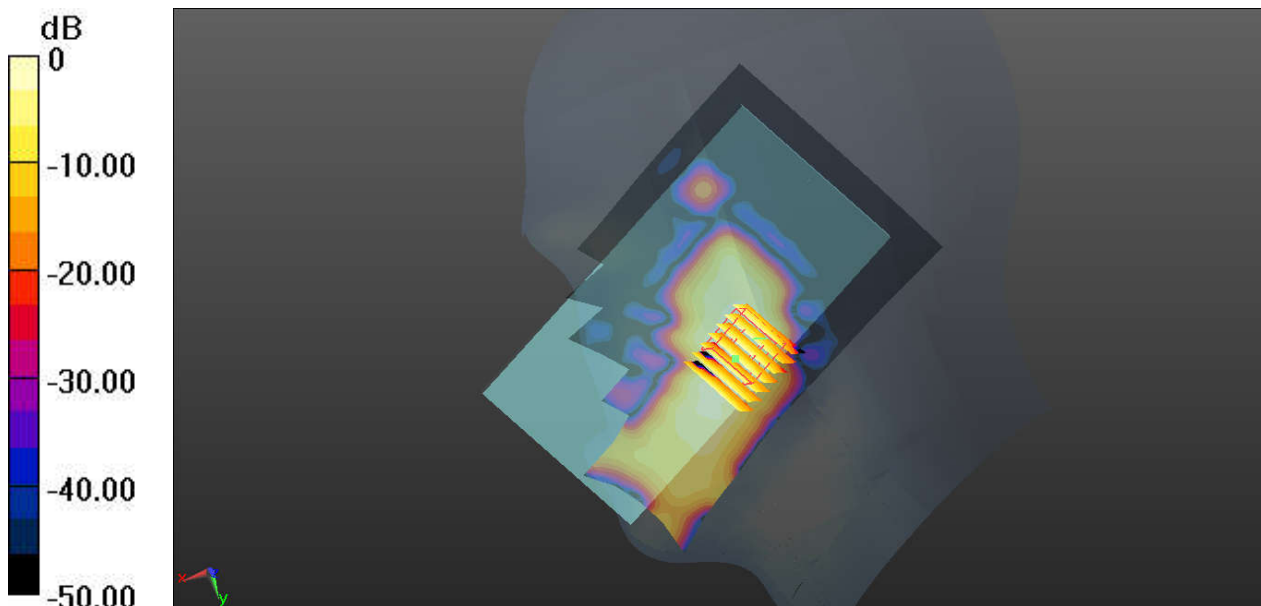

0 dB = 0.146 W/kg

11_LTE Band 38_20M_QPSK_1RB_49Offset_Right Cheek_Ch37850

Communication System: UID 0, LTE (0); Frequency: 2580 MHz; Duty Cycle: 1:1.59
Medium: HSL_2600_170816 Medium parameters used: $f = 2580$ MHz; $\sigma = 2.025$ S/m; $\epsilon_r = 38.467$;
 $\rho = 1000$ kg/m³
Ambient Temperature : 23.3 °C; Liquid Temperature : 22.6 °C

DASY5 Configuration:

- Probe: EX3DV4 - SN3911; ConvF(7.39, 7.39, 7.39); Calibrated: 2016.09.29;
- Sensor-Surface: 2mm (Mechanical Surface Detection)
- Electronics: DAE4 Sn1338; Calibrated: 2016.11.22
- Phantom: SAM (Front) with CRP v5.0; Type: QD000P40CD; Serial: TP:1795
- Measurement SW: DASY52, Version 52.8 (8); SEMCAD X Version 14.6.10 (7331)

Ch37850/Area Scan (91x151x1): Interpolated grid: dx=12mm, dy=12mm
Maximum value of SAR (interpolated) = 0.120 W/kg

Ch37850/Zoom Scan (7x7x7)/Cube 0: Measurement grid: dx=5mm, dy=5mm, dz=5mm
Reference Value = 0 V/m; Power Drift = 0.09 dB
Peak SAR (extrapolated) = 0.101 W/kg
SAR(1 g) = 0.060 W/kg; SAR(10 g) = 0.031 W/kg
Maximum value of SAR (measured) = 0.0812 W/kg

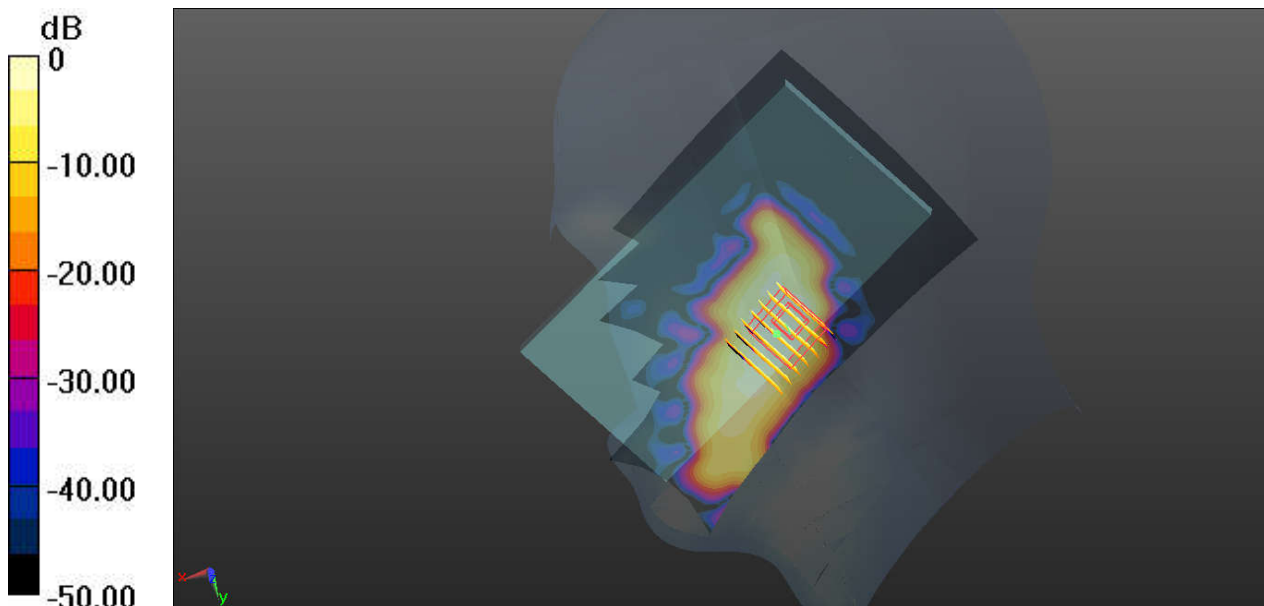

0 dB = 0.120 W/kg

12_LTE Band 41_20M_QPSK_1RB_49Offset_Right Cheek_Ch41140

Communication System: UID 0, LTE (0); Frequency: 2645 MHz; Duty Cycle: 1:1.59
 Medium: HSL_2600_170816 Medium parameters used: $f = 2645$ MHz; $\sigma = 2.109$ S/m; $\epsilon_r = 38.173$;
 $\rho = 1000$ kg/m³
 Ambient Temperature : 23.3 °C; Liquid Temperature : 22.6 °C

DASY5 Configuration:

- Probe: EX3DV4 - SN3911; ConvF(7.39, 7.39, 7.39); Calibrated: 2016.09.29;
- Sensor-Surface: 2mm (Mechanical Surface Detection)
- Electronics: DAE4 Sn1338; Calibrated: 2016.11.22
- Phantom: SAM (Front) with CRP v5.0; Type: QD000P40CD; Serial: TP:1795
- Measurement SW: DASY52, Version 52.8 (8); SEMCAD X Version 14.6.10 (7331)

Ch41140/Area Scan (91x151x1): Interpolated grid: dx=12mm, dy=12mm
 Maximum value of SAR (interpolated) = 0.141 W/kg

Ch41140/Zoom Scan (7x7x7)/Cube 0: Measurement grid: dx=5mm, dy=5mm, dz=5mm
 Reference Value = 0 V/m; Power Drift = 0.01 dB
 Peak SAR (extrapolated) = 0.123 W/kg
SAR(1 g) = 0.071 W/kg; SAR(10 g) = 0.037 W/kg
 Maximum value of SAR (measured) = 0.0968 W/kg

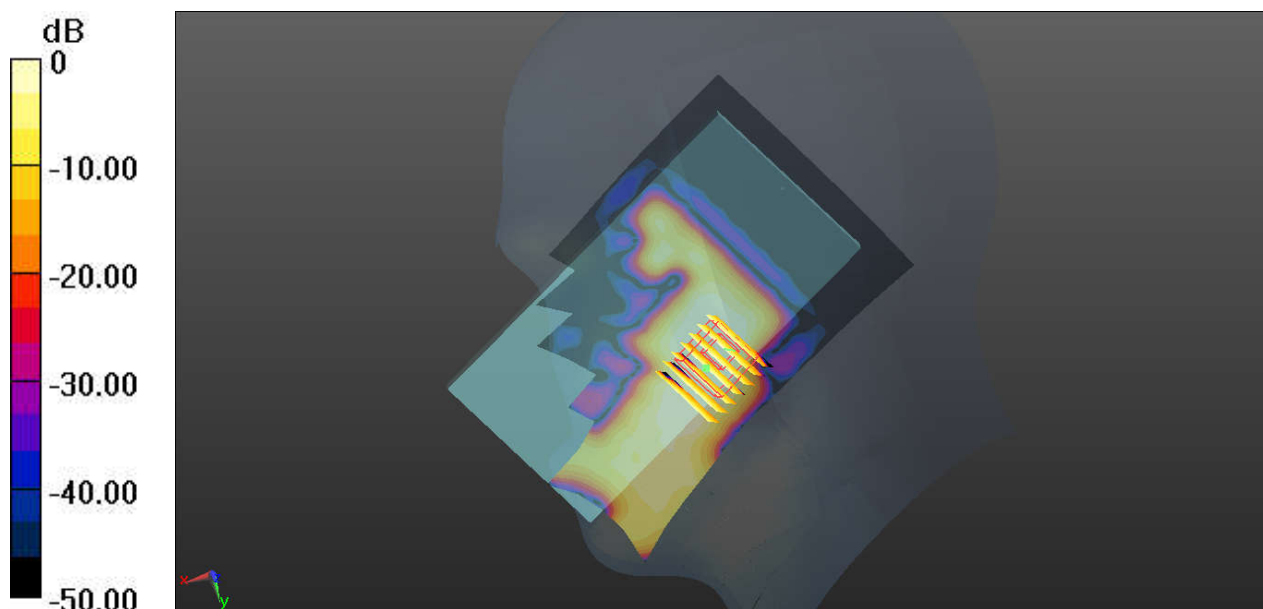

0 dB = 0.0968 W/kg

13_WLAN2.4GHz_802.11b 1Mbps_Right Cheek_Ch6

Communication System: UID 0, WIFI (0); Frequency: 2437 MHz; Duty Cycle: 1:1.025
Medium: HSL_2450_170816 Medium parameters used: $f = 2437$ MHz; $\sigma = 1.814$ S/m; $\epsilon_r = 40.127$;
 $\rho = 1000$ kg/m³
Ambient Temperature : 23.5 °C; Liquid Temperature : 22.6 °C

DASY5 Configuration:

- Probe: EX3DV4 - SN3911; ConvF(7.43, 7.43, 7.43); Calibrated: 2016.09.29;
- Sensor-Surface: 2mm (Mechanical Surface Detection)
- Electronics: DAE4 Sn1338; Calibrated: 2016.11.22
- Phantom: SAM (Front) with CRP v5.0; Type: QD000P40CD; Serial: TP:1795
- Measurement SW: DASY52, Version 52.8 (8); SEMCAD X Version 14.6.10 (7331)

Ch6/Area Scan (91x151x1): Interpolated grid: dx=12mm, dy=12mm
Maximum value of SAR (interpolated) = 1.82 W/kg

Ch6/Zoom Scan (7x7x7)/Cube 0: Measurement grid: dx=5mm, dy=5mm, dz=5mm
Reference Value = 0 V/m; Power Drift = 0.06 dB
Peak SAR (extrapolated) = 2.30 W/kg
SAR(1 g) = 1.1 W/kg; SAR(10 g) = 0.558 W/kg
Maximum value of SAR (measured) = 1.69 W/kg

