

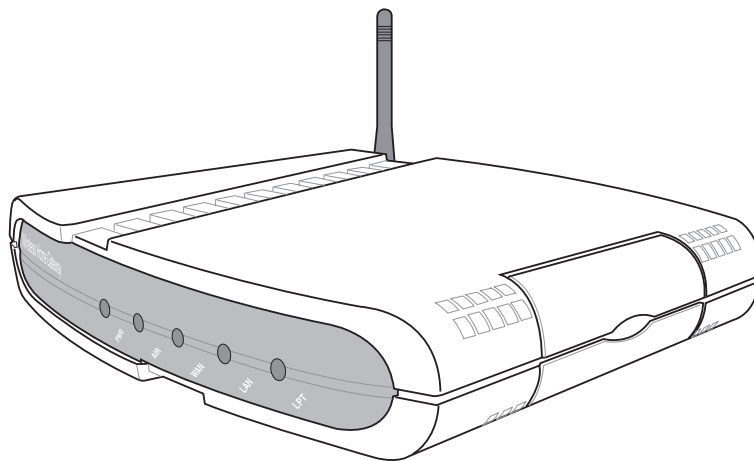

# SpaceLink Home Gateway

**WL-500**

**User's Manual**



## Copyright Information

---

No part of this manual, including the products and software described in it, may be reproduced, transmitted, transcribed, stored in a retrieval system, or translated into any language in any form or by any means, except documentation kept by the purchaser for backup purposes, without the express written permission of ASUSTeK COMPUTER INC. (“ASUS”).

ASUS PROVIDES THIS MANUAL “AS IS” WITHOUT WARRANTY OF ANY KIND, EITHER EXPRESS OR IMPLIED, INCLUDING BUT NOT LIMITED TO THE IMPLIED WARRANTIES OR CONDITIONS OF MERCHANTABILITY OR FITNESS FOR A PARTICULAR PURPOSE. IN NO EVENT SHALL ASUS, ITS DIRECTORS, OFFICERS, EMPLOYEES OR AGENTS BE LIABLE FOR ANY INDIRECT, SPECIAL, INCIDENTAL, OR CONSEQUENTIAL DAMAGES (INCLUDING DAMAGES FOR LOSS OF PROFITS, LOSS OF BUSINESS, LOSS OF USE OR DATA, INTERRUPTION OF BUSINESS AND THE LIKE), EVEN IF ASUS HAS BEEN ADVISED OF THE POSSIBILITY OF SUCH DAMAGES ARISING FROM ANY DEFECT OR ERROR IN THIS MANUAL OR PRODUCT.

Product warranty or service will not be extended if: (1) the product is repaired, modified or altered, unless such repair, modification or alteration is authorized in writing by ASUS; or (2) the serial number of the product is defaced or missing.

Products and corporate names appearing in this manual may or may not be registered trademarks or copyrights of their respective companies, and are used only for identification or explanation and to the owners’ benefit, without intent to infringe.

SPECIFICATIONS AND INFORMATION CONTAINED IN THIS MANUAL ARE FURNISHED FOR INFORMATIONAL USE ONLY, AND ARE SUBJECT TO CHANGE AT ANY TIME WITHOUT NOTICE, AND SHOULD NOT BE CONSTRUED AS A COMMITMENT BY ASUS. ASUS ASSUMES NO RESPONSIBILITY OR LIABILITY FOR ANY ERRORS OR INACCURACIES THAT MAY APPEAR IN THIS MANUAL, INCLUDING THE PRODUCTS AND SOFTWARE DESCRIBED IN IT.

Copyright © 2002 ASUSTeK COMPUTER INC. All Rights Reserved.

---

<b>Product Name:</b>	SpaceLink Home Gateway (WL-500)
<b>Manual Revision:</b>	1.00 E1062
<b>Release Date:</b>	Aug 2002

---

## Copyright Information

---

### **ASUSTeK COMPUTER INC. (Asia-Pacific)**

Address: 150 Li-Te Road, Peitou, Taipei, Taiwan 112  
General Tel: +886-2-2894-3447  
General Fax: +886-2-2894-3449  
General Email: info@asus.com.tw

#### **Technical Support**

MB/Others (Tel): +886-2-2890-7121 (English)  
Notebook (Tel): +886-2-2890-7122 (English)  
Desktop/Server (Tel): +886-2-2890-7123 (English)  
Support Fax: +886-2-2890-7698  
Support Email: tsd@asus.com.tw  
Web Site: www.asus.com.tw  
Newsgroup: cscnews.asus.com.tw

### **ASUS COMPUTER INTERNATIONAL (America)**

Address: 6737 Mowry Avenue, Mowry Business Center,  
Building 2, Newark, CA 94560, USA  
General Fax: +1-510-608-4555  
General Email: tmd1@asus.com

#### **Technical Support**

Support Fax: +1-510-608-4555  
Web Site: www.asus.com  
Support Email: tsd@asus.com

### **ASUS COMPUTER GmbH (Europe)**

Address: Harkortstr. 25, 40880 Ratingen, BRD, Germany  
General Fax: +49-2102-442066  
General Email: sales@asuscom.de (for marketing requests only)

#### **Technical Support**

Support Hotline: MB/Others: +49-2102-9599-0  
Notebook (Tel): +49-2102-9599-10  
Support Fax: +49-2102-9599-11  
Support (Email): www.asuscom.de/de/support (for online support)  
Web Site: www.asuscom.de

# Safety Statements

---

## Federal Communications Commission Statement

This device complies with FCC Rules Part 15. Operation is subject to the following two conditions:

- This device may not cause harmful interference, and
- This device must accept any interference received, including interference that may cause undesired operation.

This equipment has been tested and found to comply with the limits for a class B digital device, pursuant to Part 15 of the Federal Communications Commission (FCC) rules. These limits are designed to provide reasonable protection against harmful interference in a residential installation. This equipment generates, uses, and can radiate radio frequency energy and, if not installed and used in accordance with the instructions, may cause harmful interference to radio communications. However, there is no guarantee that interference will not occur in a particular installation. If this equipment does cause harmful interference to radio or television reception, which can be determined by turning the equipment off and on, the user is encouraged to try to correct the interference by one or more of the following measures:

- Reorient or relocate the receiving antenna.
- Increase the separation between the equipment and receiver.
- Connect the equipment into an outlet on a circuit different from that to which the receiver is connected.
- Consult the dealer or an experienced radio/TV technician for help.

---

**WARNING! The use of a shielded-type power cord is required in order to meet FCC emission limits and to prevent interference to the nearby radio and television reception. It is essential that only the supplied power cord be used. Use only shielded cables to connect I/O devices to this equipment. You are cautioned that changes or modifications not expressly approved by the party responsible for compliance could void your authority to operate the equipment.**

---

Reprinted from the Code of Federal Regulations #47, part 15.193, 1993. Washington DC: Office of the Federal Register, National Archives and Records Administration, U.S. Government Printing Office.

## Canadian Department of Communications

This digital apparatus does not exceed the Class B limits for radio noise emissions from digital apparatus set out in the Radio Interference Regulations of the Canadian Department of Communications.

---

**This Class B digital apparatus complies with Canadian ICES-003. Cet appareil numérique de la classe B est conforme à la norme NMB-003 du Canada.**

---

---

## **Safety Information**

In order to maintain compliance with the FCC RF exposure guidelines, this equipment should be installed and operated with minimum distance 20 cm between the radiator and your body. Use only with supplied antenna. Unauthorized antenna, modification, or attachments could damage the transmitter and may violate FCC regulations. Any changes of modifications not expressly approved by the grantee of this device could void the users authority to operate the equipment.

## **FCC Radio Frequency Exposure Caution Statement**

Installation and use of this Wireless LAN device must be in strict accordance with the instructions included in the user documentation provided with the product. Any changes or modifications (including the antennas) made to this device that are not expressly approved by the manufacturer may void the user's authority to operate the equipment. The manufacturer is not responsible for any radio or television interference caused by unauthorized modification of this device, or the substitution or attachment of connecting cables and equipment other than manufacturer specified. It is the responsibility of the user to correct any interference caused by such unauthorized modification, substitution or attachment. Manufacturer and its authorized resellers or distributors will assume no liability for any damage or violation of government regulations arising from failing to comply with these guidelines.

# Table of Contents

---

<b>1. Introduction</b> .....	<b>8</b>
The SpaceLink™ Family .....	8
System Requirements .....	8
The Product Package .....	9
FEATURES .....	10
The IEEE 802.11b Specification .....	11
Direct-Sequence Spread Spectrum .....	12
Wireless Operation .....	13
Roaming Between SpaceLink™ Gateways or APs .....	14
Roaming Guidelines (SpaceLink™ Gateways or APs) .....	15
SpaceLink™ Home Gateway Topology .....	16
SpaceLink Home Gateway LED Indicators .....	19
<b>2. Installation</b> .....	<b>20</b>
Installation Procedure .....	20
Wall Mounting Option .....	22
Vertical Standing Option .....	23
Connecting to the SpaceLink Home Gateway .....	24
Configuring the SpaceLink Home Gateway .....	25
Installing the Homegateway Utilities .....	26
<b>3. SpaceLink Home Gateway Utilities</b> .....	<b>27</b>
Connecting to the SpaceLink Web Manager .....	27
Home Gateway Discovery .....	27
User Name and Password .....	29
Home Page .....	29
Login Password .....	30
Basic Setup .....	30
Status .....	31
Status Details .....	32
Basic Setup - Wireless .....	33
Supported Clients .....	35
Basic Setup - LAN Configuration .....	37
Basic Setup - WAN Configuration .....	38
Network Backbone .....	38
Agent to an ISP .....	39
Agent to Another Network .....	42
Automatic IP .....	42
Static IP .....	43
Firewall .....	44

# Table of Contents

---

Wireless Access Control .....	45
Advanced WAN Configuration .....	46
Virtual Server .....	48
Special Application .....	50
Firewall Bypass Zone .....	51
PPTP Server .....	52
Firmware Upgrade .....	53
Restoring Factory Default Settings .....	54
Firmware Restoration .....	55
Using a Hub .....	55
Printer Setup Wizard .....	56
Add Printer Wizard .....	56
Printer Setup Wizard .....	58
Verifying Your Printer .....	59
VPN Client .....	60
Starting VPN Client .....	60
Main Window .....	60
Connection Properties .....	62
Connection Name .....	62
Dialing Options .....	62
Advanced Properties .....	63
Dialing a Connection .....	63
<b>4. Wireless Performance .....</b>	<b>64</b>
Site Topography .....	64
Site Surveys .....	64
Range .....	65
<b>5. Troubleshooting .....</b>	<b>66</b>
Common Problems and Solutions .....	66
Reset to Defaults .....	67
<b>6. Appendix .....</b>	<b>70</b>
Operating frequency range .....	70
Number of operating channels .....	70
DSSS PHY frequency channel plan .....	70
SpaceLink Home Gateway Specifications .....	71
Glossary .....	72

### 1. Introduction

Thank you for choosing the SpaceLink Home Gateway, a member of ASUS' SpaceLink wireless infrastructure family. The SpaceLink Home Gateway complies with the IEEE 802.11b wireless standard to provide wireless mobile clients with network connectivity at data rates of up to 11 Mbps. The stand-alone the SpaceLink Home Gateway connects to a small Ethernet network to provide wireless access for wireless mobile clients.

### The SpaceLink™ Family

The SpaceLink Home Gateway is a member of a product family that provides a complete wireless networking solution.

- The **SpaceLink Home Gateway (WL-500)** creates a wireless network using the IEEE 802.11b wireless standard and adds a router, hub, and printer server.
- The **SpaceLink Access Point (WL-300)** creates a wireless network using the IEEE 802.11b wireless standard.
- The **SpaceLink PC Card (WL-100)** is a wireless LAN adapter that fits into a PCMCIA Type II slot in a Notebook PC.
- The **SpaceLink CF Card (WL-110)** is a wireless LAN adapter that fits into a Compact Flash Type II slot in a Portable Digital Assistant (PDA).

### System Requirements

To begin using the SpaceLink Home Gateway , you must have the following minimum requirements:

- ADSL/Cable Modem and Broadband Internet Account
- An Ethernet (10Base-T or 10/100Base-TX) adapter for wired client
- At least one 802.11b wireless adapter for a wireless mobile client
- TCP/IP and Internet browser installed
- Printer, which supports standard parallel protocol (SPP) (optional)

---

**Note: The SpaceLink Home Gateway only supports 10Base-T on the WAN port and both 10Base-T and 100Base-TX on the LAN port.**

---



### The Product Package

Each the SpaceLink Home Gateway comes with:

- One SpaceLink Home Gateway (WL-500)
- One power adapter (5 Volts DC, 2 Amp)
- One RJ-45 Ethernet cable (straight-through)
- One SpaceLink Home Gateway (WL-500) Quick Start Guide
- One support CD (Utilities and User's Manual PDF)

### FEATURES

The SpaceLink Home Gateway features include:

- **Multiple local network ports.** Four 10/100Base-T Ethernet ports, offering either a connection to a hub or switch on the local wired network or a direct connection to multiple Ethernet-enabled computer.
- **Wireless antenna.** The integrated Wireless Access Point allows the SpaceLink Home Gateway to link a broadband Internet connection to your local network of 802.11b (DSSS) wireless mobile clients.
- **Broadband port.** The Broadband port connects the SpaceLink Home Gateway to your cable/DSL modem.
- **Shared Internet access.** All computers on the local network can access the Internet through the SpaceLink Home Gateway, using only a single external IP address.
- **DHCP server support.** DHCP (Dynamic Host Configuration Protocol) support allows the SpaceLink Home Gateway to automatically provide IP addresses to computers on your local network.
- **PPPoE support.** Connect to your DSL provider using PPPoE (PPP over Ethernet), if your ISP uses this method.
- **Easy setup and management.** Use your web browser from any computer on the local network to configure the SpaceLink Home Gateway.
- **Advanced features.** The SpaceLink Home Gateway supports many advanced configuration features including the following: User-defined virtual servers; special Internet applications; exposed computer; password protection and access control.
- **Firewall protection.** The SpaceLink Home Gateway's use of NAT (Network Address Translation) provides firewall protection for your local network. NAT masks the local network's IP Addresses from the Internet. Additional protection can be achieved using the advanced features of the SpaceLink Home Gateway.
- **WEP support.** Supports 64 bit and 128 bit WEP encryption on the wireless network.

### The IEEE 802.11b Specification

In 1997, the Institute of Electrical and Electronics Engineers (IEEE) adopted the 802.11 standard for wireless devices operating in the 2.4 GHz frequency band. This standard includes provisions for three radio technologies: direct sequence spread spectrum, frequency hopping spread spectrum, and infrared. Devices that comply with the 802.11 standard operate at a data rate of either 1 or 2 Mbps.

In 1999, the IEEE created the 802.11b standard. 802.11b is essentially identical to the 802.11 standard except 802.11b provides for data rates of up to 11 Mbps for direct sequence spread spectrum devices. Under 802.11b, direct sequence devices can operate at 11 Mbps, 5.5 Mbps, 2 Mbps, or 1 Mbps. This provides interoperability with existing 802.11 direct sequence devices that operate only at 2 Mbps.

Direct sequence spread spectrum devices spread a radio signal over a range of frequencies. The IEEE 802.11b specification allocates the 2.4 GHz frequency band into 14 overlapping operating Channels. Each Channel corresponds to a different set of frequencies. See the Appendix to determine the center frequency used by each Channel.

If operating multiple 802.11b Home Gateways in the same vicinity, the distance between the center frequencies must be at least 25 MHz to avoid interference. Note that the Channels available to an 802.11b Home Gateway will vary from country to country. In the United States, the 802.11b standard allocates 11 operating Channels for direct sequence devices. Channels 1, 6, and 11 are independent and do not overlap with each other. To avoid interference between 802.11b Home Gateways, It is recommended that you configure the Home Gateways using only Channels 1, 6, and 11.

### Direct-Sequence Spread Spectrum

Spread spectrum (broadband) uses a narrowband signal to spread the transmission over a segment of the radio frequency band or spectrum. Direct-sequence is a spread spectrum technique where the transmitted signal is spread over a particular frequency range. The Space Link Home Gateway uses Direct-Sequence Spread Spectrum (DSSS) for radio communication.

Direct-sequence systems communicate by continuously transmitting a redundant pattern of bits called a chipping sequence. Each bit of transmitted data is mapped into chips by the Home Gateway and rearranged into a pseudorandom spreading code to form the chipping sequence. The chipping sequence is combined with a transmitted data stream to produce the Home Gateway output signal.

Wireless mobile clients receiving a direct-sequence transmission use the spreading code to map the chips within the chipping sequence back into bits to recreate the original data transmitted by the Home Gateway. Intercepting and decoding a direct-sequence transmission requires a predefined algorithm to associate the spreading code used by the transmitting Home Gateway to the receiving wireless mobile client.

This algorithm is established by IEEE 802.11b specifications. The bit redundancy within the chipping sequence enables the receiving wireless mobile client to recreate the original data pattern, even if bits in the chipping sequence are corrupted by interference. The ratio of chips per bit is called the spreading ratio. A high spreading ratio increases the resistance of the signal to interference. A low spreading ratio increases the bandwidth available to the user. The Home Gateway uses a constant chip rate of 11Mchips/s for all data rates, but uses different modulation schemes to encode more bits per chip at the higher data rates. The Home Gateway is capable of an 11 Mbps data transmission rate, but the coverage area is less than a 1 or 2 Mbps Home Gateway since coverage area decreases as bandwidth increases.

### Wireless Operation

The SpaceLink Home Gateway will operate as a MAC layer learning bridge and forward packets between wireless mobile clients and the Ethernet network.

A wireless LAN that uses the SpaceLink Home Gateway generally consists of one or more 802.11b Access Points and one or more wireless mobile clients that have an 802.11b adapter installed.

The SpaceLink Home Gateway maintains a table of MAC addresses, which it has learned are located either on the Ethernet network or on the radio network by monitoring the source address of packets it receives. For example, if the SpaceLink Home Gateway receives a packet over its radio, it creates an entry in its table for the node that sent the packet and labels the entry as a member of the radio network. The SpaceLink Home Gateway removes an entry from the table after five minutes of inactivity.

When the SpaceLink Home Gateway receives a packet from the Ethernet network, it compares the packet's destination address with the node addresses listed in its table. If the packet's destination address is not in the table, the SpaceLink Home Gateway will forward the packet to the wireless mobile clients. If the packet's destination address is listed in the table as a member of the radio network, the SpaceLink Home Gateway will forward the packet to the wireless mobile clients. If the packet's destination address is listed in the table as a member of the Ethernet network, the SpaceLink Home Gateway will not forward the packet to the wireless mobile clients. The SpaceLink Home Gateway applies the same principles to determine if a packet received over its radio should be forwarded to the Ethernet network.

The SpaceLink Home Gateway forwards all broadcast packets to wireless mobile clients. Given this, the SpaceLink Home Gateway can only support 250 nodes.

The speed available to wireless mobile clients depends on the amount of information that each client exchanges with the network because the 11 Mbps wireless bandwidth is shared with all wireless nodes.

### Roaming Between SpaceLink™ Gateways or APs

If there are multiple SpaceLink Home Gateways or Access Points on the network, then a wireless mobile client may seamlessly roam from one the SpaceLink Home Gateway or Access Point to another.

Each SpaceLink Home Gateway or Access Point creates its own wireless cell or coverage area. This is also known as a Basic Service Set (BSS). Any wireless mobile client can communicate with a particular SpaceLink Home Gateway or Access Point if it is within the SpaceLink Home Gateway's or Access Point's coverage area.

If the cells of multiple SpaceLink Home Gateways or Access Points overlap, then the wireless mobile client may switch from one SpaceLink Home Gateway or Access Point to another as it travels throughout the facility. During the hand-off from one SpaceLink Home Gateway or Access Point to another, the wireless mobile client maintains an uninterrupted connection to the network. This is known as "roaming."

Multiple SpaceLink Home Gateways connected to a common Ethernet network form an Extended Service Set (ESS). All members of an Extended Service Set are configured with an ID, known as the SSID or ESSID. Wireless mobile clients must be configured with the same SSID as the SpaceLink Home Gateways or Access Points on the network; a client can only roam between the SpaceLink Home Gateways or Access Points that share the same SSID.

### Roaming Guidelines (SpaceLink™ Gateways or APs)

- A 802.11b PC Card can only roam between 802.11b SpaceLink Home Gateways or Access Points.
- All the SpaceLink Home Gateways or Access Points must have the same SSID.
- All computers with SpaceLink PC card or CF card adapters must have the same SSID as the Home Gateways or Access Points that they will roam between.
- If WEP encryption is enabled, then all the SpaceLink Home Gateways or Access Points and client adapters must use the same encryption level and WEP Key(s) to communicate.
- The SpaceLink Home Gateways' or Access Points' cells must overlap to ensure that there are no gaps in coverage and to ensure that the roaming client will always have a connection available.
- The SpaceLink Home Gateways or Access Points that use the same Channel should be installed as far away from each other as possible to reduce potential interference.
- It is strongly recommended that you perform a site survey using the utility provided with the SpaceLink PC card or CF card to determine the best location for each the SpaceLink Home Gateway or Access Points in the facility.

# SpaceLink™ Home Gateway Topology

There are three major ways to deploy the home gateway in your local network (I) Network backbone, (II) Agent to ISP and (III) Agent to another network.

## Network Backbone

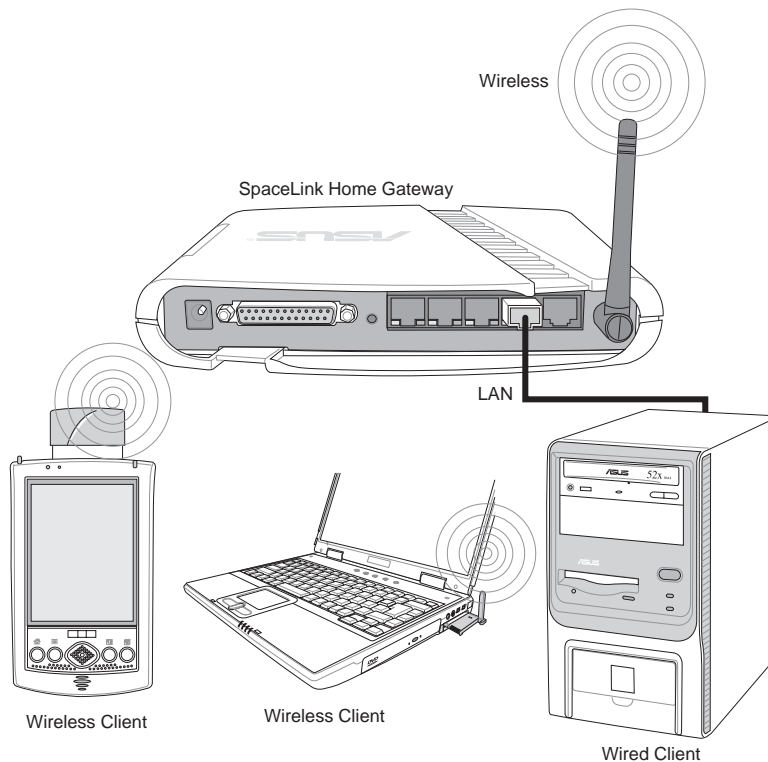

In this topology, the home gateway connects your wired and wireless devices together to form a local area network (LAN), as shown. To connect a computer (or other device) to the SpaceLink Home Gateway, you need a network cable (UTP-Cat5) with one end connected to one of the LAN ports on the back of the SpaceLink Home Gateway and the other in the 10/100 LAN port on that device. For wireless connections, wireless mobile clients must comply with the IEEE 802.11b standard.



## Agent to ISP

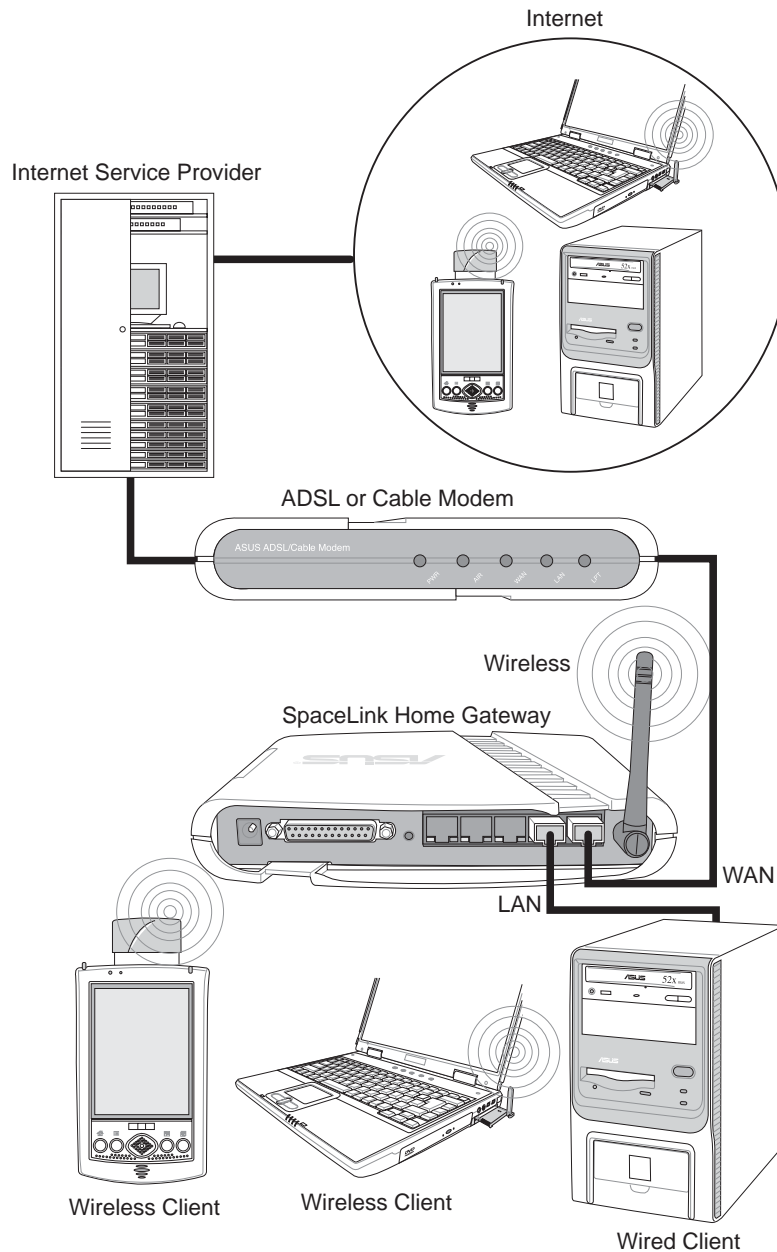

In this topology, the home gateway is not only a backbone of your LAN but also an agent to your Internet Service Provider (ISP). You may use an ADSL or Cable modem to communicate with your ISP. Connect the LAN port on the modem with the WAN port at the back of the SpaceLink Home Gateway using a network cable as shown above.

**Note:** You also need to make sure that other connections on the ADSL or Cable modem are correct.

# Chapter 1 - Introduction

## Agent to Another Network

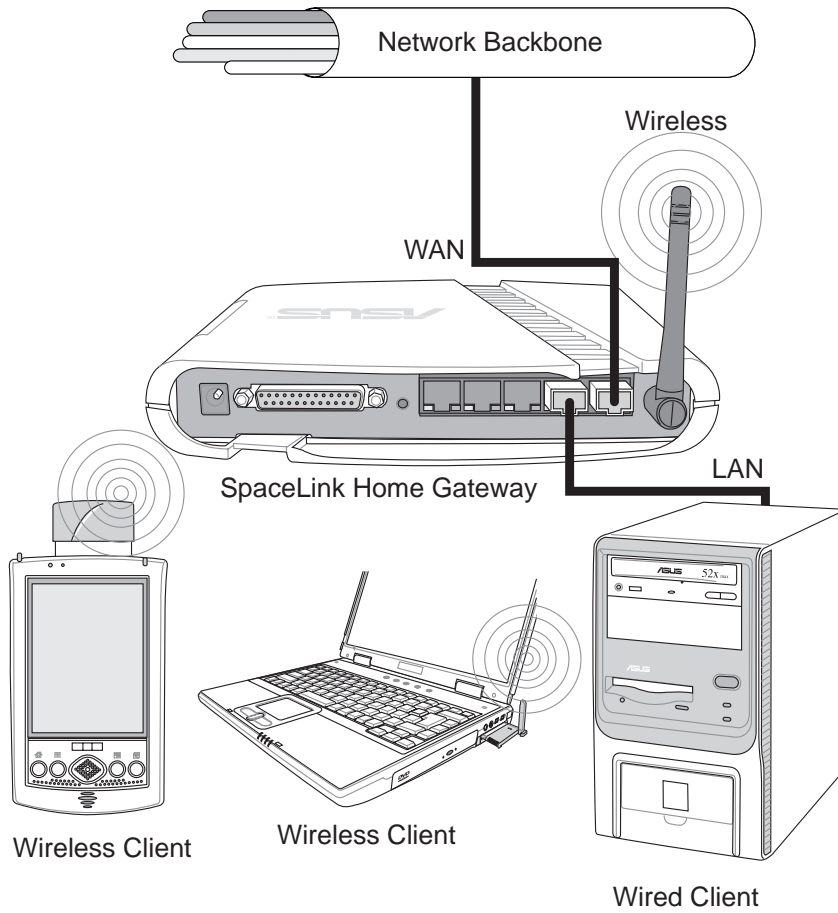

In this topology, the home gateway is an agent between your LAN and another network. Use a network cable with one end connected to the WAN port on the home gateway and the other to the other network as shown above.

## SpaceLink Home Gateway LED Indicators

The LEDs on the front of the SpaceLink Home Gateway display the status of the SpaceLink Home Gateway.

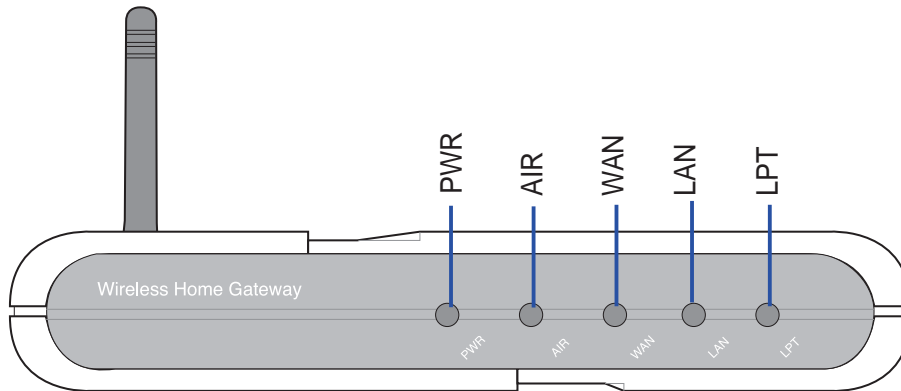

### PWR (Power)

- Off (1) No power, (2) During boot sequence
- On (1) Power ON and system ready
- Flashing (1) During boot sequence, (2) Self-test error

### AIR (Wireless)

- Off (1) No power, (2) No wireless connection
- On (1) At least one wireless client is associated
- Flashing (1) Wireless traffic through this port is detected, (2) Self-test error

### WAN (Wide Area Network)

- Off (1) No power, (2) No wired connection
- On (1) Link to another network device but no traffic
- Flashing (1) Wired traffic through this port is detected, (2) Self-test error

### LAN (Local Area Network)

- Off (1) No power, (2) No wired connection
- On (1) Link to another network device but no traffic
- Flashing (1) Wired traffic through this port is detected, (2) Self-test error

### LPT (Printer)

- Off (1) No power, (2) No printer is connected
- On (1) The connected printer is switched on
- Flashing (1) Send data to a printer

---

**Note:** The SpaceLink Home Gateway only supports 10Base-T on the WAN port and both 10Base-T and 100Base-TX on the LAN port.

---

### 2. Installation

This chapter describes the installation procedure for the SpaceLink Home Gateway and includes a description of the LEDs found on the unit.

### Installation Procedure

Follow these steps to install the SpaceLink Home Gateway.

1. **Location:** Determine the best location for the SpaceLink Home Gateway. Keep in mind the following considerations:
  - The length of the Ethernet cable that connects the Home Gateway to the network must not exceed 100 meters.
  - For standard placement, try to place the Home Gateway on a flat, sturdy surface as far from the ground as possible, such as on top of a desk or bookcase, keeping clear of metal obstructions and away from direct sunlight.
  - Try to centrally locate the Home Gateway so that it will provide coverage to all of the wireless mobile devices in the area. Orientating the antenna vertically should provide the best reception.
  - Use only the power supply that came with this unit. Other power supplies may fit but the voltage and power may not be compatible.

---

**It is the responsibility of the installer and users of the SpaceLink Home Gateway to guarantee that the antenna is operated at least 20 centimeters from any person. This is necessary to insure that the product is operated in accordance with the RF Guidelines for Human Exposure which have been adopted by the Federal Communications Commission.**

---

2. **Mounting:** Place the Home Gateway in the desired location. Wall mounting is also possible for the Home Gateway. Refer to the section entitled “Wall Mounting Option” for details.
3. **WAN Connection:** Attach one end of the provided RJ-45 Ethernet cable to the SpaceLink Home Gateway’s WAN port and attach the other end to the RJ-45 Ethernet cable to your ADSL or Cable modem.

---

**The SpaceLink Home Gateway WAN port does not support 100Base-TX; it only supports 10Base-T. The WAN port may be connected to devices that supports both 10/100, but not pure 100Base-TX.**

---

## Chapter 2 - Installation

4. **LAN Connection:** Attach one end of an RJ-45 Ethernet cable to the SpaceLink Home Gateway's LAN port (any one of the four) and attach the other end to the RJ-45 Ethernet cable to your desktop computer.
5. **Power Connection:** The SpaceLink Home Gateway requires power from an external power supply. The SpaceLink Home Gateway ships with a UL listed, Class 2 power supply (5V, 2A). Attach one end of the DC power adapter to the back of the SpaceLink Home Gateway and the other end to a power outlet.

The Power LED on the front of the Home Gateway will light up when the unit is powered ON. In addition, the green LAN or WAN LEDs will turn ON to indicate that the Home Gateway has a physical Ethernet network connection.

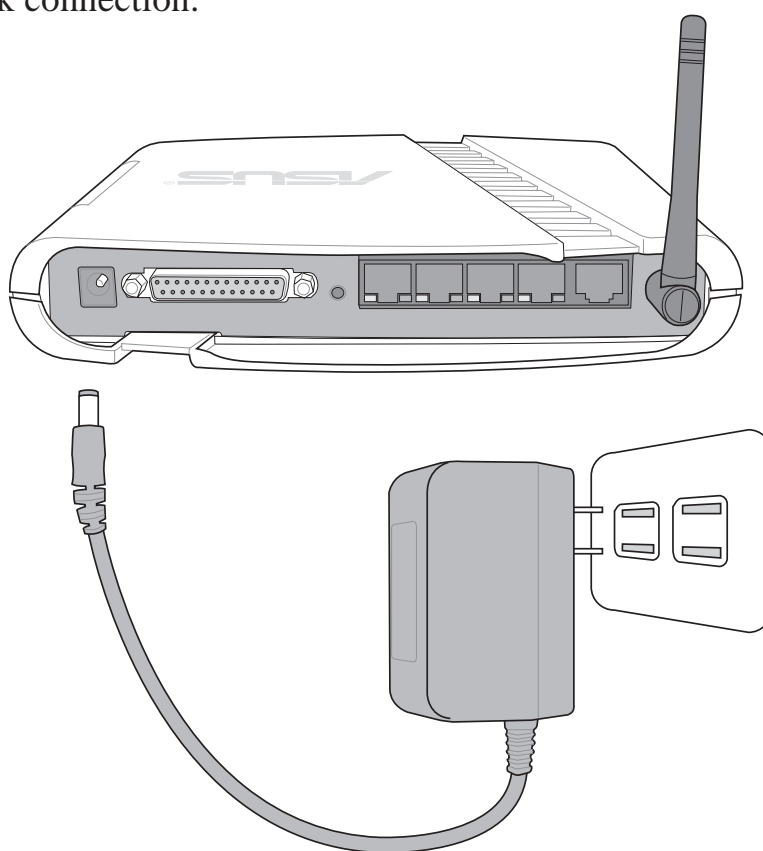

---

**Note:** Use the Home Gateway only with the power adapter supplied in the product package. Using another power supply may damage the Home Gateway.

---

6. **Printer Connection:** If you plan to use the home gateway as a printing server for your local network, connect a printer to the printer port of the home gateway via a printer cable.

### Wall Mounting Option

Out of the box, the SpaceLink Home Gateway is designed to sit on a raised flat surface like a file cabinet or book shelf. The unit may also be converted for mounting to a wall or ceiling.

Follow these steps to mount the Home Gateway to a wall:

1. Look on the underside for the four mounting hooks.
2. Mark two upper holes in a flat surface using the provided hole template.
3. Tighten two screws until only 1/4" is showing.
4. Latch the upper two hooks of the Home Gateway onto the screws.

---

**Note: Readjust the screws if you cannot latch the Home Gateway onto the screws or if it is too loose.**

---

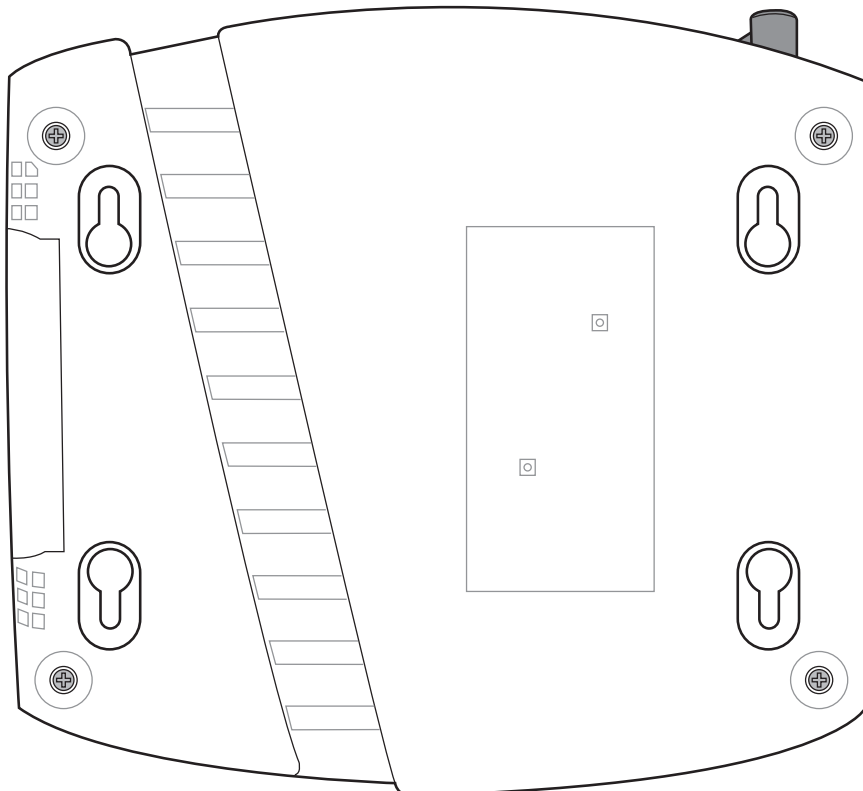

## Vertical Standing Option

The ASUS Home Gateway can also stand on its side to save space. Two hinges can be opened on the right side to support vertical standing. Orientate the antenna so that it points upwards.

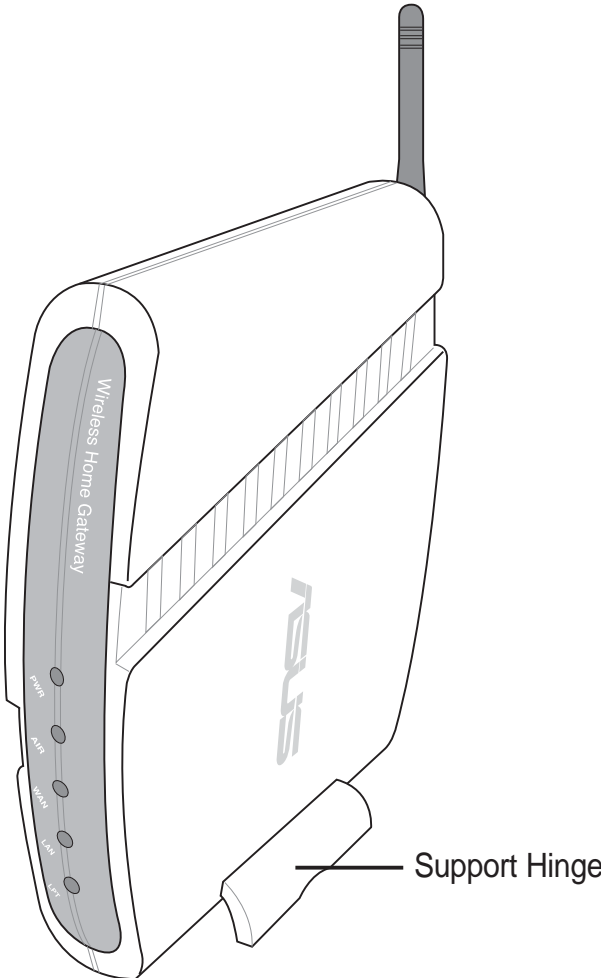

# Connecting to the SpaceLink Home Gateway

### Wired Connection

One RJ-45 cable is supplied with the SpaceLink Home Gateway. Auto crossover function is designed into the SpaceLink Home Gateway so you can use either a straight-through or a crossover Ethernet cable. Plug one end of the cable into the WAN port on the rear of the SpaceLink Home Gateway and the other end into the Ethernet port of your ADSL or Cable modem.

---

**Note: The WAN port only supports 10Base-TX.**

---

### Wireless-Connection

Refer to your wireless adapter user's manual on associating with the SpaceLink Home Gateway . The default SSID of the SpaceLink Home Gateway is "default" (lower case), encryption is disabled and open system authentication is used.

### Printer Connection

The SpaceLink Home Gateway can be utilized as a printer server to allow many wired or wireless computers to share a standard printer. A DB25 parallel cable should be supplied with your printer. Plug the male connector of this parallel cable into the printer port on the rear of the SpaceLink Home Gateway and the centronics end into your printer.

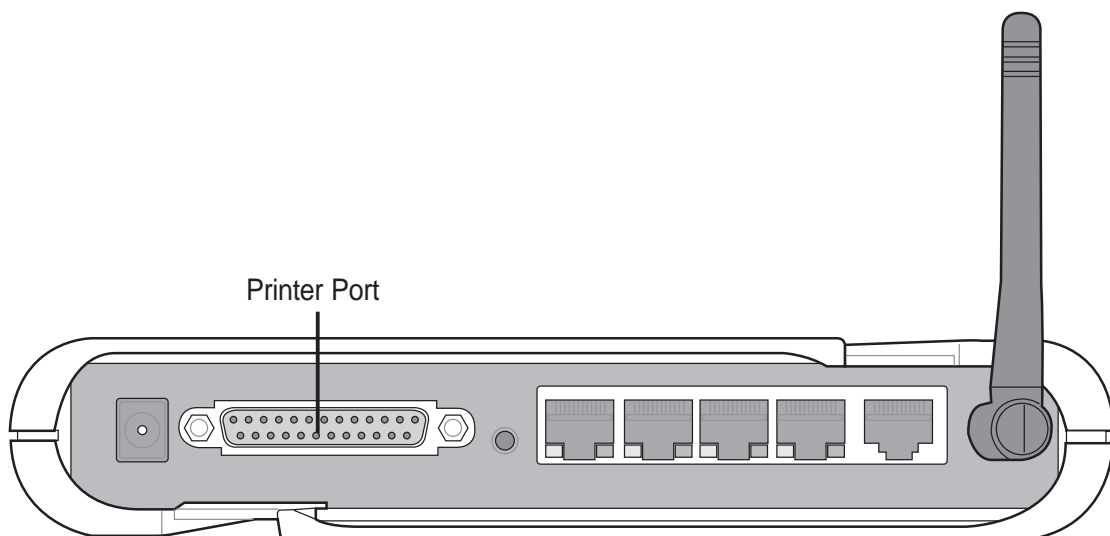



### Configuring the SpaceLink Home Gateway

The home gateway can be configured to meet various usage scenarios. Some of the factory default settings may suit your usage; however, others may need changing. Prior to using the home gateway, you must check the basic settings to guarantee it will work in your environment.

Configuring the SpaceLink Home Gateway is done through a web browser. You need a Notebook PC or desktop PC connected to the SpaceLink Home Gateway and running a web browser as a configuration terminal. The connection can be wired or wireless. For the wireless connection, you need an IEEE 802.11b compatible device, e.g. ASUS SpaceLink PC Card, installed in your Notebook PC. You should also disable WEP and set the SSID to “default” for your wireless LAN device.

If you want to configure the SpaceLink Home Gateway or want to access the Internet through the SpaceLink Home Gateway, TCP/IP settings must be correct. Normally, the TCP/IP setting should be on the IP subnet of the SpaceLink Home Gateway. The SpaceLink Home Gateway incorporates a DHCP server so the easiest method is to set your PC to get its IP address automatically and reboot your computer. So the correct IP address, gateway, DNS (Domain Name System Server) can be obtained from the SpaceLink Home Gateway.

---

**Note: Before rebooting your PC, the SpaceLink Home Gateway should be switched ON and in ready state.**

---

#### Advanced IP Settings

If you want to set your IP address manually, the following default settings of the SpaceLink Home Gateway should be known:

- IP address 192.168.123.1
- Subnet Mask 255.255.255.0.

If you set your computer’s IP manually, it needs to be on the same segment. For example:

- IP address 192.168.123.xxx (xxx can be any number between 2 and 254 that is not used by another device)
- Subnet Mask 255.255.255.0 (same as the SpaceLink Home Gateway )
- Gateway 192.168.123.1 (this is the SpaceLink Home Gateway IP address)
- DNS 192.168.123.1 (SpaceLink Home Gateway IP address or your own).

## Chapter 2 - Installation

### Installing the Homegateway Utilities

Follow these steps to install the SpaceLink Home Gateway Manager in Microsoft Windows:

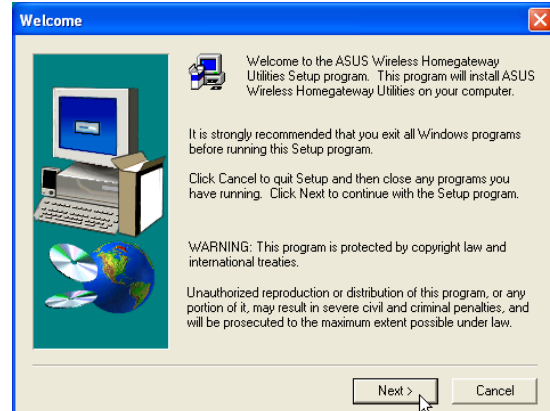

- (1) Insert the support CD and the autorun will show. Double-click **setup.exe** if your autorun has been disabled.
- (2) Click **Next** after reading the welcome screen.

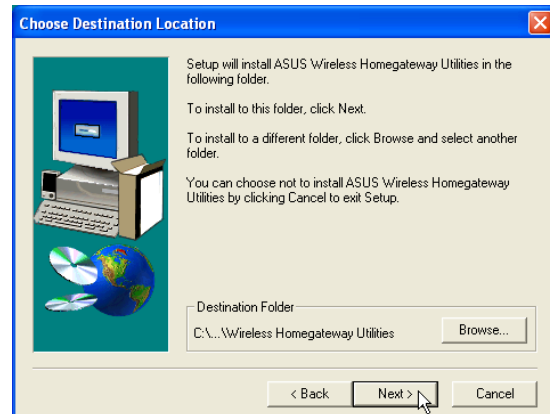
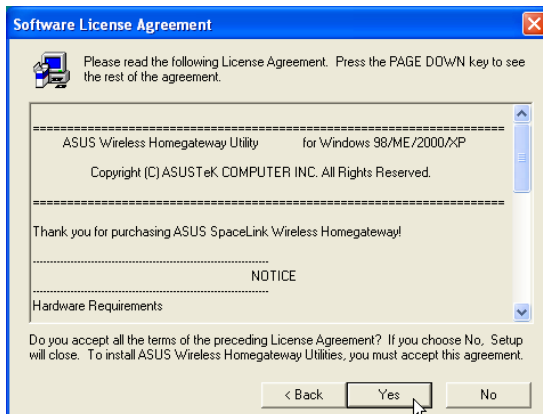

- (3) Click **Yes** after reading the license agreement.
- (4) Click **Next** to accept the default destination folder or enter another name.

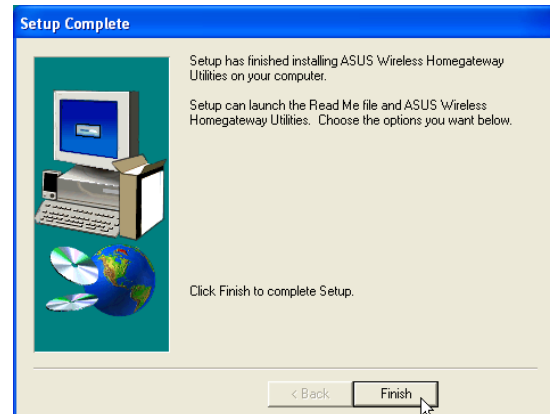
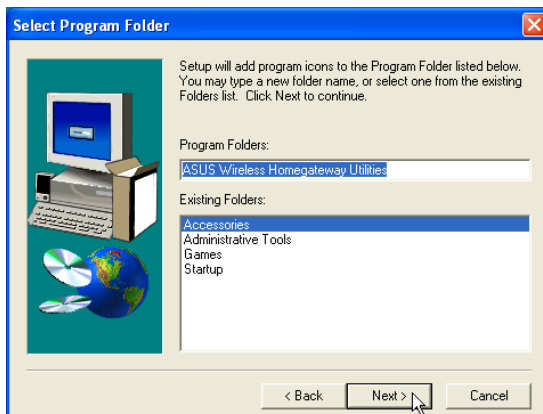

- (5) Click **Next** to accept the default program folder or enter another name.
- (6) Click **Finish** when setup is complete.

### 3. SpaceLink Home Gateway Utilities

After installation, you can launch the utilities through the Start menu.

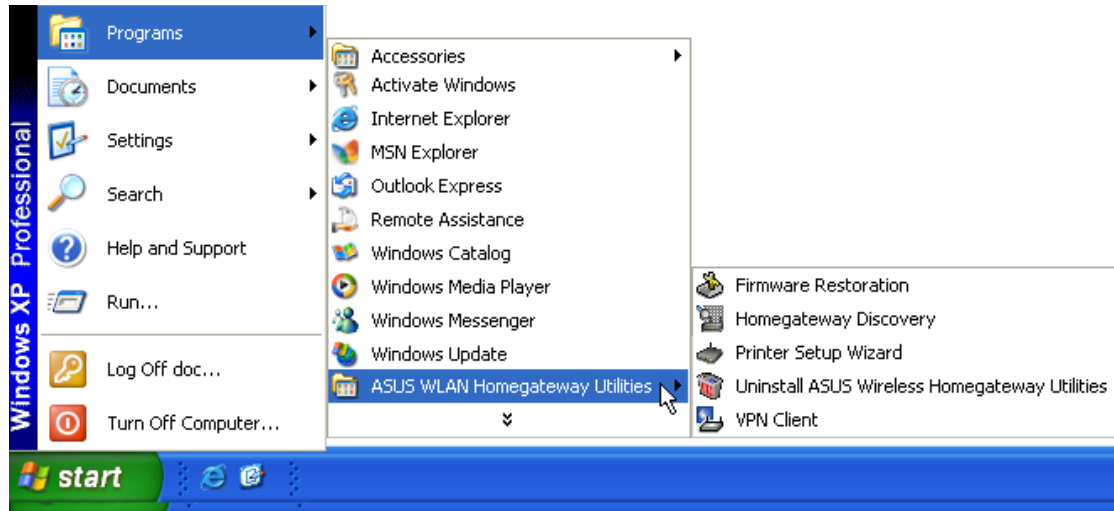

### Connecting to the SpaceLink Web Manager

#### Wired Ethernet Connection

Besides using a network hub, you can also connect a LAN cable from your computer's network card to the Home Gateway using either a straight or crossover cable because the SpaceLink Home Gateway LAN and WAN RJ-45 ports have auto-crossover capability.

#### Wireless Connection

If you are using a Notebook PC with a wireless adapter, you can connect to the SpaceLink Homegateway Web Manager without a wired Ethernet connection.

### Home Gateway Discovery

Run the **ASUS Homegateway Discovery** from the **Start** menu and click **Config** on the device.

#### Manually Entering the Address

You can also open your PC's web browser and enter the IP address of the ASUS SpaceLink Home Gateway depending on the port you are using.

## Chapter 3 - Home Gateway Utilities

If your computer is connected to the WAN port use

**http://(WAN Port IP Address):8080**

If your computer is connected to the LAN port use:

**http://192.168.123.1**

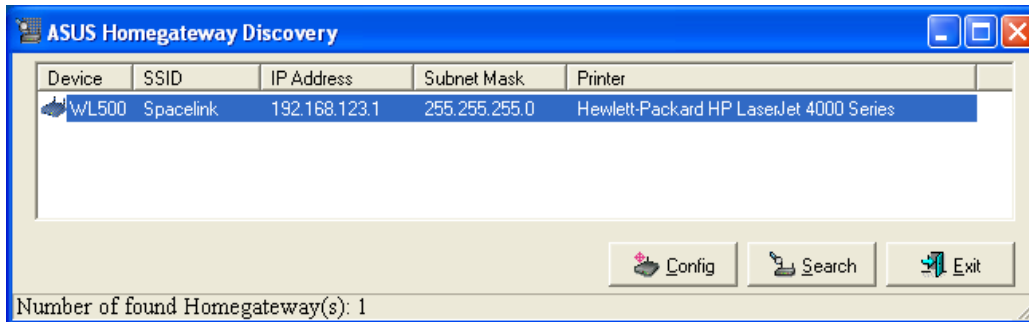

Web access through the WAN port (over the Internet) is disabled by default so that the above private IP can be used for configuration access. If Internet access through the WAN port is enabled by the user, port 8080 must be used for configuration access. In this case, you would enter the following: **http://(WAN Port IP Address):8080** in your web browser.

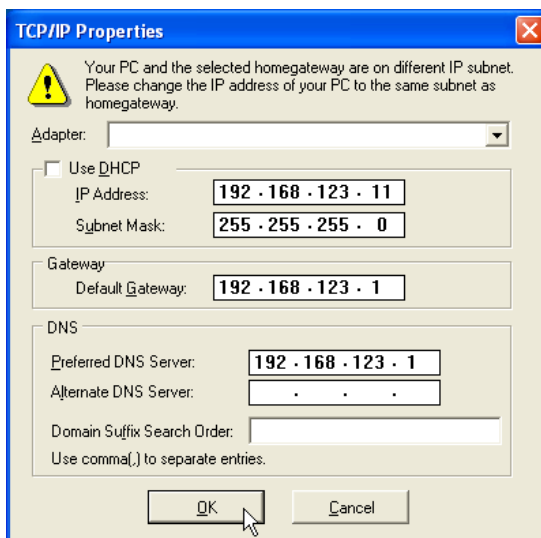

If your computer's IP is not on the same subnet as the SpaceLink Home Gateway, you will be asked to change it. The IP address can be any number from 2 to 254 that is not used by another device.

**Using a proxy server for your LAN requires that you set an exception for the SpaceLink Home Gateway or else connection will fail.**

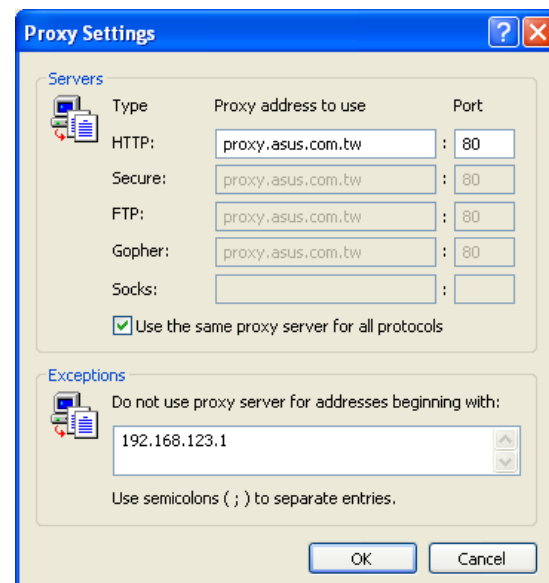

## Chapter 3 - Home Gateway Utilities

If you cannot find any the SpaceLink Home Gateways due to a problem in the IP settings, push and hold the “Restore” button over five seconds to restore factory default settings.

### User Name and Password

Once connected, a window will ask for the User name and Password in order to log in. The factory default values are “**admin**” and “**admin**”.



### Home Page

After logging in, you will see the ASUS HomeGateway home page.

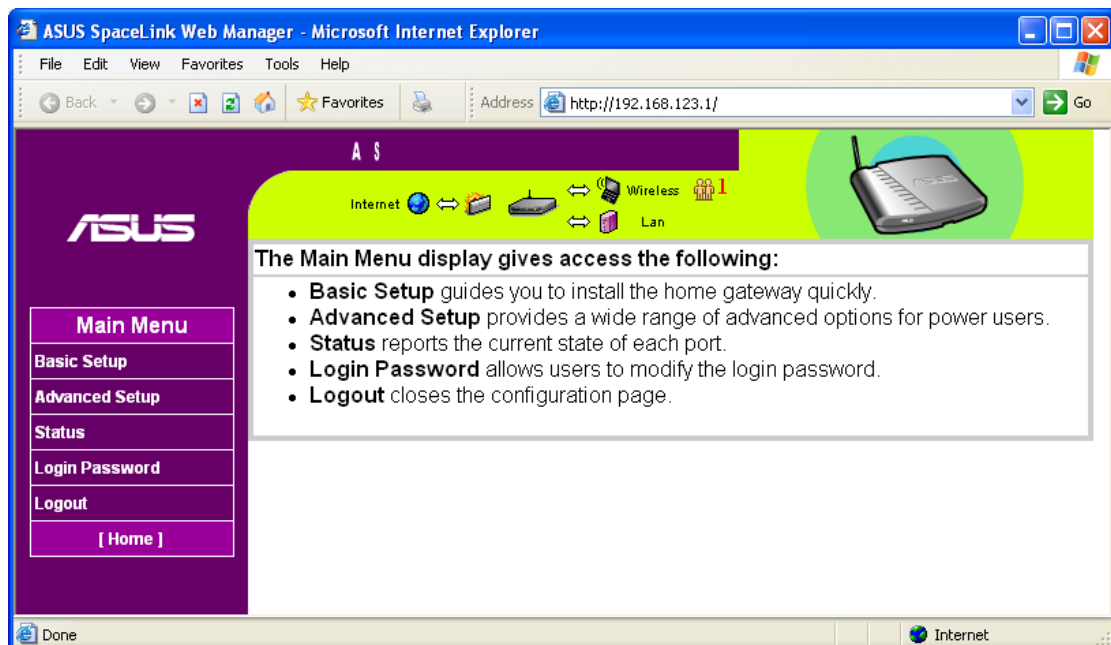

### Login Password

You can find “Login Password” on the Main Menu. This page will allow you to change the default password “admin” (lower case) to any password of your choice. You can enter any usable characters between 1-16 characters long (cannot be left blank). Click **Modify** button to save your new password. If you forget the SpaceLink Home Gateway’s password, you can reset the SpaceLink Home Gateway to its factory settings (see troubleshooting).

**Note: The password is case sensitive.**

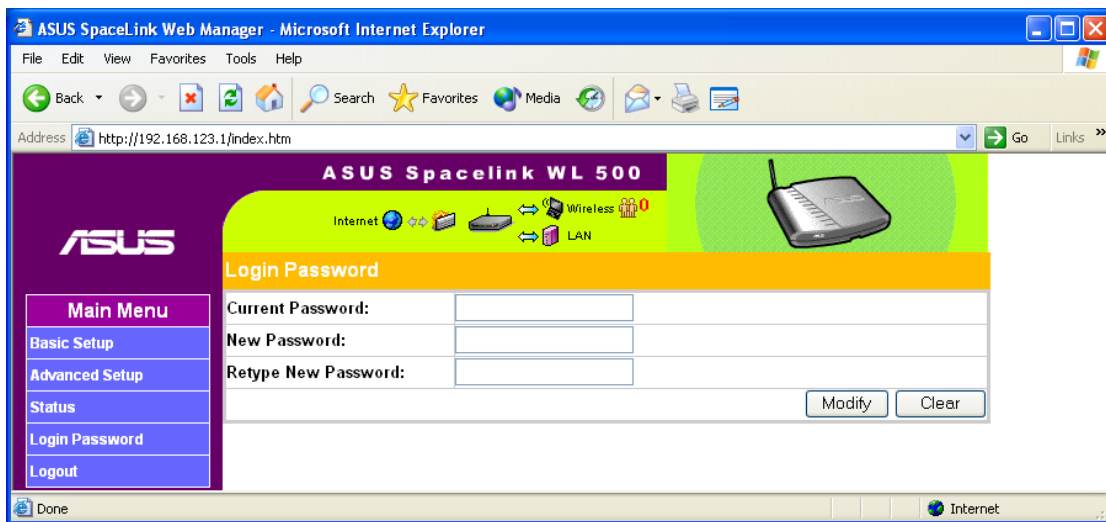

### Basic Setup

Select **Basic Setup** from the menu on the left.

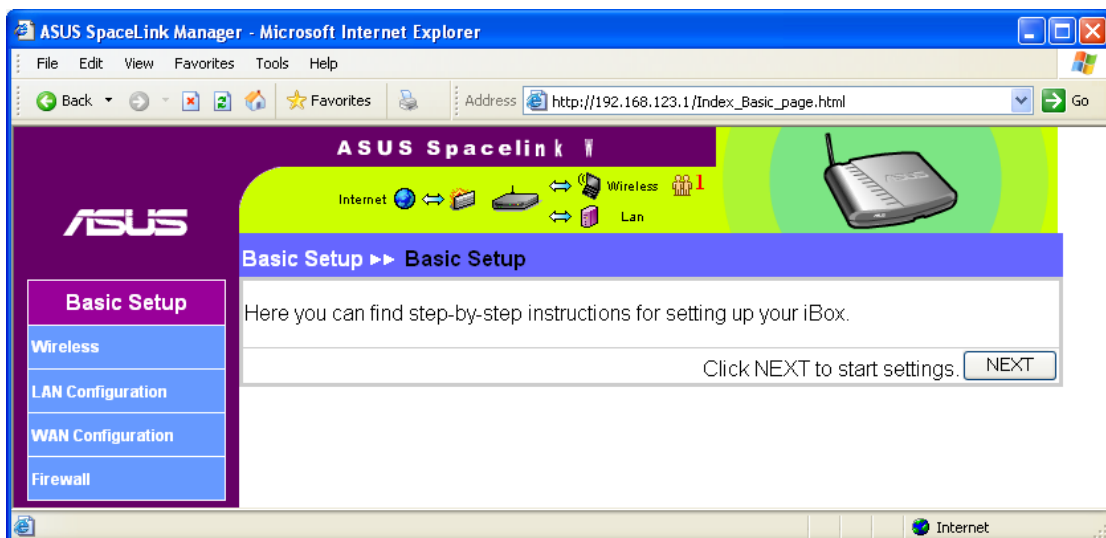

Click **Next** to enter the wireless configuration page.

## Chapter 3 - Home Gateway Utilities

### Status

The Status page available from the Main Menu gives you all the necessary information for monitoring the SpaceLink Home Gateway's condition.

The screenshot shows the ASUS SpaceLink Web Manager interface in Microsoft Internet Explorer. The browser address bar shows `http://192.168.123.1/index.htm`. The page features a purple sidebar with a 'Main Menu' containing links for 'Basic Setup', 'Advanced Setup', 'Status', 'Login Password', 'Logout', and '[ Home ]'. The main content area displays the following information:

- ASUS SpaceLink** header with navigation icons for Internet, Wireless, and LAN.
- ELAPSED TIME SINCE BOOT**: 0 Day : 0 Hour : 9 Min : 22 Sec
- Wireless** section:
  - SSID: Spacelink
  - Channel: 6
  - Encryption (WEP): Off
  - Number of Associated Stations: 1
- LAN** section:
  - IP Address: 192.168.123.1
  - Subnet Mask: 255.255.255.0
  - DHCP Server: Enabled
  - LAN Port Link State: Linked
- WAN** section:
  - IP Addressing Method: PPPoE
  - IP Address: 61.230.105.240
  - Subnet Mask: 0.0.0.0
  - Gateway: 61.230.96.254
  - DNS Server 1: 168.95.1.1
  - DNS Server 2: (empty)
  - WAN Port Link State: Linked
  - WAN Port Connection State: OK
- Printer Server** section:
  - Connected Printer Status: on-line
  - User in service: (empty)

A 'Refresh' button is located at the bottom right of the status table. The browser status bar at the bottom indicates 'Opening page http://192.168.123.1/index\_title.html...' and 'Internet' connectivity.

3. Utilities

See next page for information on this page.

## Chapter 3 - Home Gateway Utilities

---

### Status Details

Details of the Status page items are described in the configuration pages following this page.

### Wireless

**Number of Associated Stations** - Tells you how many wireless mobile clients are connected to the SpaceLink Home Gateway.

### LAN

**DHCP Server** - This shows either Enabled or Disabled.

**LAN Port Link State** - Linked or Not Linked (indicates whether the cable is plugged in or not).

### WAN

**WAN Port Link State** - Linked or Not Linked (indicates whether the cable is plugged in or not).

**WAN Port Connection State:** Disconnected, Connecting, OK (OK indicates that the IP address is working).

### Printer Server

**Connected Printer Status:** There are five possible statuses: Off-Line (no printer), On-Line (ready), Error (problem), Out of Paper, Busy (someone is printing).

**User in Service:** Shows the IP address of the user when the status is busy.



### Basic Setup - Wireless

This page allows you to configure the wireless settings. See next page for descriptions on each setting.

**ASUS Spacelink WL 500**

Internet Wireless Lan

#### Basic Setup >> Wireless

Assign an identification string, consisting of up to 32 characters, for your WLAN.

SSID:

Select the operating radio channel.

Channel:

Select 1, 2, 5.5 & 11 Mbps to maximize performance. Use 1 & 2 Mbps only when the backward compatibility is needed for some old WLAN cards whose maximal bit rate is 2 Mbps.

Basic Data Rate:  1 & 2 Mbps  1, 2, 5.5 & 11 Mbps

Enable encryption mechanism (WEP) to protect your data from eavesdroppers?

WEP:

Give a magic word to generate the WEP keys automatically or leave this field blank and type in the keys manually.

Magic Word:

WEP Key 1 (10 or 26 hex digits):

WEP Key 2 (10 or 26 hex digits):

WEP Key 3 (10 or 26 hex digits):

WEP Key 4 (10 or 26 hex digits):

Default Key:

Authentication Method:

Save:	Save the above settings and continue.
Restore:	Clear the above settings and restore the settings in effect.
Finish:	Finish all settings and restart the Home Gateway now.

**IMPORTANT:** New settings will only take effect after clicking the “Finish” button and waiting for the SpaceLink Home Gateway to restart.

## Chapter 3 - Home Gateway Utilities

---

### SSID & Channel

The SSID is an identification string of up to 32 ASCII characters that differentiate one SpaceLink Home Gateway or Access Point from another. The SSID is also referred to as the “ESSID” or “Extended Service Set ID.” You can use the default SSID and radio channel unless more than one SpaceLink Home Gateway or Access Point is deployed in the same area. In that case, you should use a different SSID and radio channel for each SpaceLink Home Gateway or Access Point. All the SpaceLink Home Gateways and SpaceLink 802.11b client adapters must have the same SSID to allow a wireless mobile client to roam between the SpaceLink Home Gateways. By default, the SSID is set to “default”.

### Channel

IEEE 802.11b devices are direct sequence spread spectrum devices that spread a radio signal over a range of frequencies. The range of frequencies used by a direct sequence device is called a Channel.

The IEEE 802.11b specification supports up to 14 overlapping Channels for radio communication. But only 11 Channels are supported in the United States and therefore on the SpaceLink Home Gateway. To minimize interference, configure each the SpaceLink Home Gateway to use Non-overlapping channels. Non-overlapping channels have 25Mhz separation beginning at the first allowed channel for the country (for the US and most of Europe, channels 1, 6 & 11 are used).

Make sure that the SpaceLink Home Gateways sharing the same Channel (or Channels close in number) are as far away from each other as possible, based on the results of your site survey of the facility. You can find the site survey utility in the SpaceLink PC card or CF card setup CD.

### Basic Data Rate

Select “1, 2, 5.5 & 11Mbps” to maximize performance. Use “1 & 2 Mbps” only when backward compatibility is needed for some older wireless LAN cards with a maximum bit rate of 2Mbps.

The IEEE 802.11b specification supports four data rates: 11 Mbps, 5.5 Mbps, 2 Mbps, and 1 Mbps. As a wireless mobile client travels further and further away from the SpaceLink Home Gateway, the data rate automatically decreases in order to maintain a usable radio connection. Therefore, a client that is close to an the SpaceLink Home Gateway may operate at 11 Mbps, but a client that is far away from the SpaceLink Home Gateway may operate at 2 Mbps.

### Supported Clients

802.11b products can operate at 11 Mbps, 5.5 Mbps, 2 Mbps or 1 Mbps. This allows 802.11b devices to communicate with any existing 802.11 direct sequence devices that operate only at 1 or 2 Mbps. By default, the SpaceLink Home Gateway will support both 802.11b and 2 Mbps 802.11 direct sequence clients.

### WEP

The IEEE 802.11b standard specifies an optional encryption feature, known as Wired Equivalent Privacy or WEP, that is designed to provide a wireless LAN with a security level equal to what is found on a wired Ethernet network.

WEP encrypts the data portion of each packet exchanged on the 802.11b network using either a 64-bit or 128-bit encryption algorithm. In addition, WEP is also used in conjunction with the optional Shared Key Authentication algorithm to prevent unauthorized devices from associating with an 802.11b network.

Enabling WEP can protect your data from eavesdroppers. If you do not need this feature, select “no” to skip the following setting. The SpaceLink Home Gateway supports both 64-bit and 128-bit encryption using the Wired Equivalent Privacy (WEP) algorithm. Select the type of encryption you want to use (64 or 128 bit) and configure one to four WEP Keys. The “128-bit” method is more secure than the “64-bit”.

### 64/128bits versus 40/104bits

You may be confused about configuring WEP encryption, especially when using multiple wireless LAN products from different vendors. There are two levels of WEP Encryption: 64 bits and 128 bits.

Firstly, 64 bit WEP and 40 bit WEP are the same encryption method and can interoperate in the wireless network. This lower level of WEP encryption uses a 40 bit (10 Hex character) as a “secret key” (set by user), and a 24 bit “Initialization Vector” (not under user control). This together makes 64 bits (40 + 24). Some vendors refer to this level of WEP as 40 bits and others refer to this as 64 bits. ASUS SpaceLink products use the term 64 bits when referring to this *lower* level of encryption.

Secondly, 104 bit WEP and 128 bit WEP are the same encryption method and can interoperate in the wireless network. This higher level of WEP encryption uses a 104 bit (26 Hex character) as a “secret key” (set by user), and a 24 bit “Initialization Vector” (not under user control). This together

## Chapter 3 - Home Gateway Utilities

---

makes 128 bits (104 + 24). Some vendors refer to this level of WEP as 104 bits and others refer to this as 128 bits. ASUS SpaceLink products use the term 128 bits when referring to this *higher* level of encryption.

### Magic Word & Generate

Automatically generate four WEP keys. A WEP key is either 10 or 26 hexadecimal digits (0~9, a~f, and A~F) based on whether you select 64 bit or 128 bit in the WEP pull-down menu. Type a combination of up to 64 letters, numbers, or symbols in the Magic Word column, then the SpaceLink Home Gateway Manager uses an algorithm to generate four WEP keys for encryption. If you want to type in the keys manually, leave this field blank.

The SpaceLink family of products all use the same algorithm to generate the keys so that they can all use the same WEP key.

---

**Note: This function eases users from having to remember their passwords and is compatible to ASUS SpaceLink family of products. But this is not as secure as manual assignment.**

---

### WEP Key

At most four keys can be set. A WEP key is either 10 or 26 hexadecimal digits (0~9, a~f, and A~F) based on whether you select 64 bit or 128 bit in the WEP pull-down menu. The home gateway and ALL of its wireless clients MUST have at least the same default key.

### Default Key

The Default Key field lets you specify which of the four encryption keys you use to transmit data on your wireless LAN. As long as the SpaceLink Home Gateway or wireless mobile client with which you are communicating has the same key in the same position, you can use any of the keys as the default key. If the home gateway and ALL of its wireless clients use the same four WEP keys, select “key rotation” to maximize security. Otherwise, choose one key in common as the default key.

### Authentication Method

It is suggested to select “Shared Key Only”. If “Open System Only” or “Shared Key and Open System” is used, the home gateway may accept connection requests from unauthorized wireless clients.

---

**Click the “Finish” button to save your new settings and restart the SpaceLink Home Gateway or click “Save” and restart later.**

---

### Basic Setup - LAN Configuration

This page does not require any settings for general use.

**ASUS Spacelink WL 500**

Internet Wireless Lan

#### Basic Setup >> LAN Configuration

The home gateway supports up to 254 IP addresses for your local network. The IP address of a local machine can be assigned manually by the network administrator or obtained automatically from the home gateway if the DHCP server is enabled. By default, the following IPs have been reserved for PPTP connections: **192.168.x.2 ~ 192.168.x.9**

#### IP Settings

IP settings for the Home Gateway:

**IP Address:** 192 . 168 . 123 . 1

**Subnet mask:** 255 . 255 . 255 . 0

**Host name:** spacelink

#### DHCP Server

If the DHCP server is enabled, a local machine adopting automatic TCP/IP configuration can acquire the following settings from the home gateway: IP address, address lease time, Domain Name Server (DNS), and Domain Name. The assigned IP is selected from the IP pool, a predefined continuous address segment.

Enable the DHCP server?  Yes  No

**IP Pool Starting Address:** 192 . 168 . 123 . 21

**IP Pool Ending Address:** 192 . 168 . 123 . 254

**DNS Server 1:** . . . .

**DNS Server 2:** 192 . 168 . 123 . 1

**Domain Name:** home

**IP Address Lease Time:** 86400 seconds

Save:	Save the above settings and continue.
Restore:	Clear the above settings and restore the settings in effect.
Finish:	Finish all settings and restart the Home Gateway now.

Click the “Finish” button to save your new settings and restart the SpaceLink Home Gateway or click “Save” and restart later.

### Basic Setup - WAN Configuration

The settings that you need to perform will vary depending on the role that your SpaceLink Home Gateway will play.

### Network Backbone

No software setting is necessary in the SpaceLink Home Gateway.

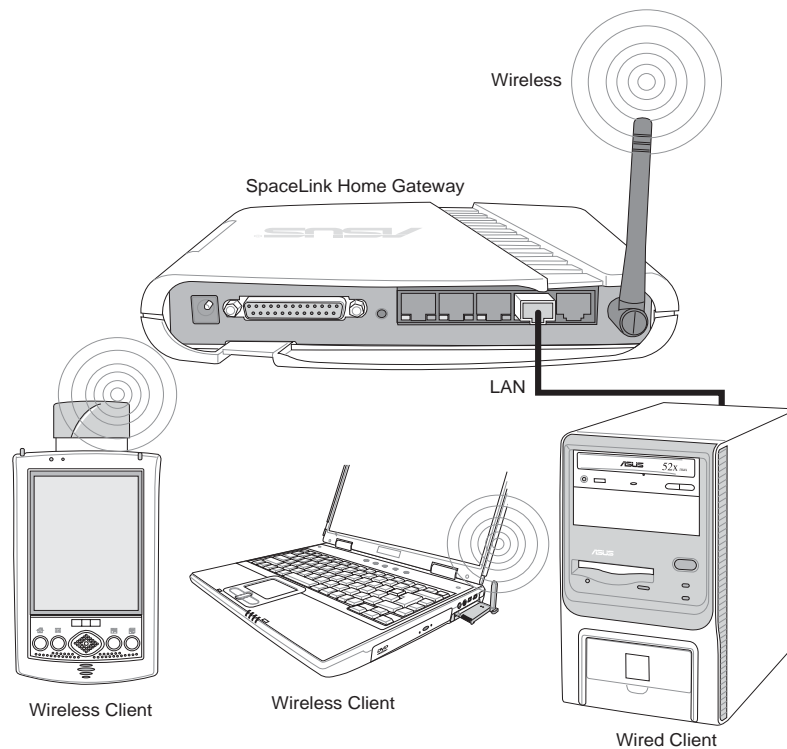

# Chapter 3 - Home Gateway Utilities

## Agent to an ISP

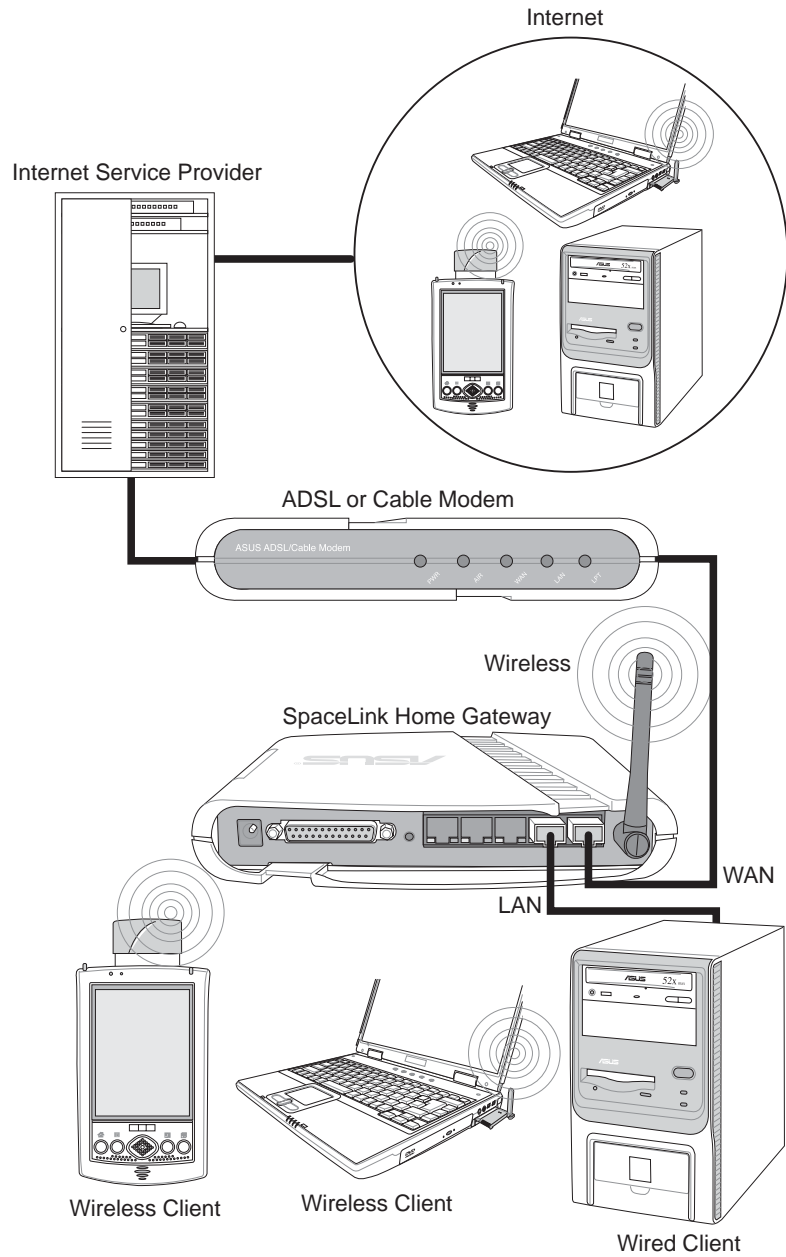

3. Utilities

## Agent to an ISP (Cont.)

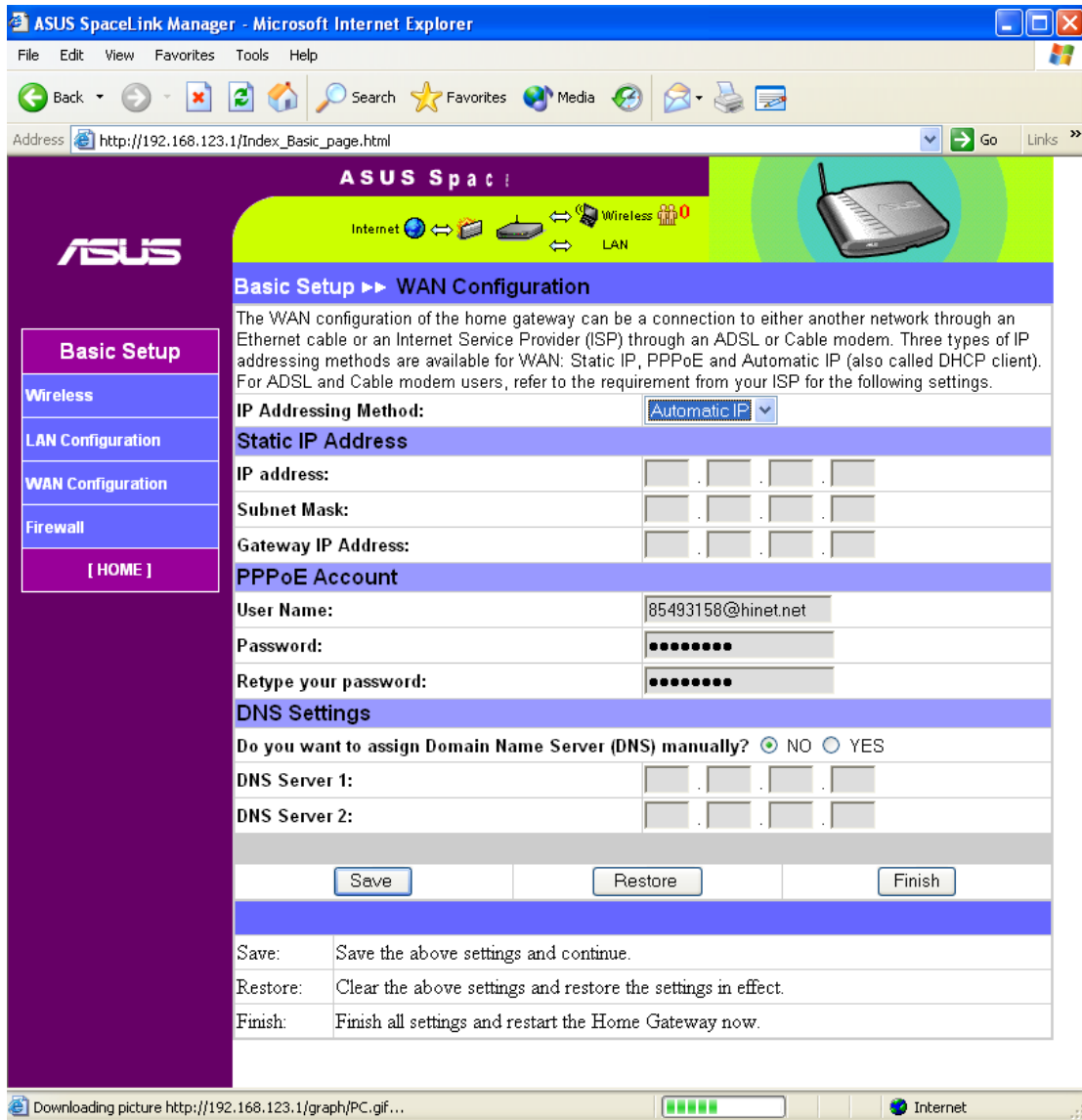

### Static IP Address

**IP Address** - Normally, this is Dynamic (because fixed IP accounts cost more) and should be set to Automatic IP. Do not use “Static IP” if your ISP’s documentation does not mention an IP Address. If your ISP provided an IP Address with instructions to use it, select Static IP from “IP Addressing Method” and enter the address into the provided field.

### PPPoE Account

**User Name** - The name of your Internet account provided by your ISP. Some ISPs work with the entire account name along with the hosting domain (such as yourname@yourdomain.com) and others require that you enter only the account name (yourname). See the example above.



## Chapter 3 - Home Gateway Utilities

---

### Agent to an ISP (Cont.)

**Password** - Enter the password for your Internet account.

**Retype your password** - Re-enter the password for confirmation.

### DNS Settings

**DNS Server** - Normally this is automatic and you would answer “NO” to the question about manually assigning DNS. If you are given instructions from your ISP to enter DNS addresses, select “YES” to manually assigning DNS and enter the IP addresses here. You can set the DNS server anytime using any connection type (Static IP, PPPoE, or Automatic IP).

---

**Click the “Finish” button to save your new settings and restart the SpaceLink Home Gateway or click “Save” and restart later.**

---

### Agent to Another Network

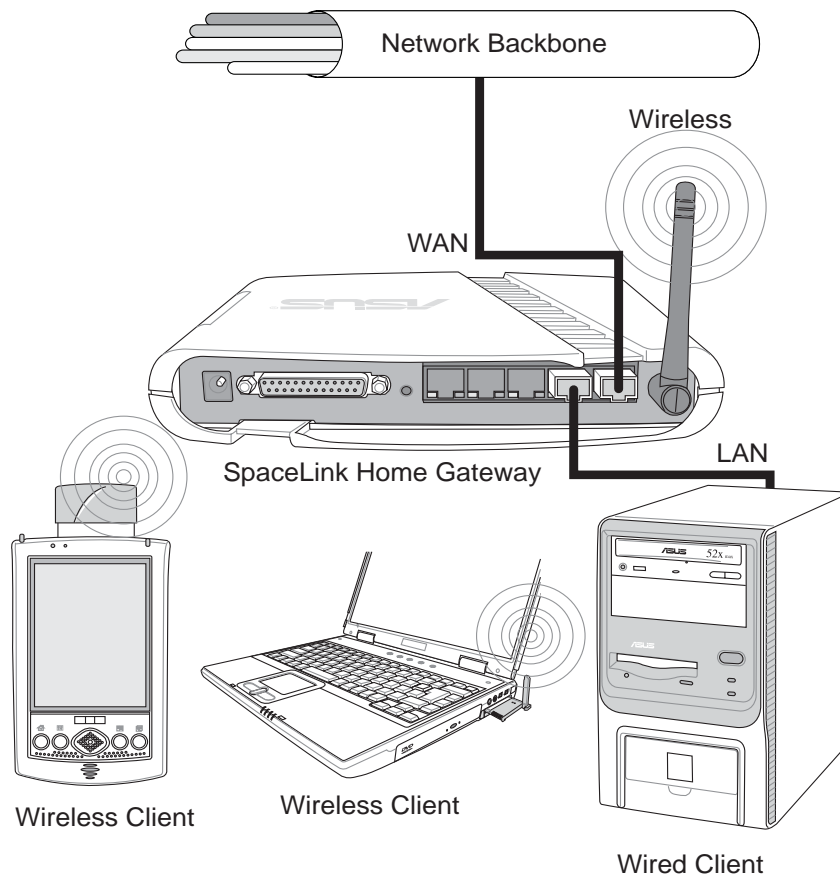

To connect to an existing network, the IP address of the home gateway can be assigned manually or automatically obtained from a DHCP server. In the first case, fill in the IP address and the DNS address(es).

### Automatic IP

This parameter determines if the SpaceLink Home Gateway will send out a DHCP request during bootup. If you have a DHCP server on the network, set this option so that the SpaceLink Home Gateway can receive an automatic IP address assignment.

If you have a DHCP (Dynamic Host Configuration Protocol) server on the network, then the DHCP server will automatically assign the SpaceLink Home Gateway an IP address when the SpaceLink Home Gateway is powered up. To determine what IP address has been assigned to the SpaceLink Home Gateway, review the IP address on the “Status” page available on the “Main Menu”.

## Chapter 3 - Home Gateway Utilities

### Static IP

The SpaceLink Home Gateway also accepts a static IP address. You may manually configure the IP address and subnet mask on the “IP Config” page. Enter an IP address and a subnet mask in the field provided to assign the SpaceLink Home Gateway a static IP address. If you don’t know your Gateway setting, leave it empty (not 0.0.0.0).

The screenshot shows the ASUS SpaceLink Manager interface in Microsoft Internet Explorer. The browser address bar shows `http://192.168.123.1/Index_Basic_page.html`. The page title is "ASUS SpaceLink Manager". The main content area is titled "Basic Setup >> WAN Configuration".

**Basic Setup >> WAN Configuration**

The WAN configuration of the home gateway can be a connection to either another network through an Ethernet cable or an Internet Service Provider (ISP) through an ADSL or Cable modem. Three types of IP addressing methods are available for WAN: Static IP, PPPoE and Automatic IP (also called DHCP client). For ADSL and Cable modem users, refer to the requirement from your ISP for the following settings.

**IP Addressing Method:** Static IP

**Static IP Address**

**IP address:** 192 . 168 . 39 . 33

**Subnet Mask:** 255 . 255 . 255 . 0

**Gateway IP Address:** . . . .

**PPPoE Account**

**User Name:** 85493158@hinet.net

**Password:** .....

**Retype your password:** .....

**DNS Settings**

**Do you want to assign Domain Name Server (DNS) manually?**  NO  YES

**DNS Server 1:** . . . .

**DNS Server 2:** . . . .

**Buttons:** Save, Restore, Finish

**Legend:**

Save:	Save the above settings and continue.
Restore:	Clear the above settings and restore the settings in effect.
Finish:	Finish all settings and restart the Home Gateway now.

3. Utilities

### Firewall

The SpaceLink Home Gateway does not only use basic NAT to protect your local network. The SPI (Stateful Packet Inspection) firewall filters out advanced forms of attacks from the Internet. A SPI firewall remembers the context of connections and continuously updates this information in dynamic connection tables.

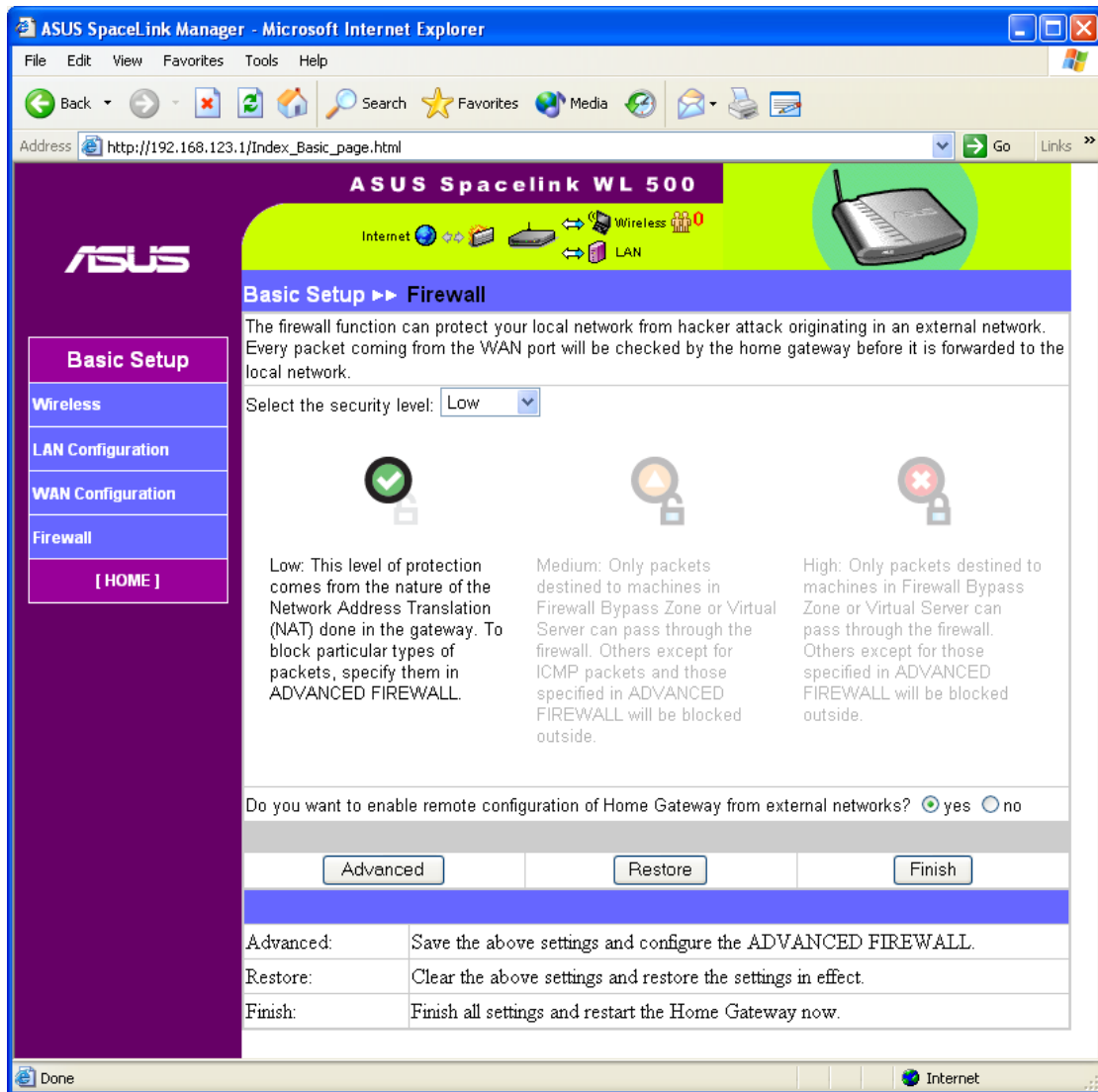

Select the security level for the firewall that you require. “Low” should be good enough for most home users. “Medium” and “High” levels can provide more protection for your local network but they may also stop you from executing some Internet applications. These problems can be overcome through advanced configuration options by clicking on the **Advanced** button.

**Click the “Finish” button to save your new settings and restart the SpaceLink Home Gateway or click “Save” and restart later.**

### Wireless Access Control

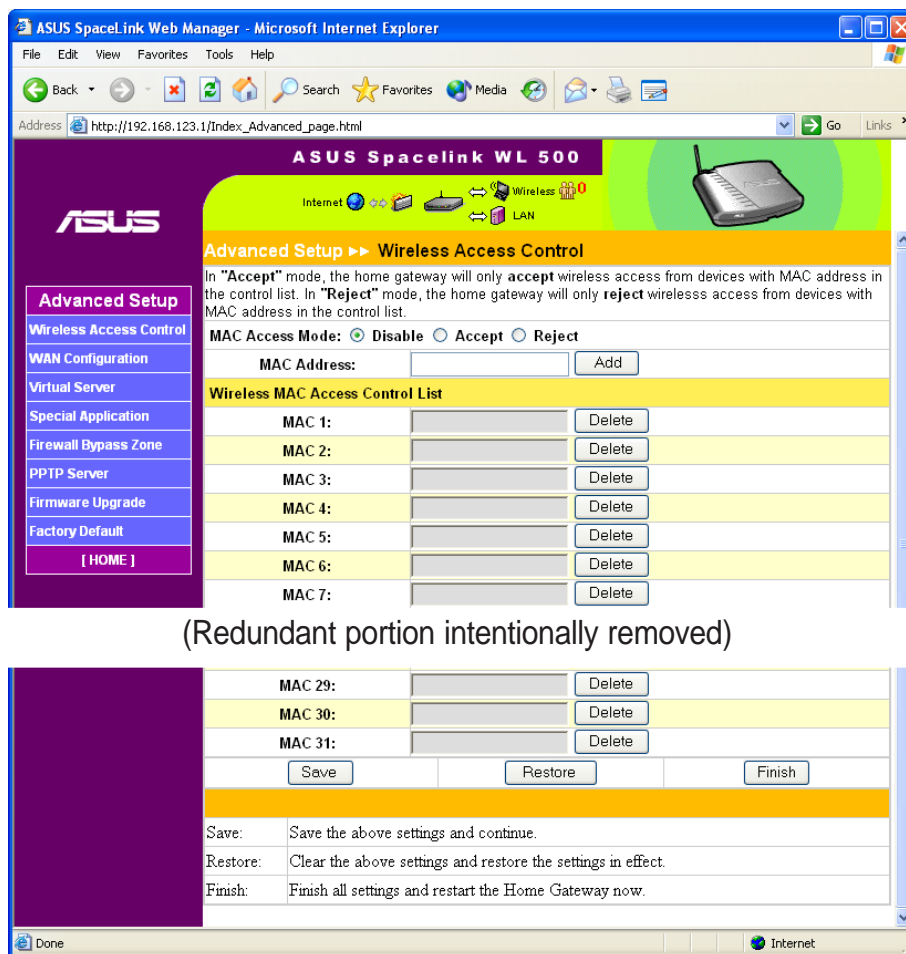

To add security, the SpaceLink Home Gateway has the ability to only associate with or not associate with wireless mobile clients that have their MAC address entered into this page.

The default setting of “Disable” will allow any wireless mobile client to connect. “Accept” will only allow those entered into this page to connect. “Reject” will prevent those entered into this page from connecting.

#### Adding a MAC Address

To add a MAC address, enter the 12 hexadecimal characters into the white box next to “MAC Address:” and click the **Add** button. The MAC address will be placed in the control list below. Only a total of 31 MAC addresses can be entered into this page so determine which will be the lesser; those you wish to accept or those you wish to reject and click the appropriate “MAC Access Mode”.

---

**Click the “Finish” button to save your new settings and restart the SpaceLink Home Gateway or click “Save” and restart later.**

---

# Advanced WAN Configuration

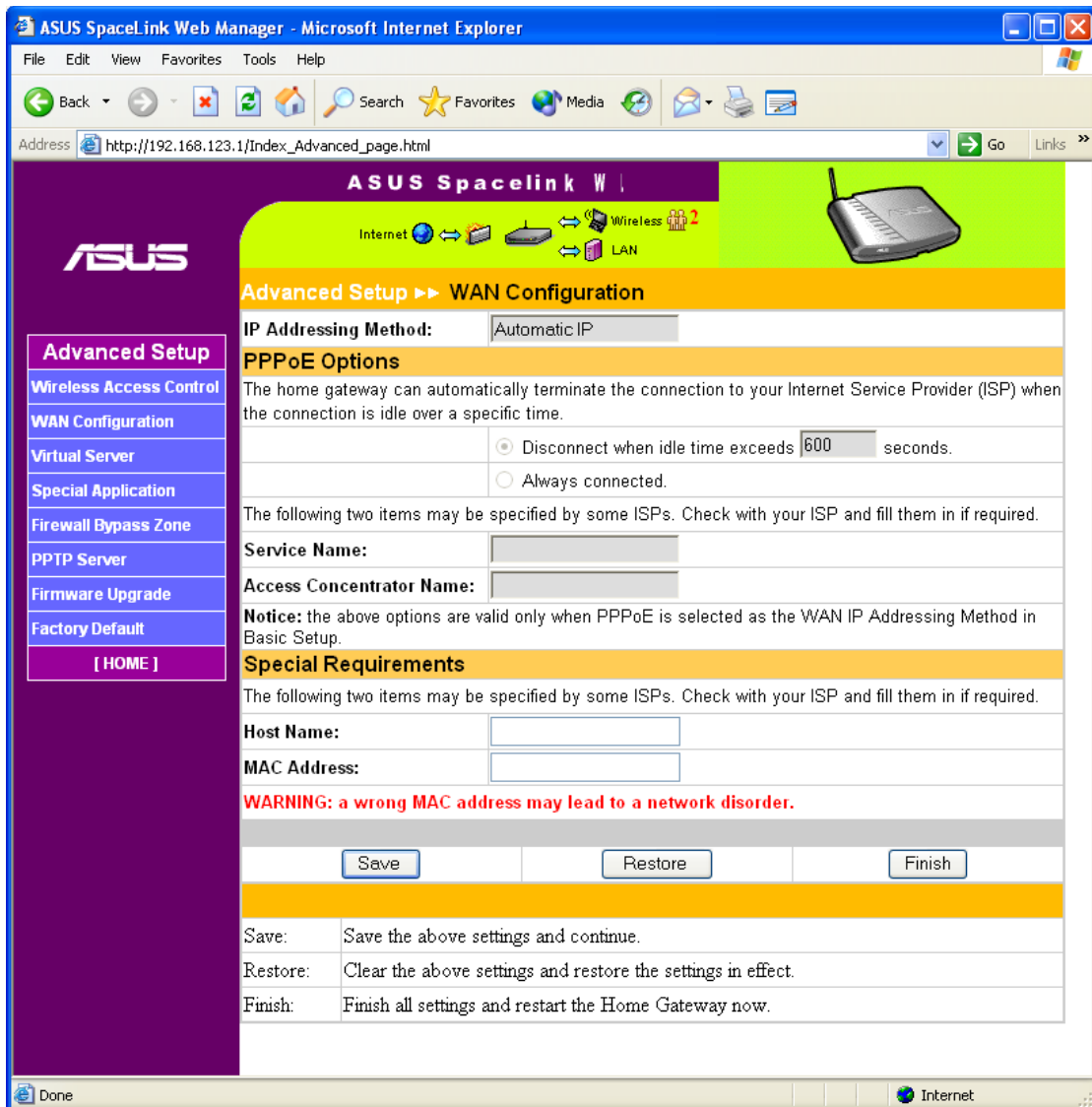

**IP Addressing Method** - This displays the current selection in the Basic Setup WAN Configuration.

### PPPoE Options

The SpaceLink Home Gateway can automatically terminate the connection to your Internet Service Provider (ISP) when the connection is idle over a specific time.

**Click the "Finish" button to save your new settings and restart the SpaceLink Home Gateway or click "Save" and restart later.**

## Chapter 3 - Home Gateway Utilities

---

**Disconnect when idle time exceeds seconds** - Enter the number of seconds of inactivity to disconnect you from your ISP.

**Always connected** - This will always keep you connected to your ISP and reconnect if connection fails.

The following two items may be specified by some ISPs. Check with your ISP and fill them in if required.

**Service Name** - Fill this in if required by your ISP.

**Access Concentrator Name** - Fill this in if required by your ISP.

---

**Note:** The above options are valid only when PPPoE is selected as the WAN IP Addressing Method in Basic Setup. Otherwise they will be grayed out.

---

### Special Requirements

The following two items may be specified by some ISPs. Check with your ISP and fill them in if required.

**Host Name** - Fill this in if required by your ISP.

**MAC Address** - Fill this in if required by your ISP.

---

**WARNING:** A wrong MAC address may lead to a network disorder.

---

## Virtual Server

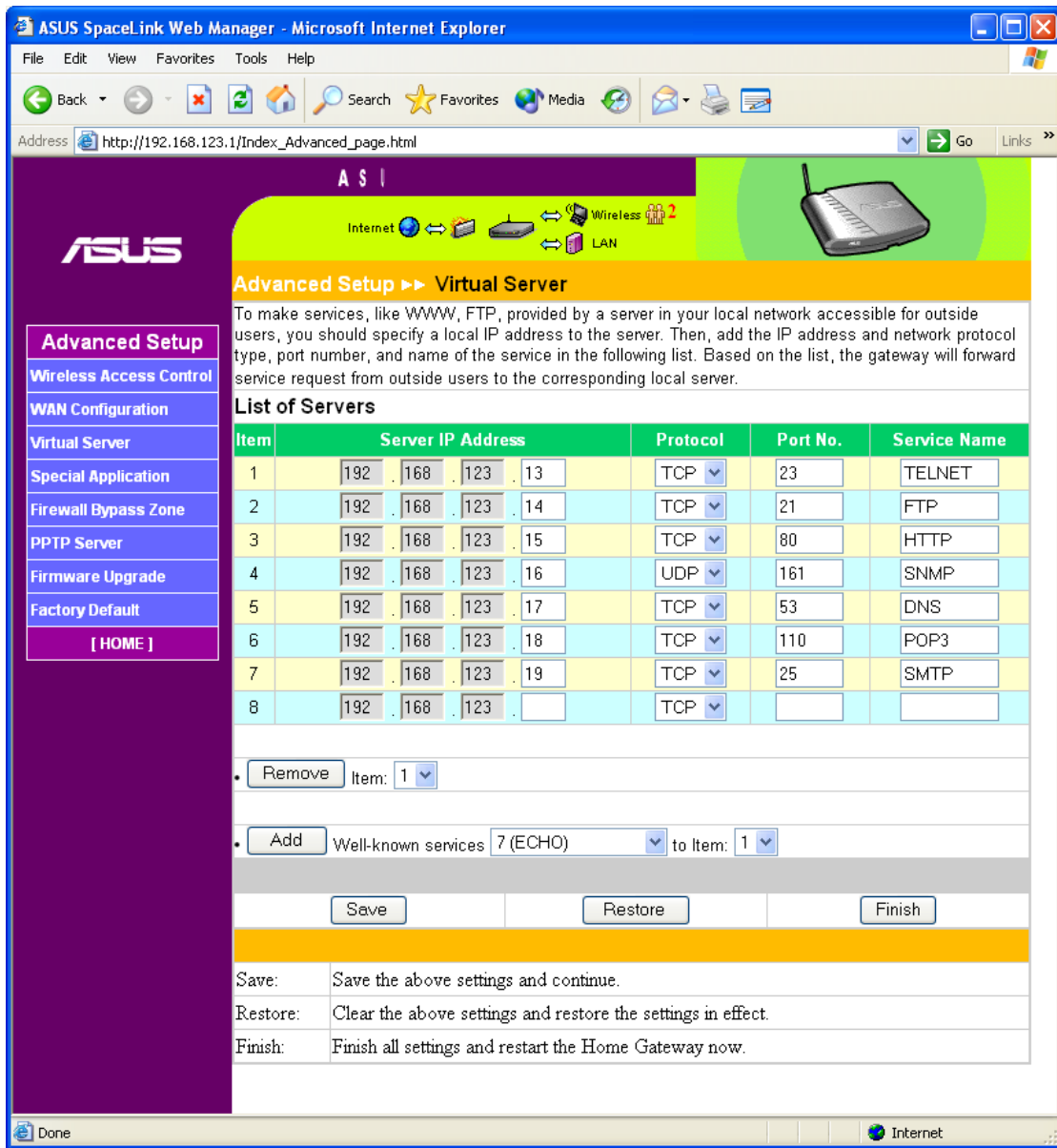

To make services, like WWW, FTP, provided by a server in your local network accessible for outside users, you should specify a local IP address to the server. Then, add the IP address and network protocol type, port number, and name of the service in the following list. Based on the list, the gateway will forward service request from outside users to the corresponding local server.

**Click the “Finish” button to save your new settings and restart the SpaceLink Home Gateway or click “Save” and restart later.**



## Chapter 3 - Home Gateway Utilities

---

### List of Servers

Enter the IP address of the servers under the SpaceLink Home Gateway. Select a protocol, port number, and enter any description you want for the service name.

### Removing an Entry

To remove one of the 8 entries, select the “Item” (1 2 3 4 5 6 7 8) number and click the **Remove** button.

### Adding an Entry

Besides entering the data manually, you can also select from a commonly used entries. To add an often used service to one of the 8 entries, select the service {7 (ECHO) 21 (FTP) 23 (TELNET) 25 (SMTP) 53 (DNS) 79 (FINGER) 80 (HTTP) 110 (POP3) 161 (SNMP) 162 (SNMP TRAP)} and select the “Item” (1 2 3 4 5 6 7 8). Click the **Add** button to replace the entry that you have selected.

# Special Application

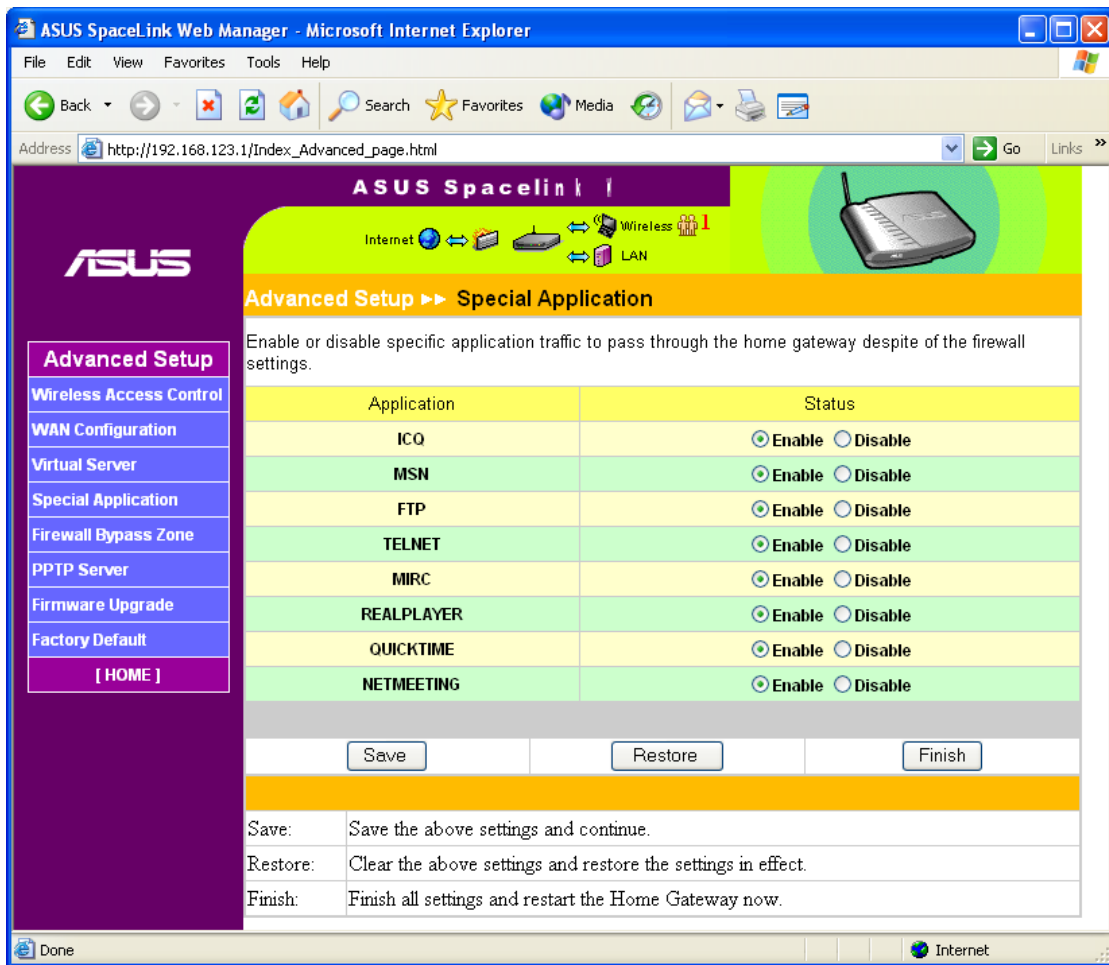

Enable or disable specific application traffic to pass through the home gateway despite any firewall settings in the SpaceLink Home Gateway.

Application Status - These commonly used applications are normally allowed to pass through the firewall. Choose Disable if you do not want users to use the following applications:

ICQ, MSN, FTP, TELNET, MIRC, REALPLAYER, QUICKTIME, NETMEETING.

---

**Click the "Finish" button to save your new settings and restart the SpaceLink Home Gateway or click "Save" and restart later.**

---

## Firewall Bypass Zone

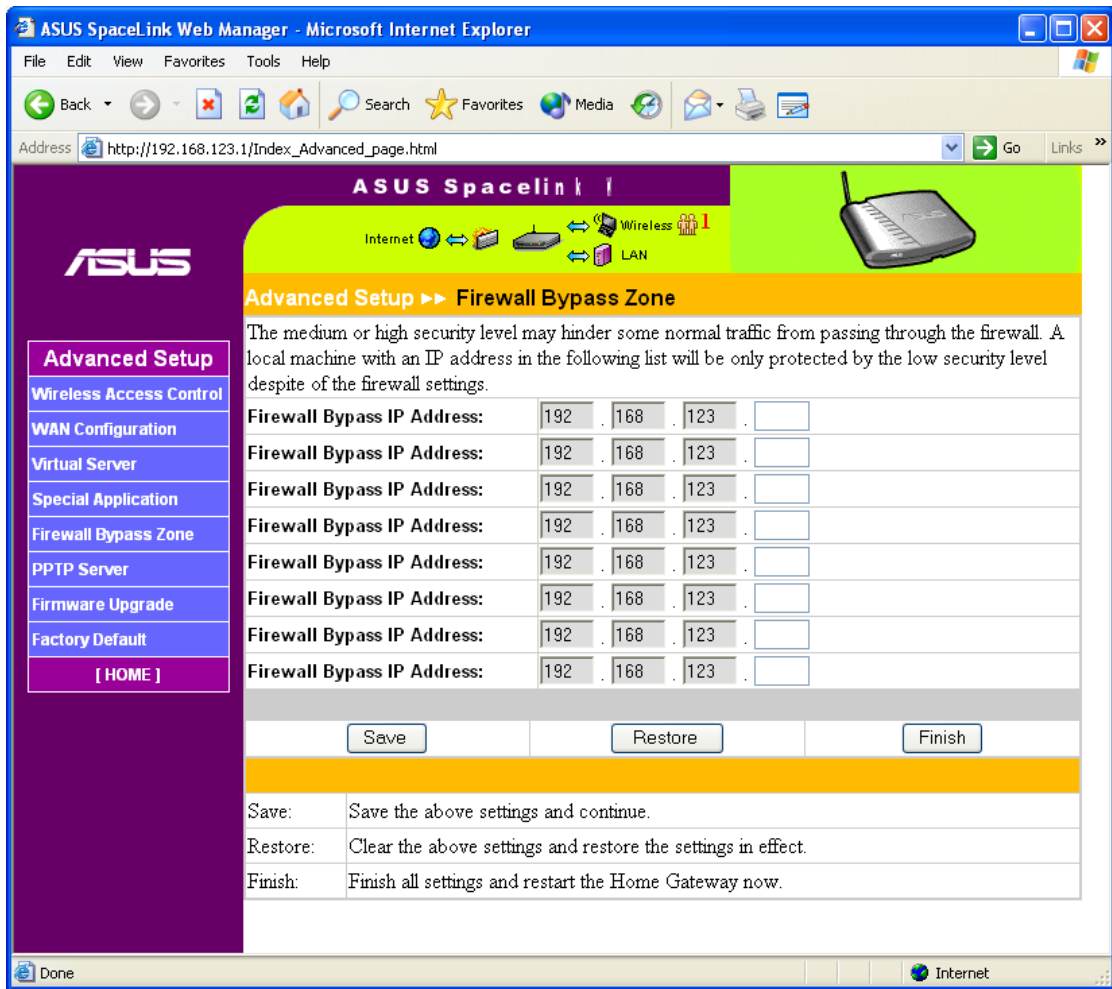

3. Utilities

The medium or high security level may hinder some normal traffic from passing through the firewall. A local machine with an IP address in the following list will be only protected by the low security level despite of the firewall settings.

**Firewall Bypass IP Address** - Enter the IP address of the computer you wish to have access through the firewall.

## PPTP Server

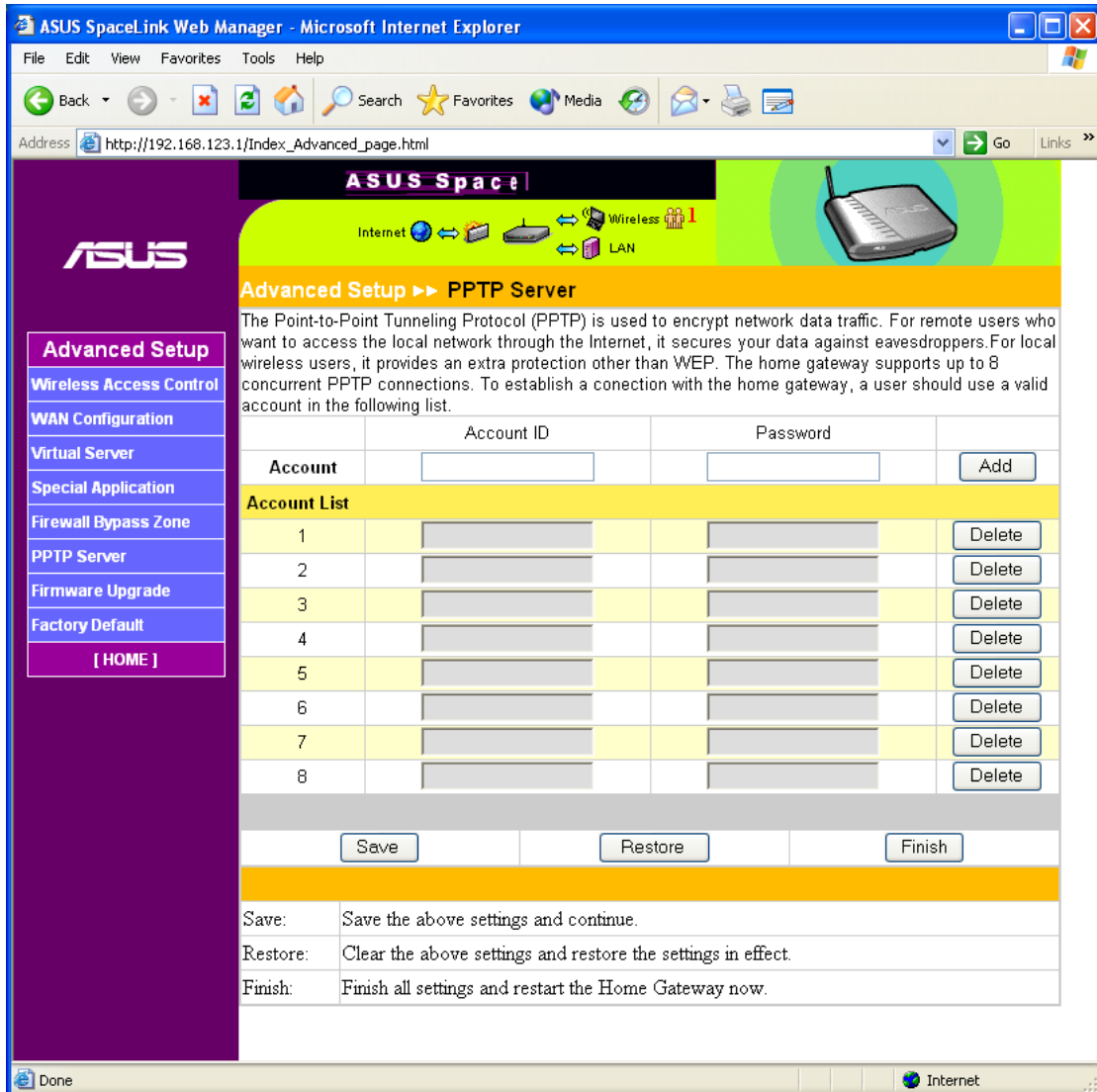

The Point-to-Point Tunneling Protocol (PPTP) is used to encrypt network data traffic. For remote users who want to access the local network through the Internet, it secures your data against eavesdroppers. For local wireless users, it provides an extra protection other than WEP. The home gateway supports up to 8 concurrent PPTP connections. To establish a connection with the home gateway, a user should use a valid account in the following list.

### Account

**Account ID** - Enter name or ID number.

**Password** - Enter password.

**Account List** - Click the Add button to move the Account ID and Password entries into this list.

### Firmware Upgrade

This page reports the Flash Code (Firmware) version installed in the SpaceLink Home Gateway. Periodically, a new Flash Code is available for the SpaceLink Home Gateways on ASUS's Web site. You can update the SpaceLink Home Gateway's Flash Code using the Firmware Upgrade page under the Advanced Setup menu of the Web Manager. If you are experiencing a problem with your SpaceLink equipment, a Technical Support representative may ask you to report the device's Flash Code (Firmware) version.

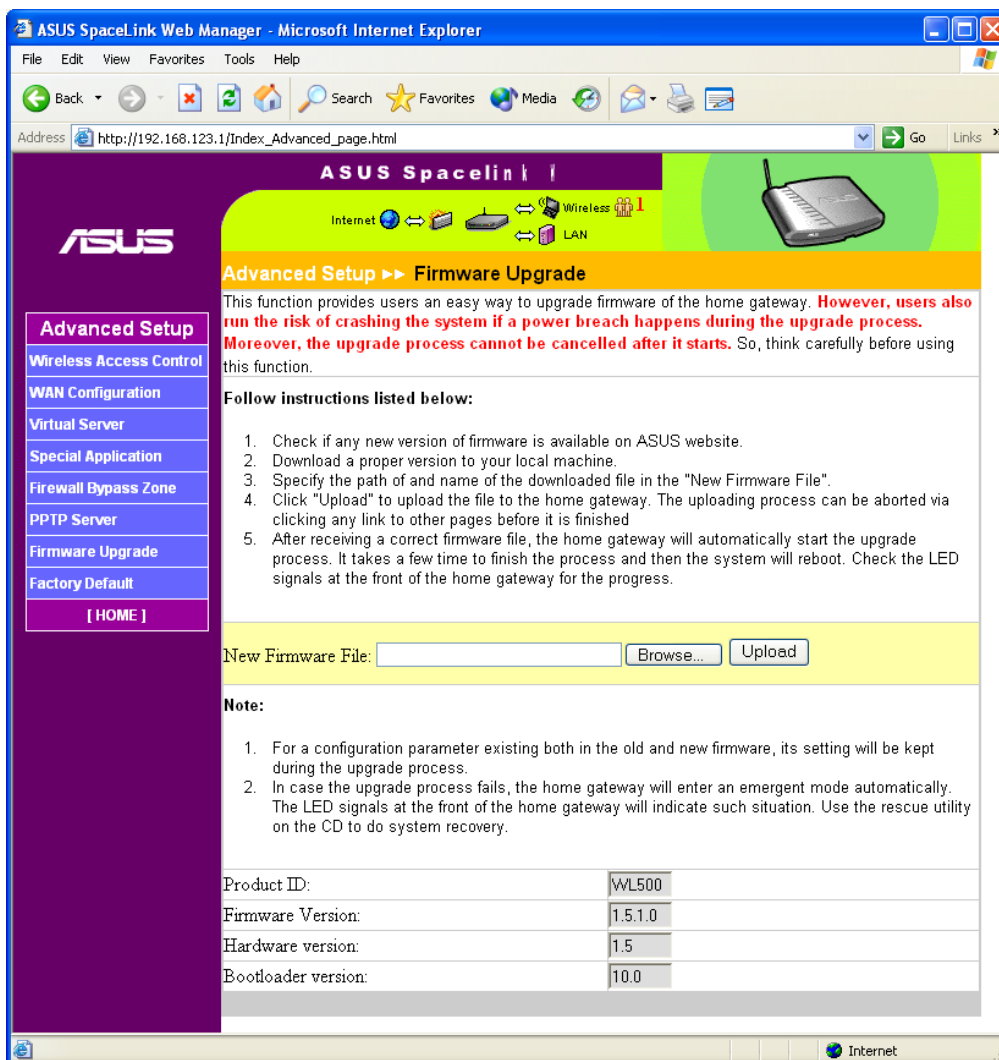

The firmware upgrade takes approximately 60 to 90 seconds. When the firmware upgrade is completed, you will be directed to the home page.

## Chapter 3 - Home Gateway Utilities

### Restoring Factory Default Settings

#### Web Manager

You can reset all settings to their factory defaults through the web manager using the “Factory Default” page in “Advanced Setup”. Click the **Restore** button and wait about 30 seconds before trying to access the SpaceLink Home Gateway.

#### Hardware

You can reset all settings to their factory defaults manually by pushing the “Restore” button in a hole on the back of the SpaceLink Home Gateway while it is ON. Use a pen or straightened paper clip to hold the “Restore” button depressed over 5 seconds until all the LEDs on the front of the SpaceLink Home Gateway start blinking. Release the button and the SpaceLink Home Gateway will reboot.

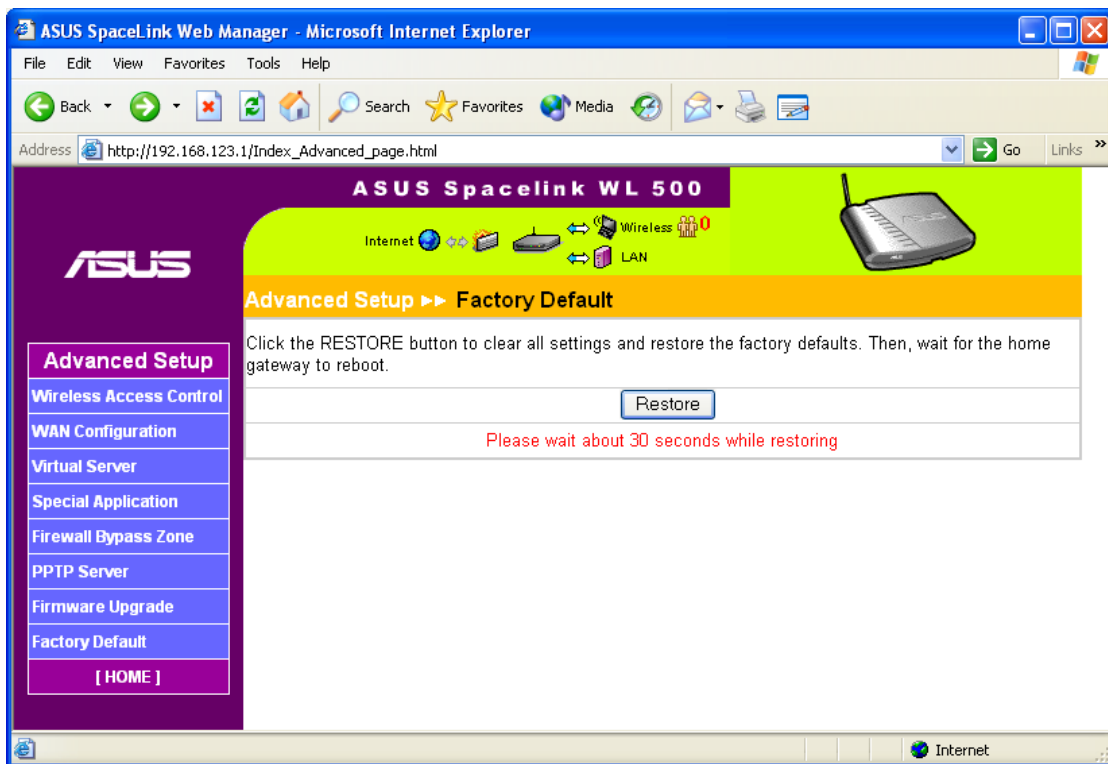

You will be notified when factory default settings are restored while using the web manager.

#### SpaceLink Setup Information

 **Success !!**

**All new settings are saved to Home Gateway now. Wait for system reboot !**

If you don't want to configure Home Gateway anymore, close your browser or click 'Logout' after Home Gateway is ready again.

[Logout](#)

### Firmware Restoration

This utility will automatically search out failed SpaceLink Home Gateways and upload a firmware that you specify. The process takes about 3 to 4 minutes and during this process the PWR, AIR, and WAN LEDs will remain lit while the LAN LED will flash slowly.

The Firmware Restoration utility is an emergency rescue tool to restore a SpaceLink Home Gateway which has failed during a previous firmware upload. A failed firmware upgrade will cause the SpaceLink Home Gateway to enter a failure mode, waiting for the user to use the Firmware Restoration utility to find and upload a new firmware. This is not a firmware upgrade utility and cannot be used on a working SpaceLink Home Gateway. Normal firmware upgrades must be done through the web manager.

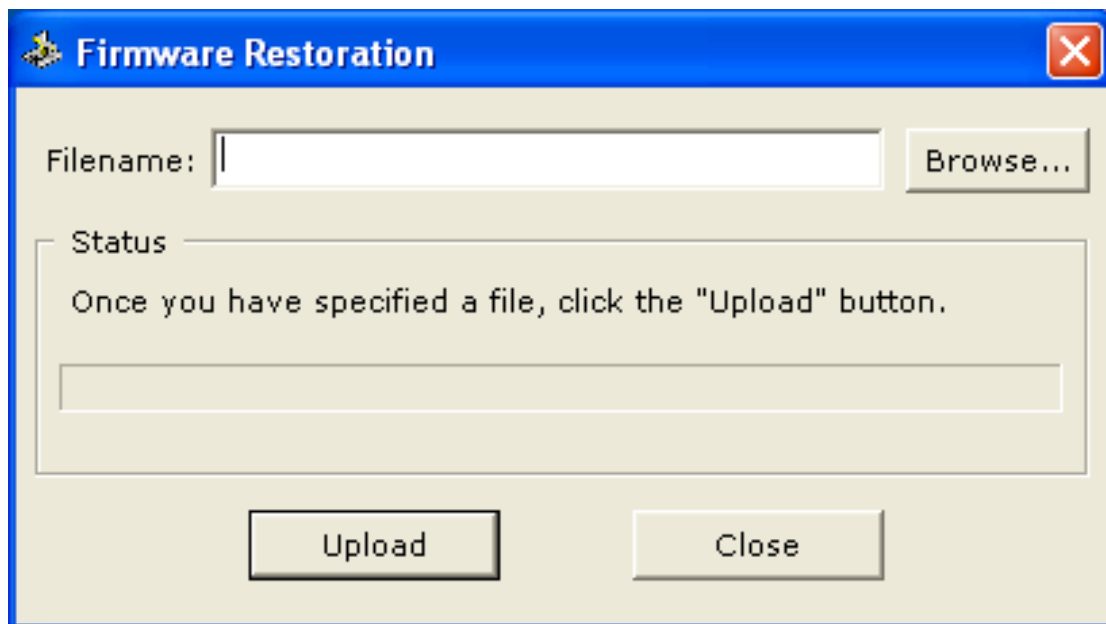

### Using a Hub

If you have problems upload a firmware while using a network hub, try connecting your computer directly to the LAN port. Either 10Base-T or 100Base-TX connections will work.

### Printer Setup Wizard

This utility helps you setup your computers to utilize the printer server function of the SpaceLink Home Gateway.

### Add Printer Wizard

You should add your printer to your computer to simplify the SpaceLink Home Gateway Printer Setup Wizard. If you run the “Printer Setup Wizard” without your printer driver installed, it will direct you to the “Add Printer Wizard”.

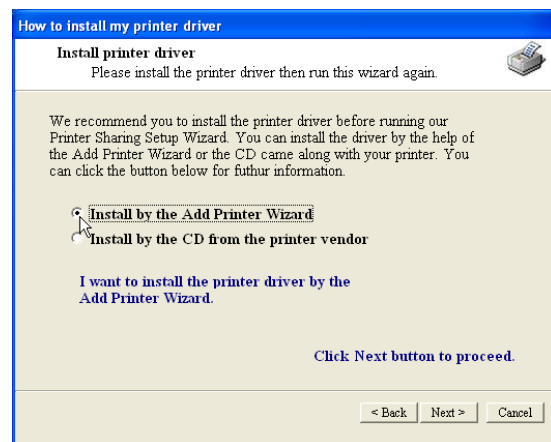

- (1) Run the “Add Printer Wizard” from **Start | Printers and Faxes | Add Printer**.
- (2) Choose “Install by the Add Printer Wizard”.

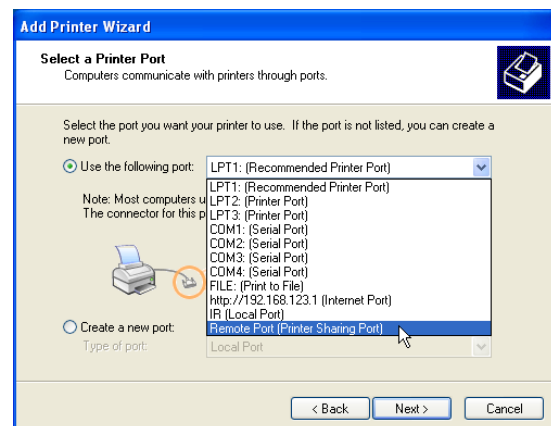
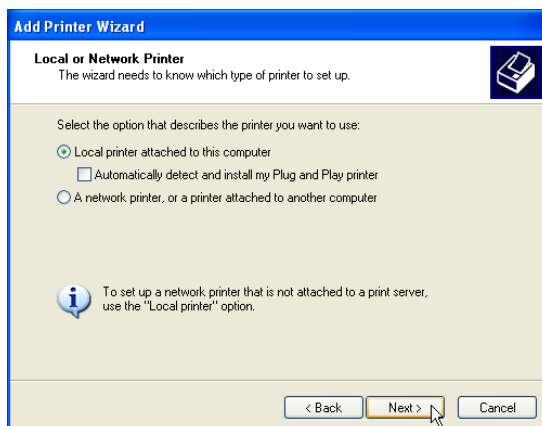

- (3) Choose “Local printer attached to this computer”.
- (4) Choose “Remote Port (Printer Sharing Port)”. If this is not available, select LPT1.



# Chapter 3 - Home Gateway Utilities

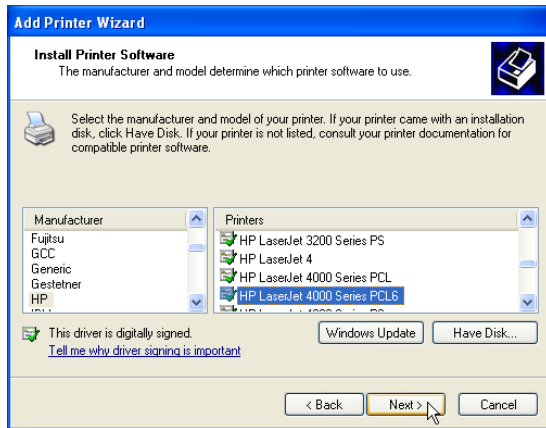

(5) Find your manufacturer and model. Click **Have Disk** if you cannot find it in the list and use the driver provided with your printer.

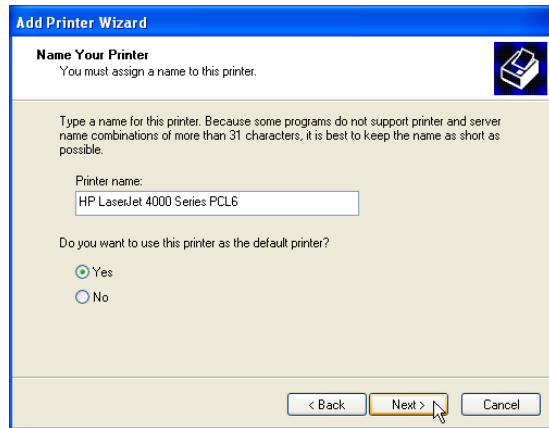

(6) Click **Next** to set this as your default printer.

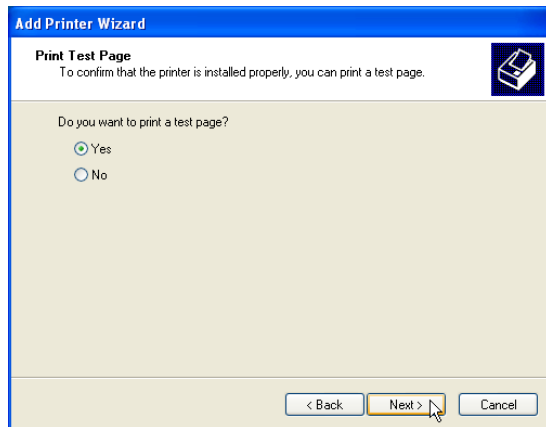

(7) You can print a test page.

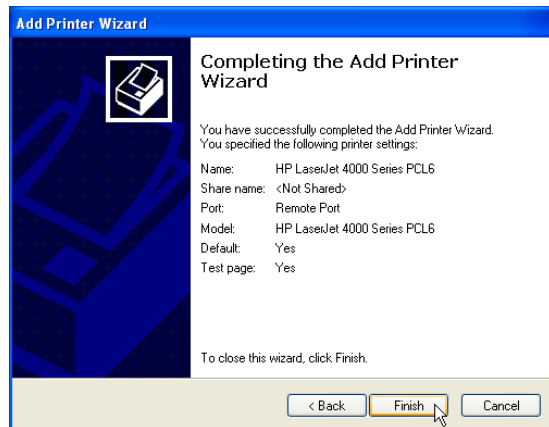

(8) Click **Finish** to close the wizard.

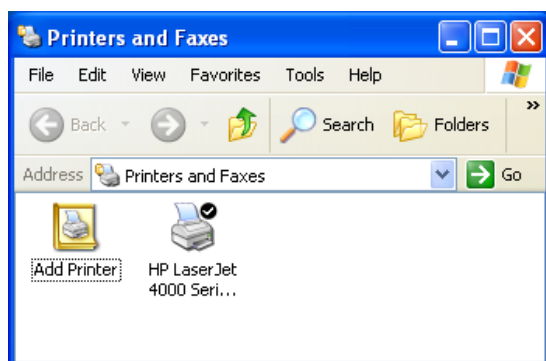

Your printer will show in the “Printers and Faxes” window and the check mark shows that it is set as your default printer.

## Chapter 3 - Home Gateway Utilities

### Printer Setup Wizard

The wizard will explore all available SpaceLink Home Gateways and model information of the printers attached to them in your local network.

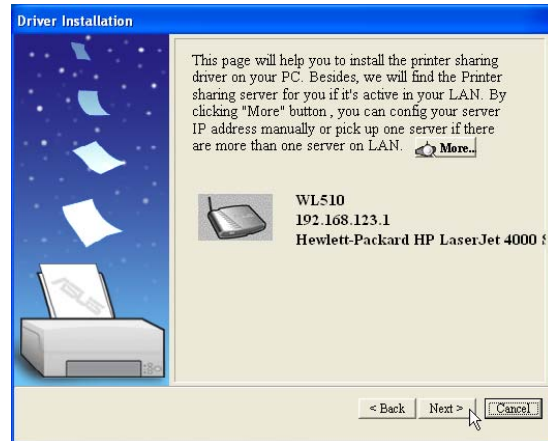
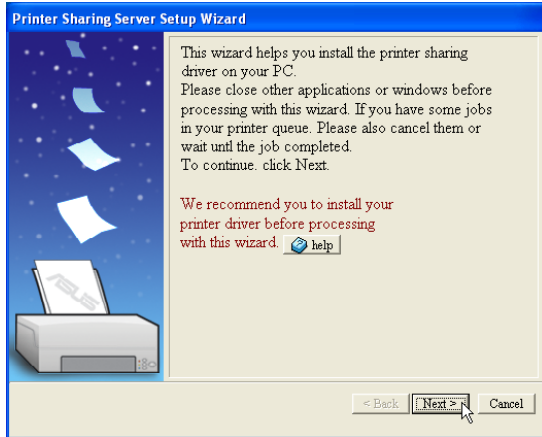

- (1) If you already have your printer installed on your printer port (LPT1), it will make this setup process much easier. See next page for instructions. Run the Printer Setup Wizard from the Windows Start menu.
- (2) If the printer is found, the name of the printer will be shown on this screen.

**Note:** If there is an error communicating with the printer, you will get this message.

If you can see this message, this means no Server found during this search. Please click "More" to search again after checking all the settings.

Make sure that the printer is ON, ready, and connected. Click **Back** and **Next**.

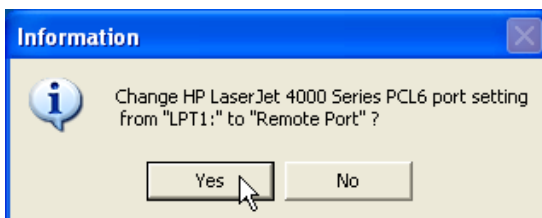

- (3) This setup wizard will change your default printer to use "Remote Port" which is serviced by the SpaceLink Home Gateway.

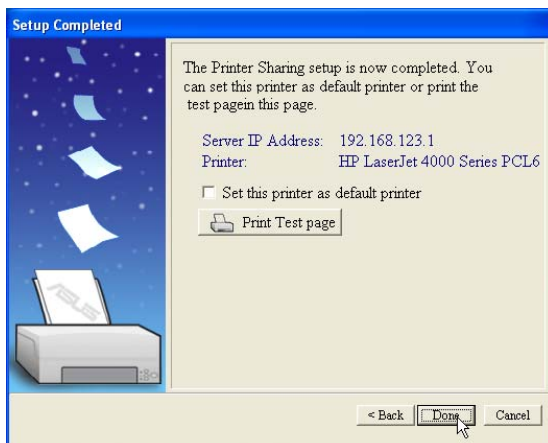

- (4) Click **Done** when setup is complete.

## Verifying Your Printer

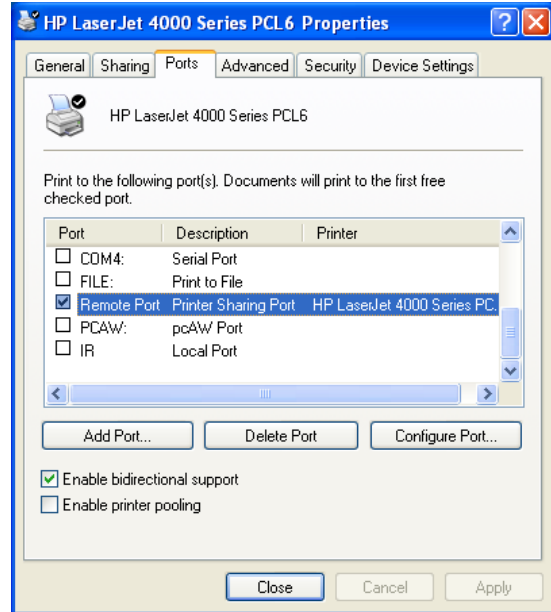
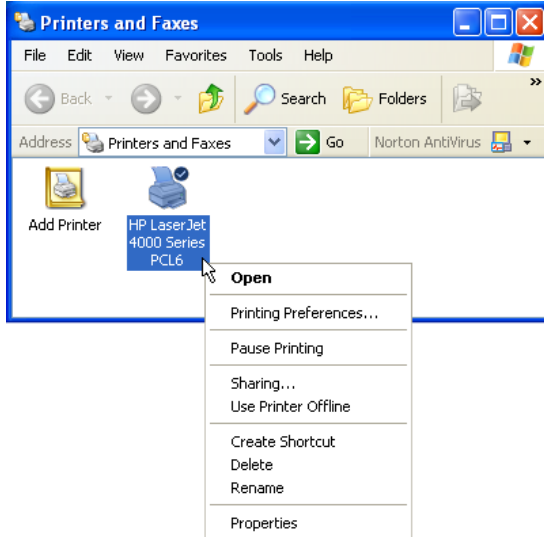

After setting up the printer, a printer icon will appear in Windows' "Printers and Faxes". Right click the printer icon and choose **Properties** to configure the printer.

If your printer was previously setup, the SpaceLink Home Gateway printer setup wizard will change your printing port from your local LPT1 (parallel) port to "Remote Port". If necessary, you can change this back at anytime or use Windows "Add Printer" to setup another printer on whatever port you require.

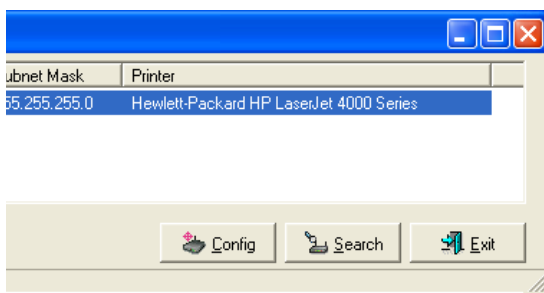

When properly setup, the SpaceLink Home Gateway will show the printer name in the "Homegateway Discovery" utility and show "on-line" under the "Printer Server" on the "Status" page of the web manager.

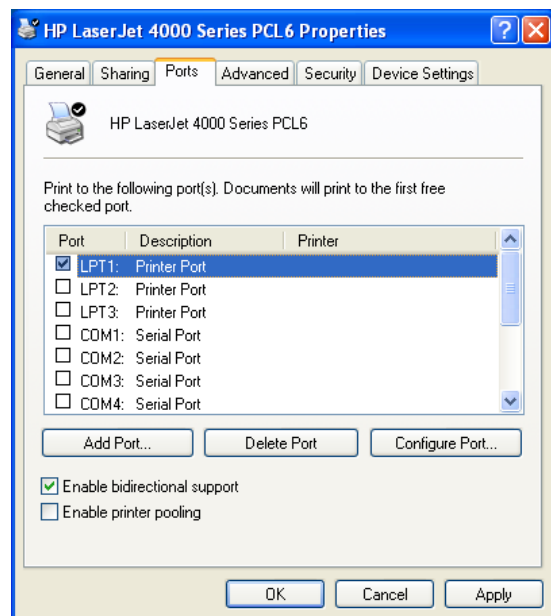

### VPN Client

A virtual private network (VPN) is the extension of a private network that encompasses links across shared or public networks like the Internet. A VPN enables you to send data between two computers across a shared or public intranet in a manner that emulates the properties of a point-to-point private link. The VPN Client utility help you to create and configure the VPN connections.

#### Starting VPN Client

Click the Windows Start button, point to Programs, point to ASUS Wireless Homegateway Utilities, and then click VPN Client.



#### Main Window

The main windows shows all the available VPN connections on your system. Click **Make New Connection** to open the VPN Connection Wizard. Follow the instructions on the next page to create a new VPN connection. When you finish, the VPN connection name will appear in the list box.

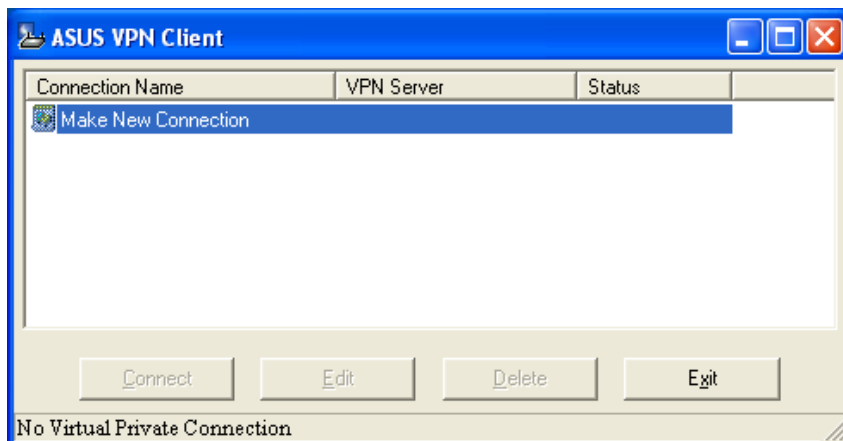

## Chapter 3 - Home Gateway Utilities

### VPN Connection Wizard

The VPN Connection Wizard helps you create a new virtual private network (VPN) connection. On the main window, double-click **Make New Connection** from the connections list box, then the VPN Connection Wizard dialog box appears. Follow the on-screen instructions to specify settings for your connection.

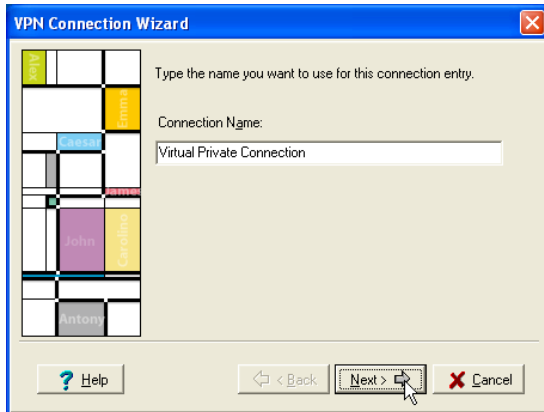

Enter a unique name for this new connection entry. The name is used to identify this connection. This name is not case-sensitive. Click **Next**.

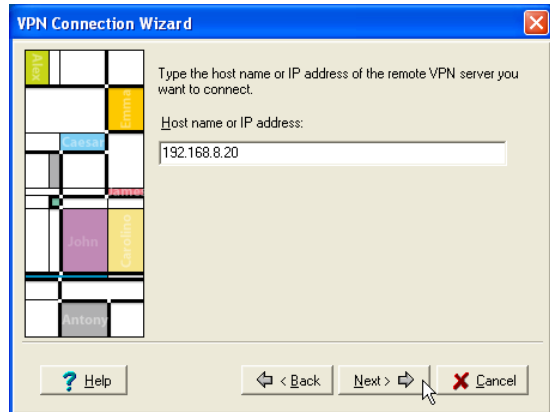

Enter the host name or IP address of the remote VPN server to which you wish to connect, and then click **Next**.

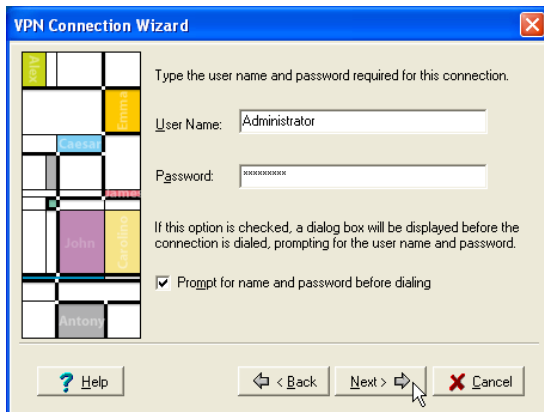

Enter the user name/password for this connection, and then click **Next**.

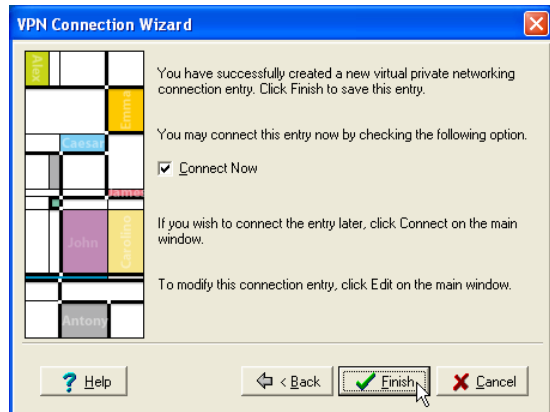

If you want to connect now, check **Connect Now** and then click **Finish**.

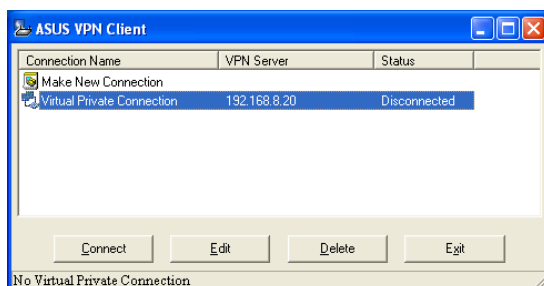

After the VPN Connection Wizard dialog box closes, your new connection entry appears in the ASUS VPN Client's main window. Select a connection name and click **Edit** to view the properties.

### Connection Properties

Select a connection name in the VPN Client window and click **Edit**.

#### Connection Name

Types the name you want to use for this connection entry in the Name field. The name is used to identify this connection. This name is not case-sensitive.

#### Properties

Opens the standard DUN properties dialog for the currently selected connection. Let user to change or set parameters for a connection entry.

When you finished setting parameters, click **OK** to close Properties dialog box and save your changes. To discard your changes, click **Cancel** to close Properties dialog box without saving your changes.

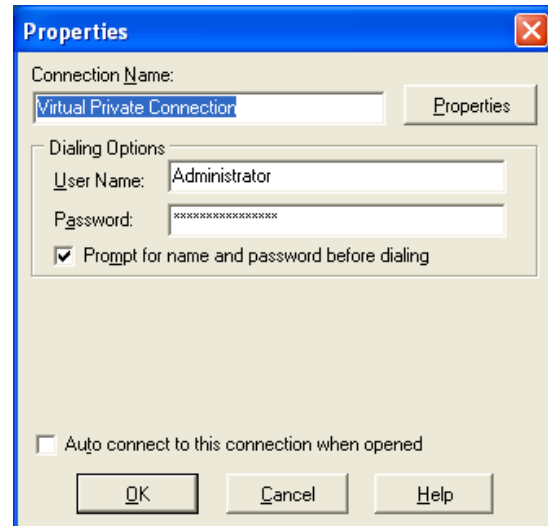

#### Dialing Options

**User Name:** Provides a space for you to type your user name for this connection.

**Password:** Provides a space for you to type your password for this connection. The password will be shown as asterisks for security.

**Prompt for name and password before dialing:** Specifies whether to request identity authentication information before attempting to connect. This information can include a user name and password. If this option is checked then a dialog box will be displayed before the connection is dialed, prompting for the user name and password. If you have already entered the user name and/or password in the edit boxes described above, then you should uncheck this box. If you want to leave the password blank on this properties page and enter your password every time you use this connection, then you should check this box.

**Auto connect to this connection when opened:** When this feature is enabled, it will automatically start connecting to this VPN connection when the VPN client utility opens.

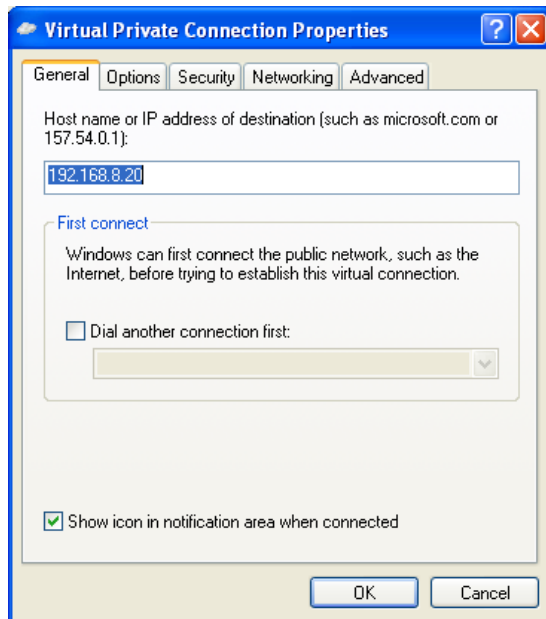

### Advanced Properties

#### Host name or IP address of destination

Enter the host name or IP address of the remote VPN server to which you are connecting, and then click **Next**.

#### Dial another connection first

Check this checkbox if you want the VPN connection to first make a call to an ISP. You must then select a dial-up connection from the drop-down list box.

### Dialing a Connection

To dial a VPN connection, select a connection name from the connections list box and click the **Connect** button. The Connect... window will show. If you only see the “Hang Up” button on the main window, that means you are already connected to the selected VPN connection. Click **Hang Up** to disconnect from the currently connected remote server.

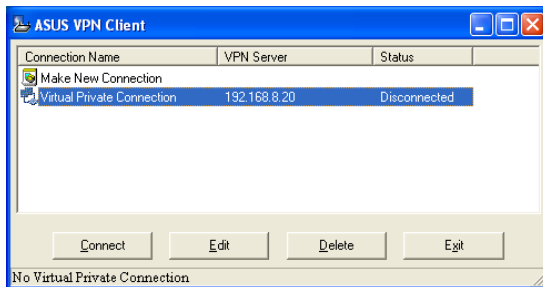

### Buttons

**Connect** - Connect to remote server.

**Hang Up** - Disconnect from remote server.

**Edit** - Displays the standard Dial-Up Networking properties dialog for the currently selected connection entry.

**Delete** - Deletes the selected connection entry.

**Exit** (or press Esc) - Closes VPN Client utility.

### 4. Wireless Performance

This section provides the user with ideas for how to improve the performance of a SpaceLink 802.11b network.

#### Site Topography

For optimal performance, locate wireless mobile clients and the SpaceLink Home Gateways away from transformers, heavy-duty motors, fluorescent lights, microwave ovens, refrigerators, and other industrial equipment. Signal loss can occur when metal, concrete, walls or floors block transmission. Locate the SpaceLink Home Gateways in open areas or add the SpaceLink Home Gateways as needed to improve coverage.

Microwave ovens operate in the same frequency band as the SpaceLink Home Gateway. Therefore, if you use a microwave within range of the SpaceLink Home Gateway you may notice network performance degradation. However, both your microwave and your the SpaceLink Home Gateway will continue to function.

#### Site Surveys

A site survey (utility provided with the SpaceLink PC card and CF card) analyzes the installation environment and provides users with recommendations for equipment and its placement. The optimum placement of 11 Mbps Home Gateways differs for 1 or 2 Mbps Home Gateways, because the locations and number of Home Gateways required are different.



### Range

Every environment is unique with different obstacles, barriers, materials, etc. and, therefore, it is difficult to determine the exact range that will be achieved without testing. However, has developed some guidelines to estimate the range that users will see when the product is installed in their facility, but there are no hard and fast specifications.

Radio signals may reflect off of some obstacles or be absorbed by others depending on their construction. For example, with two 802.11b radios, you may achieve up to 1000' in open space outdoors where two devices have a line of sight, meaning they see each other with no obstacles. However, the same two units may only achieve up to 300' of range when used indoors.

The IEEE 802.11b specification supports four data rates: 11 Mbps, 5.5 Mbps, 2 Mbps, and 1 Mbps. Operation at 1 Mbps provides greater range than operation at 11 Mbps. The SpaceLink Home Gateway will automatically adjust the data rate to maintain a usable radio connection.

Therefore, a client that is close to the SpaceLink Home Gateway may operate at 11 Mbps while a client that is on the fringe of coverage may operate at 1 Mbps. As mentioned earlier, you can configure the data rates that the SpaceLink Home Gateway will use. Note that if you limit the range of data rates available to the SpaceLink Home Gateway, you may reduce the effective wireless range of the SpaceLink 802.11b products.

### 5. Troubleshooting

The SpaceLink Home Gateway is designed to be very easy to install and operate. However, if you experience difficulties, use the information in this chapter to help diagnose and solve problems. If you cannot resolve a problem, contact Technical Support, as listed on the front of this manual.

### Common Problems and Solutions

#### Problem

SpaceLink Home Gateway does not power up:

#### Solution

- Check for faulty the SpaceLink Home Gateway power supply by measuring the output voltage with an electrical test meter.
- Check failed AC supply (power outlet)

#### Problem

Cannot communicate with the SpaceLink Home Gateway through a wired network connection.

#### Solution

- Verify network configuration by ensuring that there are no duplicate IP addresses. Power down the device in question and ping the assigned IP address of the device. Ensure no other device responds to that address.
- Check that the cables used have proper pin outs and connectors or use another LAN cable.
- Check that the hub, switch, computer, or modem connected to the WAN port of the SpaceLink Home Gateway supports 10Mbps speed.

This is the LED result if you connect the SpaceLink Home Gateway to a(n):

	Auto 10/100 Mbps Hub	Pure 100 Mbps Hub
Hub LED	ON	OFF
Home Gateway WAN LED	ON	OFF

So you will not know if the connection is bad from the SpaceLink Home Gateway Link LED alone, you will have to look at the Hub LED if you are not sure what kind of hub the SpaceLink Home Gateway is attached to.

## Chapter 5 -Troubleshooting

### Problem

The SpaceLink Home Gateway Web Manager still cannot find or connect to the SpaceLink Home Gateway after verifying the IP address and LAN cable, changes cannot be made, or password is lost.

### Solution

In case the SpaceLink Home Gateway is inaccessible, you can restore the SpaceLink Home Gateway's factory default settings. Use a straightened paper clip to press the button located in the hole labeled "Reset" on the back of the SpaceLink Home Gateway and keep it depressed over 5 seconds. The LEDs will flash when reset is successful.

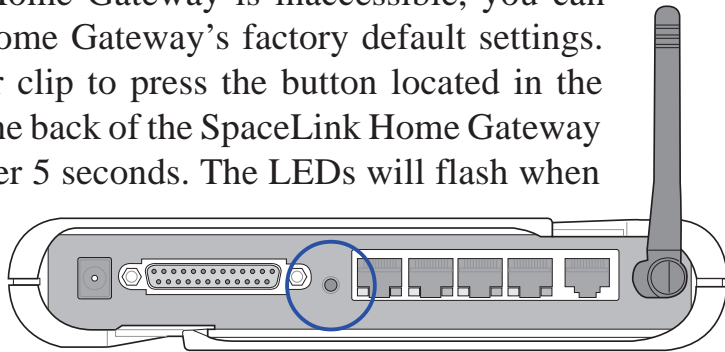

### Reset to Defaults

The following are factory default values. These values will be present when you first receive your the SpaceLink Home Gateway, if you push the reset button on the back of the SpaceLink Home Gateway over 5 seconds, or if you click the "Restore" button on the "Factory Default" page under "Advanced Setup".

Name	Default Value
User Name	admin
Password	admin
Enable DHCP	Yes
IP Address	192.168.123.1
Subnet Mask	255.255.255.0
DNS Server 1	(blank)
DNS Server 2	192.168.123.1
SSID	default
Domain Name	home

## Chapter 5 -Troubleshooting

---

### Problem

My 802.11b PC Card will not associate with the SpaceLink Home Gateway.

### Solution

Follow these steps:

1. Try to bring the devices closer together; the PC Card may be out of range of the SpaceLink Home Gateway.
2. Confirm that the SpaceLink Home Gateway and PC Card have the same SSID.
3. Confirm that the SpaceLink Home Gateway and PC Card have the same Encryption settings, if enabled.
4. Confirm that the SpaceLink Home Gateway's Air and Link LEDs are solid green.
5. Confirm that the authorization table includes or excludes the MAC address of the SpaceLink PC card if "Wireless Access Control" is enabled.

### Problem

The throughput seems slow.

### Solution

To achieve maximum throughput, verify that your antennas are well-placed, not behind metal, and do not have too many obstacles between them. If you move the client closer to the SpaceLink Home Gateway and throughput increases, you may want to consider adding a second the SpaceLink Home Gateway and implementing roaming.

- Check antenna, connectors and cabling.
- Verify network traffic does not exceed 37% of bandwidth.
- Check to see that the wired network does not exceed 10 broadcast messages per second.
- Verify wired network topology and configuration.

## Chapter 5 -Troubleshooting

---

### Problem

I cannot find the SpaceLink Home Gateways using the SpaceLink Home Gateway Discovery.

### Solution

To configure the SpaceLink Home Gateway through a wireless LAN card, your computer must be in the same subnet of the SpaceLink Home Gateway. You cannot find the SpaceLink Home Gateways with subnet different from your computer within the same gateway. You must change your computer to the same subnet as the SpaceLink Home Gateway. The factory default subnet of the SpaceLink Home Gateway is "192.168.123.1".

---

**In Windows NT/2000/XP, you must login with Administrator privileges so that all functions of the SpaceLink Home Gateway Manager can function correctly. If you do not login as a member of the Administrator group, you cannot change IP settings but can still run the Discovery utility if the original IP setting is correct.**

---

### Problem

How do I upgrade the firmware on the SpaceLink Home Gateway?

### Solution

Periodically, a new Flash Code is available for the SpaceLink Home Gateways on the ftp site at **ftp://ftp.asus.com**. Ideally, you should update the SpaceLink Home Gateway's Flash Code using "Firmware Upgrade" on the "Advanced Setup" menu of the web manager.

## 6. Appendix

### Operating frequency range

The DSSS PHY shall operate in the frequency range of 2.4 GHz to 2.4835 GHz as allocated by regulatory bodies in the USA and Europe or in the 2.471 GHz to 2.497 GHz frequency band as allocated by regulatory authority in Japan.

### Number of operating channels

The channel center frequencies and CH ID numbers shall be as shown below. The FCC (US), IC (Canada), and ETSI (Europe) specify operation from 2.4 GHz to 2.4835 GHz. For Japan, operation is specified as 2.471 GHz to 2.497 GHz. France allows operation from 2.4465 GHz to 2.4835 GHz, and Spain allows operation from 2.445 GHz to 2.475 GHz. For each supported regulatory domain, all channels marked with “Yes” shall be supported.

In a multiple cell network topology, overlapping and/or adjacent cells using different channels can operate simultaneously without interference if the distance between the center frequencies is at least 30 MHz. Channel 14 shall be designated specifically for operation in Japan.

### DSSS PHY frequency channel plan

CH ID	Frequency	(Regulatory Domains)					
		X'10' FCC	X'20' IC	X'30' ETSI	X'31' Spain	X'32' France	X'40' MKK
1	2412 MHz	Yes	Yes	Yes	-	-	Yes
2	2417 MHz	Yes	Yes	Yes	-	-	Yes
3	2422 MHz	Yes	Yes	Yes	-	-	Yes
4	2427 MHz	Yes	Yes	Yes	-	-	Yes
5	2432 MHz	Yes	Yes	Yes	-	-	Yes
6	2437 MHz	Yes	Yes	Yes	-	-	Yes
7	2442 MHz	Yes	Yes	Yes	-	-	Yes
8	2447 MHz	Yes	Yes	Yes	-	-	Yes
9	2452 MHz	Yes	Yes	Yes	-	-	Yes
10	2457 MHz	Yes	Yes	Yes	Yes	Yes	Yes
11	2462 MHz	Yes	Yes	Yes	Yes	Yes	Yes
12	2467 MHz	-	-	Yes	-	Yes	Yes
13	2472 MHz	-	-	Yes	-	Yes	Yes
14	2484 MHz	-	-	-	-	-	Yes

## SpaceLink Home Gateway Specifications

The following technical specification is for reference purposes only. Actual product's performance and compliance with local telecommunications regulations may vary from country to country. ASUS will only ship products that are type approved in the destination country.

<b>WAN Ethernet Port</b>	Support: Both Ethernet and 802.3 with Max. Bit Rate 10 Mbps Auto crossover function (MDI-X) Connector: RJ45 for 10Base-T
<b>LAN Ethernet Port</b>	Support: Both Ethernet and 802.3 with Max. Bit Rate 100Mbps Four Port Switch with Auto crossover function (MDI-X) Connector: Four RJ45 for 10Base-T or 100Base-TX
<b>Wireless</b>	Freq. Band: 2400-2497 MHz Antenna: 2 Diversity Antennas Modulation: Direct Sequence Spread Spectrum (CCK, DQPSK, DBPSK) Data rate: 1, 2, 5.5, 11 Mbps Output Power: 15 dBm
<b>Printer port</b>	Support: Standard Print Port (SPP) Connector: 25 PIN D-SUB FEMALE
<b>DC Power Adapter</b>	AC Input: 100V~240V(50~60HZ) DC Output: 5V with max. 2A current
<b>Visible LEDs</b>	PWR (Power), AIR, WAN, LAN, LPT, 10/100 indication for LAN Ports
<b>Reset button</b>	Push for 5 seconds to restore factory setting
<b>Environment</b>	Operating Temp.: 0 to 50 °C with 1 meter/sec airflow Storage Temp.: -20 to 70 °C Operating Humidity: 0 to 95% (Non-condensing) Storage Humidity: 0 to 95%
<b>Regulation Certification</b>	EMI: FCC Part 15 Class B; VCCI Class B; ETSI 300 328; CISPR 22 Class B , CE Mark, FCC Part 68, UL1950, CSA22.2, EN60950
<b>MTBF</b>	More than 10,000 hrs/failure

### Glossary

**Access Point** - An access point is a device that allows wireless clients to connect to other wireless clients and it acts as a bridge between wireless clients and a wired Ethernet network.

**Broadband** - A type of data transmission in which a single medium (such as cable) carries several channels of data at once.

**Channel** - Wireless access points allows you to choose different radio channels in the wireless spectrum. A wireless LAN device operates within the 2.4 GHz spectrum and a channel is within a FCC specified range, similar to any radio channel.

**Client** - A client is the desktop or mobile PC that is connected to your network.

**Device name** - Also known as DHCP client ID or network name. Sometimes provided by an ISP when using DHCP to assign addresses.

**DHCP (Dynamic Host Configuration Protocol)** - This protocol allows a computer (or many computers on your network) to be automatically assigned a single IP address from a DHCP server.

**DNS Server Address (Domain Name System)** - DNS allows Internet host computers to have a domain name and one or more IP addresses. A DNS server keeps a database of host computers and their respective domain names and IP addresses, so that when a user enters a domain name into the Internet browser, the user is sent to the proper IP address. The DNS server address used by the computers on your home network is the location of the DNS server your ISP has assigned.

**DSL Modem (Digital Subscriber Line)** - A DSL modem uses your existing phone lines to transmit data at high speeds.

**Encryption** - This provides wireless data transmissions with a level of security.

**ESSID (Extended Service Set Identifier)** - You must have the same ESSID entered into the gateway and each of its wireless clients. The ESSID is a unique identifier for your wireless network.

**Ethernet** - Ethernet networks are connected by cables and hubs, and move data around. This is a standard for computer networks.



**Firewall** - A firewall determines which information passes in and out of a network. NAT can create a natural firewall by hiding a local network's IP addresses from the Internet. A Firewall prevents anyone outside of your network from accessing your computer and possibly damaging or viewing your files.

**Gateway** - A network point that manages all the data traffic of your network, as well as to the Internet and connects one network to another.

**IEEE** - The Institute of Electrical and Electronics Engineers. The IEEE sets standards for networking, including Ethernet LANs. IEEE standards ensure interoperability between systems of the same type.

**IP Address (Internet Protocol)** - An IP address consists of a series of four numbers separated by periods, that identifies a unique Internet computer host, allowing messages intended for that computer to be delivered to the correct destination.

**ISP (Internet Service Provider)** - An ISP is a business that allows individuals or businesses to connect to the Internet. Users log on to the Internet using an account with an ISP or Internet Service Provider. ISPs can serve IP addresses dynamically, or assign static (fixed) IP addresses to individual computers.

**ISP Gateway Address** - The ISP Gateway Address is an IP address for the Internet router. This address is only required when using a cable or DSL modem.

**LAN (Local Area Network)** - A LAN is a group of computers and devices connected together in a relatively small area (such as a house or an office). Your home network is considered a LAN.

**MAC Address (Media Access Control)** - A MAC address is the hardware address of a device connected to a network.

**NAT (Network Address Translation)** - NAT masks a local network's group of IP addresses from the external network, allowing a local network of computers to share a single ISP account. This process allows all of the computers on your home network to use one IP address. This will enable access to the Internet from any computer on your home network without having to purchase more IP addresses from your ISP.

**PC Card** - This is an Ethernet card that connects to the PCMCIA slot on your Notebook PC. This enables the computer to communicate with wireless access points.

## Appendix

---

**PPP (Point-to-Point Protocol)** - PPP is a protocol for communication between computers using a serial interface, typically a personal computer connected by phone line to a server.

**PPPoE (Point-to-Point Protocol over Ethernet)** - Point-to-Point Protocol is a method of secure data transmission. PPP using Ethernet to connect to an ISP.

**Subnet Mask** - A subnet mask is a set of four numbers configured like an IP address. It is used to create IP address numbers used only within a particular network.

**TCP/IP (Transmission Control Protocol/Internet Protocol)** - This is the standard protocol for data transmission over the Internet. Protocols used to connect hosts on the Internet.

**WAN (Wide Area Network)** - A system of LANs, connected together. A network that connects computers located in separate areas, (i.e., different buildings, cities, countries). The Internet is a wide area network.

**WECA (Wireless Ethernet Compatibility Alliance)** - An industry group that certifies cross-vender interoperability and compatibility of IEEE 802.11b wireless networking products and to promote that standard for enterprise, small business, and home environments.

**WLAN (Wireless Local Area Network)** - This is a group of computers and other devices connected wirelessly in a small area. A wireless network is referred to as LAN or WLAN.