

MEASUREMENT REPORT
of
MIMO Wireless Router
for
Class II permissive change

Applicant : ASUSTek Computer Inc.
EUT : MIMO Wireless Router
Model No. : WL-500W
FCC ID : MSQWL500W

Tested by :

Training Research Co., Ltd.

TEL : 886-2-26935155

FAX : 886-2-26934440

No. 255, Nanyang Street, Shijr, Taipei Hsien 221, Taiwan, R.O.C.

CERTIFICATION

We here by verify that:

The test data, data evaluation, test procedures and equipment configurations shown in this report were made mainly in accordance with the procedures given in ANSI C63.4 (2003) as a reference. All test were conducted by *Training Research Co., Ltd.*, 255 Nanyang Street, Shijr, Taipei Hsien 221, Taiwan, R.O.C. Also, we attest to the accuracy of each.

We further submit that the energy emitted by the sample EUT tested as described in the report is **in compliance with** the technical requirements set forth in the FCC Rules Part 15 Subpart B (Declaration of Conformity) and C Section 15.247.

Applicant : ASUSTek Computer Inc.
Applicant Address : 4F, No. 150, Li-Te Rd., Peitou, Taipei, Taiwan, R.O.C.
Product Name : MIMO Wireless Router
Model : WL-500W
Report No. : A5415060632
Test Date : July 6, 2006 ~ July 11, 2006, October 20, 2006

Prepared by: 
Jack Tsai

Approved by: 
Frank Tsai

Conditions of issue :

- (1) **This test report shall not be reproduced except in full, without written approval of TRC. And the test result contained within this report only relate to the sample submitted for testing.**
- (2) **This report must not be used by the client to claim product endorsement by NVLAP or any agency of U.S. Government.**
- (3) **This test report, measurements made by TRC are traceable to the NIST only Conducted and Radiated Method.**



Federal Communications Commission

Declaration of Conformity

for the following equipment:

Product name : MIMO Wireless Router
 Trade name : ASUS
 Model name : WL-500W

Is herewith confirmed and found to comply with the requirements of CFR 47 part15 Subpart B - Unintentional Radiators regulation. The results of electromagnetic mission evaluation are shown in the report number : A5415060632

This device complies with Part 15 of the FCC Rules. Operation is subject to the following two conditions:

- (1) This device may not cause harmful interference, and
- (2) This device must accept any interference received, including interference that may cause undesired operation

Manufacturer	USA local representative
Company name: ASUSTeK Computer Inc.	
Computer address: 4/F, 150, Li-Te Rd., Peitou, Taipei, Taiwan	
ZIP / Postal code 112	
Contact person: Lawrence Yu	
Title: Manager	
Internet e-mail address: lawrence_yu@asus.com.tw	
Tel / Fax: 886-2-28943447 / 886-2-28950113	

Tables of Contents

I.	GENERAL	6
	1.1 Introduction	6
	1.2 Description of EUT	6
	1.3 Test method	7
	1.4 Description of Support Equipment	8
	1.5 Configuration of System Under Test	11
	1.6 Verify the Frequency and Channel	13
	1.7 Test Procedure	14
	1.8 Location of the Test Site	14
	1.9 General Test Condition	14
II.	Section 15.101(a) : Equipment Authorization of Unintentional Radiators	15
III.	Section 15.203 : Antenna Requirement	16
IV.	Section 15.207 : Power Line Conducted Emissions for AC Powered Units	17
	4.1 Test Condition & Setup	17
	4.2 List of Test Instruments	18
	4.3 Test Result of Conducted Emissions	19
	Standby mode _UNIFIVE	19
	IEEE 802.11b mode _LEI	20
	IEEE 802.11g mode _LEI	21
	IEEE 802.11n 20M mode _LEI	23
	IEEE 802.11n 40M mode _LEI	24
	IEEE 802.11b mode _UMEC	26
	IEEE 802.11g mode _UMEC	27
	IEEE 802.11n 20M mode _UMEC	29
	IEEE 802.11n 40M mode _UMEC	30
V.	Section 15.247(a) : Technical Description of the EUT	32
VI.	Section 15.247(a)(2) : Bandwidth for Direct Sequence System	33
	6.1 Test Condition & Setup	33
	6.2 Test Instruments Configuration	33
	6.3 List of Test Instruments	33

6.4	Test Result of Bandwidth	34
	IEEE 802.11b mode	35
	IEEE 802.11g mode	38
	IEEE 802.11n 20M mode	41
	IEEE 802.11n 40M mode	44
VII.	Section 15.247(b) : Power Output	47
7.1	Test Condition & Setup	47
7.2	List of Test Instruments	47
7.3	Test Result	47
VIII.	Section 15.247(c) : Spurious Emissions (Radiated)	49
8.1	Test Condition & Setup	49
8.2	List of Test Instruments	51
8.3	Test Result of Spurious Radiated Emissions	52
	Standby mode	52
	IEEE 802.11b mode	54
	IEEE 802.11g mode	60
	IEEE 802.11n 20M mode	66
	IEEE 802.11n 40M mode	72
8.4	Test Result of Bandedge.....	78
	IEEE 802.11b mode	79
	IEEE 802.11g mode	81
	IEEE 802.11n 20M mode	83
	IEEE 802.11n 40M mode	85
IX.	Section 15.247(d) : Power Spectral Density	87
9.1	Test Condition & Setup	87
9.2	Test Instruments Configuration	87
9.3	List of Test Instruments.....	87
9.4	Test Result of Power Spectral Density	88
	IEEE 802.11b mode	90
	IEEE 802.11g mode	93
	IEEE 802.11n 20M mode	96
	IEEE 802.11n 40M mode	99

I . GENERAL

1.1 Introduction

The following measurement report is submitted on behalf of applicant in support that the certification in accordance with Part 2 Subpart J and Part 15 Subpart A, B and C of the Commission's Rules and Regulations.

1.2 Description of EUT

- FCC ID** : MSQWL500W
- Product Name** : MIMO Wireless Router
- Model Name** : WL-500W
- Frequency Range** : IEEE 802.11b/g/n Draft 1.0 20M: 2.412GHz ~ 2.462GHz
IEEE 802.11n Draft 1.0 40M: 2.422GHz ~ 2.452GHz
- Channel Spacing** : 5MHz
- Support Channel** : IEEE 802.11b/g/n Draft 1.0 20M: 11 Channels
IEEE 802.11n Draft 1.0 40M: 7 Channels
- Modulation Skill** : DBPSK, DQPSK, CCK, OFDM
- Data Cable** : RJ45 cable x 1, 1.5m length, non-shielded, no ferrite core
RJ45 cable x 3, 3.0m length, non-shielded, no ferrite core
RJ45 cable x 1, 30m length, non-shielded, no ferrite core
USB cable x 1, 2.7m length, shielded, with ferrite core
- Power Type** : Powered by the power adapter,

Trade mark	LEI	UMEC	UNIFIVE
Mfg.	Leader Electronics Inc.	UMEC	UNIFIVE CO., LTD.
Model	MU18-2050300-A1	UP018B-05PC	US318-05
I/P:	100-240VAC,50/60Hz,0.6 A	100-240VAC,50/60Hz,0.4 A	100-240VAC,50/60Hz,0.4A
O/P	5VDC, 3A	5VDC, 2.5A, 12.5W	5VDC, 3A
Power cable	190cm length, non-shielded, without ferrite core	180cm length, shielded, without ferrite core	185cm length, non-shielded, without ferrite core

1.3 Test method

- 1.3.1 The DC-In connected to AC mains supply by switching adapter.
- 1.3.2 The USB-downstream port connected with a USB flash drive, another USB-downstream port connected with the camera.
- 1.3.3 The LAN1 port of EUT connected to far LAN card.
- 1.3.4 The LAN2, LAN3 and WAN ports are termination by RJ45 cables.
- 1.3.5 Connected the LAN4 port of EUT with the LAN of PC. Using PC and software provided by the manufacturer to control EUT, the test is performed under the specific conditions.
- 1.3.6 Set different data rate and channel (IEEE 802.11b/g/n Draft 1.0 20M: CH01/CH06/CH11, IEEE 802.11n Draft 1.0 40M: CH03/CH06/CH09) being tested and repeat the procedures above.
 - (a) Radiated for Intentional test:
 - making EUT to the mode of continuous transmission
 - (b) Conducted test and Radiated for unintentional test:
 - making EUT to the linking (RX/TX) mode with far support equipments

1.4 Description of Support Equipment

In order to construct the minimum testing, following equipment were used as the support units.

PC : **HP, IBM 8434**
 Model No. : Pavilion t1000, IVG
 Serial No. : TWL3320051, 99CCZA3
 FCC ID : N/A, DoC (Declaration of Confirmation) Approved
 BSMI : R33001, R33026
 Power type : 100 ~ 127VAC/200 ~ 240VAC, 6A/3A, 50 ~ 60Hz, Switching
 Power cord : Non-shielded, 1.80m length, Plastic hood, No ferrite core

Fax/Modem : **Aceex**
 Model No. : DM-1414
 Serial No. : 9010582
 FCC ID : IFAXDM1414
 Power type : 110 VAC / 50 ~ 60 Hz, Switching
 Power Cord : Non-shielded, 1.90m length, Plastic hoods, and no ferrite bead
 Data Cable : RS-232→Shielded, 1.30m length, Metal hoods , No bead
 RJ-11Cx2→Non-shielded, 7' length, Plastic hoods, No bead

Printer : **EPSON; HP**
 Model No. : B241A, C2642A
 Serial No. : FAPY155090, SG69A196GV
 FCC ID : None (DoC Approved), B94C2642X
 BSMI : R33126, None
 Power type : Switching adaptor
 Power cord : Non-shielded, 173cm length, No ferrite core
 (between adaptor and AC source)
 Non-shielded, 180cm length, with ferrite core
 (between printer and adaptor)
 Data cable : Shielded, 1.70m length, No ferrite core

WLAN AP : **ASUS**
 Model No. : SAA04-052240
 FCC ID : SFMSAA04052240

Monitor : **HP 15' Color Monitor, HP pavilion mx70, ViewSonic**
Model No. : D2827A, P1283A, VCDTS21366
Serial No. : KR91379759, TWTBQ00397, KP74620621
FCC ID : C5F7NFCMC1518X, DoC Approved, GSS17019
BSMI : 3872B039, 4872A167, 3862A401
Power type : 100 ~ 240 VAC / 50 ~ 60 Hz, Switching
Power cord : Shielded, 1.83m length, No ferrite core
Data cable : Shielded, 1.46m length, with two ferrite cores

USB Game pad : **Padix, Rockfire**
Model No. : QF-305u, QF-337uv
Serial No. : 81100848, KR91379759
FCC ID : DoC Approved, None (CE approval)
BSMI : None, 3862A574
Power type : By PC
Data cable : Shielded, 1.76m length no ferrite core (1.81m with ferrite core)

PS/2 Mouse : **HP**
Model No. : M-UR89, M-S69, M-S34
Serial No. : LZS21750238, 334684-002 323614-001, LZB90714106
FCC ID : DoC Approved
BSMI : 3892D767, R41126, 4862A011
Power type : By PC
Power cord : Shielded, 1.80m (1.90m) length, No ferrite core

PS/2 Keyboard : **HP**
Model No. : 5187-0343, KB0133, 5181
Serial No. : BE21700404, 265987-AB1 Tch 323686-AB1, BE21700405
FCC ID : DoC Approved
BSMI : 3892C981, R31310, 3892C981
Power type : By PC
Data cable : Shielded, 1.85m length, with ferrite core

Notebook : **IBM Think Pad X20**
Model No. : 2662-11T
Serial No. : FX-1192200/09
FCC ID : N/A, Doc Approved
BSMI : 3892B565

Adaptor : **IBM**
Model No. : PA2450U
Serial No. : 02K6654
Power type : I/P: 100 ~ 240Vac, 50 ~ 60 Hz, 0.5A ~ 1.2A
O/P: 16Vdc, 4.5A
Power cord : Non-shielded, 1.80m length, Plastic, with ferrite core

LAN Card : **D-Link**
Model No. : DFE-530TX
Serial No. : 0050BAE32FF3
FCC ID : N/A, DoC Approved

Ethernet Switching

HUB : **ASUS**
Model No. : GX2048
FCC ID : None (CE approval)
Power type : Switching adaptor

USB Flash Drive : **City-Netek Inc.**
Model No. : CN-2108
FCC ID : DoC Approved
Power cord : Shielded, 1.0m length, no ferrite core

Video Camera : **Logitech**
Model No. : V-UJ16 (P/N: 861095-0010)
Serial No. : LZA30600780
BSMI : 4912A026
Power type : 5V, 300mA
Power cord : Shielded, 2.7m length, with ferrite core

1.5 Configuration of System Under Test

1.5.1 Conducted and Radiated for Unintentional

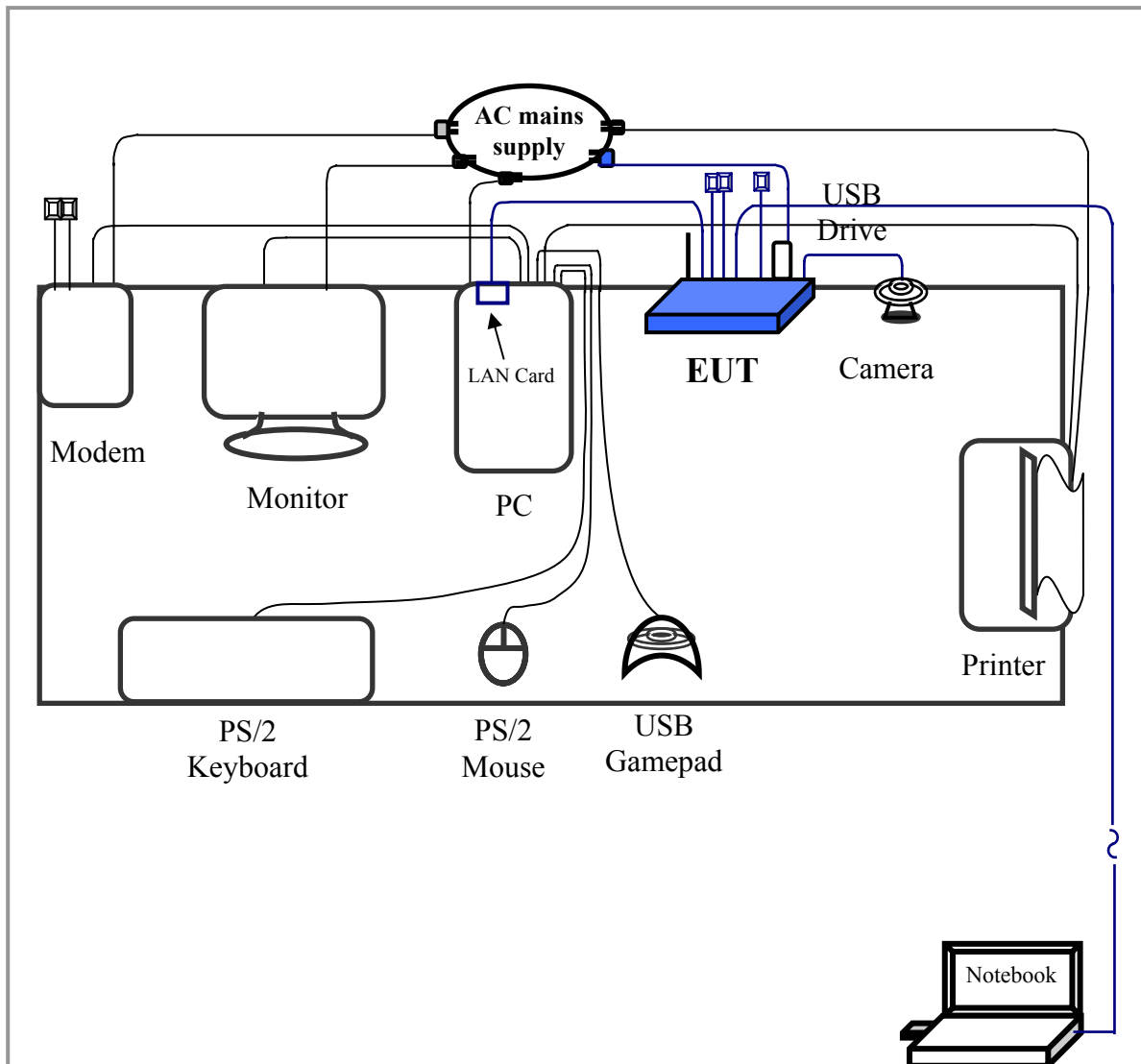

Connections of Equipment

- PC:** *Parallel Port a printer
- *VGA Port a monitor
- *Serial Port an external modem
- *USB#1 Port a USB gamepad
- *PS/2-key Port a PS/2 keyboard
- *PS/2-mouse Port a PS/2 mouse
- *LAN Port **EUT**

1.5.2 Radiated of Intentional

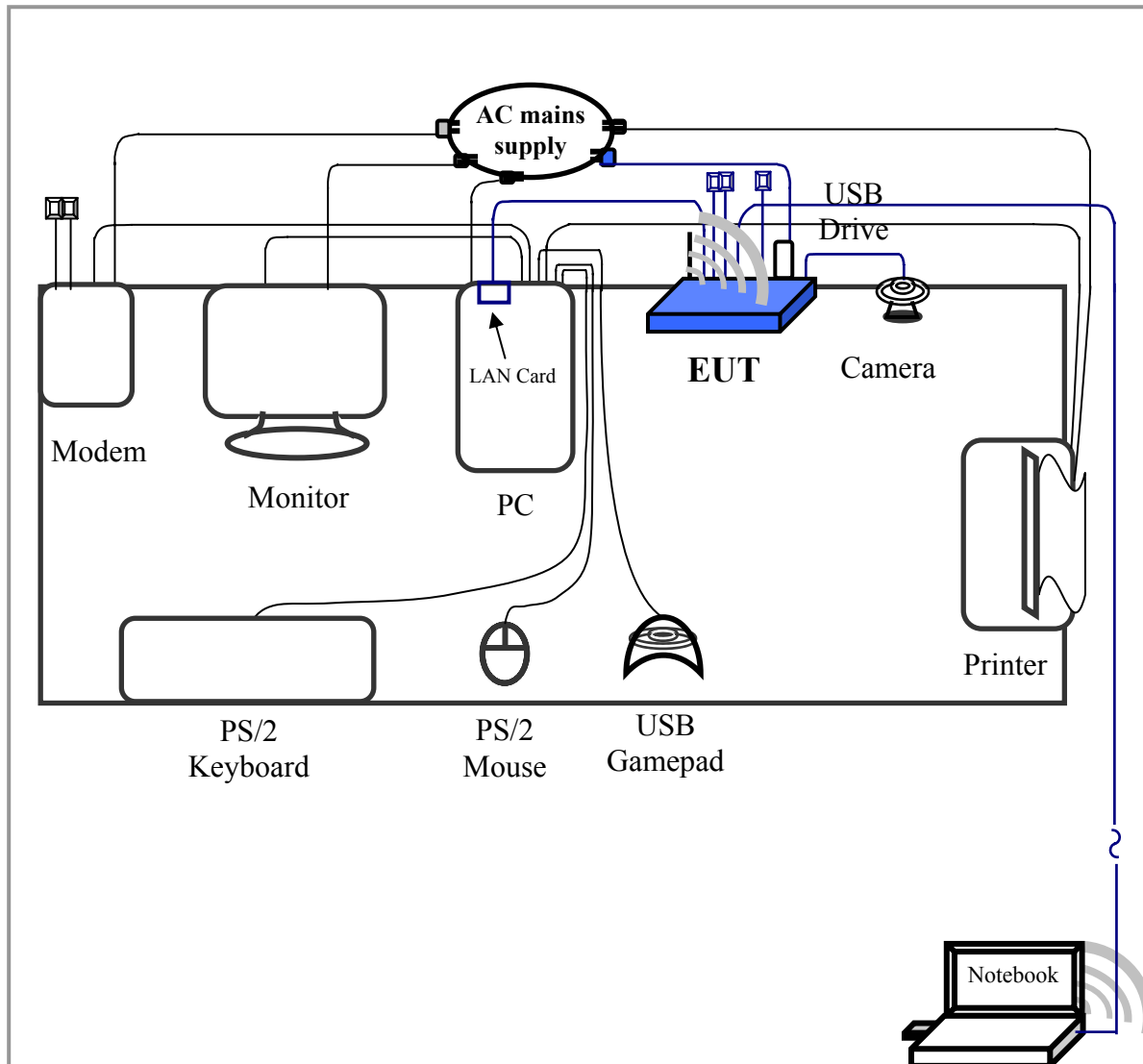

The tests below are carried with the EUT transmitter set at high power in TDD mode. The EUT is forced to select of output power level and channel number by LAN port.

The setting up procedure was recorded in 1.3 test method.

1.6 Verify the Frequency and Channel

Channel	Frequency (GHz)
1	2.412
2	2.417
3	2.422
4	2.427
5	2.432
6	2.437
7	2.442
8	2.447
9	2.452
10	2.457
11	2.462

Note:

1. This is for confirming that all frequencies of IEEE 802.11b/g/n Draft 1.0 20M are in 2.412GHz to 2.462GHz. and all frequencies of IEEE 802.11n Draft 1.0 40M are in 2.422GHz to 2.452GHz.
2. Section 15.31(m): Measurements on intentional radiators or receivers shall be performed at three frequencies for operating frequency range over 10 MHz
(The locations of these frequencies one near the top, one near the middle and one near the bottom.)
3. After test, the EUT operating frequencies are in 2.412GHz to 2.462GHz and 2.422GHz to 2.452GHz. So all the items as followed in testing report are need to test these three frequencies: IEEE 802.11b/g/n Draft 1.0 20M: CH01/CH06/CH11, IEEE 802.11n Draft 1.0 40M: CH03/CH06/CH09

1.7 Test Procedure

All measurements contained in this report were performed mainly according to the techniques described in ANSI C63.4 (2003) and the pre-setup was written on 1.3 test method, the detail setup was written on each test item.

1.8 Location of the Test Site

The radiated emissions measurements required by the rules were performed on the **three-meter, Anechoic Chamber (FCC Registration Number: 93906)** maintained by *Training Research Co., Ltd.* 1F, No. 255 Nanyang Street, Shijr, Taipei Hsien 221, Taiwan, R.O.C. Complete description and measurement data have been placed on file with the commission. The conducted power line emissions tests and other test items were performed in a anechoic chamber also located at Training Research Co., Ltd.

No. 255 Nanyang Street, Shijr, Taipei Hsien 221, Taiwan, R.O.C. *Training Research Co., Ltd.* is listed by the FCC as a facility available to do measurement work for others on a contract basis.

1.9 General Test Condition

The conditions under which the EUT operates were varied to determine their effect on the equipment's emission characteristics. The final configuration of the test system and the mode of operation used during these tests were chosen as that which produced the highest emission levels. However, only those conditions, which the EUT was considered likely to encounter in normal use were investigated.

In test, they were set in high power and continuously transmitting mode that controlled by computer. The ch01, ch06 and ch11 of EUT were all tested. The setting up procedure is recorded on 1.3 test method.

II. Section 15.101(a): Equipment authorization of unintentional radiators

The EUT equipped with a LAN interface and should be operated with the computer. It was categorized to *Class B personal computers and peripherals* as cannot be operated stand-alone. The authorization requires **Declaration of Conformity (DoC)** and the items required such as Section15.107 (Conducted limits) and Section15.109 (Radiated emission limits) is same as Section15.207 and 15.247(C).

III. Section 15.203: Antenna requirement

The EUT can be equipped with un-detachable antenna. The external antenna is affixed to the EUT using a unique connector, which allows for replacement of a broken antenna, but does not use a standard antenna jack or electrical connector. The antenna requirement stated in Section 15.203 is inapplicable to this EUT.

The custom antenna specification of list as below:

Manufacturer : WHA YU INDUSTRIAL CO., LTD.
Part No : C660-510047-A
Connector : I-PEX MHF Plug Connector
Antenna Type : Dipole Antenna
Antenna Gain : 1.80dBi

VI. Section 15.207: Power Line Conducted Emissions for AC Powered Units

4.1 Test Condition & Setup

The power line conducted emission measurements were performed in an anechoic chamber. The EUT was assembled on a wooden table, which is 80 centimeters high, was placed 40 centimeters from the backwall and at least 1 meter from the sidewall.

Power was fed to the EUT from the public utility power grid through a line filter and Line Impedance Stabilization Networks (LISNs). The LISN housing, measuring instrumentation case, ground plane, etc., were electrically bonded together at the same RF potential. The Spectrum analyzer (or EMI receiver) was connected to the AC line through an isolation transformer. The 50-ohm output of the LISN was connected to the spectrum analyzer directly. Conducted emission levels were in the CISPR quasi-peak and average detection mode. The analyzer's 6 dB bandwidth was set to 9 KHz. No post-detector video filter was used.

The spectrum was scanned from 150 KHz to 30 MHz. The physical arrangement of the test system and associated cabling was varied (within the scope of arrangements likely to be encountered in actual use) to determine the effect on the unit's emanations in amplitude and frequency. All spurious emission frequencies were observed. The highest emission amplitudes relative to the appropriate limit were measured and have been recorded in paragraph 4.3

There is a test condition apply in this test item, the test procedure description as <1.3>. Three channels were tested, one in the top, one in the middle and the other in bottom.

4.2 List of Test Instruments

Instrument Name	Model	Brand	Serial No.	Calibration Date
				Next time
EMI Receiver	8546A	HP	3520A00242	12/01/06
RF Filter Section	85460A	HP	3448A00217	12/01/06
LISN (EUT)	LISN-01	TRC	99-05	12/10/06
LISN (Support E.)	LISN-01	TRC	9912-03, 04	11/26/06
Pre-amplifier	15542 ZFL-500	Mini – Circuits	0 0117	05/20/07
6dB Attenuator	MCL BW-S6W2	Mini – Circuits	9915 – Conducted	05/20/07
10dB Attenuator	A5542 VAT010	Mini – Circuits	0215 – Conducted	05/20/07
Coaxial Cable (2.0 meter)	A30A30-0058-50FS-2M	Jyebao	SMA-08	05/20/07
Coaxial Cable (1.1 meter)	A30A30-0058-50FS-1M	Jyebao	SMA-09	05/20/07
Coaxial Cable (20 meter)	RG-214/U	Jyebao	NP-01	05/20/07
Coaxial Cable (20 meter)	RG-214/U	Jyebao	NP-02	05/20/07
Auto Switch Box (< 30MHz)	ASB-01	TRC	9904-01	05/20/07

4.3 Test Result of Power Line Conducted Emissions

The following table shows a summary of the highest emissions of power line conducted emissions on the LIVE and NETURAL conductors of the EUT power cord. Show as follows.

Test Conditions: Temperature : 25 °C Humidity : 73 % RH

Test mode: Standby mode UNIFIVE

<i>Power Connected Emissions</i>					<i>Class B</i>		
<i>Conductor</i>	<i>Frequency (KHz)</i>	<i>Peak (dBµV)</i>	<i>QP (dBµV)</i>	<i>Average (dBµV)</i>	<i>QP-limit (dBµV)</i>	<i>AVG-limit (dBµV)</i>	<i>Margin (dB)</i>
Line 1	194.935	55.50	54.91	47.06	64.77	54.77	-7.71
	387.000	43.39	---	---	59.23	49.23	-5.84
	452.000	43.08	---	---	57.37	47.37	-4.29
	1477.000	41.31	---	---	56.00	46.00	-4.69
	3811.110	45.00	44.05	30.23	56.00	46.00	-11.95
	26130.000	41.40	---	---	60.00	50.00	-8.60
Line 2	194.460	54.63	54.03	46.65	64.71	54.71	-8.06
	452.000	44.17	---	---	57.37	47.37	-3.20
	581.000	41.51	---	---	56.00	46.00	-4.49
	1346.000	40.41	---	---	56.00	46.00	-5.59
	1678.000	40.38	---	---	56.00	46.00	-5.62
	3349.000	41.28	---	---	56.00	46.00	-4.72

NOTE:

- (1)Margin = Peak Amplitude – Limit, *The reading amplitudes are all under limit.*
- (2)A "+" sign in the margin column means the emission is OVER the Class B Limit and "-" sign of means UNDER the Class B limit

Test mode: IEEE 802.11b Channel 1 LEI

<i>Power Connected Emissions</i>					<i>Class B</i>		
<i>Conductor</i>	<i>Frequency (KHz)</i>	<i>Peak (dBμV)</i>	<i>QP (dBμV)</i>	<i>Average (dBμV)</i>	<i>QP-limit (dBμV)</i>	<i>AVG-limit (dBμV)</i>	<i>Margin (dB)</i>
Line 1	191.000	47.70	---	---	64.83	54.83	-7.13
	257.000	41.78	---	---	62.94	52.94	-11.16
	2899.000	42.59	---	---	56.00	46.00	-3.41
	3975.000	42.15	---	---	56.00	46.00	-3.85
	4714.000	42.18	---	---	56.00	46.00	-3.82
	6670.000	38.12	---	---	60.00	50.00	-11.88
Line 2	191.000	48.09	---	---	64.83	54.83	-6.74
	288.000	39.77	---	---	62.06	52.06	-12.29
	1320.000	39.41	---	---	56.00	46.00	-6.59
	1696.000	41.19	---	---	56.00	46.00	-4.81
	3221.000	42.31	---	---	56.00	46.00	-3.69
	5290.000	42.64	---	---	60.00	50.00	-7.36

Test mode: IEEE 802.11b Channel 6 LEI

<i>Power Connected Emissions</i>					<i>Class B</i>		
<i>Conductor</i>	<i>Frequency (KHz)</i>	<i>Peak (dBμV)</i>	<i>QP (dBμV)</i>	<i>Average (dBμV)</i>	<i>QP-limit (dBμV)</i>	<i>AVG-limit (dBμV)</i>	<i>Margin (dB)</i>
Line 1	189.000	48.89	---	---	64.89	54.89	-6.00
	817.000	37.33	---	---	56.00	46.00	-8.67
	1320.000	41.33	---	---	56.00	46.00	-4.67
	1629.000	42.36	---	---	56.00	46.00	-3.64
	2951.000	41.89	---	---	56.00	46.00	-4.11
	4014.000	41.73	---	---	56.00	46.00	-4.27
Line 2	187.000	47.75	---	---	64.94	54.94	-7.19
	257.000	42.13	---	---	62.94	52.94	-10.81
	945.000	38.87	---	---	56.00	46.00	-7.13
	1645.000	42.90	---	---	56.00	46.00	-3.10
	2136.000	42.81	---	---	56.00	46.00	-3.19
	5540.000	40.62	---	---	60.00	50.00	-9.38

Test mode: IEEE 802.11b Channel 11 LEI

<i>Power Connected Emissions</i>					<i>Class B</i>		
<i>Conductor</i>	<i>Frequency (KHz)</i>	<i>Peak (dBµV)</i>	<i>QP (dBµV)</i>	<i>Average (dBµV)</i>	<i>QP-limit (dBµV)</i>	<i>AVG-limit (dBµV)</i>	<i>Margin (dB)</i>
Line 1	187.000	49.13	---	---	64.94	54.94	-5.81
	688.000	37.31	---	---	56.00	46.00	-8.69
	1385.000	41.82	---	---	56.00	46.00	-4.18
	3094.000	39.25	---	---	56.00	46.00	-6.75
	4014.000	42.52	---	---	56.00	46.00	-3.48
	4666.000	41.78	---	---	56.00	46.00	-4.22
Line 2	269.000	41.22	---	---	62.60	52.60	-11.38
	1070.000	38.22	---	---	56.00	46.00	-7.78
	1385.000	38.33	---	---	56.00	46.00	-7.67
	1818.000	42.22	---	---	56.00	46.00	-3.78
	2265.000	41.03	---	---	56.00	46.00	-4.97
	5110.000	43.84	---	---	60.00	50.00	-6.16

Test mode: IEEE 802.11g Channel 1 LEI

<i>Power Connected Emissions</i>					<i>Class B</i>		
<i>Conductor</i>	<i>Frequency (KHz)</i>	<i>Peak (dBµV)</i>	<i>QP (dBµV)</i>	<i>Average (dBµV)</i>	<i>QP-limit (dBµV)</i>	<i>AVG-limit (dBµV)</i>	<i>Margin (dB)</i>
Line 1	169.000	49.09	---	---	65.46	55.46	-6.37
	752.000	37.87	---	---	56.00	46.00	-8.13
	1070.000	39.29	---	---	56.00	46.00	-6.71
	1629.000	42.06	---	---	56.00	46.00	-3.94
	2899.000	41.92	---	---	56.00	46.00	-4.08
	4171.000	42.11	---	---	56.00	46.00	-3.89
Line 2	166.000	50.35	---	---	65.54	55.54	-5.19
	688.000	37.12	---	---	56.00	46.00	-8.88
	945.000	38.45	---	---	56.00	46.00	-7.55
	1198.000	38.66	---	---	56.00	46.00	-7.34
	1766.000	41.52	---	---	56.00	46.00	-4.48
	5290.000	43.56	---	---	60.00	50.00	-6.44

Test mode: IEEE 802.11g Channel 6 LEI

Power Connected Emissions					Class B		
Conductor	Frequency (KHz)	Peak (dBμV)	QP (dBμV)	Average (dBμV)	QP-limit (dBμV)	AVG-limit (dBμV)	Margin (dB)
Line 1	187.000	47.77	---	---	64.94	54.94	-7.17
	569.000	37.63	---	---	56.00	46.00	-8.37
	945.000	38.33	---	---	56.00	46.00	-7.67
	1451.000	42.85	---	---	56.00	46.00	-3.15
	3030.000	41.33	---	---	56.00	46.00	-4.67
	4014.000	41.28	---	---	56.00	46.00	-4.72
Line 2	187.000	48.56	---	---	64.94	54.94	-6.38
	633.000	36.41	---	---	56.00	46.00	-9.59
	876.000	37.51	---	---	56.00	46.00	-8.49
	1385.000	38.52	---	---	56.00	46.00	-7.48
	1818.000	41.64	---	---	56.00	46.00	-4.36
	2846.000	42.83	---	---	56.00	46.00	-3.17

Test mode: IEEE 802.11g Channel 11 LEI

Power Connected Emissions					FCC Class B		
Conductor	Frequency (KHz)	Peak (dBμV)	QP (dBμV)	Average (dBμV)	QP-limit (dBμV)	AVG-limit (dBμV)	Margin (dB)
Line 1	189.000	49.11	---	---	64.89	54.89	-5.78
	252.000	43.28	---	---	63.09	53.09	-9.81
	1134.000	39.38	---	---	56.00	46.00	-6.62
	1385.000	41.64	---	---	56.00	46.00	-4.36
	1818.000	42.41	---	---	56.00	46.00	-3.59
	4171.000	42.13	---	---	56.00	46.00	-3.87
Line 2	183.000	48.84	---	---	65.06	55.06	-6.22
	1070.000	38.87	---	---	56.00	46.00	-7.13
	1451.000	40.80	---	---	56.00	46.00	-5.20
	1818.000	42.27	---	---	56.00	46.00	-3.73
	2201.000	42.67	---	---	56.00	46.00	-3.33
	3381.000	40.41	---	---	56.00	46.00	-5.59

Test mode: IEEE 802.11n 20M Channel 1 LEI

Power Connected Emissions					Class B		
Conductor	Frequency (KHz)	Peak (dBμV)	QP (dBμV)	Average (dBμV)	QP-limit (dBμV)	AVG-limit (dBμV)	Margin (dB)
Line 1	185.000	49.25	---	---	65.00	55.00	-5.75
	945.000	36.57	---	---	56.00	46.00	-9.43
	1320.000	41.38	---	---	56.00	46.00	-4.62
	1818.000	42.03	---	---	56.00	46.00	-3.97
	2951.000	40.98	---	---	56.00	46.00	-5.02
	4014.000	42.24	---	---	56.00	46.00	-3.76
Line 2	177.000	48.86	---	---	65.23	55.23	-6.37
	255.000	43.13	---	---	63.00	53.00	-9.87
	1198.000	38.89	---	---	56.00	46.00	-7.11
	1566.000	39.91	---	---	56.00	46.00	-6.09
	1818.000	42.22	---	---	56.00	46.00	-3.78
	5240.000	43.66	---	---	60.00	50.00	-6.34

Test mode: IEEE 802.11n 20M Channel 6 LEI

Power Connected Emissions					Class B		
Conductor	Frequency (KHz)	Peak (dBμV)	QP (dBμV)	Average (dBμV)	QP-limit (dBμV)	AVG-limit (dBμV)	Margin (dB)
Line 1	189.000	47.68	---	---	64.89	54.89	-7.21
	563.000	35.99	---	---	56.00	46.00	-10.01
	817.000	36.57	---	---	56.00	46.00	-9.43
	1198.000	39.25	---	---	56.00	46.00	-6.75
	2951.000	41.38	---	---	56.00	46.00	-4.62
	4092.000	42.76	---	---	56.00	46.00	-3.24
Line 2	193.000	48.32	---	---	64.77	54.77	-6.45
	945.000	38.57	---	---	56.00	46.00	-7.43
	1320.000	38.40	---	---	56.00	46.00	-7.60
	1818.000	42.06	---	---	56.00	46.00	-3.94
	2394.000	42.45	---	---	56.00	46.00	-3.55
	5240.000	43.68	---	---	60.00	50.00	-6.32

Test mode: IEEE 802.11n 20M Channel 11 LEI

<i>Power Connected Emissions</i>					<i>Class B</i>		
<i>Conductor</i>	<i>Frequency (KHz)</i>	<i>Peak (dBμV)</i>	<i>QP (dBμV)</i>	<i>Average (dBμV)</i>	<i>QP-limit (dBμV)</i>	<i>AVG-limit (dBμV)</i>	<i>Margin (dB)</i>
Line 1	191.000	48.32	---	---	64.83	54.83	-6.51
	563.000	37.31	---	---	56.00	46.00	-8.69
	1006.000	39.75	---	---	56.00	46.00	-6.25
	1256.000	40.39	---	---	56.00	46.00	-5.61
	1518.000	41.45	---	---	56.00	46.00	-4.55
	4092.000	42.48	---	---	56.00	46.00	-3.52
Line 2	187.000	49.11	---	---	64.94	54.94	-5.83
	817.000	37.37	---	---	56.00	46.00	-8.63
	1070.000	38.45	---	---	56.00	46.00	-7.55
	1385.000	37.91	---	---	56.00	46.00	-8.09
	1629.000	40.55	---	---	56.00	46.00	-5.45
	2201.000	42.43	---	---	56.00	46.00	-3.57

Test mode: IEEE 802.11n 40M Channel 3 LEI

<i>Power Connected Emissions</i>					<i>Class B</i>		
<i>Conductor</i>	<i>Frequency (KHz)</i>	<i>Peak (dBμV)</i>	<i>QP (dBμV)</i>	<i>Average (dBμV)</i>	<i>QP-limit (dBμV)</i>	<i>AVG-limit (dBμV)</i>	<i>Margin (dB)</i>
Line 1	191.000	48.47	---	---	64.83	54.83	-6.36
	1006.000	38.73	---	---	56.00	46.00	-7.27
	1385.000	42.13	---	---	56.00	46.00	-3.87
	2072.000	42.90	---	---	56.00	46.00	-3.10
	3097.000	39.98	---	---	56.00	46.00	-6.02
	4092.000	42.81	---	---	56.00	46.00	-3.19
Line 2	191.000	48.63	---	---	64.83	54.83	-6.20
	1198.000	38.50	---	---	56.00	46.00	-7.50
	1566.000	40.12	---	---	56.00	46.00	-5.88
	1818.000	42.13	---	---	56.00	46.00	-3.87
	3285.000	41.92	---	---	56.00	46.00	-4.08
	5360.000	43.22	---	---	60.00	50.00	-6.78

Test mode: IEEE 802.11n 40M Channel 6 LEI

<i>Power Connected Emissions</i>					<i>Class B</i>		
<i>Conductor</i>	<i>Frequency (KHz)</i>	<i>Peak (dBμV)</i>	<i>QP (dBμV)</i>	<i>Average (dBμV)</i>	<i>QP-limit (dBμV)</i>	<i>AVG-limit (dBμV)</i>	<i>Margin (dB)</i>
Line 1	208.000	45.40	---	---	64.34	54.34	-8.94
	945.000	37.87	---	---	56.00	46.00	-8.13
	1320.000	41.40	---	---	56.00	46.00	-4.60
	1629.000	41.35	---	---	56.00	46.00	-4.65
	3094.000	40.16	---	---	56.00	46.00	-5.84
	4092.000	42.85	---	---	56.00	46.00	-3.15
Line 2	187.000	48.68	---	---	64.94	54.94	-6.26
	255.000	42.85	---	---	63.00	53.00	-10.15
	1134.000	39.72	---	---	56.00	46.00	-6.28
	1818.000	41.64	---	---	56.00	46.00	-4.36
	2394.000	42.45	---	---	56.00	46.00	-3.55
	5110.000	43.68	---	---	60.00	50.00	-6.32

Test mode: IEEE 802.11n 40M Channel 9 LEI

<i>Power Connected Emissions</i>					<i>FCC Class B</i>		
<i>Conductor</i>	<i>Frequency (KHz)</i>	<i>Peak (dBμV)</i>	<i>QP (dBμV)</i>	<i>Average (dBμV)</i>	<i>QP-limit (dBμV)</i>	<i>AVG-limit (dBμV)</i>	<i>Margin (dB)</i>
Line 1	185.000	49.23	---	---	65.00	55.00	-5.77
	876.000	39.27	---	---	56.00	46.00	-6.73
	1320.000	41.03	---	---	56.00	46.00	-4.97
	1645.000	42.06	---	---	56.00	46.00	-3.94
	2951.000	41.28	---	---	56.00	46.00	-4.72
	4090.000	42.31	---	---	56.00	46.00	-3.69
Line 2	191.000	48.54	---	---	64.83	54.83	-6.29
	937.000	37.54	---	---	56.00	46.00	-8.46
	1385.000	39.04	---	---	56.00	46.00	-6.96
	1818.000	42.08	---	---	56.00	46.00	-3.92
	2394.000	42.71	---	---	56.00	46.00	-3.29
	5290.000	43.66	---	---	60.00	50.00	-6.34

Test mode: IEEE 802.11b Channel 1 UMEC

<i>Power Connected Emissions</i>					<i>Class B</i>		
<i>Conductor</i>	<i>Frequency (KHz)</i>	<i>Peak (dBμV)</i>	<i>QP (dBμV)</i>	<i>Average (dBμV)</i>	<i>QP-limit (dBμV)</i>	<i>AVG-limit (dBμV)</i>	<i>Margin (dB)</i>
Line 1	194.300	55.63	50.17	42.41	64.66	54.66	-12.45
	391.000	42.32	---	---	59.11	49.11	-6.79
	681.000	41.17	---	---	56.00	46.00	-4.83
	867.000	40.10	---	---	56.00	46.00	-5.90
	1166.000	39.92	---	---	56.00	46.00	-6.08
	4367.000	41.24	---	---	56.00	46.00	-4.76
Line 2	192.435	54.46	47.41	40.57	64.71	54.71	-14.14
	485.000	40.63	---	---	56.43	46.43	-5.80
	2329.000	39.80	---	---	56.00	46.00	-6.20
	4171.000	41.22	---	---	56.00	46.00	-4.78
	10830.000	43.07	---	---	60.00	50.00	-6.93
	12860.000	44.75	---	---	60.00	50.00	-5.25

Test mode: IEEE 802.11b Channel 6 UMEC

<i>Power Connected Emissions</i>					<i>Class B</i>		
<i>Conductor</i>	<i>Frequency (KHz)</i>	<i>Peak (dBμV)</i>	<i>QP (dBμV)</i>	<i>Average (dBμV)</i>	<i>QP-limit (dBμV)</i>	<i>AVG-limit (dBμV)</i>	<i>Margin (dB)</i>
Line 1	291.000	46.58	---	---	61.97	51.97	-5.39
	485.000	40.63	---	---	56.43	46.43	-5.80
	674.000	40.03	---	---	56.00	46.00	-5.97
	963.000	40.01	---	---	56.00	46.00	-5.99
	3574.000	39.64	---	---	56.00	46.00	-6.36
	4367.000	41.34	---	---	56.00	46.00	-4.66
Line 2	222.000	48.10	---	---	63.94	53.94	-5.84
	288.000	46.02	---	---	62.06	52.06	-6.04
	485.000	40.56	---	---	56.43	46.43	-5.87
	4249.000	41.57	---	---	56.00	46.00	-4.43
	10950.000	42.91	---	---	60.00	50.00	-7.09
	13710.000	44.24	---	---	60.00	50.00	-5.76

Test mode: IEEE 802.11b Channel 11 UMEC

<i>Power Connected Emissions</i>					<i>Class B</i>		
<i>Conductor</i>	<i>Frequency (KHz)</i>	<i>Peak (dBμV)</i>	<i>QP (dBμV)</i>	<i>Average (dBμV)</i>	<i>QP-limit (dBμV)</i>	<i>AVG-limit (dBμV)</i>	<i>Margin (dB)</i>
Line 1	294.000	45.54	---	---	61.89	51.89	-6.35
	384.000	42.14	---	---	59.31	49.31	-7.17
	485.000	40.37	---	---	56.43	46.43	-6.06
	674.000	40.10	---	---	56.00	46.00	-5.90
	1155.000	39.30	---	---	56.00	46.00	-6.70
	1645.000	37.78	---	---	56.00	46.00	-8.22
Line 2	210.000	49.42	---	---	64.29	54.29	-4.87
	288.000	44.46	---	---	62.06	52.06	-7.60
	581.000	37.61	---	---	56.00	46.00	-8.39
	2329.000	40.08	---	---	56.00	46.00	-5.92
	4249.000	41.85	---	---	56.00	46.00	-4.15
	12860.000	43.95	---	---	60.00	50.00	-6.05

Test mode: IEEE 802.11g Channel 1 UMEC

<i>Power Connected Emissions</i>					<i>Class B</i>		
<i>Conductor</i>	<i>Frequency (KHz)</i>	<i>Peak (dBμV)</i>	<i>QP (dBμV)</i>	<i>Average (dBμV)</i>	<i>QP-limit (dBμV)</i>	<i>AVG-limit (dBμV)</i>	<i>Margin (dB)</i>
Line 1	291.000	46.35	---	---	61.97	51.97	-5.62
	575.000	41.71	---	---	56.00	46.00	-4.29
	867.000	39.71	---	---	56.00	46.00	-6.29
	1155.000	39.78	---	---	56.00	46.00	-6.22
	1451.000	38.74	---	---	56.00	46.00	-7.26
	3477.000	39.57	---	---	56.00	46.00	-6.43
Line 2	248.000	45.61	---	---	63.20	53.20	-7.59
	384.000	40.80	---	---	59.31	49.31	-8.51
	581.000	39.68	---	---	56.00	46.00	-6.32
	1731.000	37.69	---	---	56.00	46.00	-8.31
	2451.000	39.78	---	---	56.00	46.00	-6.22
	4249.000	41.62	---	---	56.00	46.00	-4.38

Test mode: IEEE 802.11g Channel 6 UMEC

Power Connected Emissions					Class B		
Conductor	Frequency (KHz)	Peak (dBμV)	QP (dBμV)	Average (dBμV)	QP-limit (dBμV)	AVG-limit (dBμV)	Margin (dB)
Line 1	210.000	50.18	---	---	64.29	54.29	-4.11
	485.000	42.55	---	---	56.43	46.43	-3.88
	774.000	40.25	---	---	56.00	46.00	-5.75
	1155.000	39.75	---	---	56.00	46.00	-6.25
	3381.000	39.75	---	---	56.00	46.00	-6.25
	4327.000	40.97	---	---	56.00	46.00	-5.03
Line 2	231.000	47.02	---	---	63.69	53.69	-6.67
	288.000	45.68	---	---	62.06	52.06	-6.38
	2415.000	39.99	---	---	56.00	46.00	-6.01
	4249.000	41.74	---	---	56.00	46.00	-4.26
	10950.000	43.80	---	---	60.00	50.00	-6.20
	13920.000	43.08	---	---	60.00	50.00	-6.92

Test mode: IEEE 802.11g Channel 11 UMEC

Power Connected Emissions					FCC Class B		
Conductor	Frequency (KHz)	Peak (dBμV)	QP (dBμV)	Average (dBμV)	QP-limit (dBμV)	AVG-limit (dBμV)	Margin (dB)
Line 1	218.000	48.55	---	---	64.06	54.06	-5.51
	291.000	45.17	---	---	61.97	51.97	-6.80
	387.000	40.94	---	---	59.23	49.23	-8.29
	485.000	42.62	---	---	56.43	46.43	-3.81
	674.000	40.30	---	---	56.00	46.00	-5.70
	867.000	40.53	---	---	56.00	46.00	-5.47
Line 2	206.000	49.26	---	---	64.40	54.40	-5.14
	291.000	44.94	---	---	61.97	51.97	-7.03
	1836.000	37.94	---	---	56.00	46.00	-8.06
	2415.000	39.78	---	---	56.00	46.00	-6.22
	4249.000	41.34	---	---	56.00	46.00	-4.66
	12250.000	44.00	---	---	60.00	50.00	-6.00

Test mode: IEEE 802.11n 20M Channel 1 UMEC

Power Connected Emissions					Class B		
Conductor	Frequency (KHz)	Peak (dBμV)	QP (dBμV)	Average (dBμV)	QP-limit (dBμV)	AVG-limit (dBμV)	Margin (dB)
Line 1	294.000	45.01	---	---	61.89	51.89	-6.88
	384.000	42.62	---	---	59.31	49.31	-6.69
	480.000	41.08	---	---	56.57	46.57	-5.49
	674.000	40.15	---	---	56.00	46.00	-5.85
	774.000	40.12	---	---	56.00	46.00	-5.88
	1155.000	39.99	---	---	56.00	46.00	-6.01
Line 2	199.000	50.46	---	---	64.60	54.60	-4.14
	485.000	38.29	---	---	56.43	46.43	-8.14
	674.000	39.09	---	---	56.00	46.00	-6.91
	867.000	38.67	---	---	56.00	46.00	-7.33
	2610.000	38.55	---	---	56.00	46.00	-7.45
	4249.000	41.95	---	---	56.00	46.00	-4.05

Test mode: IEEE 802.11n 20M Channel 6 UMEC

Power Connected Emissions					Class B		
Conductor	Frequency (KHz)	Peak (dBμV)	QP (dBμV)	Average (dBμV)	QP-limit (dBμV)	AVG-limit (dBμV)	Margin (dB)
Line 1	288.000	46.44	---	---	62.06	52.06	-5.62
	387.000	44.37	---	---	59.23	49.23	-4.86
	480.000	42.11	---	---	56.57	46.57	-4.46
	674.000	40.25	---	---	56.00	46.00	-5.75
	867.000	40.79	---	---	56.00	46.00	-5.21
	1155.000	40.16	---	---	56.00	46.00	-5.84
Line 2	288.000	46.70	---	---	62.06	52.06	-5.36
	2308.000	38.69	---	---	56.00	46.00	-7.31
	2899.000	37.92	---	---	56.00	46.00	-8.08
	4249.000	41.64	---	---	56.00	46.00	-4.36
	11000.000	43.57	---	---	60.00	50.00	-6.43
	14190.000	42.63	---	---	60.00	50.00	-7.37

Test mode: IEEE 802.11n 20M Channel 11 UMEC

<i>Power Connected Emissions</i>					<i>Class B</i>		
<i>Conductor</i>	<i>Frequency (KHz)</i>	<i>Peak (dBμV)</i>	<i>QP (dBμV)</i>	<i>Average (dBμV)</i>	<i>QP-limit (dBμV)</i>	<i>AVG-limit (dBμV)</i>	<i>Margin (dB)</i>
Line 1	291.000	46.05	---	---	61.97	51.97	-5.92
	480.000	41.41	---	---	56.57	46.57	-5.16
	774.000	40.63	---	---	56.00	46.00	-5.37
	1059.000	40.08	---	---	56.00	46.00	-5.92
	3189.000	38.93	---	---	56.00	46.00	-7.07
	4327.000	40.99	---	---	56.00	46.00	-5.01
Line 2	288.000	45.78	---	---	62.06	52.06	-6.28
	581.000	38.90	---	---	56.00	46.00	-7.10
	963.000	38.60	---	---	56.00	46.00	-7.40
	2308.000	39.89	---	---	56.00	46.00	-6.11
	2899.000	38.13	---	---	56.00	46.00	-7.87
	4249.000	41.64	---	---	56.00	46.00	-4.36

Test mode: IEEE 802.11n 40M Channel 3 UMEC

<i>Power Connected Emissions</i>					<i>Class B</i>		
<i>Conductor</i>	<i>Frequency (KHz)</i>	<i>Peak (dBμV)</i>	<i>QP (dBμV)</i>	<i>Average (dBμV)</i>	<i>QP-limit (dBμV)</i>	<i>AVG-limit (dBμV)</i>	<i>Margin (dB)</i>
Line 1	208.000	49.33	---	---	64.34	54.34	-5.01
	387.000	43.12	---	---	59.23	49.23	-6.11
	485.000	41.15	---	---	56.43	46.43	-5.28
	674.000	39.64	---	---	56.00	46.00	-6.36
	963.000	39.80	---	---	56.00	46.00	-6.20
	1451.000	38.41	---	---	56.00	46.00	-7.59
Line 2	224.000	47.59	---	---	63.89	53.89	-6.30
	480.000	39.44	---	---	56.57	46.57	-7.13
	581.000	38.76	---	---	56.00	46.00	-7.24
	2308.000	40.15	---	---	56.00	46.00	-5.85
	4249.000	41.31	---	---	56.00	46.00	-4.69
	12980.000	43.07	---	---	60.00	50.00	-6.93

Test mode: IEEE 802.11n 40M Channel 6 UMEC

Power Connected Emissions					Class B		
Conductor	Frequency (KHz)	Peak (dBμV)	QP (dBμV)	Average (dBμV)	QP-limit (dBμV)	AVG-limit (dBμV)	Margin (dB)
Line 1	387.000	42.77	---	---	59.23	49.23	-6.46
	581.000	41.34	---	---	56.00	46.00	-4.66
	774.000	39.71	---	---	56.00	46.00	-6.29
	1059.000	40.15	---	---	56.00	46.00	-5.85
	3004.000	38.74	---	---	56.00	46.00	-7.26
	4327.000	40.94	---	---	56.00	46.00	-5.06
Line 2	387.000	40.49	---	---	59.23	49.23	-8.74
	485.000	39.46	---	---	56.43	46.43	-6.97
	963.000	38.01	---	---	56.00	46.00	-7.99
	2308.000	40.21	---	---	56.00	46.00	-5.79
	2899.000	37.78	---	---	56.00	46.00	-8.22
	4249.000	41.85	---	---	56.00	46.00	-4.15

Test mode: IEEE 802.11n 40M Channel 9 UMEC

Power Connected Emissions					FCC Class B		
Conductor	Frequency (KHz)	Peak (dBμV)	QP (dBμV)	Average (dBμV)	QP-limit (dBμV)	AVG-limit (dBμV)	Margin (dB)
Line 1	222.000	48.05	---	---	63.94	53.94	-5.89
	387.000	42.62	---	---	59.23	49.23	-6.61
	485.000	40.30	---	---	56.43	46.43	-6.13
	581.000	40.23	---	---	56.00	46.00	-5.77
	774.000	40.03	---	---	56.00	46.00	-5.97
	4327.000	41.22	---	---	56.00	46.00	-4.78
Line 2	214.000	48.64	---	---	64.17	54.17	-5.53
	288.000	45.38	---	---	62.06	52.06	-6.68
	963.000	38.78	---	---	56.00	46.00	-7.22
	1836.000	37.73	---	---	56.00	46.00	-8.27
	2415.000	39.85	---	---	56.00	46.00	-6.15
	4249.000	41.27	---	---	56.00	46.00	-4.73

V. Section 15.247 (a): Technical description of the EUT

Direct Sequence System is a spread spectrum system in which the carrier has been modulated by a high speed spreading code and an information data stream. The high speed code sequence dominates the “modulating function” and is the direct cause of the wide spreading of the transmitted signal. In the operational description demonstrates the operation principles of the Baseband processor employed by the EUT, shows that which is a complete DSSS baseband processor and meets the definition of the direct sequence spread spectrum system.

VI. Section 15.247(a)(2): Bandwidth for Direct Sequence System.

6.1 Test Condition & Setup

The transmitter bandwidth measurements were performed by the contact manner. The EUT was set to transmit continuously, also various channels were investigated to find the maximum occupied bandwidth. The output of the EUT was connected to the spectrum analyzer. The bandwidth of the fundamental frequency is observed by the spectrum analyzer with 100kHz RBW and 100kHz VBW.

6.2 Test Instruments Configuration

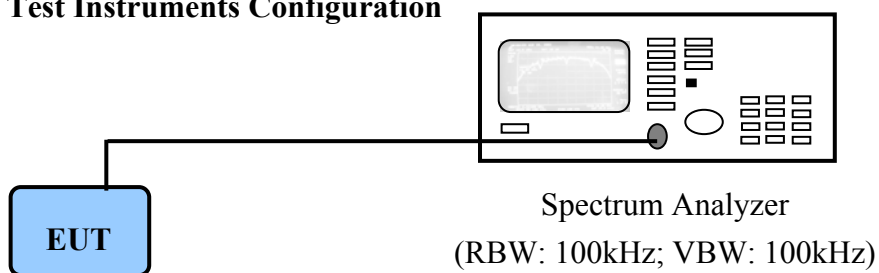

PC to control the EUT at maximal power output and channel number and set antenna kit

6.3 List of Test Instruments

Instrument Name	Model No.	Brand	Serial No.	Next time
Spectrum Analyzer	MS2665C	ANRITSU	6200175476	11/15/06

6.4 Test Result of Bandwidth

IEEE 802.11b

Channel	Limited (kHz)	Antenna(MHz)
CH01	≥ 500	11.20
CH06	≥ 500	11.20
CH11	≥ 500	11.24

IEEE 802.11g

CH01	≥ 500	16.76
CH06	≥ 500	16.80
CH11	≥ 500	16.80

IEEE 802.11n 20M

Channel	Limit (kHz)	Antenna#1(MHz)	Antenna#2(MHz)
CH01	≥ 500	17.44	17.88
CH06	≥ 500	17.44	17.84
CH11	≥ 500	17.44	17.84

IEEE 802.11n 40M

CH03	≥ 500	36.20	36.20
CH06	≥ 500	36.40	36.50
CH09	≥ 500	36.50	36.50

- Note:
1. The data in the above table are summarizing the following attachment spectrum analyzer hard copy. According to the guidance, we'd made the measurement with the spectrum analyzer's resolution bandwidth (RBW)=100kHz and set the $span \gg RBW$. The results show the measured 6dB bandwidth comply with the minimum 500kHz requirement.
 2. The attachments show these on the following pages.

6dB Bandwidth of Channel CH01 IEEE 802.11b , 2412MHz



6dB Bandwidth of Channel CH06 IEEE 802.11b , 2437MHz

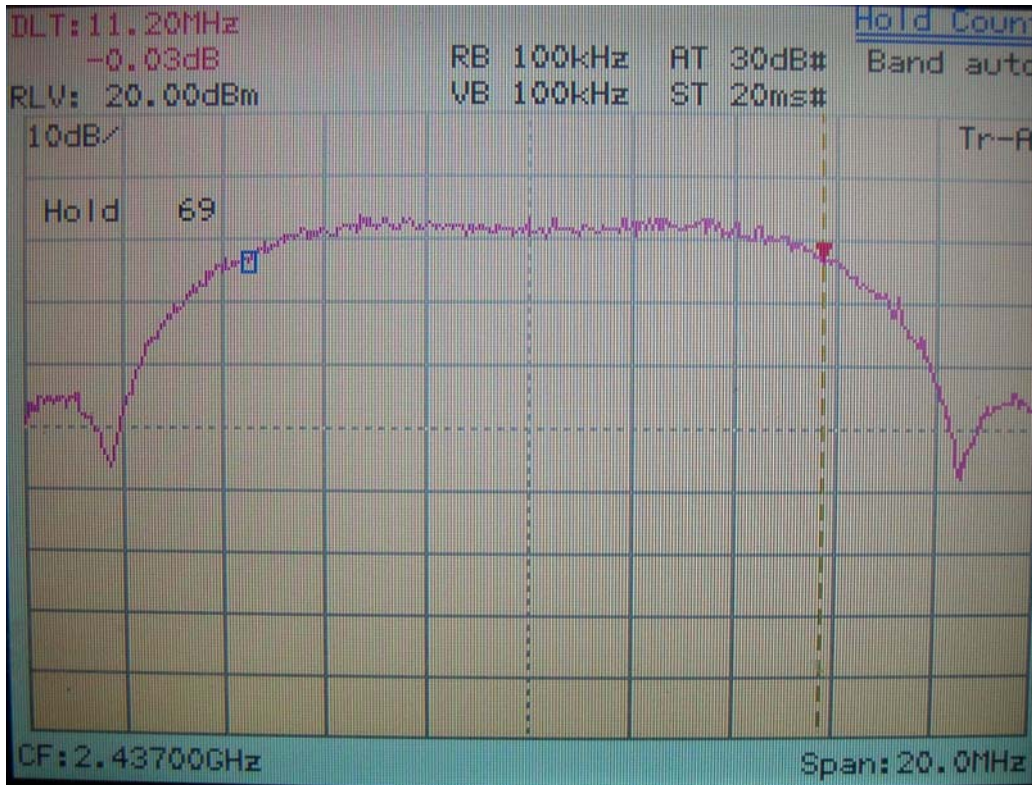

6dB Bandwidth of Channel CH01 IEEE 802.11g , 2412MHz

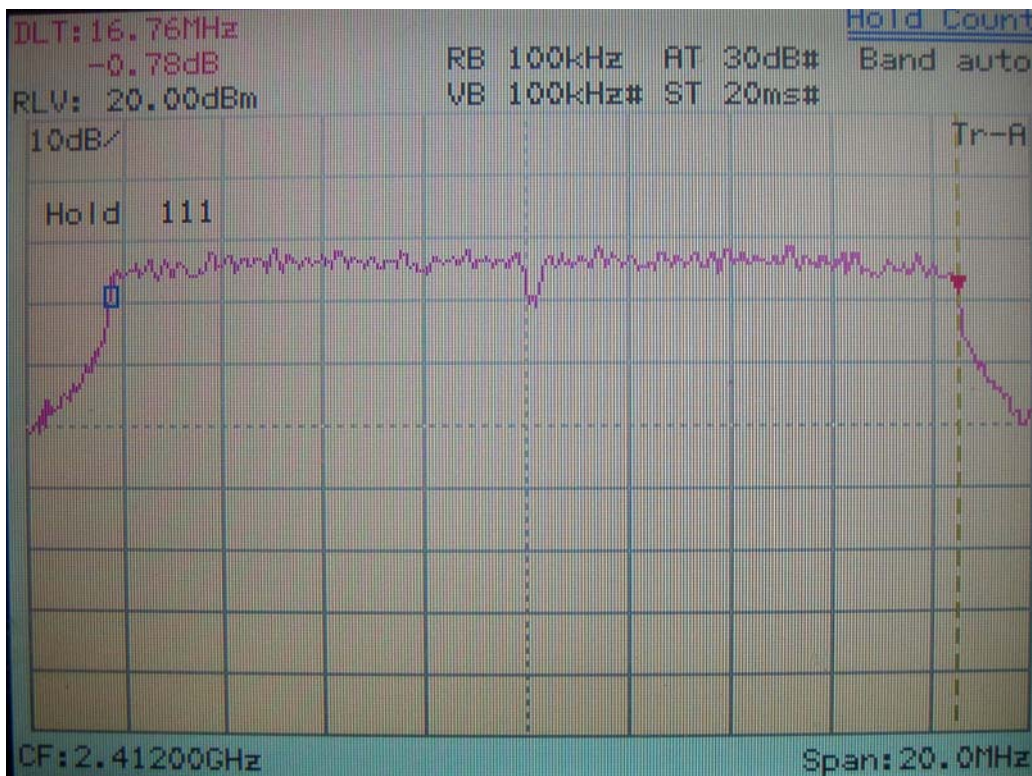

6dB Bandwidth of Channel CH06 IEEE 802.11g , 2437MHz

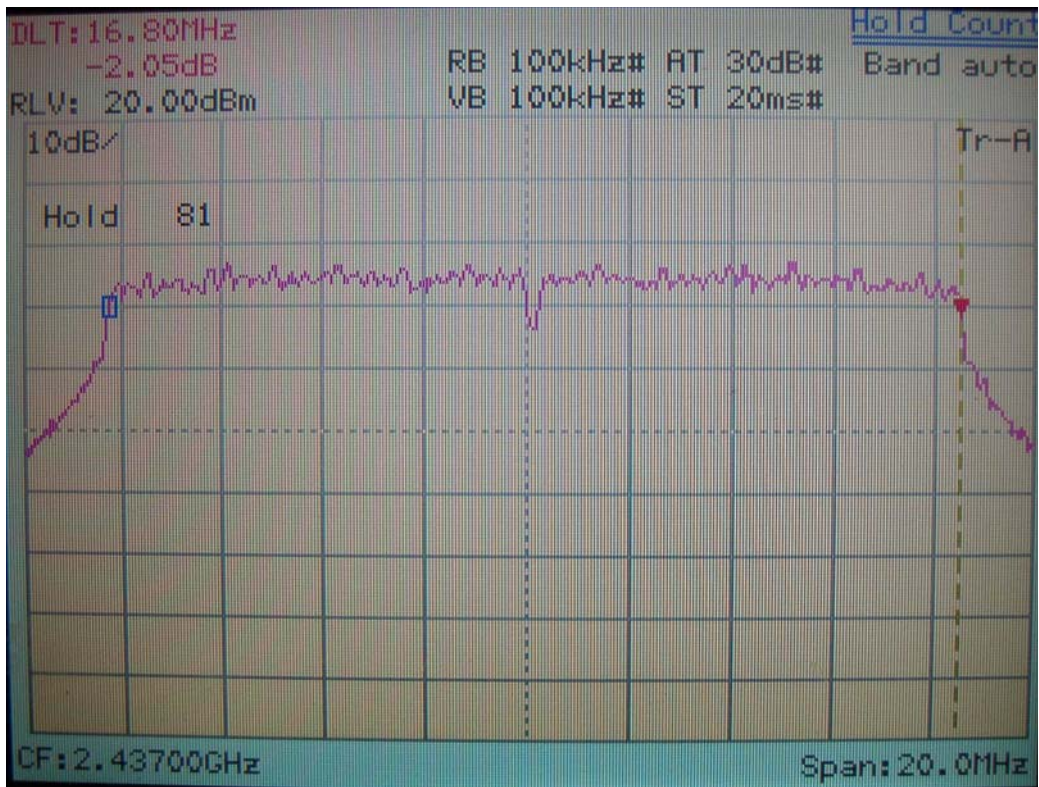

6dB Bandwidth of Channel CH11 IEEE 802.11g , 2462MHz

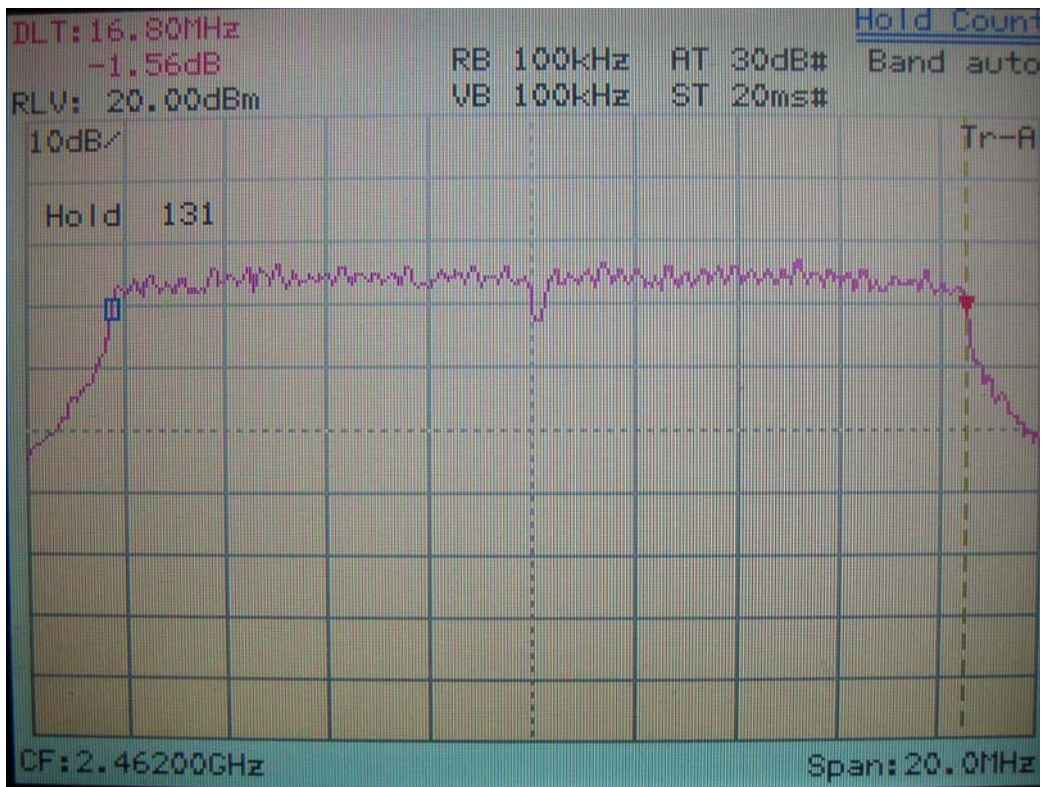

6dB Bandwidth of Channel 01 IEEE 802.11n 20M , 2412MHz

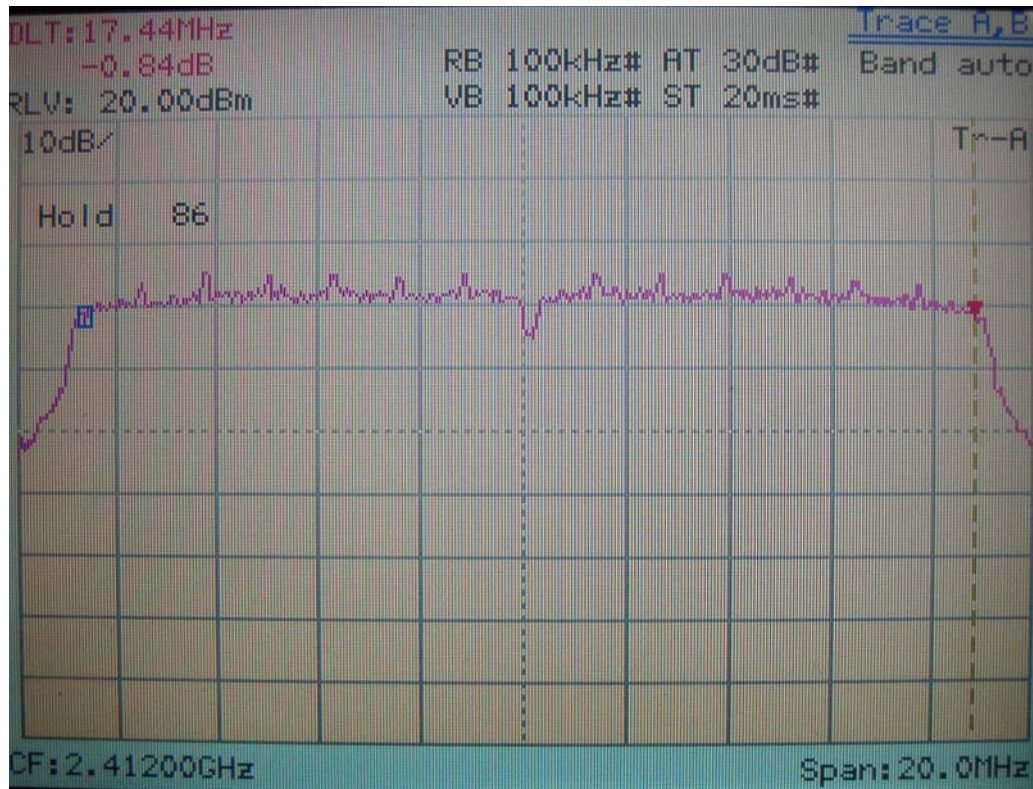

Ant#1



Ant#2

6dB Bandwidth of Channel 06 IEEE 802.11n 20M , 2437MHz

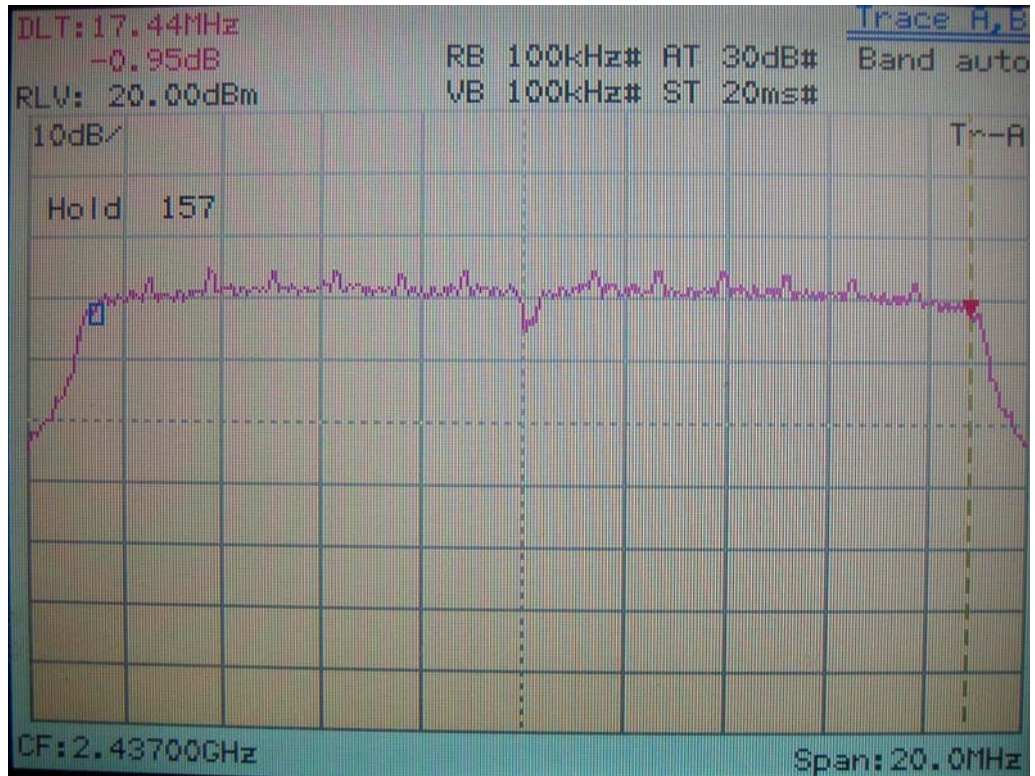

Ant#1



Ant#2

6dB Bandwidth of Channel 11 IEEE 802.11n 20M, 2462MHz

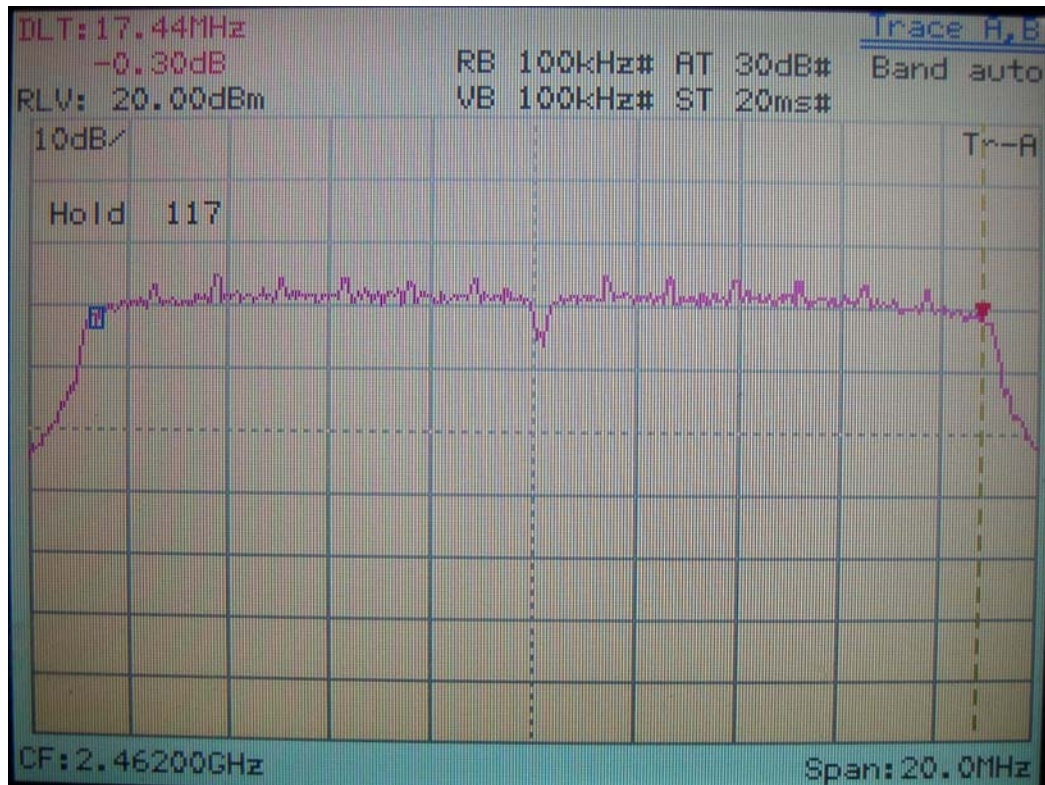

Ant#1

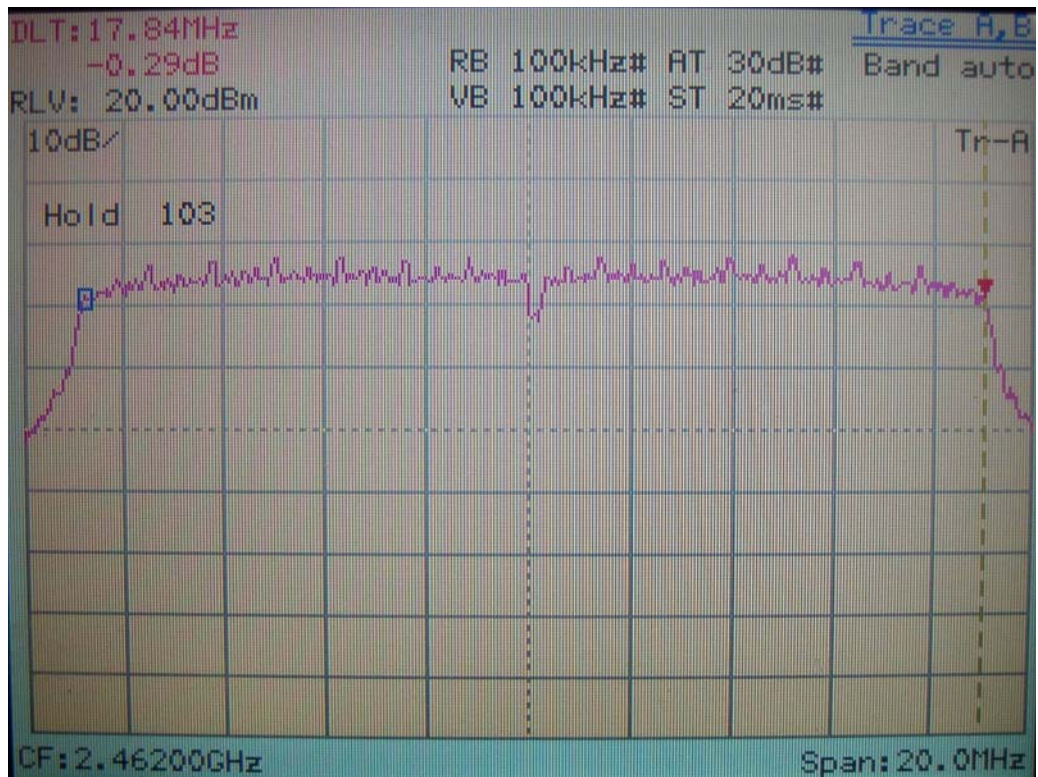

Ant#2

6dB Bandwidth of Channel 03 IEEE 802.11n 40M, 2422MHz

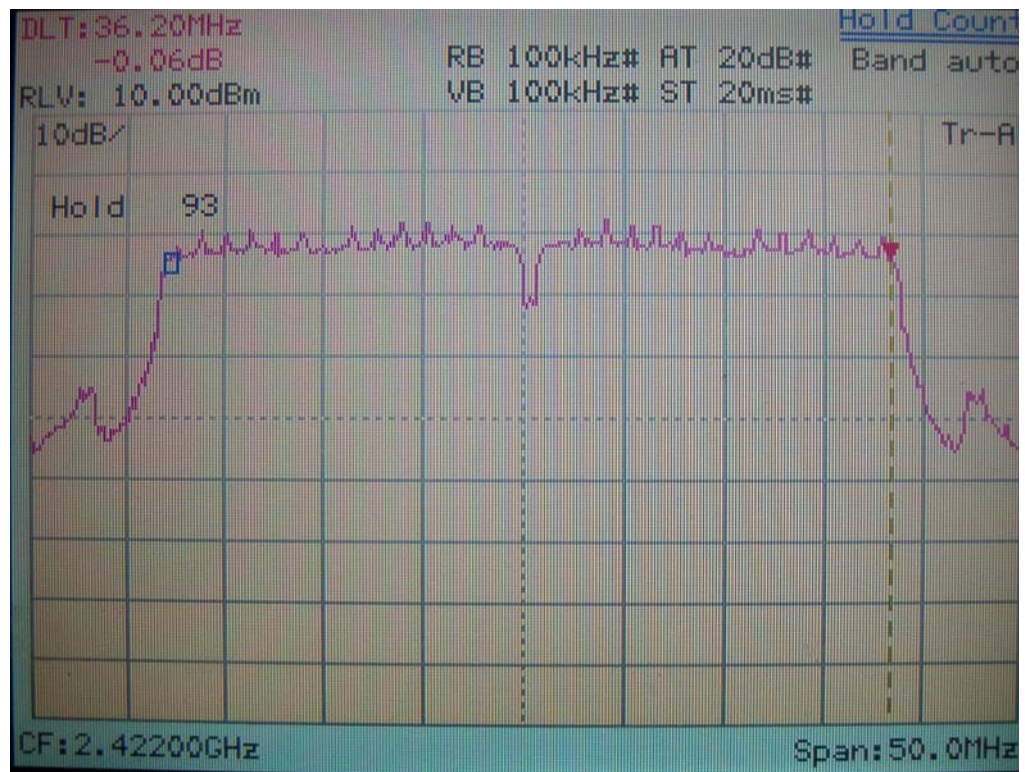

Ant#1



Ant#2

6dB Bandwidth of Channel 06 IEEE 802.11n 40M, 2437MHz

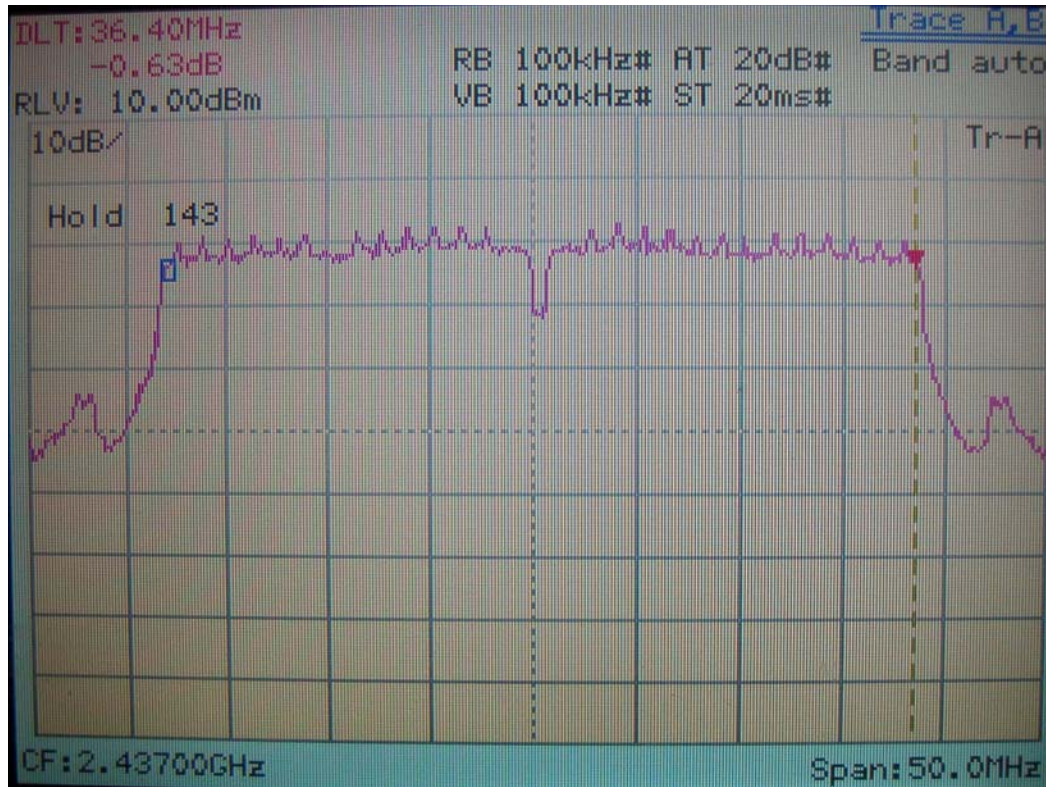

Ant#1

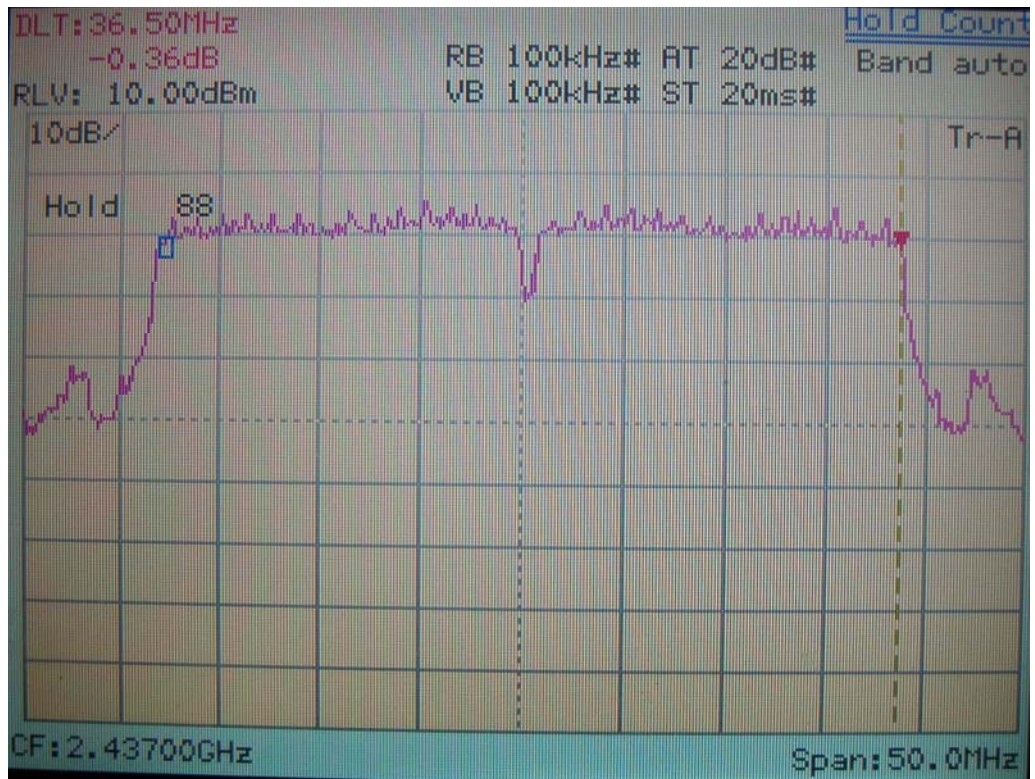

Ant#2

6dB Bandwidth of Channel 09 IEEE 802.11n 40M , 2452MHz

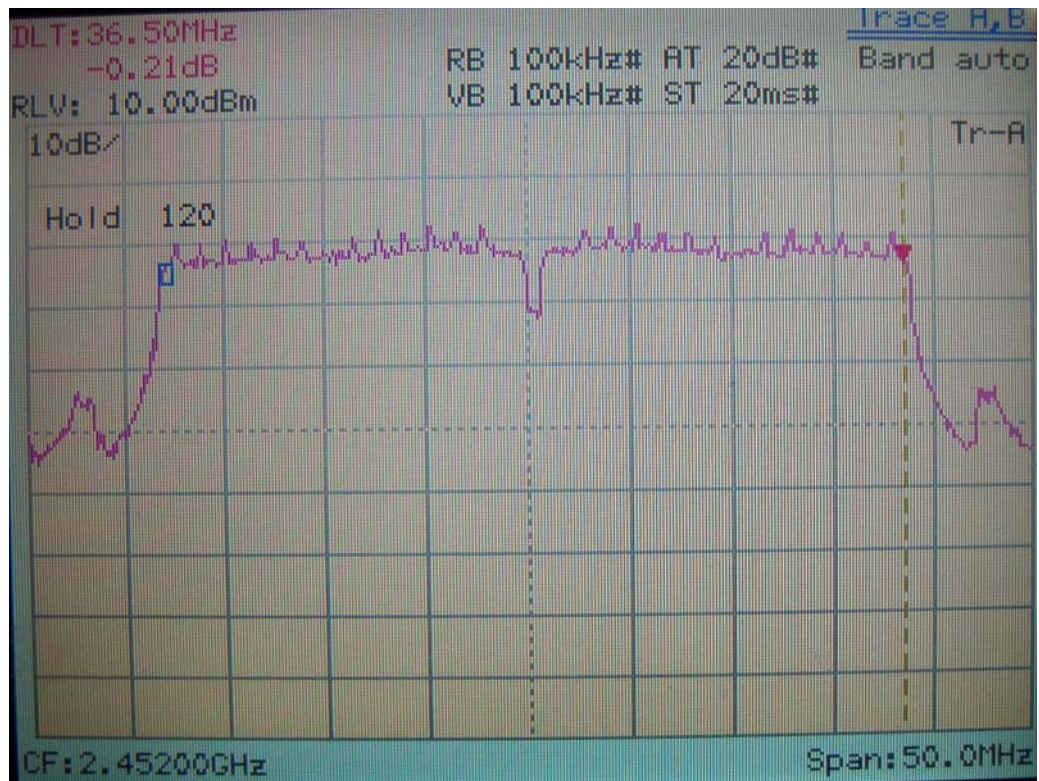

Ant#1



Ant#2

VII. Section 15.247(b): Power Output

7.1 Test Condition & Setup

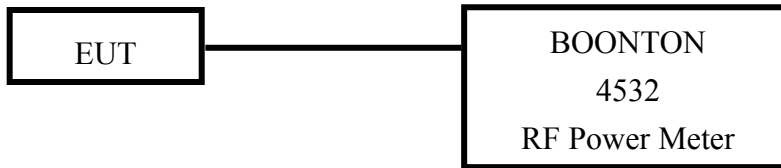

1. The output of the transmitter is connected to the BOONTON RF Power Meter.
2. The calibration is performed before every test. The values of the output power of the EUT will shown in the dBm directly are the transmitter output peak power. Recording as follows.

7.2 List of Test Instruments

Instrument Name	Model	Brand	Serial No.	Next time
RF Power Meter	4532	BOONTON	117501	05/18/07
Peak Power Sensor	57340	BOONTON	2696	05/18/07

7.3 Test Result

<p>Formula: RF Output of EUT + Cable Loss = Output Peak Power</p>
--

Channel (MHz)	Output Level	Cable Loss	Limit	Output Peak Power	
	dBm	dBm	(DSS)	dBm	mW

IEEE 802.11b

CH 01 /2412	20.44	1.00	30dBm	21.44	139.31
CH 06/2437	20.25	1.00	30dBm	21.25	133.35
CH 11/2462	20.09	1.00	30dBm	21.09	128.52

IEEE 802.11g

CH 01 /2412	21.17	1.00	30dBm	22.17	164.81
CH 06 /2437	21.04	1.00	30dBm	22.04	160.69
CH 11 /2462	20.85	1.00	30dBm	21.85	153.10

Formula:
 Total Power = 10 log (10[^] (Ant#1 Power / 10) + 10[^] (Ant#2 Power / 10))

Channel (MHz)	Output Level		Cable Loss	Limit	Total Output Peak Power	
	Ant#1	Ant#2			dBm	mW
	dBm	dBm	dB	(DSS)		

802.11n 20M

CH Lowest /2412	19.58	21.32	1.00	30dBm	24.546	284.90
CH Middle/2437	19.27	21.21	1.00	30dBm	24.357	272.76
CH Highest/2462	19.10	21.03	1.00	30dBm	24.181	262.92

802.11n 40M

CH Lowest /2422	18.38	20.87	1.00	30dBm	23.811	240.51
CH Middle/2437	18.16	20.75	1.00	30dBm	23.692	234.03
CH Highest/2452	18.07	20.59	1.00	30dBm	23.520	224.93