

# MEASUREMENT REPORT of *Wireless Multi-function Router*

**Applicant** : ASUSTek Computer Inc.  
**EUT** : Wireless Multi-function Router  
**Model No.** : WL-500gP  
**FCC ID** : MSQWL500GP

Tested by :

***Training Research Co., Ltd.***

**TEL : 886-2-26935155      FAX : 886-2-26934440**

No. 255, Nanyang Street, Shijr, Taipei Hsien 221, Taiwan, R.O.C.

# CERTIFICATION

**We here by verify that:**

The test data, data evaluation, test procedures and equipment configurations shown in this report were made mainly in accordance with the procedures given in ANSI C63.4 (2003) as a reference. All test were conducted by **Training Research Co., Ltd.**, 255 Nanyang Street, Shijr, Taipei Hsien 221, Taiwan, R.O.C. Also, we attest to the accuracy of each.

We further submit that the energy emitted by the sample EUT tested as described in the report is **in compliance with** the technical requirements set forth in the FCC Rules Part 15 Subpart B (Declaration of Conformity) and C Section 15.247.

**Applicant** : ASUSTek Computer Inc.  
**Applicant Address** : 4F, No. 150, Li-Te Rd., Peitou, Taipei, Taiwan, R.O.C.  
**Product Name** : Wireless Multi-function Router  
**Model** : WL-500gP  
**Report No.** : A5415060028  
**Test Date** : March 21, 2006

Prepared by:

  
Jack Tsai

Approved by:

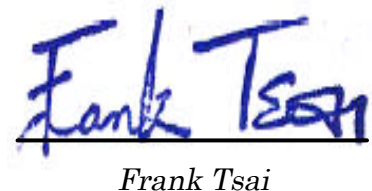
  
Frank Tsai

**Conditions of issue :**

- (1) **This test report shall not be reproduced except in full, without written approval of TRC. And the test result contained within this report only relate to the sample submitted for testing.**
- (2) **This report must not be used by the client to claim product endorsement by NVLAP or any agency of U.S. Government.**
- (3) **This test report, measurements made by TRC are traceable to the NIST only Conducted and Radiated Method.**



---

Report No.: A5415060028, FCC Part 15.247

Training Research Co., Ltd., TEL: 886-2-26935155, Fax: 886-2-26934440

## *Federal Communications Commission*

### **Declaration of Conformity**

for the following equipment:

Product name : Wireless Multi-function Router  
 Trade name : ASUS  
 Model name : WL-500gP

Is herewith confirmed and found to comply with the requirements of CFR 47 part15 Subpart B - Unintentional Radiators regulation. The results of electromagnetic mission evaluation are shown in the report number : A5415060028

This device complies with Part 15 of the FCC Rules. Operation is subject to the following two conditions:

- (1) This device may not cause harmful interference, and
- (2) This device must accept any interference received, including interference that may cause undesired operation

<b>Manufacturer</b>	<b>USA local representative</b>
<b>Company name:</b> ASUSTeK Computer Inc.	To be determined
<b>Computer address:</b> 4/F, 150, Li-Te Rd., Peitou, Taipei, Taiwan	
<b>ZIP / Postal code</b> 112	
<b>Contact person:</b> Lawrence Yu	
<b>Title:</b> Manager	
<b>Internet e-mail address:</b> lawrence_yu@asus.com.tw	
<b>Tel / Fax:</b> 886-2-28943447 / 886-2-28950113	

## Tables of Contents

<b>I. GENERAL</b>	6
1.1 Introduction	6
1.2 Description of EUT	6
1.3 Test method	7
1.4 Description of Support Equipment	8
1.5 Configuration of System Under Test	11
1.6 Verify the Frequency and Channel	13
1.7 Test Procedure	14
1.8 Location of the Test Site	14
1.9 General Test Condition	14
<b>II. Section 15.101(a) : Equipment Authorization of Unintentional Radiators</b>	15
<b>III. Section 15.203 : Antenna Requirement</b>	16
<b>IV. Section 15.207 : Power Line Conducted Emissions for AC Powered Units</b>	17
4.1 Test Condition & Setup	17
4.2 List of Test Instruments	18
4.3 Test Result of Conducted Emissions	19
Standby mode	19
IEEE 802.11b TX mode	20
IEEE 802.11g TX mode	21
<b>V. Section 15.247(a) : Technical Description of the EUT</b>	23
<b>VI. Section 15.247(a)(2) : Bandwidth for Direct Sequence System</b>	24
6.1 Test Condition & Setup	24
6.2 Test Instruments Configuration	24
6.3 List of Test Instruments	24
6.4 Test Result of Bandwidth	24
Channel 01	25
Channel 06	26
Chamel 11	27

<b>VII. Section 15.247(b) : Power Output</b> .....	28
7.1 Test Condition & Setup .....	28
7.2 List of Test Instruments .....	28
7.3 Test Result .....	28
<b>VIII. Section 15.247(c) : Spurious Emissions (Radiated)</b> .....	29
8.1 Test Condition & Setup .....	29
8.2 List of Test Instruments .....	31
8.3 Test Result of Spurious Radiated Emissions .....	32
Standby mode .....	32
IEEE 802.11b TX mode .....	34
IEEE 802.11g TX mode .....	40
8.4 Test Result of Bandedge .....	46
IEEE 802.11b TX mode .....	47
IEEE 802.11g TX mode .....	49
<b>IX. Section 15.247(d) : Power Spectral Density</b> .....	51
9.1 Test Condition & Setup .....	51
9.2 Test Instruments Configuration .....	51
9.3 List of Test Instruments.....	51
9.4 Test Result of Power Spectral Density .....	52
Channel 01 .....	53
Channel 06 .....	54
Channel 11 .....	55

## I . GENERAL

### 1.1 Introduction

The following measurement report is submitted on behalf of applicant in support that the certification in accordance with Part 2 Subpart J and Part 15 Subpart A, B and C of the Commission's Rules and Regulations.

### 1.2 Description of EUT

<b>FCC ID</b>	:	MSQWL500GP
<b>Product Name</b>	:	Wireless Multi-function Router
<b>Model Name</b>	:	WL-500gP
<b>Frequency Range</b>	:	2.412GHz ~ 2.462GHz
<b>Channel Spacing</b>	:	5MHz
<b>Support Channel</b>	:	11 Channels
<b>Modulation Skill</b>	:	DBPSK, DQPSK, CCK, OFDM
<b>Power Type</b>	:	Powered by the switching adapter, Manufacture.: UMEC Model: UP0181B-05PA I/P: 100-240VAC 50/60Hz 0.4A MAX. O/P: +5VDC 2.5A 12.5W MAX. 185cm length, non-shielded, no ferrite core
<b>Data Cable</b>	:	RJ45 cable x 3, 2.0m length, non-shielded, no ferrite core RJ45 cable x 1, 30.0m length, non-shielded, no ferrite core RJ45 cable x 1, 1.5m length, non-shielded, no ferrite core USB cable x 1, 1.0m length, shielded, no ferrite core USB cable x 1, 2.7m length, shielded, with ferrite core

### **1.3 Test method**

- 1.3.1 The DC-In connected to AC mains supply by switching adapter.
- 1.3.2 The USB-downstream port connected with a USB flash drive, another USB-downstream port connected with the camera.
- 1.3.3 The LAN1 port of EUT connected to far LAN card.
- 1.3.4 The LAN2, LAN3 and WAN ports are termination by RJ45 cables.
- 1.3.5 Connected the LAN4 port of EUT with the LAN of PC. Using PC and software provided by the manufacturer to control EUT, the test is performed under the specific conditions.
- 1.3.6 Set different data rate and channel (CH01/CH06/CH11) being tested and repeat the procedures above.
  - (a) Radiated for Intentional test:
    - making EUT to the mode of continuous transmission
  - (b) Conducted test and Radiated for unintentional test:
    - making EUT to the linking (RX/TX) mode with far support equipments

#### 1.4 Description of Support Equipment

In order to construct the minimum testing, following equipment were used as the support units.

**PC** : **HP, IBM 8434**  
Model No. : Pavilion t1000; IVG  
Serial No. : TWL3320051; 99CCZA3  
FCC ID : DoC (Declaration of Confirmation) Approved  
BSMI : R33001; R33026  
Power type : 100 ~ 127VAC/6A, 200 ~ 240VAC/3A, 50 ~ 60Hz, Switching  
Power cord : Non-shielded, 1.8m length, Plastic hood, No ferrite core

**Monitor** : **HP 15' Color Monitor**  
Model No. : D8894A  
Serial No. : CN02364355  
FCC ID : ARSCM356N  
BSMI : 3882A031  
Power type : 100 ~ 240 VAC / 1.5A, 50 ~ 60 Hz, Switching  
Power cord : Non-shielded, 1.80m length, Plastic hood, No ferrite core  
Data cable : Shielded, 1.50m length, Plastic hood, with ferrite core

**Printer** : **EPSON**  
Model No. : B241A  
Serial No. : FAPY155090  
FCC ID : N/A, DoC Approved  
BSMI : R33126  
Power type : Switching adaptor  
Power cord : Non-shielded, 198cm length, No ferrite core  
Data cable : Shielded, 1.50m length, No ferrite core

**PS/2 Mouse** : **HP**  
Model No. : M-UR89, M-S69  
Serial No. : LZS21750238, 334684-002 323614-001  
FCC ID : DoC Approved  
BSMI : 3892D767, R41126  
Power type : By PC  
Power cord : Shielded, 1.90m length, No ferrite core



**PS/2 Keyboard** : **HP**  
Model No. : 5187-0343, KB0133  
Serial No. : 265987-AB1 Tch 323686-AB1, B69360MGAPW0HF  
FCC ID : DoC Approved  
BSMI : 3892C981, R31310  
Power type : By PC  
Data cable : Shielded, 1.85m length, no ferrite core

**Modem** : **ACEEX**  
Model No. : DM-1414  
Serial No. : 9010583  
FCC ID : IFAXDM1414  
Power type : Linear  
Power cord : Non-shielded, 1.9m length, No ferrite cord  
Data cable : RS232, Shielded, 1.2m length, No ferrite core  
RJ11C x 2, 7' length non-shielded, No ferrite core

**USB Game pad** : **Logitech**  
Model No. : G-UC3B  
Serial No. : AE3500500  
FCC ID : DoC Approved  
BSMI : 4902A047  
Power Cable : Shielded, 187cm length, Plastic hood, No ferrite core.

**LAN Card** : **D-Link**  
Model No. : DFE-530TX  
Serial No. : 0050BAE3158B, 0050BAE32FF3  
FCC ID : DoC Approved

**USB**

**Flash Drive** : **City-Netek Inc.**  
Model No. : CN-2108  
FCC ID : DoC Approved  
Power cord : Shielded, 1.0m length, no ferrite core

**Video Camera** : **Logitech**  
Model No. : V-UJ16  
Serial No. : LZA30600780  
Product No. : 861095-0010  
BSMI : 4912A026  
FCC ID : N/A, DoC Approved  
Power type : 5V, 300mA  
Power cord : Shielded, 2.7m length, with ferrite core

**PC** : **IBM ThinkPad T43**  
Model No. : 2668-IVE  
Serial No. : L3TGYY  
FCC ID : N/A, DoC Approved  
BSMI : R33B65  
DGT : ETC093LPD0126, CTL093LPD0257

**Power adaptor** : **IBM**  
Part No. : 92P1018  
Serial No. : 11S92P1018Z1ZAPU57M9W6 REV: D  
FCC ID : N/A, DoC Approved  
BSMI : D33030  
Power type : 100 ~ 240VAC / 50 ~ 60Hz, 1.0 ~ 0.4A, Switching  
Power cord : Primary: Non-shielded, 1.0m length, Plastic hood, No ferrite core  
Secondary: Shielded, 1.84m length, Plastic hood, ferrite core

**WLAN Card** : **Gemtek Technology Co., Ltd.**  
Model No. : C911003  
FCC ID : MXF-C911003

**1.5 Configuration of System Under Test**

**1.5.1 Conducted and Radiated for Unintentional**

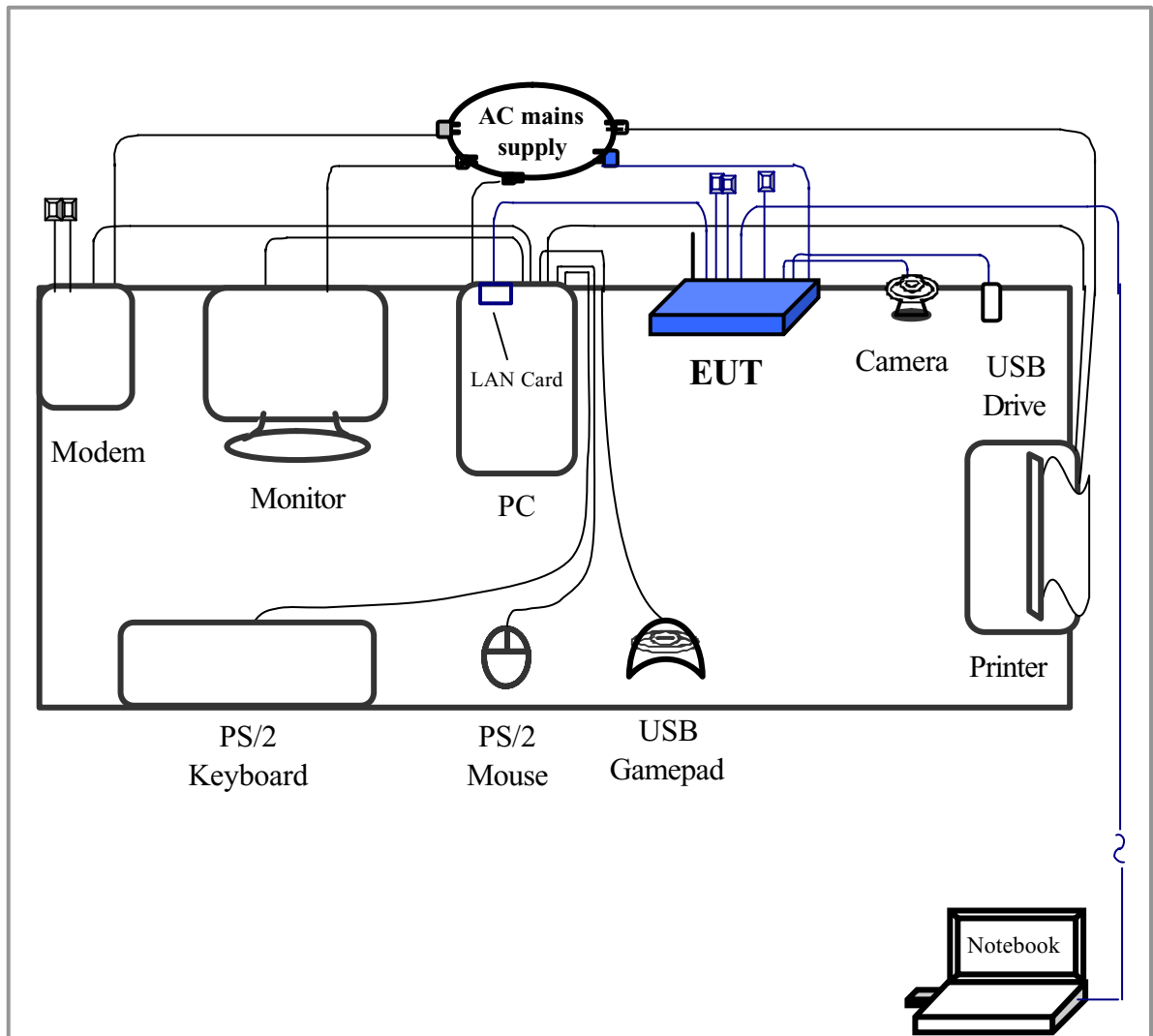

**Connections of Equipment**

- PC:** \*Parallel Port ..... a printer
- \*VGA Port ..... a monitor
- \*Serial Port ..... an external modem
- \*USB#1 Port ..... a USB gamepad
- \*PS/2-key Port ..... a PS/2 keyboard
- \*PS/2-mouse Port ..... a PS/2 mouse
- \*LAN Port ..... **EUT**

1.5.2 Radiated of Intentional

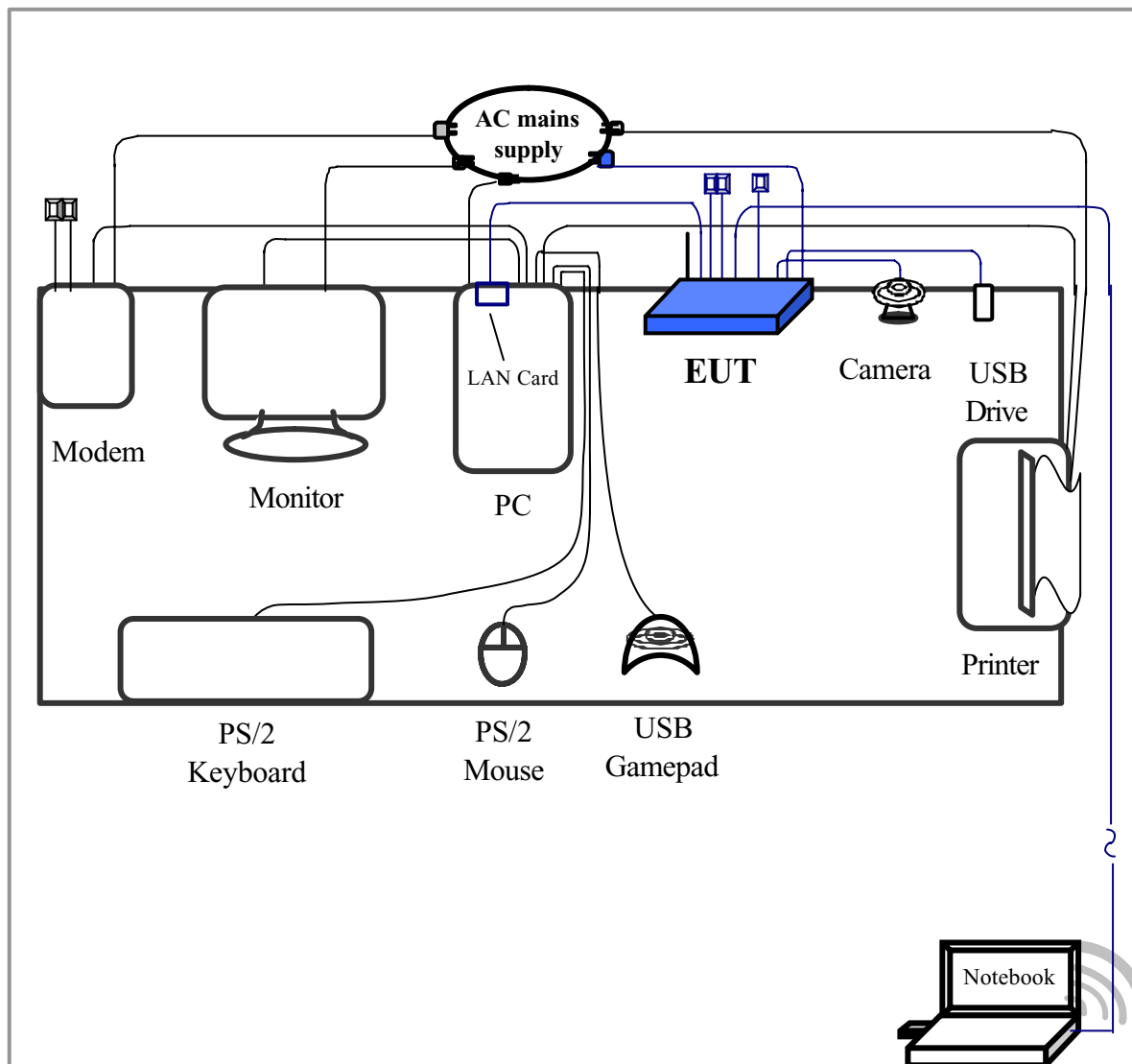

The tests below are carried with the EUT transmitter set at high power in TDD mode. The EUT is forced to select of output power level and channel number by LAN port.

The setting up procedure was recorded in 1.3 test method.

**1.6 Verify the Frequency and Channel**

Channel	Frequency (GHz)
1	2.412
2	2.417
3	2.422
4	2.427
5	2.432
6	2.437
7	2.442
8	2.447
9	2.452
10	2.457
11	2.462

Note:

1. This is for confirming that all frequencies are in 2.412GHz to 2.462GHz.
2. Section 15.31(m): Measurements on intentional radiators or receivers shall be performed at three frequencies for operating frequency range over 10 MHz  
(The locations of these frequencies one near the top, one near the middle and one near the bottom.)
3. After test, the EUT operating frequencies are in 2.412GHz to 2.462GHz. So all the items as followed in testing report are need to test these three frequencies:  
Top: Channel – 1; Middle: Channel – 6; Bottom: Channel – 11.

### **1.7 Test Procedure**

All measurements contained in this report were performed mainly according to the techniques described in ANSI C63.4 (2003) and the pre-setup was written on 1.3 test method, the detail setup was written on each test item.

### **1.8 Location of the Test Site**

The radiated emissions measurements required by the rules were performed on the **three-meter, Anechoic Chamber (FCC Registration Number: 93906)** maintained by *Training Research Co., Ltd.* 1F, No. 255 Nanyang Street, Shijr, Taipei Hsien 221, Taiwan, R.O.C. Complete description and measurement data have been placed on file with the commission. The conducted power line emissions tests and other test items were performed in a anechoic chamber also located at Training Research Co., Ltd.

No. 255 Nanyang Street, Shijr, Taipei Hsien 221, Taiwan, R.O.C. *Training Research Co., Ltd.* is listed by the FCC as a facility available to do measurement work for others on a contract basis.

### **1.9 General Test Condition**

The conditions under which the EUT operates were varied to determine their effect on the equipment's emission characteristics. The final configuration of the test system and the mode of operation used during these tests were chosen as that which produced the highest emission levels. However, only those conditions, which the EUT was considered likely to encounter in normal use were investigated.

In test, they were set in high power and continuously transmitting mode that controlled by computer. The ch01, ch06 and ch11 of EUT were all tested. The setting up procedure is recorded on 1.3 test method.

## **II. Section 15.101(a): Equipment authorization of unintentional radiators**

The EUT equipped with a LAN interface and should be operated with the computer. It was categorized to *Class B personal computers and peripherals* as cannot be operated stand-alone. The authorization requires **Declaration of Conformity (DoC)** and the items required such as Section15.107 (Conducted limits) and Section15.109 (Radiated emission limits) is same as Section15.207 and 15.247(C).

### **III. Section 15.203: Antenna requirement**

The EUT has one detachable antenna, the antennas are affixed to the EUT using a unique connector, which allows for replacement of a broken antenna, but does not use a standard antenna jack or electrical connector. The antenna requirement stated in Section 15.203 is inapplicable to this EUT.

The EUT can be equipped with two kinds of antennas, the custom antenna specification of list as below: (please refer to antenna specification of RF Exposure Calculations)

Manufacturer : JOINSOON ELECTRONICS MFG. CO., LTD.  
Part No : IA-050156  
Connector : R-SMA  
Antenna Type : Dipole Antenna  
Antenna Gain : 4.20dBi



## **VI. Section 15.207: Power Line Conducted Emissions for AC Powered Units**

### **4.1 Test Condition & Setup**

The power line conducted emission measurements were performed in an anechoic chamber. The EUT was assembled on a wooden table, which is 80 centimeters high, was placed 40 centimeters from the backwall and at least 1 meter from the sidewall.

Power was fed to the EUT from the public utility power grid through a line filter and Line Impedance Stabilization Networks (LISNs). The LISN housing, measuring instrumentation case, ground plane, etc., were electrically bonded together at the same RF potential. The Spectrum analyzer (or EMI receiver) was connected to the AC line through an isolation transformer. The 50-ohm output of the LISN was connected to the spectrum analyzer directly. Conducted emission levels were in the CISPR quasi-peak and average detection mode. The analyzer's 6 dB bandwidth was set to 9 KHz. No post-detector video filter was used.

The spectrum was scanned from 150 KHz to 30 MHz. The physical arrangement of the test system and associated cabling was varied (within the scope of arrangements likely to be encountered in actual use) to determine the effect on the unit's emanations in amplitude and frequency. All spurious emission frequencies were observed. The highest emission amplitudes relative to the appropriate limit were measured and have been recorded in paragraph 4.3

There is a test condition apply in this test item, the test procedure description as <1.3>. Three channels were tested, one in the top (CH01), one in the middle (CH06) and the other in bottom (CH11).

**4.2 List of Test Instruments**

				<u>Calibration Date</u>
<b>Instrument Name</b>	<b>Model</b>	<b>Brand</b>	<b>Serial No.</b>	<b>Next time</b>
EMI Receiver	8546A	HP	3520A00242	06/01/06
RF Filter Section	85460A	HP	3448A00217	06/01/06
LISN (EUT)	LISN-01	TRC	99-05	12/10/06
LISN (Support E.)	LISN-01	TRC	9912-03, 04	11/26/06
Pre-amplifier	15542 ZFL-500	Mini – Circuits	0 0117	05/20/06
6dB Attenuator	MCL BW-S6W2	Mini – Circuits	9915 – Conducted	05/20/06
10dB Attenuator	A5542 VAT010	Mini – Circuits	0215 – Conducted	05/20/06
Coaxial Cable (2.0 meter)	A30A30-0058-50FS-2M	Jyebao	SMA-08	05/20/06
Coaxial Cable (1.1 meter)	A30A30-0058-50FS-1M	Jyebao	SMA-09	05/20/06
Coaxial Cable (20 meter)	RG-214/U	Jyebao	NP-01	05/20/06
Coaxial Cable (20 meter)	RG-214/U	Jyebao	NP-02	05/20/06
Auto Switch Box (< 30MHz)	ASB-01	TRC	9904-01	05/20/06

**4.3 Test Result of Power Line Conducted Emissions**

The following table shows a summary of the highest emissions of power line conducted emissions on the LIVE and NETURAL conductors of the EUT power cord. Show as follows.

Test Conditions: Temperature : 25 °C Humidity : 73 % RH

*Test mode: Standby mode*

<i>Power Connected Emissions</i>					<i>Class B</i>		
<i>Conductor</i>	<i>Frequency (KHz)</i>	<i>Peak (dBµV)</i>	<i>QP (dBµV)</i>	<i>Average (dBµV)</i>	<i>QP-limit (dBµV)</i>	<i>AVG-limit (dBµV)</i>	<i>Margin (dB)</i>
Line 1	159.755	59.17	51.13	16.66	65.74	55.74	-14.61
	170.810	58.61	49.49	17.57	65.17	55.17	-15.68
	3382.405	44.58	44.01	43.43	56.00	46.00	-2.57
	3749.545	45.61	44.64	43.69	56.00	46.00	-2.31
	3931.125	46.09	45.17	44.36	56.00	46.00	-1.64
	19098.670	52.40	49.89	44.40	60.00	50.00	-5.60
Line 2	2285.610	46.83	45.99	41.78	56.00	46.00	-4.22
	2377.330	47.42	46.78	42.26	56.00	46.00	-3.74
	2559.455	47.66	46.70	42.97	56.00	46.00	-3.03
	2925.975	46.41	45.84	43.46	56.00	46.00	-2.54
	3291.905	45.10	44.31	43.35	56.00	46.00	-2.65
	20203.155	55.14	52.82	47.15	60.00	50.00	-2.85

NOTE:

- (1)Margin = Peak Amplitude – Limit, *The reading amplitudes are all under limit.*
- (2)A "+" sign in the margin column means the emission is OVER the Class B Limit and "-" sign of means UNDER the Class B limit

**Test mode: IEEE 802.11b Channel 1**

<b>Power Connected Emissions</b>					<b>Class B</b>		
<b>Conductor</b>	<b>Frequency (KHz)</b>	<b>Peak (dBμV)</b>	<b>QP (dBμV)</b>	<b>Average (dBμV)</b>	<b>QP-limit (dBμV)</b>	<b>AVG-limit (dBμV)</b>	<b>Margin (dB)</b>
Line 1	160.990	59.76	51.91	17.32	65.63	55.63	-13.72
	166.220	60.89	51.80	16.69	65.31	55.31	-13.51
	3566.765	45.54	44.90	44.36	56.00	46.00	-1.64
	.838.840	46.60	45.66	44.59	56.00	46.00	-1.41
	4021.795	46.76	45.43	44.23	56.00	46.00	-1.77
	18924.770	51.74	48.17	42.96	60.00	50.00	-7.04
Line 2	155.450	60.78	52.42	17.28	65.91	55.91	-13.49
	2470.145	47.86	46.61	42.29	56.00	46.00	-3.71
	2559.650	47.91	47.06	42.93	56.00	46.00	-3.07
	2835.115	47.15	46.23	44.07	56.00	46.00	-1.93
	3292.995	45.88	44.68	43.97	56.00	46.00	-2.03
	18108.920	54.08	50.27	45.29	60.00	50.00	-4.71

**Test mode: IEEE 802.11b Channel 6**

<b>Power Connected Emissions</b>					<b>Class B</b>		
<b>Conductor</b>	<b>Frequency (KHz)</b>	<b>Peak (dBμV)</b>	<b>QP (dBμV)</b>	<b>Average (dBμV)</b>	<b>QP-limit (dBμV)</b>	<b>AVG-limit (dBμV)</b>	<b>Margin (dB)</b>
Line 1	155.255	58.80	50.68	15.38	66.00	56.00	-15.32
	180.230	56.79	48.32	39.55	65.00	55.00	-15.45
	3657.625	46.02	45.26	44.76	56.00	46.00	-1.24
	3841.275	46.67	45.86	45.33	56.00	46.00	-0.67
	3930.915	46.71	45.64	44.27	56.00	46.00	-1.73
	19294.225	52.19	49.02	44.05	60.00	50.00	-5.95
Line 2	2104.430	45.33	44.24	40.78	56.00	46.00	-5.22
	2561.405	47.95	46.92	43.10	56.00	46.00	-2.90
	2744.710	47.02	45.88	43.58	56.00	46.00	-2.42
	3109.485	46.18	45.28	44.16	56.00	46.00	-1.84
	4298.440	45.58	44.71	43.85	56.00	46.00	-2.15
	20762.545	52.66	48.73	40.84	60.00	50.00	-9.16

**Test mode: IEEE 802.11b Channel 11**

<b>Power Connected Emissions</b>					<b>Class B</b>		
<b>Conductor</b>	<b>Frequency (KHz)</b>	<b>Peak (dBμV)</b>	<b>QP (dBμV)</b>	<b>Average (dBμV)</b>	<b>QP-limit (dBμV)</b>	<b>AVG-limit (dBμV)</b>	<b>Margin (dB)</b>
Line 1	158.355	59.50	50.95	15.94	65.77	55.77	-14.82
	3753.075	46.36	45.68	45.09	56.00	46.00	-0.91
	3845.330	46.74	45.63	44.75	56.00	46.00	-1.25
	3935.365	46.78	45.90	45.21	56.00	46.00	-0.79
	4118.155	46.16	45.43	44.58	56.00	46.00	-1.42
	19208.955	51.92	47.87	39.55	60.00	50.00	-10.45
Line 2	2379.335	47.79	47.19	43.00	56.00	46.00	-3.00
	2469.680	47.84	46.92	42.74	56.00	46.00	-3.26
	2653.250	47.45	46.72	43.35	56.00	46.00	-2.65
	2744.870	46.88	46.05	43.74	56.00	46.00	-2.26
	3110.425	46.16	45.48	44.11	56.00	46.00	-1.89
	4208.885	45.88	44.91	43.85	56.00	46.00	-2.15

**Test mode: IEEE 802.11g Channel 1**

<b>Power Connected Emissions</b>					<b>Class B</b>		
<b>Conductor</b>	<b>Frequency (KHz)</b>	<b>Peak (dBμV)</b>	<b>QP (dBμV)</b>	<b>Average (dBμV)</b>	<b>QP-limit (dBμV)</b>	<b>AVG-limit (dBμV)</b>	<b>Margin (dB)</b>
Line 1	155.355	60.06	52.48	17.87	65.94	55.94	-13.46
	181.665	59.53	51.25	42.26	65.14	55.14	-12.88
	3565.185	45.49	44.86	44.34	56.00	46.00	-1.66
	3840.145	46.57	45.78	45.29	56.00	46.00	-0.71
	4114.455	46.13	45.19	44.54	56.00	46.00	-1.46
	19109.805	52.01	48.07	42.45	60.00	50.00	-7.55
Line 2	2286.135	47.49	46.59	42.58	56.00	46.00	-3.42
	2560.475	47.88	47.01	43.00	56.00	46.00	-3.00
	2651.145	47.52	46.71	43.29	56.00	46.00	-2.71
	2834.185	47.12	46.41	44.14	56.00	46.00	-1.86
	4205.440	45.65	44.84	43.79	56.00	46.00	-2.21
	20390.050	53.42	48.09	40.46	60.00	50.00	-9.54

**Test mode: IEEE 802.11g Channel 6**

<b>Power Connected Emissions</b>					<b>Class B</b>		
<b>Conductor</b>	<b>Frequency (KHz)</b>	<b>Peak (dBμV)</b>	<b>QP (dBμV)</b>	<b>Average (dBμV)</b>	<b>QP-limit (dBμV)</b>	<b>AVG-limit (dBμV)</b>	<b>Margin (dB)</b>
Line 1	161.815	59.38	50.97	16.66	65.54	55.54	-14.57
	456.405	44.46	39.95	39.31	57.26	47.26	-7.95
	3566.525	45.49	44.81	44.04	56.00	46.00	-1.96
	3839.730	46.64	45.79	45.29	56.00	46.00	-0.71
	3931.455	46.57	45.72	45.02	56.00	46.00	-0.98
	19201.235	51.07	47.27	39.38	60.00	50.00	-10.62
Line 2	2285.645	47.42	46.55	42.56	56.00	46.00	-3.44
	2377.355	47.79	47.14	42.90	56.00	46.00	-3.10
	2467.500	47.68	46.92	42.62	56.00	46.00	-3.38
	2650.720	47.45	46.72	43.20	56.00	46.00	-2.80
	2924.205	46.53	45.72	43.95	56.00	46.00	-2.05
	4204.625	45.61	44.82	43.84	56.00	46.00	-2.16

**Test mode: IEEE 802.11g Channel 11**

<b>Power Connected Emissions</b>					<b>FCC Class B</b>		
<b>Conductor</b>	<b>Frequency (KHz)</b>	<b>Peak (dBμV)</b>	<b>QP (dBμV)</b>	<b>Average (dBμV)</b>	<b>QP-limit (dBμV)</b>	<b>AVG-limit (dBμV)</b>	<b>Margin (dB)</b>
Line 1	182.660	58.77	51.76	43.07	65.00	55.00	-11.93
	3565.560	45.49	44.85	44.45	56.00	46.00	-1.55
	3837.950	46.62	45.71	45.00	56.00	46.00	-1.00
	3930.935	46.60	45.65	45.07	56.00	46.00	-0.93
	4114.480	46.09	44.98	44.41	56.00	46.00	-1.59
	19281.825	51.30	48.43	43.49	60.00	50.00	-6.51
Line 2	2284.640	47.28	46.42	42.35	56.00	46.00	-3.65
	2651.210	47.66	46.76	43.40	56.00	46.00	-2.60
	2741.640	46.78	45.99	43.68	56.00	46.00	-2.32
	2833.575	47.19	46.38	44.16	56.00	46.00	-1.84
	3016.840	46.39	45.23	43.99	56.00	46.00	-2.01
	3381.305	45.28	44.62	44.00	56.00	46.00	-2.00

## **V. Section 15.247 (a): Technical description of the EUT**

*Direct Sequence System* is a spread spectrum system in which the carrier has been modulated by a high speed spreading code and an information data stream. The high speed code sequence dominates the “modulating function” and is the direct cause of the wide spreading of the transmitted signal. In the operational description demonstrates the operation principles of the Baseband processor employed by the EUT, shows that which is a complete DSSS baseband processor and meets the definition of the direct sequence spread spectrum system.

## VI. Section 15.247(a)(2): Bandwidth for Direct Sequence System

### 6.1 Test Condition & Setup

The transmitter bandwidth measurements were performed by the contact manner. The EUT was set to transmit continuously, also various channels were investigated to find the maximum occupied bandwidth. The output of the EUT was connected to the spectrum analyzer. The bandwidth of the fundamental frequency is observed by the spectrum analyzer with 100kHz RBW and 100kHz VBW.

### 6.2 Test Instruments Configuration

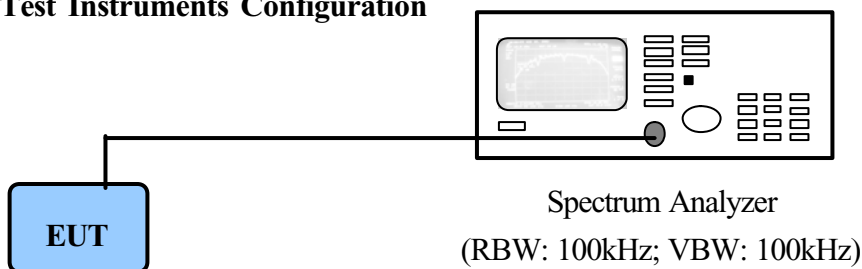

*PC to control the EUT at maximal power output and channel number and set antenna kit*

### 6.3 List of Test Instruments

Instrument Name	Model No.	Brand	Serial No.	Next time
Spectrum Analyzer	MS2665C	ANRITSU	6200175476	11/15/06

### 6.4 Test Result of Bandwidth

Channel	802.11b	802.11g
01	10.96 MHz	16.80 MHz
06	11.00 MHz	16.80 MHz
11	10.92 MHz	16.76 MHz

- Note:
- The data in the above table are summarizing the following attachment spectrum analyzer hard copy. According to the guidance, we'd made the measurement with the spectrum analyzer's resolution bandwidth ( $RBW$ )=100kHz and set the  $span \gg RBW$ . The results show the measured 6dB bandwidth comply with the minimum 500kHz requirement.
  - The attachments show these on the following pages.



6dB Bandwidth of Channel 1 (The minimum 6dB BW at least 500kHz)

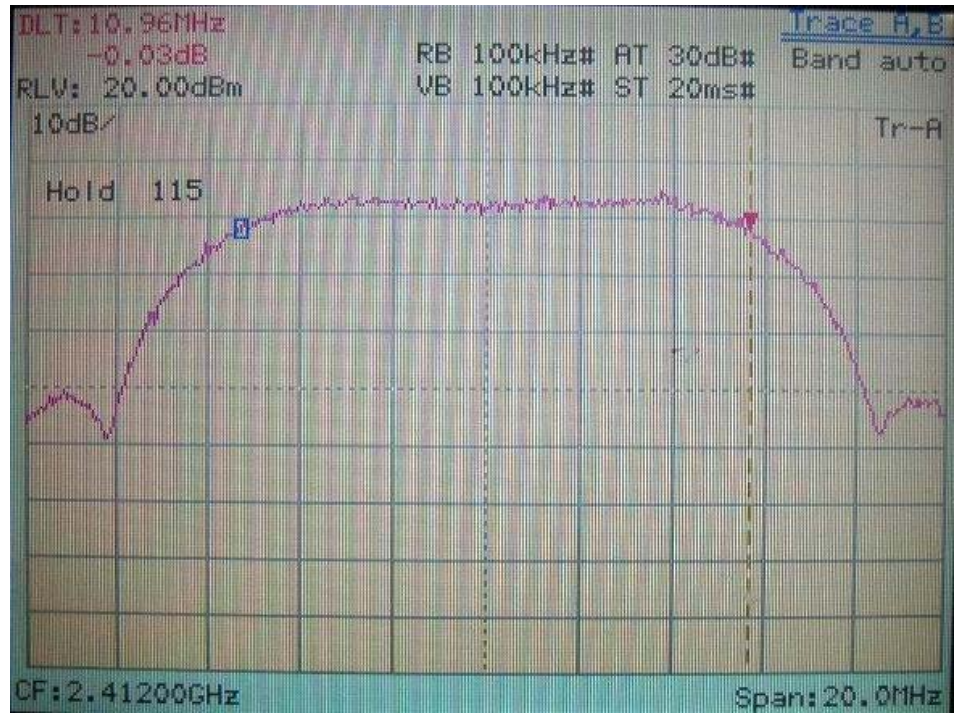

IEEE 802.11b

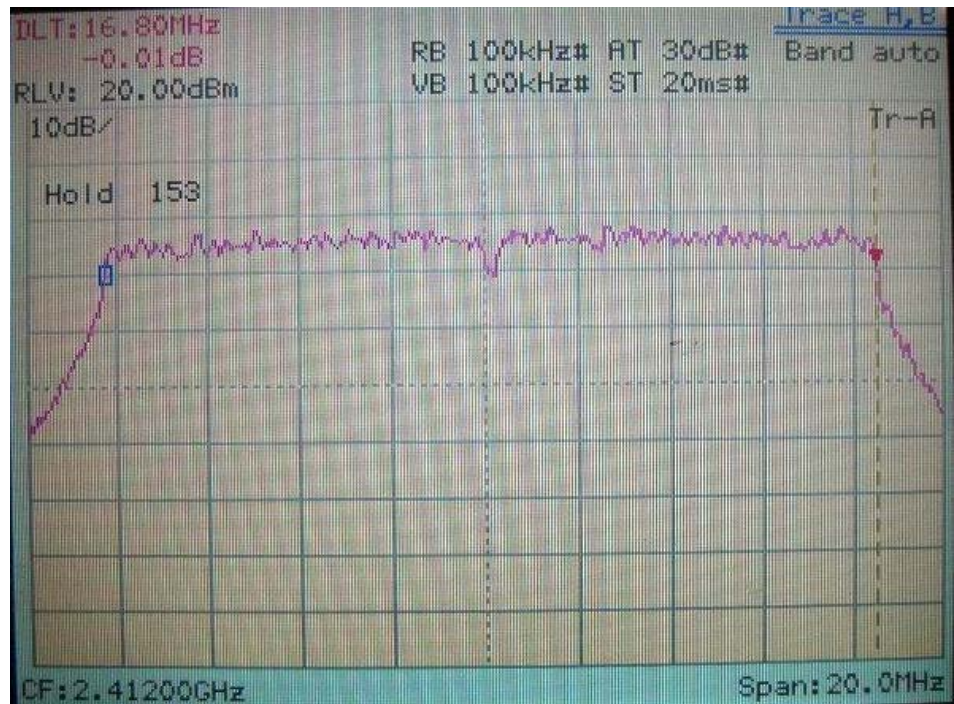

IEEE 802.11g

**6dB Bandwidth of Channel 6 (The minimum 6dB BW at least 500kHz)**

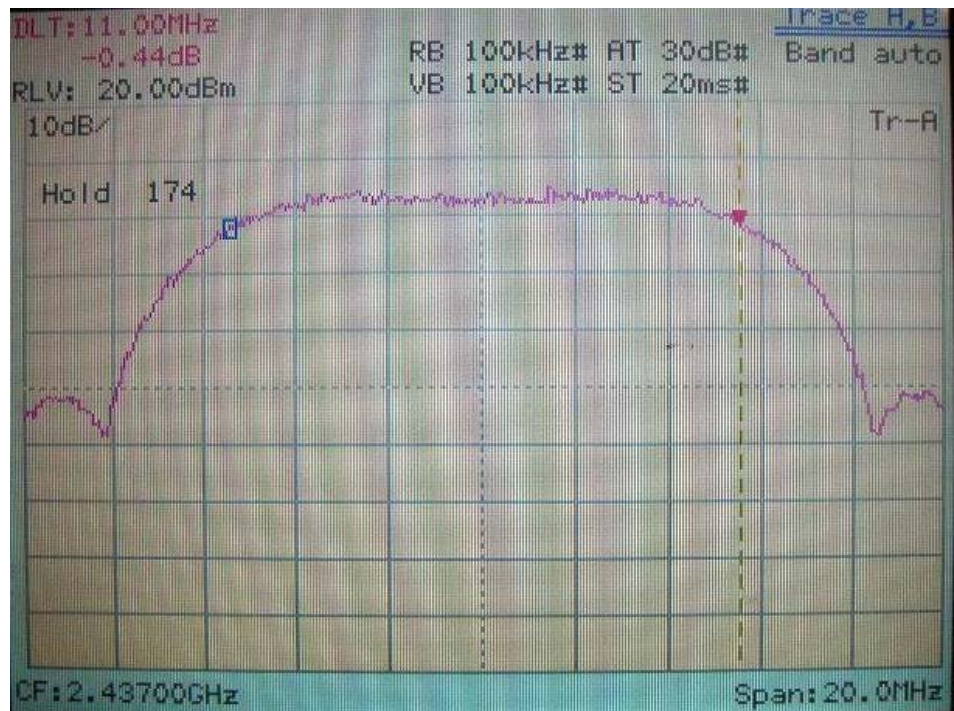

IEEE 802.11b

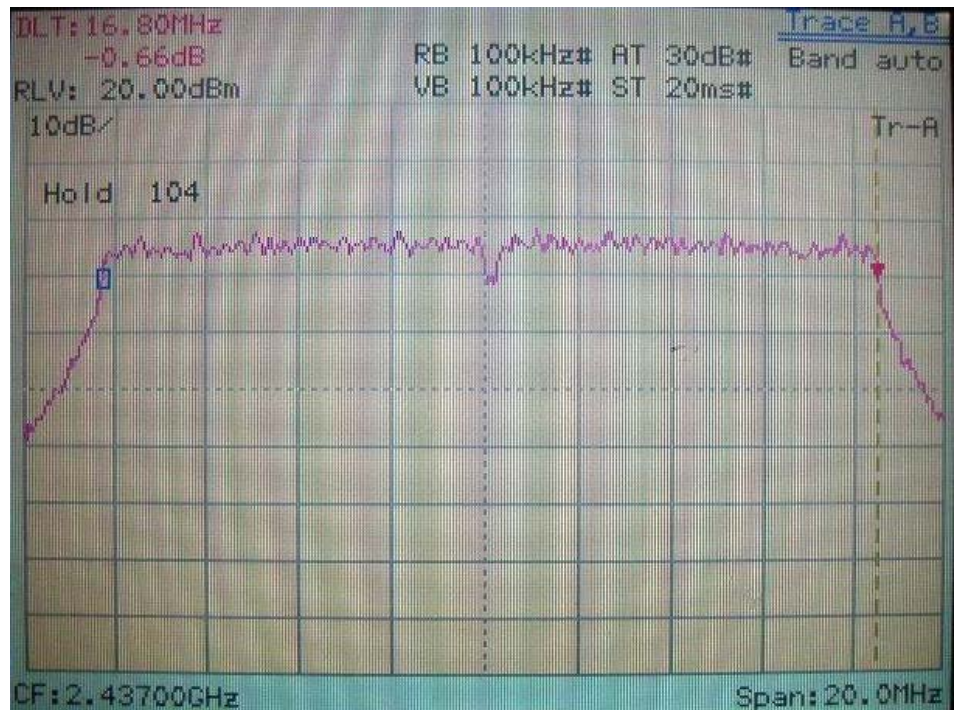

IEEE 802.11g



**6dB Bandwidth of Channel 11 (The minimum 6dB BW at least 500kHz)**

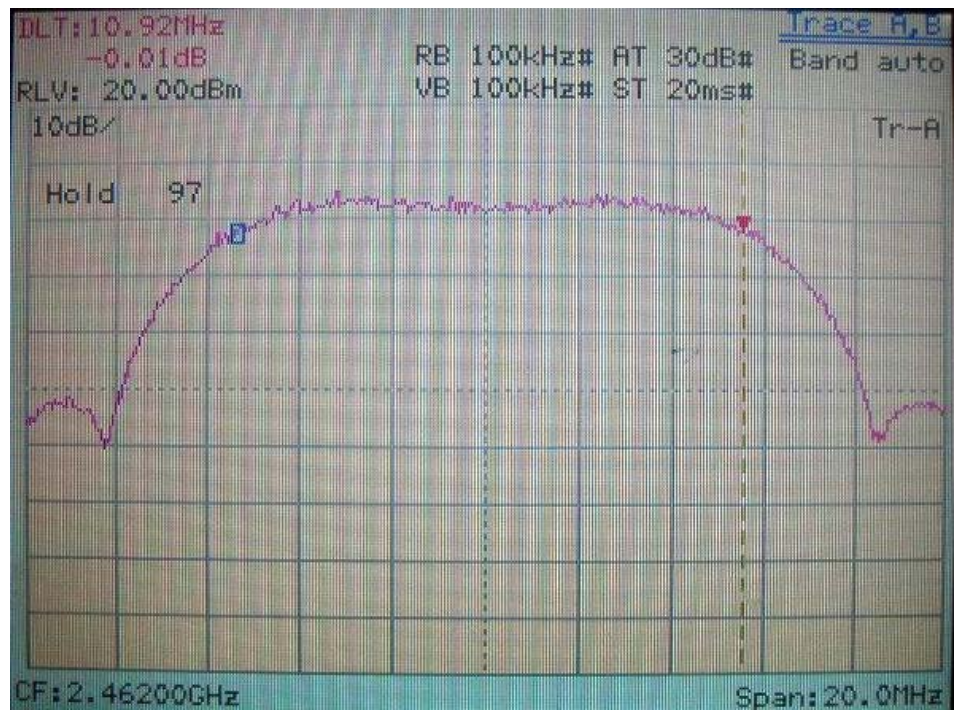

IEEE 802.11b

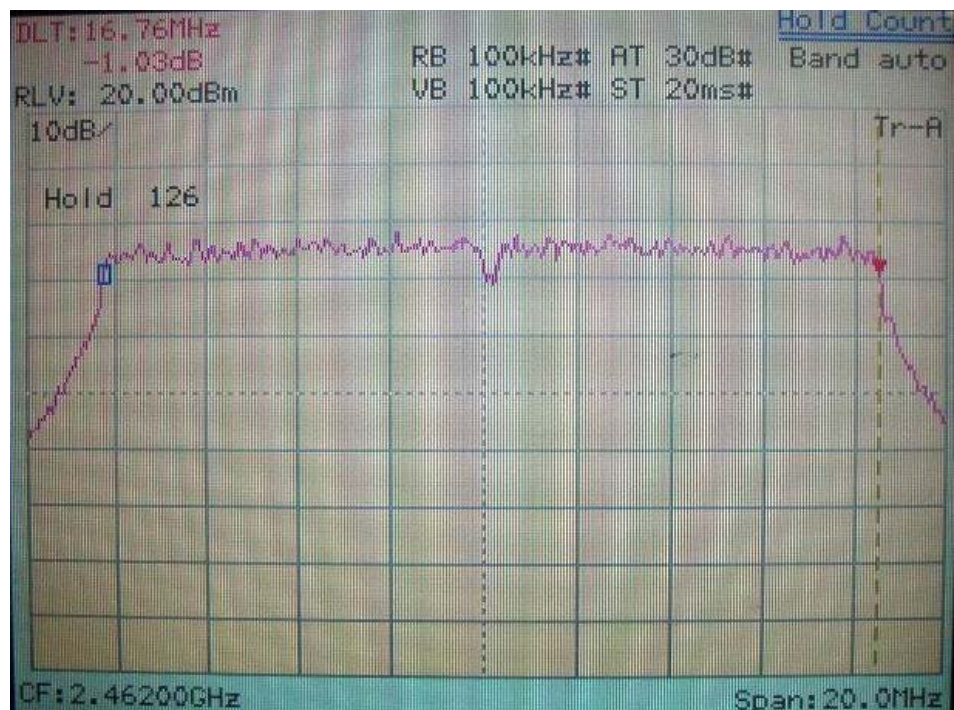

IEEE 802.11g

## VII. Section 15.247(b): Power Output

### 7.1 Test Condition & Setup

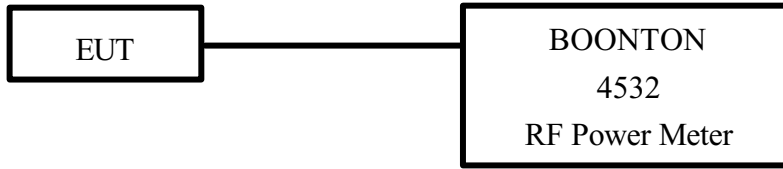

1. The output of the transmitter is connected to the BOONTON RF Power Meter.
2. The calibration is performed before every test. The values of the output power of the EUT will shown in the dBm directly are the transmitter output peak power. Recording as follows.

### 7.2 List of Test Instruments

Instrument Name	Model	Brand	Serial No.	Next time
RF Power Meter	4532	BOONTON	117501	04/21/06
Peak Power Sensor	57340	BOONTON	2696	04/26/06

### 7.3 Test Result

**Formula:**  
 $RF\ Output\ of\ EUT + |Cable\ Loss| = Output\ Peak\ Power$

Channel	RF Output	Cable Loss	Output Peak Power	
	dBm		dBm	dBm
802.11b CH01	19.95	0.70	20.65	116.14
802.11b CH06	19.67	0.70	20.37	108.89
802.11b CH11	19.74	0.70	20.44	110.66
802.11g CH01	22.36	0.70	23.06	202.30
802.11g CH06	22.25	0.70	22.95	197.24
802.11g CH11	22.12	0.70	22.82	191.43

## VIII. Section 15.247 (C): Spurious Emissions (Radiated)

### 8.1 Test Condition & Setup

We'd performed the test by the *radiated emission* skill: The EUT was placed in an anechoic chamber, and set the EUT transmitting continuously and scanned at 3-meter distance to determine its emission characteristics. The physical arrangement of the EUT was varied (within the scope of arrangements likely to be encountered in actual use) to determine the effect on the unit's emanations in amplitude, directivity, and frequency. The exact system configuration, which produced the highest emissions was noted so it could be reproduced later during the final tests. For the measurement above 1GHz, according to the guidance we'd set the spectrum analyzer's 6dB bandwidth RBW to 1MHz.

This was done to ensure that the final measurements would demonstrate the worst-case interference potential of the EUT.

Final radiation measurements were made on a three-meter, anechoic chamber. The EUT system was placed on a nonconductive turntable, which is 0.8 meters height, top surface 1.0 x 1.5 meter.

The spectrum was examined from 30MHz to 1000MHz using an Hewlett Packard 85460A EMI Receiver, SCHWARZECK whole range Small Biconical Antenna (Model No.: UBAA9114 & BBVU9135) is used to measure frequency from 30 MHz to 1GHz. The final test is used the HP 85460A spectrum and 8564E spectrum was examined from 1GHz to 25GHz using an Hewlett Packard Spectrum Analyzer, EMCO/HP Horn Antenna (Model 3115 / 84125-80008) for 1G - 25GHz.

At each frequency, the EUT was rotated 360 degrees, and the antenna was raised and lowered from one to four meters to find the maximum emission levels. Measurements were taken using both horizontal and vertical antenna polarization.

Appropriate preamplifiers were used for improving sensitivity and precautions were taken to avoid overloading or desensitizing the spectrum analyzer. There are two spectrum analyzers use on this testing, HP 85460A for frequency 30MHz to 1000MHz, and 8564E for frequency 1GHz to 25GHz. No post-detector video filters were used in the test. The spectrum analyzer's 6dB bandwidth was set to 120KHz (spectrum was examined from 30 MHz to 1000 MHz), the spectrum analyzer's 6 dB bandwidth was set to 1 MHz (spectrum was examined from 1GHz to 25GHz) and the analyzer was operated in the maximum hold mode. There is a test condition applies in this test item, the test procedure description as the following:

Three channels were tested, one in the top (CH01), one in the middle (CH06) and the other in bottom (CH11). The setting up procedure is recorded on <1.3>

With the transmitter operating from a AC source and using the internal of EUT, radiates spurious emissions falling within the restricted bands of 15.209 were measured at operating frequencies corresponding to upper, middle and bottom channels in the 2400 ~ 2483.5 MHz band.

The actual field intensity in decibels referenced to 1 microvolt per meter (dB $\mu$ V/m) is determined by algebraically adding the measured reading in dB $\mu$ V, the antenna factor (dB), and cable loss (dB) at the appropriate frequency. Since the EUT was set to transmit continuously, no *duty cycle* is present.

**For frequency between 30MHz to 1000MHz**

$$F_{Ia} \text{ (dB}\mu\text{V/m)} = F_{Ir} \text{ (dB}\mu\text{V)} + \text{Correction Factors}$$

F<sub>Ia</sub> : Actual Field Intensity

F<sub>Ir</sub> : Reading of the Field Intensity

$$\text{Correction Factors} = \text{Antenna Factor} + (\text{Cable Loss} - \text{Amplifier Gain}) + \text{Switching Box Loss}$$

**For frequency between 1GHz to 25GHz**

$$F_{Ia} \text{ (dB}\mu\text{V/m)} = F_{Ir} \text{ (dB}\mu\text{V)} + \text{Correction Factor}$$

F<sub>Ia</sub> : Actual Field Intensity

F<sub>Ir</sub> : Reading of the Field Intensity

$$\text{Correction Factors} = \text{Antenna Factor} + (\text{Cable Loss} - \text{Amplifier Gain}) + \text{Switching Box Loss}$$

**8.2 List of Test Instruments**

Instrument Name	Model	Brand	Serial No.	Calibration Date
				Next time
EMI Receiver	8546A	HP	3520A00242	06/01/06
RF Filter Section	85460A	HP	3448A00217	06/01/06
Small Biconical Antenna	UBAA9114 & BBVU9135	SCHWARZECK	127	08/17/06
Pre-amplifier	PA1F	TRC	1FAC	05/20/06
Auto Switch Box (>30MHz)	ASB-01	TRC	9904-01	05/20/06
Coaxial Cable (Double shielded, 15 meter)	A30A30-0058-50FS-15M	JYEBAO	SMA-01	05/20/06
Coaxial Cable (1.1 meter)	A30A30-0058-50FS-1M	JYEBAO	SMA-02	05/20/06
Spectrum Analyzer	8564E	HP	3720A00840	11/07/06
Microwave Pre-amplifier	84125C	HP	US36433002	11/07/06
Horn Antenna	3115	EMCO	9104-3668	01/23/07
Standard Guide Horn Antenna	84125-80008	HP	18-26.5GHz	11/09/06
Standard Guide Horn Antenna	84125-80001	HP	26.5-40GHz	11/09/06
Horn Antenna	1196E (3115)	HP (EMCO)	9704-5178	04/11/06
Pre-amplifier	PA2F	TRC	2F1GZ	06/20/06
Coaxial Cable (3 meter)	A30A30-0058-50FST118	JYEBAO	MSA-05	06/20/06
Coaxial Cable (1 meter)	A30A30-0058-50FST118	JYEBAO	MSA-04	06/20/06

**8.3 Test Result of Spurious Radiated Emissions**

The highest peak values of radiated emissions from the EUT at various antenna heights, antenna polarizations, EUT orientation, etc. are recorded on the following.

Test Conditions: Temperature : 23 ° C Humidity : 68 % RH

*Test mode: Standby mode for 30MHz to 1GHz [Horizontal]*

<b>Radiated Emission</b>				<b>Correction Factors</b>	<b>Corrected Amplitude</b>	<b>Class B (3 m)</b>	
<b>Frequency (MHz)</b>	<b>Amplitude (dBµV)</b>	<b>Ant. H. (m)</b>	<b>Table ( ° )</b>			<b>Limit (dBµV/m)</b>	<b>Margin (dB)</b>
253.10	43.57	1.00	127	-3.75	39.82	46.00	-6.18
271.29	42.12	1.00	107	-4.23	37.89	46.00	-8.11
336.76	39.08	1.00	97	-2.87	36.21	46.00	-9.79
399.81	40.48	1.00	27	-1.21	39.27	46.00	-6.73
483.47	37.28	1.00	70	1.81	39.09	46.00	-6.91
660.50	29.20	1.00	350	8.34	37.54	46.00	-8.46

*Test mode: Standby mode for 30MHz to 1GHz [Vertical]*

<b>Radiated Emission</b>				<b>Correction Factors</b>	<b>Corrected Amplitude</b>	<b>Class B (3 m)</b>	
<b>Frequency (MHz)</b>	<b>Amplitude (dBµV)</b>	<b>Ant. H. (m)</b>	<b>Table ( ° )</b>			<b>Limit (dBµV/m)</b>	<b>Margin (dB)</b>
32.60	25.04	1.00	80	7.27	32.31	40.00	-7.69
38.95	25.55	1.00	160	5.70	31.25	40.00	-8.75
100.32	35.56	1.00	263	-0.88	34.68	43.50	-8.82
660.50	32.53	1.00	360	8.34	40.87	46.00	-5.13
792.66	27.40	1.00	21	11.73	39.13	46.00	-6.87
924.83	26.61	1.00	333	15.24	41.85	46.00	-4.15

Note:

1. Margin = Amplitude – limit, if margin is minus means under limit.
2. Corrected Amplitude = Reading Amplitude + Correction Factors
3. Correction factor = Antenna factor + (Cable Loss – Amplitude gain) + Switching Box Loss



**Test mode: Standby mode for 1GHz to 25GHz [Horizontal]**

Frequency	Ant. H.	Table	Amplitude		Correction Factor	Corrected Amplitude		Limit		Margin
			Peak / Ave.			Peak / Ave.		Peak / Ave.		
MHz	m	degree	dBµV		dB/m	dBµV/m		dBµV/m		dB
1927.92	1.00	124	34.07	---	3.38	37.45	---	73.96	53.96	-16.51
3911.25	1.00	98	31.74	---	12.07	43.81	---	73.96	53.96	-10.15
7197.92	1.00	154	24.91	---	21.33	46.24	---	73.96	53.96	-7.72
10718.33	1.00	274	25.24	---	22.18	47.42	---	73.96	53.96	-6.54
24686.67	1.00	240	47.49	---	3.01	50.50	---	73.96	53.96	-3.46

**Test mode: Standby mode for 1GHz to 25GHz [Vertical]**

Frequency	Ant. H.	Table	Amplitude		Correction Factor	Corrected Amplitude		Limit		Margin
			Peak / Ave.			Peak / Ave.		Peak / Ave.		
MHz	m	degree	dBµV		dB/m	dBµV/m		dBµV/m		dB
2296.25	1.00	314	32.74	---	5.76	38.50	---	73.96	53.96	-15.46
4761.25	1.00	98	28.58	---	14.45	43.03	---	73.96	53.96	-10.93
7750.42	1.00	228	24.24	---	22.10	46.34	---	73.96	53.96	-7.62
12354.58	1.00	291	26.91	---	20.54	47.45	---	73.96	53.96	-6.51
19126.25	1.00	348	46.99	---	1.51	48.50	---	73.96	53.96	-5.46

Note:

1. Margin = Corrected - Limit.
2. The EUT utilizes a *permanently attached antenna*. In addition the spurious RF radiated emissions levels do comply with the *20dBc limit* both at its bandedges and other spurious emissions.
3. As stated in Section 15.35(b), for any frequencies above 1000MHz, radiated limits shown are based upon the use of measurement instrumentation employing an average detector function. As the results of our test, the peak amplitudes are already below the FCC limit. Thus the average amplitudes of the rest are omitted.

**Test mode: IEEE 802.11b CH01 for 30MHz to 1GHz [Horizontal]**

<b>Radiated Emission</b>				<b>Correction Factors</b>	<b>Corrected Amplitude</b>	<b>Class B (3 m)</b>	
<b>Frequency (MHz)</b>	<b>Amplitude (dBμV)</b>	<b>Ant. H. (m)</b>	<b>Table ( ° )</b>			<b>Limit (dBμV/m)</b>	<b>Margin (dB)</b>
253.10	44.35	1.00	87	-3.75	40.60	46.00	-5.40
270.07	42.51	1.00	117	-4.26	38.25	46.00	-7.75
336.76	38.78	1.00	97	-2.87	35.91	46.00	-10.09
399.81	40.10	1.00	0	-1.21	38.89	46.00	-7.11
483.47	36.94	1.00	60	1.81	38.75	46.00	-7.25
660.50	29.58	1.00	357	8.34	37.92	46.00	-8.08

**Test mode: IEEE 802.11b CH01 for 30MHz to 1GHz [Vertical]**

<b>Radiated Emission</b>				<b>Correction Factors</b>	<b>Corrected Amplitude</b>	<b>Class B (3 m)</b>	
<b>Frequency (MHz)</b>	<b>Amplitude (dBμV)</b>	<b>Ant. H. (m)</b>	<b>Table ( ° )</b>			<b>Limit (dBμV/m)</b>	<b>Margin (dB)</b>
30.64	26.44	1.00	120	8.01	34.45	40.00	-5.55
71.22	33.61	1.00	130	1.24	34.85	40.00	-5.15
399.81	38.23	1.00	147	-1.21	37.02	46.00	-8.98
660.50	31.67	1.00	121	8.34	40.01	46.00	-5.99
792.66	26.62	1.00	360	11.73	38.35	46.00	-7.65
924.83	25.71	1.00	332	15.24	40.95	46.00	-5.05

**Test mode: IEEE 802.11b CH01 for 1GHz to 25GHz [Horizontal]**

Frequency	Ant. H.	Table	Amplitude		Correction Factor	Corrected Amplitude		Limit		Margin
			Peak / Ave.			Peak / Ave.		Peak / Ave.		
MHz	m	degree	dBµV		dB/m	dBµV/m		dBµV/m		dB
1608.01	1.00	235	38.66	34.50	14.21	52.87	48.71	73.96	53.96	-5.25
2152.08	1.00	306	39.34	---	8.52	47.86	---	73.96	53.96	-6.10
2525.00	1.00	345	37.50	---	9.54	47.04	---	73.96	53.96	-6.92
9650.42	1.00	16	35.61	---	11.47	47.08	---	73.96	53.96	-6.88
12061.04	1.00	144	38.27	---	9.81	48.08	---	73.96	53.96	-5.88
21708.12	1.00	287	46.16	---	2.87	49.03	---	73.96	53.96	-4.93

**Test mode: IEEE 802.11b CH01 for 1GHz to 25GHz [Vertical]**

Frequency	Ant. H.	Table	Amplitude		Correction Factor	Corrected Amplitude		Limit		Margin
			Peak / Ave.			Peak / Ave.		Peak / Ave.		
MHz	m	degree	dBµV		dB/m	dBµV/m		dBµV/m		dB
1608.33	1.00	179	36.00	---	14.20	50.20	---	73.96	53.96	-3.76
2152.08	1.00	313	40.66	---	8.52	49.18	---	73.96	53.96	-4.78
2524.83	1.00	157	44.67	31.83	9.54	54.21	41.37	73.96	53.96	-12.59
7233.75	1.00	236	35.78	---	10.07	45.85	---	73.96	53.96	-8.11
9650.42	1.00	283	36.44	---	11.47	47.91	---	73.96	53.96	-6.05
12061.04	1.00	309	38.60	---	9.81	48.41	---	73.96	53.96	-5.55

*Test mode: IEEE 802.11b CH06 for 30MHz to 1GHz [Horizontal]*

<i>Radiated Emission</i>				<i>Correction Factors</i>	<i>Corrected Amplitude</i>	<i>Class B (3 m)</i>	
<i>Frequency (MHz)</i>	<i>Amplitude (dBμV)</i>	<i>Ant. H. (m)</i>	<i>Table (°)</i>			<i>Limit (dBμV/m)</i>	<i>Margin (dB)</i>
253.10	44.03	1.00	73	-3.75	40.28	46.00	-5.72
270.07	42.19	1.00	116	-4.26	37.93	46.00	-8.07
398.60	40.41	1.00	26	-1.24	39.17	46.00	-6.83
483.47	38.00	1.00	69	1.81	39.81	46.00	-6.19
660.50	29.96	1.00	350	8.34	38.30	46.00	-7.70
751.44	25.70	1.00	192	10.23	35.93	46.00	-10.07

*Test mode: IEEE 802.11b CH06 for 30MHz to 1GHz [Vertical]*

<i>Radiated Emission</i>				<i>Correction Factors</i>	<i>Corrected Amplitude</i>	<i>Class B (3 m)</i>	
<i>Frequency (MHz)</i>	<i>Amplitude (dBμV)</i>	<i>Ant. H. (m)</i>	<i>Table (°)</i>			<i>Limit (dBμV/m)</i>	<i>Margin (dB)</i>
30.64	26.39	1.00	79	8.01	34.40	40.00	-5.60
69.69	30.14	1.00	109	1.33	31.47	40.00	-8.53
100.32	36.04	1.00	271	-0.88	35.16	43.50	-8.34
660.50	31.78	1.00	87	8.34	40.12	46.00	-5.88
792.66	26.30	1.00	10	11.73	38.03	46.00	-7.97
924.01	24.50	1.00	31	15.23	39.73	46.00	-6.27

**Test mode: IEEE 802.11b CH06 for 1GHz to 25GHz [Horizontal]**

Frequency	Ant. H.	Table	Amplitude		Correction Factor	Corrected Amplitude		Limit		Margin
			Peak / Ave.			Peak / Ave.		Peak / Ave.		
MHz	m	degree	dBμV		dB/m	dBμV/m		dBμV/m		dB
1625.00	1.00	267	37.00	---	13.94	50.94		73.96	53.96	-3.02
2285.42	1.00	238	35.67	---	8.89	44.56	---	73.96	53.96	-9.40
7312.29	1.00	146	34.94	---	10.30	45.24	---	73.96	53.96	-8.72
9747.08	1.00	105	35.60	---	11.89	47.49	---	73.96	53.96	-6.47
12187.92	1.00	308	38.94	---	9.74	48.68	---	73.96	53.96	-5.28
24371.46	1.00	273	46.83	---	3.26	50.09	---	73.96	53.96	-3.87

**Test mode: IEEE 802.11b CH06 for 1GHz to 25GHz [Vertical]**

Frequency	Ant. H.	Table	Amplitude		Correction Factor	Corrected Amplitude		Limit		Margin
			Peak / Ave.			Peak / Ave.		Peak / Ave.		
MHz	m	degree	dBμV		dB/m	dBμV/m		dBμV/m		dB
1624.66	1.00	149	37.49	32.17	13.95	51.44	46.12	73.96	53.96	-7.84
2325.00	1.00	193	37.67	---	9.00	46.67	---	73.96	53.96	-7.29
2533.08	1.00	137	44.01	31.67	9.55	53.56	41.22	73.96	53.96	-12.74
9747.08	1.00	244	35.27	---	11.89	47.16	---	73.96	53.96	-6.80
12187.92	1.00	0	38.44	---	9.74	48.18	---	73.96	53.96	-5.78
21934.79	1.00	142	46.99	---	3.09	50.08	---	73.96	53.96	-3.88

**Test mode: IEEE 802.11b CH11 for 30MHz to 1GHz [Horizontal]**

<b>Radiated Emission</b>				<b>Correction Factors</b>	<b>Corrected Amplitude</b>	<b>Class B (3 m)</b>	
<b>Frequency (MHz)</b>	<b>Amplitude (dBμV)</b>	<b>Ant. H. (m)</b>	<b>Table (°)</b>			<b>Limit (dBμV/m)</b>	<b>Margin (dB)</b>
253.10	44.26	1.00	77	-3.75	40.51	46.00	-5.49
270.07	42.44	1.00	107	-4.26	38.18	46.00	-7.82
336.76	38.48	1.00	87	-2.87	35.61	46.00	-10.39
398.60	40.57	1.00	27	-1.24	39.33	46.00	-6.67
483.47	36.98	1.00	80	1.81	38.79	46.00	-7.21
660.50	29.61	1.00	357	8.34	37.95	46.00	-8.05

**Test mode: IEEE 802.11b CH11 for 30MHz to 1GHz [Vertical]**

<b>Radiated Emission</b>				<b>Correction Factors</b>	<b>Corrected Amplitude</b>	<b>Class B (3 m)</b>	
<b>Frequency (MHz)</b>	<b>Amplitude (dBμV)</b>	<b>Ant. H. (m)</b>	<b>Table (°)</b>			<b>Limit (dBμV/m)</b>	<b>Margin (dB)</b>
30.64	26.65	1.00	50	8.01	34.66	40.00	-5.34
71.22	33.33	1.00	83	1.24	34.57	40.00	-5.43
399.81	38.23	1.00	147	-1.21	37.02	46.00	-8.98
660.50	32.41	1.00	27	8.34	40.75	46.00	-5.25
792.66	27.54	1.00	360	11.73	39.27	46.00	-6.73
924.01	24.94	1.00	333	15.23	40.17	46.00	-5.83

*Test mode: IEEE 802.11b CH11 for 1GHz to 25GHz [Horizontal]*

Frequency	Ant. H.	Table	Amplitude		Correction Factor	Corrected Amplitude		Limit		Margin
			Peak / Ave.			Peak / Ave.		Peak / Ave.		
MHz	m	degree	dBµV		dB/m	dBµV/m		dBµV/m		dB
1641.34	1.00	249	38.32	34.50	13.69	52.01	48.19	73.96	53.96	-5.77
2152.08	1.00	285	38.33	---	8.52	46.85	---	73.96	53.96	-7.11
2593.75	1.00	178	37.00	---	9.67	46.67	---	73.96	53.96	-7.29
7384.79	1.00	17	35.11	---	10.42	45.53	---	73.96	53.96	-8.43
9849.79	1.00	259	36.11	---	11.93	48.04	---	73.96	53.96	-5.92
12308.75	1.00	229	37.44	---	9.56	47.00	---	73.96	53.96	-6.96

*Test mode: IEEE 802.11b CH11 for 1GHz to 25GHz [Vertical]*

Frequency	Ant. H.	Table	Amplitude		Correction Factor	Corrected Amplitude		Limit		Margin
			Peak / Ave.			Peak / Ave.		Peak / Ave.		
MHz	m	degree	dBµV		dB/m	dBµV/m		dBµV/m		dB
1641.34	1.00	141	38.16	34.83	13.69	51.85	48.52	73.96	53.96	-5.44
2152.08	1.00	217	37.50	---	8.52	46.02	---	73.96	53.96	-7.94
2563.78	1.00	146	43.66	30.33	9.61	53.27	39.94	73.96	53.96	-14.02
9849.79	1.00	177	35.44	---	11.93	47.37	---	73.96	53.96	-6.59
12308.75	1.00	274	38.11	---	9.56	47.67	---	73.96	53.96	-6.29
19696.46	1.00	187	47.82	---	1.81	49.63	---	73.96	53.96	-4.33

**Test mode: IEEE 802.11g CH01 for 30MHz to 1GHz [Horizontal]**

<b>Radiated Emission</b>				<b>Correction Factors</b>	<b>Corrected Amplitude</b>	<b>Class B (3 m)</b>	
<b>Frequency (MHz)</b>	<b>Amplitude (dBμV)</b>	<b>Ant. H. (m)</b>	<b>Table (°)</b>			<b>Limit (dBμV/m)</b>	<b>Margin (dB)</b>
253.10	44.10	1.00	83	-3.75	40.35	46.00	-5.65
270.07	42.61	1.00	113	-4.26	38.35	46.00	-7.65
399.81	41.24	1.00	17	-1.21	40.03	46.00	-5.97
482.26	36.44	1.00	67	1.77	38.21	46.00	-7.79
660.50	30.23	1.00	336	8.34	38.57	46.00	-7.43
961.20	28.28	1.00	55	16.11	44.39	53.96	-9.57

**Test mode: IEEE 802.11g CH01 for 30MHz to 1GHz [Vertical]**

<b>Radiated Emission</b>				<b>Correction Factors</b>	<b>Corrected Amplitude</b>	<b>Class B (3 m)</b>	
<b>Frequency (MHz)</b>	<b>Amplitude (dBμV)</b>	<b>Ant. H. (m)</b>	<b>Table (°)</b>			<b>Limit (dBμV/m)</b>	<b>Margin (dB)</b>
36.87	24.33	1.00	330	6.05	30.38	40.00	-9.62
71.22	34.20	1.00	160	1.24	35.44	40.00	-4.56
103.96	35.47	1.00	263	-1.25	34.22	43.50	-9.28
398.60	38.23	1.00	147	-1.24	36.99	46.00	-9.01
660.50	32.11	1.00	123	8.34	40.45	46.00	-5.55
792.66	27.35	1.00	350	11.73	39.08	46.00	-6.92



*Test mode: IEEE 802.11g CH01 for 1GHz to 25GHz [Horizontal]*

Frequency	Ant. H.	Table	Amplitude		Correction Factor	Corrected Amplitude		Limit		Margin
			Peak / Ave.			Peak / Ave.		Peak / Ave.		
MHz	m	degree	dBµV		dB/m	dBµV/m		dBµV/m		dB
1608.01	1.00	306	37.66	34.33	14.21	51.87	48.54	73.96	53.96	-5.42
2152.08	1.00	313	35.50	---	8.52	44.02	---	73.96	53.96	-9.94
2589.58	1.00	206	35.17	---	9.66	44.83	---	73.96	53.96	-9.13
7233.75	1.00	190	36.78	---	10.07	46.85	---	73.96	53.96	-7.11
9650.42	1.00	267	35.61	---	11.47	47.08	---	73.96	53.96	-6.88
12061.04	1.00	203	37.60	---	9.81	47.41	---	73.96	53.96	-6.55

*Test mode: IEEE 802.11g CH01 for 1GHz to 25GHz [Vertical]*

Frequency	Ant. H.	Table	Amplitude		Correction Factor	Corrected Amplitude		Limit		Margin
			Peak / Ave.			Peak / Ave.		Peak / Ave.		
MHz	m	degree	dBµV		dB/m	dBµV/m		dBµV/m		dB
1625.00	1.00	319	35.67	---	13.94	49.61		73.96	53.96	-4.35
2560.42	1.00	93	40.00	---	9.60	49.60	---	73.96	53.96	-4.36
7233.75	1.00	71	35.78	---	10.07	45.85	---	73.96	53.96	-8.11
9650.42	1.00	4	35.77	---	11.47	47.24	---	73.96	53.96	-6.72
12061.04	1.00	288	39.60	---	9.81	49.41	---	73.96	53.96	-4.55
19296.25	1.00	75	46.66	---	1.60	48.26	---	73.96	53.96	-5.70

**Test mode: IEEE 802.11g CH06 for 30MHz to 1GHz [Horizontal]**

<b>Radiated Emission</b>				<b>Correction Factors</b>	<b>Corrected Amplitude</b>	<b>Class B (3 m)</b>	
<b>Frequency (MHz)</b>	<b>Amplitude (dBμV)</b>	<b>Ant. H. (m)</b>	<b>Table (°)</b>			<b>Limit (dBμV/m)</b>	<b>Margin (dB)</b>
253.10	43.94	1.00	83	-3.75	40.19	46.00	-5.81
270.07	42.33	1.00	113	-4.26	38.07	46.00	-7.93
336.76	38.78	1.00	93	-2.87	35.91	46.00	-10.09
398.60	41.17	1.00	23	-1.24	39.93	46.00	-6.07
482.26	37.35	1.00	77	1.77	39.12	46.00	-6.88
660.50	29.38	1.00	322	8.34	37.72	46.00	-8.28

**Test mode: IEEE 802.11g CH06 for 30MHz to 1GHz [Vertical]**

<b>Radiated Emission</b>				<b>Correction Factors</b>	<b>Corrected Amplitude</b>	<b>Class B (3 m)</b>	
<b>Frequency (MHz)</b>	<b>Amplitude (dBμV)</b>	<b>Ant. H. (m)</b>	<b>Table (°)</b>			<b>Limit (dBμV/m)</b>	<b>Margin (dB)</b>
38.34	23.51	1.00	130	5.80	29.31	40.00	-10.69
71.22	33.80	1.00	100	1.24	35.04	40.00	-4.96
100.32	36.49	1.00	243	-0.88	35.61	43.50	-7.89
660.00	35.07	1.00	123	8.32	43.39	46.00	-2.61
792.66	27.85	1.00	350	11.73	39.58	46.00	-6.42
924.83	26.14	1.00	333	15.24	41.38	46.00	-4.62

**Test mode: IEEE 802.11g CH06 for 1GHz to 25GHz [Horizontal]**

Frequency	Ant. H.	Table	Amplitude		Correction Factor	Corrected Amplitude		Limit		Margin
			Peak / Ave.			Peak / Ave.		Peak / Ave.		
MHz	m	degree	dBµV		dB/m	dBµV/m		dBµV/m		dB
1504.75	1.00	324	35.70	21.83	15.82	51.52	37.65	73.96	53.96	-16.31
1624.66	1.00	257	38.16	33.33	13.95	52.11	47.28	73.96	53.96	-6.68
2283.33	1.00	360	36.34	---	8.88	45.22	---	73.96	53.96	-8.74
9747.08	1.00	11	36.44	---	11.89	48.33	---	73.96	53.96	-5.63
12187.92	1.00	305	39.77	---	9.74	49.51	---	73.96	53.96	-4.45
21934.79	1.00	261	47.32	---	3.09	50.41	---	73.96	53.96	-3.55

**Test mode: IEEE 802.11g CH06 for 1GHz to 25GHz [Vertical]**

Frequency	Ant. H.	Table	Amplitude		Correction Factor	Corrected Amplitude		Limit		Margin
			Peak / Ave.			Peak / Ave.		Peak / Ave.		
MHz	m	degree	dBµV		dB/m	dBµV/m		dBµV/m		dB
1625.00	1.00	144	36.67	---	13.94	50.61	---	73.96	53.96	-3.35
2150.00	1.00	255	35.50	---	8.51	44.01	---	73.96	53.96	-9.95
2527.08	1.00	176	40.50	---	9.54	50.04	---	73.96	53.96	-3.92
7312.29	1.00	254	34.61	---	10.30	44.91	---	73.96	53.96	-9.05
9747.08	1.00	360	35.10	---	11.89	46.99	---	73.96	53.96	-6.97
12187.92	1.00	204	39.60	---	9.74	49.34	---	73.96	53.96	-4.62

**Test mode: IEEE 802.11g CH11 for 30MHz to 1GHz [Horizontal]**

<b>Radiated Emission</b>				<b>Correction Factors</b>	<b>Corrected Amplitude</b>	<b>Class B (3 m)</b>	
<b>Frequency (MHz)</b>	<b>Amplitude (dBμV)</b>	<b>Ant. H. (m)</b>	<b>Table ( ° )</b>			<b>Limit (dBμV/m)</b>	<b>Margin (dB)</b>
253.10	44.10	1.00	117	-3.75	40.35	46.00	-5.65
270.07	42.26	1.00	107	-4.26	38.00	46.00	-8.00
336.76	38.48	1.00	97	-2.87	35.61	46.00	-10.39
399.81	40.89	1.00	37	-1.21	39.68	46.00	-6.32
483.47	37.79	1.00	70	1.81	39.60	46.00	-6.40
660.50	30.92	1.00	336	8.34	39.26	46.00	-6.74

**Test mode: IEEE 802.11g CH11 for 30MHz to 1GHz [Vertical]**

<b>Radiated Emission</b>				<b>Correction Factors</b>	<b>Corrected Amplitude</b>	<b>Class B (3 m)</b>	
<b>Frequency (MHz)</b>	<b>Amplitude (dBμV)</b>	<b>Ant. H. (m)</b>	<b>Table ( ° )</b>			<b>Limit (dBμV/m)</b>	<b>Margin (dB)</b>
33.45	23.43	1.00	109	6.95	30.38	40.00	-9.62
71.22	32.89	1.00	129	1.24	34.13	40.00	-5.87
96.69	35.78	1.00	201	-0.58	35.20	43.50	-8.30
660.01	32.06	1.00	322	8.32	40.38	46.00	-5.62
792.66	27.82	1.00	360	11.73	39.55	46.00	-6.45
924.83	25.98	1.00	353	15.24	41.22	46.00	-4.78

*Test mode: IEEE 802.11g CH11 for 1GHz to 25GHz [Horizontal]*

Frequency	Ant. H.	Table	Amplitude		Correction Factor	Corrected Amplitude		Limit		Margin
			Peak / Ave.			Peak / Ave.		Peak / Ave.		
MHz	m	degree	dBµV		dB/m	dBµV/m		dBµV/m		dB
1641.32	1.00	247	39.16	34.50	13.69	52.85	48.19	73.96	53.96	-5.77
1906.25	1.00	288	39.00	---	9.55	48.55	---	73.96	53.96	-5.41
2152.08	1.00	100	38.00	---	8.52	46.52	---	73.96	53.96	-7.44
9849.79	1.00	241	34.78	---	11.93	46.71	---	73.96	53.96	-7.25
12308.75	1.00	207	38.11	---	9.56	47.67	---	73.96	53.96	-6.29
24619.37	1.00	281	47.16	---	3.01	50.17	---	73.96	53.96	-3.79

*Test mode: IEEE 802.11g CH11 for 1GHz to 25GHz [Vertical]*

Frequency	Ant. H.	Table	Amplitude		Correction Factor	Corrected Amplitude		Limit		Margin
			Peak / Ave.			Peak / Ave.		Peak / Ave.		
MHz	m	degree	dBµV		dB/m	dBµV/m		dBµV/m		dB
1641.33	1.00	159	38.49	33.50	13.69	52.18	47.19	73.96	53.96	-6.77
2339.58	1.00	139	37.67	---	9.04	46.71	---	73.96	53.96	-7.25
2604.17	1.00	204	38.16	---	9.69	47.85	---	73.96	53.96	-6.11
7384.79	1.00	151	35.44	---	10.42	45.86	---	73.96	53.96	-8.10
9849.79	1.00	70	36.28	---	11.93	48.21	---	73.96	53.96	-5.75
12308.75	1.00	253	38.27	---	9.56	47.83	---	73.96	53.96	-6.13

#### **8.4 Test Result of the Bandedge**

If any 100 kHz bandwidth outside these frequency bands, the radio frequency power that is produced by the modulation products of the spreading sequence, the information sequence and the carrier frequency shall be either *at least 20 dB below that in any 100 kHz bandwidth within the band that contains the highest level of the desired power or shall not exceed the general levels specified in §15.209(a)*,

We perform this section by the *radiated manner*, the RBW is set to 100kHz and VBW>RBW. We'd made the observation *up to 10<sup>th</sup> harmonics and the criterion is all the harmonic/spurious emissions must be 20dB below the highest emission level measured*. If the emissions fall in the restricted bands stated in the Part15.205(a) must also *comply with the radiated emission limits specified in Part15.209(a)*. (*Peak mode: RBW=VBW=1MHz, Average mode: RBW=1MHz; VBW=10Hz*)

The following pages show our observations referring to the channel 1 and 11 respectively.

Test Condition & Setup: same as < 8.1 >

**Channel 1 of IEEE 802.11b**

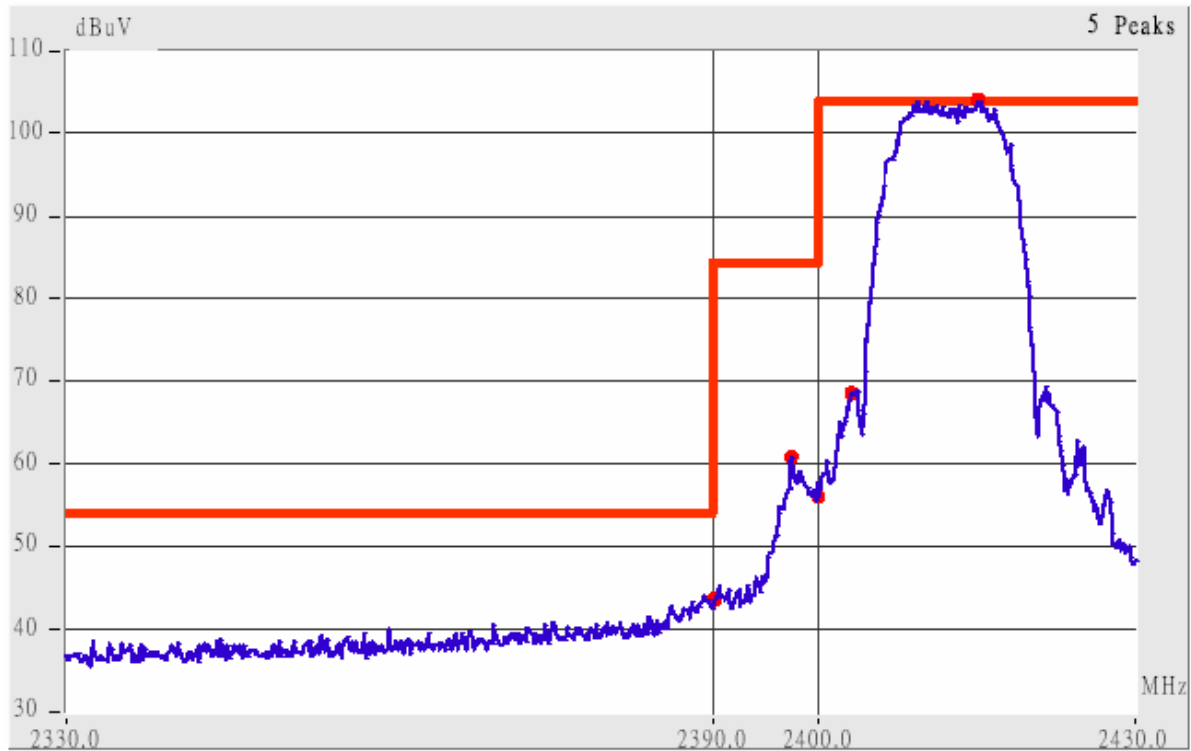

This is the hard copy of our bandedge measurement generated by our bandedge testing program. The plot shown above is the bandedge of channel 1.

1. The lobe left by the fundamental side is already 20dB below the highest emission level.
2. The emissions recorded in the restricted band is do comply with the Part 15.209(a) – as below.

<i>Radiated Emission</i>					<i>Corrected Amplitude</i>		<i>Class B ( 3m )</i>		
<i>Frequency (MHz)</i>	<i>Ant. P.</i>	<i>Ant. H. (m)</i>	<i>Table ( ° )</i>	<i>Factors (dB)</i>	<i>(dBµV/m)</i>		<i>Limit (dBµV/m)</i>		<i>Margin (dB)</i>
					<i>Peak</i>	<i>Average</i>	<i>Peak</i>	<i>Ave.</i>	
2387.31	Hor	1.00	47	9.17	49.67	---	73.96	53.96	-4.29
2390.02	Hor	1.00	44	9.18	48.85	---	73.96	53.96	-5.11
2386.05	Ver	1.00	266	9.17	52.17	39.50	73.96	53.96	-14.46
2390.44	Ver	1.00	233	9.19	52.68	42.01	73.96	53.96	-11.95

**Channel 11 of IEEE 802.11b**

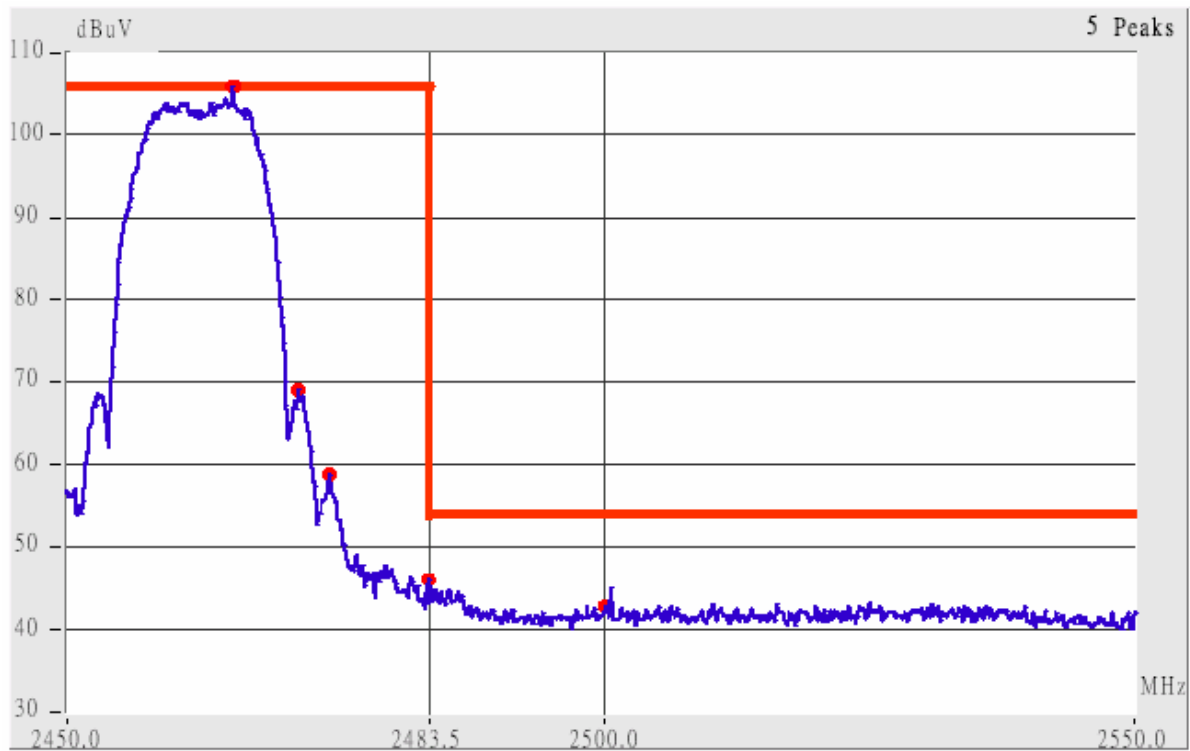

This is the hard copy of our bandedge measurement generated by our bandedge testing program. The plot shown above is the bandedge of channel 11.

- 3. The lobe right by the fundamental side is already 20dB below the highest emission level.
- 4. The emissions recorded in the restricted band is do comply with the Part 15.209(a) – as below

<i>Radiated Emission</i>					<i>Corrected Amplitude</i>		<i>Class B ( 3m )</i>		
<i>Frequency (MHz)</i>	<i>Ant. P.</i>	<i>Ant. H. (m)</i>	<i>Table ( ° )</i>	<i>Factors (dB)</i>	<i>(dBµV/m)</i>		<i>Limit (dBµV/m)</i>		<i>Margin (dB)</i>
					<i>Peak</i>	<i>Average</i>	<i>Peak</i>	<i>Ave.</i>	
2488.28	Hor	1.00	299	9.46	47.62	---	73.96	53.96	-6.34
2512.78	Hor	1.00	298	9.51	47.51	---	73.96	53.96	-6.45
2483.03	Ver	1.00	270	9.44	54.28	42.77	73.96	53.96	-11.19
2487.46	Ver	1.00	353	9.45	54.12	41.28	73.96	53.96	-12.68
2499.50	Ver	1.00	244	9.49	53.16	40.99	73.96	53.96	-12.97
2508.35	Ver	1.00	271	9.51	54.84	41.01	73.96	53.96	-12.95



**Channel 1 of IEEE 802.11g**

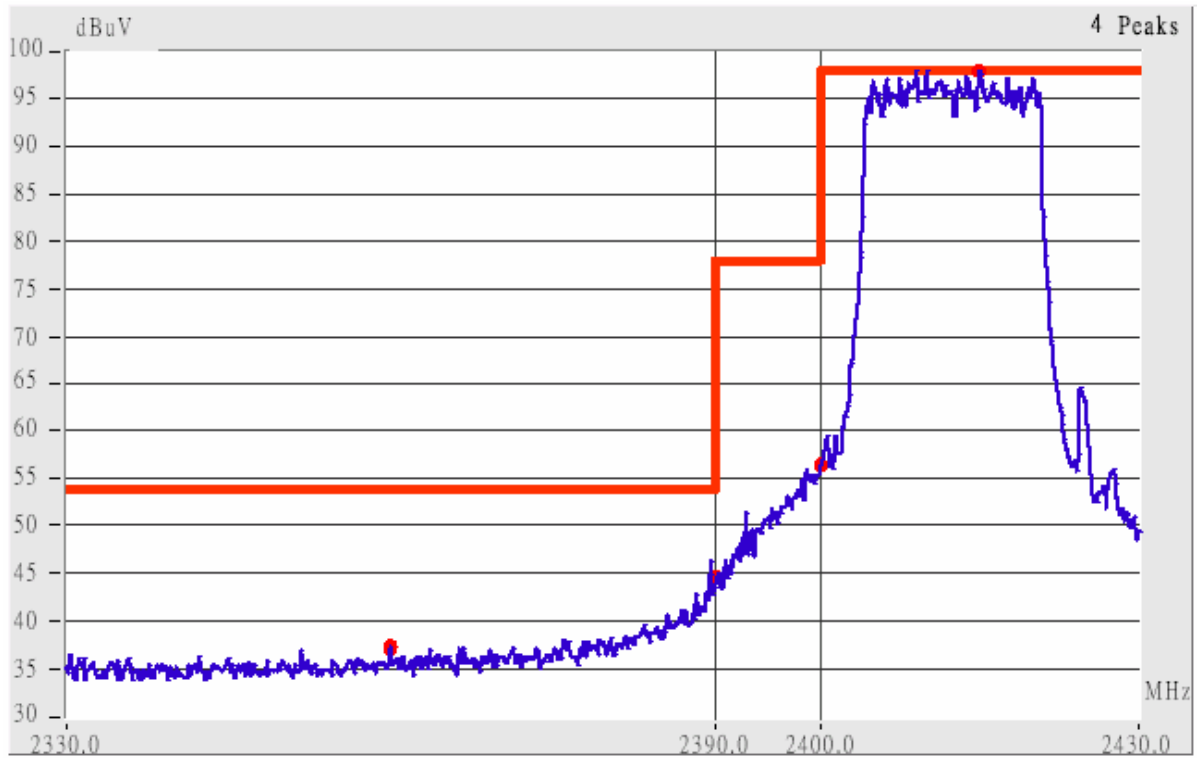

This is the hard copy of our bandedge measurement generated by our bandedge testing program. The plot shown above is the bandedge of channel 1.

- 5. The lobe left by the fundamental side is already 20dB below the highest emission level.
- 6. The emissions recorded in the restricted band is do comply with the Part 15.209(a) – as below.

<i>Radiated Emission</i>					<i>Corrected Amplitude</i>		<i>Class B ( 3m )</i>		
<i>Frequency (MHz)</i>	<i>Ant. P.</i>	<i>Ant. H. (m)</i>	<i>Table ( ° )</i>	<i>Factors (dB)</i>	<i>(dBµV/m)</i>		<i>Limit (dBµV/m)</i>		<i>Margin (dB)</i>
					<i>Peak</i>	<i>Average</i>	<i>Peak</i>	<i>Ave.</i>	
2385.63	Hor	1.00	176	9.17	49.67	---	73.96	53.96	-4.29
2390.02	Hor	1.00	204	9.18	51.52	---	73.96	53.96	-2.44
2387.04	Ver	1.00	144	9.17	55.17	36.50	73.96	53.96	-17.46
2390.52	Ver	1.00	7	9.18	55.52	39.68	73.96	53.96	-14.28

**Channel 11 of IEEE 802.11g**

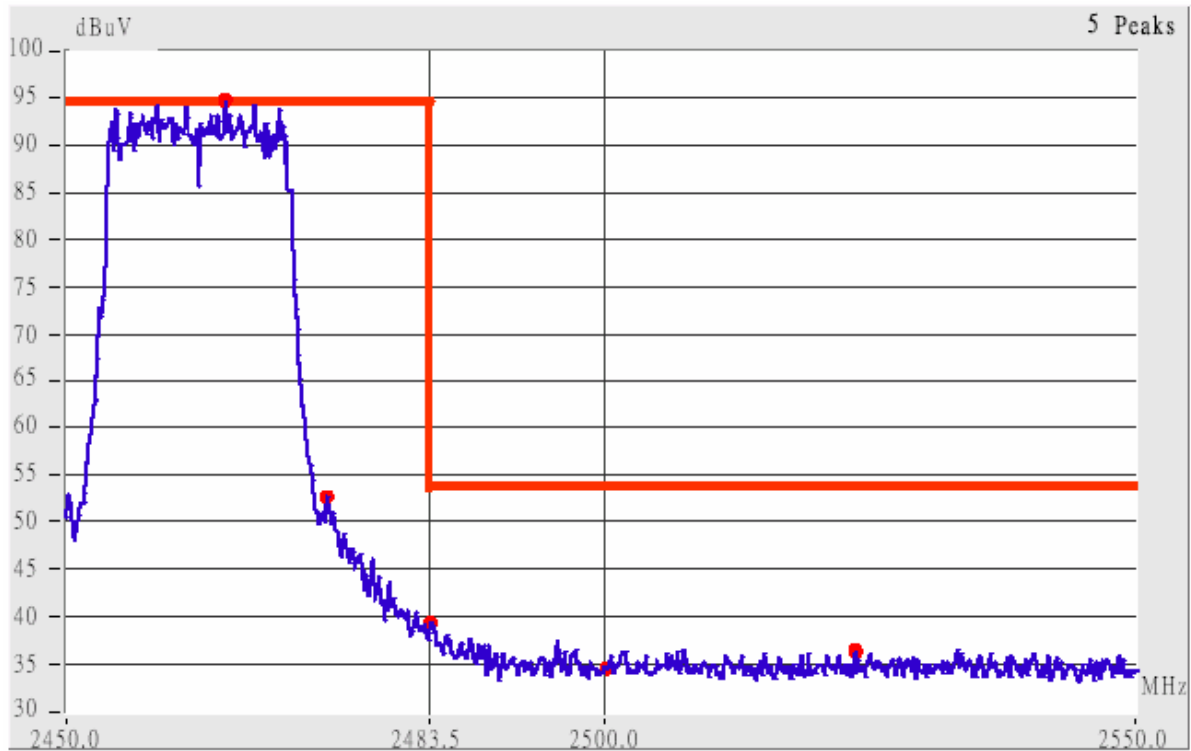

This is the hard copy of our bandedge measurement generated by our bandedge testing program. The plot shown above is the bandedge of channel 11.

- 7. The lobe right by the fundamental side is already 20dB below the highest emission level.
- 8. The emissions recorded in the restricted band is do comply with the Part 15.209(a) – as below

<i>Radiated Emission</i>					<i>Corrected Amplitude</i>		<i>Class B ( 3m )</i>		
<i>Frequency (MHz)</i>	<i>Ant. P.</i>	<i>Ant. H. (m)</i>	<i>Table ( ° )</i>	<i>Factors (dB)</i>	<i>(dBµV/m)</i>		<i>Limit (dBµV/m)</i>		<i>Margin (dB)</i>
					<i>Peak</i>	<i>Average</i>	<i>Peak</i>	<i>Ave.</i>	
2485.95	Hor	1.00	307	9.45	48.28	---	73.96	53.96	-5.68
2524.22	Hor	1.00	68	9.54	46.37	---	73.96	53.96	-7.59
2483.58	Ver	1.00	183	9.44	53.78	38.94	73.96	53.96	-15.02
2486.91	Ver	1.00	297	9.45	57.62	37.62	73.96	53.96	16.34
2500.01	Ver	1.00	202	9.49	50.49	---	73.96	53.96	-3.47
2505.32	Ver	1.00	213	9.50	50.83	---	73.96	53.96	-3.13

## IX. Section 15.247(d): Power Spectral Density

### 9.1 Test Condition & Setup

The tests below are running with the EUT transmitter set at high power in TDD mode. The EUT is needed to force selection of output power level and channel number. While testing, the EUT was set to transmit continuously and to be tested by the contact manner with the spectrum analyzer.

### 9.2 Test Instruments Configuration

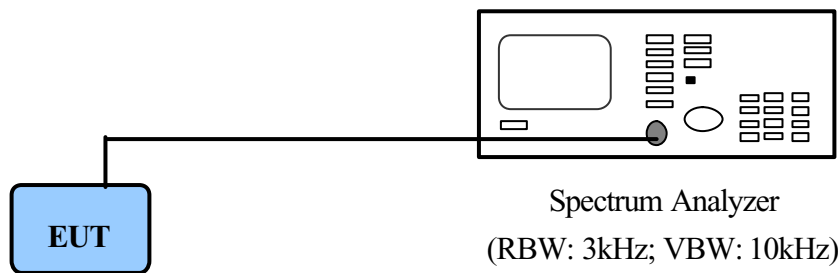

*PC to control the EUT at maximal power output and channel number and set antenna kit*

### 9.3 List of Test Instruments

Instrument Name	Model No.	Brand	Serial No.	Next time
Spectrum Analyzer	MS2665C	ANRITSU	6200175476	11/15/06

**9.4 Test Result of Power spectral density**

The following table shows a summary of the test results of the Power Spectral Density.

**IEEE 802.11b**

<i>Channel</i>	<i>Ppr (dBm)</i>	<i>Cable Loss (dB)</i>	<i>Ppq (dBm)</i>	<i>Limit (dB)</i>	<i>Margin (dB)</i>
CH 01	-9.09	0.70	-8.39	8.00	-16.39
CH 06	-8.61	0.70	-7.91	8.00	-15.91
CH 11	-8.82	0.70	-8.12	8.00	-16.12

**IEEE 802.11g**

<i>Channel</i>	<i>Ppr (dBm)</i>	<i>Cable Loss (dB)</i>	<i>Ppq (dBm)</i>	<i>Limit (dB)</i>	<i>Margin (dB)</i>
CH 01	-15.66	0.70	-14.96	8.00	-22.96
CH 06	-14.75	0.70	-14.05	8.00	-22.05
CH 11	-14.57	0.70	-13.87	8.00	-21.87

Note:

1. The following pages show the results of spectrum reading.
2. Ppr: spectrum read power density (using peak search mode),  
Ppq: actual peak power density in the spread spectrum band.
3.  $Ppq = Ppr + |Cable Loss|$

**Power Spectral Density for Channel 01**

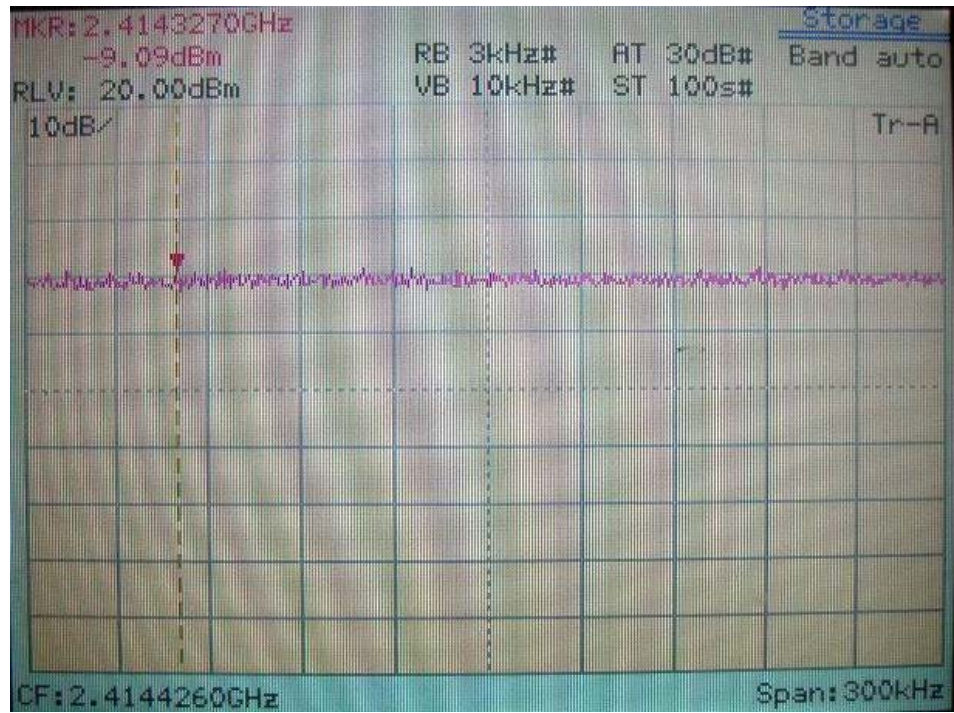

**IEEE 802.11b**

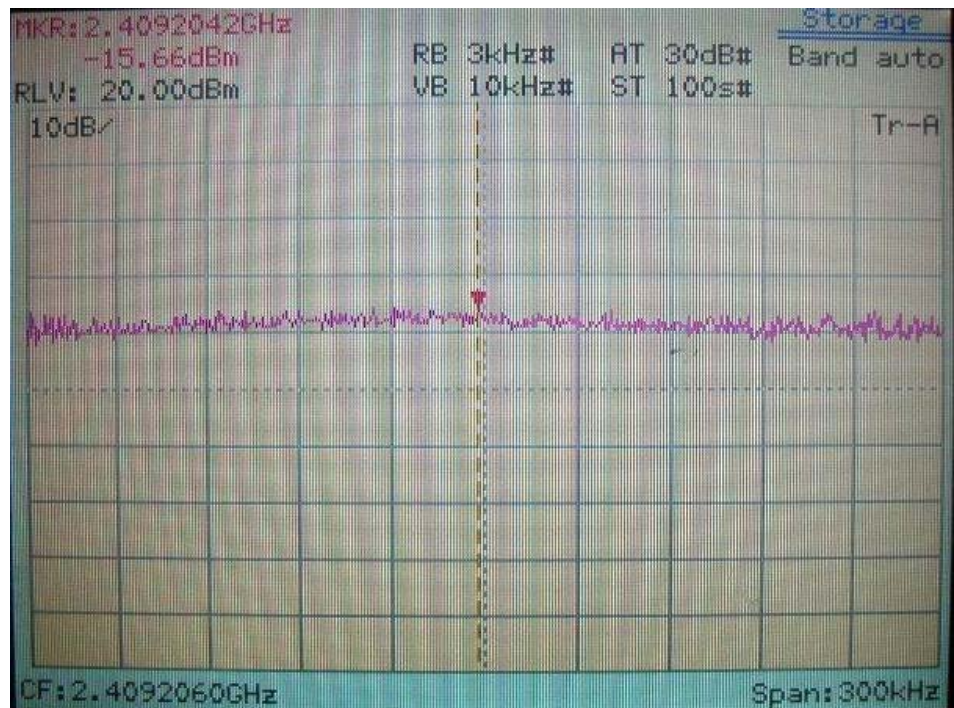

**IEEE 802.11g**



**Power Spectral Density for Channel 06**

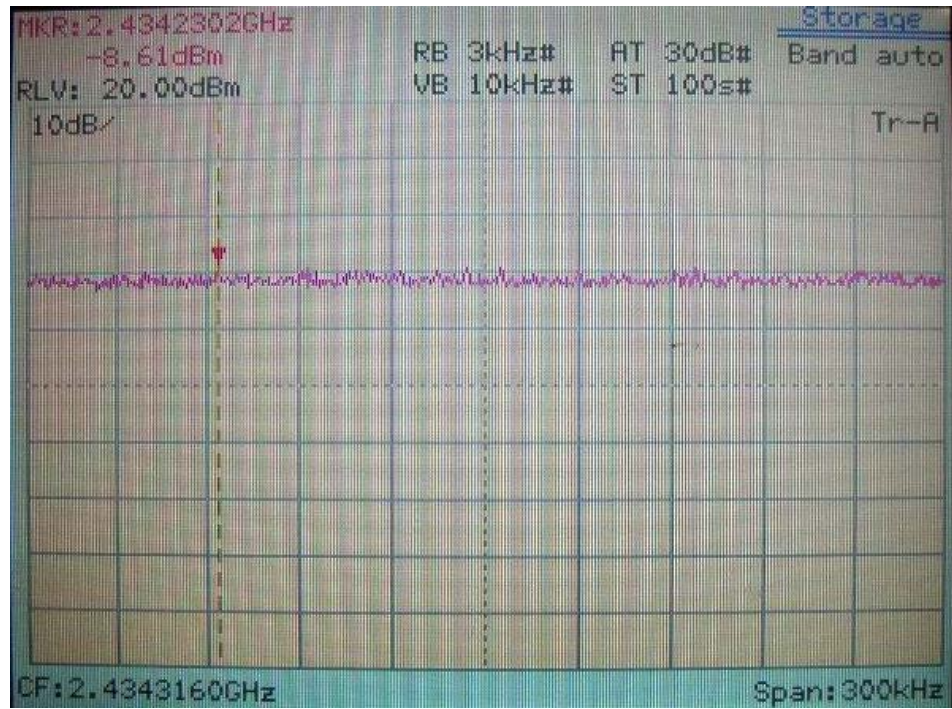

**IEEE 802.11b**

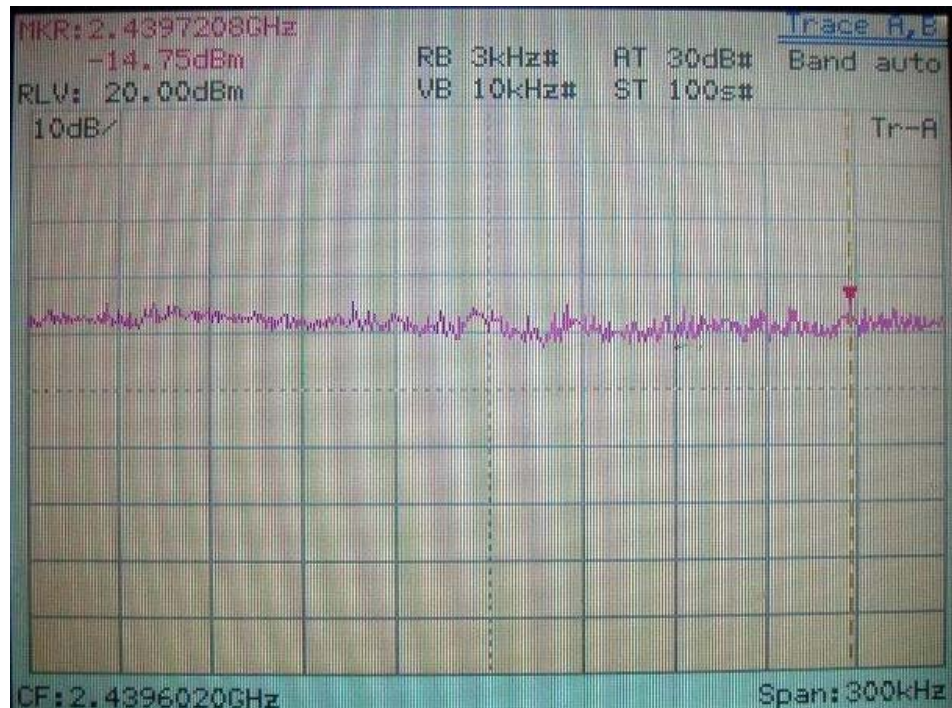

**IEEE 802.11g**

**Power Spectral Density for Channel 11**

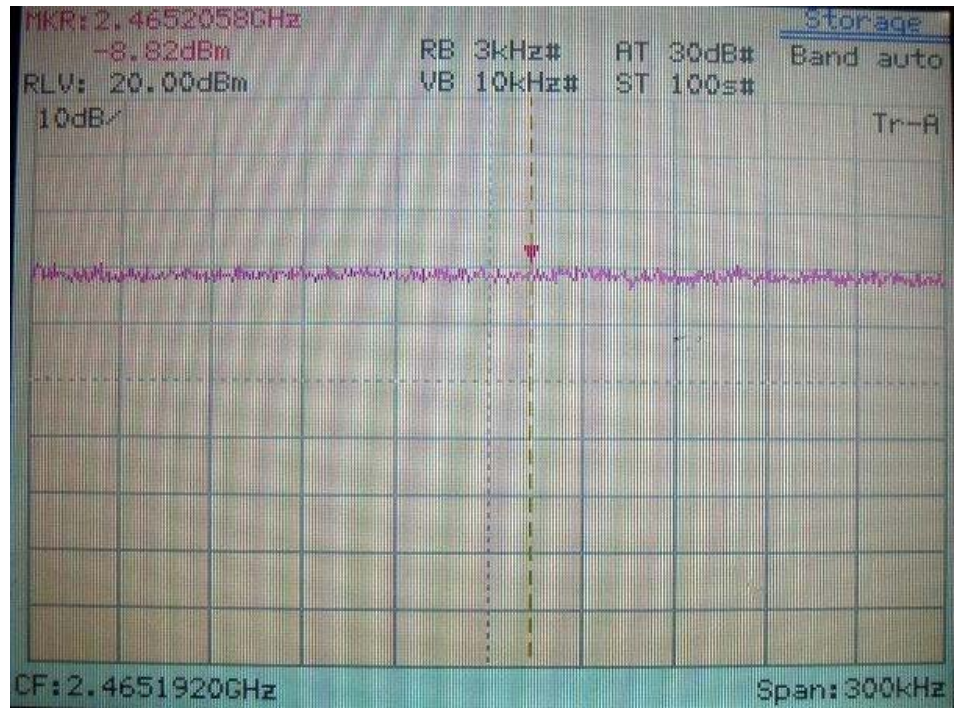

**IEEE 802.11b**

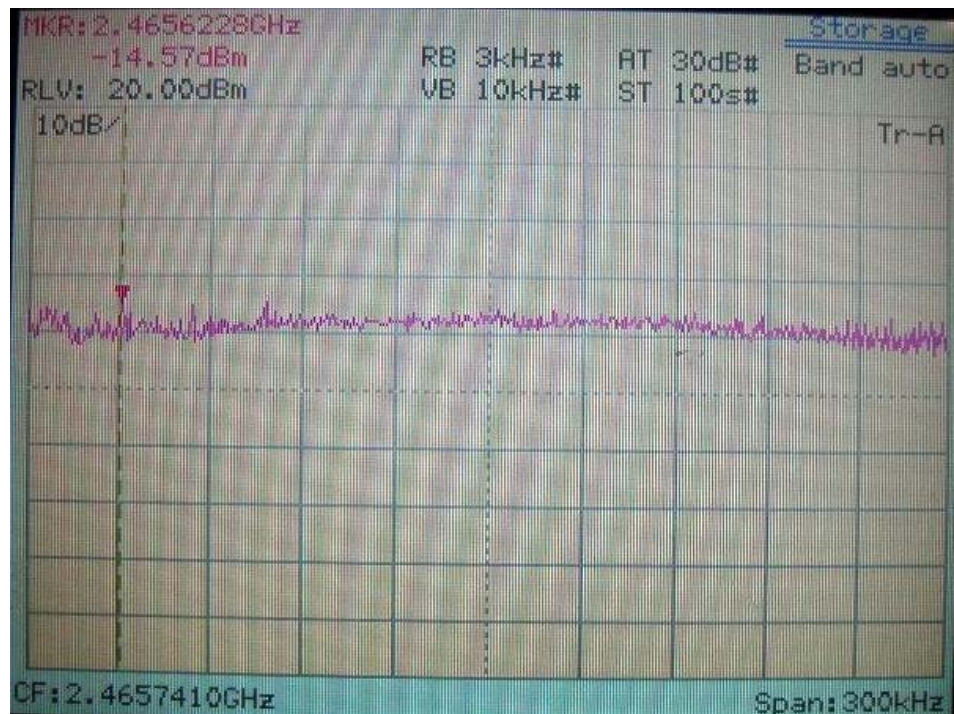

**IEEE 802.11g**