

MEASUREMENT REPORT of *ASUS Wireless AP*

Applicant : ASUSTek Computer Inc.
EUT : ASUS Wireless AP
Model No. : WL-320gP
FCC ID : MSQWL320GP

Tested by :

Training Research Co., Ltd.

TEL : 886-2-26935155 FAX : 886-2-26934440

No. 255, Nanyang Street, Shijr, Taipei Hsien 221, Taiwan, R.O.C.

CERTIFICATION

We here by verify that:

The test data, data evaluation, test procedures and equipment configurations shown in this report were made mainly in accordance with the procedures given in ANSI C63.4 (2003) as a reference. All test were conducted by *Training Research Co., Ltd.*, 255 Nanyang Street, Shijr, Taipei Hsien 221, Taiwan, R.O.C. Also, we attest to the accuracy of each.

We further submit that the energy emitted by the sample EUT tested as described in the report is **in compliance with** the technical requirements set forth in the FCC Rules Part 15 Subpart B (Declaration of Conformity) and C Section 15.247.

Applicant : ASUSTek Computer Inc.
Applicant Address : 4F, No. 150, Li-Te Rd., Peitou, Taipei, Taiwan, R.O.C.
Product Name : ASUS Wireless AP
Model : WL-320gP
Report No. : A5415060579
Test Date : October 17, 2006

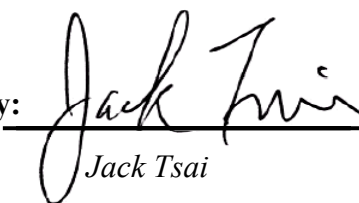
Prepared by: 
Jack Tsai

Approved by: 
Frank Tsai

Conditions of issue :

- (1) **This test report shall not be reproduced except in full, without written approval of TRC. And the test result contained within this report only relate to the sample submitted for testing.**
- (2) **This report must not be used by the client to claim product endorsement by NVLAP or any agency of U.S. Government.**
- (3) **This test report, measurements made by TRC are traceable to the NIST only Conducted and Radiated Method.**



NVLAP LAB CODE 200174-0

Report No.: A5415060579, FCC Part 15.247

Training Research Co., Ltd., TEL: 886-2-26935155, Fax: 886-2-26934440

Federal Communications Commission
Declaration of Conformity
(DoC)

for the following equipment:

Product name : ASUS Wireless AP
Model name : WL-320gP
Trade name : ASUS

Is herewith confirmed and found to comply with the requirements of CFR 47 part15 Subpart B - Unintentional Radiators regulation. The results of electromagnetic mission evaluation are shown in the report number : A5415060579

This device complies with Part 15 of the FCC Rules. Operation is subject to the following two conditions:

- (1) This device may not cause harmful interference, and
- (2) This device must accept any interference received,
including interference that may cause undesired operation

Manufacturer	USA local representative
Company name: ASUSTeK Computer Inc.	To be determined
Computer address: 4/F, 150, Li-Te Rd., Peitou, Taipei, Taiwan	
ZIP / Postal code 112	
Contact person: Lawrence Yu	
Title: Manager	
Internet e-mail address: lawrence_yu@asus.com.tw	
Tel / Fax: 886-2-28943447 / 886-2-28950113	

Tables of Contents

I.	GENERAL	6
	1.1 Introduction	6
	1.2 Description of EUT	6
	1.3 Test method	7
	1.4 Description of Support Equipment	7
	1.5 Configuration of System Under Test	10
	1.6 Verify the Frequency and Channel	12
	1.7 Test Procedure	13
	1.8 Location of the Test Site	13
	1.9 General Test Condition	13
II.	Section 15.101(a) : Equipment Authorization of Unintentional Radiators	14
III.	Section 15.203 : Antenna Requirement	15
IV.	Section 15.207 : Power Line Conducted Emissions for AC Powered Units	16
	4.1 Test Condition & Setup	16
	4.2 List of Test Instruments	17
	4.3 Test Result of Conducted Emissions	18
	RX mode.....	18
	IEEE 802.11b (UNIFIVE)	19
	IEEE 802.11g (UNIFIVE)	20
	IEEE 802.11b (DVE)	22
	IEEE 802.11g (DVE)	23
V.	Section 15.247(a) : Technical Description of the EUT	25
VI.	Section 15.247(a)(2) : Bandwidth for Direct Sequence System	26
	6.1 Test Condition & Setup	26
	6.2 Test Instruments Configuration	26
	6.3 List of Test Instruments	26
	6.4 Test Result of Bandwidth	26
	Channel 01	27
	Channel 06	28
	Channel 11	29

VII. Section 15.247(b) : Power Output	30
7.1 Test Condition & Setup	30
7.2 List of Test Instruments	30
7.3 Test Result	30
VIII. Section 15.247(c) : Spurious Emissions (Radiated)	31
8.1 Test Condition & Setup	31
8.2 List of Test Instruments	33
8.3 Test Result of Spurious Radiated Emissions	34
RX mode	34
IEEE 802.11b CH 01	36
IEEE 802.11b CH 06	38
IEEE 802.11b CH 11	40
IEEE 802.11g CH 01	42
IEEE 802.11g CH 06	44
IEEE 802.11g CH 11	46
8.4 Test Result of Bandedge	48
IEEE 802.11b CH 01	49
IEEE 802.11b CH 11	50
IEEE 802.11g CH 01	51
IEEE 802.11g CH 11	52
IX. Section 15.247(d) : Power Spectral Density	53
9.1 Test Condition & Setup	53
9.2 Test Instruments Configuration	53
9.3 List of Test Instruments	53
9.4 Test Result of Power Spectral Density	54
Channel 01	55
Channel 06	56
Channel 11	57

I . GENERAL

1.1 Introduction

The following measurement report is submitted on behalf of applicant in support that the certification in accordance with Part 2 Subpart J and Part 15 Subpart A, B and C of the Commission's Rules and Regulations.

1.2 Description of EUT

FCC ID	:	MSQWL320GP
Product Name	:	ASUS Wireless AP
Model Name	:	WL-320gP
Frequency Range	:	2.412GHz ~ 2.462GHz
Support Channel	:	11 Channels
Modulation Skill	:	DBPSK, DQPSK, CCK, OFDM
Power Type	:	Powered by the switching adapter, (1) Manufacture: UNIFIVE Model: US300520 I/P: 100 ~ 240VAC ~ 50/60Hz 0.3A O/P: 5VDC 2.0A MAX. 185cm length, non-shielded, without ferrite core (2) Manufacture: DVE Model: DSA-0101F-05 A I/P: 100 ~ 240VAC ~ 50/60Hz 0.3A 30VA O/P: 5VDC 2.0A MAX. 180cm length, non-shielded, ferrite core
Data Cable	:	RJ45 cable x1, 2.0m length, non-shielded, no ferrite core

1.3 Test method

- 1.3.1 Connected the LAN port of EUT with the LAN card of PC. Using PC and software provided by the manufacturer to control EUT, the test is performed under the specific conditions.
- 1.3.2 Set different data rate and channel (CH01/CH06/CH11) being tested
 - (a) Radiated for Intentional test:
 - making EUT to the mode of continuous transmission
 - (b) Conducted test and Radiated for unintentional test:
 - making EUT to the linking (Rx/Tx) mode with far support equipments
- 1.3.3 Radiated emission of two adaptors is pre-tested and worse case emission of AC adaptor is final test then record to test report.

1.4 Description of Support Equipment

In order to construct the minimum testing, following equipment were used as the support units.

PC : IBM 8434

Model No. : IVG

Serial No. : 99CCZG9

FCC ID : N/A, DoC (Declaration of Confirmation) Approved

BSMI : R33026

Power type : 100 ~ 127VAC/200 ~ 240VAC, 6A/3A, 50 ~ 60Hz, Switching

Power cord : Non-shielded, 1.8m long, Plastic hood, No ferrite core

Flat Panel Monitor : IBM

Model No. : 6636-AB1

Serial No. : 23T5592

FCC ID : N/A, DoC (Declaration of Confirmation) Approved

BSMI : R33037

Data cable : Shielded, 1.170 m length, Plastic hood, two ferrite cores

Power type : 100 ~ 240VAC, 1.5A, 50/60Hz, Switching

Power cord : Non-shielded, 1.80m length, Plastic hood, No ferrite core

Printer : **EPSON**
Model No. : B241A
Serial No. : FAPY155090
FCC ID : N/A, DoC Approved
BSMI : R33126
Power type : Switching adaptor
Power cord : Non-shielded, 198cm length, No ferrite core
Data cable : Shielded, 1.50m length, No ferrite core

PS/2 Mouse : **HP**
Model No. : M-S69
Serial No. : 334684-002 323614-001
FCC ID : DoC Approved
BSMI : R41126
Power type : By PC
Power cord : Shielded, 1.90m length, No ferrite core

PS/2 Keyboard : **HP**
Model No. : 5181
Serial No. : BE21700405
FCC ID : DoC Approved
BSMI : 3892C981
Power type : By PC
Data cable : Shielded, 1.73m length, no ferrite core

Modem : **ACEEX**
Model No. : DM-1414
Serial No. : 9010583
FCC ID : IFAXDM1414
Power type : Linear
Power cord : Non-shielded, 1.9m length, No ferrite cord
Data cable : RS232, Shielded, 1.2m length, No ferrite core
RJ11C x 2, 7' length non-shielded, No ferrite core

USB Game pad : Logitech
Model No. : G-UC3B
Serial No. : AE3500500
FCC ID : DoC Approved
BSMI : 4902A047
Power type : Powered by PC
Power Cable : Shielded, 187cm length, Plastic hood, No ferrite core.

LAN Card : D-Link
Model No. : DFE-530TX
Serial No. : 0050BAE32FF3
FCC ID : N/A, DoC Approved

Notebook PC : Twinhead
Model No. : N222S
Serial No. : SY3261000988
FCC ID : DoC (Declaration of Confirmation) Approved
BSMI : 71001018

Power adaptor : LI Shin International Enterprise Corp.
Model No. : LSE9802A2060
Serial No. : A20231065818
BSMI : 3882B381
Power type : 100 ~ 240VAC / 50 ~ 60Hz, 1.5A, Switching
Power cord : Non-shielded, 1.0m length, Plastic hood, No ferrite core
(Main power to adaptor)
Shielded, 1.5m length, Plastic hood, ferrite core
(DC plug to adaptor)

WLAN Card : Gemtek Technology Co., Ltd.
Model No. : C911003
FCC ID : MXF-C911003

1.5 Configuration of System Under Test

1.5.1 Conducted and Radiated for Unintentional

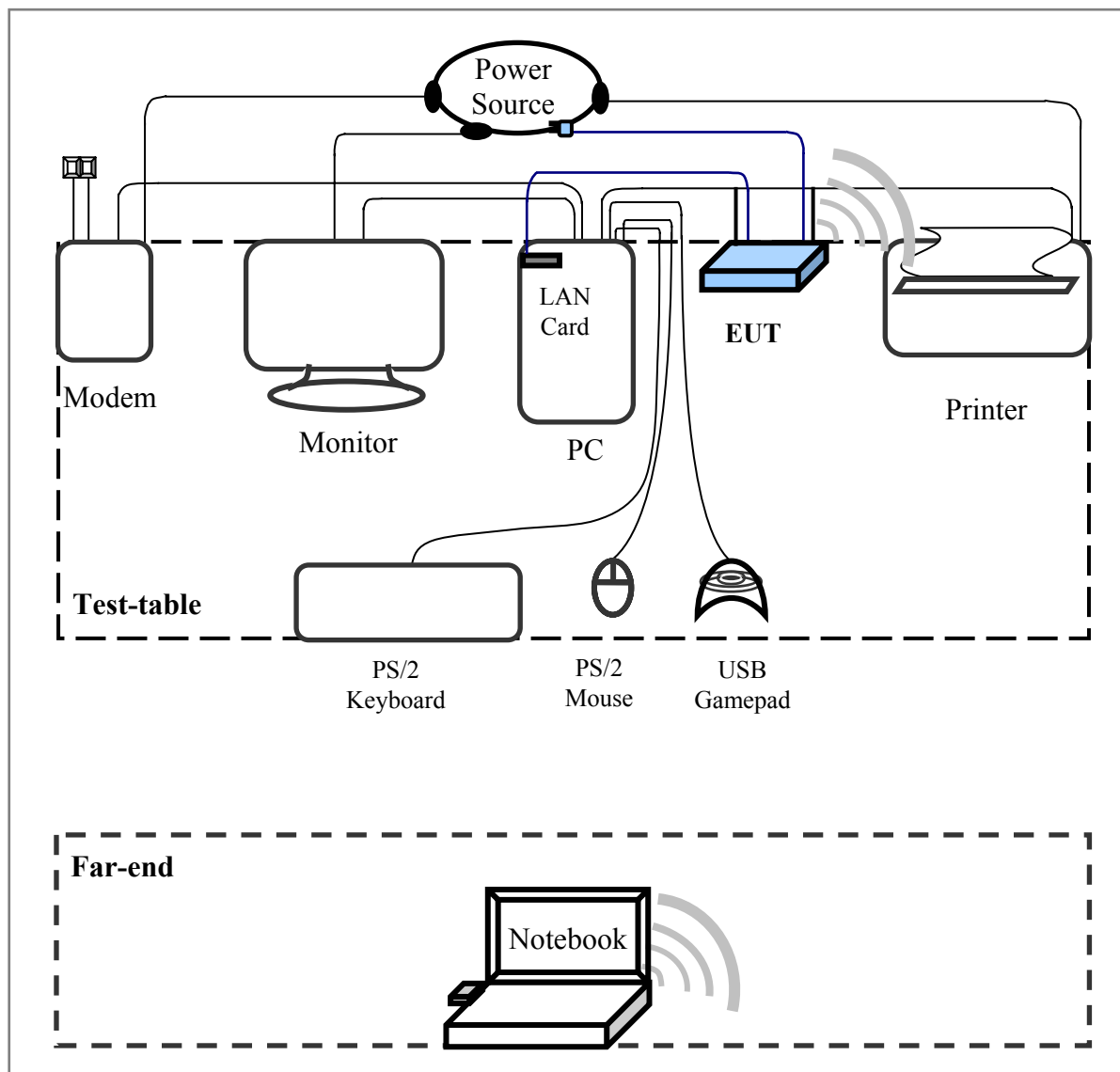

Connections of Equipment

- PC:**
- *Parallel Port --- a printer
 - *VGA Port --- a monitor
 - *Serial Port --- an external modem
 - *USB Port --- a USB gamepad
 - *LAN Interface --- EUT
 - *PS/2-key Port --- a PS/2 keyboard
 - *PS/2-mouse Port --- a PS/2 mouse

1.5.2 Radiated of Intentional

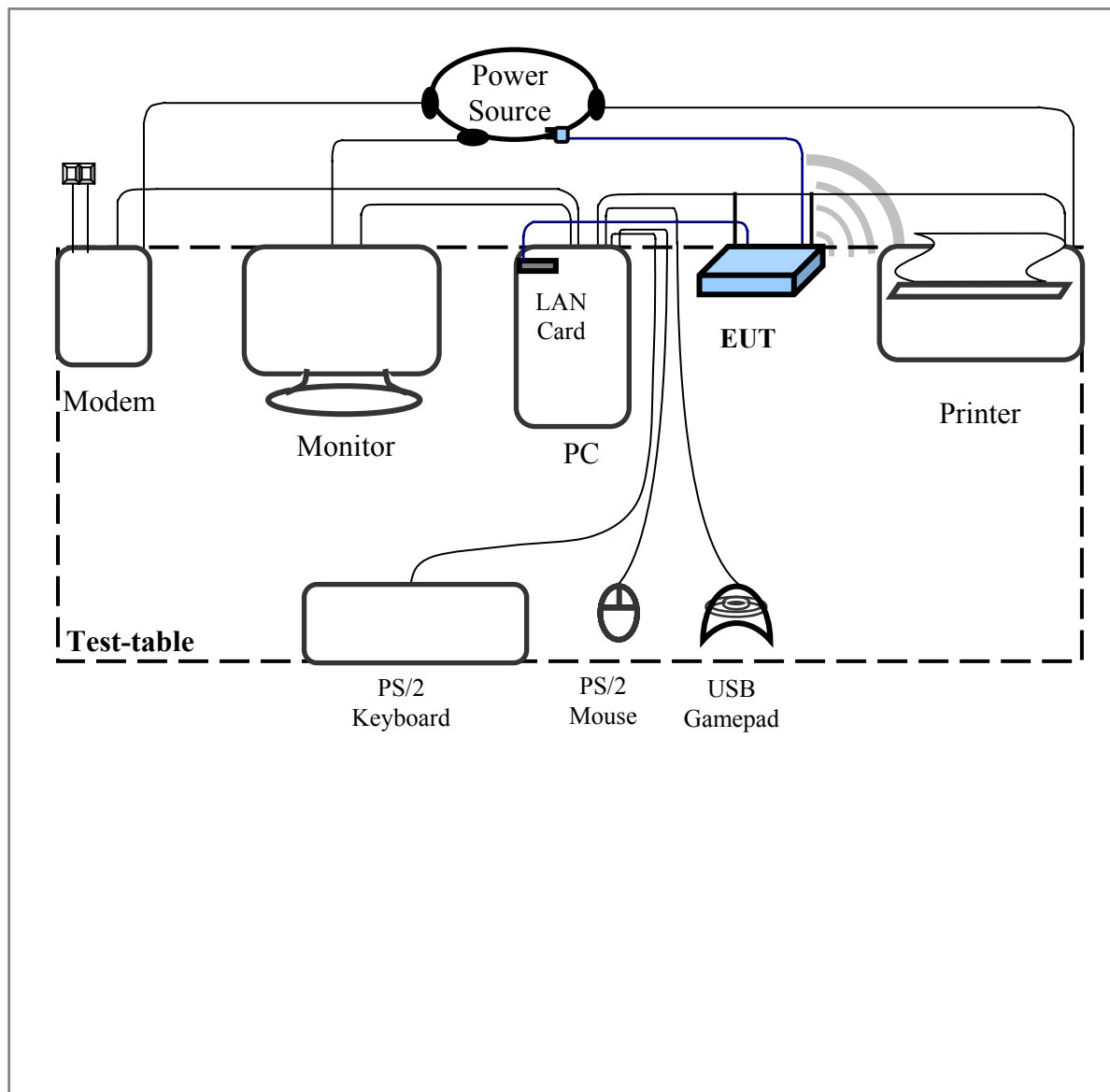

The tests below are carried with the EUT transmitter set at high power in TDD mode. The EUT is forced to select of output power level and channel number by LAN port.

The setting up procedure was recorded in 1.3 test method.

1.6 Verify the Frequency and Channel

Channel	Frequency (GHz)
1	2.412
2	2.417
3	2.422
4	2.427
5	2.432
6	2.437
7	2.442
8	2.447
9	2.452
10	2.457
11	2.462

Note:

1. This is for confirming that all frequencies are in 2.412GHz to 2.462GHz.
2. Section 15.31(m): Measurements on intentional radiators or receivers shall be performed at three frequencies for operating frequency range over 10 MHz
(The locations of these frequencies one near the top, one near the middle and one near the bottom.)
3. After test, the EUT operating frequencies are in 2.412GHz to 2.462GHz. So all the items as followed in testing report are need to test these three frequencies:
Top: Channel – 1; Middle: Channel – 6; Bottom: Channel – 11.

1.7 Test Procedure

All measurements contained in this report were performed mainly according to the techniques described in ANSI C63.4 (2003) and the pre-setup was written on 1.3 test method, the detail setup was written on each test item.

1.8 Location of the Test Site

The radiated emissions measurements required by the rules were performed on the **three-meter, Anechoic Chamber (FCC Registration Number: 93906)** maintained by *Training Research Co., Ltd.* 1F, No. 255 Nanyang Street, Shijr, Taipei Hsien 221, Taiwan, R.O.C. Complete description and measurement data have been placed on file with the commission. The conducted power line emissions tests and other test items were performed in a anechoic chamber also located at Training Research Co., Ltd.

No. 255 Nanyang Street, Shijr, Taipei Hsien 221, Taiwan, R.O.C. *Training Research Co., Ltd.* is listed by the FCC as a facility available to do measurement work for others on a contract basis.

1.9 General Test Condition

The conditions under which the EUT operates were varied to determine their effect on the equipment's emission characteristics. The final configuration of the test system and the mode of operation used during these tests were chosen as that which produced the highest emission levels. However, only those conditions, which the EUT was considered likely to encounter in normal use were investigated.

In test, they were set in high power and continuously transmitting mode that controlled by computer. The ch01, ch06 and ch11 of EUT were all tested. The setting up procedure is recorded on 1.3 test method.

II. Section 15.101(a): Equipment authorization of unintentional radiators

The EUT equipped with a LAN interface and should be operated with the computer. It was categorized to *Class B personal computers and peripherals* as cannot be operated stand-alone. The authorization requires **Declaration of Conformity (DoC)** and the items required such as Sect.15.107 (Conducted limits) and Section15.109 (Radiated emission limits) is same as Section15.207 and 15.247(C).

III. Section 15.203: Antenna requirement

The EUT can be equipped with detachable antenna. The external antenna is affixed to the EUT using a unique connector, which allows for replacement of a broken antenna, but does not use a standard antenna jack or electrical connector. The antenna requirement stated in Section 15.203 is inapplicable to this EUT.

The custom antenna specification of list as below:

Manufacturer : ARISTOTLE ENTERPRISES
Part No : RFA-02-5-C15M3
Connector : R/P SMA PLUG
Antenna Gain : 5.0dBi (MAX.)

VI. Section 15.207: Power Line Conducted Emissions for AC Powered Units

4.1 Test Condition & Setup

The power line conducted emission measurements were performed in an anechoic chamber. The EUT was assembled on a wooden table, which is 80 centimeters high, was placed 40 centimeters from the backwall and at least 1 meter from the sidewall.

Power was fed to the EUT from the public utility power grid through a line filter and Line Impedance Stabilization Networks (LISNs). The LISN housing, measuring instrumentation case, ground plane, etc., were electrically bonded together at the same RF potential. The Spectrum analyzer (or EMI receiver) was connected to the AC line through an isolation transformer. The 50-ohm output of the LISN was connected to the spectrum analyzer directly. Conducted emission levels were in the CISPR quasi-peak and average detection mode. The analyzer's 6 dB bandwidth was set to 9 KHz. No post-detector video filter was used.

The spectrum was scanned from 150 KHz to 30 MHz. The physical arrangement of the test system and associated cabling was varied (within the scope of arrangements likely to be encountered in actual use) to determine the effect on the unit's emanations in amplitude and frequency. All spurious emission frequencies were observed. The highest emission amplitudes relative to the appropriate limit were measured and have been recorded in paragraph 4.3

There is a test condition apply in this test item, the test procedure description as <1.3>. Three channels were tested, one in the top (CH01), one in the middle (CH06) and the other in bottom (CH11).

4.2 List of Test Instruments

Instrument Name	Model	Brand	Serial No.	Calibration Date
				Next time
EMI Receiver	8546A	HP	3520A00242	12/01/06
RF Filter Section	85460A	HP	3448A00217	12/01/06
LISN (EUT)	LISN-01	TRC	99-05	12/10/06
LISN (Support E.)	LISN-01	TRC	9912-03, 04	11/26/06
Pre-amplifier	15542 ZFL-500	Mini – Circuits	0 0117	05/20/07
6dB Attenuator	MCL BW-S6W2	Mini – Circuits	9915 – Conducted	05/20/07
10dB Attenuator	A5542 VAT010	Mini – Circuits	0215 – Conducted	05/20/07
Coaxial Cable (2 meter)	A30A30-0058-50FS-2M	Jyebao	SMA-08	05/20/07
Coaxial Cable (1.1 meter)	A30A30-0058-50FS-1M	Jyebao	SMA-09	05/20/07
Coaxial Cable (20 meter)	RG-214/U	Jyebao	NP-01	05/20/07
Coaxial Cable (20 meter)	RG-214/U	Jyebao	NP-02	05/20/07
Auto Switch Box (< 30MHz)	ASB-01	TRC	9904-01	05/20/07

4.3 Test Result of Power Line Conducted Emissions

The following table shows a summary of the highest emissions of power line conducted emissions on the LIVE and NETURAL conductors of the EUT power cord. Show as follows.

Test Conditions: Temperature : 25 °C Humidity : 73 % RH

Test mode: RX mode

<i>Power Connected Emissions</i>					<i>Class B</i>		
<i>Conductor</i>	<i>Frequency (KHz)</i>	<i>Peak (dBµV)</i>	<i>QP (dBµV)</i>	<i>Average (dBµV)</i>	<i>QP-limit (dBµV)</i>	<i>AVG-limit (dBµV)</i>	<i>Margin (dB)</i>
Line 1	184.795	62.60	49.12	29.08	64.94	54.94	-15.82
	194.275	62.39	60.76	50.94	64.60	54.60	-3.66
	499.000	43.13	---	---	56.03	46.03	-2.90
	795.000	43.70	---	---	56.00	46.00	-2.30
	1059.000	43.01	---	---	56.00	46.00	-2.99
	1198.000	43.36	---	---	56.00	46.00	-2.64
Line 2	166.260	64.44	49.39	13.70	65.60	55.60	-16.21
	195.465	61.37	58.62	47.50	64.54	54.54	-5.92
	252.000	46.21	---	---	63.09	53.09	-6.88
	1187.400	42.87	---	---	56.00	46.00	-3.13
	1490.000	44.14	---	---	56.00	46.00	-1.86
	3606.000	40.85	---	---	56.00	46.00	-5.15

NOTE:

- (1)Margin = Peak Amplitude – Limit, *The reading amplitudes are all under limit.*
- (2)A "+" sign in the margin column means the emission is OVER the Class B Limit and "-" sign of means UNDER the Class B limit

Test mode: IEEE 802.11b Channel 1 (UNIFIVE)

Power Connected Emissions					Class B		
Conductor	Frequency (KHz)	Peak (dBμV)	QP (dBμV)	Average (dBμV)	QP-limit (dBμV)	AVG-limit (dBμV)	Margin (dB)
Line 1	205.045	55.54	48.39	32.54	64.17	54.17	-15.78
	329.000	43.57	---	---	60.89	50.89	-7.32
	622.000	36.32	---	---	56.00	46.00	-9.68
	954.000	37.04	---	---	56.00	46.00	-8.96
	3158.000	37.06	---	---	56.00	46.00	-8.94
	6000.000	40.87	---	---	60.00	50.00	-9.13
Line 2	209.545	57.50	48.80	38.20	64.17	54.17	-15.37
	314.000	43.13	---	---	61.31	51.31	-8.18
	537.000	40.64	---	---	56.00	46.00	-5.36
	980.000	36.53	---	---	56.00	46.00	-9.47
	3510.000	35.47	---	---	56.00	46.00	-10.53
	5830.000	39.62	---	---	60.00	50.00	-10.38

Test mode: IEEE 802.11b Channel 6 (UNIFIVE)

Power Connected Emissions					Class B		
Conductor	Frequency (KHz)	Peak (dBμV)	QP (dBμV)	Average (dBμV)	QP-limit (dBμV)	AVG-limit (dBμV)	Margin (dB)
Line 1	214.900	56.77	55.52	39.02	64.17	54.17	-8.65
	314.000	43.29	---	---	61.31	51.31	-8.02
	523.000	38.43	---	---	56.00	46.00	-7.57
	858.000	37.81	---	---	56.00	46.00	-8.19
	1678.000	37.92	---	---	56.00	46.00	-8.08
	3317.000	38.36	---	---	56.00	46.00	-7.64
Line 2	209.765	53.89	52.50	43.64	64.06	54.06	-10.42
	394.000	43.11	---	---	59.03	49.03	-5.92
	552.000	39.79	---	---	56.00	46.00	-6.21
	1102.000	36.56	---	---	56.00	46.00	-9.44
	3638.000	35.52	---	---	56.00	46.00	-10.48
	5800.000	38.98	---	---	60.00	50.00	-11.02

Test mode: IEEE 802.11b Channel 11 (UNIFIVE)

Power Connected Emissions					Class B		
Conductor	Frequency (KHz)	Peak (dBμV)	QP (dBμV)	Average (dBμV)	QP-limit (dBμV)	AVG-limit (dBμV)	Margin (dB)
Line 1	212.000	52.78	---	---	64.23	54.23	-1.45
	314.000	44.52	---	---	61.31	51.31	-6.79
	547.000	39.44	---	---	56.00	46.00	-6.56
	972.000	38.57	---	---	56.00	46.00	-7.43
	1696.000	38.55	---	---	56.00	46.00	-7.45
	3158.000	38.53	---	---	56.00	46.00	-7.47
Line 2	208.960	53.30	51.38	42.71	64.43	54.43	-11.72
	323.000	44.40	---	---	61.06	51.06	-6.66
	537.000	40.57	---	---	56.00	46.00	-5.43
	752.000	36.99	---	---	56.00	46.00	-9.01
	1198.000	38.02	---	---	56.00	46.00	-7.98
	1836.000	38.32	---	---	56.00	46.00	-7.68

Test mode: IEEE 802.11g Channel 1 (UNIFIVE)

Power Connected Emissions					Class B		
Conductor	Frequency (KHz)	Peak (dBμV)	QP (dBμV)	Average (dBμV)	QP-limit (dBμV)	AVG-limit (dBμV)	Margin (dB)
Line 1	208.000	52.55	---	---	64.34	54.34	-1.79
	518.000	39.74	---	---	56.00	46.00	-6.26
	945.000	39.26	---	---	56.00	46.00	-6.74
	1398.000	40.17	---	---	56.00	46.00	-5.83
	2094.000	37.76	---	---	56.00	46.00	-8.24
	3253.000	39.26	---	---	56.00	46.00	-6.74
Line 2	214.180	56.49	55.19	40.58	64.17	54.17	-8.98
	537.000	40.54	---	---	56.00	46.00	-5.46
	972.000	39.93	---	---	56.00	46.00	-6.07
	1398.000	40.38	---	---	56.00	46.00	-5.62
	1818.000	39.17	---	---	56.00	46.00	-6.83
	3445.000	37.85	---	---	56.00	46.00	-8.15

Test mode: IEEE 802.11g Channel 6 (UNIFIVE)

Power Connected Emissions					Class B		
Conductor	Frequency (KHz)	Peak (dBμV)	QP (dBμV)	Average (dBμV)	QP-limit (dBμV)	AVG-limit (dBμV)	Margin (dB)
Line 1	210.000	52.69	---	---	64.29	54.29	-1.60
	314.000	45.40	---	---	61.31	51.31	-5.91
	937.000	38.89	---	---	56.00	46.00	-7.11
	1359.000	39.58	---	---	56.00	46.00	-6.42
	1696.000	39.62	---	---	56.00	46.00	-6.38
	3004.000	38.70	---	---	56.00	46.00	-7.30
Line 2	211.840	56.49	55.22	40.49	64.17	54.17	-8.95
	326.000	43.25	---	---	60.97	50.97	-7.72
	421.000	40.94	---	---	58.26	48.26	-7.32
	533.000	39.65	---	---	56.00	46.00	-6.35
	963.000	39.79	---	---	56.00	46.00	-6.21
	1613.000	37.95	---	---	56.00	46.00	-8.05

Test mode: IEEE 802.11g Channel 11 (UNIFIVE)

Power Connected Emissions					FCC Class B		
Conductor	Frequency (KHz)	Peak (dBμV)	QP (dBμV)	Average (dBμV)	QP-limit (dBμV)	AVG-limit (dBμV)	Margin (dB)
Line 1	214.000	52.62	---	---	64.17	54.17	-1.55
	326.000	43.72	---	---	60.97	50.97	-7.25
	945.000	38.68	---	---	56.00	46.00	-7.32
	1359.000	39.55	---	---	56.00	46.00	-6.45
	1678.000	38.50	---	---	56.00	46.00	-7.50
	3253.000	38.34	---	---	56.00	46.00	-7.66
Line 2	212.115	56.28	55.34	40.85	64.29	54.29	-8.95
	331.000	43.11	---	---	60.83	50.83	-7.72
	430.000	42.19	---	---	58.00	48.00	-5.81
	528.000	40.22	---	---	56.00	46.00	-5.78
	1503.000	39.17	---	---	56.00	46.00	-6.83
	6050.000	41.47	---	---	60.00	50.00	-8.53

Test mode: IEEE 802.11b Channel 1 (DVE)

Power Connected Emissions					Class B		
Conductor	Frequency (KHz)	Peak (dBμV)	QP (dBμV)	Average (dBμV)	QP-limit (dBμV)	AVG-limit (dBμV)	Margin (dB)
Line 1	178.680	62.30	51.90	36.69	65.06	55.06	-13.16
	275.265	52.50	46.73	33.75	62.31	52.31	-15.58
	642.675	47.23	41.98	22.55	56.00	46.00	-14.02
	738.205	46.07	42.93	24.94	56.00	46.00	-13.07
	1289.155	46.37	41.97	19.20	56.00	46.00	-14.03
	1576.375	46.69	42.87	24.62	56.00	46.00	-13.13
Line 2	178.880	63.68	52.45	36.56	65.00	55.00	-12.55
	187.645	61.30	59.77	53.79	64.77	54.77	-0.98
	279.000	50.27	---	---	62.31	52.31	-2.04
	1155.000	44.42	---	---	56.00	46.00	-1.58
	1398.000	44.24	---	---	56.00	46.00	-1.76
	1976.505	46.27	43.28	22.44	56.00	46.00	-12.72

Test mode: IEEE 802.11b Channel 6 (DVE)

Power Connected Emissions					Class B		
Conductor	Frequency (KHz)	Peak (dBμV)	QP (dBμV)	Average (dBμV)	QP-limit (dBμV)	AVG-limit (dBμV)	Margin (dB)
Line 1	195.020	61.07	59.90	53.99	64.66	54.66	-0.67
	485.900	47.34	43.45	32.80	56.43	46.43	-12.98
	674.765	47.87	43.63	27.45	56.00	46.00	-12.37
	1075.094	46.90	43.73	28.60	56.00	46.00	-12.27
	1638.025	45.75	42.92	24.40	56.00	46.00	-13.08
	2046.770	44.84	41.88	22.66	56.00	46.00	-14.12
	3512.060	44.63	42.08	23.11	56.00	46.00	-13.92
Line 2	194.865	61.02	59.80	53.53	64.71	54.71	-1.18
	249.435	51.10	35.64	17.99	63.09	53.09	-27.45
	767.450	46.55	40.88	22.73	56.00	46.00	-15.12
	1203.400	46.19	43.95	28.67	56.00	46.00	-12.05
	1750.385	46.19	43.61	25.60	56.00	46.00	-12.39
	2715.000	42.80	---	---	56.00	46.00	-3.20

Test mode: IEEE 802.11b Channel 11 (DVE)

<i>Power Connected Emissions</i>					<i>Class B</i>		
<i>Conductor</i>	<i>Frequency (KHz)</i>	<i>Peak (dBμV)</i>	<i>QP (dBμV)</i>	<i>Average (dBμV)</i>	<i>QP-limit (dBμV)</i>	<i>AVG-limit (dBμV)</i>	<i>Margin (dB)</i>
Line 1	194.615	61.04	59.96	53.41	64.66	54.66	-1.25
	290.430	51.73	50.14	38.69	62.06	52.06	-11.92
	391.000	47.59	---	---	59.11	49.11	-1.52
	782.955	47.25	43.81	31.49	56.00	46.00	-12.19
	1070.000	44.72	---	---	56.00	46.00	-1.28
	3477.000	43.84	---	---	56.00	46.00	-2.16
Line 2	187.260	62.32	49.55	43.22	64.71	54.71	-11.49
	490.000	45.21	---	---	56.29	46.29	-1.08
	802.000	43.98	---	---	56.00	46.00	-2.02
	1204.310	46.27	44.28	29.36	56.00	46.00	-11.72
	1755.290	46.41	43.74	26.28	56.00	46.00	-12.26
	2351.000	44.21	---	---	56.00	46.00	-1.79

Test mode: IEEE 802.11g Channel 1 (DVE)

<i>Power Connected Emissions</i>					<i>Class B</i>		
<i>Conductor</i>	<i>Frequency (KHz)</i>	<i>Peak (dBμV)</i>	<i>QP (dBμV)</i>	<i>Average (dBμV)</i>	<i>QP-limit (dBμV)</i>	<i>AVG-limit (dBμV)</i>	<i>Margin (dB)</i>
Line 1	184.990	62.42	51.65	33.87	64.77	54.77	-13.12
	289.500	51.68	50.57	39.52	62.14	52.14	-11.57
	391.000	46.14	---	---	59.11	49.11	-2.97
	778.635	46.95	43.69	30.93	56.00	46.00	-12.31
	1059.000	44.45	---	---	56.00	46.00	-1.55
	1789.255	45.84	42.56	25.07	56.00	46.00	-13.44
Line 2	193.450	61.02	59.90	52.87	64.77	54.77	-1.90
	288.975	49.57	47.77	36.88	61.97	51.97	-14.20
	485.000	45.24	---	---	56.43	46.43	-1.19
	963.000	44.47	---	---	56.00	46.00	-1.53
	1629.000	44.66	---	---	56.00	46.00	-1.34
	3445.000	43.98	---	---	56.00	46.00	-2.02

Test mode: IEEE 802.11g Channel 6 (DVE)

Power Connected Emissions					Class B		
Conductor	Frequency (KHz)	Peak (dBμV)	QP (dBμV)	Average (dBμV)	QP-limit (dBμV)	AVG-limit (dBμV)	Margin (dB)
Line 1	182.405	63.27	46.10	25.73	64.83	54.83	-18.73
	387.000	45.98	---	---	59.23	49.23	-3.25
	774.000	44.89	---	---	56.00	46.00	-1.11
	1206.730	46.48	44.25	29.84	56.00	46.00	-11.75
	1731.000	44.68	---	---	56.00	46.00	-1.32
	3445.000	42.33	---	---	56.00	46.00	-3.67
Line 2	194.235	60.97	59.97	53.24	64.71	54.71	-1.47
	485.000	44.82	---	---	56.43	46.43	-1.61
	674.000	43.60	---	---	56.00	46.00	-2.40
	1198.315	46.07	43.85	27.96	56.00	46.00	-12.15
	2035.675	45.89	43.02	23.79	56.00	46.00	-12.98
	3741.000	42.40	---	---	56.00	46.00	-3.60

Test mode: IEEE 802.11g Channel 11 (DVE)

Power Connected Emissions					FCC Class B		
Conductor	Frequency (KHz)	Peak (dBμV)	QP (dBμV)	Average (dBμV)	QP-limit (dBμV)	AVG-limit (dBμV)	Margin (dB)
Line 1	191.760	61.07	59.14	49.85	64.71	54.71	-4.86
	285.240	51.70	44.12	28.78	61.97	51.97	-17.85
	492.515	48.65	43.42	34.94	56.43	46.43	-11.49
	1059.000	44.47	---	---	56.00	46.00	-1.53
	1770.005	45.98	41.80	23.53	56.00	46.00	-14.20
	3477.000	43.98	---	---	56.00	46.00	-2.02
Line 2	194.485	60.97	59.86	53.32	64.77	54.77	-1.45
	490.000	44.79	---	---	56.29	46.29	-1.50
	767.000	44.21	---	---	56.00	46.00	-1.79
	1201.835	46.21	43.89	29.06	56.00	46.00	-12.11
	2192.965	45.24	40.89	22.20	56.00	46.00	-15.11
	3510.000	44.47	---	---	56.00	46.00	-1.53

V. Section 15.247 (a): Technical description of the EUT

Direct Sequence System is a spread spectrum system in which the carrier has been modulated by a high speed spreading code and an information data stream. The high speed code sequence dominates the “modulating function” and is the direct cause of the wide spreading of the transmitted signal. In the operational description demonstrates the operation principles of the Baseband processor employed by the EUT, shows that which is a complete DSSS baseband processor and meets the definition of the direct sequence spread spectrum system.

VI. Section 15.247(a)(2): Bandwidth for Direct Sequence System.

6.1 Test Condition & Setup

The transmitter bandwidth measurements were performed by the contact manner. The EUT was set to transmit continuously, also various channels were investigated to find the maximum occupied bandwidth. The output of the EUT was connected to the spectrum analyzer. The bandwidth of the fundamental frequency is observed by the spectrum analyzer with 100kHz RBW and 100kHz VBW.

6.2 Test Instruments Configuration

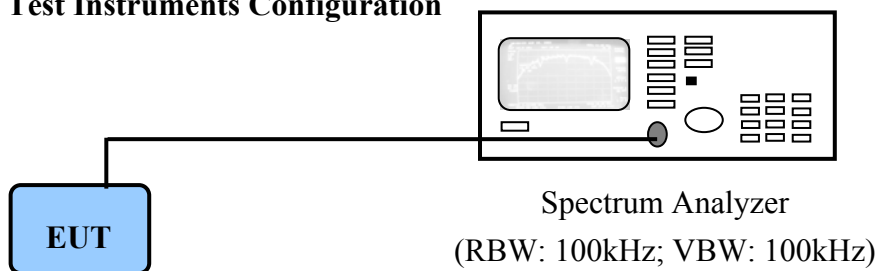

PC to control the EUT at maximal power output and channel number and set antenna kit

6.3 List of Test Instruments

Instrument Name	Model No.	Brand	Serial No.	Next time
Spectrum Analyzer	MS2665C	ANRITSU	6200175476	11/15/06

6.4 Test Result of Bandwidth

Channel	802.11b	802.11g
01	10.72 MHz	16.72 MHz
06	10.72 MHz	16.64 MHz
11	10.72 MHz	16.68 MHz

- Note:
- The data in the above table are summarizing the following attachment spectrum analyzer hard copy. According to the guidance, we'd made the measurement with the spectrum analyzer's resolution bandwidth (RBW)=100kHz and set the $span \gg RBW$. The results show the measured 6dB bandwidth comply with the minimum 500kHz requirement.
 - The attachments show these on the following pages.

6dB Bandwidth of Channel 1 (The minimum 6dB BW at least 500kHz)

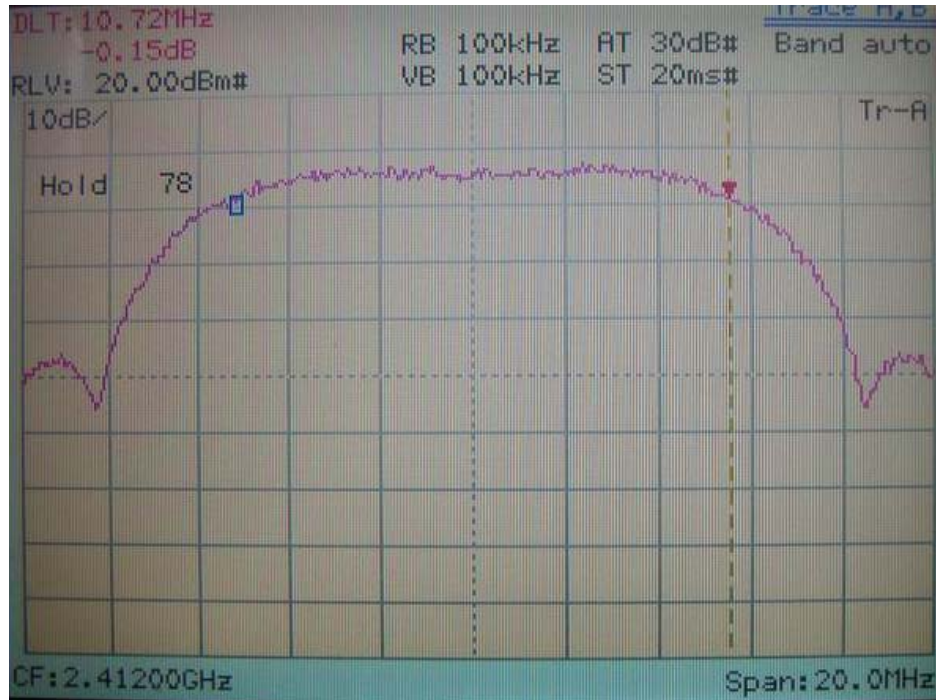

IEEE 802.11b

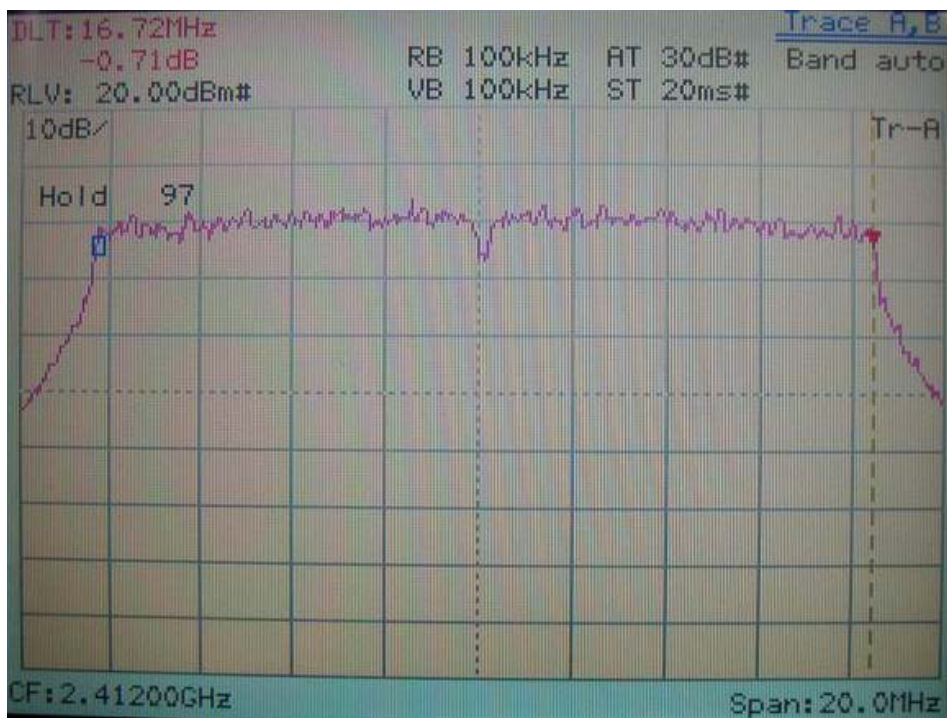

IEEE 802.11g

6dB Bandwidth of Channel 6 (The minimum 6dB BW at least 500kHz)

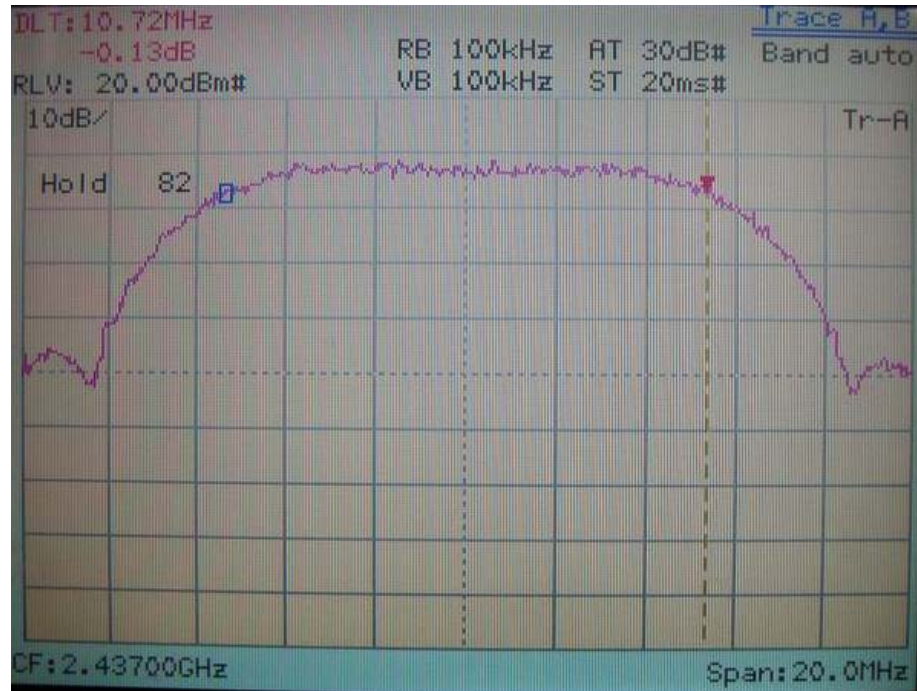

IEEE 802.11b

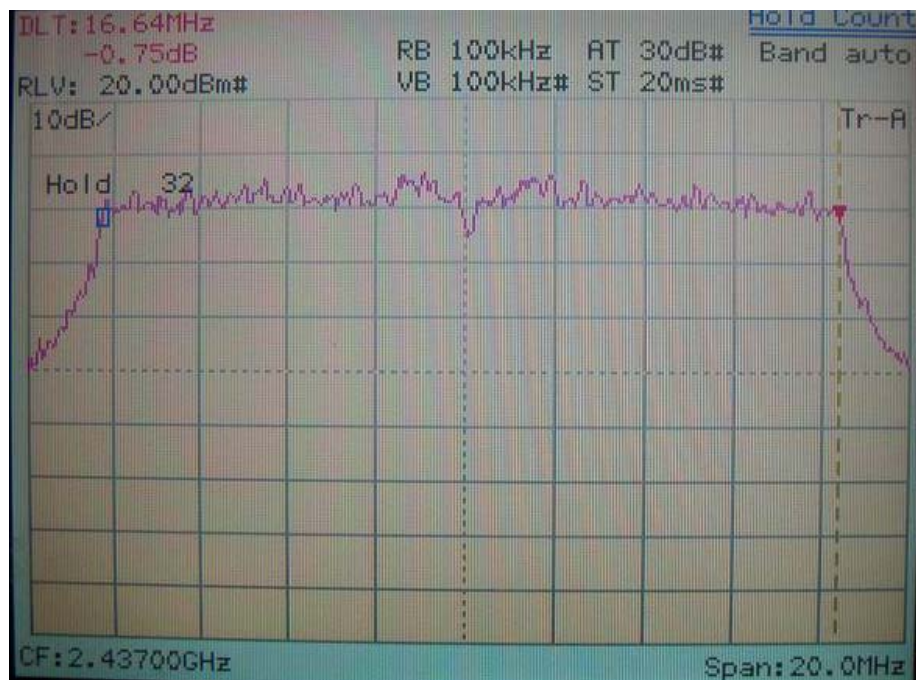

IEEE 802.11g

6dB Bandwidth of Channel 11 (The minimum 6dB BW at least 500kHz)

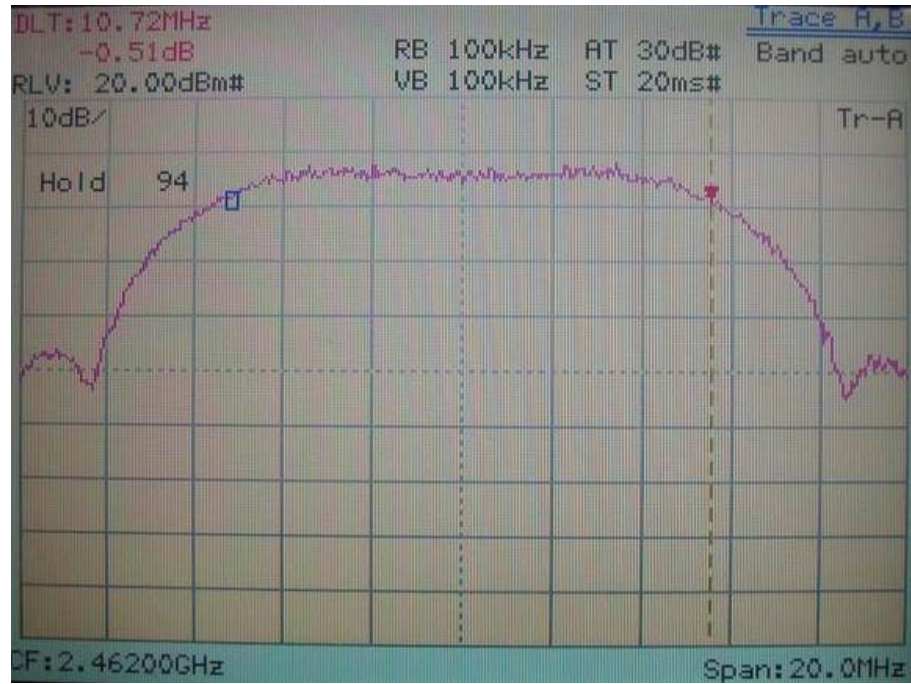

IEEE 802.11b

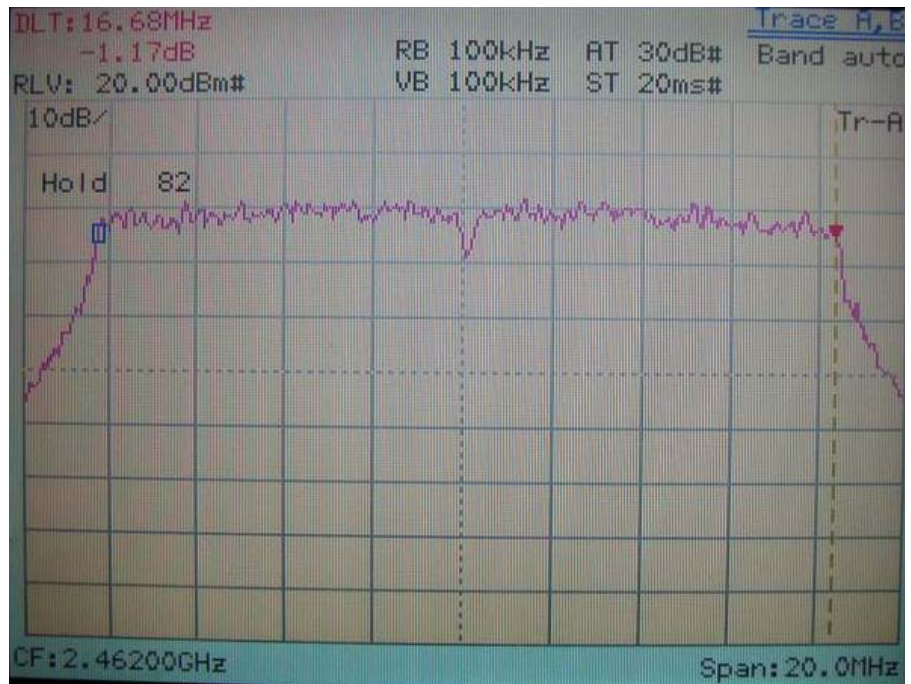

IEEE 802.11g

VII. Section 15.247(b): Power Output

7.1 Test Condition & Setup

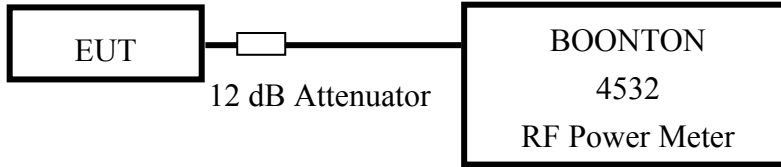

1. The output of the transmitter is connected to the BOONTON RF Power Meter.
2. The calibration is performed before every test. The values of the output power of the EUT will shown in the dBm directly are the transmitter output peak power. Recording as follows.

7.2 List of Test Instruments

Instrument Name	Model	Brand	Serial No.	Next time
RF Power Meter	4532	BOONTON	117501	05/18/07
Peak Power Sensor	57340	BOONTON	2696	05/18/07

7.3 Test Result

Formula:
 RF Output of EUT + |Cable Loss + 12dB Attenuator| = Output Peak Power

Channel	RF Output	Cable Loss + 12dB Attenuator	Output Peak Power	
	dBm		dBm	dBm
802.11b CH01	11.75	12.70	24.45	278.61
802.11b CH06	13.37	12.70	26.07	404.58
802.11b CH11	11.69	12.70	24.39	274.79
802.11g CH01	14.73	12.70	27.43	553.35
802.11g CH06	15.08	12.70	27.78	559.79
802.11g CH11	13.84	12.70	26.54	450.82

VIII. Section 15.247 (C): Spurious Emissions (Radiated)

8.1 Test Condition & Setup

We'd performed the test by the *radiated emission* skill: The EUT was placed in an anechoic chamber, and set the EUT transmitting continuously and scanned at 3-meter distance to determine its emission characteristics. The physical arrangement of the EUT was varied (within the scope of arrangements likely to be encountered in actual use) to determine the effect on the unit's emanations in amplitude, directivity, and frequency. The exact system configuration, which produced the highest emissions was noted so it could be reproduced later during the final tests. For the measurement above 1GHz, according to the guidance we'd set the spectrum analyzer's 6dB bandwidth RBW to 1MHz.

This was done to ensure that the final measurements would demonstrate the worst-case interference potential of the EUT.

Final radiation measurements were made on a three-meter, anechoic chamber. The EUT system was placed on a nonconductive turntable, which is 0.8 meters height, top surface 1.0 x 1.5 meter.

The spectrum was examined from 30MHz to 1000MHz using an Hewlett Packard 85460A EMI Receiver, SCHWARZECK whole range Small Biconical Antenna (Model No.: UBAA9114 & BBVU9135) is used to measure frequency from 30 MHz to 1GHz. The final test is used the HP 85460A spectrum and 8564E spectrum was examined from 1GHz to 25GHz using an Hewlett Packard Spectrum Analyzer, EMCO/HP Horn Antenna (Model 3115 / 84125-80008) for 1G - 25GHz.

At each frequency, the EUT was rotated 360 degrees, and the antenna was raised and lowered from one to four meters to find the maximum emission levels. Measurements were taken using both horizontal and vertical antenna polarization.

Appropriate preamplifiers were used for improving sensitivity and precautions were taken to avoid overloading or desensitizing the spectrum analyzer. There are two spectrum analyzers use on this testing, HP 85460A for frequency 30MHz to 1000MHz, and 8564E for frequency 1GHz to 25GHz. No post-detector video filters were used in the test. The spectrum analyzer's 6dB bandwidth was set to 120KHz (spectrum was examined from 30 MHz to 1000 MHz), the spectrum analyzer's 6 dB bandwidth was set to 1 MHz (spectrum was examined from 1GHz to 25GHz) and the analyzer was operated in the maximum hold mode. There is a test condition applies in this test item, the test procedure description as the following:

Three channels were tested, one in the top (CH01), one in the middle (CH06) and the other in bottom (CH11). The setting up procedure is recorded on <1.3>

With the transmitter operating from a AC source and using the internal of EUT, radiates spurious emissions falling within the restricted bands of 15.209 were measured at operating frequencies corresponding to upper, middle and bottom channels in the 2400 ~ 2483.5 MHz band.

The actual field intensity in decibels referenced to 1 microvolt per meter (dB μ V/m) is determined by algebraically adding the measured reading in dB μ V, the antenna factor (dB), and cable loss (dB) at the appropriate frequency. Since the EUT was set to transmit continuously, no *duty cycle* is present.

For frequency between 30MHz to 1000MHz

$$F_{Ia} \text{ (dB}\mu\text{V/m)} = F_{Ir} \text{ (dB}\mu\text{V)} + \text{Correction Factors}$$

F_{Ia} : Actual Field Intensity

F_{Ir} : Reading of the Field Intensity

Correction Factors = Antenna Factor + (Cable Loss – Amplifier Gain) + Switching Box Loss

For frequency between 1GHz to 25GHz

$$F_{Ia} \text{ (dB}\mu\text{V/m)} = F_{Ir} \text{ (dB}\mu\text{V)} + \text{Correction Factor}$$

F_{Ia} : Actual Field Intensity

F_{Ir} : Reading of the Field Intensity

Correction Factors = Antenna Factor + (Cable Loss – Amplifier Gain) + Switching Box Loss

8.2 List of Test Instruments

Instrument Name	Model	Brand	Serial No.	Calibration Date
				Next time
EMI Receiver	8546A	HP	3520A00242	12/01/06
RF Filter Section	85460A	HP	3448A00217	12/01/06
Small Biconical Antenna	UBAA9114 & BBVU9135	SCHWARZECK	127	11/17/06
Pre-amplifier	PA1F	TRC	1FAC	05/20/07
Auto Switch Box (>30MHz)	ASB-01	TRC	9904-01	05/20/07
Coaxial Cable (Double shielded, 15 meter)	A30A30-0058-50FS-15M	JYEBAO	SMA-01	05/20/07
Coaxial Cable (1.1 meter)	A30A30-0058-50FS-1M	JYEBAO	SMA-02	05/20/07
Spectrum Analyzer	8564E	HP	3720A00840	11/07/06
Microwave Preampfier	84125C	HP	US36433002	11/07/06
Horn Antenna	3115	EMCO	9104-3668	01/23/07
Standard Guide Horn Antenna	84125-80008	HP	18-26.5GHz	11/09/06
Standard Guide Horn Antenna	84125-80001	HP	26.5-40GHz	11/09/06
Horn Antenna	1196E (3115)	HP (EMCO)	9704-5178	01/26/07
Pre-amplifier	PA2F	TRC	2F1GZ	06/20/07
Coaxial Cable (3 miter)	A30A30-0058-50FST118	JYEBAO	MSA-05	06/20/07
Coaxial Cable (1 meter)	A30A30-0058-50FST118	JYEBAO	MSA-04	06/20/07

8.3 Test Result of Spurious Radiated Emissions

The highest peak values of radiated emissions from the EUT at various antenna heights, antenna polarizations, EUT orientation, etc. are recorded on the following.

Test Conditions: Temperature : 25 ° C Humidity : 73 % RH

Test mode: RX mode for 30MHz to 1GHz [Horizontal]

Radiated Emission				Correction Factors (dB)	Corrected Amplitude (dBµV/m)	Class B (3 m)	
Frequency (MHz)	Amplitude (dBµV)	Ant. H. (m)	Table ()			Limit (dBµV/m)	Margin (dB)
37.27	20.62	1.00	327	5.98	26.60	40.00	-13.40
353.74	39.16	1.00	244	-2.59	36.57	46.00	-9.43
403.45	38.77	1.00	264	-1.06	37.71	46.00	-8.29
625.34	32.49	1.00	171	7.18	39.67	46.00	-6.33
750.23	30.67	1.00	158	10.19	40.86	46.00	-5.14
876.33	24.73	1.00	137	13.96	38.69	46.00	-7.31

Test mode: RX mode for 30MHz to 1GHz [Vertical]

Radiated Emission				Correction Factors (dB)	Corrected Amplitude (dBµV/m)	Class B (3 m)	
Frequency (MHz)	Amplitude (dBµV)	Ant. H. (m)	Table ()			Limit (dBµV/m)	Margin (dB)
38.49	22.69	1.00	277	5.78	28.47	40.00	-11.53
403.45	37.34	1.00	284	-1.06	36.28	46.00	-9.72
625.34	27.77	1.00	185	7.18	34.95	46.00	-11.05
696.87	26.03	1.00	298	9.22	35.25	46.00	-10.75
750.23	25.67	1.00	264	10.19	35.86	46.00	-10.14
900.58	23.08	1.00	82	14.76	37.84	46.00	-8.16

Note:

1. Margin = Amplitude – limit, if margin is minus means under limit.
2. Corrected Amplitude = Reading Amplitude + Correction Factors
3. Correction factor = Antenna factor + (Cable Loss – Amplitude gain) + Switching Box Loss

Test mode: RX mode for 1GHz to 25GHz [Horizontal]

<i>Frequency</i>	<i>Ant. H.</i>	<i>Table</i>	<i>Amplitude</i>		<i>Correction Factor</i>	<i>Corrected Amplitude</i>		<i>Limit</i>		<i>Margin</i>
			<i>Peak / Ave.</i>			<i>Peak / Ave.</i>		<i>Peak / Ave.</i>		
<i>MHz</i>	<i>m</i>	<i>degree</i>	<i>dBμV</i>		<i>dB/m</i>	<i>dBμV/m</i>		<i>dBμV/m</i>		<i>dB</i>
7197.92	1.00	186	24.91	---	21.33	46.24	---	73.96	53.96	-7.72
10909.58	1.00	154	22.74	---	22.20	44.94	---	73.96	53.96	-9.02
19898.33	1.00	76	46.83	---	1.93	48.76	---	73.96	53.96	-5.20
21917.08	1.00	138	46.34	---	3.06	49.40	---	73.96	53.96	-4.56
24870.83	1.00	360	46.34	---	2.37	48.71	---	73.96	53.96	-5.25

Test mode: RX mode for 1GHz to 25GHz [Vertical]

<i>Frequency</i>	<i>Ant. H.</i>	<i>Table</i>	<i>Amplitude</i>		<i>Correction Factor</i>	<i>Corrected Amplitude</i>		<i>Limit</i>		<i>Margin</i>
			<i>Peak / Ave.</i>			<i>Peak / Ave.</i>		<i>Peak / Ave.</i>		
<i>MHz</i>	<i>m</i>	<i>degree</i>	<i>dBμV</i>		<i>dB/m</i>	<i>dBμV/m</i>		<i>dBμV/m</i>		<i>dB</i>
2629.00	1.00	333	30.24	---	14.36	44.60	---	73.96	53.96	-9.36
11702.92	1.00	269	23.08	---	21.34	44.42	---	73.96	53.96	-9.54
19700.00	1.00	190	47.82	---	1.82	49.64	---	73.96	53.96	-4.32
22193.33	1.00	153	45.49	---	3.31	48.80	---	73.96	53.96	-5.16
25274.58	1.00	316	48.99	---	2.21	51.20	---	73.96	53.96	-2.76

Note:

1. Margin = Corrected - Limit.
2. The EUT utilizes a *permanently attached antenna*. In addition the spurious RF radiated emissions levels do comply with the *20dBc limit* both at its bandedges and other spurious emissions.
3. As stated in Section 15.35(b), for any frequencies above 1000MHz, radiated limits shown are based upon the use of measurement instrumentation employing an average detector function. As the results of our test, the peak amplitudes are already below the FCC limit. Thus the average amplitudes of the rest are omitted.

Test mode: IEEE 802.11b CH01 for 30MHz to 1GHz [Horizontal]

Radiated Emission				Correction Factors	Corrected Amplitude	Class B (3 m)	
Frequency (MHz)	Amplitude (dBμV)	Ant. H. (m)	Table ()			Limit (dBμV/m)	Margin (dB)
302.81	45.20	1.00	126	-3.30	41.90	46.00	-4.10
351.31	46.26	1.00	142	-2.66	43.60	46.00	-2.40
402.24	41.80	1.00	102	-1.11	40.69	46.00	-5.31
586.54	32.17	1.00	308	5.81	37.98	46.00	-8.02
614.42	31.45	1.00	10	6.79	38.24	46.00	-7.76
900.58	27.27	1.00	159	14.76	42.03	46.00	-3.97

Test mode: IEEE 802.11b CH01 for 30MHz to 1GHz [Vertical]

Radiated Emission				Correction Factors	Corrected Amplitude	Class B (3 m)	
Frequency (MHz)	Amplitude (dBμV)	Ant. H. (m)	Table ()			Limit (dBμV/m)	Margin (dB)
44.55	30.16	1.00	139	4.67	34.83	40.00	-5.17
50.61	31.72	1.00	347	3.79	35.51	40.00	-4.49
76.07	33.99	1.00	40	0.97	34.96	40.00	-5.04
173.07	43.82	1.00	43	-3.81	40.01	43.50	-3.49
317.36	43.76	1.00	86	-3.12	40.64	46.00	-5.36
345.25	46.99	1.00	86	-2.76	44.23	46.00	-1.77

Test mode: IEEE 802.11b CH01 for 1GHz to 25GHz [Horizontal]

<i>Frequency</i>	<i>Ant. H.</i>	<i>Table</i>	<i>Amplitude</i>		<i>Correction Factor</i>	<i>Corrected Amplitude</i>		<i>Limit</i>		<i>Margin</i>
			<i>Peak / Ave.</i>			<i>Peak / Ave.</i>		<i>Peak / Ave.</i>		
<i>MHz</i>	<i>m</i>	<i>degree</i>	<i>dBμV</i>		<i>dB/m</i>	<i>dBμV/m</i>		<i>dBμV/m</i>		<i>dB</i>
2550.00	1.00	173	36.50	---	9.58	46.08	---	73.96	53.96	-7.88
4823.12	1.00	341	45.60	---	3.76	49.36	---	73.96	53.96	-4.60
7233.75	1.00	117	37.28	---	10.07	47.35	---	73.96	53.96	-6.61
19296.25	1.00	221	47.60	---	1.60	49.20	---	73.96	53.96	-4.76
21708.12	1.00	59	45.42	---	2.87	48.29	---	73.96	53.96	-5.67
24120.00	1.00	252	46.54	---	3.40	49.94	---	73.96	53.96	-4.02

Test mode: IEEE 802.11b CH01 for 1GHz to 25GHz [Vertical]

<i>Frequency</i>	<i>Ant. H.</i>	<i>Table</i>	<i>Amplitude</i>		<i>Correction Factor</i>	<i>Corrected Amplitude</i>		<i>Limit</i>		<i>Margin</i>
			<i>Peak / Ave.</i>			<i>Peak / Ave.</i>		<i>Peak / Ave.</i>		
<i>MHz</i>	<i>m</i>	<i>degree</i>	<i>dBμV</i>		<i>dB/m</i>	<i>dBμV/m</i>		<i>dBμV/m</i>		<i>dB</i>
1412.68	1.00	316	37.33	28.50	16.19	53.52	44.69	73.96	53.96	-9.27
1664.10	1.00	316	44.36	34.83	13.33	57.69	48.16	73.96	53.96	-5.80
2489.95	1.00	190	45.69	33.83	9.46	55.15	43.29	73.96	53.96	-10.67
4823.93	1.00	301	50.10	39.11	3.76	53.86	42.87	73.96	53.96	-11.09
7236.29	1.00	76	46.59	35.61	10.09	56.68	45.70	73.96	53.96	-8.26
24120.00	1.00	261	46.83	46.83	3.40	50.23	---	73.96	53.96	-3.73

Test mode: IEEE 802.11b CH06 for 30MHz to 1GHz [Horizontal]

<i>Radiated Emission</i>				<i>Correction Factors</i>	<i>Corrected Amplitude</i>	<i>Class B (3 m)</i>	
<i>Frequency (MHz)</i>	<i>Amplitude (dBμV)</i>	<i>Ant. H. (m)</i>	<i>Table ()</i>			<i>Limit (dBμV/m)</i>	<i>Margin (dB)</i>
253.10	41.72	1.00	257	-3.75	37.97	46.00	-8.03
302.81	46.87	1.00	127	-3.30	43.57	46.00	-2.43
351.31	45.04	1.00	340	-2.66	42.38	46.00	-3.62
542.89	31.72	1.00	350	4.26	35.98	46.00	-10.02
700.51	26.47	1.00	144	9.31	35.78	46.00	-10.22
887.24	28.84	1.00	161	14.33	43.17	46.00	-2.83

Test mode: IEEE 802.11b CH06 for 30MHz to 1GHz [Vertical]

<i>Radiated Emission</i>				<i>Correction Factors</i>	<i>Corrected Amplitude</i>	<i>Class B (3 m)</i>	
<i>Frequency (MHz)</i>	<i>Amplitude (dBμV)</i>	<i>Ant. H. (m)</i>	<i>Table ()</i>			<i>Limit (dBμV/m)</i>	<i>Margin (dB)</i>
44.55	29.40	1.00	99	4.67	34.07	40.00	-5.93
51.83	31.47	1.00	99	3.57	35.04	40.00	-4.96
74.86	33.34	1.00	337	1.04	34.38	40.00	-5.62
174.29	43.13	1.00	13	-3.81	39.32	43.50	-4.18
362.22	42.63	1.00	244	-2.33	40.30	46.00	-5.70
876.33	25.38	1.00	309	13.96	39.34	46.00	-6.66

Test mode: IEEE 802.11b CH06 for 1GHz to 25GHz [Horizontal]

<i>Frequency</i>	<i>Ant. H.</i>	<i>Table</i>	<i>Amplitude</i>		<i>Correction Factor</i>	<i>Corrected Amplitude</i>		<i>Limit</i>		<i>Margin</i>
			<i>Peak / Ave.</i>			<i>Peak / Ave.</i>		<i>Peak / Ave.</i>		
<i>MHz</i>	<i>m</i>	<i>degree</i>	<i>dBμV</i>		<i>dB/m</i>	<i>dBμV/m</i>		<i>dBμV/m</i>		<i>dB</i>
2533.33	1.00	118	37.67	---	9.55	47.22	---	73.96	53.96	-6.74
4873.91	1.00	327	49.26	37.44	3.96	53.22	41.40	73.96	53.96	-12.56
7313.50	1.00	152	44.61	35.27	10.30	54.91	45.57	73.96	53.96	-8.39
19494.58	1.00	146	47.02	---	1.69	48.71	---	73.96	53.96	-5.25
21934.79	1.00	57	46.20	---	3.09	49.29	---	73.96	53.96	-4.67
24371.46	1.00	158	46.58	---	3.26	49.84	---	73.96	53.96	-4.12

Test mode: IEEE 802.11b CH06 for 1GHz to 25GHz [Vertical]

<i>Frequency</i>	<i>Ant. H.</i>	<i>Table</i>	<i>Amplitude</i>		<i>Correction Factor</i>	<i>Corrected Amplitude</i>		<i>Limit</i>		<i>Margin</i>
			<i>Peak / Ave.</i>			<i>Peak / Ave.</i>		<i>Peak / Ave.</i>		
<i>MHz</i>	<i>m</i>	<i>degree</i>	<i>dBμV</i>		<i>dB/m</i>	<i>dBμV/m</i>		<i>dBμV/m</i>		<i>dB</i>
1455.86	1.00	250	41.51	32.50	16.04	57.55	48.54	73.96	53.96	-5.42
1700.46	1.00	250	49.04	39.50	12.76	61.80	52.26	73.96	53.96	-1.70
2314.58	1.00	161	40.83	---	8.97	49.80	---	73.96	53.96	-4.16
4873.90	1.00	315	54.09	43.77	3.96	58.05	47.73	73.96	53.96	-6.23
7307.07	1.00	83	52.60	42.94	10.29	62.89	53.23	73.96	53.96	-0.73
9747.08	1.00	213	40.60	---	11.89	52.49	---	73.96	53.96	-1.47

Test mode: IEEE 802.11b CH11 for 30MHz to 1GHz [Horizontal]

Radiated Emission				Correction Factors	Corrected Amplitude	Class B (3 m)	
Frequency (MHz)	Amplitude (dBμV)	Ant. H. (m)	Table ()			Limit (dBμV/m)	Margin (dB)
302.81	46.51	1.00	145	-3.30	43.21	46.00	-2.79
351.31	45.70	1.00	0	-2.66	43.04	46.00	-2.96
403.45	42.56	1.00	96	-1.06	41.50	46.00	-4.50
557.44	33.72	1.00	339	4.84	38.56	46.00	-7.44
696.87	26.82	1.00	165	9.22	36.04	46.00	-9.96
900.58	25.73	1.00	144	14.76	40.49	46.00	-5.51

Test mode: IEEE 802.11b CH11 for 30MHz to 1GHz [Vertical]

Radiated Emission				Correction Factors	Corrected Amplitude	Class B (3 m)	
Frequency (MHz)	Amplitude (dBμV)	Ant. H. (m)	Table ()			Limit (dBμV/m)	Margin (dB)
50.61	31.86	1.00	147	3.79	35.65	40.00	-4.35
70.01	35.55	1.00	69	1.31	36.86	40.00	-3.14
251.89	43.10	1.00	347	-3.66	39.44	46.00	-6.56
614.42	33.54	1.00	55	6.79	40.33	46.00	-5.67
872.69	25.95	1.00	121	13.84	39.79	46.00	-6.21
900.58	25.80	1.00	66	14.76	40.56	46.00	-5.44

Test mode: IEEE 802.11b CH11 for 1GHz to 25GHz [Horizontal]

Frequency	Ant. H.	Table	Amplitude		Correction Factor	Corrected Amplitude		Limit		Margin
			Peak / Ave.			Peak / Ave.		Peak / Ave.		
MHz	m	degree	dBμV		dB/m	dBμV/m		dBμV/m		dB
2537.50	1.00	360	38.33	---	9.56	47.89	---	73.96	53.96	-6.07
4925.83	1.00	284	44.77	---	4.13	48.90	---	73.96	53.96	-5.06
7384.79	1.00	255	39.11	---	10.42	49.53	---	73.96	53.96	-4.43
19696.46	1.00	34	47.45	---	1.81	49.26	---	73.96	53.96	-4.70
22157.92	1.00	36	44.76	---	3.25	48.01	---	73.96	53.96	-5.95
24619.37	1.00	284	46.89	---	3.01	49.90	---	73.96	53.96	-4.06

Test mode: IEEE 802.11b CH11 for 1GHz to 25GHz [Vertical]

Frequency	Ant. H.	Table	Amplitude		Correction Factor	Corrected Amplitude		Limit		Margin
			Peak / Ave.			Peak / Ave.		Peak / Ave.		
MHz	m	degree	dBμV		dB/m	dBμV/m		dBμV/m		dB
1739.31	1.00	107	44.16	35.50	12.16	56.32	47.66	73.96	53.96	-6.30
2331.25	1.00	122	42.50	---	9.02	51.52	---	73.96	53.96	-2.44
2541.67	1.00	343	42.50	---	9.57	52.07	---	73.96	53.96	-1.89
4923.90	1.00	82	48.78	38.61	4.12	52.90	42.73	73.96	53.96	-11.23
7386.42	1.00	135	48.10	38.44	10.42	58.52	48.86	73.96	53.96	-5.10
9847.82	1.00	273	40.44	32.61	11.93	52.37	44.54	73.96	53.96	-9.42

Test mode: IEEE 802.11g CH01 for 30MHz to 1GHz [Horizontal]

Radiated Emission				Correction Factors	Corrected Amplitude	Class B (3 m)	
Frequency (MHz)	Amplitude (dBμV)	Ant. H. (m)	Table ()			Limit (dBμV/m)	Margin (dB)
302.81	46.44	1.00	127	-3.30	43.14	46.00	-2.86
348.34	35.62	1.00	347	-2.72	32.90	46.00	-13.10
357.17	41.25	1.00	97	-2.48	38.77	46.00	-7.23
401.02	39.92	1.00	107	-1.16	38.76	46.00	-7.24
557.44	31.80	1.00	285	4.84	36.64	46.00	-9.36
900.58	28.06	1.00	171	14.76	42.82	46.00	-3.18

Test mode: IEEE 802.11g CH01 for 30MHz to 1GHz [Vertical]

Radiated Emission				Correction Factors	Corrected Amplitude	Class B (3 m)	
Frequency (MHz)	Amplitude (dBμV)	Ant. H. (m)	Table ()			Limit (dBμV/m)	Margin (dB)
44.55	29.71	1.00	196	4.67	34.38	40.00	-5.62
67.59	35.47	1.00	98	1.50	36.97	40.00	-3.03
145.19	40.94	1.00	33	-3.27	37.67	43.50	-5.83
253.10	42.55	1.00	347	-3.75	38.80	46.00	-7.20
403.45	38.97	1.00	115	-1.06	37.91	46.00	-8.09
900.58	25.27	1.00	69	14.76	40.03	46.00	-5.97

Test mode: IEEE 802.11g CH01 for 1GHz to 25GHz [Horizontal]

Frequency	Ant. H.	Table	Amplitude		Correction Factor	Corrected Amplitude		Limit		Margin
			Peak / Ave.			Peak / Ave.		Peak / Ave.		
MHz	m	degree	dBμV		dB/m	dBμV/m		dBμV/m		dB
2152.08	1.00	226	39.00	---	8.52	47.52	---	73.96	53.96	-6.44
9650.42	1.00	220	35.27	---	11.47	46.74	---	73.96	53.96	-7.22
12061.04	1.00	217	37.94	---	9.81	47.75	---	73.96	53.96	-6.21
19296.25	1.00	224	47.76	---	1.60	49.36	---	73.96	53.96	-4.60
21708.12	1.00	62	45.56	---	2.87	48.43	---	73.96	53.96	-5.53
24120.00	1.00	264	46.81	---	3.40	50.21	---	73.96	53.96	-3.75

Test mode: IEEE 802.11g CH01 for 1GHz to 25GHz [Vertical]

Frequency	Ant. H.	Table	Amplitude		Correction Factor	Corrected Amplitude		Limit		Margin
			Peak / Ave.			Peak / Ave.		Peak / Ave.		
MHz	m	degree	dBμV		dB/m	dBμV/m		dBμV/m		dB
1662.50	1.00	286	37.16	---	13.36	50.52		73.96	53.96	-3.44
2489.96	1.00	101	44.02	28.83	9.46	53.48	38.29	73.96	53.96	-15.67
4823.91	1.00	316	49.60	32.77	3.76	53.36	36.53	73.96	53.96	-17.43
7238.36	1.00	100	42.08	28.77	10.10	52.18	38.87	73.96	53.96	-15.09
19296.25	1.00	238	47.29	---	1.60	48.89	---	73.96	53.96	-5.07
21708.12	1.00	56	45.93	---	2.87	48.80	---	73.96	53.96	-5.16
24120.00	1.00	279	46.52	---	3.40	49.92	---	73.96	53.96	-4.04

Test mode: IEEE 802.11g CH06 for 30MHz to 1GHz [Horizontal]

Radiated Emission				Correction Factors	Corrected Amplitude	Class B (3 m)	
Frequency (MHz)	Amplitude (dBμV)	Ant. H. (m)	Table ()			Limit (dBμV/m)	Margin (dB)
302.81	47.42	1.00	142	-3.30	44.12	46.00	-1.88
318.57	47.67	1.00	320	-3.10	44.57	46.00	-1.43
350.01	38.05	1.00	122	-2.70	35.35	46.00	-10.65
403.45	40.49	1.00	92	-1.06	39.43	46.00	-6.57
643.52	28.97	1.00	301	7.84	36.81	46.00	-9.19
900.58	25.55	1.00	156	14.76	40.31	46.00	-5.69

Test mode: IEEE 802.11g CH06 for 30MHz to 1GHz [Vertical]

Radiated Emission				Correction Factors	Corrected Amplitude	Class B (3 m)	
Frequency (MHz)	Amplitude (dBμV)	Ant. H. (m)	Table ()			Limit (dBμV/m)	Margin (dB)
50.61	30.71	1.00	228	3.79	34.50	40.00	-5.50
67.59	35.17	1.00	99	1.50	36.67	40.00	-3.33
251.89	42.56	1.00	17	-3.66	38.90	46.00	-7.10
345.25	43.34	1.00	26	-2.76	40.58	46.00	-5.42
403.45	39.28	1.00	135	-1.06	38.22	46.00	-7.78
900.58	26.06	1.00	69	14.76	40.82	46.00	-5.18

Test mode: IEEE 802.11g CH06 for 1GHz to 25GHz [Horizontal]

Frequency	Ant. H.	Table	Amplitude		Correction Factor	Corrected Amplitude		Limit		Margin
			Peak / Ave.			Peak / Ave.		Peak / Ave.		
MHz	m	degree	dBμV		dB/m	dBμV/m		dBμV/m		dB
1572.92	1.00	358	35.00	---	14.75	49.75	---	73.96	53.96	-4.21
7312.29	1.00	153	40.27	---	10.30	50.57	---	73.96	53.96	-3.39
12187.92	1.00	261	38.60	---	9.74	48.34	---	73.96	53.96	-5.62
19494.58	1.00	134	47.35	---	1.69	49.04	---	73.96	53.96	-4.92
21934.79	1.00	46	46.37	---	3.09	49.46	---	73.96	53.96	-4.50
24371.46	1.00	166	46.54	---	3.26	49.80	---	73.96	53.96	-4.16

Test mode: IEEE 802.11g CH06 for 1GHz to 25GHz [Vertical]

Frequency	Ant. H.	Table	Amplitude		Correction Factor	Corrected Amplitude		Limit		Margin
			Peak / Ave.			Peak / Ave.		Peak / Ave.		
MHz	m	degree	dBμV		dB/m	dBμV/m		dBμV/m		dB
1454.86	1.00	342	40.48	26.33	16.05	56.53	42.38	73.96	53.96	-11.58
1698.33	1.00	119	51.14	31.17	12.80	63.94	43.97	73.96	53.96	-9.99
4873.94	1.00	184	55.26	33.77	3.96	59.22	37.73	73.96	53.96	-14.74
7313.74	1.00	105	51.77	30.77	10.30	62.07	41.07	73.96	53.96	-11.89
21934.79	1.00	61	46.55	---	3.09	49.64	---	73.96	53.96	-4.32
24371.46	1.00	163	46.50	---	3.26	49.76	---	73.96	53.96	-4.20

Test mode: IEEE 802.11g CH11 for 30MHz to 1GHz [Horizontal]

<i>Radiated Emission</i>				<i>Correction Factors</i>	<i>Corrected Amplitude</i>	<i>Class B (3 m)</i>	
<i>Frequency (MHz)</i>	<i>Amplitude (dBμV)</i>	<i>Ant. H. (m)</i>	<i>Table ()</i>			<i>Limit (dBμV/m)</i>	<i>Margin (dB)</i>
317.36	45.65	1.00	23	-3.12	42.53	46.00	-3.47
354.95	46.26	1.00	122	-2.55	43.71	46.00	-2.29
403.45	40.96	1.00	102	-1.06	39.90	46.00	-6.10
528.34	32.94	1.00	31	3.59	36.53	46.00	-9.47
628.98	31.23	1.00	343	7.31	38.54	46.00	-7.46
886.02	30.73	1.00	144	14.29	45.02	46.00	-0.98

Test mode: IEEE 802.11g CH11 for 30MHz to 1GHz [Vertical]

<i>Radiated Emission</i>				<i>Correction Factors</i>	<i>Corrected Amplitude</i>	<i>Class B (3 m)</i>	
<i>Frequency (MHz)</i>	<i>Amplitude (dBμV)</i>	<i>Ant. H. (m)</i>	<i>Table ()</i>			<i>Limit (dBμV/m)</i>	<i>Margin (dB)</i>
43.34	29.50	1.00	185	4.90	34.40	40.00	-5.60
67.59	35.33	1.00	46	1.50	36.83	40.00	-3.17
165.80	40.02	1.00	0	-3.68	36.34	43.50	-7.16
253.10	42.53	1.00	347	-3.75	38.78	46.00	-7.22
345.25	44.16	1.00	112	-2.76	41.40	46.00	-4.60
900.58	26.26	1.00	62	14.76	41.02	46.00	-4.98

Test mode: IEEE 802.11g CH11 for 1GHz to 25GHz [Horizontal]

Frequency	Ant. H.	Table	Amplitude		Correction Factor	Corrected Amplitude		Limit		Margin
			Peak / Ave.			Peak / Ave.		Peak / Ave.		
MHz	m	degree	dB μ V		dB/m	dB μ V/m		dB μ V/m		dB
2152.08	1.00	39	36.66	---	8.52	45.18	---	73.96	53.96	-8.78
7384.79	1.00	165	36.94	---	10.42	47.36	---	73.96	53.96	-6.60
9849.79	1.00	129	34.94	---	11.93	46.87	---	73.96	53.96	-7.09
19696.46	1.00	47	47.16	---	1.81	48.97	---	73.96	53.96	-4.99
22157.92	1.00	51	44.65	---	3.25	47.90	---	73.96	53.96	-6.06
24619.37	1.00	277	46.73	---	3.01	49.74	---	73.96	53.96	-4.22

Test mode: IEEE 802.11g CH11 for 1GHz to 25GHz [Vertical]

Frequency	Ant. H.	Table	Amplitude		Correction Factor	Corrected Amplitude		Limit		Margin
			Peak / Ave.			Peak / Ave.		Peak / Ave.		
MHz	m	degree	dB μ V		dB/m	dB μ V/m		dB μ V/m		dB
1737.50	1.00	252	40.16	---	12.19	52.35	---	73.96	53.96	-1.61
2312.50	1.00	175	43.00	---	8.96	51.96	---	73.96	53.96	-2.00
2564.58	1.00	162	40.50	---	9.61	50.11	---	73.96	53.96	-3.85
7385.48	1.00	86	45.60	30.11	10.42	56.02	40.53	73.96	53.96	-13.43
19696.46	1.00	29	47.45	---	1.81	49.26	---	73.96	53.96	-4.70
22157.92	1.00	47	44.94	---	3.25	48.19	---	73.96	53.96	-5.77
24619.37	1.00	286	46.56	---	3.01	49.57	---	73.96	53.96	-4.39

8.4 Test Result of the Bandedge

If any 100 kHz bandwidth outside these frequency bands, the radio frequency power that is produced by the modulation products of the spreading sequence, the information sequence and the carrier frequency shall be either *at least 20 dB below that in any 100 kHz bandwidth within the band that contains the highest level of the desired power or shall not exceed the general levels specified in §15.209(a)*,

We perform this section by the *radiated manner*, the RBW is set to 100kHz and VBW>RBW. We'd made the observation *up to 10th harmonics and the criterion is all the harmonic/spurious emissions must be 20dB below the highest emission level measured*. If the emissions fall in the restricted bands stated in the Part15.205(a) must also *comply with the radiated emission limits specified in Part15.209(a)*. (*Peak mode: RBW=VBW=1MHz, Average mode: RBW=1MHz; VBW=10Hz*)

The following pages show our observations referring to the channel 1 and 11 respectively.

Test Condition & Setup: same as < 8.1 >

Channel 1 of IEEE 802.11b

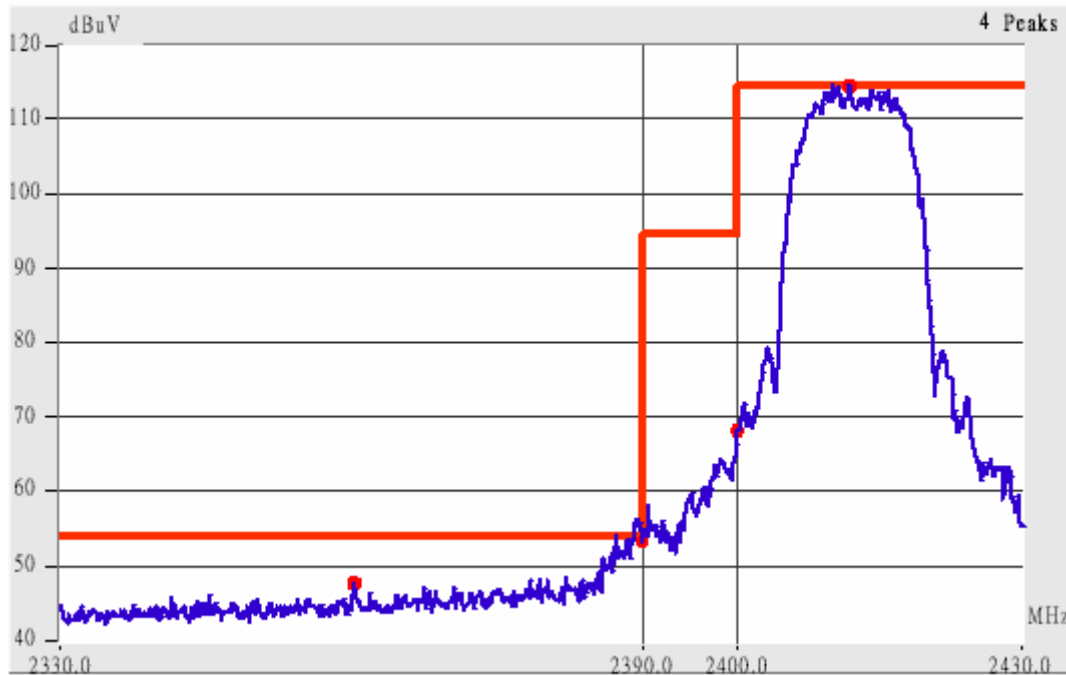

This is the hard copy of our bandedge measurement generated by our bandedge testing program. The plot shown above is the bandedge of channel 1.

1. The lobe left by the fundamental side is already 20dB below the highest emission level.
2. The emissions recorded in the restricted band is do comply with the Part 15.209(a) – as below.

<i>Radiated Emission</i>					<i>Corrected Amplitude</i>		<i>Class B (3m)</i>		
<i>Frequency (MHz)</i>	<i>Ant. P.</i>	<i>Ant. H. (m)</i>	<i>Table ()</i>	<i>Factors (dB)</i>	<i>(dBuV/m)</i>		<i>Limit (dBuV/m)</i>		<i>Margin (dB)</i>
					<i>Peak</i>	<i>Average</i>	<i>Peak</i>	<i>Ave.</i>	
2386.98	Hor	1.00	178	9.17	55.51	40.34	73.96	53.96	-13.62
2390.50	Hor	1.00	178	9.18	55.68	44.35	73.96	53.96	-9.61
2386.00	Ver	1.00	177	9.17	62.67	48.34	73.96	53.96	-5.62
2390.41	Ver	1.00	177	9.18	65.02	52.85	73.96	53.96	-1.11

Channel 11 of IEEE 802.11b

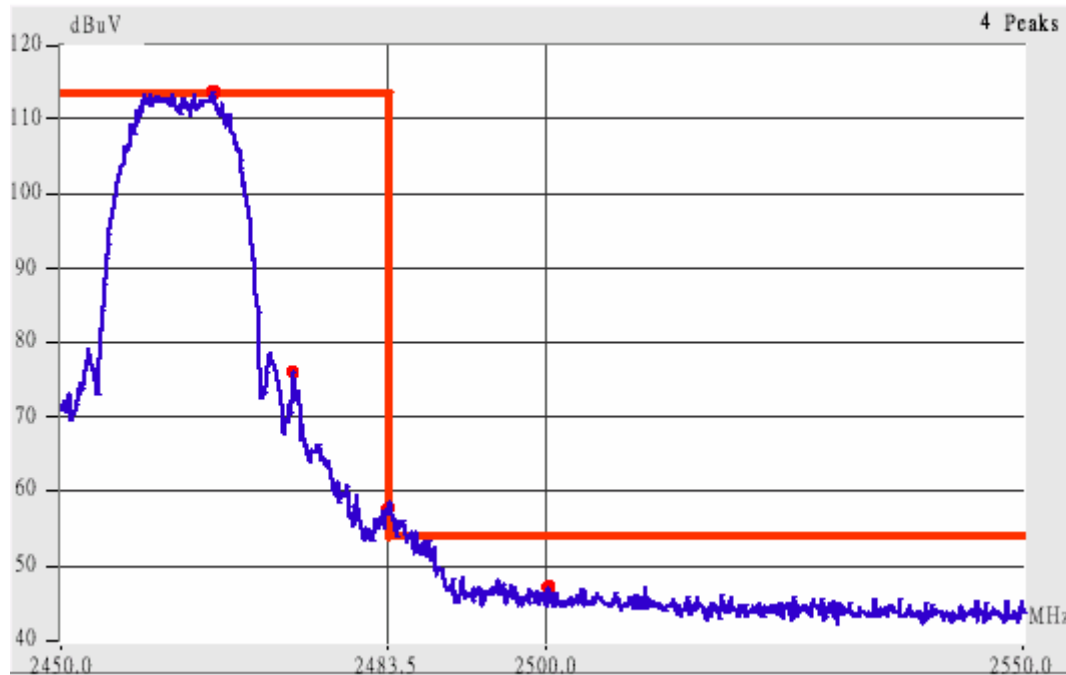

This is the hard copy of our bandedge measurement generated by our bandedge testing program. The plot shown above is the bandedge of channel 11.

- 3. The lobe right by the fundamental side is already 20dB below the highest emission level.
- 4. The emissions recorded in the restricted band is do comply with the Part 15.209(a) – as below

<i>Radiated Emission</i>					<i>Corrected Amplitude</i>		<i>Class B (3m)</i>		
<i>Frequency (MHz)</i>	<i>Ant. P.</i>	<i>Ant. H. (m)</i>	<i>Table (°)</i>	<i>Factors (dB)</i>	<i>(dBµV/m)</i>		<i>Limit (dBµV/m)</i>		<i>Margin (dB)</i>
					<i>Peak</i>	<i>Average</i>	<i>Peak</i>	<i>Ave.</i>	
2483.26	Hor	1.00	252	9.44	54.61	45.11	73.96	53.96	-8.85
2487.99	Hor	1.00	273	9.66	51.46	---	73.96	53.96	-2.50
2500.01	Hor	1.00	254	9.49	47.66	---	73.96	53.96	-6.30
2505.96	Hor	1.00	273	9.50	48.67	---	73.96	53.96	-5.29
2483.39	Ver	1.00	289	9.44	62.78	52.77	73.96	53.96	-1.19
2486.74	Ver	1.00	295	9.45	62.29	48.28	73.96	53.96	-5.68
2499.97	Ver	1.00	103	9.49	54.16	43.32	73.96	53.96	-10.64
2512.91	Ver	1.00	290	9.51	54.68	42.01	73.96	53.96	-11.95

Channel 1 of IEEE 802.11g

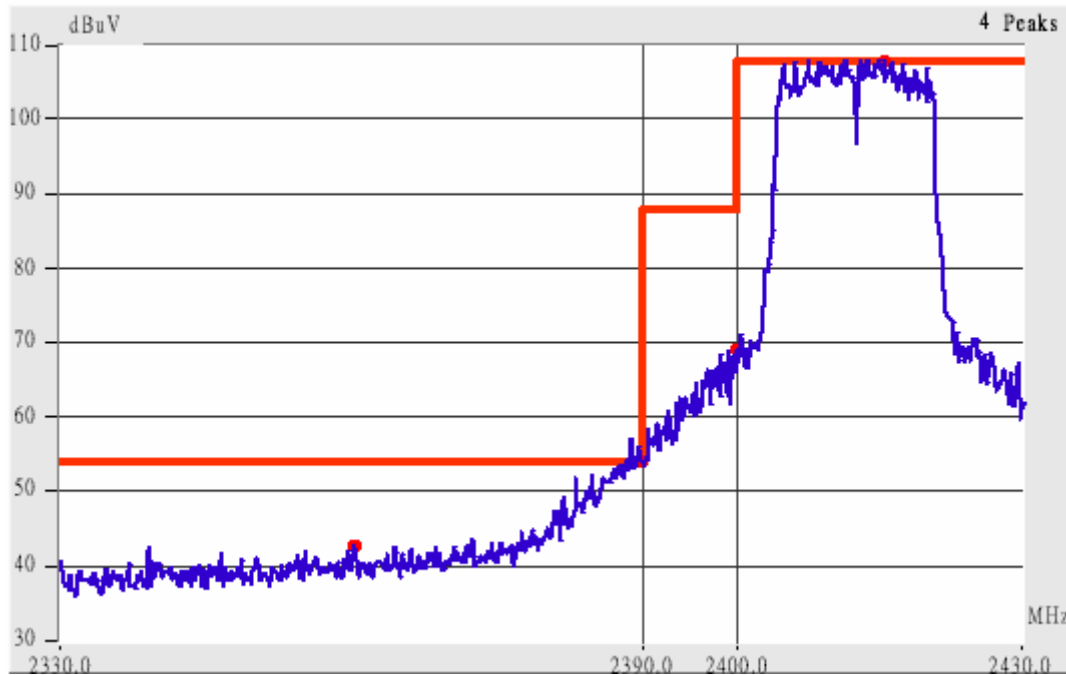

This is the hard copy of our bandedge measurement generated by our bandedge testing program. The plot shown above is the bandedge of channel 1.

- 5. The lobe left by the fundamental side is already 20dB below the highest emission level.
- 6. The emissions recorded in the restricted band is do comply with the Part 15.209(a) – as below.

<i>Radiated Emission</i>					<i>Corrected Amplitude</i>		<i>Class B (3m)</i>		
<i>Frequency (MHz)</i>	<i>Ant. P.</i>	<i>Ant. H. (m)</i>	<i>Table (°)</i>	<i>Factors (dB)</i>	<i>(dBµV/m)</i>		<i>Limit (dBµV/m)</i>		<i>Margin (dB)</i>
					<i>Peak</i>	<i>Average</i>	<i>Peak</i>	<i>Ave.</i>	
2386.67	Hor	1.00	271	9.17	55.84	35.67	73.96	53.96	-18.12
2389.83	Hor	1.00	223	9.18	57.35	37.85	73.96	53.96	-16.11
2385.46	Ver	1.00	151	9.17	62.00	41.00	73.96	53.96	-11.96
2390.34	Ver	1.00	100	9.18	66.18	44.18	73.96	53.96	-7.78

Channel 11 of IEEE 802.11g



This is the hard copy of our bandedge measurement generated by our bandedge testing program. The plot shown above is the bandedge of channel 11.

- 7. The lobe right by the fundamental side is already 20dB below the highest emission level.
- 8. The emissions recorded in the restricted band is do comply with the Part 15.209(a) – as below

Radiated Emission					Corrected Amplitude		Class B (3m)		
Frequency (MHz)	Ant. P.	Ant. H. (m)	Table (°)	Factors (dB)	(dBµV/m)		Limit (dBµV/m)		Margin (dB)
					Peak	Average	Peak	Ave.	
2483.21	Hor	1.00	299	9.44	63.11	39.61	73.96	53.96	-10.85
2487.22	Hor	1.00	277	9.45	57.62	37.12	73.96	53.96	-16.34
2500.01	Hor	1.00	93	9.49	45.99	---	73.96	53.96	-7.97
2513.07	Hor	1.00	262	9.51	47.51	---	73.96	53.96	-6.45
2483.86	Ver	1.00	350	9.44	66.28	43.77	73.96	53.96	-7.68
2491.65	Ver	1.00	81	9.47	59.47	39.80	73.96	53.96	-14.16
2499.95	Ver	1.00	117	9.49	52.32	38.99	73.96	53.96	-14.97
2518.44	Ver	1.00	23	9.52	50.52	---	73.96	53.96	-3.44

IX. Section 15.247(d): Power Spectral Density

9.1 Test Condition & Setup

The tests below are running with the EUT transmitter set at high power in TDD mode. The EUT is needed to force selection of output power level and channel number. While testing, the EUT was set to transmit continuously and to be tested by the contact manner with the spectrum analyzer.

9.2 Test Instruments Configuration

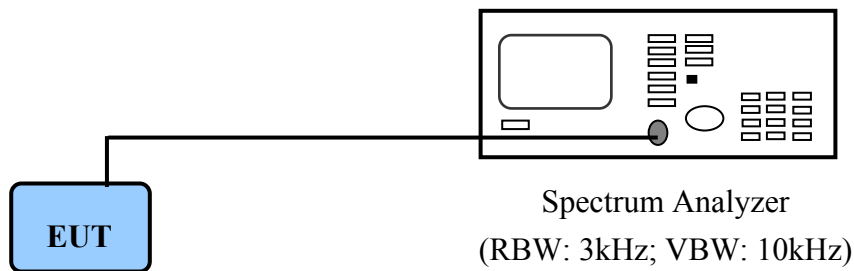

P.S.: PC to control the EUT at maximal power output and channel Number and set antenna kit

9.3 List of Test Instruments

Instrument Name	Model No.	Brand	Serial No.	Next time
Spectrum Analyzer	MS2665C	ANRITSU	6200175476	11/15/06

9.4 Test Result of Power spectral density

The following table shows a summary of the test results of the Power Spectral Density.

IEEE 802.11b

<i>Channel</i>	<i>Ppr (dBm)</i>	<i>Cable Loss (dB)</i>	<i>Ppq (dBm)</i>	<i>Limit (dB)</i>	<i>Margin (dB)</i>
CH 01	-5.53	0.70	-4.83	8.00	-12.83
CH 06	-4.21	0.70	-3.51	8.00	-11.51
CH 11	-5.61	0.70	-4.91	8.00	-12.91

IEEE 802.11g

<i>Channel</i>	<i>Ppr (dBm)</i>	<i>Cable Loss (dB)</i>	<i>Ppq (dBm)</i>	<i>Limit (dB)</i>	<i>Margin (dB)</i>
CH 01	-9.35	0.70	-8.65	8.00	-16.65
CH 06	-6.10	0.70	-5.40	8.00	-13.40
CH 11	-10.07	0.70	-9.37	8.00	-17.37

Note:

1. The following pages show the results of spectrum reading.
2. Ppr: spectrum read power density (using peak search mode),
Ppq: actual peak power density in the spread spectrum band.
3. $Ppq = Ppr + |Cable Loss|$

Power Spectral Density for Channel 01

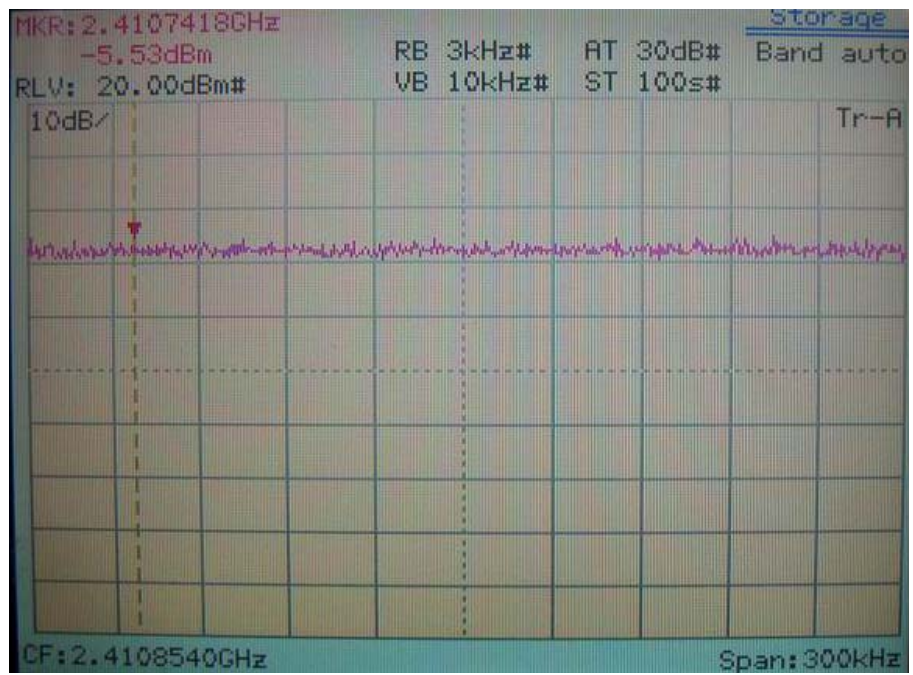

IEEE 802.11b

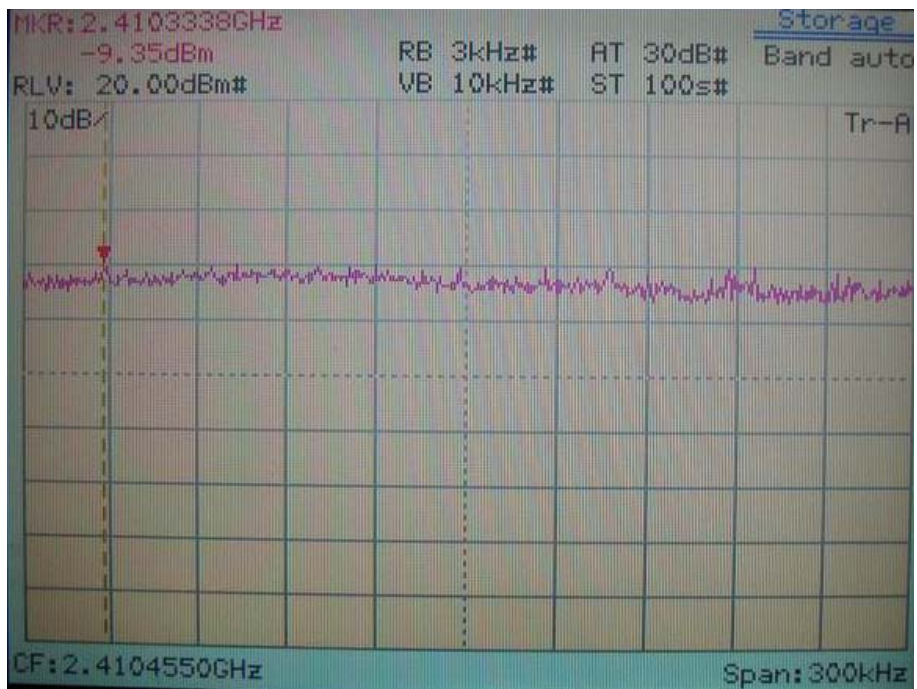

IEEE 802.11g

Power Spectral Density for Channel 06

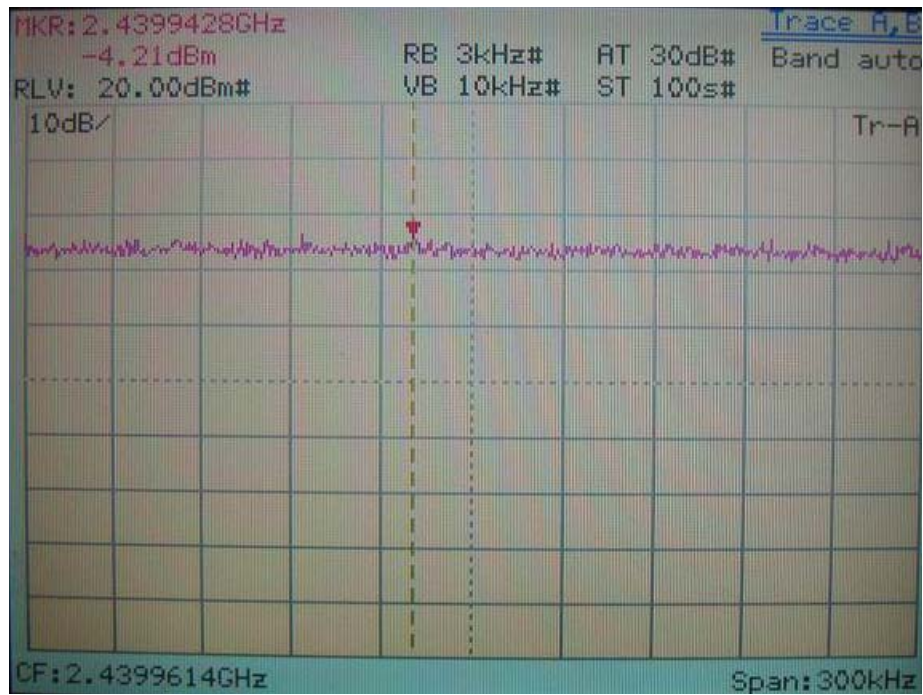

IEEE 802.11b

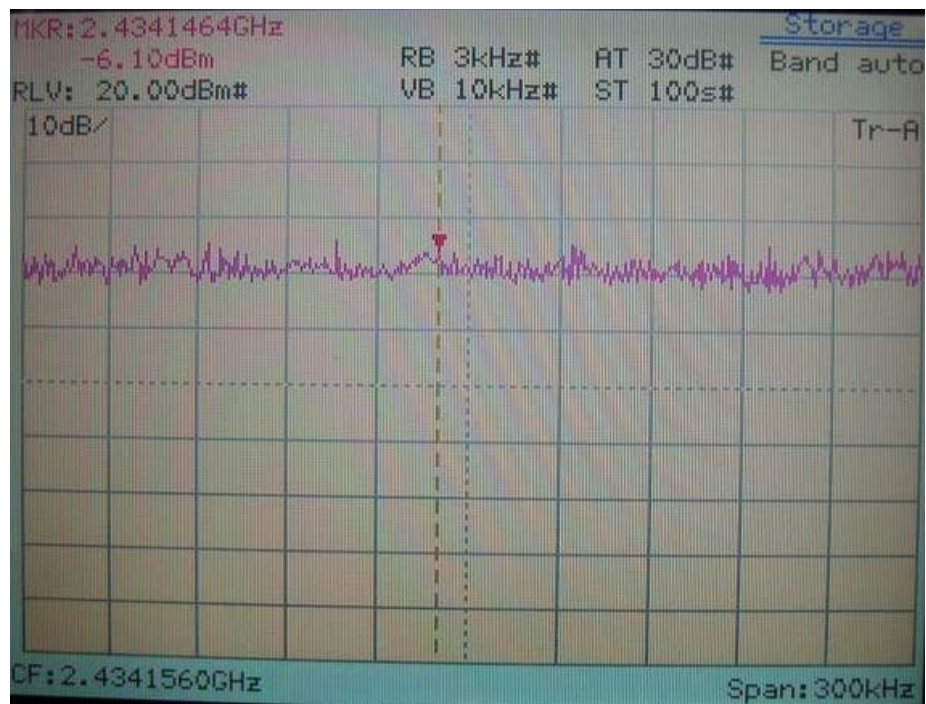

IEEE 802.11g

Power Spectral Density for Channel 11

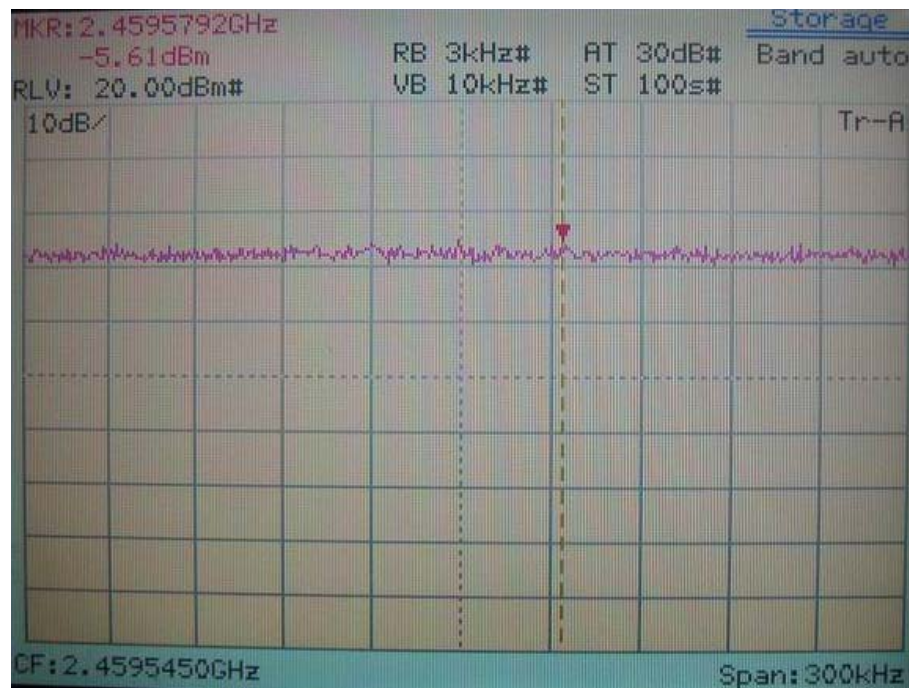

IEEE 802.11b

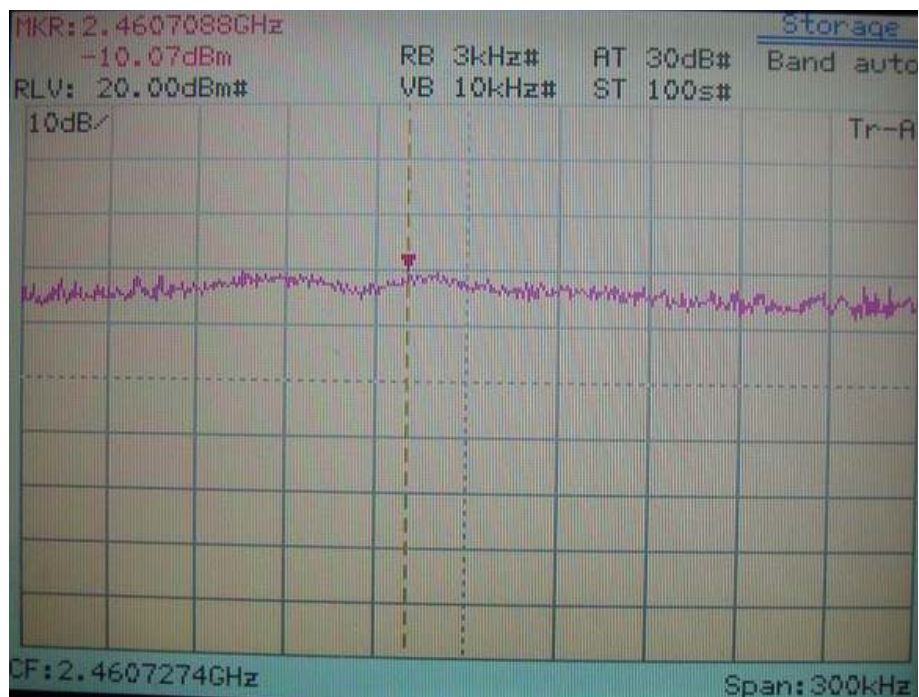

IEEE 802.11g