

**MEASUREMENT REPORT**  
**of**  
***Wireless Local Area Network***  
***Adapter***

**Applicant** : ASUSTek Computer Inc.  
**EUT** : Wireless Local Area Network Adapter  
**Model No.** : WL-160W  
**FCC ID** : MSQWL160W

Tested by :

***Training Research Co., Ltd.***

**TEL : 886-2-26935155      FAX : 886-2-26934440**

No. 255, Nanyang Street, Shijr, Taipei Hsien 221, Taiwan, R.O.C.

# CERTIFICATION

**We here by verify that:**

The test data, data evaluation, test procedures and equipment configurations shown in this report were made mainly in accordance with the procedures given in ANSI C63.4 (2003) as a reference. All test were conducted by *Training Research Co., Ltd.*, 255 Nanyang Street, Shijr, Taipei Hsien 221, Taiwan, R.O.C. Also, we attest to the accuracy of each.

We further submit that the energy emitted by the sample EUT tested as described in the report is **in compliance with** the technical requirements set forth in the FCC Rules Part 15 Subpart B (Declaration of Conformity) and C Section 15.247.

**Applicant** : ASUSTek Computer Inc.  
**Applicant Address** : 4F, No. 150, Li-Te Rd., Peitou, Taipei, Taiwan, R.O.C.  
**Product Name** : Wireless Local Area Network Adapter  
**Model** : WL-160W  
**Report No.** : A5415060762  
**Test Date** : November 20, 2006 ~ November 27, 2006

Prepared by:

  
Jack Tsai

Approved by:

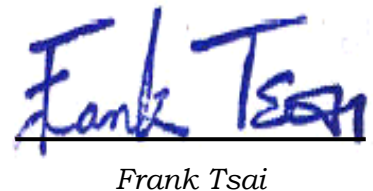
  
Frank Tsai

**Conditions of issue :**

- (1) **This test report shall not be reproduced except in full, without written approval of TRC. And the test result contained within this report only relate to the sample submitted for testing.**
- (2) **This report must not be used by the client to claim product endorsement by NVLAP or any agency of U.S. Government.**
- (3) **This test report, measurements made by TRC are traceable to the NIST only Conducted and Radiated Method.**



## *Federal Communications Commission*

### **Declaration of Conformity**

*for the following equipment:*

Product name : Wireless Local Area Network Adapter  
 Trade name : ASUS  
 Model name : WL-160W

Is herewith confirmed and found to comply with the requirements of CFR 47 part15 Subpart B - Unintentional Radiators regulation. The results of electromagnetic mission evaluation are shown in the report number : A5415060762

This device complies with Part 15 of the FCC Rules. Operation is subject to the following two conditions:

- (1) This device may not cause harmful interference, and
- (2) This device must accept any interference received, including interference that may cause undesired operation

<b>Manufacturer</b>	<b>USA local representative</b>
<b>Company name:</b> ASUSTeK Computer Inc.	To be determined
<b>Computer address:</b> 4/F, 150, Li-Te Rd., Peitou, Taipei, Taiwan	
<b>ZIP / Postal code</b> 112	
<b>Contact person:</b> Lawrence Yu	
<b>Title:</b> Manager	
<b>Internet e-mail address:</b> lawrence_yu@asus.com.tw	
<b>Tel / Fax:</b> 886-2-28943447 / 886-2-28950113	

## *Tables of Contents*

<b>I.</b>	<b>GENERAL</b> .....	6
	1.1 Introduction .....	6
	1.2 Description of EUT .....	6
	1.3 Test method .....	6
	1.4 Description of Support Equipment .....	7
	1.5 Configuration of System Under Test .....	9
	1.6 Verify the Frequency and Channel .....	11
	1.7 Test Procedure .....	12
	1.8 Location of the Test Site .....	12
	1.9 General Test Condition .....	12
<b>II.</b>	<b>Section 15.101(a) : Equipment Authorization of Unintentional Radiators</b> .....	13
<b>III.</b>	<b>Section 15.203 : Antenna Requirement</b> .....	14
<b>IV.</b>	<b>Section 15.207 : Power Line Conducted Emissions for AC Powered Units</b> .....	15
	4.1 Test Condition & Setup .....	15
	4.2 List of Test Instruments .....	16
	4.3 Test Result of Conducted Emissions .....	17
	Standby mode .....	17
	IEEE 802.11b mode .....	18
	IEEE 802.11g mode .....	19
	IEEE 802.11n 20M mode .....	21
	IEEE 802.11n 40M mode .....	22
<b>V.</b>	<b>Section 15.247(a) : Technical Description of the EUT</b> .....	24
<b>VI.</b>	<b>Section 15.247(a)(2) : Bandwidth for Direct Sequence System</b> .....	25
	6.1 Test Condition & Setup .....	25
	6.2 Test Instruments Configuration .....	25
	6.3 List of Test Instruments .....	25
	6.4 Test Result of Bandwidth .....	26

<b>VII. Section 15.247(b) : Power Output</b>	36
7.1 Test Condition & Setup	36
7.2 List of Test Instruments	36
7.3 Test Result	36
<b>VIII. Section 15.247(c) : Spurious Emissions (Radiated)</b>	38
8.1 Test Condition & Setup	38
8.2 List of Test Instruments	40
8.3 Test Result of Spurious Radiated Emissions	41
Standby mode	41
IEEE 802.11b mode	43
IEEE 802.11g mode	49
IEEE 802.11n 20M mode	55
IEEE 802.11n 40M mode	61
8.4 Test Result of Bandedge	67
IEEE 802.11b mode	68
IEEE 802.11g mode	70
IEEE 802.11n 20M mode	72
IEEE 802.11n 40M mode	74
<b>IX. Section 15.247(d) : Power Spectral Density</b>	76
9.1 Test Condition & Setup	76
9.2 Test Instruments Configuration	76
9.3 List of Test Instruments	76
9.4 Test Result of Power Spectral Density	77

## **I . GENERAL**

### **1.1 Introduction**

The following measurement report is submitted on behalf of applicant in support that the certification in accordance with Part 2 Subpart J and Part 15 Subpart A, B and C of the Commission's Rules and Regulations.

### **1.2 Description of EUT**

<b>FCC ID</b>	:	MSQWL160W
<b>Product Name</b>	:	Wireless Local Area Network Adapter
<b>Model Name</b>	:	WL-160W
<b>Frequency Range</b>	:	IEEE 802.11b/g/n Draft 1.0 20M: 2.412GHz ~ 2.462GHz IEEE 802.11n Draft 1.0 40M: 2.422GHz ~ 2.452GHz
<b>Channel Spacing</b>	:	5MHz
<b>Support Channel</b>	:	IEEE 802.11b/g/n Draft 1.0 20M: 11 Channels IEEE 802.11n Draft 1.0 40M: 7 Channels
<b>Modulation Skill</b>	:	DBPSK, DQPSK, CCK, OFDM
<b>Power Type</b>	:	Powered by Client's USB

### **1.3 Test method**

- 1.3.1 The Wireless Adapter connected with notebook computer :
  - (a) Insert the Wireless Adapter into the USB port of notebook computer.
- 1.3.2 Using the PC and software provided by the manufacturer to control EUT, the test is performed under the specific conditions.
- 1.3.3 Set different data rate and channel (IEEE 802.11b/g/n Draft 1.0 20M: CH01/CH06/CH11, IEEE 802.11n Draft 1.0 40M: CH03/CH06/CH09) being tested and repeat the procedures above.
  - (a) Radiated for Intentional test:
    - making EUT to the mode of continuous transmission
  - (b) Conducted test and Radiated for unintentional test:
    - making EUT to the linking (RX/TX) mode with far support equipments

#### **1.4 Description of Support Equipment**

In order to construct the minimum testing, following equipment were used as the support units.

**PC: IBM Think Pad T43**

Model No.:2668-IVE

Serial No. :L3TGYY

FCC ID:Doc Approved

BSMI:R33B65

DGT:ETC093LPD0126, CTL093LPD0257

**Power Adaptor:IBM**

Part No.:92P1018

Serial No. :11S92P1018Z1ZAPU57M9W6 REV:D

FCC ID:Doc Approved

BSMI:D33030

Power type:100 ~ 240VAC / 50 ~ 60Hz, 1.0 ~ 0.4A, Switching

Power cord (Main power to adaptor) :Non-shielded, 1.0m length, Plastic hood, No ferrite core

Power cord (DC plug to adaptor) :Shielded, 1.84m length, Plastic hood, ferrite core

**Printer :HP**

Model No.:C6464A, C2642A

Serial No.:TH16LEB5PK, SG69A196GV

FCC ID :None (DoC Approved), B94C2642X

BSMI :3892H381, None

Power type:Switching adaptor

Power cord:Non-shielded, 173cm length, No ferrite core

(between adaptor and AC source)

Non-shielded, 180cm length, with ferrite core

(between printer and adaptor)

Data cable :Shielded, 1.70m length, No ferrite core

**USB Gamepad : Rockfire**

Model No. : QF-337uv  
Serial No. : 10600545, KR91379759  
FCC ID : None (CE approval)  
BSMI : 3862A574  
Power type : By computer  
Data Cable : Shielded, 1.81m length, Plastic, with ferrite core

**Notebook : TWINHEAD**

Model No. : N222S8  
Serial No. : SY3261000988  
FCC ID : N/A, DoC Approved  
BSMI : 71001018

**Adaptor : LISHIN INTERNATIONAL ENTERPRISE CORP.**

Model No. : LSE9802A2060  
Serial No. : A20231065818  
BSMI : 3882B381  
Power type : I/P: 100 ~ 240Vac, 50/ 60 Hz, 1.5A ; O/P: 20Vdc, 3A 60W Max.  
Power cord : Non-shielded, 180cm length, No ferrite core  
(between adaptor and AC source)  
Non-shielded, 150cm length, with ferrite core  
(between NB and adaptor)

**AP : ASUS**

Model No. : WL-550gE  
Serial No. : N/A  
FCC ID : MSQWL550GE  
Power type : Switching, 202cm length, non-shielded, without ferrite core  
Data Cable : Non-shielded, 1.0m length, Plastic, without ferrite core



1.5 Configuration of System Under Test

1.5.1 Conducted and Radiated for Unintentional

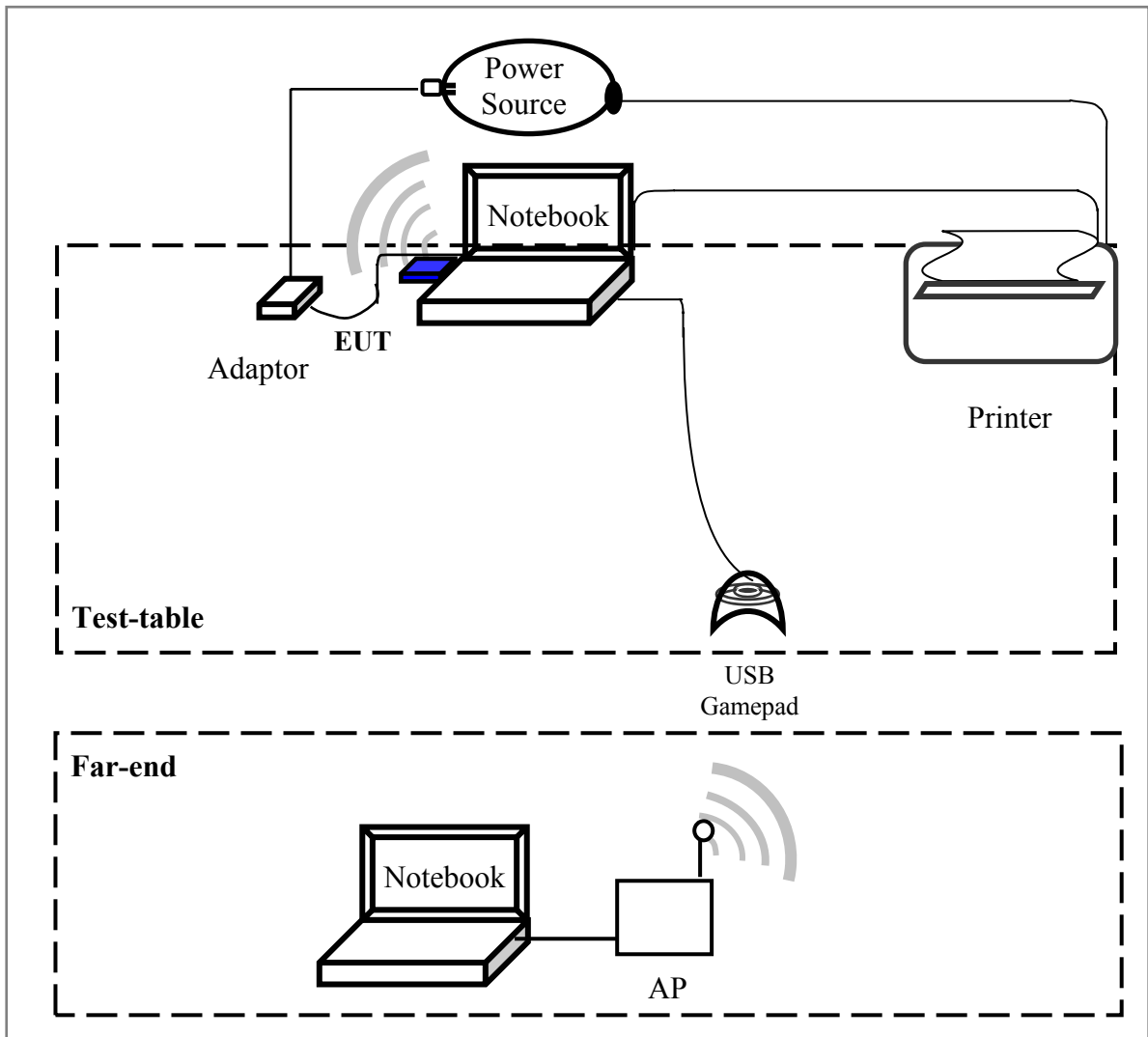

*Connections of Equipment*

**Notebook PC:**

- \* Parallel Port ..... a printer
- \* USB#1 Port ..... EUT
- \* USB#2 Port ..... Gamepad

**EUT :**

- \*Connected to USB interface of notebook PC.

1.5.2 Radiated of Intentional

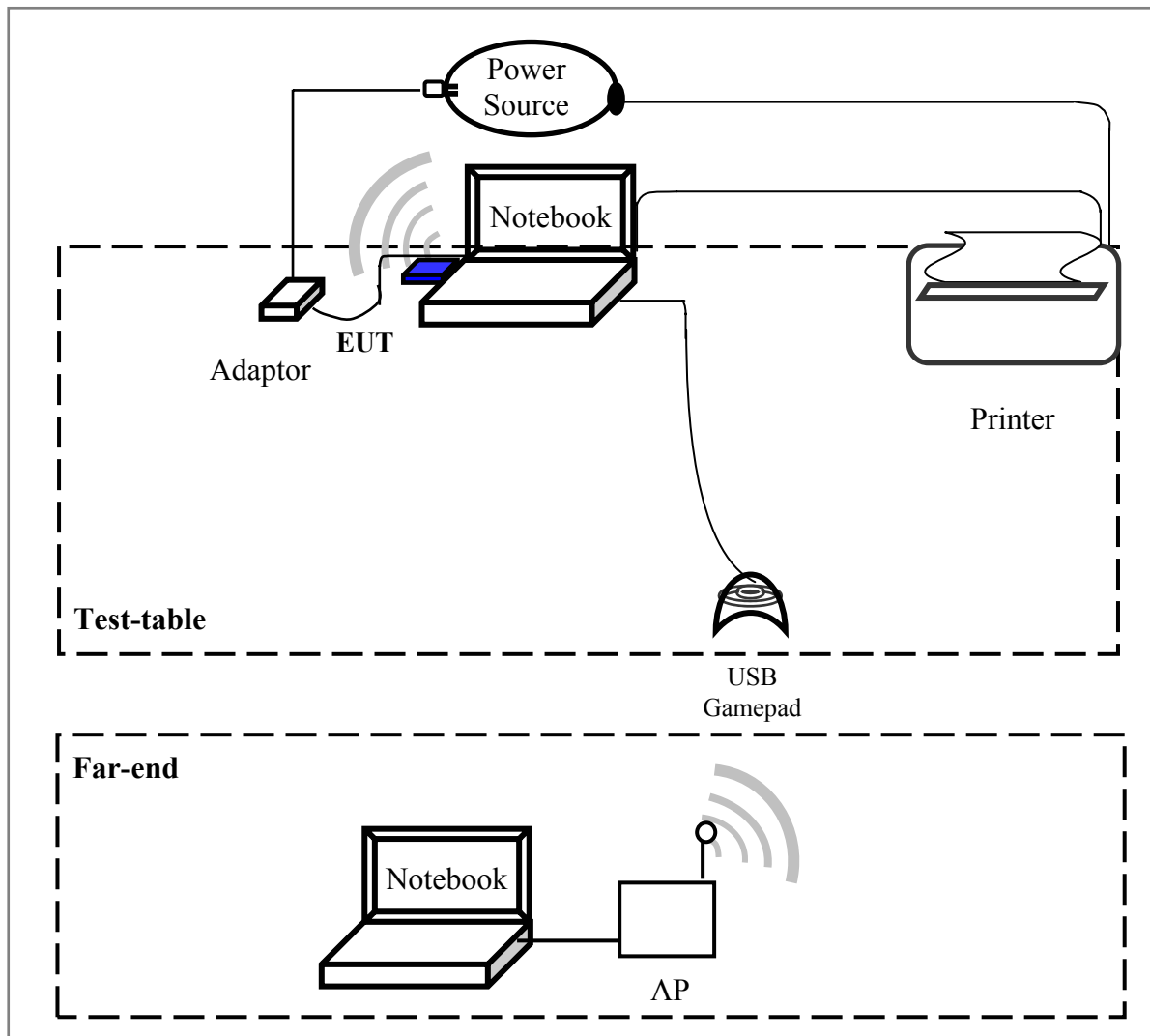

The tests below are carried with the EUT transmitter set at high power in TDD mode. The EUT is forced to select of output power level and channel number by LAN port.

The setting up procedure was recorded in 1.3 test method.

## 1.6 Verify the Frequency and Channel

Channel	Frequency (GHz)
1	2.412
2	2.417
3	2.422
4	2.427
5	2.432
6	2.437
7	2.442
8	2.447
9	2.452
10	2.457
11	2.462

Note:

1. This is for confirming that all frequencies of IEEE 802.11b/g/n Draft 1.0 20M are in 2.412GHz to 2.462GHz. and all frequencies of IEEE 802.11n Draft 1.0 40M are in 2.422GHz to 2.452GHz.
2. Section 15.31(m): Measurements on intentional radiators or receivers shall be performed at three frequencies for operating frequency range over 10 MHz  
(The locations of these frequencies one near the top, one near the middle and one near the bottom.)
3. After test, the EUT operating frequencies are in 2.412GHz to 2.462GHz and 2.422GHz to 2.452GHz. So all the items as followed in testing report are need to test these three frequencies: IEEE 802.11b/g/n Draft 1.0 20M: CH01/CH06/CH11, IEEE 802.11n Draft 1.0 40M: CH03/CH06/CH09

### **1.7 Test Procedure**

All measurements contained in this report were performed mainly according to the techniques described in ANSI C63.4 (2003) and the pre-setup was written on 1.3 test method, the detail setup was written on each test item.

### **1.8 Location of the Test Site**

The radiated emissions measurements required by the rules were performed on the **three-meter, Anechoic Chamber (FCC Registration Number: 93906)** maintained by *Training Research Co., Ltd.* 1F, No. 255 Nanyang Street, Shijr, Taipei Hsien 221, Taiwan, R.O.C. Complete description and measurement data have been placed on file with the commission. The conducted power line emissions tests and other test items were performed in a anechoic chamber also located at Training Research Co., Ltd.

No. 255 Nanyang Street, Shijr, Taipei Hsien 221, Taiwan, R.O.C. *Training Research Co., Ltd.* is listed by the FCC as a facility available to do measurement work for others on a contract basis.

### **1.9 General Test Condition**

The conditions under which the EUT operates were varied to determine their effect on the equipment's emission characteristics. The final configuration of the test system and the mode of operation used during these tests were chosen as that which produced the highest emission levels. However, only those conditions, which the EUT was considered likely to encounter in normal use were investigated.

In test, they were set in high power and continuously transmitting mode that controlled by computer. The ch01, ch06 and ch11 of EUT were all tested. The setting up procedure is recorded on 1.3 test method.

## **II. Section 15.101(a): Equipment authorization of unintentional radiators**

The EUT equipped with a LAN interface and should be operated with the computer. It was categorized to *Class B personal computers and peripherals* as cannot be operated stand-alone. The authorization requires **Declaration of Conformity (DoC)** and the items required such as Section15.107 (Conducted limits) and Section15.109 (Radiated emission limits) is same as Section15.207 and 15.247(C).

### **III. Section 15.203: Antenna requirement**

The EUT has an integrated antenna permanently attached on the PCB, which inside the housing. In addition, there is no external antenna or connector employed. The antenna requirement stated in Sect.15.203 is inapplicable to this EUT.

## **VI. Section 15.207: Power Line Conducted Emissions for AC Powered Units**

### **4.1 Test Condition & Setup**

The power line conducted emission measurements were performed in an anechoic chamber. The EUT was assembled on a wooden table, which is 80 centimeters high, was placed 40 centimeters from the backwall and at least 1 meter from the sidewall.

Power was fed to the EUT from the public utility power grid through a line filter and Line Impedance Stabilization Networks (LISNs). The LISN housing, measuring instrumentation case, ground plane, etc., were electrically bonded together at the same RF potential. The Spectrum analyzer (or EMI receiver) was connected to the AC line through an isolation transformer. The 50-ohm output of the LISN was connected to the spectrum analyzer directly. Conducted emission levels were in the CISPR quasi-peak and average detection mode. The analyzer's 6 dB bandwidth was set to 9 KHz. No post-detector video filter was used.

The spectrum was scanned from 150 KHz to 30 MHz. The physical arrangement of the test system and associated cabling was varied (within the scope of arrangements likely to be encountered in actual use) to determine the effect on the unit's emanations in amplitude and frequency. All spurious emission frequencies were observed. The highest emission amplitudes relative to the appropriate limit were measured and have been recorded in paragraph 4.3

There is a test condition apply in this test item, the test procedure description as <1.3>. Three channels were tested, one in the top, one in the middle and the other in bottom.

**4.2 List of Test Instruments**

Instrument Name	Model	Brand	Serial No.	Calibration Date
				Next time
EMI Receiver	8546A	HP	3520A00242	12/01/06
RF Filter Section	85460A	HP	3448A00217	12/01/06
LISN (EUT)	LISN-01	TRC	99-05	12/10/06
LISN (Support E.)	LISN-01	TRC	9912-03, 04	02/26/07
Pre-amplifier	15542 ZFL-500	Mini – Circuits	0 0117	05/20/07
6dB Attenuator	MCL BW-S6W2	Mini – Circuits	9915 – Conducted	05/20/07
10dB Attenuator	A5542 VAT010	Mini – Circuits	0215 – Conducted	05/20/07
Coaxial Cable (2.0 meter)	A30A30-0058-50FS-2M	Jyebao	SMA-08	05/20/07
Coaxial Cable (1.1 meter)	A30A30-0058-50FS-1M	Jyebao	SMA-09	05/20/07
Coaxial Cable (20 meter)	RG-214/U	Jyebao	NP-01	05/20/07
Coaxial Cable (20 meter)	RG-214/U	Jyebao	NP-02	05/20/07
Auto Switch Box (< 30MHz)	ASB-01	TRC	9904-01	05/20/07



### 4.3 Test Result of Power Line Conducted Emissions

The following table shows a summary of the highest emissions of power line conducted emissions on the LIVE and NETURAL conductors of the EUT power cord. Show as follows.

Test Conditions: Temperature : 25 °C Humidity : 73 % RH

*Test mode: Standby mode*

<i>Power Connected Emissions</i>					<i>Class B</i>		
<i>Conductor</i>	<i>Frequency (KHz)</i>	<i>Peak (dBµV)</i>	<i>QP (dBµV)</i>	<i>Average (dBµV)</i>	<i>QP-limit (dBµV)</i>	<i>AVG-limit (dBµV)</i>	<i>Margin (dB)</i>
Line 1	152.000	54.94	---	---	65.94	55.94	-1.00
	443.000	42.84	---	---	57.63	47.63	-4.79
	547.000	42.93	---	---	56.00	46.00	-3.07
	1081.000	39.71	---	---	56.00	46.00	-6.29
	1941.000	36.84	---	---	56.00	46.00	-9.16
	5890.000	37.15	---	---	60.00	50.00	-12.85
Line 2	155.000	56.34	53.20	34.32	65.91	55.91	-12.71
	166.000	51.67	---	---	65.54	55.54	-3.87
	547.000	40.84	---	---	56.00	46.00	-5.16
	1144.000	41.37	---	---	56.00	46.00	-4.63
	2689.000	39.46	---	---	56.00	46.00	-6.54
	19220.000	38.53	---	---	60.00	50.00	-11.47

NOTE:

- (1)Margin = Peak Amplitude – Limit, *The reading amplitudes are all under limit.*
- (2)A "+" sign in the margin column means the emission is OVER the Class B Limit and "-" sign of means UNDER the Class B limit

*Test mode: IEEE 802.11b Channel 1*

<i>Power Connected Emissions</i>					<i>Class B</i>		
<i>Conductor</i>	<i>Frequency (KHz)</i>	<i>Peak (dBμV)</i>	<i>QP (dBμV)</i>	<i>Average (dBμV)</i>	<i>QP-limit (dBμV)</i>	<i>AVG-limit (dBμV)</i>	<i>Margin (dB)</i>
Line 1	158.345	54.59	52.26	32.03	65.83	55.83	-13.57
	269.000	42.45	---	---	62.60	52.60	-10.15
	456.000	43.53	---	---	57.26	47.26	-3.73
	1102.000	39.76	---	---	56.00	46.00	-6.24
	1889.000	36.74	---	---	56.00	46.00	-9.26
	4131.000	36.14	---	---	56.00	46.00	-9.86
Line 2	166.000	53.44	---	---	65.54	55.54	-2.10
	187.000	49.09	---	---	64.94	54.94	-5.85
	547.000	40.78	---	---	56.00	46.00	-5.22
	1091.000	41.82	---	---	56.00	46.00	-4.18
	1398.000	43.84	---	---	56.00	46.00	-2.16
	2741.000	38.67	---	---	56.00	46.00	-7.33

*Test mode: IEEE 802.11b Channel 6*

<i>Power Connected Emissions</i>					<i>Class B</i>		
<i>Conductor</i>	<i>Frequency (KHz)</i>	<i>Peak (dBμV)</i>	<i>QP (dBμV)</i>	<i>Average (dBμV)</i>	<i>QP-limit (dBμV)</i>	<i>AVG-limit (dBμV)</i>	<i>Margin (dB)</i>
Line 1	164.000	51.84	---	---	65.60	55.60	-3.76
	282.000	43.20	---	---	62.23	52.23	-9.03
	461.000	42.61	---	---	57.11	47.11	-4.50
	558.000	44.31	---	---	56.00	46.00	-1.69
	1924.000	36.11	---	---	56.00	46.00	-9.89
	3030.000	36.63	---	---	56.00	46.00	-9.37
Line 2	161.000	54.35	---	---	65.69	55.69	-1.34
	461.000	40.24	---	---	57.11	47.11	-6.87
	542.000	41.24	---	---	56.00	46.00	-4.76
	788.000	40.38	---	---	56.00	46.00	-5.62
	1411.000	41.96	---	---	56.00	46.00	-4.04
	2506.000	39.03	---	---	56.00	46.00	-6.97

**Test mode: IEEE 802.11b Channel 11**

<b>Power Connected Emissions</b>					<b>Class B</b>		
<b>Conductor</b>	<b>Frequency (KHz)</b>	<b>Peak (dBμV)</b>	<b>QP (dBμV)</b>	<b>Average (dBμV)</b>	<b>QP-limit (dBμV)</b>	<b>AVG-limit (dBμV)</b>	<b>Margin (dB)</b>
Line 1	155.000	54.63	---	---	65.86	55.86	-1.23
	291.000	44.12	---	---	61.97	51.97	-7.85
	485.000	43.53	---	---	56.43	46.43	-2.90
	563.000	43.57	---	---	56.00	46.00	-2.43
	963.000	40.36	---	---	56.00	46.00	-5.64
	1941.000	35.54	---	---	56.00	46.00	-10.46
Line 2	212.000	45.91	---	---	64.23	54.23	-8.32
	297.000	44.35	---	---	61.80	51.80	-7.45
	788.000	43.34	---	---	56.00	46.00	-2.66
	1367.000	46.90	42.24	21.52	56.00	46.00	-13.76
	2012.000	41.04	---	---	56.00	46.00	-4.96
	3189.000	38.43	---	---	56.00	46.00	-7.57

**Test mode: IEEE 802.11g Channel 1**

<b>Power Connected Emissions</b>					<b>Class B</b>		
<b>Conductor</b>	<b>Frequency (KHz)</b>	<b>Peak (dBμV)</b>	<b>QP (dBμV)</b>	<b>Average (dBμV)</b>	<b>QP-limit (dBμV)</b>	<b>AVG-limit (dBμV)</b>	<b>Margin (dB)</b>
Line 1	154.000	58.13	52.91	37.83	66.00	56.00	-13.09
	341.000	41.42	---	---	60.54	50.54	-9.12
	417.000	37.92	---	---	58.37	48.37	-10.45
	616.000	39.08	---	---	56.00	46.00	-6.92
	817.000	38.41	---	---	56.00	46.00	-7.59
	1518.000	35.76	---	---	56.00	46.00	-10.24
Line 2	154.860	58.62	57.47	36.11	65.94	55.94	-8.47
	164.000	53.49	---	---	65.60	55.60	-2.11
	180.000	47.61	---	---	65.14	55.14	-7.53
	695.000	38.36	---	---	56.00	46.00	-7.64
	1282.000	37.50	---	---	56.00	46.00	-8.50
	3126.000	37.76	---	---	56.00	46.00	-8.24

**Test mode: IEEE 802.11g Channel 6**

<b>Power Connected Emissions</b>					<b>Class B</b>		
<b>Conductor</b>	<b>Frequency (KHz)</b>	<b>Peak (dBμV)</b>	<b>QP (dBμV)</b>	<b>Average (dBμV)</b>	<b>QP-limit (dBμV)</b>	<b>AVG-limit (dBμV)</b>	<b>Margin (dB)</b>
Line 1	157.545	57.97	52.03	30.39	65.77	55.77	-13.74
	169.000	51.52	---	---	65.46	55.46	-3.94
	387.000	41.15	---	---	59.23	49.23	-8.08
	480.000	40.92	---	---	56.57	46.57	-5.65
	963.000	38.89	---	---	56.00	46.00	-7.11
	2715.000	35.05	---	---	56.00	46.00	-10.95
Line 2	155.180	58.53	54.05	30.26	65.91	55.91	-11.86
	174.000	52.32	---	---	65.31	55.31	-2.99
	199.000	45.10	---	---	64.60	54.60	-9.50
	604.000	38.62	---	---	56.00	46.00	-7.38
	1166.000	39.53	---	---	56.00	46.00	-6.47
	3126.000	38.55	---	---	56.00	46.00	-7.45

**Test mode: IEEE 802.11g Channel 11**

<b>Power Connected Emissions</b>					<b>FCC Class B</b>		
<b>Conductor</b>	<b>Frequency (KHz)</b>	<b>Peak (dBμV)</b>	<b>QP (dBμV)</b>	<b>Average (dBμV)</b>	<b>QP-limit (dBμV)</b>	<b>AVG-limit (dBμV)</b>	<b>Margin (dB)</b>
Line 1	154.590	57.09	53.38	32.56	65.94	55.94	-12.56
	167.000	51.33	---	---	65.51	55.51	-4.18
	352.000	42.24	---	---	60.23	50.23	-7.99
	430.000	42.59	---	---	58.00	48.00	-5.41
	824.000	38.91	---	---	56.00	46.00	-7.09
	1661.000	36.07	---	---	56.00	46.00	-9.93
Line 2	154.635	57.90	56.46	33.04	65.94	55.94	-11.48
	182.000	51.13	---	---	65.09	55.09	-3.96
	657.000	40.27	---	---	56.00	46.00	-5.73
	1070.000	39.79	---	---	56.00	46.00	-6.21
	1731.000	39.99	---	---	56.00	46.00	-6.01
	4327.000	36.39	---	---	56.00	46.00	-9.61

**Test mode: IEEE 802.11n 20M Channel 1**

<b>Power Connected Emissions</b>					<b>Class B</b>		
<b>Conductor</b>	<b>Frequency (KHz)</b>	<b>Peak (dBμV)</b>	<b>QP (dBμV)</b>	<b>Average (dBμV)</b>	<b>QP-limit (dBμV)</b>	<b>AVG-limit (dBμV)</b>	<b>Margin (dB)</b>
Line 1	155.225	56.57	51.87	30.94	65.91	55.91	-14.04
	166.000	52.29	---	---	65.54	55.54	-3.25
	413.000	42.12	---	---	58.49	48.49	-6.37
	604.000	39.83	---	---	56.00	46.00	-6.17
	963.000	36.94	---	---	56.00	46.00	-9.06
	2094.000	35.23	---	---	56.00	46.00	-10.77
Line 2	154.635	57.18	52.77	30.13	65.94	55.94	-13.17
	179.000	48.55	---	---	65.17	55.17	-6.62
	616.000	38.41	---	---	56.00	46.00	-7.59
	1477.000	38.24	---	---	56.00	46.00	-7.76
	1977.000	38.27	---	---	56.00	46.00	-7.73
	2977.000	37.85	---	---	56.00	46.00	-8.15

**Test mode: IEEE 802.11n 20M Channel 6**

<b>Power Connected Emissions</b>					<b>Class B</b>		
<b>Conductor</b>	<b>Frequency (KHz)</b>	<b>Peak (dBμV)</b>	<b>QP (dBμV)</b>	<b>Average (dBμV)</b>	<b>QP-limit (dBμV)</b>	<b>AVG-limit (dBμV)</b>	<b>Margin (dB)</b>
Line 1	154.770	54.16	52.13	33.75	65.94	55.94	-13.81
	452.000	42.77	---	---	57.37	47.37	-4.60
	710.000	38.74	---	---	56.00	46.00	-7.26
	1091.000	37.17	---	---	56.00	46.00	-8.83
	2094.000	34.80	---	---	56.00	46.00	-11.20
	4762.000	35.67	---	---	56.00	46.00	-10.33
Line 2	156.440	54.58	52.42	32.51	65.91	55.91	-13.49
	471.000	39.26	---	---	56.83	46.83	-7.57
	824.000	39.36	---	---	56.00	46.00	-6.64
	1123.000	40.33	---	---	56.00	46.00	-5.67
	1411.000	40.24	---	---	56.00	46.00	-5.76
	3221.000	37.96	---	---	56.00	46.00	-8.04

**Test mode: IEEE 802.11n 20M Channel 11**

<b>Power Connected Emissions</b>					<b>Class B</b>		
<b>Conductor</b>	<b>Frequency (KHz)</b>	<b>Peak (dBμV)</b>	<b>QP (dBμV)</b>	<b>Average (dBμV)</b>	<b>QP-limit (dBμV)</b>	<b>AVG-limit (dBμV)</b>	<b>Margin (dB)</b>
Line 1	152.000	54.53	---	---	65.94	55.94	-1.41
	161.000	51.28	---	---	65.69	55.69	-4.41
	274.000	43.93	---	---	62.46	52.46	-8.53
	452.000	41.63	---	---	57.37	47.37	-5.74
	552.000	42.21	---	---	56.00	46.00	-3.79
	1906.000	36.30	---	---	56.00	46.00	-9.70
Line 2	158.000	53.29	---	---	65.77	55.77	-2.48
	174.000	49.61	---	---	65.31	55.31	-5.70
	558.000	39.96	---	---	56.00	46.00	-6.04
	832.000	40.91	---	---	56.00	46.00	-5.09
	1385.000	40.19	---	---	56.00	46.00	-5.81
	1713.000	40.49	---	---	56.00	46.00	-5.51

**Test mode: IEEE 802.11n 40M Channel 3**

<b>Power Connected Emissions</b>					<b>Class B</b>		
<b>Conductor</b>	<b>Frequency (KHz)</b>	<b>Peak (dBμV)</b>	<b>QP (dBμV)</b>	<b>Average (dBμV)</b>	<b>QP-limit (dBμV)</b>	<b>AVG-limit (dBμV)</b>	<b>Margin (dB)</b>
Line 1	161.000	50.27	---	---	65.69	55.69	-5.42
	285.000	44.35	---	---	62.14	52.14	-7.79
	562.430	40.80	35.97	20.57	56.00	46.00	-20.03
	842.000	40.94	---	---	56.00	46.00	-5.06
	1134.000	40.19	---	---	56.00	46.00	-5.81
	3702.000	36.51	---	---	56.00	46.00	-9.49
Line 2	153.680	56.41	53.72	36.71	66.00	56.00	-12.28
	177.000	48.89	---	---	65.23	55.23	-6.34
	504.000	40.12	---	---	56.00	46.00	-5.88
	858.000	41.84	---	---	56.00	46.00	-4.16
	1243.000	42.77	---	---	56.00	46.00	-3.23
	3158.000	37.87	---	---	56.00	46.00	-8.13

*Test mode: IEEE 802.11n 40M Channel 6*

<i>Power Connected Emissions</i>					<i>Class B</i>		
<i>Conductor</i>	<i>Frequency (KHz)</i>	<i>Peak (dBμV)</i>	<i>QP (dBμV)</i>	<i>Average (dBμV)</i>	<i>QP-limit (dBμV)</i>	<i>AVG-limit (dBμV)</i>	<i>Margin (dB)</i>
Line 1	171.000	46.23	---	---	65.40	55.40	-9.17
	300.000	44.65	---	---	61.71	51.71	-7.06
	509.000	43.12	---	---	56.00	46.00	-2.88
	604.000	44.00	---	---	56.00	46.00	-2.00
	884.000	40.80	---	---	56.00	46.00	-5.20
	3670.000	37.75	---	---	56.00	46.00	-8.25
Line 2	179.000	48.12	---	---	65.17	55.17	-7.05
	494.000	40.52	---	---	56.17	46.17	-5.65
	604.000	41.05	---	---	56.00	46.00	-4.95
	928.000	41.21	---	---	56.00	46.00	-4.79
	1282.000	42.84	---	---	56.00	46.00	-3.16
	1836.000	41.86	---	---	56.00	46.00	-4.14

*Test mode: IEEE 802.11n 40M Channel 9*

<i>Power Connected Emissions</i>					<i>FCC Class B</i>		
<i>Conductor</i>	<i>Frequency (KHz)</i>	<i>Peak (dBμV)</i>	<i>QP (dBμV)</i>	<i>Average (dBμV)</i>	<i>QP-limit (dBμV)</i>	<i>AVG-limit (dBμV)</i>	<i>Margin (dB)</i>
Line 1	311.000	45.32	---	---	61.40	51.40	-6.08
	513.000	43.83	---	---	56.00	46.00	-2.17
	598.000	43.47	---	---	56.00	46.00	-2.53
	893.000	41.12	---	---	56.00	46.00	-4.88
	1766.000	36.18	---	---	56.00	46.00	-9.82
	3317.000	37.31	---	---	56.00	46.00	-8.69
Line 2	183.000	46.29	---	---	65.06	55.06	-8.77
	288.000	42.54	---	---	62.06	52.06	-9.52
	633.000	42.35	---	---	56.00	46.00	-3.65
	1219.000	42.21	---	---	56.00	46.00	-3.79
	1582.000	42.26	---	---	56.00	46.00	-3.74
	3510.000	38.59	---	---	56.00	46.00	-7.41

## **V. Section 15.247 (a): Technical description of the EUT**

*Direct Sequence System* is a spread spectrum system in which the carrier has been modulated by a high speed spreading code and an information data stream. The high speed code sequence dominates the “modulating function” and is the direct cause of the wide spreading of the transmitted signal. In the operational description demonstrates the operation principles of the Baseband processor employed by the EUT, shows that which is a complete DSSS baseband processor and meets the definition of the direct sequence spread spectrum system.



## VI. Section 15.247(a)(2): Bandwidth for Direct Sequence System.

### 6.1 Test Condition & Setup

The transmitter bandwidth measurements were performed by the contact manner. The EUT was set to transmit continuously, also various channels were investigated to find the maximum occupied bandwidth. The output of the EUT was connected to the spectrum analyzer. The bandwidth of the fundamental frequency is observed by the spectrum analyzer with 100kHz RBW and 100kHz VBW.

### 6.2 Test Instruments Configuration

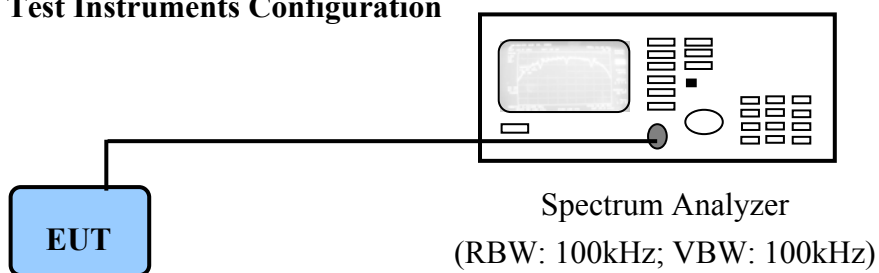

*PC to control the EUT at maximal power output and channel number and set antenna kit*

### 6.3 List of Test Instruments

Instrument Name	Model No.	Brand	Serial No.	Next time
Spectrum Analyzer	MS2665C	ANRITSU	6200175476	02/15/07

**6.4 Test Result of Bandwidth**

**IEEE 802.11b**

Channel	Limited (kHz)	Antenna(MHz)
CH01	$\geq 500$	10.72
CH06	$\geq 500$	10.68
CH11	$\geq 500$	10.68

**IEEE 802.11g**

CH01	$\geq 500$	16.80
CH06	$\geq 500$	16.84
CH11	$\geq 500$	16.84

**IEEE 802.11n 20M**

Channel	Limit (kHz)	Antenna#1(MHz)	Antenna#2(MHz)
CH01	$\geq 500$	18.12	18.12
CH06	$\geq 500$	18.12	18.12
CH11	$\geq 500$	18.12	18.12

**IEEE 802.11n 40M**

CH03	$\geq 500$	37.00	37.00
CH06	$\geq 500$	37.10	37.00
CH09	$\geq 500$	37.00	37.10

- Note:
1. The data in the above table are summarizing the following attachment spectrum analyzer hard copy. According to the guidance, we'd made the measurement with the spectrum analyzer's resolution bandwidth ( $RBW$ )=100kHz and set the  $span \gg RBW$ . The results show the measured 6dB bandwidth comply with the minimum 500kHz requirement.
  2. The attachments show these on the following pages.

6dB Bandwidth of Channel CH01, 2412MHz



IEEE 802.11b

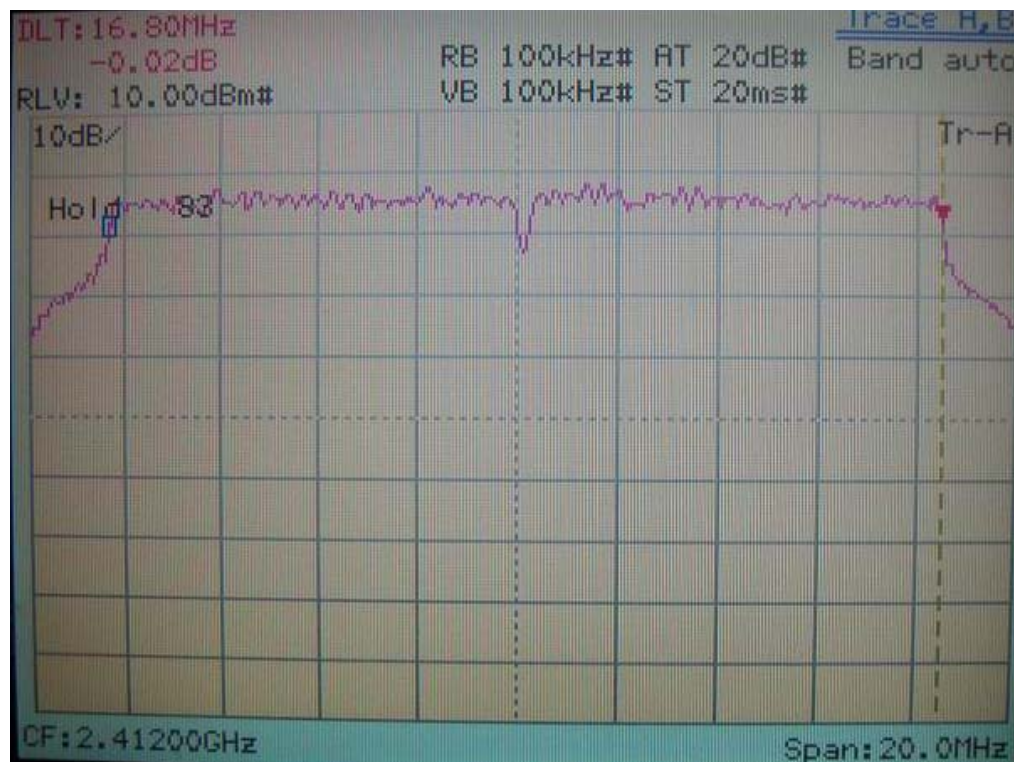

IEEE 802.11g

6dB Bandwidth of Channel CH06, 2437MHz

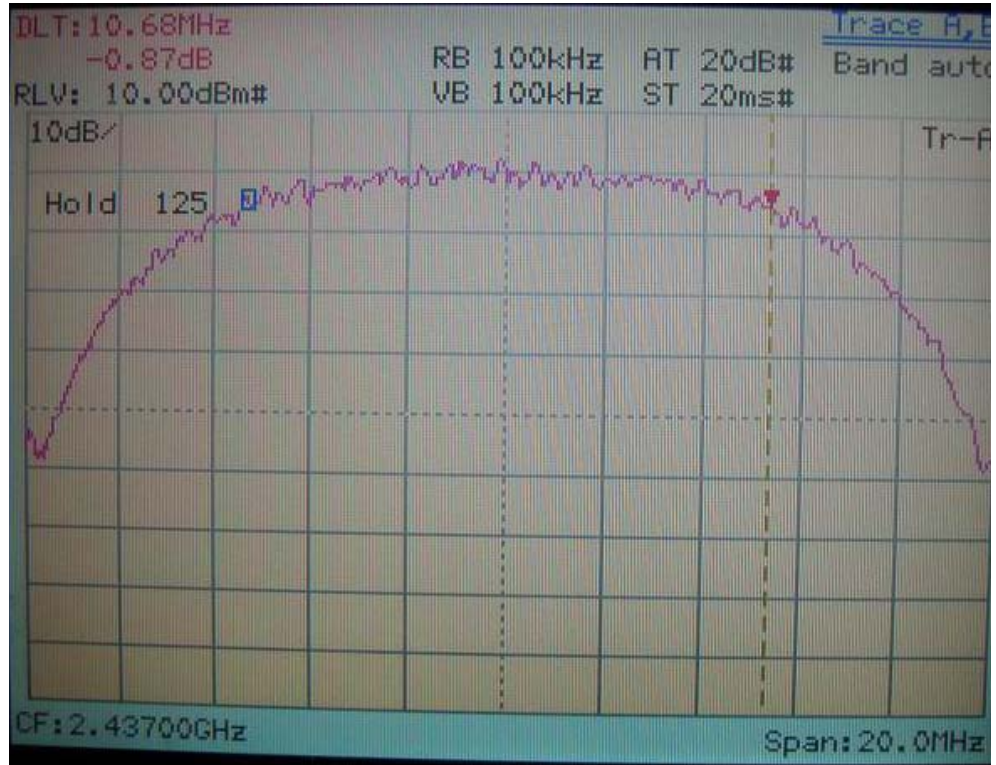

IEEE 802.11b

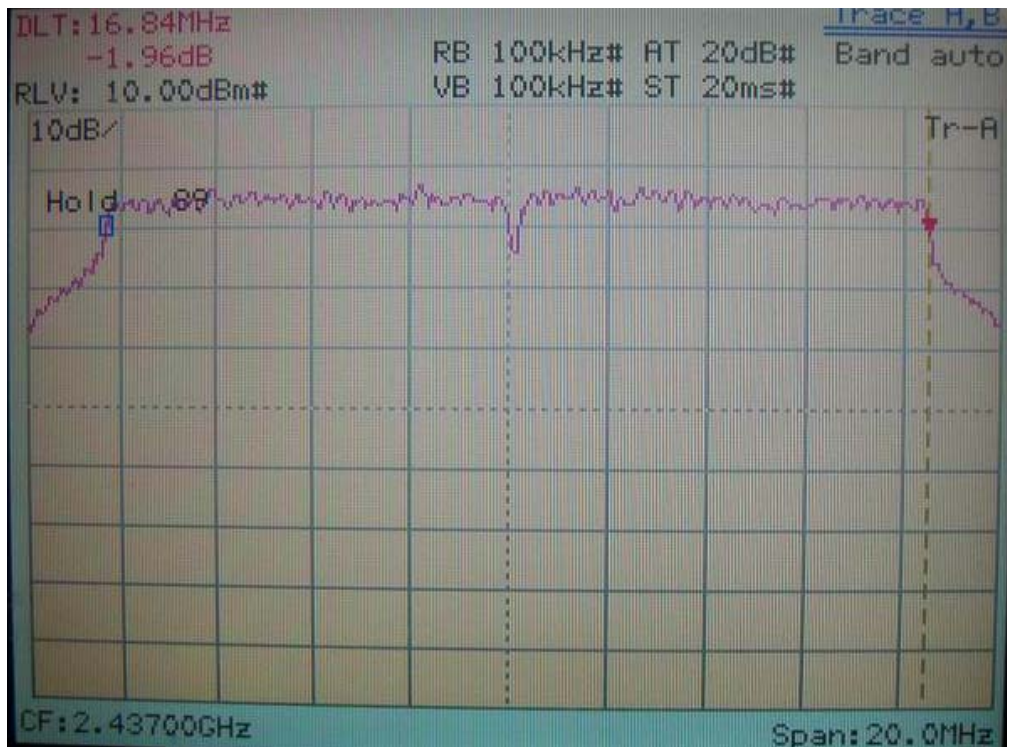

IEEE 802.11g

6dB Bandwidth of Channel CH11, 2462MHz



IEEE 802.11b

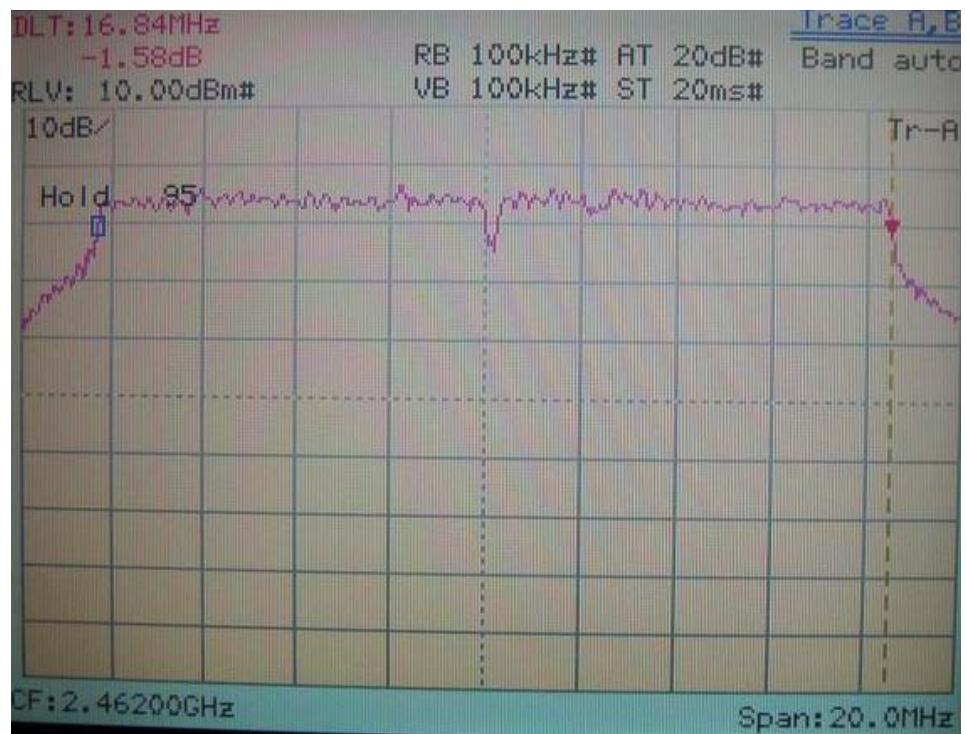

IEEE 802.11g

6dB Bandwidth of Channel 01 IEEE 802.11n 20M , 2412MHz

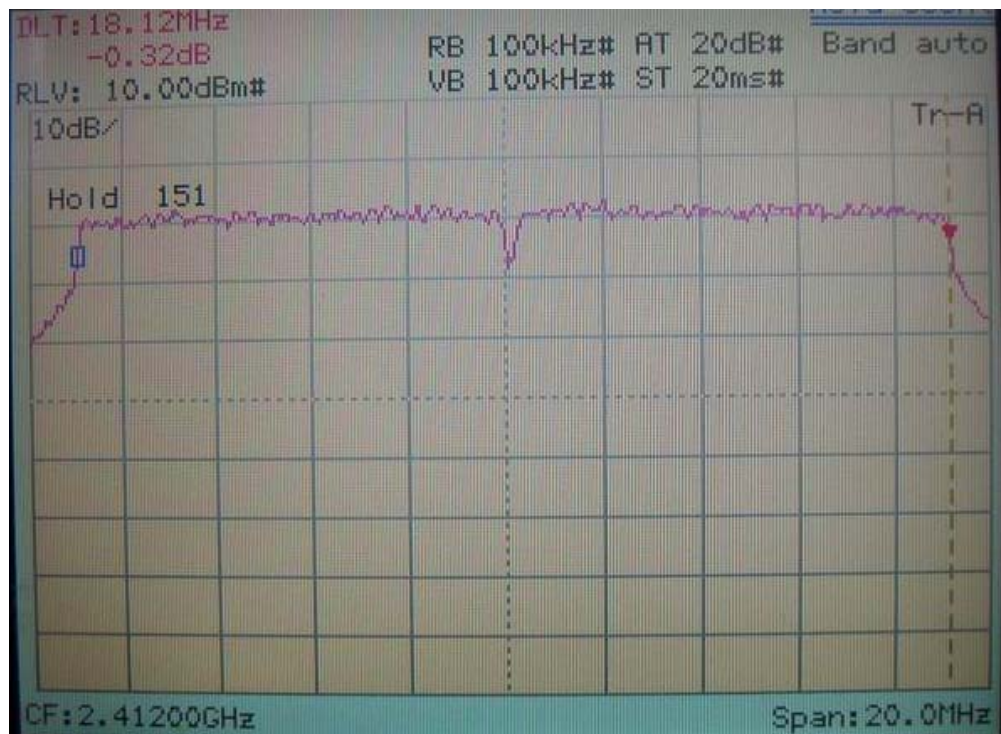

Ant#1

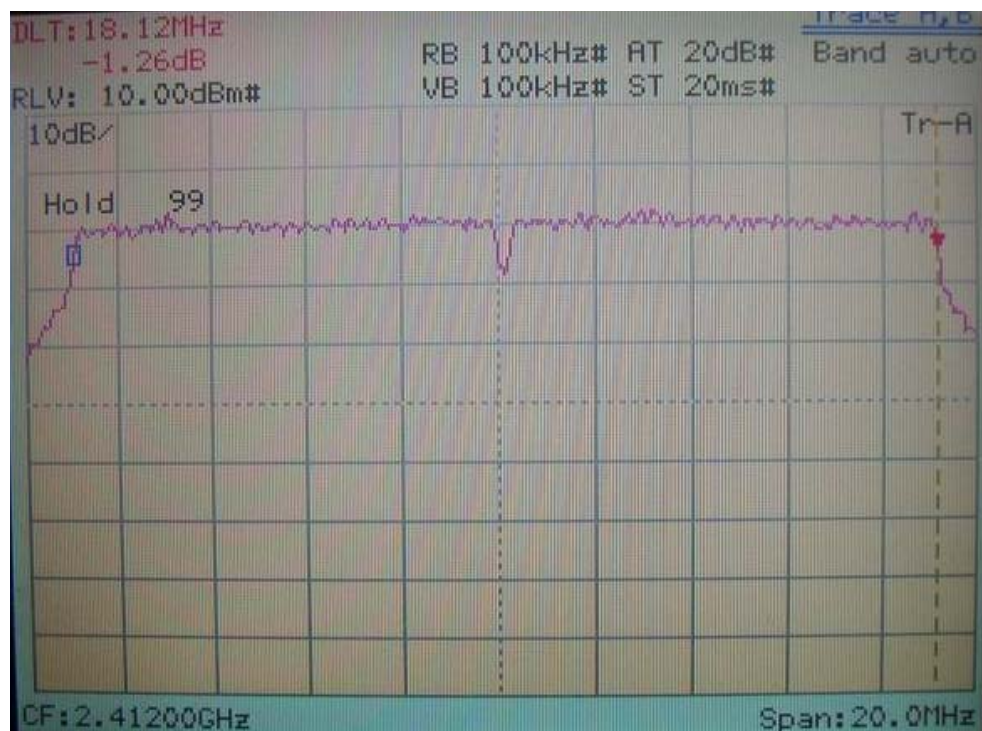

Ant#2

6dB Bandwidth of Channel 06 IEEE 802.11n 20M , 2437MHz

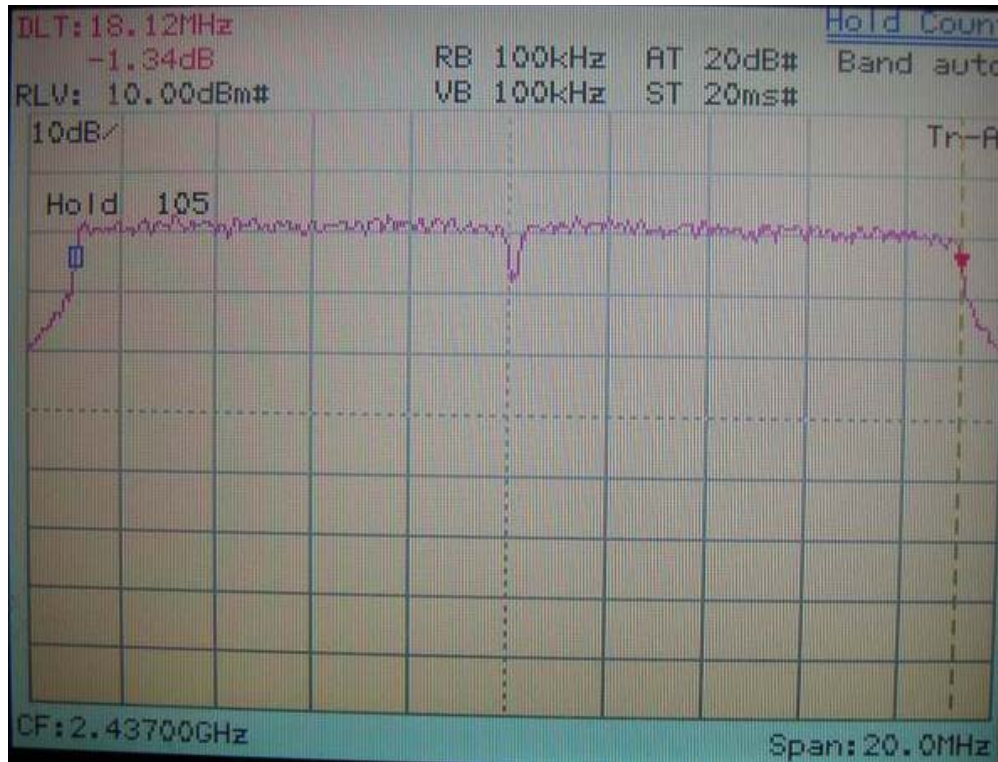

Ant#1

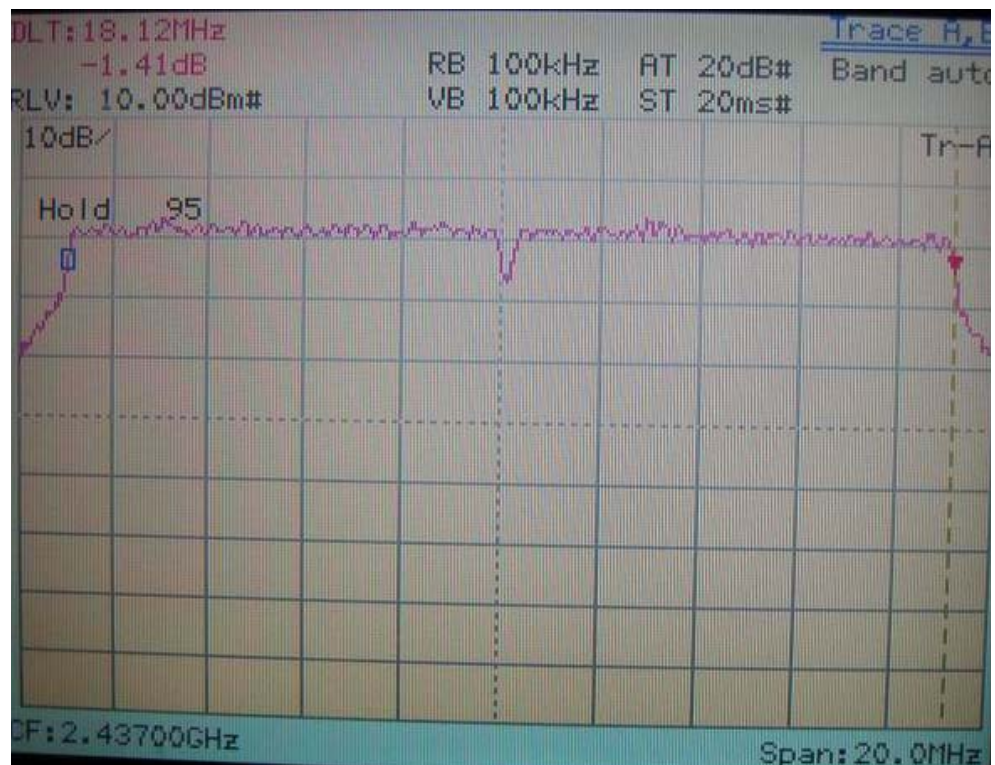

Ant#2

6dB Bandwidth of Channel 11 IEEE 802.11n 20M, 2462MHz

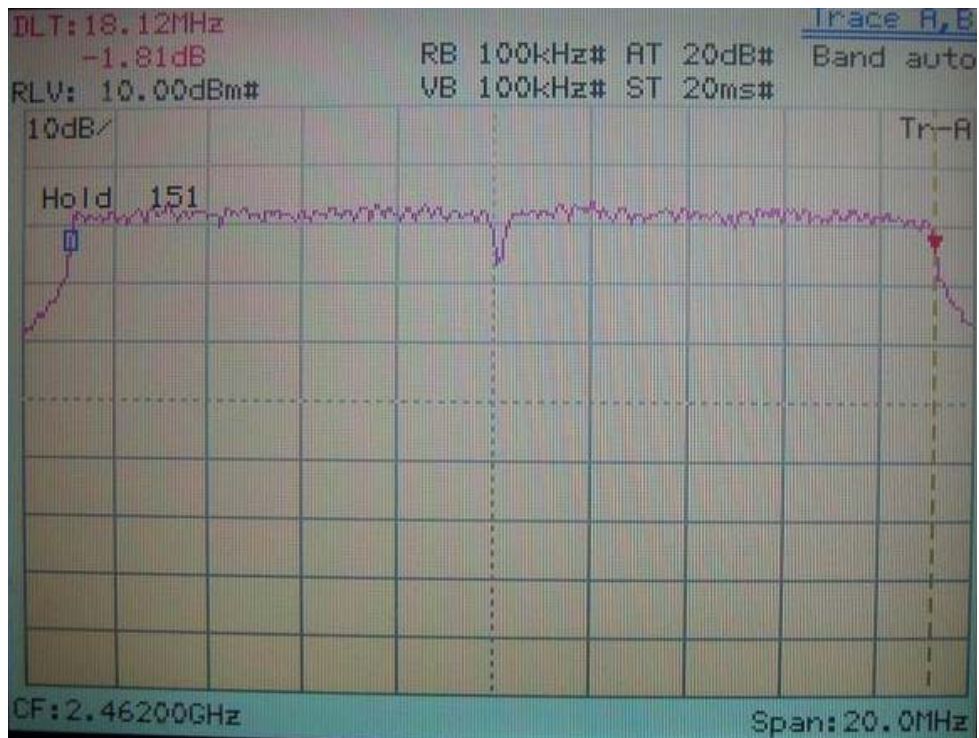

Ant#1

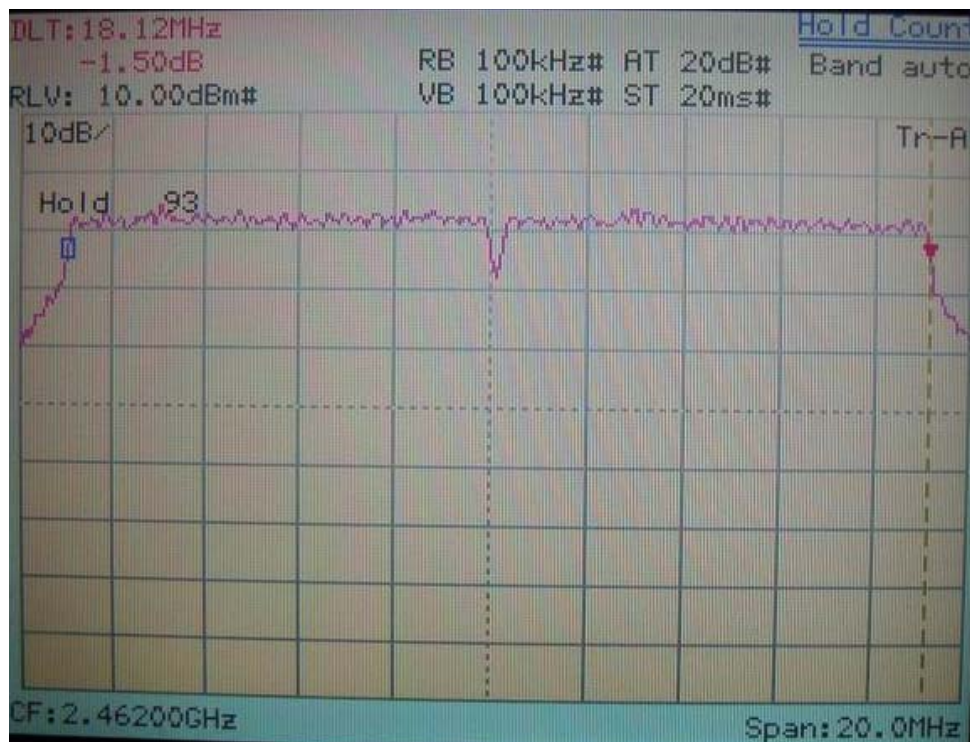

Ant#2



6dB Bandwidth of Channel 03 IEEE 802.11n 40M, 2422MHz

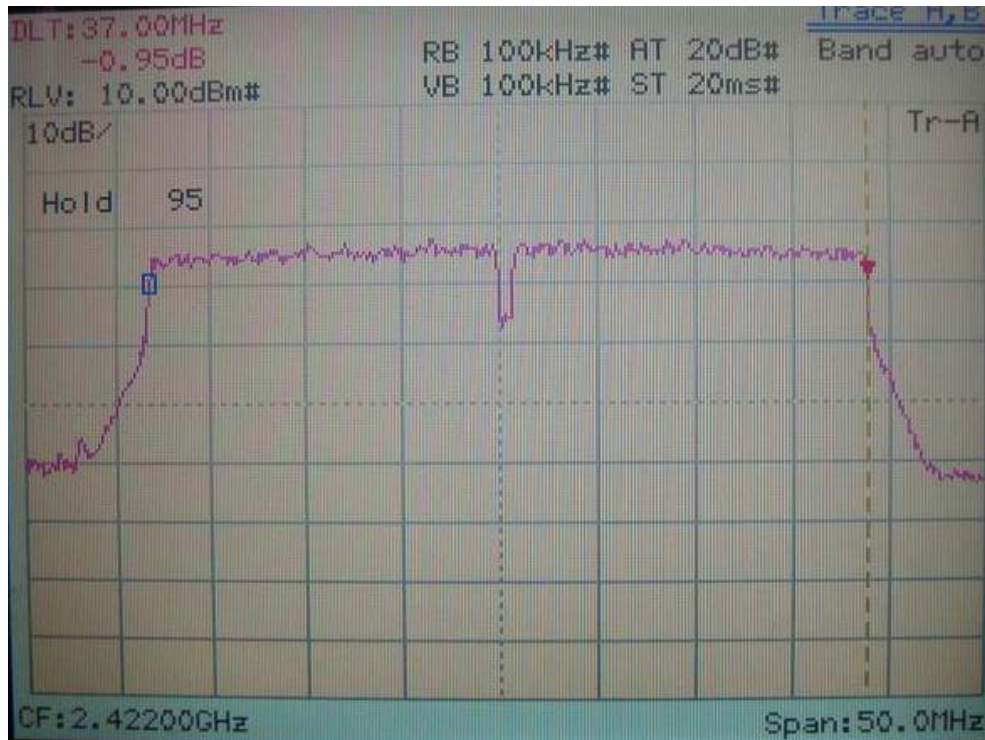

Ant#1

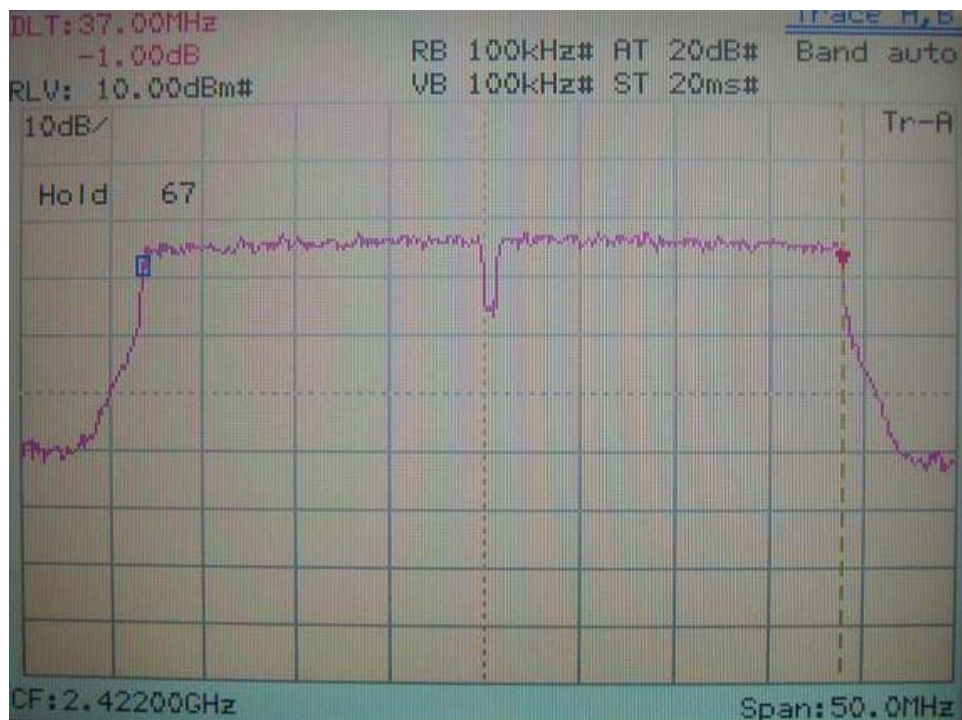

Ant#2

6dB Bandwidth of Channel 06 IEEE 802.11n 40M, 2437MHz

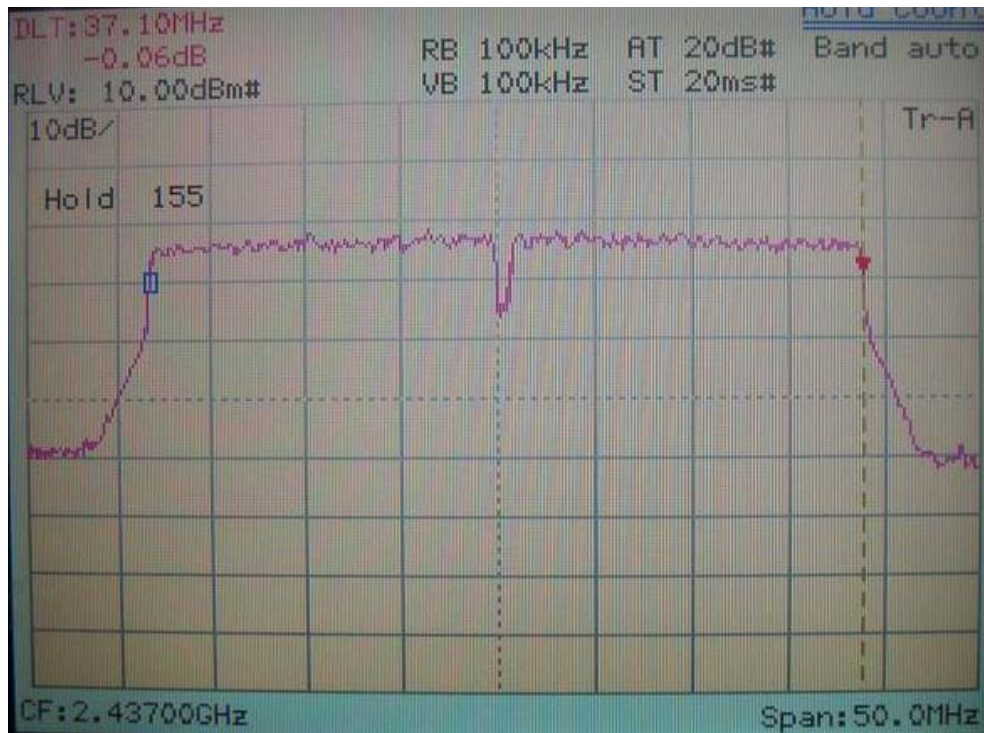

Ant#1

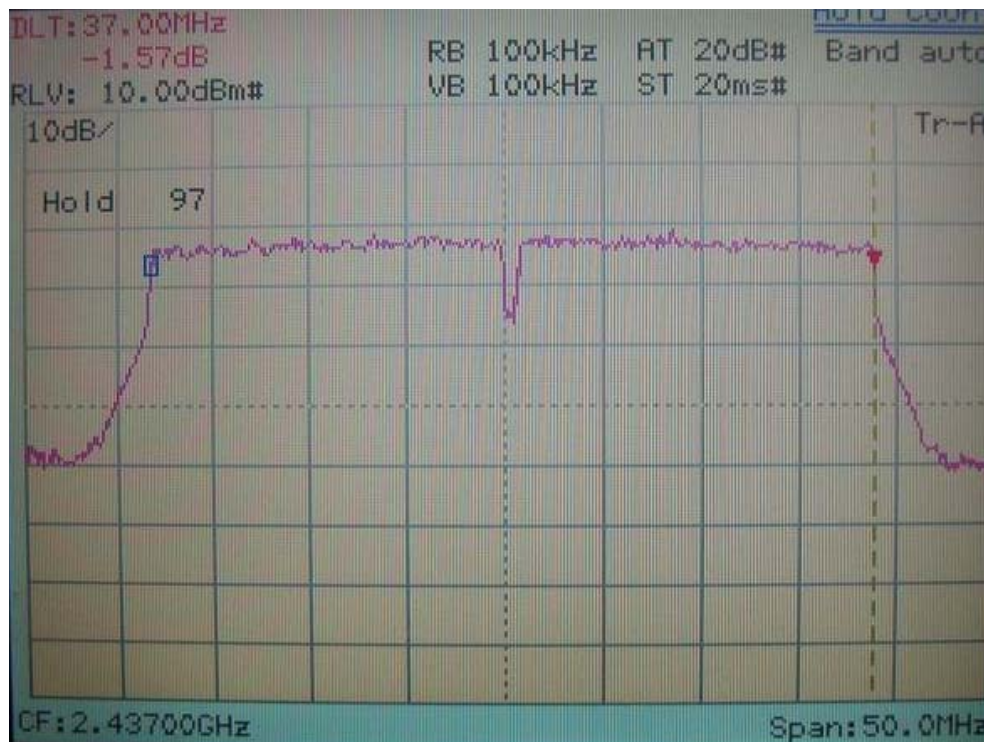

Ant#2

6dB Bandwidth of Channel 09 IEEE 802.11n 40M , 2452MHz

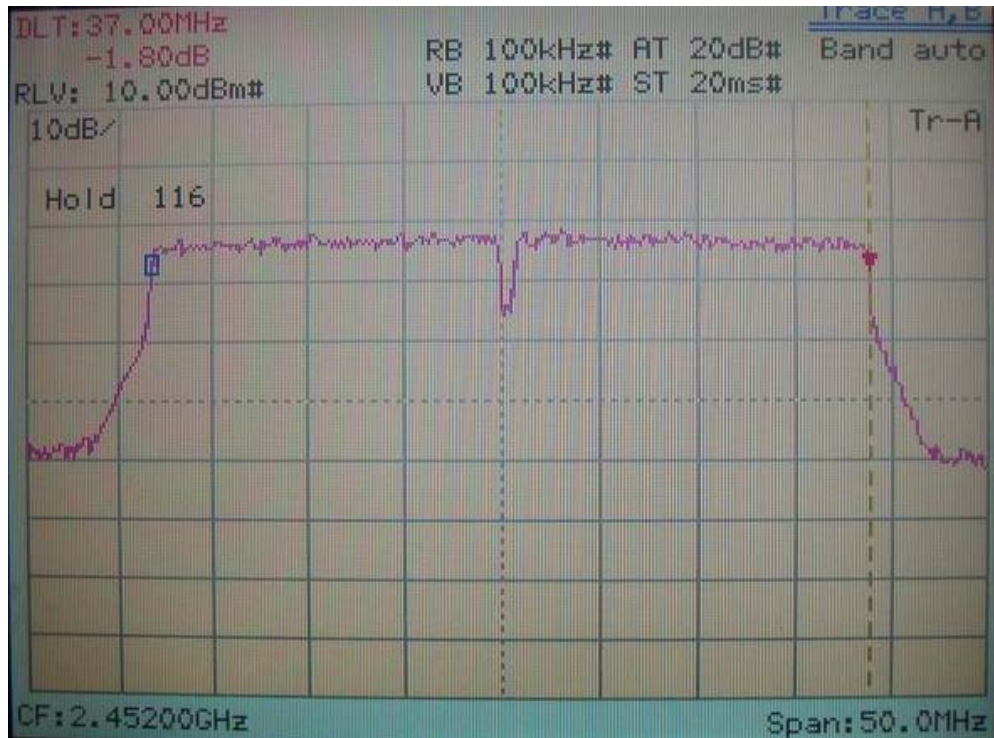

Ant#1

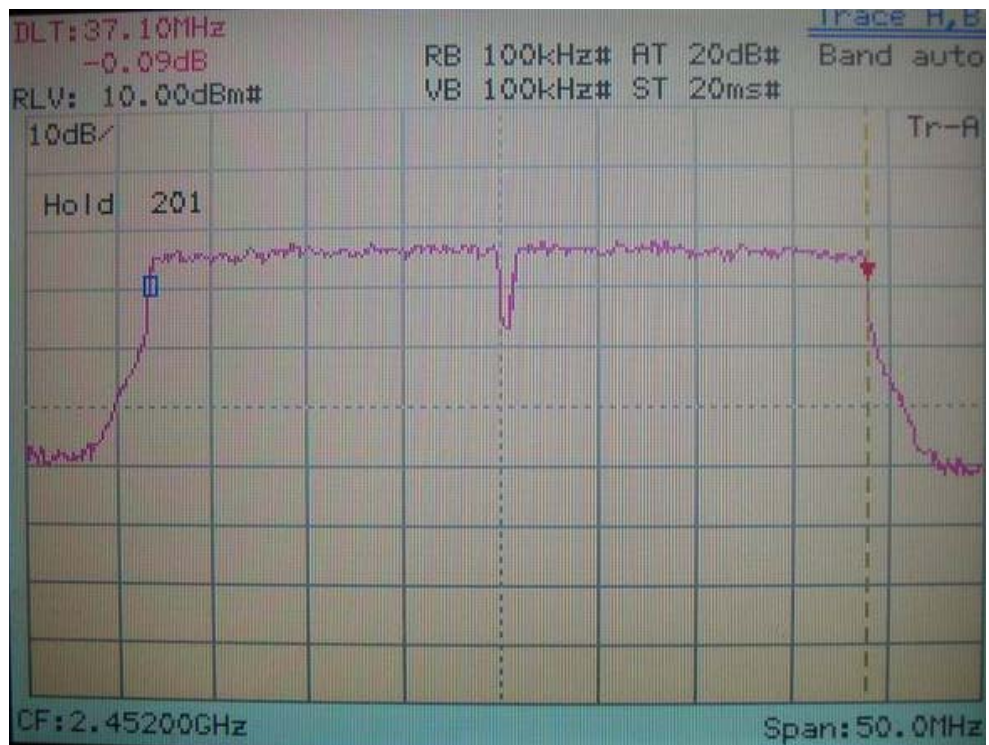

Ant#2

## VII. Section 15.247(b): Power Output

### 7.1 Test Condition & Setup

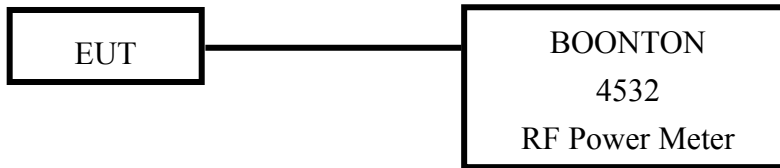

1. The output of the transmitter is connected to the BOONTON RF Power Meter.
2. The calibration is performed before every test. The values of the output power of the EUT will shown in the dBm directly are the transmitter output peak power. Recording as follows.

### 7.2 List of Test Instruments

Instrument Name	Model	Brand	Serial No.	Next time
RF Power Meter	4532	BOONTON	117501	05/18/07
Peak Power Sensor	57340	BOONTON	2696	05/18/07

### 7.3 Test Result

<b>Formula:</b> RF Output of EUT +  Cable Loss  = Output Peak Power
--

Channel (MHz)	Output Level	Cable Loss	Limit	Output Peak Power	
	dBm	dBm	(DSS)	dBm	mW

#### IEEE 802.11b

<b>CH 01 /2412</b>	16.07	2.00	30dBm	18.07	64.12
<b>CH 06/2437</b>	16.53	2.00	30dBm	18.53	71.29
<b>CH 11/2462</b>	16.15	2.00	30dBm	18.15	65.31

#### IEEE 802.11g

<b>CH 01 /2412</b>	21.95	2.00	30dBm	23.95	248.31
<b>CH 06 /2437</b>	21.08	2.00	30dBm	23.08	203.24
<b>CH 11 /2462</b>	20.16	2.00	30dBm	22.16	164.44

**Formula:**  
 Total Power =  $10 \log ( 10^{( \text{Ant\#1 Power} / 10 )} + 10^{( \text{Ant\#2 Power} / 10 )} )$

Channel (MHz)	Output Level		Cable Loss	Limit	Total Output Peak Power	
	Ant#1	Ant#2			dBm	mW
	dBm	dBm	dB	(DSS)		

**802.11n 20M**

<b>CH Lowest /2412</b>	17.63	17.74	2.00	30dBm	22.695	186.02
<b>CH Middle/2437</b>	17.70	17.81	2.00	30dBm	22.765	189.04
<b>CH Highest/2462</b>	17.74	17.82	2.00	30dBm	22.791	190.13

**802.11n 40M**

<b>CH Lowest /2422</b>	15.07	16.70	2.00	30dBm	20.971	125.06
<b>CH Middle/2437</b>	16.68	17.81	2.00	30dBm	22.292	169.51
<b>CH Highest/2452</b>	16.43	17.60	2.00	30dBm	22.064	160.86

## **VIII. Section 15.247 (C): Spurious Emissions (Radiated)**

### **8.1 Test Condition & Setup**

We'd performed the test by the *radiated emission* skill: The EUT was placed in an anechoic chamber, and set the EUT transmitting continuously and scanned at 3-meter distance to determine its emission characteristics. The physical arrangement of the EUT was varied (within the scope of arrangements likely to be encountered in actual use) to determine the effect on the unit's emanations in amplitude, directivity, and frequency. The exact system configuration, which produced the highest emissions was noted so it could be reproduced later during the final tests. For the measurement above 1GHz, according to the guidance we'd set the spectrum analyzer's 6dB bandwidth RBW to 1MHz.

This was done to ensure that the final measurements would demonstrate the worst-case interference potential of the EUT.

Final radiation measurements were made on a three-meter, anechoic chamber. The EUT system was placed on a nonconductive turntable, which is 0.8 meters height, top surface 1.0 x 1.5 meter.

The spectrum was examined from 30MHz to 1000MHz using an Hewlett Packard 85460A EMI Receiver, SCHWARZECK whole range Small Biconical Antenna (Model No.: UBAA9114 & BBVU9135) is used to measure frequency from 30 MHz to 1GHz. The final test is used the HP 85460A spectrum and 8564E spectrum was examined from 1GHz to 25GHz using an Hewlett Packard Spectrum Analyzer, EMCO/HP Horn Antenna (Model 3115 / 84125-80008) for 1G - 25GHz.

At each frequency, the EUT was rotated 360 degrees, and the antenna was raised and lowered from one to four meters to find the maximum emission levels. Measurements were taken using both horizontal and vertical antenna polarization.

Appropriate preamplifiers were used for improving sensitivity and precautions were taken to avoid overloading or desensitizing the spectrum analyzer. There are two spectrum analyzers use on this testing, HP 85460A for frequency 30MHz to 1000MHz, and 8564E for frequency 1GHz to 25GHz. No post-detector video filters were used in the test. The spectrum analyzer's 6dB bandwidth was set to 120KHz (spectrum was examined from 30 MHz to 1000 MHz), the spectrum analyzer's 6 dB bandwidth was set to 1 MHz (spectrum was examined from 1GHz to 25GHz) and the analyzer was operated in the maximum hold mode. There is a test condition applies in this test item, the test procedure description as the following:

Three channels were tested, one in the top, one in the middle and the other in bottom. The setting up procedure is recorded on <1.3>

With the transmitter operating from a AC source and using the internal of EUT, radiates spurious emissions falling within the restricted bands of 15.209 were measured at operating frequencies corresponding to upper, middle and bottom channels in the 2400 ~ 2483.5 MHz band.

The actual field intensity in decibels referenced to 1 microvolt per meter (dB $\mu$ V/m) is determined by algebraically adding the measured reading in dB $\mu$ V, the antenna factor (dB), and cable loss (dB) at the appropriate frequency. Since the EUT was set to transmit continuously, no *duty cycle* is present.

**For frequency between 30MHz to 1000MHz**

$$F_{Ia} \text{ (dBuV/m)} = F_{Ir} \text{ (dB}\mu\text{V)} + \text{Correction Factors}$$

F<sub>Ia</sub> : Actual Field Intensity

F<sub>Ir</sub> : Reading of the Field Intensity

Correction Factors = Antenna Factor + (Cable Loss – Amplifier Gain) + Switching Box Loss

**For frequency between 1GHz to 25GHz**

$$F_{Ia} \text{ (dB}\mu\text{V/m)} = F_{Ir} \text{ (dB}\mu\text{V)} + \text{Correction Factor}$$

F<sub>Ia</sub> : Actual Field Intensity

F<sub>Ir</sub> : Reading of the Field Intensity

Correction Factors = Antenna Factor + (Cable Loss – Amplifier Gain) + Switching Box Loss

## 8.2 List of Test Instruments

Instrument Name	Model	Brand	Serial No.	Calibration Date
				Next time
EMI Receiver	8546A	HP	3520A00242	12/01/06
RF Filter Section	85460A	HP	3448A00217	12/01/06
Small Biconical Antenna	UBAA9114 & BBVU9135	SCHWARZECK	127	02/17/07
Pre-amplifier	PA1F	TRC	1FAC	05/20/07
Auto Switch Box (>30MHz)	ASB-01	TRC	9904-01	05/20/07
Coaxial Cable (Double shielded, 15 meter)	A30A30-0058-50FS-15M	JYEBAO	SMA-01	05/20/07
Coaxial Cable (1.1 meter)	A30A30-0058-50FS-1M	JYEBAO	SMA-02	05/20/07
Spectrum Analyzer	8564E	HP	3720A00840	02/07/07
Microwave Preampfier	84125C	HP	US36433002	02/07/07
Horn Antenna	3115	EMCO	9104-3668	01/23/07
Standard Guide Horn Antenna	84125-80008	HP	18-26.5GHz	02/09/07
Standard Guide Horn Antenna	84125-80001	HP	26.5-40GHz	02/09/07
Horn Antenna	1196E (3115)	HP (EMCO)	9704-5178	01/26/07
Pre-amplifier	PA2F	TRC	2F1GZ	06/20/07
Coaxial Cable (3 miter)	A30A30-0058-50FST118	JYEBAO	MSA-05	06/20/07
Coaxial Cable (1 meter)	A30A30-0058-50FST118	JYEBAO	MSA-04	06/20/07



### 8.3 Test Result of Spurious Radiated Emissions

The highest peak values of radiated emissions from the EUT at various antenna heights, antenna polarizations, EUT orientation, etc. are recorded on the following.

Test Conditions: Temperature : 25 °C Humidity : 73 % RH

*Test mode: Standby mode for 30MHz to 1GHz [Horizontal]*

Radiated Emission				Correction Factors (dB)	Corrected Amplitude (dBμV/m)	Class B (3 m)	
Frequency (MHz)	Amplitude (dBμV)	Ant. H. (m)	Table ( )			Limit (dBμV/m)	Margin (dB)
43.34	21.31	1.00	119	4.90	26.21	40.00	-13.79
367.07	37.54	1.00	7	-2.19	35.35	46.00	-10.65
471.35	31.46	1.00	175	1.46	32.92	46.00	-13.08
482.26	32.88	1.00	17	1.77	34.65	46.00	-11.35
501.66	30.43	1.00	274	2.36	32.79	46.00	-13.21
729.61	22.81	1.00	192	9.82	32.63	46.00	-13.37

*Test mode: Standby mode for 30MHz to 1GHz [Vertical]*

Radiated Emission				Correction Factors (dB)	Corrected Amplitude (dBμV/m)	Class B (3 m)	
Frequency (MHz)	Amplitude (dBμV)	Ant. H. (m)	Table ( )			Limit (dBμV/m)	Margin (dB)
48.19	28.39	1.00	230	4.15	32.54	40.00	-7.46
67.59	32.86	1.00	270	1.50	34.36	40.00	-5.64
145.19	38.03	1.00	213	-3.27	34.76	43.50	-8.74
153.68	37.82	1.00	213	-3.58	34.24	43.50	-9.26
547.74	28.19	1.00	237	4.49	32.68	46.00	-13.32
729.61	28.46	1.00	343	9.82	38.28	46.00	-7.72

Note:

1. Margin = Amplitude – limit, if margin is minus means under limit.
2. Corrected Amplitude = Reading Amplitude + Correction Factors
3. Correction factor = Antenna factor + (Cable Loss – Amplitude gain) + Switching Box Loss

**Test mode: Standby mode for 1GHz to 26.5GHz [Horizontal]**

<i>Frequency</i>	<i>Ant. H.</i>	<i>Table</i>	<i>Amplitude</i>		<i>Correction Factor</i>	<i>Corrected Amplitude</i>		<i>Limit</i>		<i>Margin</i>
			<i>Peak / Ave.</i>			<i>Peak / Ave.</i>		<i>Peak / Ave.</i>		
<i>MHz</i>	<i>m</i>	<i>degree</i>	<i>dBμV</i>		<i>dB/m</i>	<i>dBμV/m</i>		<i>dBμV/m</i>		<i>dB</i>
4711.67	1.00	166	29.74	---	14.25	43.99	---	73.96	53.96	-9.97
12531.67	1.00	0	24.90	---	20.05	44.95	---	73.96	53.96	-9.01
19714.17	1.00	261	46.50	---	1.84	48.34	---	73.96	53.96	-5.62
21934.79	1.00	66	45.67	---	3.09	48.76	---	73.96	53.96	-5.20
24506.04	1.00	120	47.17	---	2.32	49.49	---	73.96	53.96	-4.47

**Test mode: Standby mode for 1GHz to 26.5GHz [Vertical]**

<i>Frequency</i>	<i>Ant. H.</i>	<i>Table</i>	<i>Amplitude</i>		<i>Correction Factor</i>	<i>Corrected Amplitude</i>		<i>Limit</i>		<i>Margin</i>
			<i>Peak / Ave.</i>			<i>Peak / Ave.</i>		<i>Peak / Ave.</i>		
<i>MHz</i>	<i>m</i>	<i>degree</i>	<i>dBμV</i>		<i>dB/m</i>	<i>dBμV/m</i>		<i>dBμV/m</i>		<i>dB</i>
6680.83	1.00	235	24.57	---	19.47	44.04	---	73.96	53.96	-9.92
10888.33	1.00	0	22.24	---	22.13	44.37	---	73.96	53.96	-9.59
19381.25	1.00	114	46.49	---	1.60	48.09	---	73.96	53.96	-5.87
22356.25	1.00	150	44.33	---	3.43	47.76	---	73.96	53.96	-6.20
24764.58	1.00	304	46.15	---	2.28	48.43	---	73.96	53.96	-5.53

Note:

1. Margin = Corrected - Limit.
2. The EUT utilizes a *permanently attached antenna*. In addition the spurious RF radiated emissions levels do comply with the *20dBc limit* both at its bandedges and other spurious emissions.
3. As stated in Section 15.35(b), for any frequencies above 1000MHz, radiated limits shown are based upon the use of measurement instrumentation employing an average detector function. As the results of our test, the peak amplitudes are already below the FCC limit. Thus the average amplitudes of the rest are omitted.

*Test mode: IEEE 802.11b CH01 for 30MHz to 1GHz [Horizontal]*

<b>Radiated Emission</b>				<b>Correction Factors</b>	<b>Corrected Amplitude</b>	<b>Class B (3 m)</b>	
<b>Frequency (MHz)</b>	<b>Amplitude (dBμV)</b>	<b>Ant. H. (m)</b>	<b>Table ( )</b>			<b>Limit (dBμV/m)</b>	<b>Margin (dB)</b>
31.21	20.74	1.00	146	7.79	28.53	40.00	-11.47
301.60	35.04	1.00	326	-3.32	31.72	46.00	-14.28
368.29	38.41	1.00	120	-2.15	36.26	46.00	-9.74
483.47	35.05	1.00	111	1.81	36.86	46.00	-9.14
729.61	23.27	1.00	62	9.82	33.09	46.00	-12.91
961.20	22.07	1.00	128	16.11	38.18	54.00	-15.82

*Test mode: IEEE 802.11b CH01 for 30MHz to 1GHz [Vertical]*

<b>Radiated Emission</b>				<b>Correction Factors</b>	<b>Corrected Amplitude</b>	<b>Class B (3 m)</b>	
<b>Frequency (MHz)</b>	<b>Amplitude (dBμV)</b>	<b>Ant. H. (m)</b>	<b>Table ( )</b>			<b>Limit (dBμV/m)</b>	<b>Margin (dB)</b>
31.21	26.30	1.00	120	7.79	34.09	40.00	-5.91
48.19	29.34	1.00	200	4.15	33.49	40.00	-6.51
67.59	32.34	1.00	225	1.50	33.84	40.00	-6.16
145.19	37.69	1.00	222	-3.27	34.42	43.50	-9.08
368.29	34.34	1.00	171	-2.15	32.19	46.00	-13.81
729.61	29.39	1.00	305	9.82	39.21	46.00	-6.79

**Test mode: IEEE 802.11b CH01 for 1GHz to 26.5GHz [Horizontal]**

Frequency	Ant. H.	Table	Amplitude		Correction Factor	Corrected Amplitude		Limit		Margin
			Peak / Ave.			Peak / Ave.		Peak / Ave.		
MHz	m	degree	dBµV		dB/m	dBµV/m		dBµV/m		dB
2172.92	1.00	177	41.17	---	8.57	49.74	---	73.96	53.96	-4.22
2319.97	1.00	76	44.99	36.67	8.99	53.98	45.66	73.96	53.96	-8.30
2479.98	1.00	179	46.00	41.50	9.43	55.43	50.93	73.96	53.96	-3.03
7239.79	1.00	59	42.10	---	10.11	52.21	---	73.96	53.96	-1.75
19296.25	1.00	127	47.00	---	1.60	48.60	---	73.96	53.96	-5.36
24120.00	1.00	143	44.33	---	3.40	47.73	---	73.96	53.96	-6.23

**Test mode: IEEE 802.11b CH01 for 1GHz to 26.5GHz [Vertical]**

Frequency	Ant. H.	Table	Amplitude		Correction Factor	Corrected Amplitude		Limit		Margin
			Peak / Ave.			Peak / Ave.		Peak / Ave.		
MHz	m	degree	dBµV		dB/m	dBµV/m		dBµV/m		dB
2152.08	1.00	167	40.83	---	8.52	49.35	---	73.96	53.96	-4.61
2310.42	1.00	96	42.17	---	8.96	51.13	---	73.96	53.96	-2.83
2527.08	1.00	87	40.67	---	9.54	50.21	---	73.96	53.96	-3.75
7233.75	1.00	215	37.78	---	10.07	47.85	---	73.96	53.96	-6.11
19296.25	1.00	347	48.00	---	1.60	49.60	---	73.96	53.96	-4.36
24120.00	1.00	358	45.67	---	3.40	49.07	---	73.96	53.96	-4.89

*Test mode: IEEE 802.11b CH06 for 30MHz to 1GHz [Horizontal]*

<b>Radiated Emission</b>				<b>Correction Factors</b>	<b>Corrected Amplitude</b>	<b>Class B (3 m)</b>	
<b>Frequency (MHz)</b>	<b>Amplitude (dBμV)</b>	<b>Ant. H. (m)</b>	<b>Table ( )</b>			<b>Limit (dBμV/m)</b>	<b>Margin (dB)</b>
302.81	34.65	1.00	330	-3.30	31.35	46.00	-14.65
339.19	33.39	1.00	340	-2.84	30.55	46.00	-15.45
357.37	41.12	1.00	43	-2.48	38.64	46.00	-7.36
368.29	38.41	1.00	122	-2.15	36.26	46.00	-9.74
482.26	35.09	1.00	102	1.77	36.86	46.00	-9.14
729.61	23.34	1.00	52	9.82	33.16	46.00	-12.84

*Test mode: IEEE 802.11b CH06 for 30MHz to 1GHz [Vertical]*

<b>Radiated Emission</b>				<b>Correction Factors</b>	<b>Corrected Amplitude</b>	<b>Class B (3 m)</b>	
<b>Frequency (MHz)</b>	<b>Amplitude (dBμV)</b>	<b>Ant. H. (m)</b>	<b>Table ( )</b>			<b>Limit (dBμV/m)</b>	<b>Margin (dB)</b>
48.19	28.80	1.00	230	4.15	32.95	40.00	-7.05
66.37	33.43	1.00	220	1.59	35.02	40.00	-4.98
145.19	38.37	1.00	233	-3.27	35.10	43.50	-8.40
367.07	34.64	1.00	177	-2.19	32.45	46.00	-13.55
729.61	29.04	1.00	302	9.82	38.86	46.00	-7.14
903.00	21.76	1.00	295	14.81	36.57	46.00	-9.43

*Test mode: IEEE 802.11b CH06 for 1GHz to 26.5GHz [Horizontal]*

<i>Frequency</i>	<i>Ant. H.</i>	<i>Table</i>	<i>Amplitude</i>		<i>Correction Factor</i>	<i>Corrected Amplitude</i>		<i>Limit</i>		<i>Margin</i>
			<i>Peak / Ave.</i>			<i>Peak / Ave.</i>		<i>Peak / Ave.</i>		
<i>MHz</i>	<i>m</i>	<i>degree</i>	<i>dBμV</i>		<i>dB/m</i>	<i>dBμV/m</i>		<i>dBμV/m</i>		<i>dB</i>
2157.64	1.00	239	46.84	35.67	8.53	55.37	44.20	73.96	53.96	-9.76
2319.97	1.00	145	46.66	39.17	8.99	55.65	48.16	73.96	53.96	-5.80
2519.98	1.00	169	43.67	35.83	9.53	53.20	45.36	73.96	53.96	-8.60
7312.70	1.00	51	45.94	34.44	10.30	56.24	44.74	73.96	53.96	-9.22
9747.08	1.00	36	37.27	---	11.89	49.16	---	73.96	53.96	-4.80
24371.46	1.00	61	46.00	---	3.26	49.26	---	73.96	53.96	-4.70

*Test mode: IEEE 802.11b CH06 for 1GHz to 26.5GHz [Vertical]*

<i>Frequency</i>	<i>Ant. H.</i>	<i>Table</i>	<i>Amplitude</i>		<i>Correction Factor</i>	<i>Corrected Amplitude</i>		<i>Limit</i>		<i>Margin</i>
			<i>Peak / Ave.</i>			<i>Peak / Ave.</i>		<i>Peak / Ave.</i>		
<i>MHz</i>	<i>m</i>	<i>degree</i>	<i>dBμV</i>		<i>dB/m</i>	<i>dBμV/m</i>		<i>dBμV/m</i>		<i>dB</i>
2152.08	1.00	131	42.16	---	8.52	50.68	---	73.96	53.96	-3.28
2329.17	1.00	146	42.50	---	9.01	51.51	---	73.96	53.96	-2.45
2560.42	1.00	134	39.50	---	9.60	49.10	---	73.96	53.96	-4.86
7312.29	1.00	159	39.94	---	10.30	50.24	---	73.96	53.96	-3.72
21934.79	1.00	43	46.00	---	3.09	49.09	---	73.96	53.96	-4.87
24371.46	1.00	300	46.00	---	3.26	49.26	---	73.96	53.96	-4.70

*Test mode: IEEE 802.11b CH11 for 30MHz to 1GHz [Horizontal]*

<i>Radiated Emission</i>				<i>Correction Factors</i>	<i>Corrected Amplitude</i>	<i>Class B (3 m)</i>	
<i>Frequency (MHz)</i>	<i>Amplitude (dB<math>\mu</math>V)</i>	<i>Ant. H. (m)</i>	<i>Table ( )</i>			<i>Limit (dB<math>\mu</math>V/m)</i>	<i>Margin (dB)</i>
38.49	21.94	1.00	170	5.78	27.72	40.00	-12.28
304.02	34.11	1.00	17	-3.29	30.82	46.00	-15.18
368.29	38.73	1.00	127	-2.15	36.58	46.00	-9.42
434.97	31.94	1.00	117	0.23	32.17	46.00	-13.83
482.26	34.59	1.00	107	1.77	36.36	46.00	-9.64
729.61	23.50	1.00	52	9.82	33.32	46.00	-12.68

*Test mode: IEEE 802.11b CH11 for 30MHz to 1GHz [Vertical]*

<i>Radiated Emission</i>				<i>Correction Factors</i>	<i>Corrected Amplitude</i>	<i>Class B (3 m)</i>	
<i>Frequency (MHz)</i>	<i>Amplitude (dB<math>\mu</math>V)</i>	<i>Ant. H. (m)</i>	<i>Table ( )</i>			<i>Limit (dB<math>\mu</math>V/m)</i>	<i>Margin (dB)</i>
32.42	29.27	1.00	3	7.34	34.57	40.00	-5.43
48.19	29.27	1.00	240	4.15	33.42	40.00	-6.58
67.59	33.23	1.00	240	1.50	34.73	40.00	-5.27
145.19	38.22	1.00	233	-3.27	34.95	43.50	-8.55
368.29	34.53	1.00	177	-2.15	32.38	46.00	-13.62
729.61	28.62	1.00	309	9.82	38.44	46.00	-7.56

*Test mode: IEEE 802.11b CH11 for 1GHz to 26.5GHz [Horizontal]*

<i>Frequency</i>	<i>Ant. H.</i>	<i>Table</i>	<i>Amplitude</i>		<i>Correction Factor</i>	<i>Corrected Amplitude</i>		<i>Limit</i>		<i>Margin</i>
			<i>Peak / Ave.</i>			<i>Peak / Ave.</i>		<i>Peak / Ave.</i>		
<i>MHz</i>	<i>m</i>	<i>degree</i>	<i>dBμV</i>		<i>dB/m</i>	<i>dBμV/m</i>		<i>dBμV/m</i>		<i>dB</i>
2157.18	1.00	154	43.85	33.17	8.53	52.38	41.70	73.96	53.96	-12.26
2317.18	1.00	79	45.99	37.67	8.98	54.97	46.65	73.96	53.96	-7.31
2399.98	1.00	79	47.15	40.50	9.21	56.36	49.71	73.96	53.96	-4.25
2559.98	1.00	79	44.67	38.50	9.60	54.27	48.10	73.96	53.96	-5.86
7384.79	1.00	168	39.61	---	10.42	50.03	---	73.96	53.96	-3.93
24619.37	1.00	78	46.50	---	3.01	49.51	---	73.96	53.96	-4.45

*Test mode: IEEE 802.11b CH11 for 1GHz to 26.5GHz [Vertical]*

<i>Frequency</i>	<i>Ant. H.</i>	<i>Table</i>	<i>Amplitude</i>		<i>Correction Factor</i>	<i>Corrected Amplitude</i>		<i>Limit</i>		<i>Margin</i>
			<i>Peak / Ave.</i>			<i>Peak / Ave.</i>		<i>Peak / Ave.</i>		
<i>MHz</i>	<i>m</i>	<i>degree</i>	<i>dBμV</i>		<i>dB/m</i>	<i>dBμV/m</i>		<i>dBμV/m</i>		<i>dB</i>
2160.42	1.00	168	42.00	---	8.54	50.54	---	73.96	53.96	-3.42
2279.97	1.00	81	44.67	35.00	8.87	53.54	43.87	73.96	53.96	-10.09
2399.98	1.00	81	42.82	36.33	9.21	52.03	45.54	73.96	53.96	-8.42
2559.98	1.00	80	42.50	36.83	9.60	52.10	46.43	73.96	53.96	-7.53
7378.55	1.00	63	44.11	34.27	10.43	54.54	44.70	73.96	53.96	-9.26
24619.37	1.00	204	45.33	---	3.01	48.34	---	73.96	53.96	-5.62



*Test mode: IEEE 802.11g CH01 for 30MHz to 1GHz [Horizontal]*

<b>Radiated Emission</b>				<b>Correction Factors</b>	<b>Corrected Amplitude</b>	<b>Class B (3 m)</b>	
<b>Frequency (MHz)</b>	<b>Amplitude (dBμV)</b>	<b>Ant. H. (m)</b>	<b>Table ( )</b>			<b>Limit (dBμV/m)</b>	<b>Margin (dB)</b>
368.29	38.92	1.00	127	-2.15	36.77	46.00	-9.23
436.19	31.98	1.00	117	0.28	32.26	46.00	-13.74
483.47	34.00	1.00	337	1.81	35.81	46.00	-10.19
729.61	23.43	1.00	58	9.82	33.25	46.00	-12.75
881.17	21.54	1.00	261	14.13	35.67	46.00	-10.33
997.58	21.12	1.00	75	17.32	38.44	54.00	-15.56

*Test mode: IEEE 802.11g CH01 for 30MHz to 1GHz [Vertical]*

<b>Radiated Emission</b>				<b>Correction Factors</b>	<b>Corrected Amplitude</b>	<b>Class B (3 m)</b>	
<b>Frequency (MHz)</b>	<b>Amplitude (dBμV)</b>	<b>Ant. H. (m)</b>	<b>Table ( )</b>			<b>Limit (dBμV/m)</b>	<b>Margin (dB)</b>
48.19	28.87	1.00	208	4.15	33.02	40.00	-6.98
67.59	32.79	1.00	188	1.50	34.29	40.00	-5.71
147.61	31.31	1.00	231	3.45	34.76	43.50	-8.74
202.17	31.62	1.00	53	-3.56	28.06	43.50	-15.44
368.29	33.90	1.00	175	-2.15	31.75	46.00	-14.25
729.61	28.99	1.00	309	9.82	38.81	46.00	-7.19

**Test mode: IEEE 802.11g CH01 for 1GHz to 26.5GHz [Horizontal]**

Frequency	Ant. H.	Table	Amplitude		Correction Factor	Corrected Amplitude		Limit		Margin
			Peak / Ave.			Peak / Ave.		Peak / Ave.		
MHz	m	degree	dBμV		dB/m	dBμV/m		dBμV/m		dB
2168.75	1.00	318	42.50	---	8.56	51.06	---	73.96	53.96	-2.90
2319.99	1.00	68	46.33	40.33	8.99	55.32	49.32	73.96	53.96	-4.64
2479.97	1.00	264	47.33	42.83	9.43	56.76	52.26	73.96	53.96	-1.70
9650.42	1.00	124	37.44	---	11.47	48.91	---	73.96	53.96	-5.05
12061.04	1.00	253	39.44	---	9.81	49.25	---	73.96	53.96	-4.71
21708.12	1.00	10	45.67	---	2.87	48.54	---	73.96	53.96	-5.42

**Test mode: IEEE 802.11g CH01 for 1GHz to 26.5GHz [Vertical]**

Frequency	Ant. H.	Table	Amplitude		Correction Factor	Corrected Amplitude		Limit		Margin
			Peak / Ave.			Peak / Ave.		Peak / Ave.		
MHz	m	degree	dBμV		dB/m	dBμV/m		dBμV/m		dB
2152.08	1.00	180	42.00	---	8.52	50.52	---	73.96	53.96	-3.44
2279.17	1.00	78	42.33	---	8.87	51.20	---	73.96	53.96	-2.76
2479.97	1.00	78	45.50	39.33	9.43	54.93	48.76	73.96	53.96	-5.20
7239.79	1.00	59	41.60	---	10.11	51.71	---	73.96	53.96	-2.25
12061.04	1.00	341	39.94	---	9.81	49.75	---	73.96	53.96	-4.21
21708.12	1.00	60	45.50	---	2.87	48.37	---	73.96	53.96	-5.59

*Test mode: IEEE 802.11g CH06 for 30MHz to 1GHz [Horizontal]*

<i>Radiated Emission</i>				<i>Correction Factors</i>	<i>Corrected Amplitude</i>	<i>Class B (3 m)</i>	
<i>Frequency (MHz)</i>	<i>Amplitude (dB<math>\mu</math>V)</i>	<i>Ant. H. (m)</i>	<i>Table ( )</i>			<i>Limit (dB<math>\mu</math>V/m)</i>	<i>Margin (dB)</i>
268.86	39.45	1.00	23	-4.26	35.19	46.00	-10.81
301.60	35.93	1.00	337	-3.32	32.61	46.00	-13.39
368.29	39.06	1.00	127	-2.15	36.91	46.00	-9.09
483.47	34.68	1.00	27	1.81	36.49	46.00	-9.51
729.61	22.49	1.00	62	9.82	32.31	46.00	-13.69
961.20	21.15	1.00	165	16.11	37.26	54.00	-16.74

*Test mode: IEEE 802.11g CH06 for 30MHz to 1GHz [Vertical]*

<i>Radiated Emission</i>				<i>Correction Factors</i>	<i>Corrected Amplitude</i>	<i>Class B (3 m)</i>	
<i>Frequency (MHz)</i>	<i>Amplitude (dB<math>\mu</math>V)</i>	<i>Ant. H. (m)</i>	<i>Table ( )</i>			<i>Limit (dB<math>\mu</math>V/m)</i>	<i>Margin (dB)</i>
31.21	26.02	1.00	167	7.79	33.81	40.00	-6.19
44.55	28.42	1.00	217	4.67	33.09	40.00	-6.91
66.37	33.16	1.00	217	1.59	34.75	40.00	-5.25
147.61	38.67	1.00	240	-3.45	35.22	43.50	-8.28
369.50	33.07	1.00	173	-1.11	31.96	46.00	-14.04
729.61	28.94	1.00	301	9.82	38.76	46.00	-7.24

*Test mode: IEEE 802.11g CH06 for 1GHz to 26.5GHz [Horizontal]*

Frequency	Ant. H.	Table	Amplitude		Correction Factor	Corrected Amplitude		Limit		Margin
			Peak / Ave.			Peak / Ave.		Peak / Ave.		
MHz	m	degree	dBµV		dB/m	dBµV/m		dBµV/m		dB
2159.97	1.00	260	48.15	35.83	8.54	56.69	44.37	73.96	53.96	-9.59
2302.18	1.00	166	48.83	40.33	8.94	57.77	49.27	73.96	53.96	-4.69
2559.99	1.00	240	45.33	41.50	9.60	54.93	51.10	73.96	53.96	-2.86
7312.29	1.00	207	38.61	---	10.30	48.91	---	73.96	53.96	-5.05
12187.92	1.00	38	39.44	---	9.74	49.18	---	73.96	53.96	-4.78
24371.46	1.00	255	46.34	---	3.26	49.60	---	73.96	53.96	-4.36

*Test mode: IEEE 802.11g CH06 for 1GHz to 26.5GHz [Vertical]*

Frequency	Ant. H.	Table	Amplitude		Correction Factor	Corrected Amplitude		Limit		Margin
			Peak / Ave.			Peak / Ave.		Peak / Ave.		
MHz	m	degree	dBµV		dB/m	dBµV/m		dBµV/m		dB
2152.08	1.00	179	42.16	---	8.52	50.68	---	73.96	53.96	-3.28
2319.98	1.00	101	45.16	36.83	8.99	54.15	45.82	73.96	53.96	-8.14
7312.44	1.00	55	42.77	31.77	10.30	53.07	42.07	73.96	53.96	-11.89
12187.92	1.00	312	39.60	---	9.74	49.34	---	73.96	53.96	-4.62
21934.79	1.00	118	45.83	---	3.09	48.92	---	73.96	53.96	-5.04
24371.46	1.00	261	45.67	---	3.26	48.93	---	73.96	53.96	-5.03

*Test mode: IEEE 802.11g CH11 for 30MHz to 1GHz [Horizontal]*

<i>Radiated Emission</i>				<i>Correction Factors</i>	<i>Corrected Amplitude</i>	<i>Class B (3 m)</i>	
<i>Frequency (MHz)</i>	<i>Amplitude (dB<math>\mu</math>V)</i>	<i>Ant. H. (m)</i>	<i>Table ( )</i>			<i>Limit (dB<math>\mu</math>V/m)</i>	<i>Margin (dB)</i>
302.81	34.06	1.00	343	-3.30	30.76	46.00	-15.24
339.19	33.37	1.00	337	-2.84	30.53	46.00	-15.47
368.29	39.44	1.00	127	-2.15	37.29	46.00	-8.71
482.26	34.81	1.00	337	1.77	36.58	46.00	-9.42
729.61	23.41	1.00	62	9.82	33.23	46.00	-12.77
961.20	21.61	1.00	171	16.11	37.72	54.00	-16.28

*Test mode: IEEE 802.11g CH11 for 30MHz to 1GHz [Vertical]*

<i>Radiated Emission</i>				<i>Correction Factors</i>	<i>Corrected Amplitude</i>	<i>Class B (3 m)</i>	
<i>Frequency (MHz)</i>	<i>Amplitude (dB<math>\mu</math>V)</i>	<i>Ant. H. (m)</i>	<i>Table ( )</i>			<i>Limit (dB<math>\mu</math>V/m)</i>	<i>Margin (dB)</i>
40.91	28.83	1.00	258	5.35	34.18	40.00	-5.82
66.37	32.73	1.00	208	1.59	34.32	40.00	-5.68
90.62	31.25	1.00	168	-0.09	31.16	43.50	-12.34
147.61	38.33	1.00	241	-3.45	34.88	43.50	-8.62
367.07	34.46	1.00	175	-2.19	32.27	46.00	-13.73
729.61	29.23	1.00	302	9.82	39.05	46.00	-6.95

*Test mode: IEEE 802.11g CH11 for 1GHz to 26.5GHz [Horizontal]*

<i>Frequency</i>	<i>Ant. H.</i>	<i>Table</i>	<i>Amplitude</i>		<i>Correction Factor</i>	<i>Corrected Amplitude</i>		<i>Limit</i>		<i>Margin</i>
			<i>Peak / Ave.</i>			<i>Peak / Ave.</i>		<i>Peak / Ave.</i>		
<i>MHz</i>	<i>m</i>	<i>degree</i>	<i>dBμV</i>		<i>dB/m</i>	<i>dBμV/m</i>		<i>dBμV/m</i>		<i>dB</i>
2157.16	1.00	158	45.85	34.67	8.53	54.38	43.20	73.96	53.96	-10.76
2319.97	1.00	84	48.65	41.50	8.99	57.64	50.49	73.96	53.96	-3.47
2559.99	1.00	247	46.50	41.33	9.60	56.10	50.93	73.96	53.96	-3.03
12308.75	1.00	0	38.11	---	9.56	47.67	---	73.96	53.96	-6.29
19696.46	1.00	338	46.33	---	1.81	48.14	---	73.96	53.96	-5.82
24619.37	1.00	222	46.83	---	3.01	49.84	---	73.96	53.96	-4.12

*Test mode: IEEE 802.11g CH11 for 1GHz to 26.5GHz [Vertical]*

<i>Frequency</i>	<i>Ant. H.</i>	<i>Table</i>	<i>Amplitude</i>		<i>Correction Factor</i>	<i>Corrected Amplitude</i>		<i>Limit</i>		<i>Margin</i>
			<i>Peak / Ave.</i>			<i>Peak / Ave.</i>		<i>Peak / Ave.</i>		
<i>MHz</i>	<i>m</i>	<i>degree</i>	<i>dBμV</i>		<i>dB/m</i>	<i>dBμV/m</i>		<i>dBμV/m</i>		<i>dB</i>
2157.68	1.00	164	44.83	32.67	8.53	53.36	41.20	73.96	53.96	-12.76
2319.98	1.00	81	46.49	39.33	8.99	55.48	48.32	73.96	53.96	-5.64
2559.97	1.00	80	44.83	39.67	9.60	54.43	49.27	73.96	53.96	-4.69
7384.61	1.00	56	43.78	32.11	10.42	54.20	42.53	73.96	53.96	-11.43
22157.92	1.00	118	44.83	---	3.25	48.08	---	73.96	53.96	-5.88
24619.37	1.00	33	46.50	---	3.01	49.51	---	73.96	53.96	-4.45

*Test mode: IEEE 802.11n 20M CH01 for 30MHz to 1GHz [Horizontal]*

<b>Radiated Emission</b>				<b>Correction Factors</b>	<b>Corrected Amplitude</b>	<b>Class B (3 m)</b>	
<b>Frequency (MHz)</b>	<b>Amplitude (dBμV)</b>	<b>Ant. H. (m)</b>	<b>Table ( )</b>			<b>Limit (dBμV/m)</b>	<b>Margin (dB)</b>
301.60	35.60	1.00	0	-3.32	32.28	46.00	-13.72
368.29	39.22	1.00	116	-2.15	37.07	46.00	-8.93
434.97	32.48	1.00	116	0.23	32.71	46.00	-13.29
483.47	34.57	1.00	106	1.81	36.38	46.00	-9.62
729.61	22.90	1.00	107	9.82	32.72	46.00	-13.28
961.20	22.45	1.00	128	16.11	38.56	54.00	-15.44

*Test mode: IEEE 802.11n 20M CH01 for 30MHz to 1GHz [Vertical]*

<b>Radiated Emission</b>				<b>Correction Factors</b>	<b>Corrected Amplitude</b>	<b>Class B (3 m)</b>	
<b>Frequency (MHz)</b>	<b>Amplitude (dBμV)</b>	<b>Ant. H. (m)</b>	<b>Table ( )</b>			<b>Limit (dBμV/m)</b>	<b>Margin (dB)</b>
67.59	32.74	1.00	225	1.50	34.24	40.00	-5.76
145.19	37.98	1.00	229	-3.27	34.71	43.50	-8.79
179.14	40.54	1.00	259	-3.79	36.75	43.50	-6.75
268.86	40.54	1.00	269	-4.26	36.28	46.00	-9.72
312.51	40.33	1.00	273	-3.18	37.15	46.00	-8.85
729.61	28.85	1.00	305	9.82	38.67	46.00	-7.33

**Test mode: IEEE 802.11n 20M CH01 for 1GHz to 26.5GHz [Horizontal]**

<i>Frequency</i>	<i>Ant. H.</i>	<i>Table</i>	<i>Amplitude</i>		<i>Correction Factor</i>	<i>Corrected Amplitude</i>		<i>Limit</i>		<i>Margin</i>
			<i>Peak / Ave.</i>			<i>Peak / Ave.</i>		<i>Peak / Ave.</i>		
<i>MHz</i>	<i>m</i>	<i>degree</i>	<i>dBμV</i>		<i>dB/m</i>	<i>dBμV/m</i>		<i>dBμV/m</i>		<i>dB</i>
2160.42	1.00	160	41.67	---	8.54	50.21	---	73.96	53.96	-3.75
2319.99	1.00	177	46.66	40.33	8.99	55.65	49.23	73.96	53.96	-4.64
2479.98	1.00	164	45.67	41.17	9.43	55.10	50.60	73.96	53.96	-3.36
7233.75	1.00	134	42.11	---	10.07	52.18	---	73.96	53.96	-1.78
21708.12	1.00	160	45.83	---	2.87	48.70	---	73.96	53.96	-5.26
24120.00	1.00	169	44.67	---	3.40	48.07	---	73.96	53.96	-5.89

**Test mode: IEEE 802.11n 20M CH01 for 1GHz to 26.5GHz [Vertical]**

<i>Frequency</i>	<i>Ant. H.</i>	<i>Table</i>	<i>Amplitude</i>		<i>Correction Factor</i>	<i>Corrected Amplitude</i>		<i>Limit</i>		<i>Margin</i>
			<i>Peak / Ave.</i>			<i>Peak / Ave.</i>		<i>Peak / Ave.</i>		
<i>MHz</i>	<i>m</i>	<i>degree</i>	<i>dBμV</i>		<i>dB/m</i>	<i>dBμV/m</i>		<i>dBμV/m</i>		<i>dB</i>
2152.08	1.00	170	40.33	---	8.52	48.85		73.96	53.96	-5.11
2316.67	1.00	69	42.16	---	8.98	51.14	---	73.96	53.96	-2.82
2558.33	1.00	69	40.33	---	9.60	49.93	---	73.96	53.96	-4.03
7233.49	1.00	50	48.61	36.77	10.07	58.68	46.84	73.96	53.96	-7.12
12061.04	1.00	109	38.94	---	9.81	48.75	---	73.96	53.96	-5.21
24120.00	1.00	291	45.33	---	3.40	48.73	---	73.96	53.96	-5.23



*Test mode: IEEE 802.11n 20M CH06 for 30MHz to 1GHz [Horizontal]*

<b>Radiated Emission</b>				<b>Correction Factors</b>	<b>Corrected Amplitude</b>	<b>Class B (3 m)</b>	
<b>Frequency (MHz)</b>	<b>Amplitude (dBμV)</b>	<b>Ant. H. (m)</b>	<b>Table ( )</b>			<b>Limit (dBμV/m)</b>	<b>Margin (dB)</b>
38.49	22.75	1.00	10	5.78	28.53	40.00	-11.47
302.81	35.62	1.00	321	-3.30	32.32	46.00	-13.68
340.40	33.13	1.00	331	-2.82	30.31	46.00	-15.69
368.29	39.30	1.00	124	-2.15	37.15	46.00	-8.85
483.47	34.52	1.00	10	1.81	36.33	46.00	-9.67
729.61	23.84	1.00	52	9.82	33.66	46.00	-12.34

*Test mode: IEEE 802.11n 20M CH06 for 30MHz to 1GHz [Vertical]*

<b>Radiated Emission</b>				<b>Correction Factors</b>	<b>Corrected Amplitude</b>	<b>Class B (3 m)</b>	
<b>Frequency (MHz)</b>	<b>Amplitude (dBμV)</b>	<b>Ant. H. (m)</b>	<b>Table ( )</b>			<b>Limit (dBμV/m)</b>	<b>Margin (dB)</b>
43.34	27.98	1.00	230	4.90	32.88	40.00	-7.12
66.37	32.66	1.00	250	1.59	34.25	40.00	-5.75
145.19	38.37	1.00	233	-3.27	35.10	43.50	-8.40
202.17	32.96	1.00	43	-3.56	29.40	43.50	-14.10
729.61	28.99	1.00	295	9.82	38.81	46.00	-7.19
912.70	20.73	1.00	96	15.00	35.73	46.00	-10.27

**Test mode: IEEE 802.11n 20M CH06 for 1GHz to 26.5GHz [Horizontal]**

Frequency	Ant. H.	Table	Amplitude		Correction Factor	Corrected Amplitude		Limit		Margin
			Peak / Ave.			Peak / Ave.		Peak / Ave.		
MHz	m	degree	dBμV		dB/m	dBμV/m		dBμV/m		dB
2175.10	1.00	217	43.02	30.17	8.58	51.60	38.75	73.96	53.96	-15.21
2319.98	1.00	184	48.49	42.50	8.99	57.48	51.49	73.96	53.96	-2.47
2559.97	1.00	201	45.33	39.50	9.60	54.93	49.10	73.96	53.96	-4.86
7312.54	1.00	194	42.77	30.77	10.30	53.07	41.07	73.96	53.96	-12.89
12187.92	1.00	200	40.60	---	9.74	50.34	---	73.96	53.96	-3.62
24371.46	1.00	120	45.67	---	3.26	48.93	---	73.96	53.96	-5.03

**Test mode: IEEE 802.11n 20M CH06 for 1GHz to 26.5GHz [Vertical]**

Frequency	Ant. H.	Table	Amplitude		Correction Factor	Corrected Amplitude		Limit		Margin
			Peak / Ave.			Peak / Ave.		Peak / Ave.		
MHz	m	degree	dBμV		dB/m	dBμV/m		dBμV/m		dB
2152.08	1.00	193	40.66	---	8.52	49.18		73.96	53.96	-4.78
2285.42	1.00	64	39.33	---	8.89	48.22	---	73.96	53.96	-5.74
7311.85	1.00	49	46.77	35.94	10.30	57.07	46.24	73.96	53.96	-7.22
12187.92	1.00	222	39.60	---	9.74	49.34	---	73.96	53.96	-4.62
21934.79	1.00	258	45.67	---	3.09	48.76	---	73.96	53.96	-5.20
24371.46	1.00	338	45.50	---	3.26	48.76	---	73.96	53.96	-5.20

*Test mode: IEEE 802.11n 20M CH11 for 30MHz to 1GHz [Horizontal]*

<i>Radiated Emission</i>				<i>Correction Factors</i>	<i>Corrected Amplitude</i>	<i>Class B (3 m)</i>	
<i>Frequency (MHz)</i>	<i>Amplitude (dB<math>\mu</math>V)</i>	<i>Ant. H. (m)</i>	<i>Table ( )</i>			<i>Limit (dB<math>\mu</math>V/m)</i>	<i>Margin (dB)</i>
31.21	20.62	1.00	90	7.79	28.41	40.00	-11.59
203.39	29.00	1.00	183	-3.62	25.38	43.50	-18.12
301.60	33.55	1.00	37	-3.32	30.23	46.00	-15.77
368.29	38.87	1.00	127	-2.15	36.72	46.00	-9.28
483.47	35.35	1.00	117	1.81	37.16	46.00	-8.84
961.20	20.83	1.00	130	16.11	36.94	54.00	-17.06

*Test mode: IEEE 802.11n 20M CH11 for 30MHz to 1GHz [Vertical]*

<i>Radiated Emission</i>				<i>Correction Factors</i>	<i>Corrected Amplitude</i>	<i>Class B (3 m)</i>	
<i>Frequency (MHz)</i>	<i>Amplitude (dB<math>\mu</math>V)</i>	<i>Ant. H. (m)</i>	<i>Table ( )</i>			<i>Limit (dB<math>\mu</math>V/m)</i>	<i>Margin (dB)</i>
67.59	33.73	1.00	228	1.50	35.23	40.00	-4.77
145.19	38.01	1.00	241	-3.27	34.74	43.50	-8.76
169.44	37.02	1.00	13	-3.80	33.22	43.50	-10.28
368.29	34.36	1.00	175	-2.15	32.21	46.00	-13.79
729.61	28.81	1.00	294	9.82	38.63	46.00	-7.37
912.70	21.37	1.00	73	15.00	36.37	46.00	-9.63

**Test mode: IEEE 802.11n 20M CH11 for 1GHz to 26.5GHz [Horizontal]**

Frequency	Ant. H.	Table	Amplitude		Correction Factor	Corrected Amplitude		Limit		Margin
			Peak / Ave.			Peak / Ave.		Peak / Ave.		
MHz	m	degree	dBμV		dB/m	dBμV/m		dBμV/m		dB
2181.25	1.00	162	42.50	---	8.60	51.10	---	73.96	53.96	-2.86
2319.97	1.00	258	47.83	40.17	8.99	56.82	49.16	73.96	53.96	-4.80
2400.00	1.00	82	47.49	40.67	9.21	56.70	49.88	73.96	53.96	-4.08
2559.97	1.00	257	43.33	38.17	9.60	52.93	47.77	73.96	53.96	-6.19
7384.79	1.00	179	41.11	---	10.42	51.53	---	73.96	53.96	-2.43
24619.37	1.00	202	45.83	---	3.01	48.84	---	73.96	53.96	-5.12

**Test mode: IEEE 802.11n 20M CH11 for 1GHz to 26.5GHz [Vertical]**

Frequency	Ant. H.	Table	Amplitude		Correction Factor	Corrected Amplitude		Limit		Margin
			Peak / Ave.			Peak / Ave.		Peak / Ave.		
MHz	m	degree	dBμV		dB/m	dBμV/m		dBμV/m		dB
2319.97	1.00	77	43.99	35.83	8.99	52.98	44.82	73.96	53.96	-9.14
2558.33	1.00	75	40.33	---	9.60	49.93	---	73.96	53.96	-4.03
7384.70	1.00	57	46.28	36.11	10.42	56.70	46.53	73.96	53.96	-7.43
19696.46	1.00	283	45.83	---	1.81	47.64	---	73.96	53.96	-6.32
22157.92	1.00	196	44.66	---	3.25	47.91	---	73.96	53.96	-6.05
24619.37	1.00	82	45.50	---	3.01	48.51	---	73.96	53.96	-5.45

*Test mode: IEEE 802.11n 40M CH03 for 30MHz to 1GHz [Horizontal]*

<b>Radiated Emission</b>				<b>Correction Factors</b>	<b>Corrected Amplitude</b>	<b>Class B (3 m)</b>	
<b>Frequency (MHz)</b>	<b>Amplitude (dBμV)</b>	<b>Ant. H. (m)</b>	<b>Table ( )</b>			<b>Limit (dBμV/m)</b>	<b>Margin (dB)</b>
93.05	29.10	1.00	117	-0.29	28.81	43.50	-14.69
368.29	39.30	1.00	123	-2.15	37.15	46.00	-8.85
468.92	31.70	1.00	203	1.39	33.09	46.00	-12.91
483.47	35.61	1.00	103	1.81	37.42	46.00	-8.58
729.61	23.20	1.00	66	9.82	33.02	46.00	-12.98
961.20	23.09	1.00	121	16.11	39.20	54.00	-14.80

*Test mode: IEEE 802.11n 40M CH03 for 30MHz to 1GHz [Vertical]*

<b>Radiated Emission</b>				<b>Correction Factors</b>	<b>Corrected Amplitude</b>	<b>Class B (3 m)</b>	
<b>Frequency (MHz)</b>	<b>Amplitude (dBμV)</b>	<b>Ant. H. (m)</b>	<b>Table ( )</b>			<b>Limit (dBμV/m)</b>	<b>Margin (dB)</b>
48.19	29.89	1.00	198	4.15	34.04	40.00	-5.96
66.37	32.31	1.00	198	1.59	33.90	40.00	-6.10
147.61	38.21	1.00	241	-3.45	34.76	43.50	-8.74
288.26	34.95	1.00	251	-3.82	31.13	46.00	-14.87
368.29	34.53	1.00	185	-2.15	32.38	46.00	-13.62
729.61	28.81	1.00	302	9.82	38.63	46.00	-7.37

*Test mode: IEEE 802.11n 40M CH03 for 1GHz to 26.5GHz [Horizontal]*

<i>Frequency</i>	<i>Ant. H.</i>	<i>Table</i>	<i>Amplitude</i>		<i>Correction Factor</i>	<i>Corrected Amplitude</i>		<i>Limit</i>		<i>Margin</i>
			<i>Peak / Ave.</i>			<i>Peak / Ave.</i>		<i>Peak / Ave.</i>		
<i>MHz</i>	<i>m</i>	<i>degree</i>	<i>dBμV</i>		<i>dB/m</i>	<i>dBμV/m</i>		<i>dBμV/m</i>		<i>dB</i>
2172.92	1.00	30	41.17	---	8.57	49.74	---	73.96	53.96	-4.22
2319.70	1.00	284	45.66	38.67	8.99	54.65	47.66	73.96	53.96	-6.30
2591.67	1.00	228	41.17	---	9.66	50.83	---	73.96	53.96	-3.13
7263.96	1.00	168	38.27	---	10.19	48.46	---	73.96	53.96	-5.50
19377.71	1.00	301	47.83	---	1.60	49.43	---	73.96	53.96	-4.53
21796.67	1.00	23	47.50	---	2.72	50.22	---	73.96	53.96	-3.74

*Test mode: IEEE 802.11n 40M CH03 for 1GHz to 26.5GHz [Vertical]*

<i>Frequency</i>	<i>Ant. H.</i>	<i>Table</i>	<i>Amplitude</i>		<i>Correction Factor</i>	<i>Corrected Amplitude</i>		<i>Limit</i>		<i>Margin</i>
			<i>Peak / Ave.</i>			<i>Peak / Ave.</i>		<i>Peak / Ave.</i>		
<i>MHz</i>	<i>m</i>	<i>degree</i>	<i>dBμV</i>		<i>dB/m</i>	<i>dBμV/m</i>		<i>dBμV/m</i>		<i>dB</i>
2154.17	1.00	107	41.50	---	8.52	50.02	---	73.96	53.96	-3.94
2318.75	1.00	97	42.50	---	8.98	51.48	---	73.96	53.96	-2.48
2558.33	1.00	84	39.33	---	9.60	48.93	---	73.96	53.96	-5.03
7270.00	1.00	50	41.61	---	10.20	51.81	---	73.96	53.96	-2.15
19377.71	1.00	247	47.33	---	1.60	48.93	---	73.96	53.96	-5.03
21800.21	1.00	231	47.33	---	2.72	50.05	---	73.96	53.96	-3.91

*Test mode: IEEE 802.11n 40M CH06 for 30MHz to 1GHz [Horizontal]*

<b>Radiated Emission</b>				<b>Correction Factors</b>	<b>Corrected Amplitude</b>	<b>Class B (3 m)</b>	
<b>Frequency (MHz)</b>	<b>Amplitude (dBμV)</b>	<b>Ant. H. (m)</b>	<b>Table ( )</b>			<b>Limit (dBμV/m)</b>	<b>Margin (dB)</b>
367.07	37.68	1.00	165	-2.19	35.49	46.00	-10.51
436.19	31.75	1.00	0	0.28	32.03	46.00	-13.97
468.92	33.13	1.00	185	1.39	34.52	46.00	-11.48
483.47	31.61	1.00	343	1.81	33.42	46.00	-12.58
574.74	27.27	1.00	97	4.49	31.76	46.00	-14.24
729.61	22.60	1.00	183	9.82	32.42	46.00	-13.58

*Test mode: IEEE 802.11n 40M CH06 for 30MHz to 1GHz [Vertical]*

<b>Radiated Emission</b>				<b>Correction Factors</b>	<b>Corrected Amplitude</b>	<b>Class B (3 m)</b>	
<b>Frequency (MHz)</b>	<b>Amplitude (dBμV)</b>	<b>Ant. H. (m)</b>	<b>Table ( )</b>			<b>Limit (dBμV/m)</b>	<b>Margin (dB)</b>
66.37	31.75	1.00	208	1.59	33.34	40.00	-6.66
147.61	38.99	1.00	231	-3.45	35.54	43.50	-7.96
288.26	34.06	1.00	92	-3.82	30.24	46.00	-15.76
547.74	27.25	1.00	249	4.49	31.74	46.00	-14.26
565.92	26.29	1.00	222	5.12	31.41	46.00	-14.59
729.61	28.67	1.00	322	9.82	38.49	46.00	-7.51

*Test mode: IEEE 802.11n 40M CH06 for 1GHz to 26.5GHz [Horizontal]*

<i>Frequency</i>	<i>Ant. H.</i>	<i>Table</i>	<i>Amplitude</i>		<i>Correction Factor</i>	<i>Corrected Amplitude</i>		<i>Limit</i>		<i>Margin</i>
			<i>Peak / Ave.</i>			<i>Peak / Ave.</i>		<i>Peak / Ave.</i>		
<i>MHz</i>	<i>m</i>	<i>degree</i>	<i>dBμV</i>		<i>dB/m</i>	<i>dBμV/m</i>		<i>dBμV/m</i>		<i>dB</i>
2177.08	1.00	251	41.66	---	8.59	50.25	---	73.96	53.96	-3.71
2319.97	1.00	175	48.83	42.83	8.99	57.82	51.82	73.96	53.96	-2.14
2519.98	1.00	203	44.00	38.33	9.53	53.53	47.86	73.96	53.96	-6.10
7312.29	1.00	191	39.44	---	10.30	49.74	---	73.96	53.96	-4.22
21934.79	1.00	97	47.17	---	3.09	50.26	---	73.96	53.96	-3.70
24371.46	1.00	242	47.34	---	3.26	50.60	---	73.96	53.96	-3.36

*Test mode: IEEE 802.11n 40M CH06 for 1GHz to 26.5GHz [Vertical]*

<i>Frequency</i>	<i>Ant. H.</i>	<i>Table</i>	<i>Amplitude</i>		<i>Correction Factor</i>	<i>Corrected Amplitude</i>		<i>Limit</i>		<i>Margin</i>
			<i>Peak / Ave.</i>			<i>Peak / Ave.</i>		<i>Peak / Ave.</i>		
<i>MHz</i>	<i>m</i>	<i>degree</i>	<i>dBμV</i>		<i>dB/m</i>	<i>dBμV/m</i>		<i>dBμV/m</i>		<i>dB</i>
2152.08	1.00	218	41.83	---	8.52	50.35	---	73.96	53.96	-3.61
2314.58	1.00	84	41.67	---	8.97	50.64	---	73.96	53.96	-3.32
7312.56	1.00	51	43.77	31.77	10.30	54.07	42.07	73.96	53.96	-11.89
12187.92	1.00	0	39.60	---	9.74	49.34	---	73.96	53.96	-4.62
21934.79	1.00	130	47.50	---	3.09	50.59	---	73.96	53.96	-3.37
24371.46	1.00	358	46.17	---	3.26	49.43	---	73.96	53.96	-4.53



*Test mode: IEEE 802.11n 40M CH09 for 30MHz to 1GHz [Horizontal]*

<i>Radiated Emission</i>				<i>Correction Factors</i>	<i>Corrected Amplitude</i>	<i>Class B (3 m)</i>	
<i>Frequency (MHz)</i>	<i>Amplitude (dBμV)</i>	<i>Ant. H. (m)</i>	<i>Table ( )</i>			<i>Limit (dBμV/m)</i>	<i>Margin (dB)</i>
142.76	36.23	1.00	23	-3.09	33.14	43.50	-10.36
368.29	37.26	1.00	157	-2.15	35.11	46.00	-10.89
468.92	31.36	1.00	187	1.39	32.75	46.00	-13.25
482.26	31.28	1.00	10	1.77	33.05	46.00	-12.95
547.74	26.97	1.00	106	4.49	31.46	46.00	-14.54
729.61	22.79	1.00	48	9.82	32.61	46.00	-13.39

*Test mode: IEEE 802.11n 40M CH09 for 30MHz to 1GHz [Vertical]*

<i>Radiated Emission</i>				<i>Correction Factors</i>	<i>Corrected Amplitude</i>	<i>Class B (3 m)</i>	
<i>Frequency (MHz)</i>	<i>Amplitude (dBμV)</i>	<i>Ant. H. (m)</i>	<i>Table ( )</i>			<i>Limit (dBμV/m)</i>	<i>Margin (dB)</i>
48.19	28.57	1.00	178	4.15	32.72	40.00	-7.28
67.59	31.88	1.00	238	1.50	33.38	40.00	-6.62
147.61	38.38	1.00	221	-3.45	34.93	43.50	-8.57
168.22	33.90	1.00	320	-3.76	30.14	43.50	-13.36
547.74	27.06	1.00	250	4.49	31.55	46.00	-14.45
729.61	28.41	1.00	302	9.82	38.23	46.00	-7.77

**Test mode: IEEE 802.11n 40M CH09 for 1GHz to 26.5GHz [Horizontal]**

<i>Frequency</i>	<i>Ant. H.</i>	<i>Table</i>	<i>Amplitude</i>		<i>Correction Factor</i>	<i>Corrected Amplitude</i>		<i>Limit</i>		<i>Margin</i>
			<i>Peak / Ave.</i>			<i>Peak / Ave.</i>		<i>Peak / Ave.</i>		
<i>MHz</i>	<i>m</i>	<i>degree</i>	<i>dBμV</i>		<i>dB/m</i>	<i>dBμV/m</i>		<i>dBμV/m</i>		<i>dB</i>
2185.42	1.00	310	41.17	---	8.61	49.78	---	73.96	53.96	-4.18
2319.98	1.00	87	45.99	40.17	8.99	54.98	49.16	73.96	53.96	-4.80
2572.92	1.00	218	41.00	---	9.63	50.63	---	73.96	53.96	-3.33
7354.58	1.00	170	39.61	---	10.39	50.00	---	73.96	53.96	-3.96
22069.37	1.00	329	47.16	---	2.77	49.93	---	73.96	53.96	-4.03
24520.21	1.00	264	47.50	---	2.37	49.87	---	73.96	53.96	-4.09

**Test mode: IEEE 802.11n 40M CH09 for 1GHz to 26.5GHz [Vertical]**

<i>Frequency</i>	<i>Ant. H.</i>	<i>Table</i>	<i>Amplitude</i>		<i>Correction Factor</i>	<i>Corrected Amplitude</i>		<i>Limit</i>		<i>Margin</i>
			<i>Peak / Ave.</i>			<i>Peak / Ave.</i>		<i>Peak / Ave.</i>		
<i>MHz</i>	<i>m</i>	<i>degree</i>	<i>dBμV</i>		<i>dB/m</i>	<i>dBμV/m</i>		<i>dBμV/m</i>		<i>dB</i>
2152.08	1.00	316	40.83	---	8.52	49.35	---	73.96	53.96	-4.61
2337.50	1.00	93	42.17	---	9.03	51.20	---	73.96	53.96	-2.76
7354.58	1.00	49	41.44	---	10.39	51.83	---	73.96	53.96	-2.13
19696.46	1.00	300	47.50	---	1.81	49.31	---	73.96	53.96	-4.65
22069.37	1.00	291	47.16	---	2.77	49.93	---	73.96	53.96	-4.03
24520.21	1.00	224	48.33	---	2.37	50.70	---	73.96	53.96	-3.26

#### **8.4 Test Result of the Bandedge**

If any 100 kHz bandwidth outside these frequency bands, the radio frequency power that is produced by the modulation products of the spreading sequence, the information sequence and the carrier frequency shall be either *at least 20 dB below that in any 100 kHz bandwidth within the band that contains the highest level of the desired power or shall not exceed the general levels specified in §15.209(a)*,

We perform this section by the *radiated manner*, the RBW is set to 100kHz and VBW>RBW. We'd made the observation *up to 10<sup>th</sup> harmonics and the criterion is all the harmonic/spurious emissions must be 20dB below the highest emission level measured*. If the emissions fall in the restricted bands stated in the Part15.205(a) must also *comply with the radiated emission limits specified in Part15.209(a)*. (*Peak mode: RBW=VBW=1MHz, Average mode: RBW=1MHz; VBW=10Hz*)

The following pages show our observations referring to the channel Lowest and Highest respectively.

Test Condition & Setup: same as < 8.1 >

**Channel 1 of IEEE 802.11b**

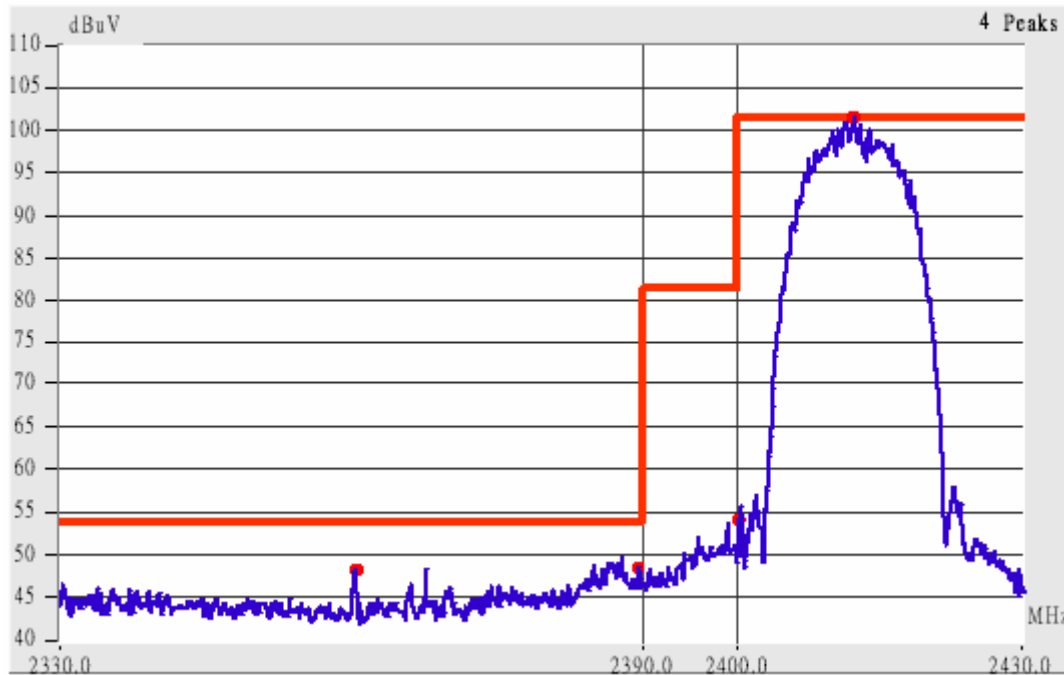

This is the hard copy of our bandedge measurement generated by our bandedge testing program. The plot shown above is the bandedge of channel 1.

1. The lobe left by the fundamental side is already 20dB below the highest emission level.
2. The emissions recorded in the restricted band is do comply with the Part 15.209(a) – as below.

<i>Radiated Emission</i>					<i>Corrected Amplitude</i>		<i>Class B ( 3m )</i>		
<i>Frequency (MHz)</i>	<i>Ant. P.</i>	<i>Ant. H. (m)</i>	<i>Table ( ° )</i>	<i>Factors (dB)</i>	<i>(dBµV/m)</i>		<i>Limit (dBµV/m)</i>		<i>Margin (dB)</i>
					<i>Peak</i>	<i>Average</i>	<i>Peak</i>	<i>Ave.</i>	
2367.18	Hor	1.00	244	9.12	55.78	45.62	73.96	53.96	-8.34
2385.66	Hor	1.00	244	9.17	59.84	48.34	73.96	53.96	-5.62
2389.98	Hor	1.00	270	9.18	56.85	47.68	73.96	53.96	-6.28
2360.28	Ver	1.00	152	9.10	51.60	---	73.96	53.96	-2.36
2386.53	Ver	1.00	81	9.17	56.35	44.34	73.96	53.96	-9.62
2389.97	Ver	1.00	78	9.18	54.52	43.51	73.96	53.96	-10.45

**Channel 11 of IEEE 802.11b**



This is the hard copy of our bandedge measurement generated by our bandedge testing program. The plot shown above is the bandedge of channel 11.

- 3. The lobe right by the fundamental side is already 20dB below the highest emission level.
- 4. The emissions recorded in the restricted band is do comply with the Part 15.209(a) – as below

<i>Radiated Emission</i>					<i>Corrected Amplitude</i>		<i>Class B ( 3m )</i>		
<i>Frequency (MHz)</i>	<i>Ant. P.</i>	<i>Ant. H. (m)</i>	<i>Table ( ° )</i>	<i>Factors (dB)</i>	<i>(dBµV/m)</i>		<i>Limit (dBµV/m)</i>		<i>Margin (dB)</i>
					<i>Peak</i>	<i>Average</i>	<i>Peak</i>	<i>Ave.</i>	
2483.87	Hor	1.00	156	9.44	54.44	45.61	73.96	53.96	-8.35
2486.79	Hor	1.00	156	9.45	57.29	45.95	73.96	53.96	-8.01
2499.96	Hor	1.00	152	9.49	52.82	43.66	73.96	53.96	-10.30
2517.18	Hor	1.00	77	9.52	55.36	44.35	73.96	53.96	-9.61
2483.50	Ver	1.00	166	9.44	51.11	---	73.96	53.96	-2.85
2487.39	Ver	1.00	168	9.45	55.95	43.95	73.96	53.96	-10.01
2500.01	Ver	1.00	175	9.49	51.49	---	73.96	53.96	-2.47
2508.99	Ver	1.00	175	9.51	50.51	---	73.96	53.96	-3.45

**Channel 1 of IEEE 802.11g**

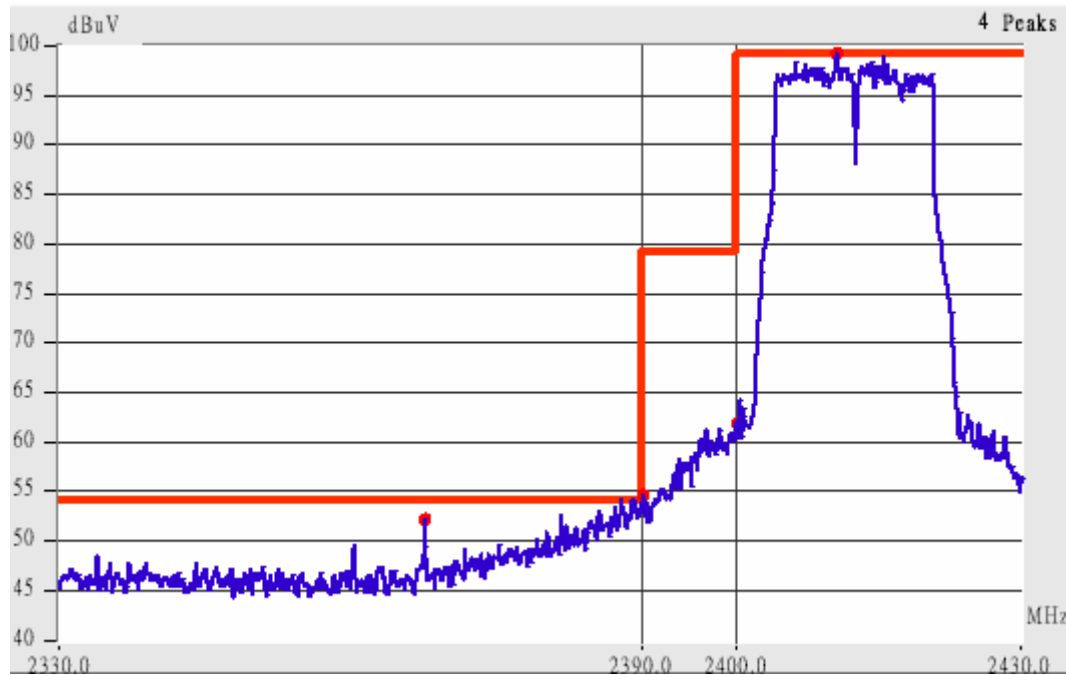

This is the hard copy of our bandedge measurement generated by our bandedge testing program. The plot shown above is the bandedge of channel 1.

- 5. The lobe left by the fundamental side is already 20dB below the highest emission level.
- 6. The emissions recorded in the restricted band is do comply with the Part 15.209(a) – as below.

<i>Radiated Emission</i>					<i>Corrected Amplitude</i>		<i>Class B ( 3m )</i>		
<i>Frequency (MHz)</i>	<i>Ant. P.</i>	<i>Ant. H. (m)</i>	<i>Table ( ° )</i>	<i>Factors (dB)</i>	<i>(dBµV/m)</i>		<i>Limit (dBµV/m)</i>		<i>Margin (dB)</i>
					<i>Peak</i>	<i>Average</i>	<i>Peak</i>	<i>Ave.</i>	
2359.97	Hor	1.00	170	9.10	57.10	46.93	73.96	53.96	-7.03
2367.19	Hor	1.00	82	9.12	59.28	48.12	73.96	53.96	-5.84
2381.01	Hor	1.00	79	9.16	61.16	48.16	73.96	53.96	-5.80
2389.48	Hor	1.00	79	9.18	66.68	52.01	73.96	53.96	-1.95
2380.16	Ver	1.00	88	9.15	56.49	44.98	73.96	53.96	-8.98
2389.81	Ver	1.00	73	9.18	60.52	49.18	73.96	53.96	-4.78

**Channel 11 of IEEE 802.11g**



This is the hard copy of our bandedge measurement generated by our bandedge testing program. The plot shown above is the bandedge of channel 11.

- 7. The lobe right by the fundamental side is already 20dB below the highest emission level.
- 8. The emissions recorded in the restricted band is do comply with the Part 15.209(a) – as below

<i>Radiated Emission</i>					<i>Corrected Amplitude</i>		<i>Class B ( 3m )</i>		
<i>Frequency (MHz)</i>	<i>Ant. P.</i>	<i>Ant. H. (m)</i>	<i>Table ( ° )</i>	<i>Factors (dB)</i>	<i>(dBµV/m)</i>		<i>Limit (dBµV/m)</i>		<i>Margin (dB)</i>
					<i>Peak</i>	<i>Average</i>	<i>Peak</i>	<i>Ave.</i>	
2483.46	Hor	1.00	153	9.44	65.94	52.61	73.96	53.96	-1.35
2486.35	Hor	1.00	153	9.45	62.29	49.12	73.96	53.96	-4.84
2500.43	Hor	1.00	151	9.49	57.32	46.82	73.96	53.96	-7.14
2517.17	Hor	1.00	80	9.52	57.86	48.35	73.96	53.96	-5.61
2483.58	Ver	1.00	160	9.44	62.11	49.27	73.96	53.96	-4.69
2492.35	Ver	1.00	164	9.47	58.63	45.30	73.96	53.96	-8.66
2500.03	Ver	1.00	161	9.49	53.82	44.82	73.96	53.96	-9.14
2517.17	Ver	1.00	79	9.52	56.86	46.35	73.96	53.96	-7.61

**Channel 01 of IEEE 802.11n 20M**

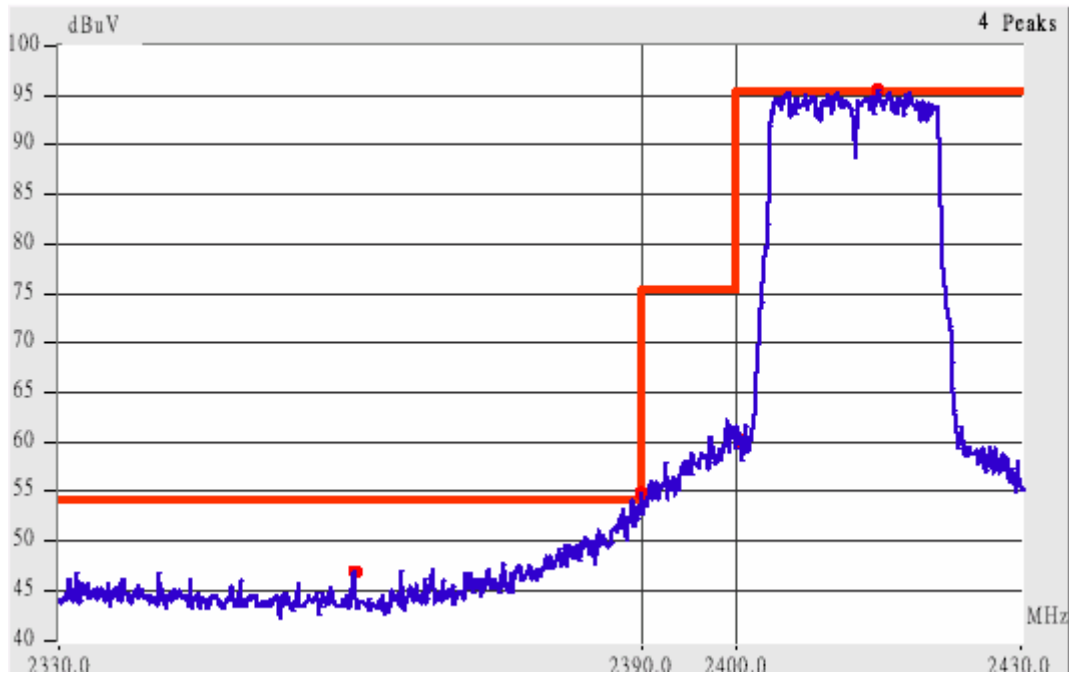

This is the hard copy of our bandedge measurement generated by our bandedge testing program. The plot shown above is the bandedge of channel 1.

9. The lobe left by the fundamental side is already 20dB below the highest emission level.

10. The emissions recorded in the restricted band is do comply with the Part 15.209(a) – as below.

<i>Radiated Emission</i>					<i>Corrected Amplitude</i>		<i>Class B ( 3m )</i>		
<i>Frequency (MHz)</i>	<i>Ant. P.</i>	<i>Ant. H. (m)</i>	<i>Table ( ° )</i>	<i>Factors (dB)</i>	<i>(dBµV/m)</i>		<i>Limit (dBµV/m)</i>		<i>Margin (dB)</i>
					<i>Peak</i>	<i>Average</i>	<i>Peak</i>	<i>Ave.</i>	
2367.18	Hor	1.00	246	9.12	57.78	45.79	73.96	53.96	-8.17
2389.52	Hor	1.00	246	9.18	64.68	52.35	73.96	53.96	-1.61
2367.17	Ver	1.00	84	9.12	54.29	42.62	73.96	53.96	-11.34
2389.40	Ver	1.00	82	9.18	61.35	49.18	73.96	53.96	-4.78



**Channel 11 of IEEE 802.11n 20M**

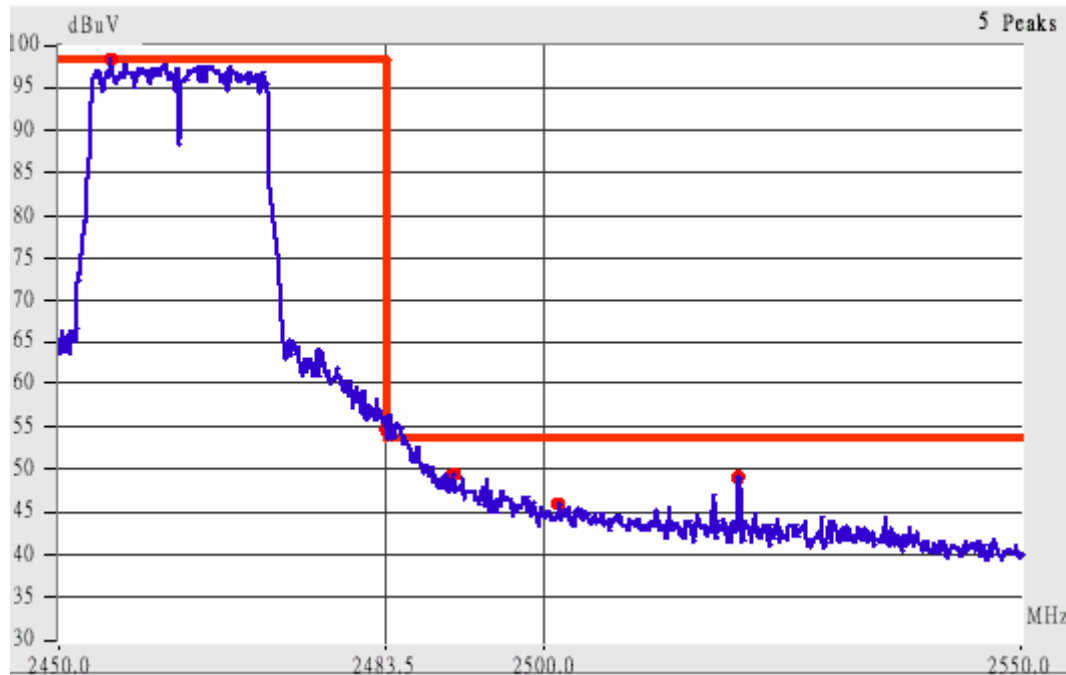

This is the hard copy of our bandedge measurement generated by our bandedge testing program. The plot shown above is the bandedge of channel 11.

- 11. The lobe right by the fundamental side is already 20dB below the highest emission level.
- 12. The emissions recorded in the restricted band do comply with the Part 15.209(a) – as below

Radiated Emission					Corrected Amplitude		Class B ( 3m )		
Frequency (MHz)	Ant. P.	Ant. H. (m)	Table ( ° )	Factors (dB)	(dBµV/m)		Limit (dBµV/m)		Margin (dB)
					Peak	Average	Peak	Ave.	
2483.01	Hor	1.00	296	9.44	61.94	51.44	73.96	53.96	-2.52
2486.33	Hor	1.00	301	9.45	59.79	48.12	73.96	53.96	-5.84
2499.40	Hor	1.00	318	9.49	53.66	43.66	73.96	53.96	-10.30
2519.97	Hor	1.00	262	9.53	55.53	44.70	73.96	53.96	-9.26
2483.26	Ver	1.00	170	9.44	56.28	46.61	73.96	53.96	-7.35
2492.95	Ver	1.00	158	9.47	51.30	---	73.96	53.96	-2.66
2500.01	Ver	1.00	170	9.49	49.16	---	73.96	53.96	-4.80
2517.28	Ver	1.00	77	9.52	51.19	---	73.96	53.96	-2.77

**Channel CH03 of IEEE 802.11n 40M**

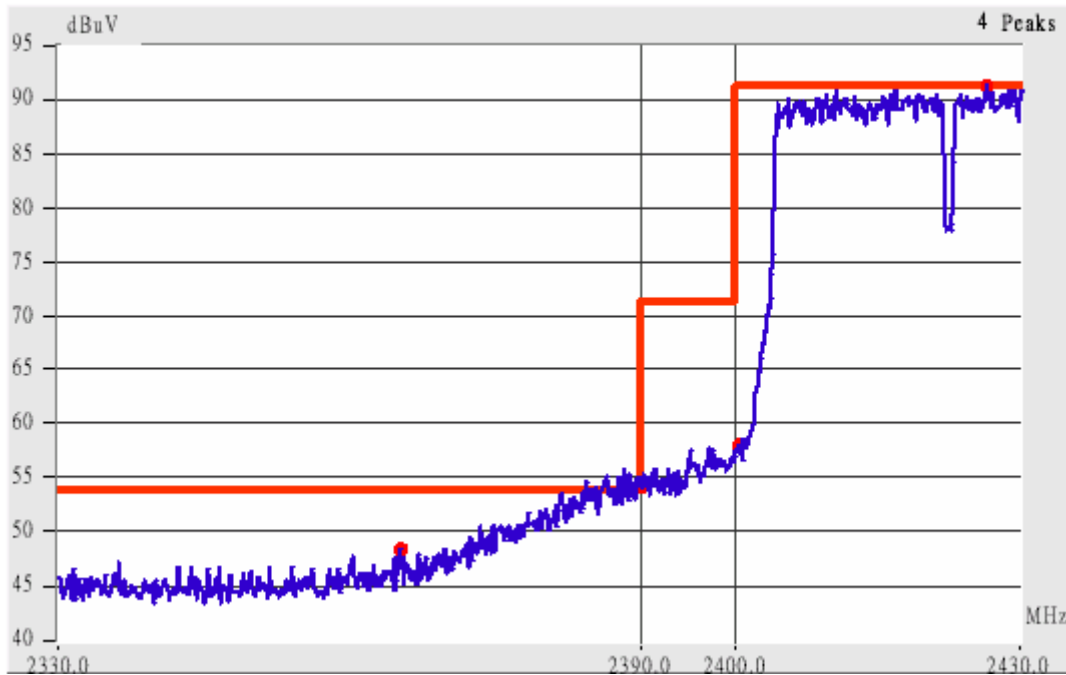

This is the hard copy of our bandedge measurement generated by our bandedge testing program. The plot shown above is the bandedge of channel 3.

13. The lobe left by the fundamental side is already 20dB below the highest emission level.

14. The emissions recorded in the restricted band do comply with the Part 15.209(a) – as below.

<i>Radiated Emission</i>					<i>Corrected Amplitude</i>		<i>Class B ( 3m )</i>		
<i>Frequency (MHz)</i>	<i>Ant. P.</i>	<i>Ant. H. (m)</i>	<i>Table ( )</i>	<i>Factors (dB)</i>	<i>(dBµV/m)</i>		<i>Limit (dBµV/m)</i>		<i>Margin (dB)</i>
					<i>Peak</i>	<i>Average</i>	<i>Peak</i>	<i>Ave.</i>	
2359.44	Hor	1.00	174	9.10	57.76	44.93	73.96	53.96	-9.03
2380.36	Hor	1.00	244	9.16	62.16	49.99	73.96	53.96	-3.97
2390.44	Hor	1.00	219	9.18	63.02	52.68	73.96	53.96	-1.28
2384.77	Ver	1.00	86	9.17	61.33	47.67	73.96	53.96	-6.29
2390.07	Ver	1.00	84	9.18	59.02	49.01	73.96	53.96	-4.95

Channel 09 of IEEE 802.11n 40M

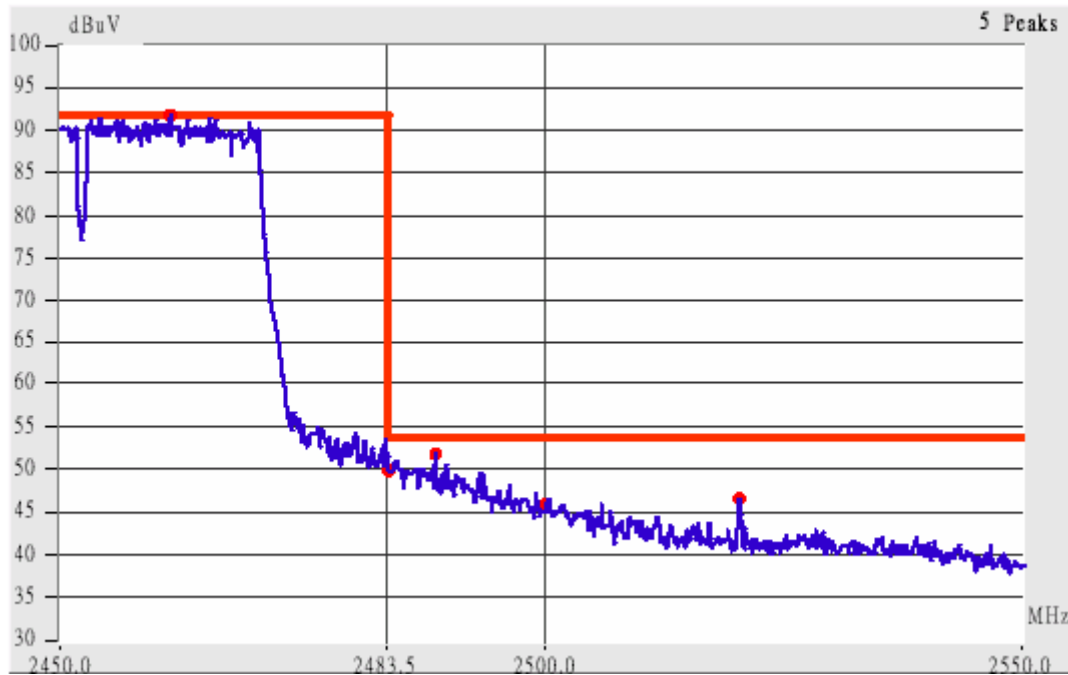

This is the hard copy of our bandedge measurement generated by our bandedge testing program. The plot shown above is the bandedge of channel 09.

15. The lobe right by the fundamental side is already 20dB below the highest emission level.

16. The emissions recorded in the restricted band do comply with the Part 15.209(a) – as below

Radiated Emission					Corrected Amplitude		Class B ( 3m )		
Frequency (MHz)	Ant. P.	Ant. H. (m)	Table ( ° )	Factors (dB)	(dBµV/m)		Limit (dBµV/m)		Margin (dB)
					Peak	Average	Peak	Ave.	
2483.24	Hor	1.00	296	9.44	65.11	51.27	73.96	53.96	-2.69
2487.92	Hor	1.00	296	9.46	62.62	49.29	73.96	53.96	-4.67
2499.49	Hor	1.00	299	9.49	55.99	45.49	73.96	53.96	-8.47
2519.51	Hor	1.00	193	9.53	55.69	44.20	73.96	53.96	-9.76
2483.26	Ver	1.00	150	9.44	54.78	45.77	73.96	53.96	-8.19
2487.87	Ver	1.00	148	9.46	56.62	44.29	73.96	53.96	-9.67
2500.01	Ver	1.00	141	9.49	50.99	---	73.96	53.96	-2.97
2519.99	Ver	1.00	73	9.53	52.53	42.53	73.96	53.96	-11.43

## IX. Section 15.247(d): Power Spectral Density

### 9.1 Test Condition & Setup

The tests below are running with the EUT transmitter set at high power in TDD mode. The EUT is needed to force selection of output power level and channel number. While testing, the EUT was set to transmit continuously and to be tested by the contact manner with the spectrum analyzer.

### 9.2 Test Instruments Configuration

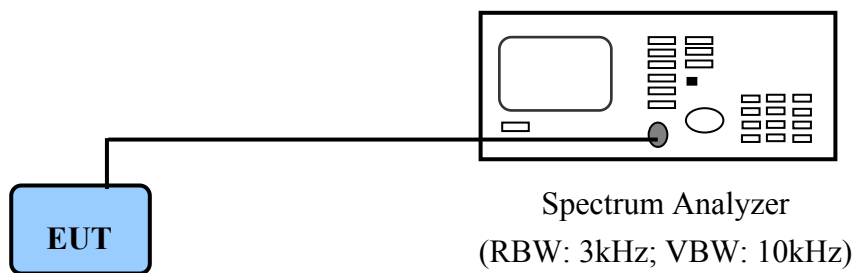

*PC to control the EUT at maximal power output and channel number and set antenna kit*

### 9.3 List of Test Instruments

Instrument Name	Model No.	Brand	Serial No.	Next time
Spectrum Analyzer	MS2665C	ANRITSU	6200175476	02/15/07

**9.4 Test Result of Power spectral density**

The following table shows a summary of the test results of the Power Spectral Density.

**IEEE 802.11b**

<i>Channel</i>	<i>Ppr (dBm)</i>	<i>Cable Loss (dB)</i>	<i>Ppq (dBm)</i>	<i>Limit (dB)</i>	<i>Margin (dB)</i>
CH 01	-11.15	2.00	-9.15	8.00	-17.15
CH 06	-10.42	2.00	-8.42	8.00	-16.42
CH 11	-11.11	2.00	-9.11	8.00	-17.11

**IEEE 802.11g**

<i>Channel</i>	<i>Ppr (dBm)</i>	<i>Cable Loss (dB)</i>	<i>Ppq (dBm)</i>	<i>Limit (dB)</i>	<i>Margin (dB)</i>
CH 01	-14.69	2.00	-12.69	8.00	-20.69
CH 06	-16.63	2.00	-14.63	8.00	-22.63
CH 11	-17.37	2.00	-15.37	8.00	-23.37

Note:

1. The following pages show the results of spectrum reading.
2. Ppr: spectrum read power density (using peak search mode),  
Ppq: actual peak power density in the spread spectrum band.
3.  $Ppq = Ppr + |Cable Loss|$

**Formula:**  
 Total PPSD (Ppq) = 10 log ( 10<sup>^</sup> ( Ant#1 Ppr + cable loss / 10 ) + 10<sup>^</sup> ( Ant#2 Ppr + cable loss/ 10 ))

**IEEE 802.11n 20M**

<i>Channel</i>	<i>Ant#1 Ppr</i>	<i>Ant#2 Ppr</i>	<i>Cable Loss</i>	<i>Ppq</i>	<i>Limit</i>	<i>Margin</i>
	<i>(dBm)</i>		<i>(dB)</i>	<i>(dBm)</i>	<i>(dB)</i>	<i>(dB)</i>
CH 01/2412	-20.30	-18.98	2.00	-20.70	8.00	-28.70
CH 06/2437	-20.16	-18.19	2.00	-20.30	8.00	-28.30
CH 11/2462	-19.33	-17.43	2.00	-19.49	8.00	-27.49

**IEEE 802.11n 40M**

<i>Channel</i>	<i>Ant#1 Ppr</i>	<i>Ant#2 Ppr</i>	<i>Cable Loss</i>	<i>Ppq</i>	<i>Limit</i>	<i>Margin</i>
	<i>(dBm)</i>		<i>(dB)</i>	<i>(dBm)</i>	<i>(dB)</i>	<i>(dB)</i>
CH 03/2412	-26.05	-23.45	2.00	-25.95	8.00	-33.95
CH 06/2437	-24.37	-21.77	2.00	-24.27	8.00	-32.27
CH 09/2452	-24.49	-22.27	2.00	-24.53	8.00	-32.53

Power Spectral Density for Channel 01, 2412MHz

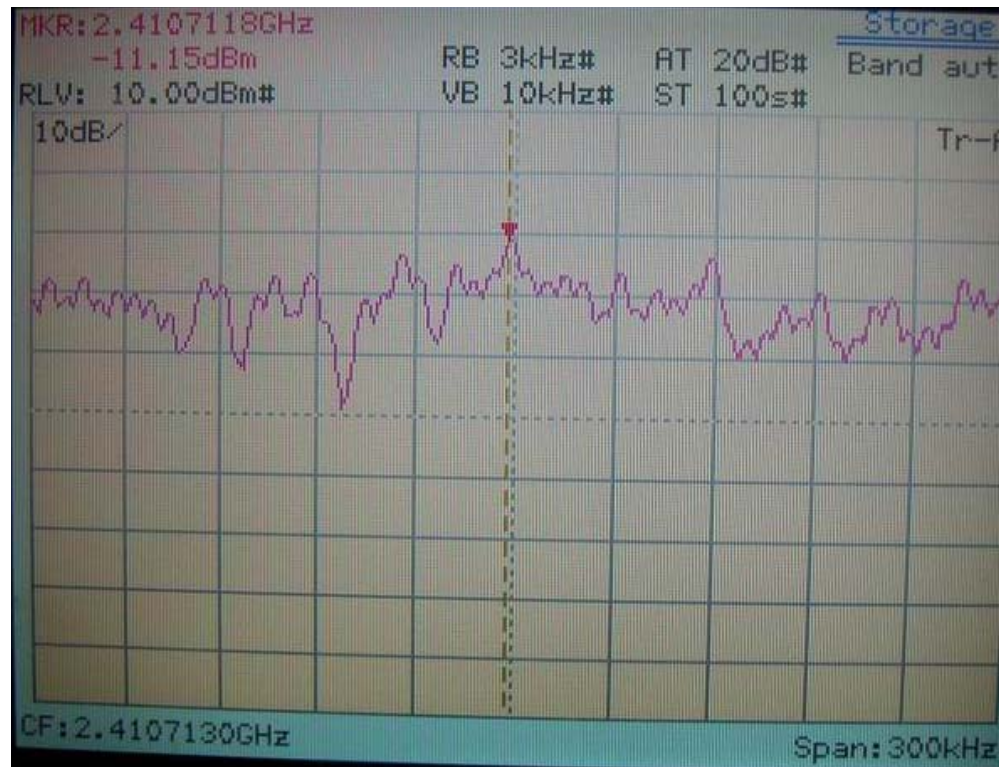

IEEE 802.11b

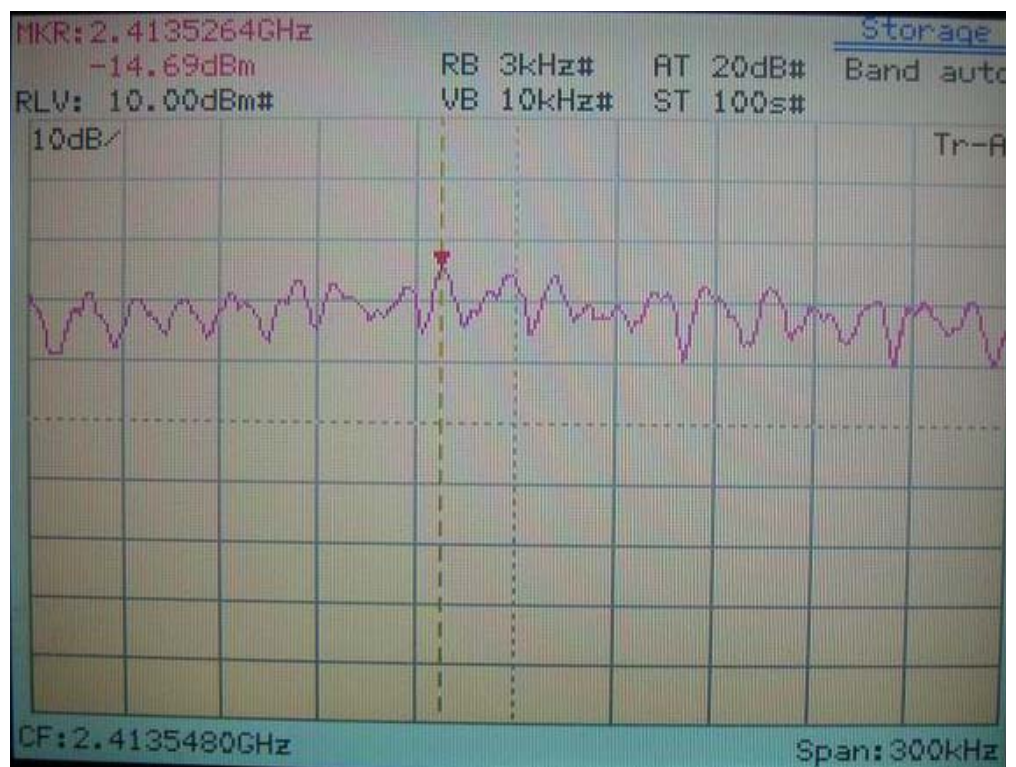

IEEE 802.11g

Power Spectral Density for Channel 06 , 2437MHz

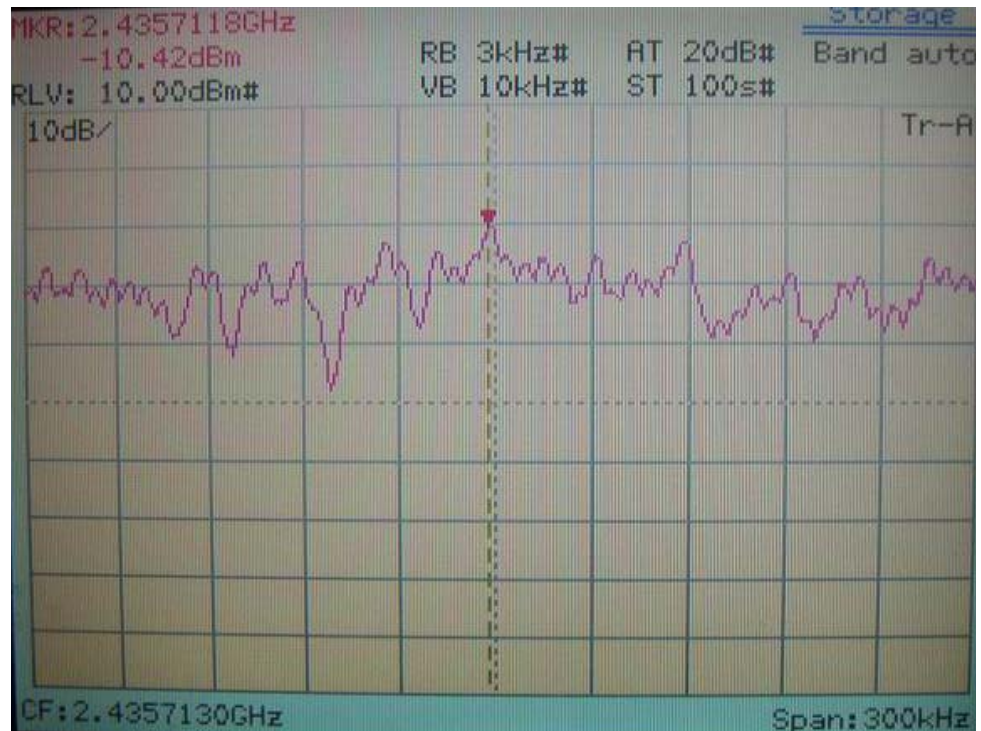

IEEE 802.11b

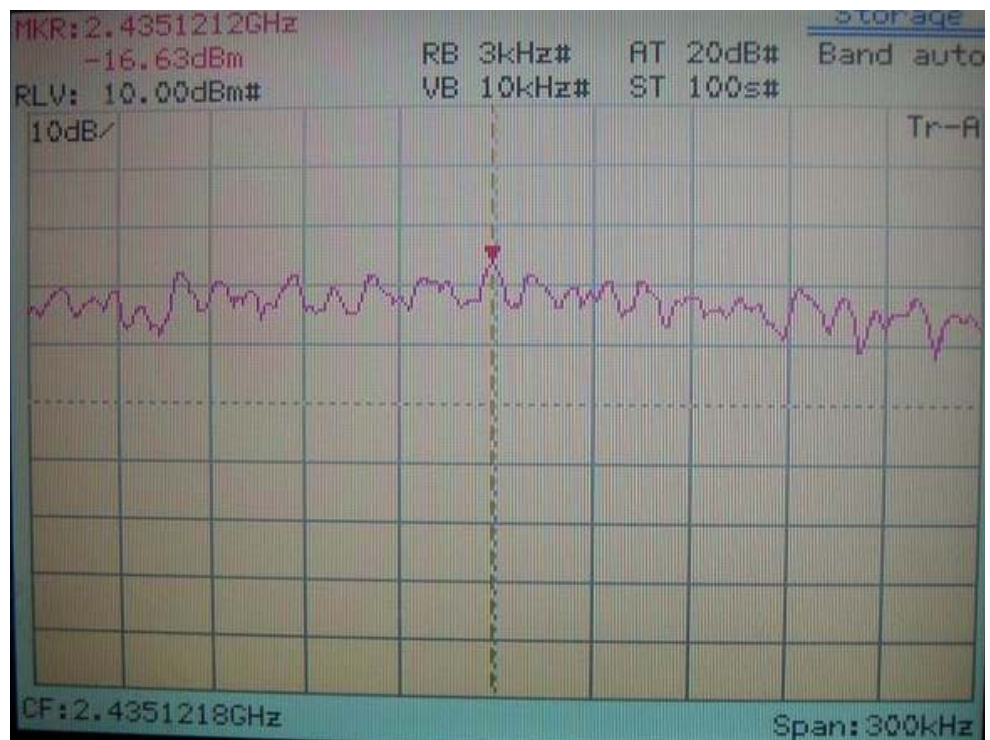

IEEE 802.11g



**Power Spectral Density for Channel 11, 2462MHz**

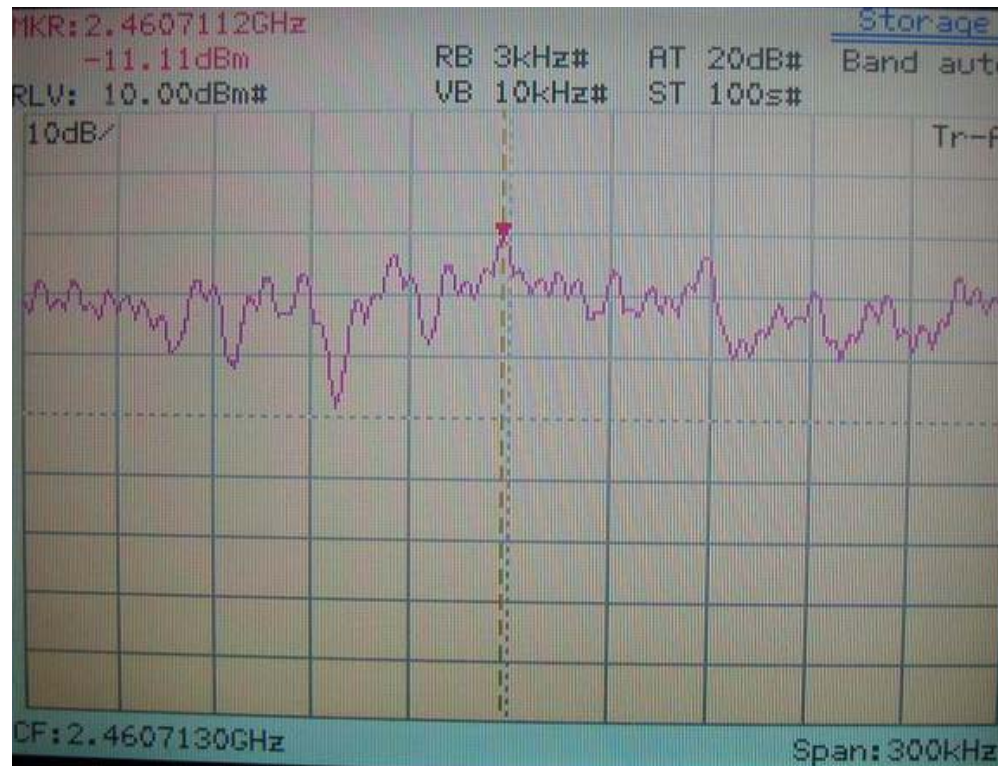

**IEEE 802.11b**

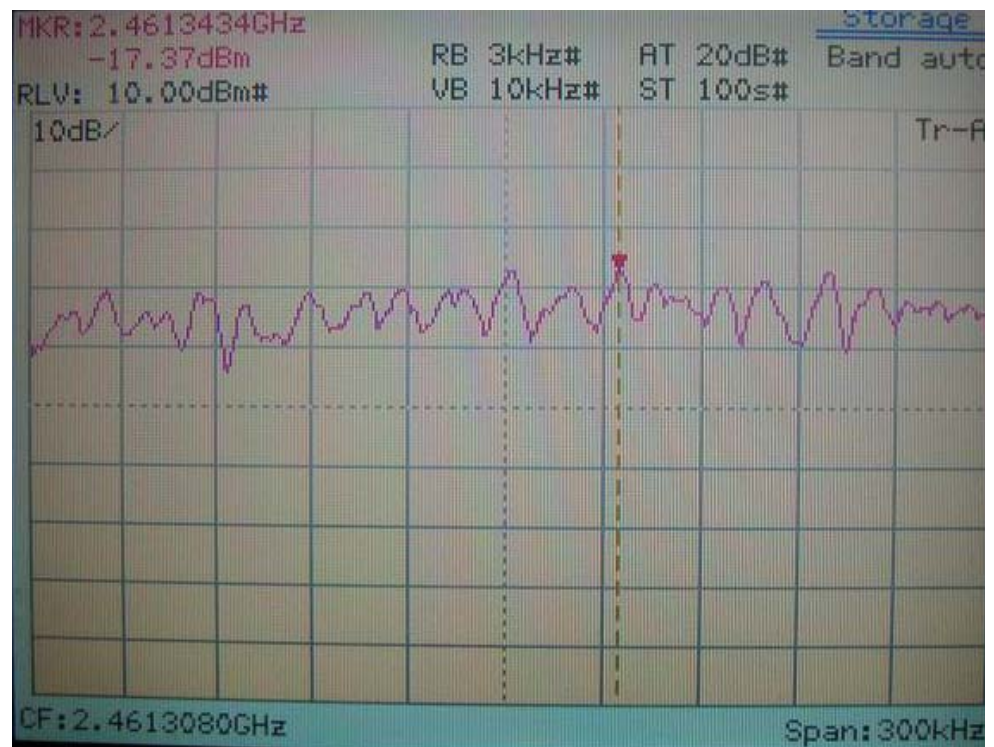

**IEEE 802.11g**

Power Spectral Density for IEEE 802.11n 20M Channel 01, 2412MHz

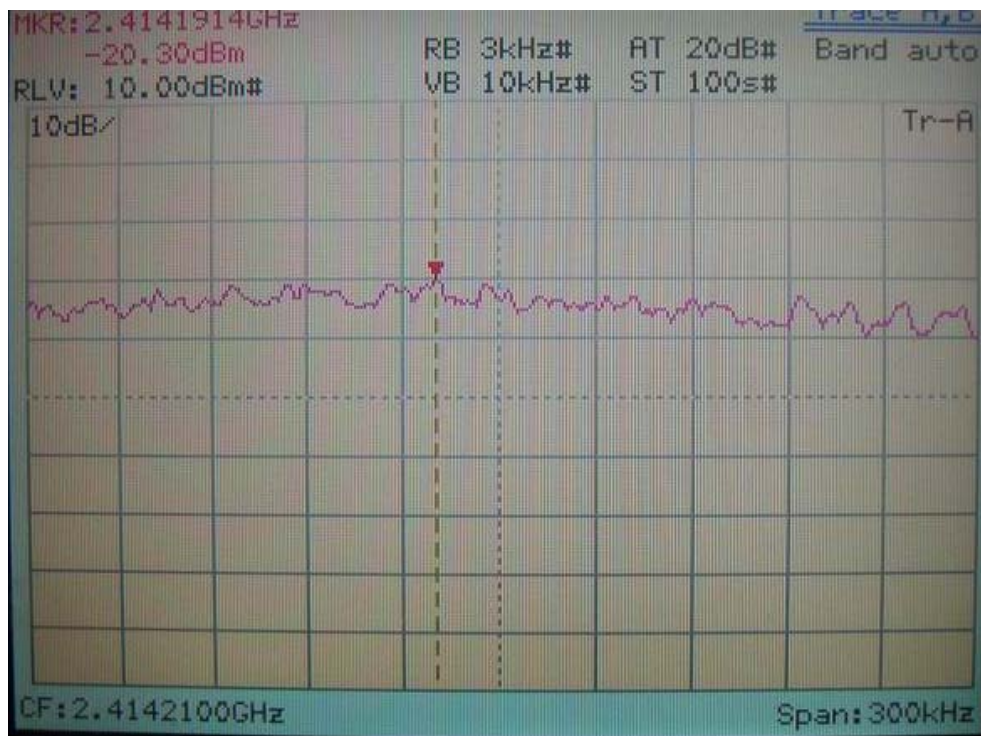

Ant #1

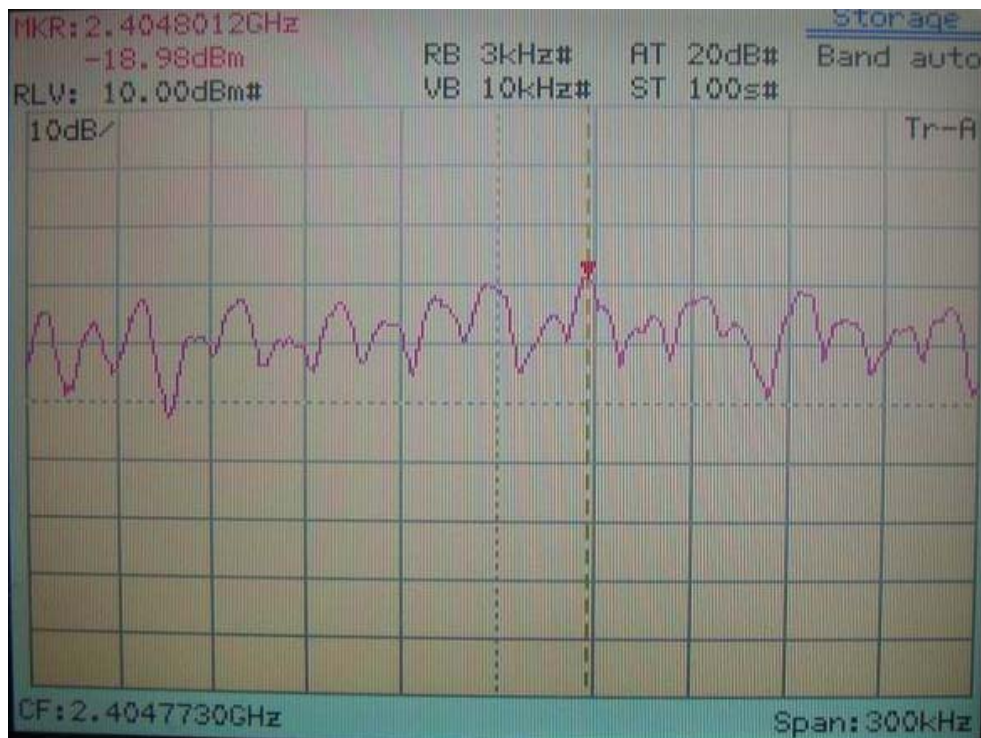

Ant #2

**Power Spectral Density for IEEE 802.11n 20M Channel 06, 2437MHz**

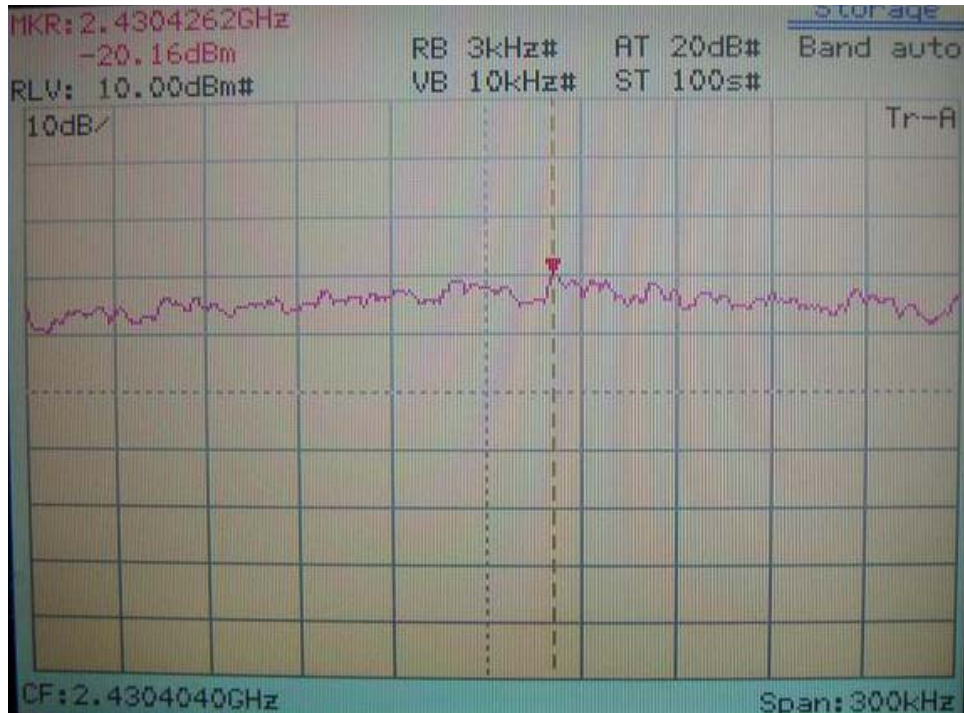

Ant #1



Ant #2

**Power Spectral Density for IEEE 802.11n 20M Channel 11, 2462MHz**

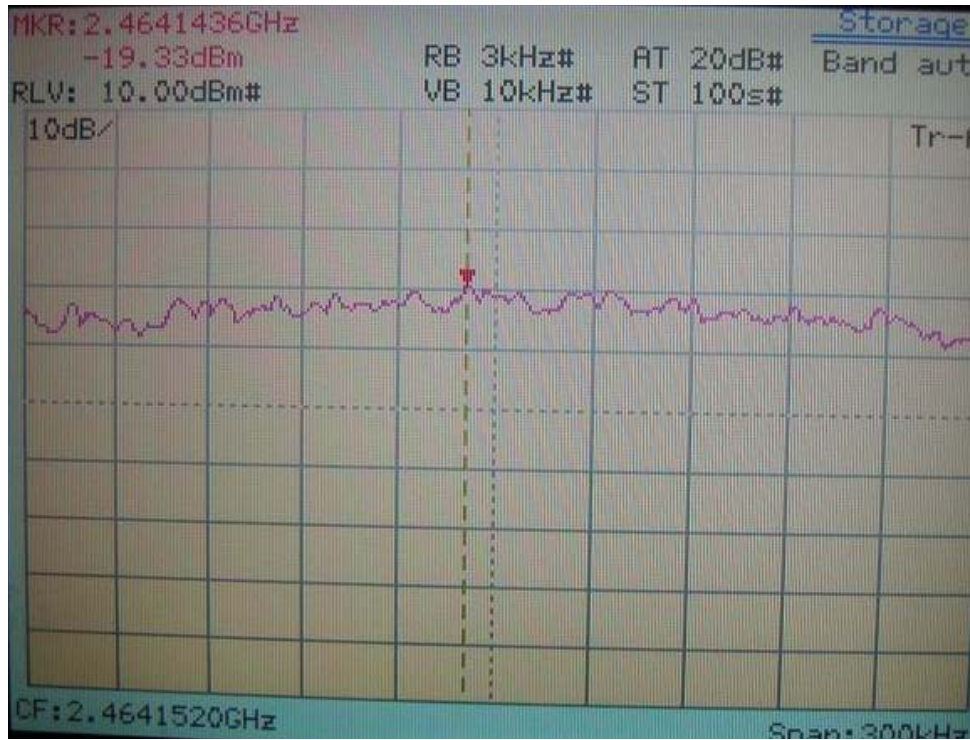

**Ant #1**

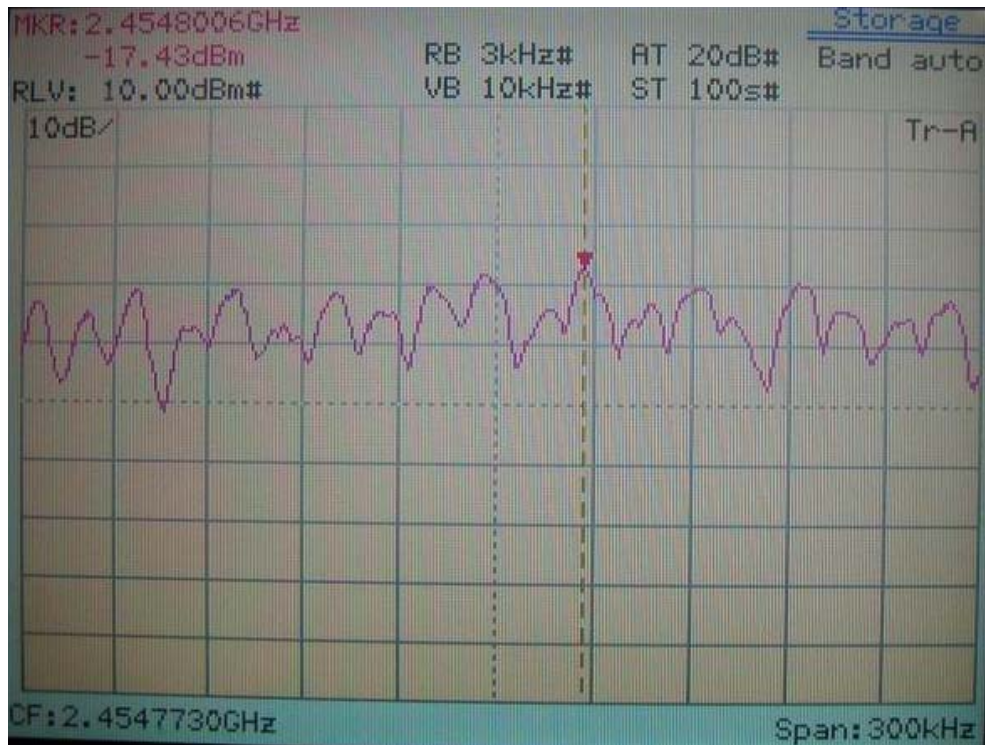

**Ant #2**

Power Spectral Density for IEEE 802.11n 40M Channel 03, 2422MHz

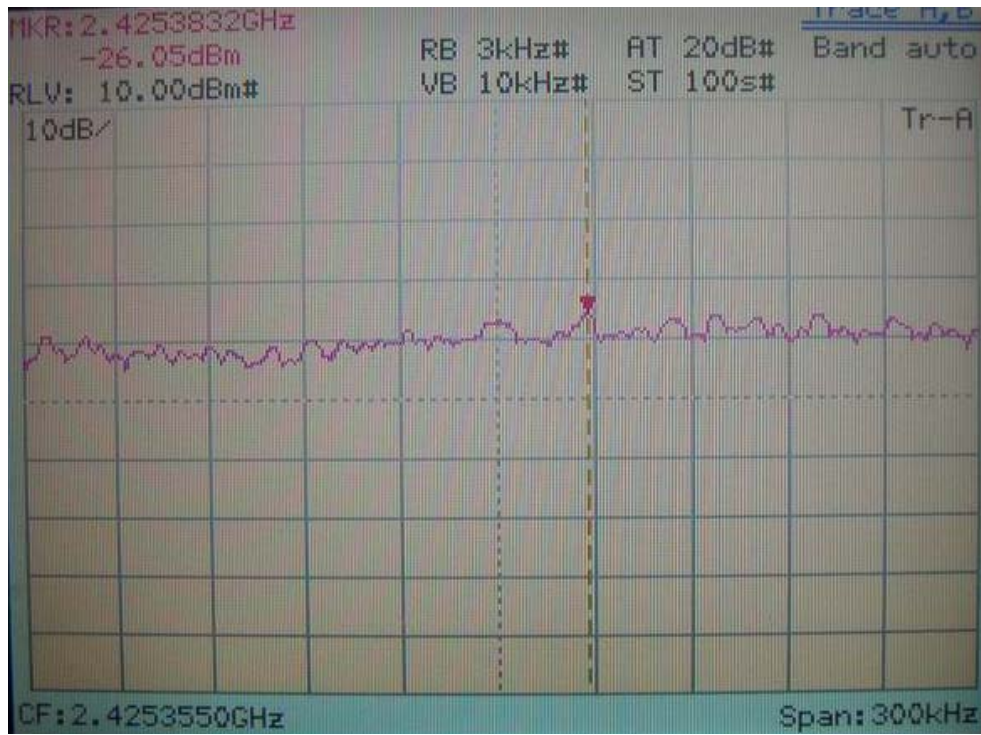

Ant #1

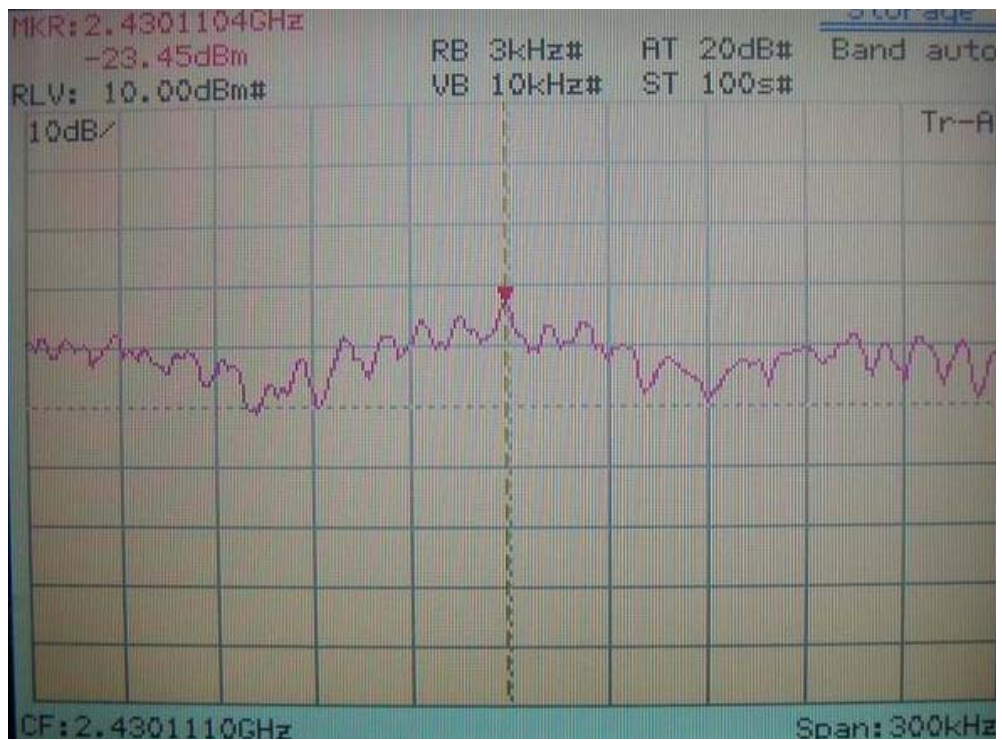

Ant #2

**Power Spectral Density for IEEE 802.11n 40M Channel 06, 2437MHz**

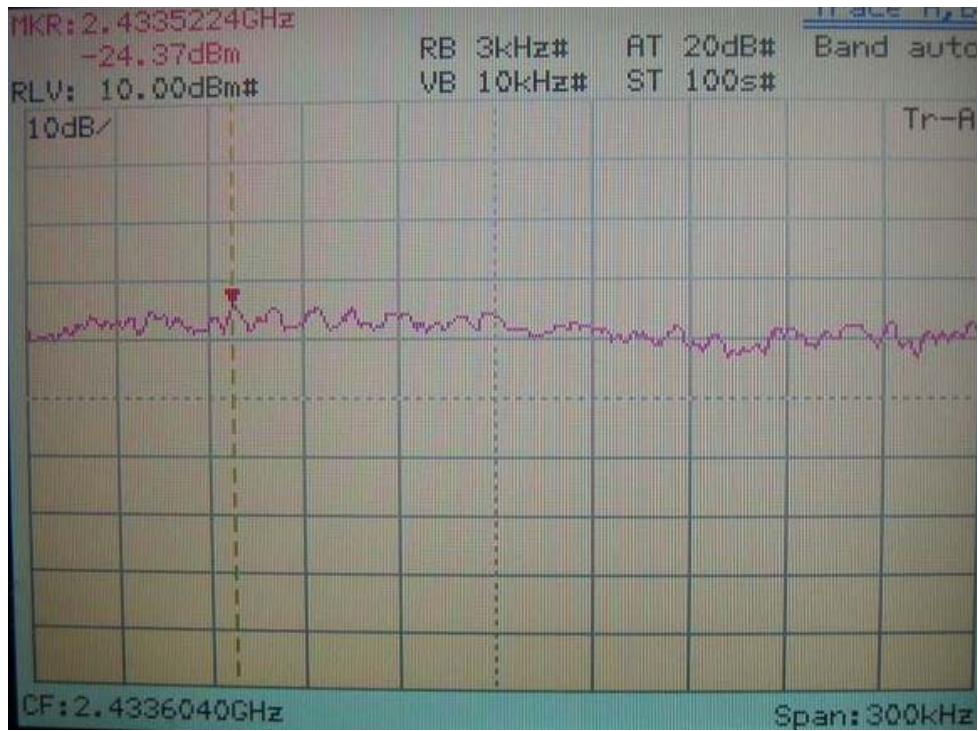

Ant #1

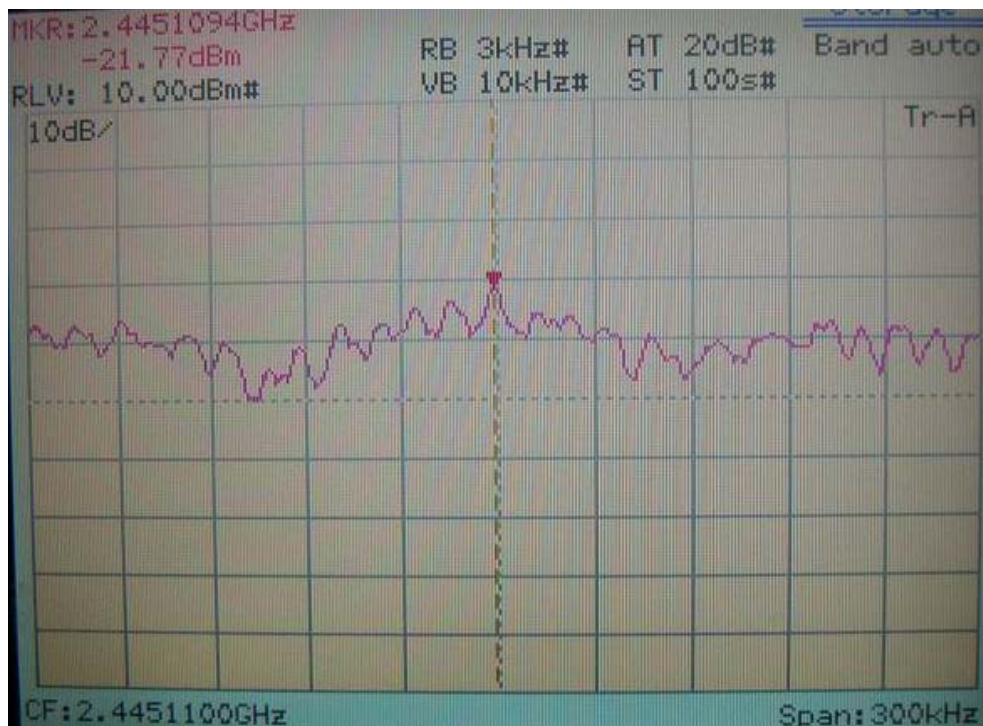

Ant #2

Power Spectral Density for IEEE 802.11n 40M Channel 09, 2452MHz

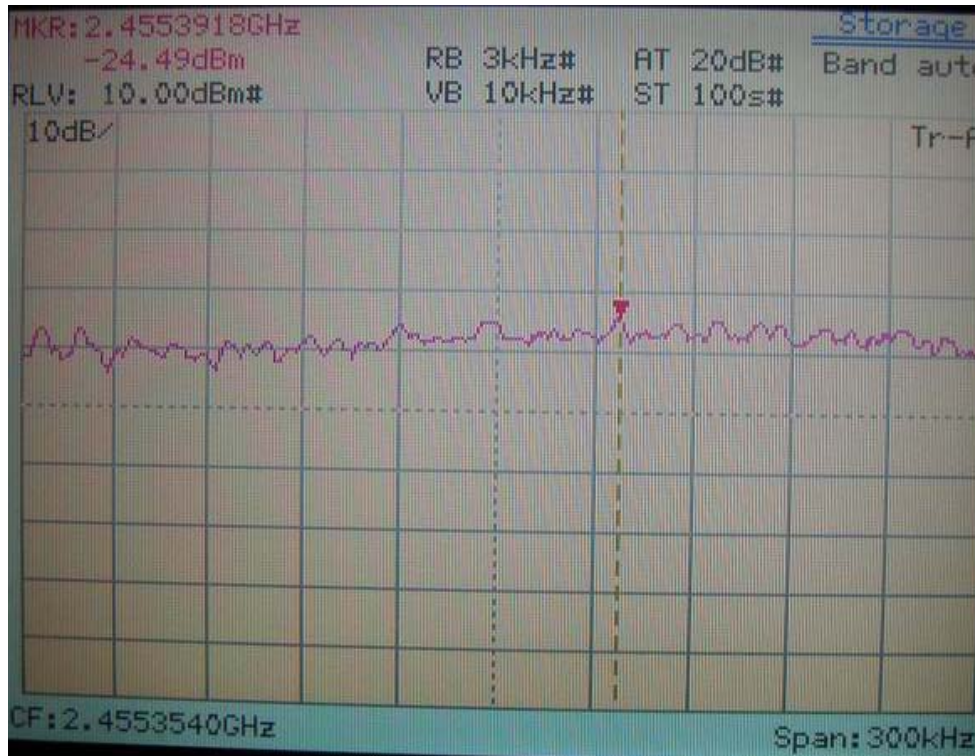

Ant #1

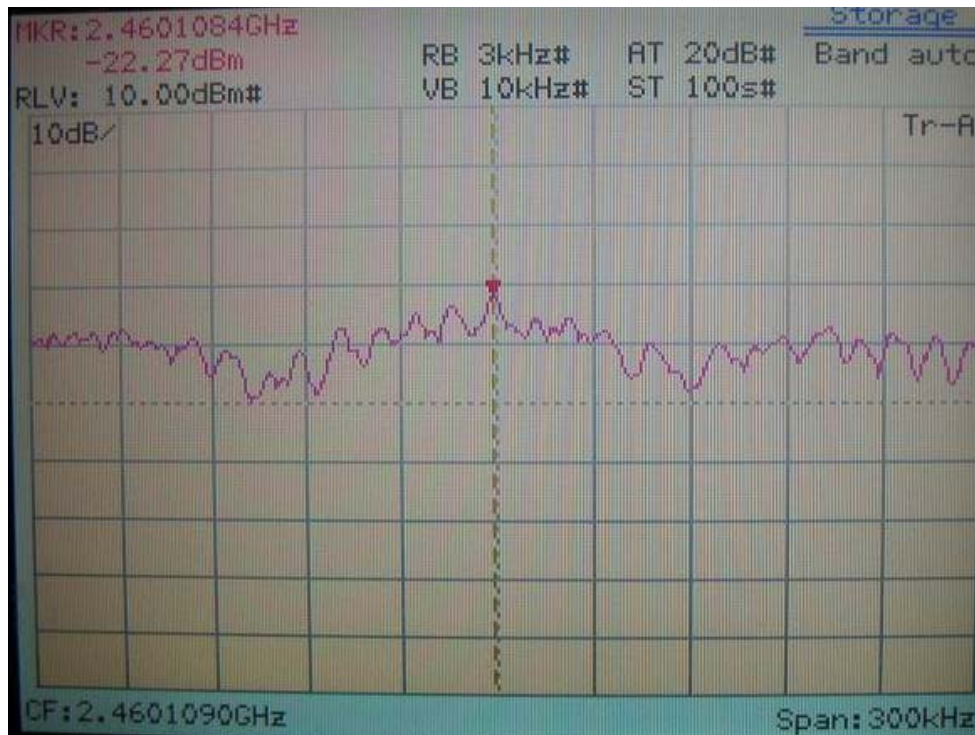

Ant #2