



FCC TEST REPORT (15.247)

REPORT NO.: RF150522C08C
MODEL NO.: WI501Q
FCC ID: MSQWI501Q
RECEIVED: May 22, 2015
TESTED: Jun. 04, 2015 ~ Jul. 16, 2015
ISSUED: Jul. 21, 2015

APPLICANT: ASUSTek COMPUTER INC.

ADDRESS: 4F, No. 150, LI-TE Rd., PEITOU, TAIPEI 112,
TAIWAN

ISSUED BY: Bureau Veritas Consumer Products Services (H.K.)
Ltd., Taoyuan Branch

LAB ADDRESS: No. 47-2, 14th Ling, Chia Pau Vil., Lin Kou Dist., New
Taipei City, Taiwan

TEST LOCATION: No. 19, Hwa Ya 2nd Rd, Wen Hwa Vil., Kwei Shan
Dist., Taoyuan City 333, Taiwan

This report should not be used by the client to claim product certification, approval, or endorsement by TAF or any government agencies.



This report is for your exclusive use. Any copying or replication of this report to or for any other person or entity, or use of our name or trademark, is permitted only with our prior written permission. This report sets forth our findings solely with respect to the test samples identified herein. The results set forth in this report are not indicative or representative of the quality or characteristics of the lot from which a test sample was taken or any similar or identical product unless specifically and expressly noted. Our report includes all of the tests requested by you and the results thereof based upon the information that you provided to us. You have 60 days from date of issuance of this report to notify us of any material error or omission caused by our negligence, provided, however, that such notice shall be in writing and shall specifically address the issue you wish to raise. A failure to raise such issue within the prescribed time shall constitute your unqualified acceptance of the completeness of this report, the tests conducted and the correctness of the report contents. Unless specific mention, the uncertainty of measurement has been explicitly taken into account to declare the compliance or non-compliance to the specification.



TABLE OF CONTENTS

- RELEASE CONTROL RECORD4
- 1. CERTIFICATION.....5
- 2. SUMMARY OF TEST RESULTS6
 - 2.1 MEASUREMENT UNCERTAINTY.....6
- 3. GENERAL INFORMATION7
 - 3.1 GENERAL DESCRIPTION OF EUT7
 - 3.2 DESCRIPTION OF TEST MODES8
 - 3.2.1 TEST MODE APPLICABILITY AND TESTED CHANNEL DETAIL9
 - 3.3 DESCRIPTION OF SUPPORT UNITS11
 - 3.3.1 CONFIGURATION OF SYSTEM UNDER TEST11
 - 3.4 DUTY CYCLE TEST SIGNAL12
 - 3.5 GENERAL DESCRIPTION OF APPLIED STANDARDS13
- 4. TEST TYPES AND RESULTS (FOR 2.4GHz BAND)14
 - 4.1 RADIATED EMISSION AND BANDEDGE MEASUREMENT14
 - 4.1.1 LIMITS OF RADIATED EMISSION AND BANDEDGE MEASUREMENT14
 - 4.1.2 TEST INSTRUMENTS15
 - 4.1.3 TEST PROCEDURES16
 - 4.1.4 DEVIATION FROM TEST STANDARD16
 - 4.1.5 TEST SETUP17
 - 4.1.6 EUT OPERATING CONDITIONS17
 - 4.1.7 TEST RESULTS.....18
 - 4.2 CONDUCTED EMISSION MEASUREMENT30
 - 4.2.1 LIMITS OF CONDUCTED EMISSION MEASUREMENT30
 - 4.2.2 TEST INSTRUMENTS30
 - 4.2.3 TEST PROCEDURES31
 - 4.2.4 DEVIATION FROM TEST STANDARD31
 - 4.2.5 TEST SETUP32
 - 4.2.6 EUT OPERATING CONDITIONS32
 - 4.2.7 TEST RESULTS.....33
 - 4.3 6dB BANDWIDTH MEASUREMENT37
 - 4.3.1 LIMITS OF 6dB BANDWIDTH MEASUREMENT37
 - 4.3.2 TEST SETUP37
 - 4.3.3 TEST INSTRUMENTS37
 - 4.3.4 TEST PROCEDURE37
 - 4.3.5 DEVIATION FROM TEST STANDARD37
 - 4.3.6 EUT OPERATING CONDITIONS37
 - 4.3.7 TEST RESULTS.....38
 - 4.4 CONDUCTED OUTPUT POWER40
 - 4.4.1 LIMITS OF CONDUCTED OUTPUT POWER MEASUREMENT40
 - 4.4.2 TEST SETUP40
 - 4.4.3 TEST INSTRUMENTS40
 - 4.4.4 TEST PROCEDURES40
 - 4.4.5 DEVIATION FROM TEST STANDARD40
 - 4.4.6 EUT OPERATING CONDITIONS40
 - 4.4.7 TEST RESULTS.....41
 - 4.5 POWER SPECTRAL DENSITY MEASUREMENT.....42
 - 4.5.1 LIMITS OF POWER SPECTRAL DENSITY MEASUREMENT42
 - 4.5.2 TEST SETUP42
 - 4.5.3 TEST INSTRUMENTS42
 - 4.5.4 TEST PROCEDURE42
 - 4.5.5 DEVIATION FROM TEST STANDARD42



A D T

4.5.6	EUT OPERATING CONDITION.....	42
4.5.7	TEST RESULTS.....	43
4.6	CONDUCTED OUT OF BAND EMISSION MEASUREMENT	45
4.6.1	LIMITS OF CONDUCTED OUT OF BAND EMISSION MEASUREMENT	45
4.6.2	TEST SETUP	45
4.6.3	TEST INSTRUMENTS	45
4.6.4	TEST PROCEDURE	45
4.6.5	DEVIATION FROM TEST STANDARD	45
4.6.6	EUT OPERATING CONDITION.....	45
4.6.7	TEST RESULTS.....	46
5.	PHOTOGRAPHS OF THE TEST CONFIGURATION.....	52
6.	INFORMATION ON THE TESTING LABORATORIES	53
7.	APPENDIX A – MODIFICATIONS RECORDERS FOR ENGINEERING CHANGES TO THE EUT BY THE LAB	54



A D T

RELEASE CONTROL RECORD

ISSUE NO.	REASON FOR CHANGE	DATE ISSUED
RF150522C08C	Original release	Jul. 21, 2015



1. CERTIFICATION

PRODUCT: ASUS ZenWatch
MODEL NO.: WI501Q
BRAND: ASUS
APPLICANT: ASUSTek COMPUTER INC.
TESTED: Jun. 04, 2015 ~ Jul. 16, 2015
TEST SAMPLE: Production Unit
STANDARDS: **FCC Part 15, Subpart C (Section 15.247)**
ANSI C63.10-2013

The above equipment (model: WI501Q) has been tested by **Bureau Veritas Consumer Products Services (H.K.) Ltd., Taoyuan Branch**, and found compliance with the requirement of the above standards. The test record, data evaluation & Equipment Under Test (EUT) configurations represented herein are true and accurate accounts of the measurements of the sample's EMC characteristics under the conditions specified in this report.

PREPARED BY :  , **DATE** : Jul. 21, 2015
Ivonne Wu / Supervisor

APPROVED BY :  , **DATE** : Jul. 21, 2015
Kay Wu / Supervisor

2. SUMMARY OF TEST RESULTS

The EUT has been tested according to the following specifications:

APPLIED STANDARD: FCC PART 15, SUBPART C (SECTION 15.247)			
STANDARD SECTION	TEST TYPE	RESULT	REMARK
15.207	AC Power Conducted Emission	PASS	Meet the requirement of limit. Minimum passing margin is -9.27dB at 0.18519MHz.
15.205 & 15.209	Radiated Emissions	PASS	Meet the requirement of limit. Minimum passing margin is -5.15dB at 240.06MHz.
15.247(d)	Band Edge Measurement	PASS	Meet the requirement of limit.
15.247(d)	Antenna Port Emission	PASS	Meet the requirement of limit.
15.247(a)(2)	6dB bandwidth	PASS	Meet the requirement of limit.
15.247(b)	Conducted power	PASS	Meet the requirement of limit.
15.247(e)	Power Spectral Density	PASS	Meet the requirement of limit.
15.203	Antenna Requirement	PASS	No antenna connector is used.

2.1 MEASUREMENT UNCERTAINTY

Where relevant, the following measurement uncertainty levels have been estimated for tests performed on the EUT as specified in CISPR 16-4-2:

MEASUREMENT	FREQUENCY	UNCERTAINTY
Conducted emissions	9kHz~30MHz	2.44 dB
Radiated emissions	30MHz ~ 200MHz	2.93 dB
	200MHz ~1000MHz	2.95 dB
	1GHz ~ 18GHz	2.26 dB
	18GHz ~ 40GHz	1.94 dB

This uncertainty represents an expanded uncertainty expressed at approximately the 95% confidence level using a coverage factor of $k = 2$.

3. GENERAL INFORMATION

3.1 GENERAL DESCRIPTION OF EUT

EUT	ASUS ZenWatch
MODEL NO.	WI501Q
POWER SUPPLY	3.85Vdc (Battery) 5.2Vdc (Adapter) 5Vdc (Host equipment)
MODULATION TYPE	CCK, DQPSK, DBPSK for DSSS 64QAM, 16QAM, QPSK, BPSK for OFDM
MODULATION TECHNOLOGY	DSSS, OFDM
TRANSFER RATE	802.11b: 11.0 / 5.5 / 2.0 / 1.0 Mbps 802.11g: 54.0 / 48.0 / 36.0 / 24.0 / 18.0 / 12.0 / 9.0 / 6.0 Mbps 802.11n: up to MCS7
OPERATING FREQUENCY	2412 ~ 2462MHz
NUMBER OF CHANNEL	11
OUTPUT POWER	263.03mW
ANTENNA TYPE	PIFA antenna with -3.05dBi gain
ANTENNA CONNECTOR	NA
DATA CABLE	Refer to Note as below
I/O PORTS	Refer to user's manual
ACCESSORY DEVICES	Refer to Note as below

NOTE:

1. There're 2 configurations for the EUT listed as below.

Main ample (A): EUT with leather strap

2nd sample (B): EUT with steel strap

✧ Only the worst data was presented in the report.

2. The EUT contains following accessory devices.

Product	Brand	Model	Description
Adapter	ASUS	AD2061320	I/P: 100-240Vac, 50/60Hz, 0.13A O/P: 5.2Vdc, 1A, 5W
Battery	ASUS	C11N1502	3.85Vdc, 1.5Wh
USB Cable	ASUS	ZENWATCH POGO PIN CABLE	0.9m shielded cable w/o core
CPU	Qualcomm	APQ8026	Up to 1.2GHz, 784 pin
LCD Panel	AUO	H163QLN01.2	1.63"
WLAN / BT Module	Murata	LBEE5KL1DX-814	--
Main Board	ASUS	SPARROW_MB	--

3. The above EUT information is declared by the manufacturer and for more detailed features description, please refer to the manufacturer's specifications or User's Manual.

3.2 DESCRIPTION OF TEST MODES

FOR 2.4GHz:

11 channels are provided for 802.11b, 802.11g and 802.11n (20MHz):

CHANNEL	FREQUENCY	CHANNEL	FREQUENCY
1	2412MHz	7	2442MHz
2	2417MHz	8	2447MHz
3	2422MHz	9	2452MHz
4	2427MHz	10	2457MHz
5	2432MHz	11	2462MHz
6	2437MHz		



A D T

3.2.1 TEST MODE APPLICABILITY AND TESTED CHANNEL DETAIL

WLAN 2.4GHz:

EUT CONFIGURE MODE	APPLICABLE TO				DESCRIPTION
	RE≥1G	RE<1G	PLC	APCM	
A	√	√	√	√	Main sample
B	√	√	√	-	2 nd sample

Where **RE≥1G**: Radiated Emission above 1GHz **RE<1G**: Radiated Emission below 1GHz
PLC: Power Line Conducted Emission **APCM**: Antenna Port Conducted Measurement

NOTE: The EUT had been pre-tested on the positioned of each 3 axis. The worst case was found when positioned on **Z-plane**.

RADIATED EMISSION TEST (ABOVE 1GHz):

- Pre-Scan has been conducted to determine the worst-case mode from all possible combinations between available modulations, data rates and antenna ports (if EUT with antenna diversity architecture).
- Following channel(s) was (were) selected for the final test as listed below.

EUT CONFIGURE MODE	MODE	AVAILABLE CHANNEL	TESTED CHANNEL	MODULATION TECHNOLOGY	MODULATION TYPE	DATA RATE (Mbps)
A	802.11b	1 to 11	1, 6, 11	DSSS	DBPSK	1.0
	802.11g	1 to 11	1, 6, 11	OFDM	BPSK	6.0
	802.11n (20MHz)	1 to 11	1, 6, 11	OFDM	BPSK	MCS0
B	802.11n (20MHz)	1 to 11	11	OFDM	BPSK	MCS0

RADIATED EMISSION TEST (BELOW 1GHz):

- Pre-Scan has been conducted to determine the worst-case mode from all possible combinations between available modulations, data rates and antenna ports (if EUT with antenna diversity architecture).
- Following channel(s) was (were) selected for the final test as listed below.

EUT CONFIGURE MODE	MODE	AVAILABLE CHANNEL	TESTED CHANNEL	MODULATION TECHNOLOGY	MODULATION TYPE	DATA RATE (Mbps)
A, B	802.11n (20MHz)	1 to 11	11	OFDM	BPSK	MCS0

POWER LINE CONDUCTED EMISSION TEST:

- Pre-Scan has been conducted to determine the worst-case mode from all possible combinations between available modulations, data rates and antenna ports (if EUT with antenna diversity architecture).
- Following channel(s) was (were) selected for the final test as listed below.

EUT CONFIGURE MODE	MODE	AVAILABLE CHANNEL	TESTED CHANNEL	MODULATION TECHNOLOGY	MODULATION TYPE	DATA RATE (Mbps)
A, B	802.11n (20MHz)	1 to 11	11	OFDM	BPSK	MCS0



BANDEDGE MEASUREMENT:

- Pre-Scan has been conducted to determine the worst-case mode from all possible combinations between available modulations, data rates and antenna ports (if EUT with antenna diversity architecture).
- Following channel(s) was (were) selected for the final test as listed below.

EUT CONFIGURE MODE	MODE	AVAILABLE CHANNEL	TESTED CHANNEL	MODULATION TECHNOLOGY	MODULATION TYPE	DATA RATE (Mbps)
A	802.11b	1 to 11	1, 6, 11	DSSS	DBPSK	1.0
	802.11g	1 to 11	1, 6, 11	OFDM	BPSK	6.0
	802.11n (20MHz)	1 to 11	1, 6, 11	OFDM	BPSK	MCS0

ANTENNA PORT CONDUCTED MEASUREMENT:

- This item includes all test value of each mode, but only includes spectrum plot of worst value of each mode.
- Pre-Scan has been conducted to determine the worst-case mode from all possible combinations between available modulations, data rates and antenna ports (if EUT with antenna diversity architecture).
- Following channel(s) was (were) selected for the final test as listed below.

EUT CONFIGURE MODE	MODE	AVAILABLE CHANNEL	TESTED CHANNEL	MODULATION TECHNOLOGY	MODULATION TYPE	DATA RATE (Mbps)
A	802.11b	1 to 11	1, 6, 11	DSSS	DBPSK	1.0
	802.11g	1 to 11	1, 6, 11	OFDM	BPSK	6.0
	802.11n (20MHz)	1 to 11	1, 6, 11	OFDM	BPSK	MCS0

TEST CONDITION:

APPLICABLE TO	ENVIRONMENTAL CONDITIONS	INPUT POWER	TESTED BY
RE≥1G	25deg. C, 65%RH	120Vac, 60Hz (System)	Charles Hsiao
RE<1G	25deg. C, 65%RH	120Vac, 60Hz (System)	Charles Hsiao
PLC	25deg. C, 65%RH	120Vac, 60Hz (System)	Toby Tian
APCM	25deg. C, 65%RH	3.85Vdc	Taylor Liu

3.3 DESCRIPTION OF SUPPORT UNITS

The EUT has been tested as an independent unit together with other necessary accessories or support units.

3.3.1 CONFIGURATION OF SYSTEM UNDER TEST

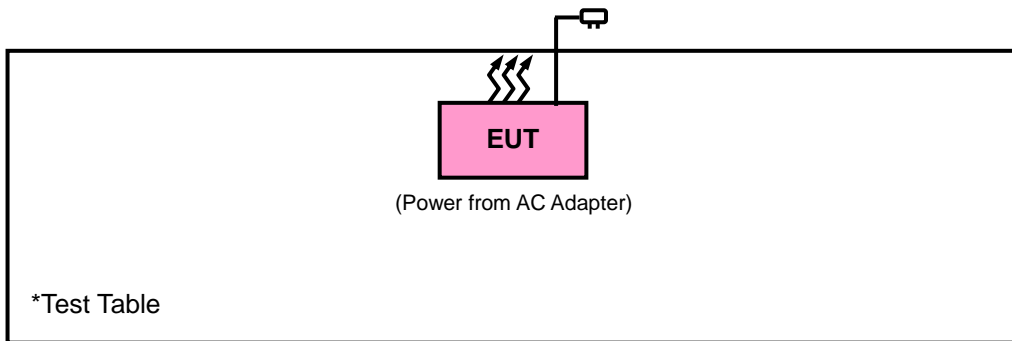

3.4 DUTY CYCLE TEST SIGNAL

WLAN 2.4GHz

802.11b: Duty cycle of test signal is 100%

802.11g: Duty cycle = $1.394/1.698 = 0.821$, Duty factor = $10 * \log(1/0.821) = 0.86$

802.11n (20MHz): Duty cycle = $1.308/1.612 = 0.811$, Duty factor = $10 * \log(1/0.811) = 0.91$

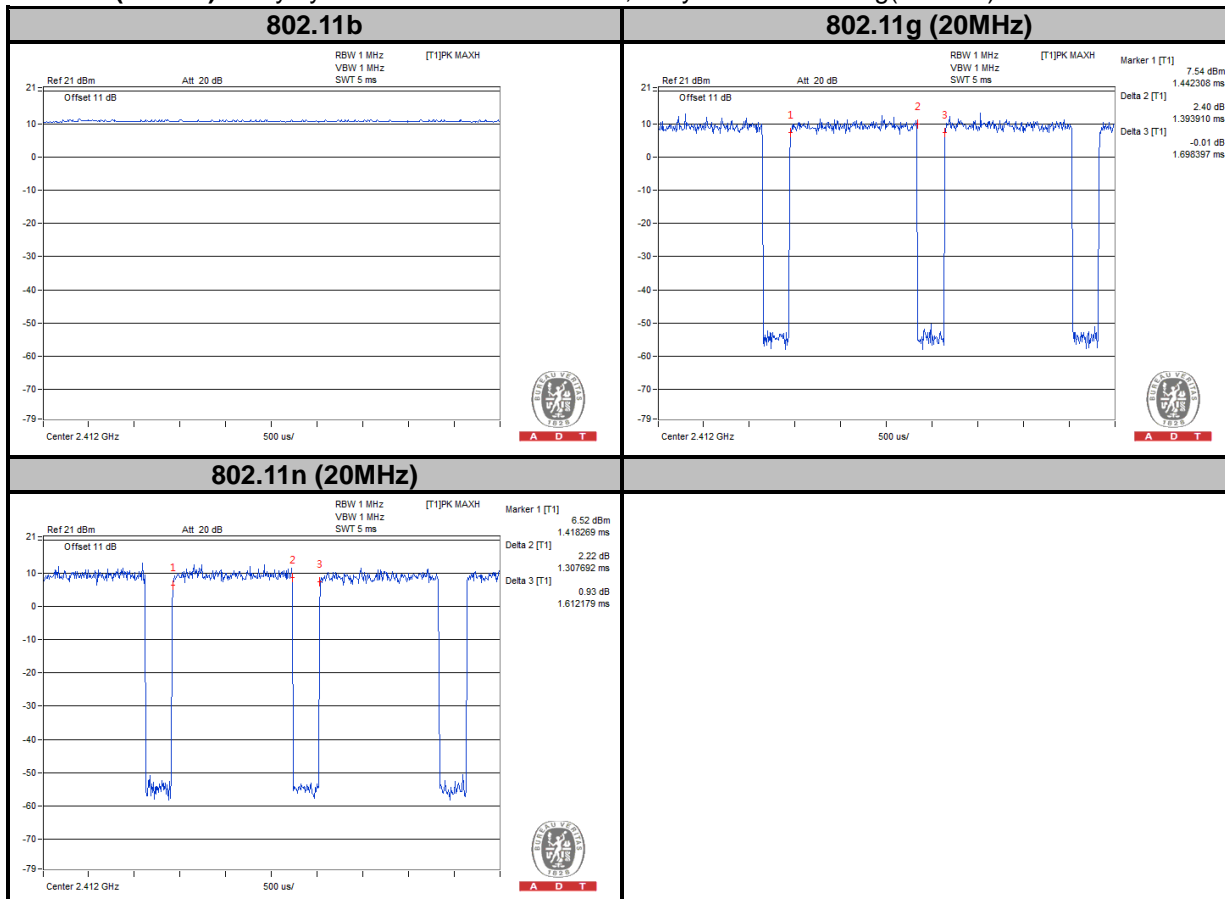



3.5 GENERAL DESCRIPTION OF APPLIED STANDARDS

The EUT is a RF Product. According to the specifications of the manufacturer, it must comply with the requirements of the following standards:

FCC Part 15, Subpart C (15.247)

558074 D01 DTS Meas Guidance v03r02

ANSI C63.10-2013

All test items have been performed and recorded as per the above standards.

NOTE: The EUT has been verified to comply with the requirements of FCC Part 15, Subpart B, Class B (DoC). The test report has been issued separately.

4. TEST TYPES AND RESULTS (FOR 2.4GHz BAND)

4.1 RADIATED EMISSION AND BANDEDGE MEASUREMENT

4.1.1 LIMITS OF RADIATED EMISSION AND BANDEDGE MEASUREMENT

Radiated emissions which fall in the restricted bands must comply with the radiated emission limits specified as below table. Other emissions shall be at least 20dB below the highest level of the desired power:

FREQUENCIES (MHz)	FIELD STRENGTH (microvolts/meter)	MEASUREMENT DISTANCE (meters)
0.009 ~ 0.490	2400/F(kHz)	300
0.490 ~ 1.705	24000/F(kHz)	30
1.705 ~ 30.0	30	30
30 ~ 88	100	3
88 ~ 216	150	3
216 ~ 960	200	3
Above 960	500	3

NOTE:

1. The lower limit shall apply at the transition frequencies.
2. Emission level (dBuV/m) = 20 log Emission level (uV/m).
3. For frequencies above 1000MHz, the field strength limits are based on average detector, however, the peak field strength of any emission shall not exceed the maximum permitted average limits, specified above by more than 20dB under any condition of modulation.



A D T

4.1.2 TEST INSTRUMENTS

DESCRIPTION & MANUFACTURER	MODEL NO.	SERIAL NO.	DATE OF CALIBRATION	DUE DATE OF CALIBRATION
Test Receiver Agilent	N9038A	MY51210203	Jan. 21, 2015	Jan. 21, 2016
Spectrum Analyzer Agilent	N9010A	MY52220314	Sep. 03, 2014	Sep. 02, 2015
Spectrum Analyzer ROHDE & SCHWARZ	FSU43	101261	Dec. 10, 2014	Dec. 09, 2015
BILOG Antenna SCHWARZBECK	VULB9168	9168-472	Feb. 04, 2015	Feb. 04, 2016
HORN Antenna SCHWARZBECK	BBHA 9120 D	9120D-969	Feb. 09, 2015	Feb. 09, 2016
HORN Antenna SCHWARZBECK	BBHA 9170	9170-480	Feb. 04, 2015	Feb. 04, 2016
Loop Antenna	EM-6879	269	Aug. 13, 2014	Aug. 12, 2015
Preamplifier EMCI	EMC 012645	980115	Dec. 12, 2014	Dec. 11, 2015
Preamplifier EMCI	EMC 184045	980116	Jan. 09, 2015	Jan. 08, 2016
Preamplifier EMCI	EMC 330H	980112	Dec. 27, 2014	Dec. 26, 2015
Power Meter Anritsu	ML2495A	1232002	Sep. 17, 2014	Sep. 16, 2015
Power Sensor Anritsu	MA2411B	1207325	Sep. 17, 2014	Sep. 16, 2015
RF signal cable HUBER+SUHNNER	SUCOFLEX 104	309219/4 2950114	Oct. 18, 2014	Oct. 17, 2015
RF signal cable HUBER+SUHNNER	SUCOFLEX 104	250130/4	Oct. 18, 2014	Oct. 17, 2015
RF Coaxial Cable Worken	8D-FB	Cable-Ch10-01	Nov. 07, 2014	Nov. 06, 2015
Software BV ADT	E3 6.120103	NA	NA	NA
Antenna Tower MF	MFA-440H	NA	NA	NA
Turn Table MF	MFT-201SS	NA	NA	NA
Antenna Tower & Turn Table Controller MF	MF-7802	NA	NA	NA

- NOTE:**
1. The calibration interval of the above test instruments is 12 months and the calibrations are traceable to NML/ROC and NIST/USA.
 2. The test was performed in HwaYa Chamber 10.
 3. The horn antenna and HP preamplifier (model: 8449B) are used only for the measurement of emission frequency above 1GHz if tested.
 4. The FCC Site Registration No. is 690701.
 5. The IC Site Registration No. is IC 7450F-10.

4.1.3 TEST PROCEDURES

- a. The EUT was placed on the top of a rotating table 0.8 meters (for below 1GHz) / 1.5 meters (for above 1GHz) above the ground at 3 meter chamber room for test. The table was rotated 360 degrees to determine the position of the highest radiation.
- b. The EUT was set 3 meters away from the interference-receiving antenna, which was mounted on the top of a variable-height antenna tower.
- c. Height of receiving antenna is varied from one meter to four meters above the ground to determine the maximum value of the field strength. Both horizontal and vertical polarizations of the antenna are set to make the measurement.
- d. For each suspected emission, the EUT was arranged to its worst case and then the antenna was tuned to heights from 1 meter to 4 meters and the rotatable table was turned from 0 degrees to 360 degrees to find the maximum reading.
- e. The test-receiver system was set to Peak Detect Function and Specified Bandwidth with Maximum Hold Mode.
- f. If the emission level of the EUT in peak mode was lower than the limit specified, then testing could be stopped and the peak values of the EUT would be reported. Otherwise the emissions would be re-tested one by one using peak, quasi-peak or average method as specified and then reported in a data sheet.

NOTE:

1. The resolution bandwidth and video bandwidth of test receiver/spectrum analyzer is 120kHz for Quasi-peak detection at frequency below 1GHz.
2. The resolution bandwidth of test receiver/spectrum analyzer is 1MHz and video bandwidth is 3MHz for Peak detection at frequency above 1GHz.
3. The resolution bandwidth of test receiver/spectrum analyzer is 1MHz and the video bandwidth is 1kHz (Duty cycle < 98%) or 10Hz (Duty cycle > 98%) for Average detection (AV) at frequency above 1GHz.
4. All modes of operation were investigated and the worst-case emissions are reported.

4.1.4 DEVIATION FROM TEST STANDARD

No deviation.

4.1.5 TEST SETUP

<Frequency Range 30MHz ~ 1GHz>

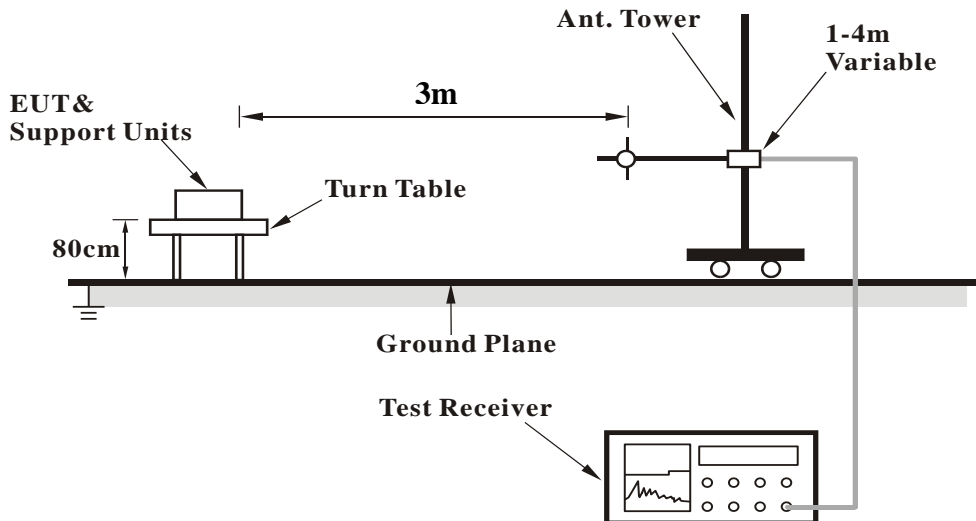

<Frequency Range above 1GHz>

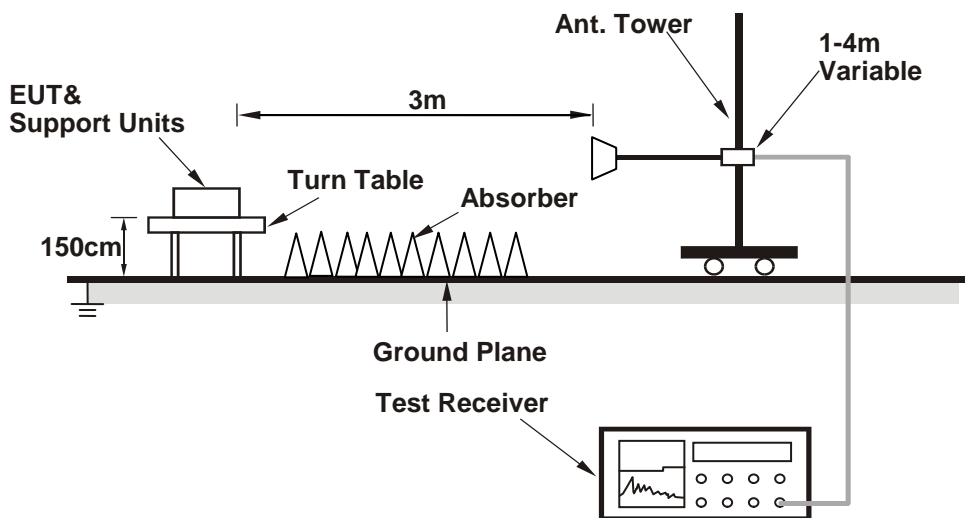

For the actual test configuration, please refer to the attached file (Test Setup Photo).

4.1.6 EUT OPERATING CONDITIONS

- a. Placed the EUT on a testing table.
- b. Use the software to control the EUT under transmission condition continuously at specific channel frequency.



A D T

4.1.7 TEST RESULTS

ABOVE 1GHz WORST-CASE DATA

Mode A

802.11b

EUT TEST CONDITION		MEASUREMENT DETAIL	
CHANNEL	Channel 1	FREQUENCY RANGE	1GHz ~ 25GHz
INPUT POWER	120Vac, 60 Hz	DETECTOR FUNCTION	Peak (PK) Average (AV)
ENVIRONMENTAL CONDITIONS	25deg. C, 65%RH	TESTED BY	Charles Hsiao

ANTENNA POLARITY & TEST DISTANCE: HORIZONTAL AT 3 M										
FREQ. (MHz)	EMISSION LEVEL (dBuV/m)	READ LEVEL (dBuV)	LIMIT (dBuV/m)	MARGIN (dB)	ANTENNA FACTOR (dB/m)	CABLE LOSS (dB)	PREAMP FACTOR (dB)	ANTENNA HEIGHT (cm)	TABLE ANGLE (Degree)	REMARK
2384	43.32	41.63	54	-10.68	31.78	5.4	35.49	141	17	Average
2384	55.52	53.83	74	-18.48	31.78	5.4	35.49	141	17	Peak
2412	104.24	102.47			31.81	5.43	35.47	141	17	Average
2412	106.5	104.73			31.81	5.43	35.47	141	17	Peak
2486	39.92	37.93	54	-14.08	31.88	5.53	35.42	141	17	Average
2486	55.77	53.78	74	-18.23	31.88	5.53	35.42	141	17	Peak
ANTENNA POLARITY & TEST DISTANCE: VERTICAL AT 3 M										
FREQ. (MHz)	EMISSION LEVEL (dBuV/m)	READ LEVEL (dBuV)	LIMIT (dBuV/m)	MARGIN (dB)	ANTENNA FACTOR (dB/m)	CABLE LOSS (dB)	PREAMP FACTOR (dB)	ANTENNA HEIGHT (cm)	TABLE ANGLE (Degree)	REMARK
2388	41.97	40.26	54	-12.03	31.8	5.4	35.49	100	178	Average
2388	55.85	54.14	74	-18.15	31.8	5.4	35.49	100	178	Peak
2412	104.64	102.87			31.81	5.43	35.47	100	178	Average
2412	107.49	105.72			31.81	5.43	35.47	100	178	Peak
2496	39.97	37.95	54	-14.03	31.9	5.53	35.41	100	178	Average
2496	55.45	53.43	74	-18.55	31.9	5.53	35.41	100	178	Peak

REMARKS:

- Emission Level = Read Level + Antenna Factor + Cable Loss - Preamp Factor
Margin value = Emission level – Limit value
- 2412MHz: Fundamental frequency.



A D T

EUT TEST CONDITION		MEASUREMENT DETAIL	
CHANNEL	Channel 6	FREQUENCY RANGE	1GHz ~ 25GHz
INPUT POWER	120Vac, 60 Hz	DETECTOR FUNCTION	Peak (PK) Average (AV)
ENVIRONMENTAL CONDITIONS	25deg. C, 65%RH	TESTED BY	Charles Hsiao

ANTENNA POLARITY & TEST DISTANCE: HORIZONTAL AT 3 M

FREQ. (MHz)	EMISSION LEVEL (dBuV/m)	READ LEVEL (dBuV)	LIMIT (dBuV/m)	MARGIN (dB)	ANTENNA FACTOR (dB/m)	CABLE LOSS (dB)	PREAMP FACTOR (dB)	ANTENNA HEIGHT (cm)	TABLE ANGLE (Degree)	REMARK
2358	39.68	38.05	54	-14.32	31.76	5.37	35.5	139	19	Average
2358	55.11	53.48	74	-18.89	31.76	5.37	35.5	139	19	Peak
2437	103.49	101.64			31.85	5.46	35.46	139	19	Average
2437	106.22	104.37			31.85	5.46	35.46	139	19	Peak
2488	40.05	38.04	54	-13.95	31.9	5.53	35.42	139	19	Average
2488	55.9	53.89	74	-18.1	31.9	5.53	35.42	139	19	Peak

ANTENNA POLARITY & TEST DISTANCE: VERTICAL AT 3 M

FREQ. (MHz)	EMISSION LEVEL (dBuV/m)	READ LEVEL (dBuV)	LIMIT (dBuV/m)	MARGIN (dB)	ANTENNA FACTOR (dB/m)	CABLE LOSS (dB)	PREAMP FACTOR (dB)	ANTENNA HEIGHT (cm)	TABLE ANGLE (Degree)	REMARK
2334	39.45	37.91	54	-14.55	31.73	5.33	35.52	129	182	Average
2334	55.66	54.12	74	-18.34	31.73	5.33	35.52	129	182	Peak
2437	104.54	102.69			31.85	5.46	35.46	129	182	Average
2437	107.55	105.7			31.85	5.46	35.46	129	182	Peak
2494	40.07	38.05	54	-13.93	31.9	5.53	35.41	129	182	Average
2494	56.17	54.15	74	-17.83	31.9	5.53	35.41	129	182	Peak

REMARKS:

- Emission Level = Read Level + Antenna Factor + Cable Loss - Preamp Factor
Margin value = Emission level – Limit value
- 2437MHz: Fundamental frequency.



A D T

EUT TEST CONDITION		MEASUREMENT DETAIL	
CHANNEL	Channel 11	FREQUENCY RANGE	1GHz ~ 25GHz
INPUT POWER	120Vac, 60 Hz	DETECTOR FUNCTION	Peak (PK) Average (AV)
ENVIRONMENTAL CONDITIONS	25deg. C, 65%RH	TESTED BY	Charles Hsiao

ANTENNA POLARITY & TEST DISTANCE: HORIZONTAL AT 3 M

FREQ. (MHz)	EMISSION LEVEL (dBuV/m)	READ LEVEL (dBuV)	LIMIT (dBuV/m)	MARGIN (dB)	ANTENNA FACTOR (dB/m)	CABLE LOSS (dB)	PREAMP FACTOR (dB)	ANTENNA HEIGHT (cm)	TABLE ANGLE (Degree)	REMARK
2346	39.45	37.88	54	-14.55	31.74	5.33	35.5	121	31	Average
2346	55.7	54.13	74	-18.3	31.74	5.33	35.5	121	31	Peak
2462	103.6	101.67			31.87	5.5	35.44	121	31	Average
2462	106.5	104.57			31.87	5.5	35.44	121	31	Peak
2496	42.03	40.01	54	-11.97	31.9	5.53	35.41	121	31	Average
2496	56.29	54.27	74	-17.71	31.9	5.53	35.41	121	31	Peak

ANTENNA POLARITY & TEST DISTANCE: VERTICAL AT 3 M

FREQ. (MHz)	EMISSION LEVEL (dBuV/m)	READ LEVEL (dBuV)	LIMIT (dBuV/m)	MARGIN (dB)	ANTENNA FACTOR (dB/m)	CABLE LOSS (dB)	PREAMP FACTOR (dB)	ANTENNA HEIGHT (cm)	TABLE ANGLE (Degree)	REMARK
2320	39.3	37.79	54	-14.7	31.73	5.3	35.52	128	182	Average
2320	55.82	54.31	74	-18.18	31.73	5.3	35.52	128	182	Peak
2462	104.64	102.71			31.87	5.5	35.44	128	182	Average
2462	107.63	105.7			31.87	5.5	35.44	128	182	Peak
2500	42.7	40.68	54	-11.3	31.9	5.53	35.41	128	182	Average
2500	55.46	53.44	74	-18.54	31.9	5.53	35.41	128	182	Peak

REMARKS:

- Emission Level = Read Level + Antenna Factor + Cable Loss - Preamp Factor
Margin value = Emission level – Limit value
- 2462MHz: Fundamental frequency.



A D T

802.11g

EUT TEST CONDITION		MEASUREMENT DETAIL	
CHANNEL	Channel 1	FREQUENCY RANGE	1GHz ~ 25GHz
INPUT POWER	120Vac, 60 Hz	DETECTOR FUNCTION	Peak (PK) Average (AV)
ENVIRONMENTAL CONDITIONS	25deg. C, 65%RH	TESTED BY	Charles Hsiao

ANTENNA POLARITY & TEST DISTANCE: HORIZONTAL AT 3 M										
FREQ. (MHz)	EMISSION LEVEL (dBuV/m)	READ LEVEL (dBuV)	LIMIT (dBuV/m)	MARGIN (dB)	ANTENNA FACTOR (dB/m)	CABLE LOSS (dB)	PREAMP FACTOR (dB)	ANTENNA HEIGHT (cm)	TABLE ANGLE (Degree)	REMARK
2390	44.48	42.75	54	-9.52	31.8	5.4	35.47	109	35	Average
2390	57.52	55.79	74	-16.48	31.8	5.4	35.47	109	35	Peak
2412	99.36	97.59			31.81	5.43	35.47	109	35	Average
2412	107.18	105.41			31.81	5.43	35.47	109	35	Peak
2490	40.83	38.82	54	-13.17	31.9	5.53	35.42	109	35	Average
2490	55.66	53.65	74	-18.34	31.9	5.53	35.42	109	35	Peak
ANTENNA POLARITY & TEST DISTANCE: VERTICAL AT 3 M										
FREQ. (MHz)	EMISSION LEVEL (dBuV/m)	READ LEVEL (dBuV)	LIMIT (dBuV/m)	MARGIN (dB)	ANTENNA FACTOR (dB/m)	CABLE LOSS (dB)	PREAMP FACTOR (dB)	ANTENNA HEIGHT (cm)	TABLE ANGLE (Degree)	REMARK
2390	45.6	43.87	54	-8.4	31.8	5.4	35.47	100	165	Average
2390	58.83	57.1	74	-15.17	31.8	5.4	35.47	100	165	Peak
2412	100.85	99.08			31.81	5.43	35.47	100	165	Average
2412	108.65	106.88			31.81	5.43	35.47	100	165	Peak
2484	40.68	38.72	54	-13.32	31.88	5.5	35.42	100	165	Average
2484	56.57	54.61	74	-17.43	31.88	5.5	35.42	100	165	Peak

REMARKS:

- Emission Level = Read Level + Antenna Factor + Cable Loss - Preamp Factor
Margin value = Emission level – Limit value
- 2412MHz: Fundamental frequency.



A D T

EUT TEST CONDITION		MEASUREMENT DETAIL	
CHANNEL	Channel 6	FREQUENCY RANGE	1GHz ~ 25GHz
INPUT POWER	120Vac, 60 Hz	DETECTOR FUNCTION	Peak (PK) Average (AV)
ENVIRONMENTAL CONDITIONS	25deg. C, 65%RH	TESTED BY	Charles Hsiao

ANTENNA POLARITY & TEST DISTANCE: HORIZONTAL AT 3 M

FREQ. (MHz)	EMISSION LEVEL (dBuV/m)	READ LEVEL (dBuV)	LIMIT (dBuV/m)	MARGIN (dB)	ANTENNA FACTOR (dB/m)	CABLE LOSS (dB)	PREAMP FACTOR (dB)	ANTENNA HEIGHT (cm)	TABLE ANGLE (Degree)	REMARK
2388	40.5	38.79	54	-13.5	31.8	5.4	35.49	106	78	Average
2388	54.85	53.14	74	-19.15	31.8	5.4	35.49	106	78	Peak
2437	99.41	97.56			31.85	5.46	35.46	106	78	Average
2437	107.45	105.6			31.85	5.46	35.46	106	78	Peak
2496	40.73	38.71	54	-13.27	31.9	5.53	35.41	106	78	Average
2496	55.69	53.67	74	-18.31	31.9	5.53	35.41	106	78	Peak

ANTENNA POLARITY & TEST DISTANCE: VERTICAL AT 3 M

FREQ. (MHz)	EMISSION LEVEL (dBuV/m)	READ LEVEL (dBuV)	LIMIT (dBuV/m)	MARGIN (dB)	ANTENNA FACTOR (dB/m)	CABLE LOSS (dB)	PREAMP FACTOR (dB)	ANTENNA HEIGHT (cm)	TABLE ANGLE (Degree)	REMARK
2378	40.55	38.89	54	-13.45	31.78	5.37	35.49	129	165	Average
2378	55.4	53.74	74	-18.6	31.78	5.37	35.49	129	165	Peak
2437	100.31	98.46			31.85	5.46	35.46	129	165	Average
2437	108.49	106.64			31.85	5.46	35.46	129	165	Peak
2496	41.13	39.11	54	-12.87	31.9	5.53	35.41	129	165	Average
2496	56.68	54.66	74	-17.32	31.9	5.53	35.41	129	165	Peak

REMARKS:

- Emission Level = Read Level + Antenna Factor + Cable Loss - Preamp Factor
Margin value = Emission level – Limit value
- 2437MHz: Fundamental frequency.



A D T

EUT TEST CONDITION		MEASUREMENT DETAIL	
CHANNEL	Channel 11	FREQUENCY RANGE	1GHz ~ 25GHz
INPUT POWER	120Vac, 60 Hz	DETECTOR FUNCTION	Peak (PK) Average (AV)
ENVIRONMENTAL CONDITIONS	25deg. C, 65%RH	TESTED BY	Charles Hsiao

ANTENNA POLARITY & TEST DISTANCE: HORIZONTAL AT 3 M

FREQ. (MHz)	EMISSION LEVEL (dBuV/m)	READ LEVEL (dBuV)	LIMIT (dBuV/m)	MARGIN (dB)	ANTENNA FACTOR (dB/m)	CABLE LOSS (dB)	PREAMP FACTOR (dB)	ANTENNA HEIGHT (cm)	TABLE ANGLE (Degree)	REMARK
2334	40.16	38.62	54	-13.84	31.73	5.33	35.52	106	34	Average
2334	55.1	53.56	74	-18.9	31.73	5.33	35.52	106	34	Peak
2462	98.36	96.43			31.87	5.5	35.44	106	34	Average
2462	106.29	104.36			31.87	5.5	35.44	106	34	Peak
2484	45.58	43.62	54	-8.42	31.88	5.5	35.42	106	34	Average
2484	59.53	57.57	74	-14.47	31.88	5.5	35.42	106	34	Peak

ANTENNA POLARITY & TEST DISTANCE: VERTICAL AT 3 M

FREQ. (MHz)	EMISSION LEVEL (dBuV/m)	READ LEVEL (dBuV)	LIMIT (dBuV/m)	MARGIN (dB)	ANTENNA FACTOR (dB/m)	CABLE LOSS (dB)	PREAMP FACTOR (dB)	ANTENNA HEIGHT (cm)	TABLE ANGLE (Degree)	REMARK
2356	40.13	38.5	54	-13.87	31.76	5.37	35.5	128	165	Average
2356	55.61	53.98	74	-18.39	31.76	5.37	35.5	128	165	Peak
2462	99.76	97.83			31.87	5.5	35.44	128	165	Average
2462	107.8	105.87			31.87	5.5	35.44	128	165	Peak
2484	45.72	43.76	54	-8.28	31.88	5.5	35.42	128	165	Average
2484	61.73	59.77	74	-12.27	31.88	5.5	35.42	128	165	Peak

REMARKS:

- Emission Level = Read Level + Antenna Factor + Cable Loss - Preamp Factor
Margin value = Emission level – Limit value
- 2462MHz: Fundamental frequency.



A D T

802.11n (20MHz)

EUT TEST CONDITION		MEASUREMENT DETAIL	
CHANNEL	Channel 1	FREQUENCY RANGE	1GHz ~ 25GHz
INPUT POWER	120Vac, 60 Hz	DETECTOR FUNCTION	Peak (PK) Average (AV)
ENVIRONMENTAL CONDITIONS	25deg. C, 65%RH	TESTED BY	Charles Hsiao

ANTENNA POLARITY & TEST DISTANCE: HORIZONTAL AT 3 M										
FREQ. (MHz)	EMISSION LEVEL (dBuV/m)	READ LEVEL (dBuV)	LIMIT (dBuV/m)	MARGIN (dB)	ANTENNA FACTOR (dB/m)	CABLE LOSS (dB)	PREAMP FACTOR (dB)	ANTENNA HEIGHT (cm)	TABLE ANGLE (Degree)	REMARK
2390	46.09	44.36	54	-7.91	31.8	5.4	35.47	109	35	Average
2390	61.15	59.42	74	-12.85	31.8	5.4	35.47	109	35	Peak
2412	99.25	97.48			31.81	5.43	35.47	109	35	Average
2412	107.74	105.97			31.81	5.43	35.47	109	35	Peak
2486	40.81	38.82	54	-13.19	31.88	5.53	35.42	109	35	Average
2486	55.47	53.48	74	-18.53	31.88	5.53	35.42	109	35	Peak

ANTENNA POLARITY & TEST DISTANCE: VERTICAL AT 3 M										
FREQ. (MHz)	EMISSION LEVEL (dBuV/m)	READ LEVEL (dBuV)	LIMIT (dBuV/m)	MARGIN (dB)	ANTENNA FACTOR (dB/m)	CABLE LOSS (dB)	PREAMP FACTOR (dB)	ANTENNA HEIGHT (cm)	TABLE ANGLE (Degree)	REMARK
2390	46.1	44.37	54	-7.9	31.8	5.4	35.47	100	165	Average
2390	60	58.27	74	-14	31.8	5.4	35.47	100	165	Peak
2412	100.35	98.58			31.81	5.43	35.47	100	165	Average
2412	108.04	106.27			31.81	5.43	35.47	100	165	Peak
2486	40.81	38.82	54	-13.19	31.88	5.53	35.42	100	165	Average
2486	57.12	55.13	74	-16.88	31.88	5.53	35.42	100	165	Peak

REMARKS:

1. Emission Level = Read Level + Antenna Factor + Cable Loss - Preamp Factor
Margin value = Emission level – Limit value
2. 2412MHz: Fundamental frequency.



A D T

EUT TEST CONDITION		MEASUREMENT DETAIL	
CHANNEL	Channel 6	FREQUENCY RANGE	1GHz ~ 25GHz
INPUT POWER	120Vac, 60 Hz	DETECTOR FUNCTION	Peak (PK) Average (AV)
ENVIRONMENTAL CONDITIONS	25deg. C, 65%RH	TESTED BY	Charles Hsiao

ANTENNA POLARITY & TEST DISTANCE: HORIZONTAL AT 3 M

FREQ. (MHz)	EMISSION LEVEL (dBuV/m)	READ LEVEL (dBuV)	LIMIT (dBuV/m)	MARGIN (dB)	ANTENNA FACTOR (dB/m)	CABLE LOSS (dB)	PREAMP FACTOR (dB)	ANTENNA HEIGHT (cm)	TABLE ANGLE (Degree)	REMARK
2310	40.61	39.13	54	-13.39	31.71	5.3	35.53	106	78	Average
2310	55.51	54.03	74	-18.49	31.71	5.3	35.53	106	78	Peak
2437	99.91	98.06			31.85	5.46	35.46	106	78	Average
2437	107.79	105.94			31.85	5.46	35.46	106	78	Peak
2494	41.03	39.01	54	-12.97	31.9	5.53	35.41	106	78	Average
2494	55.88	53.86	74	-18.12	31.9	5.53	35.41	106	78	Peak

ANTENNA POLARITY & TEST DISTANCE: VERTICAL AT 3 M

FREQ. (MHz)	EMISSION LEVEL (dBuV/m)	READ LEVEL (dBuV)	LIMIT (dBuV/m)	MARGIN (dB)	ANTENNA FACTOR (dB/m)	CABLE LOSS (dB)	PREAMP FACTOR (dB)	ANTENNA HEIGHT (cm)	TABLE ANGLE (Degree)	REMARK
2388	40.5	38.79	54	-13.5	31.8	5.4	35.49	129	165	Average
2388	55.48	53.77	74	-18.52	31.8	5.4	35.49	129	165	Peak
2437	99.91	98.06			31.85	5.46	35.46	129	165	Average
2437	108.06	106.21			31.85	5.46	35.46	129	165	Peak
2486	41.21	39.22	54	-12.79	31.88	5.53	35.42	129	165	Average
2486	55.27	53.28	74	-18.73	31.88	5.53	35.42	129	165	Peak

REMARKS:

- Emission Level = Read Level + Antenna Factor + Cable Loss - Preamp Factor
Margin value = Emission level – Limit value
- 2437MHz: Fundamental frequency.



A D T

EUT TEST CONDITION		MEASUREMENT DETAIL	
CHANNEL	Channel 11	FREQUENCY RANGE	1GHz ~ 25GHz
INPUT POWER	120Vac, 60 Hz	DETECTOR FUNCTION	Peak (PK) Average (AV)
ENVIRONMENTAL CONDITIONS	25deg. C, 65%RH	TESTED BY	Charles Hsiao

ANTENNA POLARITY & TEST DISTANCE: HORIZONTAL AT 3 M

FREQ. (MHz)	EMISSION LEVEL (dBuV/m)	READ LEVEL (dBuV)	LIMIT (dBuV/m)	MARGIN (dB)	ANTENNA FACTOR (dB/m)	CABLE LOSS (dB)	PREAMP FACTOR (dB)	ANTENNA HEIGHT (cm)	TABLE ANGLE (Degree)	REMARK
2384	40.18	38.49	54	-13.82	31.78	5.4	35.49	106	34	Average
2384	55.8	54.11	74	-18.2	31.78	5.4	35.49	106	34	Peak
2462	99.43	97.5			31.87	5.5	35.44	106	34	Average
2462	107.37	105.44			31.87	5.5	35.44	106	34	Peak
2484	46.68	44.72	54	-7.32	31.88	5.5	35.42	106	34	Average
2484	63.38	61.42	74	-10.62	31.88	5.5	35.42	106	34	Peak

ANTENNA POLARITY & TEST DISTANCE: VERTICAL AT 3 M

FREQ. (MHz)	EMISSION LEVEL (dBuV/m)	READ LEVEL (dBuV)	LIMIT (dBuV/m)	MARGIN (dB)	ANTENNA FACTOR (dB/m)	CABLE LOSS (dB)	PREAMP FACTOR (dB)	ANTENNA HEIGHT (cm)	TABLE ANGLE (Degree)	REMARK
2390	40.5	38.77	54	-13.5	31.8	5.4	35.47	128	164	Average
2390	55.47	53.74	74	-18.53	31.8	5.4	35.47	128	164	Peak
2462	100.26	98.33			31.87	5.5	35.44	128	164	Average
2462	108.33	106.4			31.87	5.5	35.44	128	164	Peak
2484	46.88	44.92	54	-7.12	31.88	5.5	35.42	128	164	Average
2484	62.97	61.01	74	-11.03	31.88	5.5	35.42	128	164	Peak

REMARKS:

- Emission Level = Read Level + Antenna Factor + Cable Loss - Preamp Factor
Margin value = Emission level – Limit value
- 2462MHz: Fundamental frequency.



A D T

Mode B

802.11n (20MHz)

EUT TEST CONDITION		MEASUREMENT DETAIL	
CHANNEL	Channel 11	FREQUENCY RANGE	1GHz ~ 25GHz
INPUT POWER	120Vac, 60 Hz	DETECTOR FUNCTION	Peak (PK) Average (AV)
ENVIRONMENTAL CONDITIONS	25deg. C, 65%RH	TESTED BY	Charles Hsiao

ANTENNA POLARITY & TEST DISTANCE: HORIZONTAL AT 3 M

FREQ. (MHz)	EMISSION LEVEL (dBuV/m)	READ LEVEL (dBuV)	LIMIT (dBuV/m)	MARGIN (dB)	ANTENNA FACTOR (dB/m)	CABLE LOSS (dB)	PREAMP FACTOR (dB)	ANTENNA HEIGHT (cm)	TABLE ANGLE (Degree)	REMARK
2324	40.07	38.56	54	-13.93	31.73	5.3	35.52	208	351	Average
2324	55.44	53.93	74	-18.56	31.73	5.3	35.52	208	351	Peak
2462	99.24	97.31			31.87	5.5	35.44	208	351	Average
2462	107.89	105.96			31.87	5.5	35.44	208	351	Peak
2484	46.07	44.11	54	-7.93	31.88	5.5	35.42	208	351	Average
2484	64.76	62.8	74	-9.24	31.88	5.5	35.42	208	351	Peak

ANTENNA POLARITY & TEST DISTANCE: VERTICAL AT 3 M

FREQ. (MHz)	EMISSION LEVEL (dBuV/m)	READ LEVEL (dBuV)	LIMIT (dBuV/m)	MARGIN (dB)	ANTENNA FACTOR (dB/m)	CABLE LOSS (dB)	PREAMP FACTOR (dB)	ANTENNA HEIGHT (cm)	TABLE ANGLE (Degree)	REMARK
2380	40.16	38.5	54	-13.84	31.78	5.37	35.49	111	30	Average
2380	55.97	54.31	74	-18.03	31.78	5.37	35.49	111	30	Peak
2462	98.71	96.78			31.87	5.5	35.44	111	30	Average
2462	106.64	104.71			31.87	5.5	35.44	111	30	Peak
2484	44.65	42.69	54	-9.35	31.88	5.5	35.42	111	30	Average
2484	56.62	54.66	74	-17.38	31.88	5.5	35.42	111	30	Peak

REMARKS:

- Emission Level = Read Level + Antenna Factor + Cable Loss - Preamp Factor
Margin value = Emission level – Limit value
- 2462MHz: Fundamental frequency.



A D T

BELOW 1GHz WORST-CASE DATA:

Mode A

802.11n (20MHz)

EUT TEST CONDITION		MEASUREMENT DETAIL	
CHANNEL	Channel 11	FREQUENCY RANGE	30MHz ~ 1GHz
INPUT POWER	120Vac, 60 Hz	DETECTOR FUNCTION	Peak (PK) Average (AV)
ENVIRONMENTAL CONDITIONS	25deg. C, 65%RH	TESTED BY	Charles Hsiao

ANTENNA POLARITY & TEST DISTANCE: HORIZONTAL AT 3 M

FREQ. (MHz)	EMISSION LEVEL (dBuV/m)	READ LEVEL (dBuV)	LIMIT (dBuV/m)	MARGIN (dB)	ANTENNA FACTOR (dB/m)	CABLE LOSS (dB)	PREAMP FACTOR (dB)	ANTENNA HEIGHT (cm)	TABLE ANGLE (Degree)	REMARK
99.93	24.23	42.93	43.5	-19.27	12.28	1.28	32.26	124	227	Peak
200.1	19.97	39.54	43.5	-23.53	11.08	1.65	32.3	110	108	Peak
240.06	40.85	59.03	46	-5.15	12.1	1.85	32.13	140	185	Peak
479.9	29.77	43.26	46	-16.23	16.07	2.56	32.12	129	87	Peak
710.9	31.71	41.31	46	-14.29	19.39	3.11	32.1	131	258	Peak
960.1	31.58	37.02	54	-22.42	21.83	3.67	30.94	170	15	Peak

ANTENNA POLARITY & TEST DISTANCE: VERTICAL AT 3 M

FREQ. (MHz)	EMISSION LEVEL (dBuV/m)	READ LEVEL (dBuV)	LIMIT (dBuV/m)	MARGIN (dB)	ANTENNA FACTOR (dB/m)	CABLE LOSS (dB)	PREAMP FACTOR (dB)	ANTENNA HEIGHT (cm)	TABLE ANGLE (Degree)	REMARK
166.89	26.8	48.54	43.5	-16.7	8.99	1.52	32.25	189	88	Peak
240.06	29.35	47.53	46	-16.65	12.1	1.85	32.13	106	350	Peak
295.68	27.14	44.26	46	-18.86	12.98	2.03	32.13	129	203	Peak
312.6	30.29	46.96	46	-15.71	13.34	2.11	32.12	187	44	Peak
639.5	25.11	36.06	46	-20.89	18.28	2.93	32.16	102	314	Peak
960.1	30.96	36.4	54	-23.04	21.83	3.67	30.94	137	206	Peak

REMARKS: Emission Level = Read Level + Antenna Factor + Cable Loss - Preamp Factor

Margin value = Emission level – Limit value



A D T

Mode B

802.11n (20MHz)

EUT TEST CONDITION		MEASUREMENT DETAIL	
CHANNEL	Channel 11	FREQUENCY RANGE	30MHz ~ 1GHz
INPUT POWER	120Vac, 60 Hz	DETECTOR FUNCTION	Peak (PK) Average (AV)
ENVIRONMENTAL CONDITIONS	25deg. C, 65%RH	TESTED BY	Charles Hsiao

ANTENNA POLARITY & TEST DISTANCE: HORIZONTAL AT 3 M										
FREQ. (MHz)	EMISSION LEVEL (dBuV/m)	READ LEVEL (dBuV)	LIMIT (dBuV/m)	MARGIN (dB)	ANTENNA FACTOR (dB/m)	CABLE LOSS (dB)	PREAMP FACTOR (dB)	ANTENNA HEIGHT (cm)	TABLE ANGLE (Degree)	REMARK
89.67	28.97	50.67	43.5	-14.53	8.9	1.11	31.71	120	212	Peak
190.65	12.2	32.45	43.5	-31.3	10.4	1.61	32.26	134	208	Peak
240.06	19.56	37.3	46	-26.44	12.54	1.85	32.13	142	120	Peak
479.9	23.99	34.63	46	-22.01	18.92	2.56	32.12	139	238	Peak
672.4	28.76	34.43	46	-17.24	23.4	3.05	32.12	177	145	Peak
864.2	28.06	31.92	46	-17.94	24.4	3.44	31.7	185	235	Peak
ANTENNA POLARITY & TEST DISTANCE: VERTICAL AT 3 M										
FREQ. (MHz)	EMISSION LEVEL (dBuV/m)	READ LEVEL (dBuV)	LIMIT (dBuV/m)	MARGIN (dB)	ANTENNA FACTOR (dB/m)	CABLE LOSS (dB)	PREAMP FACTOR (dB)	ANTENNA HEIGHT (cm)	TABLE ANGLE (Degree)	REMARK
91.02	25.77	47.45	43.5	-17.73	8.98	1.11	31.77	174	145	Peak
155.55	13.52	33.76	43.5	-29.98	10.51	1.52	32.27	196	339	Peak
240.06	19.15	36.89	46	-26.85	12.54	1.85	32.13	108	218	Peak
479.9	23.71	34.35	46	-22.29	18.92	2.56	32.12	108	269	Peak
672.4	30.32	35.99	46	-15.68	23.4	3.05	32.12	175	58	Peak
940.5	29.34	30.7	46	-16.66	26.2	3.62	31.18	176	339	Peak

REMARKS: Emission Level = Read Level + Antenna Factor + Cable Loss - Preamp Factor

Margin value = Emission level – Limit value

4.2 CONDUCTED EMISSION MEASUREMENT

4.2.1 LIMITS OF CONDUCTED EMISSION MEASUREMENT

FREQUENCY OF EMISSION (MHz)	CONDUCTED LIMIT (dB μ V)	
	Quasi-peak	Average
0.15 ~ 0.5	66 to 56	56 to 46
0.5 ~ 5	56	46
5 ~ 30	60	50

- NOTE:**
1. The lower limit shall apply at the transition frequencies.
 2. The limit decreases in line with the logarithm of the frequency in the range of 0.15 to 0.50MHz.
 3. All emanations from a class A/B digital device or system, including any network of conductors and apparatus connected thereto, shall not exceed the level of field strengths specified above.

4.2.2 TEST INSTRUMENTS

DESCRIPTION & MANUFACTURER	MODEL NO.	SERIAL NO.	DATE OF CALIBRATION	DUE DATE OF CALIBRATION
Test Receiver ROHDE & SCHWARZ	ESCI	100613	Nov. 11, 2014	Nov. 10, 2015
RF signal cable Woken	5D-FB	Cable-HYC01-01	Dec. 26, 2014	Dec. 25, 2015
LISN ROHDE & SCHWARZ (EUT)	ESH3-Z5	835239/001	Mar. 02, 2015	Mar. 01, 2016
LISN ROHDE & SCHWARZ (Peripheral)	ESH3-Z5	100311	Jul. 21, 2014	Jul. 20, 2015
Software ADT	BV ADT_Cond_ V7.3.7.3	NA	NA	NA

- NOTE:**
1. The calibration interval of the above test instruments is 12 months and the calibrations are traceable to NML/ROC and NIST/USA.
 2. The test was performed in HwaYa Shielded Room 1.
 3. The VCCI Site Registration No. is C-2040.

4.2.3 TEST PROCEDURES

- a. The EUT was placed 0.4 meters from the conducting wall of the shielded room with EUT being connected to the power mains through a line impedance stabilization network (LISN). Other support units were connected to the power mains through another LISN. The two LISNs provide 50 ohm/ 50uH of coupling impedance for the measuring instrument.
- b. Both lines of the power mains connected to the EUT were checked for maximum conducted interference.
- c. The frequency range from 150kHz to 30MHz was searched. Emission levels under (Limit - 20dB) was not recorded.

NOTE: All modes of operation were investigated and the worst-case emissions are reported.

4.2.4 DEVIATION FROM TEST STANDARD

No deviation.

4.2.5 TEST SETUP

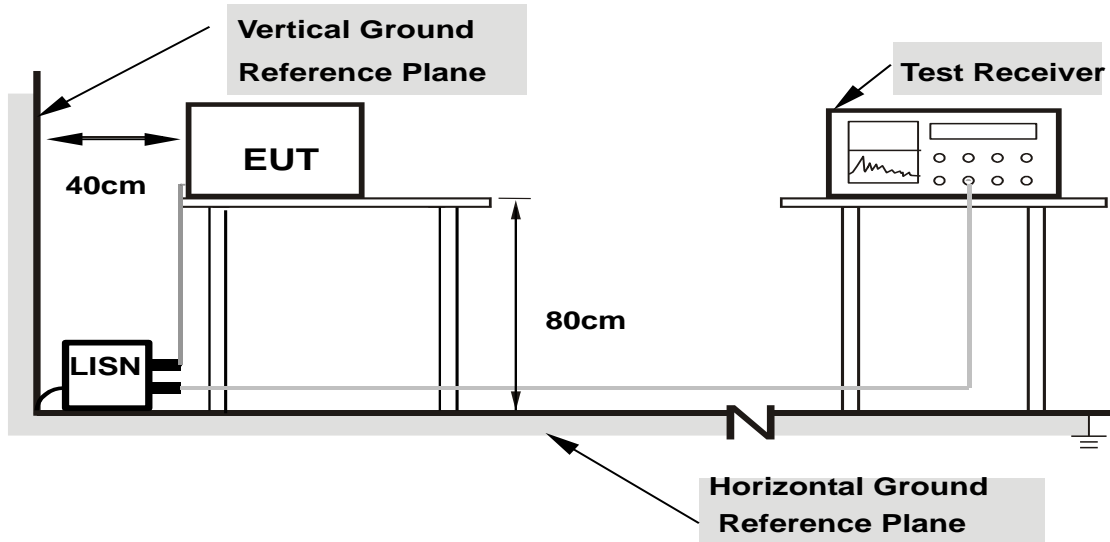

- Note:**
1. Support units were connected to second LISN.
 2. Both of LISNs (AMN) are 80 cm from EUT and at least 80 from other units and other metal planes

For the actual test configuration, please refer to the attached file (Test Setup Photo).

4.2.6 EUT OPERATING CONDITIONS

Same as section 4.1.6.

4.2.7 TEST RESULTS

Mode A

Frequency Range	150kHz ~ 30MHz	Detector Function & Resolution Bandwidth	Quasi-Peak (QP) / Average (AV), 9kHz
Input Power	120Vac, 60Hz (System)	Environmental Conditions	25°C, 65%RH
Tested by	Toby Tian	Test Date	2015/6/5

Phase Of Power : Line (L)										
No	Frequency (MHz)	Correction Factor (dB)	Reading Value (dBuV)		Emission Level (dBuV)		Limit (dBuV)		Margin (dB)	
			Q.P.	AV.	Q.P.	AV.	Q.P.	AV.	Q.P.	AV.
1	0.18519	0.06	54.92	35.92	54.98	35.98	64.25	54.25	-9.27	-18.27
2	0.19717	0.06	53.78	38.31	53.84	38.37	63.73	53.73	-9.89	-15.36
3	0.21256	0.06	45.59	29.02	45.65	29.08	63.10	53.10	-17.45	-24.02
4	0.25166	0.06	44.42	31.19	44.48	31.25	61.70	51.70	-17.22	-20.45
5	0.32272	0.06	38.25	24.15	38.31	24.21	59.64	49.64	-21.33	-25.43
6	0.39635	0.06	34.67	20.17	34.73	20.23	57.93	47.93	-23.20	-27.70

Remarks:

1. Q.P. and AV. are abbreviations of quasi-peak and average individually.
2. The emission levels of other frequencies were very low against the limit.
3. Margin value = Emission level – Limit value
4. Correction factor = Insertion loss + Cable loss
5. Emission Level = Correction Factor + Reading Value

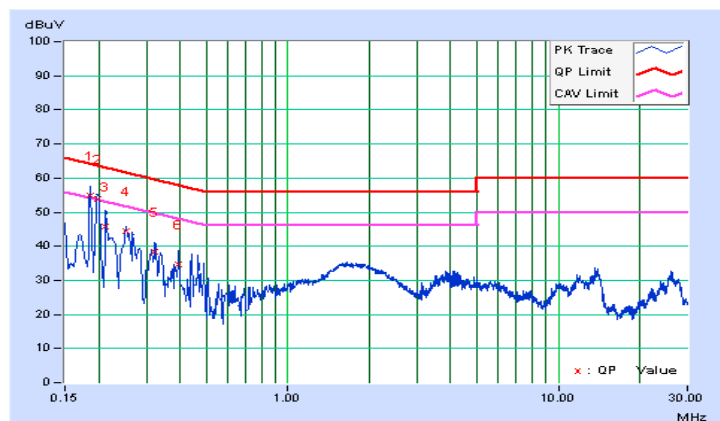



A D T

Frequency Range	150kHz ~ 30MHz	Detector Function & Resolution Bandwidth	Quasi-Peak (QP) / Average (AV), 9kHz
Input Power	120Vac, 60Hz (System)	Environmental Conditions	25°C, 65%RH
Tested by	Toby Tian	Test Date	2015/6/5

Phase Of Power : Neutral (N)										
No	Frequency (MHz)	Correction Factor (dB)	Reading Value (dBuV)		Emission Level (dBuV)		Limit (dBuV)		Margin (dB)	
			Q.P.	AV.	Q.P.	AV.	Q.P.	AV.	Q.P.	AV.
1	0.15391	0.05	40.00	31.11	40.05	31.16	65.79	55.79	-25.74	-24.63
2	0.18910	0.05	54.31	38.09	54.36	38.14	64.08	54.08	-9.72	-15.94
3	0.20458	0.05	52.41	36.75	52.46	36.80	63.42	53.42	-10.96	-16.62
4	0.27120	0.05	42.00	29.54	42.05	29.59	61.08	51.08	-19.03	-21.49
5	0.34560	0.06	36.60	21.16	36.66	21.22	59.07	49.07	-22.41	-27.85
6	0.40415	0.06	31.95	17.91	32.01	17.97	57.77	47.77	-25.76	-29.80

Remarks:

1. Q.P. and AV. are abbreviations of quasi-peak and average individually.
2. The emission levels of other frequencies were very low against the limit.
3. Margin value = Emission level – Limit value
4. Correction factor = Insertion loss + Cable loss
5. Emission Level = Correction Factor + Reading Value

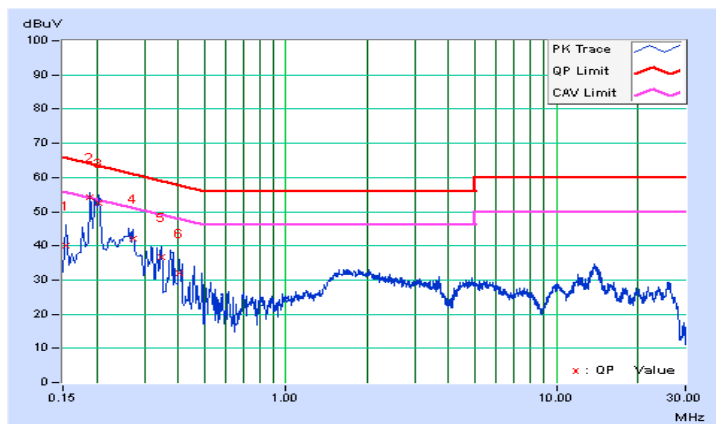



A D T

Mode B

Frequency Range	150kHz ~ 30MHz	Detector Function & Resolution Bandwidth	Quasi-Peak (QP) / Average (AV), 9kHz
Input Power	120Vac, 60Hz	Environmental Conditions	25°C, 65%RH
Tested by	Toby Tian	Test Date	2015/7/16

Phase Of Power : Line (L)										
No	Frequency (MHz)	Correction Factor (dB)	Reading Value (dBuV)		Emission Level (dBuV)		Limit (dBuV)		Margin (dB)	
			Q.P.	AV.	Q.P.	AV.	Q.P.	AV.	Q.P.	AV.
1	0.15391	0.05	42.41	31.78	42.46	31.83	65.79	55.79	-23.33	-23.96
2	0.16564	0.05	40.85	21.84	40.90	21.89	65.18	55.18	-24.27	-33.28
3	0.19692	0.06	38.97	22.92	39.03	22.98	63.74	53.74	-24.71	-30.76
4	0.23586	0.06	33.99	17.63	34.05	17.69	62.24	52.24	-28.19	-34.55
5	0.34560	0.06	37.69	27.87	37.75	27.93	59.07	49.07	-21.32	-21.14
6	0.75214	0.07	31.25	20.83	31.32	20.90	56.00	46.00	-24.68	-25.10

Remarks:

1. Q.P. and AV. are abbreviations of quasi-peak and average individually.
2. The emission levels of other frequencies were very low against the limit.
3. Margin value = Emission level – Limit value
4. Correction factor = Insertion loss + Cable loss
5. Emission Level = Correction Factor + Reading Value

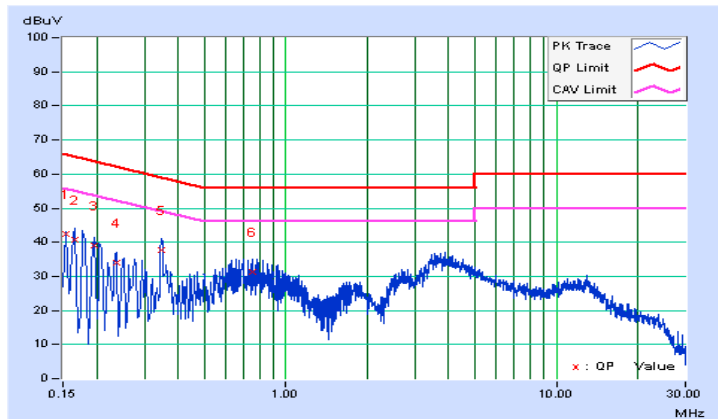



A D T

Frequency Range	150kHz ~ 30MHz	Detector Function & Resolution Bandwidth	Quasi-Peak (QP) / Average (AV), 9kHz
Input Power	120Vac, 60Hz	Environmental Conditions	25°C, 65%RH
Tested by	Toby Tian	Test Date	2015/7/16

Phase Of Power : Neutral (N)										
No	Frequency (MHz)	Correction Factor (dB)	Reading Value (dBuV)		Emission Level (dBuV)		Limit (dBuV)		Margin (dB)	
			Q.P.	AV.	Q.P.	AV.	Q.P.	AV.	Q.P.	AV.
1	0.15391	0.05	41.88	31.60	41.93	31.65	65.79	55.79	-23.86	-24.14
2	0.19692	0.05	39.14	25.79	39.19	25.84	63.74	53.74	-24.55	-27.90
3	0.22434	0.05	36.88	24.91	36.93	24.96	62.66	52.66	-25.73	-27.70
4	0.35332	0.06	40.77	35.88	40.83	35.94	58.88	48.88	-18.06	-12.95
5	0.62702	0.07	28.77	18.87	28.84	18.94	56.00	46.00	-27.16	-27.06
6	3.98180	0.19	29.51	23.23	29.70	23.42	56.00	46.00	-26.30	-22.58

Remarks:

1. Q.P. and AV. are abbreviations of quasi-peak and average individually.
2. The emission levels of other frequencies were very low against the limit.
3. Margin value = Emission level – Limit value
4. Correction factor = Insertion loss + Cable loss
5. Emission Level = Correction Factor + Reading Value

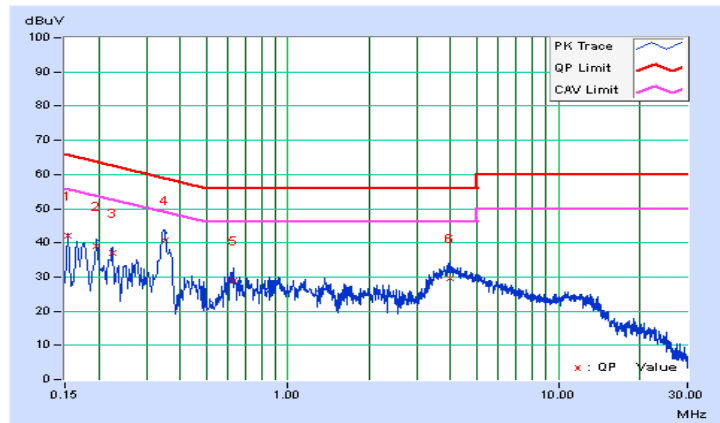

4.3 6dB BANDWIDTH MEASUREMENT

4.3.1 LIMITS OF 6dB BANDWIDTH MEASUREMENT

The minimum of 6dB Bandwidth Measurement is 0.5 MHz.

4.3.2 TEST SETUP

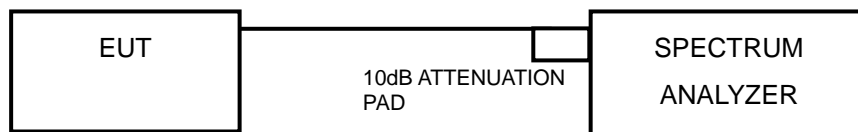

4.3.3 TEST INSTRUMENTS

Refer to section 4.1.2 to get information of above instrument.

4.3.4 TEST PROCEDURE

- Set resolution bandwidth (RBW) = 100kHz
- Set the video bandwidth (VBW) $\geq 3 \times$ RBW, Detector = Peak.
- Trace mode = max hold.
- Sweep = auto couple.
- Measure the maximum width of the emission that is constrained by the frequencies associated with the two amplitude points (upper and lower) that are attenuated by 6 dB relative to the maximum level measured in the fundamental emission

4.3.5 DEVIATION FROM TEST STANDARD

No deviation.

4.3.6 EUT OPERATING CONDITIONS

The software provided by client to enable the EUT under transmission condition continuously at lowest, middle and highest channel frequencies individually.



A D T

4.3.7 TEST RESULTS

802.11b

CHANNEL	FREQUENCY (MHz)	6dB BANDWIDTH (MHz)	MINIMUM LIMIT (MHz)	PASS / FAIL
1	2412	8.61	0.5	PASS
6	2437	9.04	0.5	PASS
11	2462	8.57	0.5	PASS

802.11g

CHANNEL	FREQUENCY (MHz)	6dB BANDWIDTH (MHz)	MINIMUM LIMIT (MHz)	PASS / FAIL
1	2412	15.16	0.5	PASS
6	2437	15.15	0.5	PASS
11	2462	15.16	0.5	PASS

802.11n (20MHz)

CHANNEL	FREQUENCY (MHz)	6dB BANDWIDTH (MHz)	MINIMUM LIMIT (MHz)	PASS / FAIL
1	2412	15.16	0.5	PASS
6	2437	15.17	0.5	PASS
11	2462	15.15	0.5	PASS



A D T

SPECTRUM PLOT OF WORST VALUE

802.11b

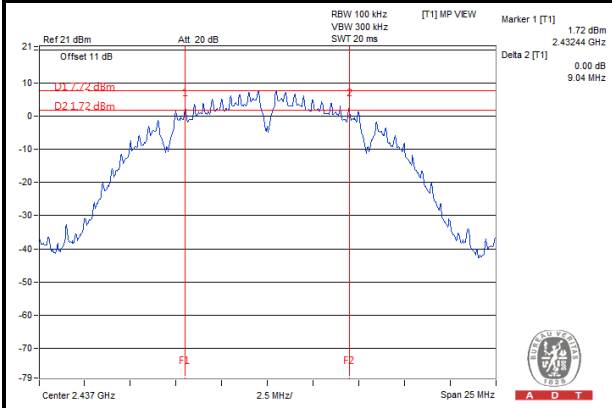

802.11g

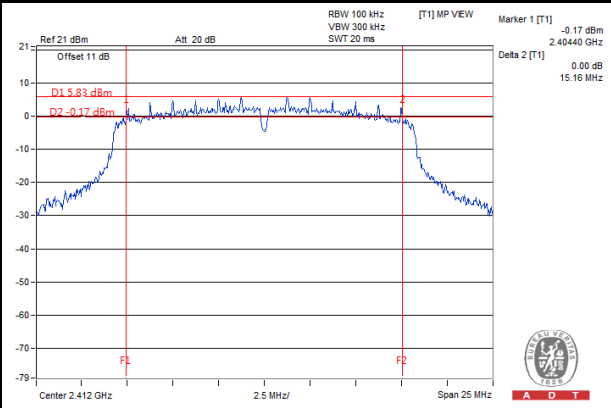

802.11n (20MHz)

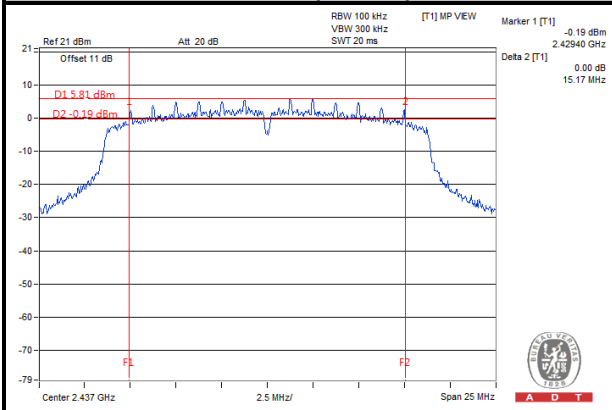

4.4 CONDUCTED OUTPUT POWER

4.4.1 LIMITS OF CONDUCTED OUTPUT POWER MEASUREMENT

For systems using digital modulation in the 2400–2483.5 MHz bands: 1 Watt (30dBm)

4.4.2 TEST SETUP

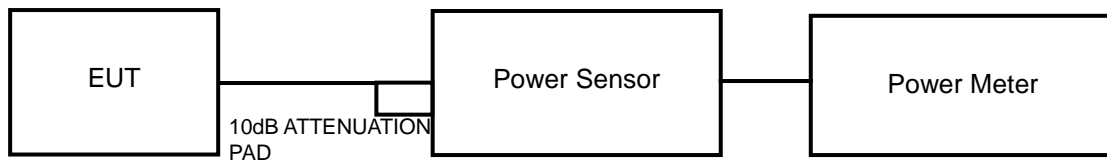

4.4.3 TEST INSTRUMENTS

Refer to section 4.1.2 to get information of above instrument.

4.4.4 TEST PROCEDURES

A peak power sensor was used on the output port of the EUT. A power meter was used to read the response of the peak power sensor. Record the peak power level.

4.4.5 DEVIATION FROM TEST STANDARD

No deviation.

4.4.6 EUT OPERATING CONDITIONS

Same as section 4.3.6.



A D T

4.4.7 TEST RESULTS

802.11b

CHANNEL	FREQUENCY (MHz)	PEAK POWER (mW)	PEAK POWER (dBm)	LIMIT (dBm)	PASS / FAIL
1	2412	60.12	17.79	30	PASS
6	2437	62.37	17.95	30	PASS
11	2462	57.94	17.63	30	PASS

802.11g

CHANNEL	FREQUENCY (MHz)	PEAK POWER (mW)	PEAK POWER (dBm)	LIMIT (dBm)	PASS / FAIL
1	2412	233.35	23.68	30	PASS
6	2437	263.03	24.2	30	PASS
11	2462	249.46	23.97	30	PASS

802.11n (20MHz)

CHANNEL	FREQUENCY (MHz)	PEAK POWER (mW)	PEAK POWER (dBm)	LIMIT (dBm)	PASS / FAIL
1	2412	242.10	23.84	30	PASS
6	2437	246.60	23.92	30	PASS
11	2462	244.34	23.88	30	PASS

4.5 POWER SPECTRAL DENSITY MEASUREMENT

4.5.1 LIMITS OF POWER SPECTRAL DENSITY MEASUREMENT

The Maximum of Power Spectral Density Measurement is 8dBm.

4.5.2 TEST SETUP

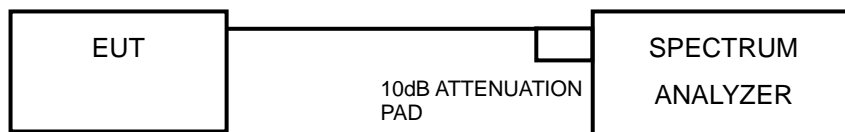

4.5.3 TEST INSTRUMENTS

Refer to section 4.1.2 to get information of above instrument.

4.5.4 TEST PROCEDURE

- Set the RBW = 3 kHz, VBW =10 kHz, Detector = peak.
- Sweep time = auto couple, Trace mode = max hold, allow trace to fully stabilize.
- Use the peak marker function to determine the maximum power level in any 100 kHz band segment within the fundamental EBW.

4.5.5 DEVIATION FROM TEST STANDARD

No deviation.

4.5.6 EUT OPERATING CONDITION

Same as section 4.3.6.



A D T

4.5.7 TEST RESULTS

802.11b

CHANNEL	FREQUENCY (MHz)	PSD (dBm/3kHz)	LIMIT (dBm/3kHz)	PASS / FAIL
1	2412	-5.98	8	PASS
6	2437	-6.00	8	PASS
11	2462	-6.52	8	PASS

802.11g

CHANNEL	FREQUENCY (MHz)	PSD (dBm/3kHz)	LIMIT (dBm/3kHz)	PASS / FAIL
1	2412	-9.35	8	PASS
6	2437	-9.25	8	PASS
11	2462	-8.90	8	PASS

802.11n (20MHz)

CHANNEL	FREQUENCY (MHz)	PSD (dBm/3kHz)	LIMIT (dBm/3kHz)	PASS / FAIL
1	2412	-9.06	8	PASS
6	2437	-9.82	8	PASS
11	2462	-8.87	8	PASS



A D T

SPECTRUM PLOT OF WORST VALUE

802.11b

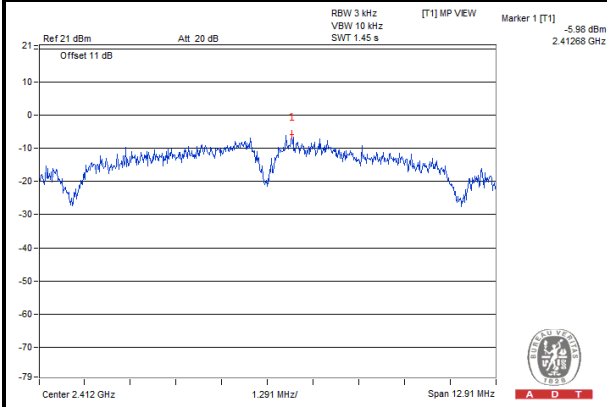

802.11g

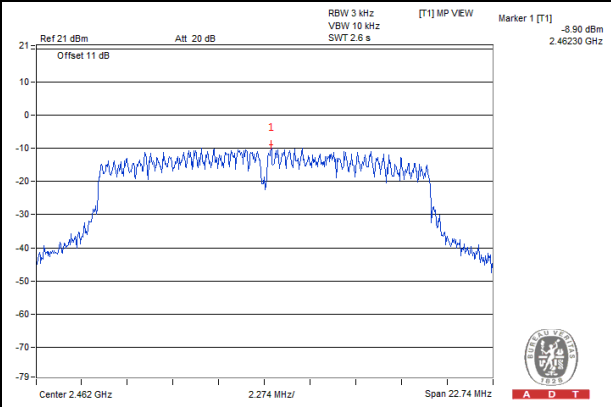

802.11n (20MHz)

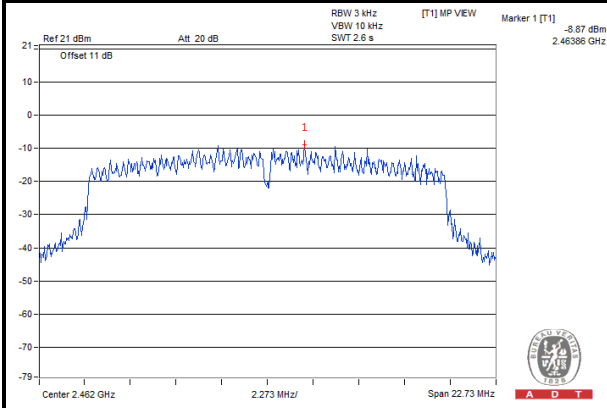

4.6 CONDUCTED OUT OF BAND EMISSION MEASUREMENT

4.6.1 LIMITS OF CONDUCTED OUT OF BAND EMISSION MEASUREMENT

Below -20dB of the highest emission level of operating band (in 100kHz Resolution Bandwidth).

4.6.2 TEST SETUP

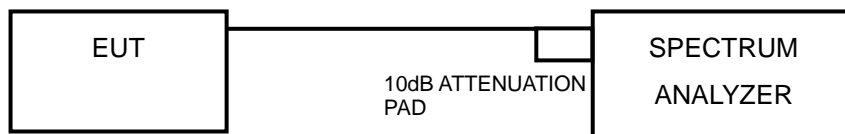

4.6.3 TEST INSTRUMENTS

Refer to section 4.1.2 to get information of above instrument.

4.6.4 TEST PROCEDURE

MEASUREMENT PROCEDURE REF

1. Set the RBW = 100 kHz .
2. Set the VBW $\geq 300\text{ kHz}$.
3. Detector = peak.
4. Sweep time = auto couple.
5. Trace mode = max hold.
6. Allow trace to fully stabilize.
7. Use the peak marker function to determine the maximum power level in any 100 kHz band segment within the fundamental EBW.

MEASUREMENT PROCEDURE OOB

1. Set RBW = 100 kHz .
2. Set VBW $\geq 300\text{ kHz}$.
3. Detector = peak.
4. Sweep = auto couple.
5. Trace Mode = max hold.
6. Allow trace to fully stabilize.
7. Use the peak marker function to determine the maximum amplitude level.

4.6.5 DEVIATION FROM TEST STANDARD

No deviation.

4.6.6 EUT OPERATING CONDITION

Same as section 4.3.6.

4.6.7 TEST RESULTS

The spectrum plots are attached on the following images. D1 line indicates the highest level, and D2 line indicates the 20dB offset below D1. It shows compliance with the requirement.

802.11b

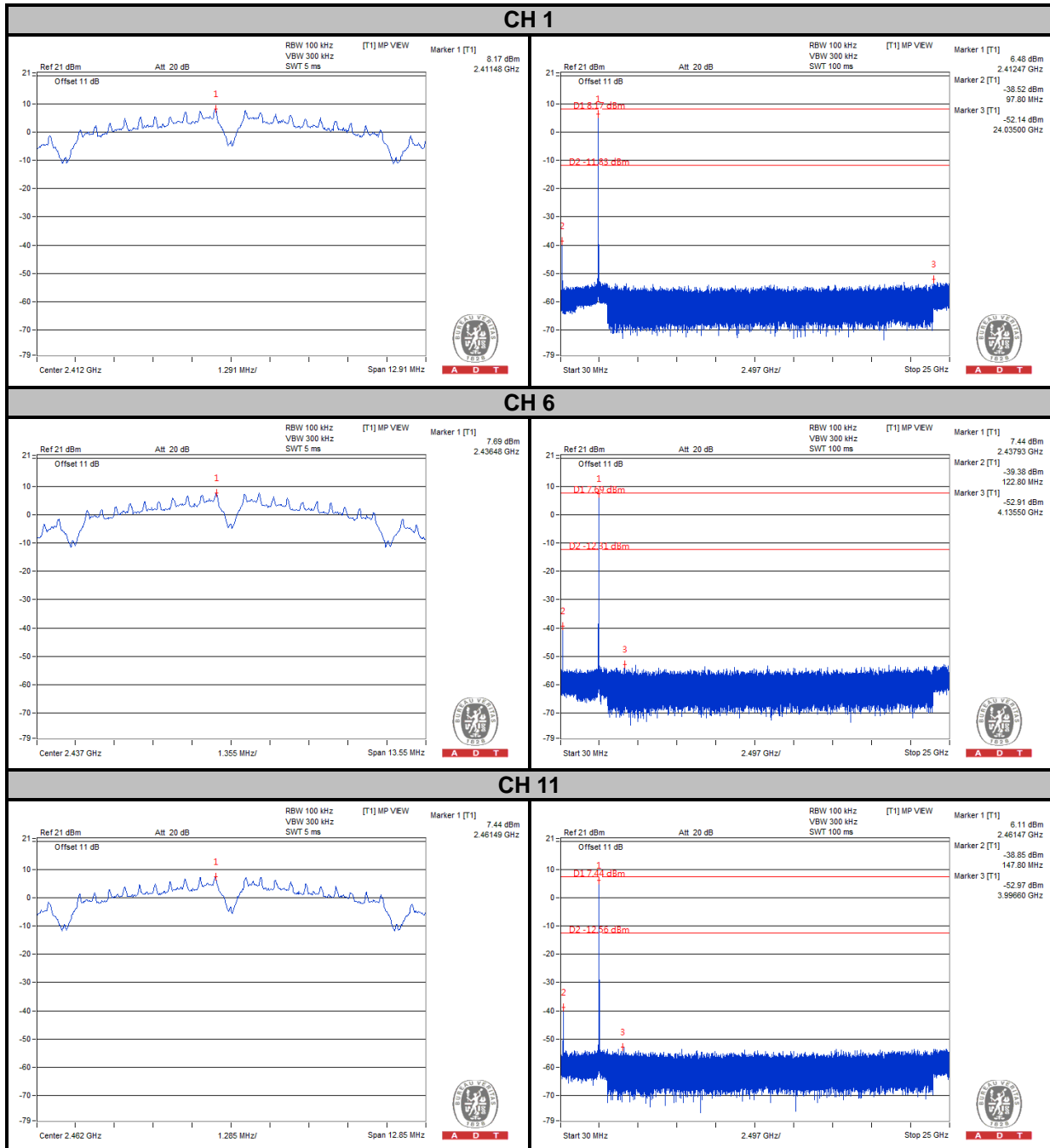



A D T

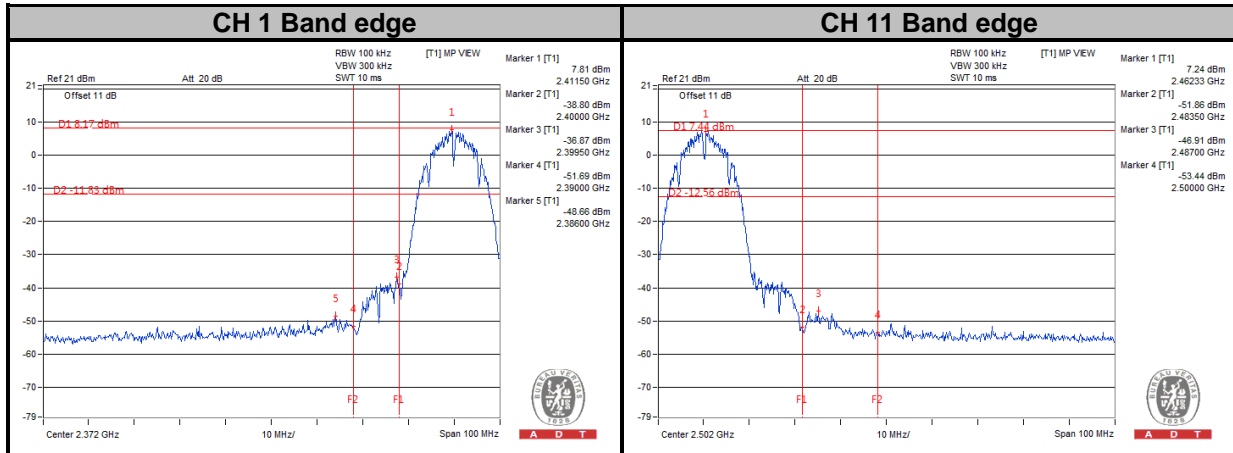



A D T

802.11g

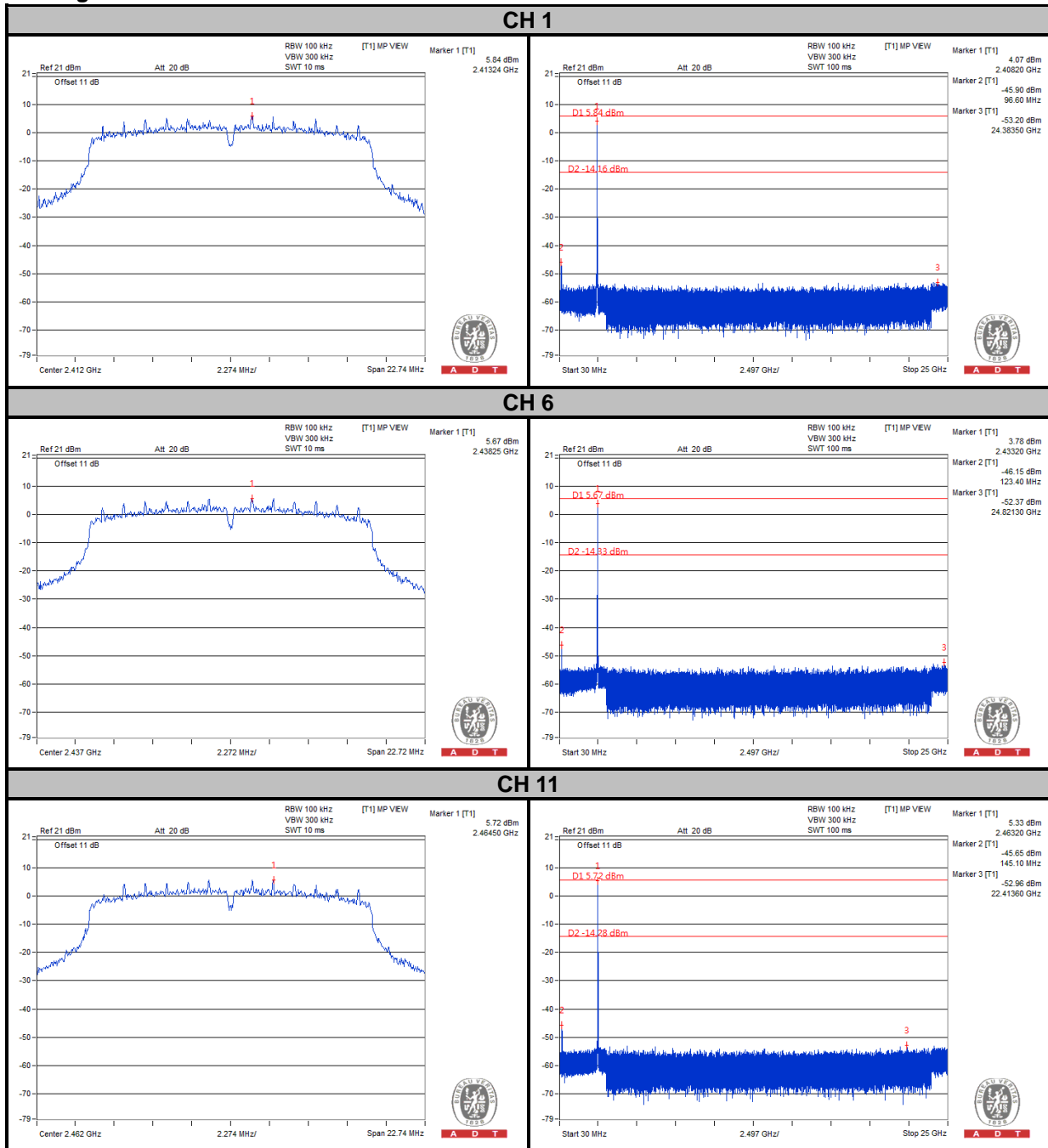



A D T

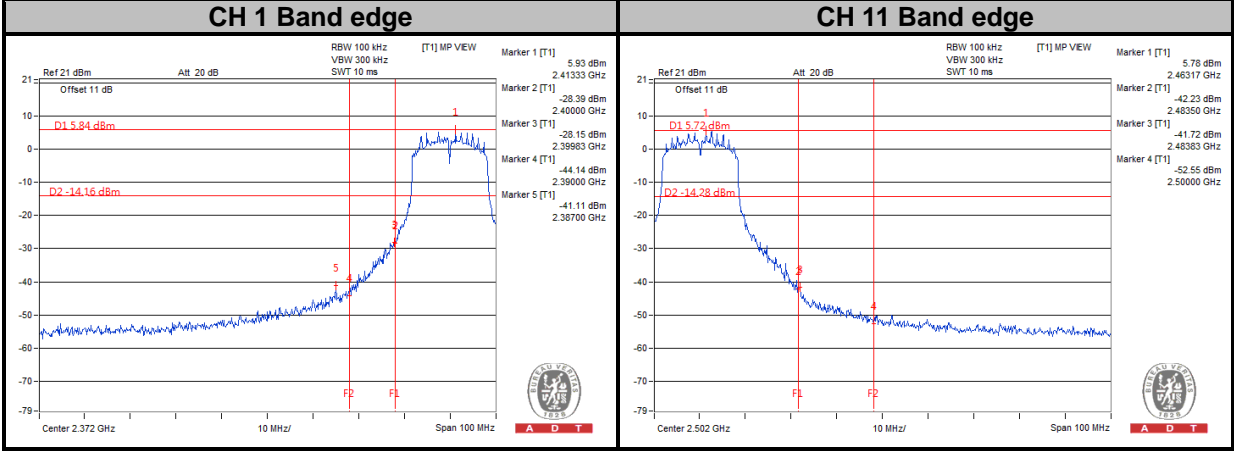



A D T

802.11n (20MHz)

CH 1

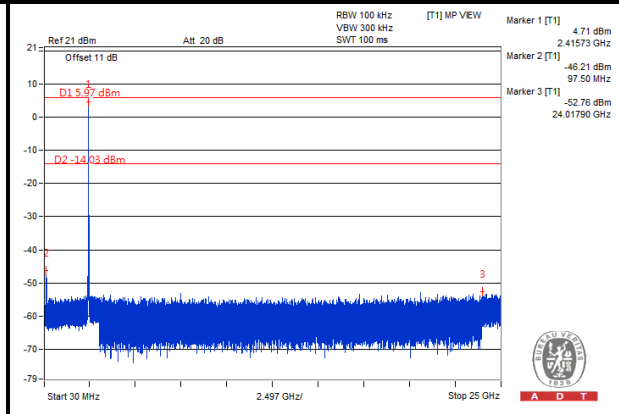
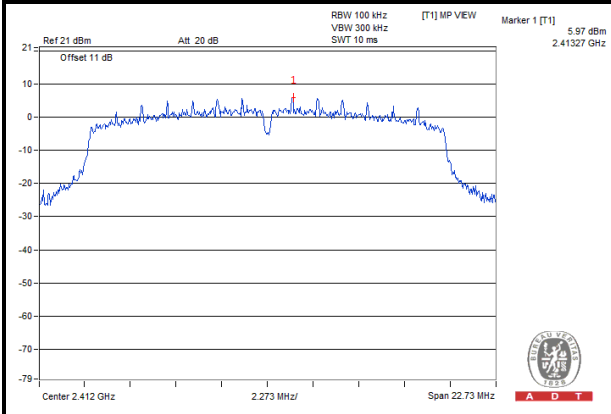

CH 6

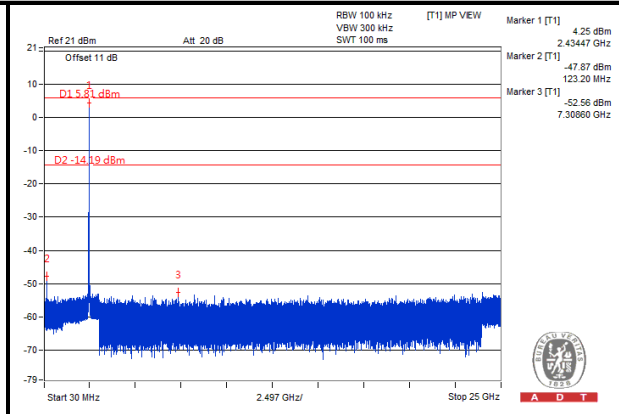
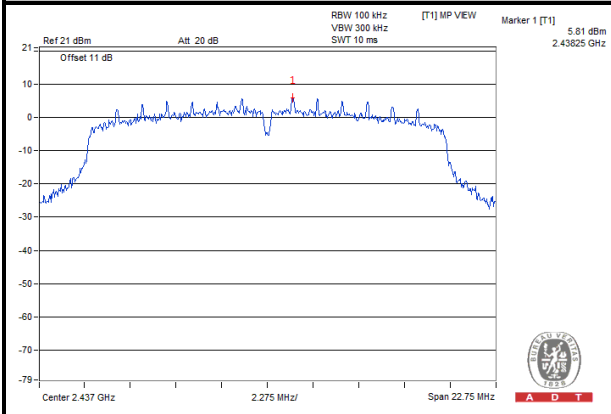

CH 11

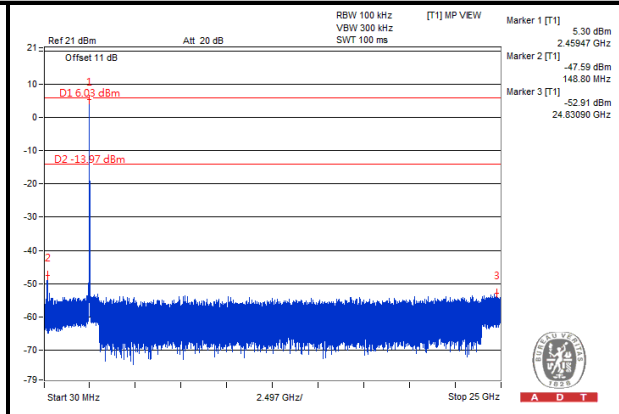
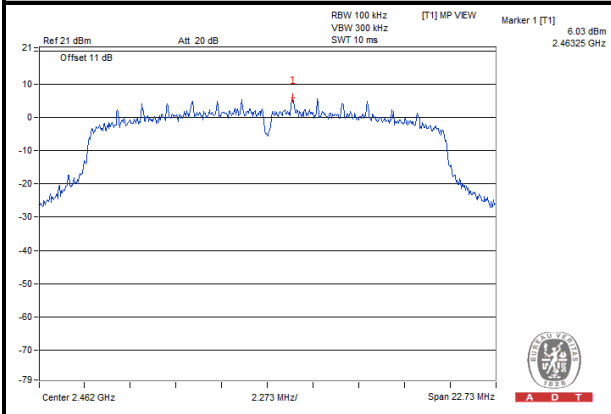



A D T

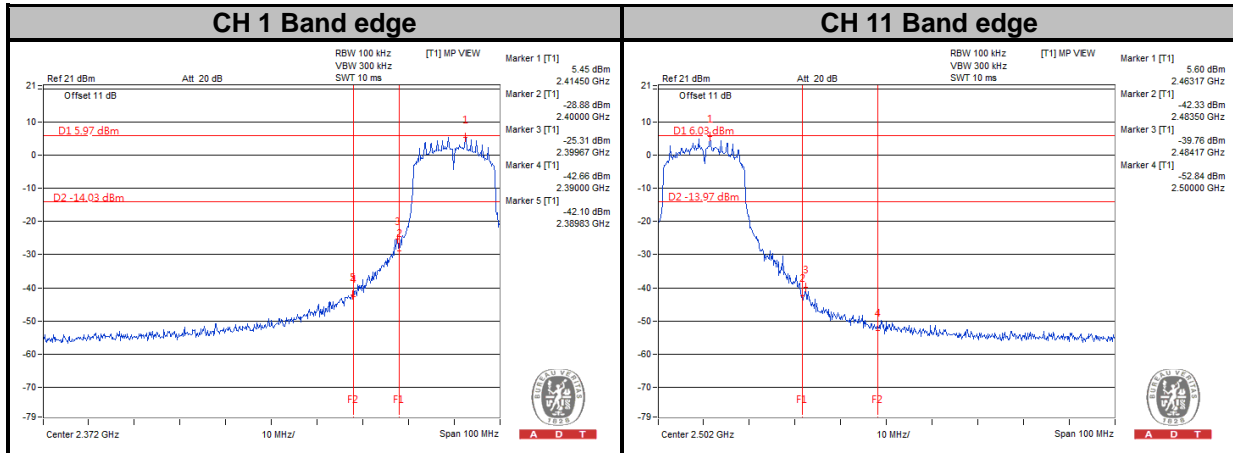



A D T

5. PHOTOGRAPHS OF THE TEST CONFIGURATION

Please refer to the attached file (Test Setup Photo).



6. INFORMATION ON THE TESTING LABORATORIES

We, Bureau Veritas Consumer Products Services (H.K.) Ltd., Taoyuan Branch, were founded in 1988 to provide our best service in EMC, Radio, Telecom and Safety consultation. Our laboratories are accredited and approved according to ISO/IEC 17025.

If you have any comments, please feel free to contact us at the following:

Linko EMC/RF Lab:

Tel: 886-2-26052180

Fax: 886-2-26051924

Hsin Chu EMC/RF/Telecom Lab:

Tel: 886-3-5935343

Fax: 886-3-5935342

Hwa Ya EMC/RF/Safety Lab:

Tel: 886-3-3183232

Fax: 886-3-3270892

Email: service.adt@tw.bureauveritas.com

Web Site: www.bureauveritas-adt.com

The address and road map of all our labs can be found in our web site also.



A D T

7. APPENDIX A – MODIFICATIONS RECORDERS FOR ENGINEERING CHANGES TO THE EUT BY THE LAB

No any modifications are made to the EUT by the lab during the test.

---END---