

FCC Test Report

(PART 90S)

Report No.: RF171013C04B-5

FCC ID: MSQTP370QL

Test Model: TP370QL

Received Date: Oct. 13, 2017

Test Date: Oct. 28, 2017 ~ Jan. 24, 2018

Issued Date: Mar. 06, 2018

Applicant: ASUSTek COMPUTER INC.

Address: 4F, No. 150, LI-TE Rd., PEITOU, TAIPEI 112, TAIWAN

Issued By: Bureau Veritas Consumer Products Services (H.K.) Ltd., Taoyuan Branch

Lab Address: No. 47-2, 14th Ling, Chia Pau Vil., Lin Kou Dist., New Taipei City, Taiwan
(R.O.C)

Test Location (1): No. 19, Hwa Ya 2nd Rd, Wen Hwa Tsuen, Kwei Shan Hsiang, Taoyuan
Hsien 333, Taiwan, R.O.C.

Test Location (2): No.215, Sec. 3, Beixin Rd., Xindian Dist., New Taipei City 231, Taiwan,
R.O.C

**FCC Registration /
Designation Number:** 427177 / TW0011



This report is for your exclusive use. Any copying or replication of this report to or for any other person or entity, or use of our name or trademark, is permitted only with our prior written permission. This report sets forth our findings solely with respect to the test samples identified herein. The results set forth in this report are not indicative or representative of the quality or characteristics of the lot from which a test sample was taken or any similar or identical product unless specifically and expressly noted. Our report includes all of the tests requested by you and the results thereof based upon the information that you provided to us. You have 60 days from date of issuance of this report to notify us of any material error or omission caused by our negligence, provided, however, that such notice shall be in writing and shall specifically address the issue you wish to raise. A failure to raise such issue within the prescribed time shall constitute your unqualified acceptance of the completeness of this report, the tests conducted and the correctness of the report contents. Unless specific mention, the uncertainty of measurement has been explicitly taken into account to declare the compliance or non-compliance to the specification. The report must not be used by the client to claim product certification, approval, or endorsement by TAF or any government agency

Table of Contents

Release Control Record	3
1 Certificate of Conformity	4
2 Summary of Test Results.....	5
2.1 Measurement Uncertainty.....	5
2.2 Test Site and Instruments	6
3 General Information	8
3.1 General Description of EUT	8
3.2 Configuration of System under Test.....	9
3.2.1 Description of Support Units	9
3.3 Test Mode Applicability and Tested Channel Detail	10
3.4 EUT Operating Conditions	11
3.5 General Description of Applied Standards.....	11
4 Test Types and Results	12
4.1 Output Power Measurement.....	12
4.1.1 Limits of Output Power Measurement	12
4.1.2 Test Procedures.....	12
4.1.3 Test Setup.....	13
4.1.4 Test Results	14
4.2 Frequency Stability Measurement	19
4.2.1 Limits of Frequency Stability Measurement.....	19
4.2.2 Test Procedure	19
4.2.3 Test Setup.....	19
4.2.4 Test Results	20
4.3 Occupied Bandwidth Measurement.....	24
4.3.1 Test Procedure	24
4.3.2 Test Setup.....	24
4.3.3 Test Result	25
4.4 Emission Mask Measurement.....	27
4.4.1 Limits of Band Edge Measurement	27
4.4.2 Test Setup.....	27
4.4.3 Test Procedures.....	27
4.4.4 Test Results	28
4.5 Conducted Spurious Emissions.....	32
4.5.1 Limits of Conducted Spurious Emissions Measurement.....	32
4.5.2 Test Setup.....	32
4.5.3 Test Procedure	32
4.5.4 Test Results	33
4.6 Radiated Emission Measurement.....	39
4.6.1 Limits of Radiated Emission Measurement	39
4.6.2 Test Procedure	39
4.6.3 Deviation from Test Standard	39
4.6.4 Test Setup.....	40
4.6.5 Test Results	41
5 Pictures of Test Arrangements.....	43
Appendix – Information on the Testing Laboratories	44

Release Control Record

Issue No.	Description	Date Issued
RF171013C04B-5	Original Release	Mar. 06, 2018

1 Certificate of Conformity

Product: Notebook PC
Brand: ASUS
Test Model: TP370QL
Sample Status: Production Unit
Applicant: ASUSTek COMPUTER INC.
Test Date: Oct. 28, 2017 ~ Jan. 24, 2018
Standards: FCC Part 90, Subpart S

The above equipment has been tested by **Bureau Veritas Consumer Products Services (H.K.) Ltd., Taoyuan Branch**, and found compliance with the requirement of the above standards. The test record, data evaluation & Equipment Under Test (EUT) configurations represented herein are true and accurate accounts of the measurements of the sample's RF characteristics under the conditions specified in this report.

Prepared by : Evonne Liu, **Date:** Mar. 06, 2018
Evonne Liu / Specialist

Approved by : Dylan Chiou, **Date:** Mar. 06, 2018
Dylan Chiou / Project Engineer

2 Summary of Test Results

Applied Standard: FCC Part 90 & Part 2			
FCC Clause	Test Item	Result	Remarks
2.1046 90.635 (b)	Effective Radiated Power	Pass	Meet the requirement of limit.
2.1055 90.213	Frequency Stability	Pass	Meet the requirement of limit.
2.1049 90.209	Occupied Bandwidth (*)	Pass	Meet the requirement of limit.
2.1051 90.209	Emission Masks	Pass	Meet the requirement of limit.
2.1051 90.691	Conducted Spurious Emissions	Pass	Meet the requirement of limit.
2.1053 90.691	Radiated Spurious Emissions	Pass	Meet the requirement of limit. Minimum passing margin is -18.08 dB at 2457 MHz.

2.1 Measurement Uncertainty

Where relevant, the following measurement uncertainty levels have been estimated for tests performed on the EUT as specified in CISPR 16-4-2:

Measurement	Frequency	Expanded Uncertainty (k=2) (±)
Conducted Emissions at mains ports	150 kHz ~ 30 MHz	2.44 dB
Radiated Emissions up to 1 GHz	30 MHz ~ 200 MHz	2.0153 dB
	200 MHz ~ 1000 MHz	2.0224 dB
Radiated Emissions above 1 GHz	1 GHz ~ 18 GHz	1.0121 dB
	18 GHz ~ 40 GHz	1.1508 dB

2.2 Test Site and Instruments

Description & Manufacturer	Model No.	Serial No.	Date of Calibration	Due Date of Calibration
Test Receiver Agilent Technologies	N9038A	MY52260177	Jul. 05, 2017	Jul. 04, 2018
Spectrum Analyzer Keysight	N9020A	MY57130210	Oct. 30, 2017	Oct. 29, 2018
BILOG Antenna SCHWARZBECK	VULB9168	9168-472	Dec. 13, 2016	Dec. 12, 2017
			Dec. 06, 2017	Dec. 05, 2018
HORN Antenna ETS-Lindgren	3117	00143293	Jun. 26, 2017	Jun. 25, 2018
HORN Antenna SCHWARZBECK	BBHA 9170	9170-480	Dec. 14, 2016	Dec. 13, 2017
			Dec. 01, 2017	Nov. 30, 2018
Fixed Attenuator Mini-Circuits	BW-N10W5+	NA	Jul. 07, 2017	Jul. 06, 2018
Preamplifier Agilent	310N	187226	Jun. 23, 2017	Jun. 22, 2018
Preamplifier Agilent	83017A	MY39501357	Jun. 23, 2017	Jun. 22, 2018
Power Meter Anritsu	ML2495A	1012010	Aug. 15, 2017	Aug. 14, 2018
Power Sensor Anritsu	MA2411B	1315050	Aug. 15, 2017	Aug. 14, 2018
RF signal cable ETS-LINDGREN	5D-FB	Cable-CH1-01(R FC-SMS-100-SM S-120+RFC-SMS -100-SMS-400)	Jun. 23, 2017	Jun. 22, 2018
RF signal cable ETS-LINDGREN	8D-FB	Cable-CH1-02(R FC-SMS-100-SM S-24)	Jun. 23, 2017	Jun. 22, 2018
Software BV ADT	E3 8.130425b	NA	NA	NA
Antenna Tower MF	NA	NA	NA	NA
Turn Table MF	NA	NA	NA	NA
Antenna Tower & Turn Table Controller MF	MF-7802	NA	NA	NA
Communications Tester-Wireless Agilent	8960 Series 10	MY53201073	Jun. 28, 2017	Jun. 27, 2019
Radio Communication Analyzer Anritsu	MT8820C	6201300638	Jul. 11, 2017	Jul. 10, 2018
Temperature & Humidity Chamber	GTH-120-40-CP-A R	MAA1306-019	Sep. 08, 2017	Sep. 07, 2018
DC Power Supply Topward	33010D	807748	Oct. 25, 2016	Oct. 24, 2018
Digital Multimeter Fluke	87-III	70360742	Jun. 30, 2017	Jun. 29, 2018

- Note:
1. The calibration interval of the above test instruments is 12 / 24 months and the calibrations are traceable to NML/ROC and NIST/USA.
 2. The test was performed in HsinTien Chamber 1.
 3. The horn antenna and preamplifier (model: 83017A) are used only for the measurement of emission frequency above 1 GHz if tested.
 4. The IC Site Registration No. is IC7450I-1.

3 General Information

3.1 General Description of EUT

Product	Notebook PC	
Brand	ASUS	
Test Model	TP370QL	
Status of EUT	Production Unit	
Power Supply Rating	15.4 Vdc (Battery) 19.0 Vdc (Adapter)	
Modulation Type	LTE	QPSK, 16QAM, 64QAM
Frequency Range	LTE Band 26 (Channel Bandwidth: 1.4 MHz)	814.7 ~ 823.3 MHz
	LTE Band 26 (Channel Bandwidth: 3 MHz)	815.5 ~ 822.5 MHz
	LTE Band 26 (Channel Bandwidth: 5 MHz)	816.5 ~ 821.5 MHz
	LTE Band 26 (Channel Bandwidth: 10 MHz)	819 MHz
Emission Designator	LTE Band 26 (Channel Bandwidth: 1.4 MHz)	1M09W7D
	LTE Band 26 (Channel Bandwidth: 3 MHz)	2M70G7D
	LTE Band 26 (Channel Bandwidth: 5 MHz)	4M49W7D
	LTE Band 26 (Channel Bandwidth: 10 MHz)	8M98W7D
Max. ERP Power	LTE Band 26 (Channel Bandwidth: 1.4 MHz)	202.86 mW
	LTE Band 26 (Channel Bandwidth: 3 MHz)	203.14 mW
	LTE Band 26 (Channel Bandwidth: 5 MHz)	204.17 mW
	LTE Band 26 (Channel Bandwidth: 10 MHz)	206.54 mW
Antenna Type	Fixed Internal Antenna	
Accessory Device	Refer to Note as below	
Data Cable Supplied	Refer to Note as below	

Note:

1. The EUT's accessories list refers to Ext. Pho.
2. The above EUT information is declared by manufacturer and for more detailed features description, please refer to the manufacturer's specifications or user's manual.

3.2 Configuration of System under Test

<Radiated Emission Test>

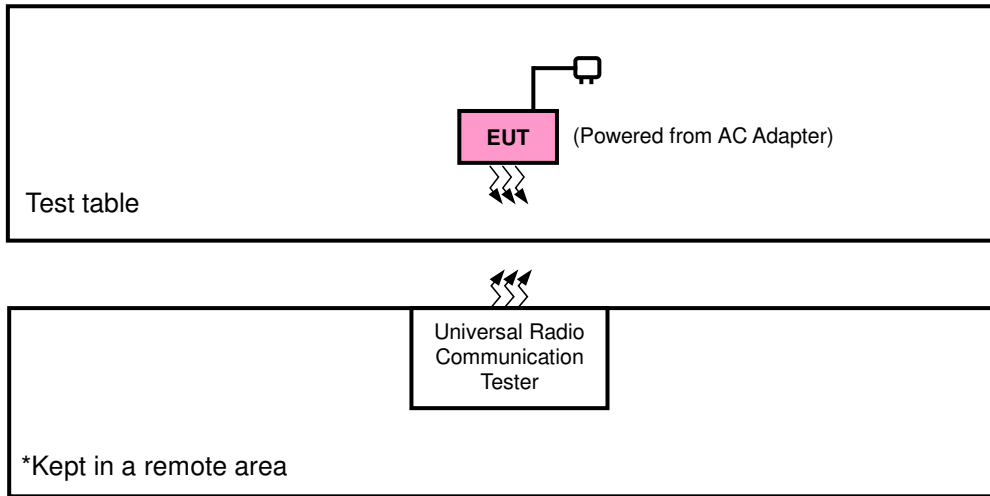

<E.R.P. Test>

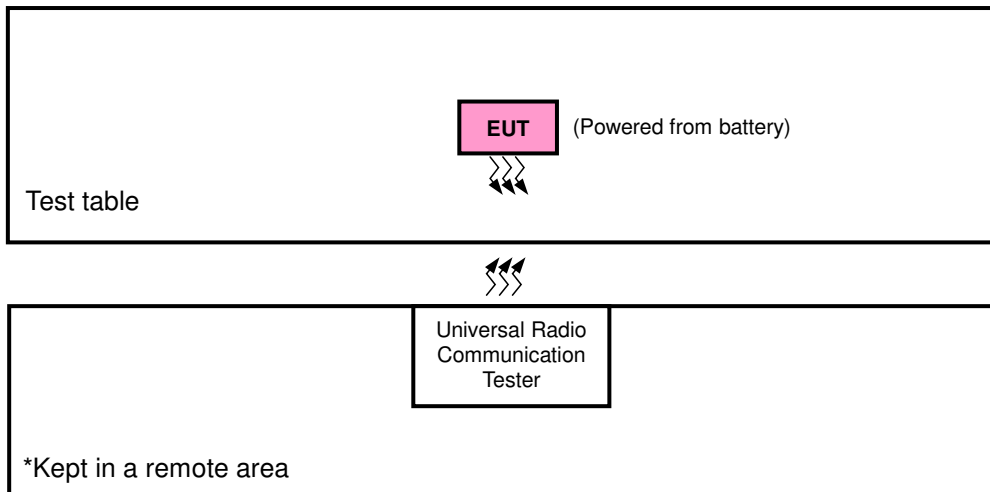

3.2.1 Description of Support Units

The EUT has been tested as an independent unit together with other necessary accessories or support units.

3.3 Test Mode Applicability and Tested Channel Detail

Pre-Scan has been conducted to determine the worst-case mode from all possible combinations between available modulations, data rates, XYZ axis, and antenna ports

The worst case was found when positioned as the table below. Following channel(s) was (were) selected for the final test as listed below:

Band	ERP	Radiated Emission
LTE Band 26	X-plane	Z-axis

LTE Band 26

EUT Configure Mode	Test Item	Available Channel	Tested Channel	Channel Bandwidth	Modulation	Mode
-	ERP	26697 to 26783	26697, 26740, 26783	1.4 MHz	QPSK, 16QAM, 64QAM	1 RB / 2 RB Offset
		26705 to 26775	26705, 26740, 26775	3 MHz	QPSK, 16QAM, 64QAM	1 RB / 7 RB Offset
		26715 to 26765	26715, 26740, 26765	5 MHz	QPSK, 16QAM, 64QAM	1 RB / 12 RB Offset
		26740	26740	10 MHz	QPSK, 16QAM, 64QAM	1 RB / 49 RB Offset
-	Frequency Stability	26697 to 26783	26697, 26783	1.4 MHz	QPSK	1 RB / 2 RB Offset
		26705 to 26775	26705, 26775	3 MHz	QPSK	1 RB / 7 RB Offset
		26715 to 26765	26715, 26765	5 MHz	QPSK	1 RB / 12 RB Offset
		26740	26740	10 MHz	QPSK	1 RB / 49 RB Offset
-	Occupied Bandwidth	26697 to 26783	26697, 26740, 26783	1.4 MHz	QPSK, 16QAM, 64QAM	6 RB / 0 RB Offset
		26705 to 26775	26705, 26740, 26775	3 MHz	QPSK, 16QAM, 64QAM	15 RB / 0 RB Offset
		26715 to 26765	26715, 26740, 26765	5 MHz	QPSK, 16QAM, 64QAM	25 RB / 0 RB Offset
		26740	26740	10 MHz	QPSK, 16QAM, 64QAM	50 RB / 0 RB Offset
-	Emission Mask	26697 to 26783	26697, 26740, 26783	1.4 MHz	QPSK, 16QAM, 64QAM	6 RB / 0 RB Offset
		26705 to 26775	26705, 26740, 26775	3 MHz	QPSK, 16QAM, 64QAM	15 RB / 0 RB Offset
		26715 to 26765	26715, 26740, 26765	5 MHz	QPSK, 16QAM, 64QAM	25 RB / 0 RB Offset
		26740	26740	10 MHz	QPSK, 16QAM, 64QAM	50 RB / 0 RB Offset
-	Conducted Emission	26697 to 26783	26697, 26740, 26783	1.4 MHz	QPSK	1 RB / 0 RB Offset
		26705 to 26775	26705, 26740, 26775	3 MHz	QPSK	1 RB / 0 RB Offset
		26715 to 26765	26715, 26740, 26765	5 MHz	QPSK	1 RB / 0 RB Offset
		26740	26740	10 MHz	QPSK	1 RB / 0 RB Offset
-	Radiated Emission	26740	26740	10 MHz	QPSK	1 RB / 49 RB Offset

Note: This device was tested under all bandwidths, RB configurations and modulations. The worst case was found in QPSK modulation.

Test Condition:

Test Item	Environmental Conditions	Input Power	Tested By
ERP	25 deg. C, 65 % RH	15.4 Vdc	Anson Lin
Frequency Stability	25 deg. C, 65 % RH	15.4 Vdc	Taylor Liu
Occupied Bandwidth	25 deg. C, 65 % RH	15.4 Vdc	Taylor Liu
Peak to Average Ratio	25 deg. C, 65 % RH	15.4 Vdc	Taylor Liu
Emission Mask	25 deg. C, 65 % RH	15.4 Vdc	Taylor Liu
Conducuted Emission	25 deg. C, 65 % RH	15.4 Vdc	Taylor Liu
Radiated Emission	25 deg. C, 65 % RH	120 Vac, 60 Hz	Charles Hsiao

3.4 EUT Operating Conditions

The EUT makes a call to the communication simulator. The communication simulator station system controlled a EUT to export maximum output power under transmission mode and specific channel frequency

3.5 General Description of Applied Standards

The EUT is a RF Product. According to the specifications of the manufacturer, it must comply with the requirements of the following standards:

FCC 47 CFR Part 2

FCC 47 CFR Part 90

ANSI/TIA/EIA-603-E 2016

ANSI 63.26-2015

Note: All test items have been performed and recorded as per the above standards.

4 Test Types and Results

4.1 Output Power Measurement

4.1.1 Limits of Output Power Measurement

Mobile / Portable station are limited to 100 watts e.r.p.

4.1.2 Test Procedures

EIRP / ERP Measurement:

- a. All measurements were done at low, middle and high operational frequency range. RBW and VBW is 5 MHz for CDMA and 10 MHz for LTE mode.
- b. Substitution method is used for E.I.R.P measurement. In the semi-anechoic chamber, EUT placed on the 0.8 m (below or equal 1 GHz) and/or 1.5 m (above 1 GHz) height of Turn Table, rotated the table around 360 degrees to search the maximum radiation power and receiver antenna shall be rotated vertical and horizontal polarization and moved height from 1 m to 4 m to find the maximum polar radiated power. The "Read Value" is the spectrum reading the maximum power value.
- c. The substitution horn antenna is substituted for EUT at the same position and signals generator export the CW signal to the substitution antenna via a tx cable. Rotated the Turn Table and moved receiving antenna to find the maximum radiation power. Adjust output power level of S.G to get a Value of spectrum reading equal to "Read Value" of step b. Record the power level of S.G.
- d. $EIRP = \text{Output power level of S.G} - \text{TX cable loss} + \text{Antenna gain of substitution horn}$. E.R.P power can be calculated form E.I.R.P power by subtracting the gain of dipole, $E.R.P \text{ power} = E.I.P.R \text{ power} - 2.15 \text{ dBi}$.

Conducted Power Measurement:

- a. The EUT was set up for the maximum power with LTE link data modulation and link up with simulator.
- b. Set the EUT to transmit under low, middle and high channel and record the power level shown on simulator.

4.1.3 Test Setup

EIRP / ERP Measurement:

<Radiated Emission below or equal 1 GHz>

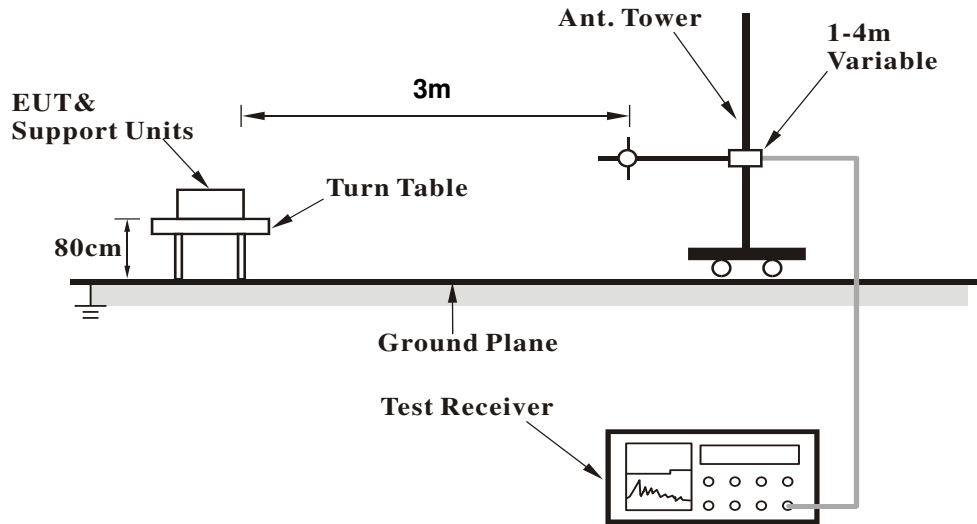

<Radiated Emission above 1 GHz>

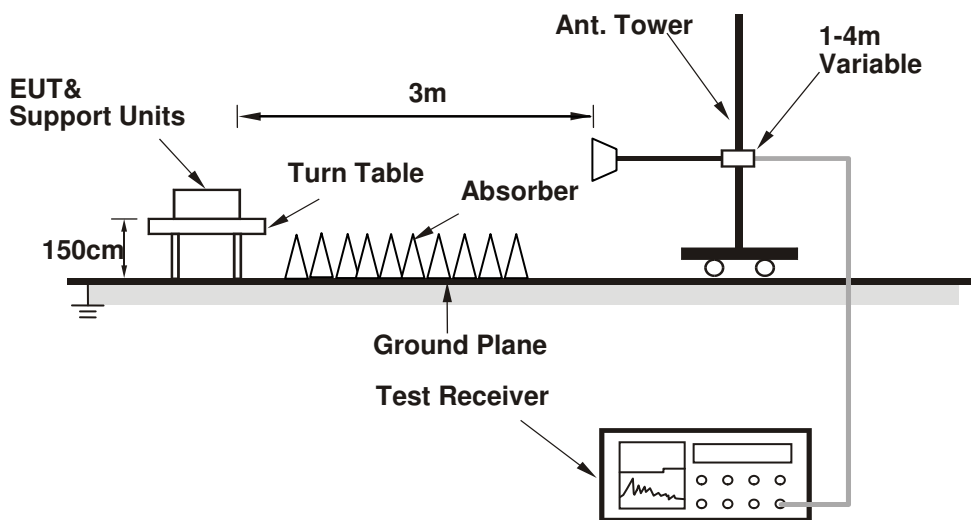

For the actual test configuration, please refer to the attached file (Test Setup Photo).

Conducted Power Measurement:



4.1.4 Test Results

Conducted Output Power (dBm)

LTE Band 26														
BW (MHz)	RB Size	RB Offset	QPSK				16QAM				64QAM			
			Mid Ch 26740 819.0 MHz			3GPP MPR (dB)	Mid Ch 26740 819.0 MHz			3GPP MPR (dB)	Mid Ch 26740 819.0 MHz			3GPP MPR (dB)
10	1	0		23.54		0		22.50		1		21.58		2
	1	24		23.08		0		22.04		1		21.23		2
	1	49		23.61		0		22.57		1		21.73		2
	25	0		22.30		1		21.26		2		20.53		3
	25	12		22.22		1		21.18		2		20.20		3
	25	25		22.34		1		21.30		2		20.60		3
	50	0		22.31		1		21.27		2		20.62		3
BW (MHz)	RB Size	RB Offset	QPSK				16QAM				64QAM			
			Low Ch 26715 816.5 MHz	Mid Ch 26740 819.0 MHz	High Ch 26765 821.5 MHz	3GPP MPR (dB)	Low Ch 26715 816.5 MHz	Mid Ch 26740 819.0 MHz	High Ch 26765 821.5 MHz	3GPP MPR (dB)	Low Ch 26715 816.5 MHz	Mid Ch 26740 819.0 MHz	High Ch 26765 821.5 MHz	3GPP MPR (dB)
5	1	0	23.46	23.00	23.06	0	22.47	22.01	22.07	1	21.58	21.57	21.61	2
	1	12	23.00	22.54	22.60	0	22.01	21.55	21.61	1	21.06	20.98	21.00	2
	1	24	23.53	23.07	23.13	0	22.54	22.08	22.14	1	21.64	21.54	21.66	2
	12	0	22.22	21.76	21.82	1	21.23	20.77	20.83	2	20.55	20.50	20.51	3
	12	6	22.14	21.68	21.74	1	21.15	20.69	20.75	2	20.22	20.13	20.09	3
	12	13	22.26	21.80	21.86	1	21.27	20.81	20.87	2	20.71	20.66	20.65	3
	25	0	22.23	21.77	21.83	1	21.24	20.78	20.84	2	20.63	20.57	20.69	3
BW (MHz)	RB Size	RB Offset	QPSK				16QAM				64QAM			
			Low Ch 26705 815.5 MHz	Mid Ch 26740 819.0 MHz	High Ch 26775 822.5 MHz	3GPP MPR (dB)	Low Ch 26705 815.5 MHz	Mid Ch 26740 819.0 MHz	High Ch 26775 822.5 MHz	3GPP MPR (dB)	Low Ch 26705 815.5 MHz	Mid Ch 26740 819.0 MHz	High Ch 26775 822.5 MHz	3GPP MPR (dB)
3	1	0	23.43	22.97	23.03	0	22.39	21.95	22.01	1	21.66	21.62	21.47	2
	1	7	22.97	22.51	22.57	0	21.93	21.49	21.55	1	21.08	20.99	20.94	2
	1	14	23.50	23.04	23.10	0	22.46	22.02	22.08	1	21.65	21.57	21.68	2
	8	0	22.19	21.73	21.79	1	21.15	20.71	20.77	2	20.64	20.61	20.42	3
	8	3	22.11	21.65	21.71	1	21.07	20.63	20.69	2	20.13	20.03	20.03	3
	8	7	22.23	21.77	21.83	1	21.19	20.75	20.81	2	20.71	20.66	20.56	3
	15	0	22.20	21.74	21.80	1	21.16	20.72	20.78	2	20.72	20.72	20.71	3
BW (MHz)	RB Size	RB Offset	QPSK				16QAM				64QAM			
			Low Ch 26697 814.7 MHz	Mid Ch 26740 819.0 MHz	High Ch 26783 823.3 MHz	3GPP MPR (dB)	Low Ch 26697 814.7 MHz	Mid Ch 26740 819.0 MHz	High Ch 26783 823.3 MHz	3GPP MPR (dB)	Low Ch 26697 814.7 MHz	Mid Ch 26740 819.0 MHz	High Ch 26783 823.3 MHz	3GPP MPR (dB)
1.4	1	0	23.41	22.95	23.01	0	22.32	21.91	21.97	1	21.65	21.59	21.52	2
	1	2	22.95	22.49	22.55	0	21.86	21.45	21.51	1	21.14	21.04	20.95	2
	1	5	23.48	23.02	23.08	0	22.39	21.98	22.04	1	21.67	21.58	21.59	2
	3	0	23.17	22.71	22.77	0	22.08	21.67	21.73	1	21.53	21.50	21.47	2
	3	1	23.09	22.63	22.69	0	22.00	21.59	21.65	1	21.22	21.14	21.06	2
	3	3	23.21	22.75	22.81	0	22.12	21.71	21.77	1	21.72	21.72	21.60	2
	6	0	22.18	21.72	21.78	1	21.09	20.68	20.74	2	20.69	20.63	20.66	3

ERP Power (dBm)

LTE Band 26							
Channel Bandwidth: 1.4 MHz / QPSK							
Plane	Channel	Frequency (MHz)	LVL (dBm)	Correction Factor (dB)	ERP (dBm)	ERP (mW)	Polarization (H/V)
X	26697	814.7	-6.01	31.208	23.05	201.74	H
	26740	819.0	-6.14	31.3	23.01	199.99	
	26783	823.3	-6.00	31.222	23.07	202.86	
	26697	814.7	-11.30	31.504	18.05	63.89	V
	26740	819.0	-10.89	31.117	18.08	64.22	
	26783	823.3	-11.74	31.922	18.03	63.56	
Channel Bandwidth: 1.4 MHz / 16QAM							
X	26697	814.7	-7.02	31.208	22.04	159.88	H
	26740	819.0	-7.06	31.3	22.09	161.81	
	26783	823.3	-7.00	31.222	22.07	161.14	
	26697	814.7	-12.35	31.504	17.00	50.16	V
	26740	819.0	-11.94	31.117	17.03	50.43	
	26783	823.3	-12.76	31.922	17.01	50.26	
Channel Bandwidth: 1.4 MHz / 64QAM							
X	26697	814.7	-8.06	31.208	21.00	125.83	H
	26740	819.0	-8.08	31.3	21.07	127.94	
	26783	823.3	-8.05	31.222	21.02	126.53	
	26697	814.7	-13.32	31.504	16.03	40.12	V
	26740	819.0	-12.95	31.117	16.02	39.97	
	26783	823.3	-13.73	31.922	16.04	40.20	

LTE Band 26							
Channel Bandwidth: 3 MHz / QPSK							
Plane	Channel	Frequency (MHz)	LVL (dBm)	Correction Factor (dB)	ERP (dBm)	ERP (mW)	Polarization (H/V)
X	26705	815.5	-5.98	31.208	23.08	203.14	H
	26740	819.0	-6.08	31.3	23.07	202.77	
	26775	822.5	-6.03	31.222	23.04	201.47	
	26705	815.5	-11.34	31.504	18.01	63.30	V
	26740	819.0	-10.92	31.117	18.05	63.78	
	26775	822.5	-11.74	31.922	18.03	63.56	
Channel Bandwidth: 3 MHz / 16QAM							
X	26705	815.5	-7.06	31.208	22.00	158.42	H
	26740	819.0	-7.09	31.3	22.06	160.69	
	26775	822.5	-7.01	31.222	22.06	160.77	
	26705	815.5	-12.27	31.504	17.08	51.10	V
	26740	819.0	-11.94	31.117	17.03	50.43	
	26775	822.5	-12.67	31.922	17.10	51.31	
Channel Bandwidth: 3 MHz / 64QAM							
X	26705	815.5	-8.02	31.208	21.04	127.00	H
	26740	819.0	-8.08	31.3	21.07	127.94	
	26775	822.5	-8.01	31.222	21.06	127.70	
	26705	815.5	-13.29	31.504	16.06	40.40	V
	26740	819.0	-12.95	31.117	16.02	39.97	
	26775	822.5	-13.67	31.922	16.10	40.76	

LTE Band 26							
Channel Bandwidth: 5 MHz / QPSK							
Plane	Channel	Frequency (MHz)	LVL (dBm)	Correction Factor (dB)	ERP (dBm)	ERP (mW)	Polarization (H/V)
X	26715	816.5	-6.03	31.208	23.03	200.82	H
	26740	819.0	-6.05	31.3	23.10	204.17	
	26765	821.5	-6.01	31.222	23.06	202.40	
	26715	816.5	-11.29	31.504	18.06	64.03	V
	26740	819.0	-10.93	31.117	18.04	63.64	
	26765	821.5	-11.72	31.922	18.05	63.86	
Channel Bandwidth: 5 MHz / 16QAM							
X	26715	816.5	-7.00	31.208	22.06	160.62	H
	26740	819.0	-7.04	31.3	22.11	162.55	
	26765	821.5	-7.06	31.222	22.01	158.93	
	26715	816.5	-12.24	31.504	17.11	51.45	V
	26740	819.0	-11.84	31.117	17.13	51.61	
	26765	821.5	-12.70	31.922	17.07	50.96	
Channel Bandwidth: 5 MHz / 64QAM							
X	26715	816.5	-8.01	31.208	21.05	127.29	H
	26740	819.0	-8.06	31.3	21.09	128.53	
	26765	821.5	-8.04	31.222	21.03	126.82	
	26715	816.5	-13.22	31.504	16.13	41.06	V
	26740	819.0	-12.87	31.117	16.10	40.71	
	26765	821.5	-13.70	31.922	16.07	40.48	

LTE Band 26							
Channel Bandwidth: 10 MHz / QPSK							
Plane	Channel	Frequency (MHz)	LVL (dBm)	Correction Factor (dB)	ERP (dBm)	ERP (mW)	Polarization (H/V)
X	26740	819.0	-6.00	31.3	23.15	206.54	H
	26740	819.0	-10.85	31.117	18.12	64.82	V
Channel Bandwidth: 10 MHz / 16QAM							
X	26740	819.0	-6.98	31.3	22.17	164.82	H
	26740	819.0	-11.77	31.117	17.20	52.44	V
Channel Bandwidth: 10 MHz / 64QAM							
X	26740	819.0	-7.99	31.3	21.16	130.62	H
	26740	819.0	-12.82	31.117	16.15	41.18	V

4.2 Frequency Stability Measurement

4.2.1 Limits of Frequency Stability Measurement

1.5 ppm is for base and fixed station. 2.5 ppm is for mobile station.

4.2.2 Test Procedure

- Device is placed at the oven room. The oven room could control the temperatures and humidity. Power warm up is at least 15 min and power applied should perform before recording frequency error.
- EUT is connected the external power supply to control the DC input power. The test voltage range is from minimum to maximum working voltage. Each step shall be record the frequency error rate.
- The temperature range step is 10 degrees in this test items. All temperature levels shall be hold the ± 0.5 °C during the measurement testing. The each temperature step shall be at least 0.5 hours, consider the EUT could be test under the stability condition.

NOTE: The frequency error was recorded frequency error from the communication simulator.

4.2.3 Test Setup

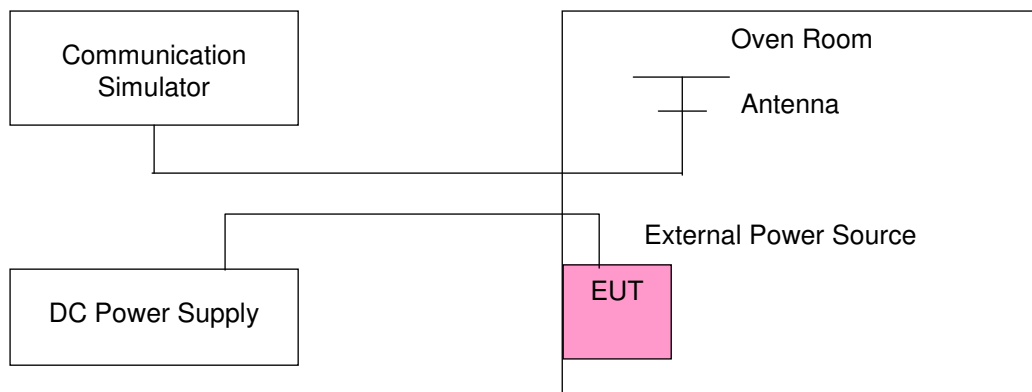

4.2.4 Test Results

Frequency Error vs. Voltage

Voltage (Volts)	LTE Band 26				Limit (ppm)
	Channel Bandwidth: 1.4 MHz				
	Low Channel		High Channel		
	Frequency (MHz)	Frequency Error (ppm)	Frequency (MHz)	Frequency Error (ppm)	
15.5	814.700004	0.005	823.300004	0.004	2.5
14.0	814.700002	0.003	823.300001	0.001	2.5
17.0	814.700004	0.005	823.300002	0.003	2.5

Note: The applicant defined the normal working voltage of the battery is from 14.0 Vdc to 17.0 Vdc.

Frequency Error vs. Temperature

Temp. (°C)	LTE Band 26				Limit (ppm)
	Channel Bandwidth: 1.4 MHz				
	Low Channel		High Channel		
	Frequency (MHz)	Frequency Error (ppm)	Frequency (MHz)	Frequency Error (ppm)	
-30	814.700002	0.003	823.300002	0.003	2.5
-20	814.700002	0.003	823.300003	0.004	2.5
-10	814.700004	0.005	823.300003	0.004	2.5
0	814.700003	0.003	823.300002	0.003	2.5
10	814.699996	-0.005	823.299998	-0.003	2.5
20	814.699998	-0.003	823.299999	-0.002	2.5
30	814.699998	-0.002	823.299998	-0.002	2.5
40	814.699997	-0.004	823.299996	-0.005	2.5
50	814.699999	-0.001	823.299996	-0.004	2.5

Frequency Error vs. Voltage

Voltage (Volts)	LTE Band 26				Limit (ppm)
	Channel Bandwidth: 3 MHz				
	Low Channel		High Channel		
	Frequency (MHz)	Frequency Error (ppm)	Frequency (MHz)	Frequency Error (ppm)	
15.5	815.500001	0.002	822.500004	0.004	2.5
14.0	815.500002	0.002	822.500002	0.003	2.5
17.0	815.500003	0.004	822.500002	0.002	2.5

Note: The applicant defined the normal working voltage of the battery is from 14.0 Vdc to 17.0 Vdc.

Frequency Error vs. Temperature

Temp. (°C)	LTE Band 26				Limit (ppm)
	Channel Bandwidth: 3 MHz				
	Low Channel		High Channel		
	Frequency (MHz)	Frequency Error (ppm)	Frequency (MHz)	Frequency Error (ppm)	
-30	815.500001	0.002	822.500003	0.004	2.5
-20	815.500002	0.002	822.500002	0.003	2.5
-10	815.500002	0.003	822.500003	0.003	2.5
0	815.500002	0.002	822.500002	0.002	2.5
10	815.499998	-0.003	822.499996	-0.005	2.5
20	815.499997	-0.004	822.499996	-0.004	2.5
30	815.499997	-0.004	822.499997	-0.003	2.5
40	815.499997	-0.004	822.499999	-0.001	2.5
50	815.499999	-0.002	822.499997	-0.004	2.5

Frequency Error vs. Voltage

Voltage (Volts)	LTE Band 26				Limit (ppm)
	Channel Bandwidth: 5 MHz				
	Low Channel		High Channel		
	Frequency (MHz)	Frequency Error (ppm)	Frequency (MHz)	Frequency Error (ppm)	
15.5	816.500002	0.002	821.500002	0.003	2.5
14.0	816.500004	0.005	821.500002	0.002	2.5
17.0	816.500004	0.005	821.500002	0.003	2.5

Note: The applicant defined the normal working voltage of the battery is from 14.0 Vdc to 17.0 Vdc.

Frequency Error vs. Temperature

Temp. (°C)	LTE Band 26				Limit (ppm)
	Channel Bandwidth: 5 MHz				
	Low Channel		High Channel		
	Frequency (MHz)	Frequency Error (ppm)	Frequency (MHz)	Frequency Error (ppm)	
-30	816.500004	0.005	821.500002	0.003	2.5
-20	816.500004	0.005	821.500004	0.005	2.5
-10	816.500003	0.003	821.500003	0.004	2.5
0	816.500003	0.004	821.500003	0.003	2.5
10	816.499997	-0.004	821.499998	-0.002	2.5
20	816.499998	-0.002	821.499998	-0.002	2.5
30	816.499998	-0.002	821.499997	-0.004	2.5
40	816.499998	-0.002	821.499997	-0.003	2.5
50	816.499997	-0.004	821.499996	-0.005	2.5

Frequency Error vs. Voltage

Voltage (Volts)	LTE Band 26		Limit (ppm)
	Channel Bandwidth: 10 MHz		
	Frequency (MHz)	Frequency Error (ppm)	
15.5	819.000003	0.004	2.5
14.0	819.000004	0.005	2.5
17.0	819.000004	0.004	2.5

Note: The applicant defined the normal working voltage of the battery is from 14.0 Vdc to 17.0 Vdc.

Frequency Error vs. Temperature

Temp. (°C)	LTE Band 26		Limit (ppm)
	Channel Bandwidth: 10 MHz		
	Frequency (MHz)	Frequency Error (ppm)	
-30	819.000004	0.004	2.5
-20	819.000004	0.004	2.5
-10	819.000003	0.004	2.5
0	819.000002	0.002	2.5
10	818.999996	-0.005	2.5
20	818.999997	-0.004	2.5
30	818.999996	-0.005	2.5
40	818.999998	-0.003	2.5
50	818.999996	-0.005	2.5

4.3 Occupied Bandwidth Measurement

4.3.1 Test Procedure

The EUT makes a call to the communication simulator. All measurements were done at low, middle and high operational frequency range. The communication simulator station system controlled a EUT to export maximum output power under transmission mode and specific channel frequency. Use OBW measurement function of Spectrum analyzer to measure 99 % occupied bandwidth.

4.3.2 Test Setup

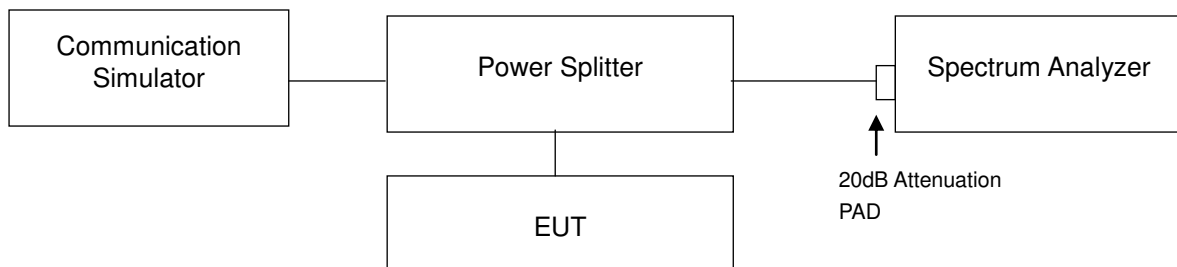

4.3.3 Test Result

LTE Band 26									
Channel Bandwidth: 1.4 MHz					Channel Bandwidth: 3 MHz				
Channel	Frequency (MHz)	99 % Occupied Bandwidth (MHz)			Channel	Frequency (MHz)	99 % Occupied Bandwidth (MHz)		
		QPSK	16QAM	64QAM			QPSK	16QAM	64QAM
26697	814.7	1.0876	1.0885	1.0887	26705	815.5	2.7013	2.6962	2.6970
26740	819.0	1.0886	1.0891	1.0896	26740	819.0	2.7016	2.6977	2.6996
26783	823.3	1.0871	1.0875	1.0887	26775	822.5	2.7014	2.6967	2.6966

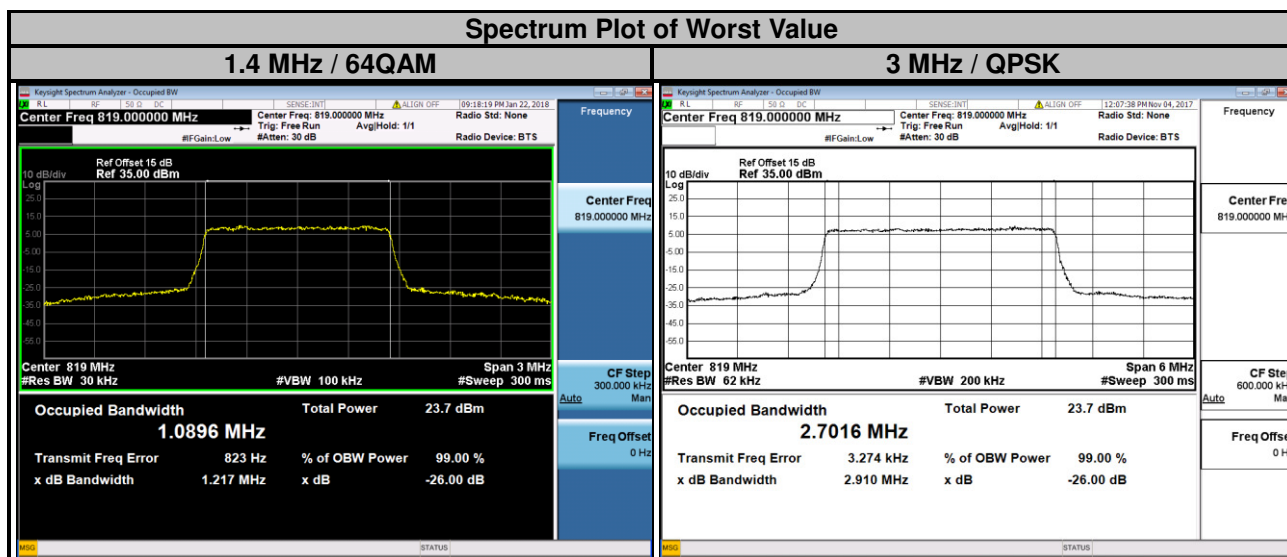

LTE Band 26									
Channel Bandwidth: 5 MHz					Channel Bandwidth: 10 MHz				
Channel	Frequency (MHz)	99 % Occupied Bandwidth (MHz)			Channel	Frequency (MHz)	99 % Occupied Bandwidth (MHz)		
		QPSK	16QAM	64QAM			QPSK	16QAM	64QAM
26715	816.5	4.4901	4.4921	4.4914	26740	819.0	8.9707	8.9756	8.9815
26740	819.0	4.4886	4.4921	4.4925					
26765	821.5	4.4864	4.4896	4.4882					

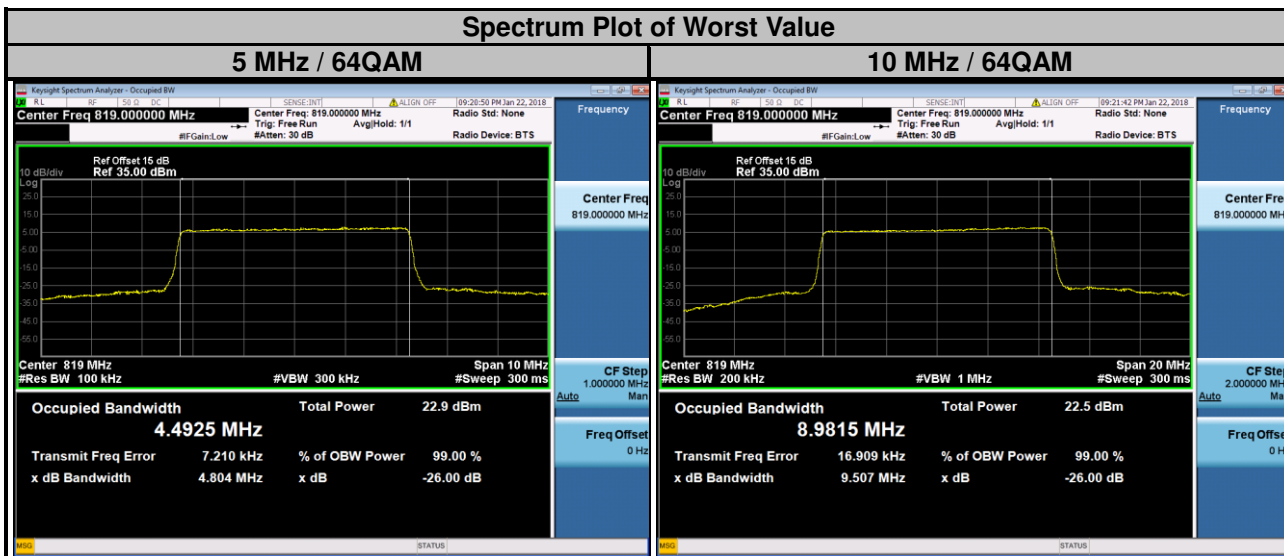

4.4 Emission Mask Measurement

4.4.1 Limits of Band Edge Measurement

According to FCC part 90.691 shall be tested the emission mask. For any frequency removed from the EA licensee's frequency block by up to and including 37.5 kHz, the power of any emission shall be attenuated below the transmitter power (P) in watts by at least $116 \text{ Log}_{10}(f/6.1)$ decibels or $50+10\text{Log}_{10}(P)$ decibels or 80 decibels, whichever is the lesser attenuation, where f is the frequency removed from the center of the outer channel in the block in kilohertz and where f is greater than 12.5 kHz.

4.4.2 Test Setup

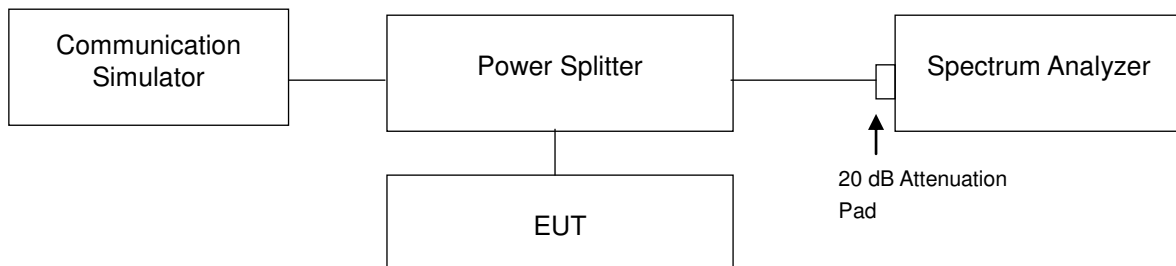

4.4.3 Test Procedures

- a. The measurement used the power splitter via EUT RF power connector between simulation base station and spectrum analyzer.
- b. Record the test plot.

4.4.4 Test Results

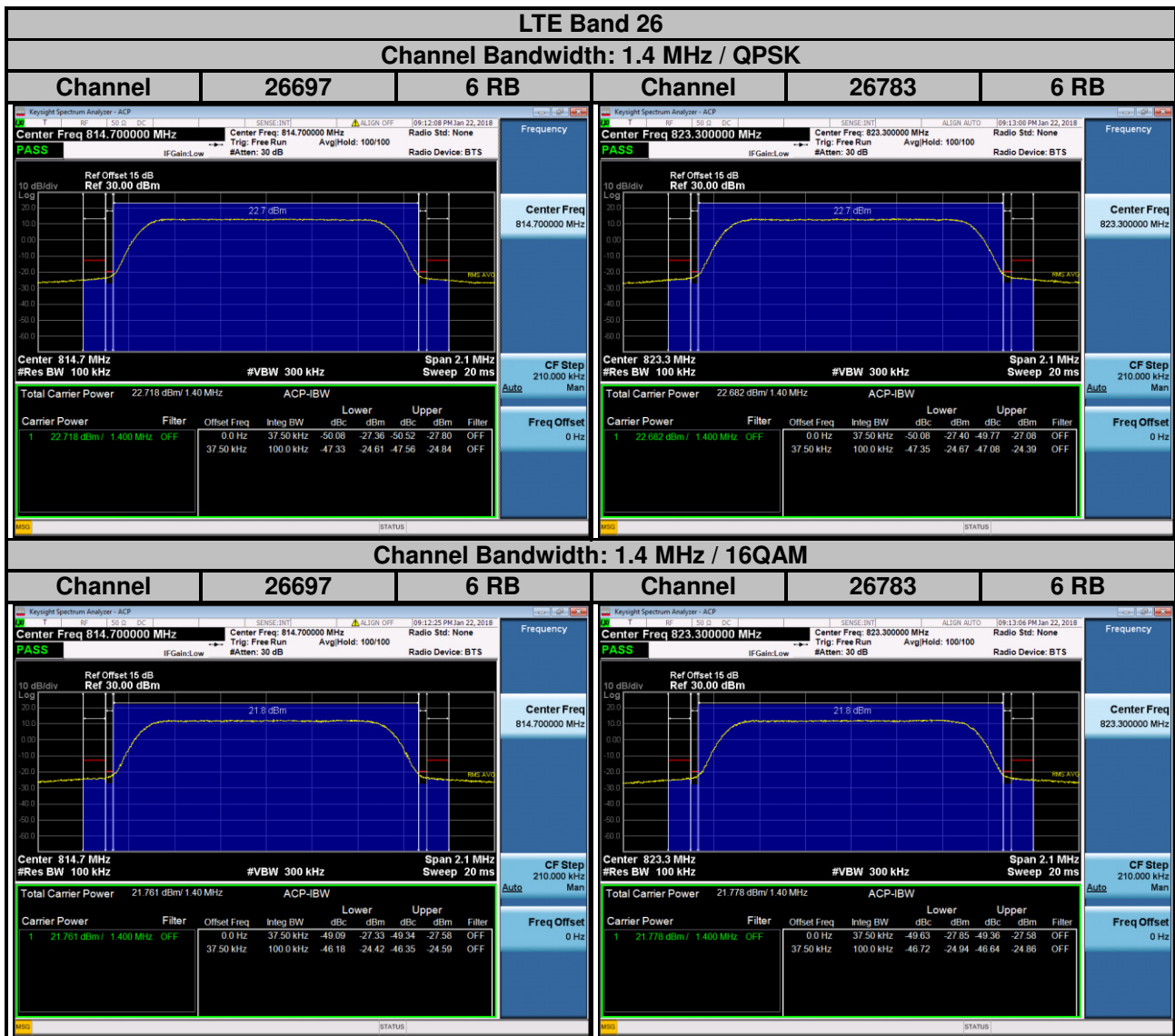

LTE Band 26

Channel Bandwidth: 3 MHz / QPSK

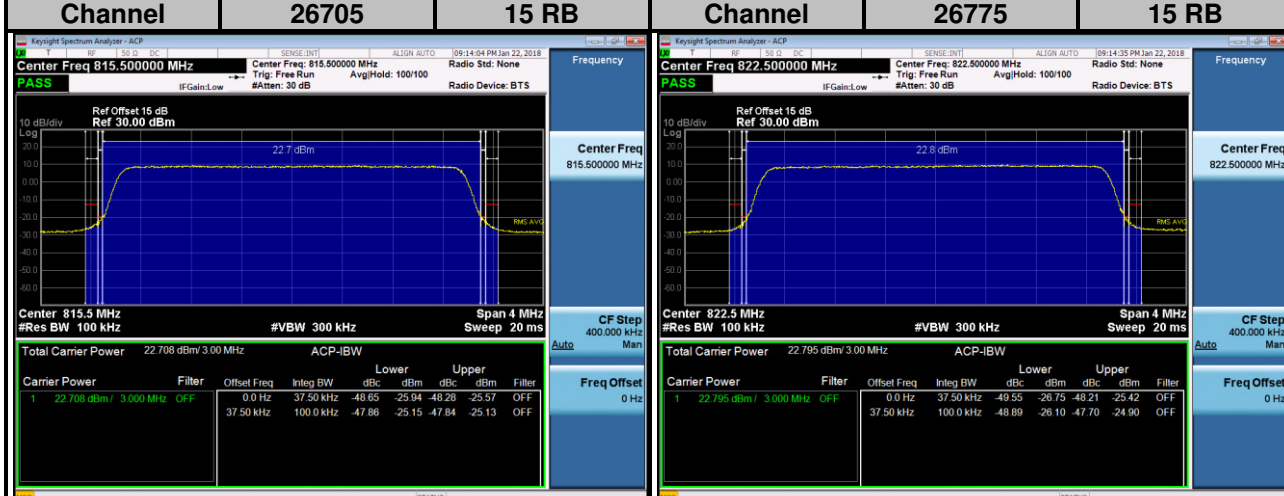

Channel Bandwidth: 3 MHz / 16QAM



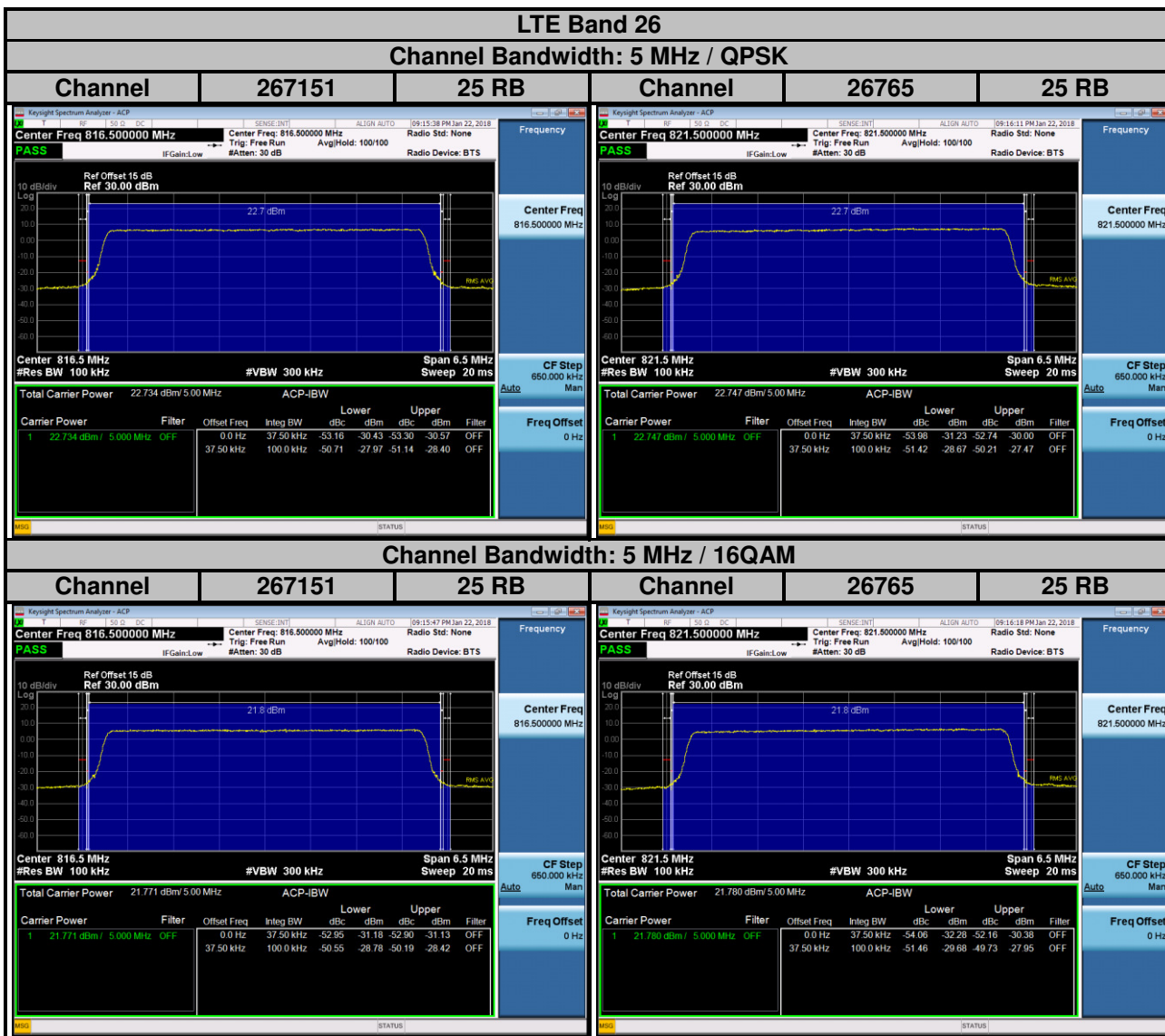

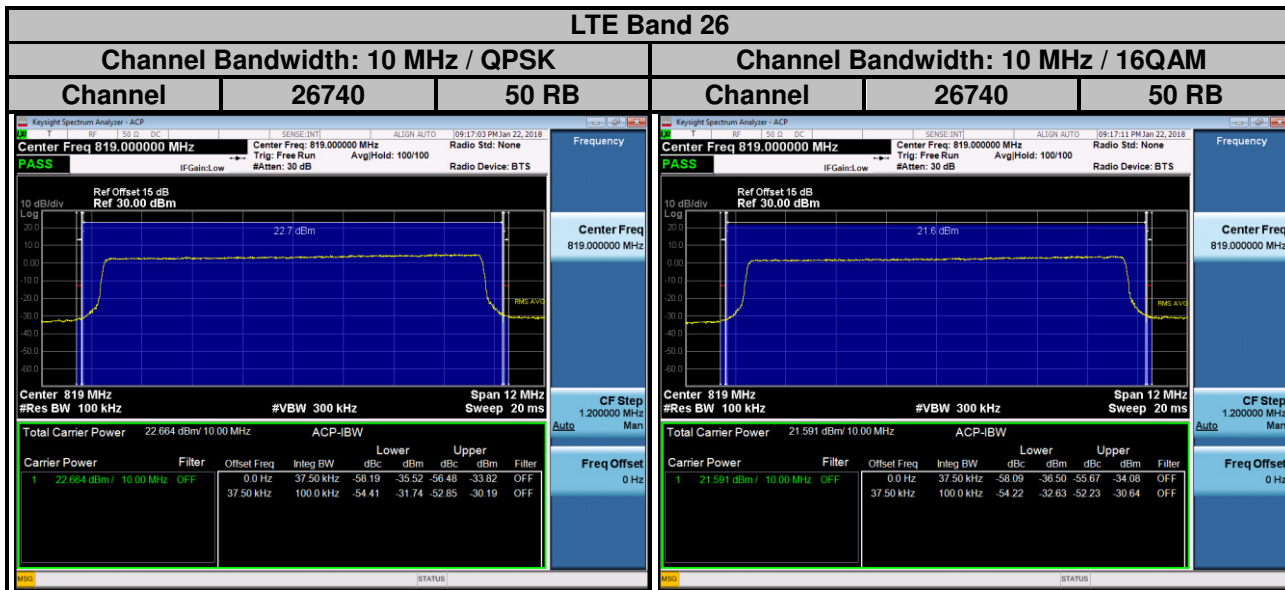

4.5 Conducted Spurious Emissions

4.5.1 Limits of Conducted Spurious Emissions Measurement

The power of any emission outside a licensee's frequency block shall be attenuated below the transmitter power (P) by at least $43 + 10 \log_{10}(P)$ dB. The limit of emission is equal to -13 dBm.

4.5.2 Test Setup

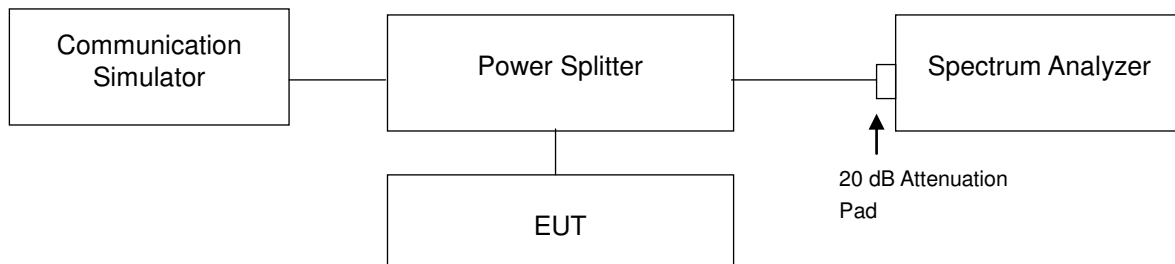

4.5.3 Test Procedure

- The EUT makes a phone call to the communication simulator. All measurements were done at low, middle and high operational frequency range.
- Measuring frequency range is from 30 MHz to 9 GHz. 10 dB attenuation pad is connected with spectrum. RBW = 100 kHz and VBW = 300 kHz are used for conducted emission measurement.

4.5.4 Test Results

LTE Band 26 30MHz ~ 1GHz

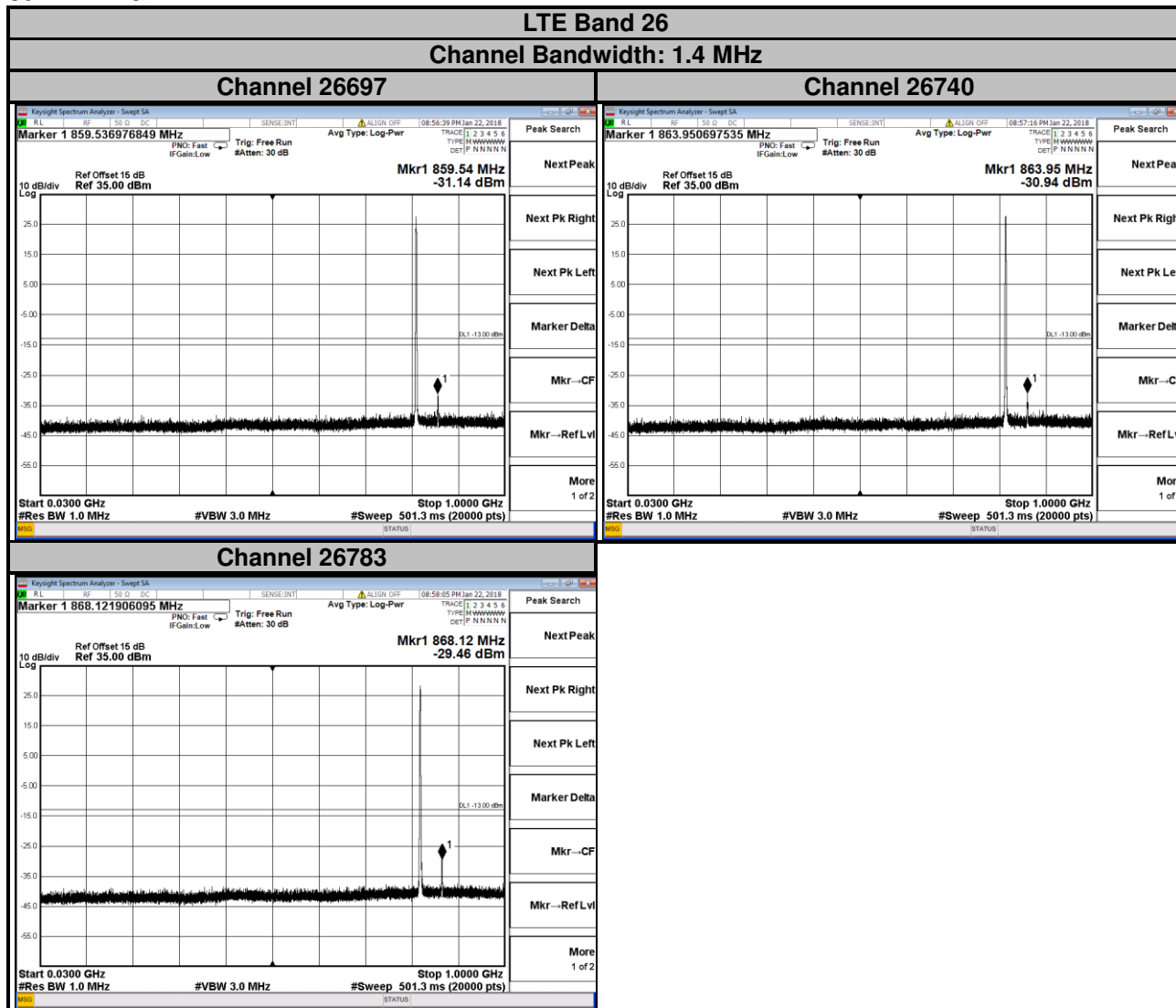

LTE Band 26
Channel Bandwidth: 3 MHz

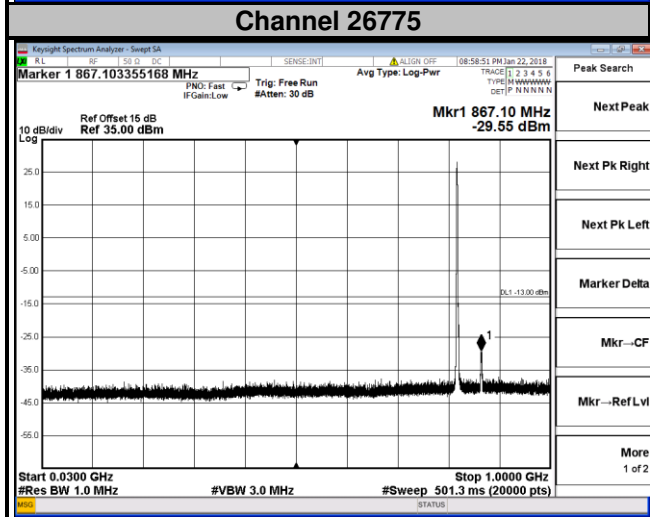
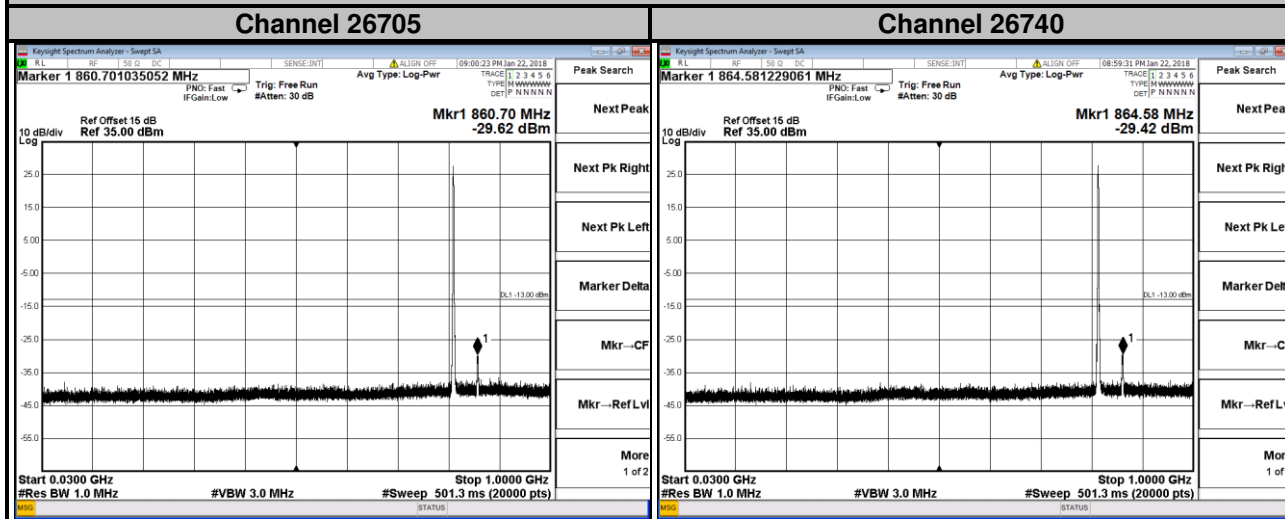

LTE Band 26
Channel Bandwidth: 5 MHz

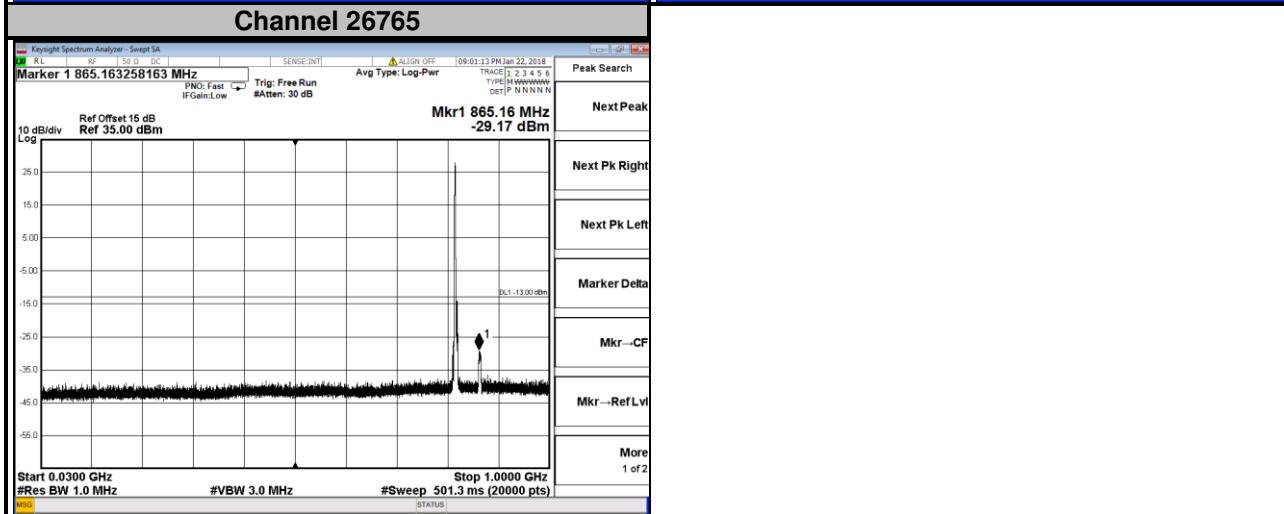
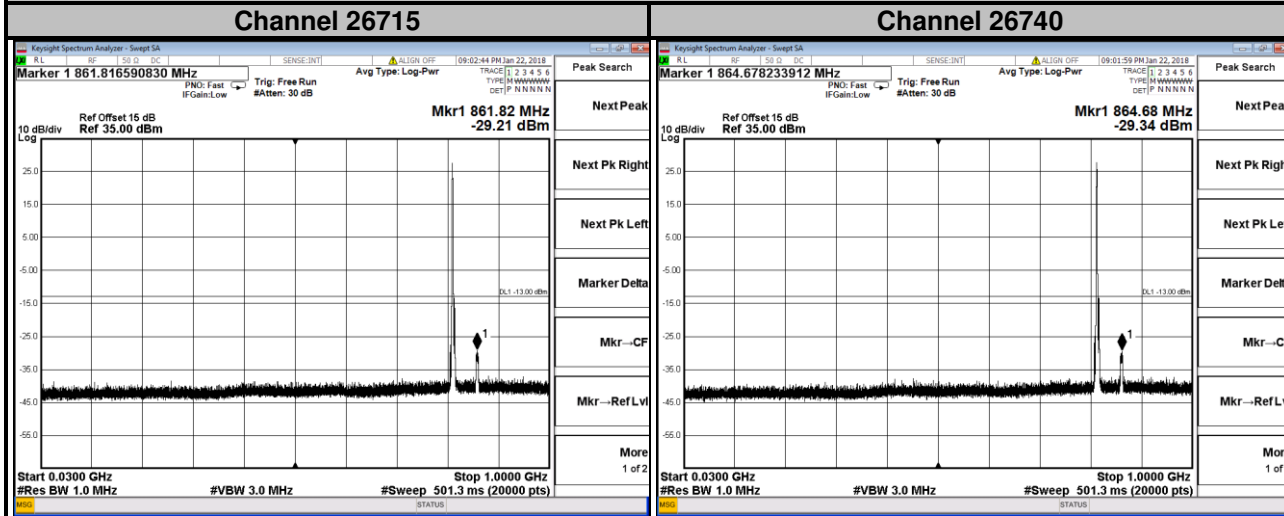

LTE Band 26
Channel Bandwidth: 10 MHz
Channel 26740

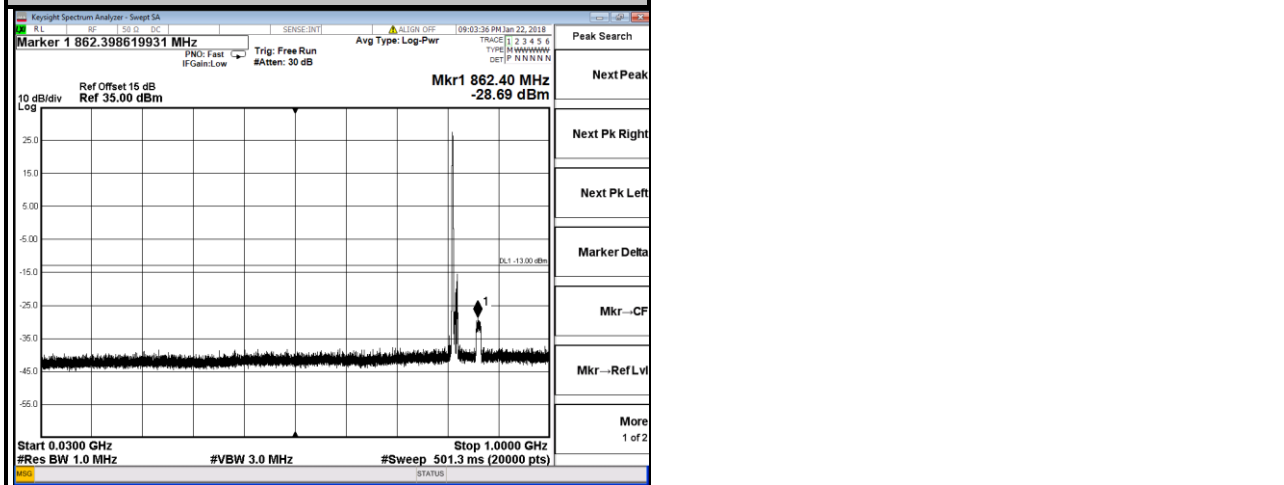

LTE Band 26
Channel Bandwidth: 3 MHz

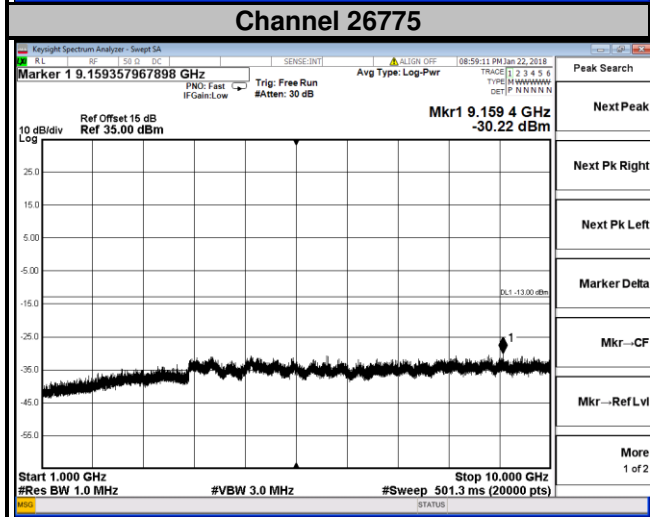
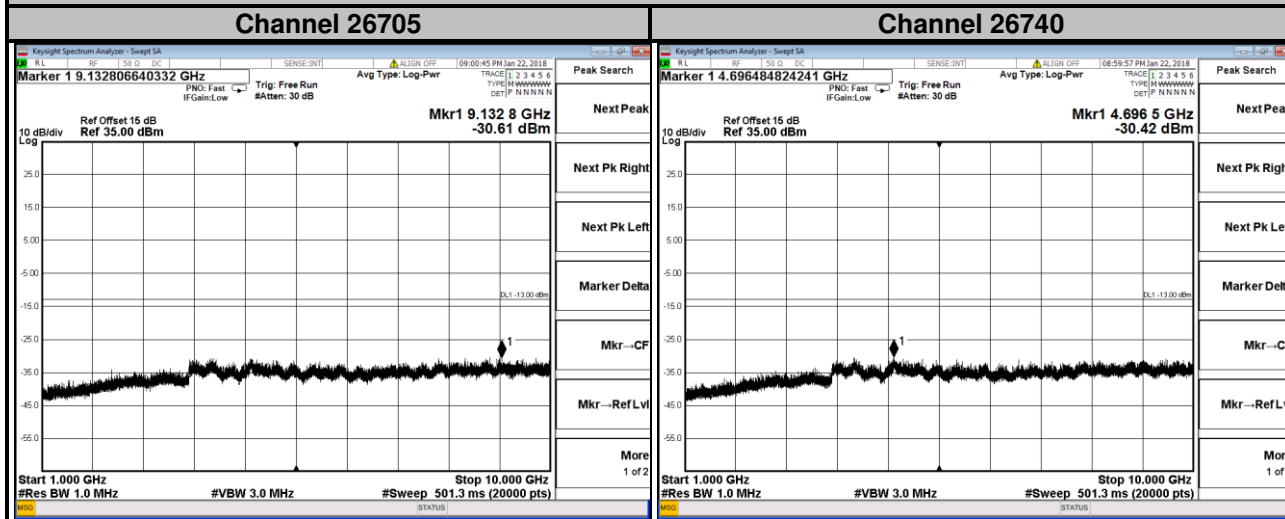

LTE Band 26
Channel Bandwidth: 5 MHz

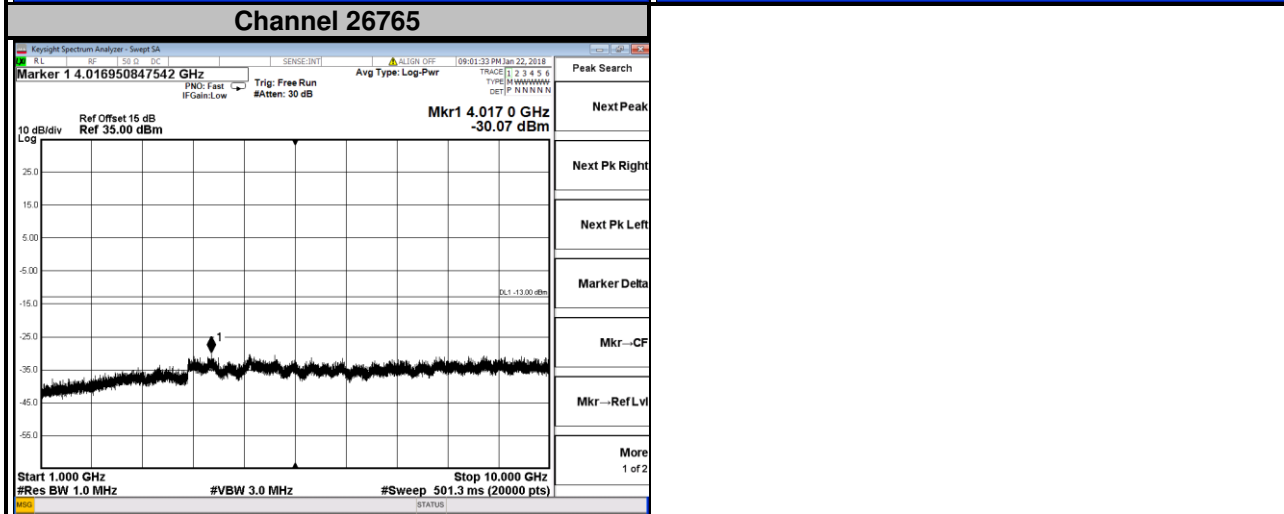
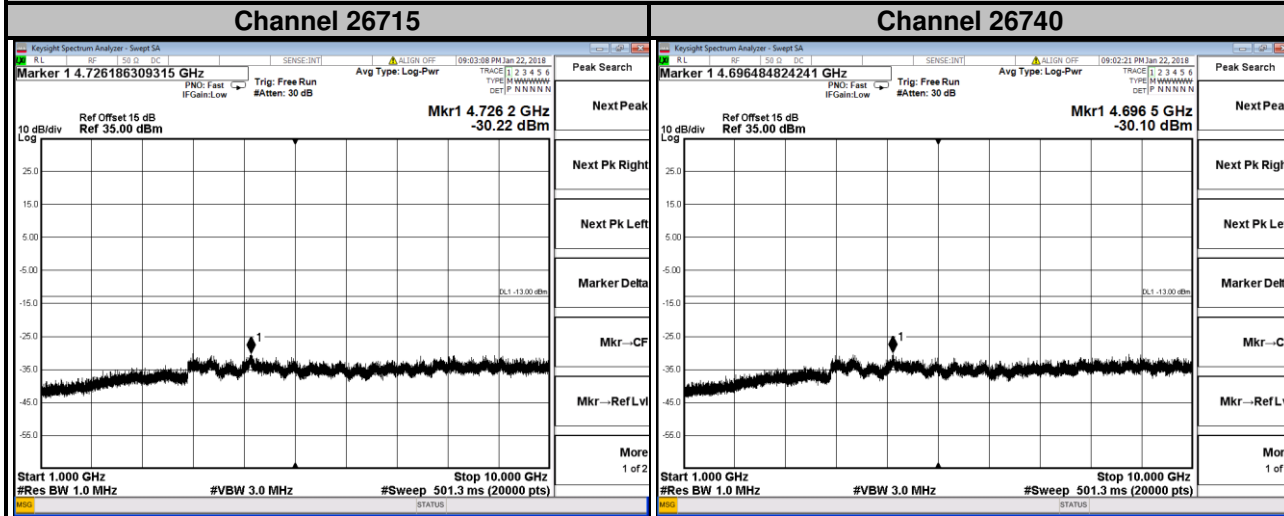

LTE Band 26
Channel Bandwidth: 10 MHz
Channel 26740

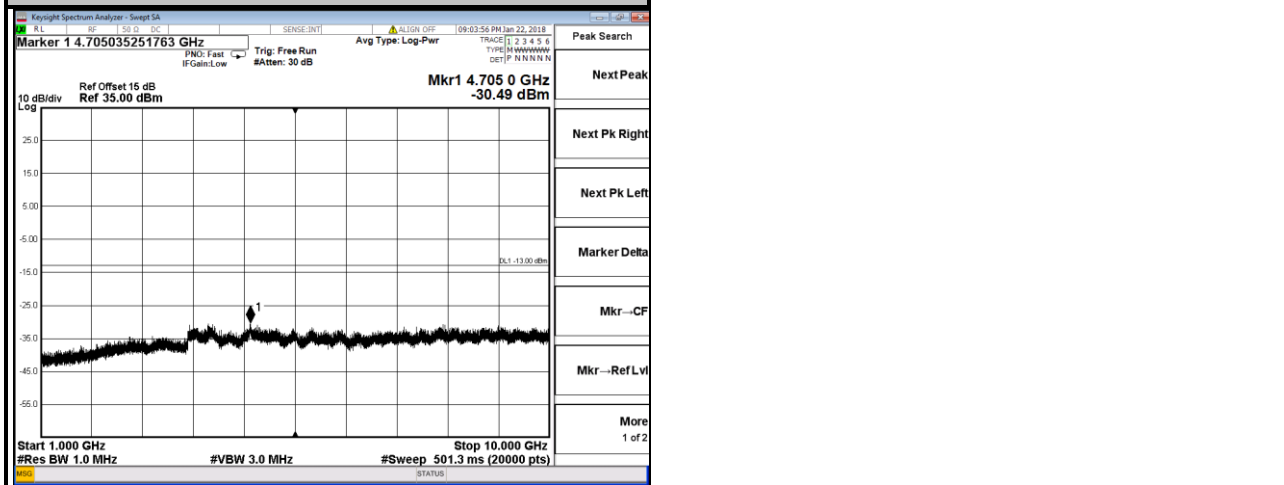

4.6 Radiated Emission Measurement

4.6.1 Limits of Radiated Emission Measurement

The power of any emission outside a licensee's frequency block shall be attenuated below the transmitter power (P) by at least $43 + 10 \log_{10}(P)$ dB. The limit of emission is equal to -13 dBm.

4.6.2 Test Procedure

- a. Substitution method is used for E.I.R.P measurement. In the semi-anechoic chamber, EUT placed on the 0.8 m (below or equal 1 GHz) and/or 1.5 m (above 1 GHz) height of Turn Table, rotated the table around 360 degrees to search the maximum radiation power and receiver antenna shall be rotated vertical and horizontal polarization and moved height from 1 m to 4 m to find the maximum polar radiated power. The "Read Value" is the spectrum reading the maximum power value.
- b. The substitution horn antenna is substituted for EUT at the same position and signals generator export the CW signal to the substitution antenna via a TX cable. Rotated the Turn Table and moved receiving antenna to find the maximum radiation power. Adjust output power level of S.G to get a Value of spectrum reading equal to "Read Value" of step a. Record the power level of S.G.
- c. EIRP = Output power level of S.G – TX cable loss + Antenna gain of substitution horn.
- d. E.R.P power can be calculated form E.I.R.P power by subtracting the gain of dipole, E.R.P power = E.I.P.R power - 2.15 dBi.

Note: The resolution bandwidth of spectrum analyzer is 1 MHz and the video bandwidth is 3 MHz.

4.6.3 Deviation from Test Standard

No deviation.

4.6.4 Test Setup

<Radiated Emission below or equal 1 GHz>

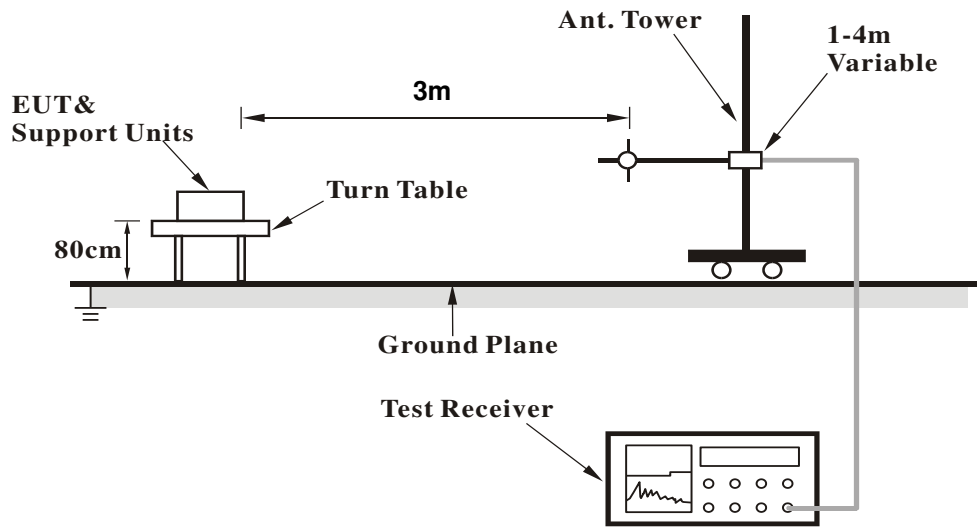

<Radiated Emission above 1 GHz>

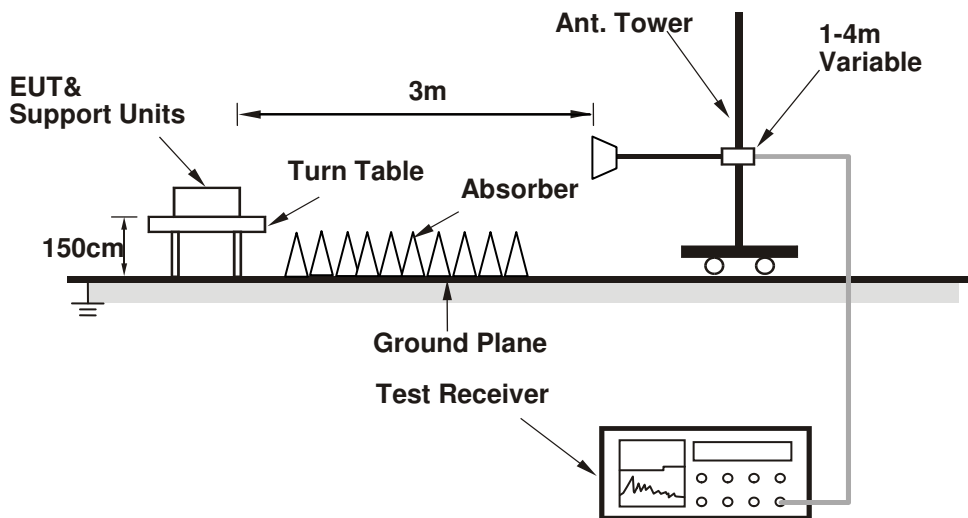

For the actual test configuration, please refer to the attached file (Test Setup Photo).

4.6.5 Test Results

LTE Band 26

Channel Bandwidth: 10 MHz / QPSK



Bureau Veritas Consumer Products Services Ltd., Taoyuan Branch

A D T

Data: 9

Date: 2017-11-28

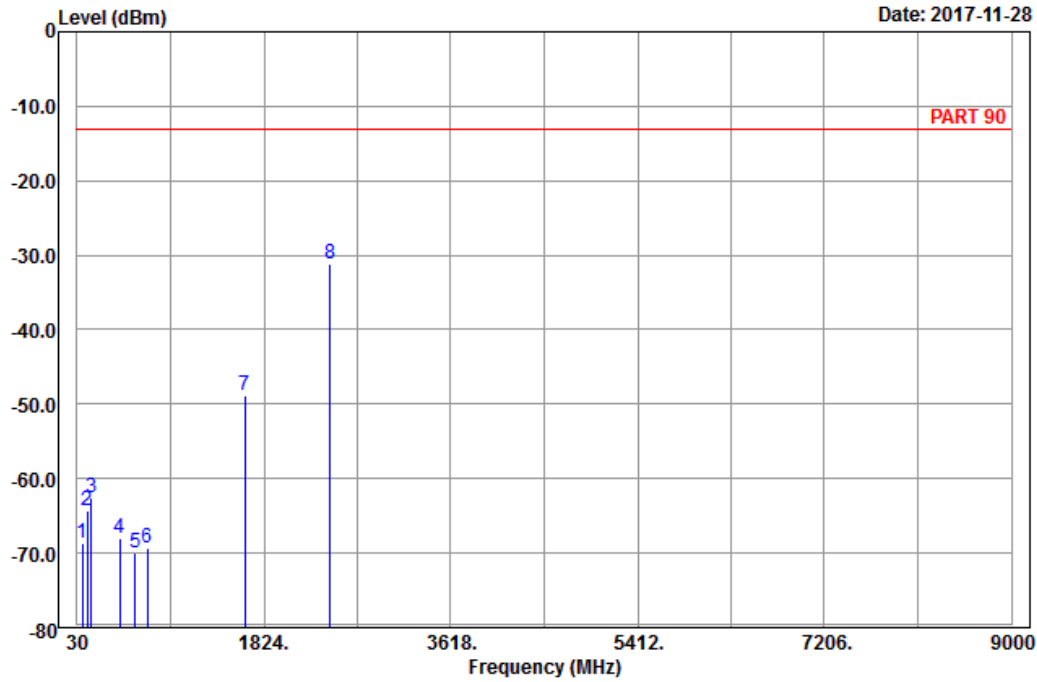

Site : 966 chamber 1
 Condition: PART 90 Horizontal
 Remark : LTE_Band 26_Link_CH26740
 Tested by: Charles Hsiao

	Freq	Level	Read Level	Limit Line	Over Limit	Factor	Remark
	MHz	dBm	dBm	dBm	dB	dB	
1	79.68	-68.64	-56.79	-13.00	-55.64	-11.85	Peak
2	127.74	-64.24	-56.47	-13.00	-51.24	-7.77	Peak
3	165.27	-62.50	-55.31	-13.00	-49.50	-7.19	Peak
4	441.40	-67.91	-64.26	-13.00	-54.91	-3.65	Peak
5	591.20	-69.95	-70.02	-13.00	-56.95	0.07	Peak
6	708.10	-69.35	-68.83	-13.00	-56.35	-0.52	Peak
7	1638.00	-48.82	-56.38	-13.00	-35.82	7.56	Peak
8 pp	2457.00	-31.08	-42.10	-13.00	-18.08	11.02	Peak



A D T

Data: 10

Date: 2017-11-28

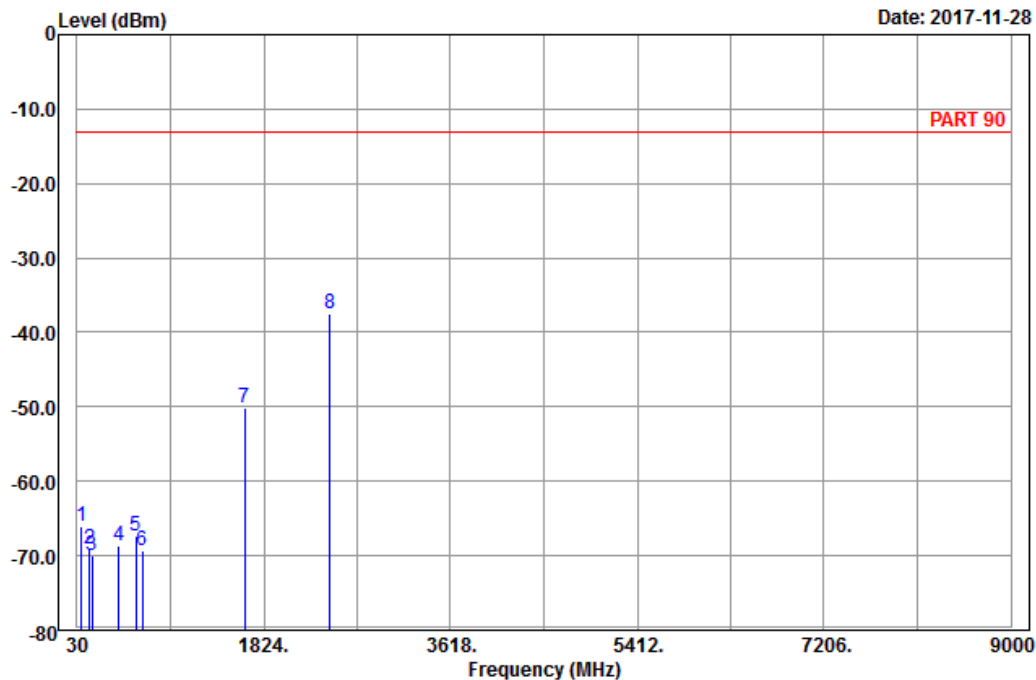

Site : 966 chamber 1
 Condition: PART 90 Vertical
 Remark : LTE_Band 26_Link_CH26740
 Tested by: Charles Hsiao

	Freq	Level	Read Level	Limit Line	Over Limit	Factor	Remark
	MHz	dBm	dBm	dBm	dB	dB	
1	75.09	-66.14	-53.87	-13.00	-53.14	-12.27	Peak
2	149.34	-69.19	-61.26	-13.00	-56.19	-7.93	Peak
3	177.15	-69.95	-64.07	-13.00	-56.95	-5.88	Peak
4	435.10	-68.68	-65.15	-13.00	-55.68	-3.53	Peak
5	595.40	-67.43	-67.66	-13.00	-54.43	0.23	Peak
6	658.40	-69.39	-69.21	-13.00	-56.39	-0.18	Peak
7	1638.00	-50.04	-57.60	-13.00	-37.04	7.56	Peak
8 pp	2457.00	-37.49	-48.51	-13.00	-24.49	11.02	Peak

5 Pictures of Test Arrangements

Please refer to the attached file (Test Setup Photo).

Appendix – Information on the Testing Laboratories

We, Bureau Veritas Consumer Products Services (H.K.) Ltd., Taoyuan Branch, were founded in 1988 to provide our best service in EMC, Radio, Telecom and Safety consultation. Our laboratories are FCC recognized accredited test firms and accredited according to ISO/IEC 17025.

If you have any comments, please feel free to contact us at the following:

Linko EMC/RF Lab

Tel: 886-2-26052180

Fax: 886-2-26051924

Hsin Chu EMC/RF/Telecom Lab

Tel: 886-3-6668565

Fax: 886-3-6668323

Hwa Ya EMC/RF/Safety

Tel: 886-3-3183232

Fax: 886-3-3270892

Email: service.adt@tw.bureauveritas.com

Web Site: www.bureauveritas-adt.com

The address and road map of all our labs can be found in our web site also.

--- END ---