

承認文號: A091221069



捷超通訊科技股份有限公司

承認書

公司料號: G1532400400900

供應商及料號: 慶陞, 6602100033-150 白色外罩

料品名稱: ANTENNA

料品規格: Frequency Range: 2.4~2.5GHZ

Gain: 2.0±0.25dBi, 150mm

COLOR: WHITE, 剝皮鍍錫

適用機型: 共用機型

注意事項: 無鉛報告起始日期: 2009/03/10 保存期限: 1年

單重(仟克): 0.0054KG

最小包裝量: 10PCS/BAG

受文單位				承認單位		
<input type="checkbox"/> 業務部	<input type="checkbox"/> 製造部	<input type="checkbox"/> 品保部	<input type="checkbox"/> 採購部	核准	審核	承辦人
				吳志強	葉新發	王培

確認日期: 2009/12/21

住址: 台北縣中和市立德街 95 號 7 樓

表單編號: F1RD06D

TO: 捷超通訊股份有限公司

SPECIFICATION FOR APPROVAL

DESCRIPTION : 2.4GHz Antenna+1.13mm(150mm) Coaxial Cable(剝皮鍍錫)

CUSTOMER DWG. NO. /PART NO : _____

KINSUN PROD. NO : 6602100033-150 白色外罩

DATE : 2009.12.17

PLEASE RETURN TO US ONE COPY OF “ SPECIFICATION FOR APPROVAL ” WITH YOUR APPROVED SIGNATURES

APPROVED SIGNATURES



1. 單體重量:5.4g
2. 保存期限:一年
3. 最小包裝:10PCS/BAG

	APPROVED	CHECKED	PREPARED
NAME	Yang Alan	Roy Wu	Stella Wang

慶陞工業股份有限公司



KINSUN INDUSTRIES INC.

桃園縣中壢市普忠路 211 巷 20 號

TEL : 886-3-4353551

FAX : 886-3-4353951

<http://www.kinsun.com>

e-mail: roy@kinsun.com

1. 規格表	3
2. 成品圖	4
3. 包裝規範	5
4. 測試報告	6~8
5. 天線外罩(TPE)材質證明	9
6. 固定座(PC)材質證明	10
7. 1.13mm Cable UL	11~13
8. 1.13mm Cable 規格書	14~16
9. 銅管材質證明	17

TECHNICAL DATA

Electrical Properties

Frequency Range: 2.4~2.5 GHz

Impedance: 50 Ohm nominal

V.S.W.R : 2.0

Gain : 2dBi±0.25

Radiation: Omni

Polarization: Vertical

Electrical Wave: Dipole array

Connector:

Mechanical Properties

Antenna Cover: TPE

Color : WHITE

Operation Temperature:-20 ~+65

Storage Temperature:-30 ~+75

RoHS COMPLIANT

MECHANICAL

Antenna Cover : TPE

Antenna Base : PC

Color : White

ELECTRICAL

Frequency : 2.4GHz

Cable : Coaxial Cable ϕ 1.13

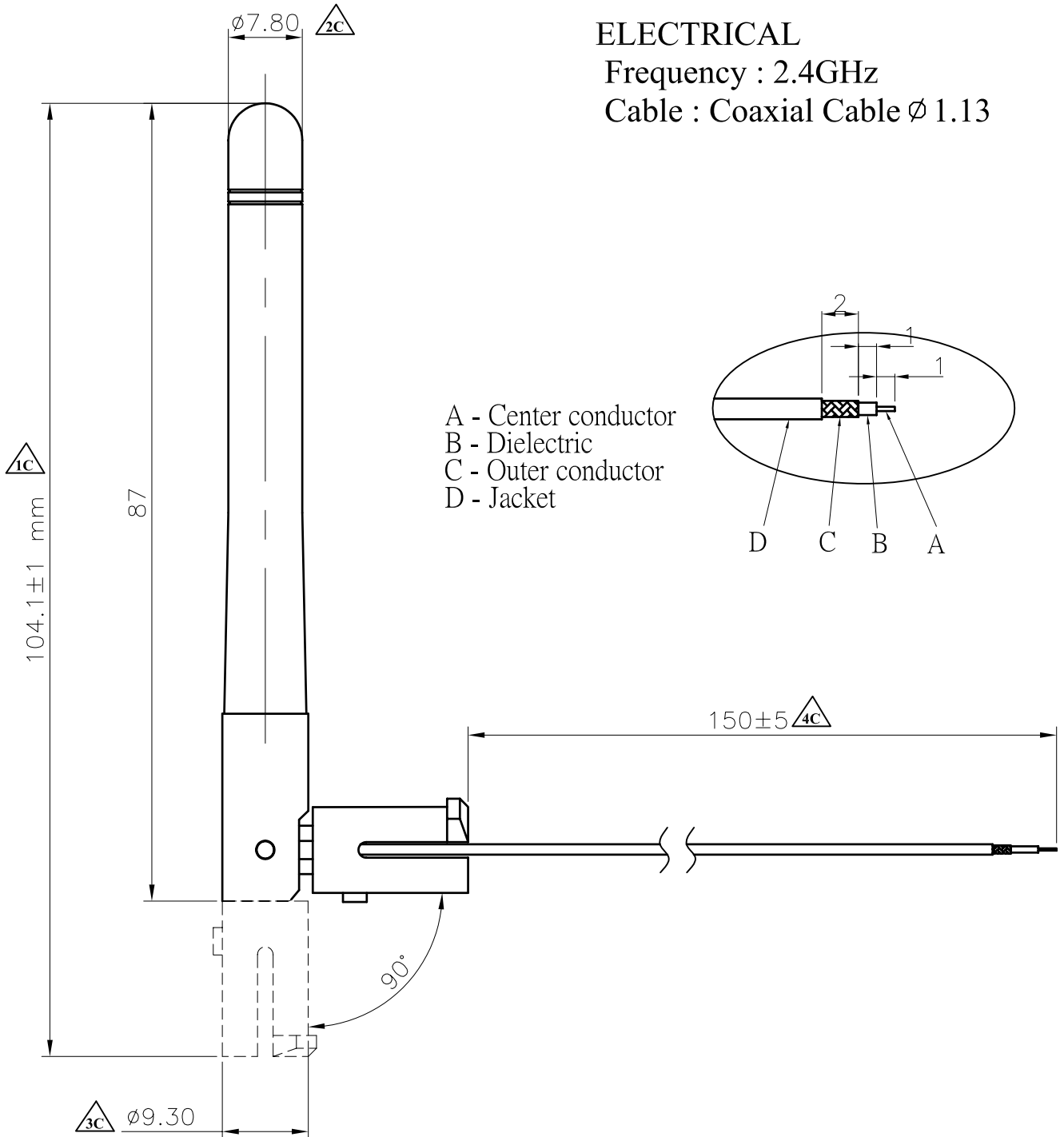

- A - Center conductor
- B - Dielectric
- C - Outer conductor
- D - Jacket

※凡標註△記號者，為品管檢驗之尺寸

設計DR. Marco 2009/12/01	核准APPD. Jerry 2009/12/01	容許公差 TOLERANCE .XXX ±0.10 .XX ±0.25 .X ±0.38 X ±0.50 ANG ±3°	品名 ARTICLE 6602-2.4GHz
版本說明 REVISION NOTE			圖號 DWG NO. 6602100033-150
			單位 UNIT 比例 SCALE 張數 SHEET 版本 REV. mm 1.5/1 1/1 A

主題 Subject	6602帶線式包裝	文件編號 NO.	EN-6602-P0101	版本 REV.	A
		核准 APPD.	Jerry	製作者 DR.	Hayato

(1) 天線朝同一個方向，10pcs一袋

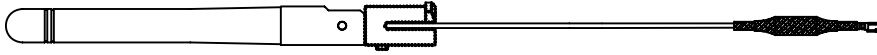

(2) 每個防水袋使用封口機於袋口處封口(封口前空氣需漏掉)

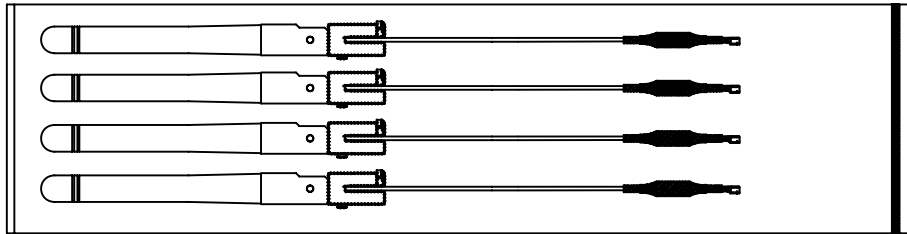

CPC0100060

封口

(3) 每箱150 Bag

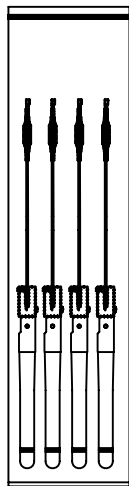

x150

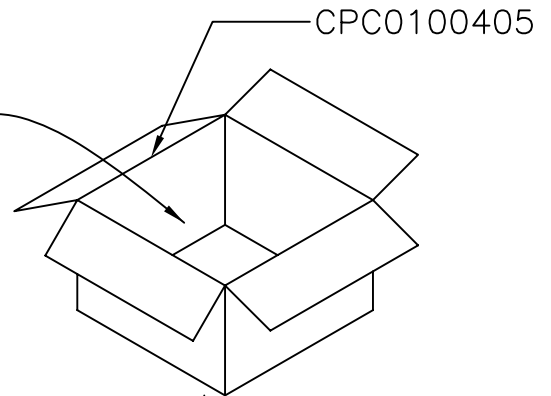

CPC0100405

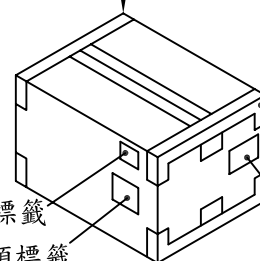

製令標籤
唛頭標籤

封箱膠帶
淨毛重標籤

1. 每箱150袋放入CPC0100405內。
2. 每箱袋數不滿以牛皮紙袋填滿。
3. 上下放隔板。
4. 封箱出貨。
5. 尾數請用CPC0100601的外箱。

Brand / Model : 6602100033-150

Remark : 2450MHz

Tested by : Nick Dai

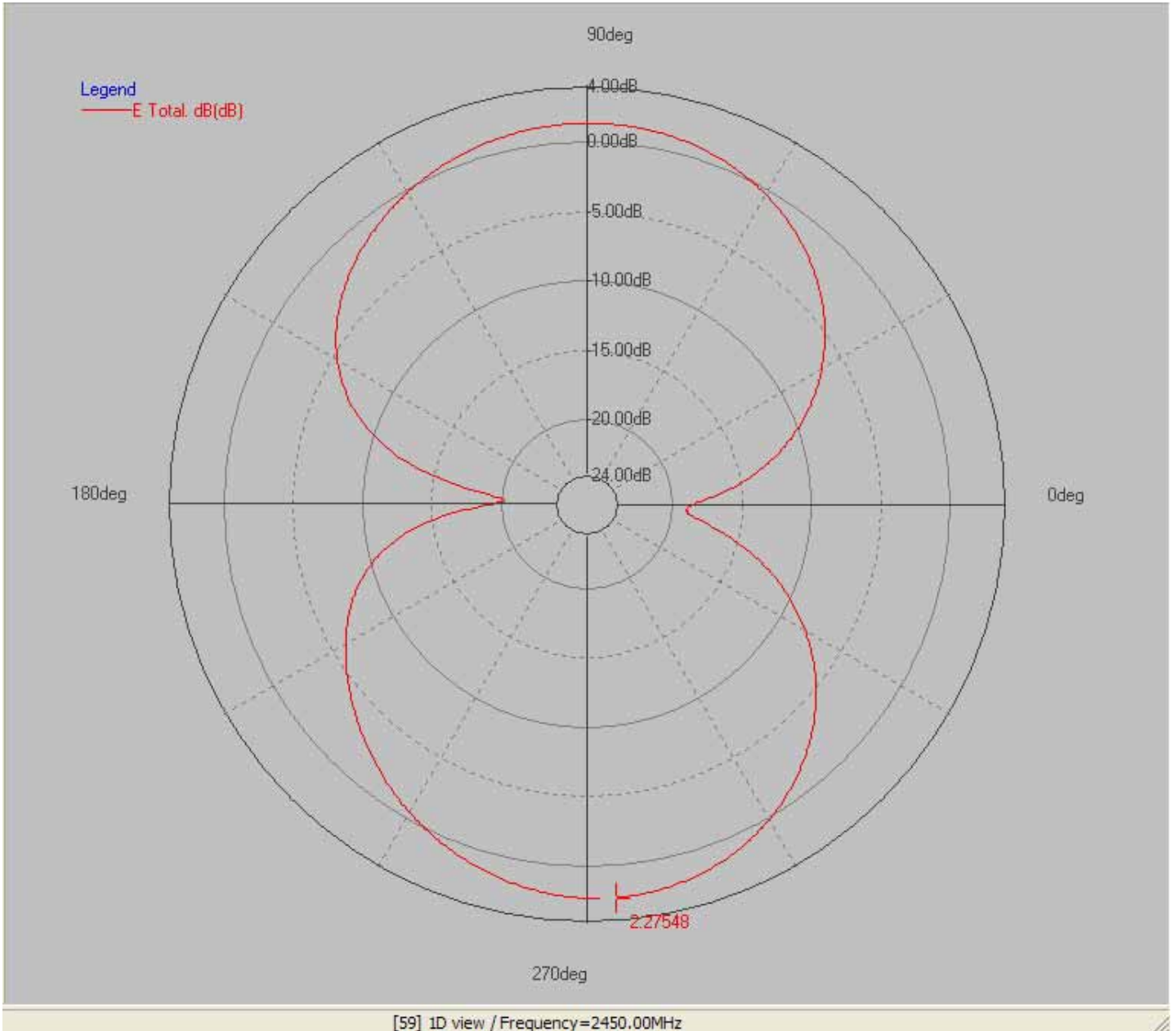

-- : Max. deg

*Unit : dBi

Frequency(MHz) : **2450.00**

Pattern Field : **E plane**

Average Gain(dB) : **-3.01dB**

Maximum Gain(dB) : **2.28dB**

Maximum Gain(degree) : **-85.71**

Minimum Gain(dB) : **-20.40dB**

Minimum Gain(degree) : **177.14**

Brand / Model : 6602100033-150

Remark : 2450MHz

Tested by : Nick Dai

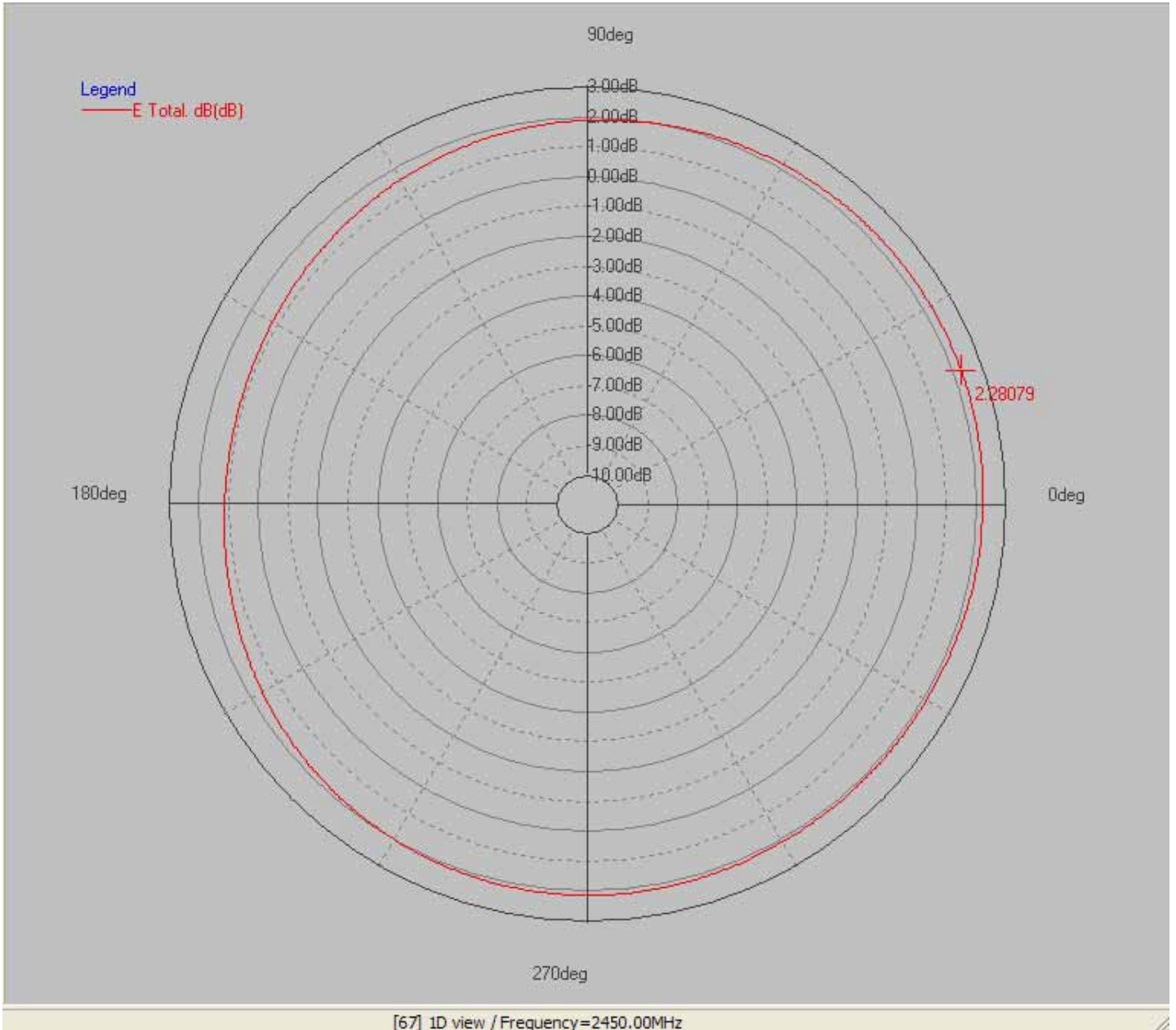

-- : Max. deg

*Unit : dBi

Frequency(MHz) : **2450.00**

Pattern Field : **H plane**

Average Gain(dB) : **1.84dB**

Maximum Gain(dB) : **2.28dB**

Maximum Gain(degree) : **19.53**

Minimum Gain(dB) : **1.07dB**

Minimum Gain(degree) : **167.42**

6602100033-150

S11



VSWR

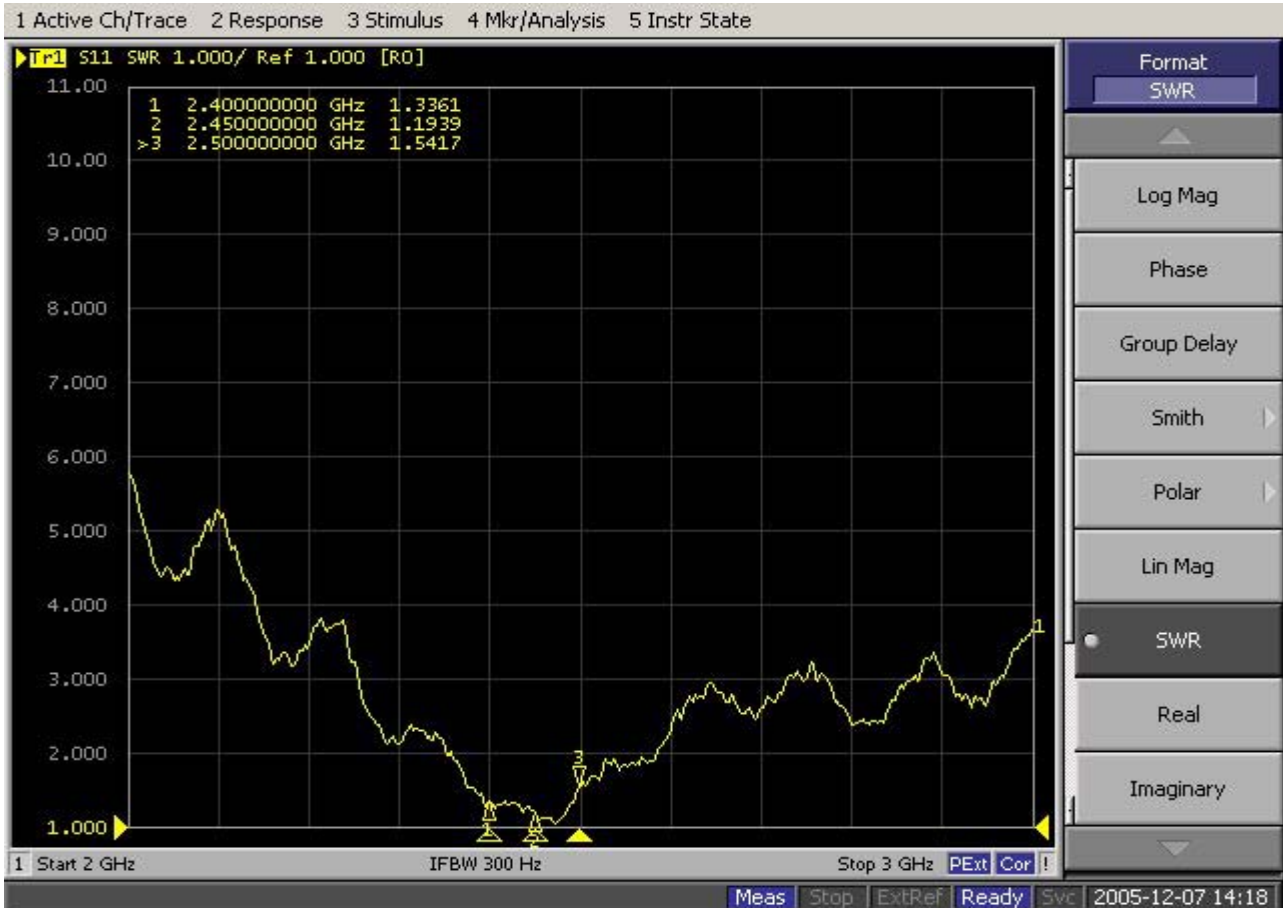

KEYFLEX BT-1063D

Applications

Fuel tanks, gears, tubes, hose

Description

KEYFLEX BT-1063D has flexibility and elastic resiliency similar to those of rubber as well as mechanical strength, heat-resistance and weather-resistance better than those of rubber. All grade of KEYFLEX BT are block copolymers consisting of a hard (crystalline) segment of polybutylene-terephthalate and a soft (amorphous) segment based on long-chain polyether glycol. Properties are determined by the ratio of hard to soft segment.

Properties	Test Method	Test Condition	Unit	Value
Physical				
Hardness	ASTM D2240	Shore D	–	63
Specific Gravity	ASTM D792		–	1.22
Water Absorption	ASTM D570	24hr, 23°C	%	0.3
Mold Shrinkage	ASTM D955		%	1.5
Mechanical				
Tensile Strength at break	ASTM D638		kg/cm ²	410
			MPa	40.2
			psi	5830
Elongation at break	ASTM D638		%	550
Tensile Strength at yield	ASTM D638		kg/cm ²	200
			MPa	19.6
			psi	2850
Tensile Strength (5% Elongation)	ASTM D638		kg/cm ²	110
			MPa	10.8
			psi	1570
Flexural modulus	ASTM D790		kg/cm ²	3100
			MPa	304
			10 ³ × psi	4410
IZOD Impact Strength	ASTM D256	Noched, 23°C	kg · cm/cm	NB
			J/m	NB
			ft · lb/in	NB
		Noched, -40°C	kg · cm/cm	10
			J/m	98
			ft · lb/in	1.8
Tear Strength	ASTM D624	R-Scale	kg/cm	165
			lb/in	925
Thermal				
Melt Flow Index (MI)	ASTM D1238	2.16kgf	g/10min	28 ³
Melt Temperature	DSC	0.45 MPa	°C	210
			°F	410
Heat Deflection Temperature	ASTM D648	0.45 MPa	°C	124
			°F	256

Characteristics

4/6

2005年10月13日

台灣帝人化成(股)有限公司

パンライト試験成績表

拝啓 貴社ますますご清祥の事と、お慶び申し上げます。
 平素は、パンライトをお引き立て賜り厚く御礼申し上げます。
 さて、標記の件につきまして、下記の通りご報告いたします。

記

G R A D E : LN - 1250GCOLOR NO. : NAT

項目：分子量測定

LOT NO.	Q'TY(KGS)	規格値	測定値	合否判定
H4605928	9,750	21,600±1000	21,630	OK

MFR測定

LOT NO.	Q'TY(KGS)	規格値	測定値	合否判定
H4605928	9,750	10.0±3.0%	11.5	OK



UL International Services Ltd.--Taiwan Branch
4th Floor
No. 260 Da-Yeh Road
Pei Tou, Taipei, Taiwan 112
Telephone: 886-2-2896-7790
Fax: 886-2-2891-7644
Email: ul.tw@tw.ul.com



MR S N WONG
WONDERFUL HI-TECH CO LTD
CHUNG LI INDUSTRIAL PARK
17 PEI YUAN RD
CHUNG-LI, FU SHING LEE
TAOYUAN HSIEN TAIWAN

Date: 2003/09/22
Subscriber: 699947002
File No: E77981
Project No: 03CA21293
PD No: 03015304
Type: L
PO Number: S WONG

Subject: Procedure And/Or Report Material

The following material resulting from the investigation under the above numbers is enclosed.

Issue

<u>Date</u>	<u>Vol</u>	<u>Sec</u>	<u>Pages</u>	<u>Revised Date</u>
1981/04/09	1	1	Revised Title of Authorized Styles H, J	2003/09/18
1981/04/09	1	1	New Facing Pages 1745, 1979	2003/09/18

Inspections at your plant will be conducted under the supervision of Mr. Hank Su, Field Supervisor, 4th Fl. 260 Da-Yeh Road, Pei Tou District, Taipei 112 Taiwan, PHONE: 886 2 28938008 ext. 108, FAX: 886 2 28978628.

Marks as needed may be obtained from: UL International Service Ltd., 4th Fl., 260 Da-Yeh Road, Peitou, Taipei City, Taiwan 112, PHONE: 886 2 28967790, FAX: 886 2 28917644, ATTN: Iris Tseng.

Please file revised pages and illustrations in place of material of like identity. New material should be filed in its proper numerical order.

NOTE: Follow-Up Service Procedure revisions DO NOT include Cover Pages, Test Records and Conclusion Pages. Report revisions DO NOT include Authorization Pages, Indices, Section General Pages and Appendixes.

Please review this material and report any inaccuracies to LAURA CHANG (886-2-2896-7790), referring to the above Project and/or PD Numbers.

c: TPI File

UL INSPECTION CENTER 408

TABLE OF AUTHORIZED STYLES
 SINGLE-CONDUCTOR THERMOPLASTIC-INSULATED WIRE

(File at Front of Section 1)

Page	Issued	Page	Issued	Page	Issued	Page	Issued
1701		1726		1751		1776	
1702		1727		1752		F 1777	1984-05-03
1703		1728		1753		1778	
1704		1729		1754		1779	
1705		1730		1755		1780	
1706		1731		1756		1781	
1707		1732		1757		1782	
1708		1733		1758		1783	
1709		1734		1759		1784	
1710		1735		1760		1785	
1711		1736		1761		1786	
1712		1737		1762		1787	
1713		1738		1763		1788	
1714		1739		1764		1789	
1715		1740		1765		1790	
1716		1741	1987-08-27	1766		1791	
1717		1742		1767		1792	1987-08-27
1718		1743	1986-02-19	1768		1793	
1719		1744		1769		1794	
1720		F 1745	2003-09-18	1770		1795	
1721		1746		1771		1796	
1722		1747		1772		1797	
1723		1748		1773		1798	
1724		1749		1774		1799	
1725		1750		1775		1800	

TABLE OF AUTHORIZED STYLES
 SINGLE-CONDUCTOR THERMOPLASTIC-INSULATED WIRE

(File at Front of Section 1)

Page	Issued	Page	Issued	Page	Issued	Page	Issued
1901		1926		1951		1976	
1902		1927		1952		1977	
1903		1928		1953	1990-05-23	1978	
1904		1929		1954		F 1979	2003-09-18
1905		1930		1955		1980	
1906		1931		1956		1981	
1907		1932		1957		1982	
1908		1933		1958		1983	
1909		1934		1959		1984	
1910		1935		1960		1985	
1911		1936		1961		1986	
1912		1937		1962		1987	
1913		1938		1963		1988	
1914		1939		1964		1989	
1915		1940		1965		1990	
1916		1941		1966		1991	
1917		1942		1967		1992	
1918		1943		1968		1993	
1919		1944		1969		1994	
1920		1945		1970		1995	
1921		1946		1971		1996	
1922		1947		1972		1997	
1923		1948		1973		1998	
1924		1949		1974		1999	
1925		1950		1975		10000	

SPECIFICATION FOR APPROVAL

DOCUMENT: A3132SP003

STYLE : COAXIAL CABLE
105°C 30V

SIZE: 32AWG×1C
BRAID : SP

RECOGNIZED: UL 1979



WONDERFUL HI-TECH CO.,LTD.

OFFICE : 72WU KONG 6TH ROAD,
WU KU IND. DISTRICT
TAIPEI HSIEN,TAIWAN

FACTORY : 17 PEI YUAN ROAD,
CHUNG-LI IND. PARK
TAIWAN, R.O.C.

TEL : (02)22988033
FAX : (02)22988031-2

TEL : (03)4527777
FAX : (03)4517214

 **WONDERFUL HI-TECH CO., LTD.**
SPECIFICATION

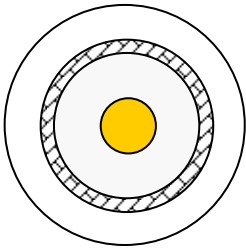
STYLE	105°C 30V UL 1979	DOCUMENT NO : A3132SP003	
SIZE	32AWG	ESTABLISHED DATE: 2008/06/23	
STANDARD :			
Conductor	Size	AWG	32
	Material	----	Silver Cover Copper
	Conductors No.	----	7
	Conductors Size	mm	0.080
	O.D.	mm	0.24
Insulation	Average Thickness	mm	0.22
	Diameter	mm	0.68 ± 0.02
	Material	----	FEP
	Color	----	Clear
Braid	Material	----	Silver Cover Copper
	Construction	mm	16 / 4 / 0.050
	Coverage	%	91.3
Jacket	Average Thickness	mm	0.13
	Diameter	mm	1.13 ±0.05
	Material	----	FEP
	Color	----	According to custom
Marking	Non		
Drawing			



WONDERFUL HI-TECH CO., LTD.

SPECIFICATION

Electrical & Physical Properties						
Item		32AWG				
Rating Temp Voltage		105°C 30V				
Conductor Resistance		850 OHM/KM/20°C MAX.				
Insulation Resistance		1000 MEGA OHM-KM MIN.				
Dielectric Strength		AC 500 V/Minute				
Spark Test		2.5 KV				
Insulation	Unaged	Tensile Strength	2500 PSI MIN.(1.76 Kg / m m ²)			
		Elongation	200% MIN.			
	Aged	Tensile Strength	UNAGED MIN. 75%(168HRS×232°C)			
		Elongation	UNAGED MIN. 75%(168HRS×232°C)			
Jacket	Unaged	Tensile Strength	2500 PSI MIN.(1.76 Kg / m m ²)			
		Elongation	200% MIN.			
	Aged	Tensile Strength	UNAGED MIN.75%(168HRS×232°C)			
		Elongation	UNAGED MIN.75%(168HRS×232°C)			
Nom. Impedance		50 ± 3 Ohms				
Nom. Capacitance		96 ± 3 pF/m				
Nom. Vel. of Prop.		69%				
VSWR Test (0 – 6 GHZ)		Max 1.3				
Flame Test		VW-1 OK				
Attenuation (dB/1m)	2.0GHZ		2.4GHZ	2.5GHZ	5.0GHZ	6.0 GHZ
	2.80		3.10	3.15	4.85	5.20

銅管材質證明

東莞信泰隆五金制品有限公司
SHIN TAY LONG FIVEMETAL PRODUCT CO.,LTD.

產品質量證明書



客戶:	豐茂材料公司		日期:	2007.8.12	
品名	規格	狀態	製造方法	數量	
H65		H			
化學成份	銅(Cu)	鐵(Fe)	鉛(pb)	鋅(Zn)	雜質
	64.878%	0.012%	0.014%	35.093%	0.003%
機械性能	抗拉強度 (不少於)	延伸率 (不少於)	直徑公差		

主管: 胡偉才

化驗員: 李國強



6303100031-140

SGS REPORT

- 1. Cable SGS REPORT----- 2~41**
- 2. TPE SGS REPORT ----- 42~44**
- 3. PC SGS REPORT ----- 45~50**
- 4. 銅管 SGS REPORT----- 51~54**

測試報告 Test Report

號碼(No.) : CE/2009/11501C 日期(Date) : 2009/01/15 頁數(Page) : 1 of 21

萬泰科技股份有限公司

WONDERFUL HI-TECH CO., LTD.

桃園縣中壢市工業區北園路17號

NO. 17, PEI-YUAN ROAD, CHUNG-LI IND., PARK, TAOYUAN TAIWAN, R. O. C.



以下測試樣品係由客戶送樣，且由客戶聲稱並經客戶確認如下 (The following samples was/were submitted and identified by/on behalf of the client as):

樣品名稱(Sample Description) : RF COAXIAL CABLE RG-178B/U, RG-179/U, RG-316U MINI 0.8mm, 1.13mm, 1.32mm, 1.37mm, 1.48mm, RF405A UL 1330, 1331, 1332, 1333, 1726, 1867, 10231, 10064

樣品型號(Style/Item No.) : BLACK(BK4025), BROWN(BN4027), RED(RD4026), ORANGE(OR4020), YELLOW(YE4029), GREEN(GN4023), BLUE(BL4021), PURPLE(PU4024), GRAY(GY4028), WHITE(WT4022)

收件日期(Sample Receiving Date) : 2009/1/9

測試期間(Testing Period) : 2009/1/9 TO 2009/1/15

=====
測試結果(Test Results) : 請見下一頁 (Please refer to next pages).

Chenyu Kung / Operation Manager
Signed for and on behalf of
SGS TAIWAN LTD.
Chemical Laboratory – Taipei

Unless otherwise stated the results shown in this test report refer only to the sample(s) tested. This test report cannot be reproduced, except in full, without prior written permission of the Company.
除非另有說明，此報告結果僅對測試之樣品負責。本報告未經本公司書面許可，不可部分複製。
This Test Report is issued by the Company under its General Conditions of Service printed overleaf or available on request and accessible at http://www.sgs.com/terms_and_conditions.htm. Attention is drawn to the limitation of liability, indemnification and jurisdiction issues defined therein. Any holder of this Test Report is advised that information contained hereon reflects the Company's findings at the time of its intervention only and within the limits of Client's instructions, if any. The Company's sole responsibility is to its Client and this document does not exonerate parties to a transaction from exercising all their rights and obligations under the transaction documents. Any unauthorized alteration, forgery or falsification of the content or appearance of this document is unlawful and offenders may be prosecuted to the fullest extent of the law.

測試報告 Test Report

號碼(No.) : CE/2009/11501C 日期(Date) : 2009/01/15 頁數(Page) : 2 of 21

萬泰科技股份有限公司

WONDERFUL HI-TECH CO., LTD.

桃園縣中壢市工業區北園路17號

NO. 17, PEI-YUAN ROAD, CHUNG-LI IND., PARK, TAOYUAN TAIWAN, R. O. C.



測試結果(Test Results)

測試部位(PART NAME) NO.1	:	黑色塑膠粒 (BLACK PLASTIC PELLETS)
測試部位(PART NAME) NO.2	:	棕色塑膠粒 (BROWN PLASTIC PELLETS)
測試部位(PART NAME) NO.3	:	紅色塑膠粒 (RED PLASTIC PELLETS)
測試部位(PART NAME) NO.4	:	橘色塑膠粒 (ORANGE PLASTIC PELLETS)
測試部位(PART NAME) NO.5	:	黃色塑膠粒 (YELLOW PLASTIC PELLETS)
測試部位(PART NAME) NO.6	:	綠色塑膠粒 (GREEN PLASTIC PELLETS)
測試部位(PART NAME) NO.7	:	藍色塑膠粒 (BLUE PLASTIC PELLETS)
測試部位(PART NAME) NO.8	:	紫色塑膠粒 (PURPLE PLASTIC PELLETS)
測試部位(PART NAME) NO.9	:	灰色塑膠粒 (GRAY PLASTIC PELLETS)
測試部位(PART NAME)	:	白色塑膠粒 (WHITE PLASTIC PELLETS)

測試項目 (Test Items)	單位 (Unit)	測試方法 (Method)	方法偵測 極限值 (MDL)	結果 (Result)		
				NO.1	NO.2	NO.3
鎘 / Cadmium (Cd)	mg/kg	參考IEC 62321: 2008方法, 用感應耦合電漿原子發射光譜儀檢測. / With reference to IEC 62321: 2008 and performed by ICP-AES.	2	n.d.	n.d.	n.d.
鉛 / Lead (Pb)	mg/kg	參考IEC 62321: 2008方法, 用感應耦合電漿原子發射光譜儀檢測. / With reference to IEC 62321: 2008 and performed by ICP-AES.	2	n.d.	n.d.	n.d.
汞 / Mercury (Hg)	mg/kg	參考IEC 62321: 2008方法, 用感應耦合電漿原子發射光譜儀檢測. / With reference to IEC 62321: 2008 and performed by ICP-AES.	2	n.d.	n.d.	n.d.
六價鉻 / Hexavalent Chromium Cr(VI) by alkaline extraction	mg/kg	參考IEC 62321: 2008方法, 用UV-VIS檢測. / With reference to IEC 62321: 2008 and performed by UV-VIS.	2	n.d.	n.d.	n.d.

Unless otherwise stated the results shown in this test report refer only to the sample(s) tested. This test report cannot be reproduced, except in full, without prior written permission of the Company. 除非另有說明, 此報告結果僅對測試之樣品負責。本報告未經本公司書面許可, 不可部分複製。

This Test Report is issued by the Company under its General Conditions of Service printed overleaf or available on request and accessible at http://www.sgs.com/terms_and_conditions.htm. Attention is drawn to the limitation of liability, indemnification and jurisdiction issues defined therein. Any holder of this Test Report is advised that information contained herein reflects the Company's findings at the time of its intervention only and within the limits of Client's instructions, if any. The Company's sole responsibility is to its Client and this document does not exonerate parties to a transaction from exercising all their rights and obligations under the transaction documents. Any unauthorized alteration, forgery or falsification of the content or appearance of this document is unlawful and offenders may be prosecuted to the fullest extent of the law.

測試報告

Test Report

號碼(No.) : CE/2009/11501C 日期(Date) : 2009/01/15 頁數(Page) : 3 of 21

萬泰科技股份有限公司

WONDERFUL HI-TECH CO., LTD.

桃園縣中壢市工業區北園路17號

NO. 17, PEI-YUAN ROAD, CHUNG-LI IND., PARK, TAOYUAN TAIWAN, R. O. C.



測試項目 (Test Items)	單位 (Unit)	測試方法 (Method)	方法偵測 極限值 (MDL)	結果 (Result)		
				NO.1	NO.2	NO.3
磷 / Phosphorus (P)	mg/kg	參考US EPA 3052 方法, 用感應 耦合電漿原子發射光譜儀檢測磷 含量. / With reference to US EPA Method 3052 for Phosphorus Content. Analysis was performed by ICP-AES.	2	n.d.	n.d.	18
三氧化二銻 / Antimony trioxide (Sb ₂ O ₃)*** (CAS No.: 001309-64-4)	mg/kg	參考US EPA 3050B方法, 用感應 耦合電漿原子發射光譜儀檢測銻 含量. / With reference to US EPA Method 3050B for Antimony Content. Analysis was performed by ICP-AES.	2	n.d.	n.d.	n.d.
全氟辛烷磺酸 / Perfluorooctane sulfonates (PFOS) PFOS — Acid PFOS — Metal Salt PFOS — Amide	mg/kg	參考US EPA 3540C: 1996方法, 以液相層析質譜儀檢測全氟辛烷 磺酸含量. / With reference to US EPA 3540C: 1996 method for PFOS Content. Analysis was performed by LC/MS.	10	n.d.	---	---
全氟辛酸(銨) / PFOA (CAS No.: 000335- 67-1)	mg/kg	參考US EPA 3540C: 1996方法, 以液相層析質譜儀檢測全氟辛酸 (銨)含量. / With reference to US EPA 3540C: 1996 method for PFOA Content. Analysis was performed by LC/MS.	10	n.d.	---	---
鹵素(氯) / Halogen-Chlorine (Cl) (CAS No.: 022537-15-1)	mg/kg	參考BS EN 14582:2007, 以離子 層析儀分析氯含量. / With reference to BS EN 14582:2007. Analysis was performed by IC method for Chlorine content.	50	n.d.	n.d.	n.d.

Unless otherwise stated the results shown in this test report refer only to the sample(s) tested. This test report cannot be reproduced, except in full, without prior written permission of the Company.
除非另有說明, 此報告結果僅對測試之樣品負責。本報告未經本公司書面許可, 不可部分複製。

This Test Report is issued by the Company under its General Conditions of Service printed overleaf or available on request and accessible at http://www.sgs.com/terms_and_conditions.htm. Attention is drawn to the limitation of liability, indemnification and jurisdiction issues defined therein. Any holder of this Test Report is advised that information contained hereon reflects the Company's findings at the time of its intervention only and within the limits of Client's instructions, if any. The Company's sole responsibility is to its Client and this document does not exonerate parties to a transaction from exercising all their rights and obligations under the transaction documents. Any unauthorized alteration, forgery or falsification of the content or appearance of this document is unlawful and offenders may be prosecuted to the fullest extent of the law.

測試報告 Test Report

號碼(No.) : CE/2009/11501C 日期(Date) : 2009/01/15 頁數(Page) : 4 of 21

萬泰科技股份有限公司

WONDERFUL HI-TECH CO., LTD.

桃園縣中壢市工業區北園路17號

NO. 17, PEI-YUAN ROAD, CHUNG-LI IND., PARK, TAOYUAN TAIWAN, R. O. C.



測試項目 (Test Items)	單位 (Unit)	測試方法 (Method)	方法偵測 極限值 (MDL)	結果 (Result)		
				NO.1	NO.2	NO.3
鹵素 (溴) / Halogen-Bromine (Br) (CAS No.: 010097-32-2)	mg/kg	參考BS EN 14582:2007, 以離子層析儀分析溴含量. / With reference to BS EN 14582:2007. Analysis was performed by IC method for Bromine content.	50	n.d.	n.d.	n.d.
鹵素 (碘) / Halogen-Iodine (I) (CAS No.: 014362-44-8)	mg/kg	參考BS EN 14582:2007, 以離子層析儀分析碘含量. / With reference to BS EN 14582:2007. Analysis was performed by IC method for Iodine content.	50	n.d.	n.d.	n.d.
多溴聯苯總和 / Sum of PBBs	mg/kg	參考IEC 62321: 2008方法, 以氣相層析儀/質譜儀檢測. / With reference to IEC 62321: 2008 and performed by GC/MS.	-	n.d.	n.d.	n.d.
一溴聯苯 / Monobromobiphenyl			5	n.d.	n.d.	n.d.
二溴聯苯 / Dibromobiphenyl			5	n.d.	n.d.	n.d.
三溴聯苯 / Tribromobiphenyl			5	n.d.	n.d.	n.d.
四溴聯苯 / Tetrabromobiphenyl			5	n.d.	n.d.	n.d.
五溴聯苯 / Pentabromobiphenyl			5	n.d.	n.d.	n.d.
六溴聯苯 / Hexabromobiphenyl			5	n.d.	n.d.	n.d.
七溴聯苯 / Heptabromobiphenyl			5	n.d.	n.d.	n.d.
八溴聯苯 / Octabromobiphenyl			5	n.d.	n.d.	n.d.
九溴聯苯 / Nonabromobiphenyl			5	n.d.	n.d.	n.d.
十溴聯苯 / Decabromobiphenyl	5	n.d.	n.d.	n.d.		

Unless otherwise stated the results shown in this test report refer only to the sample(s) tested. This test report cannot be reproduced, except in full, without prior written permission of the Company. 除非另有說明, 此報告結果僅對測試之樣品負責。本報告未經本公司書面許可, 不可部分複製。

This Test Report is issued by the Company under its General Conditions of Service printed overleaf or available on request and accessible at http://www.sgs.com/terms_and_conditions.htm. Attention is drawn to the limitation of liability, indemnification and jurisdiction issues defined therein. Any holder of this Test Report is advised that information contained hereon reflects the Company's findings at the time of its intervention only and within the limits of Client's instructions, if any. The Company's sole responsibility is to its Client and this document does not exonerate parties to a transaction from exercising all their rights and obligations under the transaction documents. Any unauthorized alteration, forgery or falsification of the content or appearance of this document is unlawful and offenders may be prosecuted to the fullest extent of the law.

測試報告

Test Report

號碼(No.) : CE/2009/11501C 日期(Date) : 2009/01/15 頁數(Page) : 5 of 21

萬泰科技股份有限公司

WONDERFUL HI-TECH CO., LTD.

桃園縣中壢市工業區北園路17號

NO. 17, PEI-YUAN ROAD, CHUNG-LI IND., PARK, TAOYUAN TAIWAN, R. O. C.



測試項目 (Test Items)	單位 (Unit)	測試方法 (Method)	方法偵測 極限值 (MDL)	結果 (Result)		
				NO.1	NO.2	NO.3
多溴聯苯醚總和 / Sum of PBDEs	mg/kg	參考IEC 62321: 2008方法, 以 氣相層析儀/質譜儀檢測. / With reference to IEC 62321: 2008 and performed by GC/MS.	-	n.d.	n.d.	n.d.
一溴聯苯醚 / Monobromodiphenyl ether			5	n.d.	n.d.	n.d.
二溴聯苯醚 / Dibromodiphenyl ether			5	n.d.	n.d.	n.d.
三溴聯苯醚 / Tribromodiphenyl ether			5	n.d.	n.d.	n.d.
四溴聯苯醚 / Tetrabromodiphenyl ether			5	n.d.	n.d.	n.d.
五溴聯苯醚 / Pentabromodiphenyl ether			5	n.d.	n.d.	n.d.
六溴聯苯醚 / Hexabromodiphenyl ether			5	n.d.	n.d.	n.d.
七溴聯苯醚 / Heptabromodiphenyl ether			5	n.d.	n.d.	n.d.
八溴聯苯醚 / Octabromodiphenyl ether			5	n.d.	n.d.	n.d.
九溴聯苯醚 / Nonabromodiphenyl ether			5	n.d.	n.d.	n.d.
十溴聯苯醚 / Decabromodiphenyl ether	5	n.d.	n.d.	n.d.		

測試項目 (Test Items)	單位 (Unit)	測試方法 (Method)	方法偵測 極限值 (MDL)	結果 (Result)		
				NO.4	NO.5	NO.6
鎘 / Cadmium (Cd)	mg/kg	參考IEC 62321: 2008方法, 用 感應耦合電漿原子發射光譜儀檢 測. / With reference to IEC 62321: 2008 and performed by ICP-AES.	2	n.d.	n.d.	n.d.
鉛 / Lead (Pb)	mg/kg	參考IEC 62321: 2008方法, 用 感應耦合電漿原子發射光譜儀檢 測. / With reference to IEC 62321: 2008 and performed by ICP-AES.	2	n.d.	n.d.	n.d.
汞 / Mercury (Hg)	mg/kg	參考IEC 62321: 2008方法, 用 感應耦合電漿原子發射光譜儀檢 測. / With reference to IEC 62321: 2008 and performed by ICP-AES.	2	n.d.	n.d.	n.d.

Unless otherwise stated the results shown in this test report refer only to the sample(s) tested. This test report cannot be reproduced, except in full, without prior written permission of the Company. 除非另有說明, 此報告結果僅對測試之樣品負責。本報告未經本公司書面許可, 不可部分複製。

This Test Report is issued by the Company under its General Conditions of Service printed overleaf or available on request and accessible at http://www.sgs.com/terms_and_conditions.htm. Attention is drawn to the limitation of liability, indemnification and jurisdiction issues defined therein. Any holder of this Test Report is advised that information contained hereon reflects the Company's findings at the time of its intervention only and within the limits of Client's instructions, if any. The Company's sole responsibility is to its Client and this document does not exonerate parties to a transaction from exercising all their rights and obligations under the transaction documents. Any unauthorized alteration, forgery or falsification of the content or appearance of this document is unlawful and offenders may be prosecuted to the fullest extent of the law.

測試報告

Test Report

號碼(No.) : CE/2009/11501C 日期(Date) : 2009/01/15 頁數(Page) : 6 of 21

萬泰科技股份有限公司

WONDERFUL HI-TECH CO., LTD.

桃園縣中壢市工業區北園路17號

NO. 17, PEI-YUAN ROAD, CHUNG-LI IND., PARK, TAOYUAN TAIWAN, R. O. C.



測試項目 (Test Items)	單位 (Unit)	測試方法 (Method)	方法偵測 極限值 (MDL)	結果 (Result)		
				NO. 4	NO. 5	NO. 6
六價鉻 / Hexavalent Chromium Cr(VI) by alkaline extraction	mg/kg	參考IEC 62321: 2008方法, 用 UV-VIS檢測. / With reference to IEC 62321: 2008 and performed by UV-VIS.	2	n.d.	n.d.	n.d.
磷 / Phosphorus (P)	mg/kg	參考US EPA 3052 方法, 用感應 耦合電漿原子發射光譜儀檢測磷 含量. / With reference to US EPA Method 3052 for Phosphorus Content. Analysis was performed by ICP-AES.	2	n.d.	n.d.	n.d.
三氧化二銻 / Antimony trioxide (Sb ₂ O ₃)*** (CAS No.: 001309-64-4)	mg/kg	參考US EPA 3050B方法, 用感應 耦合電漿原子發射光譜儀檢測銻 含量. / With reference to US EPA Method 3050B for Antimony Content. Analysis was performed by ICP-AES.	2	n.d.	n.d.	n.d.
鹵素 (氯) / Halogen-Chlorine (Cl) (CAS No.: 022537-15-1)	mg/kg	參考BS EN 14582:2007, 以離子 層析儀分析氯含量. / With reference to BS EN 14582:2007. Analysis was performed by IC method for Chlorine content.	50	n.d.	---	n.d.
鹵素 (溴) / Halogen-Bromine (Br) (CAS No.: 010097-32-2)	mg/kg	參考BS EN 14582:2007, 以離子 層析儀分析溴含量. / With reference to BS EN 14582:2007. Analysis was performed by IC method for Bromine content.	50	n.d.	n.d.	n.d.

Unless otherwise stated the results shown in this test report refer only to the sample(s) tested. This test report cannot be reproduced, except in full, without prior written permission of the Company.
除非另有說明, 此報告結果僅對測試之樣品負責。本報告未經本公司書面許可, 不可部分複製。

This Test Report is issued by the Company under its General Conditions of Service printed overleaf or available on request and accessible at http://www.sgs.com/terms_and_conditions.htm. Attention is drawn to the limitation of liability, indemnification and jurisdiction issues defined therein. Any holder of this Test Report is advised that information contained hereon reflects the Company's findings at the time of its intervention only and within the limits of Client's instructions, if any. The Company's sole responsibility is to its Client and this document does not exonerate parties to a transaction from exercising all their rights and obligations under the transaction documents. Any unauthorized alteration, forgery or falsification of the content or appearance of this document is unlawful and offenders may be prosecuted to the fullest extent of the law.

測試報告

Test Report

號碼(No.) : CE/2009/11501C 日期(Date) : 2009/01/15 頁數(Page) : 7 of 21

萬泰科技股份有限公司

WONDERFUL HI-TECH CO., LTD.

桃園縣中壢市工業區北園路17號

NO. 17, PEI-YUAN ROAD, CHUNG-LI IND., PARK, TAOYUAN TAIWAN, R. O. C.



測試項目 (Test Items)	單位 (Unit)	測試方法 (Method)	方法偵測 極限值 (MDL)	結果 (Result)		
				NO. 4	NO. 5	NO. 6
鹵素 (碘) / Halogen-Iodine (I) (CAS No.: 014362-44-8)	mg/kg	參考BS EN 14582:2007, 以離子層析儀分析碘含量. / With reference to BS EN 14582:2007. Analysis was performed by IC method for Iodine content.	50	n.d.	n.d.	n.d.
多溴聯苯總和 / Sum of PBBs	mg/kg	參考IEC 62321: 2008方法, 以氣相層析儀/質譜儀檢測. / With reference to IEC 62321: 2008 and performed by GC/MS.	-	n.d.	n.d.	n.d.
一溴聯苯 / Monobromobiphenyl			5	n.d.	n.d.	n.d.
二溴聯苯 / Dibromobiphenyl			5	n.d.	n.d.	n.d.
三溴聯苯 / Tribromobiphenyl			5	n.d.	n.d.	n.d.
四溴聯苯 / Tetrabromobiphenyl			5	n.d.	n.d.	n.d.
五溴聯苯 / Pentabromobiphenyl			5	n.d.	n.d.	n.d.
六溴聯苯 / Hexabromobiphenyl			5	n.d.	n.d.	n.d.
七溴聯苯 / Heptabromobiphenyl			5	n.d.	n.d.	n.d.
八溴聯苯 / Octabromobiphenyl			5	n.d.	n.d.	n.d.
九溴聯苯 / Nonabromobiphenyl			5	n.d.	n.d.	n.d.
十溴聯苯 / Decabromobiphenyl			5	n.d.	n.d.	n.d.
多溴聯苯醚總和 / Sum of PBDEs			-	n.d.	n.d.	n.d.
一溴聯苯醚 / Monobromodiphenyl ether			5	n.d.	n.d.	n.d.
二溴聯苯醚 / Dibromodiphenyl ether			5	n.d.	n.d.	n.d.
三溴聯苯醚 / Tribromodiphenyl ether			5	n.d.	n.d.	n.d.
四溴聯苯醚 / Tetrabromodiphenyl ether			5	n.d.	n.d.	n.d.
五溴聯苯醚 / Pentabromodiphenyl ether			5	n.d.	n.d.	n.d.
六溴聯苯醚 / Hexabromodiphenyl ether			5	n.d.	n.d.	n.d.
七溴聯苯醚 / Heptabromodiphenyl ether			5	n.d.	n.d.	n.d.
八溴聯苯醚 / Octabromodiphenyl ether			5	n.d.	n.d.	n.d.
九溴聯苯醚 / Nonabromodiphenyl ether	5	n.d.	n.d.	n.d.		
十溴聯苯醚 / Decabromodiphenyl ether	5	n.d.	n.d.	n.d.		

Unless otherwise stated the results shown in this test report refer only to the sample(s) tested. This test report cannot be reproduced, except in full, without prior written permission of the Company. 除非另有說明, 此報告結果僅對測試之樣品負責。本報告未經本公司書面許可, 不可部分複製。

This Test Report is issued by the Company under its General Conditions of Service printed overleaf or available on request and accessible at http://www.sgs.com/terms_and_conditions.htm. Attention is drawn to the limitation of liability, indemnification and jurisdiction issues defined therein. Any holder of this Test Report is advised that information contained hereon reflects the Company's findings at the time of its intervention only and within the limits of Client's instructions, if any. The Company's sole responsibility is to its Client and this document does not exonerate parties to a transaction from exercising all their rights and obligations under the transaction documents. Any unauthorized alteration, forgery or falsification of the content or appearance of this document is unlawful and offenders may be prosecuted to the fullest extent of the law.

測試報告

Test Report

號碼(No.) : CE/2009/11501C 日期(Date) : 2009/01/15 頁數(Page) : 8 of 21

萬泰科技股份有限公司

WONDERFUL HI-TECH CO., LTD.

桃園縣中壢市工業區北園路17號

NO. 17, PEI-YUAN ROAD, CHUNG-LI IND., PARK, TAOYUAN TAIWAN, R. O. C.



測試項目 (Test Items)	單位 (Unit)	測試方法 (Method)	方法偵測 極限值 (MDL)	結果(Result)		
				NO.7	NO.8	NO.9
鎘 / Cadmium (Cd)	mg/kg	參考IEC 62321: 2008方法, 用感應耦合電漿原子發射光譜儀檢測. / With reference to IEC 62321: 2008 and performed by ICP-AES.	2	n.d.	n.d.	n.d.
鉛 / Lead (Pb)	mg/kg	參考IEC 62321: 2008方法, 用感應耦合電漿原子發射光譜儀檢測. / With reference to IEC 62321: 2008 and performed by ICP-AES.	2	n.d.	n.d.	n.d.
汞 / Mercury (Hg)	mg/kg	參考IEC 62321: 2008方法, 用感應耦合電漿原子發射光譜儀檢測. / With reference to IEC 62321: 2008 and performed by ICP-AES.	2	n.d.	n.d.	n.d.
六價鉻 / Hexavalent Chromium Cr(VI) by alkaline extraction	mg/kg	參考IEC 62321: 2008方法, 用UV-VIS檢測. / With reference to IEC 62321: 2008 and performed by UV-VIS.	2	n.d.	n.d.	n.d.
磷 / Phosphorus (P)	mg/kg	參考US EPA 3052 方法, 用感應耦合電漿原子發射光譜儀檢測磷含量. / With reference to US EPA Method 3052 for Phosphorus Content. Analysis was performed by ICP-AES.	2	n.d.	---	14
三氧化二銻 / Antimony trioxide (Sb ₂ O ₃)*** (CAS No.: 001309-64-4)	mg/kg	參考US EPA 3050B方法, 用感應耦合電漿原子發射光譜儀檢測銻含量. / With reference to US EPA Method 3050B for Antimony Content. Analysis was performed by ICP-AES.	2	n.d.	n.d.	n.d.

Unless otherwise stated the results shown in this test report refer only to the sample(s) tested. This test report cannot be reproduced, except in full, without prior written permission of the Company. 除非另有說明, 此報告結果僅對測試之樣品負責。本報告未經本公司書面許可, 不可部分複製。

This Test Report is issued by the Company under its General Conditions of Service printed overleaf or available on request and accessible at http://www.sgs.com/terms_and_conditions.htm. Attention is drawn to the limitation of liability, indemnification and jurisdiction issues defined therein. Any holder of this Test Report is advised that information contained hereon reflects the Company's findings at the time of its intervention only and within the limits of Client's instructions, if any. The Company's sole responsibility is to its Client and this document does not exonerate parties to a transaction from exercising all their rights and obligations under the transaction documents. Any unauthorized alteration, forgery or falsification of the content or appearance of this document is unlawful and offenders may be prosecuted to the fullest extent of the law.

測試報告

Test Report

號碼(No.) : CE/2009/11501C 日期(Date) : 2009/01/15 頁數(Page) : 9 of 21

萬泰科技股份有限公司

WONDERFUL HI-TECH CO., LTD.

桃園縣中壢市工業區北園路17號

NO. 17, PEI-YUAN ROAD, CHUNG-LI IND., PARK, TAOYUAN TAIWAN, R. O. C.



測試項目 (Test Items)	單位 (Unit)	測試方法 (Method)	方法偵測 極限值 (MDL)	結果(Result)		
				NO.7	NO.8	NO.9
鹵素(氯) / Halogen-Chlorine (Cl) (CAS No.: 022537-15-1)	mg/kg	參考BS EN 14582:2007, 以離子層析儀分析氯含量. / With reference to BS EN 14582:2007. Analysis was performed by IC method for Chlorine content.	50	n.d.	n.d.	n.d.
鹵素(溴) / Halogen-Bromine (Br) (CAS No.: 010097-32-2)	mg/kg	參考BS EN 14582:2007, 以離子層析儀分析溴含量. / With reference to BS EN 14582:2007. Analysis was performed by IC method for Bromine content.	50	n.d.	n.d.	n.d.
鹵素(碘) / Halogen-Iodine (I) (CAS No.: 014362-44-8)	mg/kg	參考BS EN 14582:2007, 以離子層析儀分析碘含量. / With reference to BS EN 14582:2007. Analysis was performed by IC method for Iodine content.	50	n.d.	n.d.	n.d.
多溴聯苯總和 / Sum of PBBs	mg/kg	參考IEC 62321: 2008方法, 以氣相層析儀/質譜儀檢測. / With reference to IEC 62321: 2008 and performed by GC/MS.	-	n.d.	n.d.	n.d.
一溴聯苯 / Monobromobiphenyl			5	n.d.	n.d.	n.d.
二溴聯苯 / Dibromobiphenyl			5	n.d.	n.d.	n.d.
三溴聯苯 / Tribromobiphenyl			5	n.d.	n.d.	n.d.
四溴聯苯 / Tetrabromobiphenyl			5	n.d.	n.d.	n.d.
五溴聯苯 / Pentabromobiphenyl			5	n.d.	n.d.	n.d.
六溴聯苯 / Hexabromobiphenyl			5	n.d.	n.d.	n.d.
七溴聯苯 / Heptabromobiphenyl			5	n.d.	n.d.	n.d.
八溴聯苯 / Octabromobiphenyl			5	n.d.	n.d.	n.d.
九溴聯苯 / Nonabromobiphenyl			5	n.d.	n.d.	n.d.
十溴聯苯 / Decabromobiphenyl	5	n.d.	n.d.	n.d.		

Unless otherwise stated the results shown in this test report refer only to the sample(s) tested. This test report cannot be reproduced, except in full, without prior written permission of the Company.

除非另有說明, 此報告結果僅對測試之樣品負責。本報告未經本公司書面許可, 不可部分複製。

This Test Report is issued by the Company under its General Conditions of Service printed overleaf or available on request and accessible at http://www.sgs.com/terms_and_conditions.htm. Attention is drawn to the limitation of liability, indemnification and jurisdiction issues defined therein. Any holder of this Test Report is advised that information contained hereon reflects the Company's findings at the time of its intervention only and within the limits of Client's instructions, if any. The Company's sole responsibility is to its Client and this document does not exonerate parties to a transaction from exercising all their rights and obligations under the transaction documents. Any unauthorized alteration, forgery or falsification of the content or appearance of this document is unlawful and offenders may be prosecuted to the fullest extent of the law.

測試報告 Test Report

號碼(No.) : CE/2009/11501C 日期(Date) : 2009/01/15 頁數(Page) : 10 of 21

萬泰科技股份有限公司

WONDERFUL HI-TECH CO., LTD.

桃園縣中壢市工業區北園路17號

NO. 17, PEI-YUAN ROAD, CHUNG-LI IND., PARK, TAOYUAN TAIWAN, R. O. C.



測試項目 (Test Items)	單位 (Unit)	測試方法 (Method)	方法偵測 極限值 (MDL)	結果(Result)		
				NO.7	NO.8	NO.9
多溴聯苯醚總和 / Sum of PBDEs	mg/kg	參考IEC 62321: 2008方法, 以 氣相層析儀/質譜儀檢測. / With reference to IEC 62321: 2008 and performed by GC/MS.	-	n.d.	n.d.	n.d.
一溴聯苯醚 / Monobromodiphenyl ether			5	n.d.	n.d.	n.d.
二溴聯苯醚 / Dibromodiphenyl ether			5	n.d.	n.d.	n.d.
三溴聯苯醚 / Tribromodiphenyl ether			5	n.d.	n.d.	n.d.
四溴聯苯醚 / Tetrabromodiphenyl ether			5	n.d.	n.d.	n.d.
五溴聯苯醚 / Pentabromodiphenyl ether			5	n.d.	n.d.	n.d.
六溴聯苯醚 / Hexabromodiphenyl ether			5	n.d.	n.d.	n.d.
七溴聯苯醚 / Heptabromodiphenyl ether			5	n.d.	n.d.	n.d.
八溴聯苯醚 / Octabromodiphenyl ether			5	n.d.	n.d.	n.d.
九溴聯苯醚 / Nonabromodiphenyl ether			5	n.d.	n.d.	n.d.
十溴聯苯醚 / Decabromodiphenyl ether			5	n.d.	n.d.	n.d.

測試項目 (Test Items)	單位 (Unit)	測試方法 (Method)	方法偵測 極限值 (MDL)	結果 (Result)
				NO.10
鎘 / Cadmium (Cd)	mg/kg	參考IEC 62321: 2008方法, 用 感應耦合電漿原子發射光譜儀檢 測. / With reference to IEC 62321: 2008 and performed by ICP-AES.	2	n.d.
鉛 / Lead (Pb)	mg/kg	參考IEC 62321: 2008方法, 用 感應耦合電漿原子發射光譜儀檢 測. / With reference to IEC 62321: 2008 and performed by ICP-AES.	2	n.d.
汞 / Mercury (Hg)	mg/kg	參考IEC 62321: 2008方法, 用 感應耦合電漿原子發射光譜儀檢 測. / With reference to IEC 62321: 2008 and performed by ICP-AES.	2	n.d.

Unless otherwise stated the results shown in this test report refer only to the sample(s) tested. This test report cannot be reproduced, except in full, without prior written permission of the Company. 除非另有說明, 此報告結果僅對測試之樣品負責。本報告未經本公司書面許可, 不可部分複製。

This Test Report is issued by the Company under its General Conditions of Service printed overleaf or available on request and accessible at http://www.sgs.com/terms_and_conditions.htm. Attention is drawn to the limitation of liability, indemnification and jurisdiction issues defined therein. Any holder of this Test Report is advised that information contained hereon reflects the Company's findings at the time of its intervention only and within the limits of Client's instructions, if any. The Company's sole responsibility is to its Client and this document does not exonerate parties to a transaction from exercising all their rights and obligations under the transaction documents. Any unauthorized alteration, forgery or falsification of the content or appearance of this document is unlawful and offenders may be prosecuted to the fullest extent of the law.

測試報告

Test Report

號碼(No.) : CE/2009/11501C 日期(Date) : 2009/01/15 頁數(Page) : 11 of 21

萬泰科技股份有限公司

WONDERFUL HI-TECH CO., LTD.

桃園縣中壢市工業區北園路17號

NO. 17, PEI-YUAN ROAD, CHUNG-LI IND., PARK, TAOYUAN TAIWAN, R. O. C.



測試項目 (Test Items)	單位 (Unit)	測試方法 (Method)	方法偵測 極限值 (MDL)	結果 (Result)
				NO.10
六價鉻 / Hexavalent Chromium Cr(VI) by alkaline extraction	mg/kg	參考IEC 62321: 2008方法, 用 UV-VIS檢測. / With reference to IEC 62321: 2008 and performed by UV-VIS.	2	n.d.
磷 / Phosphorus (P)	mg/kg	參考US EPA 3052 方法, 用感應 耦合電漿原子發射光譜儀檢測磷 含量. / With reference to US EPA Method 3052 for Phosphorus Content. Analysis was performed by ICP-AES.	2	12
三氧化二銻 / Antimony trioxide (Sb ₂ O ₃)*** (CAS No.: 001309-64-4)	mg/kg	參考US EPA 3050B方法, 用感應 耦合電漿原子發射光譜儀檢測銻 含量. / With reference to US EPA Method 3050B for Antimony Content. Analysis was performed by ICP-AES.	2	n.d.
鹵素 (氯) / Halogen-Chlorine (Cl) (CAS No.: 022537-15-1)	mg/kg	參考BS EN 14582:2007, 以離子 層析儀分析氯含量. / With reference to BS EN 14582:2007. Analysis was performed by IC method for Chlorine content.	50	n.d.
鹵素 (溴) / Halogen-Bromine (Br) (CAS No.: 010097-32-2)	mg/kg	參考BS EN 14582:2007, 以離子 層析儀分析溴含量. / With reference to BS EN 14582:2007. Analysis was performed by IC method for Bromine content.	50	n.d.

Unless otherwise stated the results shown in this test report refer only to the sample(s) tested. This test report cannot be reproduced, except in full, without prior written permission of the Company.
除非另有說明, 此報告結果僅對測試之樣品負責。本報告未經本公司書面許可, 不可部分複製。

This Test Report is issued by the Company under its General Conditions of Service printed overleaf or available on request and accessible at http://www.sgs.com/terms_and_conditions.htm. Attention is drawn to the limitation of liability, indemnification and jurisdiction issues defined therein. Any holder of this Test Report is advised that information contained hereon reflects the Company's findings at the time of its intervention only and within the limits of Client's instructions, if any. The Company's sole responsibility is to its Client and this document does not exonerate parties to a transaction from exercising all their rights and obligations under the transaction documents. Any unauthorized alteration, forgery or falsification of the content or appearance of this document is unlawful and offenders may be prosecuted to the fullest extent of the law.

測試報告 Test Report

號碼(No.) : CE/2009/11501C 日期(Date) : 2009/01/15 頁數(Page) : 12 of 21

萬泰科技股份有限公司

WONDERFUL HI-TECH CO., LTD.

桃園縣中壢市工業區北園路17號

NO. 17, PEI-YUAN ROAD, CHUNG-LI IND., PARK, TAOYUAN TAIWAN, R. O. C.



測試項目 (Test Items)	單位 (Unit)	測試方法 (Method)	方法偵測 極限值 (MDL)	結果 (Result)
				NO.10
鹵素(碘) / Halogen-Iodine (I) (CAS No.: 014362-44-8)	mg/kg	參考BS EN 14582:2007, 以離子層析儀分析碘含量. / With reference to BS EN 14582:2007. Analysis was performed by IC method for Iodine content.	50	n.d.
多溴聯苯總和 / Sum of PBBs	mg/kg	參考IEC 62321: 2008方法, 以氣相層析儀/質譜儀檢測. / With reference to IEC 62321: 2008 and performed by GC/MS.	-	n.d.
一溴聯苯 / Monobromobiphenyl			5	n.d.
二溴聯苯 / Dibromobiphenyl			5	n.d.
三溴聯苯 / Tribromobiphenyl			5	n.d.
四溴聯苯 / Tetrabromobiphenyl			5	n.d.
五溴聯苯 / Pentabromobiphenyl			5	n.d.
六溴聯苯 / Hexabromobiphenyl			5	n.d.
七溴聯苯 / Heptabromobiphenyl			5	n.d.
八溴聯苯 / Octabromobiphenyl			5	n.d.
九溴聯苯 / Nonabromobiphenyl			5	n.d.
十溴聯苯 / Decabromobiphenyl			5	n.d.
多溴聯苯醚總和 / Sum of PBDEs			-	n.d.
一溴聯苯醚 / Monobromodiphenyl ether			5	n.d.
二溴聯苯醚 / Dibromodiphenyl ether			5	n.d.
三溴聯苯醚 / Tribromodiphenyl ether			5	n.d.
四溴聯苯醚 / Tetrabromodiphenyl ether			5	n.d.
五溴聯苯醚 / Pentabromodiphenyl ether			5	n.d.
六溴聯苯醚 / Hexabromodiphenyl ether			5	n.d.
七溴聯苯醚 / Heptabromodiphenyl ether			5	n.d.
八溴聯苯醚 / Octabromodiphenyl ether			5	n.d.
九溴聯苯醚 / Nonabromodiphenyl ether	5	n.d.		
十溴聯苯醚 / Decabromodiphenyl ether	5	n.d.		

Unless otherwise stated the results shown in this test report refer only to the sample(s) tested. This test report cannot be reproduced, except in full, without prior written permission of the Company. 除非另有說明, 此報告結果僅對測試之樣品負責。本報告未經本公司書面許可, 不可部分複製。

This Test Report is issued by the Company under its General Conditions of Service printed overleaf or available on request and accessible at http://www.sgs.com/terms_and_conditions.htm. Attention is drawn to the limitation of liability, indemnification and jurisdiction issues defined therein. Any holder of this Test Report is advised that information contained herein reflects the Company's findings at the time of its intervention only and within the limits of Client's instructions, if any. The Company's sole responsibility is to its Client and this document does not exonerate parties to a transaction from exercising all their rights and obligations under the transaction documents. Any unauthorized alteration, forgery or falsification of the content or appearance of this document is unlawful and offenders may be prosecuted to the fullest extent of the law.

測試報告

Test Report

號碼(No.) : CE/2009/11501C 日期(Date) : 2009/01/15 頁數(Page) : 13 of 21

萬泰科技股份有限公司

WONDERFUL HI-TECH CO., LTD.

桃園縣中壢市工業區北園路17號

NO. 17, PEI-YUAN ROAD, CHUNG-LI IND., PARK, TAOYUAN TAIWAN, R. O. C.



備註(Note) :

1. mg/kg = ppm ; 0.1wt% = 1000ppm
2. n.d. = Not Detected (未檢出)
3. MDL = Method Detection Limit (方法偵測極限值)
4. "-" = Not Regulated (無規格值)
5. ***: 該物質是由"三丁基錫", "三苯基錫"或各別元素(例如: 銻、鉍、矽、鋅、鈷或磷)之測試結果計算得知. 其MDL是針對"三丁基錫", "三苯基錫"或元素(例如: 銻、鉍、矽、鋅、鈷或磷)之評估.
(The substance is calculated by the test results of Tributyl Tin, Triphenyl Tin or element (Ex. Antimony、Beryllium、Silicon、Zinc、Cobalt or Phosphorus respectively).
The MDL is evaluated for Tributyl Tin, Triphenyl Tin or element (Ex. Antimony、Beryllium、Silicon、Zinc、Cobalt or Phosphorus respectively.))

PFOS參考資訊(Reference Information) : 指令 2006/122/EC (Directive 2006/122/EC)

- (1) 該物質不可置於市場上或使用於特殊物質或配置成分重量濃度等於或大於0.005%。
(May not be placed on the market or used as a substance or constituent of preparations in a concentration equal to or higher than 0.005 % by mass.)
- (2) 該物質不可置於市場上的半成品或商品或其物件；假若零件上明顯地具有PFOS並參照結構上及微細構造上計算PFOS重量濃度等於或大於0.1%，而紡織品或其他覆蓋物質，如果PFOS在覆蓋物質中含量等於或大於 $1\mu\text{g}/\text{m}^2$ 。
(May not be placed on the market in semi-finished products or articles, or parts thereof, if the concentration of PFOS is equal to or higher than 0.1 % by mass calculated with reference to the mass of structurally or microstructurally distinct parts that contain PFOS or, for textiles or other coated materials, if the amount of PFOS is equal to or higher than $1\mu\text{g}/\text{m}^2$ of the coated material.)

Unless otherwise stated the results shown in this test report refer only to the sample(s) tested. This test report cannot be reproduced, except in full, without prior written permission of the Company. 除非另有說明，此報告結果僅對測試之樣品負責。本報告未經本公司書面許可，不可部分複製。

This Test Report is issued by the Company under its General Conditions of Service printed overleaf or available on request and accessible at http://www.sgs.com/terms_and_conditions.htm. Attention is drawn to the limitation of liability, indemnification and jurisdiction issues defined therein. Any holder of this Test Report is advised that information contained hereon reflects the Company's findings at the time of its intervention only and within the limits of Client's instructions, if any. The Company's sole responsibility is to its Client and this document does not exonerate parties to a transaction from exercising all their rights and obligations under the transaction documents. Any unauthorized alteration, forgery or falsification of the content or appearance of this document is unlawful and offenders may be prosecuted to the fullest extent of the law.

測試報告 Test Report

號碼(No.) : CE/2009/11501C 日期(Date) : 2009/01/15 頁數(Page) : 14 of 21

萬泰科技股份有限公司

WONDERFUL HI-TECH CO., LTD.

桃園縣中壢市工業區北園路17號

NO. 17, PEI-YUAN ROAD, CHUNG-LI IND., PARK, TAOYUAN TAIWAN, R. O. C.



- 1) 根據以下的流程圖之條件，樣品已完全溶解。(六價鉻測試方法除外) / These samples were dissolved totally by pre-conditioning method according to below flow chart. (Cr⁶⁺ test method excluded)
- 2) 測試人員：楊登偉 / Name of the person who made measurement: Climbgreat Yang
- 3) 測試負責人：張啓興 / Name of the person in charge of measurement: Troy Chang

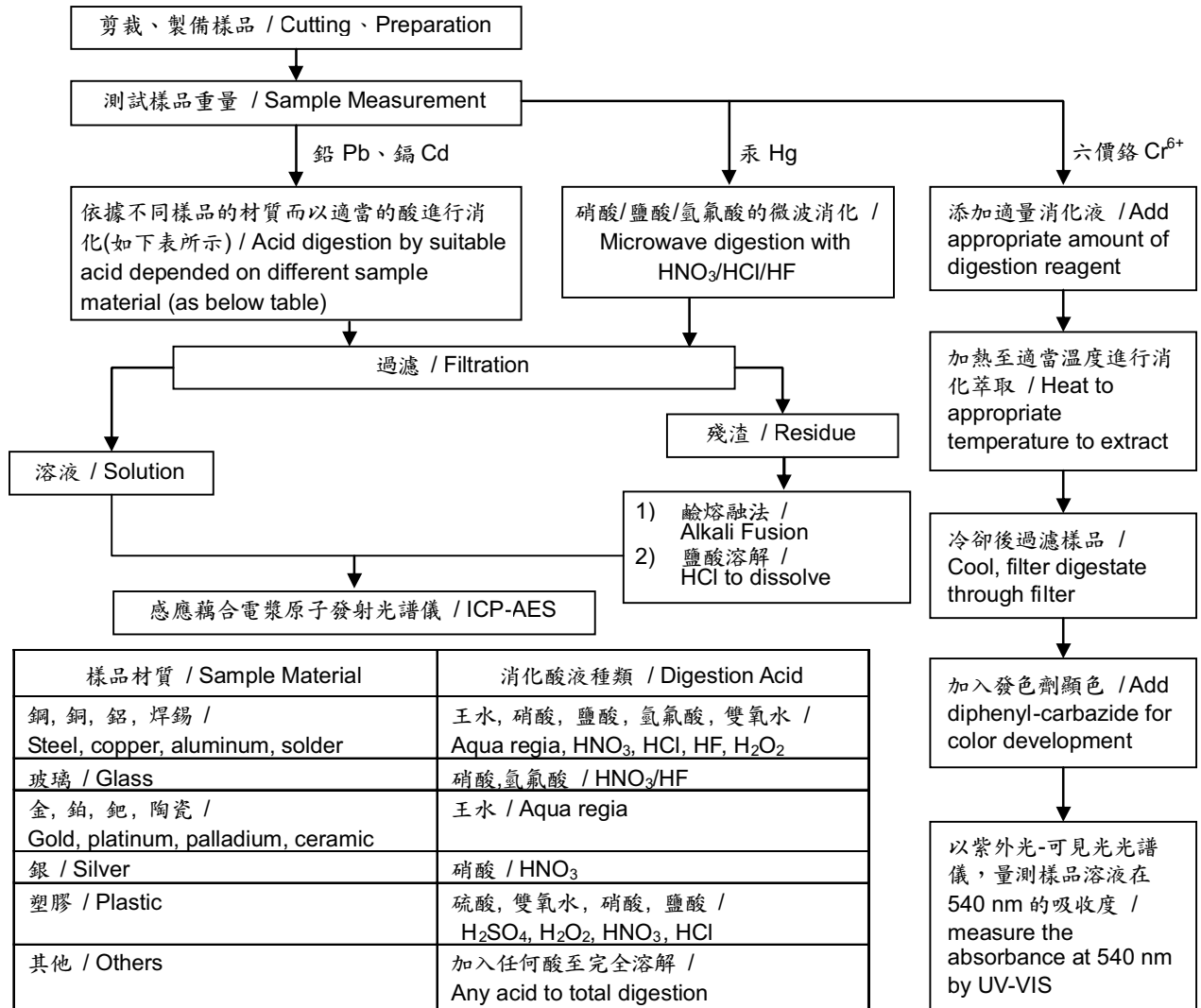

Unless otherwise stated the results shown in this test report refer only to the sample(s) tested. This test report cannot be reproduced, except in full, without prior written permission of the Company. 除非另有說明，此報告結果僅對測試之樣品負責。本報告未經本公司書面許可，不可部分複製。

This Test Report is issued by the Company under its General Conditions of Service printed overleaf or available on request and accessible at http://www.sgs.com/terms_and_conditions.htm. Attention is drawn to the limitation of liability, indemnification and jurisdiction issues defined therein. Any holder of this Test Report is advised that information contained hereon reflects the Company's findings at the time of its intervention only and within the limits of Client's instructions, if any. The Company's sole responsibility is to its Client and this document does not exonerate parties to a transaction from exercising all their rights and obligations under the transaction documents. Any unauthorized alteration, forgery or falsification of the content or appearance of this document is unlawful and offenders may be prosecuted to the fullest extent of the law.

測試報告 Test Report

號碼(No.) : CE/2009/11501C 日期(Date) : 2009/01/15 頁數(Page) : 15 of 21

萬泰科技股份有限公司

WONDERFUL HI-TECH CO., LTD.

桃園縣中壢市工業區北園路17號

NO. 17, PEI-YUAN ROAD, CHUNG-LI IND., PARK, TAOYUAN TAIWAN, R. O. C.



- 1) 根據以下的流程圖之條件，樣品已完全溶解。 / These samples were dissolved totally by pre-conditioning method according to below flow chart.
- 2) 測試人員：楊登偉 / Name of the person who made measurement: Climbgreat Yang
- 3) 測試負責人：張啓興 / Name of the person in charge of measurement: Troy Chang

元素的消化流程圖 (Flow Chart of Digestion for elements analysis)

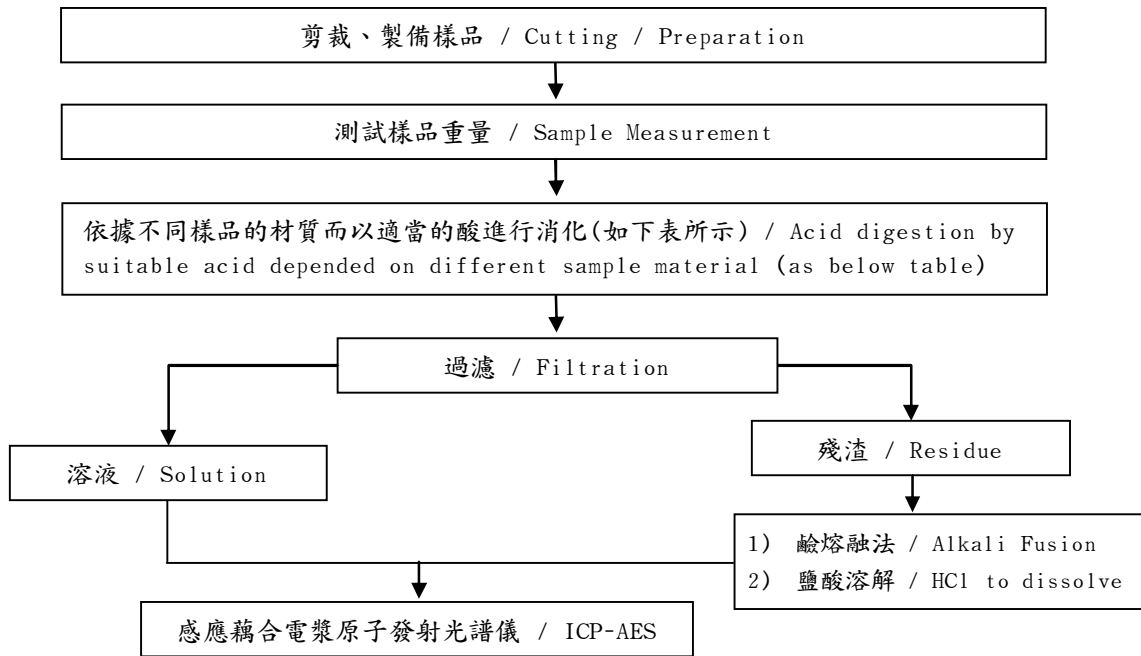

鋼, 銅, 鋁, 焊錫 / Steel, copper, aluminum, solder	王水, 硝酸, 鹽酸, 氫氟酸, 雙氧水 / Aqua regia, HNO ₃ , HCl, HF, H ₂ O ₂
玻璃 / Glass	硝酸, 氫氟酸 / HNO ₃ /HF
金, 鉑, 鈀, 陶瓷 / Gold, platinum, palladium, ceramic	王水 / Aqua regia
銀 / Silver	硝酸 / HNO ₃
塑膠 / Plastic	硫酸, 雙氧水, 硝酸, 鹽酸 / H ₂ SO ₄ , H ₂ O ₂ , HNO ₃ , HCl
其他 / Others	加入任何酸至完全溶解 / Any acid to total digestion

Unless otherwise stated the results shown in this test report refer only to the sample(s) tested. This test report cannot be reproduced, except in full, without prior written permission of the Company. 除非另有說明，此報告結果僅對測試之樣品負責。本報告未經本公司書面許可，不可部分複製。

This Test Report is issued by the Company under its General Conditions of Service printed overleaf or available on request and accessible at http://www.sgs.com/terms_and_conditions.htm. Attention is drawn to the limitation of liability, indemnification and jurisdiction issues defined therein. Any holder of this Test Report is advised that information contained hereon reflects the Company's findings at the time of its intervention only and within the limits of Client's instructions, if any. The Company's sole responsibility is to its Client and this document does not exonerate parties to a transaction from exercising all their rights and obligations under the transaction documents. Any unauthorized alteration, forgery or falsification of the content or appearance of this document is unlawful and offenders may be prosecuted to the fullest extent of the law.

測試報告 Test Report

號碼(No.) : CE/2009/11501C 日期(Date) : 2009/01/15 頁數(Page) : 16 of 21

萬泰科技股份有限公司

WONDERFUL HI-TECH CO., LTD.

桃園縣中壢市工業區北園路17號

NO. 17, PEI-YUAN ROAD, CHUNG-LI IND., PARK, TAOYUAN TAIWAN, R. O. C.



多溴聯苯/多溴聯苯醚分析流程圖 / PBB/PBDE analytical FLOW CHART

- 1) 測試人員：翁賜彬 / Name of the person who made measurement: Roman Wong
- 2) 測試負責人：陳新智 / Name of the person in charge of measurement: Shinjyh Chen

初次測試程序 / First testing process ———→

選擇性篩檢程序 / Optional screen process→

確認程序 / Confirmation process - - - ->

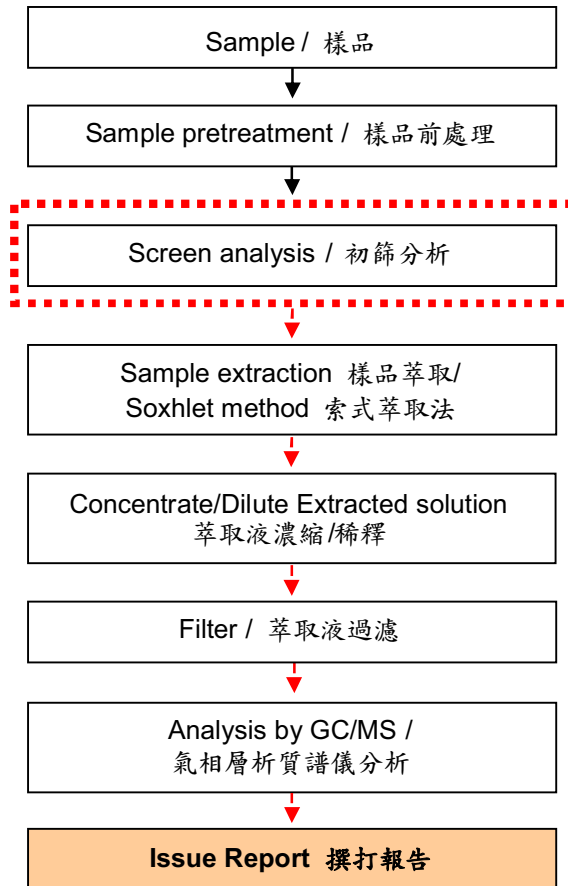

Unless otherwise stated the results shown in this test report refer only to the sample(s) tested. This test report cannot be reproduced, except in full, without prior written permission of the Company. 除非另有說明，此報告結果僅對測試之樣品負責。本報告未經本公司書面許可，不可部分複製。

This Test Report is issued by the Company under its General Conditions of Service printed overleaf or available on request and accessible at http://www.sgs.com/terms_and_conditions.htm. Attention is drawn to the limitation of liability, indemnification and jurisdiction issues defined therein. Any holder of this Test Report is advised that information contained hereon reflects the Company's findings at the time of its intervention only and within the limits of Client's instructions, if any. The Company's sole responsibility is to its Client and this document does not exonerate parties to a transaction from exercising all their rights and obligations under the transaction documents. Any unauthorized alteration, forgery or falsification of the content or appearance of this document is unlawful and offenders may be prosecuted to the fullest extent of the law.

測試報告 Test Report

號碼(No.) : CE/2009/11501C 日期(Date) : 2009/01/15 頁數(Page) : 17 of 21

萬泰科技股份有限公司

WONDERFUL HI-TECH CO., LTD.

桃園縣中壢市工業區北園路17號

NO. 17, PEI-YUAN ROAD, CHUNG-LI IND., PARK, TAOYUAN TAIWAN, R. O. C.



鹵素分析流程圖 / Analytical flow chart of halogen content

- 1) 測試人員：陳立倫 / Name of the person who made measurement: Alan Chen
- 2) 測試負責人：張啓興 / Name of the person in charge of measurement: Troy Chang

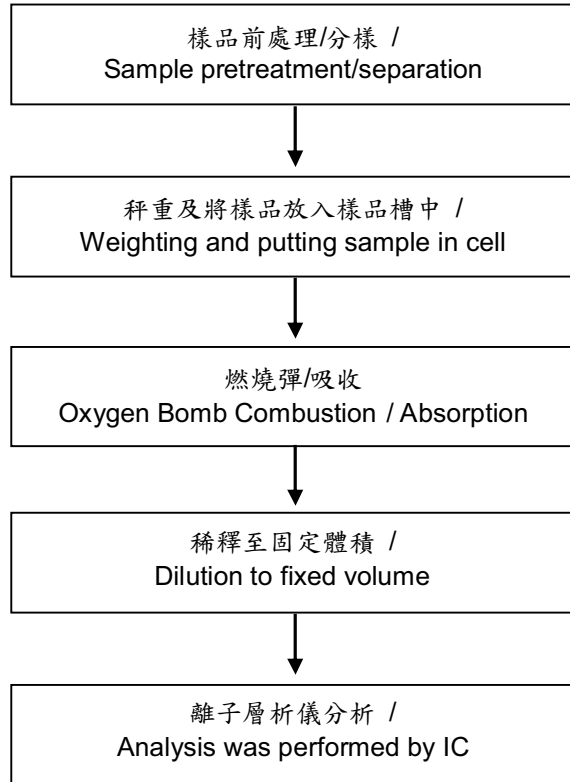

Unless otherwise stated the results shown in this test report refer only to the sample(s) tested. This test report cannot be reproduced, except in full, without prior written permission of the Company. 除非另有說明，此報告結果僅對測試之樣品負責。本報告未經本公司書面許可，不可部分複製。

This Test Report is issued by the Company under its General Conditions of Service printed overleaf or available on request and accessible at http://www.sgs.com/terms_and_conditions.htm. Attention is drawn to the limitation of liability, indemnification and jurisdiction issues defined therein. Any holder of this Test Report is advised that information contained hereon reflects the Company's findings at the time of its intervention only and within the limits of Client's instructions, if any. The Company's sole responsibility is to its Client and this document does not exonerate parties to a transaction from exercising all their rights and obligations under the transaction documents. Any unauthorized alteration, forgery or falsification of the content or appearance of this document is unlawful and offenders may be prosecuted to the fullest extent of the law.

測試報告 Test Report

號碼(No.) : CE/2009/11501C 日期(Date) : 2009/01/15 頁數(Page) : 18 of 21

萬泰科技股份有限公司

WONDERFUL HI-TECH CO., LTD.

桃園縣中壢市工業區北園路17號

NO. 17, PEI-YUAN ROAD, CHUNG-LI IND., PARK, TAOYUAN TAIWAN, R. O. C.



全氟辛酸(銨)/全氟辛烷磺酸分析流程圖 / Analytical flow chart of PFOA/PFOS content

- 1) 測試人員：劉家瑗 / Name of the person who made measurement: Carrie Liu
- 2) 測試負責人：陳新智 / Name of the person in charge of measurement: Shinjyh Chen

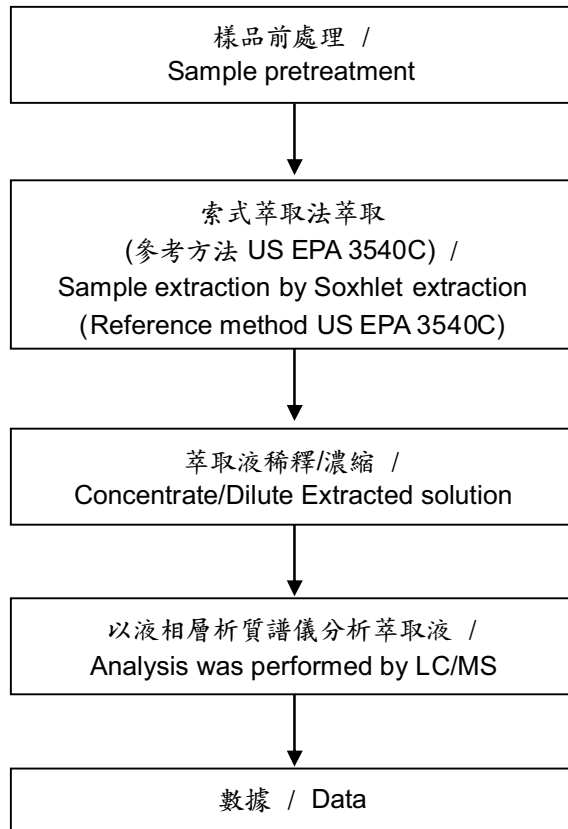

Unless otherwise stated the results shown in this test report refer only to the sample(s) tested. This test report cannot be reproduced, except in full, without prior written permission of the Company. 除非另有說明，此報告結果僅對測試之樣品負責。本報告未經本公司書面許可，不可部分複製。

This Test Report is issued by the Company under its General Conditions of Service printed overleaf or available on request and accessible at http://www.sgs.com/terms_and_conditions.htm. Attention is drawn to the limitation of liability, indemnification and jurisdiction issues defined therein. Any holder of this Test Report is advised that information contained hereon reflects the Company's findings at the time of its intervention only and within the limits of Client's instructions, if any. The Company's sole responsibility is to its Client and this document does not exonerate parties to a transaction from exercising all their rights and obligations under the transaction documents. Any unauthorized alteration, forgery or falsification of the content or appearance of this document is unlawful and offenders may be prosecuted to the fullest extent of the law.

測試報告 Test Report

號碼(No.) : CE/2009/11501C 日期(Date) : 2009/01/15 頁數(Page) : 19 of 21

萬泰科技股份有限公司

WONDERFUL HI-TECH CO., LTD.

桃園縣中壢市工業區北園路17號

NO. 17, PEI-YUAN ROAD, CHUNG-LI IND., PARK, TAOYUAN TAIWAN, R. O. C.

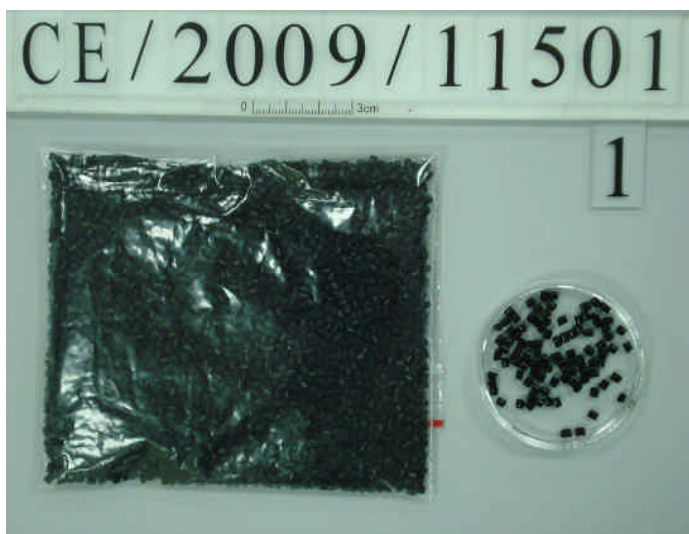

Unless otherwise stated the results shown in this test report refer only to the sample(s) tested. This test report cannot be reproduced, except in full, without prior written permission of the Company. 除非另有說明，此報告結果僅對測試之樣品負責。本報告未經本公司書面許可，不可部分複製。

This Test Report is issued by the Company under its General Conditions of Service printed overleaf or available on request and accessible at http://www.sgs.com/terms_and_conditions.htm. Attention is drawn to the limitation of liability, indemnification and jurisdiction issues defined therein. Any holder of this Test Report is advised that information contained hereon reflects the Company's findings at the time of its intervention only and within the limits of Client's instructions, if any. The Company's sole responsibility is to its Client and this document does not exonerate parties to a transaction from exercising all their rights and obligations under the transaction documents. Any unauthorized alteration, forgery or falsification of the content or appearance of this document is unlawful and offenders may be prosecuted to the fullest extent of the law.

測試報告

Test Report

號碼(No.) : CE/2009/11501C 日期(Date) : 2009/01/15 頁數(Page) : 20 of 21

萬泰科技股份有限公司

WONDERFUL HI-TECH CO., LTD.

桃園縣中壢市工業區北園路17號

NO. 17, PEI-YUAN ROAD, CHUNG-LI IND., PARK, TAOYUAN TAIWAN, R. O. C.



Unless otherwise stated the results shown in this test report refer only to the sample(s) tested. This test report cannot be reproduced, except in full, without prior written permission of the Company. 除非另有說明，此報告結果僅對測試之樣品負責。本報告未經本公司書面許可，不可部分複製。

This Test Report is issued by the Company under its General Conditions of Service printed overleaf or available on request and accessible at http://www.sgs.com/terms_and_conditions.htm. Attention is drawn to the limitation of liability, indemnification and jurisdiction issues defined therein. Any holder of this Test Report is advised that information contained hereon reflects the Company's findings at the time of its intervention only and within the limits of Client's instructions, if any. The Company's sole responsibility is to its Client and this document does not exonerate parties to a transaction from exercising all their rights and obligations under the transaction documents. Any unauthorized alteration, forgery or falsification of the content or appearance of this document is unlawful and offenders may be prosecuted to the fullest extent of the law.

測試報告 Test Report

號碼(No.) : CE/2009/11501C 日期(Date) : 2009/01/15 頁數(Page) : 21 of 21

萬泰科技股份有限公司

WONDERFUL HI-TECH CO., LTD.

桃園縣中壢市工業區北園路17號

NO. 17, PEI-YUAN ROAD, CHUNG-LI IND., PARK, TAOYUAN TAIWAN, R. O. C.



** 報告結尾(End of Report) **

Unless otherwise stated the results shown in this test report refer only to the sample(s) tested. This test report cannot be reproduced, except in full, without prior written permission of the Company. 除非另有說明，此報告結果僅對測試之樣品負責。本報告未經本公司書面許可，不可部分複製。

This Test Report is issued by the Company under its General Conditions of Service printed overleaf or available on request and accessible at http://www.sgs.com/terms_and_conditions.htm. Attention is drawn to the limitation of liability, indemnification and jurisdiction issues defined therein. Any holder of this Test Report is advised that information contained hereon reflects the Company's findings at the time of its intervention only and within the limits of Client's instructions, if any. The Company's sole responsibility is to its Client and this document does not exonerate parties to a transaction from exercising all their rights and obligations under the transaction documents. Any unauthorized alteration, forgery or falsification of the content or appearance of this document is unlawful and offenders may be prosecuted to the fullest extent of the law.

測試報告 Test Report

號碼(No.): CE/2008/C4566

日期(Date): 2008/12/24

頁數(Page): 1 of 4

有春電線股份有限公司

YEOU CHUEN WIRE CO., LTD.

桃園縣平鎮市中豐路南勢二段460巷112號

112, LANE 460, NAN HSEN 2ND SECTION, CHUNG FENG RD., PING CHEN CITY,

TAOYUAN HSIEN TAIWAN REPUBLIC OF CHINA



以下測試樣品係由客戶送樣，且由客戶聲稱並經客戶確認如下 (The following samples was/were submitted and identified by/on behalf of the client as):

樣品名稱(Sample Description) : 鍍銀銅包鋼線 (SILVER-PLATED COPPER CLAD STEEL WIRE)

收件日期(Sample Receiving Date) : 2008/12/17

測試期間(Testing Period) : 2008/12/17 TO 2008/12/24

=====
測試需求(Test Requested) : 參照 RoHS 2002/95/EC 及其修定指令要求. (In accordance with the RoHS Directive 2002/95/EC, and its amendment directives).

測試方法(Test Method) : 參考 IEC 62321/2nd CDV (111/95/CDV) 方法檢測. (With reference to IEC 62321/2nd CDV (111/95/CDV). Procedures for the Determination of Levels of Regulated Substances in Electrotechnical Products).

(1) 用感應耦合電漿原子發射光譜儀檢測鎘含量. / Determination of Cadmium by ICP-AES.

(2) 用感應耦合電漿原子發射光譜儀檢測鉛含量. / Determination of Lead by ICP-AES.

(3) 用感應耦合電漿原子發射光譜儀檢測汞含量. / Determination of Mercury by ICP-AES.

(4) 針對金屬材質之樣品，用 Spot test / boiling water extraction 方法檢測六價鉻含量. / Determination of Hexavalent Chromium for metallic samples by Spot test / boiling water extraction Method.

測試結果(Test Results) : 請見下一頁 (Please refer to next pages).

Nicole Chien / Supervisor

Signed for and on behalf of

SGS TAIWAN LTD.

Chemical Laboratory - Taipei

Unless otherwise stated the results shown in this test report refer only to the sample(s) tested. This test report cannot be reproduced, except in full, without prior written permission of the Company. 除非另有說明，此報告結果僅對測試之樣品負責。本報告未經本公司書面許可，不可部分複製。

This Test Report is issued by the Company under its General Conditions of Service printed overleaf or available on request and accessible at http://www.sgs.com/terms_and_conditions.htm. Attention is drawn to the limitation of liability, indemnification and jurisdiction issues defined therein. Any holder of this Test Report is advised that information contained hereon reflects the Company's findings at the time of its intervention only and within the limits of Client's instructions, if any. The Company's sole responsibility is to its Client and this document does not exonerate parties to a transaction from exercising all their rights and obligations under the transaction documents. Any unauthorized alteration, forgery or falsification of the content or appearance of this document is unlawful and offenders may be prosecuted to the fullest extent of the law.

測試報告

Test Report

號碼(No.): CE/2008/C4566

日期(Date): 2008/12/24

頁數(Page): 2 of 4

有春電線股份有限公司

YEOU CHUEN WIRE CO., LTD.

桃園縣平鎮市中豐路南勢二段460巷112號

112, LANE 460, NAN HSEN 2ND SECTION, CHUNG FENG RD., PING CHEN CITY,

TAOYUAN HSIEN TAIWAN REPUBLIC OF CHINA



測試結果(Test Results) 單位(Unit): mg/kg

測試項目 (Test Items)	測試方法 Method (Refer to)	結果 (Result)	方法偵測 極限值 (MDL)
		No.1	
鎘 / Cadmium (Cd)	(1)	n.d.	2
鉛 / Lead (Pb)	(2)	n.d.	2
汞 / Mercury (Hg)	(3)	n.d.	2
六價鉻 / Hexavalent Chromium Cr(VI) by Spot test / boiling water extraction	(4)	Negative	See Note 4

測試部位描述 (TEST PART DESCRIPTION):

NO.1 : 銀色金屬線 (SILVER COLORED METAL WIRE)

備註(Note):

1. mg/kg = ppm; 0.1wt% = 1000ppm
2. n.d. = Not Detected (未檢出)
3. MDL = Method Detection Limit (方法偵測極限值)
4. Spot-test:

Negative = Absence of Cr(VI) coating / surface layer(鍍層中偵測不到六價鉻),
Positive = Presence of Cr(VI) coating / surface layer(鍍層中偵測到六價鉻);
The tested sample should be further verified by boiling-water-extraction method if the
spot test result cannot be confirmed.

(當該測項無法確認時, 測試樣品可藉由boiling-water-extraction測試方法進一步確認)

Boiling-water-extraction:

Negative = Absence of Cr(VI) coating / surface layer(鍍層中偵測不到六價鉻),
Positive = Presence of Cr(VI) coating / surface layer(鍍層中偵測到六價鉻);
the detected concentration in boiling-water-extraction solution is equal or
greater than 0.02 mg/kg with 50 cm² sample surface area.
該溶液濃度 \geq 0.02 mg/kg with 50 cm² (sample surface area)

Unless otherwise stated the results shown in this test report refer only to the sample(s) tested. This test report cannot be reproduced, except in full, without prior written permission of the Company.
除非另有說明, 此報告結果僅對測試之樣品負責。本報告未經本公司書面許可, 不可部分複製。

This Test Report is issued by the Company under its General Conditions of Service printed overleaf or available on request and accessible at http://www.sgs.com/terms_and_conditions.htm. Attention is drawn to the limitation of liability, indemnification and jurisdiction issues defined therein. Any holder of this Test Report is advised that information contained hereon reflects the Company's findings at the time of its intervention only and within the limits of Client's instructions, if any. The Company's sole responsibility is to its Client and this document does not exonerate parties to a transaction from exercising all their rights and obligations under the transaction documents. Any unauthorized alteration, forgery or falsification of the content or appearance of this document is unlawful and offenders may be prosecuted to the fullest extent of the law.

測試報告 Test Report

號碼(No.): CE/2008/C4566

日期(Date): 2008/12/24

頁數(Page): 3 of 4

有春電線股份有限公司

YEOU CHUEN WIRE CO., LTD.

桃園縣平鎮市中豐路南勢二段460巷112號

112, LANE 460, NAN HSEN 2ND SECTION, CHUNG FENG RD., PING CHEN CITY,

TAOYUAN HSIEN TAIWAN REPUBLIC OF CHINA



- 1) 根據以下的流程圖之條件，樣品已完全溶解。(六價鉻測試方法除外) / These samples were dissolved totally by pre-conditioning method according to below flow chart. (Cr⁶⁺ test method excluded)
- 2) 測試人員：楊登偉 / Name of the person who made measurement: Climbgreat Yang
- 3) 測試負責人：張啓興 / Name of the person in charge of measurement: Troy Chang

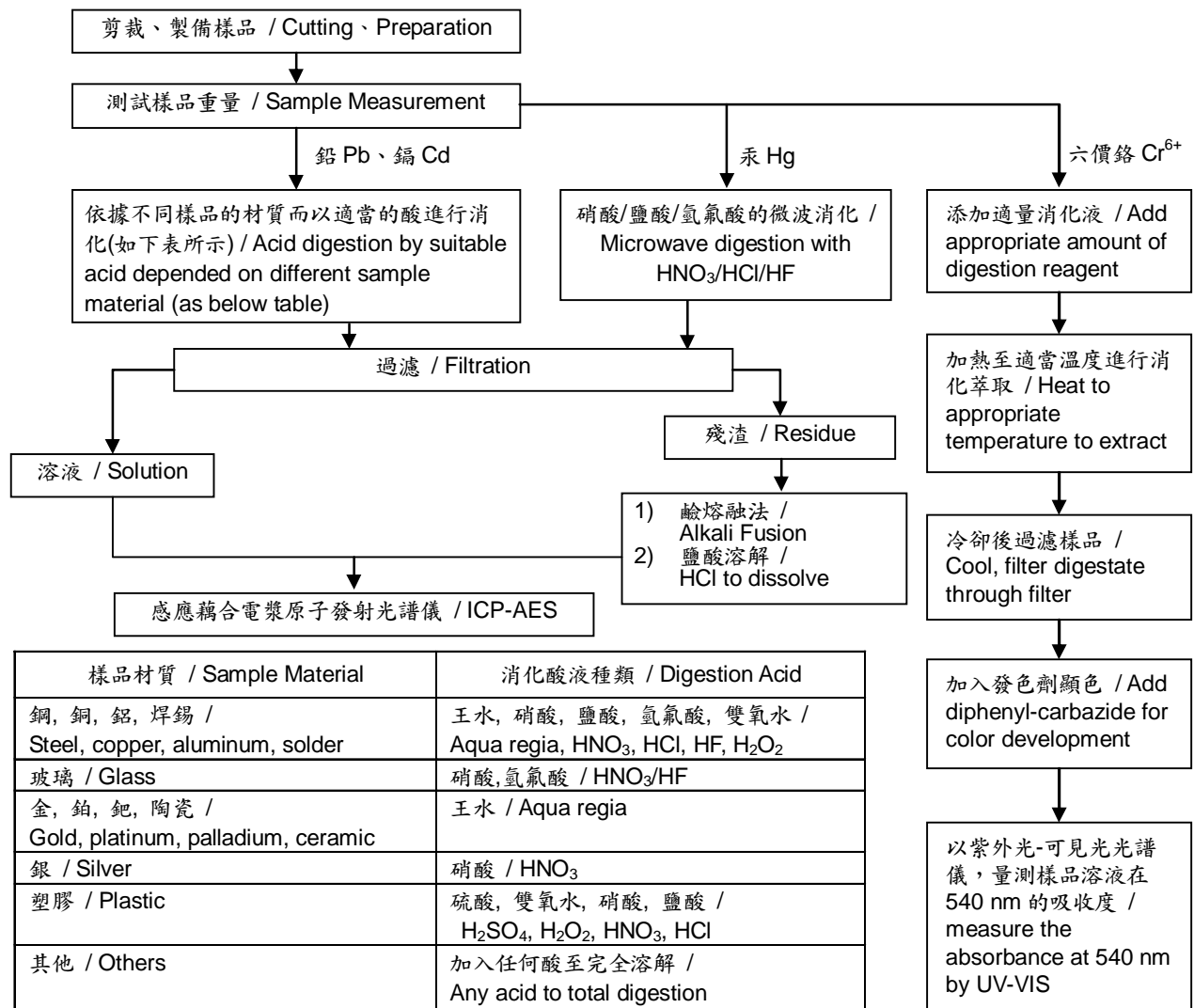

Unless otherwise stated the results shown in this test report refer only to the sample(s) tested. This test report cannot be reproduced, except in full, without prior written permission of the Company. 除非另有說明，此報告結果僅對測試之樣品負責。本報告未經本公司書面許可，不可部分複製。

This Test Report is issued by the Company under its General Conditions of Service printed overleaf or available on request and accessible at http://www.sgs.com/terms_and_conditions.htm. Attention is drawn to the limitation of liability, indemnification and jurisdiction issues defined therein. Any holder of this Test Report is advised that information contained herein reflects the Company's findings at the time of its intervention only and within the limits of Client's instructions, if any. The Company's sole responsibility is to its Client and this document does not exonerate parties to a transaction from exercising all their rights and obligations under the transaction documents. Any unauthorized alteration, forgery or falsification of the content or appearance of this document is unlawful and offenders may be prosecuted to the fullest extent of the law.

測試報告 Test Report

號碼(No.): CE/2008/C4566

日期(Date): 2008/12/24

頁數(Page): 4 of 4

有春電線股份有限公司

YEOU CHUEN WIRE CO., LTD.

桃園縣平鎮市中豐路南勢二段460巷112號

112, LANE 460, NAN HSEN 2ND SECTION, CHUNG FENG RD., PING CHEN CITY,

TAOYUAN HSIEN TAIWAN REPUBLIC OF CHINA



** 報告結尾(End of Report) **

Unless otherwise stated the results shown in this test report refer only to the sample(s) tested. This test report cannot be reproduced, except in full, without prior written permission of the Company. 除非另有說明，此報告結果僅對測試之樣品負責。本報告未經本公司書面許可，不可部分複製。

This Test Report is issued by the Company under its General Conditions of Service printed overleaf or available on request and accessible at http://www.sgs.com/terms_and_conditions.htm. Attention is drawn to the limitation of liability, indemnification and jurisdiction issues defined therein. Any holder of this Test Report is advised that information contained hereon reflects the Company's findings at the time of its intervention only and within the limits of Client's instructions, if any. The Company's sole responsibility is to its Client and this document does not exonerate parties to a transaction from exercising all their rights and obligations under the transaction documents. Any unauthorized alteration, forgery or falsification of the content or appearance of this document is unlawful and offenders may be prosecuted to the fullest extent of the law.

測試報告 Test Report

號碼(No.) : CE/2008/C7175 日期(Date) : 2009/01/07 頁數(Page) : 1 of 15

慕明企業有限公司

MOLECULE ENTERPRISE CO., LTD.

台北市中山北路二段112號11樓之4

11F-4, NO. 112, CHUNG SHAN N, RD., SEC. 2, TAIPEI, TAIWAN



以下測試樣品係由客戶送樣，且由客戶聲稱並經客戶確認如下 (The following samples was/were submitted and identified by/on behalf of the client as):

樣品名稱(Sample Description) : FEP氟碳聚合物顆粒
樣品型號(Style/Item No.) : NP-102
收件日期(Sample Receiving Date) : 2008/12/29
測試期間(Testing Period) : 2008/12/29 TO 2009/1/7

=====
測試結果(Test Results) : 請見下一頁 (Please refer to next pages).

結論(Conclusion) : 根據客戶所提供的樣品，其鎘、鉛、汞、六價鉻、多溴聯苯及多溴聯苯醚的測試結果符合RoHS(2002/95/EC)及其修定指令之要求 (Based on the performed tests on submitted samples, the test results of Cadmium, Lead, Mercury, Hexavalent Chromium Cr(VI), PBBs and PBDEs are **compliant with** the limits of RoHS Directive 2002/95/EC and its subsequent amendments).

Chenyu Kung / Operation Manager
Signed for and on behalf of
SGS TAIWAN LTD.
Chemical Laboratory – Taipei

Unless otherwise stated the results shown in this test report refer only to the sample(s) tested. This test report cannot be reproduced, except in full, without prior written permission of the Company. 除非另有說明，此報告結果僅對測試之樣品負責。本報告未經本公司書面許可，不可部分複製。

This Test Report is issued by the Company under its General Conditions of Service printed overleaf or available on request and accessible at http://www.sgs.com/terms_and_conditions.htm. Attention is drawn to the limitation of liability, indemnification and jurisdiction issues defined therein. Any holder of this Test Report is advised that information contained hereon reflects the Company's findings at the time of its intervention only and within the limits of Client's instructions, if any. The Company's sole responsibility is to its Client and this document does not exonerate parties to a transaction from exercising all their rights and obligations under the transaction documents. Any unauthorized alteration, forgery or falsification of the content or appearance of this document is unlawful and offenders may be prosecuted to the fullest extent of the law.

測試報告 Test Report

號碼(No.) : CE/2008/C7175 日期(Date) : 2009/01/07 頁數(Page) : 2 of 15

慕明企業有限公司

MOLECULE ENTERPRISE CO., LTD.

台北市中山北路二段112號11樓之4

11F-4, NO. 112, CHUNG SHAN N, RD., SEC. 2, TAIPEI, TAIWAN



測試結果(Test Results)

測試部位(PART NAME) NO.1 : 透明色塑膠粒 (TRANSPARENT PLASTIC PELLETS)

測試項目 (Test Items)	單位 (Unit)	測試方法 (Method)	方法偵測 極限值 (MDL)	結果 (Result)	法規 限值 (Limit)
				NO.1	
鎘 / Cadmium (Cd)	mg/kg	參考 IEC 62321: 2008方法, 用感應耦合電漿原子發射光譜儀檢測. / With reference to IEC 62321: 2008 and performed by ICP-AES.	2	n.d.	100
鉛 / Lead (Pb)	mg/kg	參考 IEC 62321: 2008方法, 用感應耦合電漿原子發射光譜儀檢測. / With reference to IEC 62321: 2008 and performed by ICP-AES.	2	n.d.	1000
汞 / Mercury (Hg)	mg/kg	參考 IEC 62321: 2008方法, 用感應耦合電漿原子發射光譜儀檢測. / With reference to IEC 62321: 2008 and performed by ICP-AES.	2	n.d.	1000
六價鉻 / Hexavalent Chromium Cr(VI) by alkaline extraction	mg/kg	參考 IEC 62321: 2008方法, 用UV-VIS 檢測. / With reference to IEC 62321: 2008 and performed by UV-VIS.	2	n.d.	1000
磷 / Phosphorus (P)	mg/kg	參考 US EPA 3052 方法, 用感應耦合電漿原子發射光譜儀檢測磷含量. / With reference to US EPA Method 3052 for Phosphorus Content. Analysis was performed by ICP-	2	n.d.	-
三氧化二銻 / Antimony trioxide (Sb ₂ O ₃)***(CAS No.: 001309-64-4)	mg/kg	參考 US EPA 3050B方法, 用感應耦合電漿原子發射光譜儀檢測銻含量. / With reference to US EPA Method 3050B for Antimony Content. Analysis was performed by ICP-AES.	2	n.d.	-

Unless otherwise stated the results shown in this test report refer only to the sample(s) tested. This test report cannot be reproduced, except in full, without prior written permission of the Company. 除非另有說明, 此報告結果僅對測試之樣品負責。本報告未經本公司書面許可, 不可部分複製。

This Test Report is issued by the Company under its General Conditions of Service printed overleaf or available on request and accessible at http://www.sgs.com/terms_and_conditions.htm. Attention is drawn to the limitation of liability, indemnification and jurisdiction issues defined therein. Any holder of this Test Report is advised that information contained hereon reflects the Company's findings at the time of its intervention only and within the limits of Client's instructions, if any. The Company's sole responsibility is to its Client and this document does not exonerate parties to a transaction from exercising all their rights and obligations under the transaction documents. Any unauthorized alteration, forgery or falsification of the content or appearance of this document is unlawful and offenders may be prosecuted to the fullest extent of the law.

測試報告

Test Report

號碼(No.) : CE/2008/C7175 日期(Date) : 2009/01/07 頁數(Page) : 3 of 15

慕明企業有限公司

MOLECULE ENTERPRISE CO., LTD.

台北市中山北路二段112號11樓之4

11F-4, NO. 112, CHUNG SHAN N, RD., SEC. 2, TAIPEI, TAIWAN



測試項目 (Test Items)	單位 (Unit)	測試方法 (Method)	方法偵測 極限值 (MDL)	結果 (Result)	法規 限值 (Limit)
				NO.1	
氯化石蠟 / Chlorinated Paraffin (C10~C13) (CAS No.: 010871-26-2)	%	參考US EPA 3540C方法, 以氣相層析 質譜儀(GC/MS)檢測. / With reference to US EPA 3540C method. Analysis was performed by GC/MS.	0.01	n.d.	-
聚氯乙烯 / PVC	**	以紅外光譜分析及焰色法檢測. / Analysis was performed by FTIR and FLAME Test.	-	Negative	-
全氟辛烷磺酸 / Perfluorooctane sulfonates (PFOS) PFOS — Acid PFOS — Metal Salt PFOS — Amide	mg/kg	參考US EPA 3540C: 1996方法, 以液 相層析質譜儀檢測全氟辛烷磺酸含量. / With reference to US EPA 3540C: 1996 method for PFOS Content. Analysis was performed by LC/MS.	10	n.d.	-
全氟辛酸(銨) / PFOA (CAS No.: 000335- 67-1)	mg/kg	參考US EPA 3540C: 1996方法, 以液 相層析質譜儀檢測全氟辛酸(銨)含量. / With reference to US EPA 3540C: 1996 method for PFOA Content. Analysis was performed by LC/MS.	10	n.d.	-
鹵素 / Halogen		參考BS EN 14582:2007, 以離子層析 儀分析氟, 氯, 溴, 碘含量. / With reference to BS EN 14582:2007. Analysis was performed by IC method for F, Cl, Br, I content.			
鹵素(氟) / Halogen-Fluorine (F) (CAS No.: 014762-94-8)	mg/kg	參考BS EN 14582:2007, 以離子層析 儀分析氟含量. / With reference to BS EN 14582:2007. Analysis was performed by IC method for Fluorine content.	50	222000	-
鹵素(氯) / Halogen-Chlorine (Cl) (CAS No.: 022537-15-1)	mg/kg	參考BS EN 14582:2007, 以離子層析 儀分析氯含量. / With reference to BS EN 14582:2007. Analysis was performed by IC method for Chlorine content.	50	n.d.	-

Unless otherwise stated the results shown in this test report refer only to the sample(s) tested. This test report cannot be reproduced, except in full, without prior written permission of the Company.
除非另有說明, 此報告結果僅對測試之樣品負責。本報告未經本公司書面許可, 不可部分複製。

This Test Report is issued by the Company under its General Conditions of Service printed overleaf or available on request and accessible at http://www.sgs.com/terms_and_conditions.htm. Attention is drawn to the limitation of liability, indemnification and jurisdiction issues defined therein. Any holder of this Test Report is advised that information contained hereon reflects the Company's findings at the time of its intervention only and within the limits of Client's instructions, if any. The Company's sole responsibility is to its Client and this document does not exonerate parties to a transaction from exercising all their rights and obligations under the transaction documents. Any unauthorized alteration, forgery or falsification of the content or appearance of this document is unlawful and offenders may be prosecuted to the fullest extent of the law.

測試報告

Test Report

號碼(No.) : CE/2008/C7175 日期(Date) : 2009/01/07 頁數(Page) : 4 of 15

慕明企業有限公司

MOLECULE ENTERPRISE CO., LTD.

台北市中山北路二段112號11樓之4

11F-4, NO. 112, CHUNG SHAN N, RD., SEC. 2, TAIPEI, TAIWAN



測試項目 (Test Items)	單位 (Unit)	測試方法 (Method)	方法偵測 極限值 (MDL)	結果 (Result)	法規 限值 (Limit)
				NO.1	
鹵素 (溴) / Halogen-Bromine (Br) (CAS No.: 010097-32-2)	mg/kg	參考BS EN 14582:2007, 以離子層析儀分析溴含量. / With reference to BS EN 14582:2007. Analysis was performed by IC method for Bromine content.	50	n.d.	-
鹵素 (碘) / Halogen-Iodine (I) (CAS No.: 014362-44-8)	mg/kg	參考BS EN 14582:2007, 以離子層析儀分析碘含量. / With reference to BS EN 14582:2007. Analysis was performed by IC method for Iodine content.	50	n.d.	-
可塑劑定量分析 / Phthalates					
鄰苯二甲酸二丁酯 / DBP (Dibutyl phthalate) (CAS No.: 000084-74-2)	%	本測試參考EN 14372: 2004, 以氣相層析儀/質譜儀檢測之. / With reference to EN 14372: 2004. Analysis was performed by GC/MS.	0.003	n.d.	-
鄰苯二甲酸丁酯苯甲酯 / BBP (Benzyl butyl phthalate) (CAS No.: 000085-68-7)	%	本測試參考EN 14372: 2004, 以氣相層析儀/質譜儀檢測之. / With reference to EN 14372: 2004. Analysis was performed by GC/MS.	0.003	n.d.	-
鄰苯二甲酸二(2-乙基己基)酯 / DEHP (Di-(2-ethylhexyl) phthalate) (CAS No.: 000117-81-7)	%	本測試參考EN 14372: 2004, 以氣相層析儀/質譜儀檢測之. / With reference to EN 14372: 2004. Analysis was performed by GC/MS.	0.003	n.d.	-
鄰苯二甲酸二正辛酯 / DNOP (Di-n-octyl phthalate) (CAS No.: 000117-84-0)	%	本測試參考EN 14372: 2004, 以氣相層析儀/質譜儀檢測之. / With reference to EN 14372: 2004. Analysis was performed by GC/MS.	0.003	n.d.	-
鄰苯二甲酸二異壬酯 / DINP (Di-isononyl phthalate) (CAS No.: 028553-12-0)	%	本測試參考EN 14372: 2004, 以氣相層析儀/質譜儀檢測之. / With reference to EN 14372: 2004. Analysis was performed by GC/MS.	0.01	n.d.	-

Unless otherwise stated the results shown in this test report refer only to the sample(s) tested. This test report cannot be reproduced, except in full, without prior written permission of the Company. 除非另有說明, 此報告結果僅對測試之樣品負責。本報告未經本公司書面許可, 不可部分複製。

This Test Report is issued by the Company under its General Conditions of Service printed overleaf or available on request and accessible at http://www.sgs.com/terms_and_conditions.htm. Attention is drawn to the limitation of liability, indemnification and jurisdiction issues defined therein. Any holder of this Test Report is advised that information contained hereon reflects the Company's findings at the time of its intervention only and within the limits of Client's instructions, if any. The Company's sole responsibility is to its Client and this document does not exonerate parties to a transaction from exercising all their rights and obligations under the transaction documents. Any unauthorized alteration, forgery or falsification of the content or appearance of this document is unlawful and offenders may be prosecuted to the fullest extent of the law.

測試報告 Test Report

號碼(No.) : CE/2008/C7175 日期(Date) : 2009/01/07 頁數(Page) : 5 of 15

慕明企業有限公司

MOLECULE ENTERPRISE CO., LTD.

台北市中山北路二段112號11樓之4

11F-4, NO. 112, CHUNG SHAN N. RD., SEC. 2, TAIPEI, TAIWAN



測試項目 (Test Items)	單位 (Unit)	測試方法 (Method)	方法偵測 極限值 (MDL)	結果 (Result)	法規 限值 (Limit)
				NO.1	
鄰苯二甲酸二異癸酯 / DIDP (Di-isodecyl phthalate) (CAS No.: 026761-40-0)	%	本測試參考EN 14372: 2004, 以氣相層析儀/質譜儀檢測之. / With reference to EN 14372: 2004. Analysis was performed by GC/MS.	0.01	n.d.	-
多溴聯苯總和 / Sum of PBBs	mg/kg	參考 IEC 62321: 2008方法, 以氣相層析儀/質譜儀檢測. / With reference to IEC 62321: 2008 and performed by GC/MS.	-	n.d.	1000
一溴聯苯 / Monobromobiphenyl			5	n.d.	-
二溴聯苯 / Dibromobiphenyl			5	n.d.	-
三溴聯苯 / Tribromobiphenyl			5	n.d.	-
四溴聯苯 / Tetrabromobiphenyl			5	n.d.	-
五溴聯苯 / Pentabromobiphenyl			5	n.d.	-
六溴聯苯 / Hexabromobiphenyl			5	n.d.	-
七溴聯苯 / Heptabromobiphenyl			5	n.d.	-
八溴聯苯 / Octabromobiphenyl			5	n.d.	-
九溴聯苯 / Nonabromobiphenyl			5	n.d.	-
十溴聯苯 / Decabromobiphenyl			5	n.d.	-
多溴聯苯醚總和 / Sum of PBDEs			-	n.d.	1000
一溴聯苯醚 / Monobromodiphenyl ether			5	n.d.	-
二溴聯苯醚 / Dibromodiphenyl ether			5	n.d.	-
三溴聯苯醚 / Tribromodiphenyl ether			5	n.d.	-
四溴聯苯醚 / Tetrabromodiphenyl ether			5	n.d.	-
五溴聯苯醚 / Pentabromodiphenyl ether			5	n.d.	-
六溴聯苯醚 / Hexabromodiphenyl ether			5	n.d.	-
七溴聯苯醚 / Heptabromodiphenyl ether			5	n.d.	-
八溴聯苯醚 / Octabromodiphenyl ether			5	n.d.	-
九溴聯苯醚 / Nonabromodiphenyl ether	5	n.d.	-		
十溴聯苯醚 / Decabromodiphenyl ether	5	n.d.	-		

Unless otherwise stated the results shown in this test report refer only to the sample(s) tested. This test report cannot be reproduced, except in full, without prior written permission of the Company. 除非另有說明, 此報告結果僅對測試之樣品負責。本報告未經本公司書面許可, 不可部分複製。

This Test Report is issued by the Company under its General Conditions of Service printed overleaf or available on request and accessible at http://www.sgs.com/terms_and_conditions.htm. Attention is drawn to the limitation of liability, indemnification and jurisdiction issues defined therein. Any holder of this Test Report is advised that information contained hereon reflects the Company's findings at the time of its intervention only and within the limits of Client's instructions, if any. The Company's sole responsibility is to its Client and this document does not exonerate parties to a transaction from exercising all their rights and obligations under the transaction documents. Any unauthorized alteration, forgery or falsification of the content or appearance of this document is unlawful and offenders may be prosecuted to the fullest extent of the law.

測試報告

Test Report

號碼(No.) : CE/2008/C7175 日期(Date) : 2009/01/07 頁數(Page) : 6 of 15

慕明企業有限公司

MOLECULE ENTERPRISE CO., LTD.

台北市中山北路二段112號11樓之4

11F-4, NO. 112, CHUNG SHAN N. RD., SEC. 2, TAIPEI, TAIWAN



備註(Note) :

1. mg/kg = ppm ; 0.1wt% = 1000ppm
2. n.d. = Not Detected (未檢出)
3. MDL = Method Detection Limit (方法偵測極限值)
4. "-" = Not Regulated (無規格值)
5. ** = Qualitative analysis (No Unit) 定性分析(無單位)
6. Negative = Undetectable 陰性(未偵測到); Positive = Detectable 陽性(已偵測到)
7. 若為氯化石蠟中單一化合物, 則偵測極限為5ppm (The MDL is 5ppm for the single compound of CP)
8. ***: 該物質是由"三丁基錫", "三苯基錫"或各別元素(例如: 銻、鉍、矽、鋅、鈷或磷)之測試結果計算得知. 其MDL是針對"三丁基錫", "三苯基錫"或元素(例如: 銻、鉍、矽、鋅、鈷或磷)之評估.
(The substance is calculated by the test results of Tributyl Tin, Triphenyl Tin or element (Ex. Antimony, Beryllium, Silicon, Zinc, Cobalt or Phosphorus respectively). The MDL is evaluated for Tributyl Tin, Triphenyl Tin or element (Ex. Antimony, Beryllium, Silicon, Zinc, Cobalt or Phosphorus respectively.))

PFOS參考資訊(Reference Information) : 指令 2006/122/EC (Directive 2006/122/EC)

- (1) 該物質不可置於市場上或使用於特殊物質或配置成分重量濃度等於或大於0.005%。
(May not be placed on the market or used as a substance or constituent of preparations in a concentration equal to or higher than 0.005 % by mass.)
- (2) 該物質不可置於市場上的半成品或商品或其物件; 假若零件上明顯地具有PFOS並參照結構上及微細構造上計算PFOS重量濃度等於或大於0.1%, 而紡織品或其他覆蓋物質, 如果PFOS在覆蓋物質中含量等於或大於 $1\mu\text{g}/\text{m}^2$ 。
(May not be placed on the market in semi-finished products or articles, or parts thereof, if the concentration of PFOS is equal to or higher than 0.1 % by mass calculated with reference to the mass of structurally or microstructurally distinct parts that contain PFOS or, for textiles or other coated materials, if the amount of PFOS is equal to or higher than $1\mu\text{g}/\text{m}^2$ of the coated material.)

Unless otherwise stated the results shown in this test report refer only to the sample(s) tested. This test report cannot be reproduced, except in full, without prior written permission of the Company. 除非另有說明, 此報告結果僅對測試之樣品負責。本報告未經本公司書面許可, 不可部分複製。

This Test Report is issued by the Company under its General Conditions of Service printed overleaf or available on request and accessible at http://www.sgs.com/terms_and_conditions.htm. Attention is drawn to the limitation of liability, indemnification and jurisdiction issues defined therein. Any holder of this Test Report is advised that information contained hereon reflects the Company's findings at the time of its intervention only and within the limits of Client's instructions, if any. The Company's sole responsibility is to its Client and this document does not exonerate parties to a transaction from exercising all their rights and obligations under the transaction documents. Any unauthorized alteration, forgery or falsification of the content or appearance of this document is unlawful and offenders may be prosecuted to the fullest extent of the law.

測試報告 Test Report

號碼(No.) : CE/2008/C7175 日期(Date) : 2009/01/07 頁數(Page) : 7 of 15

慕明企業有限公司

MOLECULE ENTERPRISE CO., LTD.

台北市中山北路二段112號11樓之4

11F-4, NO. 112, CHUNG SHAN N, RD., SEC. 2, TAIPEI, TAIWAN



- 1) 根據以下的流程圖之條件，樣品已完全溶解。(六價鉻測試方法除外) / These samples were dissolved totally by pre-conditioning method according to below flow chart. (Cr⁶⁺ test method excluded)
- 2) 測試人員：楊登偉 / Name of the person who made measurement: Climbgreat Yang
- 3) 測試負責人：張啓興 / Name of the person in charge of measurement: Troy Chang

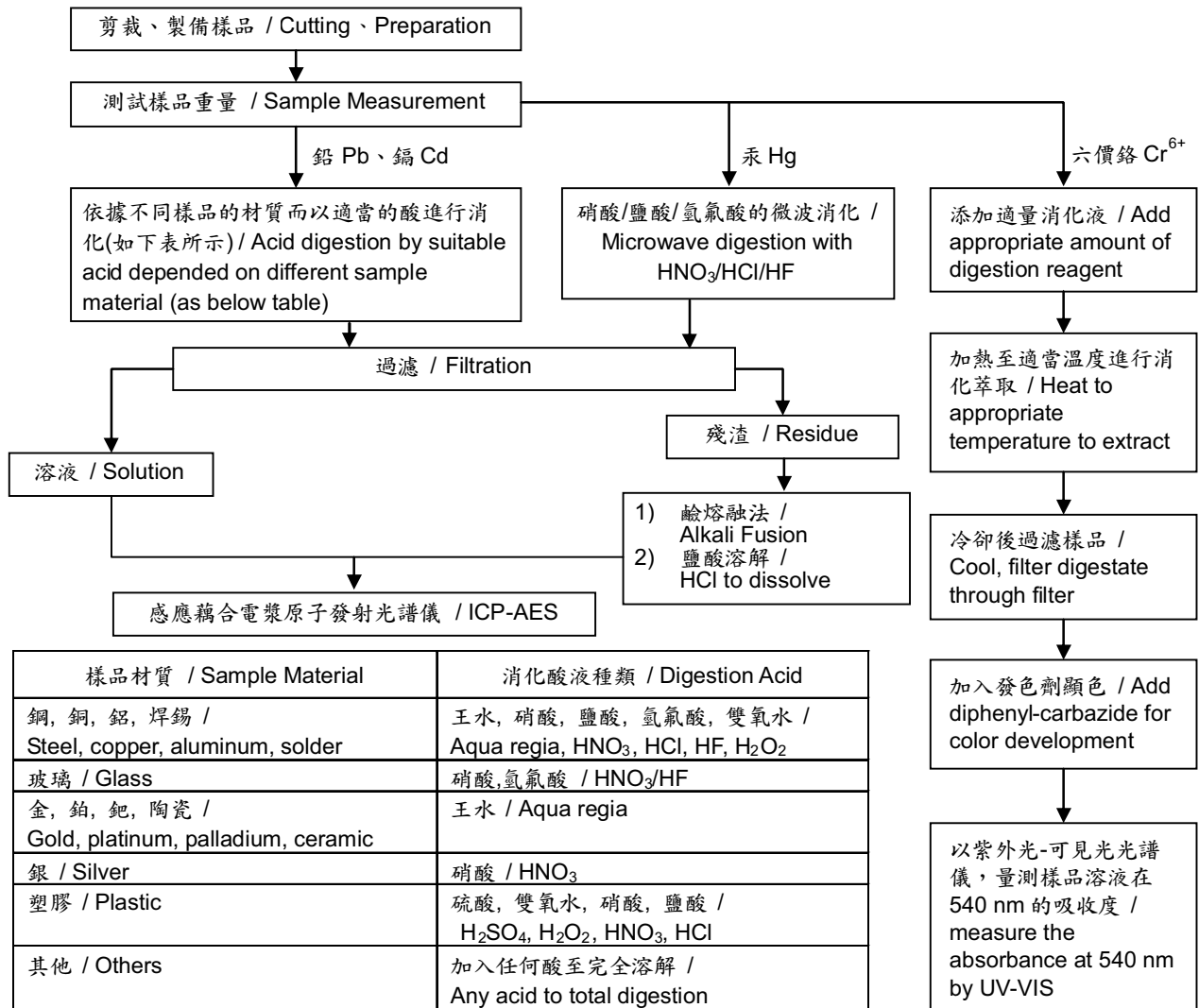

Unless otherwise stated the results shown in this test report refer only to the sample(s) tested. This test report cannot be reproduced, except in full, without prior written permission of the Company. 除非另有說明，此報告結果僅對測試之樣品負責。本報告未經本公司書面許可，不可部分複製。

This Test Report is issued by the Company under its General Conditions of Service printed overleaf or available on request and accessible at http://www.sgs.com/terms_and_conditions.htm. Attention is drawn to the limitation of liability, indemnification and jurisdiction issues defined therein. Any holder of this Test Report is advised that information contained hereon reflects the Company's findings at the time of its intervention only and within the limits of Client's instructions, if any. The Company's sole responsibility is to its Client and this document does not exonerate parties to a transaction from exercising all their rights and obligations under the transaction documents. Any unauthorized alteration, forgery or falsification of the content or appearance of this document is unlawful and offenders may be prosecuted to the fullest extent of the law.

測試報告 Test Report

號碼(No.) : CE/2008/C7175 日期(Date) : 2009/01/07 頁數(Page) : 8 of 15

慕明企業有限公司

MOLECULE ENTERPRISE CO., LTD.

台北市中山北路二段112號11樓之4

11F-4, NO. 112, CHUNG SHAN N. RD., SEC. 2, TAIPEI, TAIWAN



- 1) 根據以下的流程圖之條件，樣品已完全溶解。 / These samples were dissolved totally by pre-conditioning method according to below flow chart.
- 2) 測試人員：楊登偉 / Name of the person who made measurement: Climbgreat Yang
- 3) 測試負責人：張啓興 / Name of the person in charge of measurement: Troy Chang

元素的消化流程圖 (Flow Chart of Digestion for elements analysis)

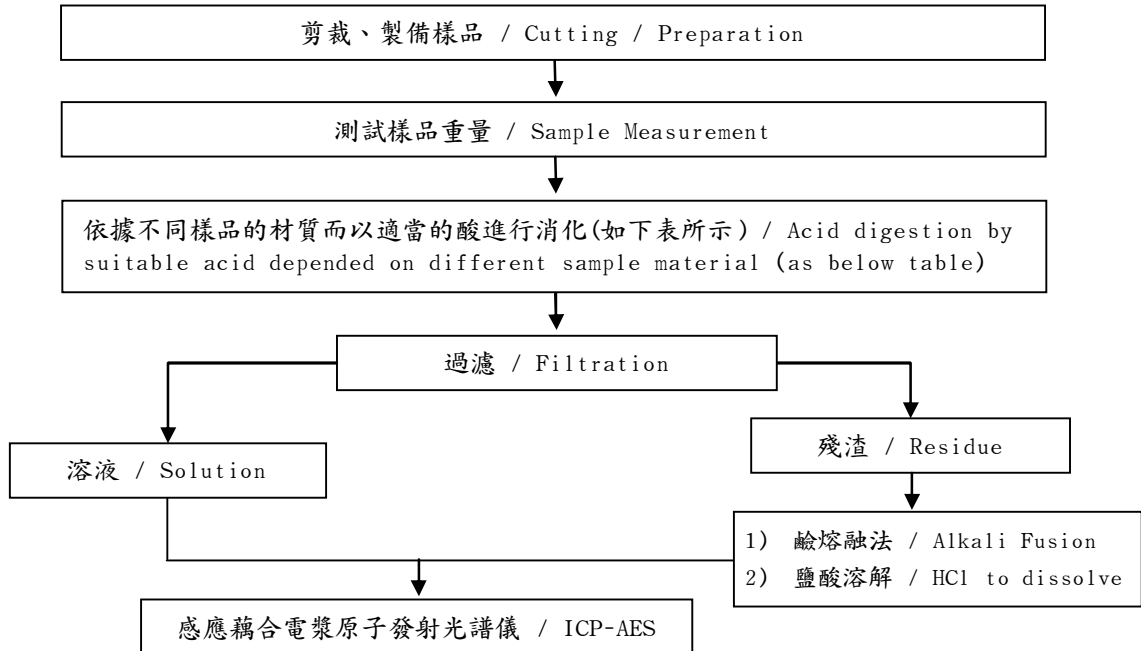

鋼, 銅, 鋁, 焊錫 / Steel, copper, aluminum, solder	王水, 硝酸, 鹽酸, 氫氟酸, 雙氧水 / Aqua regia, HNO ₃ , HCl, HF, H ₂ O ₂
玻璃 / Glass	硝酸, 氫氟酸 / HNO ₃ /HF
金, 鉑, 鈀, 陶瓷 / Gold, platinum, palladium, ceramic	王水 / Aqua regia
銀 / Silver	硝酸 / HNO ₃
塑膠 / Plastic	硫酸, 雙氧水, 硝酸, 鹽酸 / H ₂ SO ₄ , H ₂ O ₂ , HNO ₃ , HCl
其他 / Others	加入任何酸至完全溶解 / Any acid to total digestion

Unless otherwise stated the results shown in this test report refer only to the sample(s) tested. This test report cannot be reproduced, except in full, without prior written permission of the Company. 除非另有說明，此報告結果僅對測試之樣品負責。本報告未經本公司書面許可，不可部分複製。

This Test Report is issued by the Company under its General Conditions of Service printed overleaf or available on request and accessible at http://www.sgs.com/terms_and_conditions.htm. Attention is drawn to the limitation of liability, indemnification and jurisdiction issues defined therein. Any holder of this Test Report is advised that information contained herein reflects the Company's findings at the time of its intervention only and within the limits of Client's instructions, if any. The Company's sole responsibility is to its Client and this document does not exonerate parties to a transaction from exercising all their rights and obligations under the transaction documents. Any unauthorized alteration, forgery or falsification of the content or appearance of this document is unlawful and offenders may be prosecuted to the fullest extent of the law.

測試報告 Test Report

號碼(No.) : CE/2008/C7175 日期(Date) : 2009/01/07 頁數(Page) : 9 of 15

慕明企業有限公司

MOLECULE ENTERPRISE CO., LTD.

台北市中山北路二段112號11樓之4

11F-4, NO. 112, CHUNG SHAN N, RD., SEC. 2, TAIPEI, TAIWAN



多溴聯苯/多溴聯苯醚分析流程圖 / PBB/PBDE analytical FLOW CHART

- 1) 測試人員：翁賜彬 / Name of the person who made measurement: Roman Wong
- 2) 測試負責人：陳新智 / Name of the person in charge of measurement: Shinjyh Chen

初次測試程序 / First testing process ———→

選擇性篩檢程序 / Optional screen process→

確認程序 / Confirmation process - . - . →

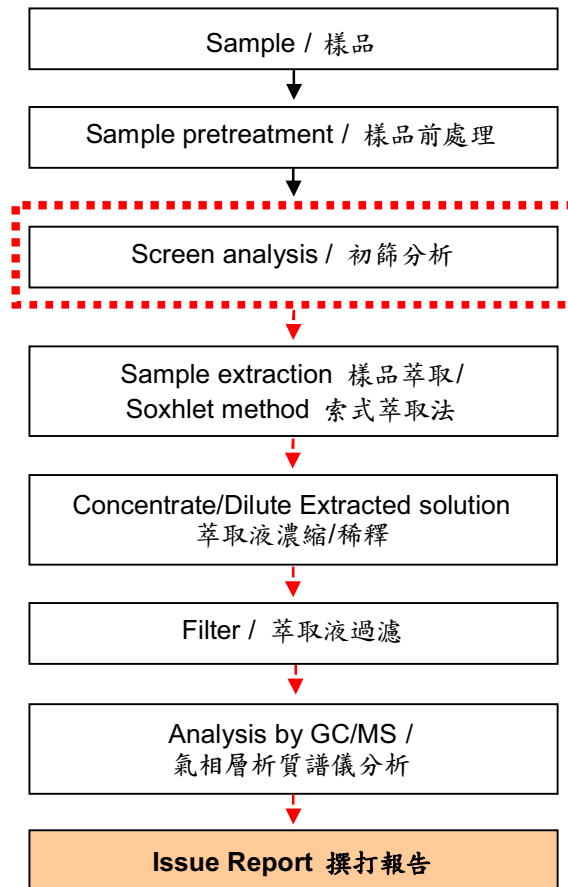

Unless otherwise stated the results shown in this test report refer only to the sample(s) tested. This test report cannot be reproduced, except in full, without prior written permission of the Company. 除非另有說明，此報告結果僅對測試之樣品負責。本報告未經本公司書面許可，不可部分複製。

This Test Report is issued by the Company under its General Conditions of Service printed overleaf or available on request and accessible at http://www.sgs.com/terms_and_conditions.htm. Attention is drawn to the limitation of liability, indemnification and jurisdiction issues defined therein. Any holder of this Test Report is advised that information contained hereon reflects the Company's findings at the time of its intervention only and within the limits of Client's instructions, if any. The Company's sole responsibility is to its Client and this document does not exonerate parties to a transaction from exercising all their rights and obligations under the transaction documents. Any unauthorized alteration, forgery or falsification of the content or appearance of this document is unlawful and offenders may be prosecuted to the fullest extent of the law.

測試報告 Test Report

號碼(No.) : CE/2008/C7175 日期(Date) : 2009/01/07 頁數(Page) : 10 of 15

慕明企業有限公司

MOLECULE ENTERPRISE CO., LTD.

台北市中山北路二段112號11樓之4

11F-4, NO. 112, CHUNG SHAN N, RD., SEC. 2, TAIPEI, TAIWAN



鹵素分析流程圖 / Analytical flow chart of halogen content

- 1) 測試人員：陳立倫 / Name of the person who made measurement: Alan Chen
- 2) 測試負責人：張啓興 / Name of the person in charge of measurement: Troy Chang

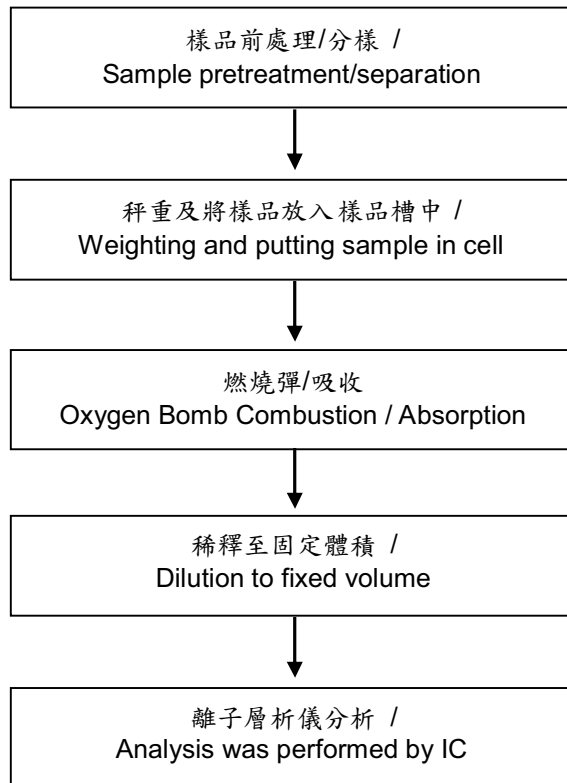

Unless otherwise stated the results shown in this test report refer only to the sample(s) tested. This test report cannot be reproduced, except in full, without prior written permission of the Company. 除非另有說明，此報告結果僅對測試之樣品負責。本報告未經本公司書面許可，不可部分複製。

This Test Report is issued by the Company under its General Conditions of Service printed overleaf or available on request and accessible at http://www.sgs.com/terms_and_conditions.htm. Attention is drawn to the limitation of liability, indemnification and jurisdiction issues defined therein. Any holder of this Test Report is advised that information contained hereon reflects the Company's findings at the time of its intervention only and within the limits of Client's instructions, if any. The Company's sole responsibility is to its Client and this document does not exonerate parties to a transaction from exercising all their rights and obligations under the transaction documents. Any unauthorized alteration, forgery or falsification of the content or appearance of this document is unlawful and offenders may be prosecuted to the fullest extent of the law.

測試報告 Test Report

號碼(No.) : CE/2008/C7175 日期(Date) : 2009/01/07 頁數(Page) : 11 of 15

慕明企業有限公司

MOLECULE ENTERPRISE CO., LTD.

台北市中山北路二段112號11樓之4

11F-4, NO. 112, CHUNG SHAN N, RD., SEC. 2, TAIPEI, TAIWAN



可塑劑分析流程圖 / Analytical flow chart of phthalate content

- 1) 測試人員：徐毓明 / Name of the person who made measurement: Andy Shu
- 2) 測試負責人：陳新智 / Name of the person in charge of measurement: Shinjyh Chen

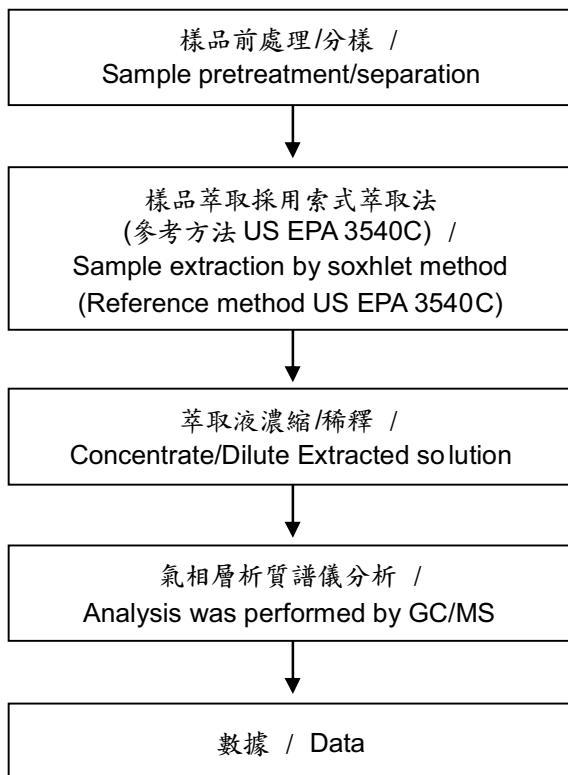

Unless otherwise stated the results shown in this test report refer only to the sample(s) tested. This test report cannot be reproduced, except in full, without prior written permission of the Company. 除非另有說明，此報告結果僅對測試之樣品負責。本報告未經本公司書面許可，不可部分複製。

This Test Report is issued by the Company under its General Conditions of Service printed overleaf or available on request and accessible at http://www.sgs.com/terms_and_conditions.htm. Attention is drawn to the limitation of liability, indemnification and jurisdiction issues defined therein. Any holder of this Test Report is advised that information contained hereon reflects the Company's findings at the time of its intervention only and within the limits of Client's instructions, if any. The Company's sole responsibility is to its Client and this document does not exonerate parties to a transaction from exercising all their rights and obligations under the transaction documents. Any unauthorized alteration, forgery or falsification of the content or appearance of this document is unlawful and offenders may be prosecuted to the fullest extent of the law.

測試報告 Test Report

號碼(No.) : CE/2008/C7175 日期(Date) : 2009/01/07 頁數(Page) : 12 of 15

慕明企業有限公司

MOLECULE ENTERPRISE CO., LTD.

台北市中山北路二段112號11樓之4

11F-4, NO. 112, CHUNG SHAN N, RD., SEC. 2, TAIPEI, TAIWAN



聚氯乙稀物質判定分析流程圖 /

Analysis flow chart for determination of PVC in material

- 1) 測試人員：趙婉愉 / Name of the person who made measurement: Eva Chao
- 2) 測試負責人：陳新智 / Name of the person in charge of measurement: Shinjyh Chen

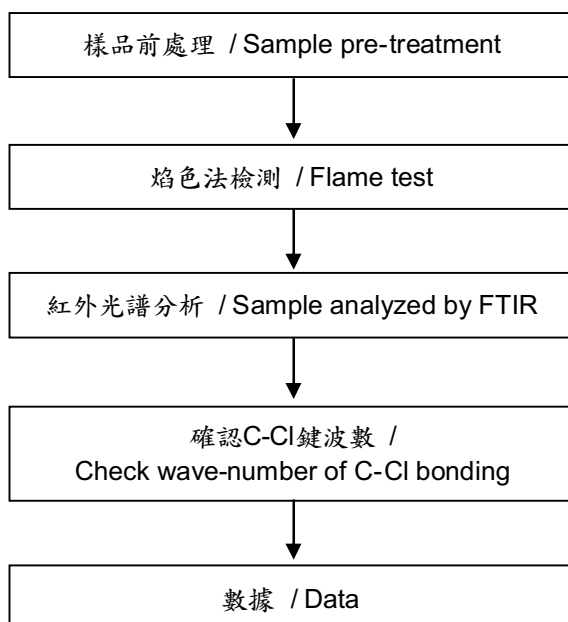

Unless otherwise stated the results shown in this test report refer only to the sample(s) tested. This test report cannot be reproduced, except in full, without prior written permission of the Company. 除非另有說明，此報告結果僅對測試之樣品負責。本報告未經本公司書面許可，不可部分複製。

This Test Report is issued by the Company under its General Conditions of Service printed overleaf or available on request and accessible at http://www.sgs.com/terms_and_conditions.htm. Attention is drawn to the limitation of liability, indemnification and jurisdiction issues defined therein. Any holder of this Test Report is advised that information contained hereon reflects the Company's findings at the time of its intervention only and within the limits of Client's instructions, if any. The Company's sole responsibility is to its Client and this document does not exonerate parties to a transaction from exercising all their rights and obligations under the transaction documents. Any unauthorized alteration, forgery or falsification of the content or appearance of this document is unlawful and offenders may be prosecuted to the fullest extent of the law.

測試報告 Test Report

號碼(No.) : CE/2008/C7175 日期(Date) : 2009/01/07 頁數(Page) : 13 of 15

慕明企業有限公司



MOLECULE ENTERPRISE CO., LTD.

台北市中山北路二段112號11樓之4

11F-4, NO. 112, CHUNG SHAN N, RD., SEC. 2, TAIPEI, TAIWAN

全氟辛酸(銨)/全氟辛烷磺酸分析流程圖 / Analytical flow chart of PFOA/PFOS content

- 1) 測試人員：劉家瑗 / Name of the person who made measurement: Carrie Liu
- 2) 測試負責人：陳新智 / Name of the person in charge of measurement: Shinjyh Chen

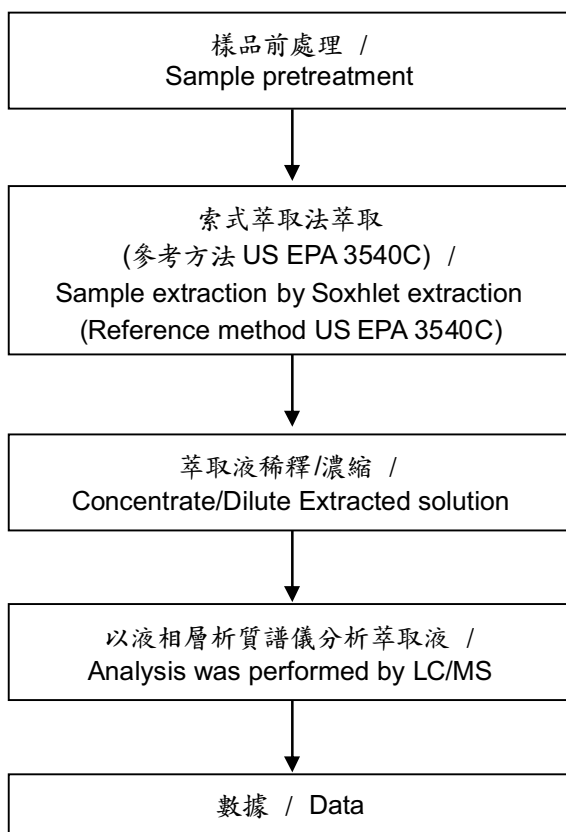

Unless otherwise stated the results shown in this test report refer only to the sample(s) tested. This test report cannot be reproduced, except in full, without prior written permission of the Company. 除非另有說明，此報告結果僅對測試之樣品負責。本報告未經本公司書面許可，不可部分複製。

This Test Report is issued by the Company under its General Conditions of Service printed overleaf or available on request and accessible at http://www.sgs.com/terms_and_conditions.htm. Attention is drawn to the limitation of liability, indemnification and jurisdiction issues defined therein. Any holder of this Test Report is advised that information contained hereon reflects the Company's findings at the time of its intervention only and within the limits of Client's instructions, if any. The Company's sole responsibility is to its Client and this document does not exonerate parties to a transaction from exercising all their rights and obligations under the transaction documents. Any unauthorized alteration, forgery or falsification of the content or appearance of this document is unlawful and offenders may be prosecuted to the fullest extent of the law.

測試報告 Test Report

號碼(No.) : CE/2008/C7175 日期(Date) : 2009/01/07 頁數(Page) : 14 of 15

慕明企業有限公司

MOLECULE ENTERPRISE CO., LTD.

台北市中山北路二段112號11樓之4

11F-4, NO. 112, CHUNG SHAN N, RD., SEC. 2, TAIPEI, TAIWAN



含氯阻燃劑分析流程 / Chlorinated Flame retardant analytical flow chart

- 1) 測試人員：劉桓易 / Name of the person who made measurement: Max Liu
 - 2) 測試負責人：陳新智 / Name of the person in charge of measurement: Shinjyh Chen
- 參考方法(Reference method): US EPA 8270D, US EPA 3540
 - 測試項目(Test Items): PCBs, PCNs, PCTs, Mirex, CP, MCCP / 多氯聯苯, 多氯奈, 多氯三聯苯, 滅蟻靈, 氯化石蠟, 中鏈氯化石蠟

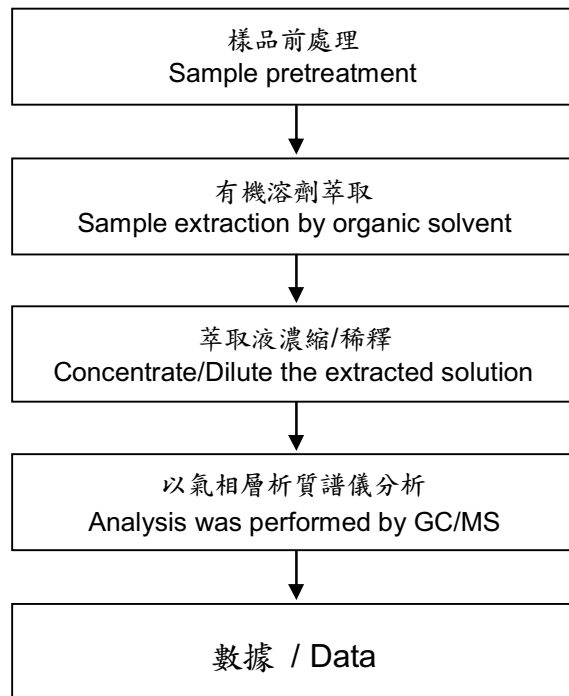

Unless otherwise stated the results shown in this test report refer only to the sample(s) tested. This test report cannot be reproduced, except in full, without prior written permission of the Company. 除非另有說明，此報告結果僅對測試之樣品負責。本報告未經本公司書面許可，不可部分複製。

This Test Report is issued by the Company under its General Conditions of Service printed overleaf or available on request and accessible at http://www.sgs.com/terms_and_conditions.htm. Attention is drawn to the limitation of liability, indemnification and jurisdiction issues defined therein. Any holder of this Test Report is advised that information contained hereon reflects the Company's findings at the time of its intervention only and within the limits of Client's instructions, if any. The Company's sole responsibility is to its Client and this document does not exonerate parties to a transaction from exercising all their rights and obligations under the transaction documents. Any unauthorized alteration, forgery or falsification of the content or appearance of this document is unlawful and offenders may be prosecuted to the fullest extent of the law.

測試報告 Test Report

號碼(No.) : CE/2008/C7175 日期(Date) : 2009/01/07 頁數(Page) : 15 of 15

慕明企業有限公司

MOLECULE ENTERPRISE CO., LTD.

台北市中山北路二段112號11樓之4

11F-4, NO. 112, CHUNG SHAN N, RD., SEC. 2, TAIPEI, TAIWAN



** 報告結尾(End of Report) **

Unless otherwise stated the results shown in this test report refer only to the sample(s) tested. This test report cannot be reproduced, except in full, without prior written permission of the Company. 除非另有說明，此報告結果僅對測試之樣品負責。本報告未經本公司書面許可，不可部分複製。

This Test Report is issued by the Company under its General Conditions of Service printed overleaf or available on request and accessible at http://www.sgs.com/terms_and_conditions.htm. Attention is drawn to the limitation of liability, indemnification and jurisdiction issues defined therein. Any holder of this Test Report is advised that information contained hereon reflects the Company's findings at the time of its intervention only and within the limits of Client's instructions, if any. The Company's sole responsibility is to its Client and this document does not exonerate parties to a transaction from exercising all their rights and obligations under the transaction documents. Any unauthorized alteration, forgery or falsification of the content or appearance of this document is unlawful and offenders may be prosecuted to the fullest extent of the law.



Test Report No. F690501/LF-CTSAYAA09-06052

Issued Date: March 10, 2009

Page 1 of 3

To: **LG CHEM. LTD.**
70-1
Hwachi-dong
Yeosu-city
JEONNAM
Korea

The following merchandise was submitted and identified by the client as :

Product Name : KEYFLEX BT1063D
SGS File No. : AYAA09-06052
Received Date : March 05, 2009
Test Performing Date : March 06, 2009
Test Performed : SGS Testing Korea tested the sample(s) selected by applicant with following results
Test Results : For further details, please refer to following page(s)

Pluto Kim
Cindy Park
Jinee Song/ Testing Person

SGS Testing Korea Co. Ltd.

Jeff Jang / Chemical Lab Mgr

This document is issued by the Company subject to its General Conditions of Service printed overleaf, available on request or accessible at www.sgs.com/terms_and_conditions.htm and, for electronic format documents, subject to Terms and Conditions for Electronic Documents at www.sgs.com/terms_e-document.htm. Attention is drawn to the limitation of liability, indemnification and jurisdiction issues defined therein. Any holder of this document is advised that information contained hereon reflects the Company's findings at the time of its intervention only and within the limits of Client's instructions, if any. The Company's sole responsibility is to its Client and this document does not exonerate parties to a transaction from exercising all their rights and obligations under the transaction documents. This document cannot be reproduced except in full, without prior written approval of the Company. Any unauthorized alteration, forgery or falsification of the content or appearance of this document is unlawful and offenders may be prosecuted to the fullest extent of the law. Unless otherwise stated the results shown in this test report refer only to the sample(s) tested and such sample(s) are retained for 180 days only.

**Test Report No. F690501/LF-CTSAYAA09-06052**

Issued Date: March 10, 2009

Page 2 of 3

Sample No. : AYAA09-06052.001
Sample Description : KEYFLEX BT1063D
Item No./Part No. : N/A

Heavy Metals

Test Items	Unit	Test Method	MDL	Results
Cadmium (Cd)	mg/kg	With reference to IEC 62321:2008, ICP-OES	0.5	N.D.
Lead (Pb)	mg/kg	With reference to IEC 62321:2008, ICP-OES	5	N.D.
Mercury (Hg)	mg/kg	With reference to IEC 62321:2008, ICP-OES	2	N.D.
Hexavalent Chromium (Cr VI)	mg/kg	With reference to IEC 62321:2008, UV-VIS	1	N.D.

Flame Retardants-PBBs/PBDEs

Test Items	Unit	Test Method	MDL	Results
Monobromobiphenyl	mg/kg	With reference to IEC 62321:2008, GC-MS	5	N.D.
Dibromobiphenyl	mg/kg	With reference to IEC 62321:2008, GC-MS	5	N.D.
Tribromobiphenyl	mg/kg	With reference to IEC 62321:2008, GC-MS	5	N.D.
Tetrabromobiphenyl	mg/kg	With reference to IEC 62321:2008, GC-MS	5	N.D.
Pentabromobiphenyl	mg/kg	With reference to IEC 62321:2008, GC-MS	5	N.D.
Hexabromobiphenyl	mg/kg	With reference to IEC 62321:2008, GC-MS	5	N.D.
Heptabromobiphenyl	mg/kg	With reference to IEC 62321:2008, GC-MS	5	N.D.
Octabromobiphenyl	mg/kg	With reference to IEC 62321:2008, GC-MS	5	N.D.
Nonabromobiphenyl	mg/kg	With reference to IEC 62321:2008, GC-MS	5	N.D.
Decabromobiphenyl	mg/kg	With reference to IEC 62321:2008, GC-MS	5	N.D.
Monobromodiphenyl ether	mg/kg	With reference to IEC 62321:2008, GC-MS	5	N.D.
Dibromodiphenyl ether	mg/kg	With reference to IEC 62321:2008, GC-MS	5	N.D.
Tribromodiphenyl ether	mg/kg	With reference to IEC 62321:2008, GC-MS	5	N.D.
Tetrabromodiphenyl ether	mg/kg	With reference to IEC 62321:2008, GC-MS	5	N.D.
Pentabromodiphenyl ether	mg/kg	With reference to IEC 62321:2008, GC-MS	5	N.D.
Hexabromodiphenyl ether	mg/kg	With reference to IEC 62321:2008, GC-MS	5	N.D.
Heptabromodiphenyl ether	mg/kg	With reference to IEC 62321:2008, GC-MS	5	N.D.
Octabromodiphenyl ether	mg/kg	With reference to IEC 62321:2008, GC-MS	5	N.D.
Nonabromodiphenyl ether	mg/kg	With reference to IEC 62321:2008, GC-MS	5	N.D.
Decabromodiphenyl ether	mg/kg	With reference to IEC 62321:2008, GC-MS	5	N.D.

- NOTE:
- (1) N.D. = Not detected.(<MDL)
 - (2) mg/kg = ppm
 - (3) MDL = Method Detection Limit
 - (4) - = No regulation
 - (5) ** = Qualitative analysis (No Unit)
 - (6) Negative = Undetectable / Positive = Detectable

This document is issued by the Company subject to its General Conditions of Service printed overleaf, available on request or accessible at www.sgs.com/terms_and_conditions.htm and, for electronic format documents, subject to Terms and Conditions for Electronic Documents at www.sgs.com/terms_e-document.htm. Attention is drawn to the limitation of liability, indemnification and jurisdiction issues defined therein. Any holder of this document is advised that information contained hereon reflects the Company's findings at the time of its intervention only and within the limits of Client's instructions, if any. The Company's sole responsibility is to its Client and this document does not exonerate parties to a transaction from exercising all their rights and obligations under the transaction documents. This document cannot be reproduced except in full, without prior written approval of the Company. Any unauthorized alteration, forgery or falsification of the content or appearance of this document is unlawful and offenders may be prosecuted to the fullest extent of the law. Unless otherwise stated the results shown in this test report refer only to the sample(s) tested and such sample(s) are retained for 180 days only.

Picture of Sample as Received:

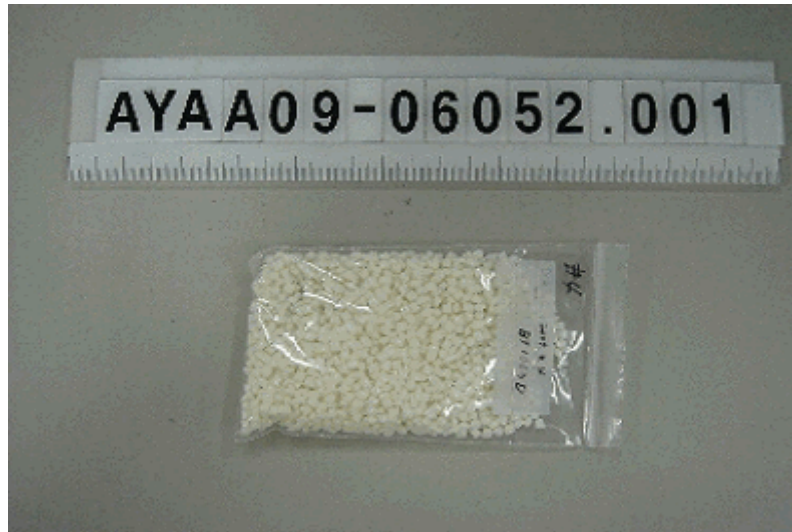

*** End ***

- NOTE:
- (1) N.D. = Not detected.(<MDL)
 - (2) mg/kg = ppm
 - (3) MDL = Method Detection Limit
 - (4) - = No regulation
 - (5) ** = Qualitative analysis (No Unit)
 - (6) Negative = Undetectable / Positive = Detectable

This document is issued by the Company subject to its General Conditions of Service printed overleaf, available on request or accessible at www.sgs.com/terms_and_conditions.htm and, for electronic format documents, subject to Terms and Conditions for Electronic Documents at www.sgs.com/terms_e-document.htm. Attention is drawn to the limitation of liability, indemnification and jurisdiction issues defined therein. Any holder of this document is advised that information contained hereon reflects the Company's findings at the time of its intervention only and within the limits of Client's instructions, if any. The Company's sole responsibility is to its Client and this document does not exonerate parties to a transaction from exercising all their rights and obligations under the transaction documents. This document cannot be reproduced except in full, without prior written approval of the Company. Any unauthorized alteration, forgery or falsification of the content or appearance of this document is unlawful and offenders may be prosecuted to the fullest extent of the law. Unless otherwise stated the results shown in this test report refer only to the sample(s) tested and such sample(s) are retained for 180 days only.

測試報告 Test Report

號碼(No.) : CE/2008/B3037B 日期(Date) : 2009/06/11 頁數(Page) : 1 of 6

太松實業股份有限公司

DYNACHEM & CO., LTD.

台北市大同區重慶北路三段139號8樓

8F, NO. 139, SEC. 3, CHUNG CHING NORTH ROAD, TAIPEI, TAIWAN, R. O. C.



以下測試樣品係由客戶送樣，且由客戶聲稱並經客戶確認如下 (The following samples was/were submitted and identified by/on behalf of the client as) :

樣品名稱(Sample Description) : 聚碳酸樹脂 (POLYCARBONATE (PC), DESIGNATED "PANLITE" FURNISHED AS PELLETS)

樣品型號(Style/Item No.) : AD5503; K1300Y; L1225L; L1225LL; L1225LM; L1225T; L1225Y; L1225Z100; L1225ZL100; L1250VX; L1250Y; L1250ZH; L1250ZG; L1250ZW; L1250Z100; LN1250G; LN2250; LV2225Y; LV2225L; LV2250Y; LN2520A; LS2250; G3110PH; G3120PH; G3410H QG1901HX; G3420 QG1005X; G3430 QG1007X; Z1705ZH; ML1103 QF1232; MN3500; MN3600H; MN3705; MN3705M; DN3715F; SD1414; SP1516

生產或供應廠商(Manufacturer/Vendor) : 帝人株式會社 (TEIJIN CHEMICALS LTD.)

收件日期(Sample Receiving Date) : 2008/11/12

測試期間(Testing Period) : 2008/11/12 TO 2008/11/19

=====
測試結果(Test Results) : 請見下一頁 (Please refer to next pages).

Chenyu Kung / Operation Manager
Signed for and on behalf of
SGS TAIWAN LTD.
Chemical Laboratory – Taipei

Unless otherwise stated the results shown in this test report refer only to the sample(s) tested. This test report cannot be reproduced, except in full, without prior written permission of the Company. 除非另有說明，此報告結果僅對測試之樣品負責。本報告未經本公司書面許可，不可部分複製。

This Test Report is issued by the Company under its General Conditions of Service printed overleaf or available on request and accessible at http://www.sgs.com/terms_and_conditions.htm. Attention is drawn to the limitation of liability, indemnification and jurisdiction issues defined therein. Any holder of this Test Report is advised that information contained hereon reflects the Company's findings at the time of its intervention only and within the limits of Client's instructions, if any. The Company's sole responsibility is to its Client and this document does not exonerate parties to a transaction from exercising all their rights and obligations under the transaction documents. Any unauthorized alteration, forgery or falsification of the content or appearance of this document is unlawful and offenders may be prosecuted to the fullest extent of the law.

測試報告

Test Report

號碼(No.) : CE/2008/B3037B 日期(Date) : 2009/06/11 頁數(Page) : 2 of 6

太松實業股份有限公司

DYNACHEM & CO., LTD.

台北市大同區重慶北路三段139號8樓

8F, NO. 139, SEC. 3, CHUNG CHING NORTH ROAD, TAIPEI, TAIWAN, R. O. C.



測試結果(Test Results)

測試部位(PART NAME) NO.1 : 透明塑膠粒 (TRANSPARENT PLASTIC PELLETS)

測試項目 (Test Items)	單位 (Unit)	測試方法 (Method)	方法偵測 極限值 (MDL)	結果 (Result)
				NO.1
鈹 / Beryllium (Be)	mg/kg	參考US EPA 3050B 方法, 用感應耦合電漿原子發射光譜儀檢測鈹含量。 / With reference to US EPA Method 3050B for Beryllium Content. Analysis was performed by ICP-AES.	2	n.d.
銻 / Antimony (Sb)	mg/kg	參考US EPA 3050B 方法, 用感應耦合電漿原子發射光譜儀檢測銻含量。 / With reference to US EPA Method 3050B for Antimony Content. Analysis was performed by ICP-AES.	2	n.d.
可塑劑定量分析 / Phthalates				
鄰苯二甲酸二丁酯 / DBP (Dibutyl phthalate) (CAS No.: 000084-74-2)	%	本測試參考EN 14372: 2004, 以氣相層析儀/質譜儀檢測之。 / With reference to EN 14372: 2004. Analysis was performed by GC/MS.	0.003	n.d.
鄰苯二甲酸丁酯苯甲酯 / BBP (Benzyl butyl phthalate) (CAS No.: 000085-68-7)	%	本測試參考EN 14372: 2004, 以氣相層析儀/質譜儀檢測之。 / With reference to EN 14372: 2004. Analysis was performed by GC/MS.	0.003	n.d.
鄰苯二甲酸二(2-乙基己基)酯 / DEHP (Di-(2-ethylhexyl) phthalate) (CAS No.: 000117-81-7)	%	本測試參考EN 14372: 2004, 以氣相層析儀/質譜儀檢測之。 / With reference to EN 14372: 2004. Analysis was performed by GC/MS.	0.003	n.d.

Unless otherwise stated the results shown in this test report refer only to the sample(s) tested. This test report cannot be reproduced, except in full, without prior written permission of the Company. 除非另有說明, 此報告結果僅對測試之樣品負責。本報告未經本公司書面許可, 不可部分複製。

This Test Report is issued by the Company under its General Conditions of Service printed overleaf or available on request and accessible at http://www.sgs.com/terms_and_conditions.htm. Attention is drawn to the limitation of liability, indemnification and jurisdiction issues defined therein. Any holder of this Test Report is advised that information contained hereon reflects the Company's findings at the time of its intervention only and within the limits of Client's instructions, if any. The Company's sole responsibility is to its Client and this document does not exonerate parties to a transaction from exercising all their rights and obligations under the transaction documents. Any unauthorized alteration, forgery or falsification of the content or appearance of this document is unlawful and offenders may be prosecuted to the fullest extent of the law.

測試報告

Test Report

號碼(No.) : CE/2008/B3037B 日期(Date) : 2009/06/11 頁數(Page) : 3 of 6

太松實業股份有限公司

DYNACHEM & CO., LTD.

台北市大同區重慶北路三段139號8樓

8F, NO. 139, SEC. 3, CHUNG CHING NORTH ROAD, TAIPEI, TAIWAN, R. O. C.



測試項目 (Test Items)	單位 (Unit)	測試方法 (Method)	方法偵測 極限值 (MDL)	結果 (Result)
				NO.1
鄰苯二甲酸二正辛酯 / DNOP (Di-n-octyl phthalate) (CAS No.: 000117-84-0)	%	本測試參考EN 14372: 2004, 以氣相層析儀/質譜儀檢測之。 / With reference to EN 14372: 2004. Analysis was performed by GC/MS.	0.003	n.d.
鄰苯二甲酸二異壬酯 / DINP (Di-isononyl phthalate) (CAS No.: 028553-12-0)	%	本測試參考EN 14372: 2004, 以氣相層析儀/質譜儀檢測之。 / With reference to EN 14372: 2004. Analysis was performed by GC/MS.	0.01	n.d.
鄰苯二甲酸二異癸酯 / DIDP (Di-isodecyl phthalate) (CAS No.: 026761-40-0)	%	本測試參考EN 14372: 2004, 以氣相層析儀/質譜儀檢測之。 / With reference to EN 14372: 2004. Analysis was performed by GC/MS.	0.01	n.d.

備註(Note) :

1. mg/kg = ppm ; 0.1wt% = 1000ppm
2. n.d. = Not Detected (未檢出)
3. MDL = Method Detection Limit (方法偵測極限值)
4. "---" = Not Conducted (未測項目)

Unless otherwise stated the results shown in this test report refer only to the sample(s) tested. This test report cannot be reproduced, except in full, without prior written permission of the Company. 除非另有說明, 此報告結果僅對測試之樣品負責。本報告未經本公司書面許可, 不可部分複製。

This Test Report is issued by the Company under its General Conditions of Service printed overleaf or available on request and accessible at http://www.sgs.com/terms_and_conditions.htm. Attention is drawn to the limitation of liability, indemnification and jurisdiction issues defined therein. Any holder of this Test Report is advised that information contained hereon reflects the Company's findings at the time of its intervention only and within the limits of Client's instructions, if any. The Company's sole responsibility is to its Client and this document does not exonerate parties to a transaction from exercising all their rights and obligations under the transaction documents. Any unauthorized alteration, forgery or falsification of the content or appearance of this document is unlawful and offenders may be prosecuted to the fullest extent of the law.

測試報告 Test Report

號碼(No.) : CE/2008/B3037B 日期(Date) : 2009/06/11 頁數(Page) : 4 of 6

太松實業股份有限公司
DYNACHEM & CO., LTD.

台北市大同區重慶北路三段139號8樓

8F, NO. 139, SEC. 3, CHUNG CHING NORTH ROAD, TAIPEI, TAIWAN, R. O. C.



- 1) 根據以下的流程圖之條件，樣品已完全溶解。 / These samples were dissolved totally by pre-conditioning method according to below flow chart.
- 2) 測試人員：楊登偉 / Name of the person who made measurement: Climbgreat Yang
- 3) 測試負責人：張啓興 / Name of the person in charge of measurement: Troy Chang

元素的消化流程圖 (Flow Chart of Digestion for elements analysis)

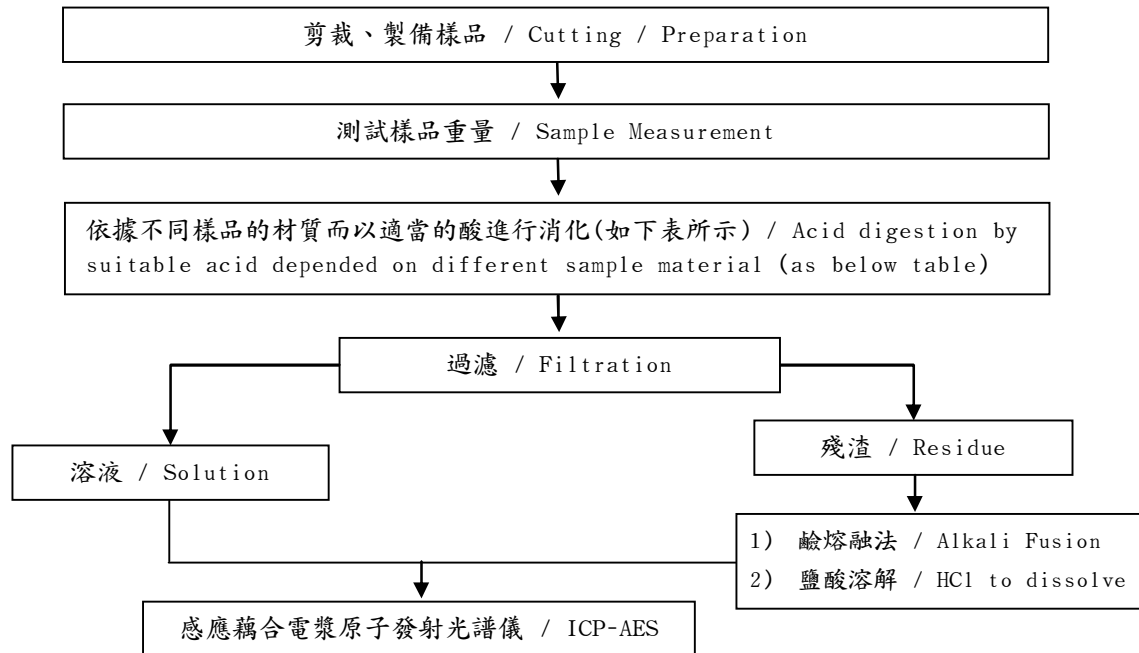

鋼, 銅, 鋁, 焊錫 / Steel, copper, aluminum, solder	王水, 硝酸, 鹽酸, 氫氟酸, 雙氧水 / Aqua regia, HNO ₃ , HCl, HF, H ₂ O ₂
玻璃 / Glass	硝酸, 氫氟酸 / HNO ₃ /HF
金, 鉑, 鈀, 陶瓷 / Gold, platinum, palladium, ceramic	王水 / Aqua regia
銀 / Silver	硝酸 / HNO ₃
塑膠 / Plastic	硫酸, 雙氧水, 硝酸, 鹽酸 / H ₂ SO ₄ , H ₂ O ₂ , HNO ₃ , HCl
其他 / Others	加入任何酸至完全溶解 / Any acid to total digestion

Unless otherwise stated the results shown in this test report refer only to the sample(s) tested. This test report cannot be reproduced, except in full, without prior written permission of the Company. 除非另有說明，此報告結果僅對測試之樣品負責。本報告未經本公司書面許可，不可部分複製。

This Test Report is issued by the Company under its General Conditions of Service printed overleaf or available on request and accessible at http://www.sgs.com/terms_and_conditions.htm. Attention is drawn to the limitation of liability, indemnification and jurisdiction issues defined therein. Any holder of this Test Report is advised that information contained herein reflects the Company's findings at the time of its intervention only and within the limits of Client's instructions, if any. The Company's sole responsibility is to its Client and this document does not exonerate parties to a transaction from exercising all their rights and obligations under the transaction documents. Any unauthorized alteration, forgery or falsification of the content or appearance of this document is unlawful and offenders may be prosecuted to the fullest extent of the law.

測試報告 Test Report

號碼(No.) : CE/2008/B3037B 日期(Date) : 2009/06/11 頁數(Page) : 5 of 6

太松實業股份有限公司

DYNACHEM & CO., LTD.

台北市大同區重慶北路三段139號8樓

8F, NO. 139, SEC. 3, CHUNG CHING NORTH ROAD, TAIPEI, TAIWAN, R. O. C.



可塑劑分析流程圖 / Analytical flow chart of phthalate content

- 1) 測試人員：徐毓明 / Name of the person who made measurement: Andy Shu
- 2) 測試負責人：陳新智 / Name of the person in charge of measurement: Shinjyh Chen

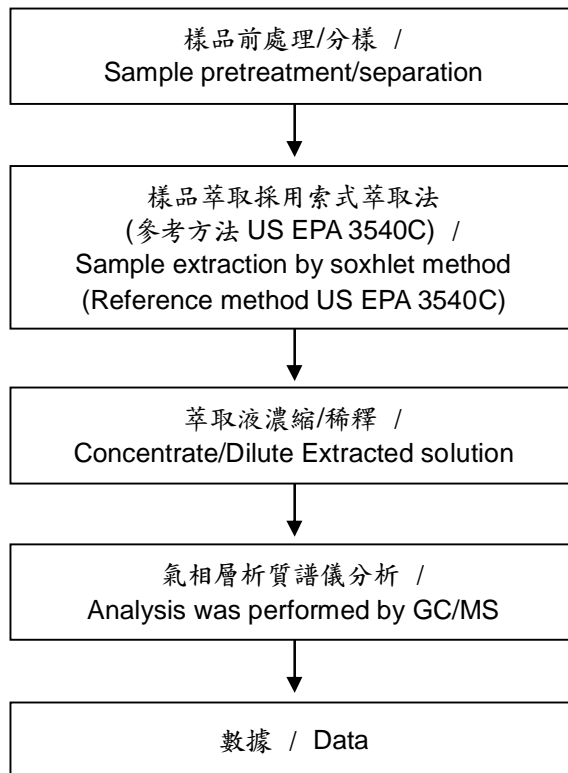

Unless otherwise stated the results shown in this test report refer only to the sample(s) tested. This test report cannot be reproduced, except in full, without prior written permission of the Company. 除非另有說明，此報告結果僅對測試之樣品負責。本報告未經本公司書面許可，不可部分複製。

This Test Report is issued by the Company under its General Conditions of Service printed overleaf or available on request and accessible at http://www.sgs.com/terms_and_conditions.htm. Attention is drawn to the limitation of liability, indemnification and jurisdiction issues defined therein. Any holder of this Test Report is advised that information contained hereon reflects the Company's findings at the time of its intervention only and within the limits of Client's instructions, if any. The Company's sole responsibility is to its Client and this document does not exonerate parties to a transaction from exercising all their rights and obligations under the transaction documents. Any unauthorized alteration, forgery or falsification of the content or appearance of this document is unlawful and offenders may be prosecuted to the fullest extent of the law.

測試報告 Test Report

號碼(No.) : CE/2008/B3037B 日期(Date) : 2009/06/11 頁數(Page) : 6 of 6

太松實業股份有限公司

DYNACHEM & CO., LTD.

台北市大同區重慶北路三段139號8樓

8F, NO. 139, SEC. 3, CHUNG CHING NORTH ROAD, TAIPEI, TAIWAN, R. O. C.



** 報告結尾(End of Report) **

Unless otherwise stated the results shown in this test report refer only to the sample(s) tested. This test report cannot be reproduced, except in full, without prior written permission of the Company. 除非另有說明，此報告結果僅對測試之樣品負責。本報告未經本公司書面許可，不可部分複製。

This Test Report is issued by the Company under its General Conditions of Service printed overleaf or available on request and accessible at http://www.sgs.com/terms_and_conditions.htm. Attention is drawn to the limitation of liability, indemnification and jurisdiction issues defined therein. Any holder of this Test Report is advised that information contained hereon reflects the Company's findings at the time of its intervention only and within the limits of Client's instructions, if any. The Company's sole responsibility is to its Client and this document does not exonerate parties to a transaction from exercising all their rights and obligations under the transaction documents. Any unauthorized alteration, forgery or falsification of the content or appearance of this document is unlawful and offenders may be prosecuted to the fullest extent of the law.

測試報告

號碼：CE/2009/71272

日期：2009/07/14

頁數：1 of 4

唐正企業有限公司
台北縣中和市中正路861巷11號



以下測試樣品係由客戶送樣，且由客戶聲稱並經客戶確認如下：

樣品名稱：空心管之黃銅材質裸面處理
樣品型號：Φ0.6-21
收件日期：2009/07/07
測試期間：2009/07/07 TO 2009/07/14

=====
測試需求：參照 RoHS 2002/95/EC 及其修定指令要求。

測試方法：參考IEC 62321：2008方法檢測。
(1) 用感應耦合電漿原子發射光譜儀(ICP-AES)檢測鎘含量。
(2) 用感應耦合電漿原子發射光譜儀(ICP-AES)檢測鉛含量。
(3) 用感應耦合電漿原子發射光譜儀(ICP-AES)檢測汞含量。
(4) 用Spot test / boiling water extraction方法檢測六價鉻含量。

測試結果：請見下一頁。

Nicole Chien / Supervisor
Signed for and on behalf of
SGS TAIWAN LTD.
Chemical Laboratory - Taipei

Unless otherwise stated the results shown in this test report refer only to the sample(s) tested. This test report cannot be reproduced, except in full, without prior written permission of the Company. 除非另有說明，此報告結果僅對測試之樣品負責。本報告未經本公司書面許可，不可部分複製。

This Test Report is issued by the Company under its General Conditions of Service printed overleaf or available on request and accessible at http://www.sgs.com/terms_and_conditions.htm. Attention is drawn to the limitation of liability, indemnification and jurisdiction issues defined therein. Any holder of this Test Report is advised that information contained hereon reflects the Company's findings at the time of its intervention only and within the limits of Client's instructions, if any. The Company's sole responsibility is to its Client and this document does not exonerate parties to a transaction from exercising all their rights and obligations under the transaction documents. Any unauthorized alteration, forgery or falsification of the content or appearance of this document is unlawful and offenders may be prosecuted to the fullest extent of the law.

測試報告

號碼：CE/2009/71272

日期：2009/07/14

頁數：2 of 4

唐正企業有限公司

台北縣中和市中正路861巷11號



測試結果 (單位: mg/kg)

測試項目	測試方法 (請參考)	結果	方法偵測 極限值
		No. 1	
鎳	(1)	n.d.	2
鉛	(2)	36	2
汞	(3)	n.d.	2
六價鉻 (Spot test / boiling water extraction)	(4)	Negative	備註4

測試部位描述:

NO.1 : 金色金屬

備註: 1. mg/kg = ppm ; 0.1wt% = 1000ppm

2. n.d. = Not Detected (未檢出)

3. MDL = Method Detection Limit (方法偵測極限值)

4. Spot-test:

Negative=鍍層中偵測不到六價鉻, Positive=鍍層中偵測到六價鉻;

當該測項無法確認時, 測試樣品可藉由boiling-water-extraction測試方法進一步確認

Boiling-water-extraction:

Negative=鍍層中偵測不到六價鉻, Positive=鍍層中偵測到六價鉻;

該溶液濃度 ≥ 0.02 mg/kg with 50 cm^2 (sample surface area)

Unless otherwise stated the results shown in this test report refer only to the sample(s) tested. This test report cannot be reproduced, except in full, without prior written permission of the Company. 除非另有說明, 此報告結果僅對測試之樣品負責。本報告未經本公司書面許可, 不可部分複製。

This Test Report is issued by the Company under its General Conditions of Service printed overleaf or available on request and accessible at http://www.sgs.com/terms_and_conditions.htm. Attention is drawn to the limitation of liability, indemnification and jurisdiction issues defined therein. Any holder of this Test Report is advised that information contained hereon reflects the Company's findings at the time of its intervention only and within the limits of Client's instructions, if any. The Company's sole responsibility is to its Client and this document does not exonerate parties to a transaction from exercising all their rights and obligations under the transaction documents. Any unauthorized alteration, forgery or falsification of the content or appearance of this document is unlawful and offenders may be prosecuted to the fullest extent of the law.

測試報告

號碼：CE/2009/71272

日期：2009/07/14

頁數：3 of 4

唐正企業有限公司

台北縣中和市中正路861巷11號



- 1) 根據以下的流程圖之條件，樣品已完全溶解。(六價鉻測試方法除外)
- 2) 測試人員：楊登偉
- 3) 測試負責人：張啓興

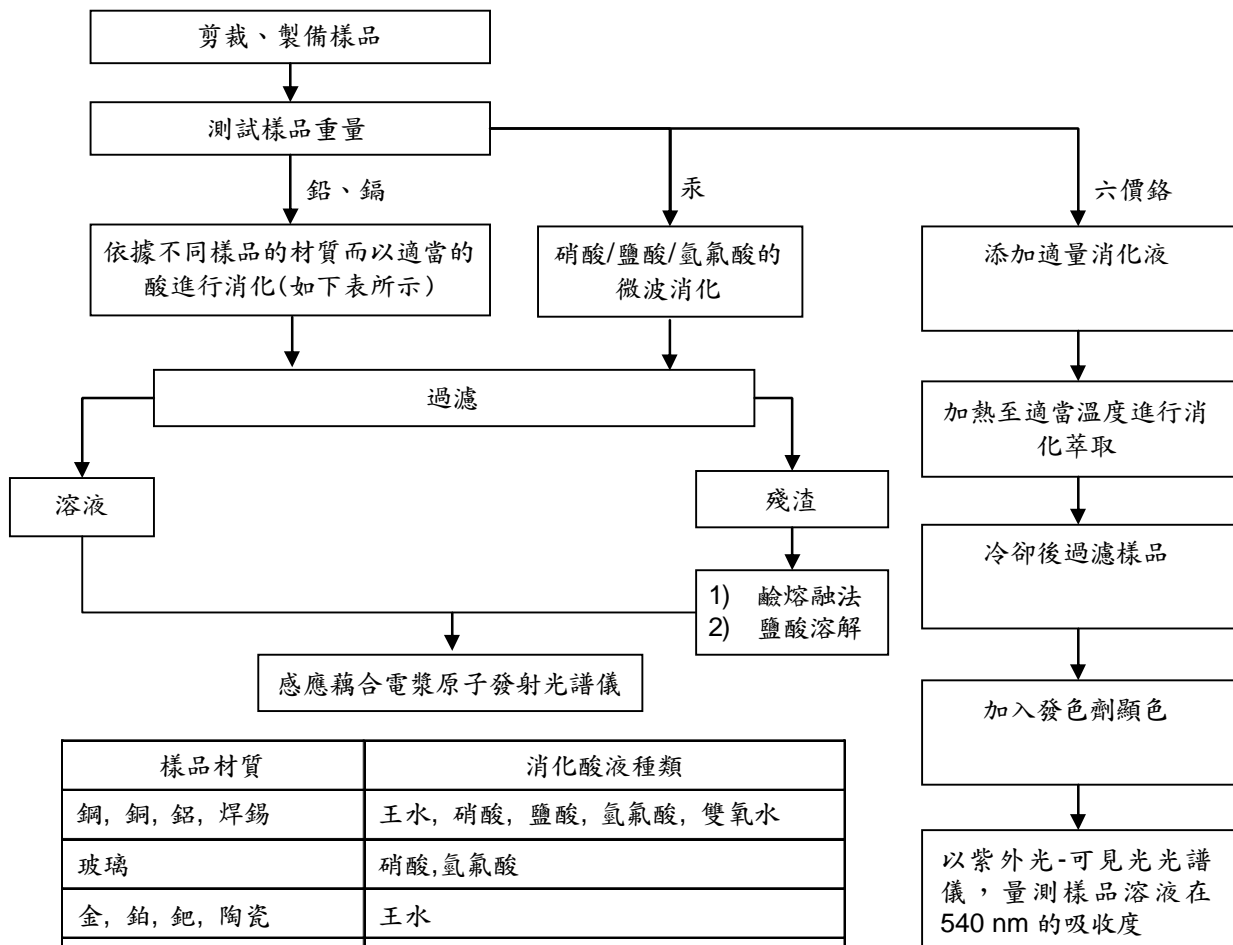

樣品材質	消化酸液種類
銅, 銅, 鋁, 焊錫	王水, 硝酸, 鹽酸, 氫氟酸, 雙氧水
玻璃	硝酸, 氫氟酸
金, 鉑, 鈀, 陶瓷	王水
銀	硝酸
塑膠	硫酸, 雙氧水, 硝酸, 鹽酸
其他	加入任何酸至完全溶解

Unless otherwise stated the results shown in this test report refer only to the sample(s) tested. This test report cannot be reproduced, except in full, without prior written permission of the Company. 除非另有說明，此報告結果僅對測試之樣品負責。本報告未經本公司書面許可，不可部分複製。

This Test Report is issued by the Company under its General Conditions of Service printed overleaf or available on request and accessible at http://www.sgs.com/terms_and_conditions.htm. Attention is drawn to the limitation of liability, indemnification and jurisdiction issues defined therein. Any holder of this Test Report is advised that information contained hereon reflects the Company's findings at the time of its intervention only and within the limits of Client's instructions, if any. The Company's sole responsibility is to its Client and this document does not exonerate parties to a transaction from exercising all their rights and obligations under the transaction documents. Any unauthorized alteration, forgery or falsification of the content or appearance of this document is unlawful and offenders may be prosecuted to the fullest extent of the law.

測試報告

號碼：CE/2009/71272

日期：2009/07/14

頁數：4 of 4

唐正企業有限公司

台北縣中和市中正路861巷11號



** 報告結尾 **

Unless otherwise stated the results shown in this test report refer only to the sample(s) tested. This test report cannot be reproduced, except in full, without prior written permission of the Company. 除非另有說明，此報告結果僅對測試之樣品負責。本報告未經本公司書面許可，不可部分複製。

This Test Report is issued by the Company under its General Conditions of Service printed overleaf or available on request and accessible at http://www.sgs.com/terms_and_conditions.htm. Attention is drawn to the limitation of liability, indemnification and jurisdiction issues defined therein. Any holder of this Test Report is advised that information contained hereon reflects the Company's findings at the time of its intervention only and within the limits of Client's instructions, if any. The Company's sole responsibility is to its Client and this document does not exonerate parties to a transaction from exercising all their rights and obligations under the transaction documents. Any unauthorized alteration, forgery or falsification of the content or appearance of this document is unlawful and offenders may be prosecuted to the fullest extent of the law.