

FCC SAR Test Report

Report No. : SA160511C17
Applicant : ASUSTek COMPUTER INC.
Address : 4F, No. 150, LI-TE Rd., PEITOU, TAIPEI 112, TAIWAN
Product : ASUS Tablet
FCC ID : MSQP027
Brand : ASUS
Model No. : P027
Standards : FCC 47 CFR Part 2 (2.1093) / IEEE C95.1:1992 / IEEE Std 1528:2013
 KDB 865664 D01 v01r04 / KDB 865664 D02 v01r02 / KDB 248227 D01 v02r02
 KDB 447498 D01 v06 / KDB 616217 D04 v01r02
Sample Received Date : May 11, 2016
Date of Testing : May 22, 2016 ~ May 23, 2016

CERTIFICATION: The above equipment have been tested by **Bureau Veritas Consumer Products Services (H.K.) Ltd., Taoyuan Branch – Lin Kou Laboratories**, and found compliance with the requirement of the above standards. The test record, data evaluation & Equipment Under Test (EUT) configurations represented herein are true and accurate accounts of the measurements of the sample’s SAR characteristics under the conditions specified in this report. It should not be reproduced except in full, without the written approval of our laboratory. The client should not use it to claim product certification, approval, or endorsement by TAF or any government agencies.

Prepared By : 

 Rona Chen / Specialist

Approved By : 

 Eli Hsu / Supervisor



This report is for your exclusive use. Any copying or replication of this report to or for any other person or entity, or use of our name or trademark, is permitted only with our prior written permission. This report sets forth our findings solely with respect to the test samples identified herein. The results set forth in this report are not indicative or representative of the quality or characteristics of the lot from which a test sample was taken or any similar or identical product unless specifically and expressly noted. Our report includes all of the tests requested by you and the results thereof based upon the information that you provided to us. You have 60 days from date of issuance of this report to notify us of any material error or omission caused by our negligence, provided, however, that such notice shall be in writing and shall specifically address the issue you wish to raise. A failure to raise such issue within the prescribed time shall constitute your unqualified acceptance of the completeness of this report, the tests conducted and the correctness of the report contents. Unless specific mention, the uncertainty of measurement has been explicitly taken into account to declare the compliance or non-compliance to the specification.

Table of Contents

| | |
|---|-----------|
| Release Control Record | 3 |
| 1. Summary of Maximum SAR Value | 4 |
| 2. Description of Equipment Under Test | 5 |
| 3. SAR Measurement System | 6 |
| 3.1 Definition of Specific Absorption Rate (SAR) | 6 |
| 3.2 SPEAG DASY System | 6 |
| 3.2.1 Robot..... | 7 |
| 3.2.2 Probes..... | 8 |
| 3.2.3 Data Acquisition Electronics (DAE) | 8 |
| 3.2.4 Phantoms | 9 |
| 3.2.5 Device Holder..... | 10 |
| 3.2.6 System Validation Dipoles..... | 10 |
| 3.2.7 Tissue Simulating Liquids..... | 11 |
| 3.3 SAR System Verification | 14 |
| 3.4 SAR Measurement Procedure | 15 |
| 3.4.1 Area & Zoom Scan Procedure | 15 |
| 3.4.2 Volume Scan Procedure..... | 15 |
| 3.4.3 Power Drift Monitoring..... | 16 |
| 3.4.4 Spatial Peak SAR Evaluation | 16 |
| 3.4.5 SAR Averaged Methods | 16 |
| 4. SAR Measurement Evaluation | 17 |
| 4.1 EUT Configuration and Setting..... | 17 |
| 4.2 EUT Testing Position | 19 |
| 4.2.1 Body Exposure Conditions | 19 |
| 4.2.2 SAR Test Exclusion Evaluations | 20 |
| 4.3 Tissue Verification | 21 |
| 4.4 System Validation..... | 21 |
| 4.5 System Verification..... | 21 |
| 4.6 Maximum Output Power..... | 22 |
| 4.6.1 Maximum Conducted Power | 22 |
| 4.6.2 Measured Conducted Power Result..... | 22 |
| 4.7 SAR Testing Results | 23 |
| 4.7.1 SAR Test Reduction Considerations | 23 |
| 4.7.2 SAR Results for Body Exposure Condition (Separation Distance is 0 cm Gap) | 24 |
| 4.7.3 SAR Measurement Variability..... | 24 |
| 5. Calibration of Test Equipment..... | 25 |
| 6. Measurement Uncertainty..... | 26 |
| 7. Information on the Testing Laboratories..... | 28 |
| | |
| Appendix A. SAR Plots of System Verification | |
| Appendix B. SAR Plots of SAR Measurement | |
| Appendix C. Calibration Certificate for Probe and Dipole | |
| Appendix D. Photographs of EUT and Setup | |

1. Summary of Maximum SAR Value

| Equipment Class | Mode | Highest Reported Body SAR _{1g} (0 cm Gap) (W/kg) |
|-----------------|-----------|---|
| DTS | 2.4G WLAN | 0.54 |
| NII | 5.2G WLAN | 1.01 |
| | 5.6G WLAN | 0.88 |
| | 5.8G WLAN | 0.76 |
| DSS | Bluetooth | 0.09 |

Note:

1. The SAR limit (**Head & Body: SAR_{1g} 1.6 W/kg, Extremity: SAR_{10g} 4.0 W/kg**) for general population / uncontrolled exposure is specified in FCC 47 CFR part 2 (2.1093) and ANSI/IEEE C95.1-1992.

2. Description of Equipment Under Test

| | |
|--|---|
| EUT Type | ASUS Tablet |
| FCC ID | MSQP027 |
| Brand Name | ASUS |
| Model Name | P027 |
| Tx Frequency Bands (Unit: MHz) | WLAN : 2412 ~ 2462, 5180 ~ 5240, 5260 ~ 5320, 5500 ~ 5700, 5745 ~ 5825 Bluetooth : 2402 ~ 2480 |
| Uplink Modulations | 802.11b : DSSS 802.11a/g/n/ac : OFDM Bluetooth : GFSK, π/4-DQPSK, 8-DPSK |
| Maximum Tune-up Conducted Power (Unit: dBm) | WLAN 2.4G : 16.0 WLAN 5.2G : 10.0 WLAN 5.3G : 10.0 WLAN 5.6G : 10.0 WLAN 5.8G : 10.0 Bluetooth : 7.0 |
| Antenna Type | PIFA Antenna |
| EUT Stage | Identical Prototype |

Note:

1. The above EUT information is declared by manufacturer and for more detailed features description please refers to the manufacturer's specifications or User's Manual.

List of Accessory:

| | | |
|-----------------------|----------------------|------------------------|
| Battery | Brand Name | SMP |
| | Model Name | C12P1601 |
| | Power Rating | 3.85Vdc, 5900mAh, 22WH |
| | Type | Li-ion |
| LCD Panel | Brand Name | TIANMA |
| | Model Name | TM097QDSP01-00 |
| | Specification | 9.7" |
| Front Camera | Brand Name | CHICONY |
| | Model Name | CBFE55720003870LH |
| | Specification | 5M |
| Rear Camera | Brand Name | CHICONY |
| | Model Name | CJAF83020003871LH |
| | Specification | 8M |
| BT/WLAN Module | Brand Name | MTK |
| | Model Name | MT6630QP |

3. SAR Measurement System

3.1 Definition of Specific Absorption Rate (SAR)

SAR is related to the rate at which energy is absorbed per unit mass in an object exposed to a radio field. The SAR distribution in a biological body is complicated and is usually carried out by experimental techniques or numerical modeling. The standard recommends limits for two tiers of groups, occupational/controlled and general population/uncontrolled, based on a person's awareness and ability to exercise control over his or her exposure. In general, occupational/controlled exposure limits are higher than the limits for general population/uncontrolled.

The SAR definition is the time derivative (rate) of the incremental energy (dW) absorbed by (dissipated in) an incremental mass (dm) contained in a volume element (dv) of a given density (ρ). The equation description is as below:

$$\text{SAR} = \frac{d}{dt} \left(\frac{dW}{dm} \right) = \frac{d}{dt} \left(\frac{dW}{\rho dv} \right)$$

SAR is expressed in units of Watts per kilogram (W/kg)

SAR measurement can be related to the electrical field in the tissue by

$$\text{SAR} = \frac{\sigma |E|^2}{\rho}$$

Where: σ is the conductivity of the tissue, ρ is the mass density of the tissue and E is the RMS electrical field strength.

3.2 SPEAG DASY System

DASY system consists of high precision robot, probe alignment sensor, phantom, robot controller, controlled measurement server and near-field probe. The robot includes six axes that can move to the precision position of the DASY4/5 software defined. The DASY software can define the area that is detected by the probe. The robot is connected to controlled box. Controlled measurement server is connected to the controlled robot box. The DAE includes amplifier, signal multiplexing, AD converter, offset measurement and surface detection. It is connected to the Electro-optical coupler (ECO). The ECO performs the conversion from the optical into digital electric signal of the DAE and transfers data to the PC.

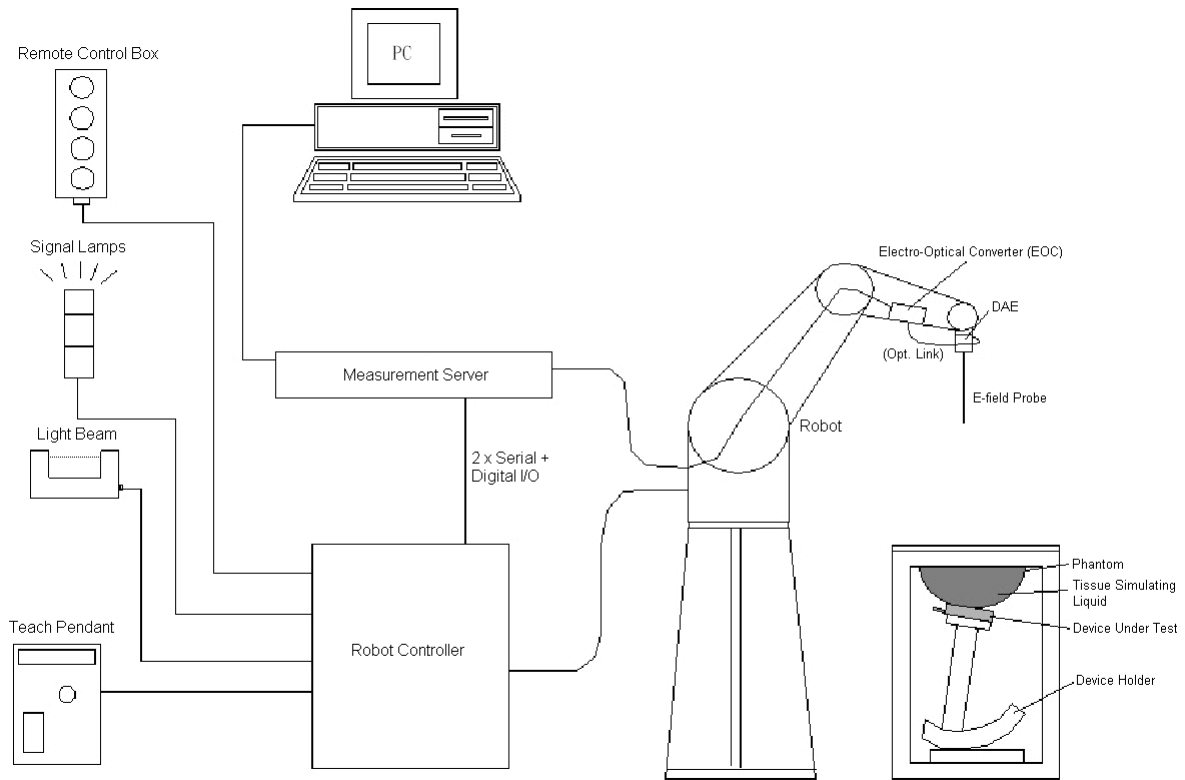

Fig-3.1 SPEAG DASY52 System Setup

3.2.1 Robot

The SPEAG DASY52 systems use the high precision robots from Stäubli SA (France). For the 6-axis controller system, the robot controller version (CS8c) from Stäubli is used. The Stäubli robot series have many features that are important for our application:

- High precision (repeatability ± 0.035 mm)
- High reliability (industrial design)
- Jerk-free straight movements
- Low ELF interference (the closed metallic construction shields against motor control fields)





Fig-3.2 SPEAG DASY52 System

FCC SAR Test Report

3.2.2 Probes

The SAR measurement is conducted with the dosimetric probe. The probe is specially designed and calibrated for use in liquid with high permittivity. The dosimetric probe has special calibration in liquid at different frequency.

| | | |
|----------------------|--|---|
| Model | EX3DV4 |  |
| Construction | Symmetrical design with triangular core. Built-in shielding against static charges. PEEK enclosure material (resistant to organic solvents, e.g., DGBE). | |
| Frequency | 10 MHz to 6 GHz Linearity: ± 0.2 dB | |
| Directivity | ± 0.3 dB in HSL (rotation around probe axis) ± 0.5 dB in tissue material (rotation normal to probe axis) | |
| Dynamic Range | 10 μ W/g to 100 mW/g Linearity: ± 0.2 dB (noise: typically < 1 μ W/g) | |
| Dimensions | Overall length: 337 mm (Tip: 20 mm) Tip diameter: 2.5 mm (Body: 12 mm) Typical distance from probe tip to dipole centers: 1 mm | |

| | | |
|----------------------|---|--|
| Model | ES3DV3 |  |
| Construction | Symmetrical design with triangular core. Interleaved sensors. Built-in shielding against static charges. PEEK enclosure material (resistant to organic solvents, e.g., DGBE). | |
| Frequency | 10 MHz to 4 GHz Linearity: ± 0.2 dB | |
| Directivity | ± 0.2 dB in HSL (rotation around probe axis) ± 0.3 dB in tissue material (rotation normal to probe axis) | |
| Dynamic Range | 5 μ W/g to 100 mW/g Linearity: ± 0.2 dB | |
| Dimensions | Overall length: 337 mm (Tip: 20 mm) Tip diameter: 3.9 mm (Body: 12 mm) Distance from probe tip to dipole centers: 2.0 mm | |

3.2.3 Data Acquisition Electronics (DAE)

| | | |
|-----------------------------|---|---|
| Model | DAE3, DAE4 |  |
| Construction | Signal amplifier, multiplexer, A/D converter and control logic. Serial optical link for communication with DASY embedded system (fully remote controlled). Two step probe touch detector for mechanical surface detection and emergency robot stop. | |
| Measurement Range | -100 to +300 mV (16 bit resolution and two range settings: 4mV, 400mV) | |
| Input Offset Voltage | < 5 μ V (with auto zero) | |
| Input Bias Current | < 50 fA | |
| Dimensions | 60 x 60 x 68 mm | |

FCC SAR Test Report

3.2.4 Phantoms

| | | |
|------------------------|---|---|
| Model | Twin SAM |  |
| Construction | The shell corresponds to the specifications of the Specific Anthropomorphic Mannequin (SAM) phantom defined in IEEE 1528 and IEC 62209-1. It enables the dosimetric evaluation of left and right hand phone usage as well as body mounted usage at the flat phantom region. A cover prevents evaporation of the liquid. Reference markings on the phantom allow the complete setup of all predefined phantom positions and measurement grids by teaching three points with the robot. | |
| Material | Vinylester, glass fiber reinforced (VE-GF) | |
| Shell Thickness | 2 ± 0.2 mm (6 ± 0.2 mm at ear point) | |
| Dimensions | Length: 1000 mm Width: 500 mm Height: adjustable feet | |
| Filling Volume | approx. 25 liters | |

| | | |
|------------------------|---|--|
| Model | ELI |  |
| Construction | Phantom for compliance testing of handheld and body-mounted wireless devices in the frequency range of 30 MHz to 6 GHz. ELI is fully compatible with the IEC 62209-2 standard and all known tissue simulating liquids. ELI has been optimized regarding its performance and can be integrated into our standard phantom tables. A cover prevents evaporation of the liquid. Reference markings on the phantom allow installation of the complete setup, including all predefined phantom positions and measurement grids, by teaching three points. The phantom is compatible with all SPEAG dosimetric probes and dipoles. | |
| Material | Vinylester, glass fiber reinforced (VE-GF) | |
| Shell Thickness | 2.0 ± 0.2 mm (bottom plate) | |
| Dimensions | Major axis: 600 mm Minor axis: 400 mm | |
| Filling Volume | approx. 30 liters | |

FCC SAR Test Report

3.2.5 Device Holder

| | | |
|---------------------|---|---|
| Model | Mounting Device |  |
| Construction | In combination with the Twin SAM Phantom or ELI4, the Mounting Device enables the rotation of the mounted transmitter device in spherical coordinates. Rotation point is the ear opening point. Transmitter devices can be easily and accurately positioned according to IEC, IEEE, FCC or other specifications. The device holder can be locked for positioning at different phantom sections (left head, right head, flat). | |
| Material | POM | |

| | | |
|---------------------|---|---|
| Model | Laptop Extensions Kit |  |
| Construction | Simple but effective and easy-to-use extension for Mounting Device that facilitates the testing of larger devices according to IEC 62209-2 (e.g., laptops, cameras, etc.). It is lightweight and fits easily on the upper part of the Mounting Device in place of the phone positioner. | |
| Material | POM, Acrylic glass, Foam | |

3.2.6 System Validation Dipoles

| | | |
|-------------------------|--|---|
| Model | D-Serial |  |
| Construction | Symmetrical dipole with 1/4 balun. Enables measurement of feed point impedance with NWA. Matched for use near flat phantoms filled with tissue simulating solutions. | |
| Frequency | 750 MHz to 5800 MHz | |
| Return Loss | > 20 dB | |
| Power Capability | > 100 W (f < 1GHz), > 40 W (f > 1GHz) | |

3.2.7 Tissue Simulating Liquids

For SAR measurement of the field distribution inside the phantom, the phantom must be filled with homogeneous tissue simulating liquid to a depth of at least 15 cm. For head SAR testing, the liquid height from the ear reference point (ERP) of the phantom to the liquid top surface is larger than 15 cm. For body SAR testing, the liquid height from the center of the flat phantom to the liquid top surface is larger than 15 cm. The nominal dielectric values of the tissue simulating liquids in the phantom and the tolerance of 5% are listed in Table-3.1.

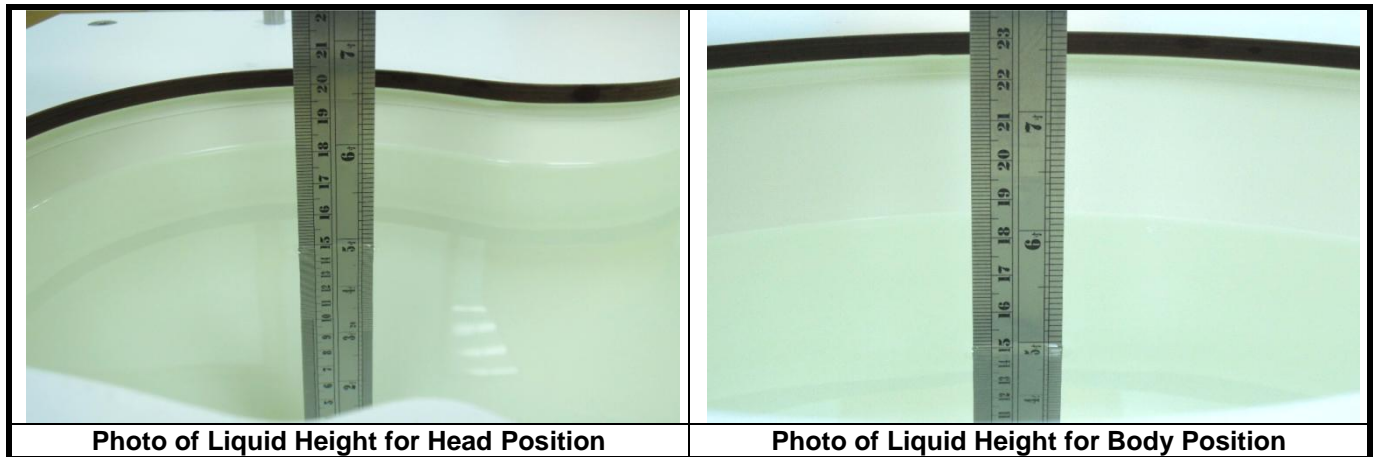

The dielectric properties of the head tissue simulating liquids are defined in IEEE 1528, and KDB 865664 D01 Appendix A. For the body tissue simulating liquids, the dielectric properties are defined in KDB 865664 D01 Appendix A. The dielectric properties of the tissue simulating liquids were verified prior to the SAR evaluation using a dielectric assessment kit and a network analyzer.

Table-3.1 Targets of Tissue Simulating Liquid

| Frequency (MHz) | Target Permittivity | Range of $\pm 5\%$ | Target Conductivity | Range of $\pm 5\%$ |
|-----------------|---------------------|--------------------|---------------------|--------------------|
| For Head | | | | |
| 750 | 41.9 | 39.8 ~ 44.0 | 0.89 | 0.85 ~ 0.93 |
| 835 | 41.5 | 39.4 ~ 43.6 | 0.90 | 0.86 ~ 0.95 |
| 900 | 41.5 | 39.4 ~ 43.6 | 0.97 | 0.92 ~ 1.02 |
| 1450 | 40.5 | 38.5 ~ 42.5 | 1.20 | 1.14 ~ 1.26 |
| 1640 | 40.3 | 38.3 ~ 42.3 | 1.29 | 1.23 ~ 1.35 |
| 1750 | 40.1 | 38.1 ~ 42.1 | 1.37 | 1.30 ~ 1.44 |
| 1800 | 40.0 | 38.0 ~ 42.0 | 1.40 | 1.33 ~ 1.47 |
| 1900 | 40.0 | 38.0 ~ 42.0 | 1.40 | 1.33 ~ 1.47 |
| 2000 | 40.0 | 38.0 ~ 42.0 | 1.40 | 1.33 ~ 1.47 |
| 2300 | 39.5 | 37.5 ~ 41.5 | 1.67 | 1.59 ~ 1.75 |
| 2450 | 39.2 | 37.2 ~ 41.2 | 1.80 | 1.71 ~ 1.89 |
| 2600 | 39.0 | 37.1 ~ 41.0 | 1.96 | 1.86 ~ 2.06 |
| 3500 | 37.9 | 36.0 ~ 39.8 | 2.91 | 2.76 ~ 3.06 |
| 5200 | 36.0 | 34.2 ~ 37.8 | 4.66 | 4.43 ~ 4.89 |
| 5300 | 35.9 | 34.1 ~ 37.7 | 4.76 | 4.52 ~ 5.00 |
| 5500 | 35.6 | 33.8 ~ 37.4 | 4.96 | 4.71 ~ 5.21 |
| 5600 | 35.5 | 33.7 ~ 37.3 | 5.07 | 4.82 ~ 5.32 |
| 5800 | 35.3 | 33.5 ~ 37.1 | 5.27 | 5.01 ~ 5.53 |
| For Body | | | | |
| 750 | 55.5 | 52.7 ~ 58.3 | 0.96 | 0.91 ~ 1.01 |
| 835 | 55.2 | 52.4 ~ 58.0 | 0.97 | 0.92 ~ 1.02 |
| 900 | 55.0 | 52.3 ~ 57.8 | 1.05 | 1.00 ~ 1.10 |
| 1450 | 54.0 | 51.3 ~ 56.7 | 1.30 | 1.24 ~ 1.37 |
| 1640 | 53.8 | 51.1 ~ 56.5 | 1.40 | 1.33 ~ 1.47 |
| 1750 | 53.4 | 50.7 ~ 56.1 | 1.49 | 1.42 ~ 1.56 |
| 1800 | 53.3 | 50.6 ~ 56.0 | 1.52 | 1.44 ~ 1.60 |
| 1900 | 53.3 | 50.6 ~ 56.0 | 1.52 | 1.44 ~ 1.60 |
| 2000 | 53.3 | 50.6 ~ 56.0 | 1.52 | 1.44 ~ 1.60 |
| 2300 | 52.9 | 50.3 ~ 55.5 | 1.81 | 1.72 ~ 1.90 |
| 2450 | 52.7 | 50.1 ~ 55.3 | 1.95 | 1.85 ~ 2.05 |
| 2600 | 52.5 | 49.9 ~ 55.1 | 2.16 | 2.05 ~ 2.27 |
| 3500 | 51.3 | 48.7 ~ 53.9 | 3.31 | 3.14 ~ 3.48 |
| 5200 | 49.0 | 46.6 ~ 51.5 | 5.30 | 5.04 ~ 5.57 |
| 5300 | 48.9 | 46.5 ~ 51.3 | 5.42 | 5.15 ~ 5.69 |
| 5500 | 48.6 | 46.2 ~ 51.0 | 5.65 | 5.37 ~ 5.93 |
| 5600 | 48.5 | 46.1 ~ 50.9 | 5.77 | 5.48 ~ 6.06 |
| 5800 | 48.2 | 45.8 ~ 50.6 | 6.00 | 5.70 ~ 6.30 |

FCC SAR Test Report

The following table gives the recipes for tissue simulating liquids.

Table-3.2 Recipes of Tissue Simulating Liquid

| Tissue Type | Bactericide | DGBE | HEC | NaCl | Sucrose | Triton X-100 | Water | Diethylene Glycol Mono-hexylether |
|-------------|-------------|------|-----|------|---------|--------------|-------|-----------------------------------|
| H750 | 0.2 | - | 0.2 | 1.5 | 56.0 | - | 42.1 | - |
| H835 | 0.2 | - | 0.2 | 1.5 | 57.0 | - | 41.1 | - |
| H900 | 0.2 | - | 0.2 | 1.4 | 58.0 | - | 40.2 | - |
| H1450 | - | 43.3 | - | 0.6 | - | - | 56.1 | - |
| H1640 | - | 45.8 | - | 0.5 | - | - | 53.7 | - |
| H1750 | - | 47.0 | - | 0.4 | - | - | 52.6 | - |
| H1800 | - | 44.5 | - | 0.3 | - | - | 55.2 | - |
| H1900 | - | 44.5 | - | 0.2 | - | - | 55.3 | - |
| H2000 | - | 44.5 | - | 0.1 | - | - | 55.4 | - |
| H2300 | - | 44.9 | - | 0.1 | - | - | 55.0 | - |
| H2450 | - | 45.0 | - | 0.1 | - | - | 54.9 | - |
| H2600 | - | 45.1 | - | 0.1 | - | - | 54.8 | - |
| H3500 | - | 8.0 | - | 0.2 | - | 20.0 | 71.8 | - |
| H5G | - | - | - | - | - | 17.2 | 65.5 | 17.3 |
| B750 | 0.2 | - | 0.2 | 0.8 | 48.8 | - | 50.0 | - |
| B835 | 0.2 | - | 0.2 | 0.9 | 48.5 | - | 50.2 | - |
| B900 | 0.2 | - | 0.2 | 0.9 | 48.2 | - | 50.5 | - |
| B1450 | - | 34.0 | - | 0.3 | - | - | 65.7 | - |
| B1640 | - | 32.5 | - | 0.3 | - | - | 67.2 | - |
| B1750 | - | 31.0 | - | 0.2 | - | - | 68.8 | - |
| B1800 | - | 29.5 | - | 0.4 | - | - | 70.1 | - |
| B1900 | - | 29.5 | - | 0.3 | - | - | 70.2 | - |
| B2000 | - | 30.0 | - | 0.2 | - | - | 69.8 | - |
| B2300 | - | 31.0 | - | 0.1 | - | - | 68.9 | - |
| B2450 | - | 31.4 | - | 0.1 | - | - | 68.5 | - |
| B2600 | - | 31.8 | - | 0.1 | - | - | 68.1 | - |
| B3500 | - | 28.8 | - | 0.1 | - | - | 71.1 | - |
| B5G | - | - | - | - | - | 10.7 | 78.6 | 10.7 |

3.3 SAR System Verification

The system check verifies that the system operates within its specifications. It is performed daily or before every SAR measurement. The system check uses normal SAR measurements in the flat section of the phantom with a matched dipole at a specified distance. The system verification setup is shown as below.

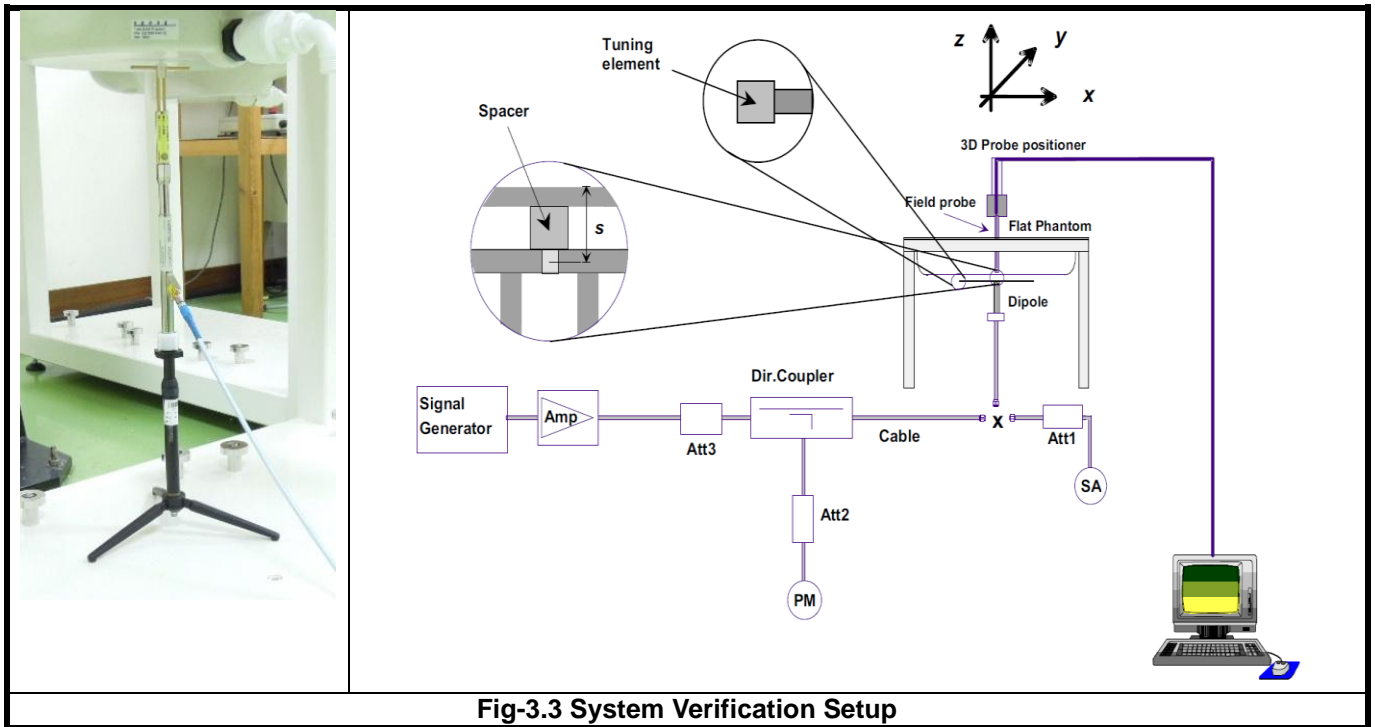

Fig-3.3 System Verification Setup

The validation dipole is placed beneath the flat phantom with the specific spacer in place. The distance spacer is touch the phantom surface with a light pressure at the reference marking and be oriented parallel to the long side of the phantom. The spectrum analyzer measures the forward power at the location of the system check dipole connector. The signal generator is adjusted for the desired forward power (250 mW is used for 700 MHz to 3 GHz, 100 mW is used for 3.5 GHz to 6 GHz) at the dipole connector and the power meter is read at that level. After connecting the cable to the dipole, the signal generator is readjusted for the same reading at power meter.

After system check testing, the SAR result will be normalized to 1W forward input power and compared with the reference SAR value derived from validation dipole certificate report. The deviation of system check should be within 10 %.

3.4 SAR Measurement Procedure

According to the SAR test standard, the recommended procedure for assessing the peak spatial-average SAR value consists of the following steps:

- (a) Power reference measurement
- (b) Area scan
- (c) Zoom scan
- (d) Power drift measurement

The SAR measurement procedures for each of test conditions are as follows:

- (a) Make EUT to transmit maximum output power
- (b) Measure conducted output power through RF cable
- (c) Place the EUT in the specific position of phantom
- (d) Perform SAR testing steps on the DASY system
- (e) Record the SAR value

3.4.1 Area & Zoom Scan Procedure

First Area Scan is used to locate the approximate location(s) of the local peak SAR value(s). The measurement grid within an Area Scan is defined by the grid extent, grid step size and grid offset. Next, in order to determine the EM field distribution in a three-dimensional spatial extension, Zoom Scan is required. The Zoom Scan is performed around the highest E-field value to determine the averaged SAR-distribution over 10 g. According to KDB 865664 D01, the resolution for Area and Zoom scan is specified in the table below.

| Items | <= 2 GHz | 2-3 GHz | 3-4 GHz | 4-5 GHz | 5-6 GHz |
|------------------------------------|----------|----------|----------|----------|----------|
| Area Scan ($\Delta x, \Delta y$) | <= 15 mm | <= 12 mm | <= 12 mm | <= 10 mm | <= 10 mm |
| Zoom Scan ($\Delta x, \Delta y$) | <= 8 mm | <= 5 mm | <= 5 mm | <= 4 mm | <= 4 mm |
| Zoom Scan (Δz) | <= 5 mm | <= 5 mm | <= 4 mm | <= 3 mm | <= 2 mm |
| Zoom Scan Volume | >= 30 mm | >= 30 mm | >= 28 mm | >= 25 mm | >= 22 mm |

Note:

When zoom scan is required and report SAR is <= 1.4 W/kg, the zoom scan resolution of $\Delta x / \Delta y$ (2-3GHz: <= 8 mm, 3-4GHz: <= 7 mm, 4-6GHz: <= 5 mm) may be applied.

3.4.2 Volume Scan Procedure

The volume scan is used for assess overlapping SAR distributions for antennas transmitting in different frequency bands. It is equivalent to an oversized zoom scan used in standalone measurements. The measurement volume will be used to enclose all the simultaneous transmitting antennas. For antennas transmitting simultaneously in different frequency bands, the volume scan is measured separately in each frequency band. In order to sum correctly to compute the 1g aggregate SAR, the EUT remain in the same test position for all measurements and all volume scan use the same spatial resolution and grid spacing. When all volume scan were completed, the software, SEMCAD postprocessor can combine and subsequently superpose these measurement data to calculating the multiband SAR.

3.4.3 Power Drift Monitoring

All SAR testing is under the EUT install full charged battery and transmit maximum output power. In DASY measurement software, the power reference measurement and power drift measurement procedures are used for monitoring the power drift of EUT during SAR test. Both these procedures measure the field at a specified reference position before and after the SAR testing. The software will calculate the field difference in dB. If the power drift more than 5%, the SAR will be retested.

3.4.4 Spatial Peak SAR Evaluation

The procedure for spatial peak SAR evaluation has been implemented according to the test standard. It can be conducted for 1g and 10g, as well as for user-specific masses. The DASY software includes all numerical procedures necessary to evaluate the spatial peak SAR value.

The base for the evaluation is a "cube" measurement. The measured volume must include the 1g and 10g cubes with the highest averaged SAR values. For that purpose, the center of the measured volume is aligned to the interpolated peak SAR value of a previously performed area scan.

The entire evaluation of the spatial peak values is performed within the post-processing engine (SEMCAD). The system always gives the maximum values for the 1g and 10g cubes. The algorithm to find the cube with highest averaged SAR is divided into the following stages:

- (a) Extraction of the measured data (grid and values) from the Zoom Scan
- (b) Calculation of the SAR value at every measurement point based on all stored data (A/D values and measurement parameters)
- (c) Generation of a high-resolution mesh within the measured volume
- (d) Interpolation of all measured values from the measurement grid to the high-resolution grid
- (e) Extrapolation of the entire 3-D field distribution to the phantom surface over the distance from sensor to surface
- (f) Calculation of the averaged SAR within masses of 1g and 10g

3.4.5 SAR Averaged Methods

In DASY, the interpolation and extrapolation are both based on the modified Quadratic Shepard's method. The interpolation scheme combines a least-square fitted function method and a weighted average method which are the two basic types of computational interpolation and approximation.

Extrapolation routines are used to obtain SAR values between the lowest measurement points and the inner phantom surface. The extrapolation distance is determined by the surface detection distance and the probe sensor offset. The uncertainty increases with the extrapolation distance. To keep the uncertainty within 1% for the 1 g and 10 g cubes, the extrapolation distance should not be larger than 5 mm.

4. SAR Measurement Evaluation

4.1 EUT Configuration and Setting

<Considerations Related to WLAN for Setup and Testing>

In general, various vendor specific external test software and chipset based internal test modes are typically used for SAR measurement. These chipset based test mode utilities are generally hardware and manufacturer dependent, and often include substantial flexibility to reconfigure or reprogram a device. A Wi-Fi device must be configured to transmit continuously at the required data rate, channel bandwidth and signal modulation, using the highest transmission duty factor supported by the test mode tools for SAR measurement. The test frequencies established using test mode must correspond to the actual channel frequencies. When 802.11 frame gaps are accounted for in the transmission, a maximum transmission duty factor of 92 - 96% is typically achievable in most test mode configurations. A minimum transmission duty factor of 85% is required to avoid certain hardware and device implementation issues related to wide range SAR scaling. In addition, a periodic transmission duty factor is required for current generation SAR systems to measure SAR correctly. The reported SAR must be scaled to 100% transmission duty factor to determine compliance at the maximum tune-up tolerance limit.

According to KDB 248227 D01, this device has installed WLAN engineering testing software which can provide continuous transmitting RF signal. During WLAN SAR testing, this device was operated to transmit continuously at the maximum transmission duty with specified transmission mode, operating frequency, lowest data rate, and maximum output power.

Initial Test Configuration

An initial test configuration is determined for OFDM transmission modes in 2.4 GHz and 5 GHz bands according to the channel bandwidth, modulation and data rate combination(s) with the highest maximum output power specified for production units in each standalone and aggregated frequency band. When the same maximum power is specified for multiple transmission modes in a frequency band, the largest channel bandwidth, lowest order modulation, lowest data rate and lowest order 802.11a/g/n/ac mode is used for SAR measurement, on the highest measured output power channel in the initial test configuration, for each frequency band.

Subsequent Test Configuration

SAR measurement requirements for the remaining 802.11 transmission mode configurations that have not been tested in the initial test configuration are determined separately for each standalone and aggregated frequency band, in each exposure condition, according to the maximum output power specified for production units. Additional power measurements may be required to determine if SAR measurements are required for subsequent highest output power channels in a subsequent test configuration. When the highest reported SAR for the initial test configuration according to the initial test position or fixed exposure position requirements, is adjusted by the ratio of the subsequent test configuration to initial test configuration specified maximum output power and the adjusted SAR is ≤ 1.2 W/kg, SAR is not required for that subsequent test configuration.

SAR Test Configuration and Channel Selection

When multiple channel bandwidth configurations in a frequency band have the same specified maximum output power, the initial test configuration is using largest channel bandwidth, lowest order modulation, lowest data rate, and lowest order 802.11 mode (i.e., 802.11a is chosen over 802.11n then 802.11ac or 802.11g is chosen over 802.11n). After an initial test configuration is determined, if multiple test channels have the same measured maximum output power, the channel chosen for SAR measurement is determined according to the following.

- 1) The channel closest to mid-band frequency is selected for SAR measurement.
- 2) For channels with equal separation from mid-band frequency; for example, high and low channels or two mid-band channels, the higher frequency (number) channel is selected for SAR measurement.

Test Reduction for U-NII-1 (5.2 GHz) and U-NII-2A (5.3 GHz) Bands

For devices that operate in both U-NII bands using the same transmitter and antenna(s), SAR test reduction is determined according to the following.

- 1) When the same maximum output power is specified for both bands, begin SAR measurement in U-NII-2A band by applying the OFDM SAR requirements. If the highest reported SAR for a test configuration is ≤ 1.2 W/kg, SAR is not required for U-NII-1 band for that configuration (802.11 mode and exposure condition).
- 2) When different maximum output power is specified for the bands, begin SAR measurement in the band with higher specified maximum output power. The highest reported SAR for the tested configuration is adjusted by the ratio of lower to higher specified maximum output power for the two bands. When the adjusted SAR is ≤ 1.2 W/kg, SAR is not required for the band with lower maximum output power in that test configuration.

<Considerations Related to Bluetooth for Setup and Testing>

This device has installed Bluetooth engineering testing software which can provide continuous transmitting RF signal. During Bluetooth SAR testing, this device was operated to transmit continuously at the maximum transmission duty with specified transmission mode, operating frequency, lowest data rate, and maximum output power.

4.2 EUT Testing Position

4.2.1 Body Exposure Conditions

For full-size tablet, according to KDB 616217 D04, SAR evaluation is required for back surface and edges of the devices. The back surface and edges of the tablet are tested with the tablet touching the phantom. Exposures from antennas through the front surface of the display section of a tablet are generally limited to the user's hands. Exposures to hands for typical consumer transmitters used in tablets are not expected to exceed the extremity SAR limit; therefore, SAR evaluation for the front surface of tablet display screens are generally not necessary. When voice mode is supported on a tablet and it is limited to speaker mode or headset operations only, additional SAR testing for this type of voice use is not required.

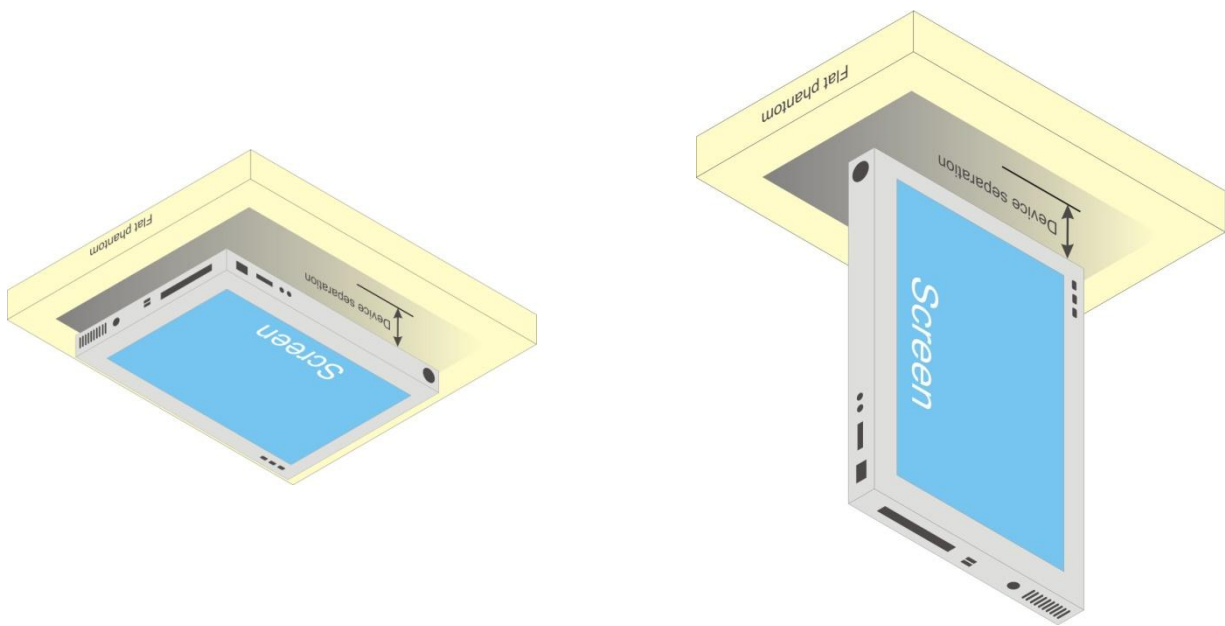

Fig-4.1 Illustration for Tablet Setup

4.2.2 SAR Test Exclusion Evaluations

According to KDB 447498 D01, the SAR test exclusion condition is based on source-based time-averaged maximum conducted output power, adjusted for tune-up tolerance, and the minimum test separation distance required for the exposure conditions. The SAR exclusion threshold is determined by the following formula.

1. For the test separation distance ≤ 50 mm

$$\frac{\text{Max. Tune up Power}_{(mW)}}{\text{Min. Test Separation Distance}_{(mm)}} \times \sqrt{f_{(GHz)}} \leq 3.0 \text{ for SAR-1g, } \leq 7.5 \text{ for SAR-10g}$$

When the minimum test separation distance is < 5 mm, a distance of 5 mm is applied to determine SAR test exclusion.

2. For the test separation distance > 50 mm, and the frequency at 100 MHz to 1500 MHz

$$\left[(\text{Threshold at 50 mm in Step 1}) + (\text{Test Separation Distance} - 50 \text{ mm}) \times \left(\frac{f_{(MHz)}}{150} \right) \right]_{(mW)}$$

3. For the test separation distance > 50 mm, and the frequency at > 1500 MHz to 6 GHz

$$[(\text{Threshold at 50 mm in Step 1}) + (\text{Test Separation Distance} - 50 \text{ mm}) \times 10]_{(mW)}$$

| Mode | Max. Tune-up Power (dBm) | Max. Tune-up Power (mW) | Rear Face | | | Left Side | | | Right Side | | | Top Side | | | Bottom Side | | |
|-----------|--------------------------|-------------------------|----------------------|-------------------|----------------------|----------------------|-------------------|----------------------|----------------------|-------------------|----------------------|----------------------|-------------------|----------------------|----------------------|-------------------|----------------------|
| | | | Ant. to Surface (mm) | Calculated Result | Require SAR Testing? | Ant. to Surface (mm) | Calculated Result | Require SAR Testing? | Ant. to Surface (mm) | Calculated Result | Require SAR Testing? | Ant. to Surface (mm) | Calculated Result | Require SAR Testing? | Ant. to Surface (mm) | Calculated Result | Require SAR Testing? |
| WLAN 2.4G | 16.00 | 39.81 | 5 | 12.49 | Yes | 33.33 | 1.87 | No | 90.78 | 503 mW | No | 2.4 | 12.49 | Yes | 225.8 65 | 1854 mW | No |
| WLAN 5.2G | 10.00 | 10.00 | 5 | 4.58 | Yes | 33.33 | 0.69 | No | 90.78 | 473 mW | No | 2.4 | 4.58 | Yes | 225.8 65 | 1824 mW | No |
| WLAN 5.3G | 10.00 | 10.00 | 5 | 4.61 | Yes | 33.33 | 0.69 | No | 90.78 | 473 mW | No | 2.4 | 4.61 | Yes | 225.8 65 | 1824 mW | No |
| WLAN 5.6G | 10.00 | 10.00 | 5 | 4.77 | Yes | 33.33 | 0.72 | No | 90.78 | 471 mW | No | 2.4 | 4.77 | Yes | 225.8 65 | 1821 mW | No |
| WLAN 5.8G | 10.00 | 10.00 | 5 | 4.83 | Yes | 33.33 | 0.72 | No | 90.78 | 470 mW | No | 2.4 | 4.83 | Yes | 225.8 65 | 1821 mW | No |
| BT | 7.00 | 5.01 | 5 | 1.58 | No | 33.33 | 0.24 | No | 90.78 | 503 mW | No | 2.4 | 1.58 | No | 225.8 65 | 1854 mW | No |

Note:

1. When separation distance ≤ 50 mm and the calculated result shown in above table is ≤ 3.0 for SAR-1g exposure condition, or ≤ 7.5 for SAR-10g exposure condition, the SAR testing exclusion is applied.
2. When separation distance > 50 mm and the device output power is less than the calculated result (power threshold, mW) shown in above table, the SAR testing exclusion is applied.

FCC SAR Test Report

4.3 Tissue Verification

The measuring results for tissue simulating liquid are shown as below.

| Test Date | Tissue Type | Frequency (MHz) | Liquid Temp. (°C) | Measured Conductivity (σ) | Measured Permittivity (ϵ_r) | Target Conductivity (σ) | Target Permittivity (ϵ_r) | Conductivity Deviation (%) | Permittivity Deviation (%) |
|---------------|-------------|-----------------|-------------------|------------------------------------|--|----------------------------------|--------------------------------------|----------------------------|----------------------------|
| May. 22, 2016 | Body | 2450 | 23.5 | 1.997 | 51.334 | 1.95 | 52.7 | 2.41 | -2.59 |
| May. 23, 2016 | Body | 5250 | 23.6 | 5.453 | 48.489 | 5.36 | 48.9 | 1.74 | -0.84 |
| May. 23, 2016 | Body | 5600 | 23.6 | 5.917 | 47.907 | 5.77 | 48.5 | 2.55 | -1.22 |
| May. 23, 2016 | Body | 5800 | 23.6 | 6.203 | 47.577 | 6.00 | 48.2 | 3.38 | -1.29 |

Note:

The dielectric properties of the tissue simulating liquid must be measured within 24 hours before the SAR testing and within $\pm 5\%$ of the target values. Liquid temperature during the SAR testing must be within $\pm 2^\circ\text{C}$.

4.4 System Validation

The SAR measurement system was validated according to procedures in KDB 865664 D01. The validation status in tabulated summary is as below.

| Test Date | Probe S/N | Calibration Point | | Measured Conductivity (σ) | Measured Permittivity (ϵ_r) | Validation for CW | | | Validation for Modulation | | |
|---------------|-----------|-------------------|------|------------------------------------|--|-------------------|-----------------|----------------|---------------------------|-------------|------|
| | | | | | | Sensitivity Range | Probe Linearity | Probe Isotropy | Modulation Type | Duty Factor | PAR |
| May. 22, 2016 | 3971 | Body | 2450 | 1.997 | 51.334 | Pass | Pass | Pass | OFDM | N/A | Pass |
| May. 23, 2016 | 3820 | Body | 5250 | 5.453 | 48.489 | Pass | Pass | Pass | OFDM | N/A | Pass |
| May. 23, 2016 | 3820 | Body | 5600 | 5.917 | 47.907 | Pass | Pass | Pass | OFDM | N/A | Pass |
| May. 23, 2016 | 3820 | Body | 5800 | 6.203 | 47.577 | Pass | Pass | Pass | OFDM | N/A | Pass |

4.5 System Verification

The measuring result for system verification is tabulated as below.

| Test Date | Mode | Frequency (MHz) | 1W Target SAR-1g (W/kg) | Measured SAR-1g (W/kg) | Normalized to 1W SAR-1g (W/kg) | Deviation (%) | Dipole S/N | Probe S/N | DAE S/N |
|---------------|------|-----------------|-------------------------|------------------------|--------------------------------|---------------|------------|-----------|---------|
| May. 22, 2016 | Body | 2450 | 51.10 | 13.00 | 52.00 | 1.76 | 737 | 3971 | 1431 |
| May. 23, 2016 | Body | 5250 | 76.40 | 7.83 | 78.30 | 2.49 | 1019 | 3820 | 1305 |
| May. 23, 2016 | Body | 5600 | 79.80 | 8.07 | 80.70 | 1.13 | 1019 | 3820 | 1305 |
| May. 23, 2016 | Body | 5800 | 77.30 | 8.17 | 81.70 | 5.69 | 1019 | 3820 | 1305 |

Note:

Comparing to the reference SAR value provided by SPEAG, the validation data should be within its specification of 10 %. The result indicates the system check can meet the variation criterion and the plots can be referred to Appendix A of this report.

4.6 Maximum Output Power

4.6.1 Maximum Conducted Power

The maximum conducted average power (Unit: dBm) including tune-up tolerance is shown as below.

| Mode | 2.4G WLAN | 5.2G WLAN | 5.3G WLAN | 5.6G WLAN | 5.8G WLAN |
|----------------|-----------|-----------|-----------|-----------|-----------|
| 802.11b | 16.0 | N/A | N/A | N/A | N/A |
| 802.11g | 14.0 | N/A | N/A | N/A | N/A |
| 802.11a | N/A | 10.0 | 10.0 | 10.0 | 10.0 |
| 802.11n HT20 | 12.0 | 10.0 | 10.0 | 10.0 | 9.5 |
| 802.11n HT40 | 11.0 | 10.0 | 10.0 | 10.0 | 10.0 |
| 802.11ac VHT80 | N/A | 8.5 | 8.5 | 8.5 | 8.5 |

| Mode | 2.4G Bluetooth |
|--------------|----------------|
| Bluetooth DH | 7.0 |

4.6.2 Measured Conducted Power Result

The measuring conducted average power (Unit: dBm) is shown as below.

<WLAN 2.4G>

| Mode | 802.11b | | |
|---------------------------|----------|----------|-----------|
| Channel / Frequency (MHz) | 1 (2412) | 6 (2437) | 11 (2462) |
| Average Power | 15.85 | 15.95 | 15.97 |

<WLAN 5.3G>

| Mode | 802.11n (HT40) | |
|---------------------------|----------------|-----------|
| Channel / Frequency (MHz) | 54 (5270) | 62 (5310) |
| Average Power | 8.94 | 8.88 |

<WLAN 5.6G>

| Mode | 802.11n (HT40) | | |
|---------------------------|----------------|------------|------------|
| Channel / Frequency (MHz) | 102 (5510) | 110 (5550) | 134 (5670) |
| Average Power | 8.59 | 8.47 | 8.85 |

<WLAN 5.8G>

| Mode | 802.11n (HT40) | |
|---------------------------|----------------|------------|
| Channel / Frequency (MHz) | 151 (5755) | 159 (5795) |
| Average Power | 8.41 | 8.35 |
| Average Power | 7.01 | |

<Bluetooth>

| Mode | Bluetooth | | |
|---------------------------|-----------|-----------|-----------|
| Channel / Frequency (MHz) | 0 (2402) | 39 (2441) | 78 (2480) |
| Average Power | 6.24 | 6.69 | 6.74 |

4.7 SAR Testing Results

4.7.1 SAR Test Reduction Considerations

<KDB 447498 D01, General RF Exposure Guidance>

Testing of other required channels within the operating mode of a frequency band is not required when the reported SAR for the mid-band or highest output power channel is:

- (1) ≤ 0.8 W/kg or 2.0 W/kg, for 1-g or 10-g respectively, when the transmission band is ≤ 100 MHz
- (2) ≤ 0.6 W/kg or 1.5 W/kg, for 1-g or 10-g respectively, when the transmission band is between 100 MHz and 200 MHz
- (3) ≤ 0.4 W/kg or 1.0 W/kg, for 1-g or 10-g respectively, when the transmission band is ≥ 200 MHz

<KDB 248227 D01, SAR Guidance for Wi-Fi Transmitters>

- (1) For handsets operating next to ear, hotspot mode or mini-tablet configurations, the initial test position procedures were applied. The test position with the highest extrapolated peak SAR will be used as the initial test position. When the reported SAR of initial test position is ≤ 0.4 W/kg, SAR testing for remaining test positions is not required. Otherwise, SAR is evaluated at the subsequent highest peak SAR positions until the reported SAR result is ≤ 0.8 W/kg or all test positions are measured.
- (2) For WLAN 2.4 GHz, the highest measured maximum output power channel for DSSS was selected for SAR measurement. When the reported SAR is ≤ 0.8 W/kg, no further SAR testing is required. Otherwise, SAR is evaluated at the next highest measured output power channel. When any reported SAR is > 1.2 W/kg, SAR is required for the third channel. For OFDM modes (802.11g/n), SAR is not required when the highest reported SAR for DSSS is adjusted by the ratio of OFDM to DSSS specified maximum output power and it is ≤ 1.2 W/kg.
- (3) For WLAN 5 GHz, the initial test configuration was selected according to the transmission mode with the highest maximum output power. When the reported SAR of initial test configuration is > 0.8 W/kg, SAR is required for the subsequent highest measured output power channel until the reported SAR result is ≤ 1.2 W/kg or all required channels are measured. For other transmission modes, SAR is not required when the highest reported SAR for initial test configuration is adjusted by the ratio of subsequent test configuration to initial test configuration specified maximum output power and it is ≤ 1.2 W/kg.

4.7.2 SAR Results for Body Exposure Condition (Separation Distance is 0 cm Gap)

| Plot No. | Band | Mode | Test Position | Ch. | Max. Tune-up Power (dBm) | Measured Conducted Power (dBm) | Scaling Factor | Power Drift (dB) | Measured SAR-1g (W/kg) | Scaled SAR-1g (W/kg) |
|----------|-----------|--------------|---------------|-----|--------------------------|--------------------------------|----------------|------------------|------------------------|----------------------|
| 01 | 2.4G WLAN | 802.11b | Rear Face | 11 | 16.0 | 15.97 | 1.01 | 0.02 | 0.241 | 0.24 |
| | 2.4G WLAN | 802.11b | Top Side | 11 | 16.0 | 15.97 | 1.01 | 0.07 | 0.540 | 0.54 |
| 02 | 5.3G WLAN | 802.11n HT40 | Rear Face | 54 | 10.0 | 8.94 | 1.28 | -0.06 | 0.083 | 0.11 |
| | 5.3G WLAN | 802.11n HT40 | Top Side | 54 | 10.0 | 8.94 | 1.28 | 0.01 | 0.793 | 1.01 |
| | 5.3G WLAN | 802.11n HT40 | Top Side | 62 | 10.0 | 8.88 | 1.29 | 0.11 | 0.698 | 0.90 |
| 03 | 5.6G WLAN | 802.11n HT40 | Rear Face | 134 | 10.0 | 8.85 | 1.30 | 0.05 | 0.053 | 0.07 |
| | 5.6G WLAN | 802.11n HT40 | Top Side | 134 | 10.0 | 8.85 | 1.30 | 0.04 | 0.675 | 0.88 |
| | 5.6G WLAN | 802.11n HT40 | Top Side | 102 | 10.0 | 8.59 | 1.38 | 0.12 | 0.594 | 0.82 |
| 04 | 5.8G WLAN | 802.11n HT40 | Rear Face | 151 | 10.0 | 8.41 | 1.44 | 0.05 | 0.038 | 0.05 |
| | 5.8G WLAN | 802.11n HT40 | Top Side | 151 | 10.0 | 8.41 | 1.44 | 0.05 | 0.528 | 0.76 |

| Plot No. | Band | Test Position | Ch. | Max. Tune-up Power (dBm) | Measured Conducted Power (dBm) | Scaling Factor | Power Drift (dB) | Measured SAR-1g (W/kg) | Scaled SAR-1g (W/kg) |
|----------|-----------|---------------|-----|--------------------------|--------------------------------|----------------|------------------|------------------------|----------------------|
| 05 | Bluetooth | Rear Face | 78 | 7.0 | 6.74 | 1.06 | 0.01 | 0.026 | 0.03 |
| | Bluetooth | Top Side | 78 | 7.0 | 6.74 | 1.06 | 0.02 | 0.088 | 0.09 |

4.7.3 SAR Measurement Variability

According to KDB 865664 D01, SAR measurement variability was assessed for each frequency band, which is determined by the SAR probe calibration point and tissue-equivalent medium used for the device measurements. When both head and body tissue-equivalent media are required for SAR measurements in a frequency band, the variability measurement procedures should be applied to the tissue medium with the highest measured SAR, using the highest measured SAR configuration for that tissue-equivalent medium. Alternatively, if the highest measured SAR for both head and body tissue-equivalent media are ≤ 1.45 W/kg and the ratio of these highest SAR values, i.e., largest divided by smallest value, is ≤ 1.10 , the highest SAR configuration for either head or body tissue-equivalent medium may be used to perform the repeated measurement. These additional measurements are repeated after the completion of all measurements requiring the same head or body tissue-equivalent medium in a frequency band. The test device should be returned to ambient conditions (normal room temperature) with the battery fully charged before it is re-mounted on the device holder for the repeated measurement(s) to minimize any unexpected variations in the repeated results.

Since all the measured SAR are less than 0.8 W/kg, the repeated measurement is not required.

Test Engineer : Willy Chang, and Chiajui Fu

5. Calibration of Test Equipment

| Equipment | Manufacturer | Model | SN | Cal. Date | Cal. Interval |
|------------------------------|--------------|---------|------------|---------------|---------------|
| System Validation Dipole | SPEAG | D2450V2 | 737 | Aug. 20, 2015 | 1 Year |
| System Validation Dipole | SPEAG | D5GHzV2 | 1019 | Aug. 28, 2015 | 1 Year |
| Dosimetric E-Field Probe | SPEAG | EX3DV4 | 3971 | Mar. 23, 2016 | 1 Year |
| Dosimetric E-Field Probe | SPEAG | EX3DV4 | 3820 | Jun. 19, 2015 | 1 Year |
| Data Acquisition Electronics | SPEAG | DAE4 | 1431 | Mar. 21, 2016 | 1 Year |
| Data Acquisition Electronics | SPEAG | DAE4 | 1305 | Dec. 11, 2015 | 1 Year |
| ENA Series Network Analyzer | Agilent | E5071C | MY46214281 | Jun. 23, 2015 | 1 Year |
| Spectrum Analyzer | R&S | FSL6 | 102006 | Mar. 25, 2016 | 1 Year |
| MXG Analog Signal Generator | Agilent | N5181A | MY50143868 | Jul. 06, 2015 | 1 Year |
| Power Meter | Anritsu | ML2495A | 1218009 | Jul. 06, 2015 | 1 Year |
| Power Sensor | Anritsu | MA2411B | 1207252 | Jul. 06, 2015 | 1 Year |
| Thermometer | YFE | YF-160A | 130504579 | Aug. 20, 2015 | 1 Year |

6. Measurement Uncertainty

| Source of Uncertainty | Tolerance (± %) | Probability Distribution | Divisor | Ci (1g) | Ci (10g) | Standard Uncertainty (± %, 1g) | Standard Uncertainty (± %, 10g) | Vi |
|--|-----------------|--------------------------|---------|---------|----------|--------------------------------|---------------------------------|----|
| Measurement System | | | | | | | | |
| Probe Calibration | 6.0 | Normal | 1 | 1 | 1 | 6.0 | 6.0 | ∞ |
| Axial Isotropy | 4.7 | Rectangular | √3 | 0.707 | 0.707 | 1.9 | 1.9 | ∞ |
| Hemispherical Isotropy | 9.6 | Rectangular | √3 | 0.707 | 0.707 | 3.9 | 3.9 | ∞ |
| Boundary Effect | 1.0 | Rectangular | √3 | 1 | 1 | 0.6 | 0.6 | ∞ |
| Linearity | 4.7 | Rectangular | √3 | 1 | 1 | 2.7 | 2.7 | ∞ |
| System Detection Limits | 0.25 | Rectangular | √3 | 1 | 1 | 0.14 | 0.14 | ∞ |
| Readout Electronics | 0.3 | Normal | 1 | 1 | 1 | 0.3 | 0.3 | ∞ |
| Response Time | 0.0 | Rectangular | √3 | 1 | 1 | 0.0 | 0.0 | ∞ |
| Integration Time | 1.7 | Rectangular | √3 | 1 | 1 | 1.0 | 1.0 | ∞ |
| RF Ambient Conditions - Noise | 3.0 | Rectangular | √3 | 1 | 1 | 1.7 | 1.7 | ∞ |
| RF Ambient Conditions - Reflections | 3.0 | Rectangular | √3 | 1 | 1 | 1.7 | 1.7 | ∞ |
| Probe Positioner Mechanical Tolerance | 0.4 | Rectangular | √3 | 1 | 1 | 0.2 | 0.2 | ∞ |
| Probe Positioning with Respect to Phantom Shell | 2.9 | Rectangular | √3 | 1 | 1 | 1.7 | 1.7 | ∞ |
| Extrapolation, interpolation, and integration algorithms for max. SAR evaluation | 2.0 | Rectangular | √3 | 1 | 1 | 1.2 | 1.2 | ∞ |
| Test Sample Related | | | | | | | | |
| Test Sample Positioning | 1.5 / 0.7 | Normal | 1 | 1 | 1 | 1.5 | 0.7 | 32 |
| Device Holder Uncertainty | 4.2 / 1.8 | Normal | 1 | 1 | 1 | 4.2 | 1.8 | 32 |
| Output Power Variation - SAR Drift Measurement | 5.0 | Rectangular | √3 | 1 | 1 | 2.9 | 2.9 | ∞ |
| Phantom and Tissue Parameters | | | | | | | | |
| Phantom Uncertainty (Shape and Thickness Tolerances) | 7.2 | Rectangular | √3 | 1 | 1 | 4.2 | 4.2 | ∞ |
| Liquid Conductivity - Deviation from Target Values | 5.0 | Rectangular | √3 | 0.64 | 0.43 | 1.8 | 1.2 | ∞ |
| Liquid Conductivity - Measurement Uncertainty | 1.0 | Normal | 1 | 0.64 | 0.43 | 0.6 | 0.4 | 25 |
| Liquid Permittivity - Deviation from Target Values | 5.0 | Rectangular | √3 | 0.60 | 0.49 | 1.7 | 1.4 | ∞ |
| Liquid Permittivity - Measurement Uncertainty | 0.5 | Normal | 1 | 0.60 | 0.49 | 0.3 | 0.2 | 25 |
| Combined Standard Uncertainty | | | | | | ± 11.2 % | ± 10.4 % | |
| Expanded Uncertainty (K=2) | | | | | | ± 22.4 % | ± 20.8 % | |

Uncertainty budget for frequency range 300 MHz to 3 GHz

FCC SAR Test Report

| Source of Uncertainty | Tolerance (± %) | Probability Distribution | Divisor | Ci (1g) | Ci (10g) | Standard Uncertainty (± %, 1g) | Standard Uncertainty (± %, 10g) | Vi |
|--|--------------------|-----------------------------|---------|------------|-------------|--------------------------------------|---------------------------------------|----|
| Measurement System | | | | | | | | |
| Probe Calibration | 6.55 | Normal | 1 | 1 | 1 | 6.55 | 6.55 | ∞ |
| Axial Isotropy | 4.7 | Rectangular | √3 | 0.707 | 0.707 | 1.9 | 1.9 | ∞ |
| Hemispherical Isotropy | 9.6 | Rectangular | √3 | 0.707 | 0.707 | 3.9 | 3.9 | ∞ |
| Boundary Effect | 2.0 | Rectangular | √3 | 1 | 1 | 1.2 | 1.2 | ∞ |
| Linearity | 4.7 | Rectangular | √3 | 1 | 1 | 2.7 | 2.7 | ∞ |
| System Detection Limits | 0.25 | Rectangular | √3 | 1 | 1 | 0.14 | 0.14 | ∞ |
| Readout Electronics | 0.3 | Normal | 1 | 1 | 1 | 0.3 | 0.3 | ∞ |
| Response Time | 0.0 | Rectangular | √3 | 1 | 1 | 0.0 | 0.0 | ∞ |
| Integration Time | 1.7 | Rectangular | √3 | 1 | 1 | 1.0 | 1.0 | ∞ |
| RF Ambient Conditions - Noise | 3.0 | Rectangular | √3 | 1 | 1 | 1.7 | 1.7 | ∞ |
| RF Ambient Conditions - Reflections | 3.0 | Rectangular | √3 | 1 | 1 | 1.7 | 1.7 | ∞ |
| Probe Positioner Mechanical Tolerance | 0.4 | Rectangular | √3 | 1 | 1 | 0.2 | 0.2 | ∞ |
| Probe Positioning with Respect to Phantom Shell | 6.7 | Rectangular | √3 | 1 | 1 | 3.9 | 3.9 | ∞ |
| Extrapolation, interpolation, and integration algorithms for max. SAR evaluation | 4.0 | Rectangular | √3 | 1 | 1 | 2.3 | 2.3 | ∞ |
| Test Sample Related | | | | | | | | |
| Test Sample Positioning | 1.5 / 0.7 | Normal | 1 | 1 | 1 | 1.5 | 0.7 | 32 |
| Device Holder Uncertainty | 4.2 / 1.8 | Normal | 1 | 1 | 1 | 4.2 | 1.8 | 32 |
| Output Power Variation - SAR Drift Measurement | 5.0 | Rectangular | √3 | 1 | 1 | 2.9 | 2.9 | ∞ |
| Phantom and Tissue Parameters | | | | | | | | |
| Phantom Uncertainty (Shape and Thickness Tolerances) | 7.6 | Rectangular | √3 | 1 | 1 | 4.4 | 4.4 | ∞ |
| Liquid Conductivity - Deviation from Target Values | 5.0 | Rectangular | √3 | 0.64 | 0.43 | 1.8 | 1.2 | ∞ |
| Liquid Conductivity - Measurement Uncertainty | 1.0 | Normal | 1 | 0.64 | 0.43 | 0.6 | 0.4 | 25 |
| Liquid Permittivity - Deviation from Target Values | 5.0 | Rectangular | √3 | 0.60 | 0.49 | 1.7 | 1.4 | ∞ |
| Liquid Permittivity - Measurement Uncertainty | 0.5 | Normal | 1 | 0.60 | 0.49 | 0.3 | 0.2 | 25 |
| Combined Standard Uncertainty | | | | | | ± 12.3 % | ± 11.5 % | |
| Expanded Uncertainty (K=2) | | | | | | ± 24.6 % | ± 23.0 % | |

Uncertainty budget for frequency range 3 GHz to 6 GHz

7. Information on the Testing Laboratories

We, Bureau Veritas Consumer Products Services (H.K.) Ltd., Taoyuan Branch, were founded in 1988 to provide our best service in EMC, Radio, Telecom and Safety consultation. Our laboratories are accredited and approved according to ISO/IEC 17025.

If you have any comments, please feel free to contact us at the following:

Taiwan HwaYa EMC/RF/Safety Lab:

Add: No.19, Hwa Ya 2nd Rd., Wen Hwa Vil., Kwei Shan Dist., Taoyuan City 33383, Taiwan, R.O.C.

Tel: 886-3-318-3232

Fax: 886-3-327-0892

Taiwan LinKo EMC/RF Lab:

Add: No. 47-2, 14th Ling, Chia Pau Vil., Linkou Dist., New Taipei City 244, Taiwan, R.O.C.

Tel: 886-2-2605-2180

Fax: 886-2-2605-1924

Taiwan HsinChu EMC/RF/Telecom Lab:

Add: No. 81-1, Lu Liao Keng, 9th Ling, Wu Lung Vil., Chiung Lin Township, Hsinchu County 307, Taiwan, R.O.C.

Tel: 886-3-666-8565

Fax: 886-3-666-8323

Email: service.adt@tw.bureauveritas.com

Web Site: www.adt.com.tw

The road map of all our labs can be found in our web site also.

---END---



Appendix A. SAR Plots of System Verification

The plots for system verification with largest deviation for each SAR system combination are shown as follows.

System Check_B2450_160522

DUT: Dipole 2450 MHz; Type: D2450V2; SN: 737

Communication System: CW; Frequency: 2450 MHz; Duty Cycle: 1:1

Medium: B19T27N3_0522 Medium parameters used: $f = 2450$ MHz; $\sigma = 1.997$ S/m; $\epsilon_r = 51.334$; $\rho = 1000$ kg/m³

Ambient Temperature : 23.7 °C ; Liquid Temperature : 23.5 °C

DASY5 Configuration:

- Probe: EX3DV4 - SN3971; ConvF(7.24, 7.24, 7.24); Calibrated: 2016/03/23;
- Sensor-Surface: 1.4mm (Mechanical Surface Detection)
- Electronics: DAE4 Sn1431; Calibrated: 2016/03/21
- Phantom: ELI Phantom_1245; Type: QDOVA;
- Measurement SW: DASY52, Version 52.8 (8); SEMCAD X Version 14.6.10 (7331)

Pin=250mW/Area Scan (81x81x1): Interpolated grid: dx=1.200 mm, dy=1.200 mm
Maximum value of SAR (interpolated) = 19.8 W/kg

Pin=250mW/Zoom Scan (7x7x7)/Cube 0: Measurement grid: dx=5mm, dy=5mm, dz=5mm
Reference Value = 100.0 V/m; Power Drift = 0.02 dB
Peak SAR (extrapolated) = 26.0 W/kg
SAR(1 g) = 13 W/kg; SAR(10 g) = 6.07 W/kg
Maximum value of SAR (measured) = 19.6 W/kg

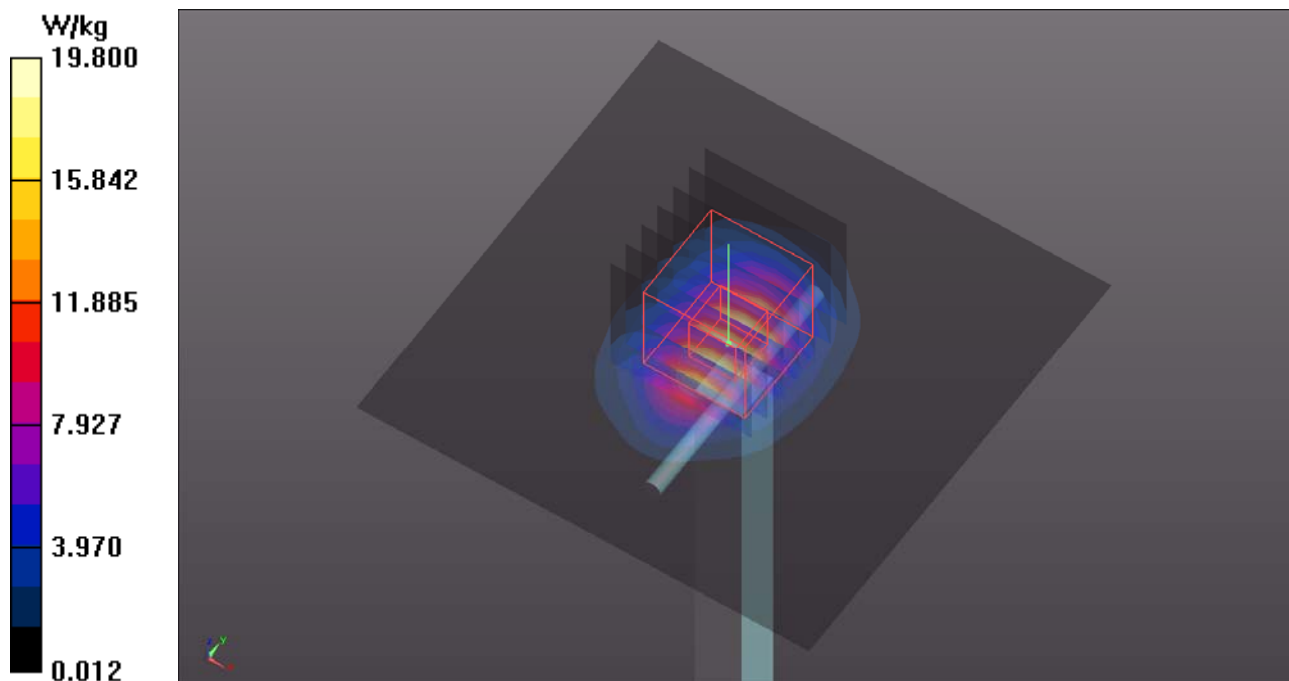

System Check_B5250_160523

DUT: Dipole 5 GHz; Type: D5GHzV2; SN: 1019

Communication System: CW; Frequency: 5250 MHz; Duty Cycle: 1:1

Medium: B34T60N2_0523 Medium parameters used: $f = 5250$ MHz; $\sigma = 5.453$ S/m; $\epsilon_r = 48.489$; $\rho = 1000$ kg/m³

Ambient Temperature : 23.8 °C ; Liquid Temperature : 23.6 °C

DASY5 Configuration:

- Probe: EX3DV4 - SN3820; ConvF(4.35, 4.35, 4.35); Calibrated: 2015/6/19;
- Sensor-Surface: 1.4mm (Mechanical Surface Detection)
- Electronics: DAE4 Sn1305; Calibrated: 2015/12/11
- Phantom: ELI Phantom_1043; Type: QDOVA;
- Measurement SW: DASY52, Version 52.8 (8); SEMCAD X Version 14.6.10 (7331)

Pin=100mW/Area Scan (91x91x1): Interpolated grid: dx=1.000 mm, dy=1.000 mm
Maximum value of SAR (interpolated) = 18.1 W/kg

Pin=100mW/Zoom Scan (7x7x12)/Cube 0: Measurement grid: dx=4mm, dy=4mm, dz=2mm
Reference Value = 58.83 V/m; Power Drift = -0.07 dB
Peak SAR (extrapolated) = 29.9 W/kg
SAR(1 g) = 7.83 W/kg; SAR(10 g) = 2.26 W/kg
Maximum value of SAR (measured) = 19.3 W/kg

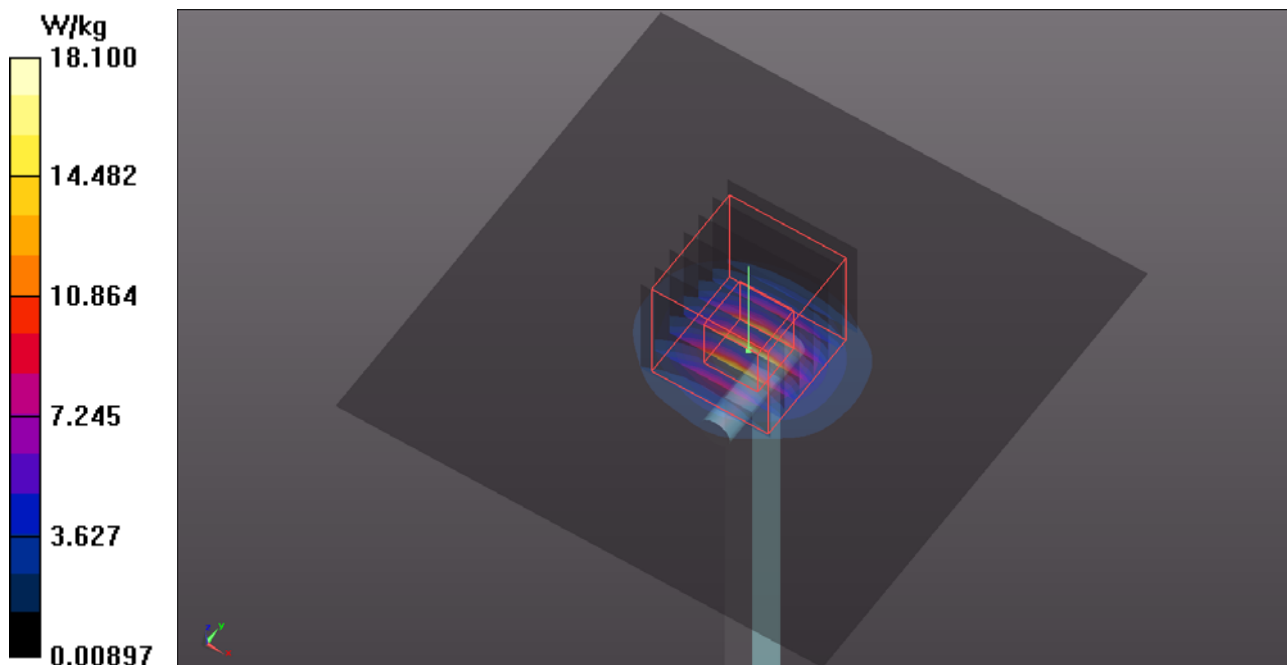

System Check_B5600_160523

DUT: Dipole 5 GHz; Type: D5GHzV2; SN: 1019

Communication System: CW; Frequency: 5600 MHz; Duty Cycle: 1:1

Medium: B34T60N2_0523 Medium parameters used: $f = 5600$ MHz; $\sigma = 5.917$ S/m; $\epsilon_r = 47.907$; $\rho = 1000$ kg/m³

Ambient Temperature : 23.8 °C ; Liquid Temperature : 23.6 °C

DASY5 Configuration:

- Probe: EX3DV4 - SN3820; ConvF(3.64, 3.64, 3.64); Calibrated: 2015/6/19;
- Sensor-Surface: 1.4mm (Mechanical Surface Detection)
- Electronics: DAE4 Sn1305; Calibrated: 2015/12/11
- Phantom: ELI Phantom_1043; Type: QDOVA;
- Measurement SW: DASY52, Version 52.8 (8); SEMCAD X Version 14.6.10 (7331)

Pin=100mW/Area Scan (91x91x1): Interpolated grid: dx=1.000 mm, dy=1.000 mm
Maximum value of SAR (interpolated) = 18.8 W/kg

Pin=100mW/Zoom Scan (7x7x12)/Cube 0: Measurement grid: dx=4mm, dy=4mm, dz=2mm
Reference Value = 66.59 V/m; Power Drift = 0.02 dB
Peak SAR (extrapolated) = 33.9 W/kg
SAR(1 g) = 8.07 W/kg; SAR(10 g) = 2.29 W/kg
Maximum value of SAR (measured) = 20.5 W/kg

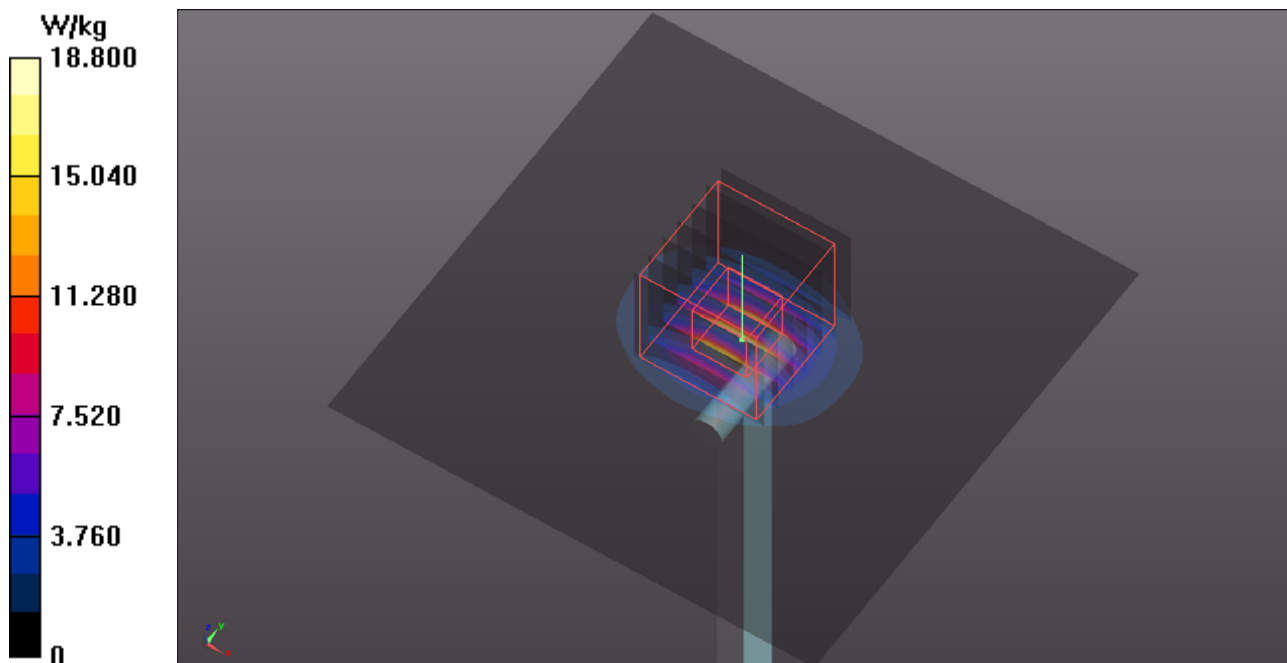

System Check_B5800_160523

DUT: Dipole 5 GHz; Type: D5GHzV2; SN: 1019

Communication System: CW; Frequency: 5800 MHz; Duty Cycle: 1:1

Medium: B34T60N2_0523 Medium parameters used: $f = 5800$ MHz; $\sigma = 6.203$ S/m; $\epsilon_r = 47.577$; $\rho = 1000$ kg/m³

Ambient Temperature : 23.8 °C ; Liquid Temperature : 23.6 °C

DASY5 Configuration:

- Probe: EX3DV4 - SN3820; ConvF(3.97, 3.97, 3.97); Calibrated: 2015/6/19;
- Sensor-Surface: 1.4mm (Mechanical Surface Detection)
- Electronics: DAE4 Sn1305; Calibrated: 2015/12/11
- Phantom: ELI Phantom_1043; Type: QDOVA;
- Measurement SW: DASY52, Version 52.8 (8); SEMCAD X Version 14.6.10 (7331)

Pin=100mW/Area Scan (91x91x1): Interpolated grid: dx=1.000 mm, dy=1.000 mm
Maximum value of SAR (interpolated) = 20.0 W/kg

Pin=100mW/Zoom Scan (7x7x12)/Cube 0: Measurement grid: dx=4mm, dy=4mm, dz=2mm
Reference Value = 58.98 V/m; Power Drift = -0.14 dB
Peak SAR (extrapolated) = 37.8 W/kg
SAR(1 g) = 8.17 W/kg; SAR(10 g) = 2.3 W/kg
Maximum value of SAR (measured) = 21.6 W/kg

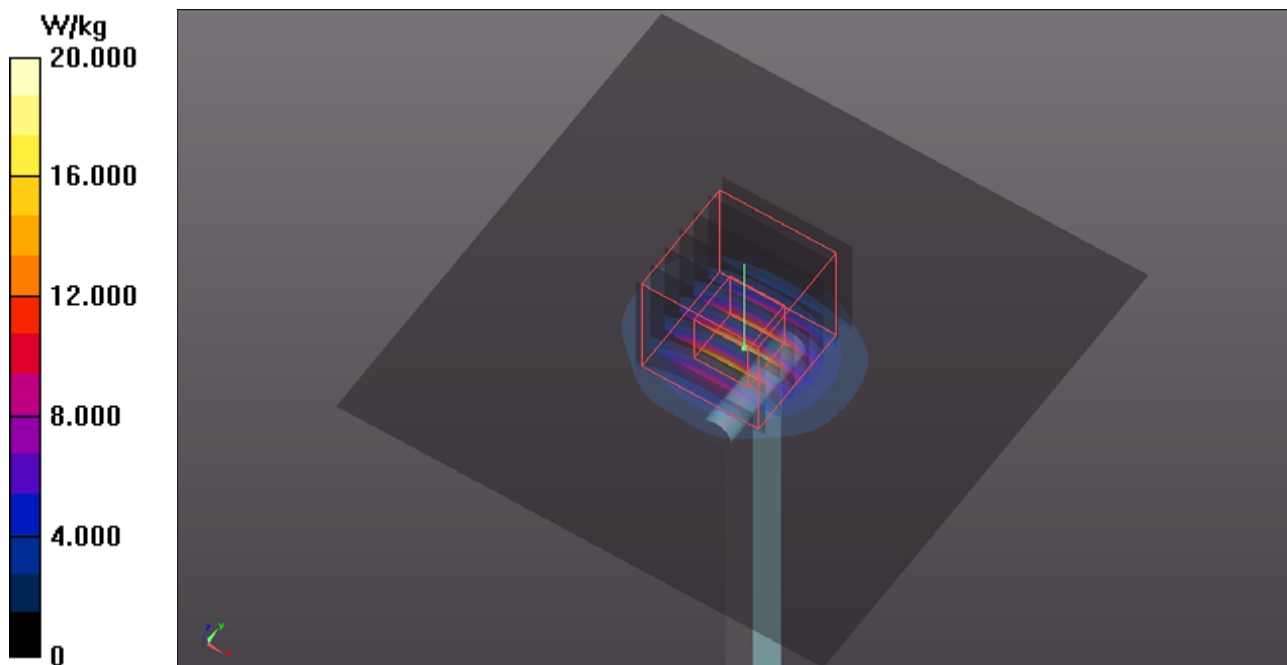



Appendix B. SAR Plots of SAR Measurement

The SAR plots for highest measured SAR in each exposure configuration, wireless mode and frequency band combination, and measured SAR > 1.5 W/kg are shown as follows.

P01 2.4G WLAN_802.11b_Top Side_0cm_Ch11

DUT: 160511C17

Communication System: WLAN_2.4G; Frequency: 2462 MHz; Duty Cycle: 1:1

Medium: B19T27N3_0522 Medium parameters used: $f = 2462$ MHz; $\sigma = 2.011$ S/m; $\epsilon_r = 51.303$; $\rho = 1000$ kg/m³

Ambient Temperature : 23.7 °C ; Liquid Temperature : 23.5 °C

DASY5 Configuration:

- Probe: EX3DV4 - SN3971; ConvF(7.24, 7.24, 7.24); Calibrated: 2016/03/23;
- Sensor-Surface: 1.4mm (Mechanical Surface Detection)
- Electronics: DAE4 Sn1431; Calibrated: 2016/03/21
- Phantom: ELI Phantom_1245; Type: QDOVA;
- Measurement SW: DASY52, Version 52.8 (8); SEMCAD X Version 14.6.10 (7331)

- Area Scan (41x161x1): Interpolated grid: dx=1.200 mm, dy=1.200 mm

Maximum value of SAR (interpolated) = 0.907 W/kg

- Zoom Scan (5x5x7)/Cube 0: Measurement grid: dx=8mm, dy=8mm, dz=5mm

Reference Value = 11.91 V/m; Power Drift = 0.07 dB

Peak SAR (extrapolated) = 1.46 W/kg

SAR(1 g) = 0.540 W/kg; SAR(10 g) = 0.206 W/kg

Maximum value of SAR (measured) = 1.03 W/kg

- Zoom Scan (5x5x7)/Cube 1: Measurement grid: dx=8mm, dy=8mm, dz=5mm

Reference Value = 11.91 V/m; Power Drift = 0.07 dB

Peak SAR (extrapolated) = 1.26 W/kg

SAR(1 g) = 0.466 W/kg; SAR(10 g) = 0.197 W/kg

Maximum value of SAR (measured) = 0.806 W/kg

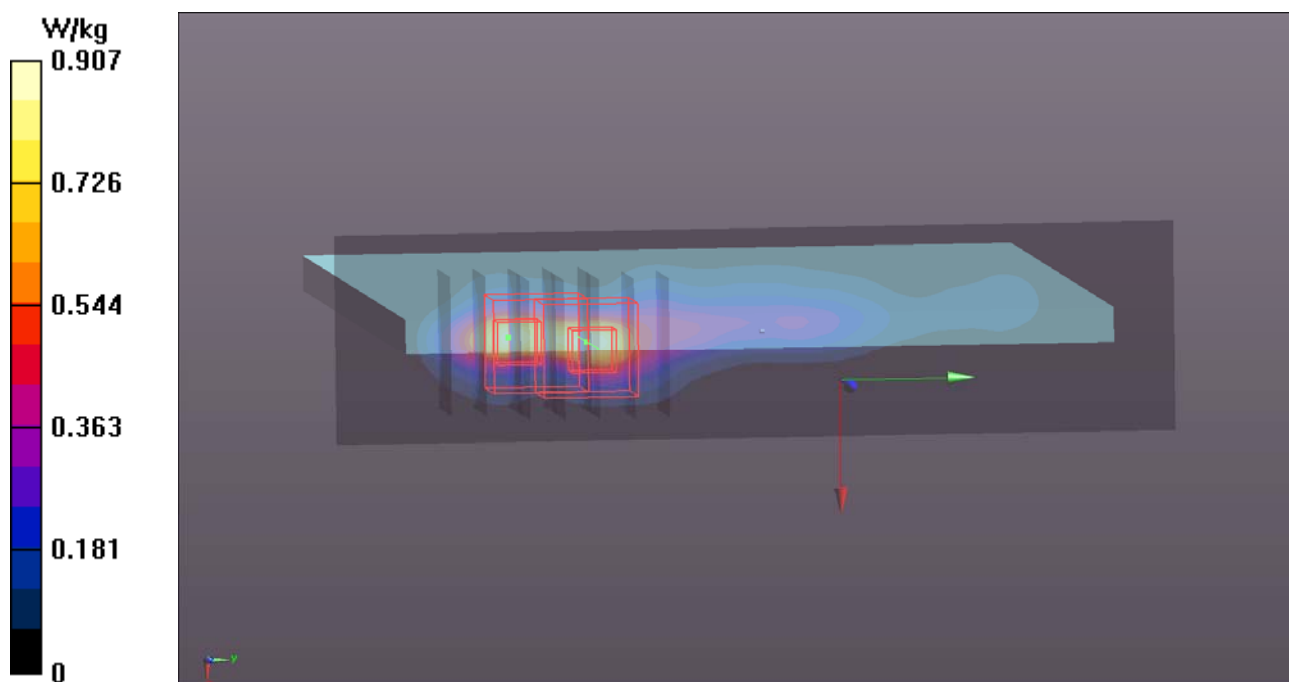

P02 5.3G WLAN_802.11n HT40_Top Side_0cm_Ch54

DUT: 160511C17

Communication System: WLAN_5G; Frequency: 5270 MHz; Duty Cycle: 1:1

Medium: B34T60N2_0523 Medium parameters used: $f = 5270$ MHz; $\sigma = 5.477$ S/m; $\epsilon_r = 48.45$; $\rho = 1000$ kg/m³

Ambient Temperature : 23.7 °C ; Liquid Temperature : 23.5 °C

DASY5 Configuration:

- Probe: EX3DV4 - SN3820; ConvF(4.04, 4.04, 4.04); Calibrated: 2015/6/19;
- Sensor-Surface: 1.4mm (Mechanical Surface Detection)
- Electronics: DAE4 Sn1305; Calibrated: 2015/12/11
- Phantom: ELI Phantom_1043; Type: QDOVA;
- Measurement SW: DASY52, Version 52.8 (8); SEMCAD X Version 14.6.10 (7331)

- **Area Scan (81x201x1):** Interpolated grid: dx=1.000 mm, dy=1.000 mm

Maximum value of SAR (interpolated) = 1.45 W/kg

- **Zoom Scan (6x6x12)/Cube 0:** Measurement grid: dx=5mm, dy=5mm, dz=2mm

Reference Value = 2.364 V/m; Power Drift = 0.01 dB

Peak SAR (extrapolated) = 5.01 W/kg

SAR(1 g) = 0.793 W/kg; SAR(10 g) = 0.178 W/kg

Maximum value of SAR (measured) = 2.65 W/kg

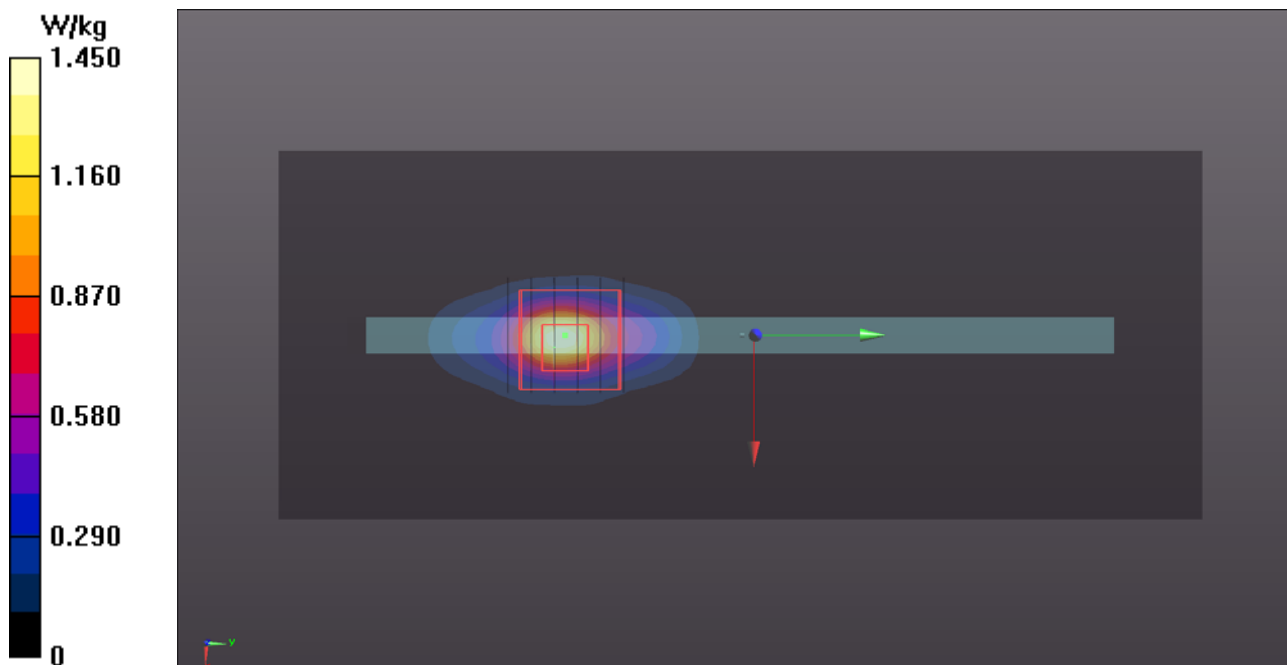

P03 5.6G WLAN_802.11n HT40_Top Side_0cm_Ch134

DUT: 160511C17

Communication System: WLAN_5G; Frequency: 5670 MHz; Duty Cycle: 1:1

Medium: B34T60N2_0523 Medium parameters used: $f = 5670$ MHz; $\sigma = 6.021$ S/m; $\epsilon_r = 47.772$; $\rho = 1000$ kg/m³

Ambient Temperature : 23.8 °C ; Liquid Temperature : 23.6 °C

DASY5 Configuration:

- Probe: EX3DV4 - SN3820; ConvF(3.64, 3.64, 3.64); Calibrated: 2015/6/19;
- Sensor-Surface: 1.4mm (Mechanical Surface Detection)
- Electronics: DAE4 Sn1305; Calibrated: 2015/12/11
- Phantom: ELI Phantom_1043; Type: QDOVA;
- Measurement SW: DASY52, Version 52.8 (8); SEMCAD X Version 14.6.10 (7331)

- **Area Scan (81x201x1):** Interpolated grid: dx=1.000 mm, dy=1.000 mm

Maximum value of SAR (interpolated) = 1.16 W/kg

- **Zoom Scan (6x6x12)/Cube 0:** Measurement grid: dx=5mm, dy=5mm, dz=2mm

Reference Value = 2.643 V/m; Power Drift = 0.04 dB

Peak SAR (extrapolated) = 4.02 W/kg

SAR(1 g) = 0.675 W/kg; SAR(10 g) = 0.166 W/kg

Maximum value of SAR (measured) = 1.94 W/kg

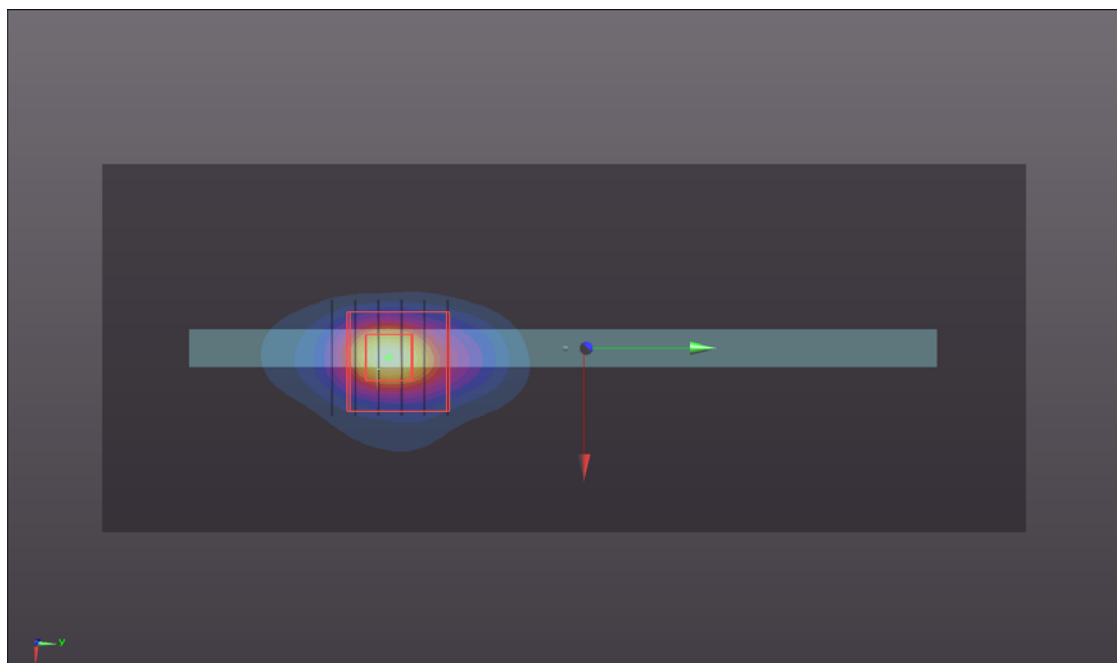
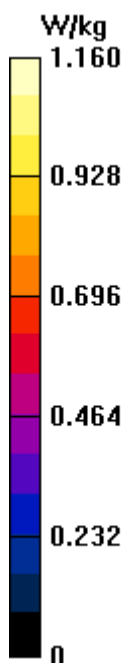

P04 5.8G WLAN_802.11n HT40_Top Side_0cm_Ch151

DUT: 160511C17

Communication System: WLAN_5G; Frequency: 5755 MHz; Duty Cycle: 1:1

Medium: B34T60N2_0523 Medium parameters used: $f = 5755$ MHz; $\sigma = 6.137$ S/m; $\epsilon_r = 47.611$; $\rho = 1000$ kg/m³

Ambient Temperature : 23.8 °C ; Liquid Temperature : 23.6 °C

DASY5 Configuration:

- Probe: EX3DV4 - SN3820; ConvF(3.97, 3.97, 3.97); Calibrated: 2015/6/19;
- Sensor-Surface: 1.4mm (Mechanical Surface Detection)
- Electronics: DAE4 Sn1305; Calibrated: 2015/12/11
- Phantom: ELI Phantom_1043; Type: QDOVA;
- Measurement SW: DASY52, Version 52.8 (8); SEMCAD X Version 14.6.10 (7331)

- Area Scan (81x201x1): Interpolated grid: dx=1.000 mm, dy=1.000 mm

Maximum value of SAR (interpolated) = 1.22 W/kg

- Zoom Scan (6x6x12)/Cube 0: Measurement grid: dx=5mm, dy=5mm, dz=2mm

Reference Value = 2.240 V/m; Power Drift = 0.05 dB

Peak SAR (extrapolated) = 3.07 W/kg

SAR(1 g) = 0.528 W/kg; SAR(10 g) = 0.135 W/kg

Maximum value of SAR (measured) = 1.48 W/kg

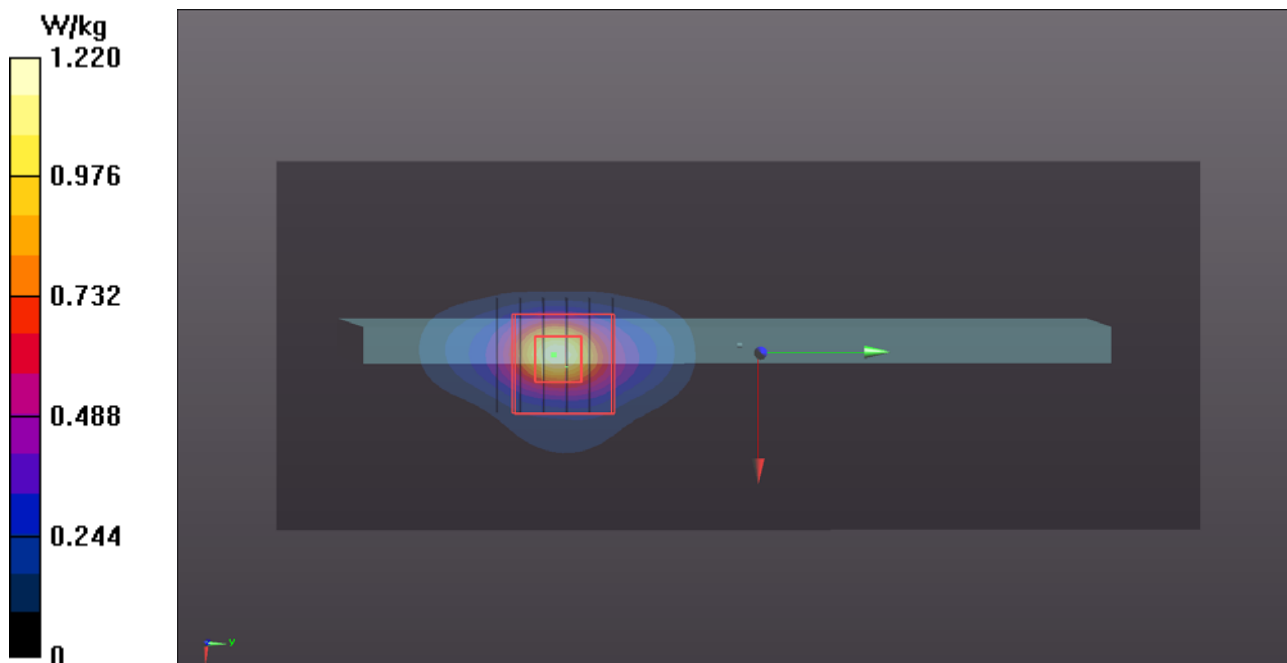

P05 Bluetooth_Top Side_0cm_Ch78

DUT: 160511C17

Communication System: BT; Frequency: 2480 MHz; Duty Cycle: 1:1.27

Medium: B19T27N3_0522 Medium parameters used: $f = 2480$ MHz; $\sigma = 2.031$ S/m; $\epsilon_r = 51.25$; $\rho = 1000$ kg/m³

Ambient Temperature : 23.7 °C ; Liquid Temperature : 23.5 °C

DASY5 Configuration:

- Probe: EX3DV4 - SN3971; ConvF(7.24, 7.24, 7.24); Calibrated: 2016/03/23;
- Sensor-Surface: 1.4mm (Mechanical Surface Detection)
- Electronics: DAE4 Sn1431; Calibrated: 2016/03/21
- Phantom: ELI Phantom_1245; Type: QDOVA;
- Measurement SW: DASY52, Version 52.8 (8); SEMCAD X Version 14.6.10 (7331)

- **Area Scan (51x171x1):** Interpolated grid: dx=1.200 mm, dy=1.200 mm

Maximum value of SAR (interpolated) = 0.116 W/kg

- **Zoom Scan (5x5x7)/Cube 0:** Measurement grid: dx=8mm, dy=8mm, dz=5mm

Reference Value = 4.840 V/m; Power Drift = 0.02 dB

Peak SAR (extrapolated) = 0.260 W/kg

SAR(1 g) = 0.088 W/kg; SAR(10 g) = 0.030 W/kg

Maximum value of SAR (measured) = 0.216 W/kg

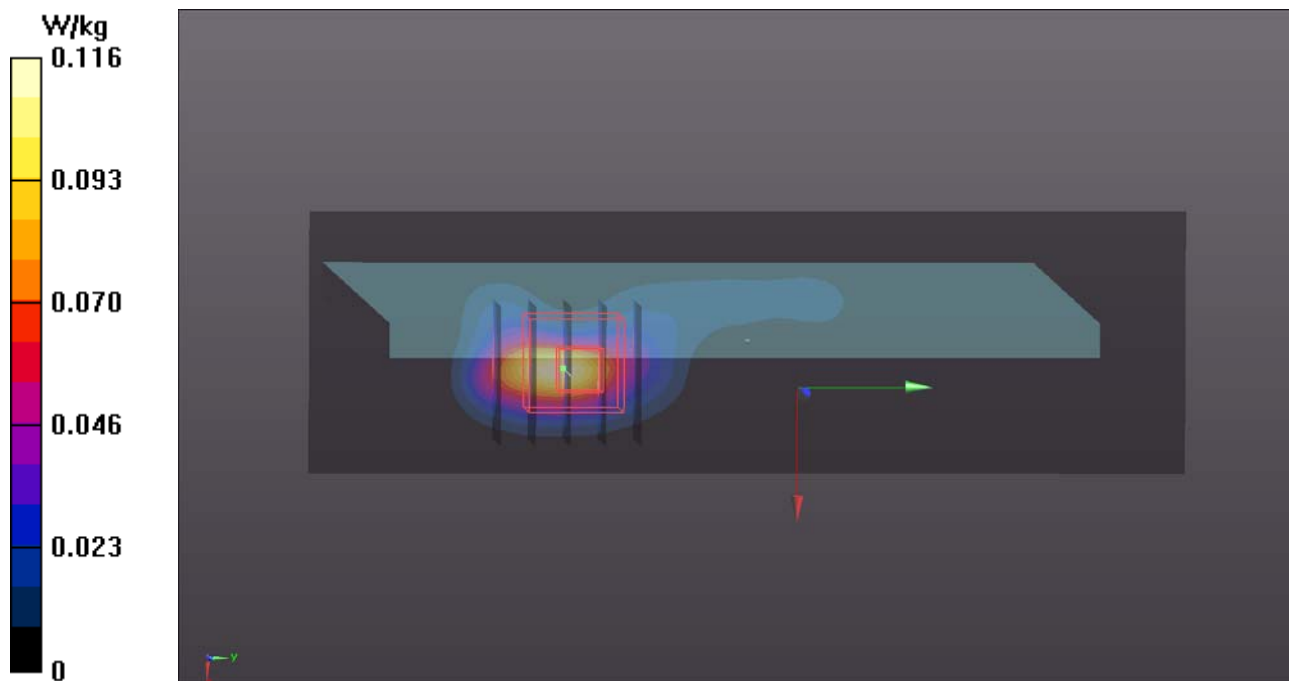



Appendix C. Calibration Certificate for Probe and Dipole

The SPEAG calibration certificates are shown as follows.



Accredited by the Swiss Accreditation Service (SAS)
The Swiss Accreditation Service is one of the signatories to the EA
Multilateral Agreement for the recognition of calibration certificates

Accreditation No.: **SCS 0108**

Client **B.V. ADT (Auden)**

Certificate No: **D2450V2-737_Aug15**

CALIBRATION CERTIFICATE

Object **D2450V2 - SN: 737**

Calibration procedure(s) **QA CAL-05.v9
Calibration procedure for dipole validation kits above 700 MHz**

Calibration date: **August 20, 2015**

This calibration certificate documents the traceability to national standards, which realize the physical units of measurements (SI).
The measurements and the uncertainties with confidence probability are given on the following pages and are part of the certificate.

All calibrations have been conducted in the closed laboratory facility: environment temperature (22 ± 3)°C and humidity < 70%.

Calibration Equipment used (M&TE critical for calibration)

| Primary Standards | ID # | Cal Date (Certificate No.) | Scheduled Calibration |
|-----------------------------|--------------------|-----------------------------------|------------------------|
| Power meter EPM-442A | GB37480704 | 07-Oct-14 (No. 217-02020) | Oct-15 |
| Power sensor HP 8481A | US37292783 | 07-Oct-14 (No. 217-02020) | Oct-15 |
| Power sensor HP 8481A | MY41092317 | 07-Oct-14 (No. 217-02021) | Oct-15 |
| Reference 20 dB Attenuator | SN: 5058 (20k) | 01-Apr-15 (No. 217-02131) | Mar-16 |
| Type-N mismatch combination | SN: 5047.2 / 06327 | 01-Apr-15 (No. 217-02134) | Mar-16 |
| Reference Probe ES3DV3 | SN: 3205 | 30-Dec-14 (No. ES3-3205_Dec14) | Dec-15 |
| DAE4 | SN: 601 | 17-Aug-15 (No. DAE4-601_Aug15) | Aug-16 |
| Secondary Standards | ID # | Check Date (in house) | Scheduled Check |
| RF generator R&S SMT-06 | 100005 | 04-Aug-99 (in house check Oct-13) | In house check: Oct-16 |
| Network Analyzer HP 8753E | US37390585 S4206 | 18-Oct-01 (in house check Oct-14) | In house check: Oct-15 |

| | | | |
|----------------|------------------------------|--|---------------|
| Calibrated by: | Name Michael Weber | Function Laboratory Technician | Signature |
| Approved by: | Katja Pokovic | Technical Manager | |

Issued: August 21, 2015

This calibration certificate shall not be reproduced except in full without written approval of the laboratory.



Accredited by the Swiss Accreditation Service (SAS)

The Swiss Accreditation Service is one of the signatories to the EA Multilateral Agreement for the recognition of calibration certificates

Accreditation No.: **SCS 0108**

Glossary:

| | |
|-------|---------------------------------|
| TSL | tissue simulating liquid |
| ConvF | sensitivity in TSL / NORM x,y,z |
| N/A | not applicable or not measured |

Calibration is Performed According to the Following Standards:

- IEEE Std 1528-2013, "IEEE Recommended Practice for Determining the Peak Spatial-Averaged Specific Absorption Rate (SAR) in the Human Head from Wireless Communications Devices: Measurement Techniques", June 2013
- IEC 62209-1, "Procedure to measure the Specific Absorption Rate (SAR) for hand-held devices used in close proximity to the ear (frequency range of 300 MHz to 3 GHz)", February 2005
- IEC 62209-2, "Procedure to determine the Specific Absorption Rate (SAR) for wireless communication devices used in close proximity to the human body (frequency range of 30 MHz to 6 GHz)", March 2010
- KDB 865664, "SAR Measurement Requirements for 100 MHz to 6 GHz"

Additional Documentation:

- DASY4/5 System Handbook

Methods Applied and Interpretation of Parameters:

- Measurement Conditions:** Further details are available from the Validation Report at the end of the certificate. All figures stated in the certificate are valid at the frequency indicated.
- Antenna Parameters with TSL:** The dipole is mounted with the spacer to position its feed point exactly below the center marking of the flat phantom section, with the arms oriented parallel to the body axis.
- Feed Point Impedance and Return Loss:** These parameters are measured with the dipole positioned under the liquid filled phantom. The impedance stated is transformed from the measurement at the SMA connector to the feed point. The Return Loss ensures low reflected power. No uncertainty required.
- Electrical Delay:** One-way delay between the SMA connector and the antenna feed point. No uncertainty required.
- SAR measured:** SAR measured at the stated antenna input power.
- SAR normalized:** SAR as measured, normalized to an input power of 1 W at the antenna connector.
- SAR for nominal TSL parameters:** The measured TSL parameters are used to calculate the nominal SAR result.

The reported uncertainty of measurement is stated as the standard uncertainty of measurement multiplied by the coverage factor $k=2$, which for a normal distribution corresponds to a coverage probability of approximately 95%.

Measurement Conditions

DASY system configuration, as far as not given on page 1.

| | | |
|-------------------------------------|------------------------|-------------|
| DASY Version | DASY5 | V52.8.8 |
| Extrapolation | Advanced Extrapolation | |
| Phantom | Modular Flat Phantom | |
| Distance Dipole Center - TSL | 10 mm | with Spacer |
| Zoom Scan Resolution | dx, dy, dz = 5 mm | |
| Frequency | 2450 MHz ± 1 MHz | |

Head TSL parameters

The following parameters and calculations were applied.

| | Temperature | Permittivity | Conductivity |
|--|-----------------|--------------|------------------|
| Nominal Head TSL parameters | 22.0 °C | 39.2 | 1.80 mho/m |
| Measured Head TSL parameters | (22.0 ± 0.2) °C | 39.2 ± 6 % | 1.87 mho/m ± 6 % |
| Head TSL temperature change during test | < 0.5 °C | ---- | ---- |

SAR result with Head TSL

| SAR averaged over 1 cm³ (1 g) of Head TSL | Condition | |
|---|--------------------|---------------------------------|
| SAR measured | 250 mW input power | 13.5 W/kg |
| SAR for nominal Head TSL parameters | normalized to 1W | 53.0 W/kg ± 17.0 % (k=2) |

| SAR averaged over 10 cm³ (10 g) of Head TSL | condition | |
|---|--------------------|---------------------------------|
| SAR measured | 250 mW input power | 6.32 W/kg |
| SAR for nominal Head TSL parameters | normalized to 1W | 25.0 W/kg ± 16.5 % (k=2) |

Body TSL parameters

The following parameters and calculations were applied.

| | Temperature | Permittivity | Conductivity |
|--|-----------------|--------------|------------------|
| Nominal Body TSL parameters | 22.0 °C | 52.7 | 1.95 mho/m |
| Measured Body TSL parameters | (22.0 ± 0.2) °C | 53.2 ± 6 % | 2.00 mho/m ± 6 % |
| Body TSL temperature change during test | < 0.5 °C | ---- | ---- |

SAR result with Body TSL

| SAR averaged over 1 cm³ (1 g) of Body TSL | Condition | |
|---|--------------------|---------------------------------|
| SAR measured | 250 mW input power | 12.9 W/kg |
| SAR for nominal Body TSL parameters | normalized to 1W | 51.1 W/kg ± 17.0 % (k=2) |

| SAR averaged over 10 cm³ (10 g) of Body TSL | condition | |
|---|--------------------|---------------------------------|
| SAR measured | 250 mW input power | 6.02 W/kg |
| SAR for nominal Body TSL parameters | normalized to 1W | 24.0 W/kg ± 16.5 % (k=2) |

Appendix (Additional assessments outside the scope of SCS 0108)

Antenna Parameters with Head TSL

| | |
|--------------------------------------|--------------------------------|
| Impedance, transformed to feed point | 53.5 Ω + 3.5 j Ω |
| Return Loss | - 26.3 dB |

Antenna Parameters with Body TSL

| | |
|--------------------------------------|--------------------------------|
| Impedance, transformed to feed point | 49.8 Ω + 4.8 j Ω |
| Return Loss | - 26.3 dB |

General Antenna Parameters and Design

| | |
|----------------------------------|----------|
| Electrical Delay (one direction) | 1.161 ns |
|----------------------------------|----------|

After long term use with 100W radiated power, only a slight warming of the dipole near the feedpoint can be measured.

The dipole is made of standard semirigid coaxial cable. The center conductor of the feeding line is directly connected to the second arm of the dipole. The antenna is therefore short-circuited for DC-signals. On some of the dipoles, small end caps are added to the dipole arms in order to improve matching when loaded according to the position as explained in the "Measurement Conditions" paragraph. The SAR data are not affected by this change. The overall dipole length is still according to the Standard.

No excessive force must be applied to the dipole arms, because they might bend or the soldered connections near the feedpoint may be damaged.

Additional EUT Data

| | |
|-----------------|-----------------|
| Manufactured by | SPEAG |
| Manufactured on | August 26, 2003 |

DASY5 Validation Report for Head TSL

Date: 20.08.2015

Test Laboratory: SPEAG, Zurich, Switzerland

DUT: Dipole 2450 MHz; Type: D2450V2; Serial: D2450V2 - SN: 737

Communication System: UID 0 - CW; Frequency: 2450 MHz

Medium parameters used: $f = 2450$ MHz; $\sigma = 1.87$ S/m; $\epsilon_r = 39.2$; $\rho = 1000$ kg/m³

Phantom section: Flat Section

Measurement Standard: DASY5 (IEEE/IEC/ANSI C63.19-2011)

DASY52 Configuration:

- Probe: ES3DV3 - SN3205; ConvF(4.54, 4.54, 4.54); Calibrated: 30.12.2014;
- Sensor-Surface: 3mm (Mechanical Surface Detection)
- Electronics: DAE4 Sn601; Calibrated: 17.08.2015
- Phantom: Flat Phantom 5.0 (front); Type: QD000P50AA; Serial: 1001
- DASY52 52.8.8(1222); SEMCAD X 14.6.10(7331)

Dipole Calibration for Head Tissue/Pin=250 mW, d=10mm/Zoom Scan (7x7x7)/Cube 0:

Measurement grid: dx=5mm, dy=5mm, dz=5mm

Reference Value = 101.6 V/m; Power Drift = -0.01 dB

Peak SAR (extrapolated) = 27.8 W/kg

SAR(1 g) = 13.5 W/kg; SAR(10 g) = 6.32 W/kg

Maximum value of SAR (measured) = 18.0 W/kg

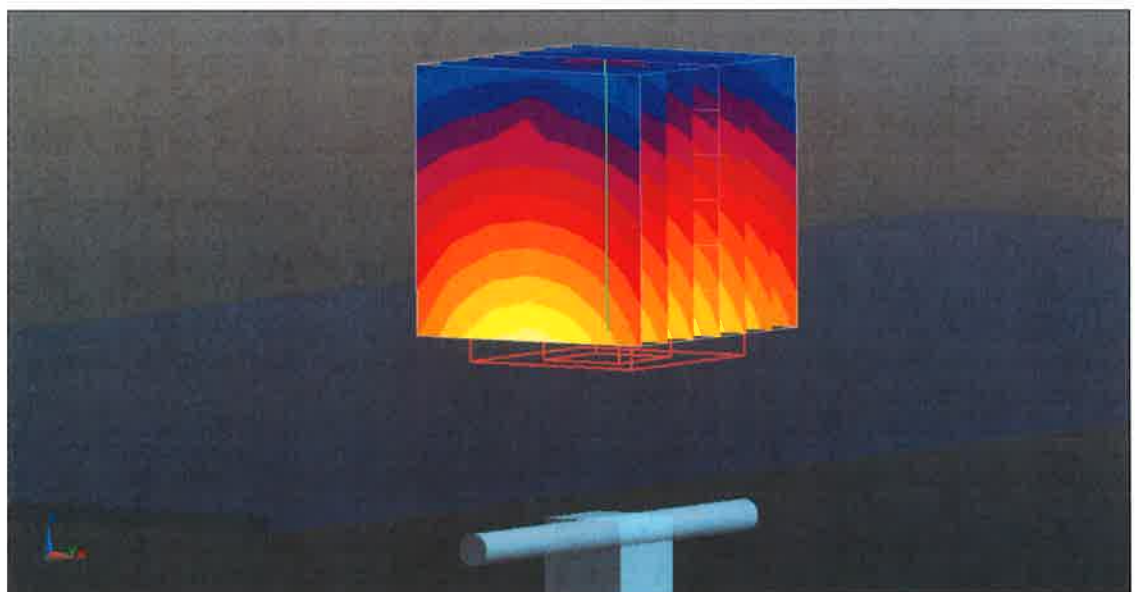
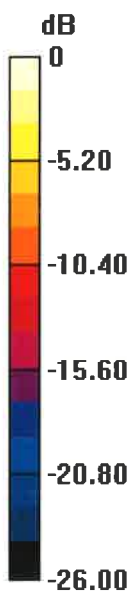

0 dB = 18.0 W/kg = 12.55 dBW/kg

Impedance Measurement Plot for Head TSL

19 Aug 2015 12:42:13

CH1 S11 1 U FS 4: 53.531 Ω 3.5332 Ω 229.52 pF 2 450.000 000 MHz

*
De l
CA

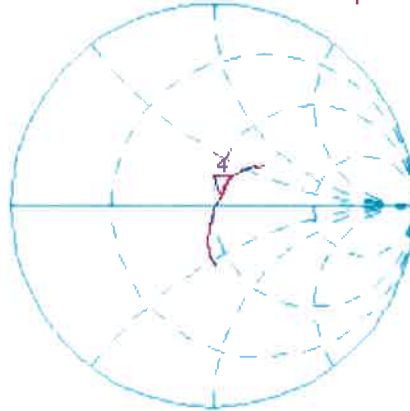

Av 9
16

H1 d

CH2 S11 LOG 5 dB/ REF -20 dB 4: -26.333 dB 2 450.000 000 MHz

CA

Av 9
16

H1 d

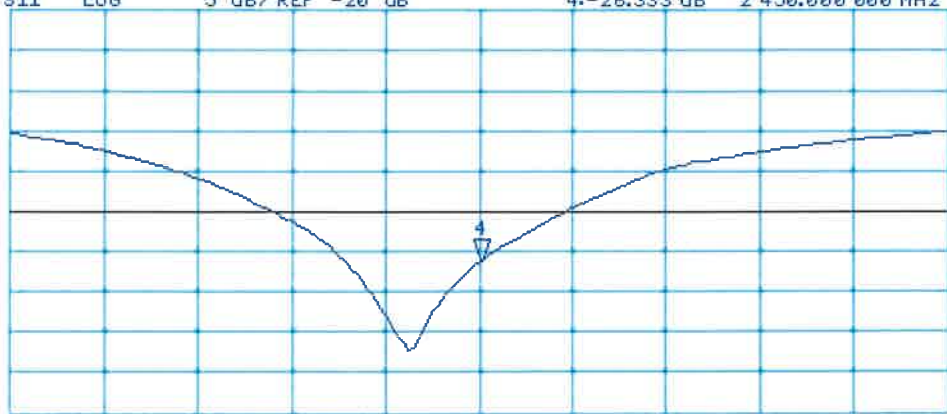

START 2 250.000 000 MHz

STOP 2 650.000 000 MHz

DASY5 Validation Report for Body TSL

Date: 19.08.2015

Test Laboratory: SPEAG, Zurich, Switzerland

DUT: Dipole 2450 MHz; Type: D2450V2; Serial: D2450V2 - SN: 737

Communication System: UID 0 - CW; Frequency: 2450 MHz

Medium parameters used: $f = 2450$ MHz; $\sigma = 2$ S/m; $\epsilon_r = 53.2$; $\rho = 1000$ kg/m³

Phantom section: Flat Section

Measurement Standard: DASY5 (IEEE/IEC/ANSI C63.19-2011)

DASY52 Configuration:

- Probe: ES3DV3 - SN3205; ConvF(4.32, 4.32, 4.32); Calibrated: 30.12.2014;
- Sensor-Surface: 3mm (Mechanical Surface Detection)
- Electronics: DAE4 Sn601; Calibrated: 17.08.2015
- Phantom: Flat Phantom 5.0 (back); Type: QD000P50AA; Serial: 1002
- DASY52 52.8.8(1222); SEMCAD X 14.6.10(7331)

Dipole Calibration for Body Tissue/Pin=250 mW, d=10mm/Zoom Scan (7x7x7)/Cube 0:

Measurement grid: dx=5mm, dy=5mm, dz=5mm

Reference Value = 95.46 V/m; Power Drift = 0.01 dB

Peak SAR (extrapolated) = 26.6 W/kg

SAR(1 g) = 12.9 W/kg; SAR(10 g) = 6.02 W/kg

Maximum value of SAR (measured) = 17.1 W/kg



0 dB = 17.1 W/kg = 12.33 dBW/kg

Impedance Measurement Plot for Body TSL

19 Aug 2015 12:40:41

CH1 S11 1 U FS 4: 49.811 Ω 4.8281 Ω 313.64 pF 2 450.000 000 MHz

*
Del

CA

Avg
16

H1d

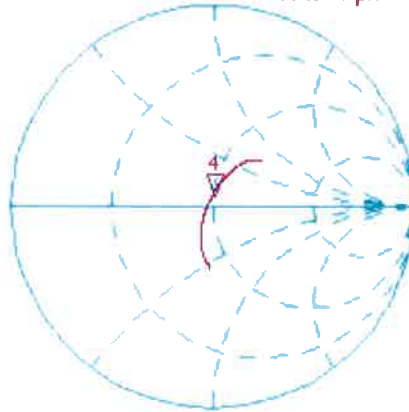

CH2 S11 LOG 5 dB/REF -20 dB 4: -26.305 dB 2 450.000 000 MHz

CA

Avg
16

H1d





Accredited by the Swiss Accreditation Service (SAS)
The Swiss Accreditation Service is one of the signatories to the EA
Multilateral Agreement for the recognition of calibration certificates

Accreditation No.: **SCS 0108**

Client **B.V. ADT (Auden)**

Certificate No: **D5GHzV2-1019_Aug15**

CALIBRATION CERTIFICATE

Object **D5GHzV2 - SN: 1019**

Calibration procedure(s) **QA CAL-22.v2
Calibration procedure for dipole validation kits between 3-6 GHz**

Calibration date: **August 28, 2015**

This calibration certificate documents the traceability to national standards, which realize the physical units of measurements (SI).
The measurements and the uncertainties with confidence probability are given on the following pages and are part of the certificate.

All calibrations have been conducted in the closed laboratory facility: environment temperature (22 ± 3)°C and humidity < 70%.

Calibration Equipment used (M&TE critical for calibration)

| Primary Standards | ID # | Cal Date (Certificate No.) | Scheduled Calibration |
|-----------------------------|--------------------|-----------------------------------|------------------------|
| Power meter EPM-442A | GB37480704 | 07-Oct-14 (No. 217-02020) | Oct-15 |
| Power sensor HP 8481A | US37292783 | 07-Oct-14 (No. 217-02020) | Oct-15 |
| Power sensor HP 8481A | MY41092317 | 07-Oct-14 (No. 217-02021) | Oct-15 |
| Reference 20 dB Attenuator | SN: 5058 (20k) | 01-Apr-15 (No. 217-02131) | Mar-16 |
| Type-N mismatch combination | SN: 5047.2 / 06327 | 01-Apr-15 (No. 217-02134) | Mar-16 |
| Reference Probe EX3DV4 | SN: 3503 | 30-Dec-14 (No. EX3-3503_Dec14) | Dec-15 |
| DAE4 | SN: 601 | 17-Aug-15 (No. DAE4-601_Aug15) | Aug-16 |
| Secondary Standards | ID # | Check Date (in house) | Scheduled Check |
| RF generator R&S SMT-06 | 100005 | 04-Aug-99 (in house check Oct-13) | In house check: Oct-16 |
| Network Analyzer HP 8753E | US37390585 S4206 | 18-Oct-01 (in house check Oct-14) | In house check: Oct-15 |

| | | | |
|----------------|----------------|-----------------------|-----------|
| | Name | Function | Signature |
| Calibrated by: | Jeton Kastrati | Laboratory Technician | |
| Approved by: | Katja Pokovic | Technical Manager | |

Issued: August 28, 2015

This calibration certificate shall not be reproduced except in full without written approval of the laboratory.



Accredited by the Swiss Accreditation Service (SAS)

The Swiss Accreditation Service is one of the signatories to the EA
Multilateral Agreement for the recognition of calibration certificates

Accreditation No.: **SCS 0108**

Glossary:

| | |
|-------|---------------------------------|
| TSL | tissue simulating liquid |
| ConvF | sensitivity in TSL / NORM x,y,z |
| N/A | not applicable or not measured |

Calibration is Performed According to the Following Standards:

- IEEE Std 1528-2013, "IEEE Recommended Practice for Determining the Peak Spatial-Averaged Specific Absorption Rate (SAR) in the Human Head from Wireless Communications Devices: Measurement Techniques", June 2013
- IEC 62209-2, "Procedure to determine the Specific Absorption Rate (SAR) for wireless communication devices used in close proximity to the human body (frequency range of 30 MHz to 6 GHz)", March 2010
- KDB 865664, "SAR Measurement Requirements for 100 MHz to 6 GHz"

Additional Documentation:

- DASY4/5 System Handbook

Methods Applied and Interpretation of Parameters:

- Measurement Conditions:** Further details are available from the Validation Report at the end of the certificate. All figures stated in the certificate are valid at the frequency indicated.
- Antenna Parameters with TSL:** The dipole is mounted with the spacer to position its feed point exactly below the center marking of the flat phantom section, with the arms oriented parallel to the body axis.
- Feed Point Impedance and Return Loss:** These parameters are measured with the dipole positioned under the liquid filled phantom. The impedance stated is transformed from the measurement at the SMA connector to the feed point. The Return Loss ensures low reflected power. No uncertainty required.
- Electrical Delay:** One-way delay between the SMA connector and the antenna feed point. No uncertainty required.
- SAR measured:** SAR measured at the stated antenna input power.
- SAR normalized:** SAR as measured, normalized to an input power of 1 W at the antenna connector.
- SAR for nominal TSL parameters:** The measured TSL parameters are used to calculate the nominal SAR result.

The reported uncertainty of measurement is stated as the standard uncertainty of measurement multiplied by the coverage factor $k=2$, which for a normal distribution corresponds to a coverage probability of approximately 95%.

Measurement Conditions

DASY system configuration, as far as not given on page 1.

| | | |
|-------------------------------------|--|----------------------------------|
| DASY Version | DASY5 | V52.8.8 |
| Extrapolation | Advanced Extrapolation | |
| Phantom | Modular Flat Phantom V5.0 | |
| Distance Dipole Center - TSL | 10 mm | with Spacer |
| Zoom Scan Resolution | dx, dy = 4.0 mm, dz = 1.4 mm | Graded Ratio = 1.4 (Z direction) |
| Frequency | 5200 MHz ± 1 MHz 5250 MHz ± 1 MHz 5300 MHz ± 1 MHz 5600 MHz ± 1 MHz 5800 MHz ± 1 MHz | |

Head TSL parameters at 5200 MHz

The following parameters and calculations were applied.

| | Temperature | Permittivity | Conductivity |
|--|-----------------|--------------|------------------|
| Nominal Head TSL parameters | 22.0 °C | 36.0 | 4.66 mho/m |
| Measured Head TSL parameters | (22.0 ± 0.2) °C | 35.0 ± 6 % | 4.49 mho/m ± 6 % |
| Head TSL temperature change during test | < 0.5 °C | ---- | ---- |

SAR result with Head TSL at 5200 MHz

| SAR averaged over 1 cm³ (1 g) of Head TSL | Condition | |
|---|--------------------|---------------------------------|
| SAR measured | 100 mW input power | 8.11 W/kg |
| SAR for nominal Head TSL parameters | normalized to 1W | 80.6 W/kg ± 19.9 % (k=2) |

| SAR averaged over 10 cm³ (10 g) of Head TSL | condition | |
|---|--------------------|---------------------------------|
| SAR measured | 100 mW input power | 2.32 W/kg |
| SAR for nominal Head TSL parameters | normalized to 1W | 23.0 W/kg ± 19.5 % (k=2) |

Head TSL parameters at 5250 MHz

The following parameters and calculations were applied.

| | Temperature | Permittivity | Conductivity |
|---|-----------------|--------------|------------------|
| Nominal Head TSL parameters | 22.0 °C | 35.9 | 4.71 mho/m |
| Measured Head TSL parameters | (22.0 ± 0.2) °C | 35.0 ± 6 % | 4.54 mho/m ± 6 % |
| Head TSL temperature change during test | < 0.5 °C | ---- | ---- |

SAR result with Head TSL at 5250 MHz

| SAR averaged over 1 cm ³ (1 g) of Head TSL | Condition | |
|---|--------------------|---------------------------------|
| SAR measured | 100 mW input power | 8.29 W/kg |
| SAR for nominal Head TSL parameters | normalized to 1W | 82.4 W/kg ± 19.9 % (k=2) |

| SAR averaged over 10 cm ³ (10 g) of Head TSL | condition | |
|---|--------------------|---------------------------------|
| SAR measured | 100 mW input power | 2.37 W/kg |
| SAR for nominal Head TSL parameters | normalized to 1W | 23.5 W/kg ± 19.5 % (k=2) |

Head TSL parameters at 5300 MHz

The following parameters and calculations were applied.

| | Temperature | Permittivity | Conductivity |
|---|-----------------|--------------|------------------|
| Nominal Head TSL parameters | 22.0 °C | 35.9 | 4.76 mho/m |
| Measured Head TSL parameters | (22.0 ± 0.2) °C | 34.9 ± 6 % | 4.59 mho/m ± 6 % |
| Head TSL temperature change during test | < 0.5 °C | ---- | ---- |

SAR result with Head TSL at 5300 MHz

| SAR averaged over 1 cm ³ (1 g) of Head TSL | Condition | |
|---|--------------------|---------------------------------|
| SAR measured | 100 mW input power | 8.56 W/kg |
| SAR for nominal Head TSL parameters | normalized to 1W | 85.0 W/kg ± 19.9 % (k=2) |

| SAR averaged over 10 cm ³ (10 g) of Head TSL | condition | |
|---|--------------------|---------------------------------|
| SAR measured | 100 mW input power | 2.45 W/kg |
| SAR for nominal Head TSL parameters | normalized to 1W | 24.3 W/kg ± 19.5 % (k=2) |

Head TSL parameters at 5600 MHz

The following parameters and calculations were applied.

| | Temperature | Permittivity | Conductivity |
|---|-----------------|--------------|------------------|
| Nominal Head TSL parameters | 22.0 °C | 35.5 | 5.07 mho/m |
| Measured Head TSL parameters | (22.0 ± 0.2) °C | 34.5 ± 6 % | 4.88 mho/m ± 6 % |
| Head TSL temperature change during test | < 0.5 °C | ---- | ---- |

SAR result with Head TSL at 5600 MHz

| SAR averaged over 1 cm ³ (1 g) of Head TSL | Condition | |
|---|--------------------|---------------------------------|
| SAR measured | 100 mW input power | 8.45 W/kg |
| SAR for nominal Head TSL parameters | normalized to 1W | 83.9 W/kg ± 19.9 % (k=2) |

| SAR averaged over 10 cm ³ (10 g) of Head TSL | condition | |
|---|--------------------|---------------------------------|
| SAR measured | 100 mW input power | 2.40 W/kg |
| SAR for nominal Head TSL parameters | normalized to 1W | 23.8 W/kg ± 19.5 % (k=2) |

Head TSL parameters at 5800 MHz

The following parameters and calculations were applied.

| | Temperature | Permittivity | Conductivity |
|---|-----------------|--------------|------------------|
| Nominal Head TSL parameters | 22.0 °C | 35.3 | 5.27 mho/m |
| Measured Head TSL parameters | (22.0 ± 0.2) °C | 34.2 ± 6 % | 5.09 mho/m ± 6 % |
| Head TSL temperature change during test | < 0.5 °C | ---- | ---- |

SAR result with Head TSL at 5800 MHz

| SAR averaged over 1 cm ³ (1 g) of Head TSL | Condition | |
|---|--------------------|---------------------------------|
| SAR measured | 100 mW input power | 8.25 W/kg |
| SAR for nominal Head TSL parameters | normalized to 1W | 81.8 W/kg ± 19.9 % (k=2) |

| SAR averaged over 10 cm ³ (10 g) of Head TSL | condition | |
|---|--------------------|---------------------------------|
| SAR measured | 100 mW input power | 2.34 W/kg |
| SAR for nominal Head TSL parameters | normalized to 1W | 23.2 W/kg ± 19.5 % (k=2) |

Body TSL parameters at 5200 MHz

The following parameters and calculations were applied.

| | Temperature | Permittivity | Conductivity |
|---|-----------------|--------------|------------------|
| Nominal Body TSL parameters | 22.0 °C | 49.0 | 5.30 mho/m |
| Measured Body TSL parameters | (22.0 ± 0.2) °C | 47.4 ± 6 % | 5.46 mho/m ± 6 % |
| Body TSL temperature change during test | < 0.5 °C | ---- | ---- |

SAR result with Body TSL at 5200 MHz

| SAR averaged over 1 cm ³ (1 g) of Body TSL | Condition | |
|---|--------------------|---------------------------------|
| SAR measured | 100 mW input power | 7.57 W/kg |
| SAR for nominal Body TSL parameters | normalized to 1W | 75.2 W/kg ± 19.9 % (k=2) |

| SAR averaged over 10 cm ³ (10 g) of Body TSL | condition | |
|---|--------------------|---------------------------------|
| SAR measured | 100 mW input power | 2.12 W/kg |
| SAR for nominal Body TSL parameters | normalized to 1W | 21.0 W/kg ± 19.5 % (k=2) |

Body TSL parameters at 5250 MHz

The following parameters and calculations were applied.

| | Temperature | Permittivity | Conductivity |
|---|-----------------|--------------|------------------|
| Nominal Body TSL parameters | 22.0 °C | 48.9 | 5.36 mho/m |
| Measured Body TSL parameters | (22.0 ± 0.2) °C | 47.3 ± 6 % | 5.52 mho/m ± 6 % |
| Body TSL temperature change during test | < 0.5 °C | ---- | ---- |

SAR result with Body TSL at 5250 MHz

| SAR averaged over 1 cm ³ (1 g) of Body TSL | Condition | |
|---|--------------------|---------------------------------|
| SAR measured | 100 mW input power | 7.69 W/kg |
| SAR for nominal Body TSL parameters | normalized to 1W | 76.4 W/kg ± 19.9 % (k=2) |

| SAR averaged over 10 cm ³ (10 g) of Body TSL | condition | |
|---|--------------------|---------------------------------|
| SAR measured | 100 mW input power | 2.15 W/kg |
| SAR for nominal Body TSL parameters | normalized to 1W | 21.3 W/kg ± 19.5 % (k=2) |

Body TSL parameters at 5300 MHz

The following parameters and calculations were applied.

| | Temperature | Permittivity | Conductivity |
|---|-----------------|--------------|------------------|
| Nominal Body TSL parameters | 22.0 °C | 48.9 | 5.42 mho/m |
| Measured Body TSL parameters | (22.0 ± 0.2) °C | 47.3 ± 6 % | 5.59 mho/m ± 6 % |
| Body TSL temperature change during test | < 0.5 °C | ---- | ---- |

SAR result with Body TSL at 5300 MHz

| SAR averaged over 1 cm ³ (1 g) of Body TSL | Condition | |
|---|--------------------|---------------------------------|
| SAR measured | 100 mW input power | 7.70 W/kg |
| SAR for nominal Body TSL parameters | normalized to 1W | 76.6 W/kg ± 19.9 % (k=2) |

| SAR averaged over 10 cm ³ (10 g) of Body TSL | condition | |
|---|--------------------|---------------------------------|
| SAR measured | 100 mW input power | 2.16 W/kg |
| SAR for nominal Body TSL parameters | normalized to 1W | 21.4 W/kg ± 19.5 % (k=2) |

Body TSL parameters at 5600 MHz

The following parameters and calculations were applied.

| | Temperature | Permittivity | Conductivity |
|---|-----------------|--------------|------------------|
| Nominal Body TSL parameters | 22.0 °C | 48.5 | 5.77 mho/m |
| Measured Body TSL parameters | (22.0 ± 0.2) °C | 46.7 ± 6 % | 5.99 mho/m ± 6 % |
| Body TSL temperature change during test | < 0.5 °C | ---- | ---- |

SAR result with Body TSL at 5600 MHz

| SAR averaged over 1 cm ³ (1 g) of Body TSL | Condition | |
|---|--------------------|---------------------------------|
| SAR measured | 100 mW input power | 8.03 W/kg |
| SAR for nominal Body TSL parameters | normalized to 1W | 79.8 W/kg ± 19.9 % (k=2) |

| SAR averaged over 10 cm ³ (10 g) of Body TSL | condition | |
|---|--------------------|---------------------------------|
| SAR measured | 100 mW input power | 2.23 W/kg |
| SAR for nominal Body TSL parameters | normalized to 1W | 22.1 W/kg ± 19.5 % (k=2) |

Body TSL parameters at 5800 MHz

The following parameters and calculations were applied.

| | Temperature | Permittivity | Conductivity |
|---|-----------------|--------------|------------------|
| Nominal Body TSL parameters | 22.0 °C | 48.2 | 6.00 mho/m |
| Measured Body TSL parameters | (22.0 ± 0.2) °C | 46.4 ± 6 % | 6.27 mho/m ± 6 % |
| Body TSL temperature change during test | < 0.5 °C | ---- | ---- |

SAR result with Body TSL at 5800 MHz

| SAR averaged over 1 cm ³ (1 g) of Body TSL | Condition | |
|---|--------------------|---------------------------------|
| SAR measured | 100 mW input power | 7.77 W/kg |
| SAR for nominal Body TSL parameters | normalized to 1W | 77.3 W/kg ± 19.9 % (k=2) |

| SAR averaged over 10 cm ³ (10 g) of Body TSL | condition | |
|---|--------------------|---------------------------------|
| SAR measured | 100 mW input power | 2.15 W/kg |
| SAR for nominal Body TSL parameters | normalized to 1W | 21.3 W/kg ± 19.5 % (k=2) |

Appendix (Additional assessments outside the scope of SCS 0108)

Antenna Parameters with Head TSL at 5200 MHz

| | |
|--------------------------------------|--------------------------------|
| Impedance, transformed to feed point | 51.5 Ω - 8.8 j Ω |
| Return Loss | - 21.2 dB |

Antenna Parameters with Head TSL at 5250 MHz

| | |
|--------------------------------------|--------------------------------|
| Impedance, transformed to feed point | 52.9 Ω - 3.7 j Ω |
| Return Loss | - 26.8 dB |

Antenna Parameters with Head TSL at 5300 MHz

| | |
|--------------------------------------|--------------------------------|
| Impedance, transformed to feed point | 53.7 Ω - 0.9 j Ω |
| Return Loss | - 28.7 dB |

Antenna Parameters with Head TSL at 5600 MHz

| | |
|--------------------------------------|--------------------------------|
| Impedance, transformed to feed point | 57.3 Ω - 2.0 j Ω |
| Return Loss | - 23.0 dB |

Antenna Parameters with Head TSL at 5800 MHz

| | |
|--------------------------------------|--------------------------------|
| Impedance, transformed to feed point | 56.5 Ω + 2.6 j Ω |
| Return Loss | - 23.7 dB |

Antenna Parameters with Body TSL at 5200 MHz

| | |
|--------------------------------------|--------------------------------|
| Impedance, transformed to feed point | 52.0 Ω - 6.7 j Ω |
| Return Loss | - 23.4 dB |

Antenna Parameters with Body TSL at 5250 MHz

| | |
|--------------------------------------|--------------------------------|
| Impedance, transformed to feed point | 53.0 Ω - 3.1 j Ω |
| Return Loss | - 27.5 dB |

Antenna Parameters with Body TSL at 5300 MHz

| | |
|--------------------------------------|--------------------------------|
| Impedance, transformed to feed point | 53.2 Ω - 0.3 j Ω |
| Return Loss | - 30.1 dB |

Antenna Parameters with Body TSL at 5600 MHz

| | |
|--------------------------------------|--------------------------------|
| Impedance, transformed to feed point | 57.3 Ω - 1.1 j Ω |
| Return Loss | - 23.2 dB |

Antenna Parameters with Body TSL at 5800 MHz

| | |
|--------------------------------------|--------------------------------|
| Impedance, transformed to feed point | 56.6 Ω + 4.0 j Ω |
| Return Loss | - 22.8 dB |

General Antenna Parameters and Design

| | |
|----------------------------------|----------|
| Electrical Delay (one direction) | 1.204 ns |
|----------------------------------|----------|

After long term use with 100W radiated power, only a slight warming of the dipole near the feedpoint can be measured.

The dipole is made of standard semirigid coaxial cable. The center conductor of the feeding line is directly connected to the second arm of the dipole. The antenna is therefore short-circuited for DC-signals. On some of the dipoles, small end caps are added to the dipole arms in order to improve matching when loaded according to the position as explained in the "Measurement Conditions" paragraph. The SAR data are not affected by this change. The overall dipole length is still according to the Standard.

No excessive force must be applied to the dipole arms, because they might bend or the soldered connections near the feedpoint may be damaged.

Additional EUT Data

| | |
|-----------------|-------------------|
| Manufactured by | SPEAG |
| Manufactured on | February 05, 2004 |

DASY5 Validation Report for Head TSL

Date: 28.08.2015

Test Laboratory: SPEAG, Zurich, Switzerland

DUT: Dipole 5GHz; Type: D5GHzV2; Serial: D5GHzV2 - SN: 1019

Communication System: UID 0 - CW; Frequency: 5200 MHz, Frequency: 5250 MHz, Frequency: 5300 MHz, Frequency: 5600 MHz, Frequency: 5800 MHz

Medium parameters used: $f = 5200$ MHz; $\sigma = 4.49$ S/m; $\epsilon_r = 35$; $\rho = 1000$ kg/m³, Medium parameters used: $f = 5250$ MHz; $\sigma = 4.54$ S/m; $\epsilon_r = 35$; $\rho = 1000$ kg/m³, Medium parameters used: $f = 5300$ MHz; $\sigma = 4.59$ S/m; $\epsilon_r = 34.9$; $\rho = 1000$ kg/m³, Medium parameters used: $f = 5600$ MHz; $\sigma = 4.88$ S/m; $\epsilon_r = 34.5$; $\rho = 1000$ kg/m³, Medium parameters used: $f = 5800$ MHz; $\sigma = 5.09$ S/m; $\epsilon_r = 34.2$; $\rho = 1000$ kg/m³

Phantom section: Flat Section

Measurement Standard: DASY5 (IEEE/IEC/ANSI C63.19-2011)

DASY52 Configuration:

- Probe: EX3DV4 - SN3503; ConvF(5.51, 5.51, 5.51); Calibrated: 30.12.2014, ConvF(5.45, 5.45, 5.45); Calibrated: 30.12.2014, ConvF(5.21, 5.21, 5.21); Calibrated: 30.12.2014, ConvF(4.92, 4.92, 4.92); Calibrated: 30.12.2014, ConvF(4.9, 4.9, 4.9); Calibrated: 30.12.2014;
- Sensor-Surface: 1.4mm (Mechanical Surface Detection)
- Electronics: DAE4 Sn601; Calibrated: 17.08.2015
- Phantom: Flat Phantom 5.0 (front); Type: QD000P50AA; Serial: 1001
- DASY52 52.8.8(1222); SEMCAD X 14.6.10(7331)

Dipole Calibration for Head Tissue/Pin=100mW, dist=10mm, f=5200 MHz/Zoom Scan, dist=1.4mm (8x8x7)/Cube 0: Measurement grid: dx=4mm, dy=4mm, dz=1.4mm

Reference Value = 67.05 V/m; Power Drift = 0.03 dB

Peak SAR (extrapolated) = 29.2 W/kg

SAR(1 g) = 8.11 W/kg; SAR(10 g) = 2.32 W/kg

Maximum value of SAR (measured) = 18.3 W/kg

Dipole Calibration for Head Tissue/Pin=100mW, dist=10mm, f=5250 MHz/Zoom Scan, dist=1.4mm (8x8x7)/Cube 0: Measurement grid: dx=4mm, dy=4mm, dz=1.4mm

Reference Value = 67.57 V/m; Power Drift = 0.02 dB

Peak SAR (extrapolated) = 30.1 W/kg

SAR(1 g) = 8.29 W/kg; SAR(10 g) = 2.37 W/kg

Maximum value of SAR (measured) = 18.8 W/kg

Dipole Calibration for Head Tissue/Pin=100mW, dist=10mm, f=5300 MHz/Zoom Scan, dist=1.4mm (8x8x7)/Cube 0: Measurement grid: dx=4mm, dy=4mm, dz=1.4mm

Reference Value = 67.84 V/m; Power Drift = -0.01 dB

Peak SAR (extrapolated) = 31.7 W/kg

SAR(1 g) = 8.56 W/kg; SAR(10 g) = 2.45 W/kg

Maximum value of SAR (measured) = 19.4 W/kg

Dipole Calibration for Head Tissue/Pin=100mW, dist=10mm, f=5600 MHz/Zoom Scan, dist=1.4mm (8x8x7)/Cube 0: Measurement grid: dx=4mm, dy=4mm, dz=1.4mm
Reference Value = 66.21 V/m; Power Drift = -0.01 dB
Peak SAR (extrapolated) = 33.1 W/kg
SAR(1 g) = 8.45 W/kg; SAR(10 g) = 2.4 W/kg
Maximum value of SAR (measured) = 19.8 W/kg

Dipole Calibration for Head Tissue/Pin=100mW, dist=10mm, f=5800 MHz/Zoom Scan, dist=1.4mm (8x8x7)/Cube 0: Measurement grid: dx=4mm, dy=4mm, dz=1.4mm
Reference Value = 63.99 V/m; Power Drift = -0.00 dB
Peak SAR (extrapolated) = 33.7 W/kg
SAR(1 g) = 8.25 W/kg; SAR(10 g) = 2.34 W/kg

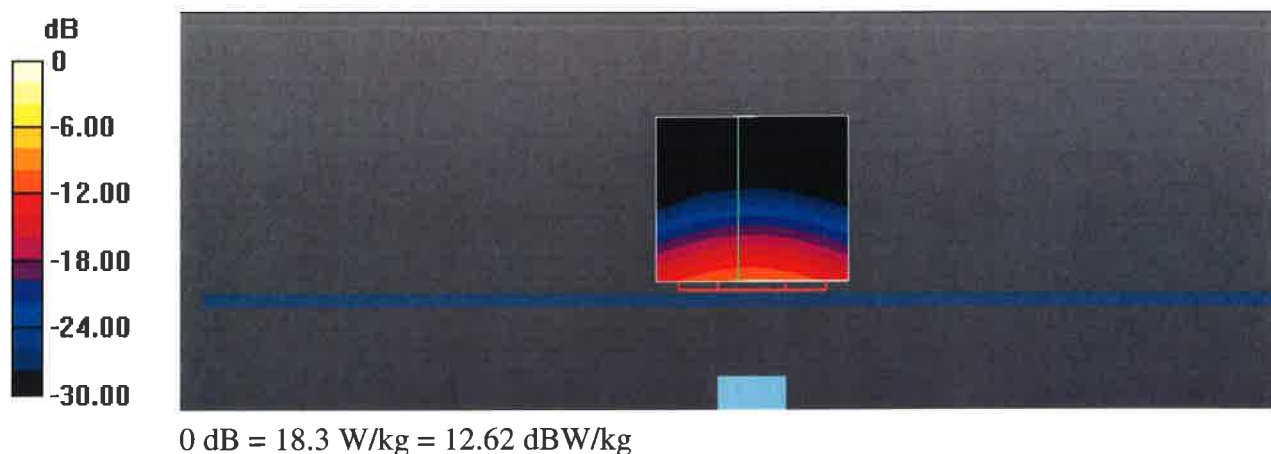

Impedance Measurement Plot for Head TSL

28 Aug 2015 14:02:22

CH1 S11 1 U FS 1: 51.523 Ω -8.7676 Ω 3.4909 pF 5 200.000 000 MHz

*
De1
Cor
Avg
16
H1d

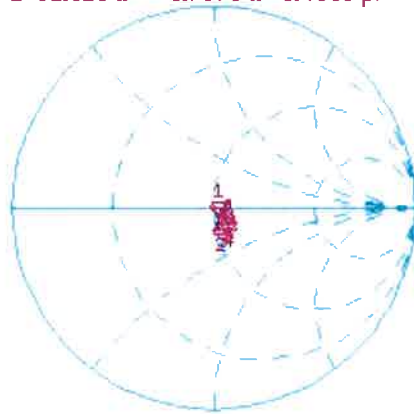

CH1 Markers
2: 52.939 Ω
-3.6992 Ω
5.25000 GHz
3: 53.695 Ω
-939.45 m Ω
5.30000 GHz
4: 57.330 Ω
-1.9707 Ω
5.60000 GHz
5: 56.473 Ω
2.6055 Ω
5.80000 GHz

CH2 S11 LOG 5 dB/REF -20 dB 1: -21.176 dB 5 200.000 000 MHz

Cor
Avg
16
H1d



CH2 Markers
2: -26.764 dB
5.25000 GHz
3: -28.683 dB
5.30000 GHz
4: -23.009 dB
5.60000 GHz
5: -23.668 dB
5.80000 GHz

START 5 000.000 000 MHz

STOP 6 000.000 000 MHz

DASY5 Validation Report for Body TSL

Date: 27.08.2015

Test Laboratory: SPEAG, Zurich, Switzerland

DUT: Dipole 5GHz; Type: D5GHzV2; Serial: D5GHzV2 - SN: 1019

Communication System: UID 0 - CW; Frequency: 5200 MHz, Frequency: 5250 MHz, Frequency: 5300 MHz, Frequency: 5600 MHz, Frequency: 5800 MHz

Medium parameters used: $f = 5200$ MHz; $\sigma = 5.46$ S/m; $\epsilon_r = 47.4$; $\rho = 1000$ kg/m³, Medium parameters used: $f = 5250$ MHz; $\sigma = 5.52$ S/m; $\epsilon_r = 47.3$; $\rho = 1000$ kg/m³, Medium parameters used: $f = 5300$ MHz; $\sigma = 5.59$ S/m; $\epsilon_r = 47.3$; $\rho = 1000$ kg/m³, Medium parameters used: $f = 5600$ MHz; $\sigma = 5.99$ S/m; $\epsilon_r = 46.7$; $\rho = 1000$ kg/m³, Medium parameters used: $f = 5800$ MHz; $\sigma = 6.27$ S/m; $\epsilon_r = 46.4$; $\rho = 1000$ kg/m³

Phantom section: Flat Section

Measurement Standard: DASY5 (IEEE/IEC/ANSI C63.19-2011)

DASY52 Configuration:

- Probe: EX3DV4 - SN3503; ConvF(4.95, 4.95, 4.95); Calibrated: 30.12.2014, ConvF(4.9, 4.9, 4.9); Calibrated: 30.12.2014, ConvF(4.78, 4.78, 4.78); Calibrated: 30.12.2014, ConvF(4.35, 4.35, 4.35); Calibrated: 30.12.2014, ConvF(4.32, 4.32, 4.32); Calibrated: 30.12.2014;
- Sensor-Surface: 1.4mm (Mechanical Surface Detection)
- Electronics: DAE4 Sn601; Calibrated: 17.08.2015
- Phantom: Flat Phantom 5.0 (back); Type: QD000P50AA; Serial: 1002
- DASY52 52.8.8(1222); SEMCAD X 14.6.10(7331)

Dipole Calibration for Body Tissue/Pin=100mW, dist=10mm, f=5200 MHz/Zoom Scan,

dist=1.4mm (8x8x7)/Cube 0: Measurement grid: dx=4mm, dy=4mm, dz=1.4mm

Reference Value = 59.22 V/m; Power Drift = -0.05 dB

Peak SAR (extrapolated) = 29.3 W/kg

SAR(1 g) = 7.57 W/kg; SAR(10 g) = 2.12 W/kg

Maximum value of SAR (measured) = 17.4 W/kg

Dipole Calibration for Body Tissue/Pin=100mW, dist=10mm, f=5250 MHz/Zoom Scan,

dist=1.4mm (8x8x7)/Cube 0: Measurement grid: dx=4mm, dy=4mm, dz=1.4mm

Reference Value = 59.60 V/m; Power Drift = -0.02 dB

Peak SAR (extrapolated) = 30.0 W/kg

SAR(1 g) = 7.69 W/kg; SAR(10 g) = 2.15 W/kg

Maximum value of SAR (measured) = 17.6 W/kg

Dipole Calibration for Body Tissue/Pin=100mW, dist=10mm, f=5300 MHz/Zoom Scan,

dist=1.4mm (8x8x7)/Cube 0: Measurement grid: dx=4mm, dy=4mm, dz=1.4mm

Reference Value = 59.29 V/m; Power Drift = -0.01 dB

Peak SAR (extrapolated) = 30.6 W/kg

SAR(1 g) = 7.7 W/kg; SAR(10 g) = 2.16 W/kg

Maximum value of SAR (measured) = 17.9 W/kg

Dipole Calibration for Body Tissue/Pin=100mW, dist=10mm, f=5600 MHz/Zoom Scan, dist=1.4mm (8x8x7)/Cube 0: Measurement grid: dx=4mm, dy=4mm, dz=1.4mm

Reference Value = 58.65 V/m; Power Drift = -0.02 dB

Peak SAR (extrapolated) = 34.8 W/kg

SAR(1 g) = 8.03 W/kg; SAR(10 g) = 2.23 W/kg

Maximum value of SAR (measured) = 19.2 W/kg

Dipole Calibration for Body Tissue/Pin=100mW, dist=10mm, f=5800 MHz/Zoom Scan, dist=1.4mm (8x8x7)/Cube 0: Measurement grid: dx=4mm, dy=4mm, dz=1.4mm

Reference Value = 56.66 V/m; Power Drift = -0.02 dB

Peak SAR (extrapolated) = 35.6 W/kg

SAR(1 g) = 7.77 W/kg; SAR(10 g) = 2.15 W/kg

Maximum value of SAR (measured) = 19.0 W/kg

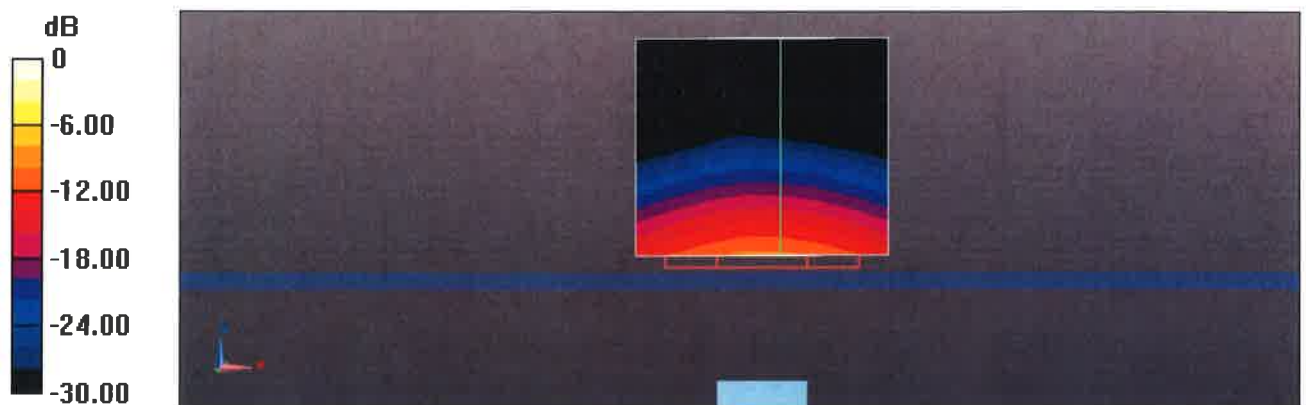

0 dB = 19.0 W/kg = 12.79 dBW/kg

Impedance Measurement Plot for Body TSL

27 Aug 2015 14:04:18

CH1 S11 1 U FS 1: 51.992 Ω -6.6523 Ω 4.6009 pF 5 200.000 000 MHz

*

De1

Cor

Avg
16

H1d

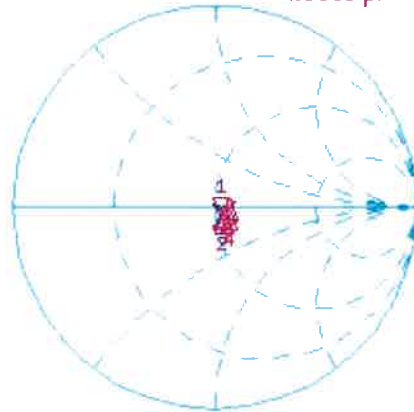

CH1 Markers

- 2: 53.043 Ω
-3.1152 Ω
5.25000 GHz
- 3: 53.219 Ω
-255.86 m Ω
5.30000 GHz
- 4: 57.346 Ω
-1.1133 Ω
5.60000 GHz
- 5: 56.588 Ω
3.9883 Ω
5.80000 GHz

CH2 S11 LOG 5 dB/REF -20 dB 1: -23.357 dB 5 200.000 000 MHz

De1

Cor

Avg
16

H1d



CH2 Markers

- 2: -27.480 dB
5.25000 GHz
- 3: -30.089 dB
5.30000 GHz
- 4: -23.195 dB
5.60000 GHz
- 5: -22.829 dB
5.80000 GHz

START 5 000.000 000 MHz

STOP 6 000.000 000 MHz



Accredited by the Swiss Accreditation Service (SAS)
The Swiss Accreditation Service is one of the signatories to the EA
Multilateral Agreement for the recognition of calibration certificates

Accreditation No.: **SCS 0108**

Client **B.V.ADT (Auden)**

Certificate No: **EX3-3971_Mar16**

CALIBRATION CERTIFICATE

Object **EX3DV4 - SN:3971**

Calibration procedure(s) **QA CAL-01.v9, QA CAL-14.v4, QA CAL-23.v5, QA CAL-25.v6
Calibration procedure for dosimetric E-field probes**

Calibration date: **March 23, 2016**

This calibration certificate documents the traceability to national standards, which realize the physical units of measurements (SI).
The measurements and the uncertainties with confidence probability are given on the following pages and are part of the certificate.

All calibrations have been conducted in the closed laboratory facility: environment temperature (22 ± 3)°C and humidity < 70%.

Calibration Equipment used (M&TE critical for calibration)

| Primary Standards | ID | Cal Date (Certificate No.) | Scheduled Calibration |
|----------------------------|-----------------|-----------------------------------|------------------------|
| Power meter E4419B | GB41293874 | 01-Apr-15 (No. 217-02128) | Mar-16 |
| Power sensor E4412A | MY41498087 | 01-Apr-15 (No. 217-02128) | Mar-16 |
| Reference 3 dB Attenuator | SN: S5054 (3c) | 01-Apr-15 (No. 217-02129) | Mar-16 |
| Reference 20 dB Attenuator | SN: S5277 (20x) | 01-Apr-15 (No. 217-02132) | Mar-16 |
| Reference 30 dB Attenuator | SN: S5129 (30b) | 01-Apr-15 (No. 217-02133) | Mar-16 |
| Reference Probe ES3DV2 | SN: 3013 | 31-Dec-15 (No. ES3-3013_Dec15) | Dec-16 |
| DAE4 | SN: 660 | 23-Dec-15 (No. DAE4-660_Dec15) | Dec-16 |
| Secondary Standards | ID | Check Date (in house) | Scheduled Check |
| RF generator HP 8648C | US3642U01700 | 4-Aug-99 (in house check Apr-13) | In house check: Apr-16 |
| Network Analyzer HP 8753E | US37390585 | 18-Oct-01 (in house check Oct-15) | In house check: Oct-16 |

| | Name | Function | Signature |
|----------------|-----------------------|------------------------------|------------------------|
| Calibrated by: | Jeton Kastrati | Laboratory Technician | |
| Approved by: | Katja Pokovic | Technical Manager | |
| | | | Issued: March 28, 2016 |

This calibration certificate shall not be reproduced except in full without written approval of the laboratory.



Accredited by the Swiss Accreditation Service (SAS)

Accreditation No.: **SCS 0108**

The Swiss Accreditation Service is one of the signatories to the EA
Multilateral Agreement for the recognition of calibration certificates

Glossary:

| | |
|--------------------------|---|
| TSL | tissue simulating liquid |
| NORM _{x,y,z} | sensitivity in free space |
| ConvF | sensitivity in TSL / NORM _{x,y,z} |
| DCP | diode compression point |
| CF | crest factor (1/duty_cycle) of the RF signal |
| A, B, C, D | modulation dependent linearization parameters |
| Polarization φ | φ rotation around probe axis |
| Polarization ϑ | ϑ rotation around an axis that is in the plane normal to probe axis (at measurement center), i.e., $\vartheta = 0$ is normal to probe axis |
| Connector Angle | information used in DASY system to align probe sensor X to the robot coordinate system |

Calibration is Performed According to the Following Standards:

- IEEE Std 1528-2013, "IEEE Recommended Practice for Determining the Peak Spatial-Averaged Specific Absorption Rate (SAR) in the Human Head from Wireless Communications Devices: Measurement Techniques", June 2013
- IEC 62209-1, "Procedure to measure the Specific Absorption Rate (SAR) for hand-held devices used in close proximity to the ear (frequency range of 300 MHz to 3 GHz)", February 2005
- IEC 62209-2, "Procedure to determine the Specific Absorption Rate (SAR) for wireless communication devices used in close proximity to the human body (frequency range of 30 MHz to 6 GHz)", March 2010
- KDB 865664, "SAR Measurement Requirements for 100 MHz to 6 GHz"

Methods Applied and Interpretation of Parameters:

- NORM_{x,y,z}**: Assessed for E-field polarization $\vartheta = 0$ ($f \leq 900$ MHz in TEM-cell; $f > 1800$ MHz: R22 waveguide). NORM_{x,y,z} are only intermediate values, i.e., the uncertainties of NORM_{x,y,z} does not affect the E²-field uncertainty inside TSL (see below *ConvF*).
- NORM(*f*)_{x,y,z} = NORM_{x,y,z} * frequency_response** (see Frequency Response Chart). This linearization is implemented in DASY4 software versions later than 4.2. The uncertainty of the frequency response is included in the stated uncertainty of *ConvF*.
- DCP_{x,y,z}**: DCP are numerical linearization parameters assessed based on the data of power sweep with CW signal (no uncertainty required). DCP does not depend on frequency nor media.
- PAR**: PAR is the Peak to Average Ratio that is not calibrated but determined based on the signal characteristics
- A_{x,y,z}; B_{x,y,z}; C_{x,y,z}; D_{x,y,z}; VR_{x,y,z}; A, B, C, D** are numerical linearization parameters assessed based on the data of power sweep for specific modulation signal. The parameters do not depend on frequency nor media. VR is the maximum calibration range expressed in RMS voltage across the diode.
- ConvF and Boundary Effect Parameters**: Assessed in flat phantom using E-field (or Temperature Transfer Standard for $f \leq 800$ MHz) and inside waveguide using analytical field distributions based on power measurements for $f > 800$ MHz. The same setups are used for assessment of the parameters applied for boundary compensation (alpha, depth) of which typical uncertainty values are given. These parameters are used in DASY4 software to improve probe accuracy close to the boundary. The sensitivity in TSL corresponds to NORM_{x,y,z} * ConvF whereby the uncertainty corresponds to that given for ConvF. A frequency dependent ConvF is used in DASY version 4.4 and higher which allows extending the validity from ± 50 MHz to ± 100 MHz.
- Spherical isotropy (3D deviation from isotropy)**: in a field of low gradients realized using a flat phantom exposed by a patch antenna.
- Sensor Offset**: The sensor offset corresponds to the offset of virtual measurement center from the probe tip (on probe axis). No tolerance required.
- Connector Angle**: The angle is assessed using the information gained by determining the NORM_x (no uncertainty required).

Probe EX3DV4

SN:3971

Manufactured: December 30, 2013
Calibrated: March 23, 2016

Calibrated for DASY/EASY Systems
(Note: non-compatible with DASY2 system!)

DASY/EASY - Parameters of Probe: EX3DV4 - SN:3971

Basic Calibration Parameters

| | Sensor X | Sensor Y | Sensor Z | Unc (k=2) |
|---|----------|----------|----------|---------------|
| Norm ($\mu\text{V}/(\text{V}/\text{m})^2$) ^A | 0.41 | 0.52 | 0.50 | $\pm 10.1 \%$ |
| DCP (mV) ^B | 104.0 | 101.0 | 97.3 | |

Modulation Calibration Parameters

| UID | Communication System Name | | A dB | B dB $\sqrt{\mu\text{V}}$ | C | D dB | VR mV | Unc ^E (k=2) |
|-----|---------------------------|---|---------|------------------------------|-----|---------|----------|---------------------------|
| 0 | CW | X | 0.0 | 0.0 | 1.0 | 0.00 | 189.2 | $\pm 3.5 \%$ |
| | | Y | 0.0 | 0.0 | 1.0 | | 172.3 | |
| | | Z | 0.0 | 0.0 | 1.0 | | 171.8 | |

The reported uncertainty of measurement is stated as the standard uncertainty of measurement multiplied by the coverage factor $k=2$, which for a normal distribution corresponds to a coverage probability of approximately 95%.

^A The uncertainties of Norm X,Y,Z do not affect the E^2 -field uncertainty inside TSL (see Pages 5 and 6).

^B Numerical linearization parameter: uncertainty not required.

^E Uncertainty is determined using the max. deviation from linear response applying rectangular distribution and is expressed for the square of the field value.

DASY/EASY - Parameters of Probe: EX3DV4 - SN:3971

Calibration Parameter Determined in Head Tissue Simulating Media

| f (MHz) ^C | Relative Permittivity ^F | Conductivity (S/m) ^F | ConvF X | ConvF Y | ConvF Z | Alpha ^G | Depth ^G (mm) | Unc (k=2) |
|----------------------|------------------------------------|---------------------------------|---------|---------|---------|--------------------|-------------------------|-----------|
| 750 | 41.9 | 0.89 | 10.30 | 10.30 | 10.30 | 0.50 | 0.83 | ± 12.0 % |
| 835 | 41.5 | 0.90 | 10.09 | 10.09 | 10.09 | 0.46 | 0.80 | ± 12.0 % |
| 900 | 41.5 | 0.97 | 9.83 | 9.83 | 9.83 | 0.35 | 0.97 | ± 12.0 % |
| 1450 | 40.5 | 1.20 | 8.60 | 8.60 | 8.60 | 0.36 | 0.90 | ± 12.0 % |
| 1640 | 40.3 | 1.29 | 8.43 | 8.43 | 8.43 | 0.32 | 0.80 | ± 12.0 % |
| 1750 | 40.1 | 1.37 | 8.43 | 8.43 | 8.43 | 0.33 | 0.80 | ± 12.0 % |
| 1900 | 40.0 | 1.40 | 8.15 | 8.15 | 8.15 | 0.27 | 0.99 | ± 12.0 % |
| 2000 | 40.0 | 1.40 | 8.19 | 8.19 | 8.19 | 0.36 | 0.80 | ± 12.0 % |
| 2300 | 39.5 | 1.67 | 7.75 | 7.75 | 7.75 | 0.33 | 0.81 | ± 12.0 % |
| 2450 | 39.2 | 1.80 | 7.46 | 7.46 | 7.46 | 0.32 | 0.84 | ± 12.0 % |
| 2600 | 39.0 | 1.96 | 7.16 | 7.16 | 7.16 | 0.32 | 0.87 | ± 12.0 % |
| 3500 | 37.9 | 2.91 | 6.94 | 6.94 | 6.94 | 0.39 | 1.09 | ± 13.1 % |
| 5200 | 36.0 | 4.66 | 5.34 | 5.34 | 5.34 | 0.30 | 1.80 | ± 13.1 % |
| 5300 | 35.9 | 4.76 | 5.00 | 5.00 | 5.00 | 0.35 | 1.80 | ± 13.1 % |
| 5500 | 35.6 | 4.96 | 4.94 | 4.94 | 4.94 | 0.40 | 1.80 | ± 13.1 % |
| 5600 | 35.5 | 5.07 | 4.66 | 4.66 | 4.66 | 0.45 | 1.80 | ± 13.1 % |
| 5800 | 35.3 | 5.27 | 4.75 | 4.75 | 4.75 | 0.40 | 1.80 | ± 13.1 % |

^C Frequency validity above 300 MHz of ± 100 MHz only applies for DASY v4.4 and higher (see Page 2), else it is restricted to ± 50 MHz. The uncertainty is the RSS of the ConvF uncertainty at calibration frequency and the uncertainty for the indicated frequency band. Frequency validity below 300 MHz is ± 10, 25, 40, 50 and 70 MHz for ConvF assessments at 30, 64, 128, 150 and 220 MHz respectively. Above 5 GHz frequency validity can be extended to ± 110 MHz.

^F At frequencies below 3 GHz, the validity of tissue parameters (ϵ and σ) can be relaxed to ± 10% if liquid compensation formula is applied to measured SAR values. At frequencies above 3 GHz, the validity of tissue parameters (ϵ and σ) is restricted to ± 5%. The uncertainty is the RSS of the ConvF uncertainty for indicated target tissue parameters.

^G Alpha/Depth are determined during calibration. SPEAG warrants that the remaining deviation due to the boundary effect after compensation is always less than ± 1% for frequencies below 3 GHz and below ± 2% for frequencies between 3-6 GHz at any distance larger than half the probe tip diameter from the boundary.

DASY/EASY - Parameters of Probe: EX3DV4 - SN:3971

Calibration Parameter Determined in Body Tissue Simulating Media

| f (MHz) ^c | Relative Permittivity ^F | Conductivity (S/m) ^F | ConvF X | ConvF Y | ConvF Z | Alpha ^G | Depth ^G (mm) | Unc (k=2) |
|----------------------|------------------------------------|---------------------------------|---------|---------|---------|--------------------|-------------------------|-----------|
| 750 | 55.5 | 0.96 | 10.00 | 10.00 | 10.00 | 0.49 | 0.86 | ± 12.0 % |
| 835 | 55.2 | 0.97 | 9.89 | 9.89 | 9.89 | 0.46 | 0.80 | ± 12.0 % |
| 900 | 55.0 | 1.05 | 9.92 | 9.92 | 9.92 | 0.47 | 0.80 | ± 12.0 % |
| 1450 | 54.0 | 1.30 | 8.57 | 8.57 | 8.57 | 0.31 | 0.80 | ± 12.0 % |
| 1640 | 53.8 | 1.40 | 8.48 | 8.48 | 8.48 | 0.25 | 1.06 | ± 12.0 % |
| 1750 | 53.4 | 1.49 | 8.08 | 8.08 | 8.08 | 0.37 | 0.80 | ± 12.0 % |
| 1900 | 53.3 | 1.52 | 7.85 | 7.85 | 7.85 | 0.40 | 0.86 | ± 12.0 % |
| 2000 | 53.3 | 1.52 | 7.98 | 7.98 | 7.98 | 0.37 | 0.82 | ± 12.0 % |
| 2300 | 52.9 | 1.81 | 7.39 | 7.39 | 7.39 | 0.34 | 0.80 | ± 12.0 % |
| 2450 | 52.7 | 1.95 | 7.24 | 7.24 | 7.24 | 0.36 | 0.80 | ± 12.0 % |
| 2600 | 52.5 | 2.16 | 6.88 | 6.88 | 6.88 | 0.25 | 0.90 | ± 12.0 % |
| 3500 | 51.3 | 3.31 | 6.69 | 6.69 | 6.69 | 0.36 | 1.21 | ± 13.1 % |
| 5200 | 49.0 | 5.30 | 4.54 | 4.54 | 4.54 | 0.50 | 1.90 | ± 13.1 % |
| 5300 | 48.9 | 5.42 | 4.26 | 4.26 | 4.26 | 0.50 | 1.90 | ± 13.1 % |
| 5500 | 48.6 | 5.65 | 3.95 | 3.95 | 3.95 | 0.55 | 1.90 | ± 13.1 % |
| 5600 | 48.5 | 5.77 | 3.68 | 3.68 | 3.68 | 0.60 | 1.90 | ± 13.1 % |
| 5800 | 48.2 | 6.00 | 3.90 | 3.90 | 3.90 | 0.60 | 1.90 | ± 13.1 % |

^c Frequency validity above 300 MHz of ± 100 MHz only applies for DASY v4.4 and higher (see Page 2), else it is restricted to ± 50 MHz. The uncertainty is the RSS of the ConvF uncertainty at calibration frequency and the uncertainty for the indicated frequency band. Frequency validity below 300 MHz is ± 10, 25, 40, 50 and 70 MHz for ConvF assessments at 30, 64, 128, 150 and 220 MHz respectively. Above 5 GHz frequency validity can be extended to ± 110 MHz.

^F At frequencies below 3 GHz, the validity of tissue parameters (ϵ and σ) can be relaxed to ± 10% if liquid compensation formula is applied to measured SAR values. At frequencies above 3 GHz, the validity of tissue parameters (ϵ and σ) is restricted to ± 5%. The uncertainty is the RSS of the ConvF uncertainty for indicated target tissue parameters.

^G Alpha/Depth are determined during calibration. SPEAG warrants that the remaining deviation due to the boundary effect after compensation is always less than ± 1% for frequencies below 3 GHz and below ± 2% for frequencies between 3-6 GHz at any distance larger than half the probe tip diameter from the boundary.

Frequency Response of E-Field (TEM-Cell:ifi110 EXX, Waveguide: R22)

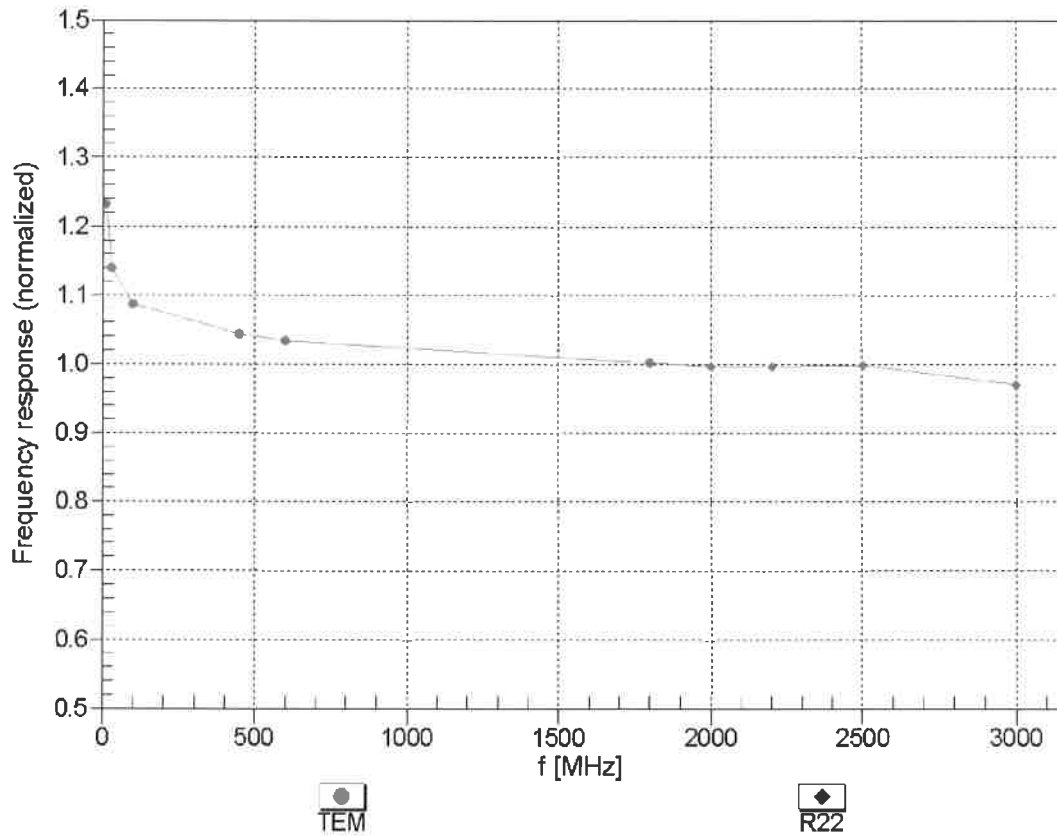

Uncertainty of Frequency Response of E-field: $\pm 6.3\%$ (k=2)

Receiving Pattern (ϕ), $\vartheta = 0^\circ$

f=600 MHz,TEM

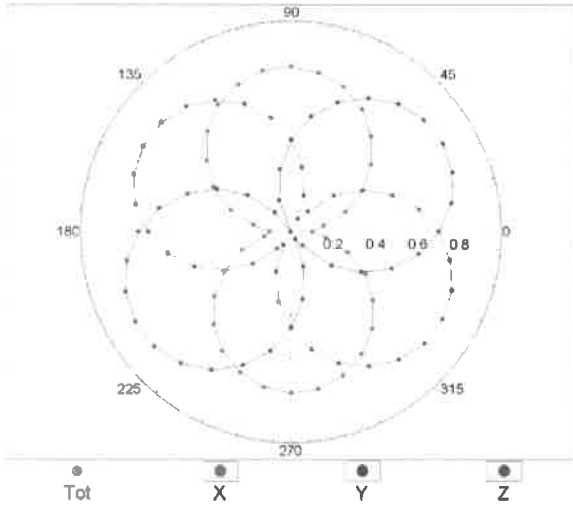

f=1800 MHz,R22

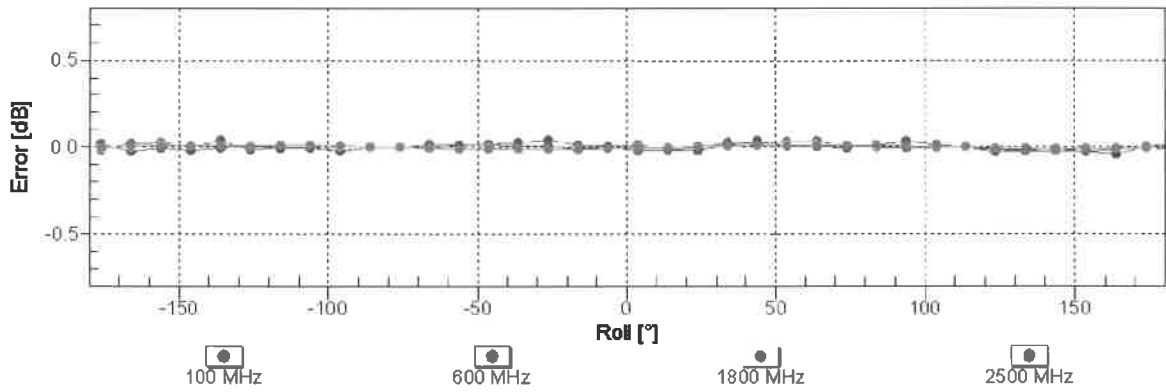
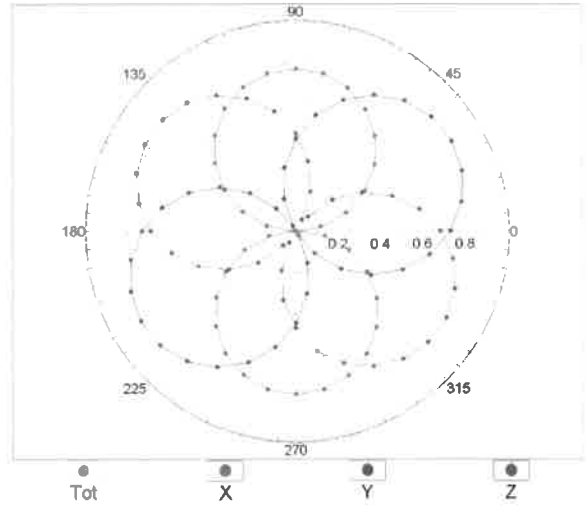

Uncertainty of Axial Isotropy Assessment: $\pm 0.5\%$ (k=2)

Dynamic Range $f(\text{SAR}_{\text{head}})$ (TEM cell , $f_{\text{eval}} = 1900 \text{ MHz}$)

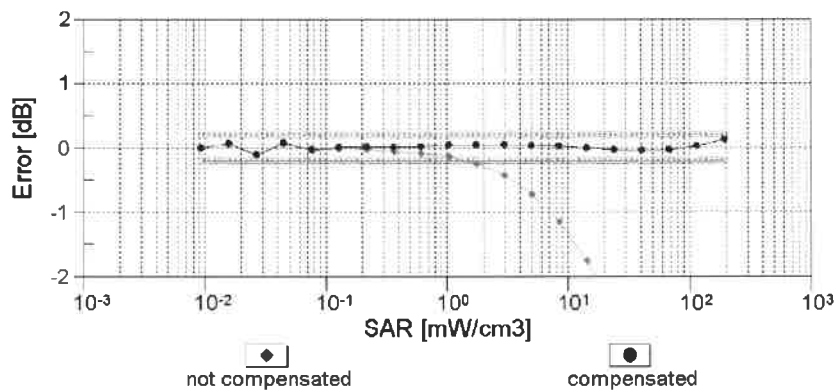
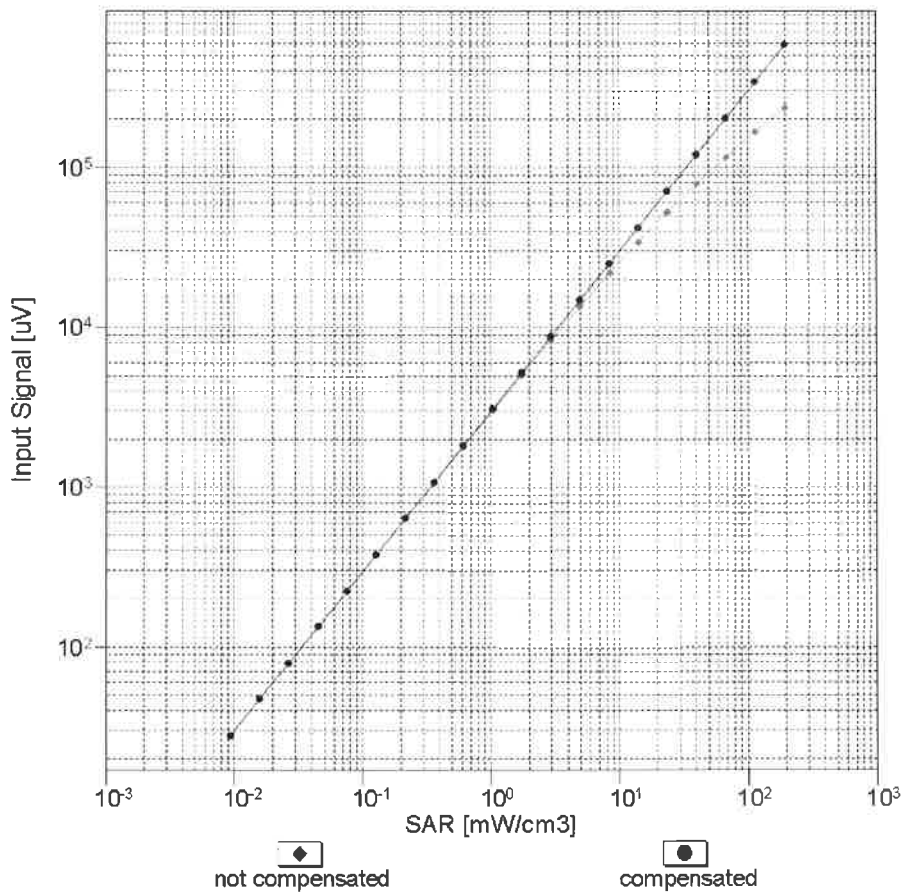

Uncertainty of Linearity Assessment: $\pm 0.6\%$ ($k=2$)

Conversion Factor Assessment

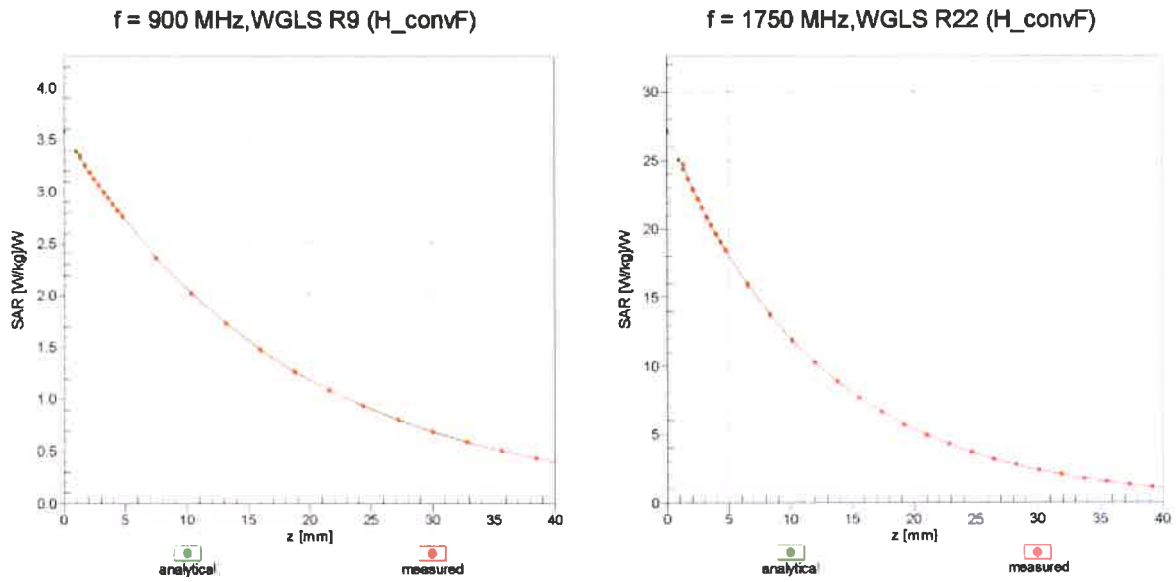

Deviation from Isotropy in Liquid Error (ϕ, ϑ), f = 900 MHz

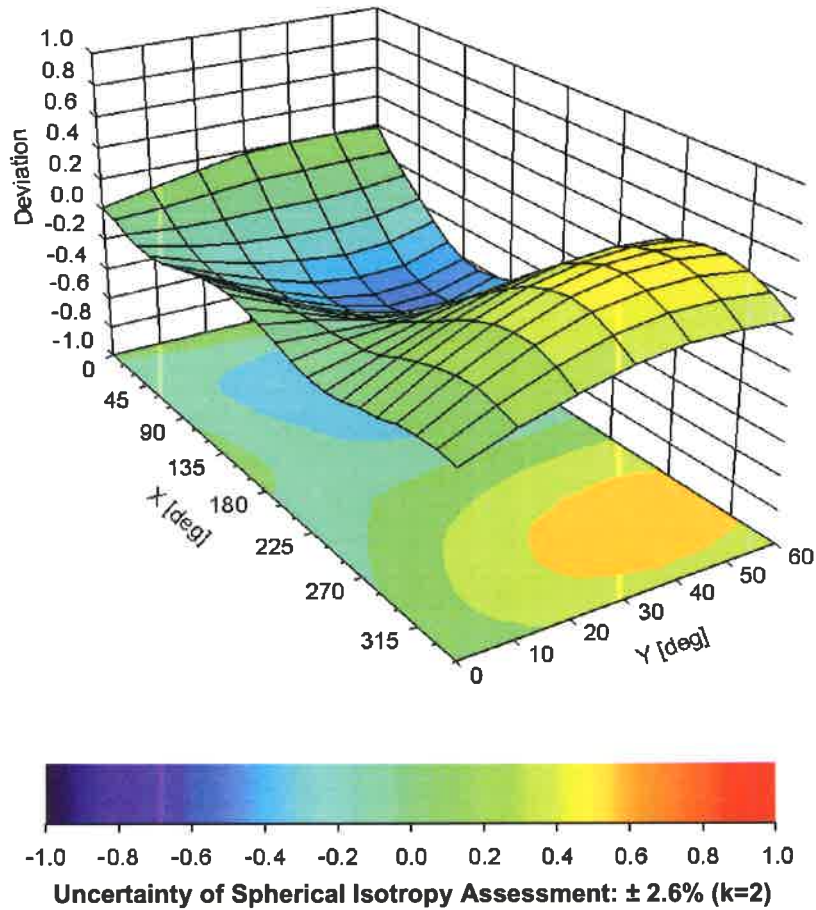

DASY/EASY - Parameters of Probe: EX3DV4 - SN:3971

Other Probe Parameters

| | |
|---|------------|
| Sensor Arrangement | Triangular |
| Connector Angle (°) | 73.8 |
| Mechanical Surface Detection Mode | enabled |
| Optical Surface Detection Mode | disabled |
| Probe Overall Length | 337 mm |
| Probe Body Diameter | 10 mm |
| Tip Length | 9 mm |
| Tip Diameter | 2.5 mm |
| Probe Tip to Sensor X Calibration Point | 1 mm |
| Probe Tip to Sensor Y Calibration Point | 1 mm |
| Probe Tip to Sensor Z Calibration Point | 1 mm |
| Recommended Measurement Distance from Surface | 1.4 mm |



Accredited by the Swiss Accreditation Service (SAS)
The Swiss Accreditation Service is one of the signatories to the EA
Multilateral Agreement for the recognition of calibration certificates

Accreditation No.: **SCS 0108**

Client **Auden**

Certificate No: **EX3-3820_Jun15**

CALIBRATION CERTIFICATE

Object **EX3DV4 - SN:3820**

Calibration procedure(s) **QA CAL-01.v9, QA CAL-14.v4, QA CAL-23.v5, QA CAL-25.v6
Calibration procedure for dosimetric E-field probes**

Calibration date: **June 19, 2015**

This calibration certificate documents the traceability to national standards, which realize the physical units of measurements (SI).
The measurements and the uncertainties with confidence probability are given on the following pages and are part of the certificate.

All calibrations have been conducted in the closed laboratory facility: environment temperature (22 ± 3)°C and humidity < 70%.

Calibration Equipment used (M&TE critical for calibration)

| Primary Standards | ID | Cal Date (Certificate No.) | Scheduled Calibration |
|----------------------------|-----------------|-----------------------------------|------------------------|
| Power meter E4419B | GB41293874 | 01-Apr-15 (No. 217-02128) | Mar-16 |
| Power sensor E4412A | MY41498087 | 01-Apr-15 (No. 217-02128) | Mar-16 |
| Reference 3 dB Attenuator | SN: S5054 (3c) | 01-Apr-15 (No. 217-02129) | Mar-16 |
| Reference 20 dB Attenuator | SN: S5277 (20x) | 01-Apr-15 (No. 217-02132) | Mar-16 |
| Reference 30 dB Attenuator | SN: S5129 (30b) | 01-Apr-15 (No. 217-02133) | Mar-16 |
| Reference Probe ES3DV2 | SN: 3013 | 30-Dec-14 (No. ES3-3013_Dec14) | Dec-15 |
| DAE4 | SN: 660 | 14-Jan-15 (No. DAE4-660_Jan15) | Jan-16 |
| Secondary Standards | ID | Check Date (in house) | Scheduled Check |
| RF generator HP 8648C | US3642U01700 | 4-Aug-99 (in house check Apr-13) | In house check: Apr-16 |
| Network Analyzer HP 8753E | US37390585 | 18-Oct-01 (in house check Oct-14) | In house check: Oct-15 |

| | Name | Function | Signature |
|---|-----------------|-----------------------|-----------------------|
| Calibrated by: | Claudio Leubler | Laboratory Technician | |
| Approved by: | Katja Pokovic | Technical Manager | |
| | | | Issued: June 20, 2015 |
| This calibration certificate shall not be reproduced except in full without written approval of the laboratory. | | | |



Accredited by the Swiss Accreditation Service (SAS)

Accreditation No.: **SCS 0108**

The Swiss Accreditation Service is one of the signatories to the EA Multilateral Agreement for the recognition of calibration certificates

Glossary:

| | |
|--------------------------|--|
| TSL | tissue simulating liquid |
| NORM _{x,y,z} | sensitivity in free space |
| ConvF | sensitivity in TSL / NORM _{x,y,z} |
| DCP | diode compression point |
| CF | crest factor (1/duty_cycle) of the RF signal |
| A, B, C, D | modulation dependent linearization parameters |
| Polarization φ | φ rotation around probe axis |
| Polarization ϑ | ϑ rotation around an axis that is in the plane normal to probe axis (at measurement center), i.e., $\vartheta = 0$ is normal to probe axis |
| Connector Angle | information used in DASY system to align probe sensor X to the robot coordinate system |

Calibration is Performed According to the Following Standards:

- IEEE Std 1528-2013, "IEEE Recommended Practice for Determining the Peak Spatial-Averaged Specific Absorption Rate (SAR) in the Human Head from Wireless Communications Devices: Measurement Techniques", June 2013
- IEC 62209-1, "Procedure to measure the Specific Absorption Rate (SAR) for hand-held devices used in close proximity to the ear (frequency range of 300 MHz to 3 GHz)", February 2005

Methods Applied and Interpretation of Parameters:

- NORM_{x,y,z}**: Assessed for E-field polarization $\vartheta = 0$ ($f \leq 900$ MHz in TEM-cell; $f > 1800$ MHz: R22 waveguide). NORM_{x,y,z} are only intermediate values, i.e., the uncertainties of NORM_{x,y,z} does not affect the E²-field uncertainty inside TSL (see below ConvF).
- NORM(f)_{x,y,z}** = NORM_{x,y,z} * frequency_response (see Frequency Response Chart). This linearization is implemented in DASY4 software versions later than 4.2. The uncertainty of the frequency response is included in the stated uncertainty of ConvF.
- DCP_{x,y,z}**: DCP are numerical linearization parameters assessed based on the data of power sweep with CW signal (no uncertainty required). DCP does not depend on frequency nor media.
- PAR**: PAR is the Peak to Average Ratio that is not calibrated but determined based on the signal characteristics
- A_{x,y,z}; B_{x,y,z}; C_{x,y,z}; D_{x,y,z}; VR_{x,y,z}**: A, B, C, D are numerical linearization parameters assessed based on the data of power sweep for specific modulation signal. The parameters do not depend on frequency nor media. VR is the maximum calibration range expressed in RMS voltage across the diode.
- ConvF and Boundary Effect Parameters**: Assessed in flat phantom using E-field (or Temperature Transfer Standard for $f \leq 800$ MHz) and inside waveguide using analytical field distributions based on power measurements for $f > 800$ MHz. The same setups are used for assessment of the parameters applied for boundary compensation (alpha, depth) of which typical uncertainty values are given. These parameters are used in DASY4 software to improve probe accuracy close to the boundary. The sensitivity in TSL corresponds to NORM_{x,y,z} * ConvF whereby the uncertainty corresponds to that given for ConvF. A frequency dependent ConvF is used in DASY version 4.4 and higher which allows extending the validity from ± 50 MHz to ± 100 MHz.
- Spherical isotropy (3D deviation from isotropy)**: in a field of low gradients realized using a flat phantom exposed by a patch antenna.
- Sensor Offset**: The sensor offset corresponds to the offset of virtual measurement center from the probe tip (on probe axis). No tolerance required.
- Connector Angle**: The angle is assessed using the information gained by determining the NORM_x (no uncertainty required).

Probe EX3DV4

SN:3820

Manufactured: September 2, 2011
Calibrated: June 19, 2015

Calibrated for DASY/EASY Systems
(Note: non-compatible with DASY2 system!)

DASY/EASY - Parameters of Probe: EX3DV4 - SN:3820

Basic Calibration Parameters

| | Sensor X | Sensor Y | Sensor Z | Unc (k=2) |
|---|----------|----------|----------|---------------|
| Norm ($\mu\text{V}/(\text{V}/\text{m})^2$) ^A | 0.43 | 0.47 | 0.48 | $\pm 10.1 \%$ |
| DCP (mV) ^B | 101.8 | 99.8 | 97.0 | |

Modulation Calibration Parameters

| UID | Communication System Name | | A dB | B dB $\sqrt{\mu\text{V}}$ | C | D dB | VR mV | Unc ^E (k=2) |
|-----|---------------------------|---|---------|------------------------------|-----|---------|----------|---------------------------|
| 0 | CW | X | 0.0 | 0.0 | 1.0 | 0.00 | 141.9 | $\pm 3.8 \%$ |
| | | Y | 0.0 | 0.0 | 1.0 | | 145.9 | |
| | | Z | 0.0 | 0.0 | 1.0 | | 143.4 | |

The reported uncertainty of measurement is stated as the standard uncertainty of measurement multiplied by the coverage factor k=2, which for a normal distribution corresponds to a coverage probability of approximately 95%.

^A The uncertainties of NormX,Y,Z do not affect the E²-field uncertainty inside TSL (see Pages 5 and 6).

^B Numerical linearization parameter: uncertainty not required.

^E Uncertainty is determined using the max. deviation from linear response applying rectangular distribution and is expressed for the square of the field value.

DASY/EASY - Parameters of Probe: EX3DV4 - SN:3820

Calibration Parameter Determined in Head Tissue Simulating Media

| f (MHz) ^C | Relative Permittivity ^F | Conductivity (S/m) ^F | ConvF X | ConvF Y | ConvF Z | Alpha ^G | Depth (mm) ^G | Unct. (k=2) |
|----------------------|------------------------------------|---------------------------------|---------|---------|---------|--------------------|-------------------------|-------------|
| 750 | 41.9 | 0.89 | 9.19 | 9.19 | 9.19 | 0.26 | 1.28 | ± 12.0 % |
| 835 | 41.5 | 0.90 | 8.89 | 8.89 | 8.89 | 0.23 | 1.41 | ± 12.0 % |
| 900 | 41.5 | 0.97 | 8.76 | 8.76 | 8.76 | 0.19 | 1.72 | ± 12.0 % |
| 1450 | 40.5 | 1.20 | 8.18 | 8.18 | 8.18 | 0.10 | 3.00 | ± 12.0 % |
| 1750 | 40.1 | 1.37 | 8.07 | 8.07 | 8.07 | 0.23 | 0.88 | ± 12.0 % |
| 1900 | 40.0 | 1.40 | 7.98 | 7.98 | 7.98 | 0.14 | 1.30 | ± 12.0 % |
| 2000 | 40.0 | 1.40 | 7.91 | 7.91 | 7.91 | 0.16 | 1.26 | ± 12.0 % |
| 2450 | 39.2 | 1.80 | 6.89 | 6.89 | 6.89 | 0.21 | 1.26 | ± 12.0 % |
| 2600 | 39.0 | 1.96 | 6.63 | 6.63 | 6.63 | 0.24 | 1.20 | ± 12.0 % |
| 5200 | 36.0 | 4.66 | 4.88 | 4.88 | 4.88 | 0.35 | 1.80 | ± 13.1 % |
| 5300 | 35.9 | 4.76 | 4.67 | 4.67 | 4.67 | 0.35 | 1.80 | ± 13.1 % |
| 5500 | 35.6 | 4.96 | 4.49 | 4.49 | 4.49 | 0.40 | 1.80 | ± 13.1 % |
| 5600 | 35.5 | 5.07 | 4.31 | 4.31 | 4.31 | 0.40 | 1.80 | ± 13.1 % |
| 5800 | 35.3 | 5.27 | 4.23 | 4.23 | 4.23 | 0.45 | 1.80 | ± 13.1 % |

^C Frequency validity above 300 MHz of ± 100 MHz only applies for DASY v4.4 and higher (see Page 2), else it is restricted to ± 50 MHz. The uncertainty is the RSS of the ConvF uncertainty at calibration frequency and the uncertainty for the indicated frequency band. Frequency validity below 300 MHz is ± 10, 25, 40, 50 and 70 MHz for ConvF assessments at 30, 64, 128, 150 and 220 MHz respectively. Above 5 GHz frequency validity can be extended to ± 110 MHz.

^F At frequencies below 3 GHz, the validity of tissue parameters (ϵ and σ) can be relaxed to ± 10% if liquid compensation formula is applied to measured SAR values. At frequencies above 3 GHz, the validity of tissue parameters (ϵ and σ) is restricted to ± 5%. The uncertainty is the RSS of the ConvF uncertainty for indicated target tissue parameters.

^G Alpha/Depth are determined during calibration. SPEAG warrants that the remaining deviation due to the boundary effect after compensation is always less than ± 1% for frequencies below 3 GHz and below ± 2% for frequencies between 3-6 GHz at any distance larger than half the probe tip diameter from the boundary.

DASY/EASY - Parameters of Probe: EX3DV4 - SN:3820

Calibration Parameter Determined in Body Tissue Simulating Media

| f (MHz) ^C | Relative Permittivity ^F | Conductivity (S/m) ^F | ConvF X | ConvF Y | ConvF Z | Alpha ^G | Depth ^G (mm) | Unct. (k=2) |
|----------------------|------------------------------------|---------------------------------|---------|---------|---------|--------------------|-------------------------|-------------|
| 750 | 55.5 | 0.96 | 8.91 | 8.91 | 8.91 | 0.20 | 1.53 | ± 12.0 % |
| 835 | 55.2 | 0.97 | 8.88 | 8.88 | 8.88 | 0.30 | 1.17 | ± 12.0 % |
| 900 | 55.0 | 1.05 | 8.71 | 8.71 | 8.71 | 0.38 | 1.00 | ± 12.0 % |
| 1450 | 54.0 | 1.30 | 8.00 | 8.00 | 8.00 | 0.10 | 1.99 | ± 12.0 % |
| 1750 | 53.4 | 1.49 | 7.75 | 7.75 | 7.75 | 0.21 | 1.01 | ± 12.0 % |
| 1900 | 53.3 | 1.52 | 7.52 | 7.52 | 7.52 | 0.18 | 1.28 | ± 12.0 % |
| 2000 | 53.3 | 1.52 | 7.63 | 7.63 | 7.63 | 0.21 | 1.17 | ± 12.0 % |
| 2450 | 52.7 | 1.95 | 6.97 | 6.97 | 6.97 | 0.30 | 1.00 | ± 12.0 % |
| 2600 | 52.5 | 2.16 | 6.73 | 6.73 | 6.73 | 0.25 | 1.15 | ± 12.0 % |
| 5200 | 49.0 | 5.30 | 4.35 | 4.35 | 4.35 | 0.45 | 1.90 | ± 13.1 % |
| 5300 | 48.9 | 5.42 | 4.04 | 4.04 | 4.04 | 0.50 | 1.90 | ± 13.1 % |
| 5500 | 48.6 | 5.65 | 3.79 | 3.79 | 3.79 | 0.50 | 1.90 | ± 13.1 % |
| 5600 | 48.5 | 5.77 | 3.64 | 3.64 | 3.64 | 0.50 | 1.90 | ± 13.1 % |
| 5800 | 48.2 | 6.00 | 3.97 | 3.97 | 3.97 | 0.50 | 1.90 | ± 13.1 % |

^C Frequency validity above 300 MHz of ± 100 MHz only applies for DASY v4.4 and higher (see Page 2), else it is restricted to ± 50 MHz. The uncertainty is the RSS of the ConvF uncertainty at calibration frequency and the uncertainty for the indicated frequency band. Frequency validity below 300 MHz is ± 10, 25, 40, 50 and 70 MHz for ConvF assessments at 30, 64, 128, 150 and 220 MHz respectively. Above 5 GHz frequency validity can be extended to ± 110 MHz.

^F At frequencies below 3 GHz, the validity of tissue parameters (ϵ and σ) can be relaxed to ± 10% if liquid compensation formula is applied to measured SAR values. At frequencies above 3 GHz, the validity of tissue parameters (ϵ and σ) is restricted to ± 5%. The uncertainty is the RSS of the ConvF uncertainty for indicated target tissue parameters.

^G Alpha/Depth are determined during calibration. SPEAG warrants that the remaining deviation due to the boundary effect after compensation is always less than ± 1% for frequencies below 3 GHz and below ± 2% for frequencies between 3-6 GHz at any distance larger than half the probe tip diameter from the boundary.

Frequency Response of E-Field (TEM-Cell:ifi110 EXX, Waveguide: R22)

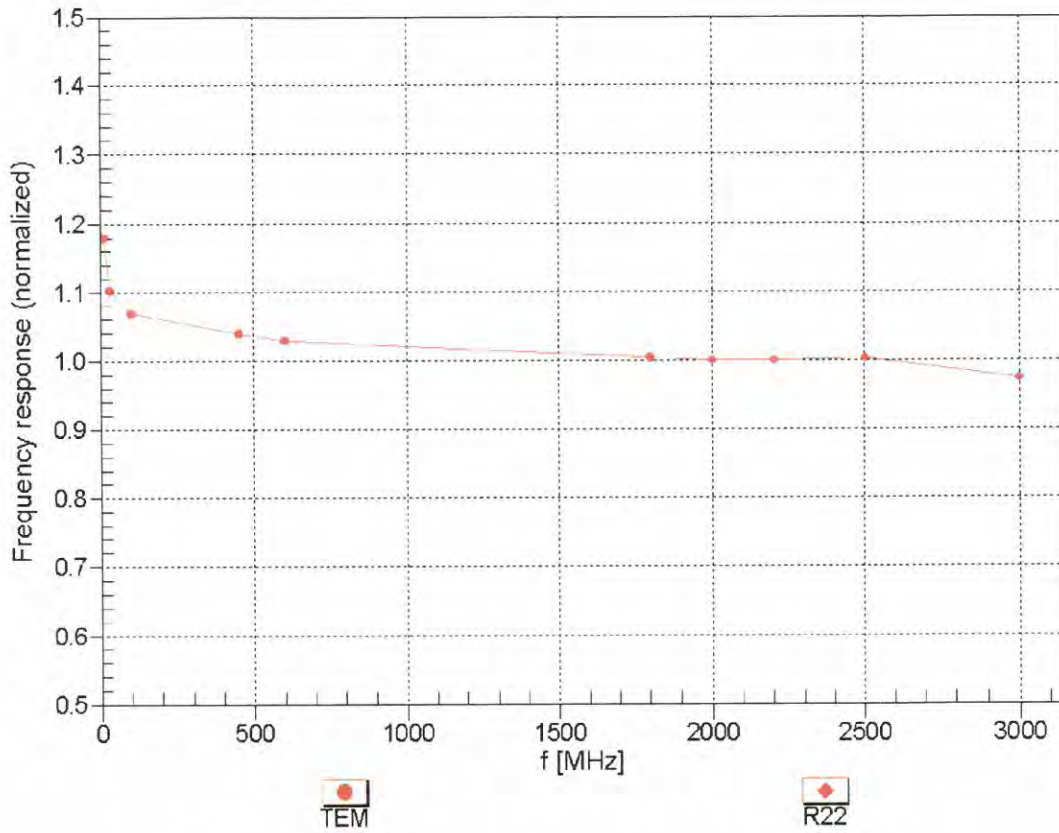

Uncertainty of Frequency Response of E-field: $\pm 6.3\%$ (k=2)

Receiving Pattern (ϕ), $\vartheta = 0^\circ$

f=600 MHz, TEM

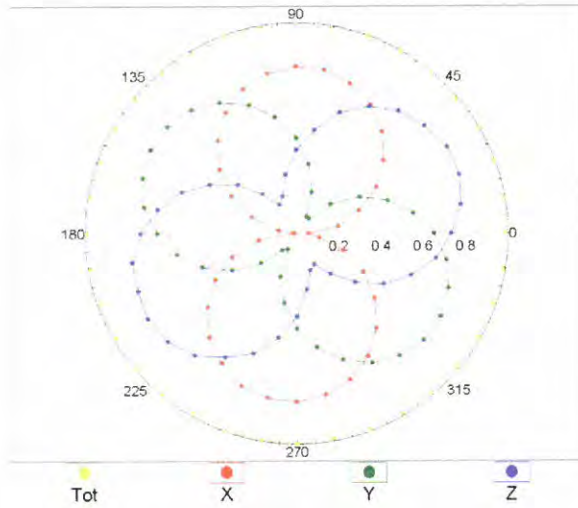

f=1800 MHz, R22

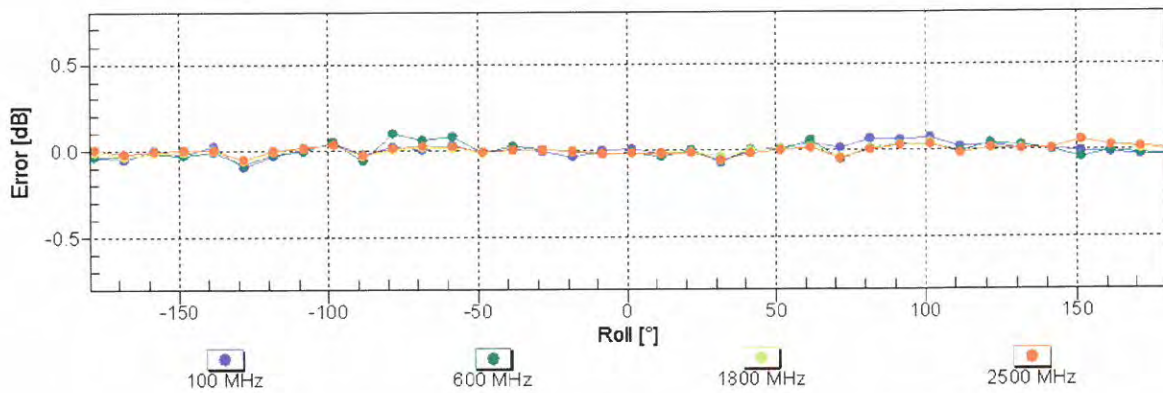
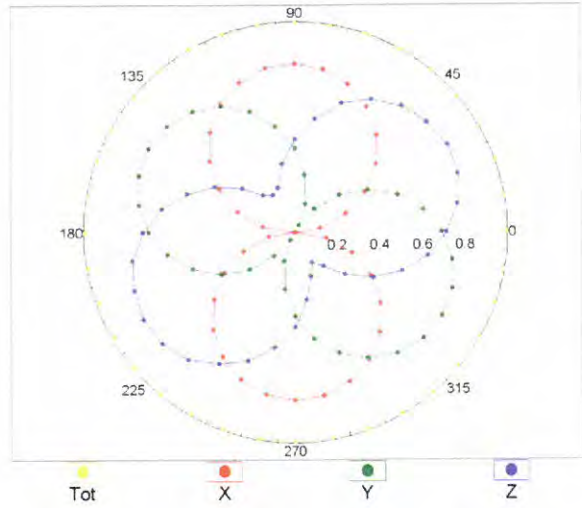

Uncertainty of Axial Isotropy Assessment: $\pm 0.5\%$ ($k=2$)

Dynamic Range $f(SAR_{head})$ (TEM cell , $f_{eval}= 1900$ MHz)

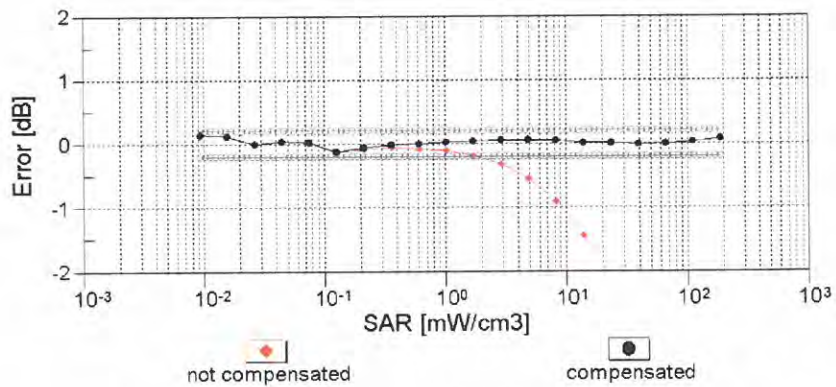
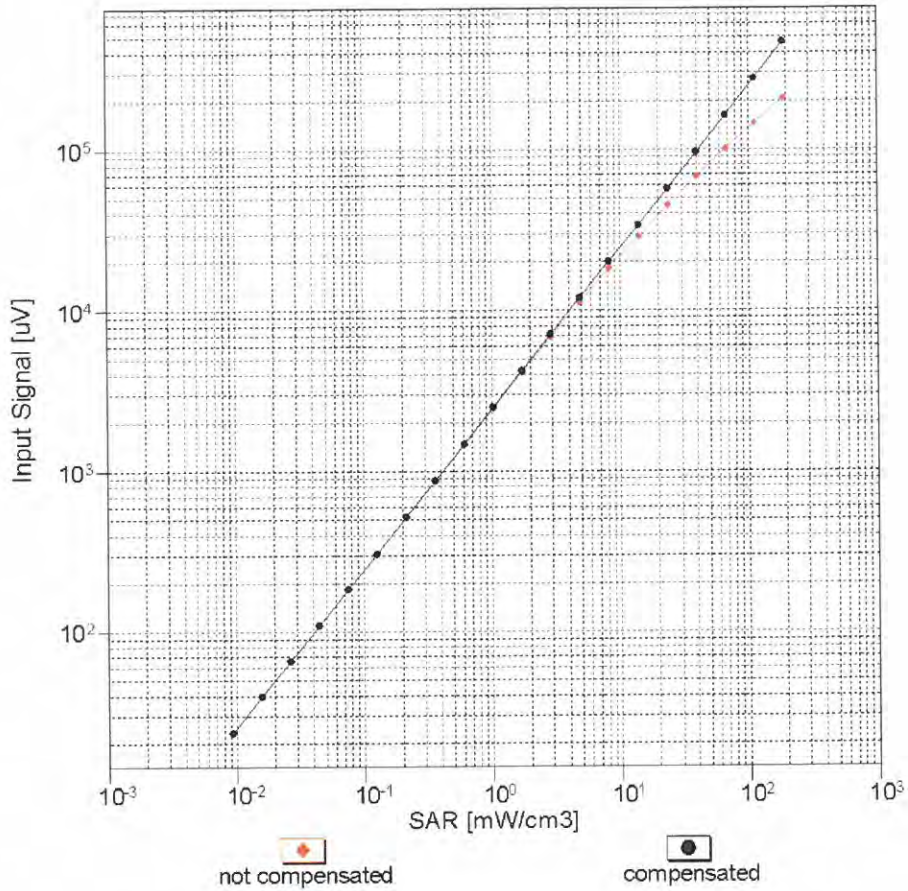

Uncertainty of Linearity Assessment: $\pm 0.6\%$ (k=2)

Conversion Factor Assessment

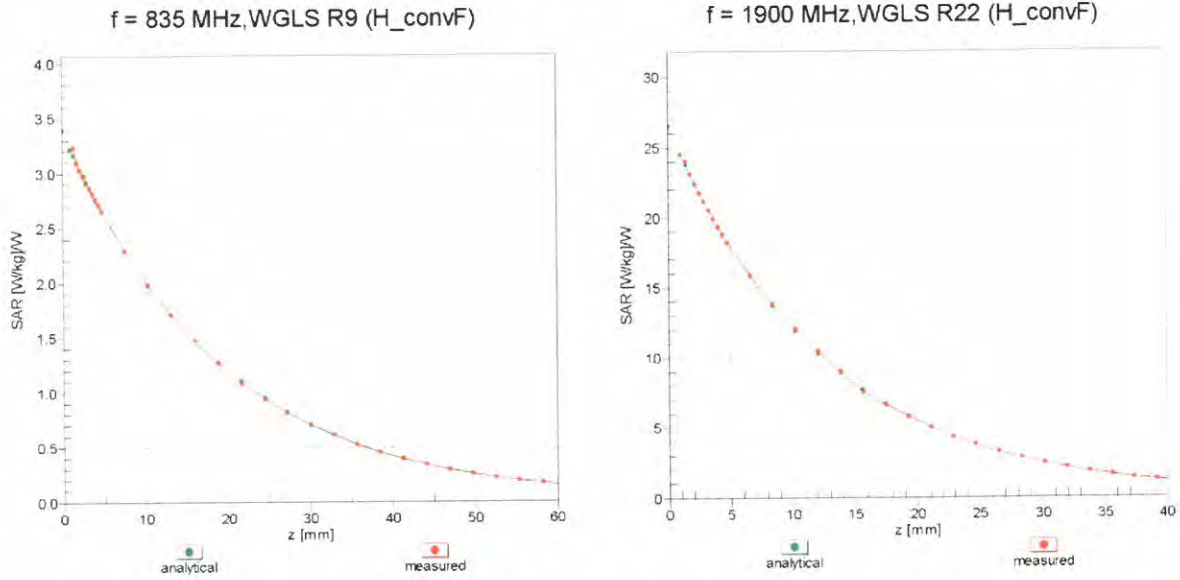

Deviation from Isotropy in Liquid Error (ϕ, θ), f = 900 MHz

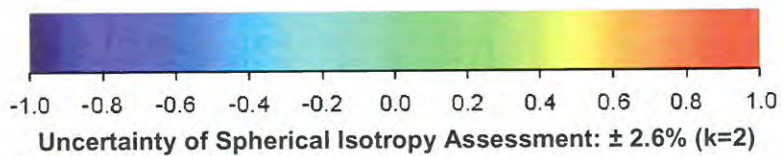
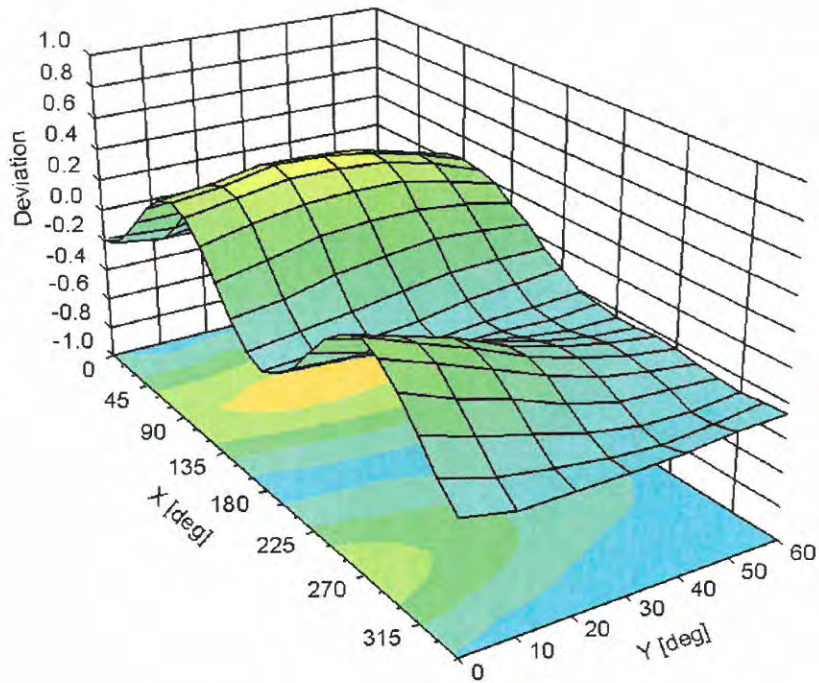

DASY/EASY - Parameters of Probe: EX3DV4 - SN:3820

Other Probe Parameters

| | |
|---|------------|
| Sensor Arrangement | Triangular |
| Connector Angle (°) | 31.6 |
| Mechanical Surface Detection Mode | enabled |
| Optical Surface Detection Mode | disabled |
| Probe Overall Length | 337 mm |
| Probe Body Diameter | 10 mm |
| Tip Length | 9 mm |
| Tip Diameter | 2.5 mm |
| Probe Tip to Sensor X Calibration Point | 1 mm |
| Probe Tip to Sensor Y Calibration Point | 1 mm |
| Probe Tip to Sensor Z Calibration Point | 1 mm |
| Recommended Measurement Distance from Surface | 1.4 mm |