

## FCC Test Report

**Report No.:** RF160304C08-3

**FCC ID:** MSQP00C

**Test Model:** P00C

**Received Date:** Mar. 04, 2016

**Test Date:** Mar. 10, 2016 ~ Mar. 18, 2016

**Issued Date:** Mar. 31, 2016

**Applicant:** ASUSTek COMPUTER INC.

**Address:** 4F, No. 150, LI-TE Rd., PEITOU, TAIPEI 112, TAIWAN

**Issued By:** Bureau Veritas Consumer Products Services (H.K.) Ltd., Taoyuan Branch

**Lab Address:** No. 47-2, 14th Ling, Chia Pau Vil., Lin Kou Dist., New Taipei City, Taiwan  
( R.O.C )

**Test Location** No.215, Sec. 3, Beixin Rd., Xindian Dist., New Taipei City 231, Taiwan,  
R.O.C



This report is for your exclusive use. Any copying or replication of this report to or for any other person or entity, or use of our name or trademark, is permitted only with our prior written permission. This report sets forth our findings solely with respect to the test samples identified herein. The results set forth in this report are not indicative or representative of the quality or characteristics of the lot from which a test sample was taken or any similar or identical product unless specifically and expressly noted. Our report includes all of the tests requested by you and the results thereof based upon the information that you provided to us. You have 60 days from date of issuance of this report to notify us of any material error or omission caused by our negligence, provided, however, that such notice shall be in writing and shall specifically address the issue you wish to raise. A failure to raise such issue within the prescribed time shall constitute your unqualified acceptance of the completeness of this report, the tests conducted and the correctness of the report contents. Unless specific mention, the uncertainty of measurement has been explicitly taken into account to declare the compliance or non-compliance to the specification. The report must not be used by the client to claim product certification, approval, or endorsement by TAF or any government agencies.

## Table of Contents

<b>Release Control Record</b> .....	<b>4</b>
<b>1 Certificate of Conformity</b> .....	<b>5</b>
<b>2 Summary of Test Results</b> .....	<b>6</b>
2.1 Measurement Uncertainty .....	6
2.2 Modification Record .....	6
<b>3 General Information</b> .....	<b>7</b>
3.1 General Description of EUT .....	7
3.2 Description of Test Modes .....	9
3.2.1 Test Mode Applicability and Tested Channel Detail .....	11
3.3 Duty Cycle of Test Signal .....	13
3.4 Description of Support Units .....	17
3.4.1 Configuration of System under Test .....	17
3.5 General Description of Applied Standards .....	17
<b>4 Test Types and Results</b> .....	<b>18</b>
4.1 Radiated Emission and Bandedge Measurement .....	18
4.1.1 Limits of Radiated Emission and Bandedge Measurement .....	18
4.1.2 Limits of Unwanted Emission Out of the Restricted Bands .....	18
4.1.3 Test Instruments .....	19
4.1.4 Test Procedures .....	20
4.1.5 Deviation from Test Standard .....	20
4.1.6 Test Set Up .....	21
4.1.7 EUT Operating Conditions .....	21
4.1.8 Test Results .....	22
4.2 Conducted Emission Measurement .....	67
4.2.1 Limits of Conducted Emission Measurement .....	67
4.2.2 Test Instruments .....	67
4.2.3 Test Procedures .....	68
4.2.4 Deviation from Test Standard .....	68
4.2.5 Test Setup .....	68
4.2.6 EUT Operating Conditions .....	68
4.2.7 Test Results .....	69
4.3 Transmit Power Measurement .....	73
4.3.1 Limits of Transmit Power Measurement .....	73
4.3.2 Test Setup .....	73
4.3.3 Test Instruments .....	74
4.3.4 Test Procedure .....	74
4.3.5 Deviation from Test Standard .....	74
4.3.6 EUT Operating Conditions .....	74
4.3.7 Test Result .....	75
4.4 Peak Power Spectral Density Measurement .....	80
4.4.1 Limits of Peak Power Spectral Density Measurement .....	80
4.4.2 Test Setup .....	80
4.4.3 Test Instruments .....	80
4.4.4 Test Procedures .....	80
4.4.5 Deviation from Test Standard .....	81
4.4.6 EUT Operating Conditions .....	81
4.4.7 Test Results .....	82
4.5 Frequency Stability .....	86
4.5.1 Limit of Frequency Stability Measurement .....	86
4.5.2 Test Setup .....	86
4.5.3 Test Instruments .....	86
4.5.4 Test Procedure .....	86
4.5.5 Deviation from Test Standard .....	86



4.5.6 EUT Operating Condition .....	86
4.5.7 Test Results .....	87
4.6 6 dB Bandwidth Measurement.....	88
4.6.1 Limits of 6 dB Bandwidth Measurement.....	88
4.6.2 Test Setup.....	88
4.6.3 Test Instruments .....	88
4.6.4 Test Procedure .....	88
4.6.5 Deviation from Test Standard .....	88
4.6.6 EUT Operating Condition .....	88
4.6.7 Test Results .....	89
<b>5 Pictures of Test Arrangements.....</b>	<b>91</b>
<b>Appendix – Information on the Testing Laboratories .....</b>	<b>92</b>



A D T

### Release Control Record

Issue No.	Description	Date Issued
RF160304C08-3	Original Release	Mar. 31, 2016



# 1 Certificate of Conformity

**Product:** ASUS Tablet  
**Brand:** ASUS  
**Test Model:** P00C  
**Sample Status:** Production Unit  
**Applicant:** ASUSTek COMPUTER INC.  
**Test Date:** Mar. 10, 2016 ~ Mar. 18, 2016  
**Standards:** 47 CFR FCC Part 15, Subpart E (Section 15.407)  
ANSI C63.10:2013

The above equipment has been tested by **Bureau Veritas Consumer Products Services (H.K.) Ltd., Taoyuan Branch**, and found compliance with the requirement of the above standards. The test record, data evaluation & Equipment Under Test (EUT) configurations represented herein are true and accurate accounts of the measurements of the sample's EMC characteristics under the conditions specified in this report.

**Prepared by :** Evonne Liu , **Date:** Mar. 31, 2016  
Evonne Liu / Specialist

**Approved by :** Stanley Wu , **Date:** Mar. 31, 2016  
Stanley Wu / Assistant Manager

## 2 Summary of Test Results

47 CFR FCC Part 15, Subpart E (Section 15.407)			
FCC Clause	Test Item	Result	Remarks
15.407(b)(6)	AC Power Conducted Emissions	Pass	Meet the requirement of limit. Minimum passing margin is -11.95 dB at 0.51742 MHz.
15.407(b)(1/2/3/4/6)	Radiated Emissions & Band Edge Measurement	Pass	Meet the requirement of limit. Minimum passing margin is -5.79 dB at 5714 MHz.
15.407(a)(1/2/3)	Max Average Transmit Power	Pass	Meet the requirement of limit.
15.407(a)(1/2/3)	Peak Power Spectral Density	Pass	Meet the requirement of limit.
15.407(e)	6 dB Bandwidth	Pass	Meet the requirement of limit. (U-NII-3 Band only)
15.407(g)	Frequency Stability	Pass	Meet the requirement of limit.
15.203	Antenna Requirement	Pass	No antenna connector is used.

### 2.1 Measurement Uncertainty

Where relevant, the following measurement uncertainty levels have been estimated for tests performed on the EUT as specified in CISPR 16-4-2:

Measurement	Frequency	Expanded Uncertainty (k=2) (±)
Conducted Emissions at mains ports	150 kHz ~ 30 MHz	2.44 dB
Radiated Emissions up to 1 GHz	30 MHz ~ 200 MHz	2.93 dB
	200 MHz ~ 1000 MHz	2.95 dB
Radiated Emissions above 1 GHz	1 GHz ~ 18 GHz	2.26 dB
	18 GHz ~ 40 GHz	1.94 dB

### 2.2 Modification Record

There were no modifications required for compliance.

### 3 General Information

#### 3.1 General Description of EUT

<b>Product</b>	ASUS Tablet
<b>Brand</b>	ASUS
<b>Test Model</b>	P00C
<b>Status of EUT</b>	Production Unit
<b>Power Supply Rating</b>	3.85Vdc (Battery) 5.2Vdc (Adapter) 5.0Vdc (Host equipment)
<b>Modulation Type</b>	64QAM, 16QAM, QPSK, BPSK
<b>Modulation Technology</b>	OFDM
<b>Transfer Rate</b>	802.11a: 54.0/ 48.0/ 36.0/ 24.0/ 18.0/ 12.0/ 9.0/ 6.0 Mbps 802.11n: up to MCS7
<b>Operating Frequency</b>	5180 ~ 5240 MHz, 5260 ~ 5320 MHz, 5500 ~ 5700 MHz, 5745 ~ 5825 MHz
<b>Number of Channel</b>	5180 ~ 5240 MHz: 4 for 802.11a, 802.11n (HT20) 2 for 802.11n (HT40) 5260 ~ 5320 MHz: 4 for 802.11a, 802.11n (HT20) 2 for 802.11n (HT40) 5500 ~ 5700 MHz: 11 for 802.11a, 802.11n (HT20) 5 for 802.11n (HT40) 5745 ~ 5825 MHz: 5 for 802.11a, 802.11n (HT20) 2 for 802.11n (HT40)
<b>Output Power</b>	11.22 mW for 5180 ~ 5240 MHz 10.45 mW for 5260 ~ 5320 MHz 10.94 mW for 5500 ~ 5700 MHz 8.18 mW for 5745 ~ 5825 MHz
<b>Antenna Type</b>	PIFA antenna with 0.65 dBi gain (5180 ~ 5240 MHz) PIFA antenna with 0.69 dBi gain (5260 ~ 5320 MHz) PIFA antenna with 2.36 dBi gain (5500 ~ 5700 MHz) PIFA antenna with 2.36 dBi gain (5745 ~ 5825 MHz)
<b>Antenna Connector</b>	N/A
<b>Accessory Device</b>	Refer to Note as below
<b>Data Cable Supplied</b>	Refer to Note as below

**Note:**

- The EUT provides 1 completed transmitter and 1 receiver.

Modulation Mode	Tx Function
802.11a	1TX
802.11n (HT20)	1TX
802.11n (HT40)	1TX

\* The modulation and bandwidth are similar for 802.11n mode for HT20 / HT40 and 802.11ac mode for HT20 / HT40, therefore investigated worst case to representative mode in test report. (Final test mode refer section 3.2.1)

2. The EUT contains following accessory devices.

Product	Brand	Model	Description
Adapter 1	ASUS	PA-1050-39	I/P: 100-240Vac, 50/60Hz, 0.25A O/P: 5.2Vdc, 1A
Adapter 2	ASUS	AS0102	I/P: 100-240Vac, 50/60Hz, 0.13A O/P: 5.2Vdc, 1A
Battery	Celxpert	C11P1517	3.85Vdc, 18Wh
USB Cable 1	HONGLIN	130-26314	0.9m shielded cable w/o core
USB Cable 2	LUXSHARE-ICT	L65U2009-CS-B	0.9m shielded cable w/o core
USB Cable 3	FOXCONN	CUBB04M-AS0D0-EF	0.9m shielded cable w/o core
LCD Panel 1	BOE	TV101WXM-NU1	10.1 inch
LCD Panel 2	CPT	CLAT101WR61W	10.1 inch
CPU	MEDIATEK SOC	C.S. MT8163V VFBGA-393 MP	393 Pin , 1.3GHz
Main Board	ASUS	Z300M_MB	--
BT/WLAN Module	MTK	MT6625L	--
Camera 1 (Front)	CHICONY	CIFF219	2M
Camera 2 (Back)	CHICONY	CJAF527	5M
Camera 3 (Front)	SUNWIN	SW08572E221B-VA	2M
Camera 4 (Back)	SUNWIN	SWCN5725602A-VA	5M
eMMC 1	SAMSUNG	KLMCG4JENB-B041	64G
eMMC 2	HYNIX	H26M78208CMR	64G
eMMC 3	SAMSUNG	KLMBG2JENB-B041	32G
eMMC 4	HYNIX	H26M64208EMR	32G
eMMC 5	SAMSUNG	KLMAG1JENB-B041	16G
eMMC 6	HYNIX	H26M52208FPR	16G
eMMC 7	SAMSUNG	KLM8G1GEND-B031	8G
eMMC 8	HYNIX	H26M41204HPR	8G
DDR 1	MICRON	MT41K512M8DA-107:P	2G
DDR 2	SAMSUNG	K4B4G0846E-BYK0	2G



3. The EUT contains two Sample listed as below.

Component	Brand	Model	Specification	Sample	
				A	B
Battery	Celxpert	C11P1517	3.85Vdc, 18Wh	V	V
LCD Panel 1	BOE	TV101WXM-NU1	10.1 inch	V	
LCD Panel 2	CPT	CLAT101WR61W	10.1 inch		V
CPU	MEDIATEK SOC	C.S. MT8163V VFBGA-393 MP	393 Pin , 1.3GHz	V	V
Main Board	ASUS	Z300M_MB	--	V	V
BT/WLAN Module	MTK	MT6625L	--	V	V
Camera 1 (Front)	CHICONY	CIFF219	2M	V	
Camera 2 (Back)	CHICONY	CJAF527	5M	V	
Camera 3 (Front)	SUNWIN	SW08572E221B-VA	2M		V
Camera 4 (Back)	SUNWIN	SWCN5725602A-VA	5M		V
eMMC 1	SAMSUNG	KLMCG4JENB-B041	64G	V	
eMMC 2	HYNIX	H26M78208CMR	64G		V
DDR 1	MICRON	MT41K512M8DA-107:P	2G	V	
DDR 2	SAMSUNG	K4B4G0846E-BYK0	2G		V

4. The above EUT information is declared by manufacturer and for more detailed features description, please refer to the manufacturer's specifications or user's manual.

### 3.2 Description of Test Modes

#### FOR 5180 ~ 5240 MHz

4 channels are provided for 802.11a, 802.11n (HT20):

Channel	Frequency (MHz)	Channel	Frequency (MHz)
36	5180	44	5220
40	5200	48	5240

2 channels are provided for 802.11n (HT40):

Channel	Frequency (MHz)	Channel	Frequency (MHz)
38	5190	46	5230

#### FOR 5260 ~ 5320 MHz

4 channels are provided for 802.11a, 802.11n (HT20):

Channel	Frequency (MHz)	Channel	Frequency (MHz)
52	5260	60	5300
56	5280	64	5320

2 channels are provided for 802.11n (HT40):

Channel	Frequency (MHz)	Channel	Frequency (MHz)
54	5270	62	5310

**FOR 5500 ~ 5700 MHz**

11 channels are provided for 802.11a, 802.11n (HT20):

Channel	Frequency (MHz)	Channel	Frequency (MHz)
100	5500	124	5620
104	5520	128	5640
108	5540	132	5660
112	5560	136	5680
116	5580	140	5700
120	5600		

5 channels are provided for 802.11n (HT40):

Channel	Frequency (MHz)	Channel	Frequency (MHz)
102	5510	126	5630
110	5550	134	5670
118	5590		

**FOR 5745 ~ 5825 MHz:**

5 channels are provided for 802.11a, 802.11n (HT20):

Channel	Frequency (MHz)	Channel	Frequency (MHz)
149	5745	161	5805
153	5765	165	5825
157	5785		

2 channels are provided for 802.11n (HT40):

Channel	Frequency (MHz)	Channel	Frequency (MHz)
151	5755	159	5795

### 3.2.1 Test Mode Applicability and Tested Channel Detail

EUT Configure Mode	Applicable To				Description
	RE $\geq$ 1G	RE $<$ 1G	PLC	APCM	
A	√	√	√	√	Sample A
B	√	√	√	-	Sample B

Where **RE $\geq$ 1G**: Radiated Emission above 1 GHz      **RE $<$ 1G**: Radiated Emission below 1 GHz  
**PLC**: Power Line Conducted Emission      **APCM**: Antenna Port Conducted Measurement

**NOTE:**

- The EUT had been pre-tested on the positioned of each 3 axis. The worst case of Sample A was found when positioned on **X-plane** in 5180-5240 & 5260-5320 & 5745-5825 and **Y-plane** in 5500-5700. The worst case of Sample B was found when positioned on **X-plane**.
- "-" means no effect.

#### **Radiated Emission Test (Above 1 GHz):**

- Pre-Scan has been conducted to determine the worst-case mode from all possible combinations between available modulations, data rates and antenna ports (if EUT with antenna diversity architecture).
- Following channel(s) was (were) selected for the final test as listed below.

EUT Configure Mode	Mode	Frequency Band (MHz)	Available Channel	Tested Channel	Modulation Technology	Modulation Type	Data Rate (Mbps)
A	802.11a	5180-5240	36 to 48	36, 44, 48	OFDM	BPSK	6.0
	802.11n (HT20)		36 to 48	36, 44, 48	OFDM	BPSK	MCS0
	802.11n (HT40)		38 to 46	38, 46	OFDM	BPSK	MCS0
	802.11a	5260-5320	52 to 64	52, 60, 64	OFDM	BPSK	6.0
	802.11n (HT20)		52 to 64	52, 60, 64	OFDM	BPSK	MCS0
	802.11n (HT40)		54 to 62	54, 62	OFDM	BPSK	MCS0
	802.11a	5500-5700	100 to 140	100, 116, 140	OFDM	BPSK	6.0
	802.11n (HT20)		100 to 140	100, 116, 140	OFDM	BPSK	MCS0
	802.11n (HT40)		102 to 134	102, 110, 134	OFDM	BPSK	MCS0
	802.11a	5745-5825	149 to 165	149, 157, 165	OFDM	BPSK	6.0
	802.11n (HT20)		149 to 165	149, 157, 165	OFDM	BPSK	MCS0
802.11n (HT40)	151 to 159		151, 159	OFDM	BPSK	MCS0	
B	802.11n (HT40)	5180-5240	38 to 46	38	OFDM	BPSK	MCS0
	802.11n (HT40)	5260-5320	54 to 62	62	OFDM	BPSK	MCS0
	802.11n (HT20)	5500-5700	100 to 140	140	OFDM	BPSK	MCS0
	802.11n (HT40)	5745-5825	151 to 159	151	OFDM	BPSK	MCS0

#### **Radiated Emission Test (Below 1 GHz):**

- Pre-Scan has been conducted to determine the worst-case mode from all possible combinations between available modulations, data rates and antenna ports (if EUT with antenna diversity architecture).
- Following channel(s) was (were) selected for the final test as listed below.

EUT Configure Mode	Mode	Frequency Band (MHz)	Available Channel	Tested Channel	Modulation Technology	Modulation Type	Data Rate (Mbps)
A, B	802.11n (HT40)	5180-5240	38 to 46	38	OFDM	BPSK	MCS0
	802.11n (HT40)	5260-5320	54 to 62	62	OFDM	BPSK	MCS0
	802.11n (HT20)	5500-5700	100 to 140	140	OFDM	BPSK	MCS0
	802.11n (HT40)	5745-5825	151 to 159	151	OFDM	BPSK	MCS0

**Power Line Conducted Emission Test:**

- Pre-Scan has been conducted to determine the worst-case mode from all possible combinations between available modulations, data rates and antenna ports (if EUT with antenna diversity architecture).
- Following channel(s) was (were) selected for the final test as listed below.

EUT Configure Mode	Mode	Frequency Band (MHz)	Available Channel	Tested Channel	Modulation Technology	Modulation Type	Data Rate (Mbps)
A, B	802.11n (HT40)	5745-5825	151 to 159	151	OFDM	BPSK	MCS0

**Antenna Port Conducted Measurement:**

- This item includes all test value of each mode, but only includes spectrum plot of worst value of each mode.
- Pre-Scan has been conducted to determine the worst-case mode from all possible combinations between available modulations, data rates and antenna ports (if EUT with antenna diversity architecture).
- Following channel(s) was (were) selected for the final test as listed below.

EUT Configure Mode	Mode	Frequency Band (MHz)	Available Channel	Tested Channel	Modulation Technology	Modulation Type	Data Rate (Mbps)
A, B	802.11a	5180-5240	36 to 48	36, 44, 48	OFDM	BPSK	6.0
	802.11n (HT20)		36 to 48	36, 44, 48	OFDM	BPSK	MCS0
	802.11n (HT40)		38 to 46	38, 46	OFDM	BPSK	MCS0
	802.11a	5260-5320	52 to 64	52, 60, 64	OFDM	BPSK	6.0
	802.11n (HT20)		52 to 64	52, 60, 64	OFDM	BPSK	MCS0
	802.11n (HT40)		54 to 62	54, 62	OFDM	BPSK	MCS0
	802.11a	5500-5700	100 to 140	100, 116, 140	OFDM	BPSK	6.0
	802.11n (HT20)		100 to 140	100, 116, 140	OFDM	BPSK	MCS0
	802.11n (HT40)		102 to 134	102, 110, 134	OFDM	BPSK	MCS0
	802.11a	5745-5825	149 to 165	149, 157, 165	OFDM	BPSK	6.0
	802.11n (HT20)		149 to 165	149, 157, 165	OFDM	BPSK	MCS0
	802.11n (HT40)		151 to 159	151, 159	OFDM	BPSK	MCS0

**Test Condition:**

Applicable To	Environmental Conditions	Input Power	Tested by
RE $\geq$ 1G	25 deg. C, 65 % RH	120 Vac, 60 Hz	Gavin Wu
RE $<$ 1G	25 deg. C, 65 % RH	120 Vac, 60 Hz	Gavin Wu
PLC	25 deg. C, 65 % RH	120 Vac, 60 Hz	Toby Tian
APCM	25 deg. C, 65 % RH	3.85 Vdc	Taylor Liu

### 3.3 Duty Cycle of Test Signal

#### MODULATION TYPE: BPSK

Duty cycle of test signal is < 98 %, duty factor is required.

802.11a: Duty cycle =  $1.386/1.434 = 0.966$ , Duty factor =  $10 * \log(1/0.966) = 0.15$

802.11n (HT20): Duty cycle =  $1.280/1.333 = 0.960$ , Duty factor =  $10 * \log(1/0.960) = 0.18$

802.11n (HT40): Duty cycle =  $0.631/0.668 = 0.944$ , Duty factor =  $10 * \log(1/0.944) = 0.25$



**MODULATION TYPE: QPSK**

Duty cycle of test signal is < 98 %, duty factor is required.

802.11a: Duty cycle =  $0.697/0.745 = 0.935$ , Duty factor =  $10 * \log(1/0.935) = 0.29$

802.11n (HT20): Duty cycle =  $0.629/0.685 = 0.918$ , Duty factor =  $10 * \log(1/0.918) = 0.37$

802.11n (HT40): Duty cycle =  $0.318/0.363 = 0.876$ , Duty factor =  $10 * \log(1/0.876) = 0.57$



**MODULATION TYPE: 16QAM**

Duty cycle of test signal is < 98 %, duty factor is required.

802.11a: Duty cycle = 0.352/0.400 = 0.880, Duty factor =  $10 * \log(1/0.880) = 0.56$

802.11n (HT20): Duty cycle = 0.325/0.373 = 0.871, Duty factor =  $10 * \log(1/0.871) = 0.60$

802.11n (HT40): Duty cycle = 0.174/0.219 = 0.795, Duty factor =  $10 * \log(1/0.795) = 0.99$



**MODULATION TYPE: 64QAM**

Duty cycle of test signal is < 98 %, duty factor is required.

802.11a: Duty cycle =  $0.182/0.227 = 0.802$ , Duty factor =  $10 * \log(1/0.802) = 0.95$

802.11n (HT20): Duty cycle =  $0.174/0.219 = 0.795$ , Duty factor =  $10 * \log(1/0.795) = 0.99$

802.11n (HT40): Duty cycle =  $0.097/0.139 = 0.701$ , Duty factor =  $10 * \log(1/0.701) = 1.54$





### 3.4 Description of Support Units

The EUT has been tested as an independent unit together with other necessary accessories or support units. The following support units or accessories were used to form a representative test configuration during the tests.

No.	Product	Brand	Model No.	Serial No.	FCC ID
1.	Earphone	N/A	N/A	N/A	N/A

No.	Signal Cable Description Of The Above Support Units
1.	N/A

Note:

1. All power cords of the above support units are non-shielded (1.8m).

#### 3.4.1 Configuration of System under Test

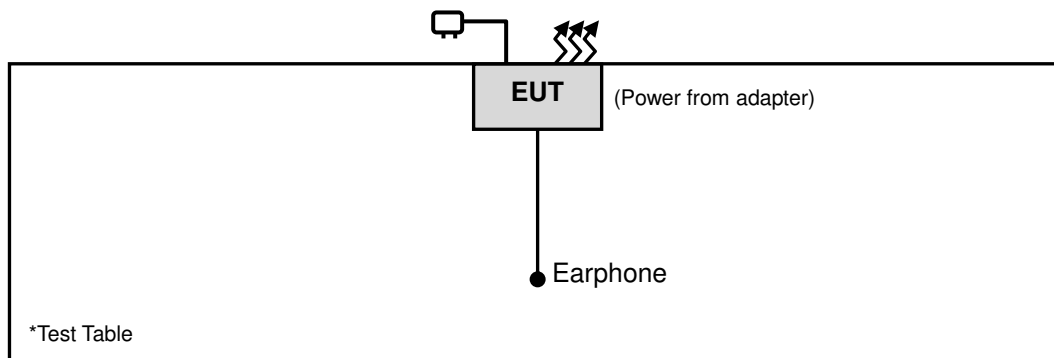

### 3.5 General Description of Applied Standards

The EUT is a RF Product. According to the specifications of the manufacturer, it must comply with the requirements of the following standards:

**FCC Part 15, Subpart E (15.407)**

**789033 D02 General UNII Test Procedures New Rules v01r01**

**662911 D01 Multiple Transmitter Output v02r01**

ANSI C63.10-2013

All test items have been performed and recorded as per the above standards.

**NOTE:** The EUT has been verified to comply with the requirements of FCC Part 15, Subpart B, Class B (DoC). The test report has been issued separately.

## 4 Test Types and Results

### 4.1 Radiated Emission and Bandedge Measurement

#### 4.1.1 Limits of Radiated Emission and Bandedge Measurement

Radiated emissions which fall in the restricted bands must comply with the radiated emission limits specified as below table. Other emissions shall be at least 20 dB below the highest level of the desired power:

Frequencies (MHz)	Field Strength (microvolts/meter)	Measurement Distance (meters)
0.009 ~ 0.490	2400/F (kHz)	300
0.490 ~ 1.705	24000/F (kHz)	30
1.705 ~ 30.0	30	30
30 ~ 88	100	3
88 ~ 216	150	3
216 ~ 960	200	3
Above 960	500	3

#### NOTE:

1. The lower limit shall apply at the transition frequencies.
2. Emission level (dBuV/m) = 20 log Emission level (uV/m).
3. For frequencies above 1000 MHz, the field strength limits are based on average detector, however, the peak field strength of any emission shall not exceed the maximum permitted average limits, specified above by more than 20 dB under any condition of modulation.

#### 4.1.2 Limits of Unwanted Emission Out of the Restricted Bands

Applicable To	Limit	
789033 D02 General UNII Test Procedures New Rules v01r01	Field Strength at 3 m	
	PK: 74 (dBμV/m)	AV: 54 (dBμV/m)
Applicable To	EIRP Limit	Equivalent Field Strength at 3 m
15.407(b)(1)	PK: -27 (dBm/MHz)	PK: 68.2 (dBμV/m)
15.407(b)(2)		
15.407(b)(3)		
15.407(b)(4)	PK: -27 (dBm/MHz) <sup>*1</sup> PK: -17 (dBm/MHz) <sup>*2</sup>	PK: 68.2 (dBμV/m) <sup>*1</sup> PK: 78.2 (dBμV/m) <sup>*2</sup>

**NOTE:** <sup>\*1</sup> beyond 10 MHz of the band edge <sup>\*2</sup> within 10 MHz of band edge

The following formula is used to convert the equipment isotropic radiated power (eirp) to field strength:

$$E = \frac{1000000\sqrt{30P}}{3} \mu\text{V/m, where } P \text{ is the eirp (Watts).}$$

**4.1.3 Test Instruments**

<b>Description &amp; Manufacturer</b>	<b>Model No.</b>	<b>Serial No.</b>	<b>Date of Calibration</b>	<b>Due Date of Calibration</b>
Test Receiver Agilent	N9038A	MY51210203	Jan. 21, 2016	Jan. 20, 2017
Spectrum Analyzer Agilent	N9010A	MY52220314	Sep. 03, 2015	Sep. 02, 2016
Spectrum Analyzer ROHDE & SCHWARZ	FSU43	101261	Dec. 17, 2015	Dec. 16, 2016
BILOG Antenna SCHWARZBECK	VULB9168	9168-472	Jan. 07, 2016	Jan. 06, 2017
HORN Antenna SCHWARZBECK	BBHA 9120 D	9120D-969	Jan. 04, 2016	Jan. 03, 2017
HORN Antenna SCHWARZBECK	BBHA 9170	9170-480	Jan. 08, 2016	Jan. 07, 2017
Loop Antenna	EM-6879	269	Jul. 31, 2015	Jul. 30, 2016
Preamplifier EMCI	EMC 012645	980115	Dec. 21, 2015	Dec. 20, 2016
Preamplifier EMCI	EMC 184045	980116	Dec. 21, 2015	Dec. 20, 2016
Preamplifier EMCI	EMC 330H	980112	Dec. 28, 2015	Dec. 27, 2016
Power Meter Anritsu	ML2495A	1232002	Sep. 21, 2015	Sep. 20, 2016
Power Sensor Anritsu	MA2411B	1207325	Sep. 21, 2015	Sep. 20, 2016
RF signal cable HUBER+SUHNNER	SUCOFLEX 104	309219/4 2950114	Oct. 12, 2015	Oct. 11, 2016
RF signal cable HUBER+SUHNNER	SUCOFLEX 104	250130/4	Oct. 12, 2015	Oct. 11, 2016
RF Coaxial Cable Worken	8D-FB	Cable-Ch10-01	Oct. 12, 2015	Oct. 11, 2016
Software BV ADT	E3 6.120103	NA	NA	NA
Antenna Tower MF	MFA-440H	NA	NA	NA
Turn Table MF	MFT-201SS	NA	NA	NA
Antenna Tower & Turn Table Controller MF	MF-7802	NA	NA	NA

- Note: 1. The calibration interval of the above test instruments is 12 months and the calibrations are traceable to NML/ROC and NIST/USA.
2. The test was performed in HwaYa Chamber 10.
3. The horn antenna and preamplifier (model: EMC 184045) are used only for the measurement of emission frequency above 1 GHz if tested.
4. The FCC Site Registration No. is 690701.
5. The IC Site Registration No. is IC7450F-10.

#### 4.1.4 Test Procedures

- a. The EUT was placed on the top of a rotating table 0.8 meters (for below 1 GHz) / 1.5 meters (for above 1 GHz) above the ground at 3 meter chamber room for test. The table was rotated 360 degrees to determine the position of the highest radiation.
- b. The EUT was set 3 meters away from the interference-receiving antenna, which was mounted on the top of a variable-height antenna tower.
- c. The height of antenna is varied from one meter to four meters above the ground to determine the maximum value of the field strength. Both horizontal and vertical polarizations of the antenna are set to make the measurement.
- d. For each suspected emission, the EUT was arranged to its worst case and then the antenna was tuned to heights from 1 meter to 4 meters and the rotatable table was turned from 0 degrees to 360 degrees to find the maximum reading.
- e. The test-receiver system was set to quasi-peak detect function and specified bandwidth with maximum hold mode when the test frequency is below 1 GHz.
- f. The test-receiver system was set to peak and average detected function and specified bandwidth with maximum hold mode when the test frequency is above 1 GHz. If the peak reading value also meets average limit, measurement with the average detector is unnecessary.

**Note:**

1. The resolution bandwidth and video bandwidth of test receiver/spectrum analyzer is 120 kHz for Quasi-peak detection (QP) at frequency below 1 GHz.
2. The resolution bandwidth of test receiver/spectrum analyzer is 1 MHz and the video bandwidth is 3 MHz for Peak detection (PK) at frequency above 1 GHz.
3. The resolution bandwidth of test receiver/spectrum analyzer is 1 MHz and the video bandwidth is 3 MHz for RMS Average (Duty cycle < 98 %) for Average detection (AV) at frequency above 1 GHz, then the measurement results was added to a correction factor ( $10 \log(1/\text{duty cycle})$ ).
4. The resolution bandwidth of test receiver/spectrum analyzer is 1 MHz and the video bandwidth is 10 Hz (Duty cycle  $\geq$  98 %) for Average detection (AV) at frequency above 1 GHz.
5. All modes of operation were investigated and the worst-case emissions are reported.

#### 4.1.5 Deviation from Test Standard

No deviation.

4.1.6 Test Set Up

**<Frequency Range below 1 GHz>**

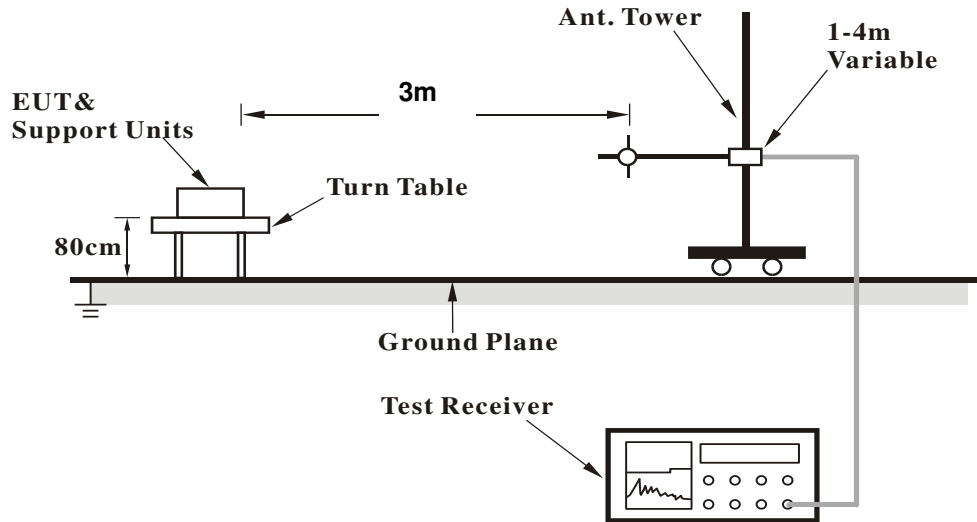

**<Frequency Range above 1 GHz>**

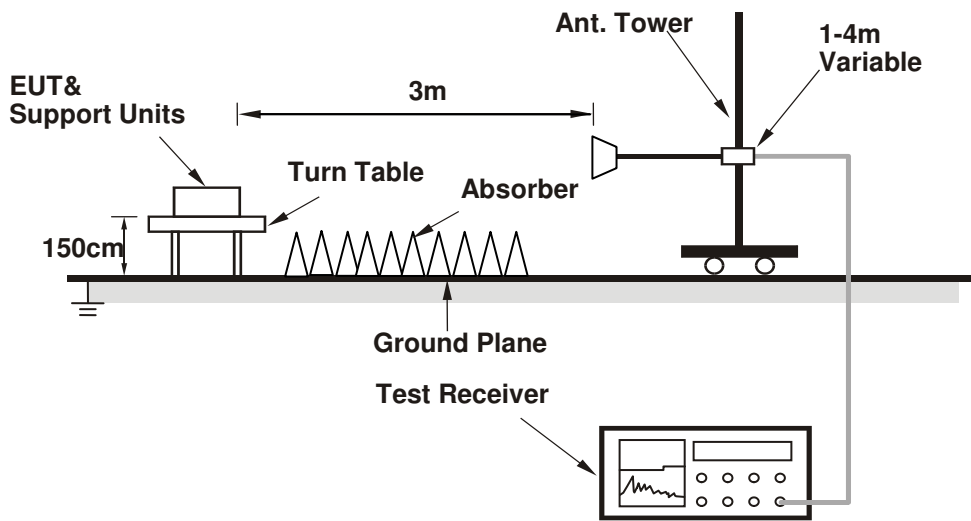

For the actual test configuration, please refer to the attached file (Test Setup Photo).

4.1.7 EUT Operating Conditions

- a. Placed the EUT on a testing table.
- b. Use the software to control the EUT under transmission condition continuously at specific channel frequency.

**4.1.8 Test Results**
**ABOVE 1 GHz DATA :**
**SAMPLE A**
**802.11a**

EUT Test Condition		Measurement Detail	
Channel	Channel 36	Frequency Range	1 GHz ~ 40 GHz
Input Power	120 Vac, 60 Hz	Detector Function	Peak (PK) Average (AV)
Environmental Conditions	25 deg. C, 65 % RH	Tested By	Gavin Wu

Antenna Polarity & Test Distance: Horizontal at 3 m										
Frequency (MHz)	Emission Level (dBuV/m)	Read Level (dBuV)	Limit (dBuV/m)	Margin (dB)	Antenna Factor (dB/m)	Cable Loss (dB)	Preamp Factor (dB)	Antenna Height (cm)	Table Angle (Degree)	Remark
5058	40.72	40.55	54	-13.28	31.25	6.17	37.25	104	278	Average
5058	60	59.83	74	-14	31.25	6.17	37.25	104	278	Peak
5180	92.92	92.69			31.35	6.22	37.34	104	278	Average
5180	101.92	101.69			31.35	6.22	37.34	104	278	Peak
5458	38.12	37.3	54	-15.88	31.56	6.34	37.08	104	278	Average
5458	59.63	58.81	74	-14.37	31.56	6.34	37.08	104	278	Peak
Antenna Polarity & Test Distance: Vertical at 3 m										
Frequency (MHz)	Emission Level (dBuV/m)	Read Level (dBuV)	Limit (dBuV/m)	Margin (dB)	Antenna Factor (dB/m)	Cable Loss (dB)	Preamp Factor (dB)	Antenna Height (cm)	Table Angle (Degree)	Remark
5064	39.25	39.08	54	-14.75	31.25	6.17	37.25	234	128	Average
5064	59.51	59.34	74	-14.49	31.25	6.17	37.25	234	128	Peak
5180	89.75	89.52			31.35	6.22	37.34	234	128	Average
5180	99.02	98.79			31.35	6.22	37.34	234	128	Peak
5404	38.06	37.4	54	-15.94	31.52	6.32	37.18	234	128	Average
5404	59.95	59.29	74	-14.05	31.52	6.32	37.18	234	128	Peak

**Remarks:**

- Emission Level = Read Level + Antenna Factor + Cable Loss - Preamp Factor  
Margin value = Emission level – Limit value
- 5180 MHz: Fundamental frequency.

EUT Test Condition		Measurement Detail	
Channel	Channel 44	Frequency Range	1 GHz ~ 40 GHz
Input Power	120 Vac, 60 Hz	Detector Function	Peak (PK) Average (AV)
Environmental Conditions	25 deg. C, 65 % RH	Tested By	Gavin Wu

Antenna Polarity & Test Distance: Horizontal at 3 m										
Frequency (MHz)	Emission Level (dBuV/m)	Read Level (dBuV)	Limit (dBuV/m)	Margin (dB)	Antenna Factor (dB/m)	Cable Loss (dB)	Preamp Factor (dB)	Antenna Height (cm)	Table Angle (Degree)	Remark
5094	40.19	40	54	-13.81	31.28	6.19	37.28	103	273	Average
5094	60.33	60.14	74	-13.67	31.28	6.19	37.28	103	273	Peak
5220	93.09	92.84			31.37	6.24	37.36	103	273	Average
5220	102.28	102.03			31.37	6.24	37.36	103	273	Peak
5368	38.15	37.53	54	-15.85	31.49	6.31	37.18	103	273	Average
5368	60.4	59.78	74	-13.6	31.49	6.31	37.18	103	273	Peak
Antenna Polarity & Test Distance: Vertical at 3 m										
Frequency (MHz)	Emission Level (dBuV/m)	Read Level (dBuV)	Limit (dBuV/m)	Margin (dB)	Antenna Factor (dB/m)	Cable Loss (dB)	Preamp Factor (dB)	Antenna Height (cm)	Table Angle (Degree)	Remark
5016	39.23	39.1	54	-14.77	31.21	6.15	37.23	235	120	Average
5016	59.65	59.52	74	-14.35	31.21	6.15	37.23	235	120	Peak
5220	90.44	90.19			31.37	6.24	37.36	235	120	Average
5220	99.62	99.37			31.37	6.24	37.36	235	120	Peak
5444	38.54	37.78	54	-15.46	31.55	6.34	37.13	235	120	Average
5444	59.52	58.76	74	-14.48	31.55	6.34	37.13	235	120	Peak

**Remarks:**

- Emission Level = Read Level + Antenna Factor + Cable Loss - Preamp Factor  
Margin value = Emission level – Limit value
- 5220 MHz: Fundamental frequency.



EUT Test Condition		Measurement Detail	
Channel	Channel 48	Frequency Range	1 GHz ~ 40 GHz
Input Power	120 Vac, 60 Hz	Detector Function	Peak (PK) Average (AV)
Environmental Conditions	25 deg. C, 65 % RH	Tested By	Gavin Wu

Antenna Polarity & Test Distance: Horizontal at 3 m										
Frequency (MHz)	Emission Level (dBuV/m)	Read Level (dBuV)	Limit (dBuV/m)	Margin (dB)	Antenna Factor (dB/m)	Cable Loss (dB)	Preamp Factor (dB)	Antenna Height (cm)	Table Angle (Degree)	Remark
5044	38.38	38.24	54	-15.62	31.24	6.15	37.25	102	285	Average
5044	60.64	60.5	74	-13.36	31.24	6.15	37.25	102	285	Peak
5240	92.75	92.43			31.39	6.25	37.32	102	285	Average
5240	101.9	101.58			31.39	6.25	37.32	102	285	Peak
5448	38.22	37.45	54	-15.78	31.56	6.34	37.13	102	285	Average
5448	59.74	58.97	74	-14.26	31.56	6.34	37.13	102	285	Peak
Antenna Polarity & Test Distance: Vertical at 3 m										
Frequency (MHz)	Emission Level (dBuV/m)	Read Level (dBuV)	Limit (dBuV/m)	Margin (dB)	Antenna Factor (dB/m)	Cable Loss (dB)	Preamp Factor (dB)	Antenna Height (cm)	Table Angle (Degree)	Remark
5054	38.25	38.09	54	-15.75	31.24	6.17	37.25	238	123	Average
5054	60.18	60.02	74	-13.82	31.24	6.17	37.25	238	123	Peak
5240	90.07	89.75			31.39	6.25	37.32	238	123	Average
5240	99.18	98.86			31.39	6.25	37.32	238	123	Peak
5378	38.21	37.57	54	-15.79	31.51	6.31	37.18	238	123	Average
5378	60.3	59.66	74	-13.7	31.51	6.31	37.18	238	123	Peak

Remarks:

- Emission Level = Read Level + Antenna Factor + Cable Loss - Preamp Factor  
Margin value = Emission level – Limit value
- 5240 MHz: Fundamental frequency.



EUT Test Condition		Measurement Detail	
Channel	Channel 52	Frequency Range	1 GHz ~ 40 GHz
Input Power	120 Vac, 60 Hz	Detector Function	Peak (PK) Average (AV)
Environmental Conditions	25 deg. C, 65 % RH	Tested By	Gavin Wu

Antenna Polarity & Test Distance: Horizontal at 3 m										
Frequency (MHz)	Emission Level (dBuV/m)	Read Level (dBuV)	Limit (dBuV/m)	Margin (dB)	Antenna Factor (dB/m)	Cable Loss (dB)	Preamp Factor (dB)	Antenna Height (cm)	Table Angle (Degree)	Remark
5088	38.63	38.44	54	-15.37	31.27	6.19	37.27	206	7	Average
5088	59.93	59.74	74	-14.07	31.27	6.19	37.27	206	7	Peak
5260	92.45	92.06			31.41	6.25	37.27	206	7	Average
5260	101.45	101.06			31.41	6.25	37.27	206	7	Peak
5444	39	38.24	54	-15	31.55	6.34	37.13	206	7	Average
5444	59.07	58.31	74	-14.93	31.55	6.34	37.13	206	7	Peak
Antenna Polarity & Test Distance: Vertical at 3 m										
Frequency (MHz)	Emission Level (dBuV/m)	Read Level (dBuV)	Limit (dBuV/m)	Margin (dB)	Antenna Factor (dB/m)	Cable Loss (dB)	Preamp Factor (dB)	Antenna Height (cm)	Table Angle (Degree)	Remark
5140	37.84	37.62	54	-16.16	31.32	6.2	37.3	200	215	Average
5140	58.59	58.37	74	-15.41	31.32	6.2	37.3	200	215	Peak
5260	89.8	89.41			31.41	6.25	37.27	200	215	Average
5260	99.35	98.96			31.41	6.25	37.27	200	215	Peak
5456	38.32	37.5	54	-15.68	31.56	6.34	37.08	200	215	Average
5456	59.85	59.03	74	-14.15	31.56	6.34	37.08	200	215	Peak

Remarks:

- Emission Level = Read Level + Antenna Factor + Cable Loss - Preamp Factor  
Margin value = Emission level – Limit value
- 5260 MHz: Fundamental frequency.

EUT Test Condition		Measurement Detail	
Channel	Channel 60	Frequency Range	1 GHz ~ 40 GHz
Input Power	120 Vac, 60 Hz	Detector Function	Peak (PK) Average (AV)
Environmental Conditions	25 deg. C, 65 % RH	Tested By	Gavin Wu

Antenna Polarity & Test Distance: Horizontal at 3 m										
Frequency (MHz)	Emission Level (dBuV/m)	Read Level (dBuV)	Limit (dBuV/m)	Margin (dB)	Antenna Factor (dB/m)	Cable Loss (dB)	Preamp Factor (dB)	Antenna Height (cm)	Table Angle (Degree)	Remark
5038	38.59	38.44	54	-15.41	31.24	6.15	37.24	169	6	Average
5038	59.15	59	74	-14.85	31.24	6.15	37.24	169	6	Peak
5300	91.52	91			31.44	6.27	37.19	169	6	Average
5300	101.82	101.3			31.44	6.27	37.19	169	6	Peak
5360	40.23	39.62	54	-13.77	31.48	6.31	37.18	169	6	Average
5360	59.55	58.94	74	-14.45	31.48	6.31	37.18	169	6	Peak
Antenna Polarity & Test Distance: Vertical at 3 m										
Frequency (MHz)	Emission Level (dBuV/m)	Read Level (dBuV)	Limit (dBuV/m)	Margin (dB)	Antenna Factor (dB/m)	Cable Loss (dB)	Preamp Factor (dB)	Antenna Height (cm)	Table Angle (Degree)	Remark
5034	38.07	37.93	54	-15.93	31.23	6.15	37.24	196	213	Average
5034	59.92	59.78	74	-14.08	31.23	6.15	37.24	196	213	Peak
5300	89.09	88.57			31.44	6.27	37.19	196	213	Average
5300	99.72	99.2			31.44	6.27	37.19	196	213	Peak
5370	39.49	38.87	54	-14.51	31.49	6.31	37.18	196	213	Average
5370	60.66	60.04	74	-13.34	31.49	6.31	37.18	196	213	Peak

Remarks:

- Emission Level = Read Level + Antenna Factor + Cable Loss - Preamp Factor  
Margin value = Emission level – Limit value
- 5300 MHz: Fundamental frequency.

EUT Test Condition		Measurement Detail	
Channel	Channel 64	Frequency Range	1 GHz ~ 40 GHz
Input Power	120 Vac, 60 Hz	Detector Function	Peak (PK) Average (AV)
Environmental Conditions	25 deg. C, 65 % RH	Tested By	Gavin Wu

Antenna Polarity & Test Distance: Horizontal at 3 m										
Frequency (MHz)	Emission Level (dBuV/m)	Read Level (dBuV)	Limit (dBuV/m)	Margin (dB)	Antenna Factor (dB/m)	Cable Loss (dB)	Preamp Factor (dB)	Antenna Height (cm)	Table Angle (Degree)	Remark
5046	37.91	37.77	54	-16.09	31.24	6.15	37.25	157	7	Average
5046	60.7	60.56	74	-13.3	31.24	6.15	37.25	157	7	Peak
5320	91.66	91.11			31.45	6.29	37.19	157	7	Average
5320	101.25	100.7			31.45	6.29	37.19	157	7	Peak
5444	41.1	40.34	54	-12.9	31.55	6.34	37.13	157	7	Average
5444	60.31	59.55	74	-13.69	31.55	6.34	37.13	157	7	Peak
Antenna Polarity & Test Distance: Vertical at 3 m										
Frequency (MHz)	Emission Level (dBuV/m)	Read Level (dBuV)	Limit (dBuV/m)	Margin (dB)	Antenna Factor (dB/m)	Cable Loss (dB)	Preamp Factor (dB)	Antenna Height (cm)	Table Angle (Degree)	Remark
5028	37.64	37.5	54	-16.36	31.23	6.15	37.24	187	212	Average
5028	59.84	59.7	74	-14.16	31.23	6.15	37.24	187	212	Peak
5320	89.4	88.85			31.45	6.29	37.19	187	212	Average
5320	99.69	99.14			31.45	6.29	37.19	187	212	Peak
5440	39.95	39.19	54	-14.05	31.55	6.34	37.13	187	212	Average
5440	59.89	59.13	74	-14.11	31.55	6.34	37.13	187	212	Peak

**Remarks:**

- Emission Level = Read Level + Antenna Factor + Cable Loss - Preamp Factor  
Margin value = Emission level – Limit value
- 5320 MHz: Fundamental frequency.

EUT Test Condition		Measurement Detail	
Channel	Channel 100	Frequency Range	1 GHz ~ 40 GHz
Input Power	120 Vac, 60 Hz	Detector Function	Peak (PK) Average (AV)
Environmental Conditions	25 deg. C, 65 % RH	Tested By	Gavin Wu

Antenna Polarity & Test Distance: Horizontal at 3 m										
Frequency (MHz)	Emission Level (dBuV/m)	Read Level (dBuV)	Limit (dBuV/m)	Margin (dB)	Antenna Factor (dB/m)	Cable Loss (dB)	Preamp Factor (dB)	Antenna Height (cm)	Table Angle (Degree)	Remark
5444	38.86	38.1	54	-15.14	31.55	6.34	37.13	196	132	Average
5444	59.96	59.2	74	-14.04	31.55	6.34	37.13	196	132	Peak
5470	58.7	57.87	68.2	-9.5	31.57	6.34	37.08	196	132	Peak
5500	88.65	87.72			31.6	6.36	37.03	196	132	Average
5500	98.11	97.18			31.6	6.36	37.03	196	132	Peak
5725	59.01	57.73	68.2	-9.19	31.96	6.75	37.43	196	132	Peak
Antenna Polarity & Test Distance: Vertical at 3 m										
Frequency (MHz)	Emission Level (dBuV/m)	Read Level (dBuV)	Limit (dBuV/m)	Margin (dB)	Antenna Factor (dB/m)	Cable Loss (dB)	Preamp Factor (dB)	Antenna Height (cm)	Table Angle (Degree)	Remark
5378	39.85	39.21	54	-14.15	31.51	6.31	37.18	194	271	Average
5378	59.4	58.76	74	-14.6	31.51	6.31	37.18	194	271	Peak
5470	58.9	58.07	68.2	-9.3	31.57	6.34	37.08	194	271	Peak
5500	91.42	90.49			31.6	6.36	37.03	194	271	Average
5500	100.62	99.69			31.6	6.36	37.03	194	271	Peak
5725	58.9	57.62	68.2	-9.3	31.96	6.75	37.43	194	271	Peak

**Remarks:**

- Emission Level = Read Level + Antenna Factor + Cable Loss - Preamp Factor  
Margin value = Emission level – Limit value
- 5500 MHz: Fundamental frequency.
- 5470 MHz & 5725 MHz: Out of restricted band

EUT Test Condition		Measurement Detail	
Channel	Channel 116	Frequency Range	1 GHz ~ 40 GHz
Input Power	120 Vac, 60 Hz	Detector Function	Peak (PK) Average (AV)
Environmental Conditions	25 deg. C, 65 % RH	Tested By	Gavin Wu

Antenna Polarity & Test Distance: Horizontal at 3 m										
Frequency (MHz)	Emission Level (dBuV/m)	Read Level (dBuV)	Limit (dBuV/m)	Margin (dB)	Antenna Factor (dB/m)	Cable Loss (dB)	Preamp Factor (dB)	Antenna Height (cm)	Table Angle (Degree)	Remark
5460	38.26	37.44	54	-15.74	31.56	6.34	37.08	194	127	Average
5460	59.61	58.79	74	-14.39	31.56	6.34	37.08	194	127	Peak
5470	57.64	56.81	68.2	-10.56	31.57	6.34	37.08	194	127	Peak
5580	88.94	87.9			31.71	6.49	37.16	194	127	Average
5580	98.1	97.06			31.71	6.49	37.16	194	127	Peak
5725	58.31	57.03	68.2	-9.89	31.96	6.75	37.43	194	127	Peak
Antenna Polarity & Test Distance: Vertical at 3 m										
Frequency (MHz)	Emission Level (dBuV/m)	Read Level (dBuV)	Limit (dBuV/m)	Margin (dB)	Antenna Factor (dB/m)	Cable Loss (dB)	Preamp Factor (dB)	Antenna Height (cm)	Table Angle (Degree)	Remark
5394	38.85	38.21	54	-15.15	31.51	6.31	37.18	192	266	Average
5394	58.67	58.03	74	-15.33	31.51	6.31	37.18	192	266	Peak
5470	58.32	57.49	68.2	-9.88	31.57	6.34	37.08	192	266	Peak
5580	92.15	91.11			31.71	6.49	37.16	192	266	Average
5580	101.08	100.04			31.71	6.49	37.16	192	266	Peak
5725	58.19	56.91	68.2	-10.01	31.96	6.75	37.43	192	266	Peak

**Remarks:**

- Emission Level = Read Level + Antenna Factor + Cable Loss - Preamp Factor  
Margin value = Emission level – Limit value
- 5580 MHz: Fundamental frequency.
- 5470 MHz & 5725 MHz: Out of restricted band

EUT Test Condition		Measurement Detail	
Channel	Channel 140	Frequency Range	1 GHz ~ 40 GHz
Input Power	120 Vac, 60 Hz	Detector Function	Peak (PK) Average (AV)
Environmental Conditions	25 deg. C, 65 % RH	Tested By	Gavin Wu

Antenna Polarity & Test Distance: Horizontal at 3 m										
Frequency (MHz)	Emission Level (dBuV/m)	Read Level (dBuV)	Limit (dBuV/m)	Margin (dB)	Antenna Factor (dB/m)	Cable Loss (dB)	Preamp Factor (dB)	Antenna Height (cm)	Table Angle (Degree)	Remark
5358	37.91	37.3	54	-16.09	31.48	6.31	37.18	190	125	Average
5358	59.51	58.9	74	-14.49	31.48	6.31	37.18	190	125	Peak
5470	56.62	55.79	68.2	-11.58	31.57	6.34	37.08	190	125	Peak
5700	90.54	89.35			31.9	6.69	37.4	190	125	Average
5700	99.92	98.73			31.9	6.69	37.4	190	125	Peak
5725	58.09	56.81	68.2	-10.11	31.96	6.75	37.43	190	125	Peak
Antenna Polarity & Test Distance: Vertical at 3 m										
Frequency (MHz)	Emission Level (dBuV/m)	Read Level (dBuV)	Limit (dBuV/m)	Margin (dB)	Antenna Factor (dB/m)	Cable Loss (dB)	Preamp Factor (dB)	Antenna Height (cm)	Table Angle (Degree)	Remark
5390	37.94	37.3	54	-16.06	31.51	6.31	37.18	189	264	Average
5390	59.6	58.96	74	-14.4	31.51	6.31	37.18	189	264	Peak
5470	57.71	56.88	68.2	-10.49	31.57	6.34	37.08	189	264	Peak
5700	91.68	90.49			31.9	6.69	37.4	189	264	Average
5700	101.39	100.2			31.9	6.69	37.4	189	264	Peak
5725	58.5	57.22	68.2	-9.7	31.96	6.75	37.43	189	264	Peak

**Remarks:**

- Emission Level = Read Level + Antenna Factor + Cable Loss - Preamp Factor  
Margin value = Emission level – Limit value
- 5700 MHz: Fundamental frequency.
- 5470 MHz & 5725 MHz: Out of restricted band

EUT Test Condition		Measurement Detail	
Channel	Channel 149	Frequency Range	1 GHz ~ 40 GHz
Input Power	120 Vac, 60 Hz	Detector Function	Peak (PK) Average (AV)
Environmental Conditions	25 deg. C, 65 % RH	Tested By	Gavin Wu

Antenna Polarity & Test Distance: Horizontal at 3 m										
Frequency (MHz)	Emission Level (dBuV/m)	Read Level (dBuV)	Limit (dBuV/m)	Margin (dB)	Antenna Factor (dB/m)	Cable Loss (dB)	Preamp Factor (dB)	Antenna Height (cm)	Table Angle (Degree)	Remark
*5714	60.48	59.29	68.2	-7.72	31.93	6.69	37.43	204	300	Peak
*5725	61.47	60.19	78.2	-16.73	31.96	6.75	37.43	204	300	Peak
5745	92.22	90.95			31.99	6.75	37.47	204	300	Average
5745	101.98	100.71			31.99	6.75	37.47	204	300	Peak
*5850	59.51	57.99	78.2	-18.69	32.15	6.88	37.51	204	300	Peak
*5861	59.82	58.19	68.2	-8.38	32.18	6.95	37.5	204	300	Peak
Antenna Polarity & Test Distance: Vertical at 3 m										
Frequency (MHz)	Emission Level (dBuV/m)	Read Level (dBuV)	Limit (dBuV/m)	Margin (dB)	Antenna Factor (dB/m)	Cable Loss (dB)	Preamp Factor (dB)	Antenna Height (cm)	Table Angle (Degree)	Remark
*5714	60.16	58.97	68.2	-8.04	31.93	6.69	37.43	278	6	Peak
*5725	61.51	60.23	78.2	-16.69	31.96	6.75	37.43	278	6	Peak
5745	89.92	88.65			31.99	6.75	37.47	278	6	Average
5745	99.18	97.91			31.99	6.75	37.47	278	6	Peak
*5850	60.91	59.39	78.2	-17.29	32.15	6.88	37.51	278	6	Peak
*5861	59.63	58	68.2	-8.57	32.18	6.95	37.5	278	6	Peak

**Remarks:**

- Emission Level = Read Level + Antenna Factor + Cable Loss - Preamp Factor  
Margin value = Emission level – Limit value
- 5745 MHz: Fundamental frequency.
- \*: Out of restricted band

EUT Test Condition		Measurement Detail	
Channel	Channel 157	Frequency Range	1 GHz ~ 40 GHz
Input Power	120 Vac, 60 Hz	Detector Function	Peak (PK) Average (AV)
Environmental Conditions	25 deg. C, 65 % RH	Tested By	Gavin Wu

Antenna Polarity & Test Distance: Horizontal at 3 m										
Frequency (MHz)	Emission Level (dBuV/m)	Read Level (dBuV)	Limit (dBuV/m)	Margin (dB)	Antenna Factor (dB/m)	Cable Loss (dB)	Preamp Factor (dB)	Antenna Height (cm)	Table Angle (Degree)	Remark
*5714	59.49	58.3	68.2	-8.71	31.93	6.69	37.43	202	302	Peak
*5725	59.57	58.29	78.2	-18.63	31.96	6.75	37.43	202	302	Peak
5785	92.36	91.04			32.04	6.82	37.54	202	302	Average
5785	101.93	100.61			32.04	6.82	37.54	202	302	Peak
*5850	59.47	57.95	78.2	-18.73	32.15	6.88	37.51	202	302	Peak
*5861	60.12	58.49	68.2	-8.08	32.18	6.95	37.5	202	302	Peak
Antenna Polarity & Test Distance: Vertical at 3 m										
Frequency (MHz)	Emission Level (dBuV/m)	Read Level (dBuV)	Limit (dBuV/m)	Margin (dB)	Antenna Factor (dB/m)	Cable Loss (dB)	Preamp Factor (dB)	Antenna Height (cm)	Table Angle (Degree)	Remark
*5714	59.06	57.87	68.2	-9.14	31.93	6.69	37.43	281	4	Peak
*5725	59.72	58.44	78.2	-18.48	31.96	6.75	37.43	281	4	Peak
5785	90.06	88.74			32.04	6.82	37.54	281	4	Average
5785	99.17	97.85			32.04	6.82	37.54	281	4	Peak
*5850	58.17	56.65	78.2	-20.03	32.15	6.88	37.51	281	4	Peak
*5861	59.68	58.05	68.2	-8.52	32.18	6.95	37.5	281	4	Peak

**Remarks:**

- Emission Level = Read Level + Antenna Factor + Cable Loss - Preamp Factor  
Margin value = Emission level – Limit value
- 5785 MHz: Fundamental frequency.
- \*: Out of restricted band



EUT Test Condition		Measurement Detail	
Channel	Channel 165	Frequency Range	1 GHz ~ 40 GHz
Input Power	120 Vac, 60 Hz	Detector Function	Peak (PK) Average (AV)
Environmental Conditions	25 deg. C, 65 % RH	Tested By	Gavin Wu

Antenna Polarity & Test Distance: Horizontal at 3 m										
Frequency (MHz)	Emission Level (dBuV/m)	Read Level (dBuV)	Limit (dBuV/m)	Margin (dB)	Antenna Factor (dB/m)	Cable Loss (dB)	Preamp Factor (dB)	Antenna Height (cm)	Table Angle (Degree)	Remark
*5714	59.69	58.5	68.2	-8.51	31.93	6.69	37.43	208	298	Peak
*5725	58.95	57.67	78.2	-19.25	31.96	6.75	37.43	208	298	Peak
5825	92.44	90.97			32.12	6.88	37.53	208	298	Average
5825	101.98	100.51			32.12	6.88	37.53	208	298	Peak
*5850	59.89	58.37	78.2	-18.31	32.15	6.88	37.51	208	298	Peak
*5861	60.78	59.15	68.2	-7.42	32.18	6.95	37.5	208	298	Peak
Antenna Polarity & Test Distance: Vertical at 3 m										
Frequency (MHz)	Emission Level (dBuV/m)	Read Level (dBuV)	Limit (dBuV/m)	Margin (dB)	Antenna Factor (dB/m)	Cable Loss (dB)	Preamp Factor (dB)	Antenna Height (cm)	Table Angle (Degree)	Remark
*5714	58.71	57.52	68.2	-9.49	31.93	6.69	37.43	277	2	Peak
*5725	59.33	58.05	78.2	-18.87	31.96	6.75	37.43	277	2	Peak
5825	90.19	88.72			32.12	6.88	37.53	277	2	Average
5825	99.24	97.77			32.12	6.88	37.53	277	2	Peak
*5850	60.18	58.66	78.2	-18.02	32.15	6.88	37.51	277	2	Peak
*5861	60.17	58.54	68.2	-8.03	32.18	6.95	37.5	277	2	Peak

**Remarks:**

- Emission Level = Read Level + Antenna Factor + Cable Loss - Preamp Factor  
Margin value = Emission level – Limit value
- 5825 MHz: Fundamental frequency.
- \*: Out of restricted band

**802.11n (HT20)**

EUT Test Condition		Measurement Detail	
Channel	Channel 36	Frequency Range	1 GHz ~ 40 GHz
Input Power	120 Vac, 60 Hz	Detector Function	Peak (PK) Average (AV)
Environmental Conditions	25 deg. C, 65 % RH	Tested By	Gavin Wu

**Antenna Polarity & Test Distance: Horizontal at 3 m**

Frequency (MHz)	Emission Level (dBuV/m)	Read Level (dBuV)	Limit (dBuV/m)	Margin (dB)	Antenna Factor (dB/m)	Cable Loss (dB)	Preamp Factor (dB)	Antenna Height (cm)	Table Angle (Degree)	Remark
5136	41.6	41.39	54	-12.4	31.31	6.2	37.3	103	277	Average
5136	60.01	59.8	74	-13.99	31.31	6.2	37.3	103	277	Peak
5180	93.14	92.91			31.35	6.22	37.34	103	277	Average
5180	102.15	101.92			31.35	6.22	37.34	103	277	Peak
5432	38.15	37.41	54	-15.85	31.55	6.32	37.13	103	277	Average
5432	59.78	59.04	74	-14.22	31.55	6.32	37.13	103	277	Peak

**Antenna Polarity & Test Distance: Vertical at 3 m**

Frequency (MHz)	Emission Level (dBuV/m)	Read Level (dBuV)	Limit (dBuV/m)	Margin (dB)	Antenna Factor (dB/m)	Cable Loss (dB)	Preamp Factor (dB)	Antenna Height (cm)	Table Angle (Degree)	Remark
5086	39.87	39.7	54	-14.13	31.27	6.17	37.27	238	132	Average
5086	59.92	59.75	74	-14.08	31.27	6.17	37.27	238	132	Peak
5180	90.46	90.23			31.35	6.22	37.34	238	132	Average
5180	99.66	99.43			31.35	6.22	37.34	238	132	Peak
5420	38.04	37.37	54	-15.96	31.53	6.32	37.18	238	132	Average
5420	59.93	59.26	74	-14.07	31.53	6.32	37.18	238	132	Peak

**Remarks:**

- Emission Level = Read Level + Antenna Factor + Cable Loss - Preamp Factor  
Margin value = Emission level – Limit value
- 5180 MHz: Fundamental frequency.

EUT Test Condition		Measurement Detail	
Channel	Channel 44	Frequency Range	1 GHz ~ 40 GHz
Input Power	120 Vac, 60 Hz	Detector Function	Peak (PK) Average (AV)
Environmental Conditions	25 deg. C, 65 % RH	Tested By	Gavin Wu

Antenna Polarity & Test Distance: Horizontal at 3 m										
Frequency (MHz)	Emission Level (dBuV/m)	Read Level (dBuV)	Limit (dBuV/m)	Margin (dB)	Antenna Factor (dB/m)	Cable Loss (dB)	Preamp Factor (dB)	Antenna Height (cm)	Table Angle (Degree)	Remark
5098	40.56	40.37	54	-13.44	31.28	6.19	37.28	103	269	Average
5098	60.39	60.2	74	-13.61	31.28	6.19	37.28	103	269	Peak
5220	92.91	92.66			31.37	6.24	37.36	103	269	Average
5220	102.08	101.83			31.37	6.24	37.36	103	269	Peak
5454	38.18	37.36	54	-15.82	31.56	6.34	37.08	103	269	Average
5454	59.76	58.94	74	-14.24	31.56	6.34	37.08	103	269	Peak
Antenna Polarity & Test Distance: Vertical at 3 m										
Frequency (MHz)	Emission Level (dBuV/m)	Read Level (dBuV)	Limit (dBuV/m)	Margin (dB)	Antenna Factor (dB/m)	Cable Loss (dB)	Preamp Factor (dB)	Antenna Height (cm)	Table Angle (Degree)	Remark
5090	38.77	38.57	54	-15.23	31.28	6.19	37.27	238	140	Average
5090	59.21	59.01	74	-14.79	31.28	6.19	37.27	238	140	Peak
5220	90.74	90.49			31.37	6.24	37.36	238	140	Average
5220	99.55	99.3			31.37	6.24	37.36	238	140	Peak
5458	38.93	38.11	54	-15.07	31.56	6.34	37.08	238	140	Average
5458	61.01	60.19	74	-12.99	31.56	6.34	37.08	238	140	Peak

**Remarks:**

- Emission Level = Read Level + Antenna Factor + Cable Loss - Preamp Factor  
Margin value = Emission level – Limit value
- 5220 MHz: Fundamental frequency.



EUT Test Condition		Measurement Detail	
Channel	Channel 48	Frequency Range	1 GHz ~ 40 GHz
Input Power	120 Vac, 60 Hz	Detector Function	Peak (PK) Average (AV)
Environmental Conditions	25 deg. C, 65 % RH	Tested By	Gavin Wu

Antenna Polarity & Test Distance: Horizontal at 3 m										
Frequency (MHz)	Emission Level (dBuV/m)	Read Level (dBuV)	Limit (dBuV/m)	Margin (dB)	Antenna Factor (dB/m)	Cable Loss (dB)	Preamp Factor (dB)	Antenna Height (cm)	Table Angle (Degree)	Remark
5140	38.45	38.23	54	-15.55	31.32	6.2	37.3	102	288	Average
5140	60.48	60.26	74	-13.52	31.32	6.2	37.3	102	288	Peak
5240	92.97	92.65			31.39	6.25	37.32	102	288	Average
5240	102.25	101.93			31.39	6.25	37.32	102	288	Peak
5406	38.2	37.54	54	-15.8	31.52	6.32	37.18	102	288	Average
5406	60.18	59.52	74	-13.82	31.52	6.32	37.18	102	288	Peak
Antenna Polarity & Test Distance: Vertical at 3 m										
Frequency (MHz)	Emission Level (dBuV/m)	Read Level (dBuV)	Limit (dBuV/m)	Margin (dB)	Antenna Factor (dB/m)	Cable Loss (dB)	Preamp Factor (dB)	Antenna Height (cm)	Table Angle (Degree)	Remark
5108	38.25	38.05	54	-15.75	31.29	6.19	37.28	234	117	Average
5108	59.46	59.26	74	-14.54	31.29	6.19	37.28	234	117	Peak
5240	90.36	90.04			31.39	6.25	37.32	234	117	Average
5240	99.61	99.29			31.39	6.25	37.32	234	117	Peak
5398	38.52	37.86	54	-15.48	31.52	6.32	37.18	234	117	Average
5398	59.89	59.23	74	-14.11	31.52	6.32	37.18	234	117	Peak

Remarks:

- Emission Level = Read Level + Antenna Factor + Cable Loss - Preamp Factor  
Margin value = Emission level – Limit value
- 5240 MHz: Fundamental frequency.



EUT Test Condition		Measurement Detail	
Channel	Channel 52	Frequency Range	1 GHz ~ 40 GHz
Input Power	120 Vac, 60 Hz	Detector Function	Peak (PK) Average (AV)
Environmental Conditions	25 deg. C, 65 % RH	Tested By	Gavin Wu

Antenna Polarity & Test Distance: Horizontal at 3 m										
Frequency (MHz)	Emission Level (dBuV/m)	Read Level (dBuV)	Limit (dBuV/m)	Margin (dB)	Antenna Factor (dB/m)	Cable Loss (dB)	Preamp Factor (dB)	Antenna Height (cm)	Table Angle (Degree)	Remark
5038	39.93	39.78	54	-14.07	31.24	6.15	37.24	187	7	Average
5038	60.02	59.87	74	-13.98	31.24	6.15	37.24	187	7	Peak
5260	91.96	91.57			31.41	6.25	37.27	187	7	Average
5260	101.64	101.25			31.41	6.25	37.27	187	7	Peak
5450	41.22	40.4	54	-12.78	31.56	6.34	37.08	187	7	Average
5450	59.93	59.11	74	-14.07	31.56	6.34	37.08	187	7	Peak
Antenna Polarity & Test Distance: Vertical at 3 m										
Frequency (MHz)	Emission Level (dBuV/m)	Read Level (dBuV)	Limit (dBuV/m)	Margin (dB)	Antenna Factor (dB/m)	Cable Loss (dB)	Preamp Factor (dB)	Antenna Height (cm)	Table Angle (Degree)	Remark
5052	39.62	39.46	54	-14.38	31.24	6.17	37.25	200	212	Average
5052	58.53	58.37	74	-15.47	31.24	6.17	37.25	200	212	Peak
5260	89.75	89.36			31.41	6.25	37.27	200	212	Average
5260	99.23	98.84			31.41	6.25	37.27	200	212	Peak
5354	40.2	39.61	54	-13.8	31.48	6.29	37.18	200	212	Average
5354	59.5	58.91	74	-14.5	31.48	6.29	37.18	200	212	Peak

Remarks:

- Emission Level = Read Level + Antenna Factor + Cable Loss - Preamp Factor  
Margin value = Emission level – Limit value
- 5260 MHz: Fundamental frequency.

EUT Test Condition		Measurement Detail	
Channel	Channel 60	Frequency Range	1 GHz ~ 40 GHz
Input Power	120 Vac, 60 Hz	Detector Function	Peak (PK) Average (AV)
Environmental Conditions	25 deg. C, 65 % RH	Tested By	Gavin Wu

Antenna Polarity & Test Distance: Horizontal at 3 m										
Frequency (MHz)	Emission Level (dBuV/m)	Read Level (dBuV)	Limit (dBuV/m)	Margin (dB)	Antenna Factor (dB/m)	Cable Loss (dB)	Preamp Factor (dB)	Antenna Height (cm)	Table Angle (Degree)	Remark
5088	38.36	38.17	54	-15.64	31.27	6.19	37.27	176	5	Average
5088	59.95	59.76	74	-14.05	31.27	6.19	37.27	176	5	Peak
5300	91.11	90.59			31.44	6.27	37.19	176	5	Average
5300	101.9	101.38			31.44	6.27	37.19	176	5	Peak
5454	40.05	39.23	54	-13.95	31.56	6.34	37.08	176	5	Average
5454	60.49	59.67	74	-13.51	31.56	6.34	37.08	176	5	Peak
Antenna Polarity & Test Distance: Vertical at 3 m										
Frequency (MHz)	Emission Level (dBuV/m)	Read Level (dBuV)	Limit (dBuV/m)	Margin (dB)	Antenna Factor (dB/m)	Cable Loss (dB)	Preamp Factor (dB)	Antenna Height (cm)	Table Angle (Degree)	Remark
5014	37.62	37.49	54	-16.38	31.21	6.15	37.23	190	212	Average
5014	60.33	60.2	74	-13.67	31.21	6.15	37.23	190	212	Peak
5300	89.72	89.2			31.44	6.27	37.19	190	212	Average
5300	99.81	99.29			31.44	6.27	37.19	190	212	Peak
5436	39.1	38.36	54	-14.9	31.55	6.32	37.13	190	212	Average
5436	60.12	59.38	74	-13.88	31.55	6.32	37.13	190	212	Peak

**Remarks:**

- Emission Level = Read Level + Antenna Factor + Cable Loss - Preamp Factor  
Margin value = Emission level – Limit value
- 5300 MHz: Fundamental frequency.

EUT Test Condition		Measurement Detail	
Channel	Channel 64	Frequency Range	1 GHz ~ 40 GHz
Input Power	120 Vac, 60 Hz	Detector Function	Peak (PK) Average (AV)
Environmental Conditions	25 deg. C, 65 % RH	Tested By	Gavin Wu

Antenna Polarity & Test Distance: Horizontal at 3 m										
Frequency (MHz)	Emission Level (dBuV/m)	Read Level (dBuV)	Limit (dBuV/m)	Margin (dB)	Antenna Factor (dB/m)	Cable Loss (dB)	Preamp Factor (dB)	Antenna Height (cm)	Table Angle (Degree)	Remark
5134	37.96	37.75	54	-16.04	31.31	6.2	37.3	182	6	Average
5134	59.79	59.58	74	-14.21	31.31	6.2	37.3	182	6	Peak
5320	91.18	90.63			31.45	6.29	37.19	182	6	Average
5320	101.75	101.2			31.45	6.29	37.19	182	6	Peak
5354	40.31	39.72	54	-13.69	31.48	6.29	37.18	182	6	Average
5354	60.72	60.13	74	-13.28	31.48	6.29	37.18	182	6	Peak
Antenna Polarity & Test Distance: Vertical at 3 m										
Frequency (MHz)	Emission Level (dBuV/m)	Read Level (dBuV)	Limit (dBuV/m)	Margin (dB)	Antenna Factor (dB/m)	Cable Loss (dB)	Preamp Factor (dB)	Antenna Height (cm)	Table Angle (Degree)	Remark
5080	37.79	37.62	54	-16.21	31.27	6.17	37.27	199	209	Average
5080	59.89	59.72	74	-14.11	31.27	6.17	37.27	199	209	Peak
5320	89.33	88.78			31.45	6.29	37.19	199	209	Average
5320	99.55	99			31.45	6.29	37.19	199	209	Peak
5442	39.75	38.99	54	-14.25	31.55	6.34	37.13	199	209	Average
5442	59.57	58.81	74	-14.43	31.55	6.34	37.13	199	209	Peak

**Remarks:**

- Emission Level = Read Level + Antenna Factor + Cable Loss - Preamp Factor  
Margin value = Emission level – Limit value
- 5320 MHz: Fundamental frequency.

EUT Test Condition		Measurement Detail	
Channel	Channel 100	Frequency Range	1 GHz ~ 40 GHz
Input Power	120 Vac, 60 Hz	Detector Function	Peak (PK) Average (AV)
Environmental Conditions	25 deg. C, 65 % RH	Tested By	Gavin Wu

Antenna Polarity & Test Distance: Horizontal at 3 m										
Frequency (MHz)	Emission Level (dBuV/m)	Read Level (dBuV)	Limit (dBuV/m)	Margin (dB)	Antenna Factor (dB/m)	Cable Loss (dB)	Preamp Factor (dB)	Antenna Height (cm)	Table Angle (Degree)	Remark
5414	38.77	38.1	54	-15.23	31.53	6.32	37.18	200	134	Average
5414	59.08	58.41	74	-14.92	31.53	6.32	37.18	200	134	Peak
5470	58.21	57.38	68.2	-9.99	31.57	6.34	37.08	200	134	Peak
5500	88.2	87.27			31.6	6.36	37.03	200	134	Average
5500	98.61	97.68			31.6	6.36	37.03	200	134	Peak
5725	59.79	58.51	68.2	-8.41	31.96	6.75	37.43	200	134	Peak
Antenna Polarity & Test Distance: Vertical at 3 m										
Frequency (MHz)	Emission Level (dBuV/m)	Read Level (dBuV)	Limit (dBuV/m)	Margin (dB)	Antenna Factor (dB/m)	Cable Loss (dB)	Preamp Factor (dB)	Antenna Height (cm)	Table Angle (Degree)	Remark
5446	39.82	39.05	54	-14.18	31.56	6.34	37.13	191	276	Average
5446	58.66	57.89	74	-15.34	31.56	6.34	37.13	191	276	Peak
5470	58.73	57.9	68.2	-9.47	31.57	6.34	37.08	191	276	Peak
5500	91.08	90.15			31.6	6.36	37.03	191	276	Average
5500	100.52	99.59			31.6	6.36	37.03	191	276	Peak
5725	58.97	57.69	68.2	-9.23	31.96	6.75	37.43	191	276	Peak

**Remarks:**

- Emission Level = Read Level + Antenna Factor + Cable Loss - Preamp Factor  
Margin value = Emission level – Limit value
- 5500 MHz: Fundamental frequency.
- 5470 MHz & 5725 MHz: Out of restricted band



EUT Test Condition		Measurement Detail	
Channel	Channel 116	Frequency Range	1 GHz ~ 40 GHz
Input Power	120 Vac, 60 Hz	Detector Function	Peak (PK) Average (AV)
Environmental Conditions	25 deg. C, 65 % RH	Tested By	Gavin Wu

Antenna Polarity & Test Distance: Horizontal at 3 m										
Frequency (MHz)	Emission Level (dBuV/m)	Read Level (dBuV)	Limit (dBuV/m)	Margin (dB)	Antenna Factor (dB/m)	Cable Loss (dB)	Preamp Factor (dB)	Antenna Height (cm)	Table Angle (Degree)	Remark
5430	38.3	37.56	54	-15.7	31.55	6.32	37.13	200	128	Average
5430	60.11	59.37	74	-13.89	31.55	6.32	37.13	200	128	Peak
5470	57.72	56.89	68.2	-10.48	31.57	6.34	37.08	200	128	Peak
5580	89.56	88.52			31.71	6.49	37.16	200	128	Average
5580	99	97.96			31.71	6.49	37.16	200	128	Peak
5725	59.83	58.55	68.2	-8.37	31.96	6.75	37.43	200	128	Peak
Antenna Polarity & Test Distance: Vertical at 3 m										
Frequency (MHz)	Emission Level (dBuV/m)	Read Level (dBuV)	Limit (dBuV/m)	Margin (dB)	Antenna Factor (dB/m)	Cable Loss (dB)	Preamp Factor (dB)	Antenna Height (cm)	Table Angle (Degree)	Remark
5398	38.73	38.07	54	-15.27	31.52	6.32	37.18	189	262	Average
5398	58.76	58.1	74	-15.24	31.52	6.32	37.18	189	262	Peak
5470	60.4	59.57	68.2	-7.8	31.57	6.34	37.08	189	262	Peak
5580	92	90.96			31.71	6.49	37.16	189	262	Average
5580	101.17	100.13			31.71	6.49	37.16	189	262	Peak
5725	58.58	57.3	68.2	-9.62	31.96	6.75	37.43	189	262	Peak

**Remarks:**

- Emission Level = Read Level + Antenna Factor + Cable Loss - Preamp Factor  
Margin value = Emission level – Limit value
- 5580 MHz: Fundamental frequency.
- 5470 MHz & 5725 MHz: Out of restricted band

EUT Test Condition		Measurement Detail	
Channel	Channel 140	Frequency Range	1 GHz ~ 40 GHz
Input Power	120 Vac, 60 Hz	Detector Function	Peak (PK) Average (AV)
Environmental Conditions	25 deg. C, 65 % RH	Tested By	Gavin Wu

Antenna Polarity & Test Distance: Horizontal at 3 m										
Frequency (MHz)	Emission Level (dBuV/m)	Read Level (dBuV)	Limit (dBuV/m)	Margin (dB)	Antenna Factor (dB/m)	Cable Loss (dB)	Preamp Factor (dB)	Antenna Height (cm)	Table Angle (Degree)	Remark
5424	37.97	37.3	54	-16.03	31.53	6.32	37.18	189	128	Average
5424	59.71	59.04	74	-14.29	31.53	6.32	37.18	189	128	Peak
5470	57.66	56.83	68.2	-10.54	31.57	6.34	37.08	189	128	Peak
5700	90.15	88.96			31.9	6.69	37.4	189	128	Average
5700	99.63	98.44			31.9	6.69	37.4	189	128	Peak
5725	60.65	59.37	68.2	-7.55	31.96	6.75	37.43	189	128	Peak
Antenna Polarity & Test Distance: Vertical at 3 m										
Frequency (MHz)	Emission Level (dBuV/m)	Read Level (dBuV)	Limit (dBuV/m)	Margin (dB)	Antenna Factor (dB/m)	Cable Loss (dB)	Preamp Factor (dB)	Antenna Height (cm)	Table Angle (Degree)	Remark
5430	38.07	37.33	54	-15.93	31.55	6.32	37.13	173	263	Average
5430	59.93	59.19	74	-14.07	31.55	6.32	37.13	173	263	Peak
5470	58.27	57.44	68.2	-9.93	31.57	6.34	37.08	173	263	Peak
5700	92.46	91.27			31.9	6.69	37.4	173	263	Average
5700	101.85	100.66			31.9	6.69	37.4	173	263	Peak
5725	59.74	58.46	68.2	-8.46	31.96	6.75	37.43	173	263	Peak

**Remarks:**

- Emission Level = Read Level + Antenna Factor + Cable Loss - Preamp Factor  
Margin value = Emission level – Limit value
- 5700 MHz: Fundamental frequency.
- 5470 MHz & 5725 MHz: Out of restricted band

EUT Test Condition		Measurement Detail	
Channel	Channel 149	Frequency Range	1 GHz ~ 40 GHz
Input Power	120 Vac, 60 Hz	Detector Function	Peak (PK) Average (AV)
Environmental Conditions	25 deg. C, 65 % RH	Tested By	Gavin Wu

Antenna Polarity & Test Distance: Horizontal at 3 m										
Frequency (MHz)	Emission Level (dBuV/m)	Read Level (dBuV)	Limit (dBuV/m)	Margin (dB)	Antenna Factor (dB/m)	Cable Loss (dB)	Preamp Factor (dB)	Antenna Height (cm)	Table Angle (Degree)	Remark
*5714	59.99	58.8	68.2	-8.21	31.93	6.69	37.43	224	291	Peak
*5725	63.56	62.28	78.2	-14.64	31.96	6.75	37.43	224	291	Peak
5745	91.95	90.68			31.99	6.75	37.47	224	291	Average
5745	101.86	100.59			31.99	6.75	37.47	224	291	Peak
*5850	60.38	58.86	78.2	-17.82	32.15	6.88	37.51	224	291	Peak
*5861	60.59	58.96	68.2	-7.61	32.18	6.95	37.5	224	291	Peak
Antenna Polarity & Test Distance: Vertical at 3 m										
Frequency (MHz)	Emission Level (dBuV/m)	Read Level (dBuV)	Limit (dBuV/m)	Margin (dB)	Antenna Factor (dB/m)	Cable Loss (dB)	Preamp Factor (dB)	Antenna Height (cm)	Table Angle (Degree)	Remark
*5714	60.25	59.06	68.2	-7.95	31.93	6.69	37.43	276	0	Peak
*5725	60.95	59.67	78.2	-17.25	31.96	6.75	37.43	276	0	Peak
5745	90.11	88.84			31.99	6.75	37.47	276	0	Average
5745	99.47	98.2			31.99	6.75	37.47	276	0	Peak
*5850	59.17	57.65	78.2	-19.03	32.15	6.88	37.51	276	0	Peak
*5861	59.57	57.94	68.2	-8.63	32.18	6.95	37.5	276	0	Peak

**Remarks:**

- Emission Level = Read Level + Antenna Factor + Cable Loss - Preamp Factor  
Margin value = Emission level – Limit value
- 5745 MHz: Fundamental frequency.
- \*: Out of restricted band

EUT Test Condition		Measurement Detail	
Channel	Channel 157	Frequency Range	1 GHz ~ 40 GHz
Input Power	120 Vac, 60 Hz	Detector Function	Peak (PK) Average (AV)
Environmental Conditions	25 deg. C, 65 % RH	Tested By	Gavin Wu

Antenna Polarity & Test Distance: Horizontal at 3 m										
Frequency (MHz)	Emission Level (dBuV/m)	Read Level (dBuV)	Limit (dBuV/m)	Margin (dB)	Antenna Factor (dB/m)	Cable Loss (dB)	Preamp Factor (dB)	Antenna Height (cm)	Table Angle (Degree)	Remark
*5714	60.64	59.45	68.2	-7.56	31.93	6.69	37.43	173	218	Peak
*5725	59.47	58.19	78.2	-18.73	31.96	6.75	37.43	173	218	Peak
5785	92.09	90.77			32.04	6.82	37.54	173	218	Average
5785	101.49	100.17			32.04	6.82	37.54	173	218	Peak
*5850	60.38	58.86	78.2	-17.82	32.15	6.88	37.51	173	218	Peak
*5861	60.88	59.25	68.2	-7.32	32.18	6.95	37.5	173	218	Peak
Antenna Polarity & Test Distance: Vertical at 3 m										
Frequency (MHz)	Emission Level (dBuV/m)	Read Level (dBuV)	Limit (dBuV/m)	Margin (dB)	Antenna Factor (dB/m)	Cable Loss (dB)	Preamp Factor (dB)	Antenna Height (cm)	Table Angle (Degree)	Remark
*5714	61.27	60.08	68.2	-6.93	31.93	6.69	37.43	281	12	Peak
*5725	62.22	60.94	78.2	-15.98	31.96	6.75	37.43	281	12	Peak
5785	88.56	87.24			32.04	6.82	37.54	281	12	Average
5785	98.58	97.26			32.04	6.82	37.54	281	12	Peak
*5850	60.25	58.73	78.2	-17.95	32.15	6.88	37.51	281	12	Peak
*5861	60.34	58.71	68.2	-7.86	32.18	6.95	37.5	281	12	Peak

**Remarks:**

- Emission Level = Read Level + Antenna Factor + Cable Loss - Preamp Factor  
Margin value = Emission level – Limit value
- 5785 MHz: Fundamental frequency.
- \*: Out of restricted band

EUT Test Condition		Measurement Detail	
Channel	Channel 165	Frequency Range	1 GHz ~ 40 GHz
Input Power	120 Vac, 60 Hz	Detector Function	Peak (PK) Average (AV)
Environmental Conditions	25 deg. C, 65 % RH	Tested By	Gavin Wu

Antenna Polarity & Test Distance: Horizontal at 3 m										
Frequency (MHz)	Emission Level (dBuV/m)	Read Level (dBuV)	Limit (dBuV/m)	Margin (dB)	Antenna Factor (dB/m)	Cable Loss (dB)	Preamp Factor (dB)	Antenna Height (cm)	Table Angle (Degree)	Remark
*5714	60.3	59.11	68.2	-7.9	31.93	6.69	37.43	177	220	Peak
*5725	61.18	59.96	78.2	-17.02	31.96	6.69	37.43	177	220	Peak
5825	92.08	90.61			32.12	6.88	37.53	177	220	Average
5825	101.68	100.21			32.12	6.88	37.53	177	220	Peak
*5850	61.71	60.19	78.2	-16.49	32.15	6.88	37.51	177	220	Peak
*5861	60.39	58.76	68.2	-7.81	32.18	6.95	37.5	177	220	Peak
Antenna Polarity & Test Distance: Vertical at 3 m										
Frequency (MHz)	Emission Level (dBuV/m)	Read Level (dBuV)	Limit (dBuV/m)	Margin (dB)	Antenna Factor (dB/m)	Cable Loss (dB)	Preamp Factor (dB)	Antenna Height (cm)	Table Angle (Degree)	Remark
*5714	60.58	59.39	68.2	-7.62	31.93	6.69	37.43	282	20	Peak
*5725	59.6	58.32	78.2	-18.6	31.96	6.75	37.43	282	20	Peak
5825	89.41	87.94			32.12	6.88	37.53	282	20	Average
5825	99.55	98.08			32.12	6.88	37.53	282	20	Peak
*5850	60.63	59.11	78.2	-17.57	32.15	6.88	37.51	282	20	Peak
*5861	60.81	59.18	68.2	-7.39	32.18	6.95	37.5	282	20	Peak

**Remarks:**

- Emission Level = Read Level + Antenna Factor + Cable Loss - Preamp Factor  
Margin value = Emission level – Limit value
- 5825 MHz: Fundamental frequency.
- \*: Out of restricted band

**802.11n (HT40)**

EUT Test Condition		Measurement Detail	
Channel	Channel 38	Frequency Range	1 GHz ~ 40 GHz
Input Power	120 Vac, 60 Hz	Detector Function	Peak (PK) Average (AV)
Environmental Conditions	25 deg. C, 65 % RH	Tested By	Gavin Wu

**Antenna Polarity & Test Distance: Horizontal at 3 m**

Frequency (MHz)	Emission Level (dBuV/m)	Read Level (dBuV)	Limit (dBuV/m)	Margin (dB)	Antenna Factor (dB/m)	Cable Loss (dB)	Preamp Factor (dB)	Antenna Height (cm)	Table Angle (Degree)	Remark
5148	47.7	47.5	54	-6.3	31.32	6.2	37.32	103	260	Average
5148	62.41	62.21	74	-11.59	31.32	6.2	37.32	103	260	Peak
5190	91.59	91.36			31.35	6.22	37.34	103	260	Average
5190	100.98	100.75			31.35	6.22	37.34	103	260	Peak
5446	38.5	37.73	54	-15.5	31.56	6.34	37.13	103	260	Average
5446	60.24	59.47	74	-13.76	31.56	6.34	37.13	103	260	Peak

**Antenna Polarity & Test Distance: Vertical at 3 m**

Frequency (MHz)	Emission Level (dBuV/m)	Read Level (dBuV)	Limit (dBuV/m)	Margin (dB)	Antenna Factor (dB/m)	Cable Loss (dB)	Preamp Factor (dB)	Antenna Height (cm)	Table Angle (Degree)	Remark
5146	46.08	45.88	54	-7.92	31.32	6.2	37.32	235	130	Average
5146	60.42	60.22	74	-13.58	31.32	6.2	37.32	235	130	Peak
5190	89.35	89.12			31.35	6.22	37.34	235	130	Average
5190	98.57	98.34			31.35	6.22	37.34	235	130	Peak
5350	38.25	37.66	54	-15.75	31.48	6.29	37.18	235	130	Average
5350	61.16	60.57	74	-12.84	31.48	6.29	37.18	235	130	Peak

**Remarks:**

- Emission Level = Read Level + Antenna Factor + Cable Loss - Preamp Factor  
Margin value = Emission level – Limit value
- 5190 MHz: Fundamental frequency.

EUT Test Condition		Measurement Detail	
Channel	Channel 46	Frequency Range	1 GHz ~ 40 GHz
Input Power	120 Vac, 60 Hz	Detector Function	Peak (PK) Average (AV)
Environmental Conditions	25 deg. C, 65 % RH	Tested By	Gavin Wu

Antenna Polarity & Test Distance: Horizontal at 3 m										
Frequency (MHz)	Emission Level (dBuV/m)	Read Level (dBuV)	Limit (dBuV/m)	Margin (dB)	Antenna Factor (dB/m)	Cable Loss (dB)	Preamp Factor (dB)	Antenna Height (cm)	Table Angle (Degree)	Remark
5036	39.87	39.73	54	-14.13	31.23	6.15	37.24	103	295	Average
5036	60.08	59.94	74	-13.92	31.23	6.15	37.24	103	295	Peak
5230	91.79	91.48			31.39	6.24	37.32	103	295	Average
5230	100.91	100.6			31.39	6.24	37.32	103	295	Peak
5434	38.81	38.07	54	-15.19	31.55	6.32	37.13	103	295	Average
5434	60.27	59.53	74	-13.73	31.55	6.32	37.13	103	295	Peak
Antenna Polarity & Test Distance: Vertical at 3 m										
Frequency (MHz)	Emission Level (dBuV/m)	Read Level (dBuV)	Limit (dBuV/m)	Margin (dB)	Antenna Factor (dB/m)	Cable Loss (dB)	Preamp Factor (dB)	Antenna Height (cm)	Table Angle (Degree)	Remark
5150	38.78	38.58	54	-15.22	31.32	6.2	37.32	242	144	Average
5150	60.01	59.81	74	-13.99	31.32	6.2	37.32	242	144	Peak
5230	89.2	88.89			31.39	6.24	37.32	242	144	Average
5230	98.55	98.24			31.39	6.24	37.32	242	144	Peak
5454	38.79	37.97	54	-15.21	31.56	6.34	37.08	242	144	Average
5454	59.78	58.96	74	-14.22	31.56	6.34	37.08	242	144	Peak

**Remarks:**

- Emission Level = Read Level + Antenna Factor + Cable Loss - Preamp Factor  
Margin value = Emission level – Limit value
- 5230 MHz: Fundamental frequency.

EUT Test Condition		Measurement Detail	
Channel	Channel 54	Frequency Range	1 GHz ~ 40 GHz
Input Power	120 Vac, 60 Hz	Detector Function	Peak (PK) Average (AV)
Environmental Conditions	25 deg. C, 65 % RH	Tested By	Gavin Wu

Antenna Polarity & Test Distance: Horizontal at 3 m										
Frequency (MHz)	Emission Level (dBuV/m)	Read Level (dBuV)	Limit (dBuV/m)	Margin (dB)	Antenna Factor (dB/m)	Cable Loss (dB)	Preamp Factor (dB)	Antenna Height (cm)	Table Angle (Degree)	Remark
5014	38.59	38.46	54	-15.41	31.21	6.15	37.23	178	6	Average
5014	59.4	59.27	74	-14.6	31.21	6.15	37.23	178	6	Peak
5270	90.69	90.3			31.41	6.25	37.27	178	6	Average
5270	100.74	100.35			31.41	6.25	37.27	178	6	Peak
5426	39	38.28	54	-15	31.53	6.32	37.13	178	6	Average
5426	59.33	58.61	74	-14.67	31.53	6.32	37.13	178	6	Peak
Antenna Polarity & Test Distance: Vertical at 3 m										
Frequency (MHz)	Emission Level (dBuV/m)	Read Level (dBuV)	Limit (dBuV/m)	Margin (dB)	Antenna Factor (dB/m)	Cable Loss (dB)	Preamp Factor (dB)	Antenna Height (cm)	Table Angle (Degree)	Remark
5142	38.46	38.24	54	-15.54	31.32	6.2	37.3	201	209	Average
5142	59.17	58.95	74	-14.83	31.32	6.2	37.3	201	209	Peak
5270	88.28	87.89			31.41	6.25	37.27	201	209	Average
5270	98.03	97.64			31.41	6.25	37.27	201	209	Peak
5422	38.89	38.22	54	-15.11	31.53	6.32	37.18	201	209	Average
5422	60.44	59.77	74	-13.56	31.53	6.32	37.18	201	209	Peak

**Remarks:**

- Emission Level = Read Level + Antenna Factor + Cable Loss - Preamp Factor  
Margin value = Emission level – Limit value
- 5270 MHz: Fundamental frequency.



EUT Test Condition		Measurement Detail	
Channel	Channel 62	Frequency Range	1 GHz ~ 40 GHz
Input Power	120 Vac, 60 Hz	Detector Function	Peak (PK) Average (AV)
Environmental Conditions	25 deg. C, 65 % RH	Tested By	Gavin Wu

Antenna Polarity & Test Distance: Horizontal at 3 m										
Frequency (MHz)	Emission Level (dBuV/m)	Read Level (dBuV)	Limit (dBuV/m)	Margin (dB)	Antenna Factor (dB/m)	Cable Loss (dB)	Preamp Factor (dB)	Antenna Height (cm)	Table Angle (Degree)	Remark
5136	38.56	38.35	54	-15.44	31.31	6.2	37.3	201	6	Average
5136	59.89	59.68	74	-14.11	31.31	6.2	37.3	201	6	Peak
5310	90.89	90.36			31.45	6.27	37.19	201	6	Average
5310	100.1	99.57			31.45	6.27	37.19	201	6	Peak
5350	44.56	43.97	54	-9.44	31.48	6.29	37.18	201	6	Average
5350	62.92	62.33	74	-11.08	31.48	6.29	37.18	201	6	Peak
Antenna Polarity & Test Distance: Vertical at 3 m										
Frequency (MHz)	Emission Level (dBuV/m)	Read Level (dBuV)	Limit (dBuV/m)	Margin (dB)	Antenna Factor (dB/m)	Cable Loss (dB)	Preamp Factor (dB)	Antenna Height (cm)	Table Angle (Degree)	Remark
5026	38.01	37.87	54	-15.99	31.23	6.15	37.24	198	209	Average
5026	59.66	59.52	74	-14.34	31.23	6.15	37.24	198	209	Peak
5310	88.59	88.06			31.45	6.27	37.19	198	209	Average
5310	98.97	98.44			31.45	6.27	37.19	198	209	Peak
5352	43.31	42.72	54	-10.69	31.48	6.29	37.18	198	209	Average
5352	60.45	59.86	74	-13.55	31.48	6.29	37.18	198	209	Peak

**Remarks:**

- Emission Level = Read Level + Antenna Factor + Cable Loss - Preamp Factor  
Margin value = Emission level – Limit value
- 5310 MHz: Fundamental frequency.

EUT Test Condition		Measurement Detail	
Channel	Channel 102	Frequency Range	1 GHz ~ 40 GHz
Input Power	120 Vac, 60 Hz	Detector Function	Peak (PK) Average (AV)
Environmental Conditions	25 deg. C, 65 % RH	Tested By	Gavin Wu

Antenna Polarity & Test Distance: Horizontal at 3 m										
Frequency (MHz)	Emission Level (dBuV/m)	Read Level (dBuV)	Limit (dBuV/m)	Margin (dB)	Antenna Factor (dB/m)	Cable Loss (dB)	Preamp Factor (dB)	Antenna Height (cm)	Table Angle (Degree)	Remark
5350	40.06	39.47	54	-13.94	31.48	6.29	37.18	175	132	Average
5350	60	59.41	74	-14	31.48	6.29	37.18	175	132	Peak
5470	60.36	59.53	68.2	-7.84	31.57	6.34	37.08	175	132	Peak
5510	87.12	86.22			31.6	6.36	37.06	175	132	Average
5510	96.57	95.67			31.6	6.36	37.06	175	132	Peak
5725	59.6	58.32	68.2	-8.6	31.96	6.75	37.43	175	132	Peak
Antenna Polarity & Test Distance: Vertical at 3 m										
Frequency (MHz)	Emission Level (dBuV/m)	Read Level (dBuV)	Limit (dBuV/m)	Margin (dB)	Antenna Factor (dB/m)	Cable Loss (dB)	Preamp Factor (dB)	Antenna Height (cm)	Table Angle (Degree)	Remark
5410	41.33	40.67	54	-12.67	31.52	6.32	37.18	173	265	Average
5410	59.77	59.11	74	-14.23	31.52	6.32	37.18	173	265	Peak
5470	59.54	58.71	68.2	-8.66	31.57	6.34	37.08	173	265	Peak
5510	88.57	87.67			31.6	6.36	37.06	173	265	Average
5510	98.26	97.36			31.6	6.36	37.06	173	265	Peak
5725	59.01	57.73	68.2	-9.19	31.96	6.75	37.43	173	265	Peak

**Remarks:**

- Emission Level = Read Level + Antenna Factor + Cable Loss - Preamp Factor  
Margin value = Emission level – Limit value
- 5510 MHz: Fundamental frequency.
- 5470 MHz & 5725 MHz: Out of restricted band

EUT Test Condition		Measurement Detail	
Channel	Channel 110	Frequency Range	1 GHz ~ 40 GHz
Input Power	120 Vac, 60 Hz	Detector Function	Peak (PK) Average (AV)
Environmental Conditions	25 deg. C, 65 % RH	Tested By	Gavin Wu

Antenna Polarity & Test Distance: Horizontal at 3 m										
Frequency (MHz)	Emission Level (dBuV/m)	Read Level (dBuV)	Limit (dBuV/m)	Margin (dB)	Antenna Factor (dB/m)	Cable Loss (dB)	Preamp Factor (dB)	Antenna Height (cm)	Table Angle (Degree)	Remark
5454	38.95	38.13	54	-15.05	31.56	6.34	37.08	170	131	Average
5454	59.82	59	74	-14.18	31.56	6.34	37.08	170	131	Peak
5470	57.03	56.2	68.2	-11.17	31.57	6.34	37.08	170	131	Peak
5550	86.65	85.64			31.68	6.42	37.09	170	131	Average
5550	96.36	95.35			31.68	6.42	37.09	170	131	Peak
5725	60.26	58.98	68.2	-7.94	31.96	6.75	37.43	170	131	Peak
Antenna Polarity & Test Distance: Vertical at 3 m										
Frequency (MHz)	Emission Level (dBuV/m)	Read Level (dBuV)	Limit (dBuV/m)	Margin (dB)	Antenna Factor (dB/m)	Cable Loss (dB)	Preamp Factor (dB)	Antenna Height (cm)	Table Angle (Degree)	Remark
5456	39.24	38.42	54	-14.76	31.56	6.34	37.08	203	262	Average
5456	59.69	58.87	74	-14.31	31.56	6.34	37.08	203	262	Peak
5470	57.87	57.04	68.2	-10.33	31.57	6.34	37.08	203	262	Peak
5550	88.3	87.29			31.68	6.42	37.09	203	262	Average
5550	98.88	97.87			31.68	6.42	37.09	203	262	Peak
5725	58.67	57.39	68.2	-9.53	31.96	6.75	37.43	203	262	Peak

**Remarks:**

- Emission Level = Read Level + Antenna Factor + Cable Loss - Preamp Factor  
Margin value = Emission level – Limit value
- 5550 MHz: Fundamental frequency.
- 5470 MHz & 5725 MHz: Out of restricted band

EUT Test Condition		Measurement Detail	
Channel	Channel 134	Frequency Range	1 GHz ~ 40 GHz
Input Power	120 Vac, 60 Hz	Detector Function	Peak (PK) Average (AV)
Environmental Conditions	25 deg. C, 65 % RH	Tested By	Gavin Wu

Antenna Polarity & Test Distance: Horizontal at 3 m										
Frequency (MHz)	Emission Level (dBuV/m)	Read Level (dBuV)	Limit (dBuV/m)	Margin (dB)	Antenna Factor (dB/m)	Cable Loss (dB)	Preamp Factor (dB)	Antenna Height (cm)	Table Angle (Degree)	Remark
5438	38.07	37.31	54	-15.93	31.55	6.34	37.13	166	128	Average
5438	59.62	58.86	74	-14.38	31.55	6.34	37.13	166	128	Peak
5470	58.07	57.24	68.2	-10.13	31.57	6.34	37.08	166	128	Peak
5670	86.91	85.75			31.88	6.62	37.34	166	128	Average
5670	96.74	95.58			31.88	6.62	37.34	166	128	Peak
5725	59.31	58.03	68.2	-8.89	31.96	6.75	37.43	166	128	Peak
Antenna Polarity & Test Distance: Vertical at 3 m										
Frequency (MHz)	Emission Level (dBuV/m)	Read Level (dBuV)	Limit (dBuV/m)	Margin (dB)	Antenna Factor (dB/m)	Cable Loss (dB)	Preamp Factor (dB)	Antenna Height (cm)	Table Angle (Degree)	Remark
5408	38.63	37.97	54	-15.37	31.52	6.32	37.18	199	272	Average
5408	59.49	58.83	74	-14.51	31.52	6.32	37.18	199	272	Peak
5470	58.42	57.59	68.2	-9.78	31.57	6.34	37.08	199	272	Peak
5670	89.29	88.13			31.88	6.62	37.34	199	272	Average
5670	98.96	97.8			31.88	6.62	37.34	199	272	Peak
5725	59.63	58.35	68.2	-8.57	31.96	6.75	37.43	199	272	Peak

**Remarks:**

- Emission Level = Read Level + Antenna Factor + Cable Loss - Preamp Factor  
Margin value = Emission level – Limit value
- 5670 MHz: Fundamental frequency.
- 5470 MHz & 5725 MHz: Out of restricted band

EUT Test Condition		Measurement Detail	
Channel	Channel 151	Frequency Range	1 GHz ~ 40 GHz
Input Power	120 Vac, 60 Hz	Detector Function	Peak (PK) Average (AV)
Environmental Conditions	25 deg. C, 65 % RH	Tested By	Gavin Wu

Antenna Polarity & Test Distance: Horizontal at 3 m										
Frequency (MHz)	Emission Level (dBuV/m)	Read Level (dBuV)	Limit (dBuV/m)	Margin (dB)	Antenna Factor (dB/m)	Cable Loss (dB)	Preamp Factor (dB)	Antenna Height (cm)	Table Angle (Degree)	Remark
*5714	62.41	61.22	68.2	-5.79	31.93	6.69	37.43	177	219	Peak
*5725	67.71	66.43	78.2	-10.49	31.96	6.75	37.43	177	219	Peak
5755	89.37	88.08			32.01	6.75	37.47	177	219	Average
5755	99.16	97.87			32.01	6.75	37.47	177	219	Peak
*5850	60.2	58.68	78.2	-18	32.15	6.88	37.51	177	219	Peak
*5861	60.18	58.55	68.2	-8.02	32.18	6.95	37.5	177	219	Peak
Antenna Polarity & Test Distance: Vertical at 3 m										
Frequency (MHz)	Emission Level (dBuV/m)	Read Level (dBuV)	Limit (dBuV/m)	Margin (dB)	Antenna Factor (dB/m)	Cable Loss (dB)	Preamp Factor (dB)	Antenna Height (cm)	Table Angle (Degree)	Remark
*5714	59.5	58.31	68.2	-8.7	31.93	6.69	37.43	295	14	Peak
*5725	64.08	62.8	78.2	-14.12	31.96	6.75	37.43	295	14	Peak
5755	86.18	84.89			32.01	6.75	37.47	295	14	Average
5755	95.59	94.3			32.01	6.75	37.47	295	14	Peak
*5850	60.18	58.66	78.2	-18.02	32.15	6.88	37.51	295	14	Peak
*5861	59.53	57.9	68.2	-8.67	32.18	6.95	37.5	295	14	Peak

**Remarks:**

- Emission Level = Read Level + Antenna Factor + Cable Loss - Preamp Factor  
Margin value = Emission level – Limit value
- 5755 MHz: Fundamental frequency.
- \*: Out of restricted band

EUT Test Condition		Measurement Detail	
Channel	Channel 159	Frequency Range	1 GHz ~ 40 GHz
Input Power	120 Vac, 60 Hz	Detector Function	Peak (PK) Average (AV)
Environmental Conditions	25 deg. C, 65 % RH	Tested By	Gavin Wu

Antenna Polarity & Test Distance: Horizontal at 3 m										
Frequency (MHz)	Emission Level (dBuV/m)	Read Level (dBuV)	Limit (dBuV/m)	Margin (dB)	Antenna Factor (dB/m)	Cable Loss (dB)	Preamp Factor (dB)	Antenna Height (cm)	Table Angle (Degree)	Remark
*5714	60.66	59.47	68.2	-7.54	31.93	6.69	37.43	167	218	Peak
*5725	60.82	59.54	78.2	-17.38	31.96	6.75	37.43	167	218	Peak
5795	89.12	87.77			32.07	6.82	37.54	167	218	Average
5795	98.99	97.64			32.07	6.82	37.54	167	218	Peak
*5850	61.15	59.63	78.2	-17.05	32.15	6.88	37.51	167	218	Peak
*5861	60.72	59.09	68.2	-7.48	32.18	6.95	37.5	167	218	Peak
Antenna Polarity & Test Distance: Vertical at 3 m										
Frequency (MHz)	Emission Level (dBuV/m)	Read Level (dBuV)	Limit (dBuV/m)	Margin (dB)	Antenna Factor (dB/m)	Cable Loss (dB)	Preamp Factor (dB)	Antenna Height (cm)	Table Angle (Degree)	Remark
*5714	59.57	58.38	68.2	-8.63	31.93	6.69	37.43	295	13	Peak
*5725	60.9	59.62	78.2	-17.3	31.96	6.75	37.43	295	13	Peak
5795	86.76	85.41			32.07	6.82	37.54	295	13	Average
5795	95.97	94.62			32.07	6.82	37.54	295	13	Peak
*5850	59.71	58.19	78.2	-18.49	32.15	6.88	37.51	295	13	Peak
*5861	60.31	58.68	68.2	-7.89	32.18	6.95	37.5	295	13	Peak

**Remarks:**

- Emission Level = Read Level + Antenna Factor + Cable Loss - Preamp Factor  
Margin value = Emission level – Limit value
- 5795 MHz: Fundamental frequency.
- \*: Out of restricted band

**SAMPLE B**
**802.11n (HT40)**

EUT Test Condition		Measurement Detail	
Channel	Channel 38	Frequency Range	1 GHz ~ 40 GHz
Input Power	120 Vac, 60 Hz	Detector Function	Peak (PK) Average (AV)
Environmental Conditions	25 deg. C, 65 % RH	Tested By	Gavin Wu

**Antenna Polarity & Test Distance: Horizontal at 3 m**

Frequency (MHz)	Emission Level (dBuV/m)	Read Level (dBuV)	Limit (dBuV/m)	Margin (dB)	Antenna Factor (dB/m)	Cable Loss (dB)	Preamp Factor (dB)	Antenna Height (cm)	Table Angle (Degree)	Remark
5148	46.56	46.36	54	-7.44	31.32	6.2	37.32	196	185	Average
5148	62.36	62.16	74	-11.64	31.32	6.2	37.32	196	185	Peak
5190	88.28	88.05			31.35	6.22	37.34	196	185	Average
5190	98.57	98.34			31.35	6.22	37.34	196	185	Peak
5460	39.12	38.3	54	-14.88	31.56	6.34	37.08	196	185	Average
5460	60.79	59.97	74	-13.21	31.56	6.34	37.08	196	185	Peak

**Antenna Polarity & Test Distance: Vertical at 3 m**

Frequency (MHz)	Emission Level (dBuV/m)	Read Level (dBuV)	Limit (dBuV/m)	Margin (dB)	Antenna Factor (dB/m)	Cable Loss (dB)	Preamp Factor (dB)	Antenna Height (cm)	Table Angle (Degree)	Remark
5148	43.39	43.19	54	-10.61	31.32	6.2	37.32	200	30	Average
5148	60.47	60.27	74	-13.53	31.32	6.2	37.32	200	30	Peak
5190	86.71	86.48			31.35	6.22	37.34	200	30	Average
5190	96.57	96.34			31.35	6.22	37.34	200	30	Peak
5368	38.92	38.3	54	-15.08	31.49	6.31	37.18	200	30	Average
5368	60.34	59.72	74	-13.66	31.49	6.31	37.18	200	30	Peak

**Remarks:**

- Emission Level = Read Level + Antenna Factor + Cable Loss - Preamp Factor  
Margin value = Emission level – Limit value
- 5190 MHz: Fundamental frequency.

**802.11n (HT40)**

EUT Test Condition		Measurement Detail	
Channel	Channel 62	Frequency Range	1 GHz ~ 40 GHz
Input Power	120 Vac, 60 Hz	Detector Function	Peak (PK) Average (AV)
Environmental Conditions	25 deg. C, 65 % RH	Tested By	Gavin Wu

**Antenna Polarity & Test Distance: Horizontal at 3 m**

Frequency (MHz)	Emission Level (dBuV/m)	Read Level (dBuV)	Limit (dBuV/m)	Margin (dB)	Antenna Factor (dB/m)	Cable Loss (dB)	Preamp Factor (dB)	Antenna Height (cm)	Table Angle (Degree)	Remark
5068	41.67	41.52	54	-12.33	31.25	6.17	37.27	211	160	Average
5068	59.53	59.38	74	-14.47	31.25	6.17	37.27	211	160	Peak
5310	88.85	88.32			31.45	6.27	37.19	211	160	Average
5310	98.78	98.25			31.45	6.27	37.19	211	160	Peak
5350	43.51	42.92	54	-10.49	31.48	6.29	37.18	211	160	Average
5350	60.76	60.17	74	-13.24	31.48	6.29	37.18	211	160	Peak

**Antenna Polarity & Test Distance: Vertical at 3 m**

Frequency (MHz)	Emission Level (dBuV/m)	Read Level (dBuV)	Limit (dBuV/m)	Margin (dB)	Antenna Factor (dB/m)	Cable Loss (dB)	Preamp Factor (dB)	Antenna Height (cm)	Table Angle (Degree)	Remark
5076	38.31	38.14	54	-15.69	31.27	6.17	37.27	202	28	Average
5076	60.27	60.1	74	-13.73	31.27	6.17	37.27	202	28	Peak
5310	86.34	85.81			31.45	6.27	37.19	202	28	Average
5310	96.57	96.04			31.45	6.27	37.19	202	28	Peak
5438	42.86	42.1	54	-11.14	31.55	6.34	37.13	202	28	Average
5438	61.07	60.31	74	-12.93	31.55	6.34	37.13	202	28	Peak

**Remarks:**

- Emission Level = Read Level + Antenna Factor + Cable Loss - Preamp Factor  
Margin value = Emission level – Limit value
- 5310 MHz: Fundamental frequency.



**802.11n (HT20)**

EUT Test Condition		Measurement Detail	
Channel	Channel 140	Frequency Range	1 GHz ~ 40 GHz
Input Power	120 Vac, 60 Hz	Detector Function	Peak (PK) Average (AV)
Environmental Conditions	25 deg. C, 65 % RH	Tested By	Gavin Wu

**Antenna Polarity & Test Distance: Horizontal at 3 m**

Frequency (MHz)	Emission Level (dBuV/m)	Read Level (dBuV)	Limit (dBuV/m)	Margin (dB)	Antenna Factor (dB/m)	Cable Loss (dB)	Preamp Factor (dB)	Antenna Height (cm)	Table Angle (Degree)	Remark
5424	38.51	37.84	54	-15.49	31.53	6.32	37.18	201	248	Average
5424	60.22	59.55	74	-13.78	31.53	6.32	37.18	201	248	Peak
5470	58.64	57.81	68.2	-9.56	31.57	6.34	37.08	201	248	Peak
5700	91.48	90.29			31.9	6.69	37.4	201	248	Average
5700	100.94	99.75			31.9	6.69	37.4	201	248	Peak
5725	60.21	58.93	68.2	-7.99	31.96	6.75	37.43	201	248	Peak

**Antenna Polarity & Test Distance: Vertical at 3 m**

Frequency (MHz)	Emission Level (dBuV/m)	Read Level (dBuV)	Limit (dBuV/m)	Margin (dB)	Antenna Factor (dB/m)	Cable Loss (dB)	Preamp Factor (dB)	Antenna Height (cm)	Table Angle (Degree)	Remark
5458	38.65	37.83	54	-15.35	31.56	6.34	37.08	200	279	Average
5458	59.93	59.11	74	-14.07	31.56	6.34	37.08	200	279	Peak
5470	59.44	58.61	68.2	-8.76	31.57	6.34	37.08	200	279	Peak
5700	88.28	87.09			31.9	6.69	37.4	200	279	Average
5700	98.19	97			31.9	6.69	37.4	200	279	Peak
5725	59.48	58.2	68.2	-8.72	31.96	6.75	37.43	200	279	Peak

**Remarks:**

- Emission Level = Read Level + Antenna Factor + Cable Loss - Preamp Factor  
Margin value = Emission level – Limit value
- 5700 MHz: Fundamental frequency.
- 5470 MHz & 5725 MHz: Out of restricted band

**802.11n (HT40)**

EUT Test Condition		Measurement Detail	
Channel	Channel 151	Frequency Range	1 GHz ~ 40 GHz
Input Power	120 Vac, 60 Hz	Detector Function	Peak (PK) Average (AV)
Environmental Conditions	25 deg. C, 65 % RH	Tested By	Gavin Wu

**Antenna Polarity & Test Distance: Horizontal at 3 m**

Frequency (MHz)	Emission Level (dBuV/m)	Read Level (dBuV)	Limit (dBuV/m)	Margin (dB)	Antenna Factor (dB/m)	Cable Loss (dB)	Preamp Factor (dB)	Antenna Height (cm)	Table Angle (Degree)	Remark
*5714	60.24	59.05	68.2	-7.96	31.93	6.69	37.43	219	247	Peak
*5725	66.56	65.28	78.2	-11.64	31.96	6.75	37.43	219	247	Peak
5755	88.98	87.69			32.01	6.75	37.47	219	247	Average
5755	98.3	97.01			32.01	6.75	37.47	219	247	Peak
*5850	60.66	59.14	78.2	-17.54	32.15	6.88	37.51	219	247	Peak
*5861	60.64	59.01	68.2	-7.56	32.18	6.95	37.5	219	247	Peak

**Antenna Polarity & Test Distance: Vertical at 3 m**

Frequency (MHz)	Emission Level (dBuV/m)	Read Level (dBuV)	Limit (dBuV/m)	Margin (dB)	Antenna Factor (dB/m)	Cable Loss (dB)	Preamp Factor (dB)	Antenna Height (cm)	Table Angle (Degree)	Remark
*5714	60.63	59.44	68.2	-7.57	31.93	6.69	37.43	204	76	Peak
*5725	60.92	59.64	78.2	-17.28	31.96	6.75	37.43	204	76	Peak
5755	85.38	84.09			32.01	6.75	37.47	204	76	Average
5755	95.37	94.08			32.01	6.75	37.47	204	76	Peak
*5850	60.6	59.08	78.2	-17.6	32.15	6.88	37.51	204	76	Peak
*5861	60.05	58.42	68.2	-8.15	32.18	6.95	37.5	204	76	Peak

**Remarks:**

- Emission Level = Read Level + Antenna Factor + Cable Loss - Preamp Factor  
Margin value = Emission level – Limit value
- 5755 MHz: Fundamental frequency.
- \*: Out of restricted band

**9 kHz ~ 30 MHz DATA:**

The amplitude of spurious emissions attenuated more than 20 dB below the permissible value is not required to be report.

**30 MHz ~ 1 GHz WORST-CASE DATA:****SAMPLE A****802.11n (HT40)**

EUT Test Condition		Measurement Detail	
Channel	Channel 38	Frequency Range	30 MHz ~ 1 GHz
Input Power	120 Vac, 60 Hz	Detector Function	Peak (PK) QP (Quasi-Peak)
Environmental Conditions	25 deg. C, 65 % RH	Tested By	Gavin Wu

**Antenna Polarity & Test Distance: Horizontal at 3 m**

Frequency (MHz)	Emission Level (dBuV/m)	Read Level (dBuV)	Limit (dBuV/m)	Margin (dB)	Antenna Factor (dB/m)	Cable Loss (dB)	Preamp Factor (dB)	Antenna Height (cm)	Table Angle (Degree)	Remark
58.13	25.09	43.51	40	-14.91	12.15	0.78	31.35	126	193	Peak
94.02	25.13	47.48	43.5	-18.37	8.6	1.01	31.96	107	249	Peak
204.6	25.16	45.98	43.5	-18.34	9.56	1.31	31.69	135	321	Peak
282.2	18.58	36.36	46	-27.42	12.42	1.59	31.79	126	294	Peak
452.92	19.43	33.03	46	-26.57	16.39	1.99	31.98	106	338	Peak
556.71	21.11	32.34	46	-24.89	18.61	2.19	32.03	106	270	Peak

**Antenna Polarity & Test Distance: Vertical at 3 m**

Frequency (MHz)	Emission Level (dBuV/m)	Read Level (dBuV)	Limit (dBuV/m)	Margin (dB)	Antenna Factor (dB/m)	Cable Loss (dB)	Preamp Factor (dB)	Antenna Height (cm)	Table Angle (Degree)	Remark
57.16	33.65	51.98	40	-6.35	12.25	0.77	31.35	104	238	Peak
89.17	27	49.67	43.5	-16.5	8.28	0.96	31.91	129	223	Peak
137.67	18.95	37.28	43.5	-24.55	12.21	1.15	31.69	138	96	Peak
204.6	18.74	39.56	43.5	-24.76	9.56	1.31	31.69	107	112	Peak
376.29	17.58	32.9	46	-28.42	14.77	1.85	31.94	112	288	Peak
559.62	22.24	33.43	46	-23.76	18.68	2.19	32.06	108	177	Peak

Remarks:

- Emission Level = Read Level + Antenna Factor + Cable Loss - Preamp Factor  
Margin value = Emission level – Limit value

**802.11n (HT40)**

EUT Test Condition		Measurement Detail	
Channel	Channel 62	Frequency Range	30 MHz ~ 1 GHz
Input Power	120 Vac, 60 Hz	Detector Function	Peak (PK) QP (Quasi-Peak)
Environmental Conditions	25 deg. C, 65 % RH	Tested By	Gavin Wu

**Antenna Polarity & Test Distance: Horizontal at 3 m**

Frequency (MHz)	Emission Level (dBuV/m)	Read Level (dBuV)	Limit (dBuV/m)	Margin (dB)	Antenna Factor (dB/m)	Cable Loss (dB)	Preamp Factor (dB)	Antenna Height (cm)	Table Angle (Degree)	Remark
56.19	24.69	42.92	40	-15.31	12.35	0.76	31.34	134	103	Peak
92.08	24.94	47.46	43.5	-18.56	8.45	0.99	31.96	105	344	Peak
204.6	23.98	44.8	43.5	-19.52	9.56	1.31	31.69	124	17	Peak
280.26	18.65	36.52	46	-27.35	12.37	1.58	31.82	130	43	Peak
415.09	19.08	33.52	46	-26.92	15.64	1.94	32.02	102	238	Peak
570.29	22.43	33.38	46	-23.57	18.92	2.21	32.08	134	244	Peak

**Antenna Polarity & Test Distance: Vertical at 3 m**

Frequency (MHz)	Emission Level (dBuV/m)	Read Level (dBuV)	Limit (dBuV/m)	Margin (dB)	Antenna Factor (dB/m)	Cable Loss (dB)	Preamp Factor (dB)	Antenna Height (cm)	Table Angle (Degree)	Remark
58.13	33	51.42	40	-7	12.15	0.78	31.35	129	132	Peak
74.62	28.26	49.51	40	-11.74	9.57	0.86	31.68	106	318	Peak
136.7	18.51	36.94	43.5	-24.99	12.14	1.14	31.71	114	53	Peak
202.66	19.3	40.23	43.5	-24.2	9.48	1.31	31.72	104	56	Peak
447.1	18.89	32.63	46	-27.11	16.27	1.98	31.99	134	156	Peak
581.93	22.45	33.15	46	-23.55	19.19	2.23	32.12	112	24	Peak

Remarks:

- Emission Level = Read Level + Antenna Factor + Cable Loss - Preamp Factor  
Margin value = Emission level – Limit value

**802.11n (HT20)**

EUT Test Condition		Measurement Detail	
Channel	Channel 140	Frequency Range	30 MHz ~ 1 GHz
Input Power	120 Vac, 60 Hz	Detector Function	Peak (PK) QP (Quasi-Peak)
Environmental Conditions	25 deg. C, 65 % RH	Tested By	Gavin Wu

**Antenna Polarity & Test Distance: Horizontal at 3 m**

Frequency (MHz)	Emission Level (dBuV/m)	Read Level (dBuV)	Limit (dBuV/m)	Margin (dB)	Antenna Factor (dB/m)	Cable Loss (dB)	Preamp Factor (dB)	Antenna Height (cm)	Table Angle (Degree)	Remark
56.19	25.05	43.28	40	-14.95	12.35	0.76	31.34	136	217	Peak
92.08	25.28	47.8	43.5	-18.22	8.45	0.99	31.96	102	322	Peak
205.57	23.84	44.59	43.5	-19.66	9.6	1.32	31.67	116	26	Peak
282.2	18.44	36.22	46	-27.56	12.42	1.59	31.79	107	324	Peak
473.29	19.78	32.83	46	-26.22	16.79	2.04	31.88	123	252	Peak
607.15	22.99	33.16	46	-23.01	19.69	2.27	32.13	101	219	Peak

**Antenna Polarity & Test Distance: Vertical at 3 m**

Frequency (MHz)	Emission Level (dBuV/m)	Read Level (dBuV)	Limit (dBuV/m)	Margin (dB)	Antenna Factor (dB/m)	Cable Loss (dB)	Preamp Factor (dB)	Antenna Height (cm)	Table Angle (Degree)	Remark
57.16	33.14	51.47	40	-6.86	12.25	0.77	31.35	132	117	Peak
73.65	26.37	47.42	40	-13.63	9.81	0.85	31.71	130	165	Peak
136.7	19.14	37.57	43.5	-24.36	12.14	1.14	31.71	137	48	Peak
191.02	19.34	39.77	43.5	-24.16	9.98	1.27	31.68	110	318	Peak
334.58	17.19	33.49	46	-28.81	13.78	1.73	31.81	127	231	Peak
547.98	20.9	32.23	46	-25.1	18.41	2.17	31.91	108	161	Peak

Remarks:

- Emission Level = Read Level + Antenna Factor + Cable Loss - Preamp Factor  
Margin value = Emission level – Limit value

**802.11n (HT40)**

EUT Test Condition		Measurement Detail	
Channel	Channel 151	Frequency Range	30 MHz ~ 1 GHz
Input Power	120 Vac, 60 Hz	Detector Function	Peak (PK) QP (Quasi-Peak)
Environmental Conditions	25 deg. C, 65 % RH	Tested By	Gavin Wu

**Antenna Polarity & Test Distance: Horizontal at 3 m**

Frequency (MHz)	Emission Level (dBuV/m)	Read Level (dBuV)	Limit (dBuV/m)	Margin (dB)	Antenna Factor (dB/m)	Cable Loss (dB)	Preamp Factor (dB)	Antenna Height (cm)	Table Angle (Degree)	Remark
57.16	24.2	42.53	40	-15.8	12.25	0.77	31.35	112	354	Peak
94.02	23.18	45.53	43.5	-20.32	8.6	1.01	31.96	106	129	Peak
207.51	23.88	44.5	43.5	-19.62	9.69	1.33	31.64	139	115	Peak
280.26	18.32	36.19	46	-27.68	12.37	1.58	31.82	104	118	Peak
446.13	18.88	32.64	46	-27.12	16.25	1.98	31.99	115	208	Peak
540.22	21.02	32.35	46	-24.98	18.24	2.16	31.73	130	232	Peak

**Antenna Polarity & Test Distance: Vertical at 3 m**

Frequency (MHz)	Emission Level (dBuV/m)	Read Level (dBuV)	Limit (dBuV/m)	Margin (dB)	Antenna Factor (dB/m)	Cable Loss (dB)	Preamp Factor (dB)	Antenna Height (cm)	Table Angle (Degree)	Remark
57.16	32.14	50.47	40	-7.86	12.25	0.77	31.35	129	243	Peak
73.65	28.49	49.54	40	-11.51	9.81	0.85	31.71	103	38	Peak
135.73	18.72	37.24	43.5	-24.78	12.08	1.14	31.74	120	150	Peak
199.75	18.88	40	43.5	-24.62	9.36	1.29	31.77	117	96	Peak
436.43	18.29	32.26	46	-27.71	16.06	1.97	32	118	52	Peak
573.2	20.93	31.81	46	-25.07	18.99	2.22	32.09	139	12	Peak

Remarks:

- Emission Level = Read Level + Antenna Factor + Cable Loss - Preamp Factor  
Margin value = Emission level – Limit value

**SAMPLE B**
**802.11n (HT40)**

EUT Test Condition		Measurement Detail	
Channel	Channel 38	Frequency Range	30 MHz ~ 1 GHz
Input Power	120 Vac, 60 Hz	Detector Function	Peak (PK) QP (Quasi-Peak)
Environmental Conditions	25 deg. C, 65 % RH	Tested By	Gavin Wu

Antenna Polarity & Test Distance: Horizontal at 3 m										
Frequency (MHz)	Emission Level (dBuV/m)	Read Level (dBuV)	Limit (dBuV/m)	Margin (dB)	Antenna Factor (dB/m)	Cable Loss (dB)	Preamp Factor (dB)	Antenna Height (cm)	Table Angle (Degree)	Remark
57.16	22.78	41.11	40	-17.22	12.25	0.77	31.35	134	161	Peak
94.99	22.8	45.06	43.5	-20.7	8.68	1.02	31.96	108	276	Peak
205.57	23.89	44.64	43.5	-19.61	9.6	1.32	31.67	130	337	Peak
438.37	19	32.93	46	-27	16.1	1.97	32	108	171	Peak
554.77	21.37	32.63	46	-24.63	18.57	2.18	32.01	125	174	Peak
644.98	23.05	32.61	46	-22.95	20.15	2.35	32.06	111	298	Peak
Antenna Polarity & Test Distance: Vertical at 3 m										
Frequency (MHz)	Emission Level (dBuV/m)	Read Level (dBuV)	Limit (dBuV/m)	Margin (dB)	Antenna Factor (dB/m)	Cable Loss (dB)	Preamp Factor (dB)	Antenna Height (cm)	Table Angle (Degree)	Remark
57.16	32.28	50.61	40	-7.72	12.25	0.77	31.35	100	270	Peak
79.47	25.51	47.79	40	-14.49	8.37	0.89	31.54	106	45	Peak
136.7	18.6	37.03	43.5	-24.9	12.14	1.14	31.71	109	229	Peak
224	18.83	38.83	46	-27.17	10.38	1.39	31.77	118	102	Peak
332.64	17.37	33.73	46	-28.63	13.73	1.72	31.81	132	24	Peak
536.34	21.6	33.01	46	-24.4	18.15	2.16	31.72	100	27	Peak

Remarks:

- Emission Level = Read Level + Antenna Factor + Cable Loss - Preamp Factor  
Margin value = Emission level – Limit value

**802.11n (HT40)**

EUT Test Condition		Measurement Detail	
Channel	Channel 62	Frequency Range	30 MHz ~ 1 GHz
Input Power	120 Vac, 60 Hz	Detector Function	Peak (PK) QP (Quasi-Peak)
Environmental Conditions	25 deg. C, 65 % RH	Tested By	Gavin Wu

**Antenna Polarity & Test Distance: Horizontal at 3 m**

Frequency (MHz)	Emission Level (dBuV/m)	Read Level (dBuV)	Limit (dBuV/m)	Margin (dB)	Antenna Factor (dB/m)	Cable Loss (dB)	Preamp Factor (dB)	Antenna Height (cm)	Table Angle (Degree)	Remark
68.8	27.45	47.48	40	-12.55	10.89	0.85	31.77	130	190	Peak
90.14	24.21	46.9	43.5	-19.29	8.3	0.97	31.96	125	336	Peak
191.99	26.7	47.21	43.5	-16.8	9.91	1.27	31.69	135	12	Peak
429.64	19.42	33.55	46	-26.58	15.93	1.95	32.01	105	311	Peak
544.1	21.61	32.93	46	-24.39	18.33	2.17	31.82	103	331	Peak
614.91	22.9	32.94	46	-23.1	19.79	2.29	32.12	113	72	Peak

**Antenna Polarity & Test Distance: Vertical at 3 m**

Frequency (MHz)	Emission Level (dBuV/m)	Read Level (dBuV)	Limit (dBuV/m)	Margin (dB)	Antenna Factor (dB/m)	Cable Loss (dB)	Preamp Factor (dB)	Antenna Height (cm)	Table Angle (Degree)	Remark
32.91	31.97	49.99	40	-8.03	12.47	0.6	31.09	120	337	Peak
66.86	33.02	52.73	40	-6.98	11.12	0.85	31.68	133	251	Peak
81.41	25.5	48.01	40	-14.5	8.15	0.9	31.56	134	248	Peak
222.06	18.4	38.46	46	-27.6	10.3	1.38	31.74	114	58	Peak
323.91	16.42	33.06	46	-29.58	13.52	1.7	31.86	102	129	Peak
543.13	21.32	32.66	46	-24.68	18.3	2.16	31.8	103	68	Peak

Remarks:

- Emission Level = Read Level + Antenna Factor + Cable Loss - Preamp Factor  
Margin value = Emission level – Limit value



**802.11n (HT20)**

EUT Test Condition		Measurement Detail	
Channel	Channel 140	Frequency Range	30 MHz ~ 1 GHz
Input Power	120 Vac, 60 Hz	Detector Function	Peak (PK) QP (Quasi-Peak)
Environmental Conditions	25 deg. C, 65 % RH	Tested By	Gavin Wu

**Antenna Polarity & Test Distance: Horizontal at 3 m**

Frequency (MHz)	Emission Level (dBuV/m)	Read Level (dBuV)	Limit (dBuV/m)	Margin (dB)	Antenna Factor (dB/m)	Cable Loss (dB)	Preamp Factor (dB)	Antenna Height (cm)	Table Angle (Degree)	Remark
67.83	27.11	46.99	40	-12.89	11	0.85	31.73	124	216	Peak
90.14	24.8	47.49	43.5	-18.7	8.3	0.97	31.96	106	163	Peak
197.81	26.16	47.13	43.5	-17.34	9.5	1.28	31.75	119	356	Peak
341.37	19.19	35.33	46	-26.81	13.94	1.74	31.82	133	258	Peak
506.27	21.87	33.9	46	-24.13	17.46	2.11	31.6	113	283	Peak
610.06	23.49	33.56	46	-22.51	19.73	2.28	32.08	115	41	Peak

**Antenna Polarity & Test Distance: Vertical at 3 m**

Frequency (MHz)	Emission Level (dBuV/m)	Read Level (dBuV)	Limit (dBuV/m)	Margin (dB)	Antenna Factor (dB/m)	Cable Loss (dB)	Preamp Factor (dB)	Antenna Height (cm)	Table Angle (Degree)	Remark
30	31.87	50.45	40	-8.13	11.98	0.58	31.14	114	196	Peak
66.86	32.53	52.24	40	-7.47	11.12	0.85	31.68	137	208	Peak
76.56	24.99	46.65	40	-15.01	9.09	0.87	31.62	128	233	Peak
224	18.06	38.06	46	-27.94	10.38	1.39	31.77	127	240	Peak
332.64	18.3	34.66	46	-27.7	13.73	1.72	31.81	117	337	Peak
477.17	19.96	32.9	46	-26.04	16.87	2.05	31.86	100	324	Peak

Remarks:

- Emission Level = Read Level + Antenna Factor + Cable Loss - Preamp Factor  
Margin value = Emission level – Limit value

**802.11n (HT40)**

EUT Test Condition		Measurement Detail	
Channel	Channel 151	Frequency Range	30 MHz ~ 1 GHz
Input Power	120 Vac, 60 Hz	Detector Function	Peak (PK) QP (Quasi-Peak)
Environmental Conditions	25 deg. C, 65 % RH	Tested By	Gavin Wu

**Antenna Polarity & Test Distance: Horizontal at 3 m**

Frequency (MHz)	Emission Level (dBuV/m)	Read Level (dBuV)	Limit (dBuV/m)	Margin (dB)	Antenna Factor (dB/m)	Cable Loss (dB)	Preamp Factor (dB)	Antenna Height (cm)	Table Angle (Degree)	Remark
32.91	24.87	42.89	40	-15.13	12.47	0.6	31.09	114	324	Peak
67.83	27.01	46.89	40	-12.99	11	0.85	31.73	127	302	Peak
193.93	25.84	46.51	43.5	-17.66	9.77	1.27	31.71	122	49	Peak
397.63	18.83	33.76	46	-27.17	15.28	1.9	32.11	123	61	Peak
496.57	21.37	33.71	46	-24.63	17.25	2.08	31.67	103	230	Peak
571.26	21.8	32.72	46	-24.2	18.95	2.21	32.08	131	308	Peak

**Antenna Polarity & Test Distance: Vertical at 3 m**

Frequency (MHz)	Emission Level (dBuV/m)	Read Level (dBuV)	Limit (dBuV/m)	Margin (dB)	Antenna Factor (dB/m)	Cable Loss (dB)	Preamp Factor (dB)	Antenna Height (cm)	Table Angle (Degree)	Remark
32.91	31.72	49.74	40	-8.28	12.47	0.6	31.09	125	166	Peak
66.86	33.59	53.3	40	-6.41	11.12	0.85	31.68	134	140	Peak
83.35	25.38	47.93	40	-14.62	8.18	0.92	31.65	119	12	Peak
221.09	18.47	38.55	46	-27.53	10.26	1.38	31.72	133	322	Peak
415.09	19.12	33.56	46	-26.88	15.64	1.94	32.02	118	313	Peak
541.19	21.75	33.08	46	-24.25	18.26	2.16	31.75	107	219	Peak

Remarks:

- Emission Level = Read Level + Antenna Factor + Cable Loss - Preamp Factor  
Margin value = Emission level – Limit value

## 4.2 Conducted Emission Measurement

### 4.2.1 Limits of Conducted Emission Measurement

Frequency (MHz)	Conducted Limit (dBuV)	
	Quasi-peak	Average
0.15 - 0.5	66 - 56	56 - 46
0.50 - 5.0	56	46
5.0 - 30.0	60	50

Note: 1. The lower limit shall apply at the transition frequencies.

2. The limit decreases in line with the logarithm of the frequency in the range of 0.15 to 0.50 MHz.

### 4.2.2 Test Instruments

Description & Manufacturer	Model No.	Serial No.	Date Of Calibration	Due Date Of Calibration
Test Receiver ROHDE & SCHWARZ	ESCI	100613	Nov. 16, 2015	Nov. 15, 2016
RF signal cable (with 10dB PAD) Woken	5D-FB	Cable-cond1-01	Dec. 26, 2015	Dec. 25, 2016
LISN ROHDE & SCHWARZ (EUT)	ESH3-Z5	835239/001	Feb. 26, 2016	Feb. 25, 2017
LISN ROHDE & SCHWARZ (Peripheral)	ESH3-Z5	100311	Jul. 24, 2015	Jul. 23, 2016
Software ADT	BV ADT_Cond_ V7.3.7.3	NA	NA	NA

**Note:** 1. The calibration interval of the above test instruments is 12 months and the calibrations are traceable to NML/ROC and NIST/USA.

2. The test was performed in HwaYa Shielded Room 1.

3. The VCCI Site Registration No. is C-2040.

#### 4.2.3 Test Procedures

- The EUT was placed 0.4 meters from the conducting wall of the shielded room with EUT being connected to the power mains through a line impedance stabilization network (LISN). Other support units were connected to the power mains through another LISN. The two LISNs provide 50 ohm/ 50uH of coupling impedance for the measuring instrument.
- Both lines of the power mains connected to the EUT were checked for maximum conducted interference.
- The frequency range from 150 kHz to 30 MHz was searched. Emission levels under (Limit -20 dB) was not recorded.

**NOTE:** All modes of operation were investigated and the worst-case emissions are reported.

#### 4.2.4 Deviation from Test Standard

No deviation.

#### 4.2.5 Test Setup

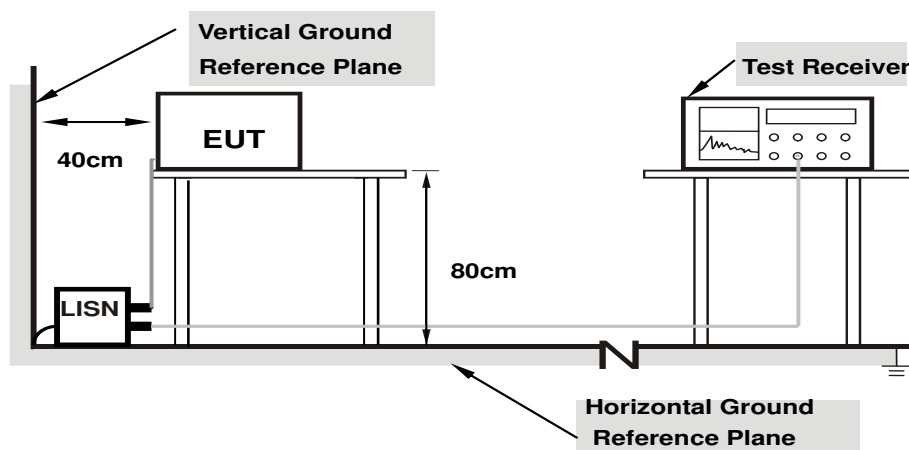

- Note: 1.Support units were connected to second LISN.**  
**2.Both of LISNs (AMN) are 80 cm from EUT and at least 80 from other units and other metal planes**

For the actual test configuration, please refer to the attached file (Test Setup Photo).

#### 4.2.6 EUT Operating Conditions

- Placed the EUT on a testing table.
- Use the software to control the EUT under transmission condition continuously at specific channel frequency.

#### 4.2.7 Test Results

##### SAMPLE A

Frequency Range	150kHz ~ 30MHz	Detector Function & Resolution Bandwidth	Quasi-Peak (QP) / Average (AV), 9kHz
Input Power	120Vac, 60Hz	Environmental Conditions	25°C, 65%RH
Tested by	Toby Tian	Test Date	2016/3/10

Phase Of Power : Line (L)										
No	Frequency (MHz)	Correction Factor (dB)	Reading Value (dBuV)		Emission Level (dBuV)		Limit (dBuV)		Margin (dB)	
			Q.P.	AV.	Q.P.	AV.	Q.P.	AV.	Q.P.	AV.
1	0.16190	10.04	35.36	18.78	45.40	28.82	65.37	55.37	-19.97	-26.55
2	0.22624	10.12	31.32	17.86	41.44	27.98	62.59	52.59	-21.15	-24.61
3	0.34600	10.13	27.38	9.89	37.51	20.02	59.06	49.06	-21.55	-29.04
4	0.50000	10.16	29.58	7.86	39.74	18.02	56.00	46.00	-16.26	-27.98
5	0.86200	10.25	31.94	8.10	42.19	18.35	56.00	46.00	-13.81	-27.65
6	3.41400	10.38	21.57	12.49	31.95	22.87	56.00	46.00	-24.05	-23.13

#### Remarks:

1. Q.P. and AV. are abbreviations of quasi-peak and average individually.
2. The emission levels of other frequencies were very low against the limit.
3. Margin value = Emission level – Limit value
4. Correction factor = Insertion loss + Cable loss
5. Emission Level = Correction Factor + Reading Value

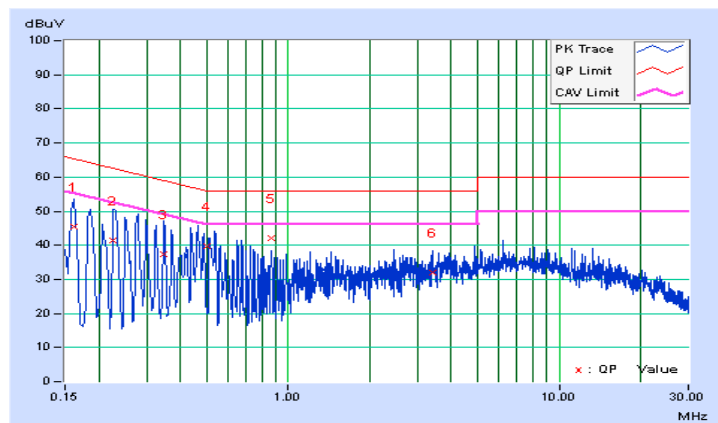

Frequency Range	150kHz ~ 30MHz	Detector Function & Resolution Bandwidth	Quasi-Peak (QP) / Average (AV), 9kHz
Input Power	120Vac, 60Hz	Environmental Conditions	25°C, 65%RH
Tested by	Toby Tian	Test Date	2016/3/10

Phase Of Power : Neutral (N)										
No	Frequency (MHz)	Correction Factor (dB)	Reading Value (dBuV)		Emission Level (dBuV)		Limit (dBuV)		Margin (dB)	
			Q.P.	AV.	Q.P.	AV.	Q.P.	AV.	Q.P.	AV.
1	0.15000	10.00	35.96	22.46	45.96	32.46	66.00	56.00	-20.04	-23.54
2	0.26200	10.07	34.10	14.79	44.17	24.86	61.37	51.37	-17.19	-26.50
<b>3</b>	<b>0.51742</b>	<b>10.17</b>	<b>33.88</b>	<b>23.34</b>	<b>44.05</b>	<b>33.51</b>	<b>56.00</b>	<b>46.00</b>	<b>-11.95</b>	<b>-12.49</b>
4	0.59000	10.18	22.99	15.60	33.17	25.78	56.00	46.00	-22.83	-20.22
5	1.55400	10.26	24.30	13.09	34.56	23.35	56.00	46.00	-21.44	-22.65
6	3.71800	10.43	26.38	18.16	36.81	28.59	56.00	46.00	-19.19	-17.41

**Remarks:**

1. Q.P. and AV. are abbreviations of quasi-peak and average individually.
2. The emission levels of other frequencies were very low against the limit.
3. Margin value = Emission level – Limit value
4. Correction factor = Insertion loss + Cable loss
5. Emission Level = Correction Factor + Reading Value

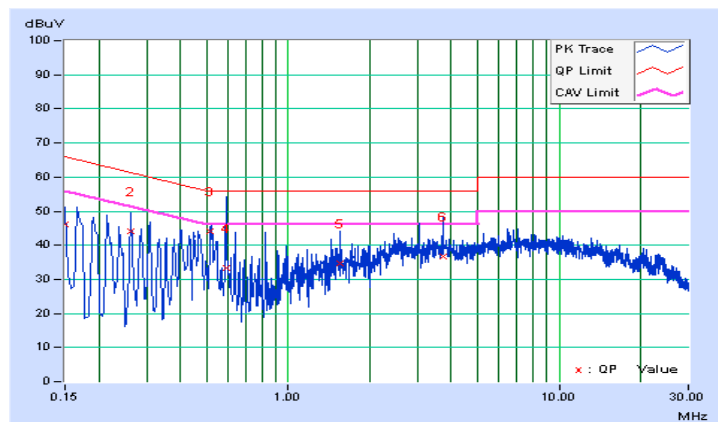

**SAMPLE B**

Frequency Range	150kHz ~ 30MHz	Detector Function & Resolution Bandwidth	Quasi-Peak (QP) / Average (AV), 9kHz
Input Power	120Vac, 60Hz	Environmental Conditions	25°C, 65%RH
Tested by	Toby Tian	Test Date	2016/3/10

Phase Of Power : Line (L)										
No	Frequency (MHz)	Correction Factor (dB)	Reading Value (dBuV)		Emission Level (dBuV)		Limit (dBuV)		Margin (dB)	
			Q.P.	AV.	Q.P.	AV.	Q.P.	AV.	Q.P.	AV.
1	0.15400	10.02	27.18	23.25	37.20	33.27	65.78	55.78	-28.58	-22.51
2	0.18133	10.08	27.64	15.29	37.72	25.37	64.42	54.42	-26.70	-29.05
3	0.41799	10.13	24.39	13.53	34.52	23.66	57.49	47.49	-22.96	-23.82
4	0.46200	10.15	26.03	17.46	36.18	27.61	56.66	46.66	-20.48	-19.05
5	0.52984	10.16	27.22	19.49	37.38	29.65	56.00	46.00	-18.62	-16.35
6	2.98200	10.35	20.47	11.24	30.82	21.59	56.00	46.00	-25.18	-24.41

Remarks:

1. Q.P. and AV. are abbreviations of quasi-peak and average individually.
2. The emission levels of other frequencies were very low against the limit.
3. Margin value = Emission level – Limit value
4. Correction factor = Insertion loss + Cable loss
5. Emission Level = Correction Factor + Reading Value

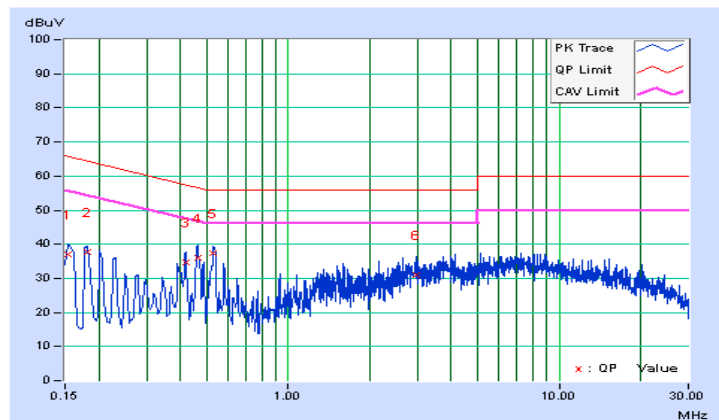

Frequency Range	150kHz ~ 30MHz	Detector Function & Resolution Bandwidth	Quasi-Peak (QP) / Average (AV), 9kHz
Input Power	120Vac, 60Hz	Environmental Conditions	25°C, 65%RH
Tested by	Toby Tian	Test Date	2016/3/10

Phase Of Power : Neutral (N)										
No	Frequency (MHz)	Correction Factor (dB)	Reading Value (dBuV)		Emission Level (dBuV)		Limit (dBuV)		Margin (dB)	
			Q.P.	AV.	Q.P.	AV.	Q.P.	AV.	Q.P.	AV.
1	0.17384	10.02	27.80	16.16	37.82	26.18	64.77	54.77	-26.95	-28.59
2	0.40179	10.15	28.93	21.16	39.08	31.31	57.82	47.82	-18.74	-16.51
3	0.45356	10.16	29.14	17.29	39.30	27.45	56.81	46.81	-17.51	-19.36
4	0.51800	10.17	32.46	21.89	42.63	32.06	56.00	46.00	-13.37	-13.94
5	3.43400	10.40	23.66	14.71	34.06	25.11	56.00	46.00	-21.94	-20.89
6	9.72200	10.60	25.17	17.02	35.77	27.62	60.00	50.00	-24.23	-22.38

**Remarks:**

1. Q.P. and AV. are abbreviations of quasi-peak and average individually.
2. The emission levels of other frequencies were very low against the limit.
3. Margin value = Emission level – Limit value
4. Correction factor = Insertion loss + Cable loss
5. Emission Level = Correction Factor + Reading Value

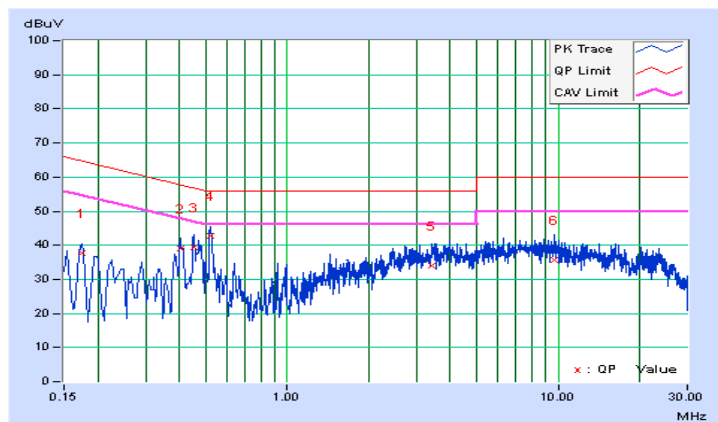



### 4.3 Transmit Power Measurement

#### 4.3.1 Limits of Transmit Power Measurement

Operation Band	EUT Category	Limit
U-NII-1	Outdoor Access Point	1 Watt (30 dBm) (Max. e.i.r.p $\leq$ 125 mW (21 dBm) at any elevation angle above 30 degrees as measured from the horizon)
	Fixed point-to-point Access Point	1 Watt (30 dBm)
	Indoor Access Point	1 Watt (30 dBm)
	√ Mobile and Portable client device	250 mW (24 dBm)
U-NII-2A	√	250 mW (24 dBm) or 11 dBm+10 log B*
U-NII-2C	√	250 mW (24 dBm) or 11 dBm+10 log B*
U-NII-3	√	1 Watt (30 dBm)

\*B is the 26 dB emission bandwidth in megahertz

Per KDB 662911 Method of conducted output power measurement on IEEE 802.11 devices,

Array Gain = 0 dB (i.e., no array gain) for  $N_{ANT} \leq 4$ ;

Array Gain = 0 dB (i.e., no array gain) for channel widths  $\geq 40$  MHz for any  $N_{ANT}$ ;

Array Gain =  $5 \log(N_{ANT}/N_{SS})$  dB or 3 dB, whichever is less for 20 MHz channel widths with  $N_{ANT} \geq 5$ .

For power measurements on all other devices: Array Gain =  $10 \log(N_{ANT}/N_{SS})$  dB.

#### 4.3.2 Test Setup

##### <Power Output Measurement>

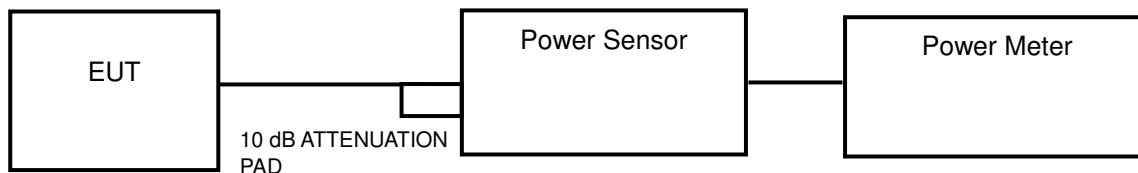

##### <26 dB Bandwidth>

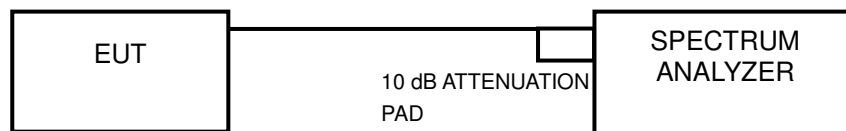

#### 4.3.3 Test Instruments

Refer to section 4.1.2 to get information of above instrument.

#### 4.3.4 Test Procedure

##### **Average Power Measurement**

Method PM is used to perform output power measurement, trigger and gating function of wide band power meter is enabled to measure max output power of TX on burst. Duty factor is not added to measured value.

##### **26 dB Bandwidth**

- 1) Set RBW = approximately 1 % of the emission bandwidth.
- 2) Set the VBW > RBW.
- 3) Detector = Peak.
- 4) Trace mode = max hold.
- 5) Measure the maximum width of the emission that is 26 dB down from the peak of the emission. Compare this with the RBW setting of the analyzer. Readjust RBW and repeat measurement as needed until the RBW/EBW ratio is approximately 1 %.

#### 4.3.5 Deviation from Test Standard

No deviation.

#### 4.3.6 EUT Operating Conditions

The software provided by client to enable the EUT under transmission condition continuously at lowest, middle and highest channel frequencies individually.

#### 4.3.7 Test Result

##### Power Output:

##### 802.11a

Channel	Frequency (MHz)	Maximum Conducted Power (mW)	Maximum Conducted Power (dBm)	Power Limit (dBm)	Pass / Fail
36	5180	10.84	10.35	24	Pass
44	5220	10.54	10.23	24	Pass
48	5240	10.12	10.05	24	Pass
52	5260	10.02	10.01	24	Pass
60	5300	10.26	10.11	24	Pass
64	5320	10.21	10.09	24	Pass
100	5500	10.81	10.34	24	Pass
116	5580	10.69	10.29	24	Pass
140	5700	10.28	10.12	24	Pass
149	5745	7.91	8.98	30	Pass
157	5785	7.71	8.87	30	Pass
165	5825	7.83	8.94	30	Pass

##### NOTE:

##### For U-NII-2A, U-NII-2C Band:

1.  $11 \text{ dBm} + 10\log(20.12) = 24.04 \text{ dBm} > 24 \text{ dBm}$ .
2.  $11 \text{ dBm} + 10\log(20.10) = 24.03 \text{ dBm} > 24 \text{ dBm}$ .
3.  $11 \text{ dBm} + 10\log(20.09) = 24.03 \text{ dBm} > 24 \text{ dBm}$ .
4.  $11 \text{ dBm} + 10\log(20.09) = 24.03 \text{ dBm} > 24 \text{ dBm}$ .
5.  $11 \text{ dBm} + 10\log(20.06) = 24.02 \text{ dBm} > 24 \text{ dBm}$ .
6.  $11 \text{ dBm} + 10\log(20.08) = 24.03 \text{ dBm} > 24 \text{ dBm}$ .

**802.11n (HT20)**

Channel	Frequency (MHz)	Maximum Conducted Power (mW)	Maximum Conducted Power (dBm)	Power Limit (dBm)	Pass / Fail
36	5180	10.91	10.38	24	Pass
44	5220	10.40	10.17	24	Pass
48	5240	10.50	10.21	24	Pass
52	5260	10.00	10.00	24	Pass
60	5300	10.19	10.08	24	Pass
64	5320	10.07	10.03	24	Pass
100	5500	10.64	10.27	24	Pass
116	5580	10.52	10.22	24	Pass
140	5700	10.42	10.18	24	Pass
149	5745	7.74	8.89	30	Pass
157	5785	7.35	8.66	30	Pass
165	5825	7.69	8.86	30	Pass

**NOTE:**
**For U-NII-2A, U-NII-2C Band:**

1.  $11 \text{ dBm} + 10\log(20.41) = 24.10 \text{ dBm} > 24 \text{ dBm}$ .
2.  $11 \text{ dBm} + 10\log(20.34) = 24.08 \text{ dBm} > 24 \text{ dBm}$ .
3.  $11 \text{ dBm} + 10\log(20.33) = 24.08 \text{ dBm} > 24 \text{ dBm}$ .
4.  $11 \text{ dBm} + 10\log(20.30) = 24.07 \text{ dBm} > 24 \text{ dBm}$ .
5.  $11 \text{ dBm} + 10\log(20.41) = 24.10 \text{ dBm} > 24 \text{ dBm}$ .
6.  $11 \text{ dBm} + 10\log(20.36) = 24.09 \text{ dBm} > 24 \text{ dBm}$ .

**802.11n (HT40)**

Channel	Frequency (MHz)	Maximum Conducted Power (mW)	Maximum Conducted Power (dBm)	Power Limit (dBm)	Pass / Fail
38	5190	10.81	10.34	24	Pass
46	5230	<b>11.22</b>	<b>10.50</b>	24	Pass
54	5270	<b>10.45</b>	<b>10.19</b>	24	Pass
62	5310	10.35	10.15	24	Pass
102	5510	10.84	10.35	24	Pass
110	5550	<b>10.94</b>	<b>10.39</b>	24	Pass
134	5670	10.62	10.26	24	Pass
151	5755	<b>8.18</b>	<b>9.13</b>	30	Pass
159	5795	8.04	9.05	30	Pass

**NOTE:**
**For U-NII-2A, U-NII-2C Band:**

1.  $11 \text{ dBm} + 10\log(41.68) = 27.20 \text{ dBm} > 24 \text{ dBm}$ .
2.  $11 \text{ dBm} + 10\log(41.32) = 27.16 \text{ dBm} > 24 \text{ dBm}$ .
3.  $11 \text{ dBm} + 10\log(41.52) = 27.18 \text{ dBm} > 24 \text{ dBm}$ .
4.  $11 \text{ dBm} + 10\log(41.55) = 27.19 \text{ dBm} > 24 \text{ dBm}$ .
5.  $11 \text{ dBm} + 10\log(41.28) = 27.16 \text{ dBm} > 24 \text{ dBm}$ .

**26 dB Bandwidth:**
**802.11a**

Channel	Frequency (MHz)	26 dBc Bandwidth (MHz)	Pass / Fail
36	5180	20.08	Pass
44	5220	20.05	Pass
48	5240	20.22	Pass
52	5260	20.12	Pass
60	5300	20.10	Pass
64	5320	20.09	Pass
100	5500	20.09	Pass
116	5580	20.06	Pass
140	5700	20.08	Pass

**802.11n (HT20)**

Channel	Frequency (MHz)	26 dBc Bandwidth (MHz)	Pass / Fail
36	5180	20.40	Pass
44	5220	20.39	Pass
48	5240	20.41	Pass
52	5260	20.41	Pass
60	5300	20.34	Pass
64	5320	20.33	Pass
100	5500	20.30	Pass
116	5580	20.41	Pass
140	5700	20.36	Pass

**802.11n (HT40)**

Channel	Frequency (MHz)	26 dBc Bandwidth (MHz)	Pass / Fail
38	5190	41.55	Pass
46	5230	41.38	Pass
54	5270	41.68	Pass
62	5310	41.32	Pass
102	5510	41.52	Pass
110	5550	41.55	Pass
134	5670	41.28	Pass

### Spectrum Plot of Worst Value

#### 802.11a

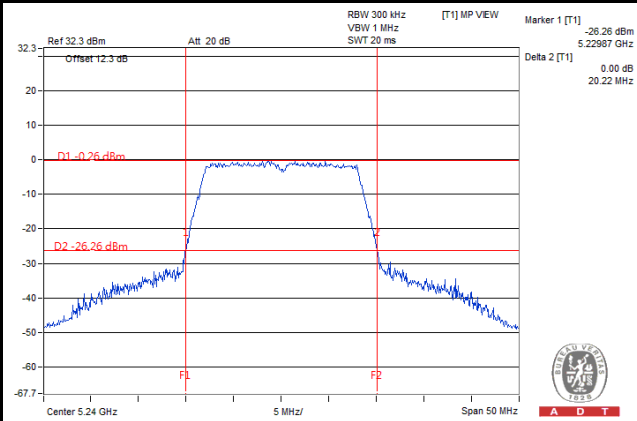

#### 802.11n (HT20)

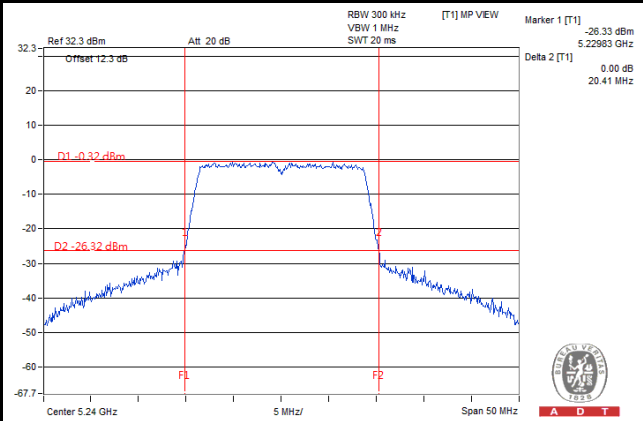

#### 802.11n (HT40)

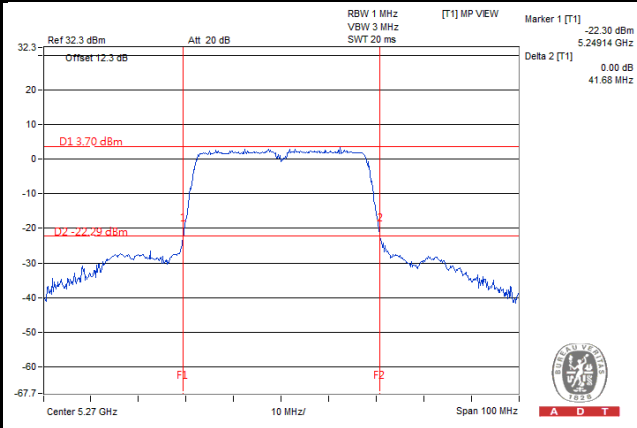

#### 4.4 Peak Power Spectral Density Measurement

##### 4.4.1 Limits of Peak Power Spectral Density Measurement

Operation Band	EUT Category		Limit
U-NII-1		Outdoor Access Point	17 dBm/MHz
		Fixed point-to-point Access Point	
		Indoor Access Point	
	√	Mobile and Portable client device	11 dBm/MHz
U-NII-2A		√	11 dBm/MHz
U-NII-2C		√	11 dBm/MHz
U-NII-3		√	30 dBm/500 kHz

##### 4.4.2 Test Setup

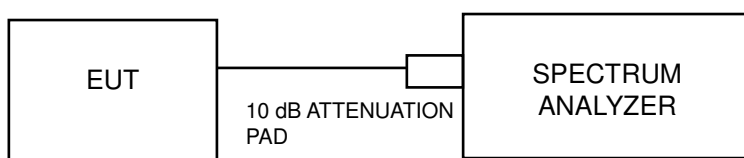

##### 4.4.3 Test Instruments

Refer to section 4.1.3 to get information of above instrument.

##### 4.4.4 Test Procedures

**For U-NII-1, U-NII-2A, U-NII-2C:**

Using method SA-1

1. Set span to encompass the entire emission bandwidth (EBW) of the signal.
2. Set RBW = 1 MHz, Set VBW ≥ 3 RBW, Detector = RMS
3. Sweep time = auto, trigger set to “free run”.
4. Trace average at least 100 traces in power averaging mode.
5. Record the max value



**For U-NII-3:**

1. Set span to encompass the entire emission bandwidth (EBW) of the signal.
2. Set RBW = 500 kHz, Set VBW  $\geq$  3 RBW, Detector = RMS
3. Use the peak marker function to determine the maximum power level in any 500 kHz band segment within the fundamental EBW.
4. Sweep time = auto, trigger set to "free run".
5. Trace average at least 100 traces in power averaging mode.
6. Record the max value and add 10 log (1/duty cycle)

**4.4.5 Deviation from Test Standard**

No deviation.

**4.4.6 EUT Operating Conditions**

The software provided by client to enable the EUT under transmission condition continuously at lowest, middle and highest channel frequencies individually.

#### 4.4.7 Test Results

### For U-NII-1, U-NII-2A, U-NII-2C Band

#### 802.11a

Channel	Frquency (MHz)	PSD w/o Duty Factor (dBm)	Duty Factor	PSD with Duty Factor (dBm)	Maximum Limit (dBm)	Pass / Fail
36	5180	-4.63	0.15	-4.48	11	Pass
44	5220	-3.28	0.15	-3.13	11	Pass
48	5240	-3.55	0.15	-3.40	11	Pass
52	5260	-3.82	0.15	-3.67	11	Pass
60	5300	-3.08	0.15	-2.93	11	Pass
64	5320	-3.11	0.15	-2.96	11	Pass
100	5500	-2.09	0.15	-1.94	11	Pass
116	5580	-2.44	0.15	-2.29	11	Pass
140	5700	-3.23	0.15	-3.08	11	Pass

**NOTE:** Refer to section 3.3 for duty cycle spectrum plot.

#### 802.11n (HT20)

Channel	Frequency (MHz)	PSD w/o Duty Factor (dBm)	Duty Factor	PSD with Duty Factor (dBm)	Maximum Limit (dBm)	Pass / Fail
36	5180	-3.88	0.18	-3.70	11	Pass
44	5220	-3.47	0.18	-3.29	11	Pass
48	5240	-3.89	0.18	-3.71	11	Pass
52	5260	-4.09	0.18	-3.91	11	Pass
60	5300	-3.36	0.18	-3.18	11	Pass
64	5320	-3.27	0.18	-3.09	11	Pass
100	5500	-2.39	0.18	-2.21	11	Pass
116	5580	-2.78	0.18	-2.60	11	Pass
140	5700	-3.23	0.18	-3.05	11	Pass

**NOTE:** Refer to section 3.3 for duty cycle spectrum plot.

**802.11n (HT40)**

Channel	Frequency (MHz)	PSD w/o Duty Factor (dBm)	Duty Factor	PSD with Duty Factor (dBm)	Maximum Limit (dBm)	Pass / Fail
38	5190	-6.13	0.25	-5.88	11	Pass
46	5230	-6.01	0.25	-5.76	11	Pass
54	5270	-6.33	0.25	-6.08	11	Pass
62	5310	-5.30	0.25	-5.05	11	Pass
102	5510	-4.72	0.25	-4.47	11	Pass
110	5550	-4.99	0.25	-4.74	11	Pass
134	5670	-5.16	0.25	-4.91	11	Pass

**NOTE:** Refer to section 3.3 for duty cycle spectrum plot.

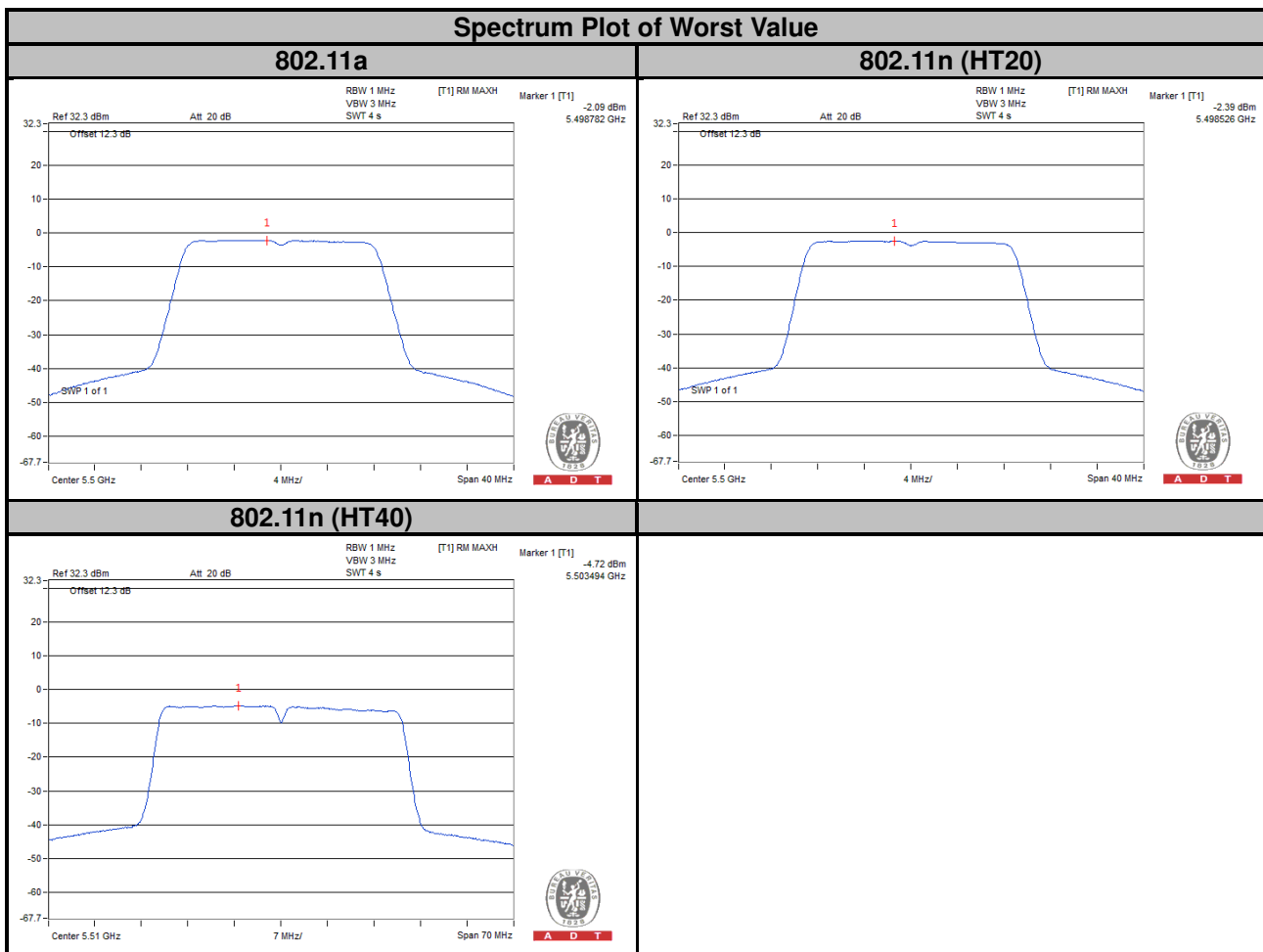

## For U-NII-3 Band

### 802.11a

Channel	Frequency (MHz)	PSD w/o Duty Factor (dBm)	Duty Factor	PSD with Duty Factor (dBm)	Limit (dBm/500 kHz)	Pass / Fail
149	5745	-6.75	0.15	-6.60	30	Pass
157	5785	-6.84	0.15	-6.69	30	Pass
5	5825	-5.91	0.15	-5.76	30	Pass

**NOTE:** Refer to section 3.3 for duty cycle spectrum plot.

### 802.11n (HT20)

Channel	Frequency (MHz)	PSD w/o Duty Factor (dBm)	Duty Factor	PSD with Duty Factor (dBm)	Limit (dBm/500 kHz)	Pass / Fail
149	5745	-7.11	0.18	-6.93	30	Pass
157	5785	-7.16	0.18	-6.98	30	Pass
5	5825	-6.97	0.18	-6.79	30	Pass

**NOTE:** Refer to section 3.3 for duty cycle spectrum plot.

### 802.11n (HT40)

Channel	Frequency (MHz)	PSD w/o Duty Factor (dBm)	Duty Factor	PSD with Duty Factor (dBm)	Limit (dBm/500 kHz)	Pass / Fail
151	5755	-8.16	0.25	-7.91	30	Pass
159	5795	-8.70	0.25	-8.45	30	Pass

**NOTE:** Refer to section 3.3 for duty cycle spectrum plot.

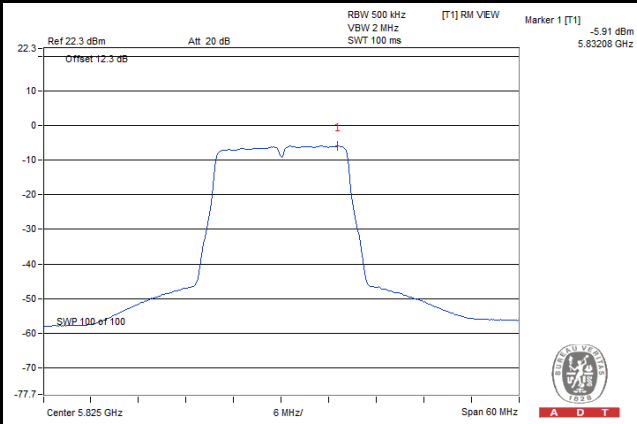
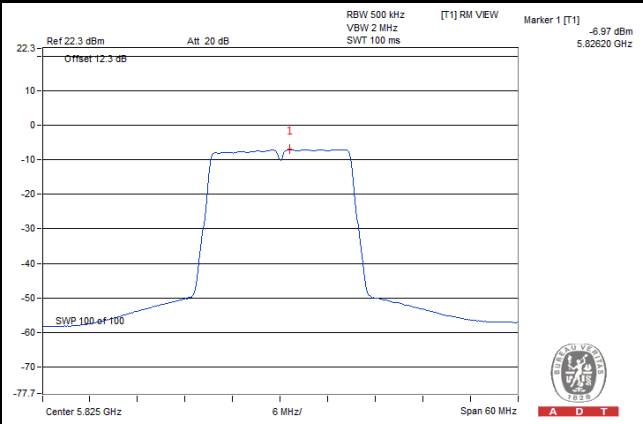
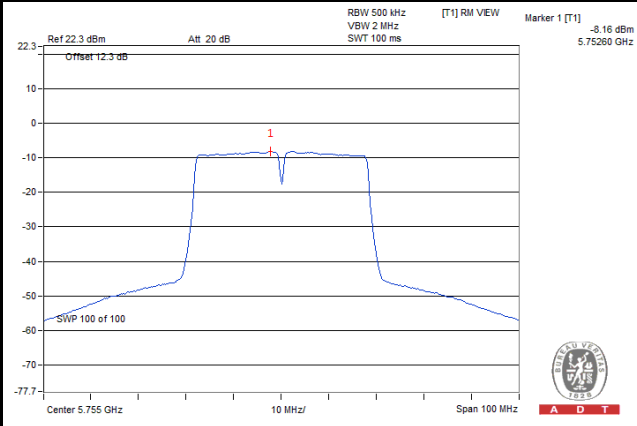
**Spectrum Plot of Worst Value****802.11a****802.11n (HT20)****802.11n (HT40)**

## 4.5 Frequency Stability

### 4.5.1 Limit of Frequency Stability Measurement

The frequency of the carrier signal shall be maintained within band of operation

### 4.5.2 Test Setup

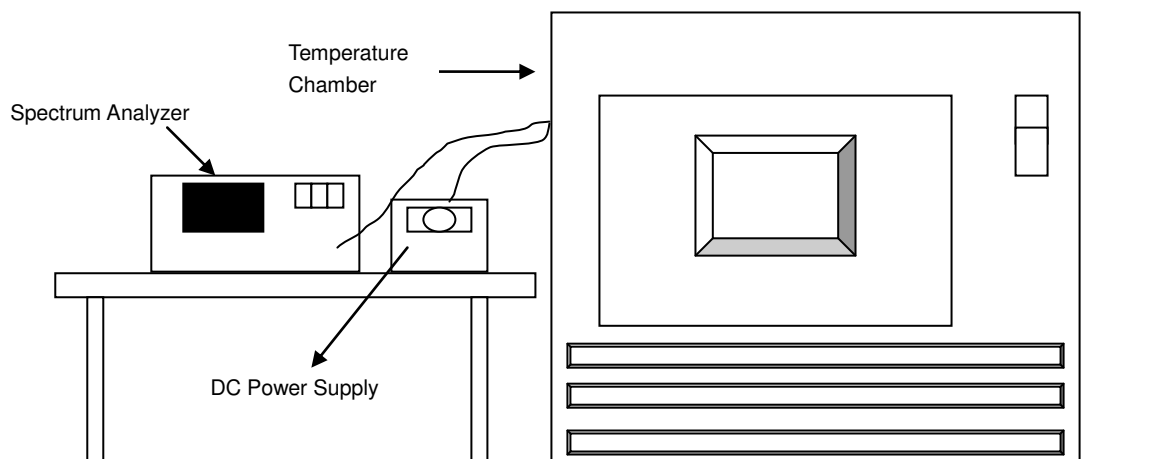

### 4.5.3 Test Instruments

Refer to section 4.1.3 to get information of above instrument.

### 4.5.4 Test Procedure

- a. To ensure emission at the band edge is maintained within the authorized band, those values shall be measured by radiation emissions at upper and lower frequency points, and finally compensated by frequency deviation as procedures below.
- b. The EUT was operated at the maximum output power, and connected to the spectrum analyzer, which is set to maximum hold function and peak detector. The peak value of the power envelope was measured and noted. The upper and lower frequency points were respectively measured relatively 10 dB lower than the measured peak value.
- c. The frequency deviation was calculated by adding the upper frequency point and the lower frequency point divided by two. Those detailed values of frequency deviation are provided in table below.

### 4.5.5 Deviation from Test Standard

No deviation.

### 4.5.6 EUT Operating Condition

Set the EUT transmit at un-modulation mode to test frequency stability.

**4.5.7 Test Results**

<b>Frequency Stability Versus Temp.</b>									
<b>Operating Frequency: 5320 MHz</b>									
<b>Temp. (°C)</b>	<b>Power Supply (Vdc)</b>	<b>0 Minute</b>		<b>2 Minute</b>		<b>5 Minute</b>		<b>10 Minute</b>	
		<b>Measured Frequency (MHz)</b>	<b>Frequency Drift (ppm)</b>	<b>Measured Frequency (MHz)</b>	<b>Frequency Drift (ppm)</b>	<b>Measured Frequency (MHz)</b>	<b>Frequency Drift (ppm)</b>	<b>Measured Frequency (MHz)</b>	<b>Frequency Drift (ppm)</b>
50	3.85	5320.017026	3.200	5320.017290	3.250	5320.017081	3.211	5320.017350	3.261
40	3.85	5320.017345	3.260	5320.017156	3.225	5320.016730	3.145	5320.016771	3.152
30	3.85	5320.018352	3.450	5320.018271	3.434	5320.018521	3.481	5320.018428	3.464
20	3.85	5320.019781	3.718	5320.019702	3.703	5320.019474	3.661	5320.019758	3.714
10	3.85	5320.020774	3.905	5320.020566	3.866	5320.021022	3.952	5320.020990	3.945
0	3.85	5320.019095	3.589	5320.019285	3.625	5320.019306	3.629	5320.019482	3.662
-10	3.85	5320.017711	3.329	5320.018068	3.396	5320.018055	3.394	5320.017560	3.301
-20	3.85	5320.017165	3.227	5320.017445	3.279	5320.016932	3.183	5320.017380	3.267
-30	3.85	5320.016395	3.082	5320.016576	3.116	5320.016528	3.107	5320.016459	3.094

<b>Frequency Stability Versus Temp.</b>									
<b>Operating Frequency: 5320 MHz</b>									
<b>Temp. (°C)</b>	<b>Power Supply (Vdc)</b>	<b>0 Minute</b>		<b>2 Minute</b>		<b>5 Minute</b>		<b>10 Minute</b>	
		<b>Measured Frequency (MHz)</b>	<b>Frequency Drift (ppm)</b>	<b>Measured Frequency (MHz)</b>	<b>Frequency Drift (ppm)</b>	<b>Measured Frequency (MHz)</b>	<b>Frequency Drift (ppm)</b>	<b>Measured Frequency (MHz)</b>	<b>Frequency Drift (ppm)</b>
20	3.60	5320.020443	3.843	5320.020125	3.783	5320.020366	3.828	5320.020437	3.842
	3.85	5320.019781	3.718	5320.019702	3.703	5320.019474	3.661	5320.019758	3.714
	4.30	5320.022410	4.212	5320.022211	4.175	5320.022361	4.203	5320.021897	4.116

## 4.6 6 dB Bandwidth Measurement

### 4.6.1 Limits of 6 dB Bandwidth Measurement

The minimum of 6 dB Bandwidth Measurement is 0.5 MHz.

### 4.6.2 Test Setup

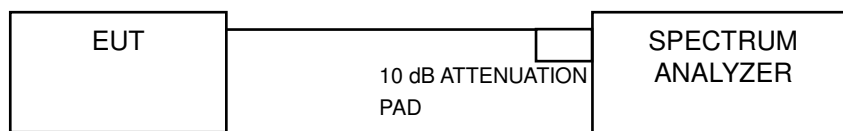

### 4.6.3 Test Instruments

Refer to section 4.1.3 to get information of above instrument.

### 4.6.4 Test Procedure

#### MEASUREMENT PROCEDURE REF

- Set resolution bandwidth (RBW) = 100 kHz
- Set the video bandwidth (VBW)  $\geq 3 \times$  RBW, Detector = Peak.
- Trace mode = max hold.
- Sweep = auto couple.
- Measure the maximum width of the emission that is constrained by the frequencies associated with the two amplitude points (upper and lower) that are attenuated by 6 dB relative to the maximum level measured in the fundamental emission

### 4.6.5 Deviation from Test Standard

No deviation.

### 4.6.6 EUT Operating Condition

The software provided by client to enable the EUT under transmission condition continuously at lowest, middle and highest channel frequencies individually.



## 4.6.7 Test Results

## 802.11a

Channel	Frequency (MHz)	6 dB Bandwidth (MHz)	Minimum Limit (MHz)	Pass / Fail
149	5745	16.39	0.5	Pass
157	5785	16.39	0.5	Pass
165	5825	16.39	0.5	Pass

## 802.11n (HT20)

Channel	Frequency (MHz)	6 dB Bandwidth (MHz)	Minimum Limit (MHz)	Pass / Fail
149	5745	17.62	0.5	Pass
157	5785	17.62	0.5	Pass
165	5825	17.65	0.5	Pass

## 802.11n (HT40)

Channel	Frequency (MHz)	6 dB Bandwidth (MHz)	Minimum Limit (MHz)	Pass / Fail
151	5755	35.92	0.5	Pass
159	5795	36.38	0.5	Pass

### Spectrum Plot of Worst Value

#### 802.11a

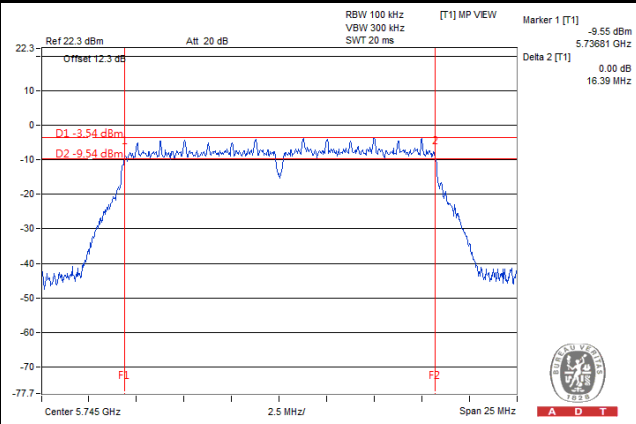

#### 802.11n (HT20)

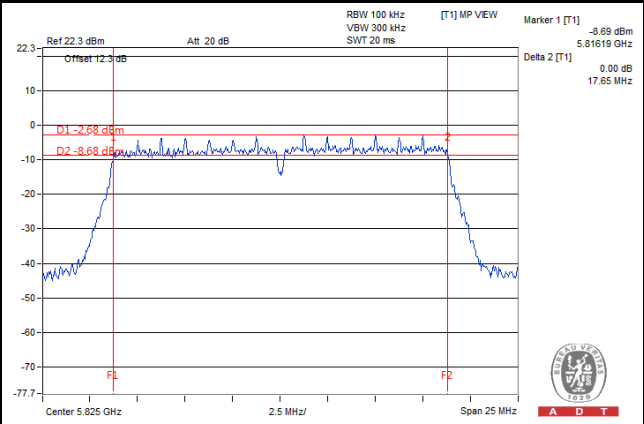

#### 802.11n (HT40)

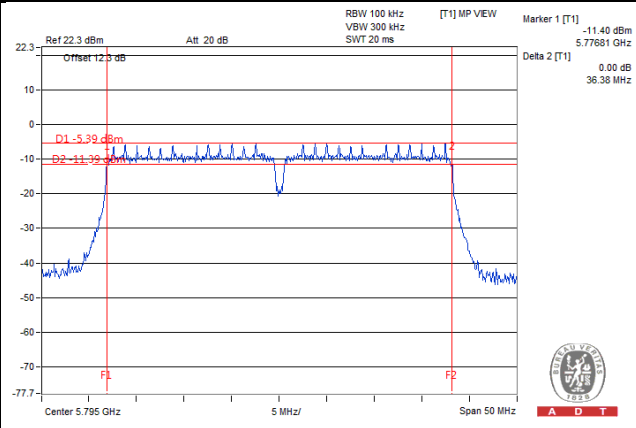



## 5 Pictures of Test Arrangements

Please refer to the attached file (Test Setup Photo).



## Appendix – Information on the Testing Laboratories

We, Bureau Veritas Consumer Products Services (H.K.) Ltd., Taoyuan Branch, were founded in 1988 to provide our best service in EMC, Radio, Telecom and Safety consultation. Our laboratories are accredited and approved according to ISO/IEC 17025.

If you have any comments, please feel free to contact us at the following:

**Linko EMC/RF Lab**

Tel: 886-2-26052180

Fax: 886-2-26051924

**Hsin Chu EMC/RF/Telecom Lab**

Tel: 886-3-6668565

Fax: 886-3-6668323

**Hwa Ya EMC/RF/Safety**

Tel: 886-3-3183232

Fax: 886-3-3270892

**Email:** [service.adt@tw.bureauveritas.com](mailto:service.adt@tw.bureauveritas.com)

**Web Site:** [www.bureauveritas-adt.com](http://www.bureauveritas-adt.com)

The address and road map of all our labs can be found in our web site also.

--- END ---