

FCC Test Report

Report No.: RF160304C08-4

FCC ID: MSQP00C

Test Model: P00C

Received Date: Mar. 04, 2016

Test Date: Mar. 10, 2016 ~ Mar. 17, 2016

Issued Date: Mar. 31, 2016

Applicant: ASUSTek COMPUTER INC.

Address: 4F, No. 150, LI-TE Rd., PEITOU, TAIPEI 112, TAIWAN

Issued By: Bureau Veritas Consumer Products Services (H.K.) Ltd., Taoyuan Branch

Lab Address: No. 47-2, 14th Ling, Chia Pau Vil., Lin Kou Dist., New Taipei City, Taiwan (R.O.C)

Test Location: No. 19, Hwa Ya 2nd Rd, Wen Hwa Tsuen, Kwei Shan Hsiang, Taoyuan Hsien 333, Taiwan, R.O.C.



This report is for your exclusive use. Any copying or replication of this report to or for any other person or entity, or use of our name or trademark, is permitted only with our prior written permission. This report sets forth our findings solely with respect to the test samples identified herein. The results set forth in this report are not indicative or representative of the quality or characteristics of the lot from which a test sample was taken or any similar or identical product unless specifically and expressly noted. Our report includes all of the tests requested by you and the results thereof based upon the information that you provided to us. You have 60 days from date of issuance of this report to notify us of any material error or omission caused by our negligence, provided, however, that such notice shall be in writing and shall specifically address the issue you wish to raise. A failure to raise such issue within the prescribed time shall constitute your unqualified acceptance of the completeness of this report, the tests conducted and the correctness of the report contents. Unless specifically mentioned, the uncertainty of measurement has been explicitly taken into account to declare the compliance or non-compliance to the specification.



Table of Contents

Release Control Record	4
1 Certificate of Conformity	5
2 Summary of Test Results	6
2.1 Measurement Uncertainty	6
2.2 Modification Record	6
3 General Information	7
3.1 General Description of EUT	7
3.2 Description of Test Modes	9
3.2.1 Test Mode Applicability and Tested Channel Detail	10
3.3 Description of Support Units	12
3.3.1 Configuration of System under Test	12
3.4 General Description of Applied Standards	12
4 Test Types and Results	13
4.1 Radiated Emission and Bandedge Measurement	13
4.1.1 Limits of Radiated Emission and Bandedge Measurement	13
4.1.2 Test Instruments	14
4.1.3 Test Procedures	15
4.1.4 Deviation from Test Standard	15
4.1.5 Test Set Up	16
4.1.6 EUT Operating Conditions	16
4.1.7 Test Results	17
4.2 Conducted Emission Measurement	23
4.2.1 Limits of Conducted Emission Measurement	23
4.2.2 Test Instruments	23
4.2.3 Test Procedures	23
4.2.4 Deviation from Test Standard	23
4.2.5 TEST SETUP	24
4.2.6 EUT Operating Conditions	24
4.2.7 Test Results	25
4.3 6 dB Bandwidth Measurement	29
4.3.1 Limits of 6 dB Bandwidth Measurement	29
4.3.2 Test Setup	29
4.3.3 Test Instruments	29
4.3.4 Test Procedure	29
4.3.5 Deviation from Test Standard	29
4.3.6 EUT Operating Conditions	29
4.3.7 Test Result	30
4.4 Conducted Output Power Measurement	31
4.4.1 Limits of Conducted Output Power Measurement	31
4.4.2 Test Setup	31
4.4.3 Test Instruments	31
4.4.4 Test Procedures	31
4.4.5 Deviation from Test Standard	31
4.4.6 EUT Operating Conditions	31
4.4.7 Test Results	31
4.5 Power Spectral Density Measurement	32
4.5.1 Limits of Power Spectral Density Measurement	32
4.5.2 Test Setup	32
4.5.3 Test Instruments	32
4.5.4 Test Procedure	32
4.5.5 Deviation from Test Standard	32
4.5.6 EUT Operating Condition	32
4.5.7 Test Results	33



4.6	Conducted Out of Band Emission Measurement	34
4.6.1	Limits of Conducted Out of Band Emission Measurement.....	34
4.6.2	Test Setup.....	34
4.6.3	Test Instruments	34
4.6.4	Test Procedure	34
4.6.5	Deviation from Test Standard	34
4.6.6	EUT Operating Condition	34
4.6.7	TEST RESULTS	35
5	Pictures of Test Arrangements.....	37
	Appendix – Information on the Testing Laboratories	38



A D T

Release Control Record

Issue No.	Description	Date Issued
RF160304C08-4	Original Release	Mar. 31, 2016



1 Certificate of Conformity

Product: ASUS Tablet
Brand: ASUS
Test Model: P00C
Sample Status: Production Unit
Applicant: ASUSTek COMPUTER INC.
Test Date: Mar. 10, 2016 ~ Mar. 17, 2016
Standards: 47 CFR FCC Part 15, Subpart C (Section 15.247)
ANSI C63.10:2013

The above equipment has been tested by **Bureau Veritas Consumer Products Services (H.K.) Ltd., Taoyuan Branch**, and found compliance with the requirement of the above standards. The test record, data evaluation & Equipment Under Test (EUT) configurations represented herein are true and accurate accounts of the measurements of the sample's EMC characteristics under the conditions specified in this report.

Prepared by : Evonne Liu , **Date:** Mar. 31, 2016
Evonne Liu / Specialist

Approved by : Stanley Wu , **Date:** Mar. 31, 2016
Stanley Wu / Assistant Manager

2 Summary of Test Results

47 CFR FCC Part 15, Subpart C (Section 15.247)			
FCC Clause	Test Item	Result	Remarks
15.207	AC Power Conducted Emission	Pass	Meet the requirement of limit. Minimum passing margin is -13.65 dB at 0.51470 MHz.
15.205 & 209	Radiated Emissions	Pass	Meet the requirement of limit. Minimum passing margin is -6.3 dB at 57.16 MHz.
15.247(d)	Band Edge Measurement	Pass	Meet the requirement of limit.
15.247(d)	Antenna Port Emission	Pass	Meet the requirement of limit.
15.247(a)(2)	6 dB Bandwidth	Pass	Meet the requirement of limit.
15.247(b)	Conducted power	Pass	Meet the requirement of limit.
15.247(e)	Power Spectral Density	Pass	Meet the requirement of limit.
15.203	Antenna Requirement	Pass	No antenna connector is used.

2.1 Measurement Uncertainty

Where relevant, the following measurement uncertainty levels have been estimated for tests performed on the EUT:

The listed uncertainties are the worst case uncertainty for the entire range of measurement. Please note that the uncertainty values are provided for informational purposes only and are not used in determining the PASS/FAIL results.

Measurement	Frequency	Expanded Uncertainty (k=2) (\pm)
Conducted Emissions at mains ports	150 kHz ~ 30 MHz	2.44 dB
Radiated Emissions up to 1 GHz	30 MHz ~ 200 MHz	2.93 dB
	200 MHz ~ 1000 MHz	2.95 dB
Radiated Emissions above 1 GHz	1 GHz ~ 18 GHz	2.26 dB
	18 GHz ~ 40 GHz	1.94 dB

2.2 Modification Record

There were no modifications required for compliance.

3 General Information

3.1 General Description of EUT

Product	ASUS Tablet
Brand	ASUS
Test Model	P00C
Status of EUT	Production Unit
Power Supply Rating	3.85Vdc (Battery) 5.2Vdc (Adapter) 5.0Vdc (Host equipment)
Modulation Type	GFSK
Transfer Rate	1 Mbps
Operating Frequency	2402 ~ 2480 MHz
Number of Channel	40
Output Power	0.995 mW
Antenna Type	PIFA antenna with 1.98 dBi gain
Antenna Connector	N/A
Accessory Device	Refer to Note as below
Data Cable Supplied	Refer to Note as below

Note:

- The EUT contains following accessory devices.

Product	Brand	Model	Description
Adapter 1	ASUS	PA-1050-39	I/P: 100-240Vac, 50/60Hz, 0.25A O/P: 5.2Vdc, 1A
Adapter 2	ASUS	AS0102	I/P: 100-240Vac, 50/60Hz, 0.13A O/P: 5.2Vdc, 1A
Battery	Celxpert	C11P1517	3.85Vdc, 18Wh
USB Cable 1	HONGLIN	130-26314	0.9m shielded cable w/o core
USB Cable 2	LUXSHARE-ICT	L65U2009-CS-B	0.9m shielded cable w/o core
USB Cable 3	FOXCONN	CUBB04M-AS0D0-EF	0.9m shielded cable w/o core
LCD Panel 1	BOE	TV101WXM-NU1	10.1 inch
LCD Panel 2	CPT	CLAT101WR61W	10.1 inch
CPU	MEDIATEK SOC	C.S. MT8163V VFBGA-393 MP	393 Pin , 1.3GHz
Main Board	ASUS	Z300M_MB	--
BT/WLAN Module	MTK	MT6625L	--
Camera 1 (Front)	CHICONY	C1FF219	2M
Camera 2 (Back)	CHICONY	C1JAF527	5M
Camera 3 (Front)	SUNWIN	SW08572E221B-VA	2M
Camera 4 (Back)	SUNWIN	SWCN5725602A-VA	5M

Product	Brand	Model	Description
eMMC 1	SAMSUNG	KLMCG4JENB-B041	64G
eMMC 2	HYNIX	H26M78208CMR	64G
eMMC 3	SAMSUNG	KLMBG2JENB-B041	32G
eMMC 4	HYNIX	H26M64208EMR	32G
eMMC 5	SAMSUNG	KLMAG1JENB-B041	16G
eMMC 6	HYNIX	H26M52208FPR	16G
eMMC 7	SAMSUNG	KLM8G1GEND-B031	8G
eMMC 8	HYNIX	H26M41204HPR	8G
DDR 1	MICRON	MT41K512M8DA-107:P	2G
DDR 2	SAMSUNG	K4B4G0846E-BYK0	2G

2. The EUT contains two Sample listed as below.

Component	Brand	Model	Specification	Sample	
				A	B
Battery	Celxpert	C11P1517	3.85Vdc, 18Wh	V	V
LCD Panel 1	BOE	TV101WXM-NU1	10.1 inch	V	
LCD Panel 2	CPT	CLAT101WR61W	10.1 inch		V
CPU	MEDIATEK SOC	C.S. MT8163V VFBGA-393 MP	393 Pin , 1.3GHz	V	V
Main Board	ASUS	Z300M_MB	--	V	V
BT/WLAN Module	MTK	MT6625L	--	V	V
Camera 1 (Front)	CHICONY	CIFF219	2M	V	
Camera 2 (Back)	CHICONY	CJAF527	5M	V	
Camera 3 (Front)	SUNWIN	SW08572E221B-VA	2M		V
Camera 4 (Back)	SUNWIN	SWCN5725602A-VA	5M		V
eMMC 1	SAMSUNG	KLMCG4JENB-B041	64G	V	
eMMC 2	HYNIX	H26M78208CMR	64G		V
DDR 1	MICRON	MT41K512M8DA-107:P	2G	V	
DDR 2	SAMSUNG	K4B4G0846E-BYK0	2G		V

3. The above EUT information is declared by manufacturer and for more detailed features description, please refer to the manufacturer's specifications or User's Manual.

3.2 Description of Test Modes

40 channels are provided to this EUT:

Channel	Freq. (MHz)	Channel	Freq. (MHz)	Channel	Freq. (MHz)	Channel	Freq. (MHz)
0	2402	10	2422	20	2442	30	2462
1	2404	11	2424	21	2444	31	2464
2	2406	12	2426	22	2446	32	2466
3	2408	13	2428	23	2448	33	2468
4	2410	14	2430	24	2450	34	2470
5	2412	15	2432	25	2452	35	2472
6	2414	16	2434	26	2454	36	2474
7	2416	17	2436	27	2456	37	2476
8	2418	18	2438	28	2458	38	2478
9	2420	19	2440	29	2460	39	2480

3.2.1 Test Mode Applicability and Tested Channel Detail

EUT Configure Mode	Applicable To				Description
	RE \geq 1G	RE<1G	PLC	APCM	
A	√	√	√	√	Sample A
B	√	√	√	-	Sample B

Where **RE \geq 1G**: Radiated Emission above 1 GHz **RE<1G**: Radiated Emission below 1 GHz
PLC: Power Line Conducted Emission **APCM**: Antenna Port Conducted Measurement

NOTE:

1. The EUT had been pre-tested on the positioned of each 3 axis. The worst case was found when positioned on **X-plane**.
2. “-” means no effect.

Radiated Emission Test (Above 1 GHz):

- Pre-Scan has been conducted to determine the worst-case mode from all possible combinations between available modulations, data rates and antenna ports (if EUT with antenna diversity architecture).
- Following channel(s) was (were) selected for the final test as listed below.

EUT Configure Mode	Available Channel	Tested Channel	Modulation Type	Data Rate (Mbps)
A	0 to 39	0, 19, 39	GFSK	1
B	0 to 39	0	GFSK	1

Radiated Emission Test (Below 1 GHz):

- Pre-Scan has been conducted to determine the worst-case mode from all possible combinations between available modulations, data rates and antenna ports (if EUT with antenna diversity architecture).
- Following channel(s) was (were) selected for the final test as listed below.

EUT Configure Mode	Available Channel	Tested Channel	Modulation Type	Data Rate (Mbps)
A, B	0 to 39	0	GFSK	1

Power Line Conducted Emission Test:

- Pre-Scan has been conducted to determine the worst-case mode from all possible combinations between available modulations, data rates and antenna ports (if EUT with antenna diversity architecture).
- Following channel(s) was (were) selected for the final test as listed below.

EUT Configure Mode	Available Channel	Tested Channel	Modulation Type	Data Rate (Mbps)
A, B	0 to 39	0	GFSK	1

**Antenna Port Conducted Measurement:**

- This item includes all test value of each mode, but only includes spectrum plot of worst value of each mode.
- Pre-Scan has been conducted to determine the worst-case mode from all possible combinations between available modulations, data rates and antenna ports (if EUT with antenna diversity architecture).
- Following channel(s) was (were) selected for the final test as listed below.

EUT Configure Mode	Available Channel	Tested Channel	Modulation Type	Data Rate (Mbps)
A	0 to 39	0, 19, 39	GFSK	1

Test Condition:

Applicable To	Environmental Conditions	Input Power	Tested by
RE \geq 1G	25 deg. C, 65 % RH	120 Vac, 60 Hz	Gavin Wu
RE $<$ 1G	25 deg. C, 65 % RH	120 Vac, 60 Hz	Gavin Wu
PLC	25 deg. C, 65 % RH	120 Vac, 60 Hz	Toby Tian
APCM	25 deg. C, 65 % RH	3.85 Vdc	Taylor Liu

3.3 Description of Support Units

The EUT has been tested as an independent unit together with other necessary accessories or support units. The following support units or accessories were used to form a representative test configuration during the tests.

No.	Product	Brand	Model No.	Serial No.	FCC ID
1.	Earphone	N/A	N/A	N/A	N/A

No.	Signal Cable Description Of The Above Support Units
1.	N/A

Note:

1. All power cords of the above support units are non-shielded (1.8m).

3.3.1 Configuration of System under Test

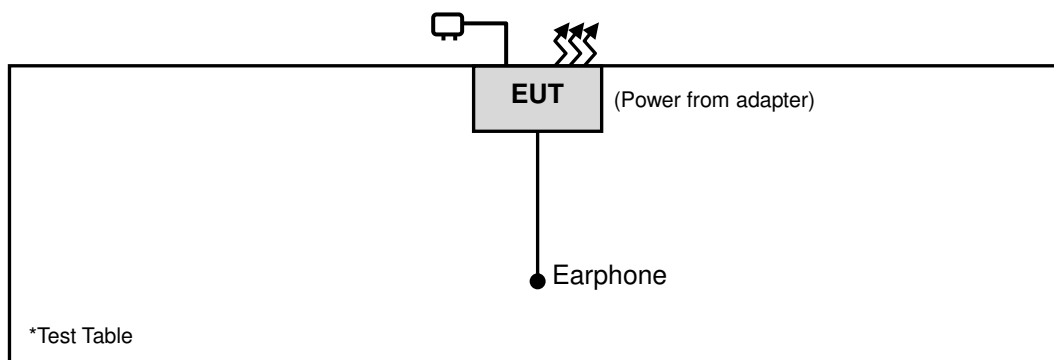

3.4 General Description of Applied Standards

The EUT is a RF Product. According to the specifications of the manufacturer, it must comply with the requirements of the following standards:

FCC Part 15, Subpart C (15.247)

558074 D01 DTS Meas Guidance v03r04

ANSI C63.10-2013

All test items have been performed and recorded as per the above standards.

NOTE: The EUT has been verified to comply with the requirements of FCC Part 15, Subpart B, Class B (DoC). The test report has been issued separately.

4 Test Types and Results

4.1 Radiated Emission and Bandedge Measurement

4.1.1 Limits of Radiated Emission and Bandedge Measurement

Radiated emissions which fall in the restricted bands must comply with the radiated emission limits specified as below table. Other emissions shall be at least 20 dB below the highest level of the desired power:

Frequencies (MHz)	Field Strength (microvolts/meter)	Measurement Distance (meters)
0.009 ~ 0.490	2400/F (kHz)	300
0.490 ~ 1.705	24000/F (kHz)	30
1.705 ~ 30.0	30	30
30 ~ 88	100	3
88 ~ 216	150	3
216 ~ 960	200	3
Above 960	500	3

NOTE:

1. The lower limit shall apply at the transition frequencies.
2. Emission level (dBuV/m) = 20 log Emission level (uV/m).
3. For frequencies above 1000 MHz, the field strength limits are based on average detector, however, the peak field strength of any emission shall not exceed the maximum permitted average limits, specified above by more than 20 dB under any condition of modulation.



4.1.2 Test Instruments

Description & Manufacturer	Model No.	Serial No.	Date of Calibration	Due Date of Calibration
Test Receiver Agilent	N9038A	MY51210203	Jan. 21, 2016	Jan. 20, 2017
Spectrum Analyzer Agilent	N9010A	MY52220314	Sep. 03, 2015	Sep. 02, 2016
Spectrum Analyzer ROHDE & SCHWARZ	FSU43	101261	Dec. 17, 2015	Dec. 16, 2016
BILOG Antenna SCHWARZBECK	VULB9168	9168-472	Jan. 07, 2016	Jan. 06, 2017
HORN Antenna SCHWARZBECK	BBHA 9120 D	9120D-969	Jan. 04, 2016	Jan. 03, 2017
HORN Antenna SCHWARZBECK	BBHA 9170	9170-480	Jan. 08, 2016	Jan. 07, 2017
Loop Antenna	EM-6879	269	Jul. 31, 2015	Jul. 30, 2016
Preamplifier EMCI	EMC 012645	980115	Dec. 21, 2015	Dec. 20, 2016
Preamplifier EMCI	EMC 184045	980116	Dec. 21, 2015	Dec. 20, 2016
Preamplifier EMCI	EMC 330H	980112	Dec. 28, 2015	Dec. 27, 2016
Power Meter Anritsu	ML2495A	1232002	Sep. 21, 2015	Sep. 20, 2016
Power Sensor Anritsu	MA2411B	1207325	Sep. 21, 2015	Sep. 20, 2016
RF signal cable HUBER+SUHNNER	SUCOFLEX 104	309219/4 2950114	Oct. 12, 2015	Oct. 11, 2016
RF signal cable HUBER+SUHNNER	SUCOFLEX 104	250130/4	Oct. 12, 2015	Oct. 11, 2016
RF Coaxial Cable Worken	8D-FB	Cable-Ch10-01	Oct. 12, 2015	Oct. 11, 2016
Software BV ADT	E3 6.120103	NA	NA	NA
Antenna Tower MF	MFA-440H	NA	NA	NA
Turn Table MF	MFT-201SS	NA	NA	NA
Antenna Tower & Turn Table Controller MF	MF-7802	NA	NA	NA

- Note: 1. The calibration interval of the above test instruments is 12 months and the calibrations are traceable to NML/ROC and NIST/USA.
2. The test was performed in HwaYa Chamber 10.
3. The horn antenna and preamplifier (model: EMC 184045) are used only for the measurement of emission frequency above 1 GHz if tested.
4. The FCC Site Registration No. is 690701.
5. The IC Site Registration No. is IC7450F-10.

4.1.3 Test Procedures

- a. The EUT was placed on the top of a rotating table 0.8 meters (for below 1 GHz) / 1.5 meters (for above 1 GHz) above the ground at 3 meter chamber room for test. The table was rotated 360 degrees to determine the position of the highest radiation.
- b. The EUT was set 3 meters away from the interference-receiving antenna, which was mounted on the top of a variable-height antenna tower.
- c. The height of antenna is varied from one meter to four meters above the ground to determine the maximum value of the field strength. Both horizontal and vertical polarizations of the antenna are set to make the measurement.
- d. For each suspected emission, the EUT was arranged to its worst case and then the antenna was tuned to heights from 1 meter to 4 meters and the rotatable table was turned from 0 degrees to 360 degrees to find the maximum reading.
- e. The test-receiver system was set to quasi-peak detect function and specified bandwidth with maximum hold mode when the test frequency is below 1 GHz.
- f. The test-receiver system was set to peak and average detected function and specified bandwidth with maximum hold mode when the test frequency is above 1 GHz. If the peak reading value also meets average limit, measurement with the average detector is unnecessary.

Note:

1. The resolution bandwidth and video bandwidth of test receiver/spectrum analyzer is 120 kHz for Quasi-peak detection (QP) at frequency below 1 GHz.
2. The resolution bandwidth of test receiver/spectrum analyzer is 1 MHz and the video bandwidth is 3 MHz for Peak detection (PK) at frequency above 1 GHz.
3. The resolution bandwidth of test receiver/spectrum analyzer is 1 MHz and the video bandwidth is 3 MHz for RMS Average (Duty cycle < 98 %) for Average detection (AV) at frequency above 1 GHz, then the measurement results was added to a correction factor ($10 \log(1/\text{duty cycle})$).
4. The resolution bandwidth of test receiver/spectrum analyzer is 1 MHz and the video bandwidth is 10 Hz (Duty cycle ≥ 98 %) for Average detection (AV) at frequency above 1 GHz.
5. All modes of operation were investigated and the worst-case emissions are reported.

4.1.4 Deviation from Test Standard

No deviation.

4.1.5 Test Set Up

<Frequency Range below 1 GHz>

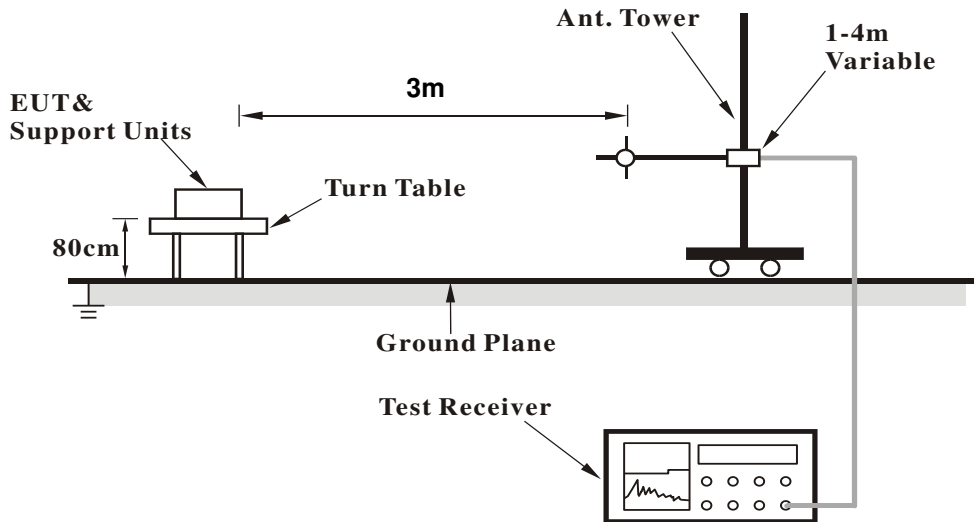

<Frequency Range above 1 GHz>

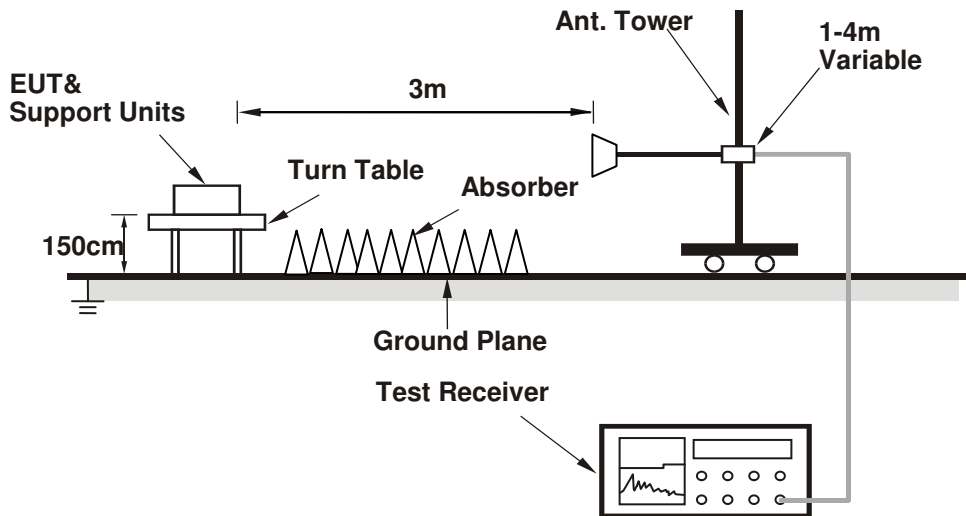

For the actual test configuration, please refer to the attached file (Test Setup Photo).

4.1.6 EUT Operating Conditions

- a. Placed the EUT on the testing table.
- b. Set the EUT under transmission condition continuously at specific channel frequency.

4.1.7 Test Results
ABOVE 1 GHz DATA :
SAMPLE A

EUT Test Condition		Measurement Detail	
Channel	Channel 0	Frequency Range	1 GHz ~ 25 GHz
Input Power	120 Vac, 60 Hz	Detector Function	Peak (PK) Average (AV)
Environmental Conditions	25 deg. C, 65 % RH	Tested By	Gavin Wu

Antenna Polarity & Test Distance: Horizontal at 3 m										
Frequency (MHz)	Emission Level (dBuV/m)	Read Level (dBuV)	Limit (dBuV/m)	Margin (dB)	Antenna Factor (dB/m)	Cable Loss (dB)	Preamp Factor (dB)	Antenna Height (cm)	Table Angle (Degree)	Remark
2312	33.76	40.51	54	-20.24	26.67	4.03	37.45	104	244	Average
2312	56.35	63.1	74	-17.65	26.67	4.03	37.45	104	244	Peak
2402	94.13	100.65			26.91	4.09	37.52	104	244	Average
2402	94.94	101.46			26.91	4.09	37.52	104	244	Peak
2490	34.61	40.57	54	-19.39	27.2	4.16	37.32	104	244	Average
2490	57.37	63.33	74	-16.63	27.2	4.16	37.32	104	244	Peak
Antenna Polarity & Test Distance: Vertical at 3 m										
Frequency (MHz)	Emission Level (dBuV/m)	Read Level (dBuV)	Limit (dBuV/m)	Margin (dB)	Antenna Factor (dB/m)	Cable Loss (dB)	Preamp Factor (dB)	Antenna Height (cm)	Table Angle (Degree)	Remark
2350	34.09	40.76	54	-19.91	26.77	4.05	37.49	208	247	Average
2350	55.55	62.22	74	-18.45	26.77	4.05	37.49	208	247	Peak
2402	86.08	92.6			26.91	4.09	37.52	208	247	Average
2402	86.97	93.49			26.91	4.09	37.52	208	247	Peak
2494	34.66	40.55	54	-19.34	27.2	4.16	37.25	208	247	Average
2494	56.37	62.26	74	-17.63	27.2	4.16	37.25	208	247	Peak

Remarks:

- Emission Level = Read Level + Antenna Factor + Cable Loss - Preamp Factor
Margin value = Emission level – Limit value
- 2402 MHz: Fundamental frequency.



A D T

EUT Test Condition		Measurement Detail	
Channel	Channel 19	Frequency Range	1 GHz ~ 25 GHz
Input Power	120 Vac, 60 Hz	Detector Function	Peak (PK) Average (AV)
Environmental Conditions	25 deg. C, 65 % RH	Tested By	Gavin Wu

Antenna Polarity & Test Distance: Horizontal at 3 m

Frequency (MHz)	Emission Level (dBuV/m)	Read Level (dBuV)	Limit (dBuV/m)	Margin (dB)	Antenna Factor (dB/m)	Cable Loss (dB)	Preamp Factor (dB)	Antenna Height (cm)	Table Angle (Degree)	Remark
2356	34.22	40.85	54	-19.78	26.81	4.05	37.49	104	244	Average
2356	56.11	62.74	74	-17.89	26.81	4.05	37.49	104	244	Peak
2440	93.69	99.97			27.06	4.12	37.46	104	244	Average
2440	94.46	100.74			27.06	4.12	37.46	104	244	Peak
2496	34.6	40.49	54	-19.4	27.2	4.16	37.25	104	244	Average
2496	55.82	61.71	74	-18.18	27.2	4.16	37.25	104	244	Peak

Antenna Polarity & Test Distance: Vertical at 3 m

Frequency (MHz)	Emission Level (dBuV/m)	Read Level (dBuV)	Limit (dBuV/m)	Margin (dB)	Antenna Factor (dB/m)	Cable Loss (dB)	Preamp Factor (dB)	Antenna Height (cm)	Table Angle (Degree)	Remark
2322	33.76	40.48	54	-20.24	26.72	4.03	37.47	203	268	Average
2322	56.67	63.39	74	-17.33	26.72	4.03	37.47	203	268	Peak
2440	85.31	91.59			27.06	4.12	37.46	203	268	Average
2440	86.23	92.51			27.06	4.12	37.46	203	268	Peak
2490	34.63	40.59	54	-19.37	27.2	4.16	37.32	203	268	Average
2490	55.92	61.88	74	-18.08	27.2	4.16	37.32	203	268	Peak

Remarks:

- Emission Level = Read Level + Antenna Factor + Cable Loss - Preamp Factor
Margin value = Emission level – Limit value
- 2440 MHz: Fundamental frequency.



A D T

EUT Test Condition		Measurement Detail	
Channel	Channel 39	Frequency Range	1 GHz ~ 25 GHz
Input Power	120 Vac, 60 Hz	Detector Function	Peak (PK) Average (AV)
Environmental Conditions	25 deg. C, 65 % RH	Tested By	Gavin Wu

Antenna Polarity & Test Distance: Horizontal at 3 m										
Frequency (MHz)	Emission Level (dBuV/m)	Read Level (dBuV)	Limit (dBuV/m)	Margin (dB)	Antenna Factor (dB/m)	Cable Loss (dB)	Preamp Factor (dB)	Antenna Height (cm)	Table Angle (Degree)	Remark
2368	34.13	40.75	54	-19.87	26.81	4.07	37.5	102	245	Average
2368	56.03	62.65	74	-17.97	26.81	4.07	37.5	102	245	Peak
2480	94.16	100.18			27.15	4.15	37.32	102	245	Average
2480	94.89	100.91			27.15	4.15	37.32	102	245	Peak
2494	34.9	40.79	54	-19.1	27.2	4.16	37.25	102	245	Average
2494	55.8	61.69	74	-18.2	27.2	4.16	37.25	102	245	Peak
Antenna Polarity & Test Distance: Vertical at 3 m										
Frequency (MHz)	Emission Level (dBuV/m)	Read Level (dBuV)	Limit (dBuV/m)	Margin (dB)	Antenna Factor (dB/m)	Cable Loss (dB)	Preamp Factor (dB)	Antenna Height (cm)	Table Angle (Degree)	Remark
2362	34.09	40.72	54	-19.91	26.81	4.05	37.49	200	291	Average
2362	56.93	63.56	74	-17.07	26.81	4.05	37.49	200	291	Peak
2480	85.7	91.72			27.15	4.15	37.32	200	291	Average
2480	86.46	92.48			27.15	4.15	37.32	200	291	Peak
2500	34.85	40.74	54	-19.15	27.2	4.16	37.25	200	291	Average
2500	57.18	63.07	74	-16.82	27.2	4.16	37.25	200	291	Peak

Remarks:

- Emission Level = Read Level + Antenna Factor + Cable Loss - Preamp Factor
Margin value = Emission level – Limit value
- 2480 MHz: Fundamental frequency.

SAMPLE B

EUT Test Condition		Measurement Detail	
Channel	Channel 0	Frequency Range	1 GHz ~ 25 GHz
Input Power	120 Vac, 60 Hz	Detector Function	Peak (PK) Average (AV)
Environmental Conditions	25 deg. C, 65 % RH	Tested By	Gavin Wu

Antenna Polarity & Test Distance: Horizontal at 3 m										
Frequency (MHz)	Emission Level (dBuV/m)	Read Level (dBuV)	Limit (dBuV/m)	Margin (dB)	Antenna Factor (dB/m)	Cable Loss (dB)	Preamp Factor (dB)	Antenna Height (cm)	Table Angle (Degree)	Remark
2314	34.18	40.95	54	-19.82	26.67	4.03	37.47	168	220	Average
2314	56.06	62.83	74	-17.94	26.67	4.03	37.47	168	220	Peak
2402	92.2	98.72			26.91	4.09	37.52	168	220	Average
2402	92.97	99.49			26.91	4.09	37.52	168	220	Peak
2500	34.75	40.64	54	-19.25	27.2	4.16	37.25	168	220	Average
2500	56.16	62.05	74	-17.84	27.2	4.16	37.25	168	220	Peak
Antenna Polarity & Test Distance: Vertical at 3 m										
Frequency (MHz)	Emission Level (dBuV/m)	Read Level (dBuV)	Limit (dBuV/m)	Margin (dB)	Antenna Factor (dB/m)	Cable Loss (dB)	Preamp Factor (dB)	Antenna Height (cm)	Table Angle (Degree)	Remark
2368	34	40.62	54	-20	26.81	4.07	37.5	103	38	Average
2368	55.53	62.15	74	-18.47	26.81	4.07	37.5	103	38	Peak
2402	87.02	93.54			26.91	4.09	37.52	103	38	Average
2402	87.98	94.5			26.91	4.09	37.52	103	38	Peak
2496	34.41	40.3	54	-19.59	27.2	4.16	37.25	103	38	Average
2496	55.43	61.32	74	-18.57	27.2	4.16	37.25	103	38	Peak

Remarks:

- Emission Level = Read Level + Antenna Factor + Cable Loss - Preamp Factor
Margin value = Emission level – Limit value
- 2402 MHz: Fundamental frequency.

9 kHz ~ 30 MHz DATA:

The amplitude of spurious emissions attenuated more than 20 dB below the permissible value is not required to be report.

30 MHz ~ 1 GHz WORST-CASE DATA:
SAMPLE A

EUT Test Condition		Measurement Detail	
Channel	Channel 0	Frequency Range	30 MHz ~ 1 GHz
Input Power	120 Vac, 60 Hz	Detector Function	Peak (PK) Quasi-peak (QP)
Environmental Conditions	25 deg. C, 65 % RH	Tested By	Gavin Wu

Antenna Polarity & Test Distance: Horizontal at 3 m										
Frequency (MHz)	Emission Level (dBuV/m)	Read Level (dBuV)	Limit (dBuV/m)	Margin (dB)	Antenna Factor (dB/m)	Cable Loss (dB)	Preamp Factor (dB)	Antenna Height (cm)	Table Angle (Degree)	Remark
58.13	25.54	43.96	40	-14.46	12.15	0.78	31.35	126	168	Peak
93.05	26.25	48.69	43.5	-17.25	8.53	0.99	31.96	120	16	Peak
205.57	24.04	44.79	43.5	-19.46	9.6	1.32	31.67	110	55	Peak
280.26	18.19	36.06	46	-27.81	12.37	1.58	31.82	121	141	Peak
473.29	20.19	33.24	46	-25.81	16.79	2.04	31.88	136	325	Peak
581.93	21.56	32.26	46	-24.44	19.19	2.23	32.12	119	67	Peak
Antenna Polarity & Test Distance: Vertical at 3 m										
Frequency (MHz)	Emission Level (dBuV/m)	Read Level (dBuV)	Limit (dBuV/m)	Margin (dB)	Antenna Factor (dB/m)	Cable Loss (dB)	Preamp Factor (dB)	Antenna Height (cm)	Table Angle (Degree)	Remark
57.16	33.7	52.03	40	-6.3	12.25	0.77	31.35	110	147	Peak
91.11	28.02	50.63	43.5	-15.48	8.38	0.97	31.96	132	345	Peak
136.7	19.65	38.08	43.5	-23.85	12.14	1.14	31.71	111	271	Peak
201.69	18.52	39.52	43.5	-24.98	9.44	1.3	31.74	112	226	Peak
471.35	20.5	33.61	46	-25.5	16.75	2.03	31.89	130	306	Peak
574.17	22.48	33.35	46	-23.52	19.01	2.22	32.1	134	36	Peak

Remarks:

- Emission Level = Read Level + Antenna Factor + Cable Loss - Preamp Factor
Margin value = Emission level – Limit value



A D T

SAMPLE B

EUT Test Condition		Measurement Detail	
Channel	Channel 0	Frequency Range	30 MHz ~ 1 GHz
Input Power	120 Vac, 60 Hz	Detector Function	Peak (PK) Quasi-peak (QP)
Environmental Conditions	25 deg. C, 65 % RH	Tested By	Gavin Wu

Antenna Polarity & Test Distance: Horizontal at 3 m

Frequency (MHz)	Emission Level (dBuV/m)	Read Level (dBuV)	Limit (dBuV/m)	Margin (dB)	Antenna Factor (dB/m)	Cable Loss (dB)	Preamp Factor (dB)	Antenna Height (cm)	Table Angle (Degree)	Remark
57.16	23.97	42.3	40	-16.03	12.25	0.77	31.35	124	358	Peak
94.02	22.71	45.06	43.5	-20.79	8.6	1.01	31.96	132	34	Peak
205.57	24.42	45.17	43.5	-19.08	9.6	1.32	31.67	118	52	Peak
277.35	17.76	35.79	46	-28.24	12.28	1.57	31.88	110	201	Peak
480.08	20.16	33.03	46	-25.84	16.93	2.05	31.85	133	72	Peak
547.01	21.33	32.65	46	-24.67	18.39	2.17	31.88	139	327	Peak

Antenna Polarity & Test Distance: Vertical at 3 m

Frequency (MHz)	Emission Level (dBuV/m)	Read Level (dBuV)	Limit (dBuV/m)	Margin (dB)	Antenna Factor (dB/m)	Cable Loss (dB)	Preamp Factor (dB)	Antenna Height (cm)	Table Angle (Degree)	Remark
56.19	33.23	51.46	40	-6.77	12.35	0.76	31.34	125	336	Peak
79.47	26.48	48.76	40	-13.52	8.37	0.89	31.54	135	164	Peak
137.67	18.83	37.16	43.5	-24.67	12.21	1.15	31.69	115	210	Peak
222.06	18.61	38.67	46	-27.39	10.3	1.38	31.74	105	311	Peak
430.61	18.96	33.06	46	-27.04	15.95	1.96	32.01	126	174	Peak
573.2	22.27	33.15	46	-23.73	18.99	2.22	32.09	128	96	Peak

Remarks:

- Emission Level = Read Level + Antenna Factor + Cable Loss - Preamp Factor
Margin value = Emission level – Limit value

4.2 Conducted Emission Measurement

4.2.1 Limits of Conducted Emission Measurement

Frequency (MHz)	Conducted Limit (dBuV)	
	Quasi-peak	Average
0.15 - 0.5	66 - 56	56 - 46
0.50 - 5.0	56	46
5.0 - 30.0	60	50

4.2.2 Test Instruments

Description & Manufacturer	Model No.	Serial No.	Date Of Calibration	Due Date Of Calibration
Test Receiver ROHDE & SCHWARZ	ESCI	100613	Nov. 16, 2015	Nov. 15, 2016
RF signal cable (with 10dB PAD) Woken	5D-FB	Cable-cond1-01	Dec. 26, 2015	Dec. 25, 2016
LISN ROHDE & SCHWARZ (EUT)	ESH3-Z5	835239/001	Feb. 26, 2016	Feb. 25, 2017
LISN ROHDE & SCHWARZ (Peripheral)	ESH3-Z5	100311	Jul. 24, 2015	Jul. 23, 2016
Software ADT	BV ADT_Cond_ V7.3.7.3	NA	NA	NA

Note: 1. The calibration interval of the above test instruments is 12 months and the calibrations are traceable to NML/ROC and NIST/USA.

2. The test was performed in HwaYa Shielded Room 1.

3. The VCCI Site Registration No. is C-2040.

4.2.3 Test Procedures

- a. The EUT was placed 0.4 meters from the conducting wall of the shielded room with EUT being connected to the power mains through a line impedance stabilization network (LISN). Other support units were connected to the power mains through another LISN. The two LISNs provide 50 ohm/50 uH of coupling impedance for the measuring instrument.
- b. Both lines of the power mains connected to the EUT were checked for maximum conducted interference.
- c. The frequency range from 150 kHz to 30 MHz was searched. Emission levels under (Limit – 20 dB) was not recorded.

NOTE: All modes of operation were investigated and the worst-case emissions are reported.

4.2.4 Deviation from Test Standard

No deviation.

4.2.5 TEST SETUP

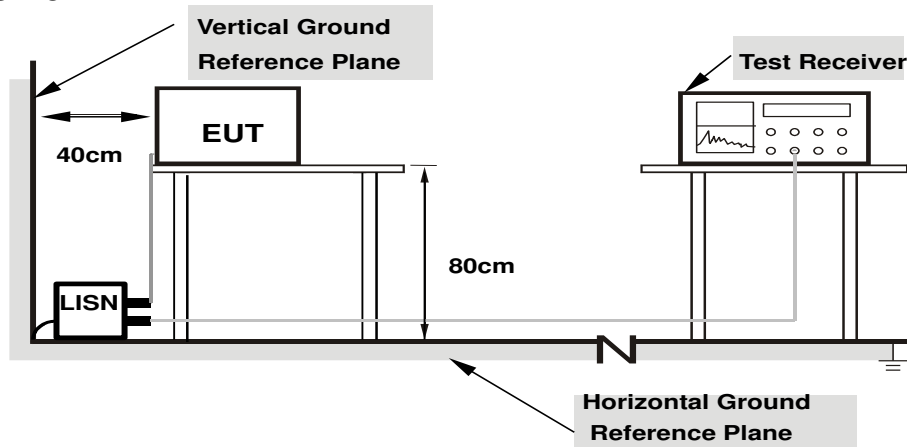

- Note:**
1. Support units were connected to second LISN.
 2. Both of LISNs (AMN) are 80 cm from EUT and at least 80 from other units and other metal planes

4.2.6 EUT Operating Conditions

- a. Placed the EUT on the testing table.
- b. Set the EUT under transmission condition continuously at specific channel frequency.

4.2.7 Test Results

CONDUCTED WORST-CASE DATA

SAMPLE A

Frequency Range	150kHz ~ 30MHz	Detector Function & Resolution Bandwidth	Quasi-Peak (QP) / Average (AV), 9kHz
Input Power	120Vac, 60Hz	Environmental Conditions	25°C, 65%RH
Tested by	Toby Tian	Test Date	2016/3/10

Phase Of Power : Line (L)										
No	Frequency (MHz)	Correction Factor (dB)	Reading Value (dBuV)		Emission Level (dBuV)		Limit (dBuV)		Margin (dB)	
			Q.P.	AV.	Q.P.	AV.	Q.P.	AV.	Q.P.	AV.
1	0.17384	10.07	35.85	20.43	45.92	30.50	64.77	54.77	-18.86	-24.28
2	0.23848	10.12	31.89	14.28	42.01	24.40	62.15	52.15	-20.14	-27.75
3	0.31283	10.13	28.19	9.40	38.32	19.53	59.90	49.90	-21.58	-30.37
4	0.44999	10.14	24.80	9.07	34.94	19.21	56.88	46.88	-21.93	-27.66
5	0.52200	10.16	27.01	17.92	37.17	28.08	56.00	46.00	-18.83	-17.92
6	7.07000	10.58	20.75	13.06	31.33	23.64	60.00	50.00	-28.67	-26.36

Remarks:

1. Q.P. and AV. are abbreviations of quasi-peak and average individually.
2. The emission levels of other frequencies were very low against the limit.
3. Margin value = Emission level – Limit value
4. Correction factor = Insertion loss + Cable loss
5. Emission Level = Correction Factor + Reading Value

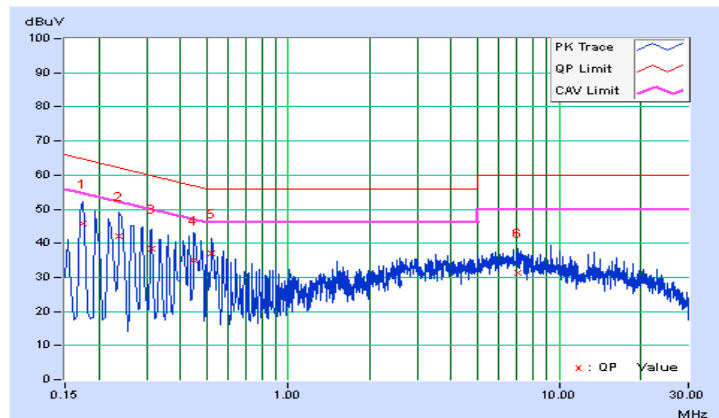

Frequency Range	150kHz ~ 30MHz	Detector Function & Resolution Bandwidth	Quasi-Peak (QP) / Average (AV), 9kHz
Input Power	120Vac, 60Hz	Environmental Conditions	25°C, 65%RH
Tested by	Toby Tian	Test Date	2016/3/10

Phase Of Power : Neutral (N)										
No	Frequency (MHz)	Correction Factor (dB)	Reading Value (dBuV)		Emission Level (dBuV)		Limit (dBuV)		Margin (dB)	
			Q.P.	AV.	Q.P.	AV.	Q.P.	AV.	Q.P.	AV.
1	0.15000	10.00	36.36	22.02	46.36	32.02	66.00	56.00	-19.64	-23.98
2	0.18600	10.03	35.10	19.69	45.13	29.72	64.21	54.21	-19.08	-24.49
3	0.32600	10.11	27.89	10.86	38.00	20.97	59.55	49.55	-21.55	-28.58
4	0.39758	10.15	29.16	20.54	39.31	30.69	57.90	47.90	-18.60	-17.22
5	0.51470	10.17	32.18	20.65	42.35	30.82	56.00	46.00	-13.65	-15.18
6	6.85800	10.53	25.61	17.80	36.14	28.33	60.00	50.00	-23.86	-21.67

Remarks:

1. Q.P. and AV. are abbreviations of quasi-peak and average individually.
2. The emission levels of other frequencies were very low against the limit.
3. Margin value = Emission level – Limit value
4. Correction factor = Insertion loss + Cable loss
5. Emission Level = Correction Factor + Reading Value

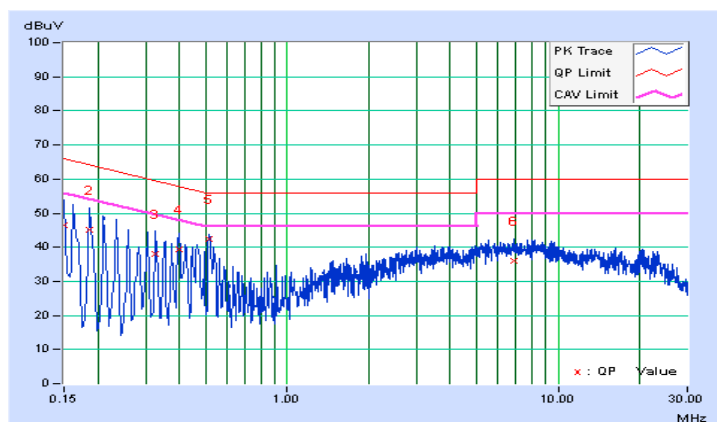

SAMPLE B

Frequency Range	150kHz ~ 30MHz	Detector Function & Resolution Bandwidth	Quasi-Peak (QP) / Average (AV), 9kHz
Input Power	120Vac, 60Hz	Environmental Conditions	25°C, 65%RH
Tested by	Toby Tian	Test Date	2016/3/10

Phase Of Power : Line (L)										
No	Frequency (MHz)	Correction Factor (dB)	Reading Value (dBuV)		Emission Level (dBuV)		Limit (dBuV)		Margin (dB)	
			Q.P.	AV.	Q.P.	AV.	Q.P.	AV.	Q.P.	AV.
1	0.17430	10.07	27.99	15.39	38.06	25.46	64.75	54.75	-26.70	-29.30
2	0.19832	10.12	25.59	12.98	35.71	23.10	63.68	53.68	-27.97	-30.58
3	0.41035	10.13	25.57	16.90	35.70	27.03	57.64	47.64	-21.94	-20.61
4	0.48200	10.15	25.56	12.51	35.71	22.66	56.30	46.30	-20.59	-23.64
5	0.52705	10.16	28.43	21.89	38.59	32.05	56.00	46.00	-17.41	-13.95
6	6.62200	10.56	20.87	12.84	31.43	23.40	60.00	50.00	-28.57	-26.60

Remarks:

1. Q.P. and AV. are abbreviations of quasi-peak and average individually.
2. The emission levels of other frequencies were very low against the limit.
3. Margin value = Emission level – Limit value
4. Correction factor = Insertion loss + Cable loss
5. Emission Level = Correction Factor + Reading Value

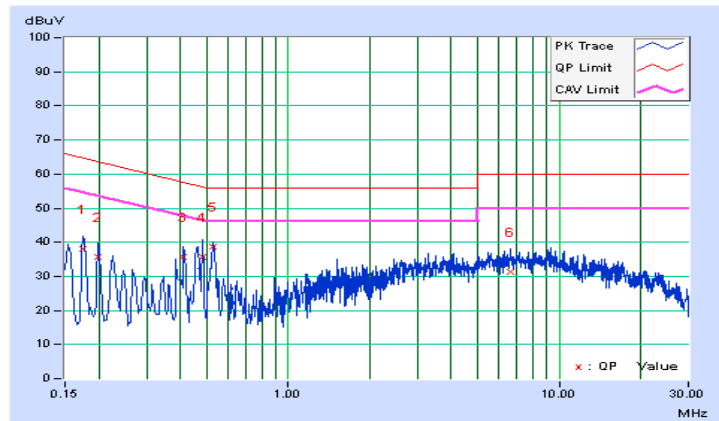

Frequency Range	150kHz ~ 30MHz	Detector Function & Resolution Bandwidth	Quasi-Peak (QP) / Average (AV), 9kHz
Input Power	120Vac, 60Hz	Environmental Conditions	25°C, 65%RH
Tested by	Toby Tian	Test Date	2016/3/10

Phase Of Power : Neutral (N)										
No	Frequency (MHz)	Correction Factor (dB)	Reading Value (dBuV)		Emission Level (dBuV)		Limit (dBuV)		Margin (dB)	
			Q.P.	AV.	Q.P.	AV.	Q.P.	AV.	Q.P.	AV.
1	0.15645	10.01	25.77	20.58	35.78	30.59	65.65	55.65	-29.87	-25.06
2	0.41000	10.15	28.32	20.27	38.47	30.42	57.65	47.65	-19.18	-17.23
3	0.45476	10.16	29.68	18.44	39.84	28.60	56.79	46.79	-16.95	-18.19
4	0.50600	10.16	25.37	12.93	35.53	23.09	56.00	46.00	-20.47	-22.91
5	4.02600	10.45	24.41	15.95	34.86	26.40	56.00	46.00	-21.14	-19.60
6	7.43000	10.54	25.29	17.43	35.83	27.97	60.00	50.00	-24.17	-22.03

Remarks:

1. Q.P. and AV. are abbreviations of quasi-peak and average individually.
2. The emission levels of other frequencies were very low against the limit.
3. Margin value = Emission level – Limit value
4. Correction factor = Insertion loss + Cable loss
5. Emission Level = Correction Factor + Reading Value

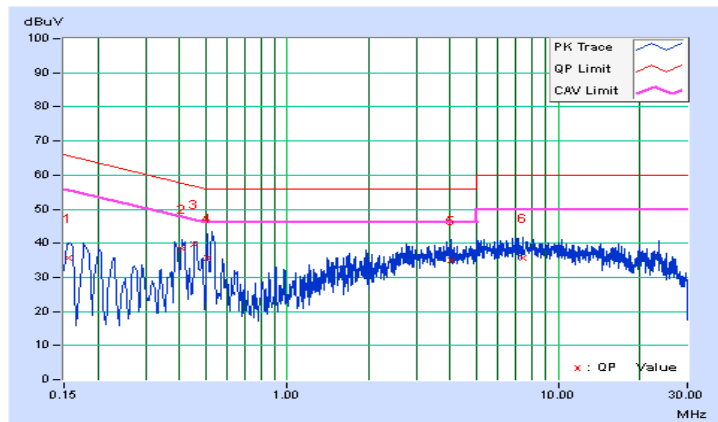

4.3 6 dB Bandwidth Measurement

4.3.1 Limits of 6 dB Bandwidth Measurement

The minimum of 6 dB Bandwidth Measurement is 0.5 MHz.

4.3.2 Test Setup

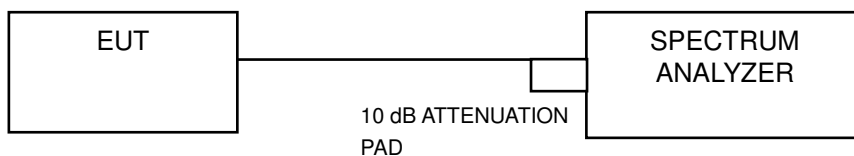

4.3.3 Test Instruments

Refer to section 4.1.2 to get information of above instrument.

4.3.4 Test Procedure

- Set resolution bandwidth (RBW) = 100 kHz
- Set the video bandwidth (VBW) $\geq 3 \times$ RBW, Detector = Peak.
- Trace mode = max hold.
- Sweep = auto couple.
- Measure the maximum width of the emission that is constrained by the frequencies associated with the two amplitude points (upper and lower) that are attenuated by 6 dB relative to the maximum level measured in the fundamental emission

4.3.5 Deviation from Test Standard

No deviation.

4.3.6 EUT Operating Conditions

The software provided by client to enable the EUT under transmission condition continuously at lowest, middle and highest channel frequencies individually.

4.3.7 Test Result

Channel	Frequency (MHz)	6 dB Bandwidth (kHz)	Minimum Limit (MHz)	Pass / Fail
0	2402	700.370	0.5	Pass
19	2440	693.930	0.5	Pass
39	2480	691.010	0.5	Pass

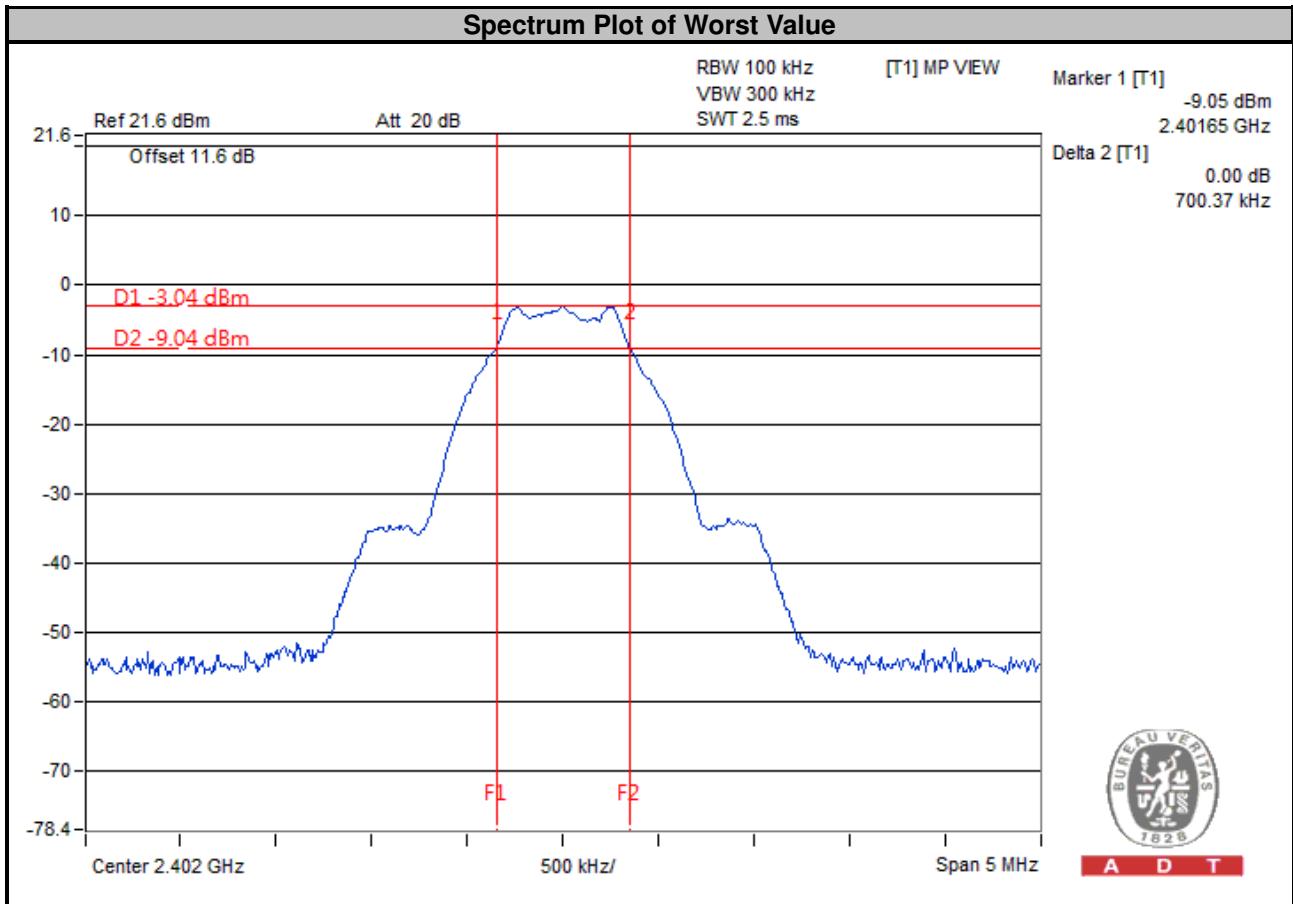

4.4 Conducted Output Power Measurement

4.4.1 Limits of Conducted Output Power Measurement

For systems using digital modulation in the 2400–2483.5 MHz bands: 1 Watt (30 dBm)

4.4.2 Test Setup

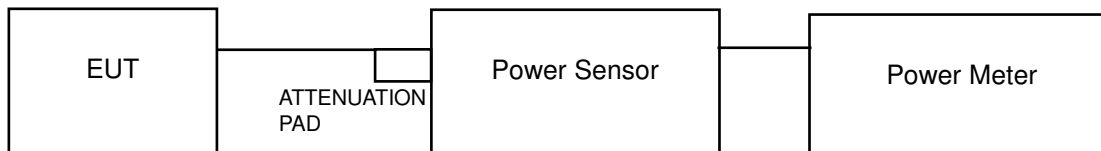

4.4.3 Test Instruments

Refer to section 4.1.2 to get information of above instrument.

4.4.4 Test Procedures

A peak / average power sensor was used on the output port of the EUT. A power meter was used to read the response of the peak / average power sensor. Record the power level.

4.4.5 Deviation from Test Standard

No deviation.

4.4.6 EUT Operating Conditions

The software provided by client to enable the EUT under transmission condition continuously at lowest, middle and highest channel frequencies individually.

4.4.7 Test Results

Channel	Frequency (MHz)	Peak Power (mW)	Peak Power (dBm)	Limit (dBm)	Pass / Fail
0	2402	0.662	-1.79	30	Pass
19	2440	0.995	-0.02	30	Pass
39	2480	0.748	-1.26	30	Pass

4.5 Power Spectral Density Measurement

4.5.1 Limits of Power Spectral Density Measurement

The Maximum of Power Spectral Density Measurement is 8 dBm.

4.5.2 Test Setup

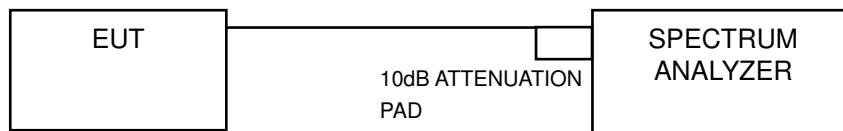

4.5.3 Test Instruments

Refer to section 4.1.2 to get information of above instrument.

4.5.4 Test Procedure

- Set the RBW = 3 kHz, VBW = 10 kHz, Detector = peak.
- Sweep time = auto couple, Trace mode = max hold, allow trace to fully stabilize.
- Use the peak marker function to determine the maximum power level in any 100 kHz band segment within the fundamental EBW.

4.5.5 Deviation from Test Standard

No deviation.

4.5.6 EUT Operating Condition

The software provided by client to enable the EUT under transmission condition continuously at lowest, middle and highest channel frequencies individually.

4.5.7 Test Results

Channel	Frequency (MHz)	PSD (dBm/3kHz)	Limit (dBm/3kHz)	Pass / Fail
0	2402	-17.54	8	Pass
19	2440	-15.72	8	Pass
39	2480	-17.00	8	Pass

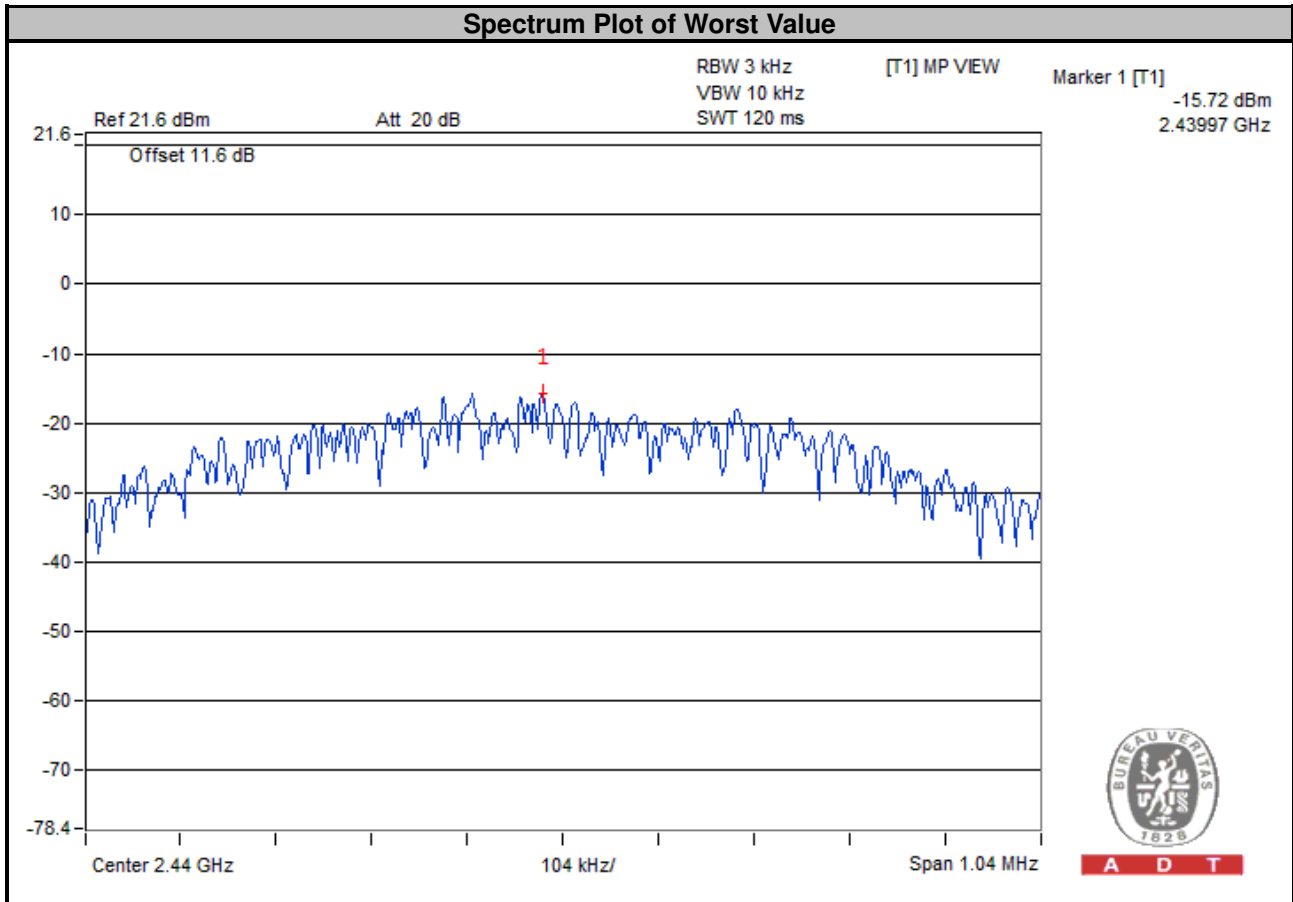

4.6 Conducted Out of Band Emission Measurement

4.6.1 Limits of Conducted Out of Band Emission Measurement

Below -20 dB of the highest emission level of operating band (in 100 kHz Resolution Bandwidth).

4.6.2 Test Setup

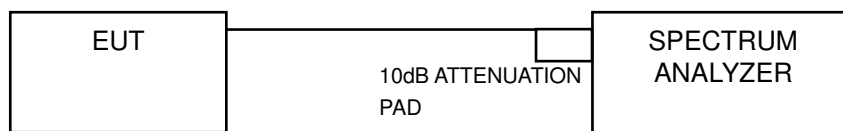

4.6.3 Test Instruments

Refer to section 4.1.2 to get information of above instrument.

4.6.4 Test Procedure

MEASUREMENT PROCEDURE REF

1. Set the RBW = 100 kHz.
2. Set the VBW \geq 300 kHz.
3. Detector = peak.
4. Sweep time = auto couple.
5. Trace mode = max hold.
6. Allow trace to fully stabilize.
7. Use the peak marker function to determine the maximum power level in any 100 kHz band segment within the fundamental EBW.

MEASUREMENT PROCEDURE OOB

1. Set RBW = 100 kHz.
2. Set VBW \geq 300 kHz.
3. Detector = peak.
4. Sweep = auto couple.
5. Trace Mode = max hold.
6. Allow trace to fully stabilize.
7. Use the peak marker function to determine the maximum amplitude level.

4.6.5 Deviation from Test Standard

No deviation.

4.6.6 EUT Operating Condition

The software provided by client to enable the EUT under transmission condition continuously at lowest, middle and highest channel frequencies individually.

4.6.7 TEST RESULTS

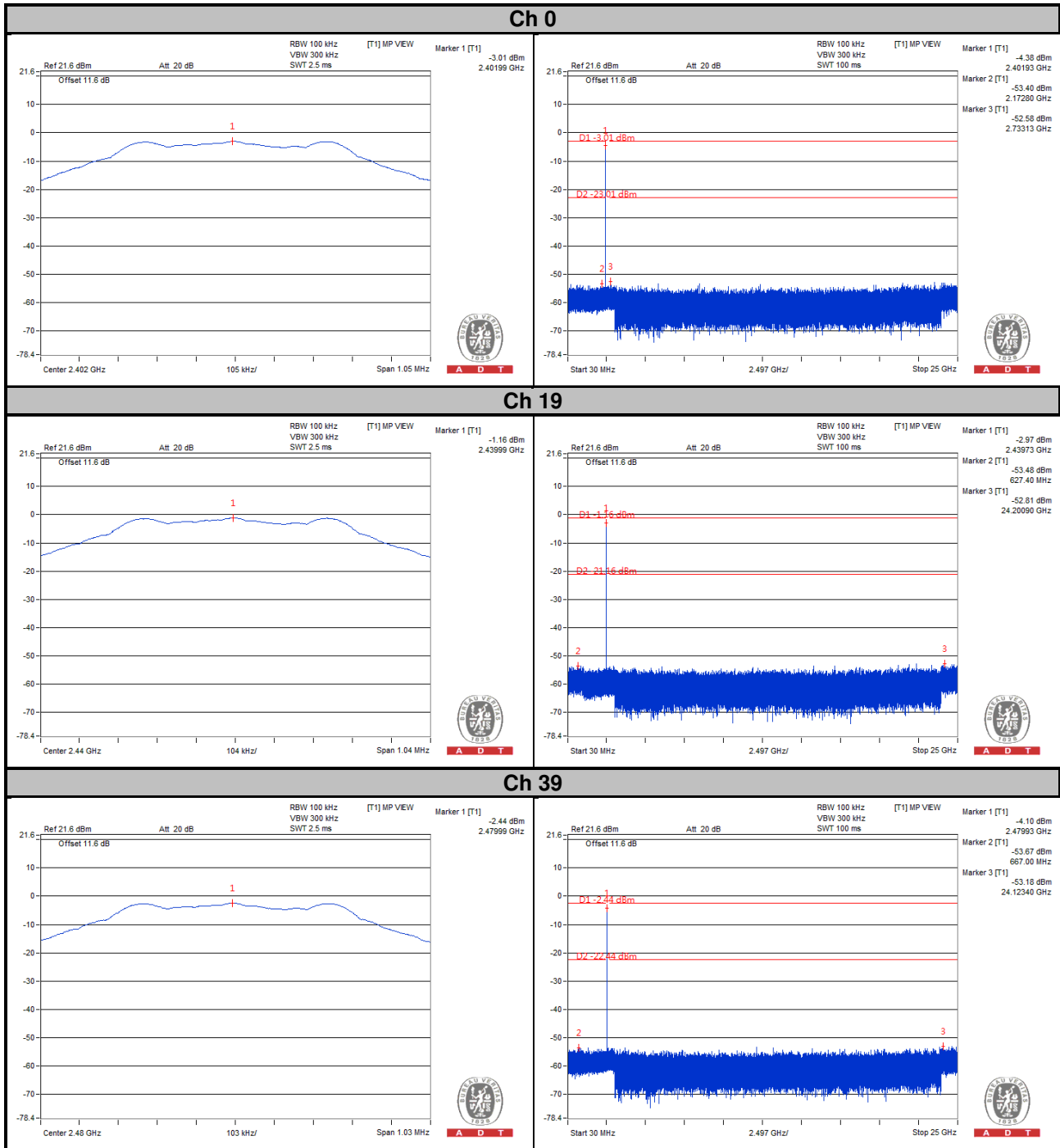

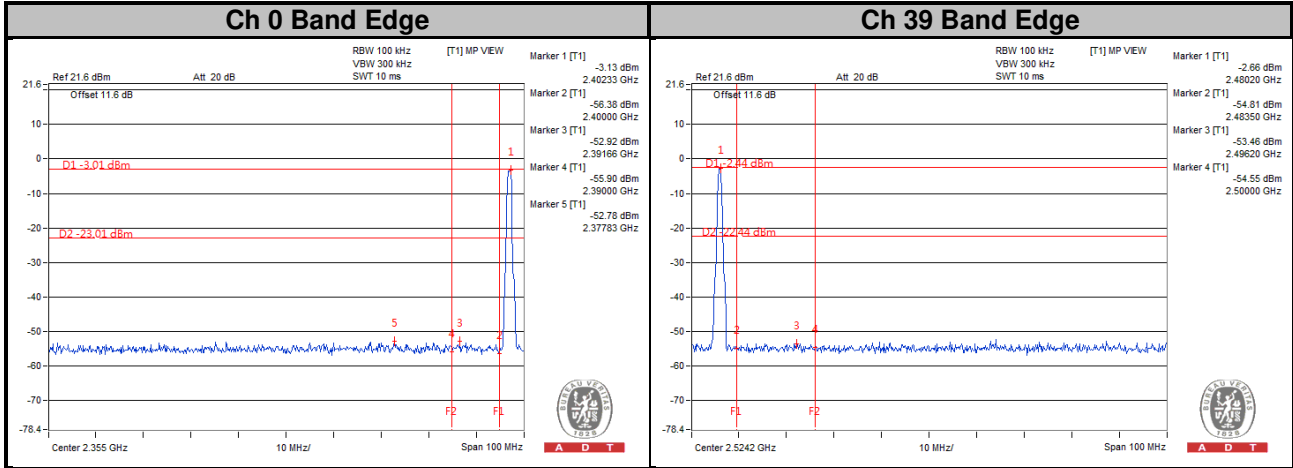



5 Pictures of Test Arrangements

Please refer to the attached file (Test Setup Photo).



A D T

Appendix – Information on the Testing Laboratories

We, Bureau Veritas Consumer Products Services (H.K.) Ltd., Taoyuan Branch, were founded in 1988 to provide our best service in EMC, Radio, Telecom and Safety consultation. Our laboratories are accredited and approved according to ISO/IEC 17025.

If you have any comments, please feel free to contact us at the following:

Linko EMC/RF Lab

Tel: 886-2-26052180

Fax: 886-2-26051924

Hsin Chu EMC/RF/Telecom Lab

Tel: 886-3-6668565

Fax: 886-3-6668323

Hwa Ya EMC/RF/Safety

Tel: 886-3-3183232

Fax: 886-3-3270892

Email: service.adt@tw.bureauveritas.com

Web Site: www.bureauveritas-adt.com

The address and road map of all our labs can be found in our web site also.

--- END ---