



FCC TEST REPORT

for 47 CFR Part 24E

Equipment : O2 Xda Zinc Windows Mobile Pocket PC Phone
(GSM900/DCS1800/PCS1900/UMTS2100/Bluetooth/WLAN)
Trade Name : O2
Model No. : O2Z1, O2 XDA Zinc
FCC ID : MSQO2Z1
Tx Frequency Range : PCS1900 : 1850.2~1909.8MHz
Max. ERP/EIRP Power : PCS1900 : 0.64 W
Emission Designator : 300KGXW
Applicant : ASUSTek Computer Inc.
No. 150, Li-Te Rd., Peitou, Taipei, Taiwan, R.O.C.

- The test result refers exclusively to the test presented test model / sample.
- Without written approval of SPORTON International Inc., the test report shall not be reproduced except in full.
- **Certificate or Test Report must not be used by the applicant to claim the product in this test report endorsement by NVLAP or any agency of U.S. government.**
- The data shown in this test report were carried out during Aug. 28, 2006 at **Sporton International Inc. LAB.**
- Report No.: FG681516-B, Report Version: Rev. 01.

Roy Wu
Deputy Manager

SPORTON International Inc.

6F, No.106, Sec. 1, Hsin Tai Wu Rd., Hsi Chih, Taipei Hsien, Taiwan, R.O.C.



Table of Contents

History of this test report.....ii

1. General Information 1

 1.1. Applicant1

 1.2. Manufacturer1

 1.3. Basic Description of Equipment under Test.....1

 1.4. Feature of Equipment under Test2

 1.5. Report Date.....2

2 Test Configuration of Equipment under Test3

 2.1 Test Manner3

 2.2 Test Mode3

 2.3 Connection Diagram of Test System3

 2.4 Ancillary Equipment List.....3

3. General Information of Test Site4

 3.1 Test Voltage4

 3.2 Test in Compliance with4

 3.3 Frequency Range Investigated4

 3.4 Test Distance4

4. Test Data and Test Result.....5

 4.1 List of Measurements and Examinations5

 4.2 RF Output Power6

 4.3 ERP / EIRP Measurement7

 4.4 Occupied Bandwidth and Band Edge Measurement10

 4.5 Conducted Emission15

 4.6 Field Strength of Spurious Radiation21

 4.7 Frequency Stability (Temperature Variation)47

 4.8 Frequency Stability (Voltage Variation).....49

5 List of Measurement Equipments50

6 Uncertainty Evaluation.....51

- Appendix A. External Photographs of EUT**
- Appendix B. Internal Photographs of EUT**
- Appendix C. Photographs of Setup**



History of this test report

Report Issue Date: Sep. 07, 2006

Report No.	Description



1. General Information

1.1. Applicant

ASUSTek Computer Inc.

No. 150, Li-Te Rd., Peitou, Taipei, Taiwan, R.O.C.

1.2 Manufacturer

ASUSTek Computer Inc.

No. 150, Li-Te Rd., Peitou, Taipei, Taiwan, R.O.C.

ASUSTeK Computer Inc.

No.5, Shing Yeh Street, 333 Kwei Shan Hsiang, Taoyuan Hsien, Taiwan

ASUSTek Computer Inc.

No.76, Ligung St., Peitou, 112 Taipei, Taiwan

North Tec Asia (Shanghai) Limited

Factory 2, 3678 Xiu Yan Rd., 201319 Nanhui District, Shanghai, People's Republic of China

1.3 Basic Description of Equipment under Test

Equipment : O2 Xda Zinc Windows Mobile Pocket PC Phone
(GSM900/DCS1800/PCS1900/UMTS2100/Bluetooth/WLAN)

Trade Name : O2

Model No. : O2Z1, O2 XDA Zinc

FCC ID : MSQO2Z1

Power Supply Type : Switching

AC Power Cord : AC 120V, Wall-mount, 1.8 meter, 2 pin

Adapter : Phihong, PSC05R-050CP PH

Battery : ASUS, SBP-06

Earphone 1 : O2, CHM-201STV1017(TPE)

Earphone 2 : ASUS, CHM-201STV1017(TPE)

Earphone 3 : COTRON, CHM-71STS01005(TPE)

USB Cable : FOXCONN, CUHD004B-S17-E

Remark:

1. Earphone 1 & Earphone 2 have the same circuit design, only earphone 1 used for testing.



1.4 Feature of Equipment under Test

DUT Type :	O2 Xda Zinc Windows Mobile Pocket PC Phone (GSM900/DCS1800/PCS1900/UMTS2100/Bluetooth/WLAN)
Trade Name :	O2
Model Name :	O2Z1, O2 XDA Zinc
FCC ID :	MSQO2Z1
HW Version :	1.3
SW Version :	2.0.9
Tx Frequency :	PCS1900 : 1850 ~1910 MHz Bluetooth : 2400~2483.5 MHz WLAN : 2400 ~ 2483.5 MHz
Rx Frequency :	PCS1900 : 1930 ~ 1990 MHz Bluetooth : 2400~2483.5 MHz WLAN : 2400 ~ 2483.5 MHz
Number of Channels :	Bluetooth : 79 WLAN : 11
Carrier Frequency of Each Channel :	Bluetooth : 2402+n*1 MHz; n=0~78 WLAN : 2412+(n-1)*5 MHz; n=1~11
Maximum ERP/EIRP :	PCS1900 : 0.64 W (28.05 dBm)
Type of Modulation :	GSM/GPRS : GMSK Bluetooth : GFSK WLAN : DSSS / OFDM
Antenna Type :	GSM : PIFA Antenna Bluetooth : PIFA Antenna WLAN : PIFA Antenna
Type of Antenna Connector :	GSM : Spring Bluetooth : SMT WLAN : SMT
Maximum Output Power to Antenna :	PCS1900 : 29 dBm Bluetooth : 0.01 dBm 802.11b : 13.73 dBm / 802.11g : 16.78 dBm
Antenna Gain :	GSM : 0 dBi Bluetooth : -4 dBi WLAN : -4 dBi
Duty Cycle :	Bluetooth : 39.00% WLAN : 100%
DUT Stage :	Identical Prototype
Power Rating :	GSM : 4.2V / 190mA

1.5 Report Date

EUT Received : Aug. 15, 2006

Report Date : Sep. 07, 2006

2 Test Configuration of Equipment under Test

2.1 Test Manner

- a. The spurious emission measurements were carried out in semi-anechoic chamber with 3-meter test range.
- b. During all testings, EUT is in link mode with base station emulator at maximum power level. (PCL=0 for PCS1900)
- c. Frequency range investigated: radiated emission 30MHz to 19000 MHz for PCS1900.

2.2 Test Mode

Application	PCS 1900
Radiated Emission	<input checked="" type="checkbox"/> Mode 1 PCS1900 Link Mode_CH661 + Adapter <input checked="" type="checkbox"/> Mode 2: PCS1900 Link Mode_CH661 + WLAN Link_CH01 + Adapter
Conducted Measurement	<input checked="" type="checkbox"/> Mode 1 PCS1900 Link Mode_CH661

2.3 Connection Diagram of Test System

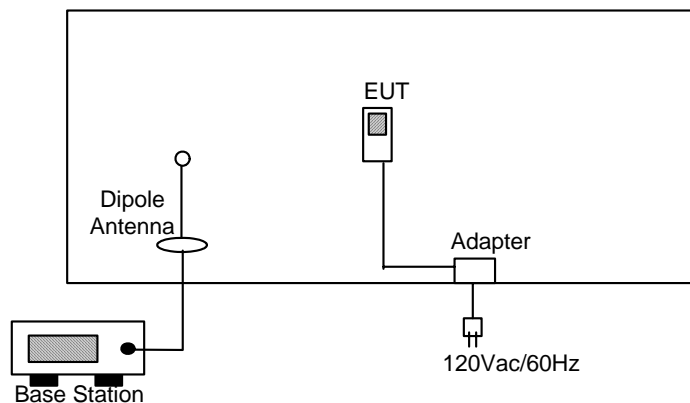

2.4 Ancillary Equipment List

Item	Asset	Model Name	Power Cord
1.	Base Station (R&S)	CMU 200	N/A



3. General Information of Test Site

Test Site Location : No. 52, Hwa Ya 1st Rd., Hwa Ya Technology Park,
Kwei-Shan Hsiang, Tao Yuan Hsien, Taiwan, R.O.C.
TEL : 886-3-327-3456
FAX : 886-3-318-0055

Test Site No : 03CH06-HY

The chamber meets the characteristics of ANSI C63.4-2003. This site is on file with the FCC.

3.1 Test Voltage

120V/ 60Hz

3.2 Test in Compliance with

47 CFR Part 24E, and Part 2

3.3 Frequency Range Investigated

- a. Radiation: from 30MHz to 9000MHz for GSM850.
- b. Radiation: from 30 MHz to 19000 MHz for PCS1900.

3.4 Test Distance

The test distance of radiated emission from antenna to EUT is 3 m.



4. Test Data and Test Result

4.1 List of Measurements and Examinations

FCC Rule	DESCRIPTION OF TEST	Result	Section
§2.1046	RF Output Power	Passed	4.2
§ 22.913 §24.232	ERP / EIRP	Passed	4.3
§2.1049, § 22.917, § 24.238(b)	Occupied Bandwidth & Band Edge Measurement	Passed	4.4
§2.1051	Conducted Emission	Passed	4.5
§2.1053	Field Strength of Spurious Radiation	Passed	4.6
§2.1055, § 22.355, §24.235	Frequency Stability vs. Temperature	Passed	4.7
§2.1055, §22.355, §24.235	Frequency Stability vs. Voltage	Passed	4.8

4.2 RF Output Power

4.2.1 Measurement Instruments :

As described in chapter 5 of this test report.

4.2.2 Test Procedure :

1. The transmitter output was connected to power meter and base station through power divider.
2. Set EUT at PCL=0 for PCS1900 maximum power through base station.,
3. Select lowest, middle, and highest channels for each band.

4.2.3 Test Setup Layout :

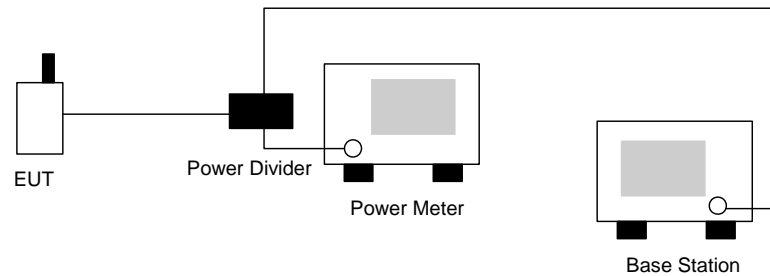

4.2.4 Test Result :

Bands	Channel	Frequency (MHz)	Conducted Power (dBm)	Conducted Power (Watts)
PCS1900	512	1850.2 (Low)	29.00	0.794
	661	1880.0 (Mid)	28.80	0.759
	810	1909.8 (High)	28.80	0.759



4.3 ERP / EIRP Measurement

Equivalent isotropic radiated power measurements by substitution method according to ANSI/TIA/EIA-603-A.

4.3.1 Measurement Instruments

As described in chapter 5 of this test report.

4.3.2 Test Procedure

1. The EUT was placed on a rotatable table with 1.0 meter height in an fully anechoic chamber.
2. The EUT was set 1.2 meters from the receiving antenna which was mounted on the antenna tower.
3. The table was rotated 360 degrees to determine the position of the highest radiated power.
4. The height of the receiving antenna is also kept at 1.0M height.
5. Taking the record of maximum ERP/EIRP.
6. A dipole antenna was substituted in place of the EUT and was driven by a signal generator.
7. The conducted power at the terminal of the dipole antenna is measured.
8. Repeat step 3 to step 5 to get the maximum ERP/EIRP of the substitution antenna.
9. $ERP/EIRP = P_s + E_t - E_s + G_s = P_s + R_t - R_s + G_s$

P_s (dBm) : Input power to substitution antenna.

G_s (dBi or dBd) : Substitution antenna Gain.

$E_t = R_t + AF$

$E_s = R_s + AF$

AF (dB/m) : Receive antenna factor

R_t : The highest received signal in Spectrum Analyzer for EUT.

R_s : The highest received signal in spectrum analyzer for substitution antenna.

4.3.3 Test Setup Layout of ERP/EIRP

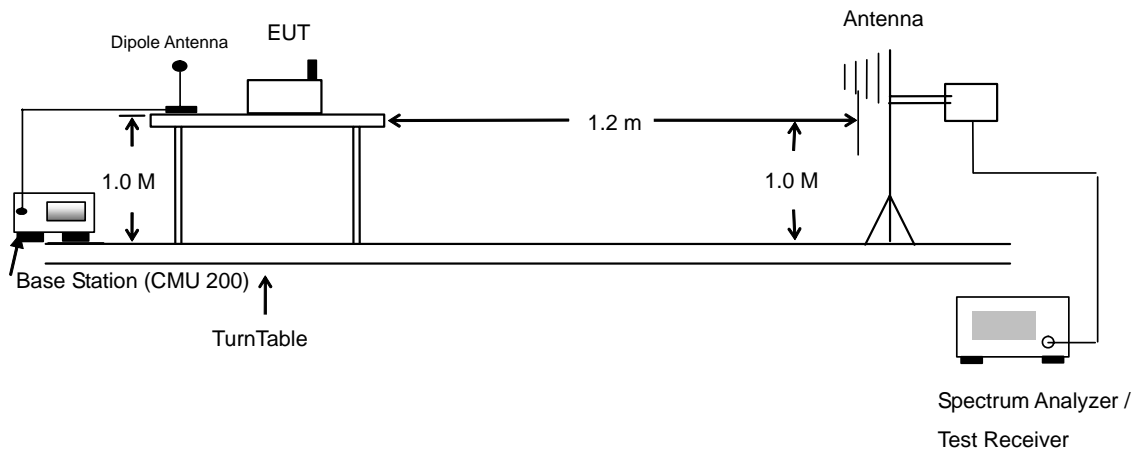



4.3.4 Test Result

PCS1900 Radiated Power EIRP						
Horizontal Polarization						
Frequency (MHz)	Rt (dBm)	Rs (dBm)	Ps (dBm)	Gs (dBi)	EIRP (dBm)	EIRP (W)
1850.20	-28.94	-51.88	0.00	1.96	24.90	0.31
1880.00	-31.74	-52.99	0.00	2.00	23.25	0.21
1909.80	-35.42	-54.28	0.00	1.98	20.84	0.12
Vertical Polarization						
Frequency (MHz)	Rt (dBm)	Rs (dBm)	Ps (dBm)	Gs (dBi)	EIRP (dBm)	EIRP (W)
1850.20	-26.04	-52.13	0.00	1.96	28.05	0.64
1880.00	-29.66	-53.17	0.00	2.00	25.51	0.36
1909.80	-33.14	-54.13	0.00	1.98	22.97	0.20

4.4 Occupied Bandwidth and Band Edge Measurement

4.4.1 Measurement Instruments

As described in chapter 5 of this test report.

4.4.2 Test Procedure

1. The EUT was connected to Spectrum Analyzer and Base Station via power divider.
2. The occupied bandwidth of middle channel for the highest and lowest RF powers were measured.
3. The bandedge of low and high channels for the highest RF powers within the transmitting frequency band were measured. Setting RBW as roughly $BW/100$.

4.4.3 Test Setup Layout

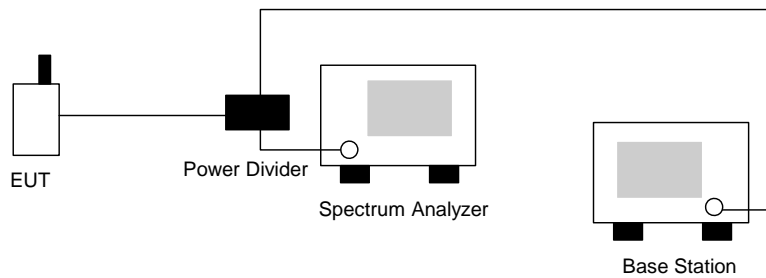



4.4.4 Test Result

- Test Mode : PCS 1900 CH512 Lower Band Edge
- Power State : High

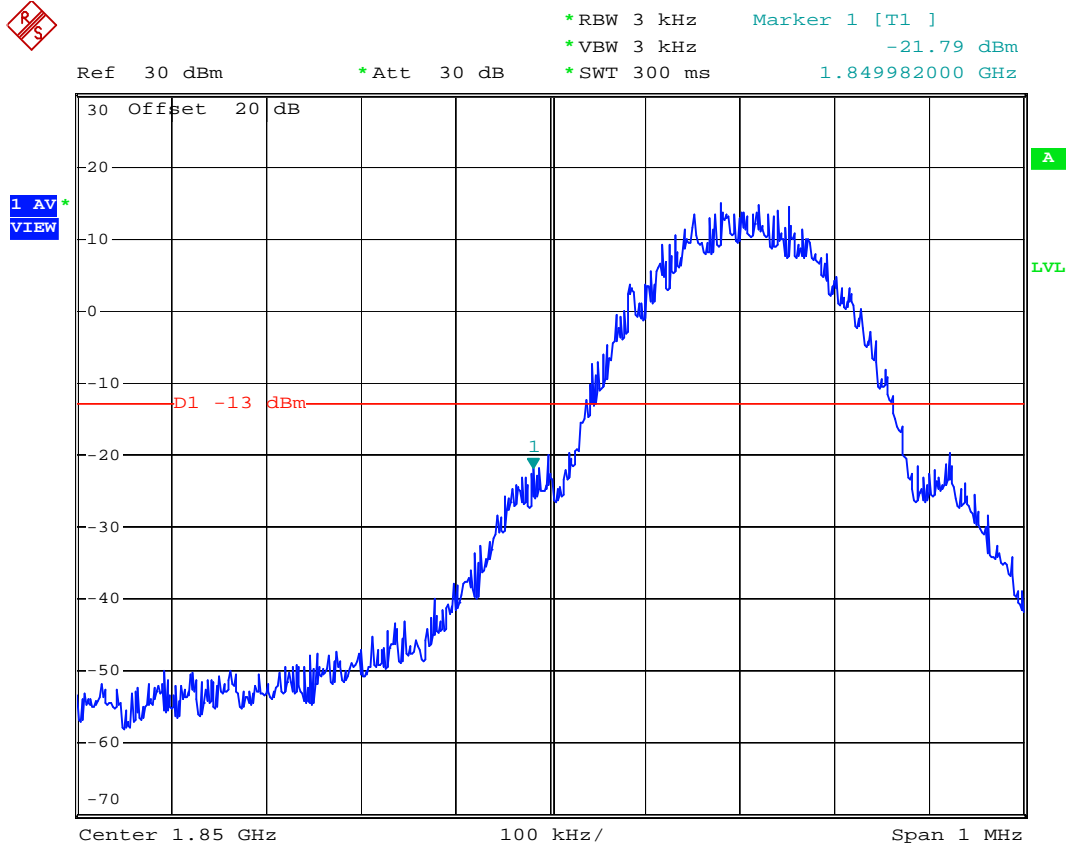

Date: 22.AUG.2006 05:07:00



- Test Mode : PCS 1900 CH661 99% Occupied Bandwidth
- Power State : Low

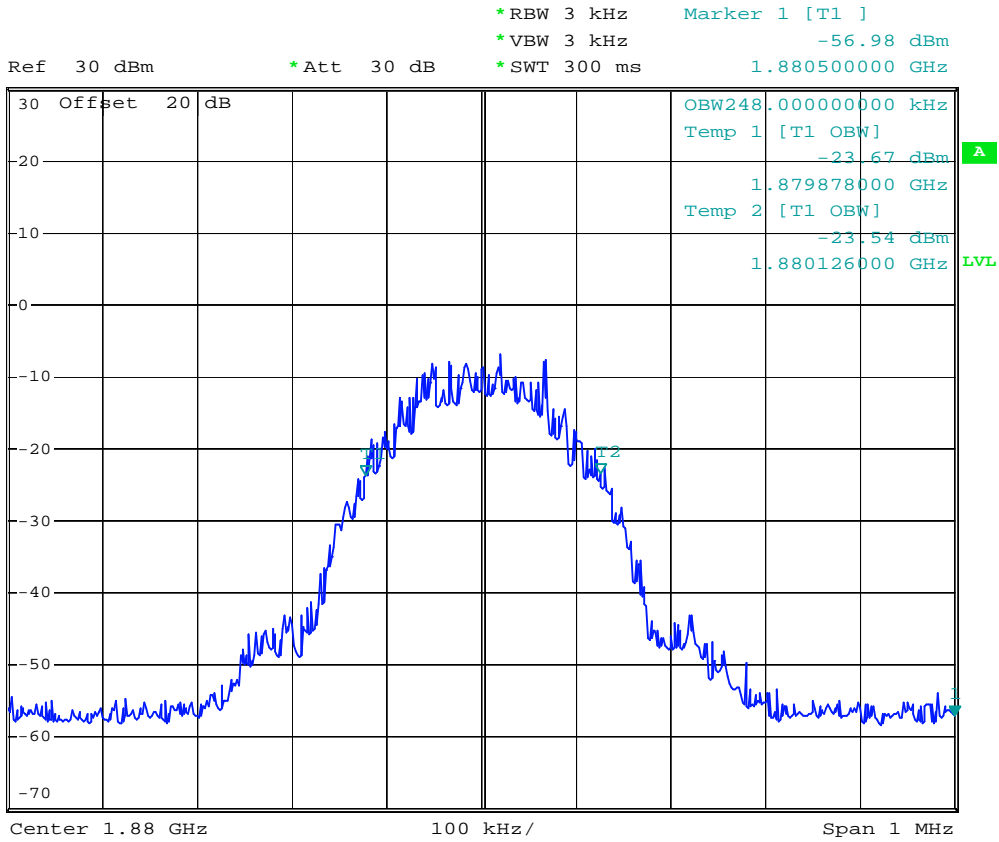

Date: 22.AUG.2006 05:03:57



- Test Mode : PCS 1900 CH661 99% Occupied Bandwidth
- Power State : High

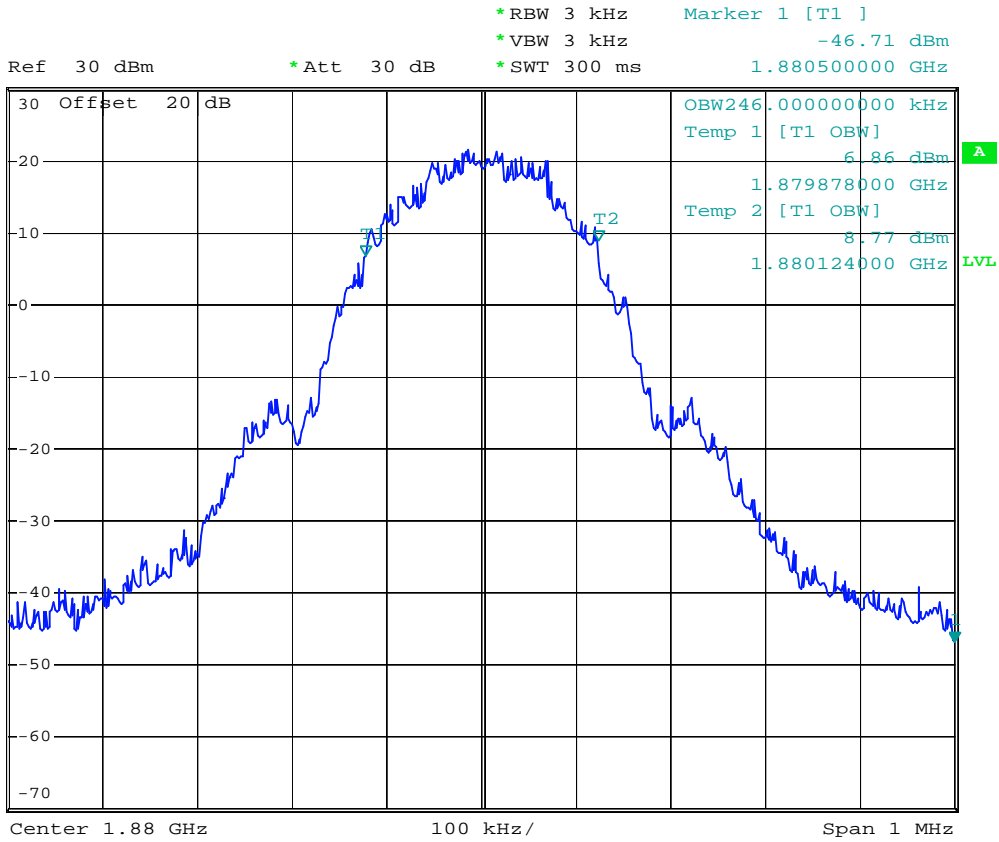

Date: 22.AUG.2006 05:03:08



- Test Mode : PCS 1900 CH810 Higher Band Edge
- Power State : High



Ref 30 dBm *Att 30 dB *RBW 3 kHz Marker 1 [T1]
*VBW 3 kHz -16.48 dBm
*SWT 300 ms 1.910018000 GHz

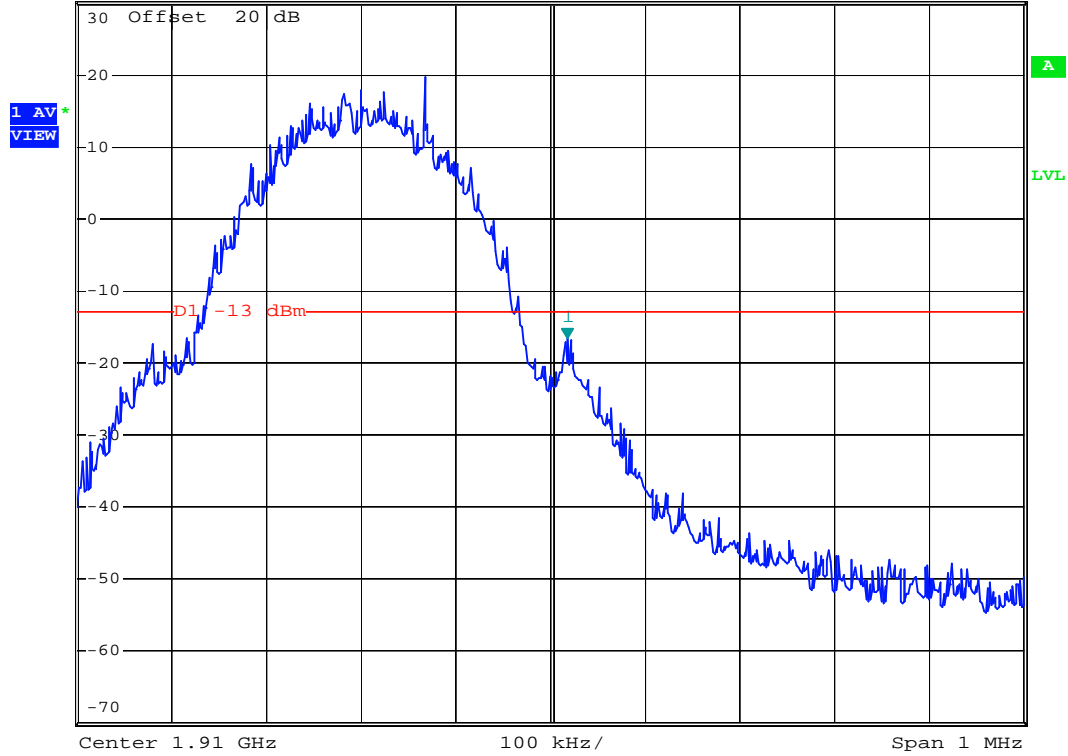

Date: 22.AUG.2006 05:08:01

4.5 Conducted Emission

4.5.1 Measurement Instruments

As described in chapter 5 of this test report.

4.5.2 Test Procedure

1. The EUT was connected to Spectrum Analyzer and Base Station via power divider.
2. The middle channel for the highest RF power within the transmitting frequency was measured.
3. The conducted spurious emission for the whole frequency range was taken.

4.5.3 Test Setup Layout

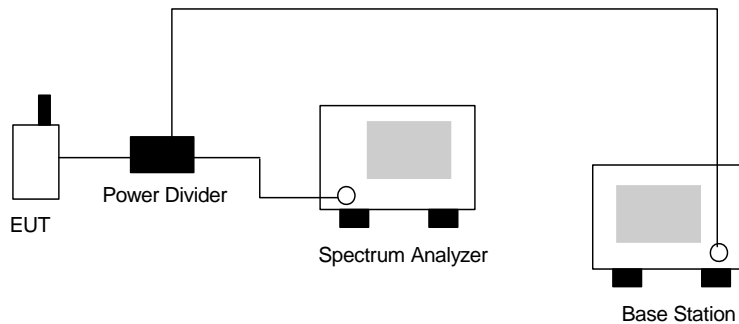



4.5.4 Test Result

- Test Mode : PCS 1900 CH661
- Frequency Range : 30M-1G

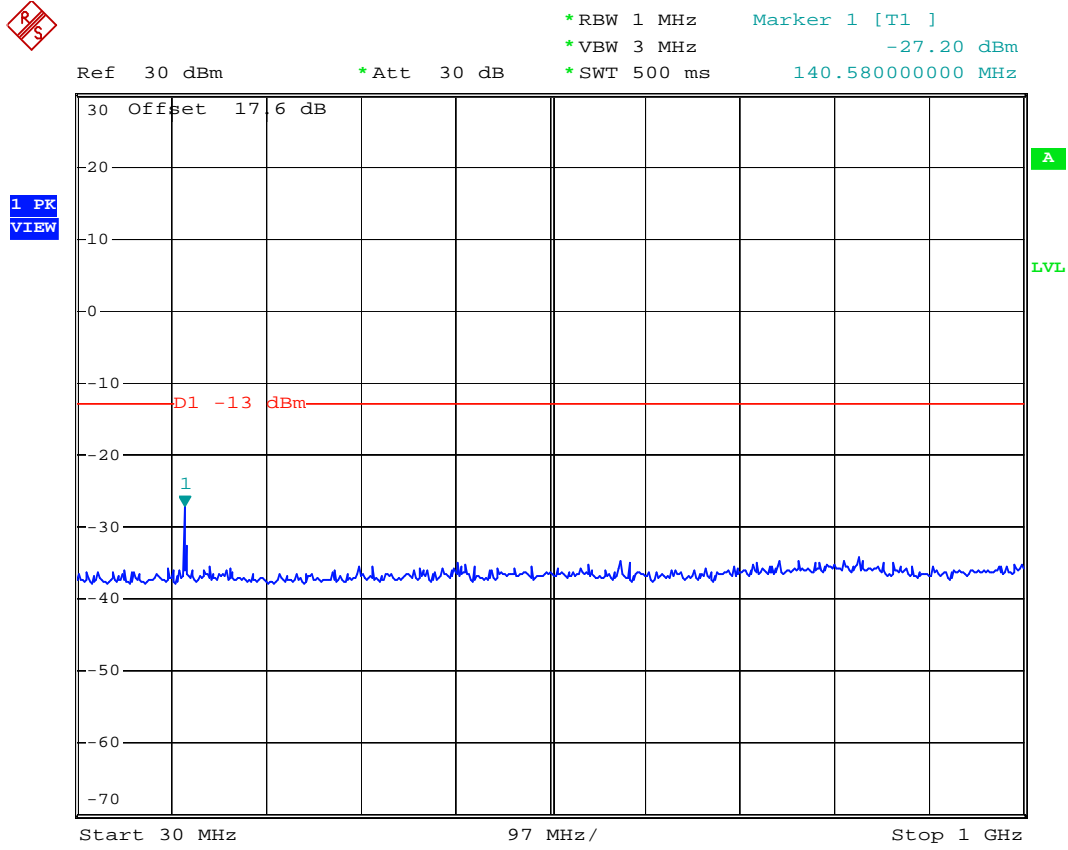

Date: 22.AUG.2006 05:09:59



- Test Mode : PCS 1900 CH661
- Frequency Range : 1G-3G

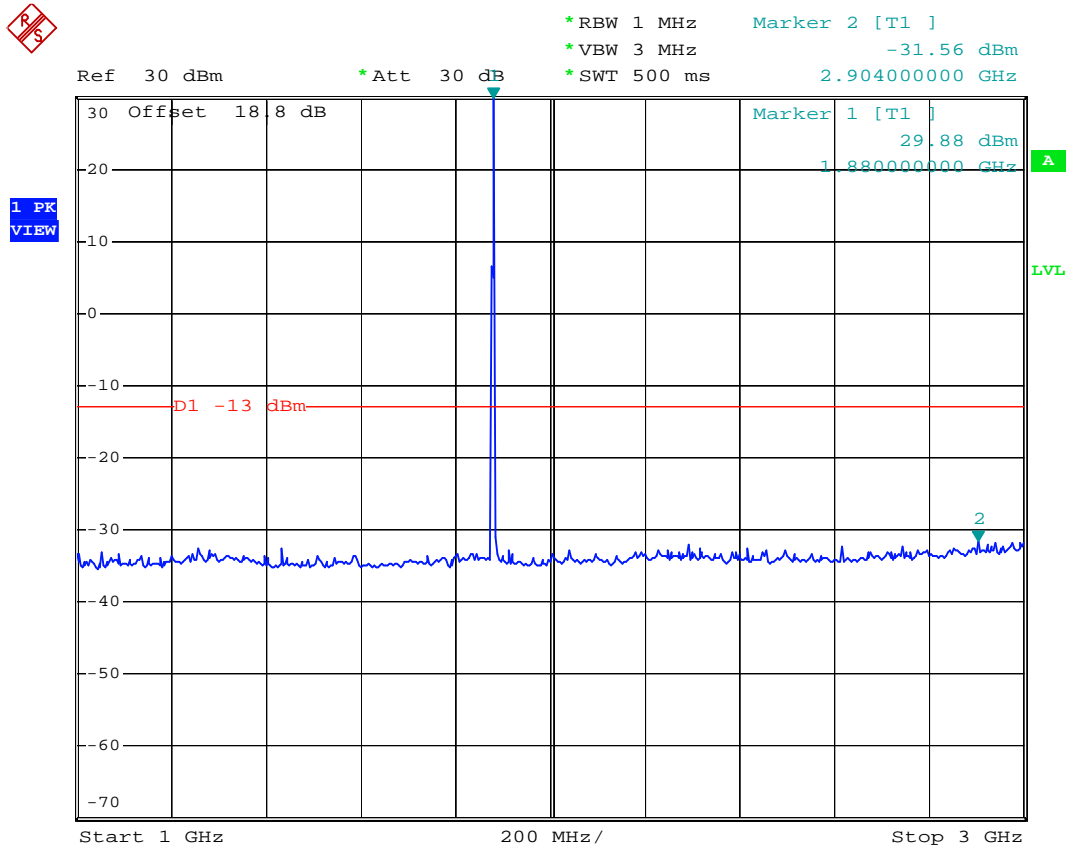

Date: 22.AUG.2006 05:11:10



- Test Mode : PCS 1900 CH661
- Frequency Range : 3G-7G



Ref 0 dBm *Att 0 dB *RBW 1 MHz Marker 1 [T1]
*VBW 3 MHz -30.80 dBm
*SWT 500 ms 3.760000000 GHz

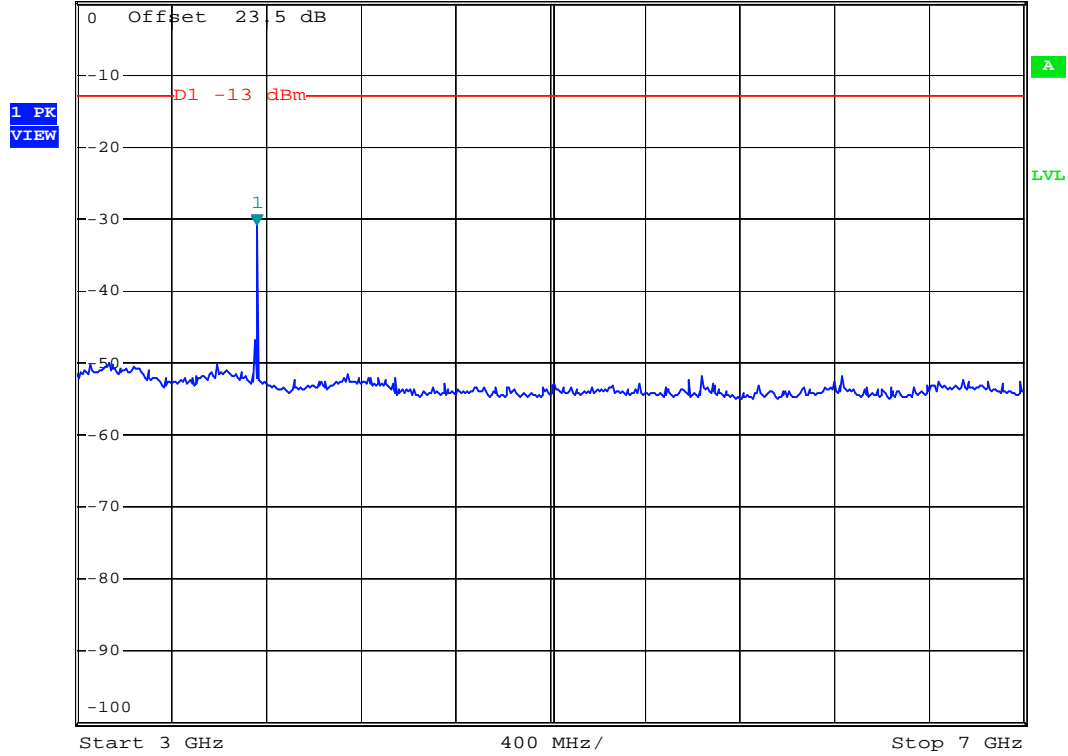

Date: 22.AUG.2006 05:15:58



- Test Mode : PCS 1900 CH661
- Frequency Range : 7G-13.6G

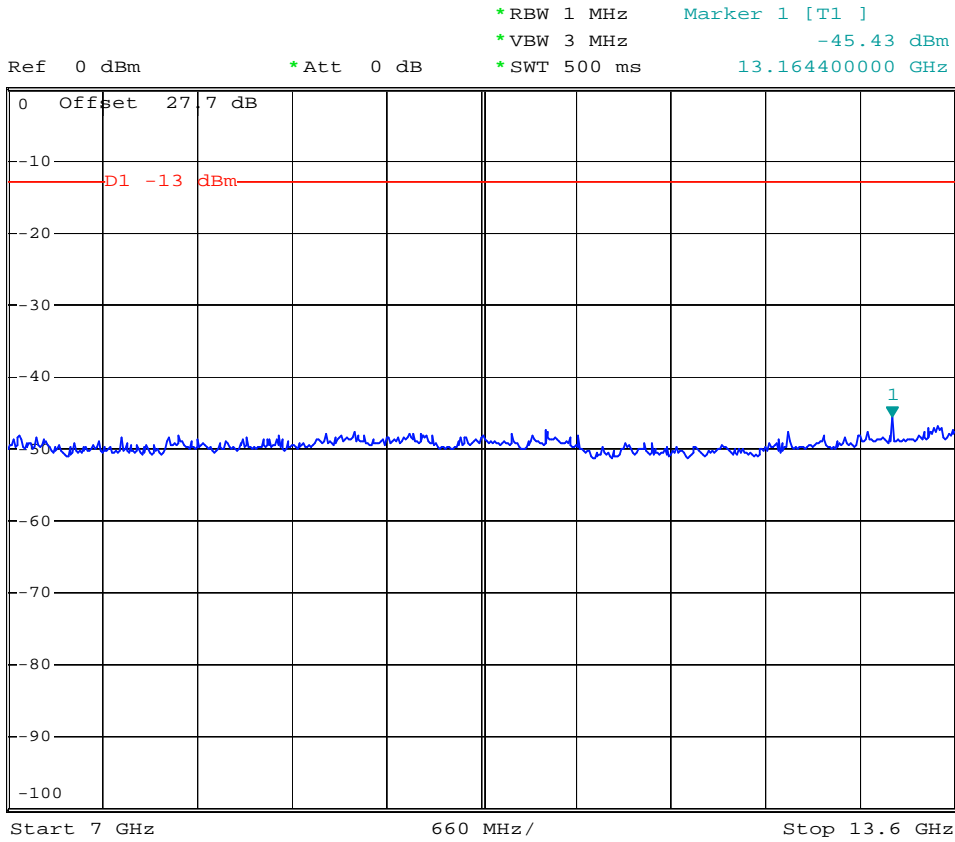

Date: 22.AUG.2006 05:17:41



- Test Mode : PCS 1900 CH661
- Frequency Range : 13.6G-19.1G

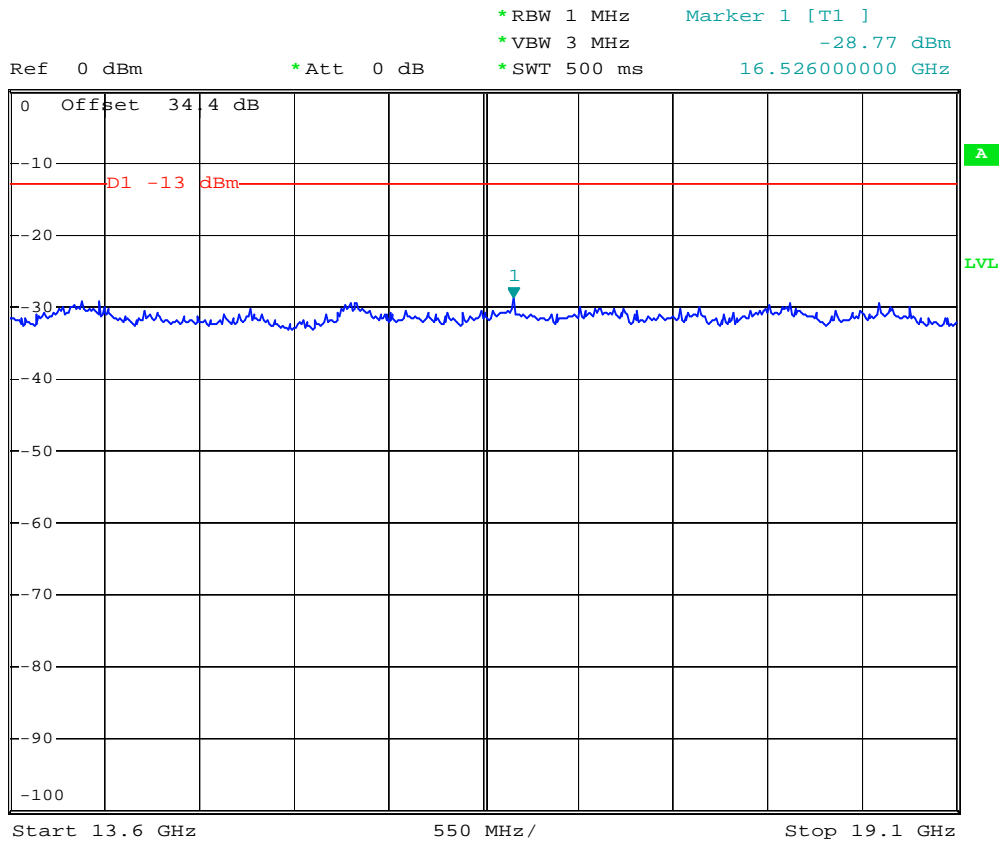

Date: 22.AUG.2006 05:18:46

4.6 Field Strength of Spurious Radiation

Equivalent isotropic radiated Power Measurements by substitution method according to ANSI/TIA/EIA-603-A.

4.6.1 Measurement Instruments

As described in chapter 5 of this test report.

4.6.2 Test Procedure

1. The EUT was placed on a rotatable wooden table with 0.8 meter about ground.
2. The EUT was set 3 meters from the receiving antenna which was mounted on the antenna tower.
3. The table was rotated 360 degrees to determine the position of the highest spurious emission.
4. The height of the receiving antenna is varied between one meter and four meters to reach the maximum spurious emission for both horizontal and vertical polarizations.
5. Taking the record of maximum spurious emission.
6. A Horn antenna was substituted in place of the EUT and was driven by a signal generator.
7. Tune the output power of signal generator to the same emission level with EUT maximum spurious emission.
8. Taking the record of output power at antenna port.
9. Repeat step 7 to step 8 for another polarization.
10. Emission level (dBm) = output power + substitution Gain.

4.6.3 Test Setup Layout

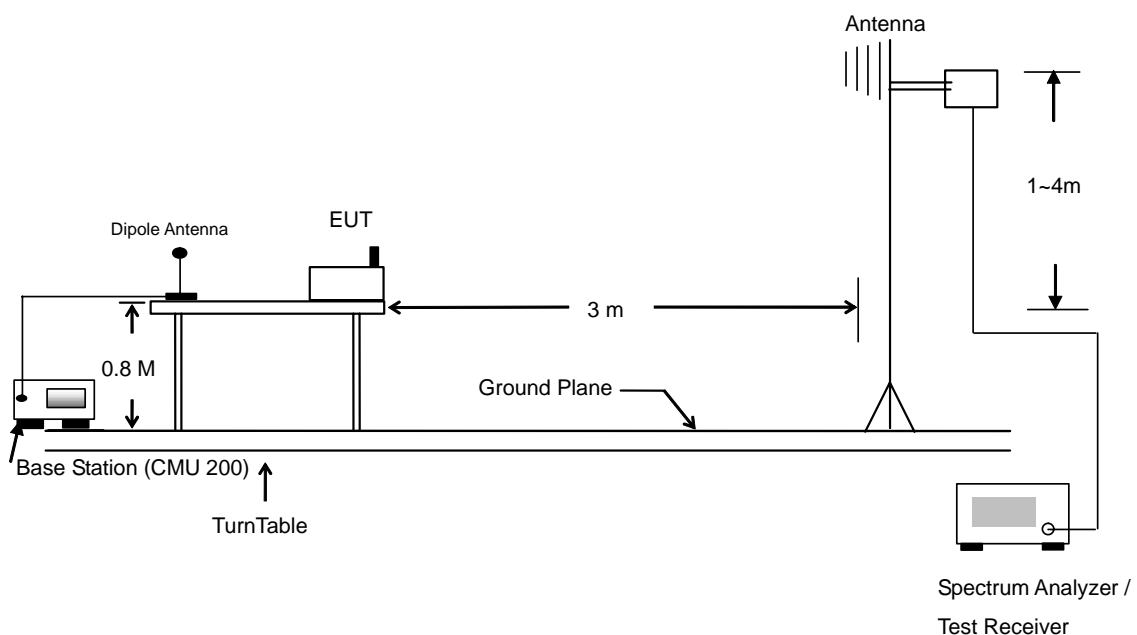



4.6.4 Test Result

- Test Mode : Mode 1

PCS1900 Radiated Spurious EIRP							
H Polarization				V Polarization			
Frequency (MHz)	EIRP (dBm)	Limit (dBm)	Margin (dB)	Frequency (MHz)	EIRP (dBm)	Limit (dBm)	Margin (dB)
49.980	-47.840	-13	-34.84	56.730	-51.300	-13	-38.30
80.490	-45.240	-13	-32.24	79.680	-44.590	-13	-31.59
147.990	-58.850	-13	-45.85	182.280	-60.120	-13	-47.12
301.400	-64.690	-13	-51.69	388.900	-65.550	-13	-52.55
337.800	-63.430	-13	-50.43	682.900	-65.550	-13	-52.55
938.400	-65.020	-13	-52.02	876.800	-62.170	-13	-49.17
1774.000	-53.460	-13	-40.46	1774.000	-49.140	-13	-36.14
1864.000	-48.480	-13	-35.48	1794.000	-50.260	-13	-37.26
3758.000	-44.390	-13	-31.39	3758.000	-42.220	-13	-29.22
5638.000	-47.980	-13	-34.98	5638.000	-51.350	-13	-38.35
11278.000	-37.370	-13	-24.37	11278.000	-39.410	-13	-26.41
13158.000	-39.100	-13	-26.10	13158.000	-43.770	-13	-30.77



- Test Mode : Mode 2

PCS1900 with WLAN Co-location Radiated Spurious EIRP							
H Polarization				V Polarization			
Frequency (MHz)	EIRP (dBm)	Limit (dBm)	Margin (dB)	Frequency (MHz)	EIRP (dBm)	Limit (dBm)	Margin (dB)
37.830	-63.150	-13	-50.15	40.530	-56.980	-13	-43.98
79.140	-55.330	-13	-42.33	58.080	-52.640	-13	-39.64
153.930	-63.840	-13	-50.84	78.330	-51.960	-13	-38.96
791.400	-66.320	-13	-53.32	672.400	-64.510	-13	-51.51
929.300	-65.400	-13	-52.40	714.400	-65.060	-13	-52.06
983.900	-65.100	-13	-52.10	822.900	-60.500	-13	-47.50
1774.000	-51.120	-13	-38.12	1958.000	-46.390	-13	-33.39
3758.000	-42.370	-13	-29.37	3758.000	-45.200	-13	-32.20
5638.000	-47.370	-13	-34.37	9398.000	-42.430	-13	-29.43
7518.000	-44.160	-13	-31.16	11278.000	-40.650	-13	-27.65
11278.000	-32.880	-13	-19.88	13158.000	-42.760	-13	-29.76
15036.000	-42.360	-13	-29.36				



4.6.5 Test Data

4.6.5.1 Mode 1

Horizontal Polarization

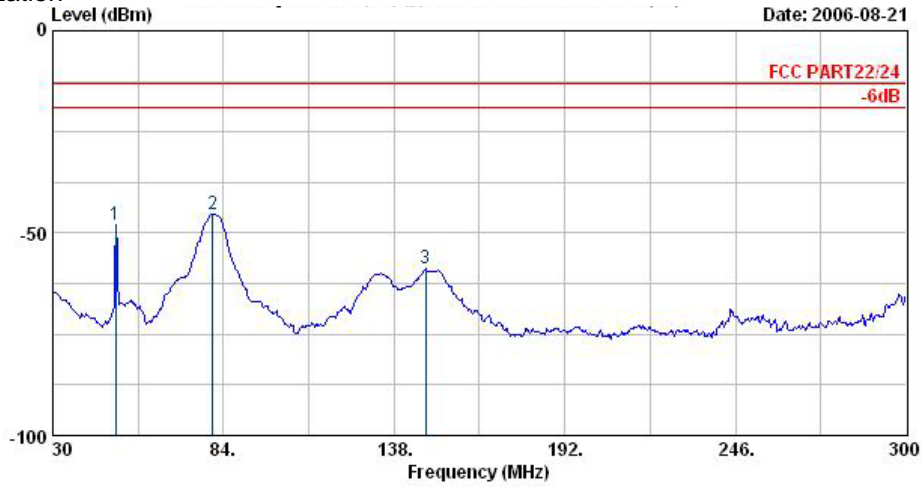

Site : 03CH06-HY
 Condition : LF-SPURIOUS HORIZONTAL
 EUT : PDA Phone
 Power : 120Wac/60Hz
 Model : FG 681516
 Memo : PCS1900 Link;CH661+Adaptor
 Plane : H

	Freq	Level	Over	Limit	Read		
	MHz	dBm	dB	dBm	dBm	dB	
1	49.98	-47.84	-34.84	-13.00	-35.41	-12.43	Peak
2 @	80.49	-45.24	-32.24	-13.00	-32.93	-12.31	Peak
3	147.99	-58.85	-45.85	-13.00	-46.05	-12.80	Peak

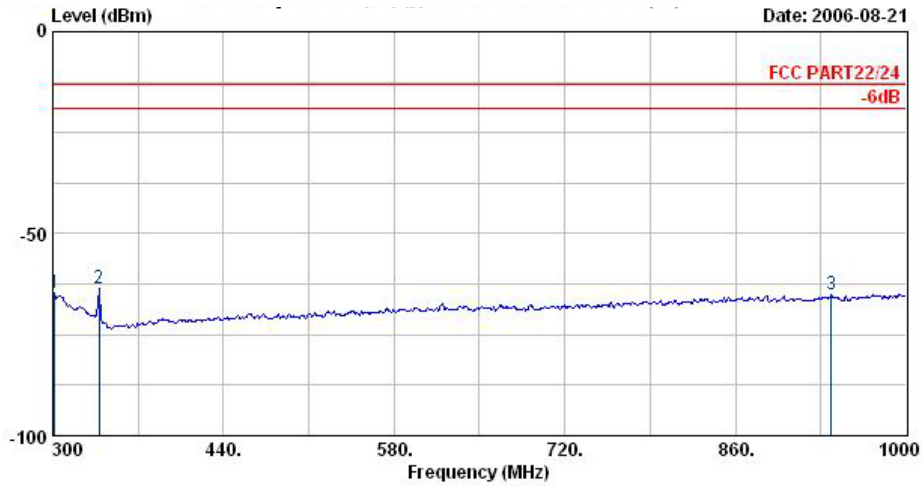

Site : 03CH06-HY
 Condition : LF-SPURIOUS HORIZONTAL
 EUT : PDA Phone
 Power : 120Vac/60Hz
 Model : FG 681516
 Memo : PCS1900 Link;CH661+Adaptor
 Plane : H

	Freq	Level	Over	Limit	Read		
	MHz	dBm	Limit	Line	Level	Factor	Remark
			dB	dBm	dBm	dB	
1	301.40	-64.69	-51.69	-13.00	-54.81	-9.88	Peak
2	337.80	-63.43	-50.43	-13.00	-54.79	-8.64	Peak
3	938.40	-65.02	-52.02	-13.00	-64.66	-0.36	Peak

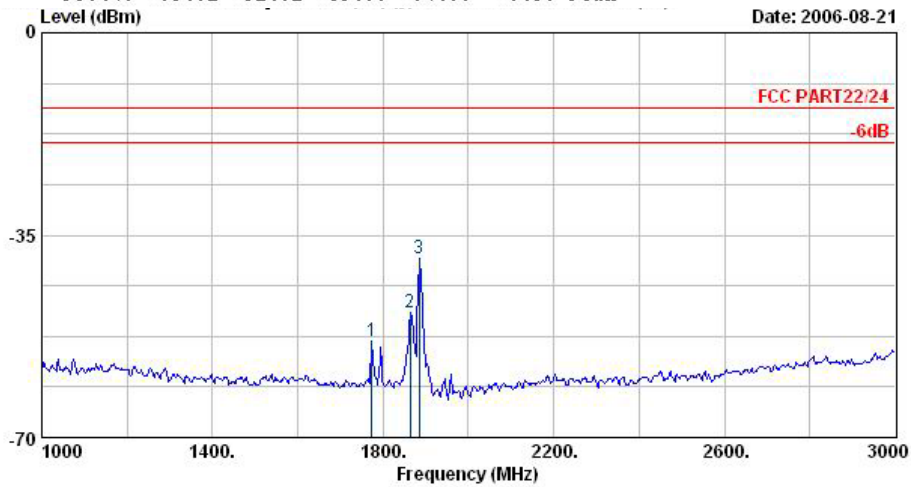

Site : 03CH06-HY
 Condition : HF-SPURIOUS HORIZONTAL
 EUT : PDA Phone
 Power : 120Vac/60Hz
 Model : FG 681516
 Memo : PCS1900 Link;CH661+Adaptor
 Plane : H

	Freq	Level	Over	Limit	Read		
	MHz	dBm	Limit	Line	Level	Factor	Remark
			dB	dBm	dBm	dB	
1	1774.00	-53.46	-40.46	-13.00	-53.39	-0.07	Peak
2	1864.00	-48.48	-35.48	-13.00	-47.97	-0.51	Peak
3 @	1884.00	-38.91			-38.23	-0.68	Peak

Remark:
 1. #3: MS Signal

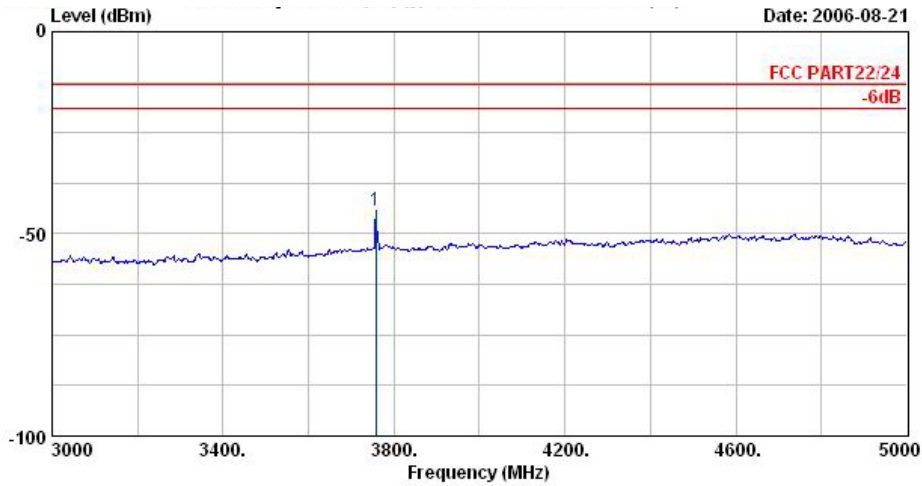

Site : 03CH06-HY
 Condition : HF-SPURIOUS HORIZONTAL
 EUT : PDA Phone
 Power : 120Vac/60Hz
 Model : FG 681516
 Memo : PCS1900 Link;CH661+Adaptor
 Plane : H

	Freq	Level	Over	Limit	Read	Factor	Remark
	MHz	dBm	dB	dBm	dBm	dB	
1 @	3758.00	-44.39	-31.39	-13.00	-52.31	7.92	Peak

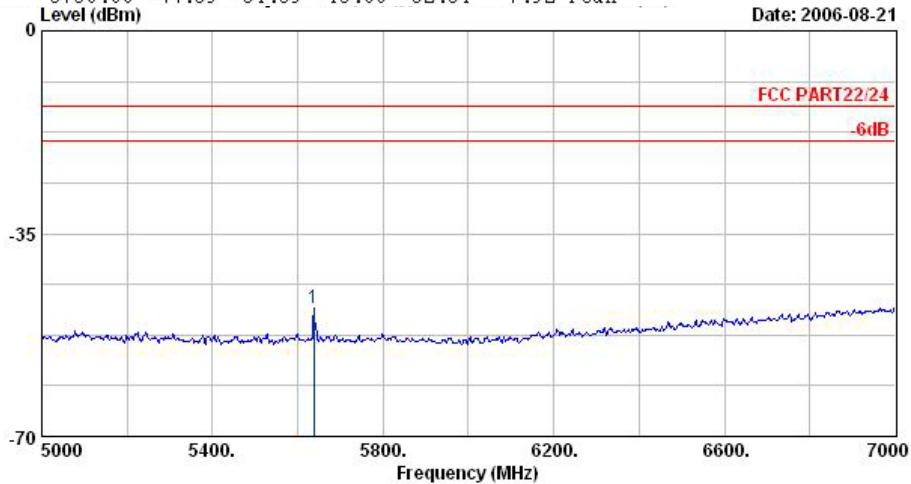

Site : 03CH06-HY
 Condition : HF-SPURIOUS HORIZONTAL
 EUT : PDA Phone
 Power : 120Vac/60Hz
 Model : FG 681516
 Memo : PCS1900 Link;CH661+Adaptor
 Plane : H

	Freq	Level	Over	Limit	Read	Factor	Remark
	MHz	dBm	dB	dBm	dBm	dB	
1	5638.00	-47.98	-34.98	-13.00	-57.95	9.97	Peak

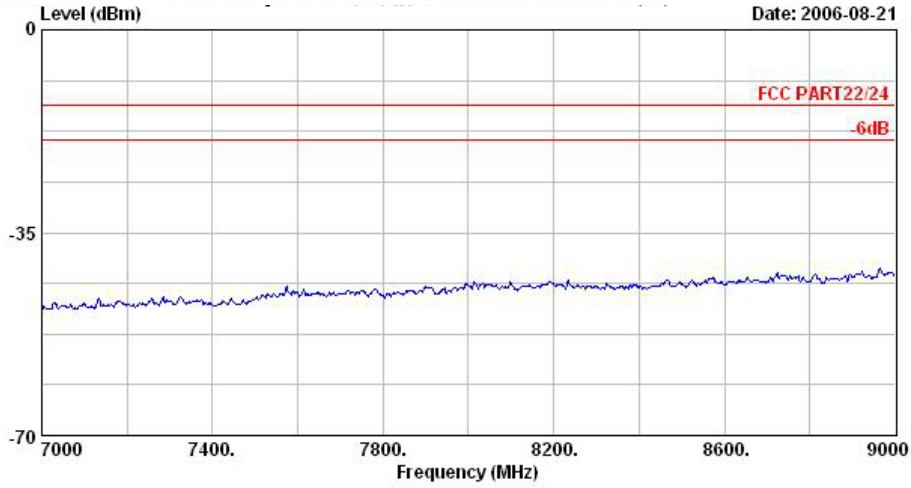

Site : 03CH06-HY
Condition : HF-SPURIOUS HORIZONTAL
EUT : PDA Phone
Power : 120Vac/60Hz
Model : FG 681516
Memo : PCS1900 Link;CH661+Adaptor
Plane : H

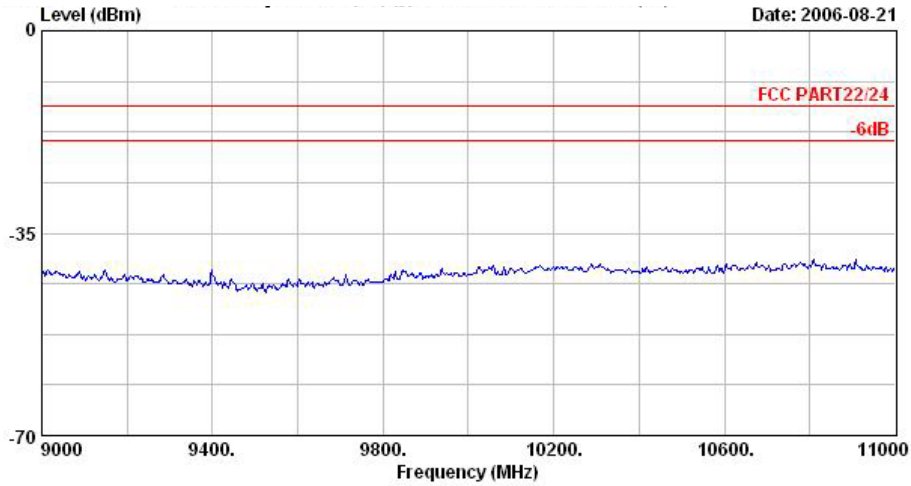

Site : 03CH06-HY
Condition : HF-SPURIOUS HORIZONTAL
EUT : PDA Phone
Power : 120Vac/60Hz
Model : FG 681516
Memo : PCS1900 Link;CH661+Adaptor
Plane : H

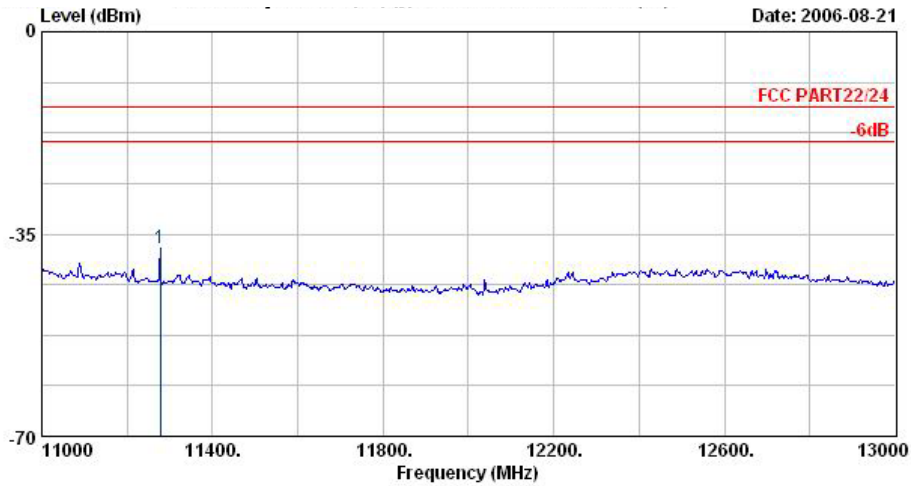

Site : 03CH06-HY
 Condition : HF-SPURIOUS HORIZONTAL
 EUT : PDA Phone
 Power : 120Vac/60Hz
 Model : FG 681516
 Memo : PCS1900 Link;CH661+Adaptor
 Plane : H

Freq	Level	Over	Limit	Read	Factor	Remark
MHz	dBm	dB	dBm	dBm	dB	
1 @ 11278.00	-37.37	-24.37	-13.00	-57.67	20.30	Peak

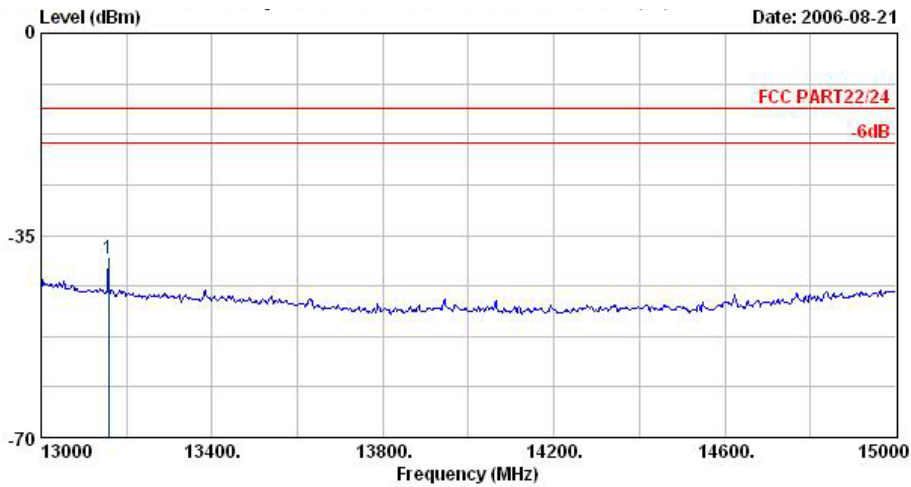

Site : 03CH06-HY
 Condition : HF-SPURIOUS HORIZONTAL
 EUT : PDA Phone
 Power : 120Vac/60Hz
 Model : FG 681516
 Memo : PCS1900 Link;CH661+Adaptor
 Plane : H

Freq	Level	Over	Limit	Read	Factor	Remark
MHz	dBm	dB	dBm	dBm	dB	
1 @ 13158.00	-39.10	-26.10	-13.00	-57.81	18.71	Peak

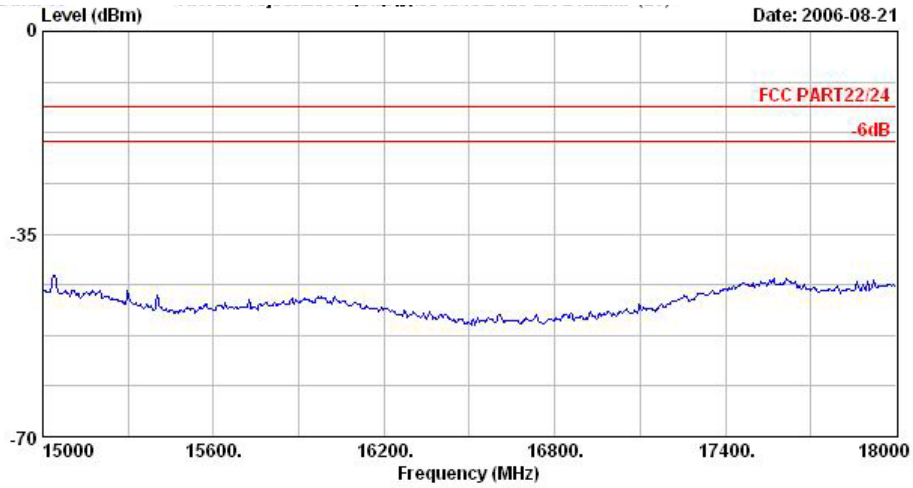

Site : 03CH06-HY
Condition : HF-SPURIOUS HORIZONTAL
EUT : PDA Phone
Power : 120Wac/60Hz
Model : FG 681516
Memo : PCS1900 Link;CH661+Adaptor
Plane : H



Vertical Polarization

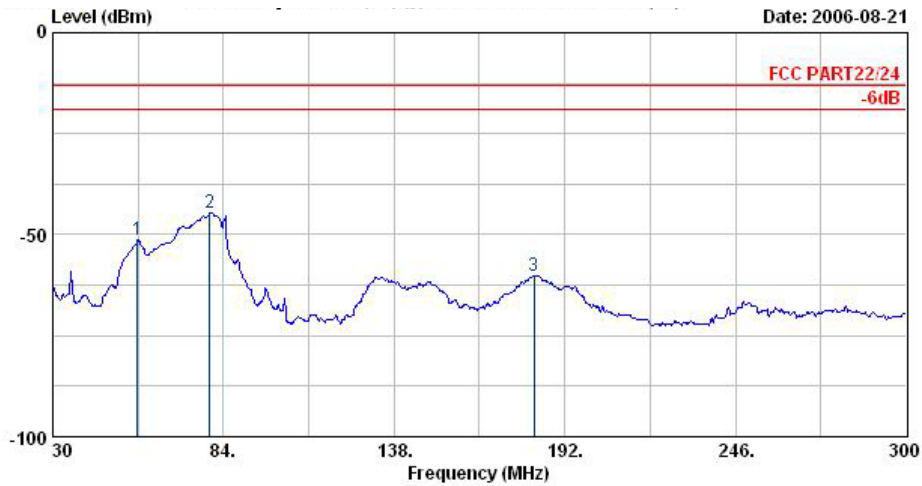

Site : 03CH06-HY
 Condition : LF-SPURIOUS VERTICAL
 EUT : PDA Phone
 Power : 120Vac/60Hz
 Model : FG 681516
 Memo : PCS1900 Link;CH661+Adaptor
 Plane : H

	Freq MHz	Level dBm	Over Limit dB	Limit Line dBm	Read Level dBm	Factor dB	Remark
1	56.73	-51.30	-38.30	-13.00	-37.46	-13.84	Peak
2 @	79.68	-44.59	-31.59	-13.00	-33.97	-10.63	Peak
3	182.28	-60.12	-47.12	-13.00	-51.69	-8.43	Peak

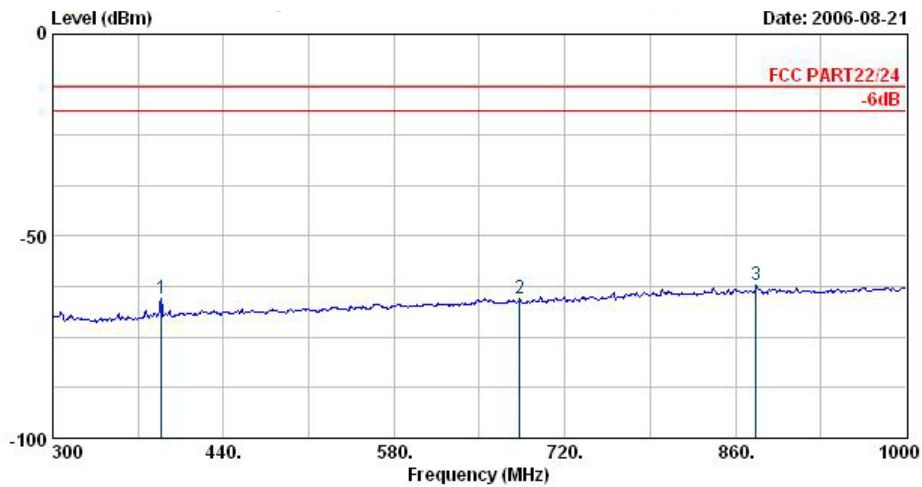

Site : 03CH06-HY
 Condition : LF-SPURIOUS VERTICAL
 EUT : PDA Phone
 Power : 120Vac/60Hz
 Model : FG 681516
 Memo : PCS1900 Link;CH661+Adaptor
 Plane : H

	Freq MHz	Level dBm	Over Limit dB	Limit Line dBm	Read Level dBm	Factor dB	Remark
1	388.90	-65.55	-52.55	-13.00	-60.99	-4.56	Peak
2	682.90	-65.55	-52.55	-13.00	-64.86	-0.69	Peak
3	876.80	-62.17	-49.17	-13.00	-63.85	1.68	Peak

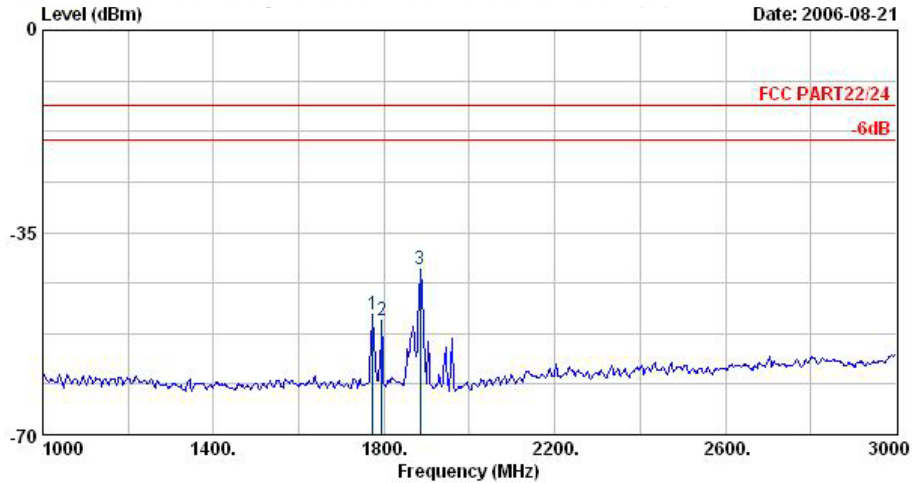

Site : 03CH06-HY
 Condition : HF-SPURIOUS VERTICAL
 EUT : PDA Phone
 Power : 120Vac/60Hz
 Model : FG 681516
 Memo : PCS1900 Link;CH661+Adaptor
 Plane : H

	Freq	Level	Over	Limit	Read		
	MHz	dBm	Limit	Line	Level	Factor	Remark
			dB	dBm	dBm	dB	
1	1774.00	-49.14	-36.14	-13.00	-48.78	-0.36	Peak
2	1794.00	-50.26	-37.26	-13.00	-49.87	-0.39	Peak
3 @	1884.00	-41.45			-40.95	-0.50	Peak

Remark:

- 1. #3: MS Signal

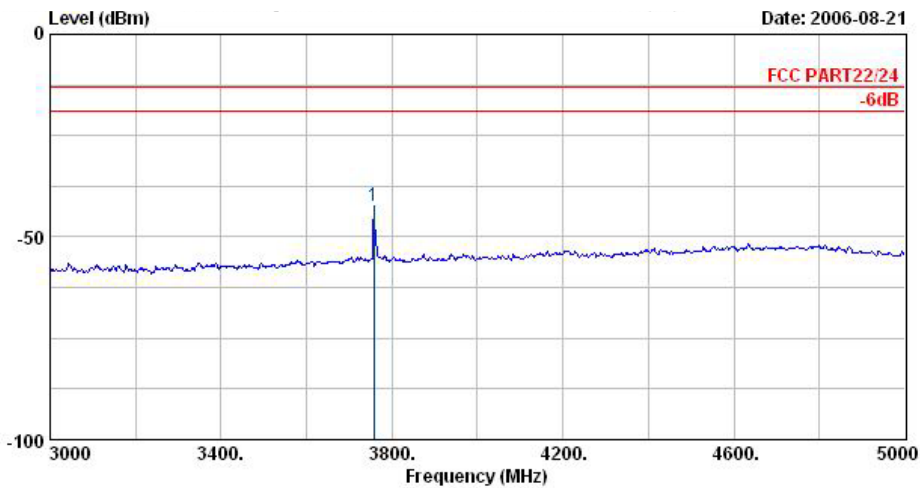

Site : 03CH06-HY
 Condition : HF-SPURIOUS VERTICAL
 EUT : PDA Phone
 Power : 120Vac/60Hz
 Model : FG 681516
 Memo : PCS1900 Link;CH661+Adaptor
 Plane : H

	Freq	Level	Over	Limit	Read		
	MHz	dBm	Limit	Line	Level	Factor	Remark
			dB	dBm	dBm	dB	
1 @	3758.00	-42.22	-29.22	-13.00	-48.86	6.64	Peak

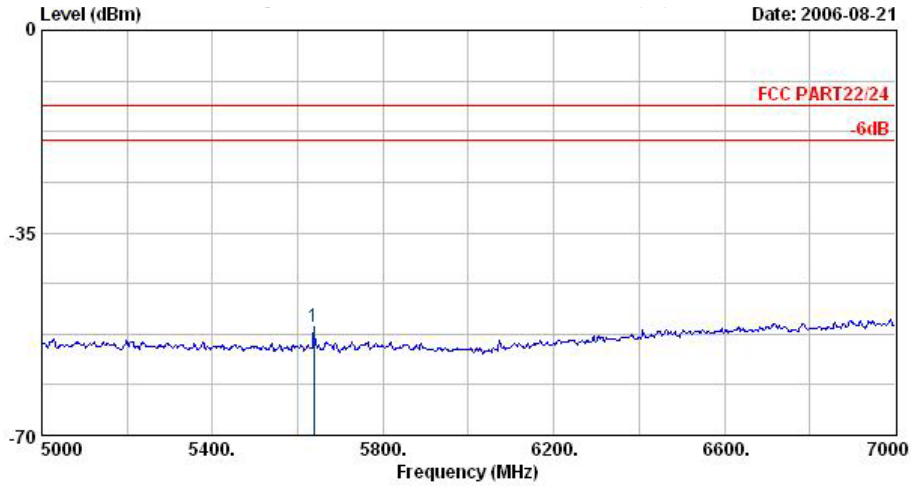

Site : 03CH06-HY
 Condition : HF-SPURIOUS VERTICAL
 EUT : PDA Phone
 Power : 120Vac/60Hz
 Model : FG 681516
 Memo : PCS1900 Link;CH661+Adaptor
 Plane : H

	Freq	Level	Over	Limit	Read	
	MHz	dBm	Limit	Line	Level	Factor Remark
			dB	dBm	dBm	dB
1	5638.00	-51.35	-38.35	-13.00	-60.00	8.65 Peak

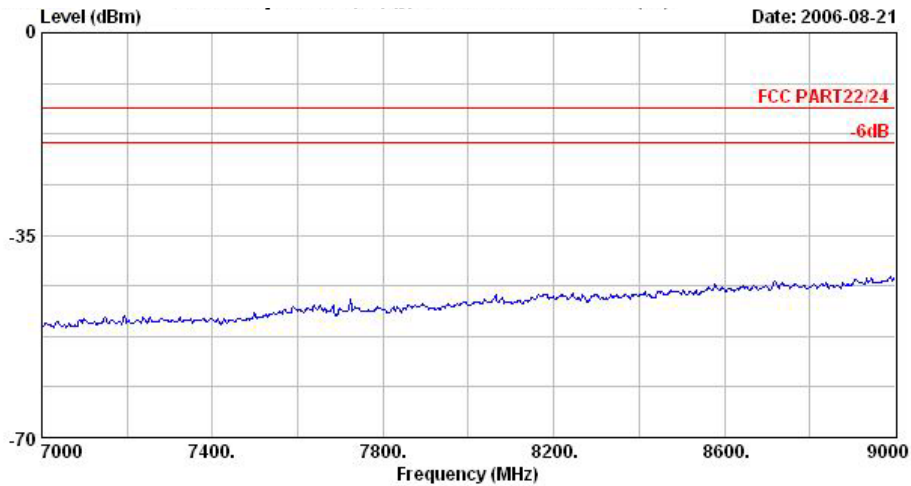

Site : 03CH06-HY
 Condition : HF-SPURIOUS VERTICAL
 EUT : PDA Phone
 Power : 120Vac/60Hz
 Model : FG 681516
 Memo : PCS1900 Link;CH661+Adaptor
 Plane : H

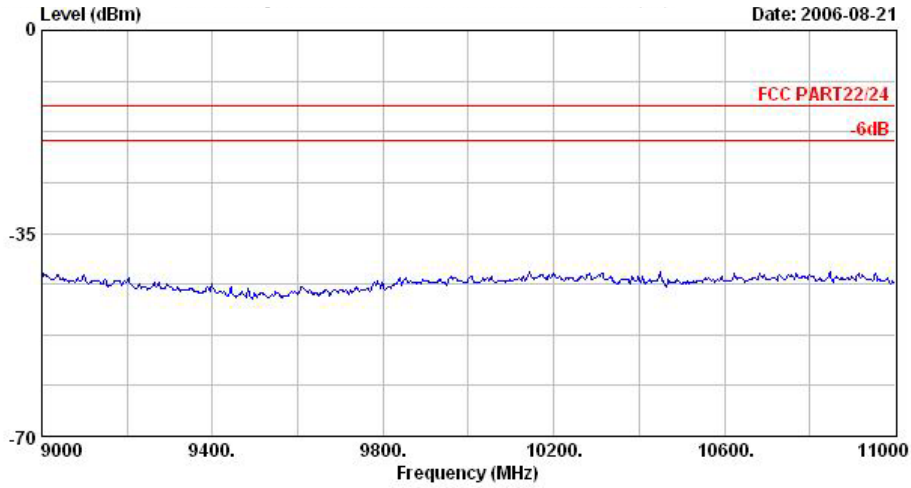

Site : 03CH06-HY
 Condition : HF-SPURIOUS VERTICAL
 EUT : PDA Phone
 Power : 120Vac/60Hz
 Model : FG 681516
 Memo : PCS1900 Link;CH661+Adaptor
 Plane : H

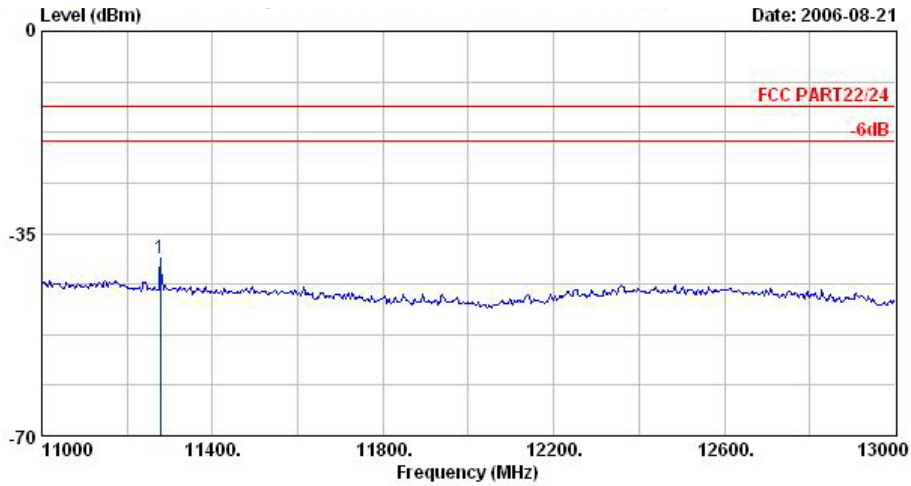

Site : 03CH06-HY
 Condition : HF-SPURIOUS VERTICAL
 EUT : PDA Phone
 Power : 120Vac/60Hz
 Model : FG 681516
 Memo : PCS1900 Link;CH661+Adaptor
 Plane : H

	Freq	Level	Over	Limit	Read		
	MHz	dBm	Limit	Line	Level	Factor	Remark
			dB	dBm	dBm	dB	
1 @	11278.00	-39.41	-26.41	-13.00	-58.28	18.87	Peak

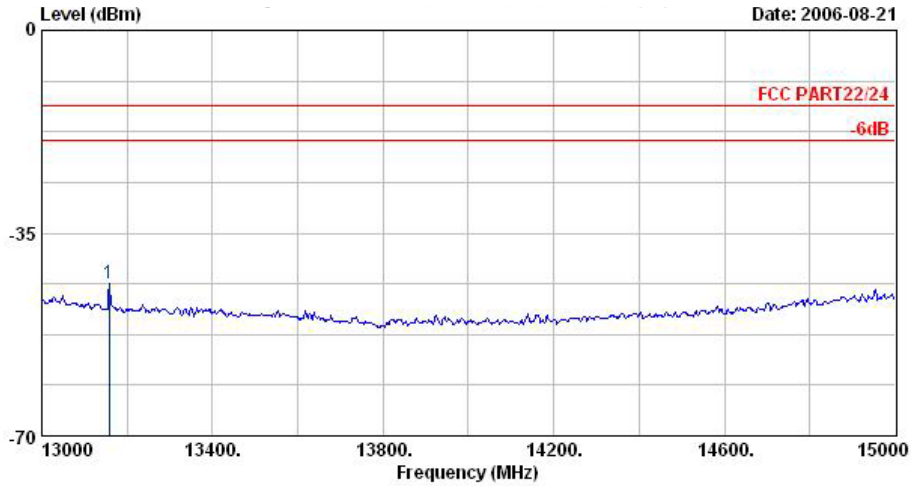

Site : 03CH06-HY
 Condition : HF-SPURIOUS VERTICAL
 EUT : PDA Phone
 Power : 120Vac/60Hz
 Model : FG 681516
 Memo : PCS1900 Link;CH661+Adaptor
 Plane : H

	Freq	Level	Over	Limit	Read	Factor	Remark
	MHz	dBm	dB	dBm	dBm	dB	
1 @	13158.00	-43.77	-30.77	-13.00	-59.56	15.79	Peak

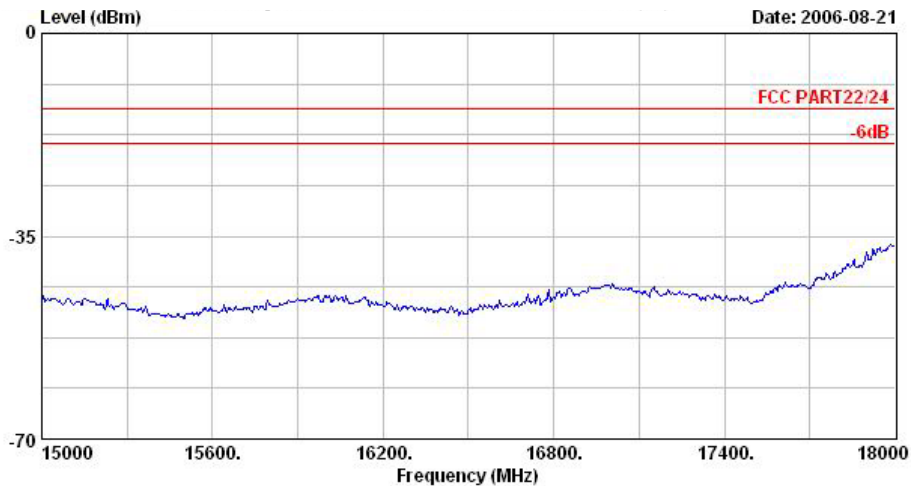

Site : 03CH06-HY
 Condition : HF-SPURIOUS VERTICAL
 EUT : PDA Phone
 Power : 120Vac/60Hz
 Model : FG 681516
 Memo : PCS1900 Link;CH661+Adaptor
 Plane : H

Remark : There is no more obvious emission except the listings above.



4.6.5.2 Mode 2
Horizontal Polarization

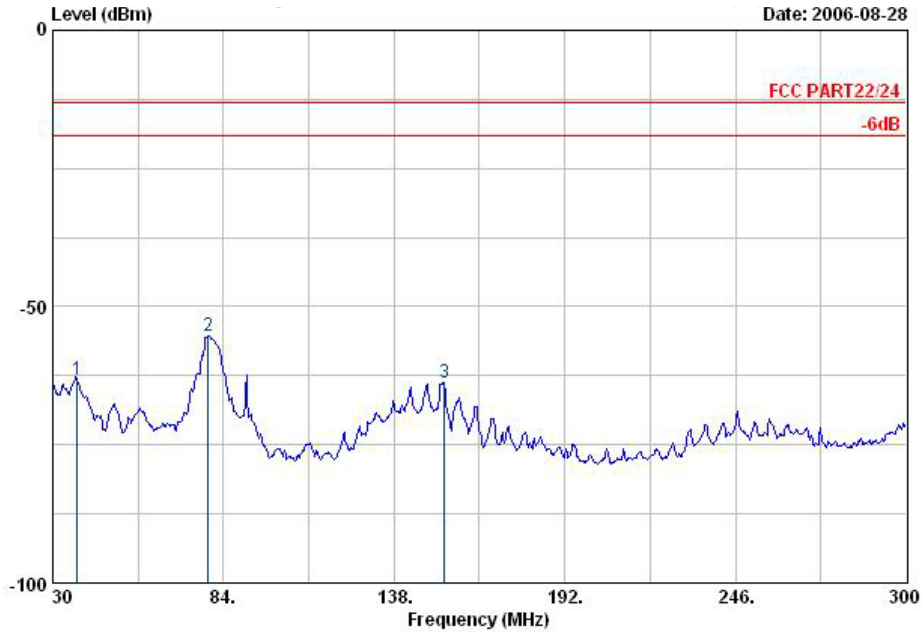

Site : 03CH06-HY
 Condition : LF-SPURIOUS HORIZONTAL
 EUT : PDA Phone
 Power : 120Vac/60Hz
 Model : FG 681516
 Memo : PCS1900 Link;CH661+WLAN Link;CH01
 Memo : +Adaptor
 Plane : H

	Freq	Level	Over	Limit	Read		Remark	Pol/Phase
	MHz	dBm	dB	dBm	dBm	dB		
1	37.83	-63.15	-50.15	-13.00	-58.63	-4.51	Peak	HORIZONTAL
2 @	79.14	-55.33	-42.33	-13.00	-43.01	-12.32	Peak	HORIZONTAL
3	153.93	-63.84	-50.84	-13.00	-50.97	-12.87	Peak	HORIZONTAL

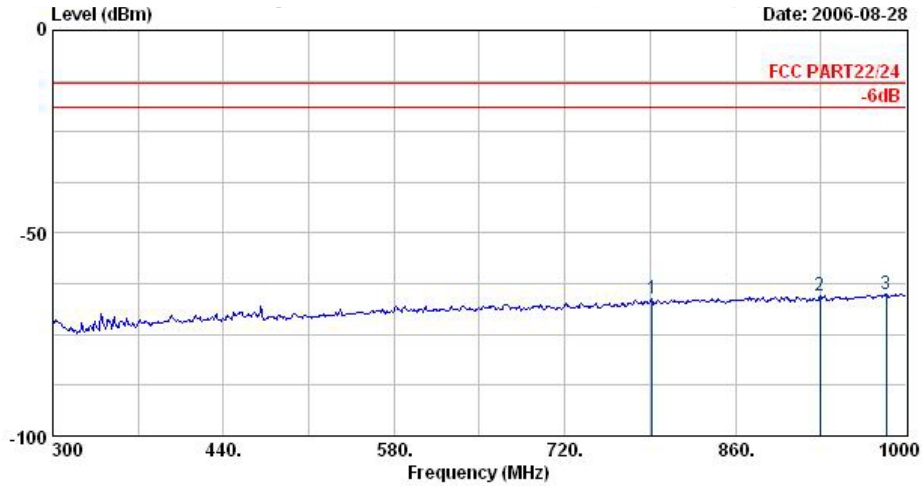

Site : 03CH06-HY
 Condition : LF-SPURIOUS HORIZONTAL
 EUT : PDA Phone
 Power : 120Vac/60Hz
 Model : FG 681516
 Memo : PCS1900 Link;CH661+WLAN Link;CH01
 Memo : +Adaptor
 Plane : H

	Freq	Level	Over	Limit	Read		
	MHz	dBm	Limit	Line	Level	Factor	Remark
			dB	dBm	dBm	dB	
1 @	791.40	-66.32	-53.32	-13.00	-64.54	-1.78	Peak
2 @	929.30	-65.40	-52.40	-13.00	-64.96	-0.44	Peak
3 @	983.90	-65.10	-52.10	-13.00	-65.18	0.08	Peak

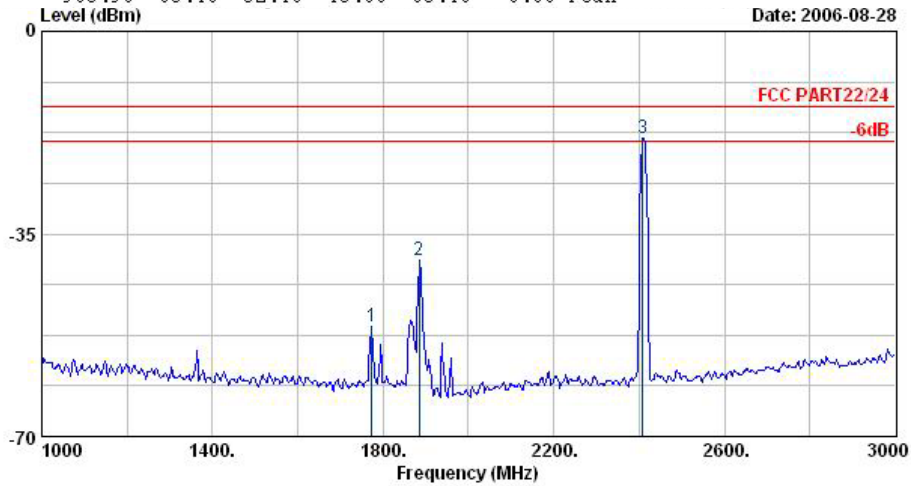

Site : 03CH06-HY
 Condition : HF-SPURIOUS HORIZONTAL
 EUT : PDA Phone
 Power : 120Vac/60Hz
 Model : FG 681516
 Memo : PCS1900 Link;CH661+WLAN Link;CH01
 Memo : +Adaptor
 Plane : H

	Freq	Level	Over	Limit	Read		
	MHz	dBm	Limit	Line	Level	Factor	Remark
			dB	dBm	dBm	dB	
1 @	1774.00	-51.12	-38.12	-13.00	-51.05	-0.07	Peak
2 @	1884.00	-39.64			-38.96	-0.68	Peak
3 @	2408.00	-18.42			-19.31	0.89	Peak

Remark : 1. #2 MS Signal
 2. #3 WLAN Signal

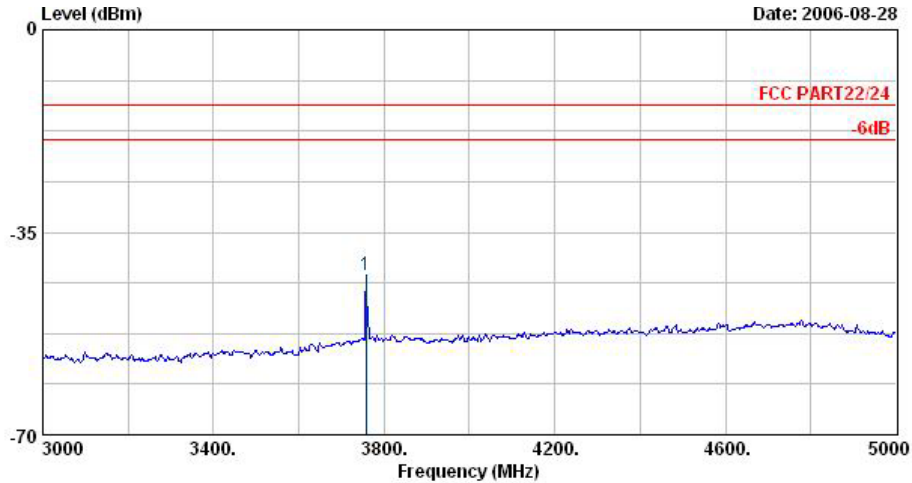

Site : 03CH06-HY
 Condition : HF-SPURIOUS HORIZONTAL
 EUT : PDA Phone
 Power : 120Vac/60Hz
 Model : FG 681516
 Memo : PCS1900 Link;CH661+WLAN Link;CH01
 Memo : +Adaptor
 Plane : H

	Freq	Level	Over	Limit	Read	Factor	Remark
	MHz	dBm	dB	dBm	dBm	dB	
1 @	3758.00	-42.37	-29.37	-13.00	-50.29	7.92	Peak

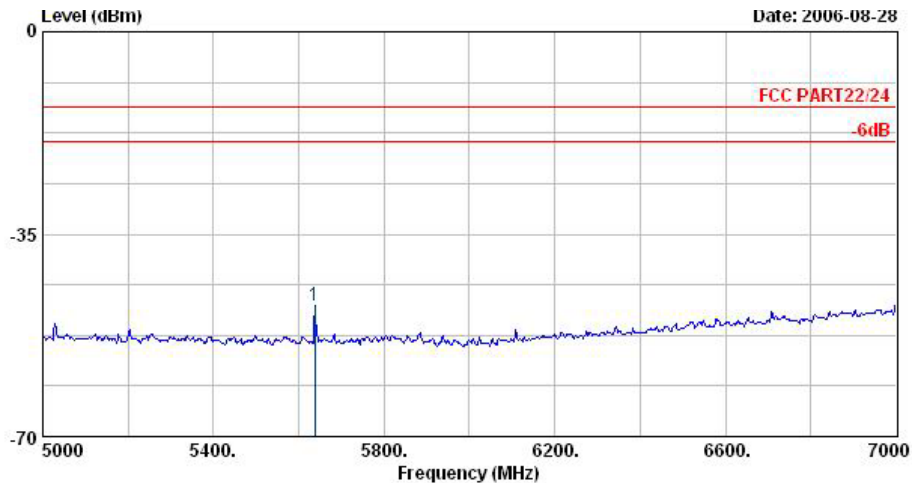

Site : 03CH06-HY
 Condition : HF-SPURIOUS HORIZONTAL
 EUT : PDA Phone
 Power : 120Vac/60Hz
 Model : FG 681516
 Memo : PCS1900 Link;CH661+WLAN Link;CH01
 Memo : +Adaptor
 Plane : H

	Freq	Level	Over	Limit	Read	Factor	Remark
	MHz	dBm	dB	dBm	dBm	dB	
1 @	5638.00	-47.37	-34.37	-13.00	-57.34	9.97	Peak

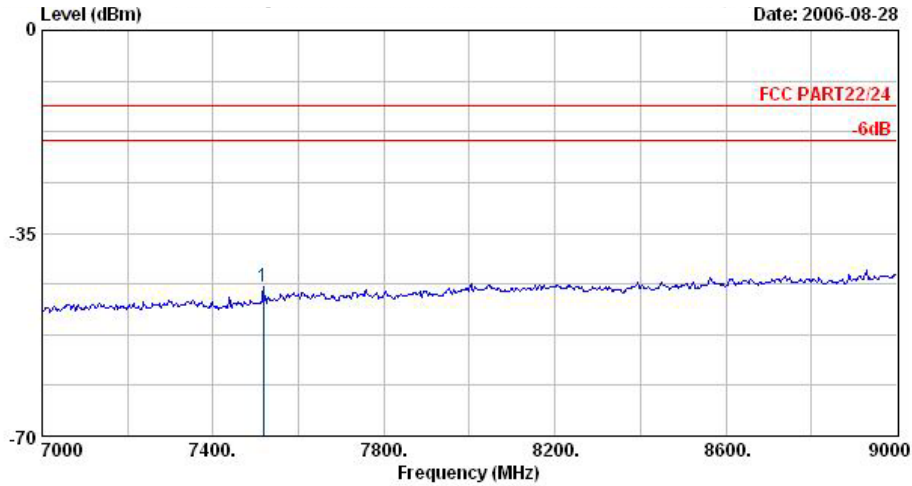

Site : 03CH06-HY
 Condition : HF-SPURIOUS HORIZONTAL
 EUT : PDA Phone
 Power : 120Vac/60Hz
 Model : FG 681516
 Memo : PCS1900 Link;CH661+WLAN Link;CH01
 Memo : +Adaptor
 Plane : H

	Freq	Level	Over	Limit	Read	
	MHz	dBm	Limit	Line	Level	Factor Remark
			dB	dBm	dBm	dB
1 @	7518.00	-44.16	-31.16	-13.00	-59.96	15.80 Peak

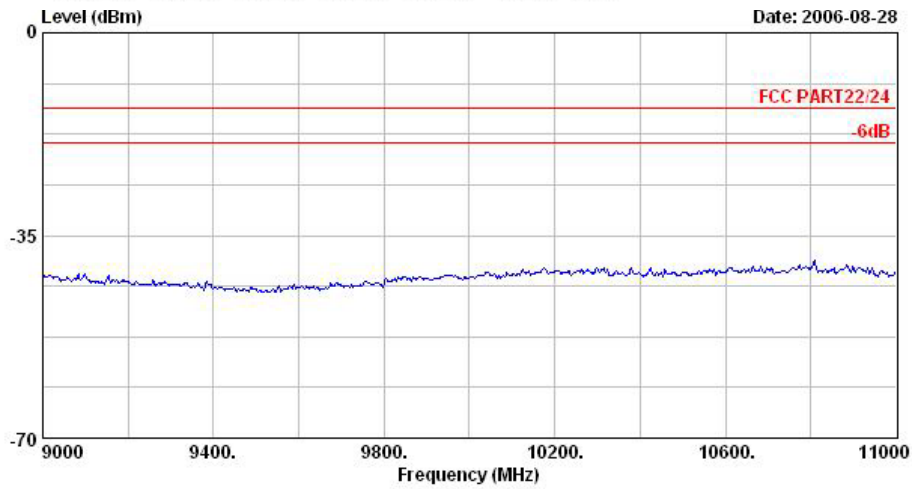

Site : 03CH06-HY
 Condition : HF-SPURIOUS HORIZONTAL
 EUT : PDA Phone
 Power : 120Vac/60Hz
 Model : FG 681516
 Memo : PCS1900 Link;CH661+WLAN Link;CH01
 Memo : +Adaptor
 Plane : H

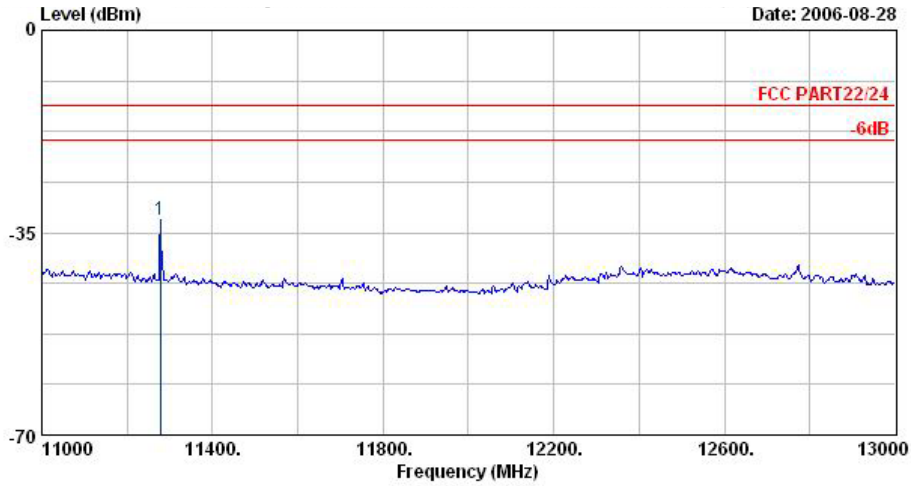

Site : 03CH06-HY
 Condition : HF-SPURIOUS HORIZONTAL
 EUT : PDA Phone
 Power : 120Vac/60Hz
 Model : FG 681516
 Memo : PCS1900 Link;CH661+WLAN Link;CH01
 Memo : +Adaptor
 Plane : H

	Freq	Level	Over	Limit	Read	Factor	Remark
	MHz	dBm	dB	dBm	dBm	dB	
1 @	11278.00	-32.88	-19.88	-13.00	-53.18	20.30	Peak

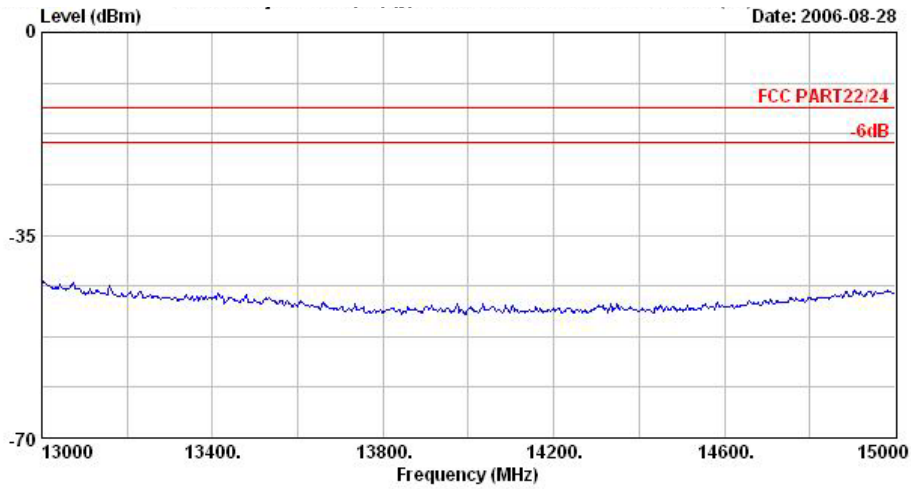

Site : 03CH06-HY
 Condition : HF-SPURIOUS HORIZONTAL
 EUT : PDA Phone
 Power : 120Vac/60Hz
 Model : FG 681516
 Memo : PCS1900 Link;CH661+WLAN Link;CH01
 Memo : +Adaptor
 Plane : H

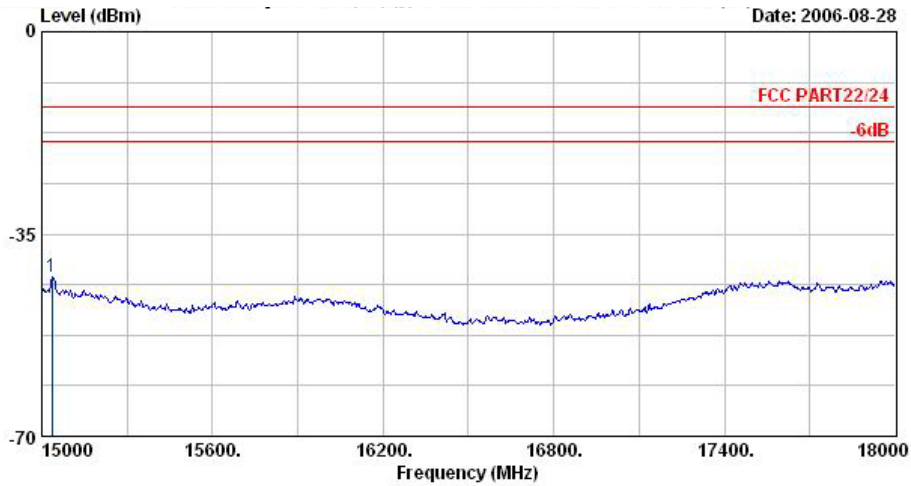

Site : 03CH06-HY
 Condition : HF-SPURIOUS HORIZONTAL
 EUT : PDA Phone
 Power : 120Vac/60Hz
 Model : FG 681516
 Memo : PCS1900 Link;CH661+WLAN Link;CH01
 Memo : +Adaptor
 Plane : H

	Freq	Level	Over	Limit	Read		
	MHz	dBm	Limit	Line	Level	Factor	Remark
			dB	dBm	dBm	dB	
1 @	15036.00	-42.36	-29.36	-13.00	-60.12	17.76	Peak



Vertical Polarization

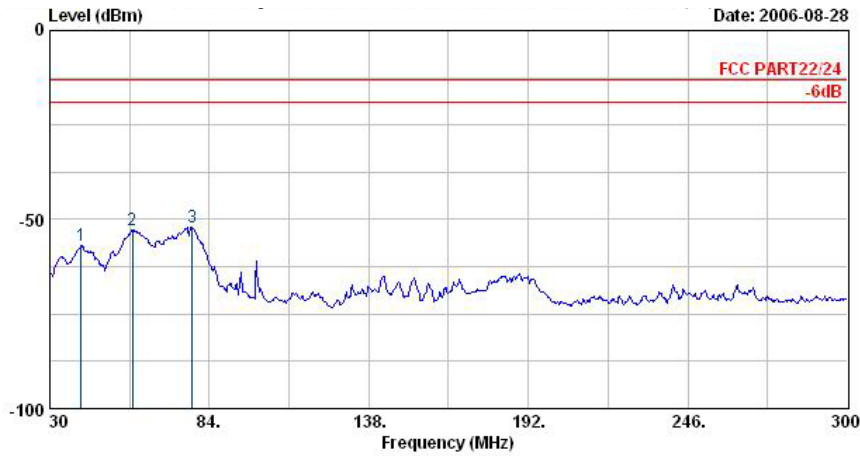

Site : 03CH06-HY
 Condition : LF-SPURIOUS VERTICAL
 EUT : PDA Phone
 Power : 120Vac/60Hz
 Model : FG 681516
 Memo : PCS1900 Link;CH661+WLAN Link;CH01
 Memo : +Adaptor
 Plane : H

	Freq MHz	Level dBm	Over Limit dB	Limit Line dBm	Read Level dBm	Factor dB	Remark
1 @	40.53	-56.98	-43.98	-13.00	-44.90	-12.08	Peak
2 @	58.08	-52.64	-39.64	-13.00	-38.94	-13.70	Peak
3 @	78.33	-51.96	-38.96	-13.00	-41.19	-10.77	Peak

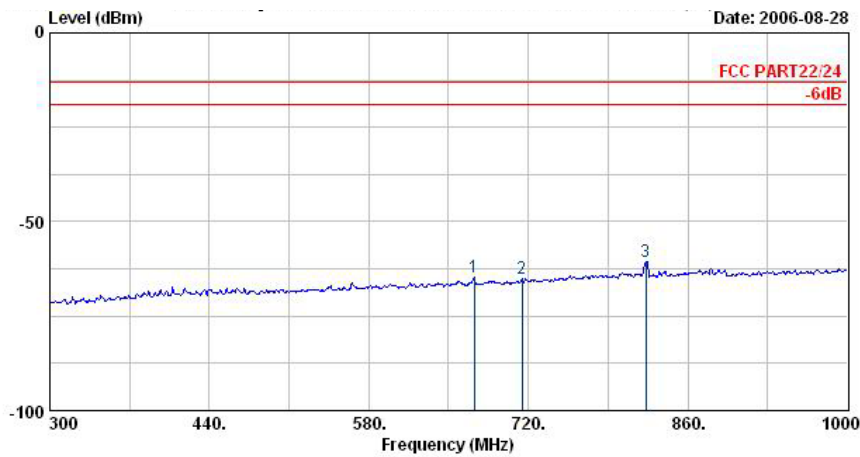

Site : 03CH06-HY
 Condition : LF-SPURIOUS VERTICAL
 EUT : PDA Phone
 Power : 120Vac/60Hz
 Model : FG 681516
 Memo : PCS1900 Link;CH661+WLAN Link;CH01
 Memo : +Adaptor
 Plane : H

	Freq MHz	Level dBm	Over Limit dB	Limit Line dBm	Read Level dBm	Factor dB	Remark
1 @	672.40	-64.51	-51.51	-13.00	-63.66	-0.85	Peak
2 @	714.40	-65.06	-52.06	-13.00	-64.85	-0.21	Peak
3 @	822.90	-60.50	-47.50	-13.00	-61.75	1.25	Peak

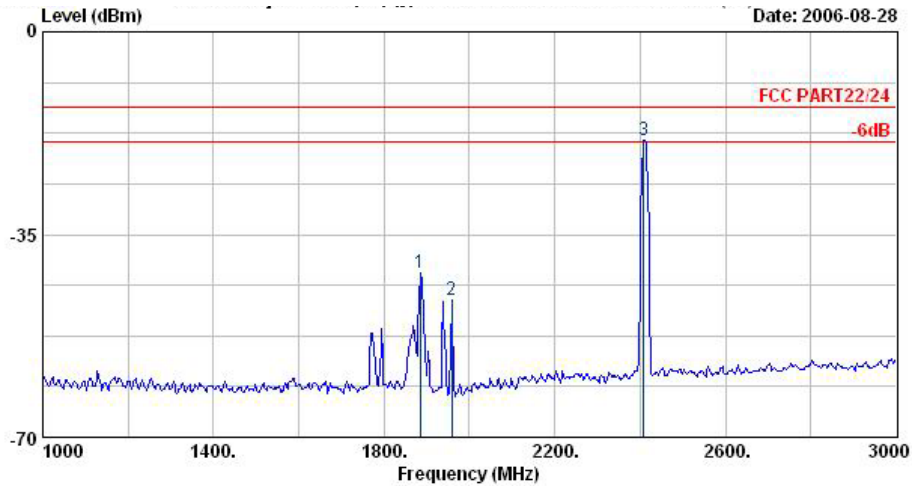

Site : 03CH06-HY
 Condition : HF-SPURIOUS VERTICAL
 EUT : PDA Phone
 Power : 120Vac/60Hz
 Model : FG 681516
 Memo : PCS1900 Link;CH661+WLAN Link;CH01
 Memo : +Adaptor
 Plane : H

	Freq	Level	Over	Limit	Read		
	MHz	dBm	Limit	Line	Level	Factor	Remark
			dB	dBm	dBm	dB	
1 @	1884.00	-41.58			-41.08	-0.50	Peak
2 @	1958.00	-46.39	-33.39	-13.00	-45.80	-0.60	Peak
3 @	2408.00	-18.81			-20.68	1.87	Peak

Remark :

- #1 MS Signal
- #3 WLAN Signal

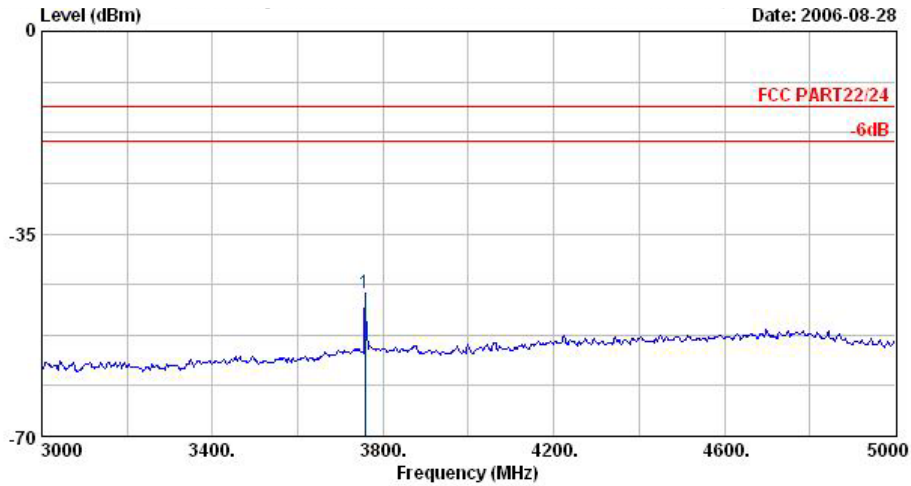

Site : 03CH06-HY
 Condition : HF-SPURIOUS VERTICAL
 EUT : PDA Phone
 Power : 120Vac/60Hz
 Model : FG 681516
 Memo : PCS1900 Link;CH661+WLAN Link;CH01
 Memo : +Adaptor
 Plane : H

	Freq	Level	Over	Limit	Read	Factor	Remark
	MHz	dBm	dB	dBm	dBm	dB	
1 @	3758.00	-45.20	-32.20	-13.00	-51.84	6.64	Peak

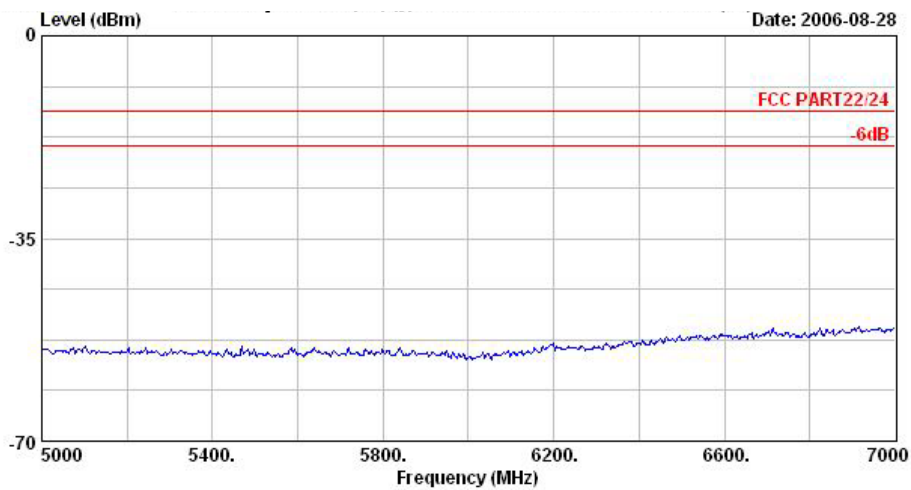

Site : 03CH06-HY
 Condition : HF-SPURIOUS VERTICAL
 EUT : PDA Phone
 Power : 120Vac/60Hz
 Model : FG 681516
 Memo : PCS1900 Link;CH661+WLAN Link;CH01
 Memo : +Adaptor
 Plane : H

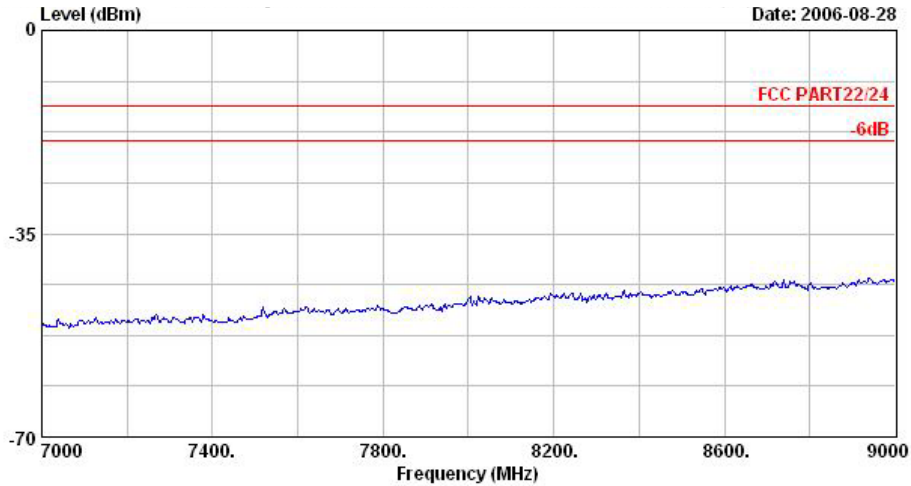

Site : 03CH06-HY
 Condition : HF-SPURIOUS VERTICAL
 EUT : PDA Phone
 Power : 120Vac/60Hz
 Model : FG 681516
 Memo : PCS1900 Link;CH661+WLAN Link;CH01
 Memo : +Adaptor
 Plane : H

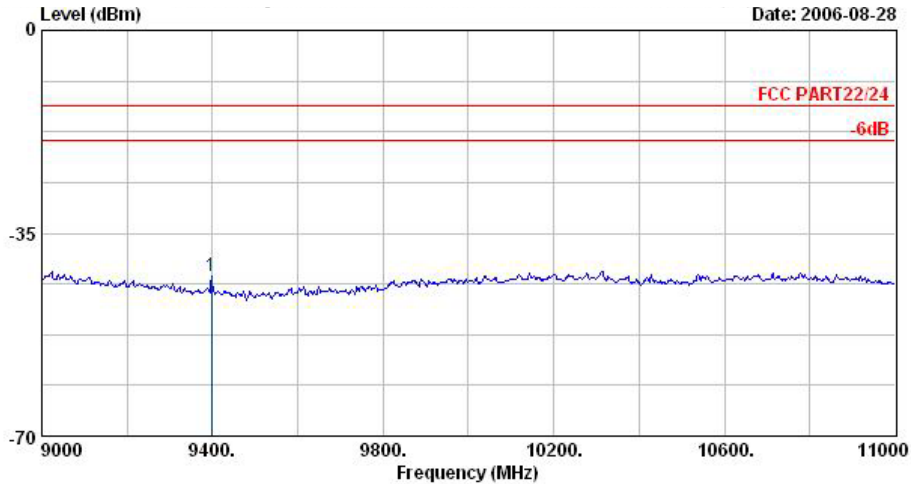

Site : 03CH06-HY
 Condition : HF-SPURIOUS VERTICAL
 EUT : PDA Phone
 Power : 120Vac/60Hz
 Model : FG 681516
 Memo : PCS1900 Link;CH661+WLAN Link;CH01
 Memo : +Adaptor
 Plane : H

	Freq	Level	Over	Limit	Read		
	MHz	dBm	dB	dBm	dBm	dB	Remark
1 @	9398.00	-42.43	-29.43	-13.00	-59.63	17.20	Peak

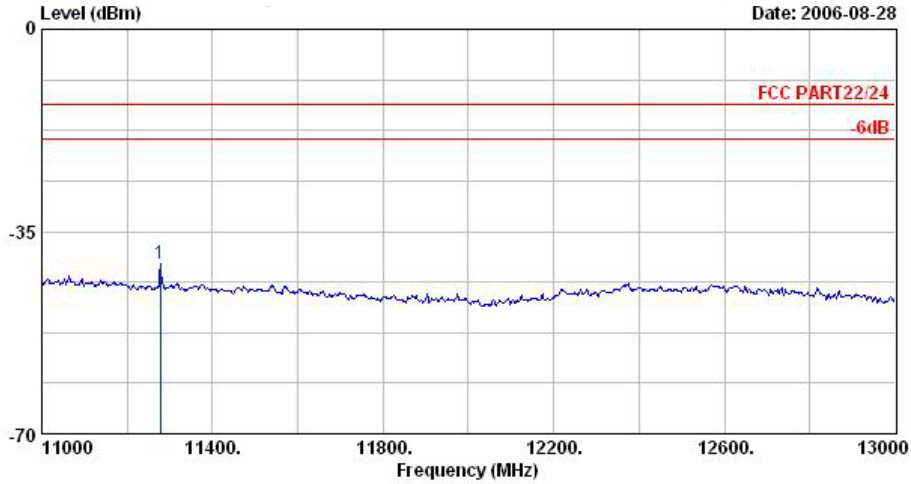

Site : 03CH06-HY
 Condition : HF-SPURIOUS VERTICAL
 EUT : PDA Phone
 Power : 120Vac/60Hz
 Model : FG 681516
 Memo : PCS1900 Link;CH661+WLAN Link;CH01
 Memo : +Adaptor
 Plane : H

	Freq	Level	Over	Limit	Read		
	MHz	dBm	dB	dBm	dBm	dB	Remark
1 @	11278.00	-40.65	-27.65	-13.00	-59.52	18.87	Peak

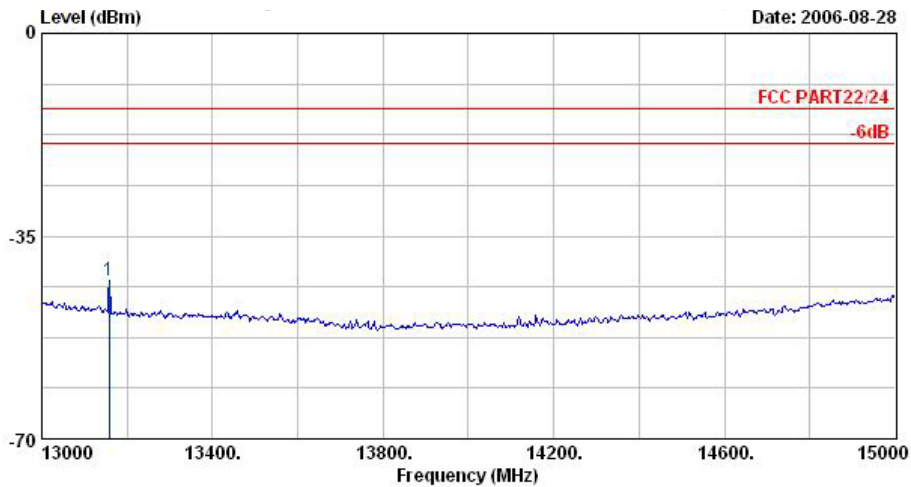

Site : 03CH06-HY
 Condition : HF-SPURIOUS VERTICAL
 EUT : PDA Phone
 Power : 120Vac/60Hz
 Model : FG 681516
 Memo : PCS1900 Link;CH661+WLAN Link;CH01
 Memo : +Adaptor
 Plane : H

	Freq	Level	Over	Limit	Read		
	MHz	dBm	dB	dBm	dBm	dB	Remark
1 @	13158.00	-42.76	-29.76	-13.00	-58.55	15.79	Peak

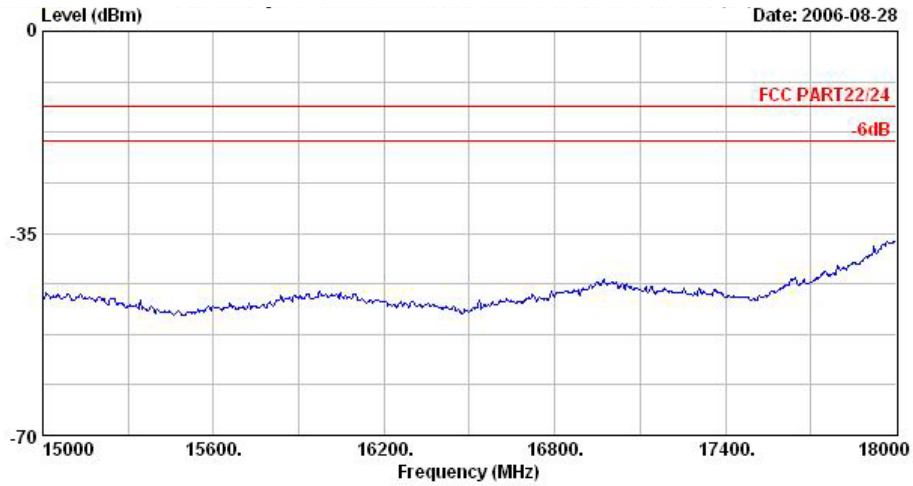

Site : 03CH06-HY
Condition : HF-SPURIOUS VERTICAL
EUT : PDA Phone
Power : 120Vac/60Hz
Model : FG 681516
Memo : PCS1900 Link;CH661+WLAN Link;CH01
Memo : +Adaptor
Plane : H

Remark : There is no more obvious emission except the listings above.

4.7 Frequency Stability (Temperature Variation)

4.7.1 Measurement Instrument

As described in chapter 5 of this test report.

4.7.2 Test Procedure

1. The EUT and test equipment were set up as shown on the following section.
2. With all power removed, the temperature was decreased to -30°C and permitted to stabilize for three hours. Power was applied and the maximum change in frequency was noted within one minute.
3. With power OFF, the temperature was raised in 10°C steps. The sample was permitted to stabilize at each step for at least one-half hour. Power was applied and the maximum frequency change was noted within one minute.
4. The temperature tests were performed for the worst case.
5. Test data was recorded.

4.7.3 Test Setup Layout

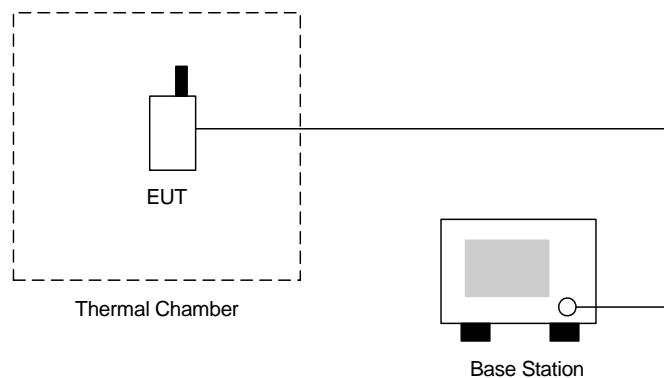



4.7.4 Test Result

- Test Mode : PCS1900 CH661

Temperature(°C)	Change (Hz)	Change (ppm)	Limit (ppm)	Result
-30	131	0.07	2.5	Passed
-20	89	0.05		
-10	76	0.04		
0	68	0.04		
10	45	0.02		
20	48	0.03		
30	-58	-0.03		
40	-29	-0.02		
50	-27	-0.01		

4.8 Frequency Stability (Voltage Variation)

4.8.1 Measurement Instrument

As described in chapter 5 of this test report.

4.8.2 Test Procedure

1. The EUT was placed in a temperature chamber at $25\pm 5^{\circ}\text{C}$ and connected as the following section.
2. The power supply voltage to the EUT was varied from BEP to 115% of the nominal value measured at the input to the EUT.
3. The variation in frequency was measured for the worst case.

4.8.3 Test Setup Layout

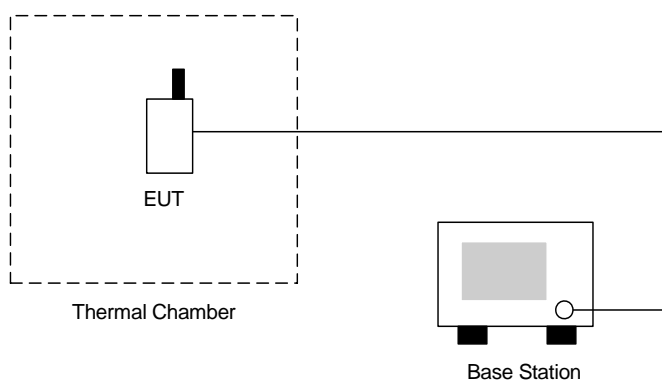

4.8.4 Test Result

- Test Mode : PCS (GSM) CH661

Voltage(Volt)	Change (Hz)	Change (ppm)	Limit (ppm)	Result
3.7	44.0	0.02	2.5	Passed
BEP	127.0	0.07		
4.3	47.0	0.02		

Remark:

1. Normal Voltage=3.7V.
2. Battery End Point (BEP)=3.3 V.



5 List of Measurement Equipments

Instrument	Manufacturer	Model No.	Serial No.	Characteristics	Calibration Date	Due Date	Remark
Spectrum analyzer	Agilent	E4408B	MY44211030	9KHz-26.5GHz	Jul. 25, 2006	Jul. 24, 2007	Radiation (03CH06-HY)
Receiver	R&S	ESCS30	100356	9KHz-2.75GHz	Jun. 26, 2006	Jun. 25, 2007	Radiation (03CH06-HY)
Controller	CT	SC100	N/A	N/A	N/A	N/A	Radiation (03CH06-HY)
Bilog Antenna	SCHAFFNER	CBL6112B	2885	30MHz -2GHz	Nov. 21, 2004	Nov. 20, 2006	Radiation (03CH06-HY)
Horn Antenna	Com-Power	AH118	071025	1G-18G	Feb. 1, 2005	Jan. 31, 2007	Radiation (03CH06-HY)
SHF-EHF Horn	SCHWARZBECK	BBHA 9170	9170-249	14G - 40G	Jul. 21, 2006	Jul. 20, 2007	Radiation (03CH06-HY)
HF Amplifier	MITEQ	AFS44	973248	0.1G - 26.5G	Dec. 17, 2005	Dec. 17, 2006	Radiation (03CH06-HY)
Amplifier	MITEQ	AMF-6F	997165	26G - 40G	Jul. 21, 2006	Jul. 20, 2007	Radiation (03CH06-HY)
Turn Table	HD	DS 420	420/650/00	0 ~ 360 degree	N/A	N/A	Radiation (03CH06-HY)
Antenna Mast	HD	MA 240	240/560/00	1 m - 4 m	N/A	N/A	Radiation (03CH06-HY)



6 Uncertainty Evaluation

Uncertainty of Radiated Emission Measurement (30MHz ~ 1000MHz)

Contribution	Uncertainty of x_i		$u(x_i)$
	dB	Probability Distribution	
Receiver reading	0.41	Normal(k=2)	0.21
Antenna factor calibration	0.83	Normal(k=2)	0.42
Cable loss calibration	0.25	Normal(k=2)	0.13
Pre Amplifier Gain calibration	0.27	Normal(k=2)	0.14
RCV/SPA specification	2.50	Rectangular	0.72
Antenna Factor Interpolation for Frequency	1.00	Rectangular	0.29
Site imperfection	1.43	Rectangular	0.83
Mismatch	+0.39/-0.41	U-shaped	0.28
combined standard uncertainty Uc(y)	1.27		
Measuring uncertainty for a level of confidence of 95% U=2Uc(y)	2.54		

Uncertainty of Radiated Emission Measurement (1GHz ~ 40GHz)

Contribution	Uncertainty of x_i		$u(x_i)$	C_i	$C_i * u(x_i)$
	dB	Probability Distribution			
Receiver reading	±0.10	Normal(k=1)	0.10	1	0.10
Antenna factor calibration	±1.70	Normal(k=2)	0.85	1	0.85
Cable loss calibration	±0.50	Normal(k=2)	0.25	1	0.25
Receiver Correction	±2.00	Rectangular	1.15	1	1.15
Antenna Factor Directional	±1.50	Rectangular	0.87	1	0.87
Site imperfection	±2.80	Triangular	1.14	1	1.14
Mismatch Receiver VSWR $\Gamma_1 = 0.197$ Antenna VSWR $\Gamma_2 = 0.194$ Uncertainty = $20 \log(1 - \Gamma_1 * \Gamma_2 * \Gamma_3)$	+0.34/-0.35	U-shaped	0.244	1	0.244
Combined standard uncertainty Uc(y)	2.36				
Measuring uncertainty for a level of confidence of 95% U=2Ue(y)	4.72				

END OF TEST REPORT