

FCC TEST REPORT (15.247)

REPORT NO.: RF140331C10-1
MODEL NO.: K01A
FCC ID: MSQK01A
RECEIVED: Mar. 21, 2014
TESTED: Mar. 31, 2014 ~ Apr. 15, 2014
ISSUED: Apr. 21, 2014

APPLICANT: ASUSTek COMPUTER INC.

ADDRESS: 4F, No. 150, LI-TE Rd., PEITOU, TAIPEI 112, TAIWAN

ISSUED BY: Bureau Veritas Consumer Products Services
(H.K.) Ltd., Taoyuan Branch

LAB ADDRESS: No. 47, 14th Ling, Chia Pau Vil., Lin Kou Dist.,
New Taipei City, Taiwan (R.O.C)

TEST LOCATION: No. 19, Hwa Ya 2nd Rd, Wen Hwa Tsuen, Kwei
Shan Hsiang, Taoyuan Hsien 333, Taiwan, R.O.C.

This report should not be used by the client to claim product certification, approval, or endorsement by TAF or any government agencies.



This report is for your exclusive use. Any copying or replication of this report to or for any other person or entity, or use of our name or trademark, is permitted only with our prior written permission. This report sets forth our findings solely with respect to the test samples identified herein. The results set forth in this report are not indicative or representative of the quality or characteristics of the lot from which a test sample was taken or any similar or identical product unless specifically and expressly noted. Our report includes all of the tests requested by you and the results thereof based upon the information that you provided to us. You have 60 days from date of issuance of this report to notify us of any material error or omission caused by our negligence, provided, however, that such notice shall be in writing and shall specifically address the issue you wish to raise. A failure to raise such issue within the prescribed time shall constitute your unqualified acceptance of the completeness of this report, the tests conducted and the correctness of the report contents. Unless specific mention, the uncertainty of measurement has been explicitly taken into account to declare the compliance or non-compliance to the specification.



TABLE OF CONTENTS

- RELEASE CONTROL RECORD4
- 1. CERTIFICATION.....5
- 2. SUMMARY OF TEST RESULTS6
 - 2.1 MEASUREMENT UNCERTAINTY.....6
- 3. GENERAL INFORMATION7
 - 3.1 GENERAL DESCRIPTION OF EUT7
 - 3.2 DESCRIPTION OF TEST MODES8
 - 3.2.1 TEST MODE APPLICABILITY AND TESTED CHANNEL DETAIL9
 - 3.3 DESCRIPTION OF SUPPORT UNITS11
 - 3.3.1 CONFIGURATION OF SYSTEM UNDER TEST11
 - 3.4 DUTY CYCLE TEST SIGNAL12
 - 3.5 GENERAL DESCRIPTION OF APPLIED STANDARDS12
- 4. TEST TYPES AND RESULTS (FOR 2.4GHz BAND)13
 - 4.1 RADIATED EMISSION AND BANDEDGE MEASUREMENT13
 - 4.1.1 LIMITS OF RADIATED EMISSION AND BANDEDGE MEASUREMENT13
 - 4.1.2 TEST INSTRUMENTS14
 - 4.1.3 TEST PROCEDURES15
 - 4.1.4 DEVIATION FROM TEST STANDARD15
 - 4.1.5 TEST SETUP16
 - 4.1.6 EUT OPERATING CONDITIONS16
 - 4.1.7 TEST RESULTS.....17
 - 4.2 CONDUCTED EMISSION MEASUREMENT27
 - 4.2.1 LIMITS OF CONDUCTED EMISSION MEASUREMENT27
 - 4.2.2 TEST INSTRUMENTS27
 - 4.2.3 TEST PROCEDURES28
 - 4.2.4 DEVIATION FROM TEST STANDARD28
 - 4.2.5 TEST SETUP29
 - 4.2.6 EUT OPERATING CONDITIONS29
 - 4.2.7 TEST RESULTS.....30
 - 4.3 6dB BANDWIDTH MEASUREMENT32
 - 4.3.1 LIMITS OF 6dB BANDWIDTH MEASUREMENT32
 - 4.3.2 TEST SETUP32
 - 4.3.3 TEST INSTRUMENTS32
 - 4.3.4 TEST PROCEDURE32
 - 4.3.5 DEVIATION FROM TEST STANDARD32
 - 4.3.6 EUT OPERATING CONDITIONS32
 - 4.3.7 TEST RESULTS.....33
 - 4.4 CONDUCTED OUTPUT POWER35
 - 4.4.1 LIMITS OF CONDUCTED OUTPUT POWER MEASUREMENT35
 - 4.4.2 TEST SETUP35
 - 4.4.3 TEST INSTRUMENTS35
 - 4.4.4 TEST PROCEDURES35
 - 4.4.5 DEVIATION FROM TEST STANDARD35
 - 4.4.6 EUT OPERATING CONDITIONS35
 - 4.4.7 TEST RESULTS.....36
 - 4.5 POWER SPECTRAL DENSITY MEASUREMENT37
 - 4.5.1 LIMITS OF POWER SPECTRAL DENSITY MEASUREMENT37
 - 4.5.2 TEST SETUP37
 - 4.5.3 TEST INSTRUMENTS37
 - 4.5.4 TEST PROCEDURE37
 - 4.5.5 DEVIATION FROM TEST STANDARD37
 - 4.5.6 EUT OPERATING CONDITION.....37



A D T

| | | |
|-------|--|----|
| 4.5.7 | TEST RESULTS..... | 38 |
| 4.6 | CONDUCTED OUT OF BAND EMISSION MEASUREMENT | 40 |
| 4.6.1 | LIMITS OF CONDUCTED OUT OF BAND EMISSION MEASUREMENT | 40 |
| 4.6.2 | TEST SETUP | 40 |
| 4.6.3 | TEST INSTRUMENTS | 40 |
| 4.6.4 | TEST PROCEDURE | 40 |
| 4.6.5 | DEVIATION FROM TEST STANDARD | 40 |
| 4.6.6 | EUT OPERATING CONDITION..... | 40 |
| 4.6.7 | TEST RESULTS..... | 41 |
| 5. | PHOTOGRAPHS OF THE TEST CONFIGURATION..... | 44 |
| 6. | INFORMATION ON THE TESTING LABORATORIES | 45 |
| 7. | APPENDIX A – MODIFICATIONS RECORDERS FOR ENGINEERING CHANGES TO THE EUT BY THE LAB | 46 |



A D T

RELEASE CONTROL RECORD

| ISSUE NO. | REASON FOR CHANGE | DATE ISSUED |
|---------------|-------------------|---------------|
| RF140331C10-1 | Original release | Apr. 21, 2014 |



1. CERTIFICATION

PRODUCT: ASUS Tablet (WiFi/Bluetooth/GPS)
MODEL NO.: K01A
BRAND: ASUS
APPLICANT: ASUSTek COMPUTER INC.
TESTED: Mar. 31, 2014 ~ Apr. 15, 2014
TEST SAMPLE: Production Unit
STANDARDS: **FCC Part 15, Subpart C (Section 15.247)**
ANSI C63.10-2009

The above equipment (model: K01A) has been tested by **Bureau Veritas Consumer Products Services (H.K.) Ltd., Taoyuan Branch**, and found compliance with the requirement of the above standards. The test record, data evaluation & Equipment Under Test (EUT) configurations represented herein are true and accurate accounts of the measurements of the sample's EMC characteristics under the conditions specified in this report.

PREPARED BY : Rona Chen , **DATE :** Apr. 21, 2014
Rona Chen / Specialist

APPROVED BY : Sam chen , **DATE :** Apr. 21, 2014
Sam Chen / Senior Project Engineer

2. SUMMARY OF TEST RESULTS

The EUT has been tested according to the following specifications:

| APPLIED STANDARD: FCC PART 15, SUBPART C (SECTION 15.247) | | | |
|---|-----------------------------|--------|--|
| STANDARD SECTION | TEST TYPE | RESULT | REMARK |
| 15.207 | AC Power Conducted Emission | PASS | Meet the requirement of limit. Minimum passing margin is -14.13dB at 0.48594MHz. |
| 15.247(d) 15.209 | Radiated Emissions | PASS | Meet the requirement of limit. Minimum passing margin is -0.34dB at 2484MHz. |
| 15.247(d) | Band Edge Measurement | PASS | Meet the requirement of limit. |
| 15.247(a)(2) | 6dB bandwidth | PASS | Meet the requirement of limit. |
| 15.247(b) | Conducted power | PASS | Meet the requirement of limit. |
| 15.247(e) | Power Spectral Density | PASS | Meet the requirement of limit. |
| 15.203 | Antenna Requirement | PASS | No antenna connector is used. |

2.1 MEASUREMENT UNCERTAINTY

Where relevant, the following measurement uncertainty levels have been estimated for tests performed on the EUT as specified in CISPR 16-4-2:

| MEASUREMENT | FREQUENCY | UNCERTAINTY |
|---------------------|-----------------|-------------|
| Conducted emissions | 9kHz~30MHz | 2.44 dB |
| Radiated emissions | 30MHz ~ 200MHz | 2.93 dB |
| | 200MHz ~1000MHz | 2.95 dB |
| | 1GHz ~ 18GHz | 2.26 dB |
| | 18GHz ~ 40GHz | 1.94 dB |

This uncertainty represents an expanded uncertainty expressed at approximately the 95% confidence level using a coverage factor of $k = 2$.



A D T

3. GENERAL INFORMATION

3.1 GENERAL DESCRIPTION OF EUT

| | |
|------------------------------|--|
| EUT | ASUS Tablet (WiFi/Bluetooth/GPS) |
| MODEL NO. | K01A |
| POWER SUPPLY | 3.8Vdc (Battery) 5Vdc / 5.2Vdc (Adapter or host equipment) |
| MODULATION TYPE | CCK, DQPSK, DBPSK for DSSS 64QAM, 16QAM, QPSK, BPSK for OFDM |
| MODULATION TECHNOLOGY | DSSS, OFDM |
| TRANSFER RATE | 802.11b: 11.0 / 5.5 / 2.0 / 1.0 Mbps 802.11g: 54.0 / 48.0 / 36.0 / 24.0 / 18.0 / 12.0 / 9.0 / 6.0 Mbps 802.11n: up to MCS7 |
| OPERATING FREQUENCY | 2412 ~ 2462MHz |
| NUMBER OF CHANNEL | 11 for 802.11b, 802.11g, 802.11n (20MHz) |
| OUTPUT POWER | 194.54mW for 2412 ~ 2462MHz |
| ANTENNA TYPE | PIFA antenna with 1.63dBi gain |
| ANTENNA CONNECTOR | NA |
| DATA CABLE | Refer to Note as below |
| I/O PORTS | Refer to user's manual |
| ACCESSORY DEVICES | Refer to Note as below |



NOTE:

1. The EUT contains following accessory devices.

| ITEM | BRAND | MODEL | SPECIFICATION |
|-----------------|----------|-------------------|---|
| Adapter 1 | ASUS | PA-1070-07 | I/P: 100-240Vac, 50/60Hz, 0.25A O/P: 5.2Vdc, 1.35A |
| Adapter 2 | ASUS | PSM06A-050Q | I/P: 100-240Vac, 50/60Hz, 0.25A O/P: 5.2Vdc, 1.35A |
| Adapter 3 | ASUS | AD2005320 | I/P: 100-240Vac, 50/60Hz, 0.25A O/P: 5.2Vdc, 1.35A |
| Adapter 4 | ASUS | PSAC05A-050 | I/P: 100-240Vac, 50/60Hz, 0.2A O/P: 5Vdc, 1A |
| Battery | ASUS | B11P1405 | 3.8Vdc, 12.2Wh |
| USB Cable 1 | ASUS | AA781000 | 0.9m cable |
| USB Cable 2 | ASUS | L65U2009-CS-B | 0.9m cable |
| Earphone 1 | ASUS | CHM-801STS07001 | 1.15m cable |
| Earphone 2 | ASUS | CHM-125STS02001 | 1.15m cable |
| eMMC 1 | Hynix | H26M31003GMR | 4G |
| eMMC 2 | Sandisk | SDIN7DU2-8G | 8G |
| LCD Panel | AUO | B070ATN02.0 | -- |
| Front Camera | Chicony | CIFD01820003870LH | -- |
| Rear Camera | Ability | SS2BF218 | -- |
| WLAN Module | BROADCOM | BCM43362 | -- |
| BT & GPS Module | BROADCOM | BCM2076 | -- |

2. The EUT provides one completed transmitter and one receiver.

| MODULATION MODE | TX FUNCTION |
|-----------------|-------------|
| 802.11b | 1TX |
| 802.11g | 1TX |
| 802.11n (20MHz) | 1TX |

3. The above EUT information is declared by the manufacturer and for more detailed features description, please refer to the manufacturer's specifications or User's Manual.

3.2 DESCRIPTION OF TEST MODES

FOR 2.4GHz:

11 channels are provided for 802.11b, 802.11g and 802.11n (20MHz):

| CHANNEL | FREQUENCY | CHANNEL | FREQUENCY |
|---------|-----------|---------|-----------|
| 1 | 2412MHz | 7 | 2442MHz |
| 2 | 2417MHz | 8 | 2447MHz |
| 3 | 2422MHz | 9 | 2452MHz |
| 4 | 2427MHz | 10 | 2457MHz |
| 5 | 2432MHz | 11 | 2462MHz |
| 6 | 2437MHz | | |



A D T

3.2.1 TEST MODE APPLICABILITY AND TESTED CHANNEL DETAIL

WLAN 2.4GHz:

| EUT CONFIGURE MODE | APPLICABLE TO | | | | DESCRIPTION |
|--------------------|---------------|-----------|-----|------|-------------|
| | RE \geq 1G | RE $<$ 1G | PLC | APCM | |
| - | √ | √ | √ | √ | - |

Where **RE \geq 1G**: Radiated Emission above 1GHz **RE $<$ 1G**: Radiated Emission below 1GHz
PLC: Power Line Conducted Emission **APCM**: Antenna Port Conducted Measurement

NOTE: The EUT had been pre-tested on the positioned of each 3 axis. The worst case was found when positioned on **Y-plane**.

RADIATED EMISSION TEST (ABOVE 1GHz):

Pre-Scan has been conducted to determine the worst-case mode from all possible combinations between available modulations, data rates and antenna ports (if EUT with antenna diversity architecture).

Following channel(s) was (were) selected for the final test as listed below.

| EUT CONFIGURE MODE | MODE | AVAILABLE CHANNEL | TESTED CHANNEL | MODULATION TECHNOLOGY | MODULATION TYPE | DATA RATE (Mbps) |
|--------------------|-----------------|-------------------|----------------|-----------------------|-----------------|------------------|
| - | 802.11b | 1 to 11 | 1, 6, 11 | DSSS | DBPSK | 1.0 |
| - | 802.11g | 1 to 11 | 1, 6, 11 | OFDM | BPSK | 6.0 |
| - | 802.11n (20MHz) | 1 to 11 | 1, 6, 11 | OFDM | BPSK | MCS0 |

RADIATED EMISSION TEST (BELOW 1GHz):

Pre-Scan has been conducted to determine the worst-case mode from all possible combinations between available modulations, data rates and antenna ports (if EUT with antenna diversity architecture).

Following channel(s) was (were) selected for the final test as listed below.

| EUT CONFIGURE MODE | MODE | AVAILABLE CHANNEL | TESTED CHANNEL | MODULATION TECHNOLOGY | MODULATION TYPE | DATA RATE (Mbps) |
|--------------------|---------|-------------------|----------------|-----------------------|-----------------|------------------|
| - | 802.11g | 1 to 11 | 1 | OFDM | BPSK | 6.0 |

POWER LINE CONDUCTED EMISSION TEST:

| EUT CONFIGURE MODE | MODE | AVAILABLE CHANNEL | TESTED CHANNEL | MODULATION TECHNOLOGY | MODULATION TYPE | DATA RATE (Mbps) |
|--------------------|---------|-------------------|----------------|-----------------------|-----------------|------------------|
| - | 802.11g | 1 to 11 | 1 | OFDM | BPSK | 6.0 |



BANDEDGE MEASUREMENT:

- Pre-Scan has been conducted to determine the worst-case mode from all possible combinations between available modulations, data rates and antenna ports (if EUT with antenna diversity architecture).
- Following channel(s) was (were) selected for the final test as listed below.

| EUT CONFIGURE MODE | MODE | AVAILABLE CHANNEL | TESTED CHANNEL | MODULATION TECHNOLOGY | MODULATION TYPE | DATA RATE (Mbps) |
|--------------------|-----------------|-------------------|----------------|-----------------------|-----------------|------------------|
| - | 802.11b | 1 to 11 | 1, 6, 11 | DSSS | DBPSK | 1.0 |
| - | 802.11g | 1 to 11 | 1, 6, 11 | OFDM | BPSK | 6.0 |
| - | 802.11n (20MHz) | 1 to 11 | 1, 6, 11 | OFDM | BPSK | MCS0 |

ANTENNA PORT CONDUCTED MEASUREMENT:

- This item includes all test value of each mode, but only includes spectrum plot of worst value of each mode.
- Pre-Scan has been conducted to determine the worst-case mode from all possible combinations between available modulations, data rates and antenna ports (if EUT with antenna diversity architecture).
- Following channel(s) was (were) selected for the final test as listed below.

| EUT CONFIGURE MODE | MODE | AVAILABLE CHANNEL | TESTED CHANNEL | MODULATION TECHNOLOGY | MODULATION TYPE | DATA RATE (Mbps) |
|--------------------|-----------------|-------------------|----------------|-----------------------|-----------------|------------------|
| - | 802.11b | 1 to 11 | 1, 6, 11 | DSSS | DBPSK | 1.0 |
| - | 802.11g | 1 to 11 | 1, 6, 11 | OFDM | BPSK | 6.0 |
| - | 802.11n (20MHz) | 1 to 11 | 1, 6, 11 | OFDM | BPSK | MCS0 |

Test CONDITION:

| APPLICABLE TO | ENVIRONMENTAL CONDITIONS | INPUT POWER | TESTED BY |
|---------------|--------------------------|--------------|--------------|
| RE≥1G | 25deg. C, 65%RH | 120Vac, 60Hz | Kay Wu |
| RE<1G | 25deg. C, 65%RH | 120Vac, 60Hz | Kay Wu |
| PLC | 25deg. C, 65%RH | 120Vac, 60Hz | Johnson Liao |
| APCM | 25deg. C, 65%RH | 120Vac, 60Hz | Howard Kao |

3.3 DESCRIPTION OF SUPPORT UNITS

The EUT has been tested as an independent unit together with other necessary accessories or support units.

3.3.1 CONFIGURATION OF SYSTEM UNDER TEST

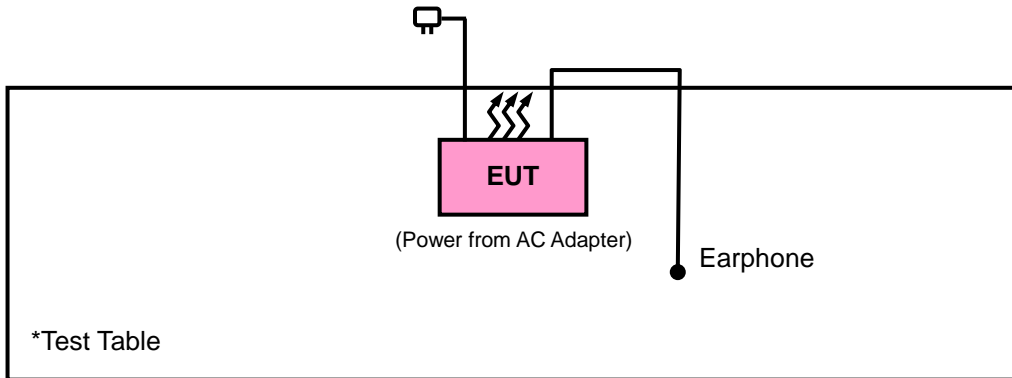

3.4 DUTY CYCLE TEST SIGNAL

802.11b: Duty cycle of test signal is > 98 %, duty factor is not required.

802.11g: Duty cycle = 1.389/1.510 = 0.92, Duty factor = $10 * \log(1/0.92) = 0.36$

802.11n (20MHz): Duty cycle = 1.306/1.418 = 0.92, Duty factor = $10 * \log(1/0.92) = 0.36$

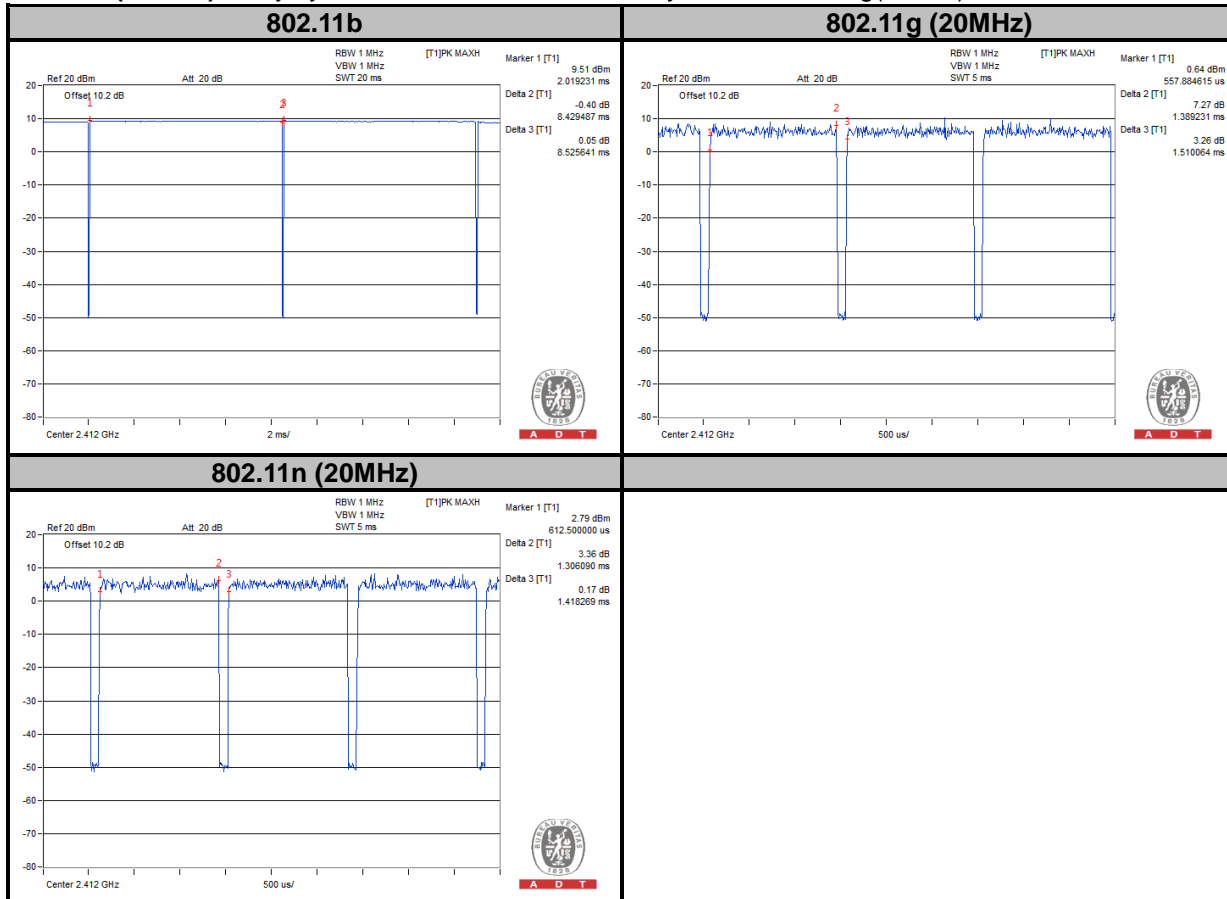

3.5 GENERAL DESCRIPTION OF APPLIED STANDARDS

The EUT is a RF Product. According to the specifications of the manufacturer, it must comply with the requirements of the following standards:

FCC Part 15, Subpart C (15.247)

ANSI C63.10-2009

558074 D01 DTS Meas Guidance v03r01

All test items have been performed and recorded as per the above standards.

NOTE: The EUT is also considered as a kind of computer peripheral, because the connection to computer is necessary for typical use. It has been verified to comply with the requirements of FCC Part 15, Subpart B, Class B (DoC). The test report has been issued separately.

4. TEST TYPES AND RESULTS (FOR 2.4GHz BAND)

4.1 RADIATED EMISSION AND BANDEDGE MEASUREMENT

4.1.1 LIMITS OF RADIATED EMISSION AND BANDEDGE MEASUREMENT

Radiated emissions which fall in the restricted bands must comply with the radiated emission limits specified as below table. Other emissions shall be at least 20dB below the highest level of the desired power:

| FREQUENCIES (MHz) | FIELD STRENGTH (microvolts/meter) | MEASUREMENT DISTANCE (meters) |
|-------------------|-----------------------------------|-------------------------------|
| 0.009 ~ 0.490 | 2400/F(kHz) | 300 |
| 0.490 ~ 1.705 | 24000/F(kHz) | 30 |
| 1.705 ~ 30.0 | 30 | 30 |
| 30 ~ 88 | 100 | 3 |
| 88 ~ 216 | 150 | 3 |
| 216 ~ 960 | 200 | 3 |
| Above 960 | 500 | 3 |

NOTE:

1. The lower limit shall apply at the transition frequencies.
2. Emission level (dBuV/m) = 20 log Emission level (uV/m).
3. For frequencies above 1000MHz, the field strength limits are based on average detector, however, the peak field strength of any emission shall not exceed the maximum permitted average limits, specified above by more than 20dB under any condition of modulation.



4.1.2 TEST INSTRUMENTS

| DESCRIPTION & MANUFACTURER | MODEL NO. | SERIAL NO. | DATE OF CALIBRATION | DUE DATE OF CALIBRATION |
|--|----------------|------------|---------------------|-------------------------|
| Test Receiver ROHDE & SCHWARZ | ESCI | 100744 | Apr. 15, 20143 | Apr. 14, 2015 |
| Spectrum Analyzer ROHDE & SCHWARZ | FSU43 | 101261 | Dec. 21, 2013 | Dec. 20, 2014 |
| BILOG Antenna SCHWARZBECK | VULB9168 | 9168-472 | Feb. 27, 2014 | Feb. 26, 2015 |
| HORN Antenna SCHWARZBECK | BBHA 9120 D | 9120D- 209 | Sep. 12, 2013 | Sep. 11, 2014 |
| HORN Antenna SCHWARZBECK | BBHA 9170 | 9170-480 | Dec. 18, 2013 | Dec. 17, 2014 |
| Preamplifier EMCI | EMC 012645 | 980115 | Dec. 26, 2013 | Dec. 25, 2014 |
| Preamplifier EMCI | EMC 184045 | 980116 | Jan. 13, 2014 | Jan. 12, 2015 |
| Preamplifier EMCI | EMC 330H | 980112 | Dec. 27, 2013 | Dec. 26, 2014 |
| RF signal cable HUBER+SUHNNER | SUCOFLEX 104 | 309219/4 | Oct. 18, 2013 | Oct. 17, 2014 |
| RF signal cable HUBER+SUHNNER | SUCOFLEX 104 | 250130/4 | Oct. 18, 2013 | Oct. 17, 2014 |
| RF signal cable Worken | RG-213 | NA | Nov. 07, 2013 | Nov. 06, 2014 |
| Software BV ADT | E3 6.120103 | NA | NA | NA |
| Antenna Tower MF | MFA-440H | NA | NA | NA |
| Turn Table MF | MFT-201SS | NA | NA | NA |
| Antenna Tower & Turn Table Controller MF | MF-7802 | NA | NA | NA |
| Power Meter | ML2495A | 1232002 | Aug. 23, 2013 | Aug. 22, 2014 |
| Power Sensor | MA2411B | 1207325 | Aug. 23, 2013 | Aug. 22, 2014 |

- NOTE:**
1. The calibration interval of the above test instruments is 12 months and the calibrations are traceable to NML/ROC and NIST/USA.
 2. The calibration interval of the loop antenna is 24 months and the calibrations are traceable to NML/ROC and NIST/USA.
 3. The test was performed in HwaYa Chamber 10.
 4. The horn antenna and HP preamplifier (model: 8449B) are used only for the measurement of emission frequency above 1GHz if tested.
 5. The FCC Site Registration No. is 690701.
 6. The IC Site Registration No. is IC 7450F-10.

4.1.3 TEST PROCEDURES

- a. The EUT was placed on the top of a rotating table 0.8 meters above the ground at a 3 meters semi-anechoic chamber. The table was rotated 360 degrees to determine the position of the highest radiation.
- b. The EUT was set 3 meters away from the interference-receiving antenna, which was mounted on the top of a variable-height antenna tower.
- c. Height of receiving antenna is varied from one meter to four meters above the ground to determine the maximum value of the field strength. Both horizontal and vertical polarizations of the antenna are set to make the measurement.
- d. For each suspected emission, the EUT was arranged to its worst case and then the antenna was tuned to heights from 1 meter to 4 meters and the rotatable table was turned from 0 degrees to 360 degrees to find the maximum reading.
- e. The test-receiver system was set to Peak Detect Function and Specified Bandwidth with Maximum Hold Mode.
- f. If the emission level of the EUT in peak mode was lower than the limit specified, then testing could be stopped and the peak values of the EUT would be reported. Otherwise the emissions would be re-tested one by one using peak, quasi-peak or average method as specified and then reported in a data sheet.

NOTE:

1. The resolution bandwidth and video bandwidth of test receiver/spectrum analyzer is 120kHz for Quasi-peak detection at frequency below 1GHz.
2. The resolution bandwidth of test receiver/spectrum analyzer is 1MHz and video bandwidth is 3MHz for Peak detection at frequency above 1GHz.
3. The resolution bandwidth of test receiver/spectrum analyzer is 1MHz and the video bandwidth is 1kHz (Duty cycle < 98%) or 10Hz (Duty cycle > 98%) for Average detection (AV) at frequency above 1GHz.
4. All modes of operation were investigated and the worst-case emissions are reported.

4.1.4 DEVIATION FROM TEST STANDARD

No deviation.

4.1.5 TEST SETUP

Frequency Range 30MHz ~ 1GHz

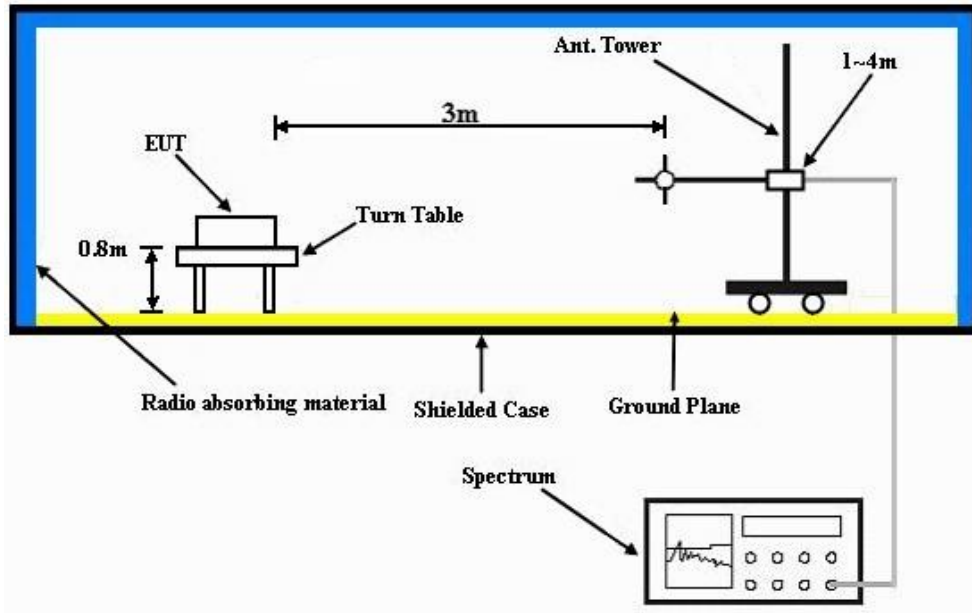

Frequency Range above 1GHz

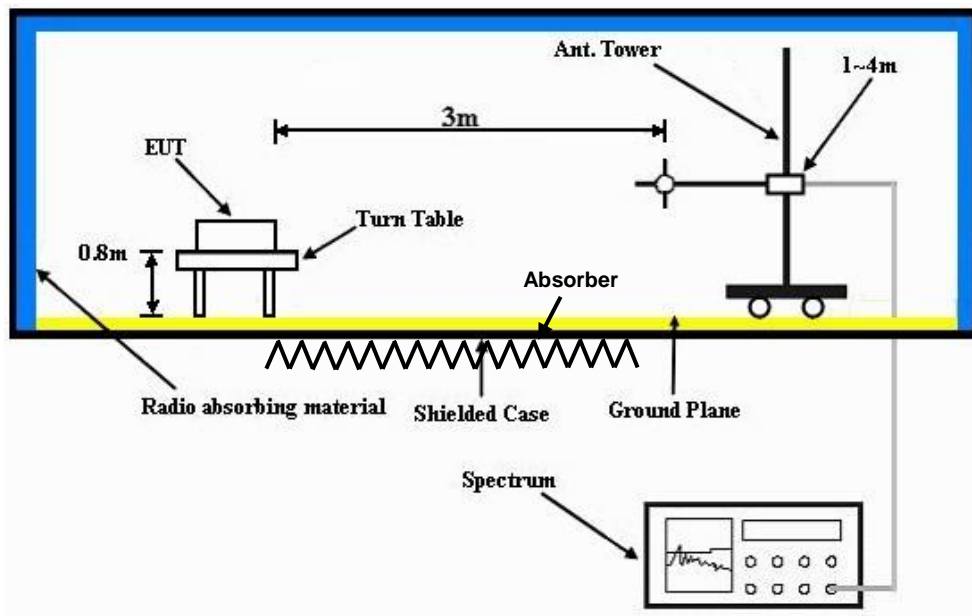

For the actual test configuration, please refer to the attached file (Test Setup Photo).

4.1.6 EUT OPERATING CONDITIONS

- a. Placed the EUT on a testing table.
- b. Use the software to control the EUT under transmission condition continuously at specific channel frequency.



A D T

4.1.7 TEST RESULTS

ABOVE 1GHz WORST-CASE DATA

802.11b

| EUT TEST CONDITION | | MEASUREMENT DETAIL | |
|--------------------------|-----------------|--------------------|---------------------------|
| CHANNEL | Channel 1 | FREQUENCY RANGE | 1GHz ~ 25GHz |
| INPUT POWER | 120Vac, 60 Hz | DETECTOR FUNCTION | Peak (PK) Average (AV) |
| ENVIRONMENTAL CONDITIONS | 25deg. C, 65%RH | TESTED BY | Kay Wu |

| ANTENNA POLARITY & TEST DISTANCE: HORIZONTAL AT 3 M | | | | | | | | | | |
|---|-------------------------|-------------------|----------------|-------------|-----------------------|-----------------|--------------------|---------------------|----------------------|---------|
| FREQ. (MHz) | EMISSION LEVEL (dBuV/m) | READ LEVEL (dBuV) | LIMIT (dBuV/m) | MARGIN (dB) | ANTENNA FACTOR (dB/m) | CABLE LOSS (dB) | PREAMP FACTOR (dB) | ANTENNA HEIGHT (cm) | TABLE ANGLE (Degree) | REMARK |
| 2390 | 45.55 | 43.82 | 54 | -8.45 | 31.8 | 5.4 | 35.47 | 122 | 306 | Average |
| 2390 | 57.28 | 55.55 | 74 | -16.72 | 31.8 | 5.4 | 35.47 | 122 | 306 | Peak |
| 2412 | 103.91 | 102.14 | | | 31.81 | 5.43 | 35.47 | 122 | 306 | Average |
| 2412 | 106.59 | 104.82 | | | 31.81 | 5.43 | 35.47 | 122 | 306 | Peak |
| 2496 | 39.98 | 37.96 | 54 | -14.02 | 31.9 | 5.53 | 35.41 | 122 | 306 | Average |
| 2496 | 55.01 | 52.99 | 74 | -18.99 | 31.9 | 5.53 | 35.41 | 122 | 306 | Peak |
| 4824 | 51.61 | 43.48 | 54 | -2.39 | 33.97 | 8.26 | 34.1 | 115 | 294 | Average |
| 4824 | 53.33 | 45.2 | 74 | -20.67 | 33.97 | 8.26 | 34.1 | 115 | 294 | Peak |
| ANTENNA POLARITY & TEST DISTANCE: VERTICAL AT 3 M | | | | | | | | | | |
| FREQ. (MHz) | EMISSION LEVEL (dBuV/m) | READ LEVEL (dBuV) | LIMIT (dBuV/m) | MARGIN (dB) | ANTENNA FACTOR (dB/m) | CABLE LOSS (dB) | PREAMP FACTOR (dB) | ANTENNA HEIGHT (cm) | TABLE ANGLE (Degree) | REMARK |
| 2378 | 42.74 | 41.08 | 54 | -11.26 | 31.78 | 5.37 | 35.49 | 140 | 287 | Average |
| 2378 | 55.41 | 53.75 | 74 | -18.59 | 31.78 | 5.37 | 35.49 | 140 | 287 | Peak |
| 2412 | 99.92 | 98.15 | | | 31.81 | 5.43 | 35.47 | 140 | 287 | Average |
| 2412 | 102.6 | 100.83 | | | 31.81 | 5.43 | 35.47 | 140 | 287 | Peak |
| 2492 | 39.83 | 37.81 | 54 | -14.17 | 31.9 | 5.53 | 35.41 | 140 | 287 | Average |
| 2492 | 54.84 | 52.82 | 74 | -19.16 | 31.9 | 5.53 | 35.41 | 140 | 287 | Peak |
| 4824 | 49.07 | 40.94 | 54 | -4.93 | 33.97 | 8.26 | 34.1 | 100 | 271 | Average |
| 4824 | 52.03 | 43.9 | 74 | -21.97 | 33.97 | 8.26 | 34.1 | 100 | 271 | Peak |

REMARKS:

- Emission Level = Read Level + Antenna Factor + Cable Loss - Preamp Factor
Margin value = Emission level – Limit value
- 2412MHz: Fundamental frequency.



A D T

| EUT TEST CONDITION | | MEASUREMENT DETAIL | |
|--------------------------|-----------------|--------------------|---------------------------|
| CHANNEL | Channel 6 | FREQUENCY RANGE | 1GHz ~ 25GHz |
| INPUT POWER | 120Vac, 60 Hz | DETECTOR FUNCTION | Peak (PK) Average (AV) |
| ENVIRONMENTAL CONDITIONS | 25deg. C, 65%RH | TESTED BY | Kay Wu |

ANTENNA POLARITY & TEST DISTANCE: HORIZONTAL AT 3 M

| FREQ. (MHz) | EMISSION LEVEL (dBuV/m) | READ LEVEL (dBuV) | LIMIT (dBuV/m) | MARGIN (dB) | ANTENNA FACTOR (dB/m) | CABLE LOSS (dB) | PREAMP FACTOR (dB) | ANTENNA HEIGHT (cm) | TABLE ANGLE (Degree) | REMARK |
|-------------|-------------------------|-------------------|----------------|-------------|-----------------------|-----------------|--------------------|---------------------|----------------------|---------|
| 2366 | 44.68 | 43.04 | 54 | -9.32 | 31.76 | 5.37 | 35.49 | 181 | 310 | Average |
| 2366 | 57.57 | 55.93 | 74 | -16.43 | 31.76 | 5.37 | 35.49 | 181 | 310 | Peak |
| 2437 | 104.99 | 103.14 | | | 31.85 | 5.46 | 35.46 | 181 | 310 | Average |
| 2437 | 107.71 | 105.86 | | | 31.85 | 5.46 | 35.46 | 181 | 310 | Peak |
| 2500 | 41.07 | 39.05 | 54 | -12.93 | 31.9 | 5.53 | 35.41 | 181 | 310 | Average |
| 2500 | 55.55 | 53.53 | 74 | -18.45 | 31.9 | 5.53 | 35.41 | 181 | 310 | Peak |
| 4874 | 52.67 | 44.48 | 54 | -1.33 | 33.98 | 8.27 | 34.06 | 100 | 293 | Average |
| 4874 | 55.56 | 47.37 | 74 | -18.44 | 33.98 | 8.27 | 34.06 | 100 | 293 | Peak |

ANTENNA POLARITY & TEST DISTANCE: VERTICAL AT 3 M

| FREQ. (MHz) | EMISSION LEVEL (dBuV/m) | READ LEVEL (dBuV) | LIMIT (dBuV/m) | MARGIN (dB) | ANTENNA FACTOR (dB/m) | CABLE LOSS (dB) | PREAMP FACTOR (dB) | ANTENNA HEIGHT (cm) | TABLE ANGLE (Degree) | REMARK |
|-------------|-------------------------|-------------------|----------------|-------------|-----------------------|-----------------|--------------------|---------------------|----------------------|---------|
| 2386 | 43.29 | 41.58 | 54 | -10.71 | 31.8 | 5.4 | 35.49 | 107 | 336 | Average |
| 2386 | 56.83 | 55.12 | 74 | -17.17 | 31.8 | 5.4 | 35.49 | 107 | 336 | Peak |
| 2437 | 103.26 | 101.41 | | | 31.85 | 5.46 | 35.46 | 107 | 336 | Average |
| 2437 | 106.07 | 104.22 | | | 31.85 | 5.46 | 35.46 | 107 | 336 | Peak |
| 2498 | 41.01 | 38.99 | 54 | -12.99 | 31.9 | 5.53 | 35.41 | 107 | 336 | Average |
| 2498 | 55.61 | 53.59 | 74 | -18.39 | 31.9 | 5.53 | 35.41 | 107 | 336 | Peak |
| 4874 | 49.43 | 41.24 | 54 | -4.57 | 33.98 | 8.27 | 34.06 | 100 | 269 | Average |
| 4874 | 51.3 | 43.11 | 74 | -22.7 | 33.98 | 8.27 | 34.06 | 100 | 269 | Peak |

REMARKS:

- Emission Level = Read Level + Antenna Factor + Cable Loss - Preamp Factor
Margin value = Emission level – Limit value
- 2437MHz: Fundamental frequency.



A D T

| EUT TEST CONDITION | | MEASUREMENT DETAIL | |
|--------------------------|-----------------|--------------------|---------------------------|
| CHANNEL | Channel 11 | FREQUENCY RANGE | 1GHz ~ 25GHz |
| INPUT POWER | 120Vac, 60 Hz | DETECTOR FUNCTION | Peak (PK) Average (AV) |
| ENVIRONMENTAL CONDITIONS | 25deg. C, 65%RH | TESTED BY | Kay Wu |

ANTENNA POLARITY & TEST DISTANCE: HORIZONTAL AT 3 M

| FREQ. (MHz) | EMISSION LEVEL (dBuV/m) | READ LEVEL (dBuV) | LIMIT (dBuV/m) | MARGIN (dB) | ANTENNA FACTOR (dB/m) | CABLE LOSS (dB) | PREAMP FACTOR (dB) | ANTENNA HEIGHT (cm) | TABLE ANGLE (Degree) | REMARK |
|-------------|-------------------------|-------------------|----------------|-------------|-----------------------|-----------------|--------------------|---------------------|----------------------|---------|
| 2386 | 43.36 | 41.65 | 54 | -10.64 | 31.8 | 5.4 | 35.49 | 178 | 299 | Average |
| 2386 | 56.78 | 55.07 | 74 | -17.22 | 31.8 | 5.4 | 35.49 | 178 | 299 | Peak |
| 2462 | 104.95 | 103.02 | | | 31.87 | 5.5 | 35.44 | 178 | 299 | Average |
| 2462 | 107.73 | 105.8 | | | 31.87 | 5.5 | 35.44 | 178 | 299 | Peak |
| 2484 | 44.22 | 42.26 | 54 | -9.78 | 31.88 | 5.5 | 35.42 | 178 | 299 | Average |
| 2488 | 56.71 | 54.7 | 74 | -17.29 | 31.9 | 5.53 | 35.42 | 178 | 299 | Peak |
| 4924 | 52.72 | 44.47 | 54 | -1.28 | 33.99 | 8.28 | 34.02 | 100 | 293 | Average |
| 4924 | 54.61 | 46.36 | 74 | -19.39 | 33.99 | 8.28 | 34.02 | 100 | 293 | Peak |

ANTENNA POLARITY & TEST DISTANCE: VERTICAL AT 3 M

| FREQ. (MHz) | EMISSION LEVEL (dBuV/m) | READ LEVEL (dBuV) | LIMIT (dBuV/m) | MARGIN (dB) | ANTENNA FACTOR (dB/m) | CABLE LOSS (dB) | PREAMP FACTOR (dB) | ANTENNA HEIGHT (cm) | TABLE ANGLE (Degree) | REMARK |
|-------------|-------------------------|-------------------|----------------|-------------|-----------------------|-----------------|--------------------|---------------------|----------------------|---------|
| 2386 | 43.25 | 41.54 | 54 | -10.75 | 31.8 | 5.4 | 35.49 | 104 | 338 | Average |
| 2386 | 56.53 | 54.82 | 74 | -17.47 | 31.8 | 5.4 | 35.49 | 104 | 338 | Peak |
| 2462 | 102.98 | 101.05 | | | 31.87 | 5.5 | 35.44 | 104 | 338 | Average |
| 2462 | 105.91 | 103.98 | | | 31.87 | 5.5 | 35.44 | 104 | 338 | Peak |
| 2484 | 43.7 | 41.74 | 54 | -10.3 | 31.88 | 5.5 | 35.42 | 104 | 338 | Average |
| 2484 | 56.36 | 54.4 | 74 | -17.64 | 31.88 | 5.5 | 35.42 | 104 | 338 | Peak |
| 4924 | 51.67 | 43.42 | 54 | -2.33 | 33.99 | 8.28 | 34.02 | 113 | 285 | Average |
| 4924 | 53.71 | 45.46 | 74 | -20.29 | 33.99 | 8.28 | 34.02 | 113 | 285 | Peak |

REMARKS:

- Emission Level = Read Level + Antenna Factor + Cable Loss - Preamp Factor
Margin value = Emission level – Limit value
- 2462MHz: Fundamental frequency.



A D T

802.11g

| EUT TEST CONDITION | | MEASUREMENT DETAIL | |
|--------------------------|-----------------|--------------------|---------------------------|
| CHANNEL | Channel 1 | FREQUENCY RANGE | 1GHz ~ 25GHz |
| INPUT POWER | 120Vac, 60 Hz | DETECTOR FUNCTION | Peak (PK) Average (AV) |
| ENVIRONMENTAL CONDITIONS | 25deg. C, 65%RH | TESTED BY | Harry Hsueh |

ANTENNA POLARITY & TEST DISTANCE: HORIZONTAL AT 3 M

| FREQ. (MHz) | EMISSION LEVEL (dBuV/m) | READ LEVEL (dBuV) | LIMIT (dBuV/m) | MARGIN (dB) | ANTENNA FACTOR (dB/m) | CABLE LOSS (dB) | PREAMP FACTOR (dB) | ANTENNA HEIGHT (cm) | TABLE ANGLE (Degree) | REMARK |
|-------------|-------------------------|-------------------|----------------|-------------|-----------------------|-----------------|--------------------|---------------------|----------------------|---------|
| 2390 | 51.9 | 50.17 | 54 | -2.1 | 31.8 | 5.4 | 35.47 | 122 | 304 | Average |
| 2390 | 63.09 | 61.36 | 74 | -10.91 | 31.8 | 5.4 | 35.47 | 122 | 304 | Peak |
| 2412 | 99.82 | 98.05 | | | 31.81 | 5.43 | 35.47 | 122 | 304 | Average |
| 2412 | 107.3 | 105.53 | | | 31.81 | 5.43 | 35.47 | 122 | 304 | Peak |
| 2494 | 40.93 | 38.91 | 54 | -13.07 | 31.9 | 5.53 | 35.41 | 122 | 304 | Average |
| 2494 | 55.63 | 53.61 | 74 | -18.37 | 31.9 | 5.53 | 35.41 | 122 | 304 | Peak |

ANTENNA POLARITY & TEST DISTANCE: VERTICAL AT 3 M

| FREQ. (MHz) | EMISSION LEVEL (dBuV/m) | READ LEVEL (dBuV) | LIMIT (dBuV/m) | MARGIN (dB) | ANTENNA FACTOR (dB/m) | CABLE LOSS (dB) | PREAMP FACTOR (dB) | ANTENNA HEIGHT (cm) | TABLE ANGLE (Degree) | REMARK |
|-------------|-------------------------|-------------------|----------------|-------------|-----------------------|-----------------|--------------------|---------------------|----------------------|---------|
| 2390 | 49.36 | 47.63 | 54 | -4.64 | 31.8 | 5.4 | 35.47 | 106 | 346 | Average |
| 2390 | 59.62 | 57.89 | 74 | -14.38 | 31.8 | 5.4 | 35.47 | 106 | 346 | Peak |
| 2412 | 96.79 | 95.02 | | | 31.81 | 5.43 | 35.47 | 106 | 346 | Average |
| 2412 | 104.1 | 102.33 | | | 31.81 | 5.43 | 35.47 | 106 | 346 | Peak |
| 2490 | 40.77 | 38.76 | 54 | -13.23 | 31.9 | 5.53 | 35.42 | 106 | 346 | Average |
| 2490 | 56.26 | 54.25 | 74 | -17.74 | 31.9 | 5.53 | 35.42 | 106 | 346 | Peak |

REMARKS:

- Emission Level = Read Level + Antenna Factor + Cable Loss - Preamp Factor
Margin value = Emission level – Limit value
- 2412MHz: Fundamental frequency.



A D T

| EUT TEST CONDITION | | MEASUREMENT DETAIL | |
|--------------------------|-----------------|--------------------|---------------------------|
| CHANNEL | Channel 6 | FREQUENCY RANGE | 1GHz ~ 25GHz |
| INPUT POWER | 120Vac, 60 Hz | DETECTOR FUNCTION | Peak (PK) Average (AV) |
| ENVIRONMENTAL CONDITIONS | 25deg. C, 65%RH | TESTED BY | Kay Wu |

ANTENNA POLARITY & TEST DISTANCE: HORIZONTAL AT 3 M

| FREQ. (MHz) | EMISSION LEVEL (dBuV/m) | READ LEVEL (dBuV) | LIMIT (dBuV/m) | MARGIN (dB) | ANTENNA FACTOR (dB/m) | CABLE LOSS (dB) | PREAMP FACTOR (dB) | ANTENNA HEIGHT (cm) | TABLE ANGLE (Degree) | REMARK |
|-------------|-------------------------|-------------------|----------------|-------------|-----------------------|-----------------|--------------------|---------------------|----------------------|---------|
| 2384 | 46.79 | 45.1 | 54 | -7.21 | 31.78 | 5.4 | 35.49 | 180 | 306 | Average |
| 2384 | 58.34 | 56.65 | 74 | -15.66 | 31.78 | 5.4 | 35.49 | 180 | 306 | Peak |
| 2437 | 102.16 | 100.31 | | | 31.85 | 5.46 | 35.46 | 180 | 306 | Average |
| 2437 | 109.43 | 107.58 | | | 31.85 | 5.46 | 35.46 | 180 | 306 | Peak |
| 2496 | 42.55 | 40.53 | 54 | -11.45 | 31.9 | 5.53 | 35.41 | 180 | 306 | Average |
| 2496 | 55.3 | 53.28 | 74 | -18.7 | 31.9 | 5.53 | 35.41 | 180 | 306 | Peak |
| 4874 | 42.05 | 33.86 | 54 | -11.95 | 33.98 | 8.27 | 34.06 | 100 | 345 | Average |
| 4874 | 51.85 | 43.66 | 74 | -22.15 | 33.98 | 8.27 | 34.06 | 100 | 345 | Peak |

ANTENNA POLARITY & TEST DISTANCE: VERTICAL AT 3 M

| FREQ. (MHz) | EMISSION LEVEL (dBuV/m) | READ LEVEL (dBuV) | LIMIT (dBuV/m) | MARGIN (dB) | ANTENNA FACTOR (dB/m) | CABLE LOSS (dB) | PREAMP FACTOR (dB) | ANTENNA HEIGHT (cm) | TABLE ANGLE (Degree) | REMARK |
|-------------|-------------------------|-------------------|----------------|-------------|-----------------------|-----------------|--------------------|---------------------|----------------------|---------|
| 2388 | 45.19 | 43.48 | 54 | -8.81 | 31.8 | 5.4 | 35.49 | 105 | 337 | Average |
| 2388 | 56.05 | 54.34 | 74 | -17.95 | 31.8 | 5.4 | 35.49 | 105 | 337 | Peak |
| 2437 | 100.18 | 98.33 | | | 31.85 | 5.46 | 35.46 | 105 | 337 | Average |
| 2437 | 107.32 | 105.47 | | | 31.85 | 5.46 | 35.46 | 105 | 337 | Peak |
| 2486 | 42.38 | 40.39 | 54 | -11.62 | 31.88 | 5.53 | 35.42 | 105 | 337 | Average |
| 2486 | 56.05 | 54.06 | 74 | -17.95 | 31.88 | 5.53 | 35.42 | 105 | 337 | Peak |
| 4874 | 40.45 | 32.26 | 54 | -13.55 | 33.98 | 8.27 | 34.06 | 100 | 274 | Average |
| 4874 | 50.64 | 42.45 | 74 | -23.36 | 33.98 | 8.27 | 34.06 | 100 | 274 | Peak |

REMARKS:

- Emission Level = Read Level + Antenna Factor + Cable Loss - Preamp Factor
Margin value = Emission level – Limit value
- 2437MHz: Fundamental frequency.



A D T

| EUT TEST CONDITION | | MEASUREMENT DETAIL | |
|--------------------------|-----------------|--------------------|---------------------------|
| CHANNEL | Channel 11 | FREQUENCY RANGE | 1GHz ~ 25GHz |
| INPUT POWER | 120Vac, 60 Hz | DETECTOR FUNCTION | Peak (PK) Average (AV) |
| ENVIRONMENTAL CONDITIONS | 25deg. C, 65%RH | TESTED BY | Kay Wu |

ANTENNA POLARITY & TEST DISTANCE: HORIZONTAL AT 3 M

| FREQ. (MHz) | EMISSION LEVEL (dBuV/m) | READ LEVEL (dBuV) | LIMIT (dBuV/m) | MARGIN (dB) | ANTENNA FACTOR (dB/m) | CABLE LOSS (dB) | PREAMP FACTOR (dB) | ANTENNA HEIGHT (cm) | TABLE ANGLE (Degree) | REMARK |
|-------------|-------------------------|-------------------|----------------|--------------|-----------------------|-----------------|--------------------|---------------------|----------------------|----------------|
| 2384 | 43.9 | 42.21 | 54 | -10.1 | 31.78 | 5.4 | 35.49 | 177 | 298 | Average |
| 2384 | 56.92 | 55.23 | 74 | -17.08 | 31.78 | 5.4 | 35.49 | 177 | 298 | Peak |
| 2462 | 100.91 | 98.98 | | | 31.87 | 5.5 | 35.44 | 177 | 298 | Average |
| 2462 | 108.58 | 106.65 | | | 31.87 | 5.5 | 35.44 | 177 | 298 | Peak |
| 2484 | 53.66 | 51.7 | 54 | -0.34 | 31.88 | 5.5 | 35.42 | 177 | 298 | Average |
| 2484 | 64.28 | 62.32 | 74 | -9.72 | 31.88 | 5.5 | 35.42 | 177 | 298 | Peak |
| 4924 | 41.72 | 33.47 | 54 | -12.28 | 33.99 | 8.28 | 34.02 | 100 | 346 | Average |
| 4924 | 51.16 | 42.91 | 74 | -22.84 | 33.99 | 8.28 | 34.02 | 100 | 346 | Peak |

ANTENNA POLARITY & TEST DISTANCE: VERTICAL AT 3 M

| FREQ. (MHz) | EMISSION LEVEL (dBuV/m) | READ LEVEL (dBuV) | LIMIT (dBuV/m) | MARGIN (dB) | ANTENNA FACTOR (dB/m) | CABLE LOSS (dB) | PREAMP FACTOR (dB) | ANTENNA HEIGHT (cm) | TABLE ANGLE (Degree) | REMARK |
|-------------|-------------------------|-------------------|----------------|-------------|-----------------------|-----------------|--------------------|---------------------|----------------------|---------|
| 2378 | 43.35 | 41.69 | 54 | -10.65 | 31.78 | 5.37 | 35.49 | 105 | 335 | Average |
| 2378 | 57.34 | 55.68 | 74 | -16.66 | 31.78 | 5.37 | 35.49 | 105 | 335 | Peak |
| 2462 | 97.9 | 95.97 | | | 31.87 | 5.5 | 35.44 | 105 | 335 | Average |
| 2462 | 105.41 | 103.48 | | | 31.87 | 5.5 | 35.44 | 105 | 335 | Peak |
| 2484 | 52.31 | 50.35 | 54 | -1.69 | 31.88 | 5.5 | 35.42 | 105 | 335 | Average |
| 2484 | 63.05 | 61.09 | 74 | -10.95 | 31.88 | 5.5 | 35.42 | 105 | 335 | Peak |
| 4924 | 40.58 | 32.33 | 54 | -13.42 | 33.99 | 8.28 | 34.02 | 130 | 270 | Average |
| 4924 | 49.02 | 40.77 | 74 | -24.98 | 33.99 | 8.28 | 34.02 | 130 | 270 | Peak |

REMARKS:

- Emission Level = Read Level + Antenna Factor + Cable Loss - Preamp Factor
Margin value = Emission level – Limit value
- 2462MHz: Fundamental frequency.



A D T

802.11n (20MHz)

| EUT TEST CONDITION | | MEASUREMENT DETAIL | |
|--------------------------|-----------------|--------------------|---------------------------|
| CHANNEL | Channel 1 | FREQUENCY RANGE | 1GHz ~ 25GHz |
| INPUT POWER | 120Vac, 60 Hz | DETECTOR FUNCTION | Peak (PK) Average (AV) |
| ENVIRONMENTAL CONDITIONS | 25deg. C, 65%RH | TESTED BY | Kay Wu |

ANTENNA POLARITY & TEST DISTANCE: HORIZONTAL AT 3 M

| FREQ. (MHz) | EMISSION LEVEL (dBuV/m) | READ LEVEL (dBuV) | LIMIT (dBuV/m) | MARGIN (dB) | ANTENNA FACTOR (dB/m) | CABLE LOSS (dB) | PREAMP FACTOR (dB) | ANTENNA HEIGHT (cm) | TABLE ANGLE (Degree) | REMARK |
|-------------|-------------------------|-------------------|----------------|-------------|-----------------------|-----------------|--------------------|---------------------|----------------------|---------|
| 2390 | 52.8 | 51.07 | 54 | -1.2 | 31.8 | 5.4 | 35.47 | 180 | 307 | Average |
| 2390 | 66.17 | 64.44 | 74 | -7.83 | 31.8 | 5.4 | 35.47 | 180 | 307 | Peak |
| 2412 | 98.88 | 97.11 | | | 31.81 | 5.43 | 35.47 | 180 | 307 | Average |
| 2412 | 106.48 | 104.71 | | | 31.81 | 5.43 | 35.47 | 180 | 307 | Peak |
| 2498 | 40.86 | 38.84 | 54 | -13.14 | 31.9 | 5.53 | 35.41 | 180 | 307 | Average |
| 2498 | 55.38 | 53.36 | 74 | -18.62 | 31.9 | 5.53 | 35.41 | 180 | 307 | Peak |
| 4824 | 42.36 | 34.23 | 54 | -11.64 | 33.97 | 8.26 | 34.1 | 100 | 323 | Average |
| 4824 | 50.45 | 42.32 | 74 | -23.55 | 33.97 | 8.26 | 34.1 | 100 | 323 | Peak |

ANTENNA POLARITY & TEST DISTANCE: VERTICAL AT 3 M

| FREQ. (MHz) | EMISSION LEVEL (dBuV/m) | READ LEVEL (dBuV) | LIMIT (dBuV/m) | MARGIN (dB) | ANTENNA FACTOR (dB/m) | CABLE LOSS (dB) | PREAMP FACTOR (dB) | ANTENNA HEIGHT (cm) | TABLE ANGLE (Degree) | REMARK |
|-------------|-------------------------|-------------------|----------------|-------------|-----------------------|-----------------|--------------------|---------------------|----------------------|---------|
| 2390 | 50.64 | 48.91 | 54 | -3.36 | 31.8 | 5.4 | 35.47 | 108 | 340 | Average |
| 2390 | 61.63 | 59.9 | 74 | -12.37 | 31.8 | 5.4 | 35.47 | 108 | 340 | Peak |
| 2412 | 96.95 | 95.18 | | | 31.81 | 5.43 | 35.47 | 108 | 340 | Average |
| 2412 | 104.38 | 102.61 | | | 31.81 | 5.43 | 35.47 | 108 | 340 | Peak |
| 2492 | 40.87 | 38.85 | 54 | -13.13 | 31.9 | 5.53 | 35.41 | 108 | 340 | Average |
| 2492 | 56.63 | 54.61 | 74 | -17.37 | 31.9 | 5.53 | 35.41 | 108 | 340 | Peak |
| 4824 | 41.59 | 33.46 | 54 | -12.41 | 33.97 | 8.26 | 34.1 | 100 | 271 | Average |
| 4824 | 50.74 | 42.61 | 74 | -23.26 | 33.97 | 8.26 | 34.1 | 100 | 271 | Peak |

REMARKS:

- Emission Level = Read Level + Antenna Factor + Cable Loss - Preamp Factor
Margin value = Emission level – Limit value
- 2412MHz: Fundamental frequency.



A D T

| EUT TEST CONDITION | | MEASUREMENT DETAIL | |
|--------------------------|-----------------|--------------------|---------------------------|
| CHANNEL | Channel 6 | FREQUENCY RANGE | 1GHz ~ 25GHz |
| INPUT POWER | 120Vac, 60 Hz | DETECTOR FUNCTION | Peak (PK) Average (AV) |
| ENVIRONMENTAL CONDITIONS | 25deg. C, 65%RH | TESTED BY | Kay Wu |

ANTENNA POLARITY & TEST DISTANCE: HORIZONTAL AT 3 M

| FREQ. (MHz) | EMISSION LEVEL (dBuV/m) | READ LEVEL (dBuV) | LIMIT (dBuV/m) | MARGIN (dB) | ANTENNA FACTOR (dB/m) | CABLE LOSS (dB) | PREAMP FACTOR (dB) | ANTENNA HEIGHT (cm) | TABLE ANGLE (Degree) | REMARK |
|-------------|-------------------------|-------------------|----------------|-------------|-----------------------|-----------------|--------------------|---------------------|----------------------|---------|
| 2390 | 46.54 | 44.81 | 54 | -7.46 | 31.8 | 5.4 | 35.47 | 180 | 308 | Average |
| 2390 | 58.05 | 56.32 | 74 | -15.95 | 31.8 | 5.4 | 35.47 | 180 | 308 | Peak |
| 2437 | 100.85 | 99 | | | 31.85 | 5.46 | 35.46 | 180 | 308 | Average |
| 2437 | 108.01 | 106.16 | | | 31.85 | 5.46 | 35.46 | 180 | 308 | Peak |
| 2484 | 42.36 | 40.4 | 54 | -11.64 | 31.88 | 5.5 | 35.42 | 180 | 308 | Average |
| 2484 | 55.47 | 53.51 | 74 | -18.53 | 31.88 | 5.5 | 35.42 | 180 | 308 | Peak |
| 4874 | 41.42 | 33.23 | 54 | -12.58 | 33.98 | 8.27 | 34.06 | 112 | 324 | Average |
| 4874 | 51.35 | 43.16 | 74 | -22.65 | 33.98 | 8.27 | 34.06 | 112 | 324 | Peak |

ANTENNA POLARITY & TEST DISTANCE: VERTICAL AT 3 M

| FREQ. (MHz) | EMISSION LEVEL (dBuV/m) | READ LEVEL (dBuV) | LIMIT (dBuV/m) | MARGIN (dB) | ANTENNA FACTOR (dB/m) | CABLE LOSS (dB) | PREAMP FACTOR (dB) | ANTENNA HEIGHT (cm) | TABLE ANGLE (Degree) | REMARK |
|-------------|-------------------------|-------------------|----------------|-------------|-----------------------|-----------------|--------------------|---------------------|----------------------|---------|
| 2384 | 44.82 | 43.13 | 54 | -9.18 | 31.78 | 5.4 | 35.49 | 108 | 338 | Average |
| 2384 | 56.51 | 54.82 | 74 | -17.49 | 31.78 | 5.4 | 35.49 | 108 | 338 | Peak |
| 2437 | 98.71 | 96.86 | | | 31.85 | 5.46 | 35.46 | 108 | 338 | Average |
| 2437 | 105.99 | 104.14 | | | 31.85 | 5.46 | 35.46 | 108 | 338 | Peak |
| 2500 | 41.97 | 39.95 | 54 | -12.03 | 31.9 | 5.53 | 35.41 | 108 | 338 | Average |
| 2500 | 55.19 | 53.17 | 74 | -18.81 | 31.9 | 5.53 | 35.41 | 108 | 338 | Peak |
| 4874 | 41.47 | 33.28 | 54 | -12.53 | 33.98 | 8.27 | 34.06 | 120 | 269 | Average |
| 4874 | 49.52 | 41.33 | 74 | -24.48 | 33.98 | 8.27 | 34.06 | 120 | 269 | Peak |

REMARKS:

- Emission Level = Read Level + Antenna Factor + Cable Loss - Preamp Factor
Margin value = Emission level – Limit value
- 2437MHz: Fundamental frequency.



A D T

| EUT TEST CONDITION | | MEASUREMENT DETAIL | |
|--------------------------|-----------------|--------------------|---------------------------|
| CHANNEL | Channel 11 | FREQUENCY RANGE | 1GHz ~ 25GHz |
| INPUT POWER | 120Vac, 60 Hz | DETECTOR FUNCTION | Peak (PK) Average (AV) |
| ENVIRONMENTAL CONDITIONS | 25deg. C, 65%RH | TESTED BY | Kay Wu |

| ANTENNA POLARITY & TEST DISTANCE: HORIZONTAL AT 3 M | | | | | | | | | | |
|---|-------------------------|-------------------|----------------|-------------|-----------------------|-----------------|--------------------|---------------------|----------------------|---------|
| FREQ. (MHz) | EMISSION LEVEL (dBuV/m) | READ LEVEL (dBuV) | LIMIT (dBuV/m) | MARGIN (dB) | ANTENNA FACTOR (dB/m) | CABLE LOSS (dB) | PREAMP FACTOR (dB) | ANTENNA HEIGHT (cm) | TABLE ANGLE (Degree) | REMARK |
| 2380 | 43.93 | 42.27 | 54 | -10.07 | 31.78 | 5.37 | 35.49 | 177 | 312 | Average |
| 2380 | 58.09 | 56.43 | 74 | -15.91 | 31.78 | 5.37 | 35.49 | 177 | 312 | Peak |
| 2462 | 99.3 | 97.37 | | | 31.87 | 5.5 | 35.44 | 177 | 312 | Average |
| 2462 | 106.31 | 104.38 | | | 31.87 | 5.5 | 35.44 | 177 | 312 | Peak |
| 2484 | 52.98 | 51.02 | 54 | -1.02 | 31.88 | 5.5 | 35.42 | 177 | 312 | Average |
| 2484 | 63.55 | 61.59 | 74 | -10.45 | 31.88 | 5.5 | 35.42 | 177 | 312 | Peak |
| 4924 | 40.81 | 32.56 | 54 | -13.19 | 33.99 | 8.28 | 34.02 | 100 | 346 | Average |
| 4924 | 49.87 | 41.62 | 74 | -24.13 | 33.99 | 8.28 | 34.02 | 100 | 346 | Peak |
| ANTENNA POLARITY & TEST DISTANCE: VERTICAL AT 3 M | | | | | | | | | | |
| FREQ. (MHz) | EMISSION LEVEL (dBuV/m) | READ LEVEL (dBuV) | LIMIT (dBuV/m) | MARGIN (dB) | ANTENNA FACTOR (dB/m) | CABLE LOSS (dB) | PREAMP FACTOR (dB) | ANTENNA HEIGHT (cm) | TABLE ANGLE (Degree) | REMARK |
| 2372 | 43.49 | 41.83 | 54 | -10.51 | 31.78 | 5.37 | 35.49 | 106 | 337 | Average |
| 2372 | 56.03 | 54.37 | 74 | -17.97 | 31.78 | 5.37 | 35.49 | 106 | 337 | Peak |
| 2462 | 98 | 96.07 | | | 31.87 | 5.5 | 35.44 | 106 | 337 | Average |
| 2462 | 105.64 | 103.71 | | | 31.87 | 5.5 | 35.44 | 106 | 337 | Peak |
| 2484 | 52.71 | 50.75 | 54 | -1.29 | 31.88 | 5.5 | 35.42 | 106 | 337 | Average |
| 2484 | 65.17 | 63.21 | 74 | -8.83 | 31.88 | 5.5 | 35.42 | 106 | 337 | Peak |
| 4924 | 40.53 | 32.28 | 54 | -13.47 | 33.99 | 8.28 | 34.02 | 115 | 284 | Average |
| 4924 | 50.4 | 42.15 | 74 | -23.6 | 33.99 | 8.28 | 34.02 | 115 | 284 | Peak |

REMARKS:

- Emission Level = Read Level + Antenna Factor + Cable Loss - Preamp Factor
Margin value = Emission level – Limit value
- 2462MHz: Fundamental frequency.



A D T

BELOW 1GHz WORST-CASE DATA:

802.11g

| EUT TEST CONDITION | | MEASUREMENT DETAIL | |
|--------------------------|-----------------|--------------------|--------------|
| CHANNEL | Channel 1 | FREQUENCY RANGE | 30MHz ~ 1GHz |
| INPUT POWER | 120Vac, 60 Hz | DETECTOR FUNCTION | Peak (PK) |
| ENVIRONMENTAL CONDITIONS | 25deg. C, 65%RH | TESTED BY | Harry Hsueh |

ANTENNA POLARITY & TEST DISTANCE: HORIZONTAL AT 3 M

| FREQ. (MHz) | EMISSION LEVEL (dBuV/m) | READ LEVEL (dBuV) | LIMIT (dBuV/m) | MARGIN (dB) | ANTENNA FACTOR (dB/m) | CABLE LOSS (dB) | PREAMP FACTOR (dB) | ANTENNA HEIGHT (cm) | TABLE ANGLE (Degree) | REMARK |
|-------------|-------------------------|-------------------|----------------|-------------|-----------------------|-----------------|--------------------|---------------------|----------------------|--------|
| 92.64 | 19.17 | 40.8 | 43.5 | -24.33 | 9.14 | 1.11 | 31.88 | 126 | 201 | Peak |
| 145.02 | 20.86 | 42.02 | 43.5 | -22.64 | 9.73 | 1.38 | 32.27 | 112 | 101 | Peak |
| 193.62 | 27.76 | 47.85 | 43.5 | -15.74 | 10.57 | 1.61 | 32.27 | 102 | 147 | Peak |
| 338.5 | 23.38 | 37.38 | 46 | -22.62 | 15.89 | 2.19 | 32.08 | 166 | 214 | Peak |
| 465.2 | 18.9 | 29.93 | 46 | -27.1 | 18.54 | 2.56 | 32.13 | 155 | 225 | Peak |
| 601 | 29.24 | 37.46 | 46 | -16.76 | 21.1 | 2.87 | 32.19 | 166 | 201 | Peak |

ANTENNA POLARITY & TEST DISTANCE: VERTICAL AT 3 M

| FREQ. (MHz) | EMISSION LEVEL (dBuV/m) | READ LEVEL (dBuV) | LIMIT (dBuV/m) | MARGIN (dB) | ANTENNA FACTOR (dB/m) | CABLE LOSS (dB) | PREAMP FACTOR (dB) | ANTENNA HEIGHT (cm) | TABLE ANGLE (Degree) | REMARK |
|-------------|-------------------------|-------------------|----------------|-------------|-----------------------|-----------------|--------------------|---------------------|----------------------|--------|
| 48.63 | 18.53 | 41.62 | 40 | -21.47 | 8.23 | 0.9 | 32.22 | 168 | 229 | Peak |
| 79.14 | 20.32 | 43.04 | 40 | -19.68 | 8.38 | 1.11 | 32.21 | 105 | 185 | Peak |
| 145.83 | 17.23 | 38.33 | 43.5 | -26.27 | 9.79 | 1.38 | 32.27 | 165 | 352 | Peak |
| 338.5 | 22.1 | 36.1 | 46 | -23.9 | 15.89 | 2.19 | 32.08 | 162 | 251 | Peak |
| 524.7 | 20.98 | 29.73 | 46 | -25.02 | 20.7 | 2.7 | 32.15 | 135 | 221 | Peak |
| 601 | 28.02 | 36.24 | 46 | -17.98 | 21.1 | 2.87 | 32.19 | 166 | 251 | Peak |

REMARKS: Emission Level = Read Level + Antenna Factor + Cable Loss - Preamp Factor

Margin value = Emission level – Limit value

4.2 CONDUCTED EMISSION MEASUREMENT

4.2.1 LIMITS OF CONDUCTED EMISSION MEASUREMENT

| FREQUENCY OF EMISSION (MHz) | CONDUCTED LIMIT (dB μ V) | |
|-----------------------------|------------------------------|----------|
| | Quasi-peak | Average |
| 0.15 ~ 0.5 | 66 to 56 | 56 to 46 |
| 0.5 ~ 5 | 56 | 46 |
| 5 ~ 30 | 60 | 50 |

- NOTE:**
1. The lower limit shall apply at the transition frequencies.
 2. The limit decreases in line with the logarithm of the frequency in the range of 0.15 to 0.50MHz.
 3. All emanations from a class A/B digital device or system, including any network of conductors and apparatus connected thereto, shall not exceed the level of field strengths specified above.

4.2.2 TEST INSTRUMENTS

| DESCRIPTION & MANUFACTURER | MODEL NO. | SERIAL NO. | DATE OF CALIBRATION | DUE DATE OF CALIBRATION |
|---|--------------------------|----------------|---------------------|-------------------------|
| Test Receiver ROHDE & SCHWARZ | ESCS30 | 100288 | Nov. 17, 2013 | Nov. 16, 2014 |
| RF signal cable Woken | 5D-FB | Cable-HYCO2-01 | Dec. 27, 2013 | Dec. 26, 2014 |
| LISN ROHDE & SCHWARZ (EUT) | ESH2-Z5 | 100100 | Dec. 23, 2013 | Dec. 22, 2014 |
| LISN ROHDE & SCHWARZ (Peripheral) | ESH3-Z5 | 100312 | Jul. 08, 2013 | Jul. 07, 2014 |
| Software ADT | BV ADT_Cond_ V7.3.7.3 | NA | NA | NA |

- NOTE:**
1. The calibration interval of the above test instruments is 12 months and the calibrations are traceable to NML/ROC and NIST/USA.
 2. The test was performed in HwaYa Shielded Room 2.
 3. The VCCI Site Registration No. is C-2047.

4.2.3 TEST PROCEDURES

- a. The EUT was placed 0.4 meters from the conducting wall of the shielded room with EUT being connected to the power mains through a line impedance stabilization network (LISN). Other support units were connected to the power mains through another LISN. The two LISNs provide 50 ohm/ 50uH of coupling impedance for the measuring instrument.
- b. Both lines of the power mains connected to the EUT were checked for maximum conducted interference.
- c. The frequency range from 150kHz to 30MHz was searched. Emission levels under (Limit - 20dB) was not recorded.

NOTE: All modes of operation were investigated and the worst-case emissions are reported.

4.2.4 DEVIATION FROM TEST STANDARD

No deviation.

4.2.5 TEST SETUP

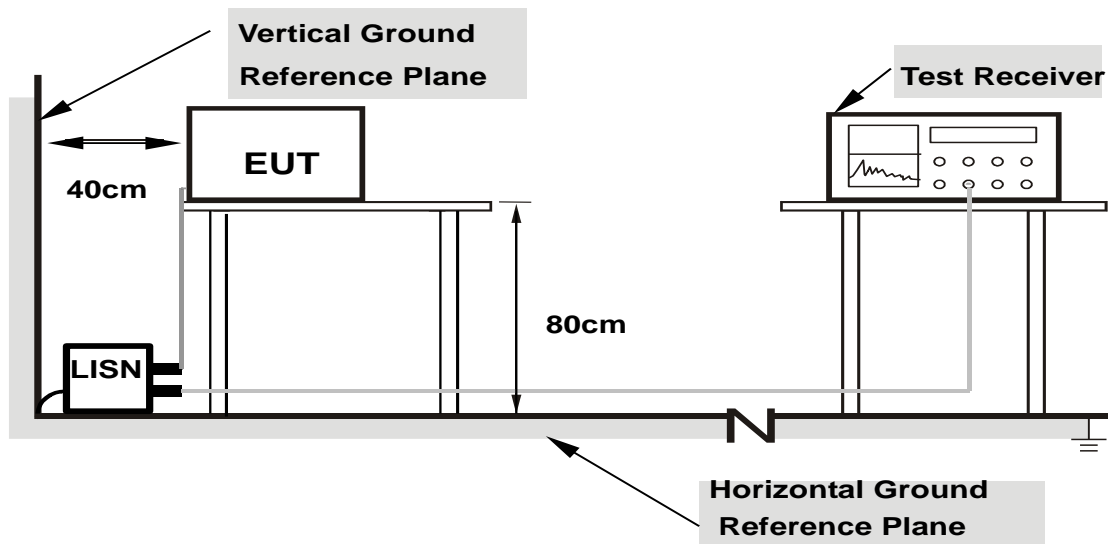

- Note:**
1. Support units were connected to second LISN.
 2. Both of LISNs (AMN) are 80 cm from EUT and at least 80 from other units and other metal planes

For the actual test configuration, please refer to the attached file (Test Setup Photo).

4.2.6 EUT OPERATING CONDITIONS

Same as section 4.1.6.

4.2.7 TEST RESULTS

CONDUCTED WORST-CASE DATA :

| | | | |
|-------|--------|---------------|------|
| PHASE | Line 1 | 6dB BANDWIDTH | 9kHz |
|-------|--------|---------------|------|

| No | Freq. | Corr. Factor | Reading Value | | Emission Level | | Limit | | Margin | |
|----|----------|--------------|---------------|-------|----------------|-------|-----------|-------|--------|--------|
| | [MHz] | | [dB (uV)] | | [dB (uV)] | | [dB (uV)] | | (dB) | |
| | | | Q.P. | AV. | Q.P. | AV. | Q.P. | AV. | Q.P. | AV. |
| 1 | 0.16172 | 0.27 | 47.70 | 35.40 | 47.97 | 35.67 | 65.38 | 55.38 | -17.41 | -19.71 |
| 2 | 0.33359 | 0.29 | 37.86 | 25.14 | 38.15 | 25.43 | 59.36 | 49.36 | -21.21 | -23.93 |
| 3 | 0.64609 | 0.32 | 34.96 | 24.79 | 35.28 | 25.11 | 56.00 | 46.00 | -20.72 | -20.89 |
| 4 | 2.32031 | 0.37 | 26.78 | 17.56 | 27.15 | 17.93 | 56.00 | 46.00 | -28.85 | -28.07 |
| 5 | 4.94922 | 0.44 | 21.28 | 11.44 | 21.72 | 11.88 | 56.00 | 46.00 | -34.28 | -34.12 |
| 6 | 12.83203 | 0.52 | 20.13 | 11.91 | 20.65 | 12.43 | 60.00 | 50.00 | -39.35 | -37.57 |

REMARKS:

1. Q.P. and AV. are abbreviations of quasi-peak and average individually.
2. The emission levels of other frequencies were very low against the limit.
3. Margin value = Emission level - Limit value
4. Correction factor = Insertion loss + Cable loss
5. Emission Level = Correction Factor + Reading Value

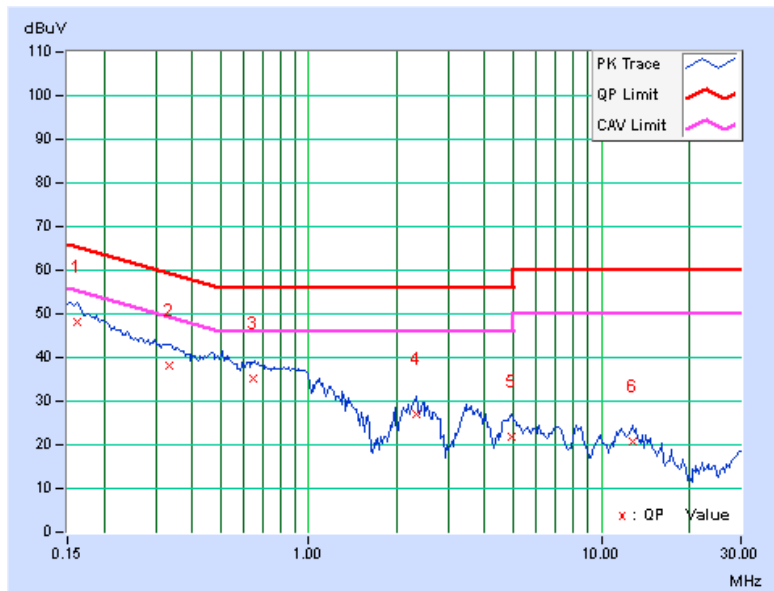

| | | | |
|-------|--------|---------------|------|
| PHASE | Line 2 | 6dB BANDWIDTH | 9kHz |
|-------|--------|---------------|------|

| No | Freq. [MHz] | Corr. Factor (dB) | Reading Value [dB (uV)] | | Emission Level [dB (uV)] | | Limit [dB (uV)] | | Margin (dB) | |
|----|----------------|-------------------------|----------------------------|--------------|-----------------------------|--------------|--------------------|--------------|----------------|---------------|
| | | | Q.P. | AV. | Q.P. | AV. | Q.P. | AV. | Q.P. | AV. |
| | | | 1 | 0.20469 | 0.28 | 40.45 | 26.25 | 40.73 | 26.53 | 63.42 |
| 2 | 0.48594 | 0.31 | 40.13 | 31.80 | 40.44 | 32.11 | 56.24 | 46.24 | -15.80 | -14.13 |
| 3 | 0.94297 | 0.34 | 31.35 | 19.44 | 31.69 | 19.78 | 56.00 | 46.00 | -24.31 | -26.22 |
| 4 | 2.51563 | 0.39 | 22.83 | 13.77 | 23.22 | 14.16 | 56.00 | 46.00 | -32.78 | -31.84 |
| 5 | 3.62500 | 0.43 | 18.35 | 9.72 | 18.78 | 10.15 | 56.00 | 46.00 | -37.22 | -35.85 |
| 6 | 11.28516 | 0.53 | 12.89 | 8.11 | 13.42 | 8.64 | 60.00 | 50.00 | -46.58 | -41.36 |

REMARKS:

1. Q.P. and AV. are abbreviations of quasi-peak and average individually.
2. The emission levels of other frequencies were very low against the limit.
3. Margin value = Emission level - Limit value
4. Correction factor = Insertion loss + Cable loss
5. Emission Level = Correction Factor + Reading Value

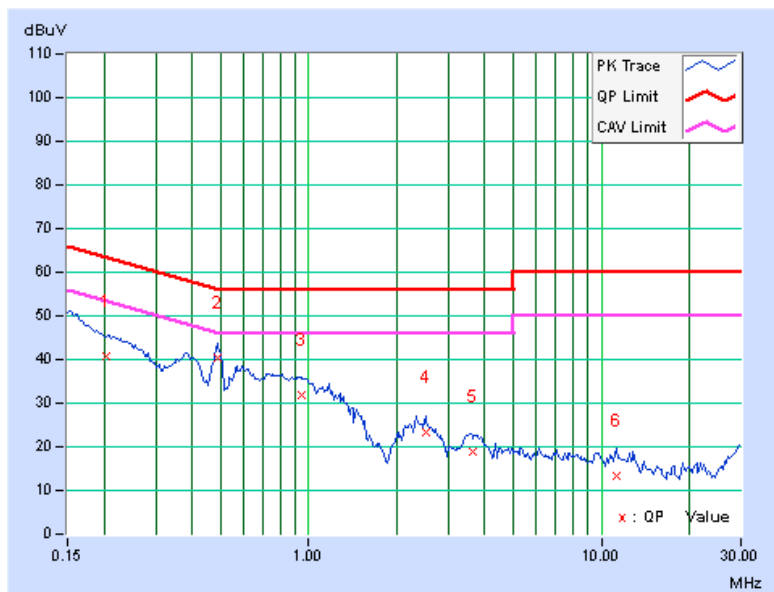

4.3 6dB BANDWIDTH MEASUREMENT

4.3.1 LIMITS OF 6dB BANDWIDTH MEASUREMENT

The minimum of 6dB Bandwidth Measurement is 0.5 MHz.

4.3.2 TEST SETUP

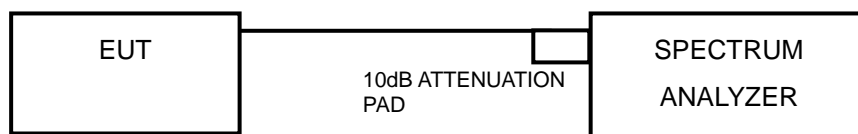

4.3.3 TEST INSTRUMENTS

Refer to section 4.1.2 to get information of above instrument.

4.3.4 TEST PROCEDURE

- Set resolution bandwidth (RBW) = 100kHz
- Set the video bandwidth (VBW) $\geq 3 \times$ RBW, Detector = Peak.
- Trace mode = max hold.
- Sweep = auto couple.
- Measure the maximum width of the emission that is constrained by the frequencies associated with the two amplitude points (upper and lower) that are attenuated by 6 dB relative to the maximum level measured in the fundamental emission

4.3.5 DEVIATION FROM TEST STANDARD

No deviation.

4.3.6 EUT OPERATING CONDITIONS

The software provided by client to enable the EUT under transmission condition continuously at lowest, middle and highest channel frequencies individually.



A D T

4.3.7 TEST RESULTS

802.11b

| CHANNEL | FREQUENCY (MHz) | 6dB BANDWIDTH (MHz) | MINIMUM LIMIT (MHz) | PASS / FAIL |
|---------|-----------------|---------------------|---------------------|-------------|
| 1 | 2412 | 7.58 | 0.5 | PASS |
| 6 | 2437 | 7.58 | 0.5 | PASS |
| 11 | 2462 | 7.57 | 0.5 | PASS |

802.11g

| CHANNEL | FREQUENCY (MHz) | 6dB BANDWIDTH (MHz) | MINIMUM LIMIT (MHz) | PASS / FAIL |
|---------|-----------------|---------------------|---------------------|-------------|
| 1 | 2412 | 15.09 | 0.5 | PASS |
| 6 | 2437 | 15.14 | 0.5 | PASS |
| 11 | 2462 | 15.38 | 0.5 | PASS |

802.11n (20MHz)

| CHANNEL | FREQUENCY (MHz) | 6dB BANDWIDTH (MHz) | MINIMUM LIMIT (MHz) | PASS / FAIL |
|---------|-----------------|---------------------|---------------------|-------------|
| 1 | 2412 | 15.14 | 0.5 | PASS |
| 6 | 2437 | 15.13 | 0.5 | PASS |
| 11 | 2462 | 15.15 | 0.5 | PASS |



A D T

SPECTRUM PLOT OF WORST VALUE

802.11b

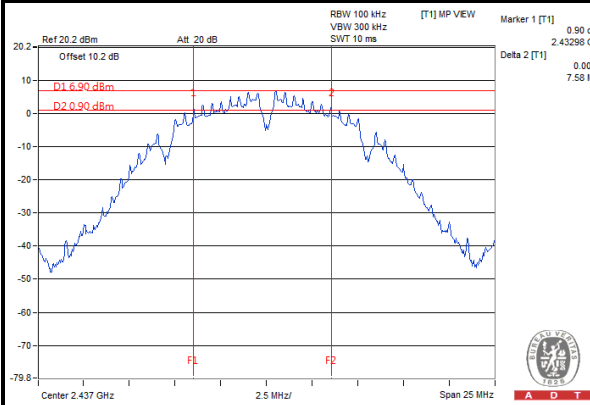

802.11g

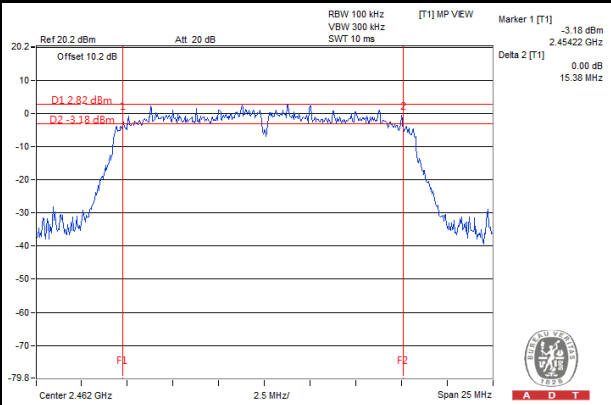

802.11n (20MHz)

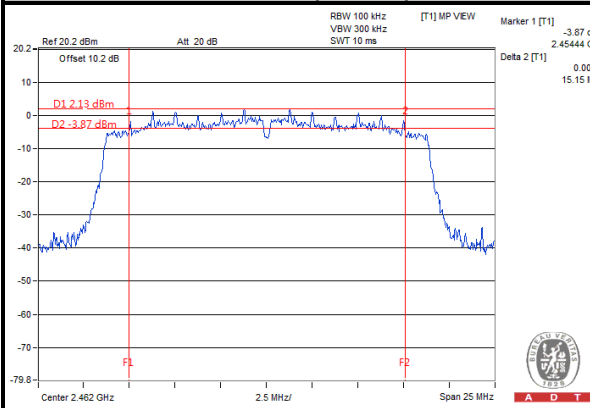

4.4 CONDUCTED OUTPUT POWER

4.4.1 LIMITS OF CONDUCTED OUTPUT POWER MEASUREMENT

For systems using digital modulation in the 2400–2483.5 MHz bands: 1 Watt (30dBm)

4.4.2 TEST SETUP

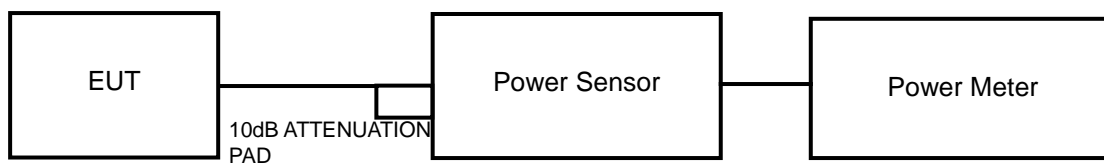

4.4.3 TEST INSTRUMENTS

Refer to section 4.1.2 to get information of above instrument.

4.4.4 TEST PROCEDURES

A peak power sensor was used on the output port of the EUT. A power meter was used to read the response of the peak power sensor. Record the peak power level.

4.4.5 DEVIATION FROM TEST STANDARD

No deviation.

4.4.6 EUT OPERATING CONDITIONS

Same as section 4.3.6.

4.4.7 TEST RESULTS

802.11b

| CHANNEL | FREQUENCY (MHz) | PEAK POWER (mW) | PEAK POWER (dBm) | LIMIT (dBm) | PASS / FAIL |
|---------|-----------------|-----------------|------------------|-------------|-------------|
| 1 | 2412 | 56.62 | 17.53 | 30 | PASS |
| 6 | 2437 | 52.60 | 17.21 | 30 | PASS |
| 11 | 2462 | 18.84 | 12.75 | 30 | PASS |

802.11g

| CHANNEL | FREQUENCY (MHz) | PEAK POWER (mW) | PEAK POWER (dBm) | LIMIT (dBm) | PASS / FAIL |
|---------|-----------------|-----------------|------------------|-------------|-------------|
| 1 | 2412 | 127.35 | 21.05 | 30 | PASS |
| 6 | 2437 | 194.54 | 22.89 | 30 | PASS |
| 11 | 2462 | 108.14 | 20.34 | 30 | PASS |

802.11n (20MHz)

| CHANNEL | FREQUENCY (MHz) | PEAK POWER (mW) | PEAK POWER (dBm) | LIMIT (dBm) | PASS / FAIL |
|---------|-----------------|-----------------|------------------|-------------|-------------|
| 1 | 2412 | 177.83 | 22.50 | 30 | PASS |
| 6 | 2437 | 186.21 | 22.70 | 30 | PASS |
| 11 | 2462 | 179.89 | 22.55 | 30 | PASS |

4.5 POWER SPECTRAL DENSITY MEASUREMENT

4.5.1 LIMITS OF POWER SPECTRAL DENSITY MEASUREMENT

The Maximum of Power Spectral Density Measurement is 8dBm.

4.5.2 TEST SETUP

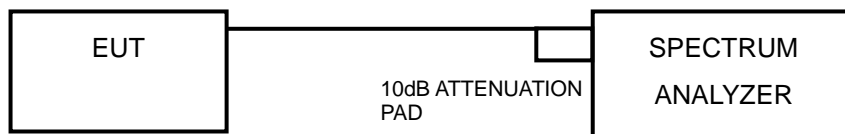

4.5.3 TEST INSTRUMENTS

Refer to section 4.1.2 to get information of above instrument.

4.5.4 TEST PROCEDURE

- Set the RBW = 3 kHz, VBW =10 kHz, Detector = peak.
- Sweep time = auto couple, Trace mode = max hold, allow trace to fully stabilize.
- Use the peak marker function to determine the maximum power level in any 100 kHz band segment within the fundamental EBW.

4.5.5 DEVIATION FROM TEST STANDARD

No deviation.

4.5.6 EUT OPERATING CONDITION

Same as section 4.3.6.



A D T

4.5.7 TEST RESULTS

802.11b

| CHANNEL | FREQUENCY (MHz) | PSD (dBm/3kHz) | LIMIT (dBm/3kHz) | PASS / FAIL |
|---------|-----------------|----------------|------------------|-------------|
| 1 | 2412 | -7.06 | 8 | PASS |
| 6 | 2437 | -6.93 | 8 | PASS |
| 11 | 2462 | -7.31 | 8 | PASS |

802.11g

| CHANNEL | FREQUENCY (MHz) | PSD (dBm/3kHz) | LIMIT (dBm/3kHz) | PASS / FAIL |
|---------|-----------------|----------------|------------------|-------------|
| 1 | 2412 | -10.87 | 8 | PASS |
| 6 | 2437 | -10.73 | 8 | PASS |
| 11 | 2462 | -10.15 | 8 | PASS |

802.11n (20MHz)

| CHANNEL | FREQUENCY (MHz) | PSD (dBm/3kHz) | LIMIT (dBm/3kHz) | PASS / FAIL |
|---------|-----------------|----------------|------------------|-------------|
| 1 | 2412 | -12.78 | 8 | PASS |
| 6 | 2437 | -10.53 | 8 | PASS |
| 11 | 2462 | -12.31 | 8 | PASS |



A D T

SPECTRUM PLOT OF WORST VALUE

802.11b

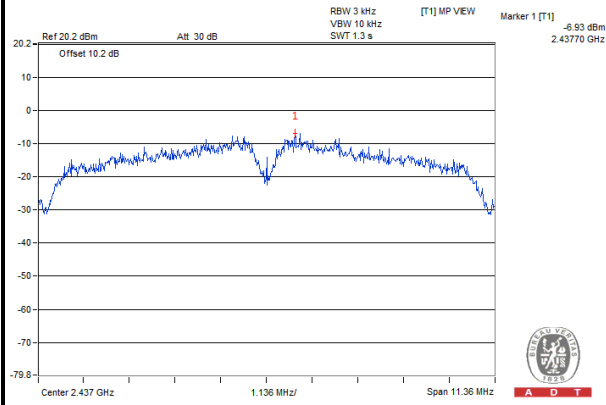

802.11g

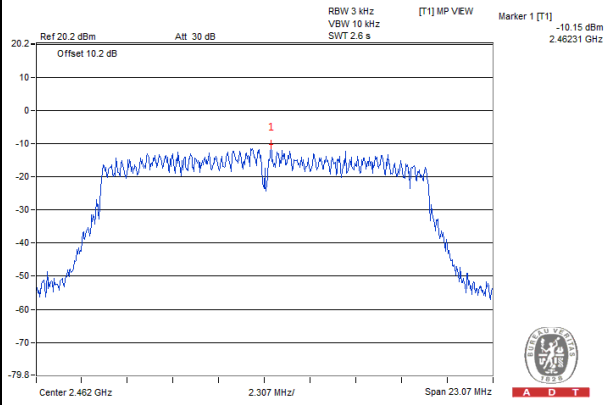

802.11n (20MHz)

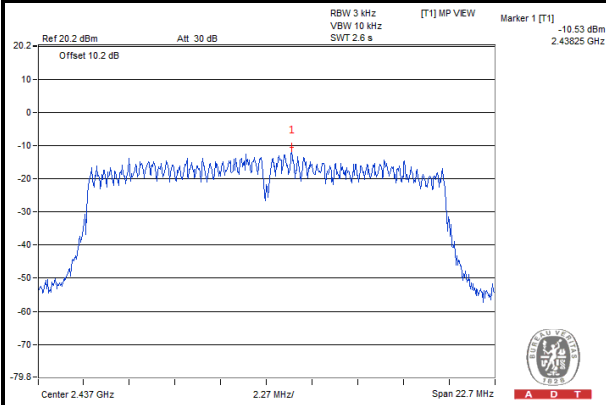

4.6 CONDUCTED OUT OF BAND EMISSION MEASUREMENT

4.6.1 LIMITS OF CONDUCTED OUT OF BAND EMISSION MEASUREMENT

Below -20dB of the highest emission level of operating band (in 100kHz Resolution Bandwidth).

4.6.2 TEST SETUP

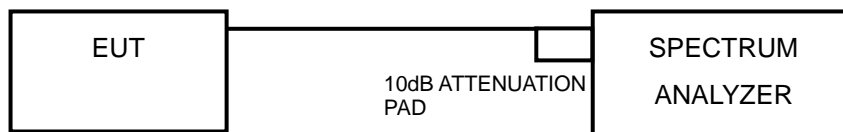

4.6.3 TEST INSTRUMENTS

Refer to section 4.1.2 to get information of above instrument.

4.6.4 TEST PROCEDURE

MEASUREMENT PROCEDURE REF

1. Set the RBW = 100 kHz.
2. Set the VBW \geq 300 kHz.
3. Detector = peak.
4. Sweep time = auto couple.
5. Trace mode = max hold.
6. Allow trace to fully stabilize.
7. Use the peak marker function to determine the maximum power level in any 100 kHz band segment within the fundamental EBW.

MEASUREMENT PROCEDURE OOB

1. Set RBW = 100 kHz.
2. Set VBW \geq 300 kHz.
3. Ensure that the number of measurement points \geq span/RBW
4. According to measurement points to set differ measurement span.
5. Detector = peak.
6. Trace Mode = max hold.
7. Sweep = auto couple.

4.6.5 DEVIATION FROM TEST STANDARD

No deviation.

4.6.6 EUT OPERATING CONDITION

Same as section 4.3.6.

4.6.7 TEST RESULTS

The spectrum plots are attached on the following images. D1 line indicates the highest level, and D2 line indicates the 20dB offset below D1. It shows compliance with the requirement.

802.11b

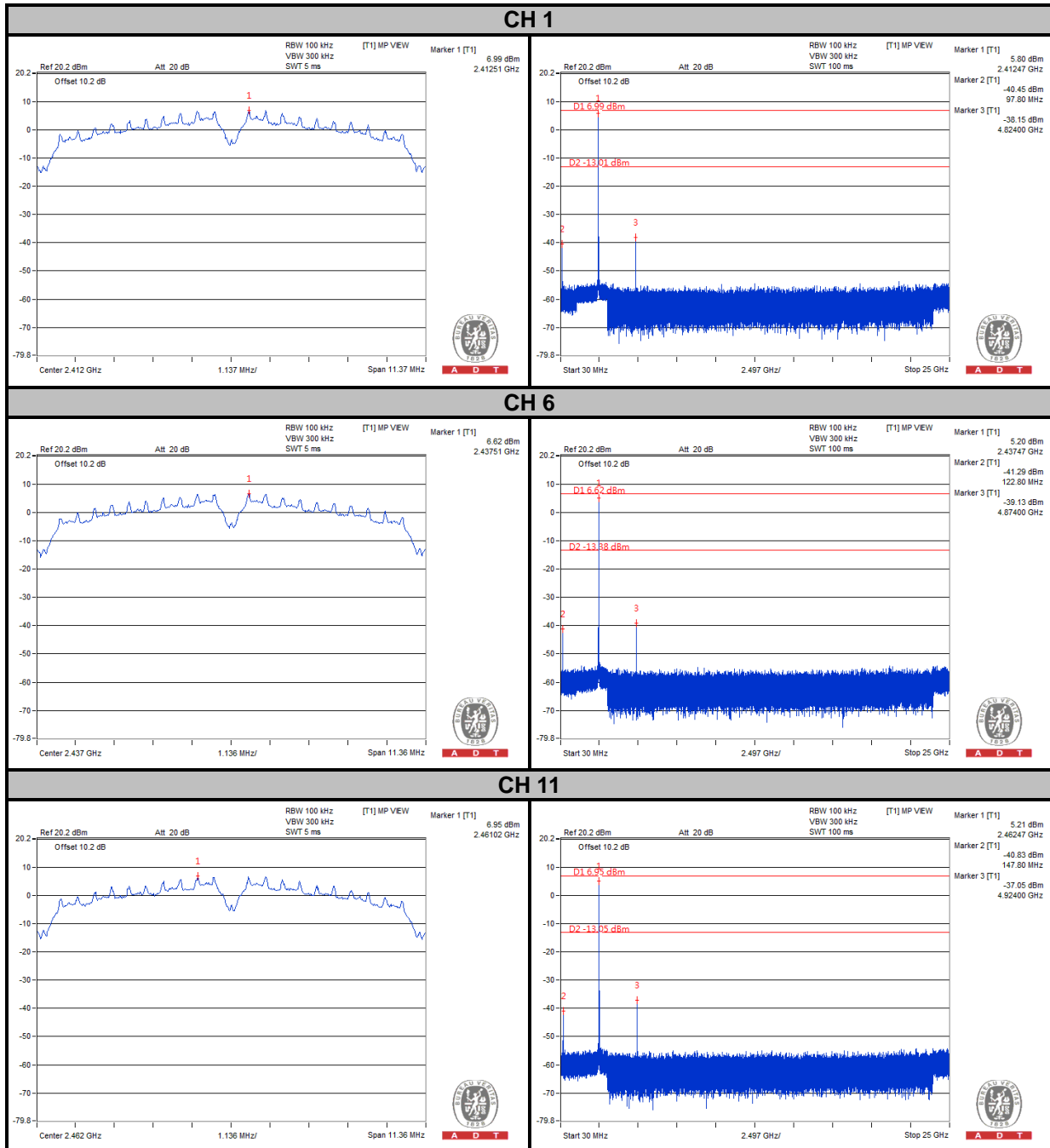



A D T

802.11g

CH 1

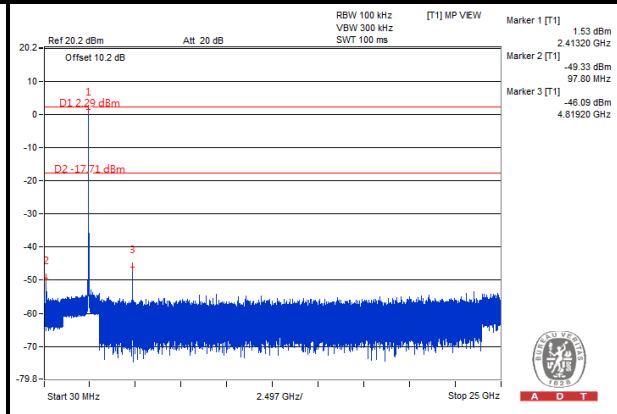
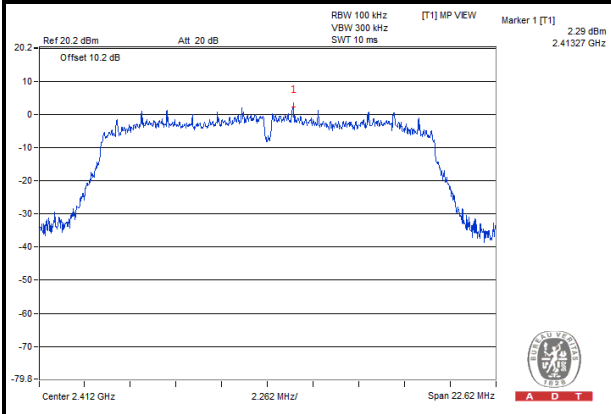

CH 6

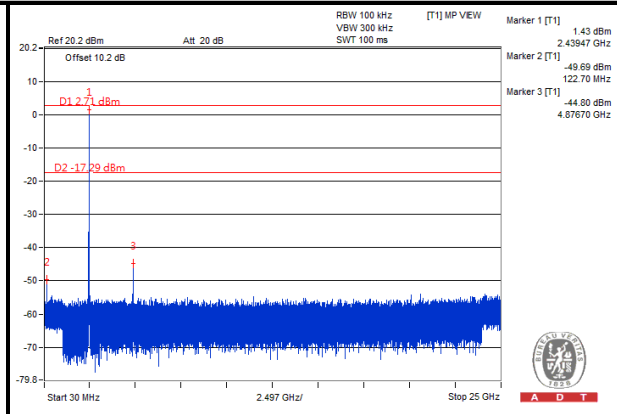
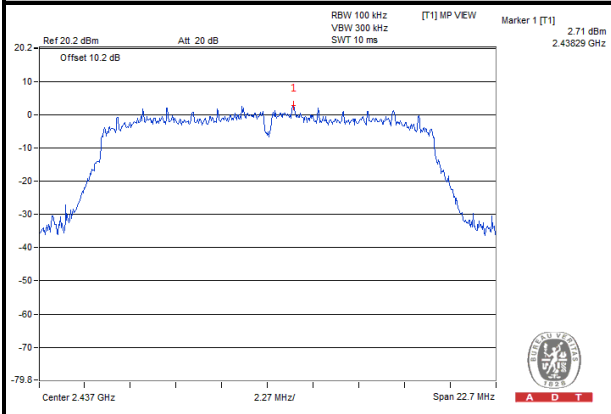

CH 11

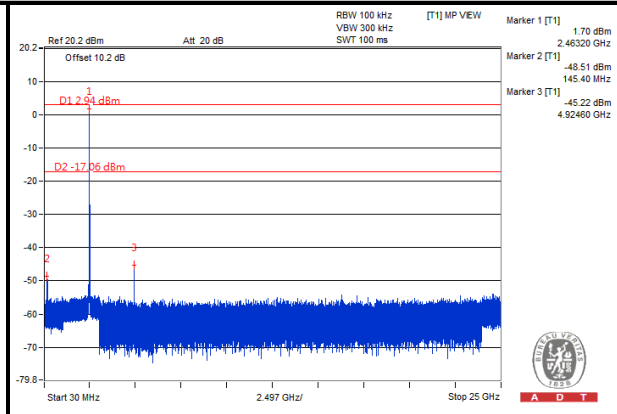
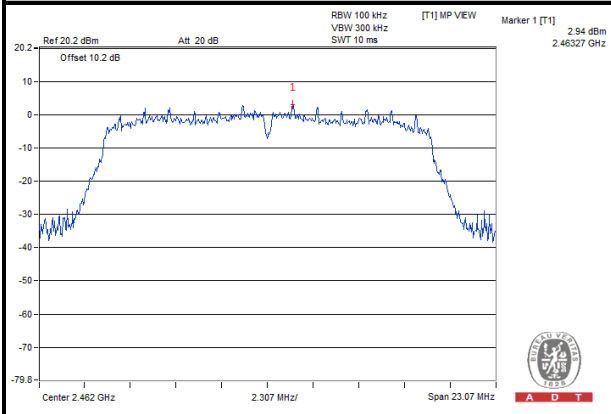



A D T

802.11n (20MHz)

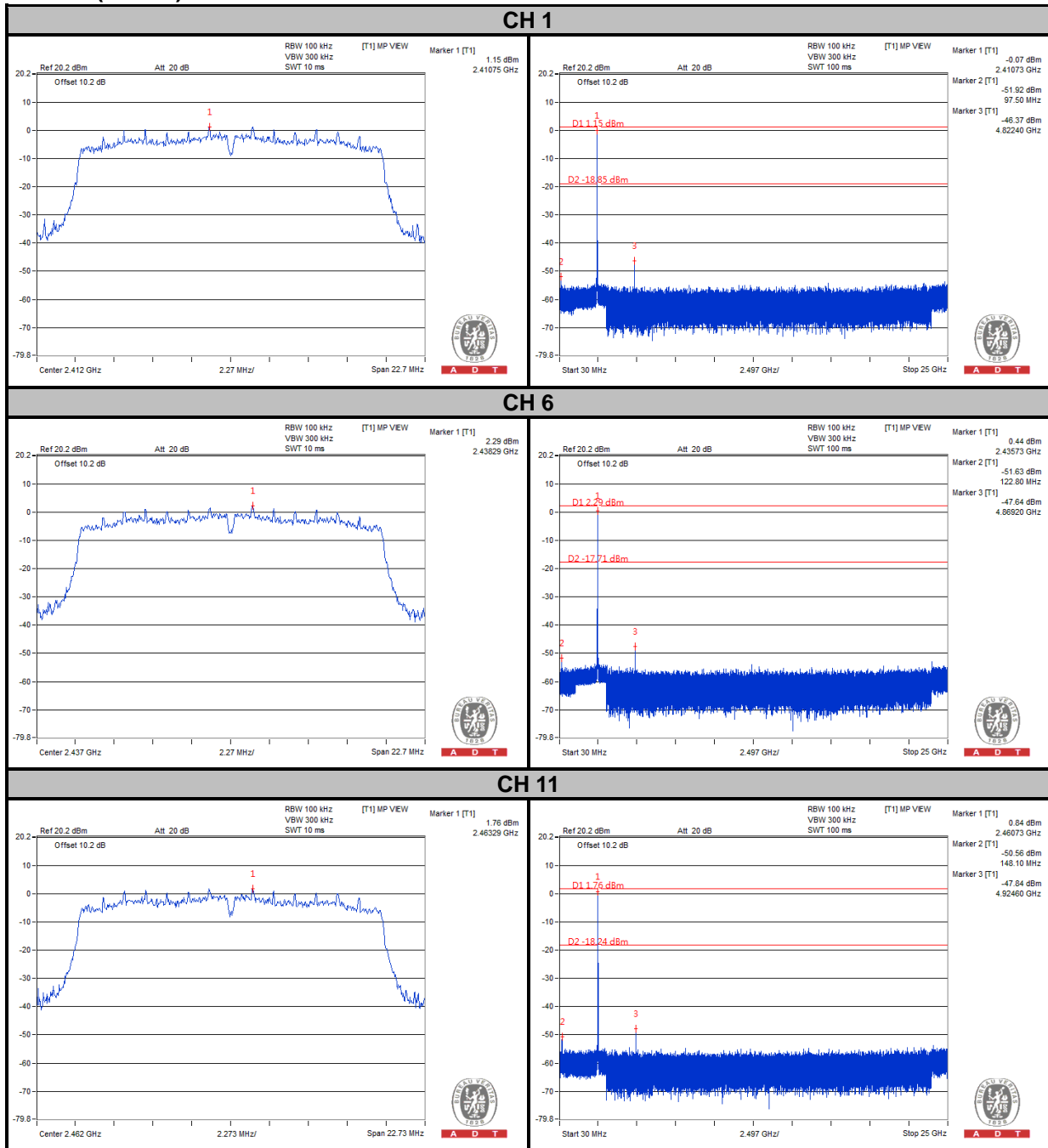



A D T

5. PHOTOGRAPHS OF THE TEST CONFIGURATION

Please refer to the attached file (Test Setup Photo).



6. INFORMATION ON THE TESTING LABORATORIES

We, Bureau Veritas Consumer Products Services (H.K.) Ltd., Taoyuan Branch, were founded in 1988 to provide our best service in EMC, Radio, Telecom and Safety consultation. Our laboratories are accredited and approved according to ISO/IEC 17025.

If you have any comments, please feel free to contact us at the following:

Linko EMC/RF Lab:

Tel: 886-2-26052180

Fax: 886-2-26051924

Hsin Chu EMC/RF Lab:

Tel: 886-3-5935343

Fax: 886-3-5935342

Hwa Ya EMC/RF/Safety Telecom Lab:

Tel: 886-3-3183232

Fax: 886-3-3270892

Email: service.adt@tw.bureauveritas.com

Web Site: www.bureauveritas-adt.com

The address and road map of all our labs can be found in our web site also.



A D T

7. APPENDIX A – MODIFICATIONS RECORDERS FOR ENGINEERING CHANGES TO THE EUT BY THE LAB

No any modifications are made to the EUT by the lab during the test.

---END---