



FCC TEST REPORT (PART 27)

REPORT NO.: RF141015C15-4

MODEL NO.: K00X

FCC ID: MSQK00X

RECEIVED: Oct. 15, 2014

TESTED: Oct. 22, 2014 ~ Nov. 12, 2014

ISSUED: Nov. 19, 2014

APPLICANT: ASUSTek COMPUTER INC.

ADDRESS: No. 150, LI-TE Rd., PEITOU, TAIPEI 112, TAIWAN

ISSUED BY: Bureau Veritas Consumer Products Services
(H.K.) Ltd., Taoyuan Branch

LAB ADDRESS: No. 47-2, 14th Ling, Chia Pau Vil., Lin Kou Dist.,
New Taipei City, Taiwan, R.O.C.

TEST LOCATION: No. 19, Hwa Ya 2nd Rd, Wen Hwa Tsuen, Kwei
Shan Hsiang, Taoyuan Hsien 333, Taiwan, R.O.C.

This report should not be used by the client to claim product certification, approval, or endorsement by TAF or any government agencies.



This report is for your exclusive use. Any copying or replication of this report to or for any other person or entity, or use of our name or trademark, is permitted only with our prior written permission. This report sets forth our findings solely with respect to the test samples identified herein. The results set forth in this report are not indicative or representative of the quality or characteristics of the lot from which a test sample was taken or any similar or identical product unless specifically and expressly noted. Our report includes all of the tests requested by you and the results thereof based upon the information that you provided to us. You have 60 days from date of issuance of this report to notify us of any material error or omission caused by our negligence, provided, however, that such notice shall be in writing and shall specifically address the issue you wish to raise. A failure to raise such issue within the prescribed time shall constitute your unqualified acceptance of the completeness of this report, the tests conducted and the correctness of the report contents. Unless specific mention, the uncertainty of measurement has been explicitly taken into account to declare the compliance or non-compliance to the specification



TABLE OF CONTENTS

RELEASE CONTROL RECORD.....	3
1 CERTIFICATION	4
2 SUMMARY OF TEST RESULTS.....	5
2.1 MEASUREMENT UNCERTAINTY	6
2.2 TEST SITE AND INSTRUMENTS	7
3 GENERAL INFORMATION	8
3.1 GENERAL DESCRIPTION OF EUT.....	8
3.2 CONFIGURATION OF SYSTEM UNDER TEST	11
3.3 DESCRIPTION OF SUPPORT UNITS.....	11
3.4 DESCRIPTION OF TEST MODES.....	12
3.5 GENERAL DESCRIPTION OF APPLIED STANDARDS.....	14
4 TEST TYPES AND RESULTS.....	15
4.1 OUTPUT POWER MEASUREMENT	15
4.1.1 LIMITS OF OUTPUT POWER MEASUREMENT	15
4.1.2 TEST PROCEDURES.....	15
4.1.3 TEST SETUP	16
4.1.4 TEST RESULTS	17
4.2 FREQUENCY STABILITY MEASUREMENT	27
4.2.1 LIMITS OF FREQUENCY STABILITY MEASUREMENT	27
4.2.2 TEST PROCEDURE	27
4.2.3 TEST SETUP	27
4.2.4 TEST RESULTS	28
4.3 OCCUPIED BANDWIDTH MEASUREMENT.....	30
4.3.1 LIMITS OF OCCUPIED BANDWIDTH MEASUREMENT.....	30
4.3.2 TEST SETUP	30
4.3.3 TEST PROCEDURES.....	30
4.3.4 TEST RESULTS	31
4.4 PEAK TO AVERAGE RATIO.....	35
4.4.1 LIMITS OF PEAK TO AVERAGE RATIO MEASUREMENT	35
4.4.2 TEST SETUP	35
4.4.3 TEST PROCEDURES.....	35
4.4.4 TEST RESULTS	36
4.5 BAND EDGE MEASUREMENT	40
4.5.1 LIMITS OF BAND EDGE MEASUREMENT	40
4.5.2 TEST SETUP	40
4.5.3 TEST PROCEDURES.....	40
4.5.4 TEST RESULTS	41
4.6 CONDUCTED SPURIOUS EMISSIONS.....	49
4.6.1 LIMITS OF CONDUCTED SPURIOUS EMISSIONS MEASUREMENT.....	49
4.6.2 TEST PROCEDURE	49
4.6.3 TEST SETUP	49
4.6.4 TEST RESULTS	49
4.7 RADIATED EMISSION MEASUREMENT	51
4.7.1 LIMITS OF RADIATED EMISSION MEASUREMENT	51
4.7.2 TEST PROCEDURES.....	51
4.7.3 DEVIATION FROM TEST STANDARD	51
4.7.4 TEST SETUP	52
4.7.5 TEST RESULTS	53
5 PHOTOGRAPHS OF THE TEST CONFIGURATION	57
6 INFORMATION ON THE TESTING LABORATORIES	58
7 APPENDIX A – MODIFICATIONS RECORDERS FOR ENGINEERING CHANGES TO THE EUT BY THE LAB.....	59



A D T

RELEASE CONTROL RECORD

ISSUE NO.	REASON FOR CHANGE	DATE ISSUED
RF141015C15-4	Original release	Nov. 19, 2014



A D T

1 CERTIFICATION

PRODUCT: ASUS Tablet
MODEL NO.: K00X
BRAND: ASUS
APPLICANT: ASUSTek COMPUTER INC.
TESTED: Oct. 22, 2014 ~ Nov. 12, 2014
TEST SAMPLE: Production Unit
TEST STANDARDS: **FCC Part 27, Subpart C, L**
FCC Part 2
ANSI C63.4-2003

The above equipment (model: K00X) has been tested by **Bureau Veritas Consumer Products Services (H.K.) Ltd., Taoyuan Branch**, and found compliance with the requirement of the above standards. The test record, data evaluation & Equipment Under Test (EUT) configurations represented herein are true and accurate accounts of the measurements of the sample's EMC characteristics under the conditions specified in this report.

PREPARED BY : Vera Huang , **DATE:** Nov. 19, 2014

Vera Huang / Specialist

APPROVED BY : Sam chen , **DATE:** Nov. 19, 2014

Sam Chen / Senior Project Engineer

2 SUMMARY OF TEST RESULTS

The EUT has been tested according to the following specifications:

LTE Band 17			
STANDARD SECTION	TEST TYPE AND LIMIT	RESULT	REMARK
2.1046 27.50(C)(10)	Maximum Peak Output Power	PASS	Meet the requirement of limit.
2.1055 27.54	Frequency Stability	PASS	Meet the requirement of limit.
2.1049 27.53(g)	Occupied Bandwidth	PASS	Meet the requirement of limit.
27.50(d)(5)	Peak to Average Ratio	PASS	Meet the requirement of limit.
27.53(g)	Band Edge Measurements	PASS	Meet the requirement of limit.
2.1051 27.53(g)	Conducted Spurious Emissions	PASS	Meet the requirement of limit.
2.1053 27.53(g)	Radiated Spurious Emissions	PASS	Meet the requirement of limit. Minimum passing margin is -27.14dB at 31.07MHz.

LTE Band 4			
STANDARD SECTION	TEST TYPE AND LIMIT	RESULT	REMARK
2.1046 27.50(d)(4)	Maximum Peak Output Power	PASS	Meet the requirement of limit.
2.1055 27.54	Frequency Stability	PASS	Meet the requirement of limit.
2.1049 27.53(h)	Occupied Bandwidth	PASS	Meet the requirement of limit.
27.50(d)(5)	Peak to Average Ratio	PASS	Meet the requirement of limit.
27.53(h)	Band Edge Measurements	PASS	Meet the requirement of limit.
2.1051 27.53(h)	Conducted Spurious Emissions	PASS	Meet the requirement of limit.
2.1053 27.53(h)	Radiated Spurious Emissions	PASS	Meet the requirement of limit. Minimum passing margin is -5.00dB at 3447.40MHz.

2.1 MEASUREMENT UNCERTAINTY

Where relevant, the following measurement uncertainty levels have been estimated for tests performed on the EUT as specified in CISPR 16-4-2:

MEASUREMENT	FREQUENCY	UNCERTAINTY
Conducted emissions	150kHz~30MHz	2.44 dB
Radiated emissions	30MHz ~ 200MHz	2.93 dB
	200MHz ~1000MHz	2.95 dB
	1GHz ~ 18GHz	2.26 dB
	18GHz ~ 40GHz	1.94 dB

This uncertainty represents an expanded uncertainty expressed at approximately the 95% confidence level using a coverage factor of $k=2$.



2.2 TEST SITE AND INSTRUMENTS

DESCRIPTION & MANUFACTURER	MODEL NO.	SERIAL NO.	DATE OF CALIBRATION	DUE DATE OF CALIBRATION
Test Receiver Agilent	N9038A	MY51210203	Jan. 17, 2014	Jan. 16, 2015
Spectrum Analyzer ROHDE & SCHWARZ	FSU43	101261	Dec. 21, 2013	Dec. 20, 2014
BILOG Antenna SCHWARZBECK	VULB9168	9168-472	Feb. 27, 2014	Feb. 26, 2015
HORN Antenna SCHWARZBECK	BBHA 9120 D	9120D-969	Feb. 19, 2014	Feb. 18, 2015
HORN Antenna SCHWARZBECK	BBHA 9170	9170-480	Dec. 18, 2013	Dec. 17, 2014
Loop Antenna	HFH2-Z2	100070	Mar. 06, 2014	Mar. 05, 2016
Preamplifier EMCI	EMC 012645	980115	Dec. 26, 2013	Dec. 25, 2014
Preamplifier EMCI	EMC 184045	980116	Jan. 13, 2014	Jan. 12, 2015
Preamplifier EMCI	EMC 330H	980112	Dec. 27, 2013	Dec. 26, 2014
RF signal cable HUBER+SUHNNER	SUCOFLEX 104	CABLE-CH9-03 (27409214)	Aug. 09, 2014	Aug. 08, 2015
RF signal cable HUBER+SUHNNER	SUCOFLEX 104	CABLE-CH9-02 (309222 +248780)	Aug. 09, 2014	Aug. 08, 2015
RF signal cable Worken	8D-FB	Cable-CH9-01	Aug. 11, 2014	Aug. 10, 2015
Software BV ADT	E3 6.120103	NA	NA	NA
Antenna Tower MF	MFA-440H	NA	NA	NA
Turn Table MF	MFT-201SS	NA	NA	NA
Antenna Tower & Turn Table Controller MF	MF-7802	NA	NA	NA

- NOTE:** 1. The calibration interval of the above test instruments is 12 months and the calibrations are traceable to NML/ROC and NIST/USA.
2. The test was performed in HwaYa Chamber 10.
3. The horn antenna and HP preamplifier (model: 8449B) are used only for the measurement of emission frequency above 1GHz if tested.
4. The FCC Site Registration No. is 690701.
5. The IC Site Registration No. is IC 7450F-10.



3 GENERAL INFORMATION

3.1 GENERAL DESCRIPTION OF EUT

PRODUCT	ASUS Tablet	
MODEL NO.	K00X	
POWER SUPPLY	5.2Vdc (adapter or host equipment) 3.8Vdc (battery)	
MODULATION TECHNOLOGY	LTE Band 17	QPSK, 16QAM
	LTE Band 4	QPSK, 16QAM
FREQUENCY RANGE	LTE Band 17 Channel Bandwidth: 5MHz	706.5MHz ~ 713.5MHz
	LTE Band 17 Channel Bandwidth: 10MHz	709MHz ~ 711MHz
	LTE Band 4 Channel Bandwidth: 1.4MHz	1710.7MHz ~1754.3MHz
	LTE Band 4 Channel Bandwidth: 3MHz	1711.5MHz ~1753.5MHz
	LTE Band 4 Channel Bandwidth: 5MHz	1712.5MHz ~1752.5MHz
	LTE Band 4 Channel Bandwidth: 10MHz	1715.0MHz ~1750.0MHz
	LTE Band 4 Channel Bandwidth: 15MHz	1717.5MHz ~1747.5MHz
	LTE Band 4 Channel Bandwidth: 20MHz	1720.0MHz ~1745.0MHz
	EMISSION DESIGNATOR	LTE Band 17 Channel Bandwidth: 5MHz
LTE Band 17 Channel Bandwidth: 10MHz		8M99G7D
LTE Band 4 Channel Bandwidth: 1.4MHz		1M09G7D
LTE Band 4 Channel Bandwidth: 3MHz		2M70W7D
LTE Band 4 Channel Bandwidth: 5MHz		4M49W7D
LTE Band 4 Channel Bandwidth: 10MHz		8M97G7D
LTE Band 4 Channel Bandwidth: 15MHz		13M5G7D
LTE Band 4 Channel Bandwidth: 20MHz		18M0W7D



A D T

MAX. ERP POWER	LTE Band 17 Channel Bandwidth: 5MHz	49.66mW
	LTE Band 17 Channel Bandwidth: 10MHz	50.93mW
MAX. EIRP POWER	LTE Band 4 Channel Bandwidth: 1.4MHz	126.68mW
	LTE Band 4 Channel Bandwidth: 3MHz	131.13mW
	LTE Band 4 Channel Bandwidth: 5MHz	127.35mW
	LTE Band 4 Channel Bandwidth: 10MHz	129.69mW
	LTE Band 4 Channel Bandwidth: 15MHz	137.37mW
	LTE Band 4 Channel Bandwidth: 20MHz	160.32mW
ANTENNA TYPE	Fixed Internal Antenna	
DATA CABLE	Refer to Note as below	
I/O PORTS	Refer to users' manual	
ACCESSORY DEVICES	Refer to Note as below	



NOTE:

1. The EUT contains following accessory devices.

ITEM	BRAND	MODEL	SPECIFICATION
Adapter 1	ASUS	PA-1070-07	I/P: 100-240Vac, 0.25A O/P: 5.2Vdc, 1.35A
Adapter 2	ASUS	PSM06A-050Q	I/P: 100-240Vac, 0.25A O/P: 5.2Vdc, 1.35A
Adapter 3	ASUS	AD2005320	I/P: 100-240Vac, 0.25A O/P: 5.2Vdc, 1.35A
Battery	ASUS	C11P1402	3.8Vdc, 15Wh
USB Cable 1	ASUS	L65U2009-CS-B	0.95m cable
USB Cable 2	ASUS	CUBB04M-AS0D0-EF	0.95m cable
EMMC	Toshiba	THGBMBG7D2KBAIL-16G	16 GB
CPU	INTEL	INT MOOREFIELD B0 1.33G/2M BGA	1.33 G / pin: 1064pin
LCD Panel	INNOLUX	LCD TFT 7' WXGA GL SLIM LED	--
Front Camera	LITEON	LITEON/4SF208T2	--
Rear Camera	CHICONY	CHICONY/CJAE511200038 70LH	--
WWAN Module	Intel	SMARTi 4.5G	--
WLAN / BT Module	Broadcom	BCM4343S	--

2. The above EUT information is declared by the manufacturer and for more detailed features description, please refer to the manufacturer's specifications or User's Manual.

3.2 CONFIGURATION OF SYSTEM UNDER TEST

FOR RADIATION EMISSION TEST

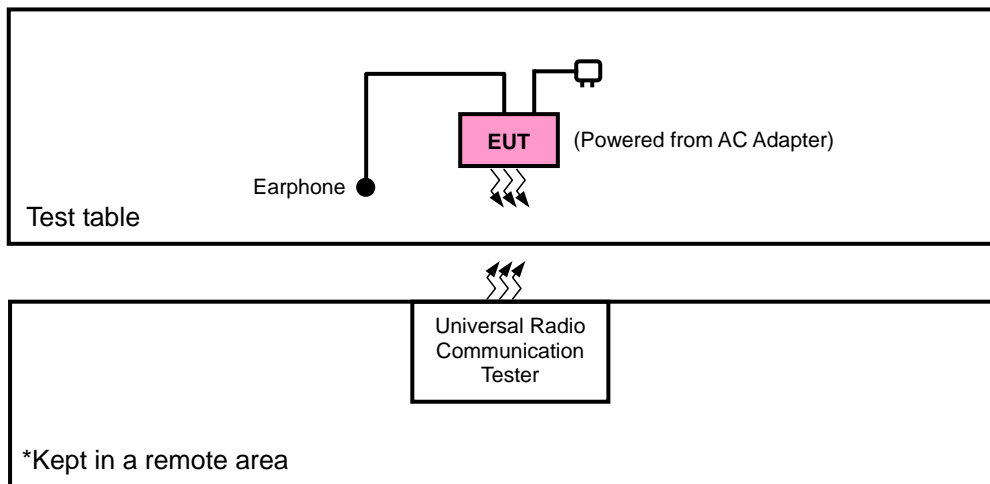

FOR E.R.P. / E.I.R.P. TEST

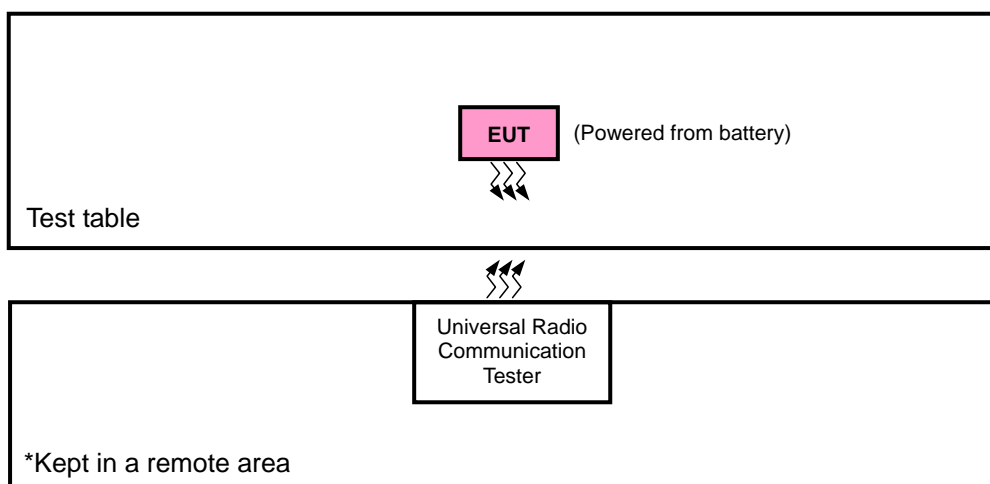

3.3 DESCRIPTION OF SUPPORT UNITS

The EUT has been tested as an independent unit together with other necessary accessories or support units. The following support units or accessories were used to form a representative test configuration during the tests.

NO.	PRODUCT	BRAND	MODEL NO.	SERIAL NO.	FCC ID
1	Earphone	N/A	N/A	N/A	N/A

NO.	SIGNAL CABLE DESCRIPTION OF THE ABOVE SUPPORT UNITS
1	N/A

NOTE: 1. All power cords of the above support units are non shielded (1.8m).



A D T

3.4 DESCRIPTION OF TEST MODES

Pre-Scan has been conducted to determine the worst-case mode from all possible combinations between available modulations, data rates, XYZ axis and antenna ports. The worst case was found and listed as below table. Following channel(s) was (were) selected for the final test as listed below:

	BAND	AXIS FOR RADIATED EMISSION
ERP / EIRP	LTE 17	Y
	LTE 4	Y
RADIATED EMISSION	LTE 17	Y
	LTE 4	Z

LTE Band 17

EUT CONFIGURE MODE	TEST ITEM	AVAILABLE CHANNEL	TESTED CHANNEL	CHANNEL BANDWIDTH	MODULATION	MODE
-	ERP	23755 to 23825	23755, 23790, 23825	5MHz	QPSK, 16QAM	1 RB / 0 RB Offset
		23780 to 23800	23780, 23790, 23800	10MHz	QPSK, 16QAM	1 RB / 0 RB Offset
-	FREQUENCY STABILITY	23755 to 23825	23790	5MHz	QPSK	1 RB / 0 RB Offset
		23780 to 23800	23790	10MHz	QPSK	1 RB / 0 RB Offset
-	OCCUPIED BANDWIDTH	23755 to 23825	23755, 23790, 23825	5MHz	QPSK, 16QAM	25 RB / 0 RB Offset
		23780 to 23800	23780, 23790, 23800	10MHz	QPSK, 16QAM	50 RB / 0 RB Offset
-	PEAK TO AVERAGE RATIO	23755 to 23825	23755, 23790, 23825	5MHz	QPSK, 16QAM	1 RB / 12 RB Offset
		23780 to 23800	23780, 23790, 23800	10MHz	QPSK, 16QAM	1 RB / 24 RB Offset
-	BAND EDGE	23755 to 23825	23755	5MHz	QPSK	1 RB / 0 RB Offset
						25 RB / 0 RB Offset
			23825	5MHz	QPSK	1 RB / 24 RB Offset
		23780 to 23800				25 RB / 0 RB Offset
			23780	10MHz	QPSK	1 RB / 0 RB Offset
			23800	10MHz	QPSK	50 RB / 0 RB Offset
-	CONDUCTED EMISSION	23755 to 23825	23790	5MHz	QPSK	1 RB / 49 RB Offset
		23780 to 23800	23790	10MHz	QPSK	50 RB / 0 RB Offset
-	RADIATED EMISSION	23780 to 23800	23790	10MHz	QPSK	1 RB / 0 RB Offset

Note: This device was tested under all bandwidths, RB configurations and modulations. The worst case was found in QPSK modulation.



LTE Band 4

EUT CONFIGURE MODE	TEST ITEM	AVAILABLE CHANNEL	TESTED CHANNEL	CHANNEL BANDWIDTH	MODULATION	MODE
-	EIRP	19957 to 20393	19957, 20175, 20393	1.4MHz	QPSK, 16QAM	1 RB / 0 RB Offset
		19965 to 20385	19965, 20175, 20385	3MHz	QPSK, 16QAM	1 RB / 0 RB Offset
		19975 to 20375	19975, 20175, 20375	5MHz	QPSK, 16QAM	1 RB / 0 RB Offset
		20000 to 20350	20000, 20175, 20350	10MHz	QPSK, 16QAM	1 RB / 0 RB Offset
		20025 to 20325	20025, 20175, 20325	15MHz	QPSK, 16QAM	1 RB / 0 RB Offset
		20050 to 20300	20050, 20175, 20300	20MHz	QPSK, 16QAM	1 RB / 0 RB Offset
-	FREQUENCY STABILITY	19957 to 20393	20175	1.4MHz	QPSK	1 RB / 0 RB Offset
		19965 to 20385	20175	3MHz	QPSK	1 RB / 0 RB Offset
		19975 to 20375	20175	5MHz	QPSK	1 RB / 0 RB Offset
		20000 to 20350	20175	10MHz	QPSK	1 RB / 0 RB Offset
		20025 to 20325	20175	15MHz	QPSK	1 RB / 0 RB Offset
		20050 to 20300	20175	20MHz	QPSK	1 RB / 0 RB Offset
-	OCCUPIED BANDWIDTH	19957 to 20393	19957, 20175, 20393	1.4MHz	QPSK, 16QAM	6 RB / 0 RB Offset
		19965 to 20385	19965, 20175, 20385	3MHz	QPSK, 16QAM	15 RB / 0 RB Offset
		19975 to 20375	19975, 20175, 20375	5MHz	QPSK, 16QAM	25 RB / 0 RB Offset
		20000 to 20350	20000, 20175, 20350	10MHz	QPSK, 16QAM	50 RB / 0 RB Offset
		20025 to 20325	20025, 20175, 20325	15MHz	QPSK, 16QAM	75 RB / 0 RB Offset
		20050 to 20300	20050, 20175, 20300	20MHz	QPSK, 16QAM	100 RB / 0 RB Offset
-	PEAK TO AVERAGE RATIO	19957 to 20393	19957, 20175, 20393	1.4MHz	QPSK, 16QAM	1 RB / 2 RB Offset
		19965 to 20385	19965, 20175, 20385	3MHz	QPSK, 16QAM	1 RB / 7 RB Offset
		19975 to 20375	19975, 20175, 20375	5MHz	QPSK, 16QAM	12 RB / 0 RB Offset
		20000 to 20350	20000, 20175, 20350	10MHz	QPSK, 16QAM	1 RB / 24 RB Offset
		20025 to 20325	20025, 20175, 20325	15MHz	QPSK, 16QAM	36 RB / 0 RB Offset
		20050 to 20300	20050, 20175, 20300	20MHz	QPSK, 16QAM	50 RB / 0 RB Offset
-	BAND EDGE	19957 to 20393	19957	1.4MHz	QPSK	1 RB / 0 RB Offset
						6 RB / 0 RB Offset
			20393	1.4MHz	QPSK	1 RB / 5 RB Offset
						6 RB / 0 RB Offset
		19965 to 20385	19965	3MHz	QPSK	1 RB / 0 RB Offset
						15 RB / 0 RB Offset
			20385	3MHz	QPSK	1 RB / 14 RB Offset
						15 RB / 0 RB Offset
		19975 to 20375	19975	5MHz	QPSK	1 RB / 0 RB Offset
						25 RB / 0 RB Offset
			20375	5MHz	QPSK	1 RB / 24 RB Offset
						25 RB / 0 RB Offset
20000 to 20350	20000	10MHz	QPSK	1 RB / 0 RB Offset		
				50 RB / 0 RB Offset		
	20350	10MHz	QPSK	1 RB / 49 RB Offset		
				50 RB / 0 RB Offset		



A D T

EUT CONFIGURE MODE	TEST ITEM	AVAILABLE CHANNEL	TESTED CHANNEL	CHANNEL BANDWIDTH	MODULATION	MODE
-	BAND EDGE	20025 to 20325	20025	15MHz	QPSK	1 RB / 0 RB Offset
						75 RB / 0 RB Offset
		20050 to 20300	20325	15MHz	QPSK	1 RB / 74 RB Offset
						75 RB / 0 RB Offset
		20050 to 20300	20050	20MHz	QPSK	1 RB / 0 RB Offset
			20300	20MHz	QPSK	100 RB / 0 RB Offset
-	CONDUCTED EMISSION	19957 to 20393	20175	1.4MHz	QPSK	1 RB / 2 RB Offset
		19965 to 20385	20175	3MHz	QPSK	1 RB / 7 RB Offset
		19975 to 20375	20175	5MHz	QPSK	12 RB / 0 RB Offset
		20000 to 20350	20175	10MHz	QPSK	50 RB / 0 RB Offset
		20025 to 20325	20175	15MHz	QPSK	36 RB / 0 RB Offset
		20050 to 20300	20175	20MHz	QPSK	50 RB / 0 RB Offset
-	RADIATED EMISSION	20050 to 20300	20175	20MHz	QPSK	1 RB / 0 RB Offset

Note: This device was tested under all bandwidths, RB configurations and modulations. The worst case was found in QPSK modulation.

TEST CONDITION:

TEST ITEM	ENVIRONMENTAL CONDITIONS	INPUT POWER	TESTED BY
ERP/EIRP	26deg. C, 58%RH	3.8Vdc	Howard Kao
FREQUENCY STABILITY	26deg. C, 58%RH	3.8Vdc	Howard Kao
OCCUPIED BANDWIDTH	26deg. C, 58%RH	3.8Vdc	Howard Kao
PEAK TO AVERAGE RATIO	26deg. C, 58%RH	3.8Vdc	Howard Kao
BAND EDGE	26deg. C, 58%RH	3.8Vdc	Howard Kao
CONDUCTED EMISSION	26deg. C, 58%RH	3.8Vdc	Howard Kao
RADIATED EMISSION	25deg. C, 65%RH	120Vac, 60Hz	Gavin Wu

3.5 GENERAL DESCRIPTION OF APPLIED STANDARDS

The EUT is a RF product. According to the specifications of the manufacturer, it must comply with the requirements of the following standards:

FCC 47 CFR Part 2

FCC 47 CFR Part 27

ANSI C63.4-2003

ANSI/TIA/EIA-603-C 2004

NOTE: All test items have been performed and recorded as per the above standards.

4 TEST TYPES AND RESULTS

4.1 OUTPUT POWER MEASUREMENT

4.1.1 LIMITS OF OUTPUT POWER MEASUREMENT

Fixed, mobile, and portable (hand-held) stations operating in the 1710–1755 MHz band are limited to 1 watt EIRP.

Portable stations (hand-held devices) operating in the 704-716 MHz band are limited to 3 watts ERP

4.1.2 TEST PROCEDURES

EIRP MEASUREMENT:

- a. All measurements were done at low, middle and high operational frequency range. RBW and VBW is 1MHz for GSM, GPRS & EDGE, 5MHz for CDMA & WCDMA, and 10MHz for LTE mode.
- b. Substitution method is used for E.I.R.P measurement. In the semi-anechoic chamber, EUT placed on the 0.8m height of Turn Table, rotated the table around 360 degrees to search the maximum radiation power and receiver antenna shall be rotated vertical and horizontal polarization and moved height from 1m to 4m to find the maximum polar radiated power. The “Read Value” is the spectrum reading the maximum power value.
- c. The substitution horn antenna is substituted for EUT at the same position and signals generator export the CW signal to the substitution antenna via a tx cable. Rotated the Turn Table and moved receiving antenna to find the maximum radiation power. Adjust output power level of S.G to get a Value of spectrum reading equal to “Read Value” of step b. Record the power level of S.G
- d. $EIRP = \text{Output power level of S.G} - \text{TX cable loss} + \text{Antenna gain of substitution horn}.$

CONDUCTED POWER MEASUREMENT:

- a. The EUT was set up for the maximum power with LTE link data modulation and link up with simulator.
- b. Set the EUT to transmit under low, middle and high channel and record the power level shown on simulator.

4.1.3 TEST SETUP

EIRP / ERP MEASUREMENT:

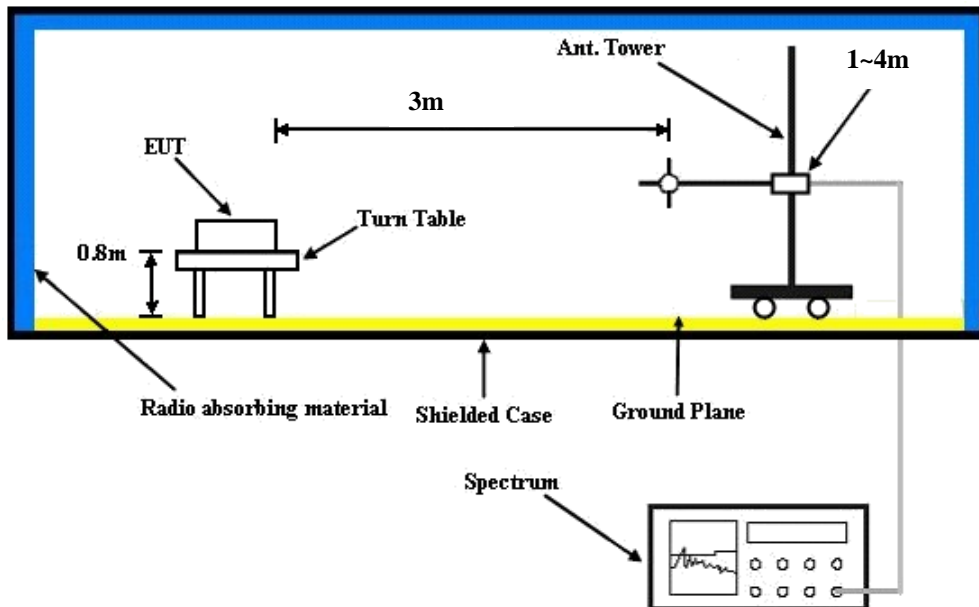

CONDUCTED POWER MEASUREMENT:

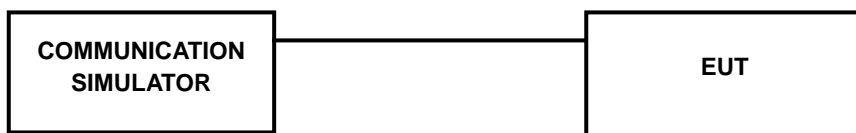



4.1.4 TEST RESULTS

Average Conducted Output Power (dBm)

Band / BW	RB Size	RB Offset	QPSK			3GPP MPR (dB)	16QAM			3GPP MPR (dB)
			Low CH 23755	Mid CH 23790	High CH 23825		Low CH 23755	Mid CH 23790	High CH 23825	
			706.5 MHz	710.0 MHz	713.5 MHz		706.5 MHz	710.0 MHz	713.5 MHz	
17 / 5M	1	0	22.65	22.64	22.58	0	21.63	21.62	21.56	1
	1	12	22.57	22.47	22.46	0	21.55	21.45	21.44	1
	1	24	22.53	22.39	22.32	0	21.51	21.37	21.30	1
	12	0	21.72	21.67	21.66	1	20.70	20.65	20.64	2
	12	6	21.71	21.69	21.69	1	20.69	20.67	20.67	2
	12	13	21.70	21.62	21.60	1	20.68	20.60	20.58	2
	25	0	21.71	21.64	21.63	1	20.69	20.62	20.61	2

Band / BW	RB Size	RB Offset	QPSK			3GPP MPR (dB)	16QAM			3GPP MPR (dB)
			Low CH 23780	Mid CH 23790	High CH 23800		Low CH 23780	Mid CH 23790	High CH 23800	
			709.0 MHz	710.0 MHz	711.0 MHz		709.0 MHz	710.0 MHz	711.0 MHz	
17 / 10M	1	0	22.77	22.76	22.70	0	21.75	21.74	21.68	1
	1	24	22.69	22.59	22.58	0	21.67	21.57	21.56	1
	1	49	22.65	22.51	22.44	0	21.63	21.49	21.42	1
	25	0	21.84	21.79	21.78	1	20.82	20.77	20.76	2
	25	12	21.83	21.81	21.81	1	20.81	20.79	20.79	2
	25	25	21.82	21.74	21.72	1	20.80	20.72	20.70	2
	50	0	21.83	21.76	21.75	1	20.81	20.74	20.73	2

Band / BW	RB Size	RB Offset	QPSK			3GPP MPR (dB)	16QAM			3GPP MPR (dB)
			Low CH 19957	Mid CH 20175	High CH 20393		Low CH 19957	Mid CH 20175	High CH 20393	
			1710.7 MHz	1732.5 MHz	1754.3 MHz		1710.7 MHz	1732.5 MHz	1754.3 MHz	
4 / 1.4M	1	0	22.69	22.59	22.54	0	21.76	21.65	21.62	1
	1	2	22.63	22.55	22.49	0	21.69	21.60	21.61	1
	1	5	22.42	22.33	22.28	0	21.62	21.54	21.54	1
	3	0	21.78	21.66	21.63	0	21.68	21.58	21.53	1
	3	1	21.70	21.61	21.62	0	21.60	21.52	21.46	1
	3	3	21.63	21.55	21.55	0	21.41	21.32	21.27	1
	6	0	21.68	21.61	21.60	1	20.67	20.60	20.59	2

Band / BW	RB Size	RB Offset	QPSK			3GPP MPR (dB)	16QAM			3GPP MPR (dB)
			Low CH 19965	Mid CH 20175	High CH 20385		Low CH 19965	Mid CH 20175	High CH 20385	
			1711.5 MHz	1732.5 MHz	1753.5 MHz		1711.5 MHz	1732.5 MHz	1753.5 MHz	
4 / 3M	1	0	22.79	22.69	22.64	0	21.78	21.68	21.63	1
	1	7	22.73	22.65	22.59	0	21.72	21.64	21.58	1
	1	14	22.52	22.43	22.38	0	21.51	21.42	21.37	1
	8	0	21.88	21.76	21.73	1	20.87	20.75	20.72	2
	8	3	21.80	21.71	21.72	1	20.79	20.70	20.71	2
	8	7	21.73	21.65	21.65	1	20.72	20.64	20.64	2
	15	0	21.78	21.71	21.70	1	20.77	20.70	20.69	2



Band / BW	RB Size	RB Offset	QPSK			3GPP MPR (dB)	16QAM			3GPP MPR (dB)
			Low CH 19975	Mid CH 20175	High CH 20375		Low CH 19975	Mid CH 20175	High CH 20375	
			1712.5 MHz	1732.5 MHz	1752.5 MHz		1712.5 MHz	1732.5 MHz	1752.5 MHz	
4 / 5M	1	0	22.87	22.77	22.72	0	21.86	21.76	21.71	1
	1	12	22.81	22.73	22.67	0	21.80	21.72	21.66	1
	1	24	22.60	22.51	22.46	0	21.59	21.50	21.45	1
	12	0	21.96	21.84	21.81	1	20.95	20.83	20.80	2
	12	6	21.88	21.79	21.80	1	20.87	20.78	20.79	2
	12	13	21.81	21.73	21.73	1	20.80	20.72	20.72	2
	25	0	21.86	21.79	21.78	1	20.85	20.78	20.77	2

Band / BW	RB Size	RB Offset	QPSK			3GPP MPR (dB)	16QAM			3GPP MPR (dB)
			Low CH 20000	Mid CH 20175	High CH 20350		Low CH 20000	Mid CH 20175	High CH 20350	
			1715.0 MHz	1732.5 MHz	1750.0 MHz		1715.0 MHz	1732.5 MHz	1750.0 MHz	
4 / 10M	1	0	22.98	22.88	22.83	0	21.97	21.87	21.82	1
	1	24	22.92	22.84	22.78	0	21.91	21.83	21.77	1
	1	49	22.71	22.62	22.57	0	21.70	21.61	21.56	1
	25	0	22.07	21.95	21.92	1	21.06	20.94	20.91	2
	25	12	21.99	21.90	21.91	1	20.98	20.89	20.90	2
	25	25	21.92	21.84	21.84	1	20.91	20.83	20.83	2
	50	0	21.97	21.90	21.89	1	20.96	20.89	20.88	2

Band / BW	RB Size	RB Offset	QPSK			3GPP MPR (dB)	16QAM			3GPP MPR (dB)
			Low CH 20025	Mid CH 20175	High CH 20325		Low CH 20025	Mid CH 20175	High CH 20325	
			1717.5 MHz	1732.5 MHz	1747.5 MHz		1717.5 MHz	1732.5 MHz	1747.5 MHz	
4 / 15M	1	0	23.14	23.04	22.99	0	22.08	21.98	21.93	1
	1	37	23.08	23.00	22.94	0	22.02	21.94	21.88	1
	1	74	22.87	22.78	22.73	0	21.81	21.72	21.67	1
	36	0	22.23	22.11	22.08	1	21.17	21.05	21.02	2
	36	19	22.15	22.06	22.07	1	21.09	21.00	21.01	2
	36	39	22.08	22.00	22.00	1	21.02	20.94	20.94	2
	75	0	22.13	22.06	22.05	1	21.07	21.00	20.99	2

Band / BW	RB Size	RB Offset	QPSK			3GPP MPR (dB)	16QAM			3GPP MPR (dB)
			Low CH 20050	Mid CH 20175	High CH 20300		Low CH 20050	Mid CH 20175	High CH 20300	
			1720.0 MHz	1732.5 MHz	1745.0 MHz		1720.0 MHz	1732.5 MHz	1745.0 MHz	
4 / 20M	1	0	23.27	23.17	23.12	0	22.19	22.09	22.04	1
	1	50	23.21	23.13	23.07	0	22.13	22.05	21.99	1
	1	99	23.00	22.91	22.86	0	21.92	21.83	21.78	1
	50	0	22.36	22.24	22.21	1	21.28	21.16	21.13	2
	50	25	22.28	22.19	22.20	1	21.20	21.11	21.12	2
	50	50	22.21	22.13	22.13	1	21.13	21.05	21.05	2
	100	0	22.26	22.19	22.18	1	21.18	21.11	21.10	2



A D T

AVERAGE ERP (dBm)

LTE Band 17							
Channel Bandwidth: 5MHz / QPSK							
Plane	Channel	Frequency (MHz)	LVL (dBm)	Correction Factor(dB)	ERP(dBm)	ERP(mW)	Polarization (H/V)
Y	23755	706.5	-11.25	30.36	16.96	49.66	H
	23790	710.0	-11.56	30.17	16.46	44.26	
	23825	713.5	-11.96	30.17	16.06	40.36	
	23755	706.5	-17.03	32.03	12.85	19.28	V
	23790	710.0	-17.01	31.98	12.82	19.14	
	23825	713.5	-16.91	32.06	13.00	19.95	

LTE Band 17							
Channel Bandwidth: 5MHz / 16QAM							
Plane	Channel	Frequency (MHz)	LVL (dBm)	Correction Factor(dB)	ERP(dBm)	ERP(mW)	Polarization (H/V)
Y	23755	706.5	-13.12	30.36	15.09	32.28	H
	23790	710.0	-12.88	30.17	15.14	32.66	
	23825	713.5	-12.02	30.17	16.00	39.81	
	23755	706.5	-16.53	32.03	13.35	21.63	V
	23790	710.0	-16.49	31.98	13.34	21.58	
	23825	713.5	-16.55	32.06	13.36	21.68	



A D T

LTE Band 17							
Channel Bandwidth: 10MHz / QPSK							
Plane	Channel	Frequency (MHz)	LVL (dBm)	Correction Factor(dB)	ERP(dBm)	ERP(mW)	Polarization (H/V)
Y	23780	709.0	-11.61	30.17	16.41	43.75	H
	23790	710.0	-10.95	30.17	17.07	50.93	
	23800	711.0	-11.55	30.18	16.48	44.46	
	23780	709.0	-16.96	31.96	12.85	19.28	V
	23790	710.0	-17.00	31.98	12.83	19.19	
	23800	711.0	-17.04	32.03	12.84	19.23	

LTE Band 17							
Channel Bandwidth: 10MHz / 16QAM							
Plane	Channel	Frequency (MHz)	LVL (dBm)	Correction Factor(dB)	ERP(dBm)	ERP(mW)	Polarization (H/V)
Y	23780	709.0	-12.39	30.17	15.63	36.56	H
	23790	710.0	-12.26	30.17	15.76	37.67	
	23800	711.0	-11.98	30.18	16.05	40.27	
	23780	709.0	-16.76	31.96	13.05	20.18	V
	23790	710.0	-16.77	31.98	13.06	20.23	
	23800	711.0	-16.51	32.03	13.37	21.73	



A D T

AVERAGE EIRP (dBm)

LTE Band 4							
Channel Bandwidth: 1.4MHz / QPSK							
Plane	Channel	Frequency (MHz)	LVL (dBm)	Correction Factor(dB)	EIRP(dBm)	EIRP(mW)	Polarization (H/V)
Y	19957	1710.7	-18.01	36.45	18.44	69.82	H
	20175	1732.5	-18.56	36.80	18.24	66.67	
	20393	1754.3	-18.85	36.94	18.09	64.46	
	19957	1710.7	-16.25	37.28	21.03	126.68	V
	20175	1732.5	-17.11	37.63	20.52	112.72	
	20393	1754.3	-17.20	37.64	20.44	110.66	

LTE Band 4							
Channel Bandwidth: 1.4MHz / 16QAM							
Plane	Channel	Frequency (MHz)	LVL (dBm)	Correction Factor(dB)	EIRP(dBm)	EIRP(mW)	Polarization (H/V)
Y	19957	1710.7	-19.20	36.45	17.25	53.09	H
	20175	1732.5	-19.85	36.80	16.95	49.53	
	20393	1754.3	-19.93	36.94	17.01	50.27	
	19957	1710.7	-17.35	37.28	19.93	98.33	V
	20175	1732.5	-17.78	37.63	19.85	96.61	
	20393	1754.3	-18.25	37.64	19.39	86.90	



LTE Band 4							
Channel Bandwidth: 3MHz / QPSK							
Plane	Channel	Frequency (MHz)	LVL (dBm)	Correction Factor(dB)	EIRP(dBm)	EIRP(mW)	Polarization (H/V)
Y	19965	1711.5	-18.38	36.45	18.07	64.12	H
	20175	1732.5	-19.00	36.80	17.80	60.24	
	20385	1753.5	-19.35	36.94	17.59	57.45	
	19965	1711.5	-16.10	37.28	21.18	131.13	V
	20175	1732.5	-17.25	37.63	20.38	109.14	
	20385	1753.5	-17.02	37.64	20.62	115.35	

LTE Band 4							
Channel Bandwidth: 3MHz / 16QAM							
Plane	Channel	Frequency (MHz)	LVL (dBm)	Correction Factor(dB)	EIRP(dBm)	EIRP(mW)	Polarization (H/V)
Y	19965	1711.5	-19.10	36.45	17.35	54.33	H
	20175	1732.5	-19.58	36.80	17.22	52.71	
	20385	1753.5	-19.78	36.94	17.16	52.04	
	19965	1711.5	-17.20	37.28	20.08	101.79	V
	20175	1732.5	-18.25	37.63	19.38	86.70	
	20385	1753.5	-17.95	37.64	19.69	93.11	



LTE Band 4							
Channel Bandwidth: 5MHz / QPSK							
Plane	Channel	Frequency (MHz)	LVL (dBm)	Correction Factor(dB)	EIRP(dBm)	EIRP(mW)	Polarization (H/V)
Y	19975	1712.5	-18.20	36.45	18.25	66.83	H
	20175	1732.5	-17.95	36.80	18.85	76.72	
	20375	1752.5	-18.56	36.94	18.38	68.91	
	19975	1712.5	-16.52	37.28	20.76	119.04	V
	20175	1732.5	-16.58	37.63	21.05	127.35	
	20375	1752.5	-17.25	37.64	20.39	109.40	

LTE Band 4							
Channel Bandwidth: 5MHz / 16QAM							
Plane	Channel	Frequency (MHz)	LVL (dBm)	Correction Factor(dB)	EIRP(dBm)	EIRP(mW)	Polarization (H/V)
Y	19975	1712.5	-19.20	36.45	17.25	53.09	H
	20175	1732.5	-18.89	36.80	17.91	61.79	
	20375	1752.5	-19.82	36.94	17.12	51.56	
	19975	1712.5	-18.12	37.28	19.16	82.36	V
	20175	1732.5	-17.25	37.63	20.38	109.14	
	20375	1752.5	-18.25	37.64	19.39	86.90	



A D T

LTE Band 4							
Channel Bandwidth: 10MHz / QPSK							
Plane	Channel	Frequency (MHz)	LVL (dBm)	Correction Factor(dB)	EIRP(dBm)	EIRP(mW)	Polarization (H/V)
Y	20000	1715.0	-18.23	36.64	18.41	69.34	H
	20175	1732.5	-18.25	36.80	18.55	71.53	
	20350	1750.0	-18.56	36.80	18.24	66.68	
	20000	1715.0	-17.20	37.44	20.24	105.66	V
	20175	1732.5	-16.50	37.63	21.13	129.69	
	20350	1750.0	-17.56	37.64	20.08	101.74	

LTE Band 4							
Channel Bandwidth: 10MHz / 16QAM							
Plane	Channel	Frequency (MHz)	LVL (dBm)	Correction Factor(dB)	EIRP(dBm)	EIRP(mW)	Polarization (H/V)
Y	20000	1715.0	-19.56	36.64	17.08	51.05	H
	20175	1732.5	-19.03	36.80	17.77	59.77	
	20350	1750.0	-19.52	36.80	17.28	53.46	
	20000	1715.0	-17.95	37.44	19.49	88.90	V
	20175	1732.5	-17.23	37.63	20.40	109.62	
	20350	1750.0	-17.86	37.64	19.78	94.95	



LTE Band 4							
Channel Bandwidth: 15MHz / QPSK							
Plane	Channel	Frequency (MHz)	LVL (dBm)	Correction Factor(dB)	EIRP(dBm)	EIRP(mW)	Polarization (H/V)
Y	20025	1717.5	-18.25	36.64	18.39	69.02	H
	20175	1732.5	-17.91	36.80	18.89	77.36	
	20325	1747.5	-18.12	36.80	18.68	73.79	
	20025	1717.5	-16.85	37.44	20.59	114.52	V
	20175	1732.5	-16.25	37.63	21.38	137.37	
	20325	1747.5	-16.72	37.64	20.92	123.45	

LTE Band 4							
Channel Bandwidth: 15MHz / 16QAM							
Plane	Channel	Frequency (MHz)	LVL (dBm)	Correction Factor(dB)	EIRP(dBm)	EIRP(mW)	Polarization (H/V)
Y	20025	1717.5	-19.20	36.64	17.44	55.46	H
	20175	1732.5	-19.04	36.80	17.76	59.63	
	20325	1747.5	-19.79	36.80	17.01	50.23	
	20025	1717.5	-17.25	37.44	20.19	104.45	V
	20175	1732.5	-17.11	37.63	20.52	112.69	
	20325	1747.5	-17.56	37.64	20.08	101.74	



A D T

LTE Band 4							
Channel Bandwidth: 20MHz / QPSK							
Plane	Channel	Frequency (MHz)	LVL (dBm)	Correction Factor(dB)	EIRP(dBm)	EIRP(mW)	Polarization (H/V)
Y	20050	1720.0	-17.25	36.45	19.20	83.18	H
	20175	1732.5	-17.02	36.80	19.78	95.04	
	20300	1745.0	-17.35	36.94	19.59	91.05	
	20050	1720.0	-16.25	37.28	21.03	126.68	V
	20175	1732.5	-15.58	37.63	22.05	160.32	
	20300	1745.0	-16.35	37.64	21.29	134.59	

LTE Band 4							
Channel Bandwidth: 20MHz / 16QAM							
Plane	Channel	Frequency (MHz)	LVL (dBm)	Correction Factor(dB)	EIRP(dBm)	EIRP(mW)	Polarization (H/V)
Y	20050	1720.0	-18.32	36.45	18.13	65.01	H
	20175	1732.5	-18.32	36.80	18.48	70.45	
	20300	1745.0	-18.89	36.94	18.05	63.87	
	20050	1720.0	-17.25	37.28	20.03	100.62	V
	20175	1732.5	-16.65	37.63	20.98	125.31	
	20300	1745.0	-17.12	37.64	20.52	112.72	

4.2 FREQUENCY STABILITY MEASUREMENT

4.2.1 LIMITS OF FREQUENCY STABILITY MEASUREMENT

The frequency stability shall be sufficient to ensure that the fundamental emissions stay within the authorized bands of operation.

4.2.2 TEST PROCEDURE

- a. Device is placed at the oven room. The oven room could control the temperatures and humidity. Power warm up is at least 15 min and power applied should perform before recording frequency error.
- b. EUT is connected the external power supply to control the DC input power. The test voltage range is from minimum to maximum working voltage. Each step shall be record the frequency error rate.
- c. The temperature range step is 10 degrees in this test items. All temperature levels shall be hold the $\pm 0.5^{\circ}\text{C}$ during the measurement testing. The each temperature step shall be at least 0.5 hours, consider the EUT could be test under the stability condition.

NOTE: The frequency error was recorded frequency error from the communication simulator.

4.2.3 TEST SETUP

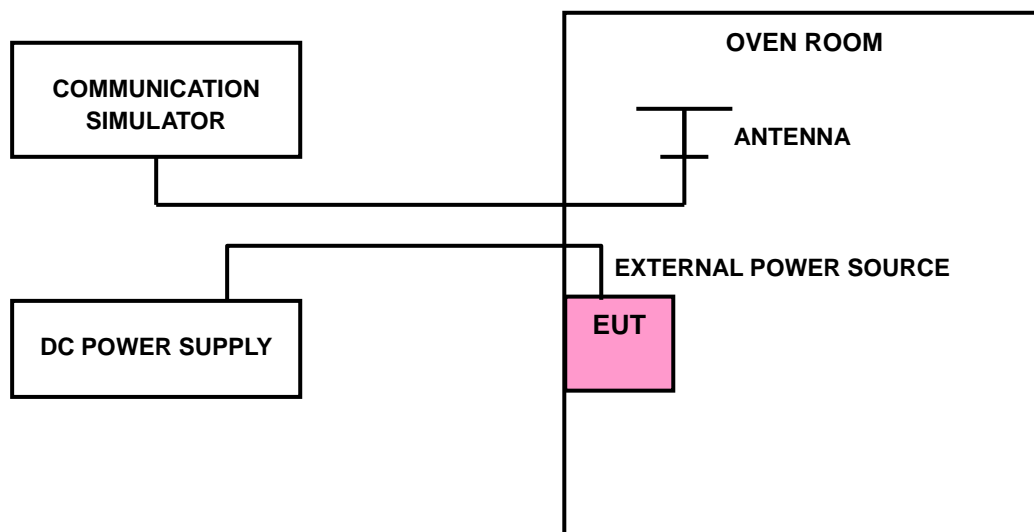



4.2.4 TEST RESULTS

FREQUENCY ERROR vs. VOLTAGE

VOLTAGE (Volts)	FREQUENCY ERROR (ppm)		LIMIT (ppm)
	LTE BAND 17		
	5MHz	10MHz	
4.0	-0.001690141	0.000704225	2.5
3.6	-0.004929577	0.002676056	2.5
4.3	-0.003802817	0.005211268	2.5

NOTE: The applicant defined the normal working voltage of the battery is from 3.6Vdc to 4.3Vdc.

FREQUENCY ERROR vs. TEMPERATURE

TEMP. (°C)	FREQUENCY ERROR (ppm)		LIMIT (ppm)
	LTE BAND 17		
	5MHz	10MHz	
-30	-0.004507042	-0.005070423	2.5
-20	-0.001549296	-0.001971831	2.5
-10	-0.000985915	0.001126761	2.5
0	0.002535211	0.003098592	2.5
10	0.001126761	0.005492958	2.5
20	0.003661972	0.006478873	2.5
30	0.004788732	-0.005915493	2.5
40	0.006338028	-0.004366197	2.5
50	0.000704225	-0.003943662	2.5



VOLTAGE (Volts)	FREQUENCY ERROR (ppm)						LIMIT (ppm)
	LTE BAND 4						
	1.4MHz	3MHz	5MHz	10MHz	15MHz	20MHz	
4.0	0.0002886	0.000634921	-0.0002886	0.001500722	0.000519481	0.001038961	2.5
3.6	-0.002655123	-0.000519481	-0.001096681	0.00046176	0.000692641	-0.000808081	2.5
4.3	-0.001616162	-0.001327561	0.001212121	0.000923521	-0.00034632	-0.001038961	2.5

NOTE: The applicant defined the normal working voltage of the battery is from 3.6Vdc to 4.3Vdc.

FREQUENCY ERROR vs. TEMPERATURE

TEMP. (°C)	FREQUENCY ERROR (ppm)						LIMIT (ppm)
	LTE BAND 4						
	1.4MHz	3MHz	5MHz	10MHz	15MHz	20MHz	
-30	0.001327561	0.000692641	0.001443001	-0.00011544	-0.000634921	-0.001500722	2.5
-20	0.00011544	0.00023088	-0.001673882	-0.002077922	-0.001847042	-0.002193362	2.5
-10	-0.000865801	-0.002077922	-0.000692641	-0.000865801	-0.001038961	-0.0002886	2.5
0	-0.001500722	-0.001673882	-0.00046176	0.000519481	0.000519481	0.000923521	2.5
10	-0.002077922	-0.000750361	0.002251082	0.000981241	0.001443001	0.0002886	2.5
20	0.002597403	0.00034632	0.002424242	0.001327561	0.002135642	-0.002655123	2.5
30	0.001789322	0.001096681	-0.001212121	0.000519481	0.000634921	-0.000808081	2.5
40	0.001673882	0.002077922	0.001038961	0.001789322	0.00046176	0.001443001	2.5
50	0.000634921	0.001616162	0.001500722	-0.000923521	-0.000750361	0.001962482	2.5

4.3 OCCUPIED BANDWIDTH MEASUREMENT

4.3.1 LIMITS OF OCCUPIED BANDWIDTH MEASUREMENT

The width of a frequency band such that, below the lower and above the upper frequency limits, the mean powers emitted are each equal to a specified percentage 0.5 %of the total mean power of a given emission.

4.3.2 TEST SETUP

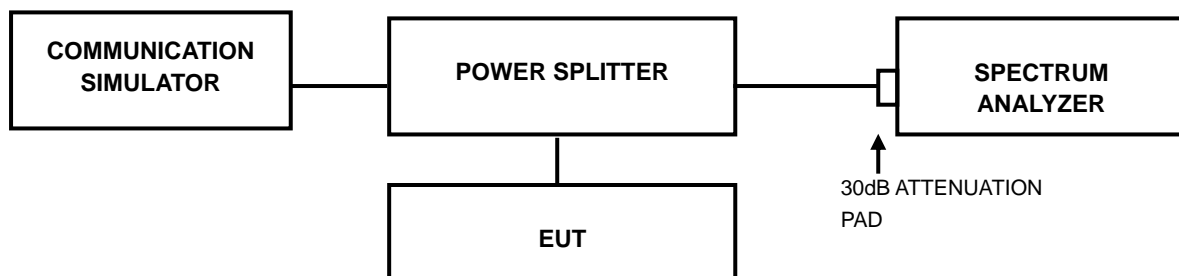

4.3.3 TEST PROCEDURES

- The conducted occupied bandwidth used the power splitter via EUT RF power connector between simulation base station and spectrum analyzer.
- Use OBW measurement function of Spectrum analyzer to measure 99 % occupied bandwidth.



A D T

4.3.4 TEST RESULTS

LTE BAND 17							
CHANNEL BANDWIDTH: 5MHz				CHANNEL BANDWIDTH: 10MHz			
CHANNEL	FREQUENCY (MHz)	99% OCCUPIED BANDWIDTH (MHz)		CHANNEL	FREQUENCY (MHz)	99% OCCUPIED BANDWIDTH (MHz)	
		QPSK	16QAM			QPSK	16QAM
23755	706.5	4.4857	4.4829	23780	709.0	8.9860	8.9848
23790	710.0	4.4896	4.4865	23790	710.0	8.9914	8.9872
23825	713.5	4.4895	4.4841	23800	711.0	8.9895	8.9826

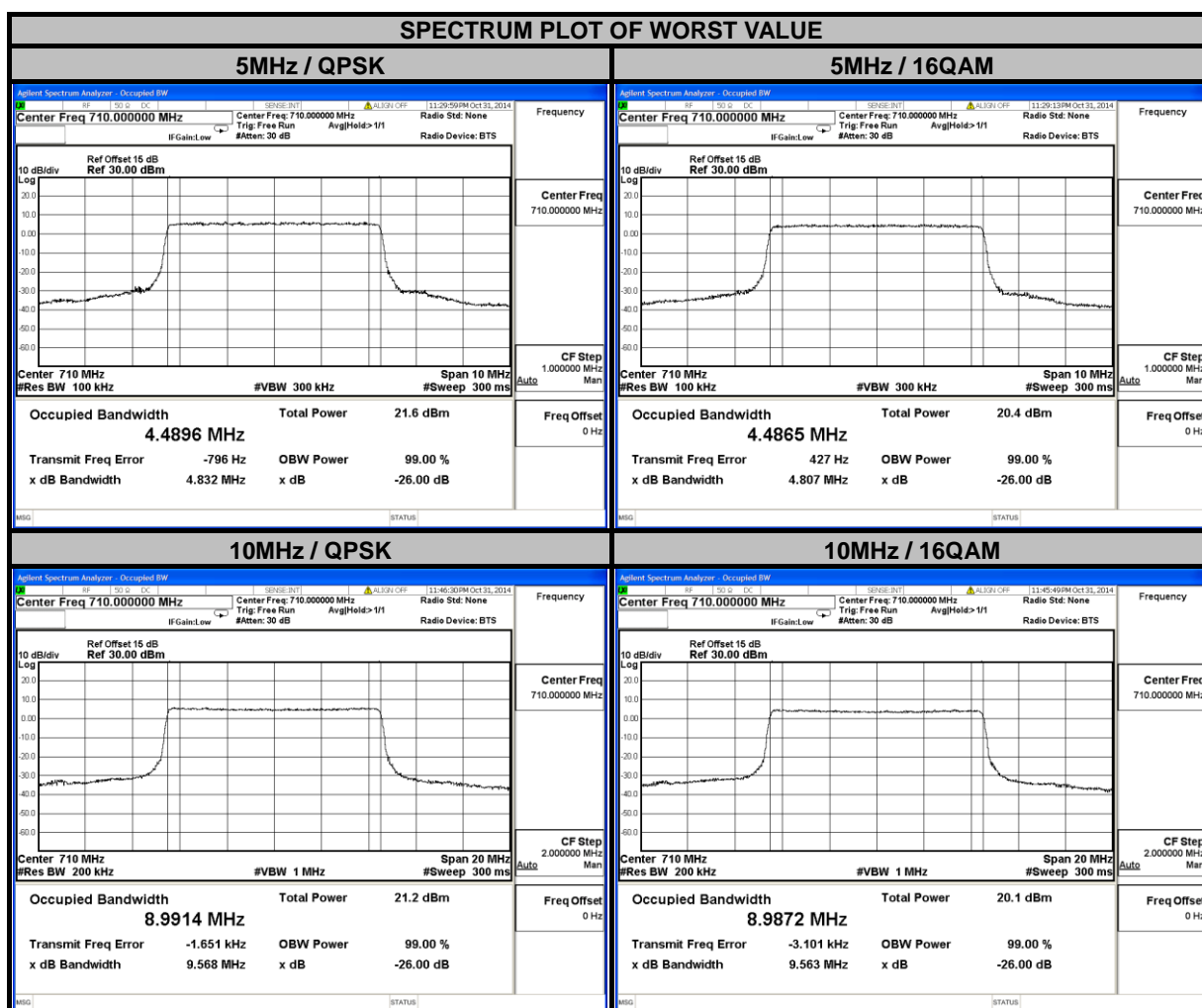



LTE BAND 4							
CHANNEL BANDWIDTH: 1.4MHz				CHANNEL BANDWIDTH: 3MHz			
CHANNEL	FREQUENCY (MHz)	99% OCCUPIED BANDWIDTH (MHz)		CHANNEL	FREQUENCY (MHz)	99% OCCUPIED BANDWIDTH (MHz)	
		QPSK	16QAM			QPSK	16QAM
19957	1710.7	1.0897	1.0887	19965	1711.5	2.6973	2.7030
20175	1732.5	1.0897	1.0885	20175	1732.5	2.6954	2.7007
20393	1754.3	1.0879	1.0883	20385	1753.5	2.6944	2.6995

SPECTRUM PLOT OF WORST VALUE

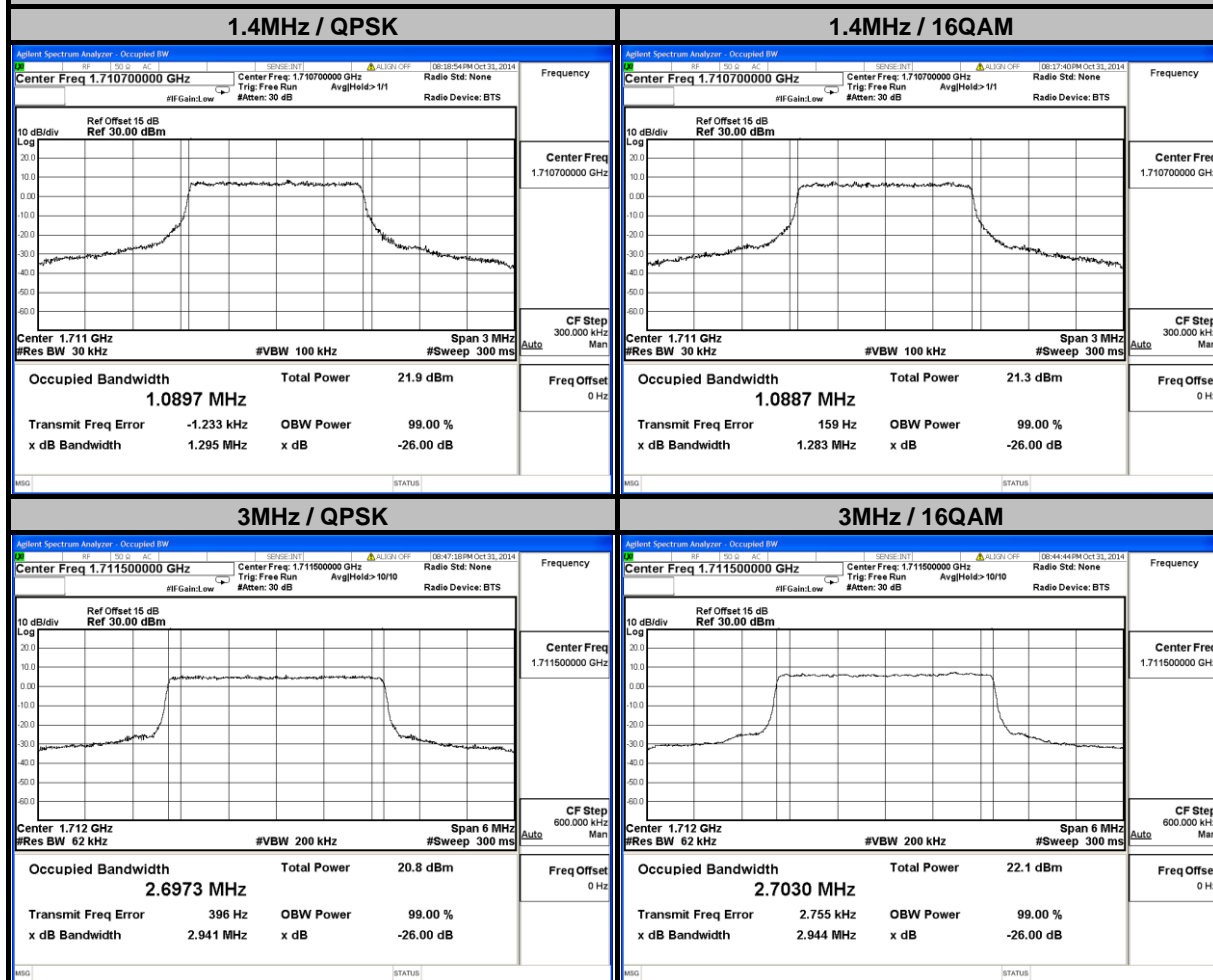



A D T

LTE BAND 4							
CHANNEL BANDWIDTH: 5MHz				CHANNEL BANDWIDTH: 10MHz			
CHANNEL	FREQUENCY (MHz)	99% OCCUPIED BANDWIDTH (MHz)		CHANNEL	FREQUENCY (MHz)	99% OCCUPIED BANDWIDTH (MHz)	
		QPSK	16QAM			QPSK	16QAM
19975	1712.5	4.4855	4.4873	20000	1715.0	8.9679	8.9676
20175	1732.5	4.4864	4.4838	20175	1732.5	8.9707	8.9698
20375	1752.5	4.4818	4.4847	20350	1750.0	8.9630	8.9638

SPECTRUM PLOT OF WORST VALUE

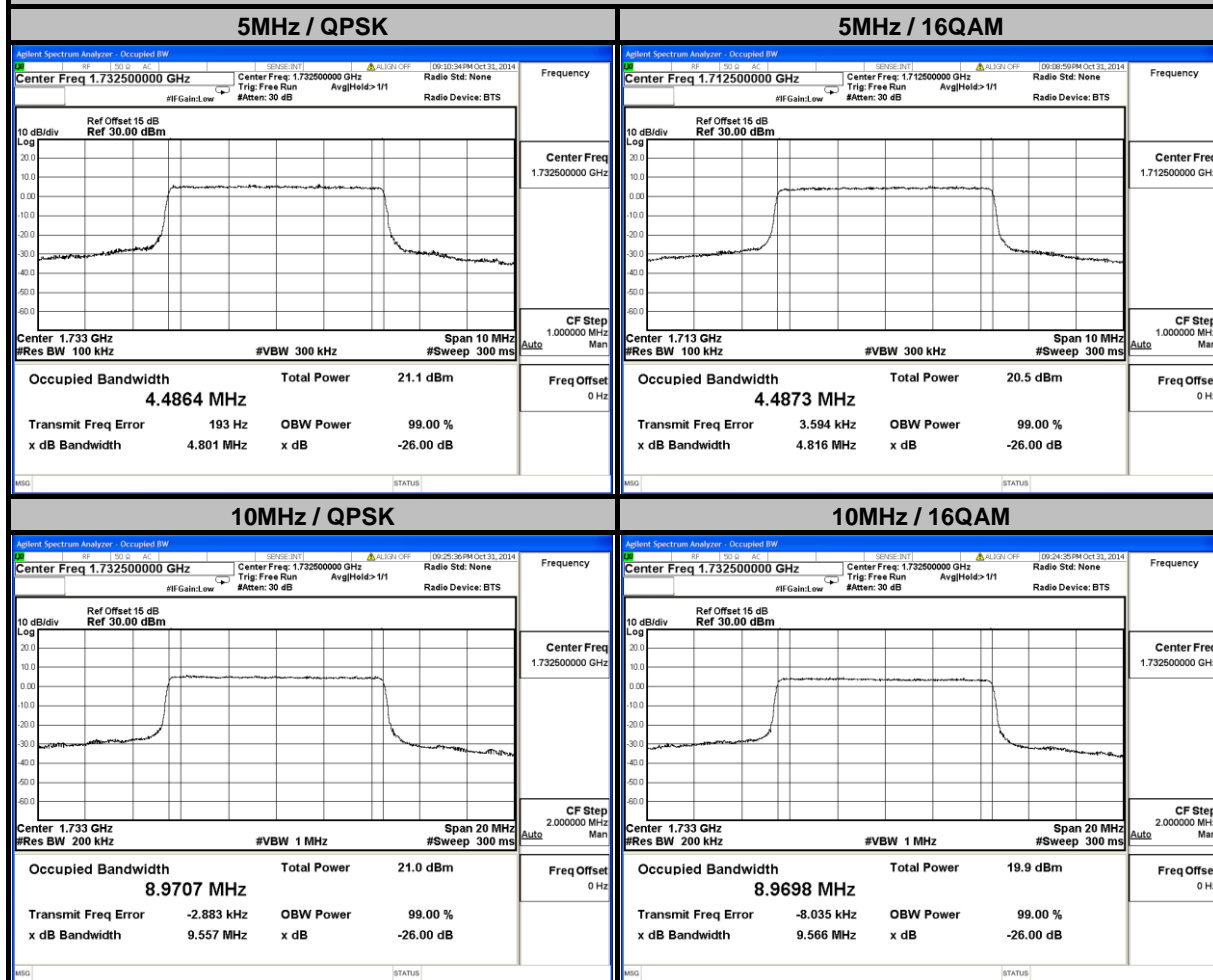



A D T

LTE BAND 4							
CHANNEL BANDWIDTH: 15MHz				CHANNEL BANDWIDTH: 20MHz			
CHANNEL	FREQUENCY (MHz)	99% OCCUPIED BANDWIDTH (MHz)		CHANNEL	FREQUENCY (MHz)	99% OCCUPIED BANDWIDTH (MHz)	
		QPSK	16QAM			QPSK	16QAM
20025	1717.5	13.448	13.443	20050	1720.0	17.898	17.919
20175	1732.5	13.471	13.465	20175	1732.5	17.960	17.968
20325	1747.5	13.464	13.453	20300	1745.0	17.956	17.971

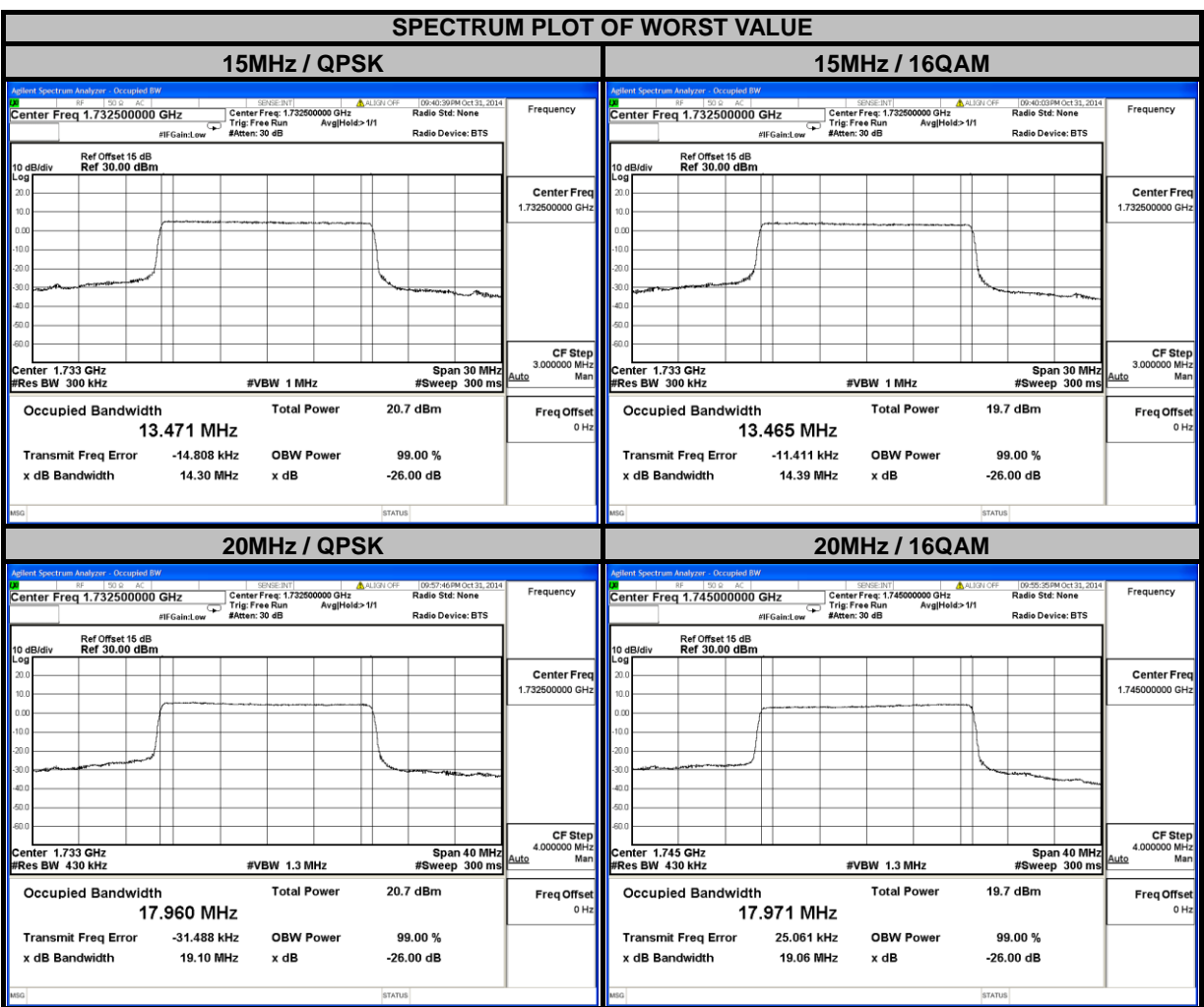

4.4 PEAK TO AVERAGE RATIO

4.4.1 LIMITS OF PEAK TO AVERAGE RATIO MEASUREMENT

In measuring transmissions in this band using an average power technique, the peak to-average ratio (PAR) of the transmission may not exceed 13 dB.

4.4.2 TEST SETUP

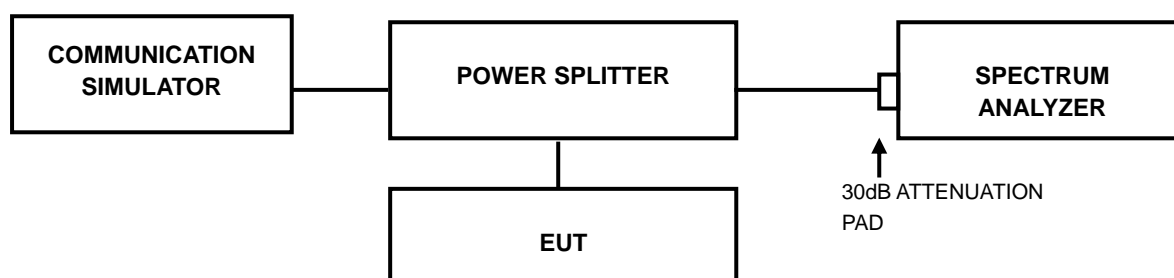

4.4.3 TEST PROCEDURES

1. Set resolution/measurement bandwidth \geq signal's occupied bandwidth;
2. Set the number of counts to a value that stabilizes the measured CCDF curve;
3. Record the maximum PAPR level associated with a probability of 0.1%.

4.4.4 TEST RESULTS

LTE BAND 17							
CHANNEL BANDWIDTH: 5MHz				CHANNEL BANDWIDTH: 10MHz			
CHANNEL	FREQUENCY (MHz)	PEAK TO AVERAGE RATIO (dB)		CHANNEL	FREQUENCY (MHz)	PEAK TO AVERAGE RATIO (dB)	
		QPSK	16QAM			QPSK	16QAM
23755	706.5	5.63	6.83	23780	709.0	5.69	6.72
23790	710.0	5.87	6.95	23790	710.0	5.74	6.67
23825	713.5	5.89	6.98	23800	711.0	5.85	6.81

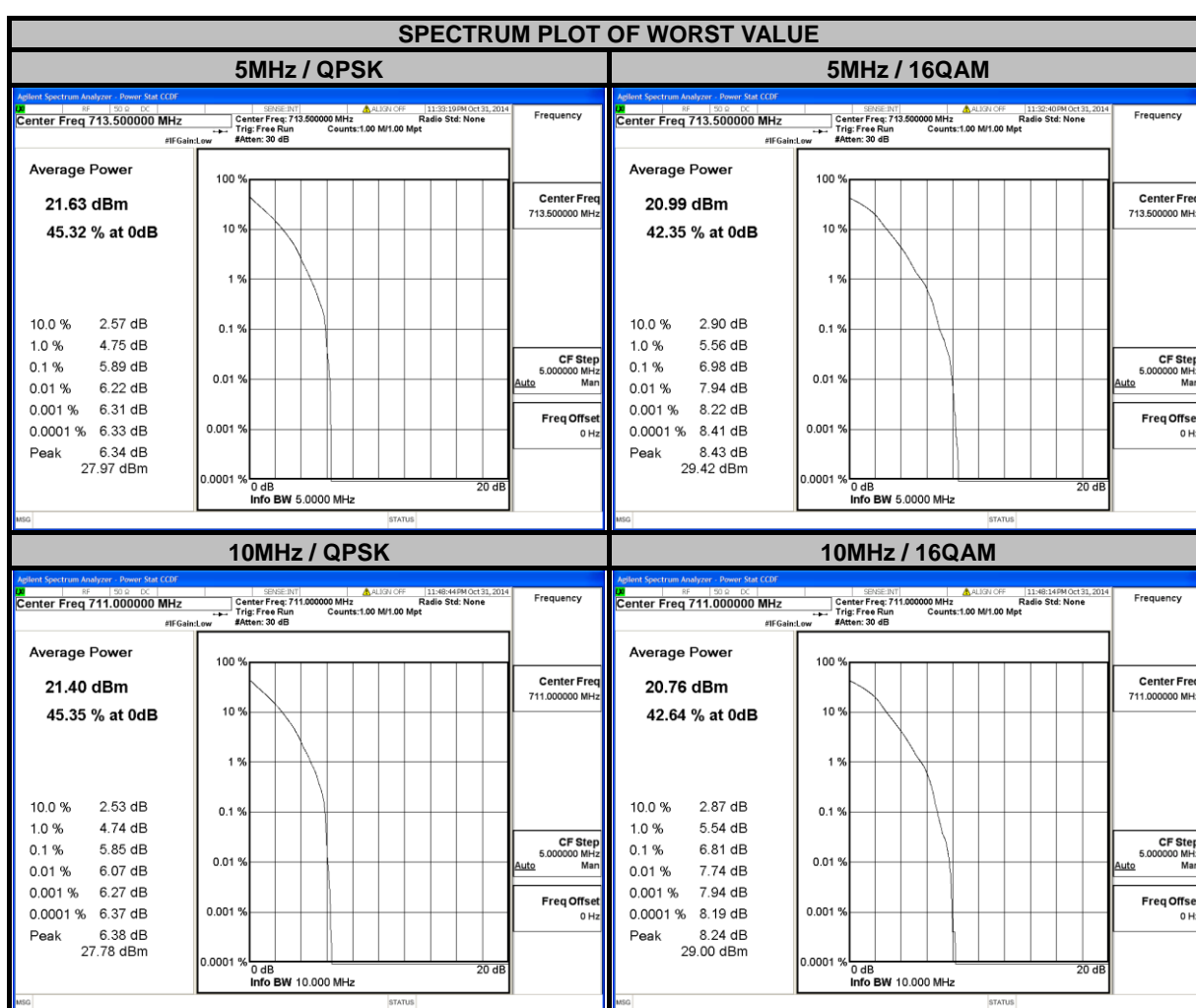



A D T

LTE BAND 4							
CHANNEL BANDWIDTH: 1.4MHz				CHANNEL BANDWIDTH: 3MHz			
CHANNEL	FREQUENCY (MHz)	PEAK TO AVERAGE RATIO (dB)		CHANNEL	FREQUENCY (MHz)	PEAK TO AVERAGE RATIO (dB)	
		QPSK	16QAM			QPSK	16QAM
19957	1710.7	6.09	7.45	19965	1711.5	5.70	6.65
20175	1732.5	6.06	7.44	20175	1732.5	5.86	6.60
20393	1754.3	5.51	6.65	20385	1753.5	5.41	6.36

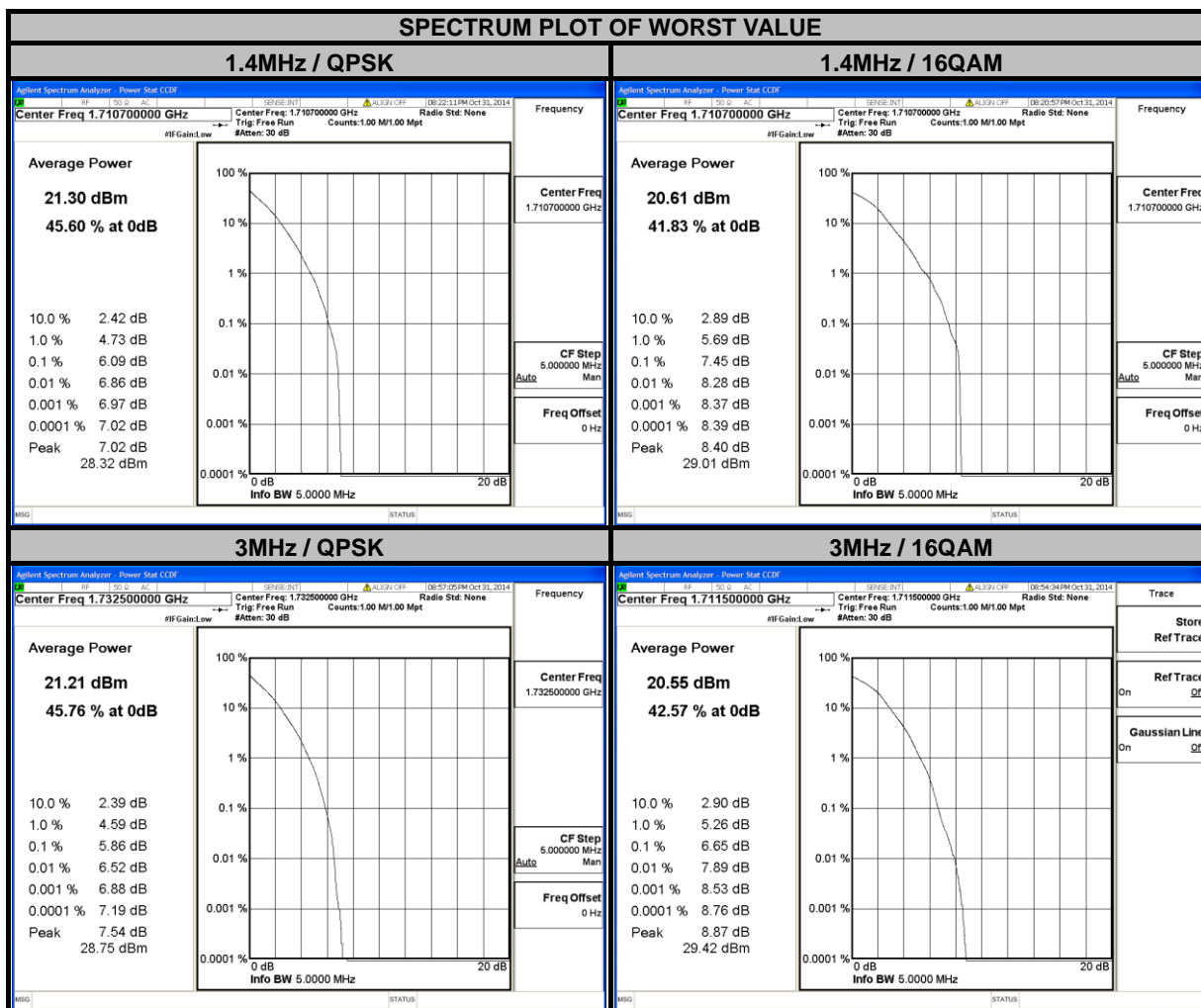



A D T

LTE BAND 4							
CHANNEL BANDWIDTH: 5MHz				CHANNEL BANDWIDTH: 10MHz			
CHANNEL	FREQUENCY (MHz)	PEAK TO AVERAGE RATIO (dB)		CHANNEL	FREQUENCY (MHz)	PEAK TO AVERAGE RATIO (dB)	
		QPSK	16QAM			QPSK	16QAM
19975	1712.5	5.99	7.20	20000	1715.0	6.05	6.97
20175	1732.5	5.99	6.91	20175	1732.5	5.73	6.75
20375	1752.5	5.74	6.67	20350	1750.0	6.17	7.01

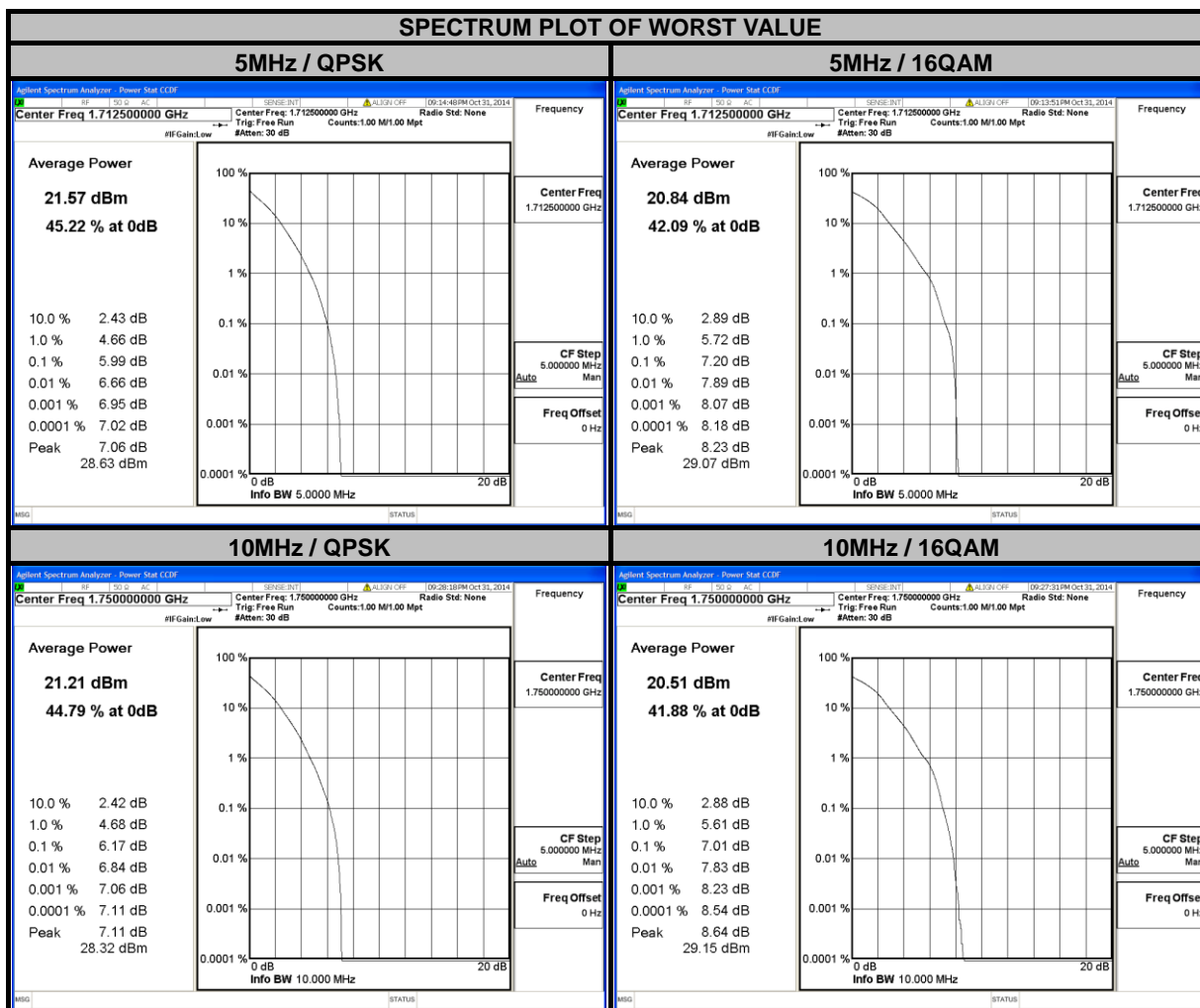



A D T

LTE BAND 4							
CHANNEL BANDWIDTH: 15MHz				CHANNEL BANDWIDTH: 20MHz			
CHANNEL	FREQUENCY (MHz)	PEAK TO AVERAGE RATIO (dB)		CHANNEL	FREQUENCY (MHz)	PEAK TO AVERAGE RATIO (dB)	
		QPSK	16QAM			QPSK	16QAM
20025	1717.5	6.03	7.47	20050	1720	5.91	6.96
20175	1732.5	5.75	6.88	20175	1732.5	5.54	6.65
20325	1747.5	6.03	7.31	20300	1745	6.30	7.20

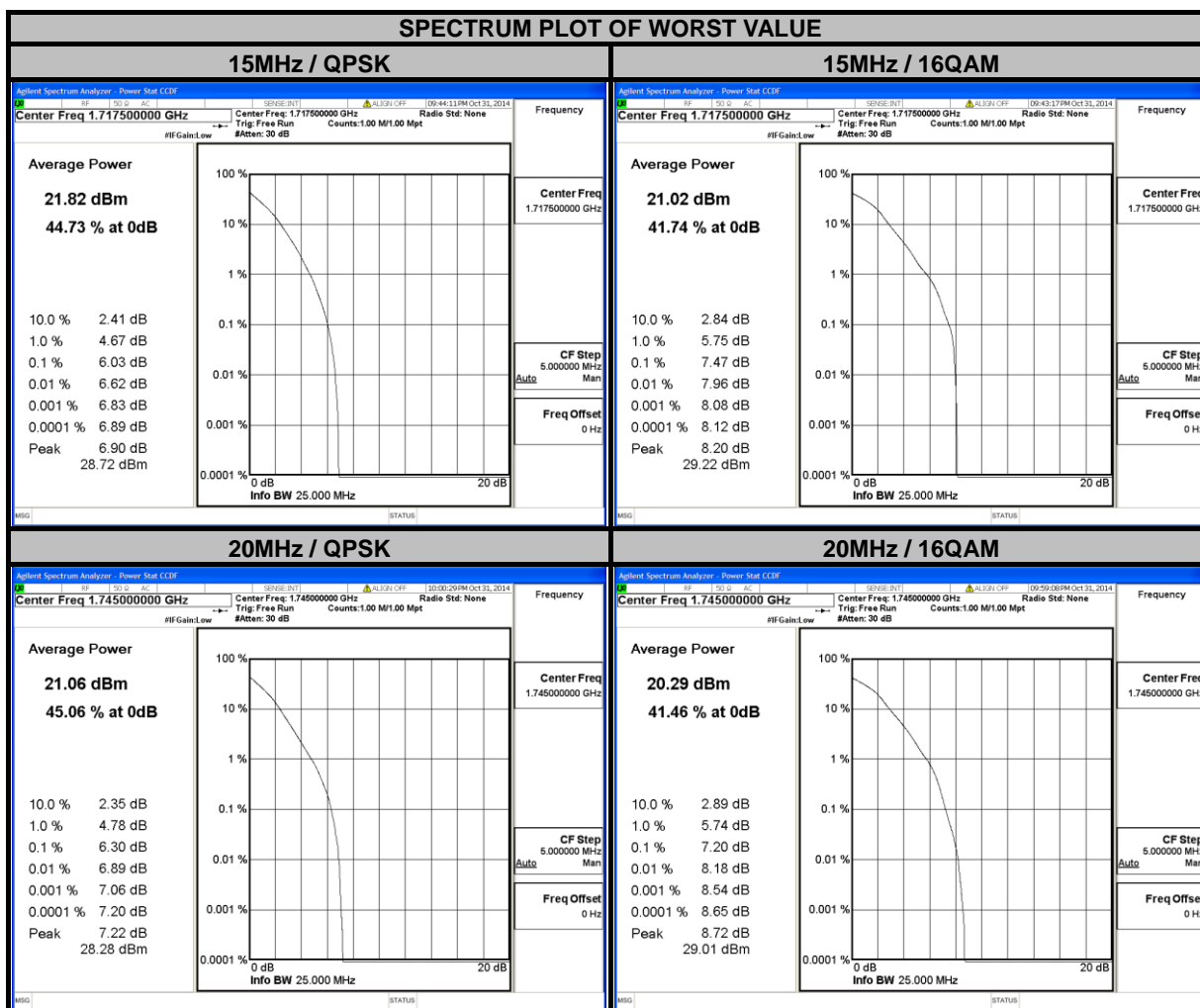

4.5 BAND EDGE MEASUREMENT

4.5.1 LIMITS OF BAND EDGE MEASUREMENT

For operations in the 704-716 MHz band, the power of any emission outside a licensee's frequency band(s) of operation shall be attenuated below the transmitter power (P) within the licensed band(s) of operation, measured in watts, by at least $43 + 10 \log(P)$ dB. Compliance with this provision is based on the use of measurement instrumentation employing a resolution bandwidth of 100 kilohertz or greater. However, in the 100 kilohertz bands immediately outside and adjacent to a licensee's frequency block, a resolution bandwidth of at least 30 kHz may be employed.

For operations in the 1710–1755 MHz bands, the power of any emission outside a licensee's frequency block shall be attenuated below the transmitter power (P) by at least $43 + 10 \log_{10}(P)$ dB.

4.5.2 TEST SETUP

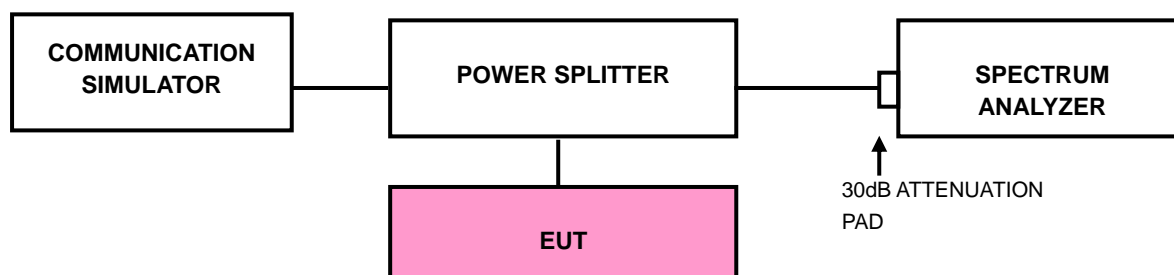

4.5.3 TEST PROCEDURES

- The EUT was set up for the maximum peak power with LTE link data modulation. The power was measured with R&S Spectrum Analyzer. All measurements were done at 2 channels (low and high operational frequency range.).
- The band edge measurement used the power splitter via EUT RF power connector between simulation base station and spectrum analyzer.
- The center frequency of spectrum is the band edge frequency and span is 2 MHz. RB of the spectrum is 100kHz and VB of the spectrum is 300kHz.
- The center frequency of spectrum is the band edge frequency and span is 1 MHz. RB of the spectrum is 91kHz and VB of the spectrum is 300kHz (LTE Band 4 Bandwidth 5MHz).
- Record the max trace plot into the test report.



A D T

4.5.4 TEST RESULTS

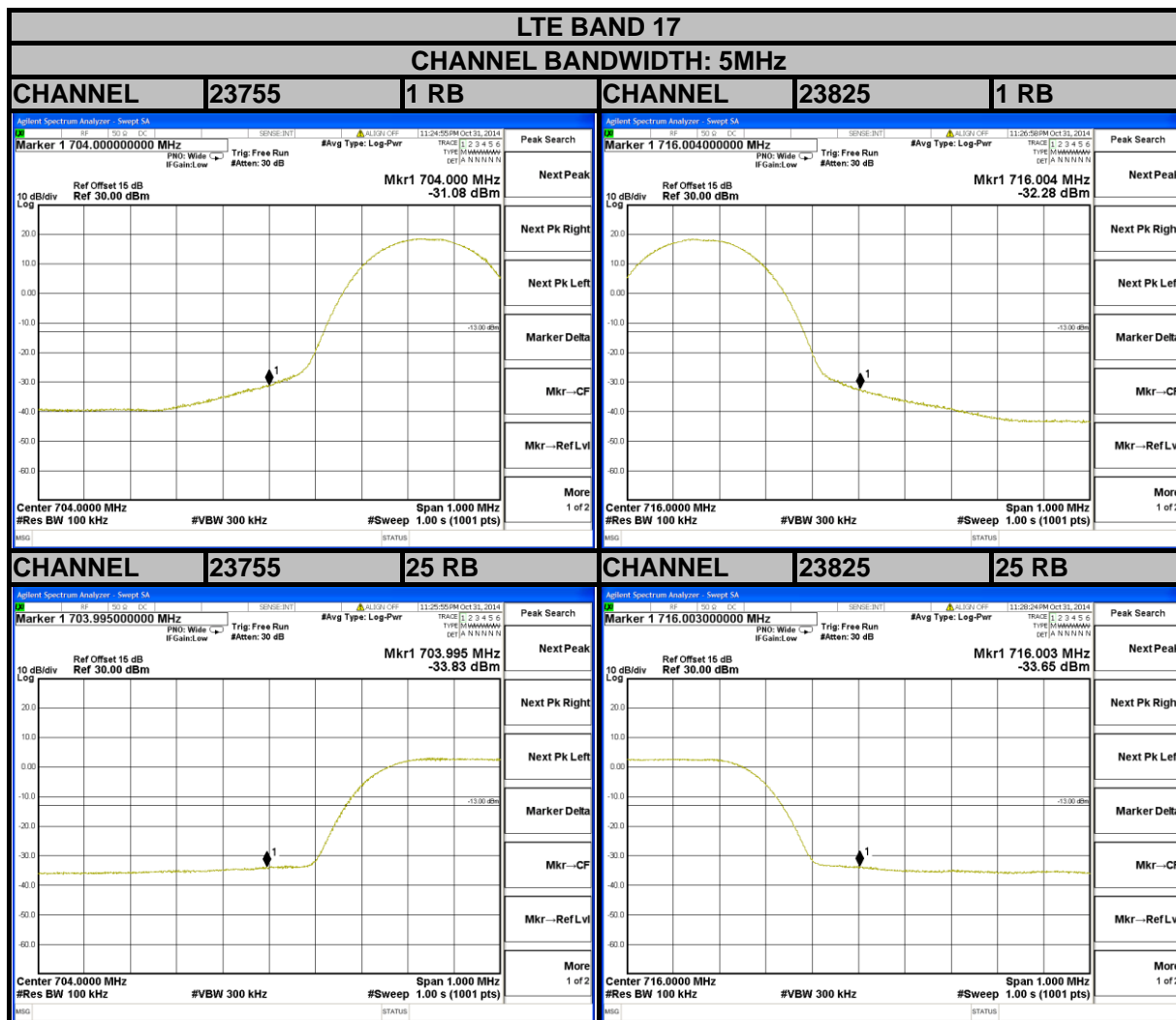



A D T

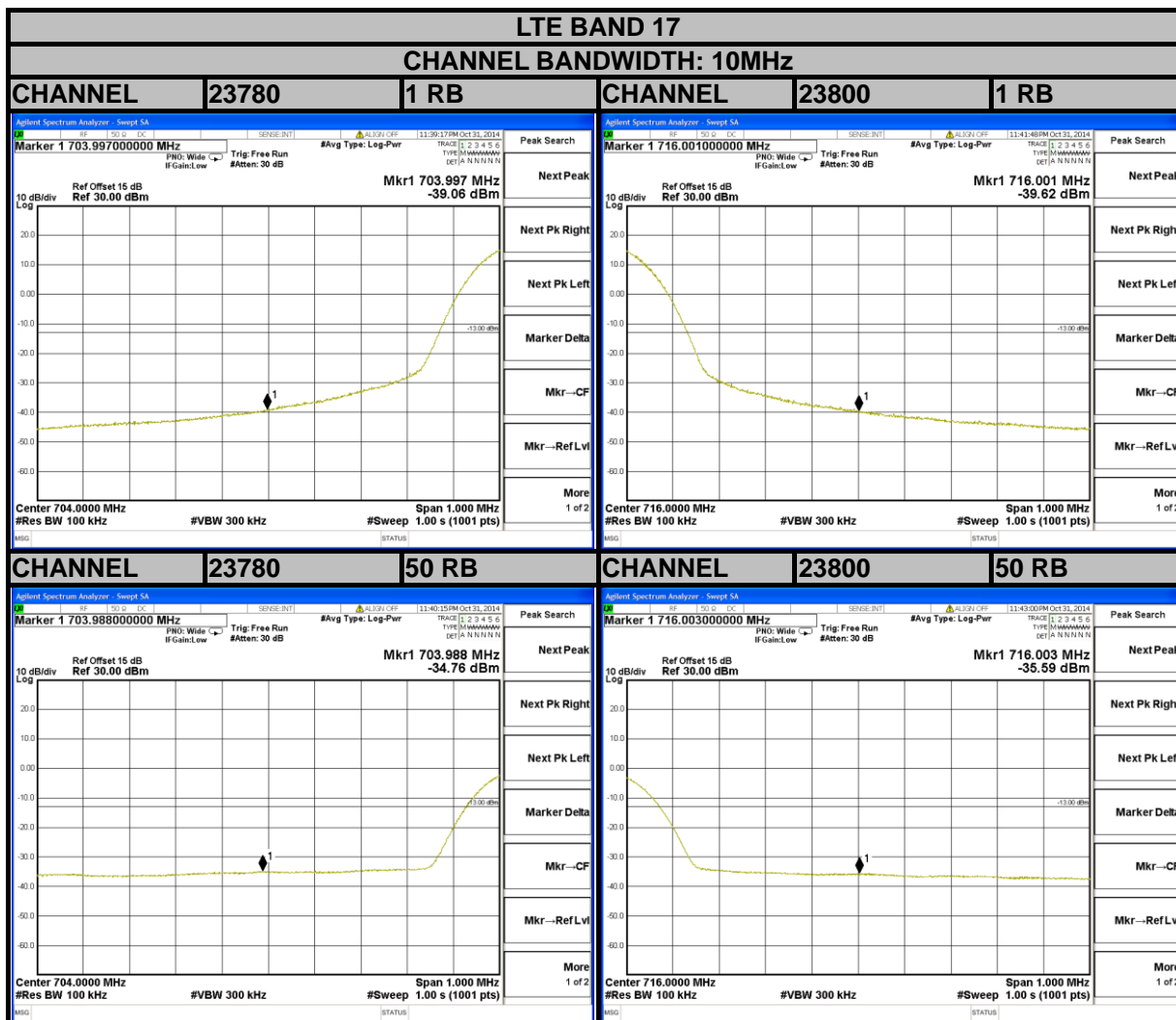



A D T

LTE BAND 4

CHANNEL BANDWIDTH: 1.4MHz

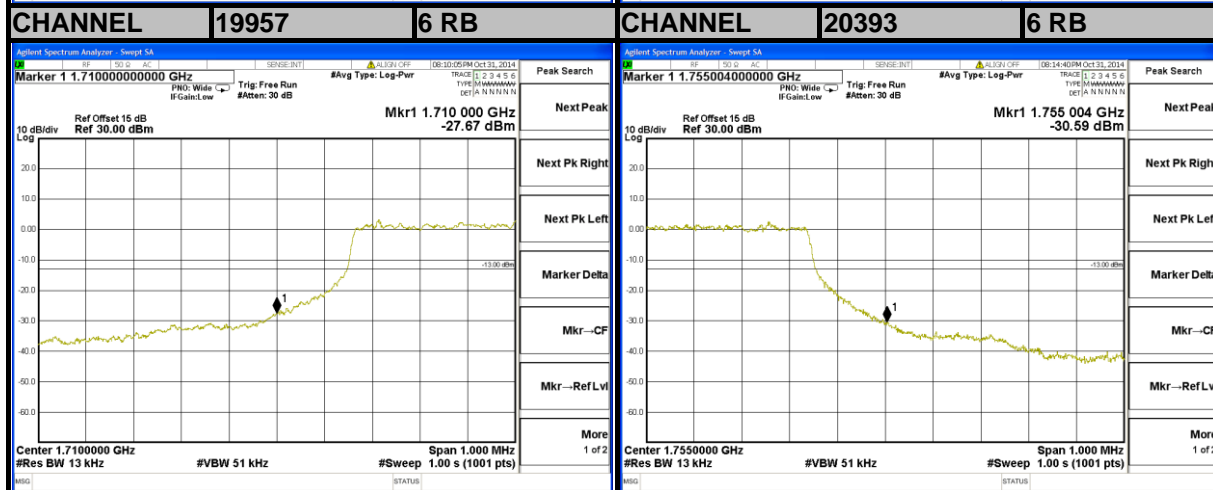
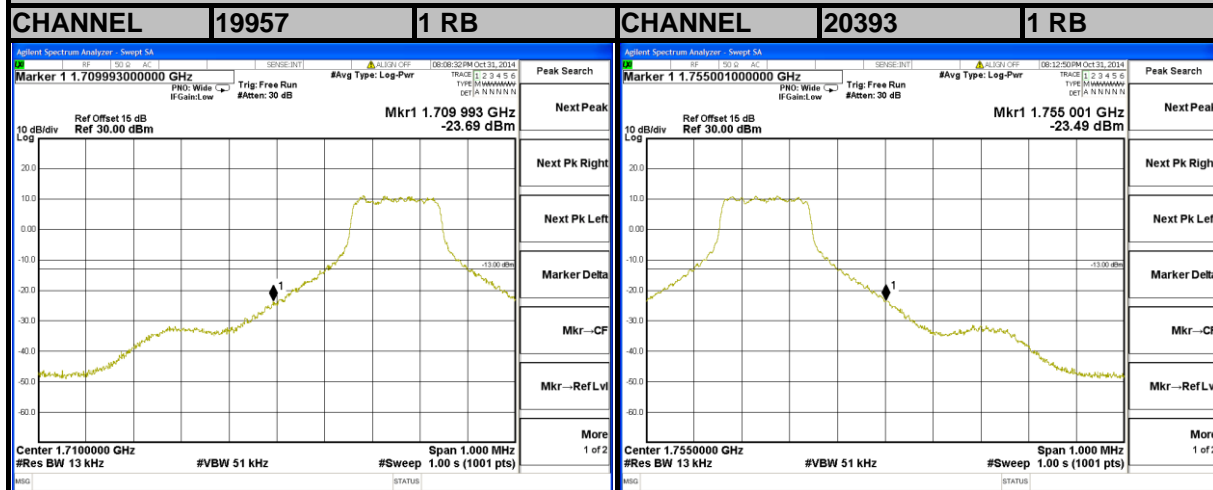



A D T

LTE BAND 4

CHANNEL BANDWIDTH: 3MHz

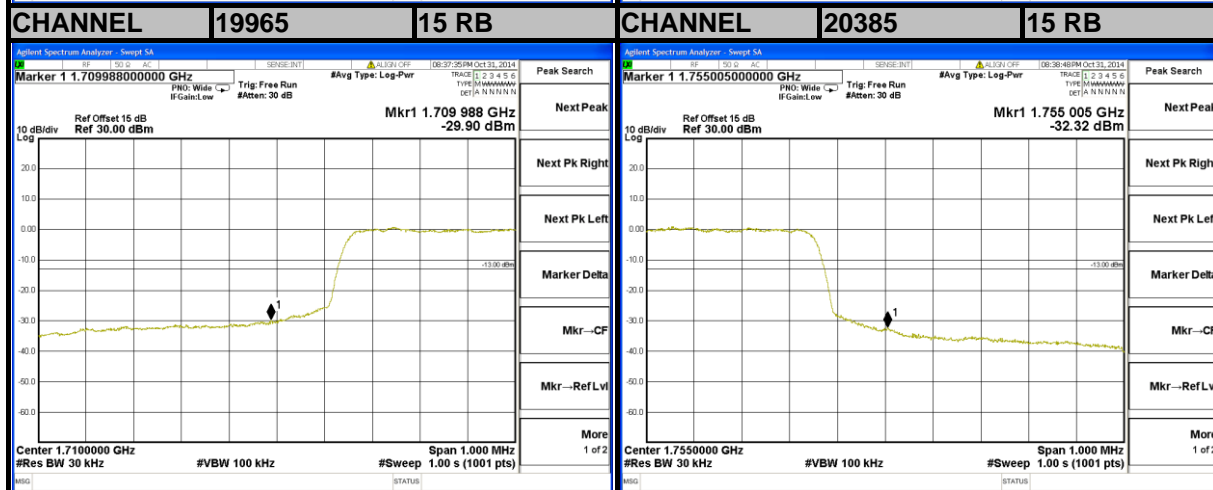
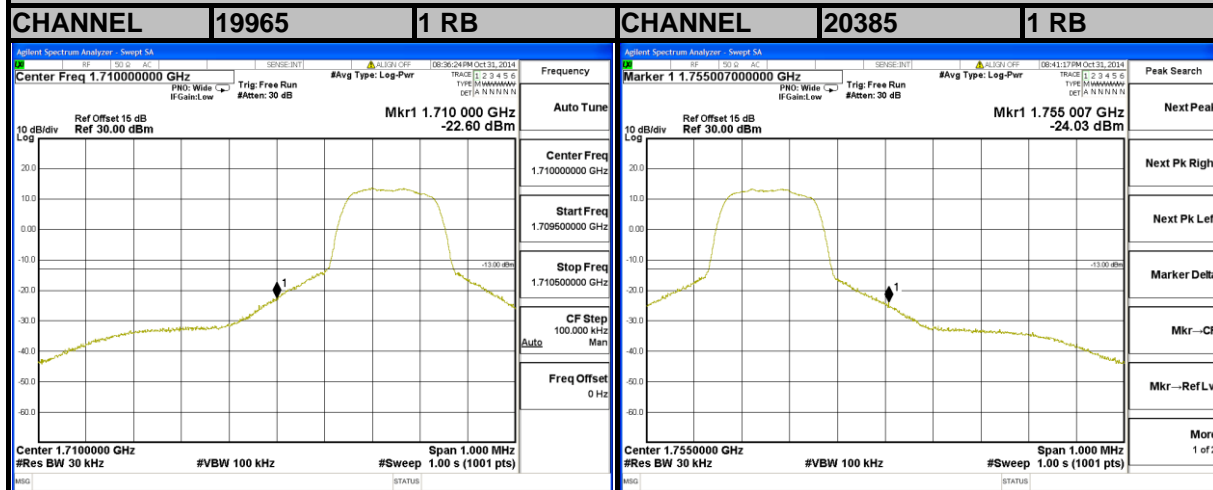



A D T

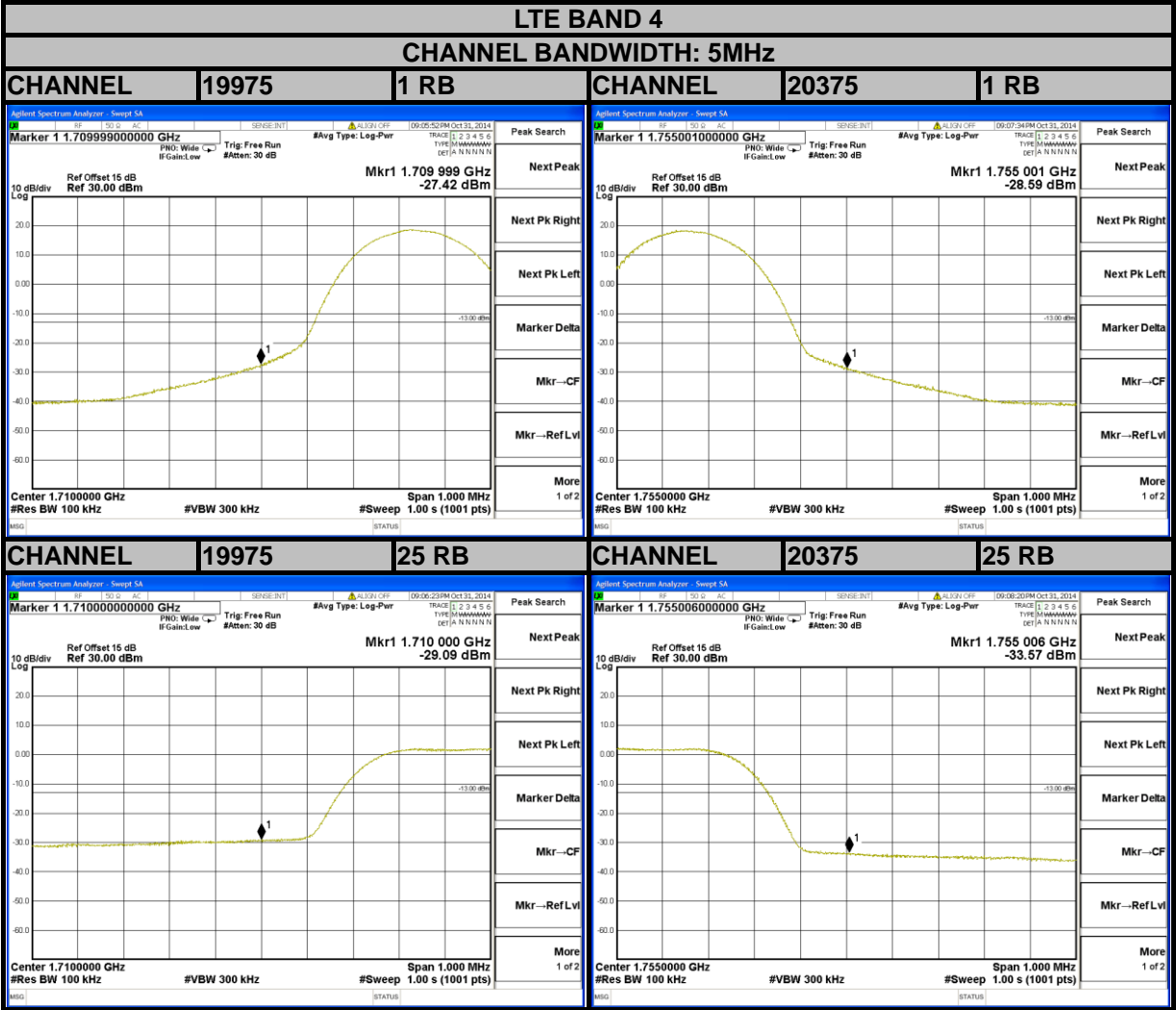



A D T

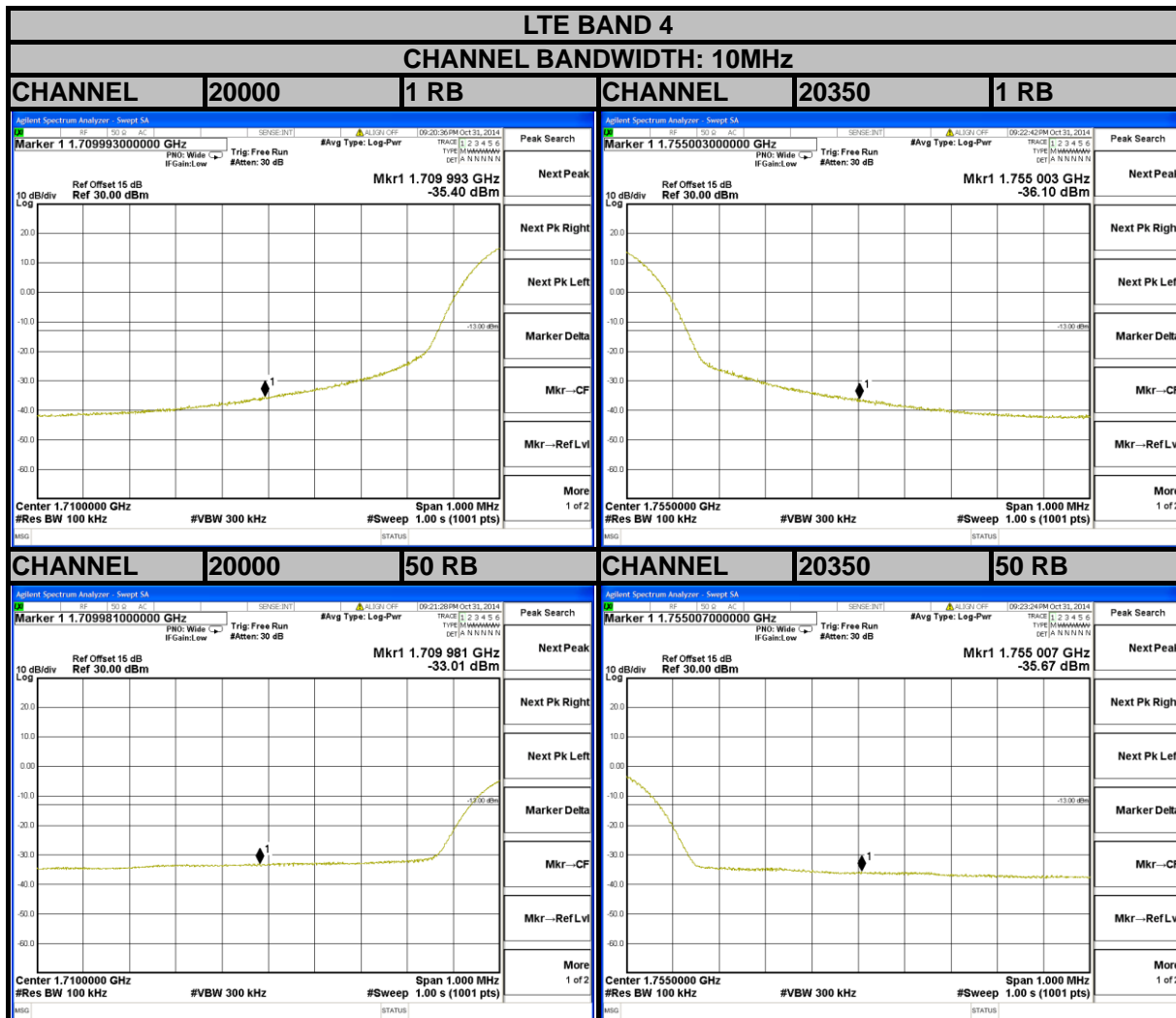



A D T

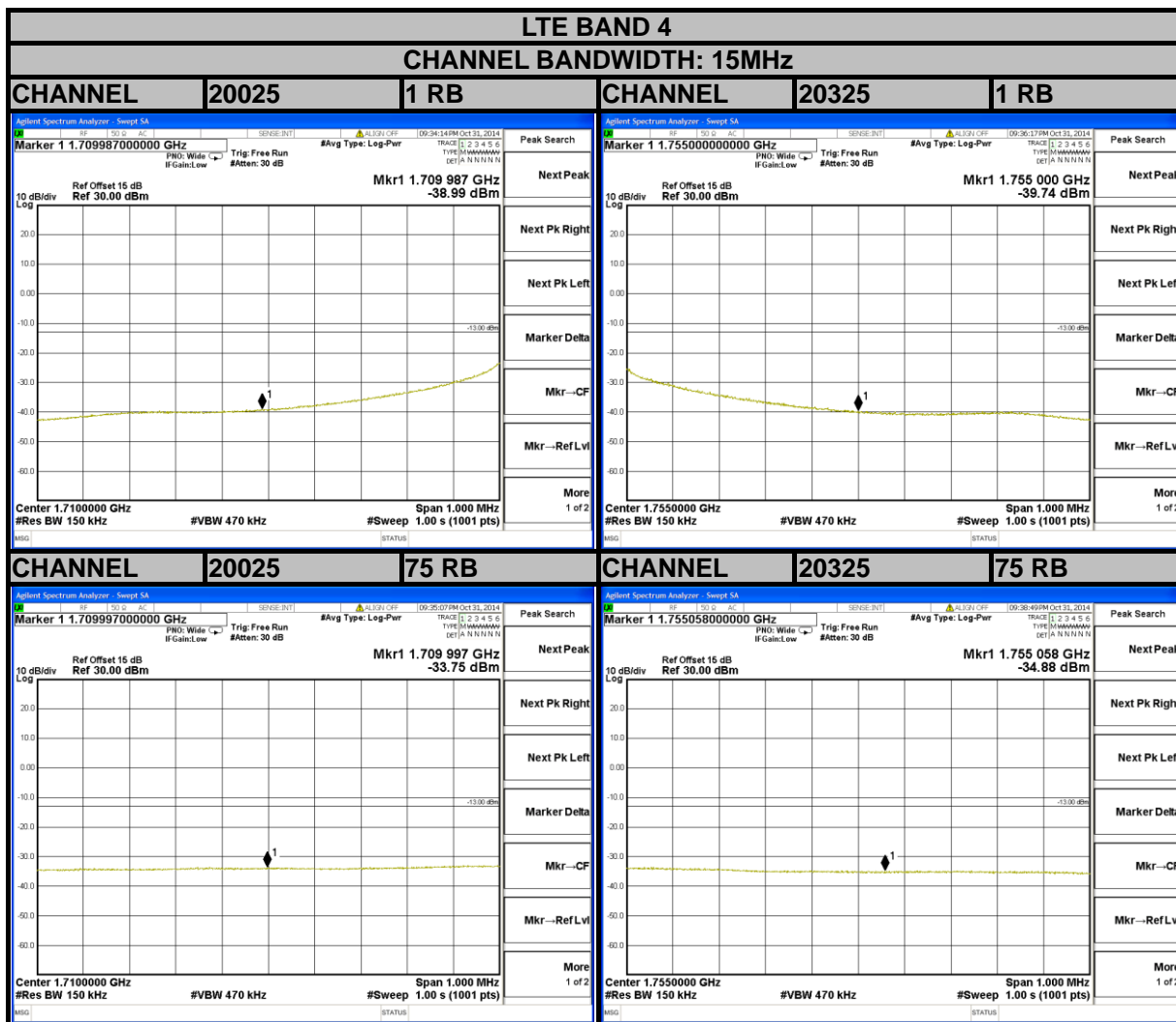



A D T

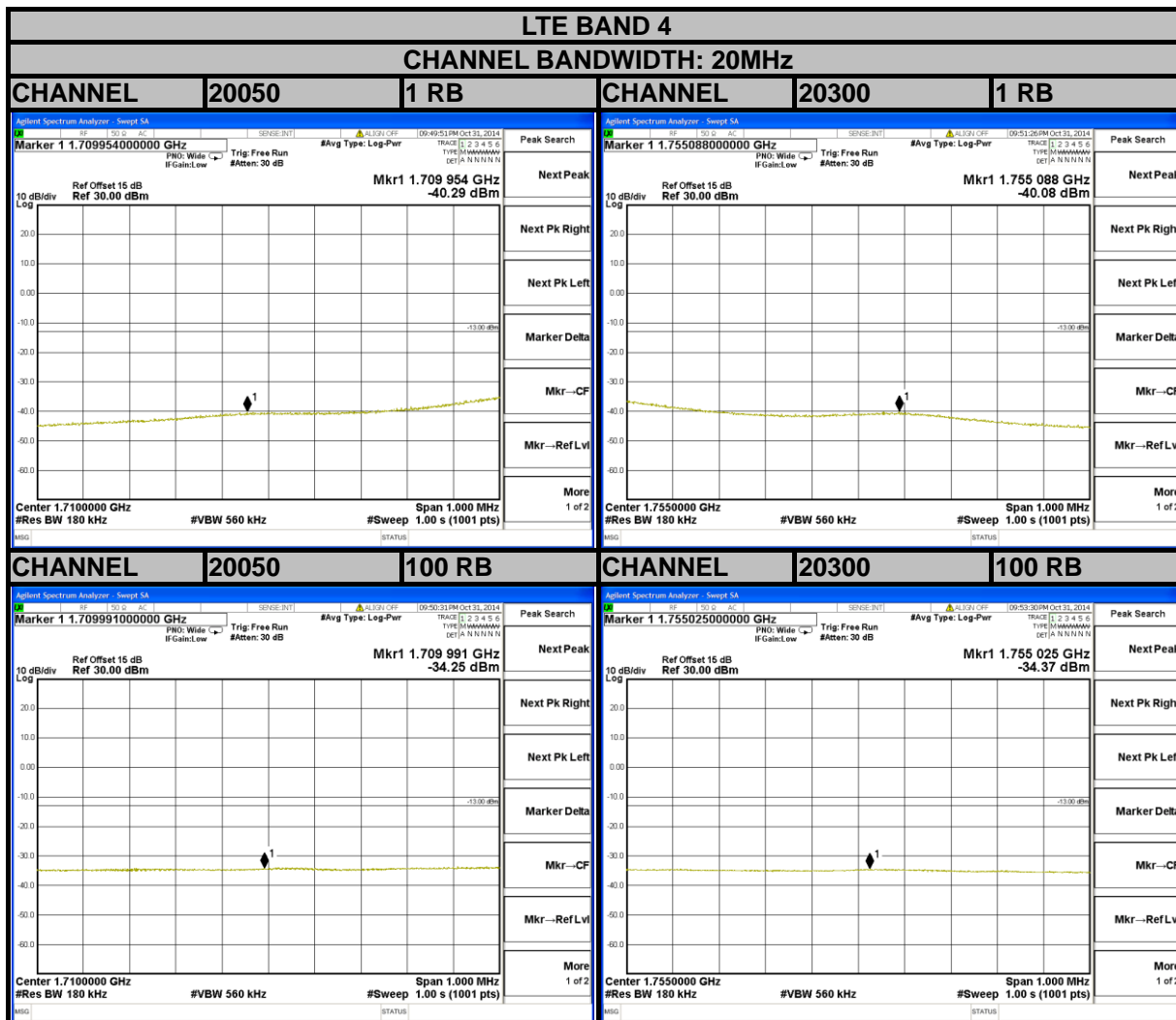

4.6 CONDUCTED SPURIOUS EMISSIONS

4.6.1 LIMITS OF CONDUCTED SPURIOUS EMISSIONS MEASUREMENT

The power of any emission outside a licensee's frequency block shall be attenuated below the transmitter power (P) by at least $43 + 10 \log_{10}(P)$ dB. The limit of emission is equal to -13dBm.

4.6.2 TEST PROCEDURE

- The EUT makes a phone call to the communication simulator. All measurements were done at low, middle and high operational frequency range.
- Measuring frequency range is from 30 MHz to 8GHz for LTE Band 17 and from 30MHz to 18GHz for LTE Band 4. 10dB attenuation pad is connected with spectrum. RBW=1MHz and VBW=3MHz are used for conducted emission measurement.

4.6.3 TEST SETUP

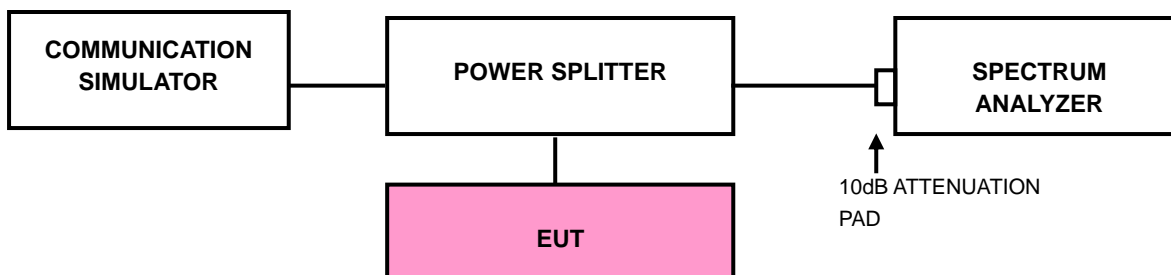

4.6.4 TEST RESULTS

FREQUENCY RANGE: 30MHz~8GHz

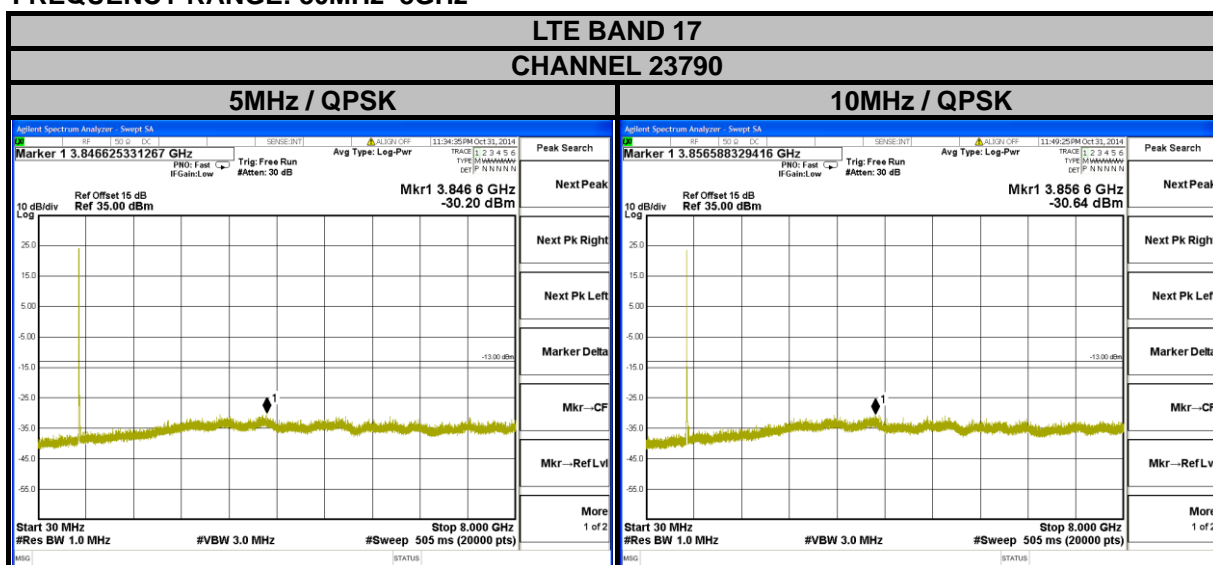

FREQUENCY RANGE: 30MHz~18GHz

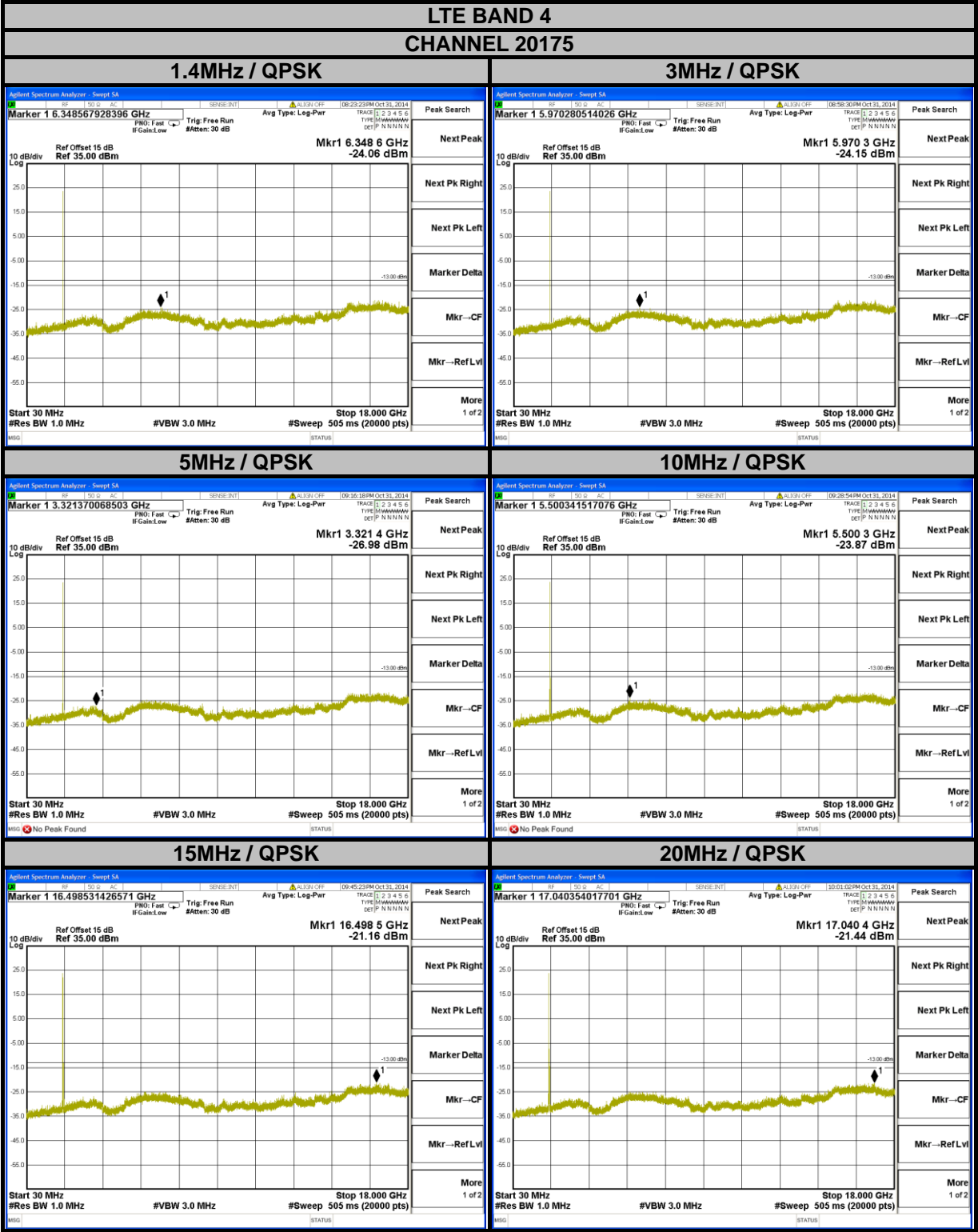

4.7 RADIATED EMISSION MEASUREMENT

4.7.1 LIMITS OF RADIATED EMISSION MEASUREMENT

The power of any emission outside a licensee's frequency block shall be attenuated below the transmitter power (P) by at least $43 + 10 \log_{10}(P)$ dB. The limit of emission equal to -13dBm

4.7.2 TEST PROCEDURES

- a. Substitution method is used for E.I.R.P measurement. In the semi-anechoic chamber, EUT placed on the 0.8m height of Turn Table, rotated the table around 360 degrees to search the maximum radiation power and receiver antenna shall be rotated vertical and horizontal polarization and moved height from 1m to 4m to find the maximum polar radiated power. The "Read Value" is the spectrum reading the maximum power value.
- b. The substitution horn antenna is substituted for EUT at the same position and signals generator export the CW signal to the substitution antenna via a TX cable. Rotated the Turn Table and moved receiving antenna to find the maximum radiation power. Adjust output power level of S.G to get a Value of spectrum reading equal to "Read Value " of step a. Record the power level of S.G
- c. $\text{EIRP} = \text{Output power level of S.G} - \text{TX cable loss} + \text{Antenna gain of substitution horn.}$
- d. E.R.P power can be calculated form E.I.R.P power by subtracting the gain of dipole, $\text{E.R.P power} = \text{E.I.P.R power} - 2.15\text{dBi.}$

NOTE: The resolution bandwidth of spectrum analyzer is 1 MHz and the video bandwidth is 3 MHz.

4.7.3 DEVIATION FROM TEST STANDARD

No deviation

4.7.4 TEST SETUP

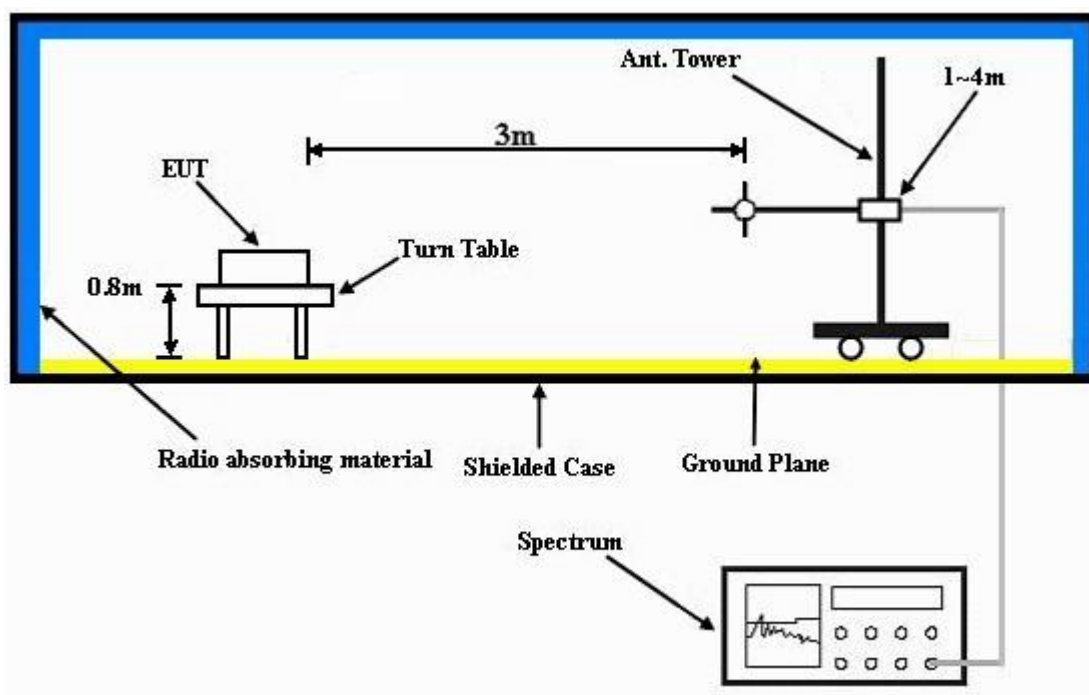

For the actual test configuration, please refer to the attached file (Test Setup Photo).



A D T

4.7.5 TEST RESULTS

LTE BAND 17

CHANNEL BANDWIDTH: 10MHz / QPSK



Bureau Veritas Consumer Products Services Ltd., Taoyuan Branch

A D T

Data: 9

Date: 2014-10-25

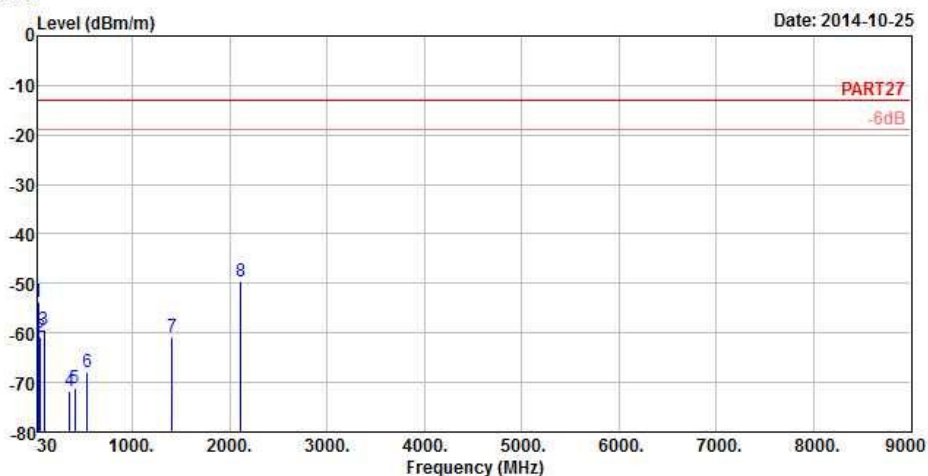

Site : 966 Chamber 5
 Condition: PART27 3m HORIZONTAL
 Remark : LTE Band 17 10M_QPSK(1,0) Link
 Tested by: Gavin Wu
 Plane : Y

	Freq	Level	Read Level	Limit Line	Over Limit	Factor	Remark
	MHz	dBm/m	dBm	dBm/m	dB	dB/m	
1	31.18	-53.75	-54.09	-13.00	-40.75	0.34	Peak
2	55.34	-60.67	-55.32	-13.00	-47.67	-5.35	Peak
3	90.92	-59.35	-48.79	-13.00	-46.35	-10.56	Peak
4	352.50	-71.60	-65.61	-13.00	-58.60	-5.99	Peak
5	406.40	-71.25	-65.78	-13.00	-58.25	-5.47	Peak
6	533.10	-68.00	-65.81	-13.00	-55.00	-2.19	Peak
7	1411.20	-60.74	-47.15	-13.00	-47.74	-13.59	Peak
8 pp	2116.80	-49.47	-37.65	-13.00	-36.47	-11.82	Peak



A D T



Bureau Veritas Consumer Products Services Ltd., Taoyuan Branch

A D T

Data: 10

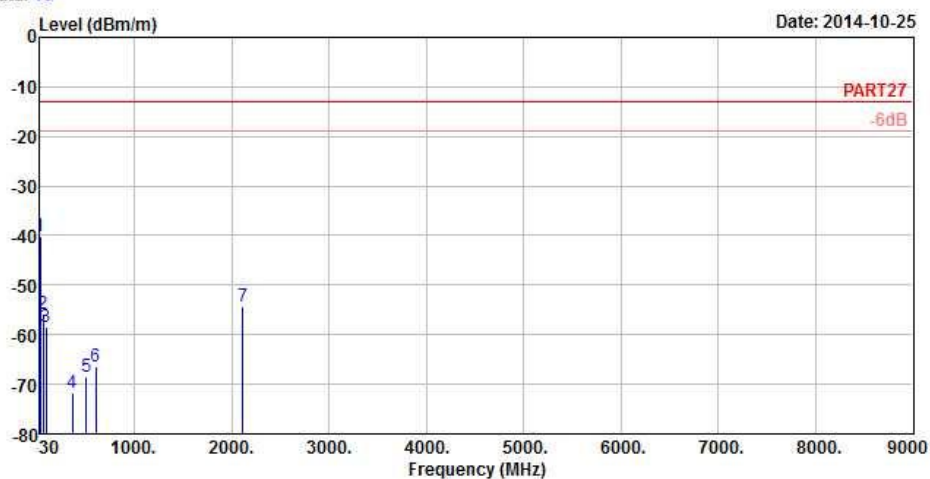

Site : 966 Chamber 5
 Condition: PART27 3m VERTICAL
 Remark : LTE Band 17 10M_QPSK(1,0) Link
 Tested by: Gavin Wu
 Plane : Y

	Freq	Level	Read Level	Limit Line	Over Limit	Factor	Remark
	MHz	dBm/m	dBm	dBm/m	dB	dB/m	
1	pp	31.07	-40.14	-40.48	-13.00	-27.14	0.34 Peak
2		63.71	-55.69	-48.29	-13.00	-42.69	-7.40 Peak
3		88.87	-58.40	-47.85	-13.00	-45.40	-10.55 Peak
4		365.10	-71.80	-65.90	-13.00	-58.80	-5.90 Peak
5		506.50	-68.46	-65.53	-13.00	-55.46	-2.93 Peak
6		606.60	-66.52	-66.27	-13.00	-53.52	-0.25 Peak
7		2116.80	-54.42	-42.60	-13.00	-41.42	-11.82 Peak



A D T

LTE BAND 4
CHANNEL BANDWIDTH: 20MHz / QPSK



Bureau Veritas Consumer Products Services Ltd., Taoyuan Branch

A D T

Data: 13

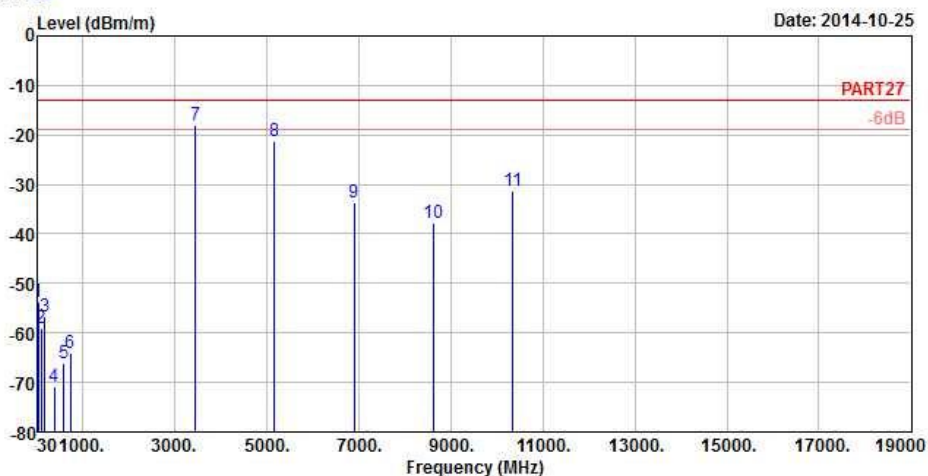

Site : 966 Chamber 5
 Condition: PART27 3m HORIZONTAL
 Remark : LTE Band 4 20M_QPSK(1,0) Link
 Tested by: Gavin Wu
 Plane : Z

	Freq	Level	Read Level	Limit Line	Over Limit	Factor	Remark
	MHz	dBm/m	dBm	dBm/m	dB	dB/m	
1	31.08	-53.75	-54.09	-13.00	-40.75	0.34	Peak
2	90.75	-59.14	-48.58	-13.00	-46.14	-10.56	Peak
3	181.20	-56.60	-50.82	-13.00	-43.60	-5.78	Peak
4	379.80	-70.79	-65.01	-13.00	-57.79	-5.78	Peak
5	584.90	-66.18	-65.40	-13.00	-53.18	-0.78	Peak
6	726.30	-64.06	-65.69	-13.00	-51.06	1.63	Peak
7 pp	3447.40	-18.00	-8.91	-13.00	-5.00	-9.09	Peak
8	5171.10	-21.20	-18.05	-13.00	-8.20	-3.15	Peak
9	6894.80	-33.73	-35.90	-13.00	-20.73	2.17	Peak
10	8618.50	-37.65	-42.14	-13.00	-24.65	4.49	Peak
11	10342.20	-31.31	-38.36	-13.00	-18.31	7.05	Peak



A D T



Bureau Veritas Consumer Products Services Ltd., Taoyuan Branch

A D T

Data: 14

Date: 2014-10-25

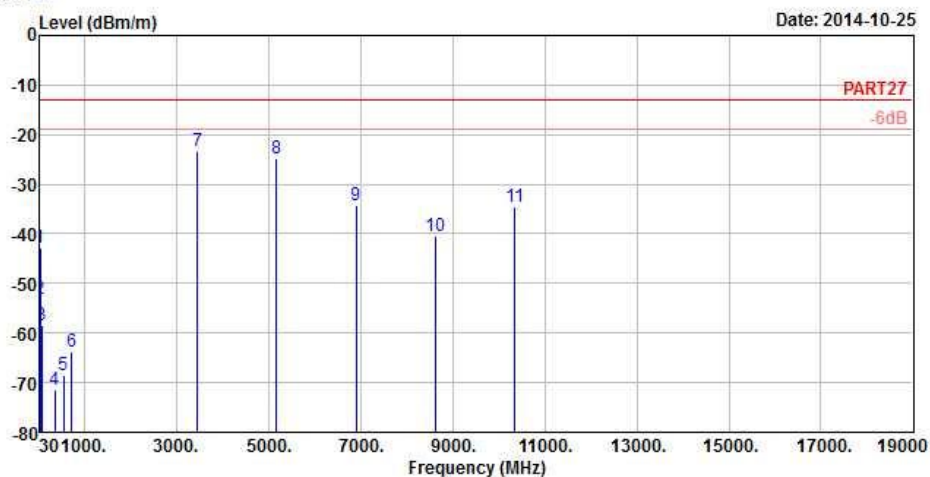

Site : 966 Chamber 5
 Condition: PART27 3m VERTICAL
 Remark : LTE Band 4 20M_QPSK(1,0) Link
 Tested by: Gavin Wu
 Plane : Z

	Freq	Level	Read Level	Limit Line	Over Limit	Factor	Remark
	MHz	dBm/m	dBm	dBm/m	dB	dB/m	
1	30.81	-42.88	-43.22	-13.00	-29.88	0.34	Peak
2	41.88	-53.16	-51.77	-13.00	-40.16	-1.39	Peak
3	61.86	-58.45	-51.70	-13.00	-45.45	-6.75	Peak
4	349.70	-71.44	-65.43	-13.00	-58.44	-6.01	Peak
5	539.40	-68.49	-66.46	-13.00	-55.49	-2.03	Peak
6	717.20	-63.82	-65.38	-13.00	-50.82	1.56	Peak
7 pp	3447.40	-23.25	-14.16	-13.00	-10.25	-9.09	Peak
8	5171.10	-24.67	-21.52	-13.00	-11.67	-3.15	Peak
9	6894.80	-34.16	-36.33	-13.00	-21.16	2.17	Peak
10	8618.50	-40.56	-45.05	-13.00	-27.56	4.49	Peak
11	10342.20	-34.58	-41.63	-13.00	-21.58	7.05	Peak



A D T

5 PHOTOGRAPHS OF THE TEST CONFIGURATION

Please refer to the attached file (Test Setup Photo).



6 INFORMATION ON THE TESTING LABORATORIES

We, Bureau Veritas Consumer Products Services (H.K.) Ltd., Taoyuan Branch, were founded in 1988 to provide our best service in EMC, Radio, Telecom and Safety consultation. Our laboratories are accredited and approved according to ISO/IEC 17025.

If you have any comments, please feel free to contact us at the following:

Linko EMC/RF Lab:

Tel: 886-2-26052180

Fax: 886-2-26051924

Hsin Chu EMC/RF/Telecom Lab:

Tel: 886-3-5935343

Fax: 886-3-5935342

Hwa Ya EMC/RF/Safety Lab:

Tel: 886-3-3183232

Fax: 886-3-3270892

Email: service.adt@tw.bureauveritas.com

Web Site: www.adt.com.tw

The address and road map of all our labs can be found in our web site also.



7 APPENDIX A – MODIFICATIONS RECORDERS FOR ENGINEERING CHANGES TO THE EUT BY THE LAB

No modifications were made to the EUT by the lab during the test.

---END---