



FCC RF Test Report

APPLICANT : ASUSTeK COMPUTER INC.
EQUIPMENT : ASUS Phone(Mobile Phone)
BRAND NAME : ASUS
MODEL NAME : ASUS_I005D, ASUS_I005DC
FCC ID : MSQI005D
STANDARD : 47 CFR Part 2, 96
CLASSIFICATION : Citizens Band End User Devices (CBE)
EQUIPMENT TYPE : End User Equipment

The product was received on Nov. 03, 2020 and completely tested on Jan. 13, 2021. We, Sporton International (Kunshan) Inc., would like to declare that the tested sample has been evaluated in accordance with the procedures given in ANSI C63.26 and shown compliance with the applicable technical standards.

The test results in this report apply exclusively to the tested model / sample. Without written approval of Sporton International (Kunshan) Inc., the test report shall not be reproduced except in full.

Reviewed by: Jason Jia / Supervisor

Approved by: James Huang / Manager



Sporton International (Kunshan) Inc.

**No. 1098, Pengxi North Road, Kunshan Economic Development Zone Jiangsu Province 215300
People's Republic of China**



Table of Contents

History of this test report..... 3

Summary of Test Result..... 4

1 General Description 5

 1.1 Applicant..... 5

 1.2 Manufacturer 1 5

 1.3 Manufacturer 2 5

 1.4 Feature of Equipment Under Test..... 5

 1.5 Maximum EIRP Power, Frequency Tolerance, and Emission Designator 6

 1.6 Testing Site..... 6

 1.7 Test Software 6

 1.8 Applied Standards 6

2 Test Configuration of Equipment Under Test 8

 2.1 Test Mode..... 8

 2.2 Connection Diagram of Test System 9

 2.3 Support Unit used in test configuration 9

 2.4 Measurement Results Explanation Example 9

 2.5 Frequency List of Low/Middle/High Channels..... 10

3 Conducted Test Items 11

 3.1 Measuring Instruments..... 11

 3.2 Conducted Output Power 12

 3.3 EIRP 13

 3.4 Occupied Bandwidth 14

 3.5 Conducted Band Edge 15

 3.6 Conducted Spurious Emission 16

 3.7 Frequency Stability..... 17

4 Radiated Test Items 18

 4.1 Measuring Instruments..... 18

 4.2 Test Setup 18

 4.3 Test Result of Radiated Test..... 18

 4.4 Radiated Spurious Emission 19

5 List of Measuring Equipment..... 20

6 Uncertainty of Evaluation 21

Appendix A. Test Results of Conducted Test

Appendix B. Test Results of Radiated Test

Appendix C. Test Setup Photographs



History of this test report

Report No.	Version	Description	Issued Date
FG0N0335F	01	Initial issue of report	Feb. 02, 2021



Summary of Test Result

Report Clause	Ref Std. Clause	Test Items	Result (PASS/FAIL)	Remark
3.2	§2.1046	Conducted Output Power	Reporting only	-
-	§96.41	Peak-to-Average Ratio	Not Required	Not applicable for End User Devices
3.3	§96.41	Maximum E.I.R.P	Pass	-
		Maximum Power Spectral Density	Not Required	Not applicable for End User Devices
3.4	§2.1049 §96.41	Occupied Bandwidth	Reporting only	-
3.5	§2.1051 §96.41	Conducted Band Edge Measurement Adjacent Channel Leakage Ratio	Pass	-
3.6	§2.1051 §96.41	Conducted Spurious Emission	Pass	-
3.7	§2.1055	Frequency Stability for Temperature & Voltage	Pass	-
4.4	§2.1051 §96.41	Radiated Spurious Emission	Pass	Under limit 15.31 dB at 10848.000 MHz

Declaration of Conformity:
The test results with all measurement uncertainty excluded are presented in accordance with the regulation limits or requirements declared by manufacturers.
Comments and Explanations:
The declared of product specification for EUT presented in the report are provided by the manufacturer, and the manufacturer takes all the responsibilities for the accuracy of product specification.



1 General Description

1.1 Applicant

ASUSTeK COMPUTER INC.

1F., No. 15, Lide Rd., Beitou Dist., Taipei City 112, Taiwan

1.2 Manufacturer 1

Guangdong Enok Communication Co., Ltd.

No. 137, 139, Lixiang Road., Songmushan Village, Dalang Town, Dongguan City, Guangdong Province, China

1.3 Manufacturer 2

PT. SAT NUSAPERSADA TBK

JALAN PELITA VI. NO. 99, BATAM, 29443, INDONESIA

1.4 Feature of Equipment Under Test

Product Feature	
Equipment	ASUS Phone(Mobile Phone)
Brand Name	ASUS
Model Name	ASUS_I005D, ASUS_I005DC
FCC ID	MSQI005D
Tx Frequency	LTE Band 48: 3552.5 MHz ~ 3697.5 MHz
Rx Frequency	LTE Band 48: 3552.5 MHz ~ 3697.5 MHz
Bandwidth	5MHz / 10MHz / 15MHz / 20MHz
Maximum Output Power to Antenna	24.32 dBm
Type of Modulation	QPSK / 16QAM / 64QAM
IMEI Code	Conducted: N/A Radiation: 352977280003313/352977280003321
HW Version	R2.0B
SW Version	Android R
EUT Stage	Identical Prototype

Remark:

1. The above EUT's information was declared by manufacturer. Please refer to the specifications or user's manual for more detailed description.
2. The differences between two Models: ASUS_I005D and ASUS_I005DC refer to the Product Equality Declaration

1.5 Maximum EIRP Power, Frequency Tolerance, and Emission Designator

LTE Band 48		QPSK			16QAM		
BW (MHz)	Frequency Range (MHz)	Emission Designator (99%OBW)	Frequency Tolerance (ppm)	Maximum EIRP (W)	Emission Designator (99%OBW)	Frequency Tolerance (ppm)	Maximum EIRP (W)
20	3560~3690	17M9G7D	0.0044	0.1746	17M9W7D	-	0.1409

1.6 Testing Site

Sporton International (Kunshan) Inc. is accredited to ISO/IEC 17025:2017 by American Association for Laboratory Accreditation with Certificate Number 5145.02.

Test Firm	Sporton International (Kunshan) Inc.		
Test Site Location	No. 1098, Pengxi North Road, Kunshan Economic Development Zone Jiangsu Province 215300 People's Republic of China TEL : +86-512-57900158 FAX : +86-512-57900958		
Test Site No.	Sporton Site No.	FCC Designation No.	FCC Test Firm Registration No.
	TH01-KS 03CH04-KS	CN1257	314309

1.7 Test Software

Item	Site	Manufacturer	Name	Version
1.	03CH04-KS	AUDIX	E3	6.2009-8-24a

1.8 Applied Standards

According to the specifications of the manufacturer, the EUT must comply with the requirements of the following standards:

- ♦ ANSI C63.26-2015
- ♦ ANSI / TIA-603-E
- ♦ 47 CFR Part 2, 96
- ♦ FCC KDB 971168 D01 Power Meas. License Digital Systems v03r01
- ♦ FCC KDB 940660 D01 Part 96 CBRS v03
- ♦ FCC KDB 412172 D01 Determining ERP and EIRP v01r01



Remark: All test items were verified and recorded according to the standards and without any deviation during the test.



2 Test Configuration of Equipment Under Test

2.1 Test Mode

Antenna port conducted and radiated test items listed below are performed according to KDB 971168 D01 Power Meas. License Digital Systems v03r01 with maximum output power.

For radiated measurement, pre-scanned in three orthogonal panels, X, Y, Z. The worst cases (Y plane) were recorded in this report.

Test Items	Band	Bandwidth (MHz)						Modulation			RB #			Test Channel		
		1.4	3	5	10	15	20	QPSK	16QAM	64QAM	1	Half	Full	L	M	H
Max. Output Power	48	-	-	v	v	v	v	v	v	v	v	v	v	v	v	v
26dB and 99% Bandwidth	48	-	-				v	v	v				v	v	v	v
Conducted Band Edge	48	-	-	v	v	v	v	v	v	v	v		v	v		v
Conducted Spurious Emission	48	-	-	v	v	v	v	v	v	v	v		v	v	v	v
E.R.P / E.I.R.P	48	-	-	v	v	v	v	v	v	v	v			v	v	v
Frequency Stability	48	-	-				v	v					v		v	v
Radiated Spurious Emission	48	Worst Case												v		
Remark	<ol style="list-style-type: none"> The mark "v " means that this configuration is chosen for testing The mark "- " means that this bandwidth is not supported. The device is investigated from 30MHz to 10 times of fundamental signal for radiated spurious emission test under different RB size/offset and modulations in exploratory test. Subsequently, only the worst case emissions are reported. All the radiated test cases were performed with Adapter and USB Cable. 															

2.2 Connection Diagram of Test System

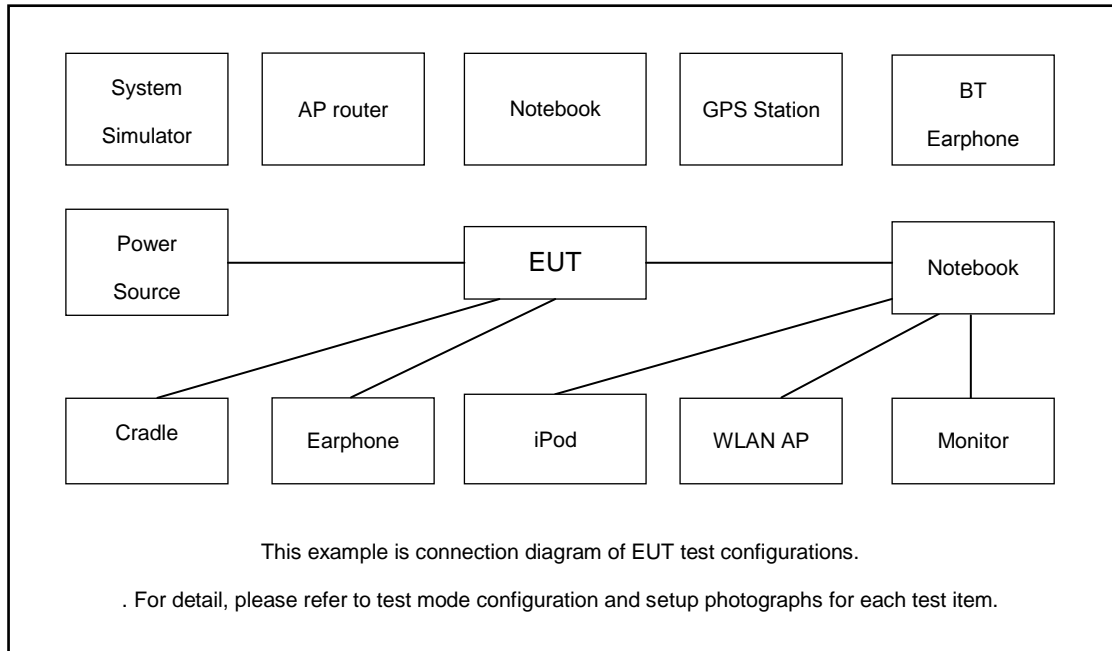

2.3 Support Unit used in test configuration

Item	Equipment	Trade Name	Model No.	FCC ID	Data Cable	Power Cord
1.	Power Supply	GWINSTEK	PSS-2002	N/A	N/A	Unshielded, 1.8 m
2.	LTE Base Station	Anritsu	MT8821C	N/A	N/A	Unshielded, 1.8 m

2.4 Measurement Results Explanation Example

For all conducted test items:

The offset level is set in the spectrum analyzer to compensate the RF cable loss and attenuator factor between EUT conducted output port and spectrum analyzer. With the offset compensation, the spectrum analyzer reading level is exactly the EUT RF output level.

The spectrum analyzer offset is derived from RF cable loss and attenuator factor.

$Offset = RF\ cable\ loss.$

Following shows an offset computation example with cable loss 8.52 dB.

Example :

$$Offset(dB) = RF\ cable\ loss(dB).$$

$$= 8.52\ (dB)$$



2.5 Frequency List of Low/Middle/High Channels

LTE Band 48 Channel and Frequency List				
BW [MHz]	Channel/Frequency(MHz)	Lowest	Middle	Highest
20	Channel	55340	55990	56640
	Frequency	3560.0	3625.0	3690.0
15	Channel	55315	55990	56665
	Frequency	3557.5	3625.0	3692.5
10	Channel	55290	55990	56690
	Frequency	3555.0	3625.0	3695.0
5	Channel	55265	55990	56715
	Frequency	3552.5	3625.0	3697.5

3 Conducted Test Items

3.1 Measuring Instruments

See list of measuring instruments of this test report.

3.1.1 Test Setup

3.1.2 Conducted Output Power

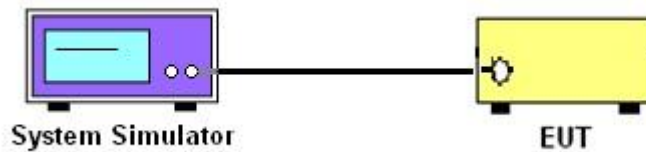

3.1.3 Occupied Bandwidth, Conducted Band-Edge and Conducted Spurious Emission

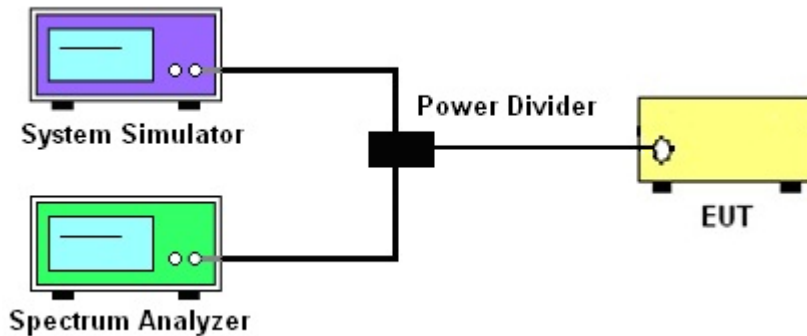

3.1.4 Frequency Stability

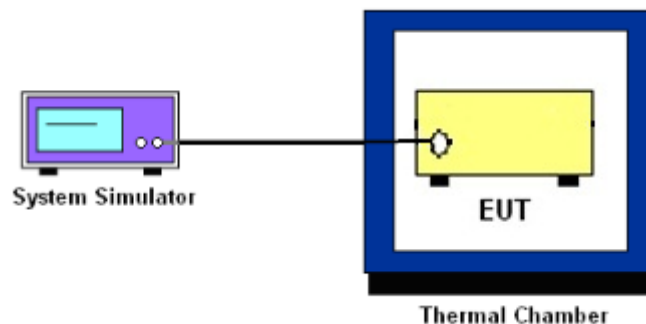

3.1.5 Test Result of Conducted Test

Please refer to Appendix A.



3.2 Conducted Output Power

3.2.1 Description of the Conducted Output Power Measurement

A system simulator was used to establish communication with the EUT. Its parameters were set to force the EUT transmitting at maximum output power. The measured power in the radio frequency on the transmitter output terminals shall be reported.

3.2.2 Test Procedures

1. The transmitter output port was connected to the system simulator.
2. Set EUT at maximum power through the system simulator.
3. Select lowest, middle, and highest channels for each band and different modulation.
4. Measure and record the power level from the system simulator.

3.3 EIRP

3.3.1 Description of the EIRP Measurement

EIRP limits for CBRS equipment as below table:

Device		Maximum EIRP (dBm/10 MHz)	Maximum PSD (dBm/MHz)
Applied	End User Device	23	n/a
<input type="checkbox"/>	Category A CBSD	30	20
<input type="checkbox"/>	Category B CBSD	47	37

Remark: The worst case EIRP shown in this section is found with LTE operating only using 1RB. As such, the EIRP/10MHz and full channel EIRP values will be identical since 1RB is fully contained within all available channel bandwidths for LTE Band 48 (i.e. 5, 10, 15, 20MHz)

3.3.2 Test Procedures for EIRP

1. Establishing a communications link with the call box (Base station) to measure the Maximum conducted power, the parameters were set to force the EUT transmitting at maximum output power level. Use the average power measurement function to measure total channel power of each channel bandwidth (per ANSI C63.26-2015 Section 5.2.1)
2. Determining ERP and/or EIRP from conducted RF output power measurements (Per ANSI C63.26-2015 Section 5.2.5.5)
 - EIRP = $P_T + G_T - L_C$, ERP = EIRP -2.15, where
 - P_T = transmitter output power in dBm
 - G_T = gain of the transmitting antenna in dBi
 - L_C = signal attenuation in the connecting cable between the transmitter and antenna in dB



3.4 Occupied Bandwidth

3.4.1 Description of Occupied Bandwidth Measurement

The occupied bandwidth is the width of a frequency band such that, below the lower and above the upper frequency limits, the mean powers emitted are each equal to a specified percentage 0.5% of the total mean transmitted power.

The 26 dB emission bandwidth is defined as the frequency range between two points, one above and one below the carrier frequency, at which the spectral density of the emission is attenuated 26 dB below the maximum in-band spectral density of the modulated signal. Spectral density (power per unit bandwidth) is to be measured with a detector of resolution bandwidth equal to approximately 1.0% of the emission bandwidth.

3.4.2 Test Procedures

The testing follows ANSI C63.26-2015 Section 5.4.3 (26dB) and Section 5.4.4 (99OB)

1. The EUT was connected to spectrum analyzer and system simulator via a power divider.
2. The spectrum analyzer center frequency is set to the nominal EUT channel center frequency. The span range for the spectrum analyzer shall be between two and five times the anticipated OBW.
3. The nominal resolution bandwidth (RBW) shall be in the range of 1 to 5 % of the anticipated OBW, and the VBW shall be at least 3 times the RBW.
4. Set the detection mode to peak, and the trace mode to max hold.
5. Determine the reference value: Set the EUT to transmit a modulated signal. Allow the trace to stabilize. Set the spectrum analyzer marker to the highest level of the displayed trace.
(this is the reference value)
6. Determine the “-26 dB down amplitude” as equal to (Reference Value – X).
7. Place two markers, one at the lowest and the other at the highest frequency of the envelope of the spectral display such that each marker is at or slightly below the “-X dB down amplitude” determined in step 6. If a marker is below this “-X dB down amplitude” value it shall be placed as close as possible to this value. The OBW is the positive frequency difference between the two markers.
8. Use the 99 % power bandwidth function of the spectrum analyzer and report the measured bandwidth.



3.5 Conducted Band Edge

3.5.1 Description of Conducted Band Edge Measurement

Part 96.41 (e) (1) (i)

For CBSD the emission limits outside the fundamental are as follows:

Within 0 MHz to 10 MHz above and below the assigned channel ≤ -13 dBm/MHz

Greater than 10 MHz above and below the assigned channel ≤ -25 dBm/MHz

Part 96.41 (e) (1) (ii)

For End User Devices the emission limits outside the fundamental are as follows:

Within 0 MHz to B MHz above and below the assigned channel ≤ -13 dBm/MHz

Greater than B MHz above and below the assigned channel ≤ -25 dBm/MHz

where B is the bandwidth in megahertz of the assigned channel or multiple contiguous channels of the End User Device.

Notwithstanding the emission limits in this paragraph, the Adjacent Channel Leakage Ratio for End User Devices shall be at least 30 dB.

Part 96.41 (e) (2)

For CBSDs and End User Devices, the conducted power of emissions below 3540 MHz or above 3710 MHz shall not exceed -25 dBm/MHz, and the conducted power of emissions below 3530 MHz or above 3720 MHz shall not exceed -40 dBm/MHz

3.5.2 Test Procedures

The testing follows FCC KDB 971168 D01 v03r01 Section 6.1.

1. The EUT was connected to spectrum analyzer and system simulator via a power divider.
2. The band edges of low and high channels for the highest RF powers were measured.
3. Set RBW $\geq 1\%$ EBW in the 1MHz band immediately outside and adjacent to the band edge.
4. Beyond the 1 MHz band from the band edge, RBW=1MHz was used
5. Offset has included the duty factor for LTE Band 48. Duty factor $=10 \log (1/x)$, where x is the measured duty cycle.
6. Set spectrum analyzer with RMS detector.
7. The RF fundamental frequency should be excluded against the limit line in the operating frequency band.



3.6 Conducted Spurious Emission

3.6.1 Description of Conducted Spurious Emission Measurement

96.41 (e)(2)

The conducted power of any emissions below 3530 MHz or above 3720 MHz shall not exceed -40dBm/MHz.

3.6.2 Test Procedures

The testing follows FCC KDB 971168 D01 v03r01 Section 6.1.

1. The EUT was connected to spectrum analyzer and system simulator via a power divider.
2. The RF output of EUT was connected to the spectrum analyzer by RF cable and attenuator. The path loss was compensated to the results for each measurement.
3. The middle channel for the highest RF power within the transmitting frequency was measured.
4. The conducted spurious emission for the whole frequency range was taken.
5. Make the measurement with the spectrum analyzer's RBW = 1MHz, VBW = 3MHz.
6. Set spectrum analyzer with RMS detector.
7. Taking the record of maximum spurious emission.
8. The RF fundamental frequency should be excluded against the limit line in the operating frequency band.
9. The limit line is -40dBm/MHz.

3.7 Frequency Stability

3.7.1 Description of Frequency Stability Measurement

The frequency stability shall be measured by variation of ambient temperature and variation of primary supply voltage to ensure that the fundamental emission stays within the authorized frequency block. The frequency stability of the transmitter shall be maintained within $\pm 0.00025\%$ ($\pm 2.5\text{ppm}$) of the center frequency

3.7.2 Test Procedures for Temperature Variation

The testing follows FCC KDB 971168 D01 v03r01 Section 9.0.

1. The EUT was set up in the thermal chamber and connected with the system simulator.
2. With power OFF, the temperature was decreased to -30°C and the EUT was stabilized before testing. Power was applied and the maximum change in frequency was recorded within one minute.
3. With power OFF, the temperature was raised in 10°C step up to 50°C . The EUT was stabilized at each step for at least half an hour. Power was applied and the maximum frequency change was recorded within one minute.

3.7.3 Test Procedures for Voltage Variation

The testing follows FCC KDB 971168 D01 v03r01 Section 9.0.

1. The EUT was placed in a temperature chamber at $25\pm 5^{\circ}\text{C}$ and connected with the system simulator.
2. The power supply voltage to the EUT was varied from 85% to 115% of the nominal value measured at the input to the EUT.
3. The variation in frequency was measured for the worst case.

4 Radiated Test Items

4.1 Measuring Instruments

See list of measuring instruments of this test report.

4.2 Test Setup

For radiated emissions from 30MHz to 1GHz

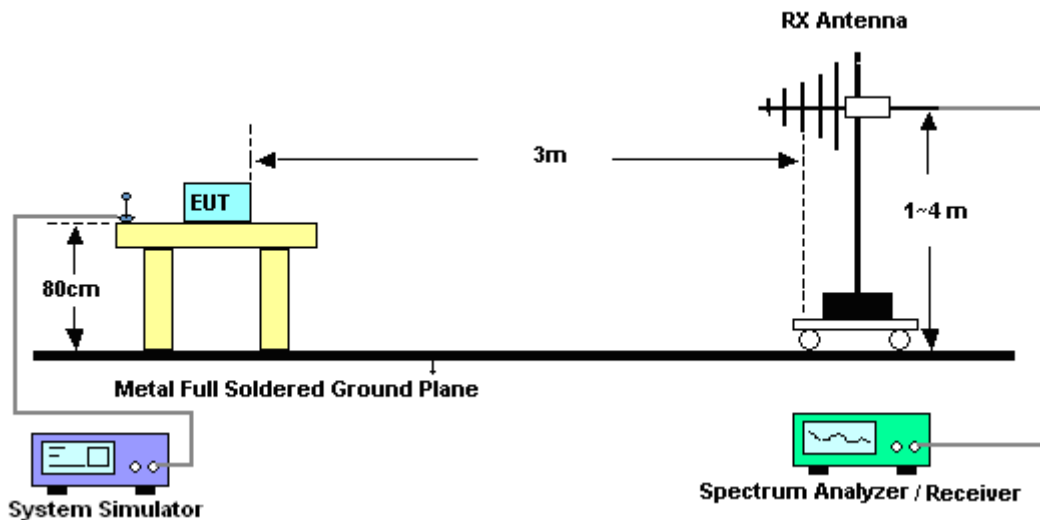

For radiated emissions above 1GHz

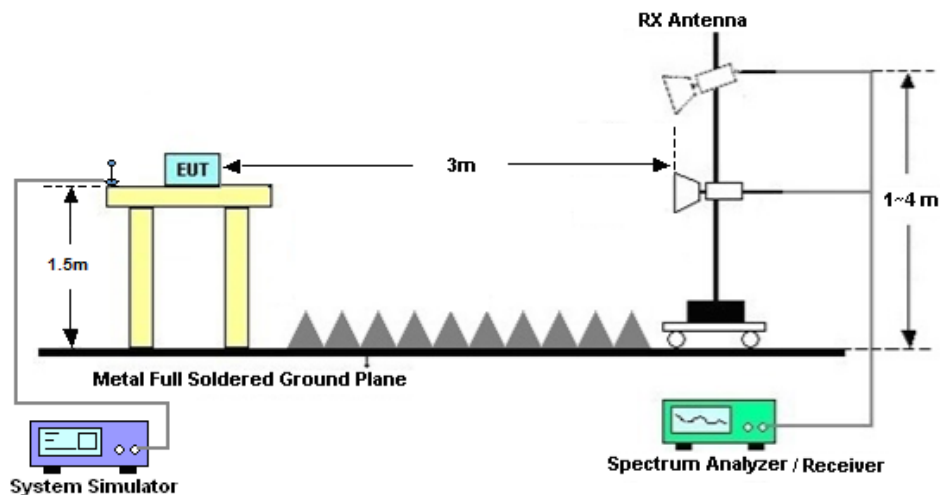

4.3 Test Result of Radiated Test

Please refer to Appendix B.



4.4 Radiated Spurious Emission

4.4.1 Description of Radiated Spurious Emission Measurement

The radiated spurious emission was measured by substitution method according to ANSI / TIA-603-E. The power of any emission outside of the authorized operating frequency ranges must be attenuated below the transmitter power (P) by a factor of at least -40dBm / MHz. The spectrum is scanned from 30 MHz up to a frequency including its 10th harmonic.

4.4.2 Test Procedures

1. The EUT was placed on a turntable with 0.8 meter height for frequency below 1GHz and 1.5 meter height for frequency above 1GHz respectively above ground.
2. The EUT was set 3 meters from the receiving antenna mounted on the antenna tower.
3. The table was rotated 360 degrees to determine the position of the highest spurious emission.
4. The height of the receiving antenna is varied between 1m to 4m to search the maximum spurious emission for both horizontal and vertical polarizations.
5. During the measurement, the system simulator parameters were set to force the EUT transmitting at maximum output power.
6. Make the measurement with the spectrum analyzer's RBW = 1MHz, VBW = 3MHz, taking the record of maximum spurious emission.
7. A horn antenna was substituted in place of the EUT and was driven by a signal generator. Tune the output power of signal generator to the same emission level with EUT maximum spurious emission.
$$\text{EIRP (dBm)} = \text{S.G. Power} - \text{Tx Cable Loss} + \text{Tx Antenna Gain}$$
$$\text{ERP (dBm)} = \text{EIRP} - 2.15$$
8. The RF fundamental frequency should be excluded against the limit line in the operating frequency band.
The limit line is -40dBm/MHz



5 List of Measuring Equipment

Instrument	Manufacturer	Model No.	Serial No.	Characteristics	Calibration Date	Test Date	Due Date	Remark
Spectrum Analyzer	R&S	FSV40	101040	10Hz~40GHz	Nov. 01, 2020	Jan. 07, 2021~ Jan. 13, 2021	Oct. 31, 2021	Conducted (TH01-KS)
Thermal Chamber	Ten Billion	TTC-B3S	TBN-9605 02	-40~+150°C	Oct. 27, 2020	Jan. 07, 2021~ Jan. 13, 2021	Oct. 26, 2021	Conducted (TH01-KS)
EXA Spectrum Analyzer	Keysight	N9010A	MY551502 44	10Hz~44G,MAX 30dB	Apr. 15, 2020	Jan. 05, 2021	Apr. 14, 2021	Radiation (03CH04-KS)
Bilog Antenna	TeseQ	CBL6111D	49922	30MHz-1GHz	Dec. 29, 2020	Jan. 05, 2021	Dec. 28, 2021	Radiation (03CH04-KS)
Double Ridge Horn Antenna	ETS-Lindgren	3117	218642	1GHz~18GHz	Dec. 29, 2020	Jan. 05, 2021	Dec. 28, 2021	Radiation (03CH04-KS)
SHF-EHF Horn	Com-power	AH-840	101070	18GHz~40GHz	Dec. 29, 2020	Jan. 05, 2021	Dec. 28, 2021	Radiation (03CH04-KS)
Amplifier	MITEQ	AMF-7D-0010 1800-30-10P	2025788	1Ghz-18Ghz	Dec. 26, 2020	Jan. 05, 2021	Dec. 25, 2021	Radiation (03CH04-KS)
Amplifier	Burgeon	BPA-530	102219	0.01MHz ~3000MHz	Dec. 29, 2020	Jan. 05, 2021	Dec. 28, 2021	Radiation (03CH04-KS)
Amplifier	Agilent	8449B	MV532703 16	1GHz~26.5GHz >23dB	Dec. 27, 2020	Jan. 05, 2021	Dec. 26, 2021	Radiation (03CH04-KS)
Amplifier	MITEQ	TTA1840-35- HG	2014749	18~40GHz	Dec. 29, 2020	Jan. 05, 2021	Dec. 28, 2021	Radiation (03CH04-KS)
Turn Table	ChamPro	EM 1000-T	060762-T	0~360 degree	NCR	Jan. 05, 2021	NCR	Radiation (03CH04-KS)
Antenna Mast	ChamPro	EM 1000-A	060762-A	1 m~4 m	NCR	Jan. 05, 2021	NCR	Radiation (03CH04-KS)

NCR: No Calibration Required



6 Uncertainty of Evaluation

Uncertainty of Radiated Emission Measurement (30 MHz ~ 1000 MHz)

Measuring Uncertainty for a Level of Confidence of 95% ($U = 2Uc(y)$)	3.3dB
---	-------

Uncertainty of Radiated Emission Measurement (1 GHz ~ 18 GHz)

Measuring Uncertainty for a Level of Confidence of 95% ($U = 2Uc(y)$)	2.8dB
---	-------

Uncertainty of Radiated Emission Measurement (18 GHz ~ 40 GHz)

Measuring Uncertainty for a Level of Confidence of 95% ($U = 2Uc(y)$)	2.8dB
---	-------

Appendix A. Test Results of Conducted Test

Conducted Output Power(Average power)

BW [MHz]	Modulation	RB Size	RB Offset	Power Low Ch. / Freq.	Power Middle Ch. / Freq.	Power High Ch. / Freq.
Channel				55340	55990	56640
Frequency (MHz)				3560	3625	3690
20	QPSK	1	0	24.32	24.30	24.02
20	QPSK	1	49	24.11	24.10	23.81
20	QPSK	1	99	24.11	24.04	23.73
20	QPSK	50	0	23.34	23.24	23.02
20	QPSK	50	24	23.26	23.18	22.95
20	QPSK	50	50	23.21	23.09	22.86
20	QPSK	100	0	23.28	23.14	22.94
20	16QAM	1	0	23.39	23.37	23.10
20	16QAM	1	49	23.17	23.14	22.84
20	16QAM	1	99	23.18	23.09	22.81
20	16QAM	50	0	22.30	22.26	22.05
20	16QAM	50	24	22.28	22.21	21.99
20	16QAM	50	50	22.24	22.15	21.89
20	16QAM	100	0	22.27	22.18	21.99
20	64QAM	1	0	22.13	22.10	21.86
20	64QAM	1	49	21.91	21.91	21.61
20	64QAM	1	99	21.99	21.85	21.51
20	64QAM	50	0	21.32	21.29	21.05
20	64QAM	50	24	21.29	21.24	20.99
20	64QAM	50	50	21.23	21.14	20.90
20	64QAM	100	0	21.29	21.21	20.98
Channel				55315	55990	56665
Frequency (MHz)				3557.5	3625	3692.5
15	QPSK	1	0	24.26	24.24	23.96
15	QPSK	1	37	24.05	24.01	23.74
15	QPSK	1	74	24.09	23.96	23.63



15	QPSK	36	0	23.23	23.19	23.01
15	QPSK	36	20	23.18	23.09	22.95
15	QPSK	36	39	23.18	23.02	22.81
15	QPSK	75	0	23.24	23.10	22.87
15	16QAM	1	0	23.33	23.29	23.02
15	16QAM	1	37	23.08	23.05	22.81
15	16QAM	1	74	23.12	23.04	22.71
15	16QAM	36	0	22.26	22.21	21.95
15	16QAM	36	20	22.22	22.20	21.93
15	16QAM	36	39	22.16	22.06	21.79
15	16QAM	75	0	22.17	22.09	21.93
15	64QAM	1	0	22.13	22.04	21.81
15	64QAM	1	37	21.87	21.87	21.52
15	64QAM	1	74	21.94	21.84	21.50
15	64QAM	36	0	21.24	21.26	21.00
15	64QAM	36	20	21.29	21.16	20.99
15	64QAM	36	39	21.16	21.05	20.86
15	64QAM	75	0	21.20	21.14	20.96
Channel				55290	55990	56690
Frequency (MHz)				3555	3625	3695
10	QPSK	1	0	24.15	24.13	23.83
10	QPSK	1	25	24.04	24.04	23.75
10	QPSK	1	49	24.07	24.01	23.74
10	QPSK	25	0	23.20	23.23	22.93
10	QPSK	25	12	23.20	23.15	22.90
10	QPSK	25	25	23.18	23.09	22.86
10	QPSK	50	0	23.21	23.13	22.89
10	16QAM	1	0	23.26	23.24	22.95
10	16QAM	1	25	23.15	23.13	22.83
10	16QAM	1	49	23.15	23.07	22.82
10	16QAM	25	0	22.21	22.22	21.92
10	16QAM	25	12	22.22	22.16	21.93
10	16QAM	25	25	22.18	22.09	21.86
10	16QAM	50	0	22.22	22.16	21.92
10	64QAM	1	0	21.98	22.00	21.70
10	64QAM	1	25	21.87	21.88	21.59



10	64QAM	1	49	21.91	21.82	21.59
10	64QAM	25	0	21.28	21.30	21.00
10	64QAM	25	12	21.28	21.20	20.97
10	64QAM	25	25	21.24	21.13	20.91
10	64QAM	50	0	21.21	21.15	20.92
Channel				55265	55990	56715
Frequency (MHz)				3552.5	3625	3697.5
5	QPSK	1	0	24.30	24.21	23.93
5	QPSK	1	12	24.08	24.05	23.77
5	QPSK	1	24	24.01	24.00	23.65
5	QPSK	12	0	23.24	23.22	23.01
5	QPSK	12	7	23.23	23.10	22.95
5	QPSK	12	13	23.13	22.99	22.80
5	QPSK	25	0	23.15	23.14	22.85
5	16QAM	1	0	23.39	23.33	23.01
5	16QAM	1	12	23.17	23.13	22.83
5	16QAM	1	24	23.08	23.08	22.80
5	16QAM	12	0	22.22	22.25	22.01
5	16QAM	12	7	22.20	22.11	21.89
5	16QAM	12	13	22.21	22.11	21.82
5	16QAM	25	0	22.17	22.13	21.92
5	64QAM	1	0	22.05	22.09	21.78
5	64QAM	1	12	21.90	21.90	21.57
5	64QAM	1	24	21.96	21.83	21.50
5	64QAM	12	0	21.31	21.29	20.97
5	64QAM	12	7	21.28	21.19	20.90
5	64QAM	12	13	21.22	21.14	20.81
5	64QAM	25	0	21.28	21.17	20.97



EIRP

LTE Band 48 (GT - LC = -1.90 dB) QPSK									
Bandwidth	5M			10M			15M		
Channel	55265	55990	56715	55290	55990	56690	55315	55990	56665
	(Low)	(Mid)	(High)	(Low)	(Mid)	(High)	(Low)	(Mid)	(High)
Frequency (MHz)	3552.5	3625	3697.5	3555	3625	3695	3557.5	3625	3692.5
Conducted Power (dBm)	24.30	24.21	23.93	24.15	24.13	23.83	24.26	24.24	23.96
Conducted Power (Watts)	0.2692	0.2636	0.2472	0.2600	0.2588	0.2415	0.2667	0.2655	0.2489
ERP(dBm)	22.40	22.31	22.03	22.25	22.23	21.93	22.36	22.34	22.06
ERP(Watts)	0.1738	0.1702	0.1596	0.1679	0.1671	0.1560	0.1722	0.1714	0.1607

LTE Band 48 (GT - LC = -1.90 dB) QPSK			
Bandwidth	20M		
Channel	55340	55990	56640
	(Low)	(Mid)	(High)
Frequency (MHz)	3560	3625	3690
Conducted Power (dBm)	24.32	24.30	24.02
Conducted Power (Watts)	0.2704	0.2692	0.2523
ERP(dBm)	22.42	22.40	22.12
ERP(Watts)	0.1746	0.1738	0.1629



LTE Band 48 (GT - LC = -1.90 dB) 16QAM									
Bandwidth	5M			10M			15M		
Channel	55265	55990	56715	55290	55990	56690	55315	55990	56665
	(Low)	(Mid)	(High)	(Low)	(Mid)	(High)	(Low)	(Mid)	(High)
Frequency (MHz)	3552.5	3625	3697.5	3555	3625	3695	3557.5	3625	3692.5
Conducted Power (dBm)	23.39	23.33	23.01	23.26	23.24	22.95	23.33	23.29	23.02
Conducted Power (Watts)	0.2183	0.2153	0.2000	0.2118	0.2109	0.1972	0.2153	0.2133	0.2004
ERP(dBm)	21.49	21.43	21.11	21.36	21.34	21.05	21.43	21.39	21.12
ERP(Watts)	0.1409	0.1390	0.1291	0.1368	0.1361	0.1274	0.1390	0.1377	0.1294

LTE Band 48 (GT - LC = -1.90 dB) 16QAM			
Bandwidth	20M		
Channel	55340	55990	56640
	(Low)	(Mid)	(High)
Frequency (MHz)	3560	3625	3690
Conducted Power (dBm)	23.39	23.37	23.10
Conducted Power (Watts)	0.2183	0.2173	0.2042
ERP(dBm)	21.49	21.47	21.20
ERP(Watts)	0.1409	0.1403	0.1318



LTE Band 48 (GT - LC = -1.90 dB) 64QAM									
Bandwidth	5M			10M			15M		
Channel	55265	55990	56715	55290	55990	56690	55315	55990	56665
	(Low)	(Mid)	(High)	(Low)	(Mid)	(High)	(Low)	(Mid)	(High)
Frequency (MHz)	3552.5	3625	3697.5	3555	3625	3695	3557.5	3625	3692.5
Conducted Power (dBm)	22.05	22.09	21.78	21.98	22.00	21.70	22.13	22.04	21.81
Conducted Power (Watts)	0.1603	0.1618	0.1507	0.1578	0.1585	0.1479	0.1633	0.1600	0.1517
ERP(dBm)	20.15	20.19	19.88	20.08	20.10	19.80	20.23	20.14	19.91
ERP(Watts)	0.1035	0.1045	0.0973	0.1019	0.1023	0.0955	0.1054	0.1033	0.0979

LTE Band 48 (GT - LC = -1.90 dB) 64QAM			
Bandwidth	20M		
Channel	55340	55990	56640
	(Low)	(Mid)	(High)
Frequency (MHz)	3560	3625	3690
Conducted Power (dBm)	22.13	22.10	21.86
Conducted Power (Watts)	0.1633	0.1622	0.1535
ERP(dBm)	20.23	20.20	19.96
ERP(Watts)	0.1054	0.1047	0.0991



LTE Band 48

ACLR

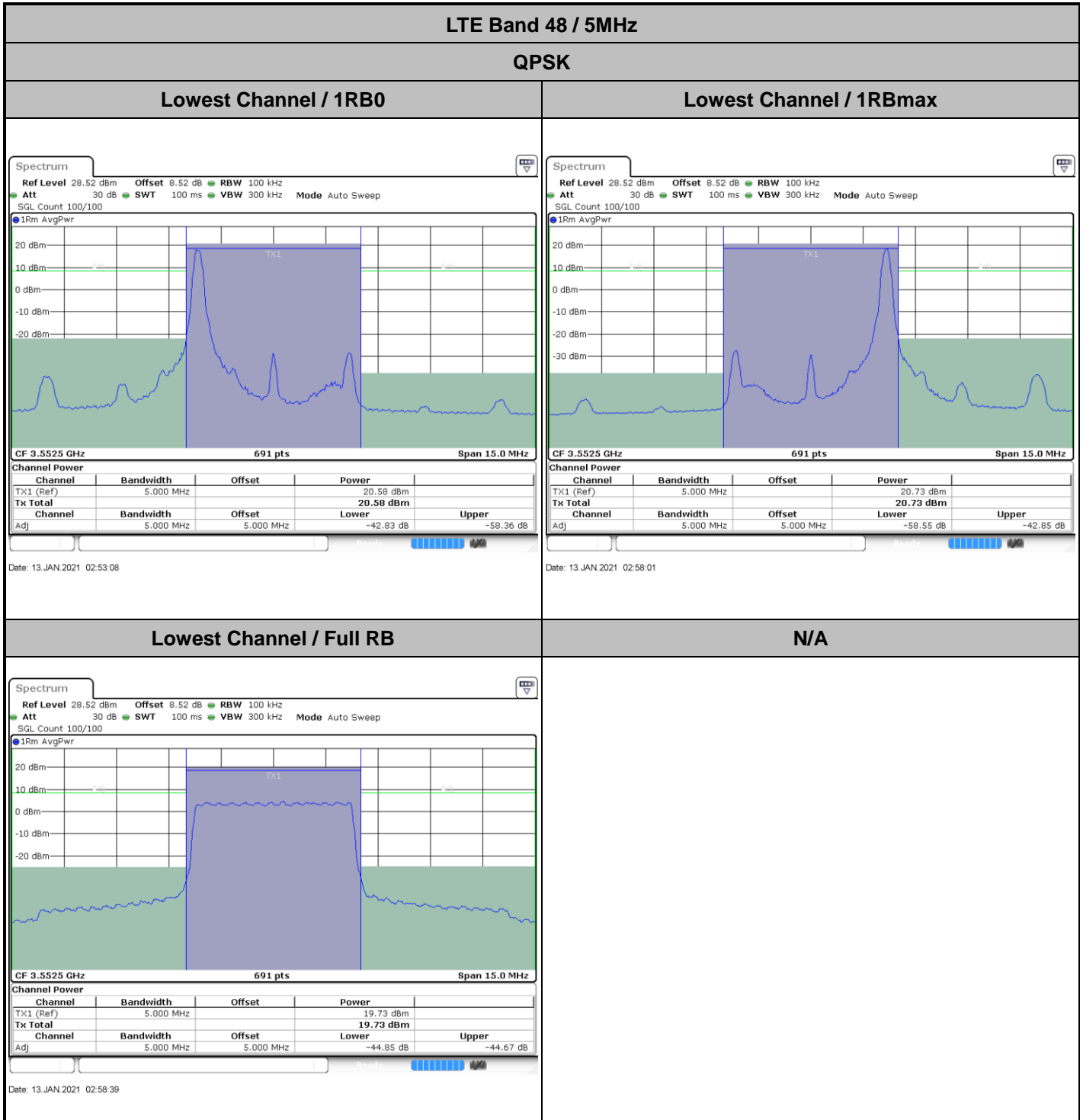

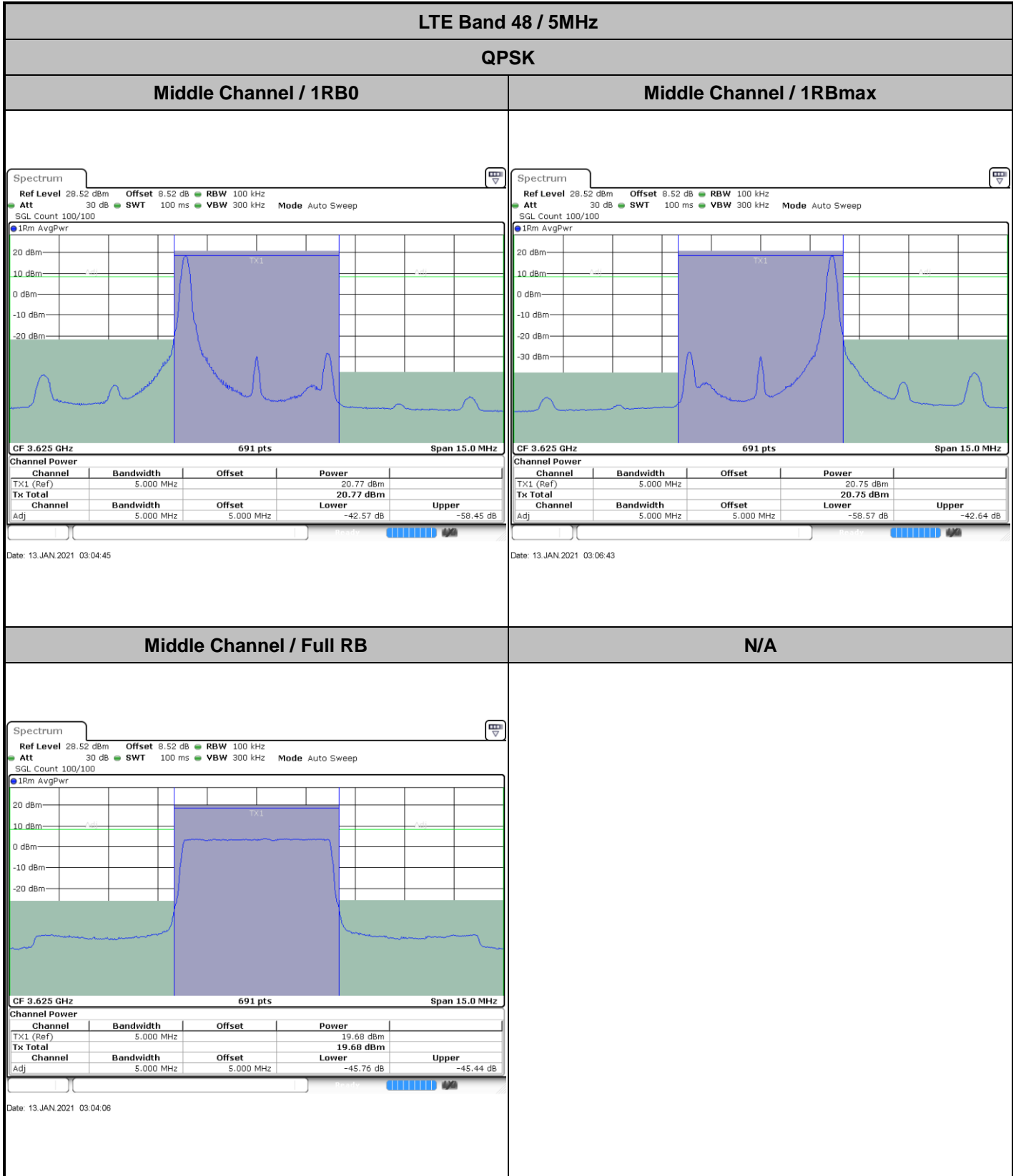

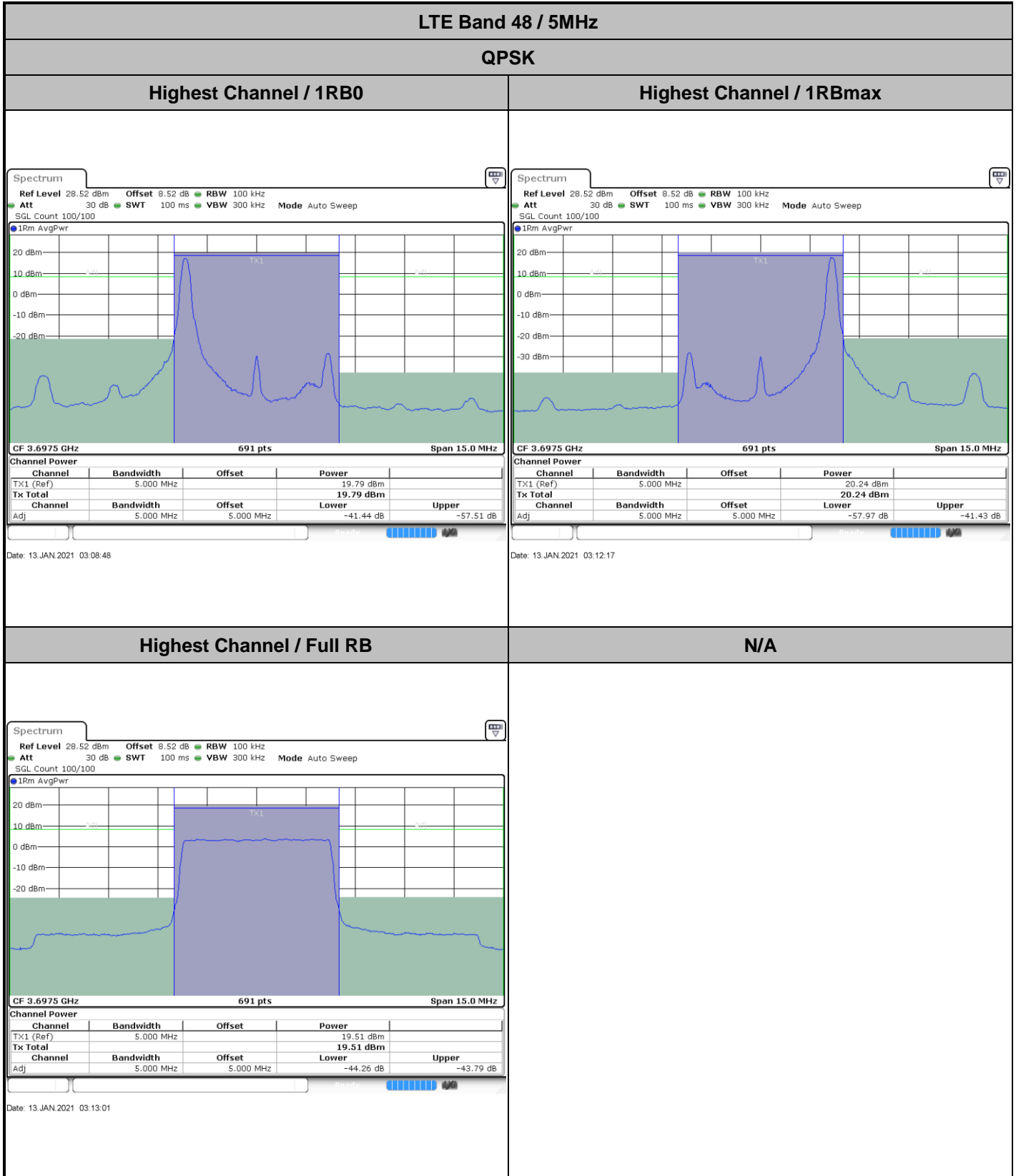

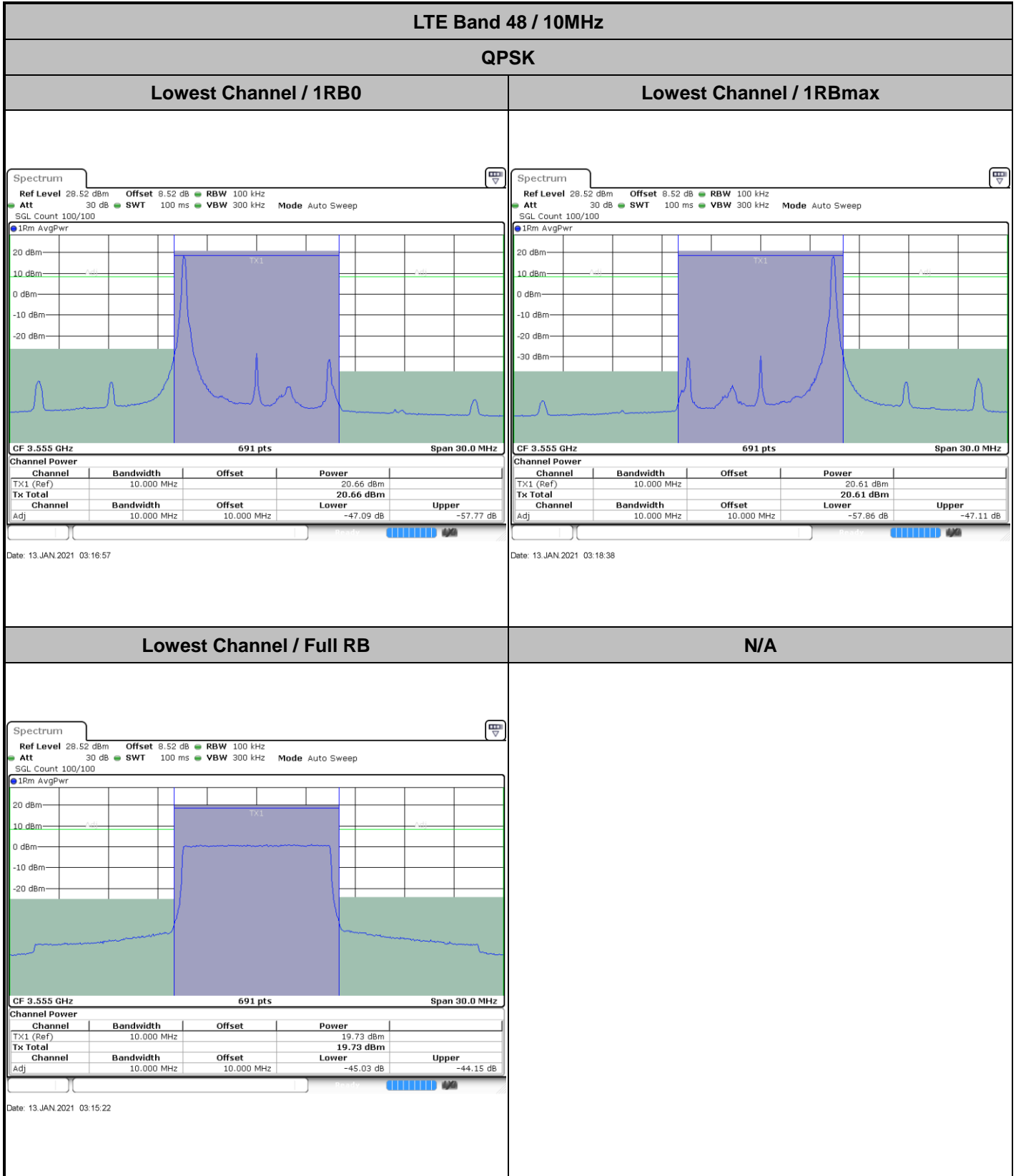



LTE Band 48 / 10MHz

QPSK

MiddleChannel / 1RB0

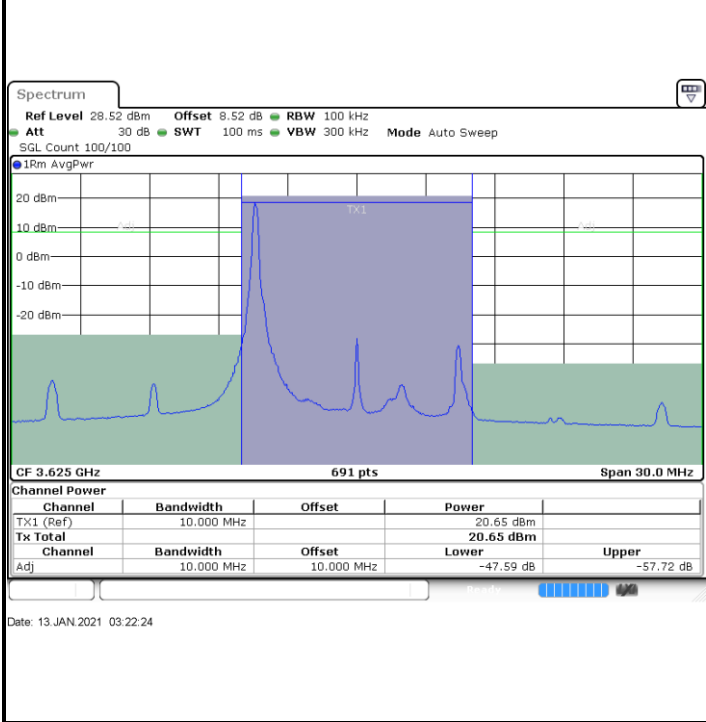

Middle Channel / 1RBmax

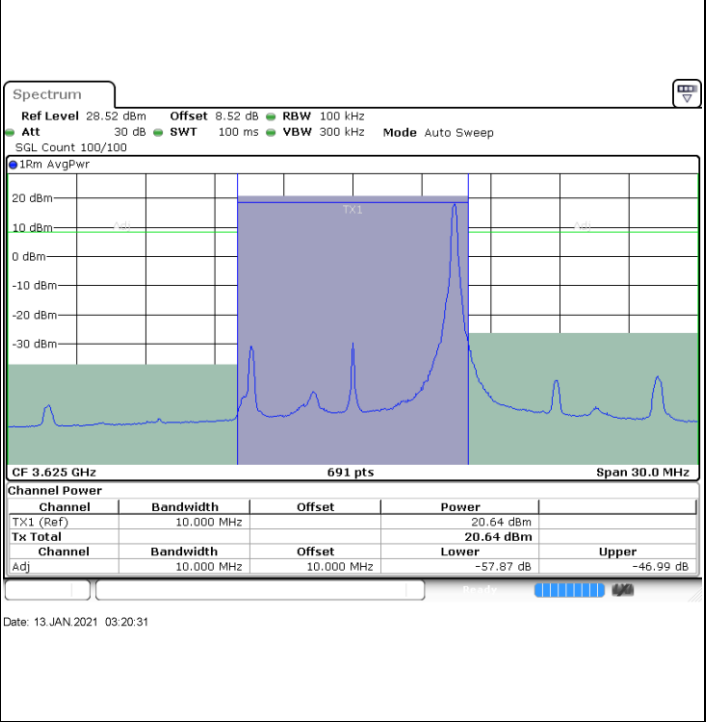

Middle Channel / Full RB

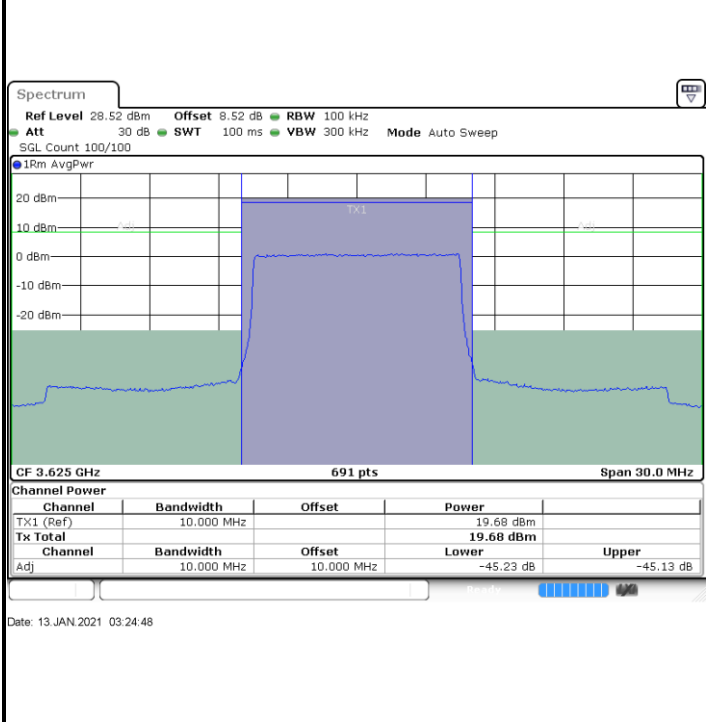

N/A

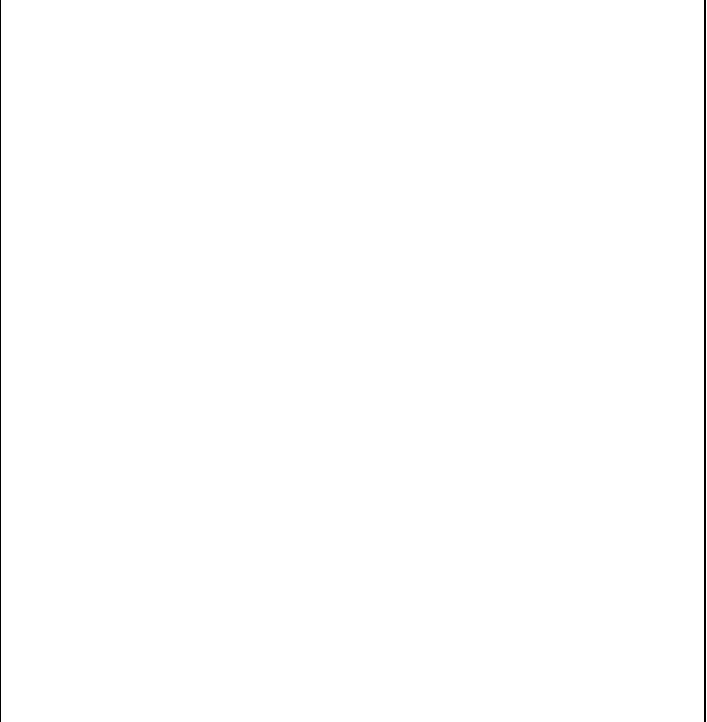



LTE Band 48 / 10MHz

QPSK

Highest Channel / 1RB0	Highest Channel / 1RBmax
-------------------------------	---------------------------------

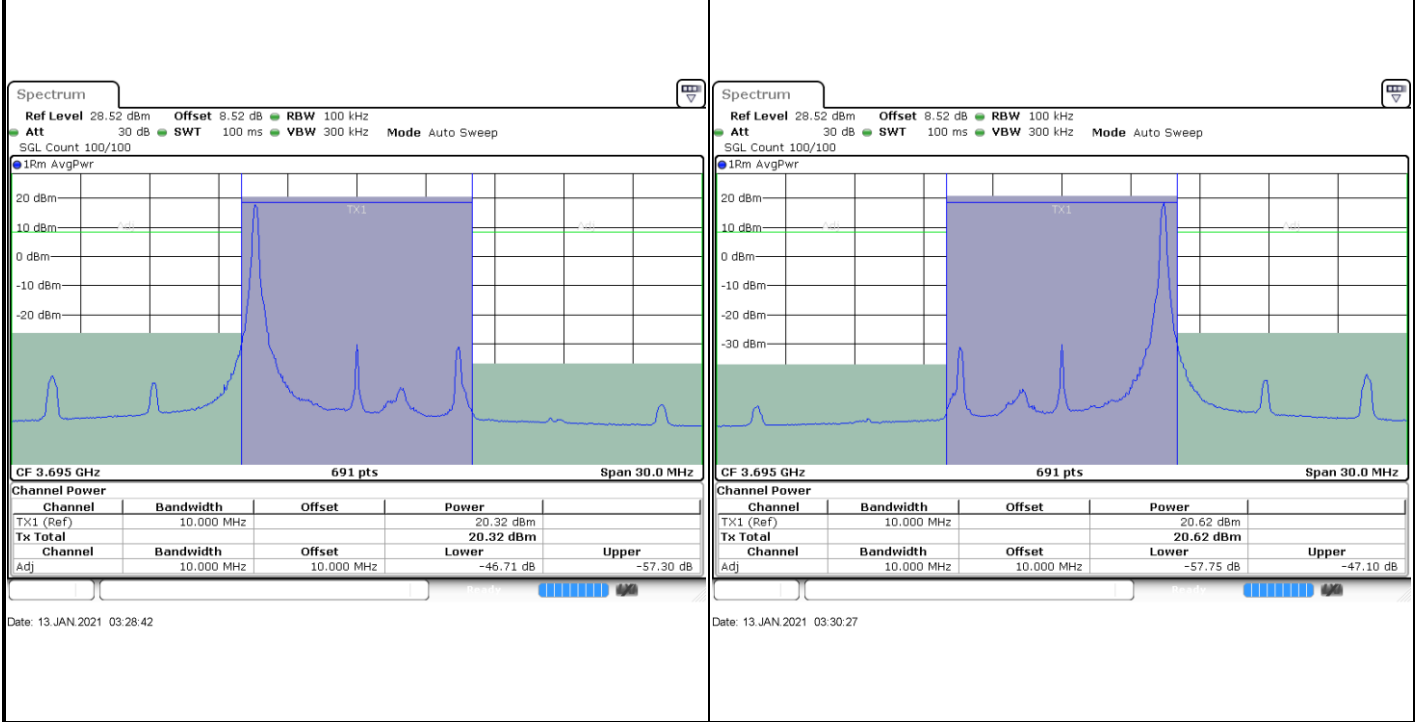

Highest Channel / Full RB	N/A
----------------------------------	------------

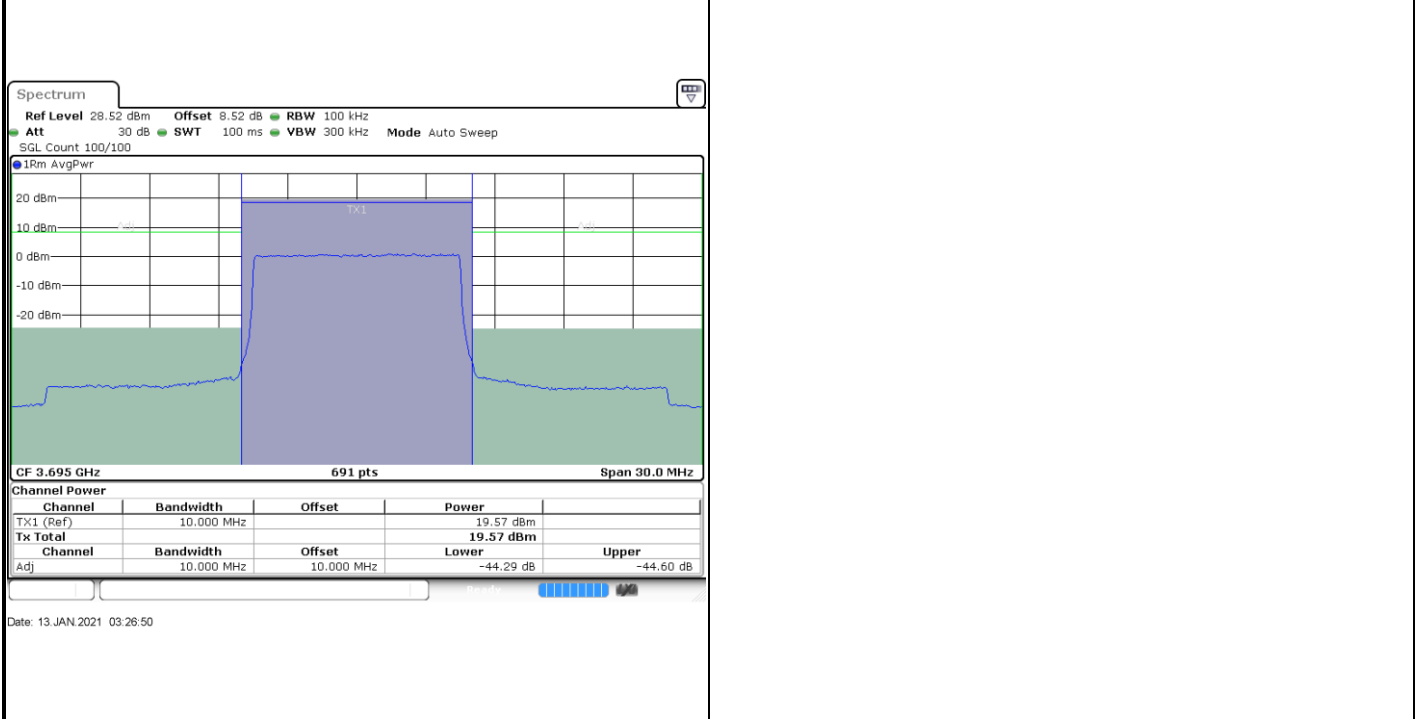



LTE Band 48 / 15MHz

QPSK

Lowest Channel / 1RB0

Lowest Channel / 1RBmax

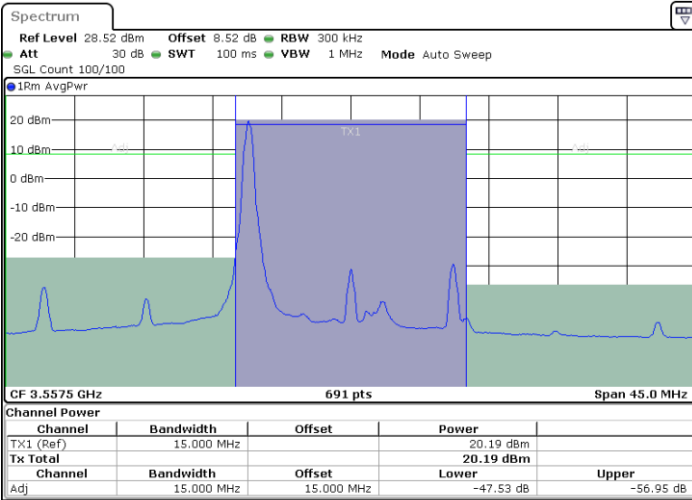

Date: 13 JAN 2021 03:36:01

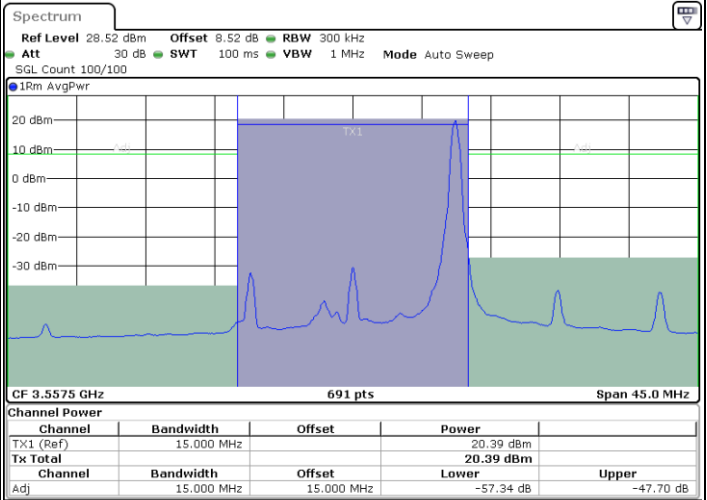

Date: 13 JAN 2021 03:37:55

Lowest Channel / Full RB

N/A

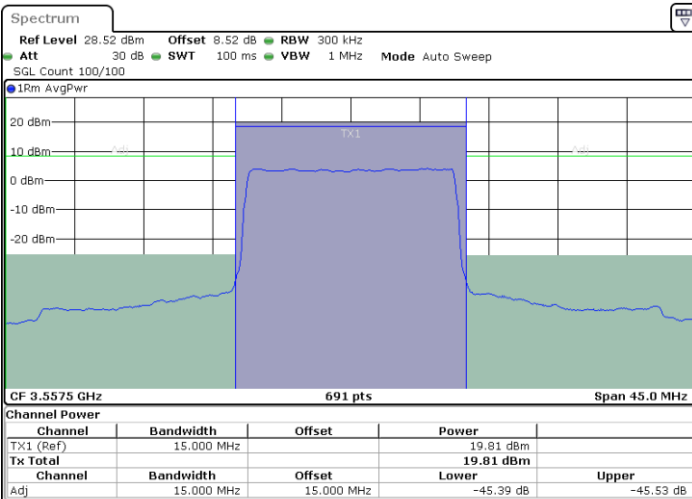

Date: 13 JAN 2021 03:33:35



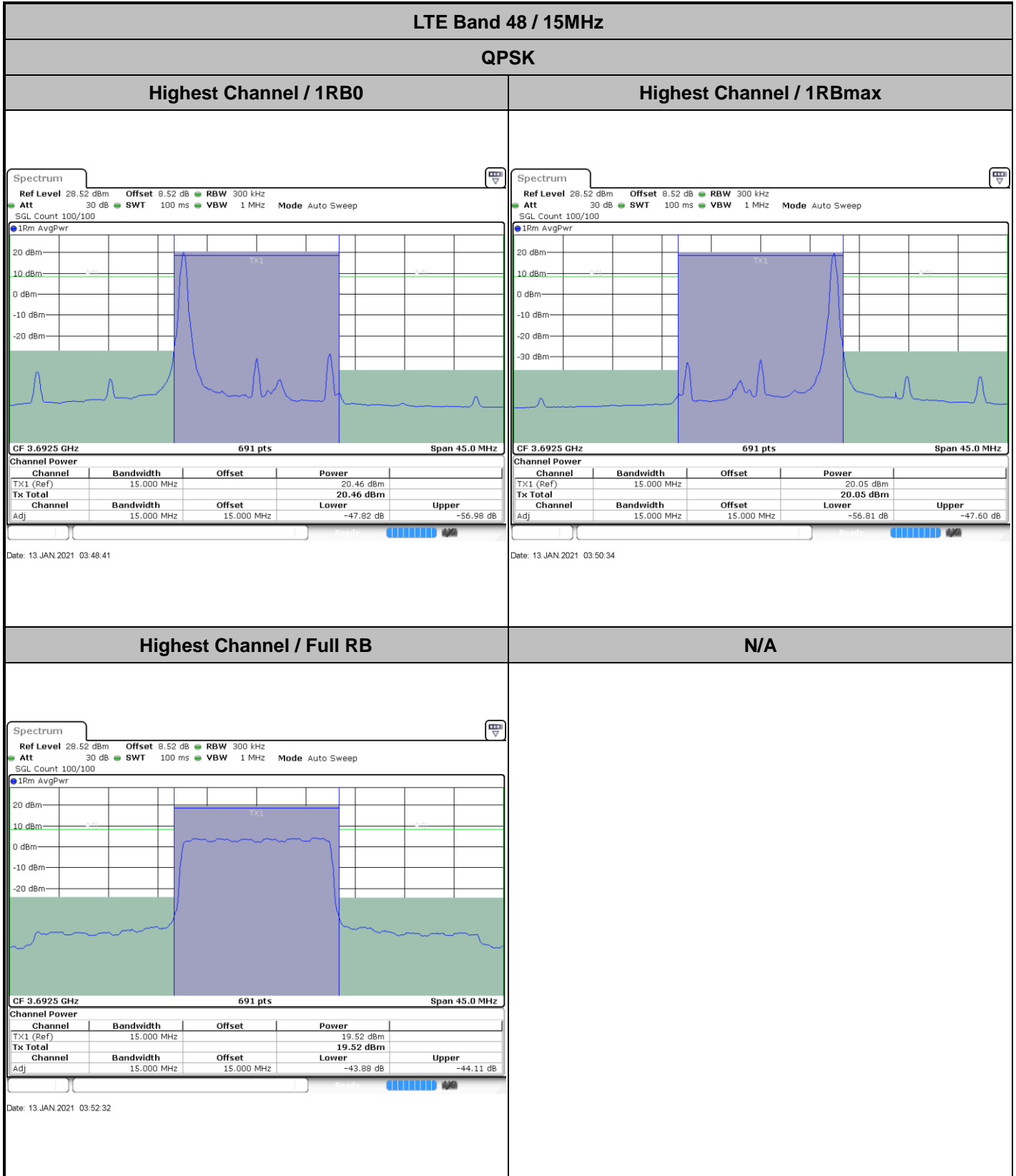



LTE Band 48 / 20MHz

QPSK

Lowest Channel / 1RB0

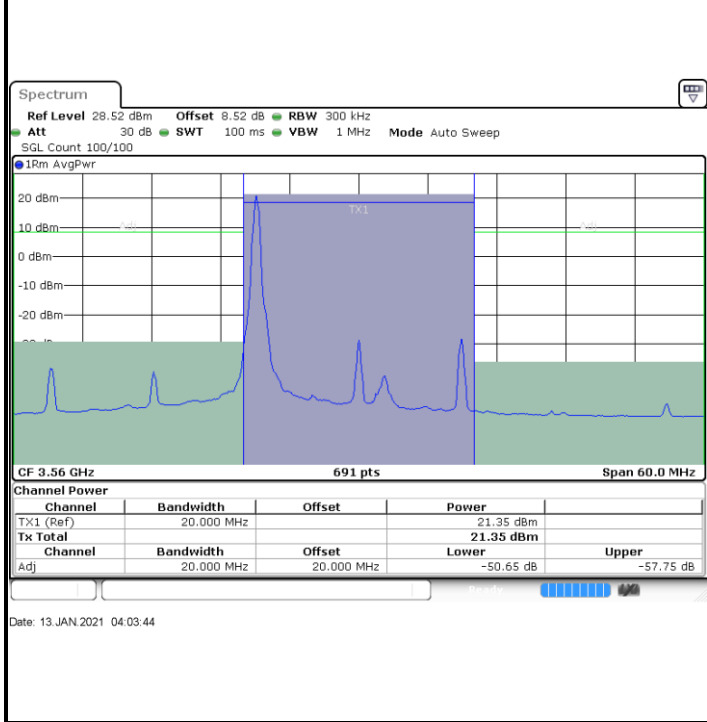

Lowest Channel / 1RBmax

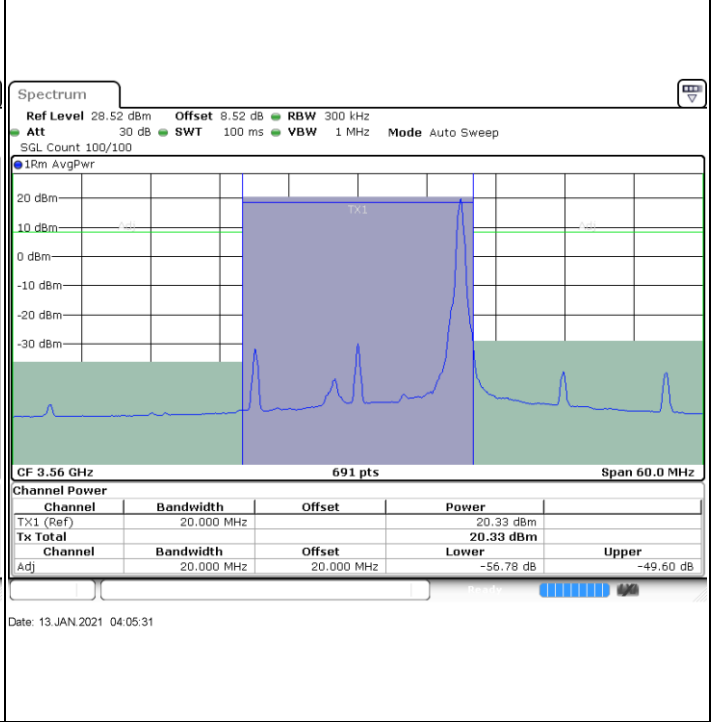

Lowest Channel / Full RB

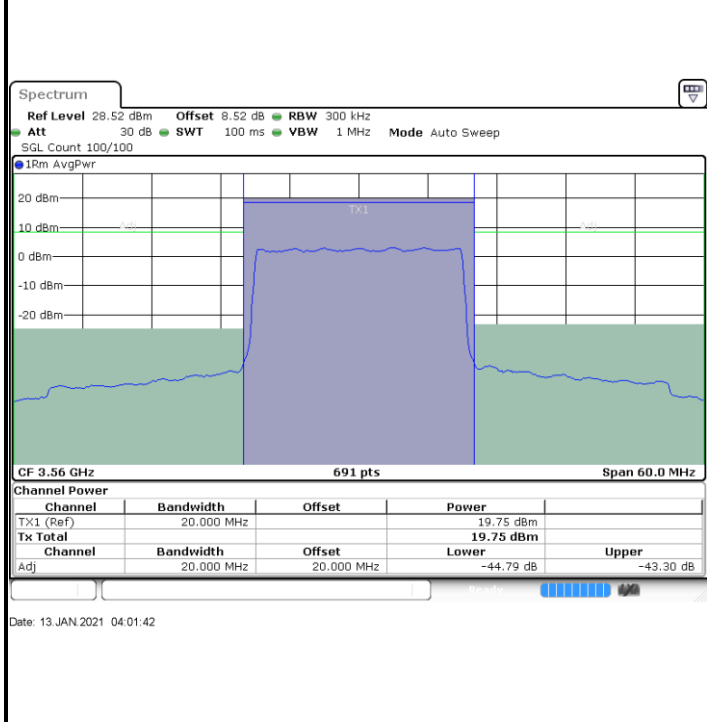

N/A





LTE Band 48 / 20MHz

QPSK

Highest Channel / 1RB0

Highest Channel / 1RBmax

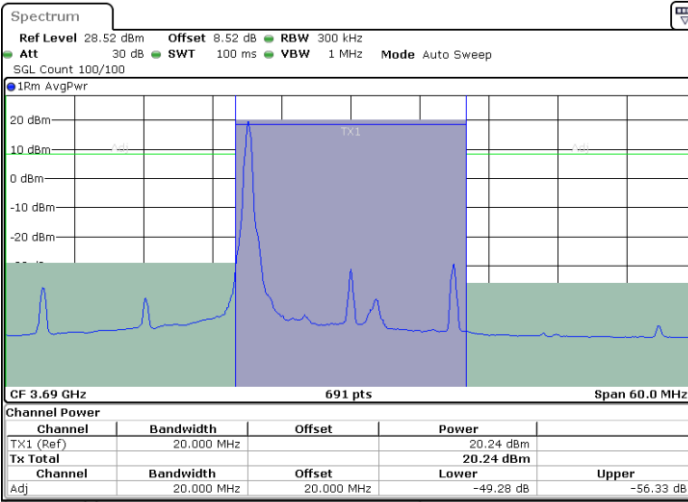

Date: 13 JAN 2021 04:14:00

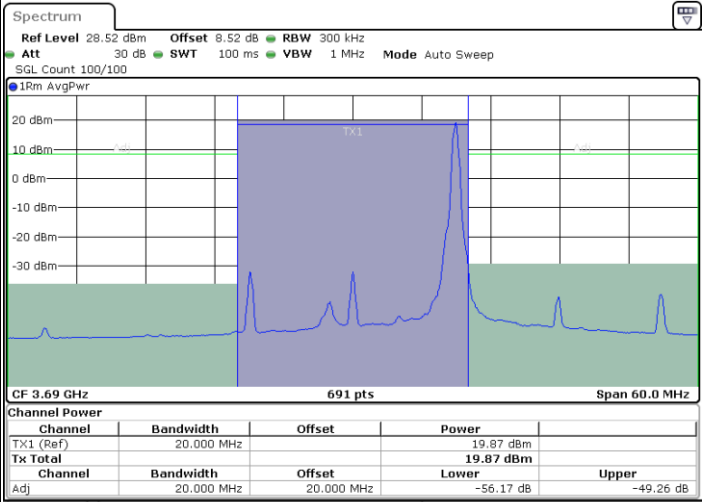

Date: 13 JAN 2021 04:15:52

Highest Channel / Full RB

N/A

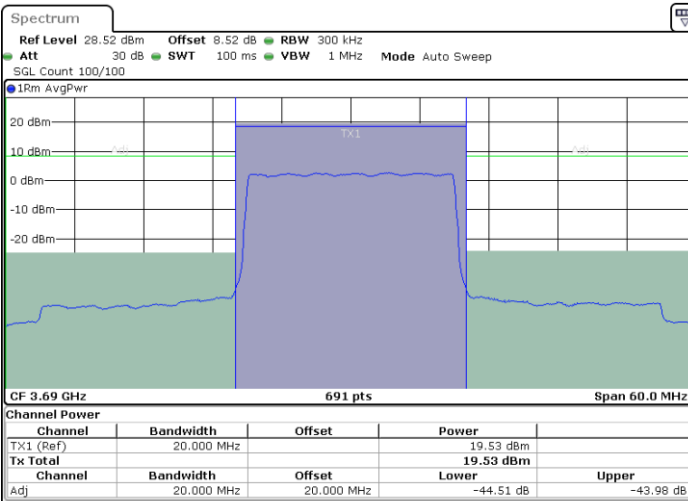

Date: 13 JAN 2021 04:12:16



LTE Band 48 / 5MHz

16QAM

Lowest Channel / 1RB0

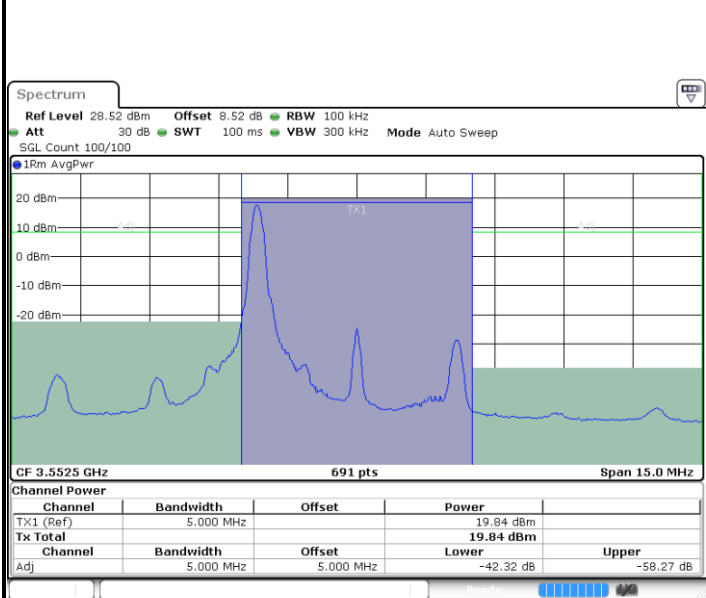

Date: 13 JAN 2021 02:54:52

Lowest Channel / 1RBmax

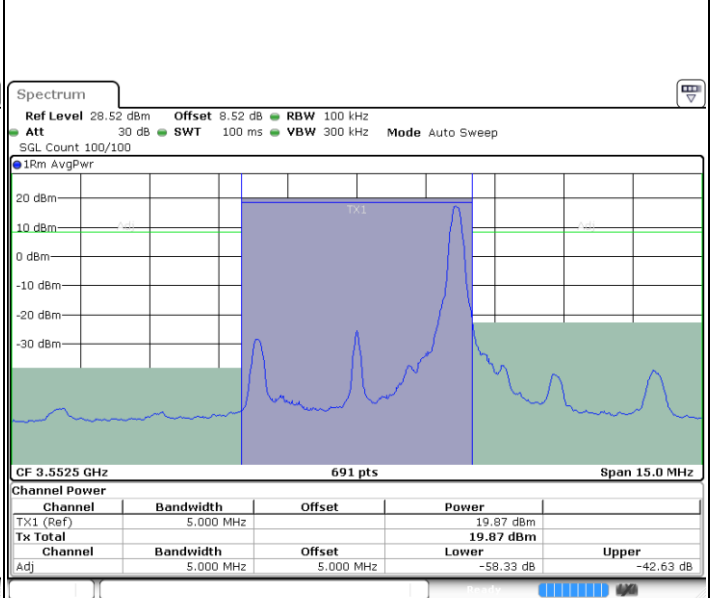

Date: 13 JAN 2021 02:57:19

Lowest Channel / Full RB

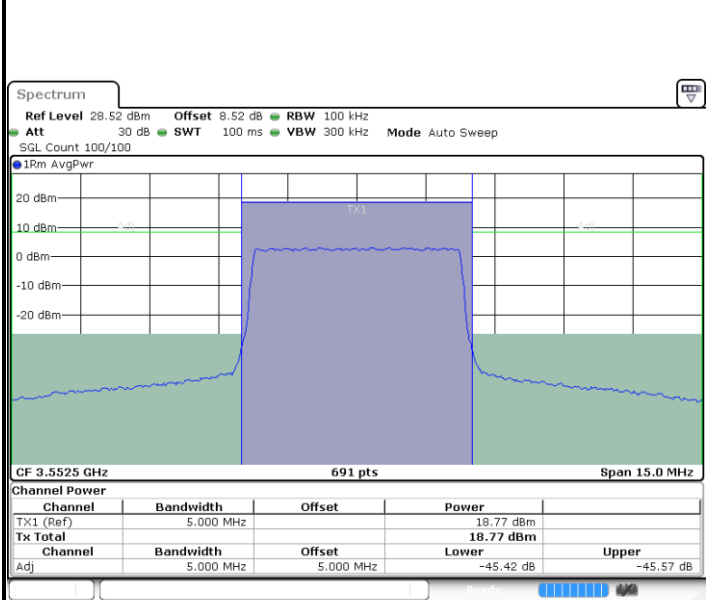

Date: 13 JAN 2021 03:00:13

N/A

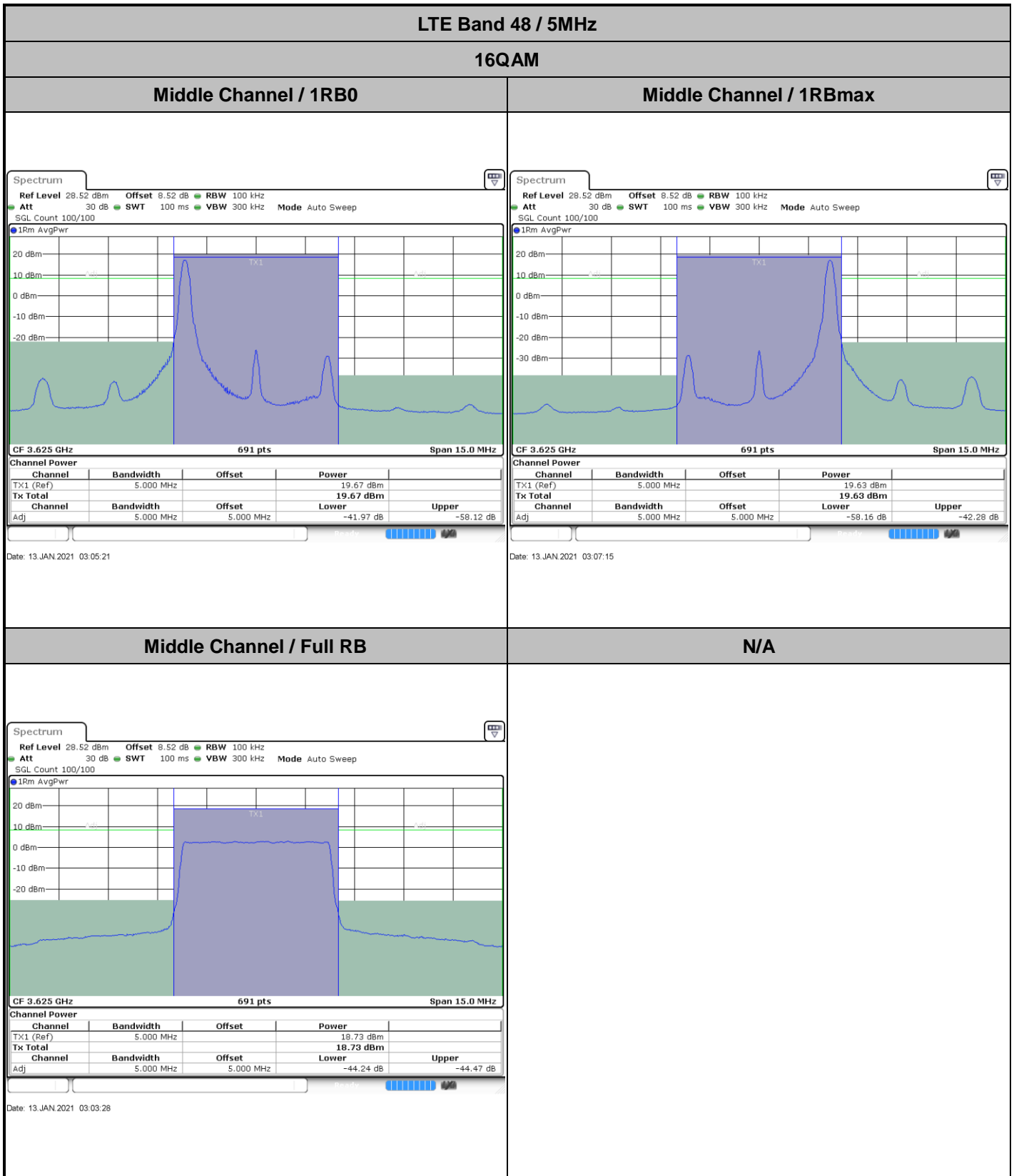



LTE Band 48 / 5MHz

16QAM

Highest Channel / 1RB0

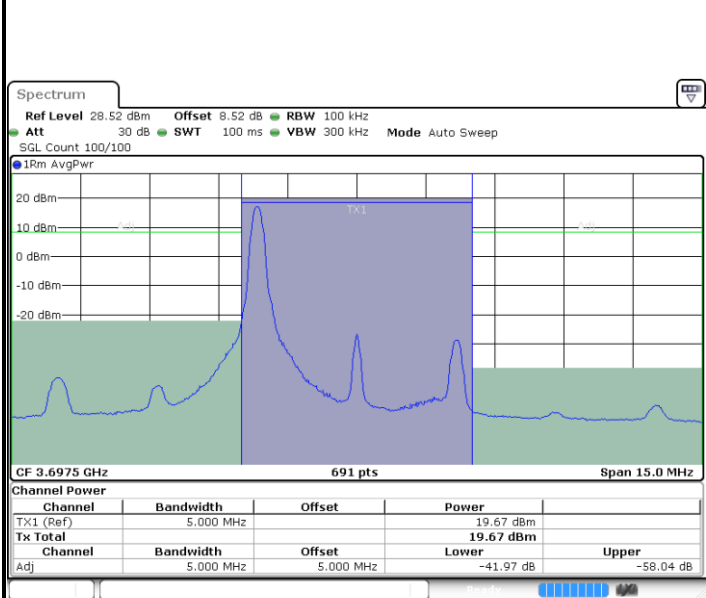

Date: 13 JAN 2021 03:09:31

Highest Channel / 1RBmax

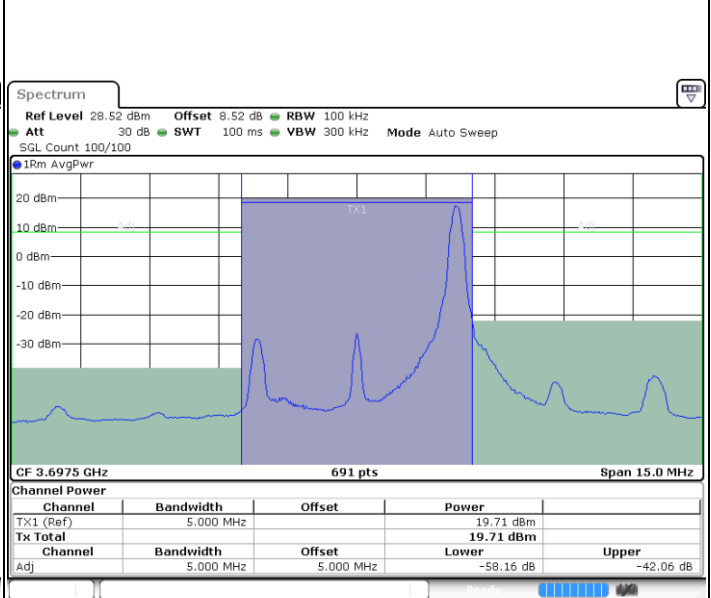

Date: 13 JAN 2021 03:11:39

Highest Channel / Full RB

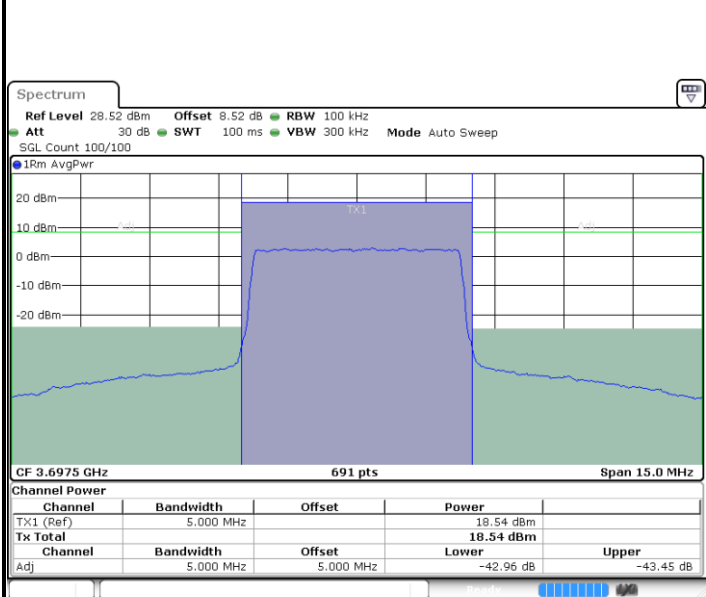

Date: 13 JAN 2021 03:13:32

N/A



LTE Band 48 / 10MHz

16QAM

Lowest Channel / 1RB0

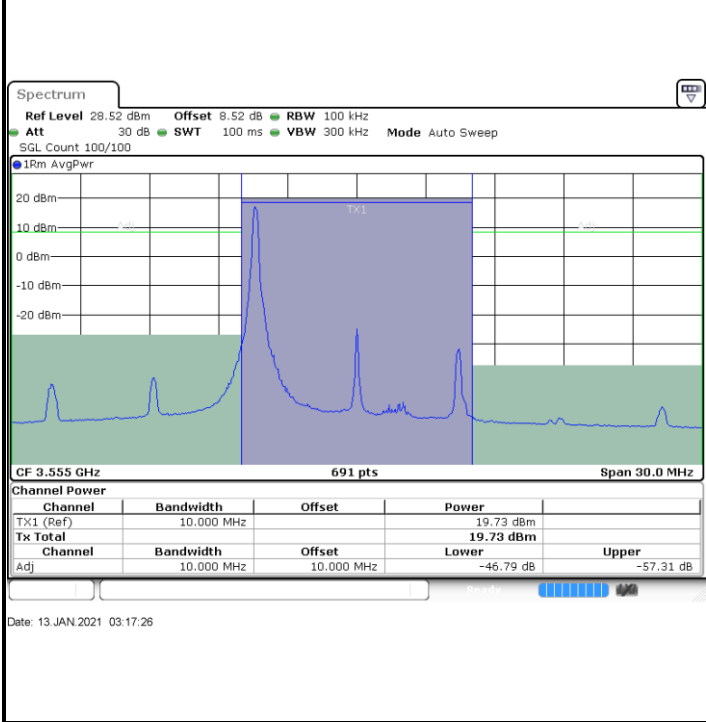

Lowest Channel / 1RBmax

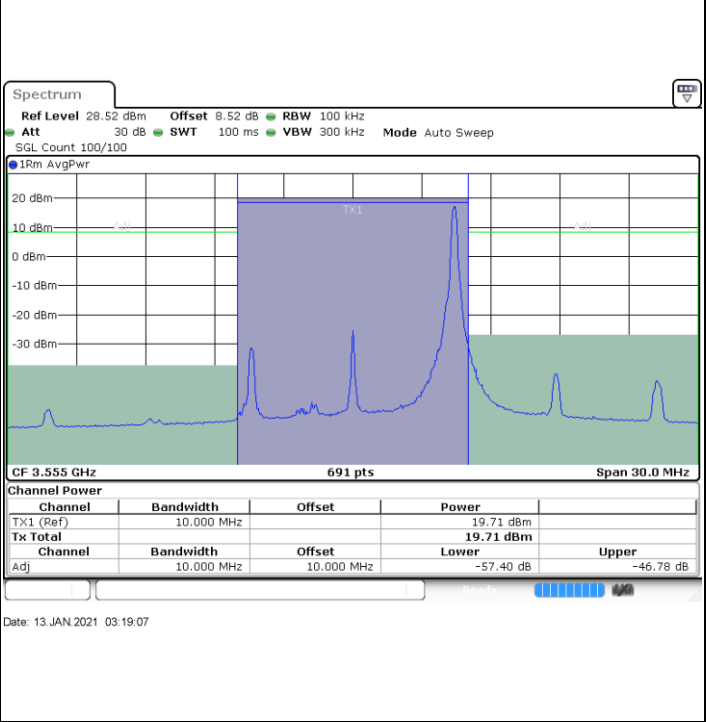

Lowest Channel / Full RB

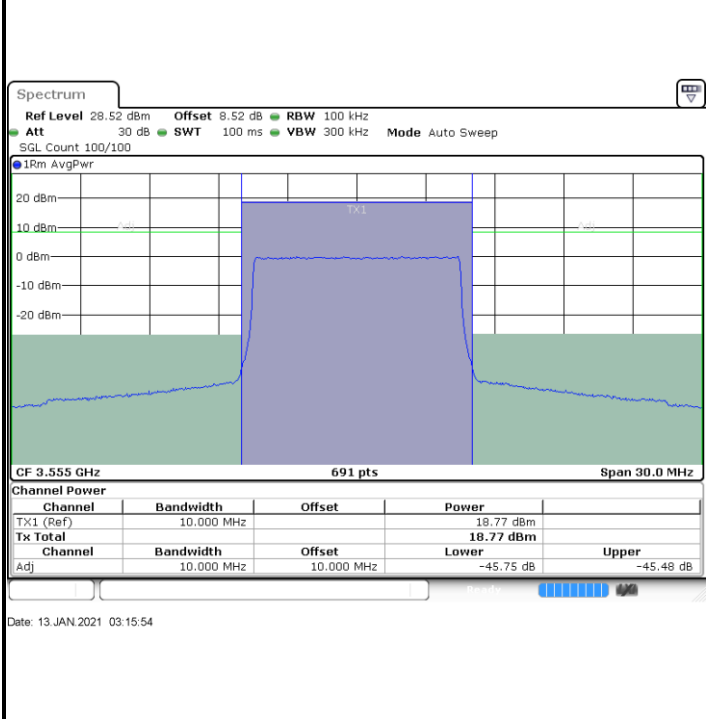

N/A



LTE Band 48 / 10MHz

16QAM

MiddleChannel / 1RB0

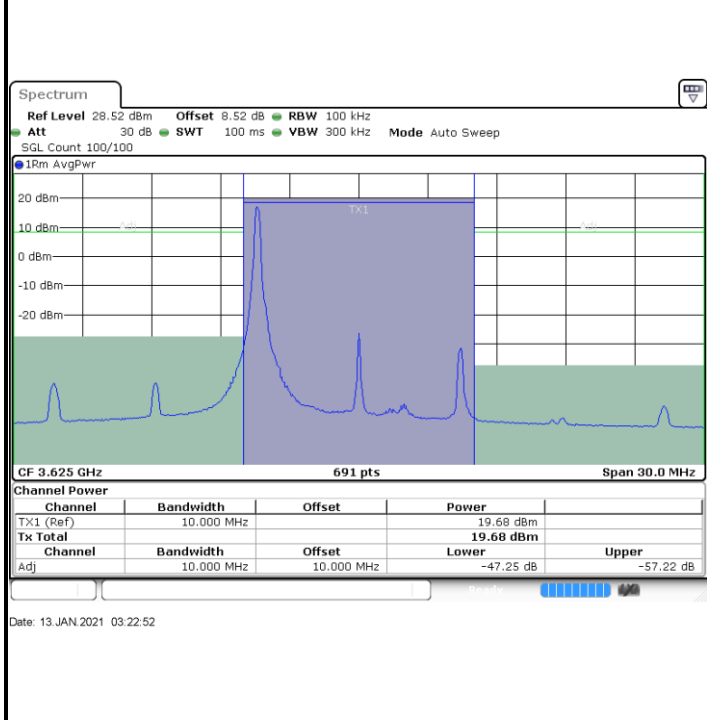

Middle Channel / 1RBmax

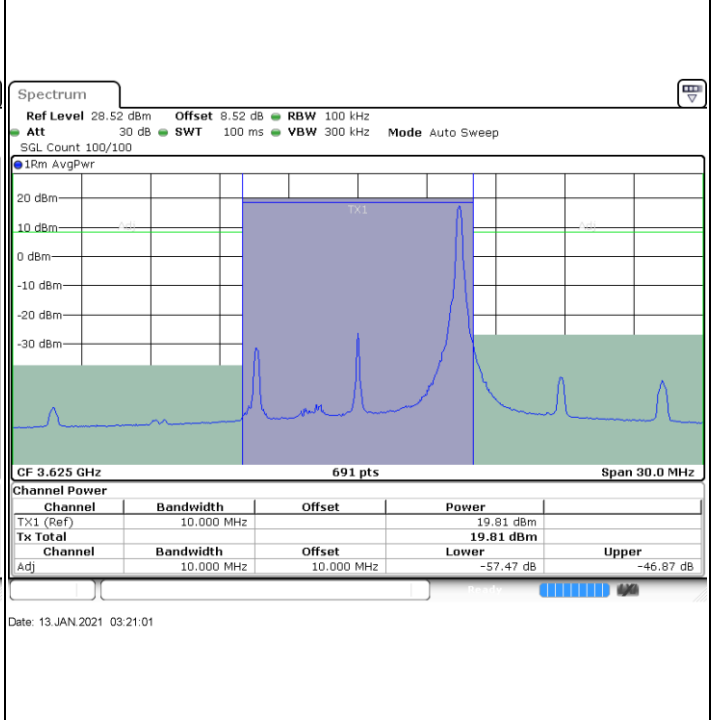

Middle Channel / Full RB

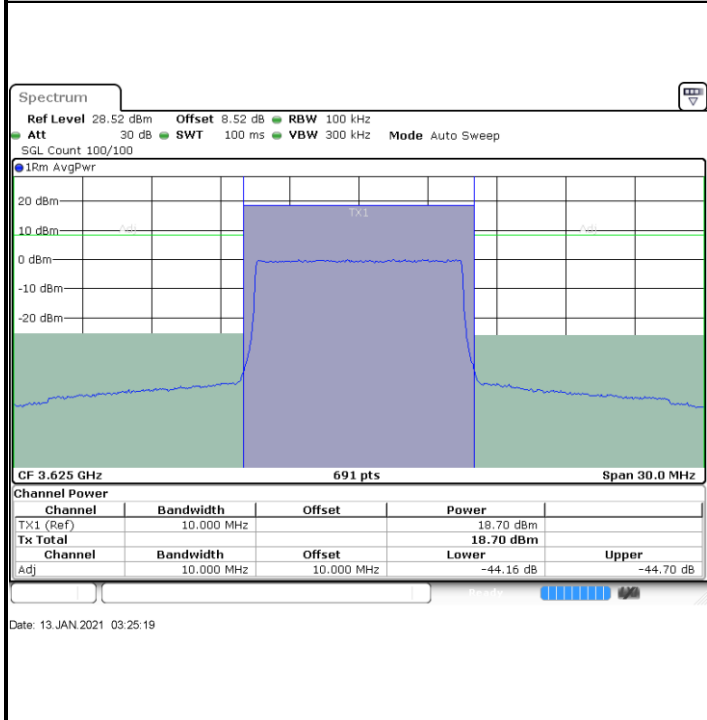

N/A

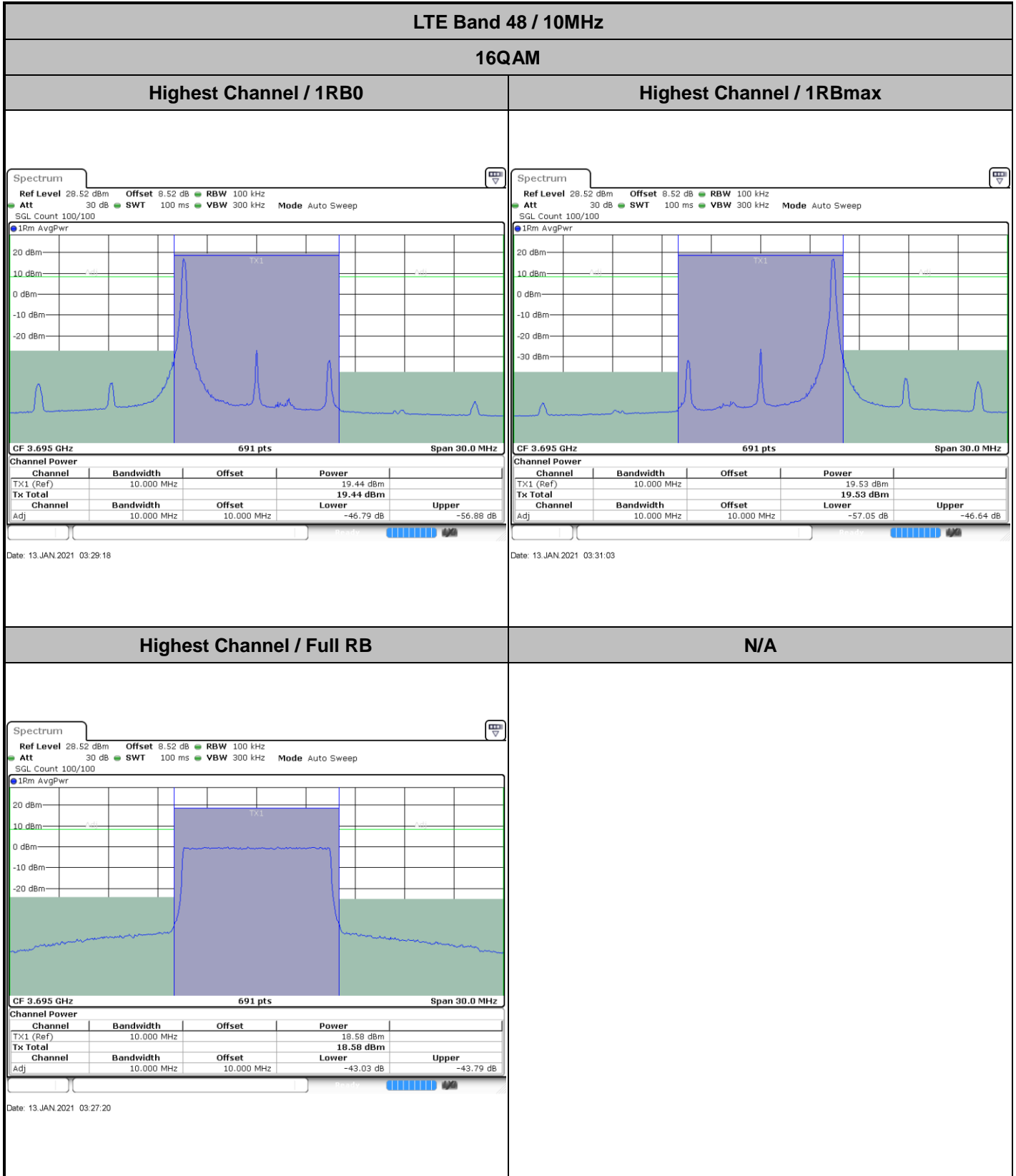



LTE Band 48 / 15MHz

16QAM

Lowest Channel / 1RB0

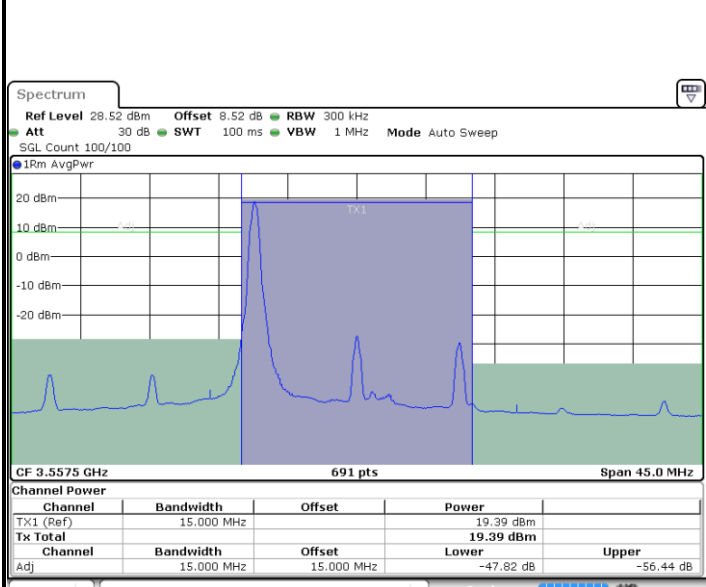

Date: 13 JAN 2021 03:36:31

Lowest Channel / 1RBmax

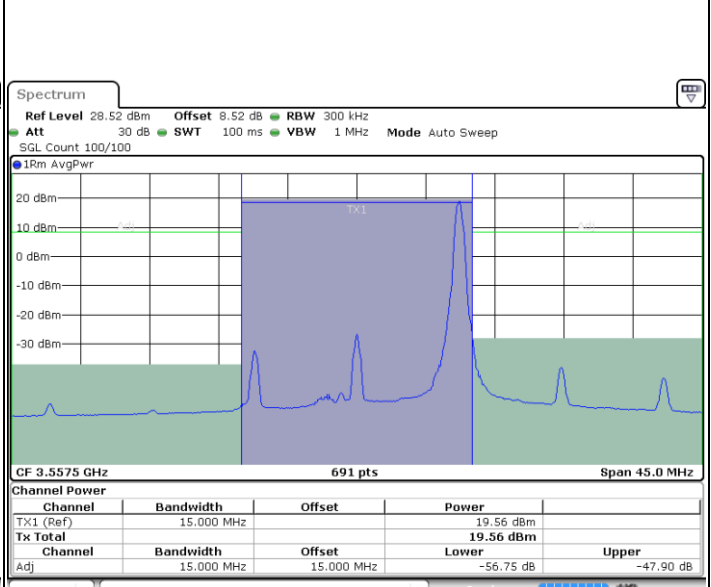

Date: 13 JAN 2021 03:38:26

Lowest Channel / Full RB

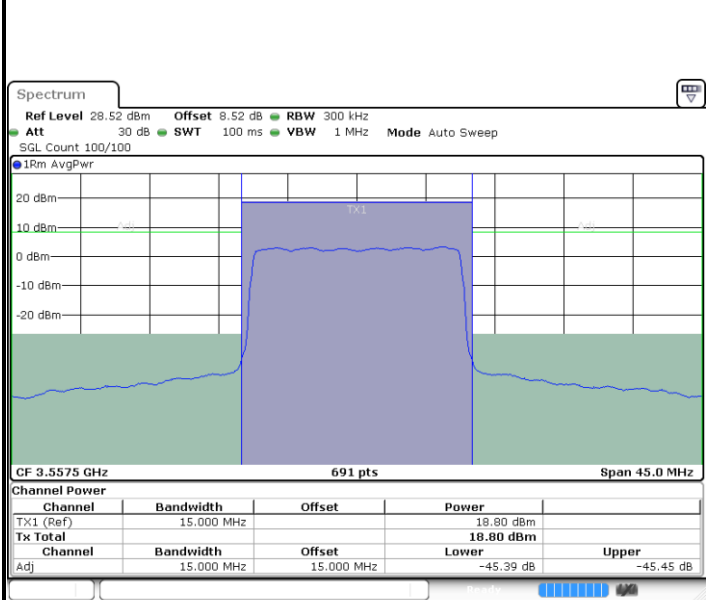

Date: 13 JAN 2021 03:34:47

N/A

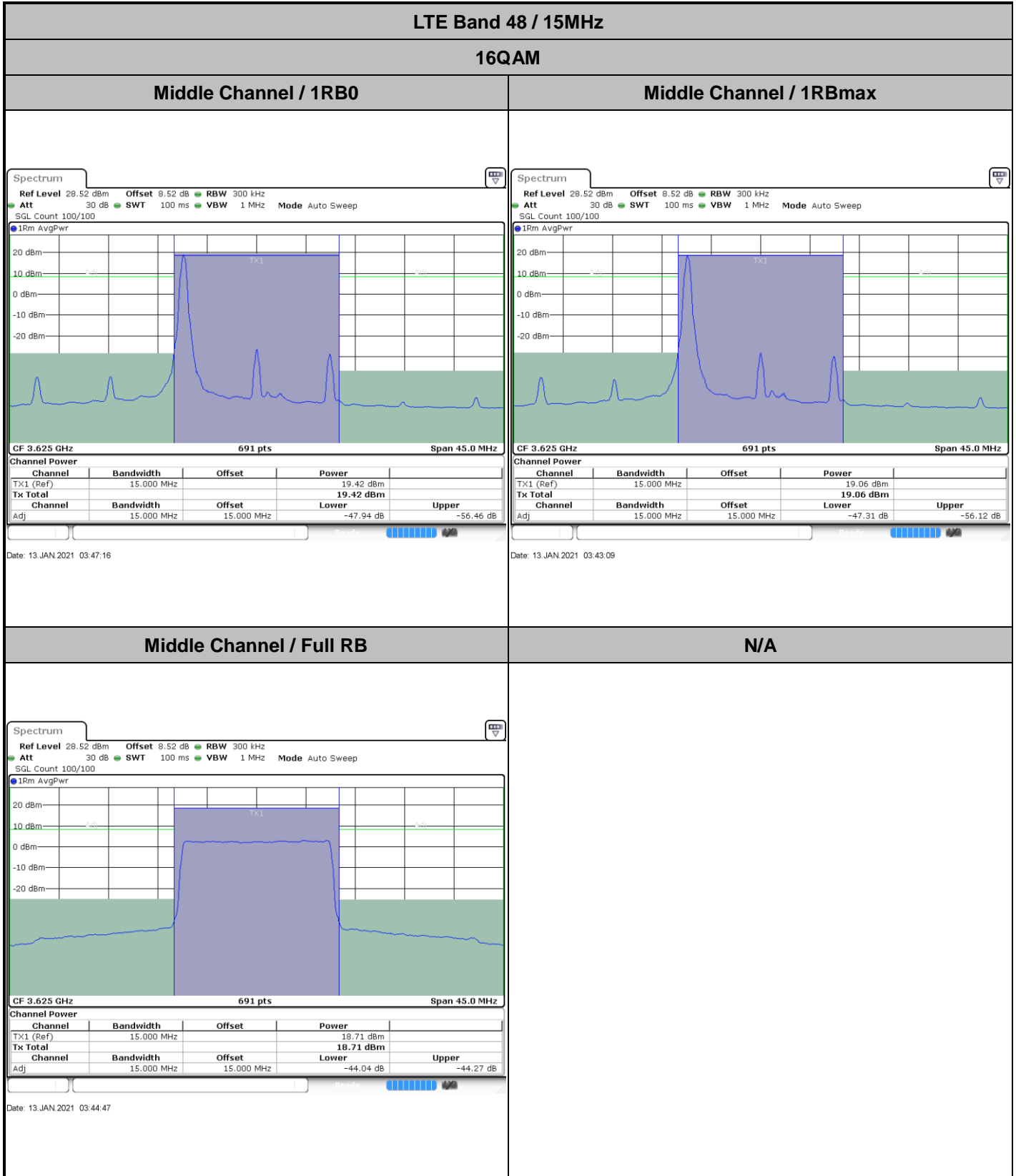

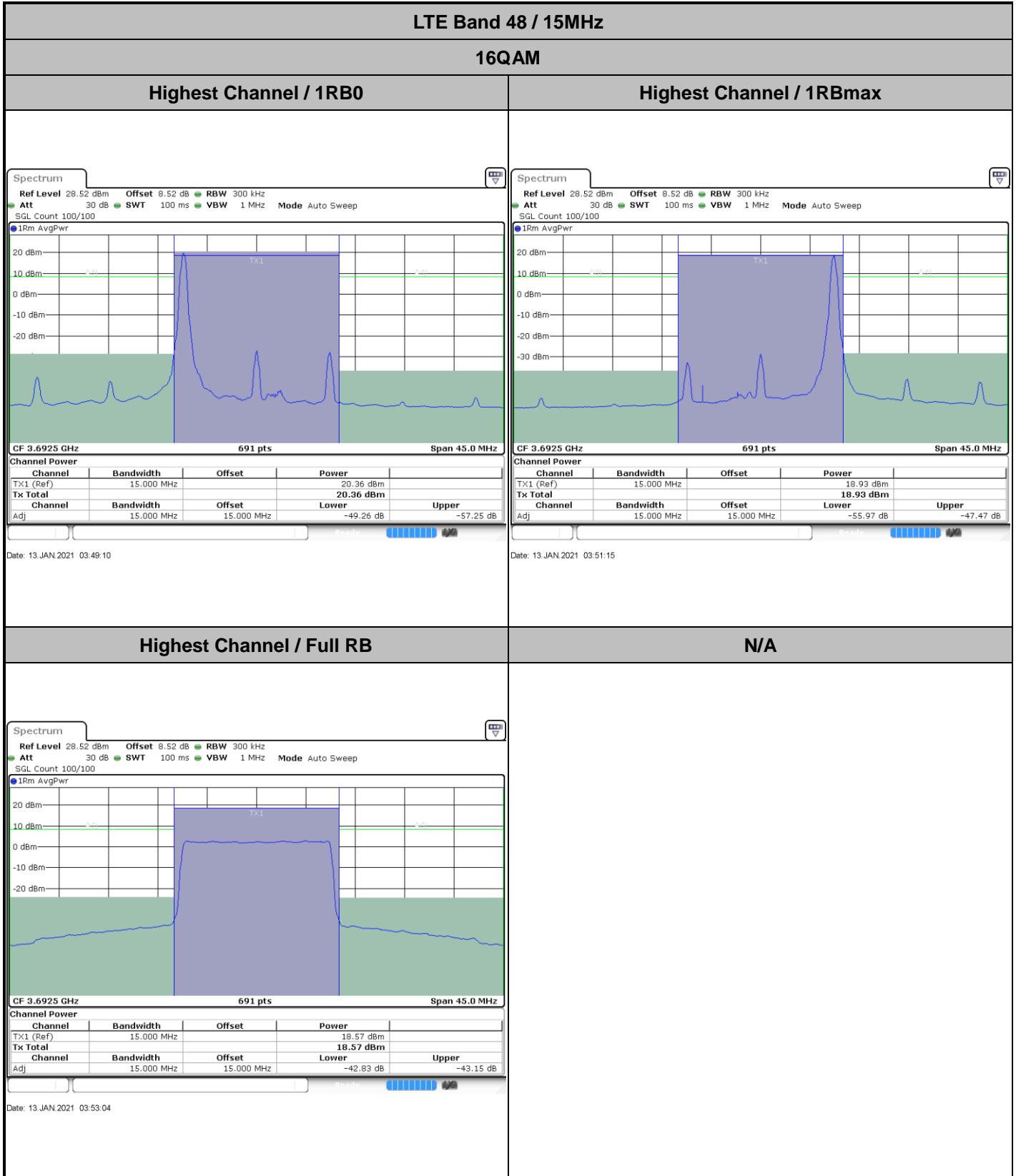



LTE Band 48 / 20MHz

16QAM

Lowest Channel / 1RB0

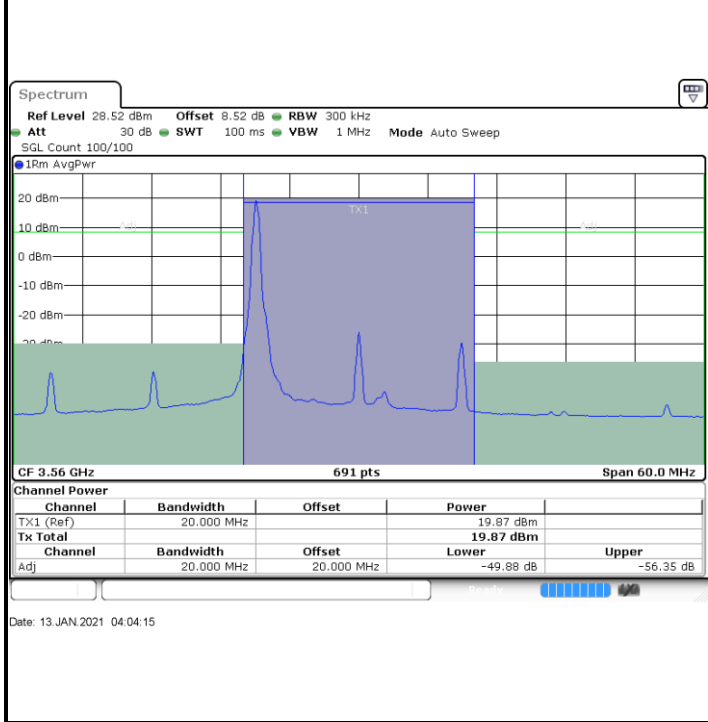

Lowest Channel / 1RBmax

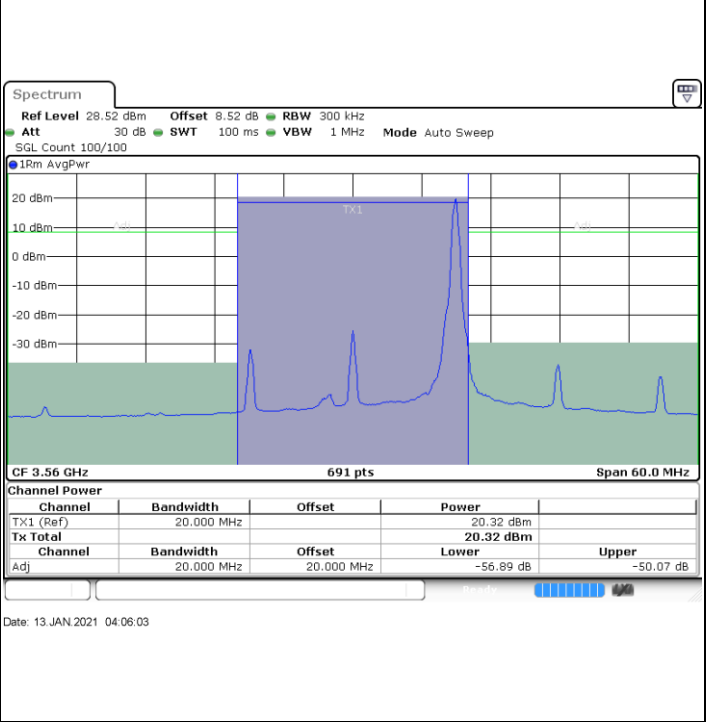

Lowest Channel / Full RB

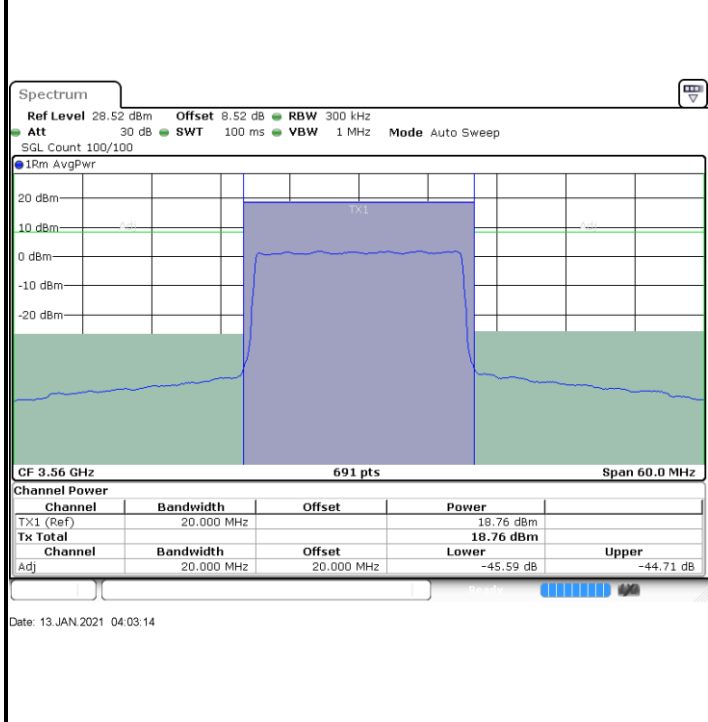

N/A

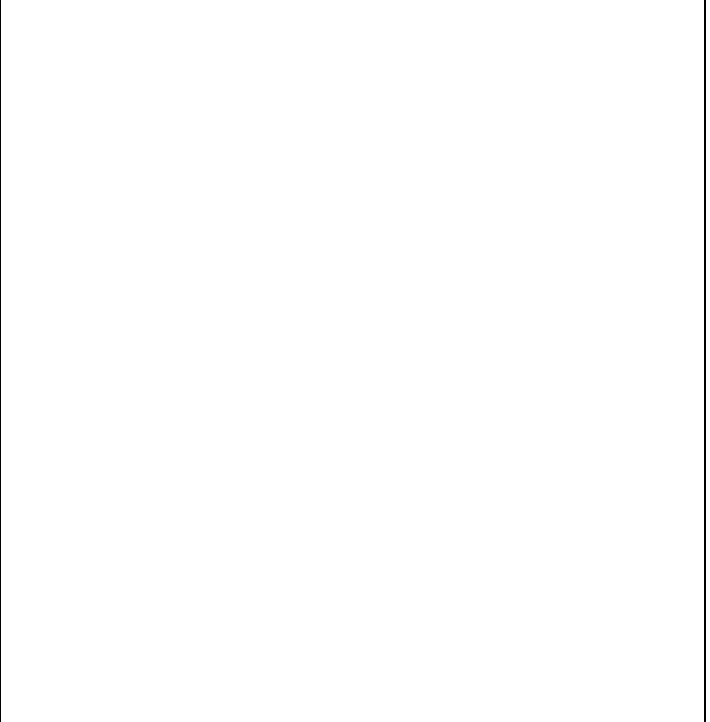



LTE Band 48 / 20MHz

16QAM

Middle Channel / 1RB0

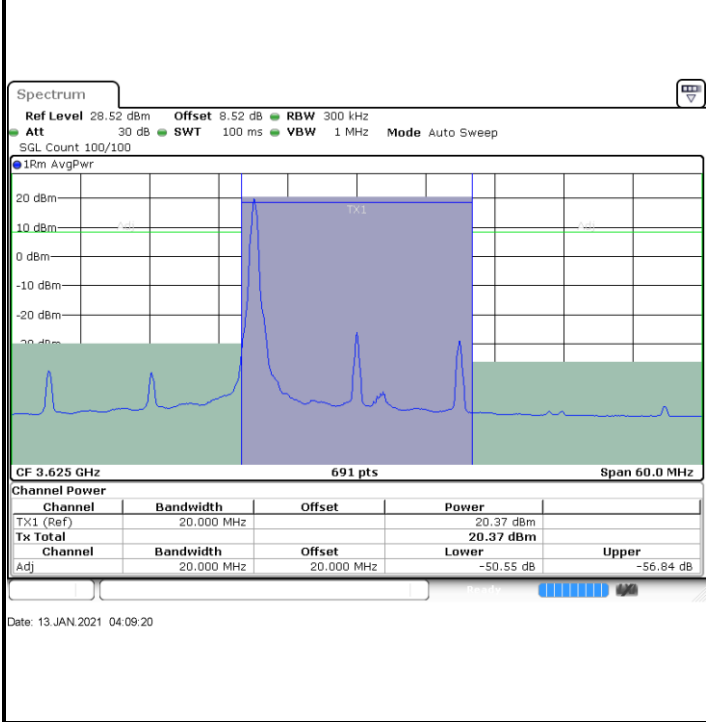

Middle Channel / 1RBmax

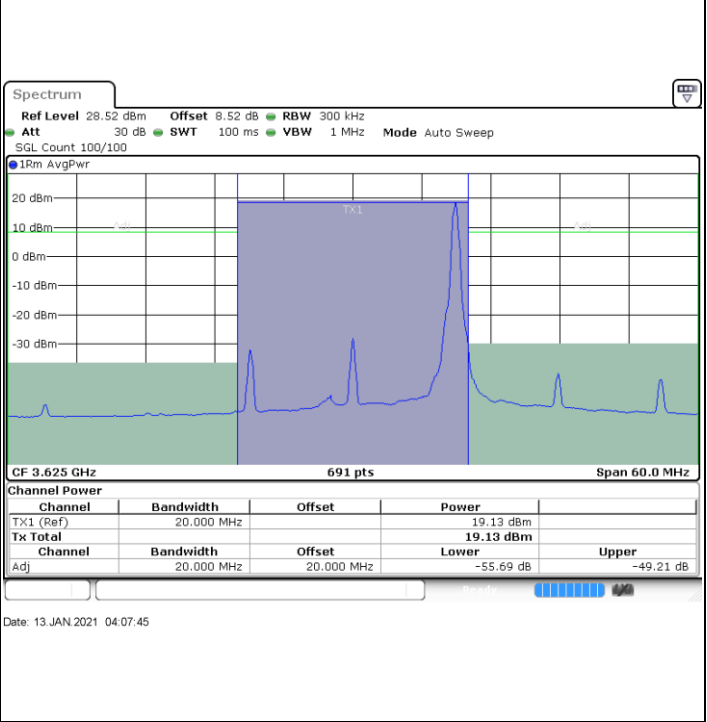

Middle Channel / Full RB

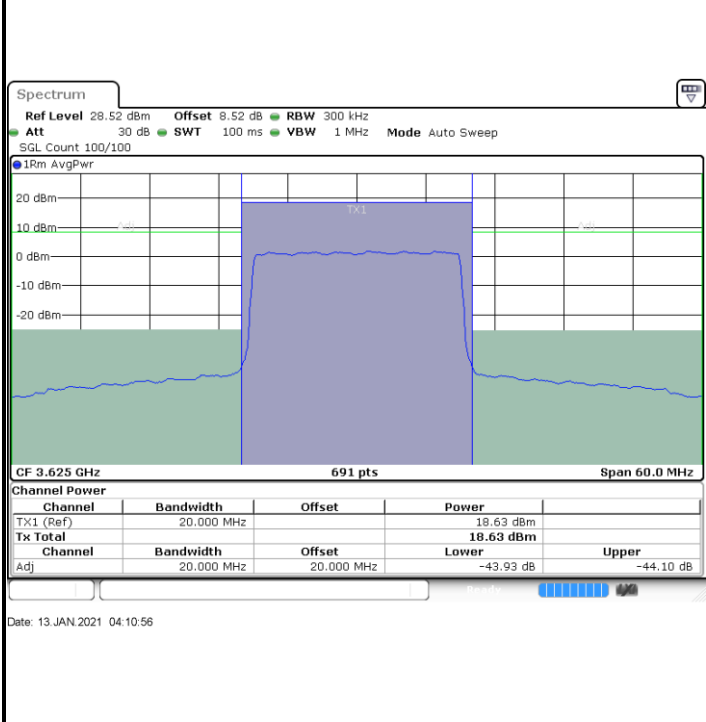

N/A

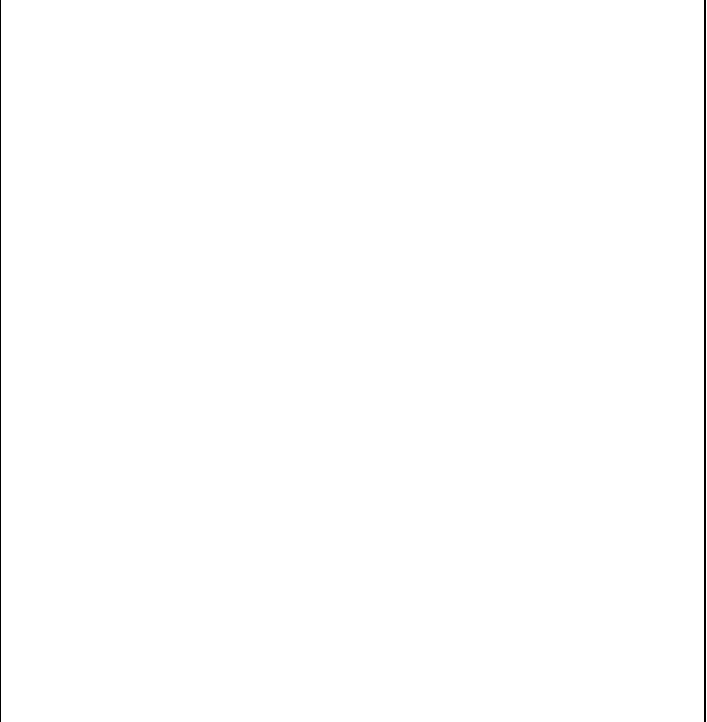



LTE Band 48 / 20MHz

16QAM

Highest Channel / 1RB0

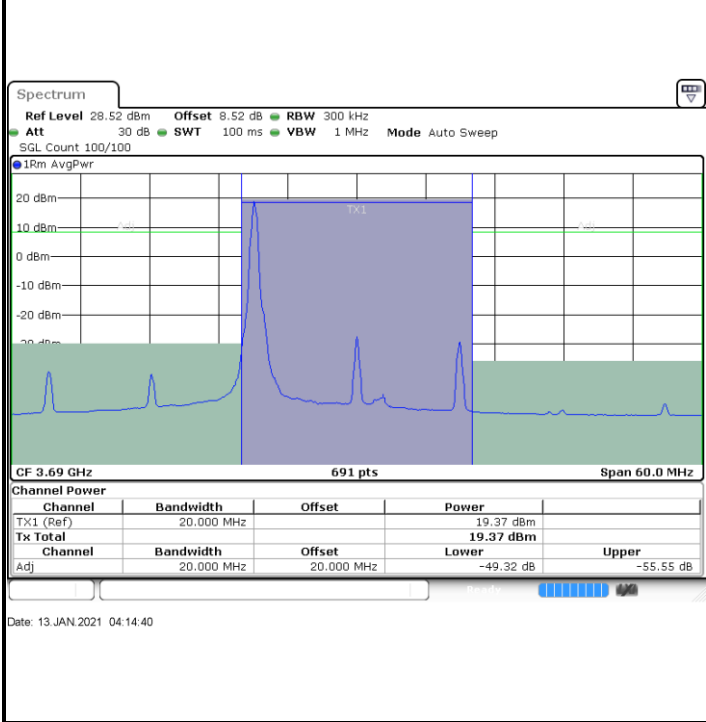

Highest Channel / 1RBmax

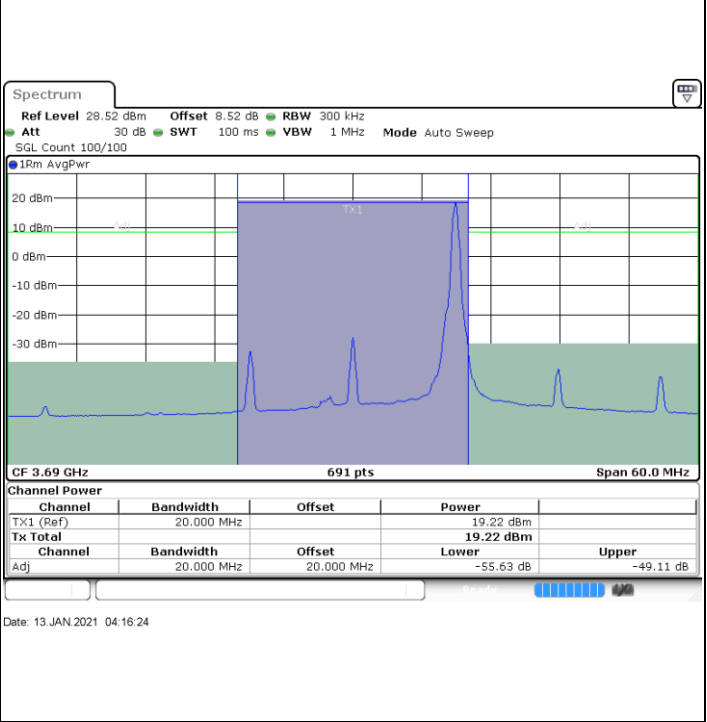

Highest Channel / Full RB

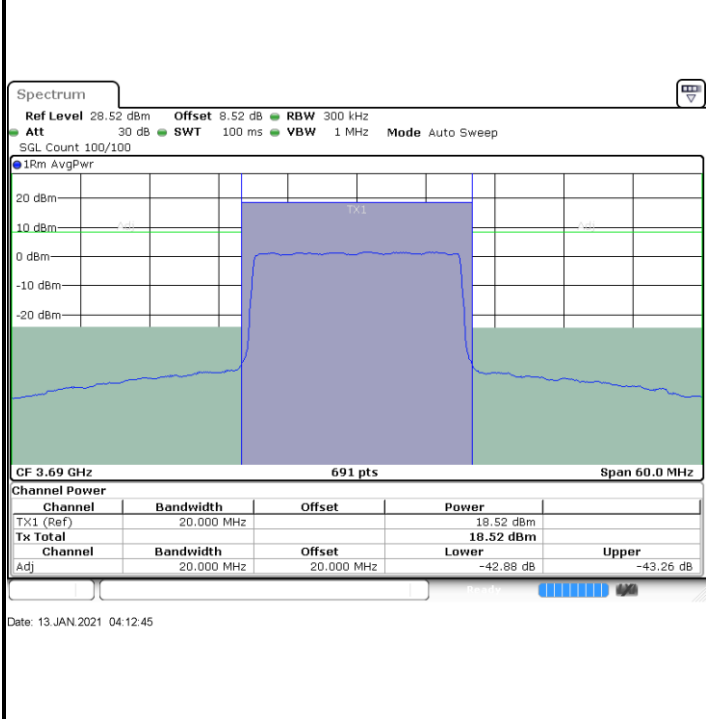

N/A

