

Measurements

Date: 2020/7/15

Report No. : ES/2020/30005

GSM 850_Head_Re Cheek_CH 251_UAT

Communication System: GSM; Frequency: 848.8 MHz; Duty cycle= 1:8.3

Medium parameters used: $f = 849$ MHz; $\sigma = 0.925$ S/m; $\epsilon_r = 41.847$; $\rho = 1000$ kg/m³

Phantom section: Right Section

Ambient temperature: 21.4°C; Liquid temperature: 21.8°C

DASY5 Configuration:

- Probe: EX3DV4 - SN3770; ConvF(9.5, 9.5, 9.5) @ 849 MHz; Calibrated: 2020/5/27
- Sensor-Surface: 2mm (Mechanical Surface Detection)
- Electronics: DAE4 Sn877; Calibrated: 2020/3/17
- Phantom: SAM
- DASY52 52.10.4(1527); SEMCAD X 14.6.14(7483)

Area Scan (71x151x1): Interpolated grid: dx=15 mm, dy=15 mm

Maximum value of SAR (interpolated) = 0.973 W/kg

Zoom Scan (5x5x7)/Cube 0: Measurement grid: dx=8mm, dy=8mm, dz=5mm

Reference Value = 12.67 V/m; Power Drift = 0.01 dB

Peak SAR (extrapolated) = 1.09 W/kg

SAR(1 g) = 0.759 W/kg; SAR(10 g) = 0.501 W/kg

Smallest distance from peaks to all points 3 dB below = 10.4 mm

Ratio of SAR at M2 to SAR at M1 = 78.9%

Maximum value of SAR (measured) = 0.936 W/kg

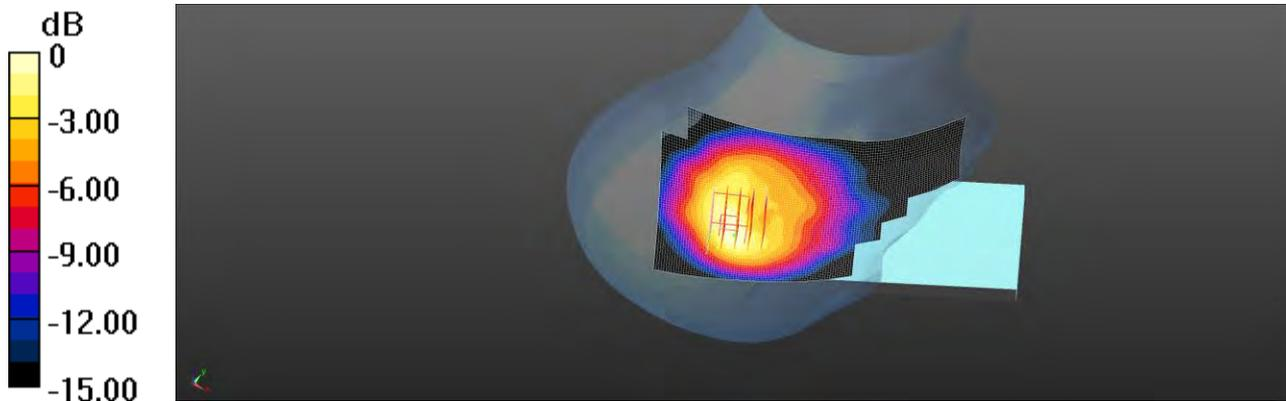

0 dB = 0.936 W/kg = -0.29 dBW/kg

Unless otherwise stated the results shown in this test report refer only to the sample(s) tested and such sample(s) are retained for 90 days only.

除非另有說明，此報告結果僅對測試之樣品負責，同時此樣品僅保留90天。本報告未經本公司書面許可，不可部份複製。

This document is issued by the Company subject to its General Conditions of Service printed overleaf, available on request or accessible at <http://www.sgs.com.tw/Terms-and-Conditions> and for electronic format documents, subject to Terms and Conditions for Electronic Documents at <http://www.sgs.com.tw/Terms-and-Conditions>. Attention is drawn to the limitation of liability, indemnification and jurisdiction issues defined therein. Any holder of this document is advised that information contained hereon reflects the Company's findings at the time of its intervention only and within the limits of Client's instructions, if any. The Company's sole responsibility is to its Client and this document does not exonerate parties to a transaction from exercising all their rights and obligations under the transaction documents. This document cannot be reproduced except in full, without prior written approval of the Company. Any unauthorized alteration, forgery or falsification of the content or appearance of this document is unlawful and offenders may be prosecuted to the fullest extent of the law.

Date: 2020/7/15

Report No. : ES/2020/30005

WCDMA Band V_Head_Re Cheek_CH 4183_UAT

Communication System: WCDMA; Frequency: 836.6 MHz; Duty cycle= 1:1

Medium parameters used: $f = 837$ MHz; $\sigma = 0.904$ S/m; $\epsilon_r = 42.057$; $\rho = 1000$ kg/m³

Phantom section: Right Section

Ambient temperature: 21.9°C; Liquid temperature: 22.3°C

DASY5 Configuration:

- Probe: EX3DV4 - SN3770; ConvF(9.5, 9.5, 9.5) @ 837 MHz; Calibrated: 2020/5/27
- Sensor-Surface: 2mm (Mechanical Surface Detection)
- Electronics: DAE4 Sn877; Calibrated: 2020/3/17
- Phantom: SAM
- DASY52 52.10.4(1527); SEMCAD X 14.6.14(7483)

Area Scan (71x151x1): Interpolated grid: dx=15 mm, dy=15 mm

Maximum value of SAR (interpolated) = 0.952 W/kg

Zoom Scan (5x5x7)/Cube 0: Measurement grid: dx=8mm, dy=8mm, dz=5mm

Reference Value = 18.35 V/m; Power Drift = -0.09 dB

Peak SAR (extrapolated) = 1.08 W/kg

SAR(1 g) = 0.730 W/kg; SAR(10 g) = 0.478 W/kg

Smallest distance from peaks to all points 3 dB below = 10.3 mm

Ratio of SAR at M2 to SAR at M1 = 69.4%

Maximum value of SAR (measured) = 0.938 W/kg

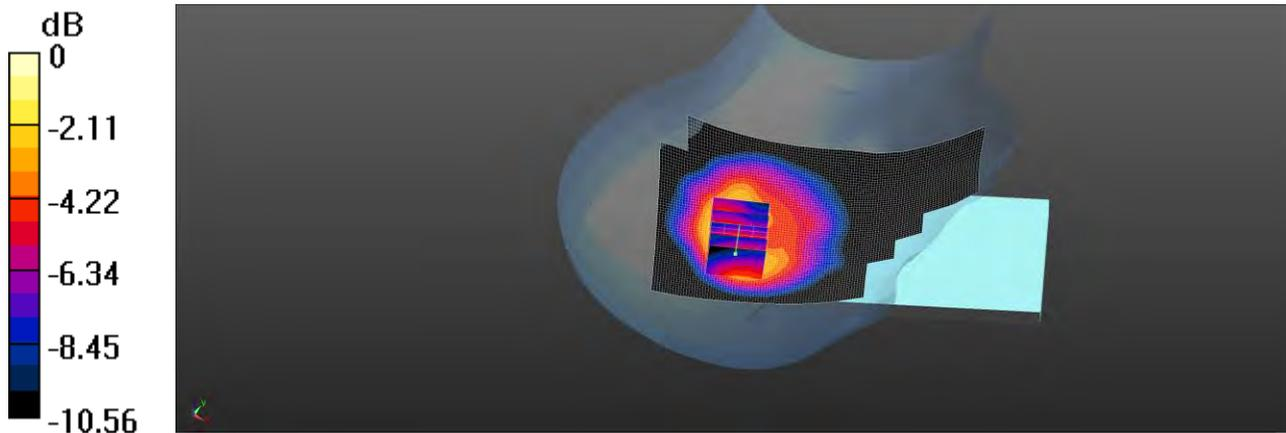

0 dB = 0.938 W/kg = -0.28 dBW/kg

Unless otherwise stated the results shown in this test report refer only to the sample(s) tested and such sample(s) are retained for 90 days only.

除非另有說明，此報告結果僅對測試之樣品負責，同時此樣品僅保留90天。本報告未經本公司書面許可，不可部份複製。

This document is issued by the Company subject to its General Conditions of Service printed overleaf, available on request or accessible at <http://www.sgs.com.tw/Terms-and-Conditions> and for electronic format documents, subject to Terms and Conditions for Electronic Documents at <http://www.sgs.com.tw/Terms-and-Conditions>. Attention is drawn to the limitation of liability, indemnification and jurisdiction issues defined therein. Any holder of this document is advised that information contained hereon reflects the Company's findings at the time of its intervention only and within the limits of Client's instructions, if any. The Company's sole responsibility is to its Client and this document does not exonerate parties to a transaction from exercising all their rights and obligations under the transaction documents. This document cannot be reproduced except in full, without prior written approval of the Company. Any unauthorized alteration, forgery or falsification of the content or appearance of this document is unlawful and offenders may be prosecuted to the fullest extent of the law.

Date: 2020/7/14

Report No. :ES/2020/30005

LTE Band 12 (10MHz)_Head_Re Cheek_CH 23060_QPSK_1-0_UAT

Communication System: LTE; Frequency: 704 MHz; Duty cycle= 1:1

Medium parameters used: $f = 704 \text{ MHz}$; $\sigma = 0.89 \text{ S/m}$; $\epsilon_r = 43.194$; $\rho = 1000 \text{ kg/m}^3$

Phantom section: Right Section

Ambient temperature: 21.3°C; Liquid temperature: 21.6°C

DASY5 Configuration:

- Probe: EX3DV4 - SN3770; ConvF(9.84, 9.84, 9.84) @ 704 MHz; Calibrated: 2020/5/27
- Sensor-Surface: 2mm (Mechanical Surface Detection)
- Electronics: DAE4 Sn877; Calibrated: 2020/3/17
- Phantom: SAM
- DASY52 52.10.4(1527); SEMCAD X 14.6.14(7483)

Area Scan (71x151x1): Interpolated grid: dx=15 mm, dy=15 mm

Maximum value of SAR (interpolated) = 0.704 W/kg

Zoom Scan (5x5x7)/Cube 0: Measurement grid: dx=8mm, dy=8mm, dz=5mm

Reference Value = 16.26 V/m; Power Drift = 0.03 dB

Peak SAR (extrapolated) = 0.708 W/kg

SAR(1 g) = 0.498 W/kg; SAR(10 g) = 0.357 W/kg

Smallest distance from peaks to all points 3 dB below = 9.9 mm

Ratio of SAR at M2 to SAR at M1 = 88.6%

Maximum value of SAR (measured) = 0.573 W/kg

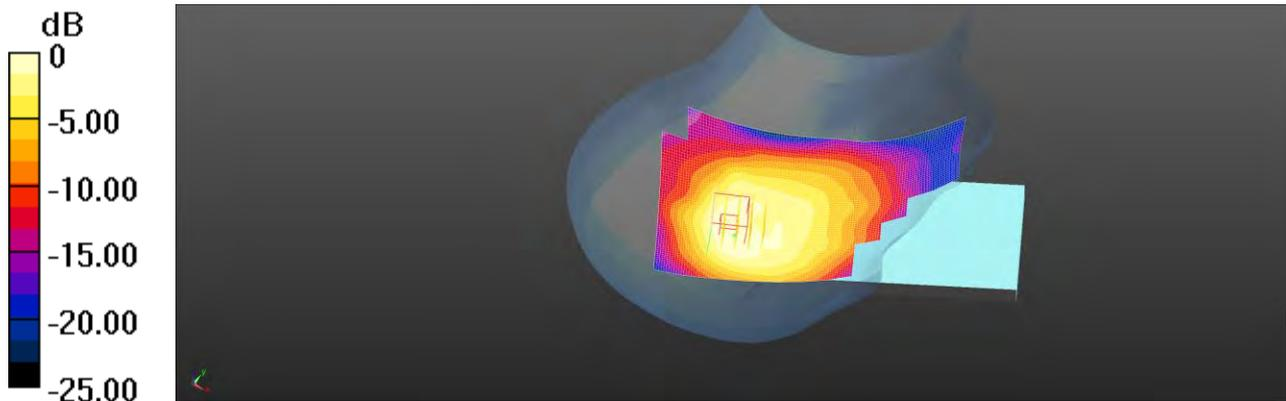

0 dB = 0.573 W/kg = -2.42 dBW/kg

Unless otherwise stated the results shown in this test report refer only to the sample(s) tested and such sample(s) are retained for 90 days only.

除非另有說明，此報告結果僅對測試之樣品負責，同時此樣品僅保留90天。本報告未經本公司書面許可，不可部份複製。

This document is issued by the Company subject to its General Conditions of Service printed overleaf, available on request or accessible at <http://www.sgs.com.tw/Terms-and-Conditions> and for electronic format documents, subject to Terms and Conditions for Electronic Documents at <http://www.sgs.com.tw/Terms-and-Conditions>. Attention is drawn to the limitation of liability, indemnification and jurisdiction issues defined therein. Any holder of this document is advised that information contained hereon reflects the Company's findings at the time of its intervention only and within the limits of Client's instructions, if any. The Company's sole responsibility is to its Client and this document does not exonerate parties to a transaction from exercising all their rights and obligations under the transaction documents. This document cannot be reproduced except in full, without prior written approval of the Company. Any unauthorized alteration, forgery or falsification of the content or appearance of this document is unlawful and offenders may be prosecuted to the fullest extent of the law.

Date: 2020/7/14

Report No. :ES/2020/30005

LTE Band 13 (10MHz)_Head_Re Cheek_CH 23230_QPSK_1-0_UAT

Communication System: LTE; Frequency: 782 MHz; Duty cycle= 1:1

Medium parameters used: $f = 782 \text{ MHz}$; $\sigma = 0.882 \text{ S/m}$; $\epsilon_r = 42.621$; $\rho = 1000 \text{ kg/m}^3$

Phantom section: Right Section

Ambient temperature: 21.3°C; Liquid temperature: 21.6°C

DASY5 Configuration:

- Probe: EX3DV4 - SN3770; ConvF(9.84, 9.84, 9.84) @ 782 MHz; Calibrated: 2020/5/27
- Sensor-Surface: 2mm (Mechanical Surface Detection)
- Electronics: DAE4 Sn877; Calibrated: 2020/3/17
- Phantom: SAM
- DASY52 52.10.4(1527); SEMCAD X 14.6.14(7483)

Area Scan (71x151x1): Interpolated grid: dx=15 mm, dy=15 mm

Maximum value of SAR (interpolated) = 1.30 W/kg

Zoom Scan (5x5x7)/Cube 0: Measurement grid: dx=8mm, dy=8mm, dz=5mm

Reference Value = 21.59 V/m; Power Drift = -0.04 dB

Peak SAR (extrapolated) = 1.40 W/kg

SAR(1 g) = 0.897 W/kg; SAR(10 g) = 0.563 W/kg

Smallest distance from peaks to all points 3 dB below = 18.3 mm

Ratio of SAR at M2 to SAR at M1 = 75.5%

Maximum value of SAR (measured) = 1.16 W/kg

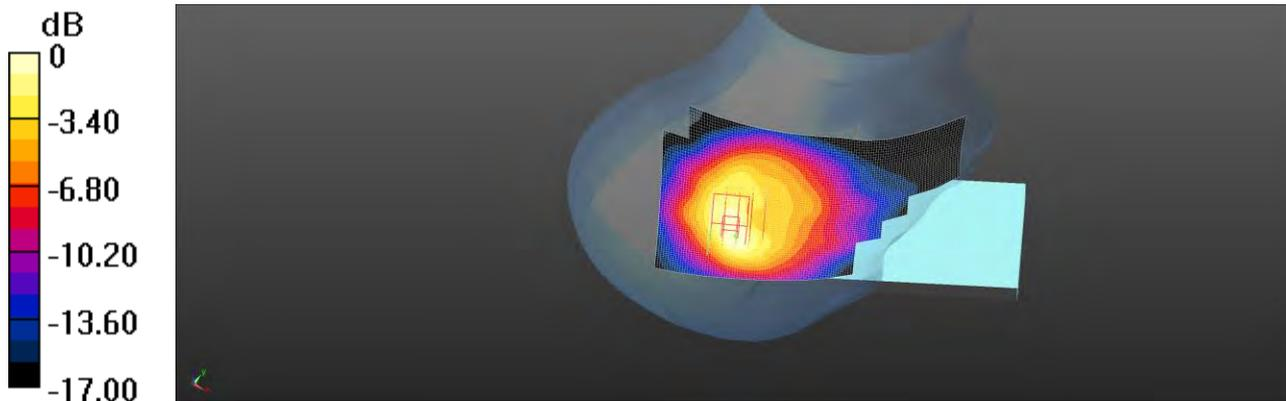

0 dB = 1.16 W/kg = 0.64 dBW/kg

Unless otherwise stated the results shown in this test report refer only to the sample(s) tested and such sample(s) are retained for 90 days only.

除非另有說明，此報告結果僅對測試之樣品負責，同時此樣品僅保留90天。本報告未經本公司書面許可，不可部份複製。

This document is issued by the Company subject to its General Conditions of Service printed overleaf, available on request or accessible at <http://www.sgs.com.tw/Terms-and-Conditions> and for electronic format documents, subject to Terms and Conditions for Electronic Documents at <http://www.sgs.com.tw/Terms-and-Conditions>. Attention is drawn to the limitation of liability, indemnification and jurisdiction issues defined therein. Any holder of this document is advised that information contained hereon reflects the Company's findings at the time of its intervention only and within the limits of Client's instructions, if any. The Company's sole responsibility is to its Client and this document does not exonerate parties to a transaction from exercising all their rights and obligations under the transaction documents. This document cannot be reproduced except in full, without prior written approval of the Company. Any unauthorized alteration, forgery or falsification of the content or appearance of this document is unlawful and offenders may be prosecuted to the fullest extent of the law.

Date: 2020/7/15

Report No. :ES/2020/30005

LTE Band 26 (15MHz)_Head_Re Cheek_CH 26765_QPSK_1-0_UAT

Communication System: LTE; Frequency: 821.5 MHz; Duty cycle= 1:1

Medium parameters used: $f = 821.5$ MHz; $\sigma = 0.884$ S/m; $\epsilon_r = 42.515$; $\rho = 1000$ kg/m³

Phantom section: Right Section

Ambient temperature: 21.4°C; Liquid temperature: 21.8°C

DASY5 Configuration:

- Probe: EX3DV4 - SN3770; ConvF(9.5, 9.5, 9.5) @ 821.5 MHz; Calibrated: 2020/5/27
- Sensor-Surface: 2mm (Mechanical Surface Detection)
- Electronics: DAE4 Sn877; Calibrated: 2020/3/17
- Phantom: SAM
- DASY52 52.10.4(1527); SEMCAD X 14.6.14(7483)

Area Scan (71x151x1): Interpolated grid: dx=15 mm, dy=15 mm

Maximum value of SAR (interpolated) = 1.16 W/kg

Zoom Scan (5x5x7)/Cube 0: Measurement grid: dx=8mm, dy=8mm, dz=5mm

Reference Value = 10.60 V/m; Power Drift = -0.12 dB

Peak SAR (extrapolated) = 1.23 W/kg

SAR(1 g) = 0.855 W/kg; SAR(10 g) = 0.557 W/kg

Smallest distance from peaks to all points 3 dB below = 13.7 mm

Ratio of SAR at M2 to SAR at M1 = 85.6%

Maximum value of SAR (measured) = 1.07 W/kg

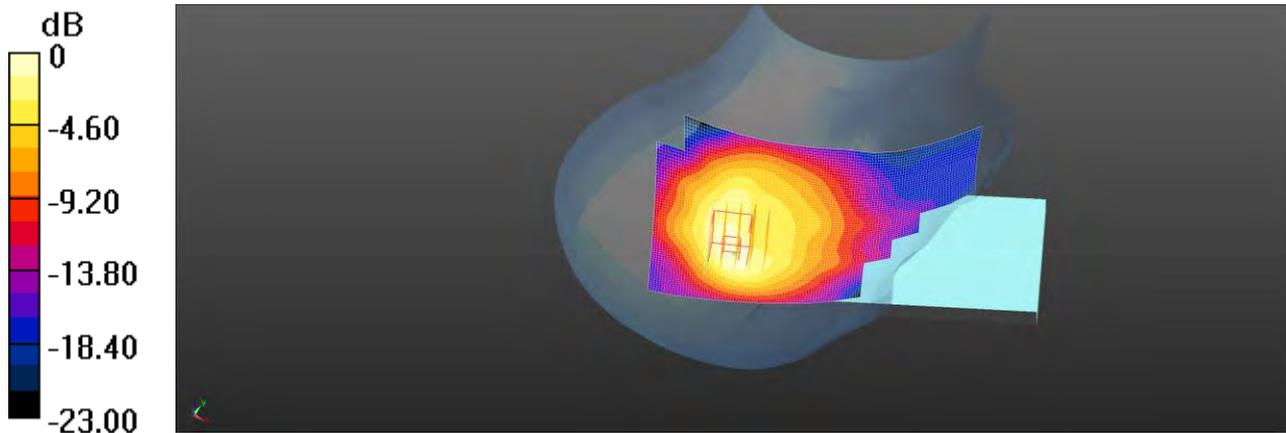

0 dB = 1.07 W/kg = 0.29 dBW/kg

Unless otherwise stated the results shown in this test report refer only to the sample(s) tested and such sample(s) are retained for 90 days only.

除非另有說明，此報告結果僅對測試之樣品負責，同時此樣品僅保留90天。本報告未經本公司書面許可，不可部份複製。

This document is issued by the Company subject to its General Conditions of Service printed overleaf, available on request or accessible at <http://www.sgs.com.tw/Terms-and-Conditions> and for electronic format documents, subject to Terms and Conditions for Electronic Documents at <http://www.sgs.com.tw/Terms-and-Conditions>. Attention is drawn to the limitation of liability, indemnification and jurisdiction issues defined therein. Any holder of this document is advised that information contained hereon reflects the Company's findings at the time of its intervention only and within the limits of Client's instructions, if any. The Company's sole responsibility is to its Client and this document does not exonerate parties to a transaction from exercising all their rights and obligations under the transaction documents. This document cannot be reproduced except in full, without prior written approval of the Company. Any unauthorized alteration, forgery or falsification of the content or appearance of this document is unlawful and offenders may be prosecuted to the fullest extent of the law.

Date: 2020/7/14

Report No. :ES/2020/30005

LTE Band 71 (20MHz)_Head_Re Cheek_CH 133372_QPSK_1-0_UAT

Communication System: LTE; Frequency: 688 MHz; Duty cycle= 1:1

Medium parameters used: $f = 688 \text{ MHz}$; $\sigma = 0.853 \text{ S/m}$; $\epsilon_r = 43.354$; $\rho = 1000 \text{ kg/m}^3$

Phantom section: Right Section

Ambient temperature: 21.3°C; Liquid temperature: 21.6°C

DASY5 Configuration:

- Probe: EX3DV4 - SN3770; ConvF(9.84, 9.84, 9.84) @ 688 MHz; Calibrated: 2020/5/27
- Sensor-Surface: 2mm (Mechanical Surface Detection)
- Electronics: DAE4 Sn877; Calibrated: 2020/3/17
- Phantom: SAM
- DASY52 52.10.4(1527); SEMCAD X 14.6.14(7483)

Area Scan (71x151x1): Interpolated grid: dx=15 mm, dy=15 mm

Maximum value of SAR (interpolated) = 0.772 W/kg

Zoom Scan (5x5x7)/Cube 0: Measurement grid: dx=8mm, dy=8mm, dz=5mm

Reference Value = 18.01 V/m; Power Drift = -0.12 dB

Peak SAR (extrapolated) = 0.758 W/kg

SAR(1 g) = 0.552 W/kg; SAR(10 g) = 0.396 W/kg

Smallest distance from peaks to all points 3 dB below = 9.2 mm

Ratio of SAR at M2 to SAR at M1 = 75.5%

Maximum value of SAR (measured) = 0.635 W/kg

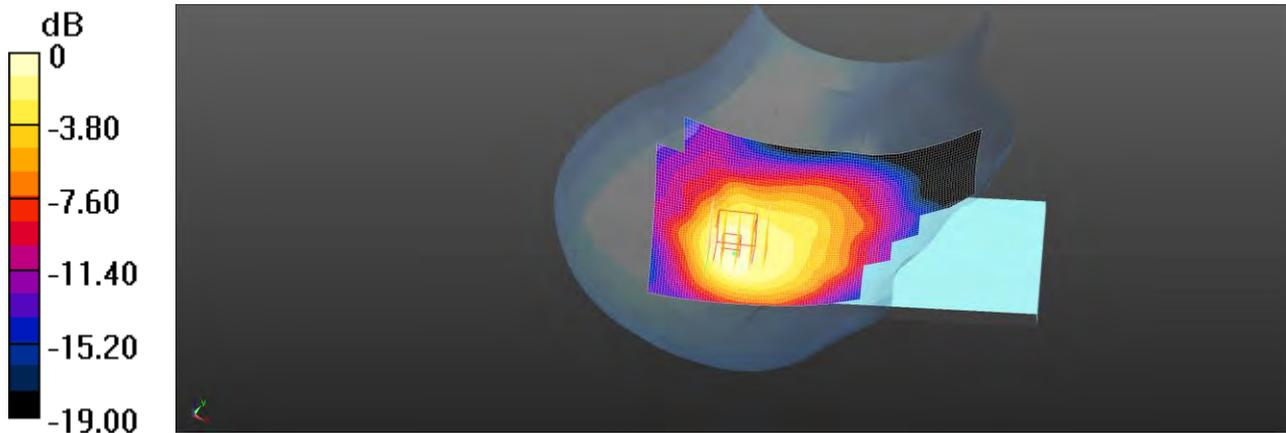

0 dB = 0.635 W/kg = -1.97 dBW/kg

Unless otherwise stated the results shown in this test report refer only to the sample(s) tested and such sample(s) are retained for 90 days only.

除非另有說明，此報告結果僅對測試之樣品負責，同時此樣品僅保留90天。本報告未經本公司書面許可，不可部份複製。

This document is issued by the Company subject to its General Conditions of Service printed overleaf, available on request or accessible at <http://www.sgs.com.tw/Terms-and-Conditions> and for electronic format documents, subject to Terms and Conditions for Electronic Documents at <http://www.sgs.com.tw/Terms-and-Conditions>. Attention is drawn to the limitation of liability, indemnification and jurisdiction issues defined therein. Any holder of this document is advised that information contained hereon reflects the Company's findings at the time of its intervention only and within the limits of Client's instructions, if any. The Company's sole responsibility is to its Client and this document does not exonerate parties to a transaction from exercising all their rights and obligations under the transaction documents. This document cannot be reproduced except in full, without prior written approval of the Company. Any unauthorized alteration, forgery or falsification of the content or appearance of this document is unlawful and offenders may be prosecuted to the fullest extent of the law.

Date: 2020/7/15

Report No. : ES/2020/30005

GSM 850_Head_Re Cheek_CH 190_LAT

Communication System: GSM; Frequency: 836.6 MHz; Duty cycle= 1:8.3

Medium parameters used: $f = 837$ MHz; $\sigma = 0.904$ S/m; $\epsilon_r = 42.057$; $\rho = 1000$ kg/m³

Phantom section: Right Section

Ambient temperature: 21.4°C; Liquid temperature: 21.8°C

DASY5 Configuration:

- Probe: EX3DV4 - SN3770; ConvF(9.5, 9.5, 9.5) @ 837 MHz; Calibrated: 2020/5/27
- Sensor-Surface: 2mm (Mechanical Surface Detection)
- Electronics: DAE4 Sn877; Calibrated: 2020/3/17
- Phantom: SAM
- DASY52 52.10.4(1527); SEMCAD X 14.6.14(7483)

Area Scan (71x151x1): Interpolated grid: dx=15 mm, dy=15 mm

Maximum value of SAR (interpolated) = 0.198 W/kg

Zoom Scan (5x5x7)/Cube 0: Measurement grid: dx=8mm, dy=8mm, dz=5mm

Reference Value = 2.981 V/m; Power Drift = 0.16 dB

Peak SAR (extrapolated) = 0.200 W/kg

SAR(1 g) = 0.196 W/kg; SAR(10 g) = 0.184 W/kg

Smallest distance from peaks to all points 3 dB below: Larger than measurement grid

Ratio of SAR at M2 to SAR at M1 = 91.3%

Maximum value of SAR (measured) = 0.199 W/kg

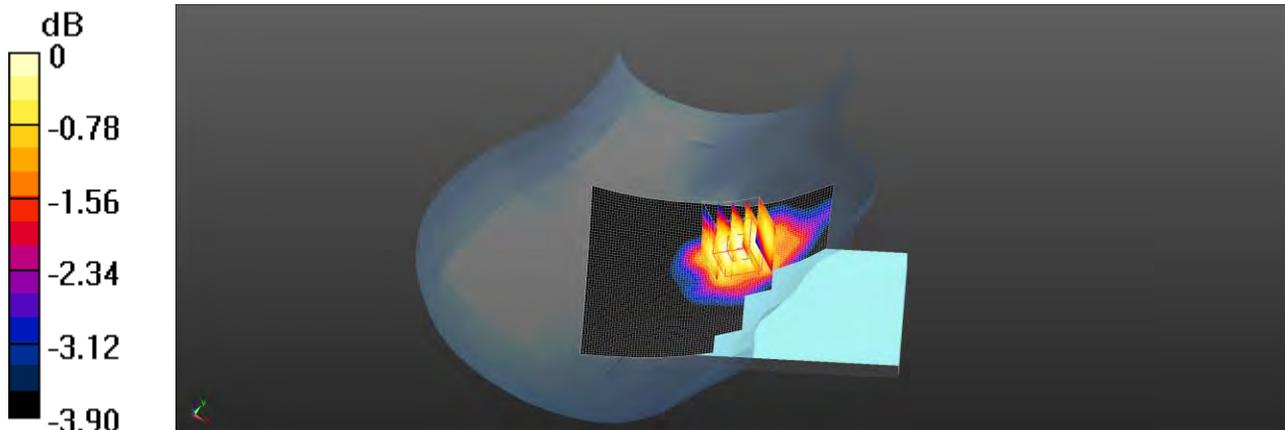

0 dB = 0.199 W/kg = -7.01 dBW/kg

Unless otherwise stated the results shown in this test report refer only to the sample(s) tested and such sample(s) are retained for 90 days only.

除非另有說明，此報告結果僅對測試之樣品負責，同時此樣品僅保留90天。本報告未經本公司書面許可，不可部份複製。

This document is issued by the Company subject to its General Conditions of Service printed overleaf, available on request or accessible at <http://www.sgs.com.tw/Terms-and-Conditions> and for electronic format documents, subject to Terms and Conditions for Electronic Documents at <http://www.sgs.com.tw/Terms-and-Conditions>. Attention is drawn to the limitation of liability, indemnification and jurisdiction issues defined therein. Any holder of this document is advised that information contained hereon reflects the Company's findings at the time of its intervention only and within the limits of Client's instructions, if any. The Company's sole responsibility is to its Client and this document does not exonerate parties to a transaction from exercising all their rights and obligations under the transaction documents. This document cannot be reproduced except in full, without prior written approval of the Company. Any unauthorized alteration, forgery or falsification of the content or appearance of this document is unlawful and offenders may be prosecuted to the fullest extent of the law.

Date: 2020/7/17

Report No. : ES/2020/30005

GSM 1900_Head_Le Cheek_CH 661_LAT

Communication System: GSM; Frequency: 1880 MHz; Duty cycle= 1:8.3

Medium parameters used: $f = 1880 \text{ MHz}$; $\sigma = 1.394 \text{ S/m}$; $\epsilon_r = 39.878$; $\rho = 1000 \text{ kg/m}^3$

Phantom section: Left Section

Ambient temperature: 22.1°C; Liquid temperature: 22.4°C

DASY5 Configuration:

- Probe: EX3DV4 - SN3770; ConvF(8.03, 8.03, 8.03) @ 1880 MHz; Calibrated: 2020/5/27
- Sensor-Surface: 2mm (Mechanical Surface Detection)
- Electronics: DAE4 Sn877; Calibrated: 2020/3/17
- Phantom: SAM
- DASY52 52.10.4(1527); SEMCAD X 14.6.14(7483)

Area Scan (71x151x1): Interpolated grid: dx=15 mm, dy=15 mm

Maximum value of SAR (interpolated) = 0.135 W/kg

Zoom Scan (5x5x7)/Cube 0: Measurement grid: dx=8mm, dy=8mm, dz=5mm

Reference Value = 3.711 V/m; Power Drift = 0.08 dB

Peak SAR (extrapolated) = 0.137 W/kg

SAR(1 g) = 0.105 W/kg; SAR(10 g) = 0.075 W/kg

Smallest distance from peaks to all points 3 dB below = 12 mm

Ratio of SAR at M2 to SAR at M1 = 81%

Maximum value of SAR (measured) = 0.122 W/kg

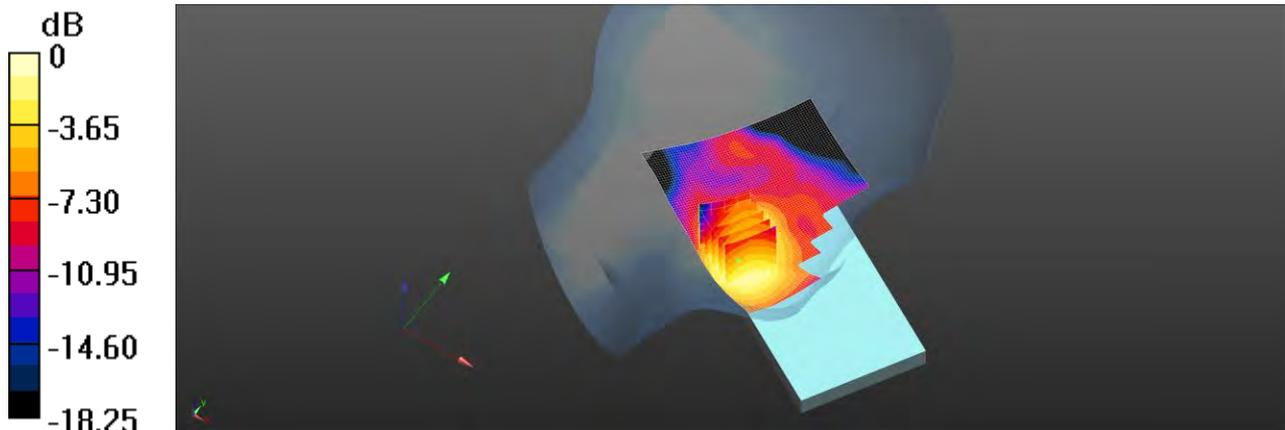

0 dB = 0.122 W/kg = -9.14 dBW/kg

Unless otherwise stated the results shown in this test report refer only to the sample(s) tested and such sample(s) are retained for 90 days only.

除非另有說明，此報告結果僅對測試之樣品負責，同時此樣品僅保留90天。本報告未經本公司書面許可，不可部份複製。

This document is issued by the Company subject to its General Conditions of Service printed overleaf, available on request or accessible at <http://www.sgs.com.tw/Terms-and-Conditions> and for electronic format documents, subject to Terms and Conditions for Electronic Documents at <http://www.sgs.com.tw/Terms-and-Conditions>. Attention is drawn to the limitation of liability, indemnification and jurisdiction issues defined therein. Any holder of this document is advised that information contained hereon reflects the Company's findings at the time of its intervention only and within the limits of Client's instructions, if any. The Company's sole responsibility is to its Client and this document does not exonerate parties to a transaction from exercising all their rights and obligations under the transaction documents. This document cannot be reproduced except in full, without prior written approval of the Company. Any unauthorized alteration, forgery or falsification of the content or appearance of this document is unlawful and offenders may be prosecuted to the fullest extent of the law.

Date: 2020/7/17

Report No. : ES/2020/30005

WCDMA Band II_Head_Le Cheek_CH 9400_LAT

Communication System: WCDMA; Frequency: 1880 MHz; Duty cycle= 1:1

Medium parameters used: $f = 1880$ MHz; $\sigma = 1.394$ S/m; $\epsilon_r = 39.878$; $\rho = 1000$ kg/m³

Phantom section: Left Section

Ambient temperature: 22.1°C; Liquid temperature: 22.4°C

DASY5 Configuration:

- Probe: EX3DV4 - SN3770; ConvF(8.03, 8.03, 8.03) @ 1880 MHz; Calibrated: 2020/5/27
- Sensor-Surface: 2mm (Mechanical Surface Detection)
- Electronics: DAE4 Sn877; Calibrated: 2020/3/17
- Phantom: SAM
- DASY52 52.10.4(1527); SEMCAD X 14.6.14(7483)

Area Scan (71x151x1): Interpolated grid: dx=15 mm, dy=15 mm

Maximum value of SAR (interpolated) = 0.288 W/kg

Zoom Scan (5x5x7)/Cube 0: Measurement grid: dx=8mm, dy=8mm, dz=5mm

Reference Value = 4.791 V/m; Power Drift = 0.11 dB

Peak SAR (extrapolated) = 0.279 W/kg

SAR(1 g) = 0.219 W/kg; SAR(10 g) = 0.160 W/kg

Smallest distance from peaks to all points 3 dB below = 14.5 mm

Ratio of SAR at M2 to SAR at M1 = 81%

Maximum value of SAR (measured) = 0.253 W/kg

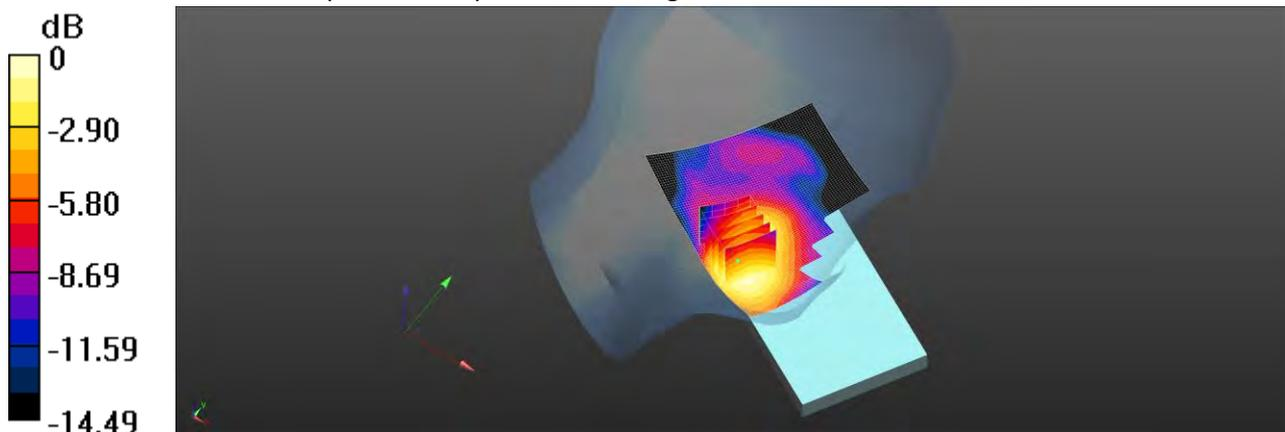

0 dB = 0.253 W/kg = -5.97 dBW/kg

Unless otherwise stated the results shown in this test report refer only to the sample(s) tested and such sample(s) are retained for 90 days only.

除非另有說明，此報告結果僅對測試之樣品負責，同時此樣品僅保留90天。本報告未經本公司書面許可，不可部份複製。

This document is issued by the Company subject to its General Conditions of Service printed overleaf, available on request or accessible at <http://www.sgs.com.tw/Terms-and-Conditions> and for electronic format documents, subject to Terms and Conditions for Electronic Documents at <http://www.sgs.com.tw/Terms-and-Conditions>. Attention is drawn to the limitation of liability, indemnification and jurisdiction issues defined therein. Any holder of this document is advised that information contained hereon reflects the Company's findings at the time of its intervention only and within the limits of Client's instructions, if any. The Company's sole responsibility is to its Client and this document does not exonerate parties to a transaction from exercising all their rights and obligations under the transaction documents. This document cannot be reproduced except in full, without prior written approval of the Company. Any unauthorized alteration, forgery or falsification of the content or appearance of this document is unlawful and offenders may be prosecuted to the fullest extent of the law.

Date: 2020/7/16

Report No. : ES/2020/30005

WCDMA Band IV_Head_Le Cheek_CH 1513_LAT

Communication System: WCDMA; Frequency: 1752.6 MHz; Duty cycle= 1:1

Medium parameters used: $f = 1753$ MHz; $\sigma = 1.382$ S/m; $\epsilon_r = 40.257$; $\rho = 1000$ kg/m³

Phantom section: Left Section

Ambient temperature: 22.5°C; Liquid temperature: 22.1°C

DASY5 Configuration:

- Probe: EX3DV4 - SN3770; ConvF(8.36, 8.36, 8.36) @ 1753 MHz; Calibrated: 2020/5/27
- Sensor-Surface: 2mm (Mechanical Surface Detection)
- Electronics: DAE4 Sn877; Calibrated: 2020/3/17
- Phantom: SAM
- DASY52 52.10.4(1527); SEMCAD X 14.6.14(7483)

Area Scan (71x151x1): Interpolated grid: dx=15 mm, dy=15 mm

Maximum value of SAR (interpolated) = 0.274 W/kg

Zoom Scan (5x5x7)/Cube 0: Measurement grid: dx=8mm, dy=8mm, dz=5mm

Reference Value = 5.660 V/m; Power Drift = 0.13 dB

Peak SAR (extrapolated) = 0.268 W/kg

SAR(1 g) = 0.218 W/kg; SAR(10 g) = 0.163 W/kg

Smallest distance from peaks to all points 3 dB below = 14.3 mm

Ratio of SAR at M2 to SAR at M1 = 83.1%

Maximum value of SAR (measured) = 0.248 W/kg

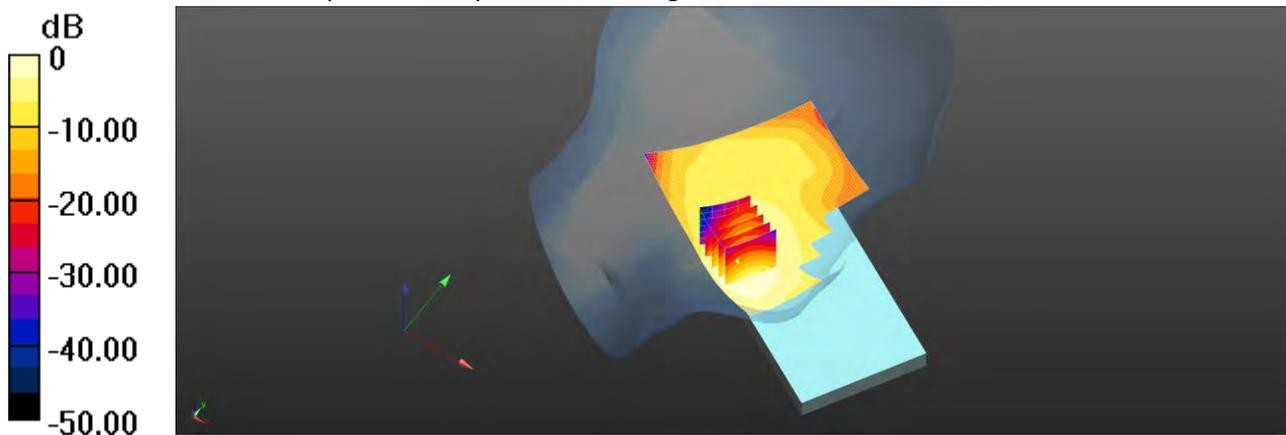

0 dB = 0.274 W/kg = -5.63 dBW/kg

Unless otherwise stated the results shown in this test report refer only to the sample(s) tested and such sample(s) are retained for 90 days only.

除非另有說明，此報告結果僅對測試之樣品負責，同時此樣品僅保留90天。本報告未經本公司書面許可，不可部份複製。

This document is issued by the Company subject to its General Conditions of Service printed overleaf, available on request or accessible at <http://www.sgs.com.tw/Terms-and-Conditions> and for electronic format documents, subject to Terms and Conditions for Electronic Documents at <http://www.sgs.com.tw/Terms-and-Conditions>. Attention is drawn to the limitation of liability, indemnification and jurisdiction issues defined therein. Any holder of this document is advised that information contained hereon reflects the Company's findings at the time of its intervention only and within the limits of Client's instructions, if any. The Company's sole responsibility is to its Client and this document does not exonerate parties to a transaction from exercising all their rights and obligations under the transaction documents. This document cannot be reproduced except in full, without prior written approval of the Company. Any unauthorized alteration, forgery or falsification of the content or appearance of this document is unlawful and offenders may be prosecuted to the fullest extent of the law.

Date: 2020/7/15

Report No. : ES/2020/30005

WCDMA Band V_Head_Re Cheek_CH 4132_LAT

Communication System: WCDMA; Frequency: 826.4 MHz; Duty cycle= 1:1

Medium parameters used: $f = 826.4$ MHz; $\sigma = 0.889$ S/m; $\epsilon_r = 42.486$; $\rho = 1000$ kg/m³

Phantom section: Right Section

Ambient temperature: 21.4°C; Liquid temperature: 21.8°C

DASY5 Configuration:

- Probe: EX3DV4 - SN3770; ConvF(9.5, 9.5, 9.5) @ 826.4 MHz; Calibrated: 2020/5/27
- Sensor-Surface: 2mm (Mechanical Surface Detection)
- Electronics: DAE4 Sn877; Calibrated: 2020/3/17
- Phantom: SAM
- DASY52 52.10.4(1527); SEMCAD X 14.6.14(7483)

Area Scan (71x151x1): Interpolated grid: dx=15 mm, dy=15 mm

Maximum value of SAR (interpolated) = 0.0994 W/kg

Zoom Scan (5x5x7)/Cube 0: Measurement grid: dx=8mm, dy=8mm, dz=5mm

Reference Value = 3.773 V/m; Power Drift = 0.05 dB

Peak SAR (extrapolated) = 0.107 W/kg

SAR(1 g) = 0.104 W/kg; SAR(10 g) = 0.097 W/kg

Smallest distance from peaks to all points 3 dB below: Larger than measurement grid

Ratio of SAR at M2 to SAR at M1 = 85.2%

Maximum value of SAR (measured) = 0.106 W/kg

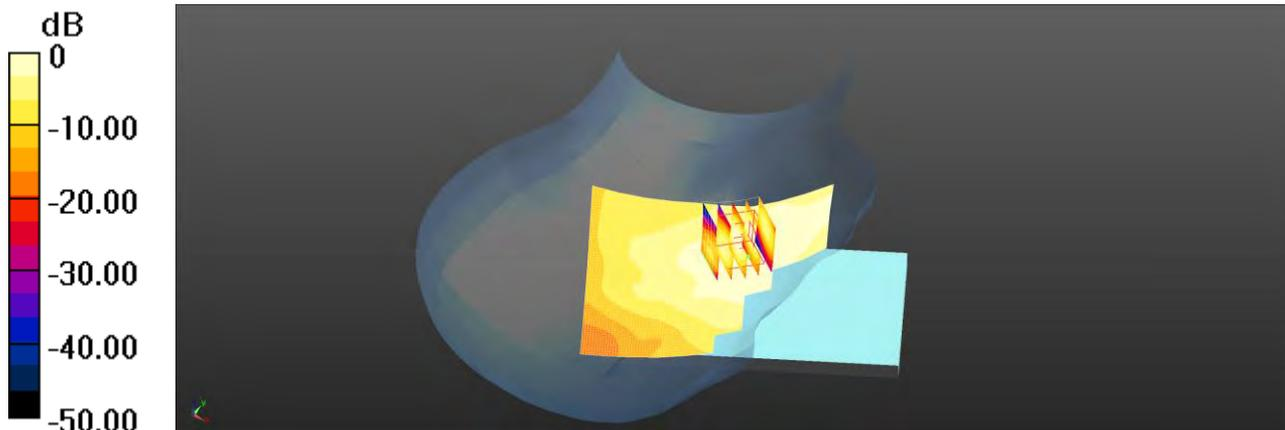

0 dB = 0.0994 W/kg = -10.03 dBW/kg

Unless otherwise stated the results shown in this test report refer only to the sample(s) tested and such sample(s) are retained for 90 days only.

除非另有說明，此報告結果僅對測試之樣品負責，同時此樣品僅保留90天。本報告未經本公司書面許可，不可部份複製。

This document is issued by the Company subject to its General Conditions of Service printed overleaf, available on request or accessible at <http://www.sgs.com.tw/Terms-and-Conditions> and for electronic format documents, subject to Terms and Conditions for Electronic Documents at <http://www.sgs.com.tw/Terms-and-Conditions>. Attention is drawn to the limitation of liability, indemnification and jurisdiction issues defined therein. Any holder of this document is advised that information contained hereon reflects the Company's findings at the time of its intervention only and within the limits of Client's instructions, if any. The Company's sole responsibility is to its Client and this document does not exonerate parties to a transaction from exercising all their rights and obligations under the transaction documents. This document cannot be reproduced except in full, without prior written approval of the Company. Any unauthorized alteration, forgery or falsification of the content or appearance of this document is unlawful and offenders may be prosecuted to the fullest extent of the law.

Date: 2020/7/19

Report No. :ES/2020/30005

LTE Band 7 (20MHz)_Head_Le Cheek_CH 21350_QPSK_1-99_LAT

Communication System: LTE; Frequency: 2560 MHz; Duty cycle= 1:1

Medium parameters used: $f = 2560$ MHz; $\sigma = 1.904$ S/m; $\epsilon_r = 38.521$; $\rho = 1000$ kg/m³

Phantom section: Left Section

Ambient temperature: 22.1°C; Liquid temperature: 21.8°C

DASY5 Configuration:

- Probe: EX3DV4 - SN3770; ConvF(7.21, 7.21, 7.21) @ 2560 MHz; Calibrated: 2020/5/27
- Sensor-Surface: 2mm (Mechanical Surface Detection)
- Electronics: DAE4 Sn877; Calibrated: 2020/3/17
- Phantom: SAM
- DASY52 52.10.4(1527); SEMCAD X 14.6.14(7483)

Area Scan (91x181x1): Interpolated grid: dx=12 mm, dy=12 mm

Maximum value of SAR (interpolated) = 0.157 W/kg

Zoom Scan (7x7x7)/Cube 0: Measurement grid: dx=5mm, dy=5mm, dz=5mm

Reference Value = 1.514 V/m; Power Drift = 0.14 dB

Peak SAR (extrapolated) = 0.167 W/kg

SAR(1 g) = 0.106 W/kg; SAR(10 g) = 0.066 W/kg

Smallest distance from peaks to all points 3 dB below = 11.1 mm

Ratio of SAR at M2 to SAR at M1 = 67.9%

Maximum value of SAR (measured) = 0.136 W/kg

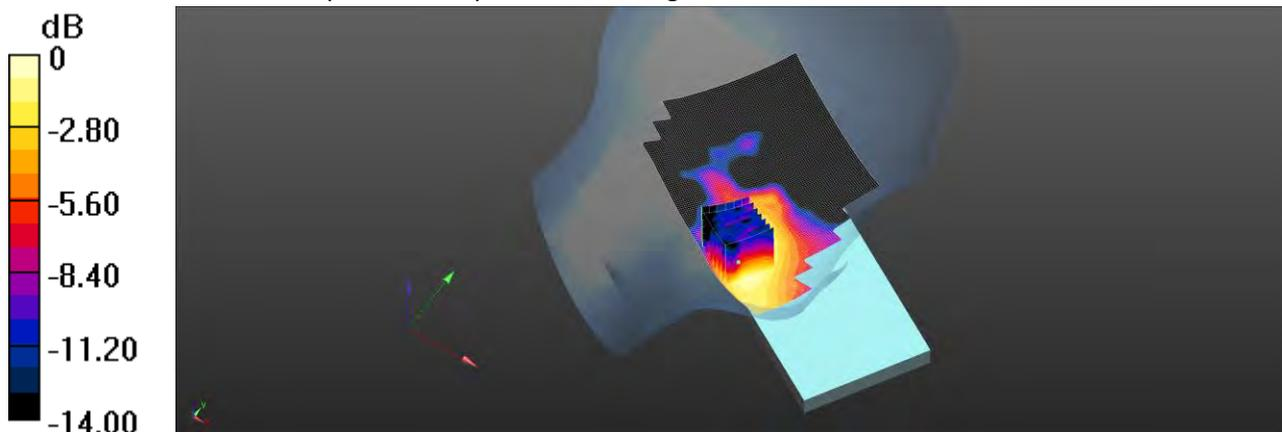

0 dB = 0.136 W/kg = -8.66 dBW/kg

Unless otherwise stated the results shown in this test report refer only to the sample(s) tested and such sample(s) are retained for 90 days only.

除非另有說明，此報告結果僅對測試之樣品負責，同時此樣品僅保留90天。本報告未經本公司書面許可，不可部份複製。

This document is issued by the Company subject to its General Conditions of Service printed overleaf, available on request or accessible at <http://www.sgs.com.tw/Terms-and-Conditions> and for electronic format documents, subject to Terms and Conditions for Electronic Documents at <http://www.sgs.com.tw/Terms-and-Conditions>. Attention is drawn to the limitation of liability, indemnification and jurisdiction issues defined therein. Any holder of this document is advised that information contained hereon reflects the Company's findings at the time of its intervention only and within the limits of Client's instructions, if any. The Company's sole responsibility is to its Client and this document does not exonerate parties to a transaction from exercising all their rights and obligations under the transaction documents. This document cannot be reproduced except in full, without prior written approval of the Company. Any unauthorized alteration, forgery or falsification of the content or appearance of this document is unlawful and offenders may be prosecuted to the fullest extent of the law.

Date: 2020/7/14

Report No. :ES/2020/30005

LTE Band 12 (10MHz)_Head_Re Cheek_CH 23060_QPSK_1-0_LAT

Communication System: LTE; Frequency: 704 MHz; Duty cycle= 1:1

Medium parameters used: $f = 704 \text{ MHz}$; $\sigma = 0.858 \text{ S/m}$; $\epsilon_r = 43.194$; $\rho = 1000 \text{ kg/m}^3$

Phantom section: Right Section

Ambient temperature: 21.3°C; Liquid temperature: 21.6°C

DASY5 Configuration:

- Probe: EX3DV4 - SN3770; ConvF(9.84, 9.84, 9.84) @ 704 MHz; Calibrated: 2020/5/27
- Sensor-Surface: 2mm (Mechanical Surface Detection)
- Electronics: DAE4 Sn877; Calibrated: 2020/3/17
- Phantom: SAM
- DASY52 52.10.4(1527); SEMCAD X 14.6.14(7483)

Area Scan (71x151x1): Interpolated grid: dx=15 mm, dy=15 mm

Maximum value of SAR (interpolated) = 0.115 W/kg

Zoom Scan (5x5x7)/Cube 0: Measurement grid: dx=8mm, dy=8mm, dz=5mm

Reference Value = 3.521 V/m; Power Drift = 0.05 dB

Peak SAR (extrapolated) = 0.116 W/kg

SAR(1 g) = 0.113 W/kg; SAR(10 g) = 0.104 W/kg

Smallest distance from peaks to all points 3 dB below = 13.8 mm

Ratio of SAR at M2 to SAR at M1 = 92.2%

Maximum value of SAR (measured) = 0.115 W/kg

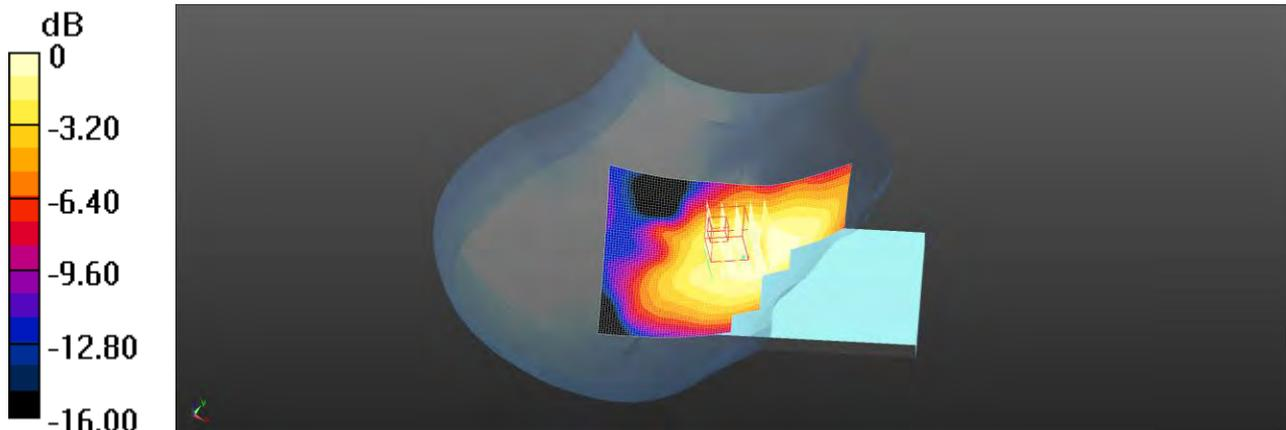

0 dB = 0.115 W/kg = -9.39 dBW/kg

Unless otherwise stated the results shown in this test report refer only to the sample(s) tested and such sample(s) are retained for 90 days only.

除非另有說明，此報告結果僅對測試之樣品負責，同時此樣品僅保留90天。本報告未經本公司書面許可，不可部份複製。

This document is issued by the Company subject to its General Conditions of Service printed overleaf, available on request or accessible at <http://www.sgs.com.tw/Terms-and-Conditions> and for electronic format documents, subject to Terms and Conditions for Electronic Documents at <http://www.sgs.com.tw/Terms-and-Conditions>. Attention is drawn to the limitation of liability, indemnification and jurisdiction issues defined therein. Any holder of this document is advised that information contained hereon reflects the Company's findings at the time of its intervention only and within the limits of Client's instructions, if any. The Company's sole responsibility is to its Client and this document does not exonerate parties to a transaction from exercising all their rights and obligations under the transaction documents. This document cannot be reproduced except in full, without prior written approval of the Company. Any unauthorized alteration, forgery or falsification of the content or appearance of this document is unlawful and offenders may be prosecuted to the fullest extent of the law.

Date: 2020/7/14

Report No. :ES/2020/30005

LTE Band 13 (10MHz)_Head_Re Cheek_CH 23230_QPSK_1-0_LAT

Communication System: LTE; Frequency: 782 MHz; Duty cycle= 1:1

Medium parameters used: $f = 782 \text{ MHz}$; $\sigma = 0.882 \text{ S/m}$; $\epsilon_r = 42.621$; $\rho = 1000 \text{ kg/m}^3$

Phantom section: Right Section

Ambient temperature: 21.3°C; Liquid temperature: 21.6°C

DASY5 Configuration:

- Probe: EX3DV4 - SN3770; ConvF(9.84, 9.84, 9.84) @ 782 MHz; Calibrated: 2020/5/27
- Sensor-Surface: 2mm (Mechanical Surface Detection)
- Electronics: DAE4 Sn877; Calibrated: 2020/3/17
- Phantom: SAM
- DASY52 52.10.4(1527); SEMCAD X 14.6.14(7483)

Area Scan (71x151x1): Interpolated grid: dx=15 mm, dy=15 mm

Maximum value of SAR (interpolated) = 0.136 W/kg

Zoom Scan (5x5x7)/Cube 0: Measurement grid: dx=8mm, dy=8mm, dz=5mm

Reference Value = 2.263 V/m; Power Drift = 0.10 dB

Peak SAR (extrapolated) = 0.135 W/kg

SAR(1 g) = 0.131 W/kg; SAR(10 g) = 0.122 W/kg

Smallest distance from peaks to all points 3 dB below = 10.8 mm

Ratio of SAR at M2 to SAR at M1 = 89.9%

Maximum value of SAR (measured) = 0.134 W/kg

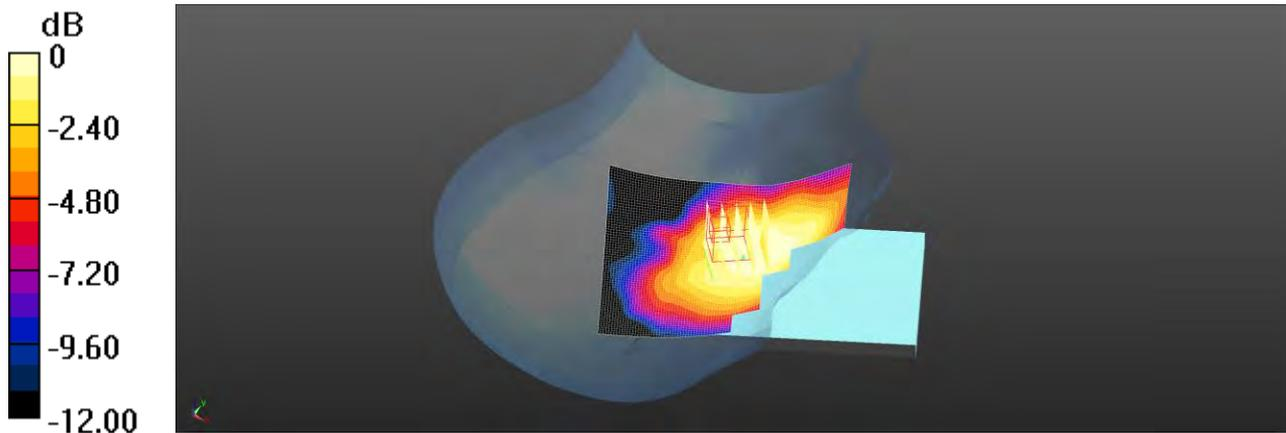

0 dB = 0.134 W/kg = -8.73 dBW/kg

Unless otherwise stated the results shown in this test report refer only to the sample(s) tested and such sample(s) are retained for 90 days only.

除非另有說明，此報告結果僅對測試之樣品負責，同時此樣品僅保留90天。本報告未經本公司書面許可，不可部份複製。

This document is issued by the Company subject to its General Conditions of Service printed overleaf, available on request or accessible at <http://www.sgs.com.tw/Terms-and-Conditions> and for electronic format documents, subject to Terms and Conditions for Electronic Documents at <http://www.sgs.com.tw/Terms-and-Conditions>. Attention is drawn to the limitation of liability, indemnification and jurisdiction issues defined therein. Any holder of this document is advised that information contained hereon reflects the Company's findings at the time of its intervention only and within the limits of Client's instructions, if any. The Company's sole responsibility is to its Client and this document does not exonerate parties to a transaction from exercising all their rights and obligations under the transaction documents. This document cannot be reproduced except in full, without prior written approval of the Company. Any unauthorized alteration, forgery or falsification of the content or appearance of this document is unlawful and offenders may be prosecuted to the fullest extent of the law.

Date: 2020/7/17

Report No. :ES/2020/30005

LTE Band 25 (20MHz)_Head_Le Cheek_CH 26590_QPSK_1-0_LAT

Communication System: LTE; Frequency: 1905 MHz; Duty cycle= 1:1

Medium parameters used: $f = 1905$ MHz; $\sigma = 1.421$ S/m; $\epsilon_r = 39.533$; $\rho = 1000$ kg/m³

Phantom section: Left Section

Ambient temperature: 22.1°C; Liquid temperature: 22.4°C

DASY5 Configuration:

- Probe: EX3DV4 - SN3770; ConvF(8.03, 8.03, 8.03) @ 1905 MHz; Calibrated: 2020/5/27
- Sensor-Surface: 2mm (Mechanical Surface Detection)
- Electronics: DAE4 Sn877; Calibrated: 2020/3/17
- Phantom: SAM
- DASY52 52.10.4(1527); SEMCAD X 14.6.14(7483)

Area Scan (71x141x1): Interpolated grid: dx=15 mm, dy=15 mm

Maximum value of SAR (interpolated) = 0.340 W/kg

Zoom Scan (5x5x7)/Cube 0: Measurement grid: dx=8mm, dy=8mm, dz=5mm

Reference Value = 4.128 V/m; Power Drift = 0.12 dB

Peak SAR (extrapolated) = 0.335 W/kg

SAR(1 g) = 0.256 W/kg; SAR(10 g) = 0.183 W/kg

Smallest distance from peaks to all points 3 dB below = 9.8 mm

Ratio of SAR at M2 to SAR at M1 = 85.4%

Maximum value of SAR (measured) = 0.294 W/kg

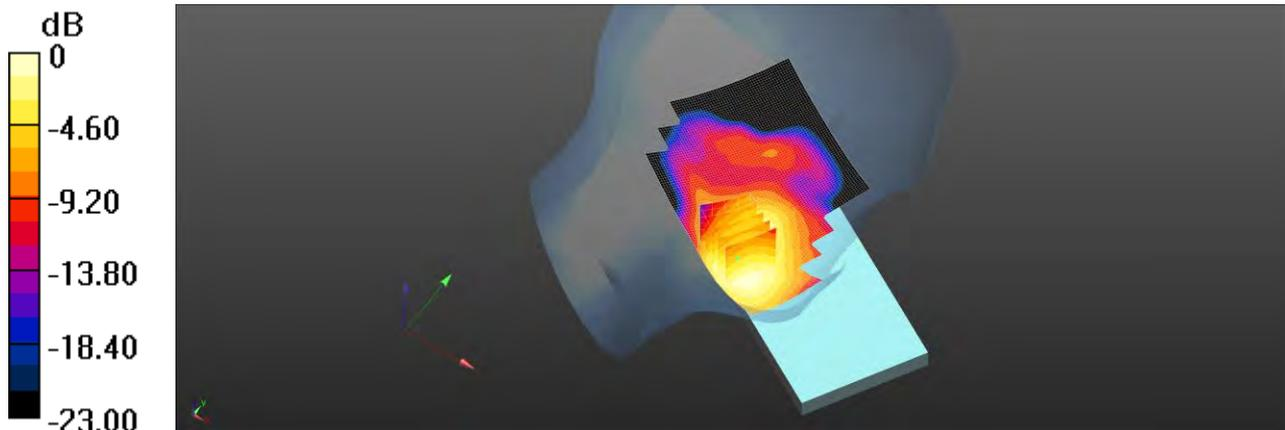

0 dB = 0.294 W/kg = -5.32 dBW/kg

Unless otherwise stated the results shown in this test report refer only to the sample(s) tested and such sample(s) are retained for 90 days only.

除非另有說明，此報告結果僅對測試之樣品負責，同時此樣品僅保留90天。本報告未經本公司書面許可，不可部份複製。

This document is issued by the Company subject to its General Conditions of Service printed overleaf, available on request or accessible at <http://www.sgs.com.tw/Terms-and-Conditions> and for electronic format documents, subject to Terms and Conditions for Electronic Documents at <http://www.sgs.com.tw/Terms-and-Conditions>. Attention is drawn to the limitation of liability, indemnification and jurisdiction issues defined therein. Any holder of this document is advised that information contained hereon reflects the Company's findings at the time of its intervention only and within the limits of Client's instructions, if any. The Company's sole responsibility is to its Client and this document does not exonerate parties to a transaction from exercising all their rights and obligations under the transaction documents. This document cannot be reproduced except in full, without prior written approval of the Company. Any unauthorized alteration, forgery or falsification of the content or appearance of this document is unlawful and offenders may be prosecuted to the fullest extent of the law.

Date: 2020/7/15

Report No. :ES/2020/30005

LTE Band 26 (15MHz)_Head_Re Cheek_CH 26765_QPSK_1-0_LAT

Communication System: LTE; Frequency: 821.5 MHz; Duty cycle= 1:1

Medium parameters used: $f = 821.5$ MHz; $\sigma = 0.884$ S/m; $\epsilon_r = 42.515$; $\rho = 1000$ kg/m³

Phantom section: Right Section

Ambient temperature: 21.4°C; Liquid temperature: 21.8°C

DASY5 Configuration:

- Probe: EX3DV4 - SN3770; ConvF(9.5, 9.5, 9.5) @ 821.5 MHz; Calibrated: 2020/5/27
- Sensor-Surface: 2mm (Mechanical Surface Detection)
- Electronics: DAE4 Sn877; Calibrated: 2020/3/17
- Phantom: SAM
- DASY52 52.10.4(1527); SEMCAD X 14.6.14(7483)

Area Scan (71x151x1): Interpolated grid: dx=15 mm, dy=15 mm

Maximum value of SAR (interpolated) = 0.112 W/kg

Zoom Scan (5x5x7)/Cube 0: Measurement grid: dx=8mm, dy=8mm, dz=5mm

Reference Value = 1.764 V/m; Power Drift = 0.16 dB

Peak SAR (extrapolated) = 0.120 W/kg

SAR(1 g) = 0.117 W/kg; SAR(10 g) = 0.109 W/kg

Smallest distance from peaks to all points 3 dB below = 11.8 mm

Ratio of SAR at M2 to SAR at M1 = 94.4%

Maximum value of SAR (measured) = 0.120 W/kg

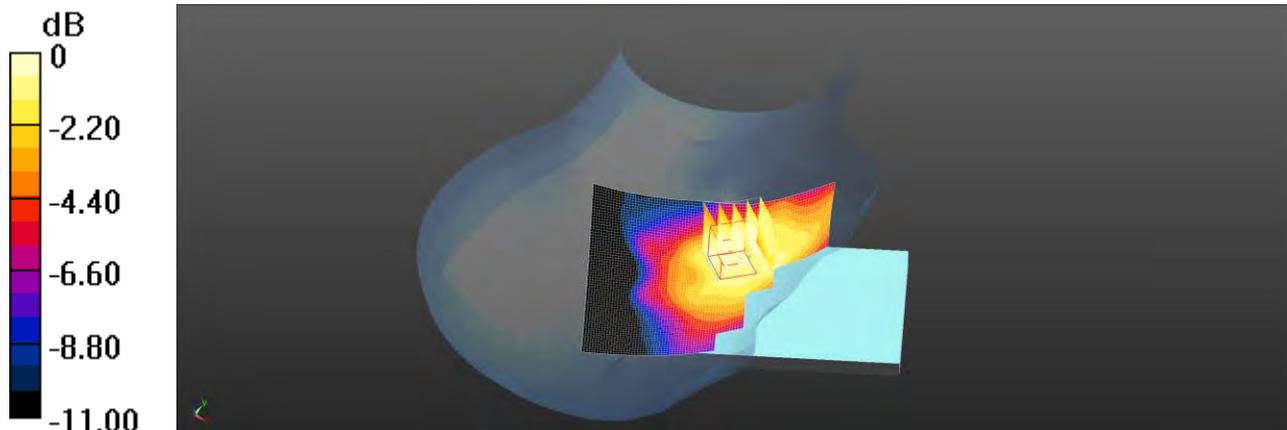

0 dB = 0.120 W/kg = -9.21 dBW/kg

Unless otherwise stated the results shown in this test report refer only to the sample(s) tested and such sample(s) are retained for 90 days only.

除非另有說明，此報告結果僅對測試之樣品負責，同時此樣品僅保留90天。本報告未經本公司書面許可，不可部份複製。

This document is issued by the Company subject to its General Conditions of Service printed overleaf, available on request or accessible at <http://www.sgs.com.tw/Terms-and-Conditions> and for electronic format documents, subject to Terms and Conditions for Electronic Documents at <http://www.sgs.com.tw/Terms-and-Conditions>. Attention is drawn to the limitation of liability, indemnification and jurisdiction issues defined therein. Any holder of this document is advised that information contained hereon reflects the Company's findings at the time of its intervention only and within the limits of Client's instructions, if any. The Company's sole responsibility is to its Client and this document does not exonerate parties to a transaction from exercising all their rights and obligations under the transaction documents. This document cannot be reproduced except in full, without prior written approval of the Company. Any unauthorized alteration, forgery or falsification of the content or appearance of this document is unlawful and offenders may be prosecuted to the fullest extent of the law.

Date: 2020/7/27

Report No. :ES/2020/30005

LTE Band 30 (10MHz)_Head_Le Cheek_CH 27710_QPSK_1-0_LAT

Communication System: LTE; Frequency: 2310 MHz; Duty cycle= 1:1

Medium parameters used: $f = 2310$ MHz; $\sigma = 1.678$ S/m; $\epsilon_r = 39.212$; $\rho = 1000$ kg/m³

Phantom section: Left Section

Ambient temperature: 21.6°C; Liquid temperature: 21.9°C

DASY5 Configuration:

- Probe: EX3DV4 - SN3770; ConvF(7.67, 7.67, 7.67) @ 2310 MHz; Calibrated: 2020/5/27
- Sensor-Surface: 2mm (Mechanical Surface Detection)
- Electronics: DAE4 Sn877; Calibrated: 2020/3/17
- Phantom: SAM
- DASY52 52.10.4(1527); SEMCAD X 14.6.14(7483)

Area Scan (91x181x1): Interpolated grid: dx=12 mm, dy=12 mm

Maximum value of SAR (interpolated) = 0.224 W/kg

Zoom Scan (7x7x7)/Cube 0: Measurement grid: dx=5mm, dy=5mm, dz=5mm

Reference Value = 3.921 V/m; Power Drift = 0.11 dB

Peak SAR (extrapolated) = 0.237 W/kg

SAR(1 g) = 0.165 W/kg; SAR(10 g) = 0.107 W/kg

Smallest distance from peaks to all points 3 dB below = 14 mm

Ratio of SAR at M2 to SAR at M1 = 79.4%

Maximum value of SAR (measured) = 0.205 W/kg

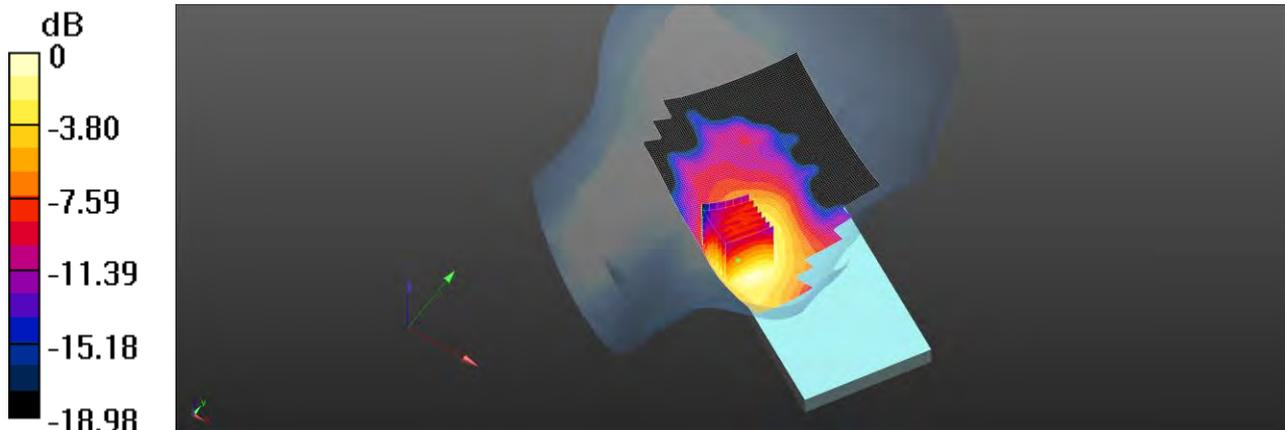

0 dB = 0.205 W/kg = -6.88 dBW/kg

Unless otherwise stated the results shown in this test report refer only to the sample(s) tested and such sample(s) are retained for 90 days only.

除非另有說明，此報告結果僅對測試之樣品負責，同時此樣品僅保留90天。本報告未經本公司書面許可，不可部份複製。

This document is issued by the Company subject to its General Conditions of Service printed overleaf, available on request or accessible at <http://www.sgs.com.tw/Terms-and-Conditions> and for electronic format documents, subject to Terms and Conditions for Electronic Documents at <http://www.sgs.com.tw/Terms-and-Conditions>. Attention is drawn to the limitation of liability, indemnification and jurisdiction issues defined therein. Any holder of this document is advised that information contained hereon reflects the Company's findings at the time of its intervention only and within the limits of Client's instructions, if any. The Company's sole responsibility is to its Client and this document does not exonerate parties to a transaction from exercising all their rights and obligations under the transaction documents. This document cannot be reproduced except in full, without prior written approval of the Company. Any unauthorized alteration, forgery or falsification of the content or appearance of this document is unlawful and offenders may be prosecuted to the fullest extent of the law.

Date: 2020/7/19

Report No. :ES/2020/30005

LTE Band 41 (20MHz)_Head_Le Cheek_CH 41490_QPSK_1-0_LAT

Communication System: LTE; Frequency: 2680 MHz; Duty cycle= 1:1.59956

Medium parameters used: $f = 2680$ MHz; $\sigma = 2.059$ S/m; $\epsilon_r = 38.252$; $\rho = 1000$ kg/m³

Phantom section: Left Section

Ambient temperature: 22.1°C; Liquid temperature: 21.8°C

DASY5 Configuration:

- Probe: EX3DV4 - SN3770; ConvF(7.21, 7.21, 7.21) @ 2680 MHz; Calibrated: 2020/5/27
- Sensor-Surface: 2mm (Mechanical Surface Detection)
- Electronics: DAE4 Sn877; Calibrated: 2020/3/17
- Phantom: SAM
- DASY52 52.10.4(1527); SEMCAD X 14.6.14(7483)

Area Scan (91x181x1): Interpolated grid: dx=12 mm, dy=12 mm

Maximum value of SAR (interpolated) = 0.193 W/kg

Zoom Scan (7x7x7)/Cube 0: Measurement grid: dx=5mm, dy=5mm, dz=5mm

Reference Value = 4.672 V/m; Power Drift = 0.02 dB

Peak SAR (extrapolated) = 0.291 W/kg

SAR(1 g) = 0.150 W/kg; SAR(10 g) = 0.059 W/kg

Smallest distance from peaks to all points 3 dB below = 8.3 mm

Ratio of SAR at M2 to SAR at M1 = 65.4%

Maximum value of SAR (measured) = 0.211 W/kg

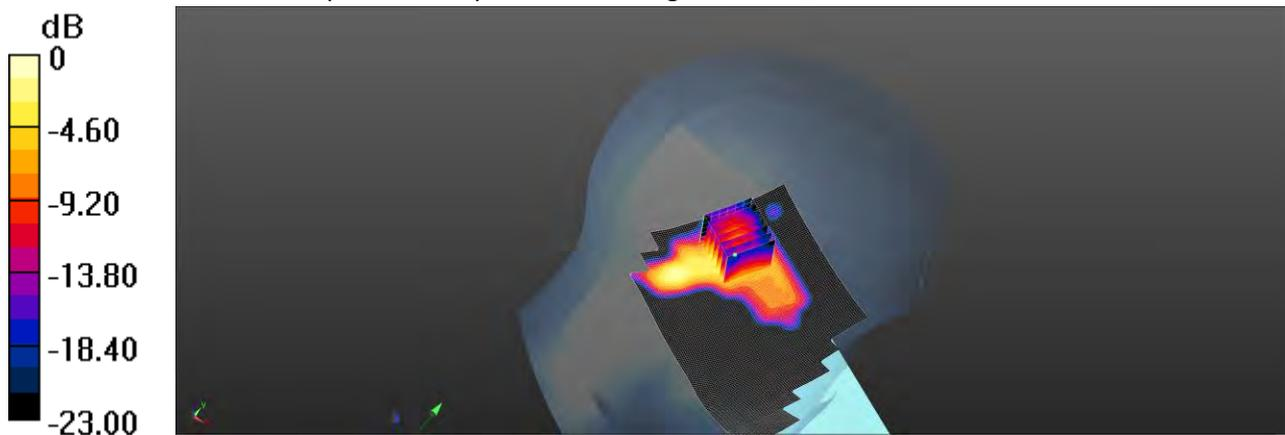

0 dB = 0.211 W/kg = -6.76 dBW/kg

Unless otherwise stated the results shown in this test report refer only to the sample(s) tested and such sample(s) are retained for 90 days only.

除非另有說明，此報告結果僅對測試之樣品負責，同時此樣品僅保留90天。本報告未經本公司書面許可，不可部份複製。

This document is issued by the Company subject to its General Conditions of Service printed overleaf, available on request or accessible at <http://www.sgs.com.tw/Terms-and-Conditions> and for electronic format documents, subject to Terms and Conditions for Electronic Documents at <http://www.sgs.com.tw/Terms-and-Conditions>. Attention is drawn to the limitation of liability, indemnification and jurisdiction issues defined therein. Any holder of this document is advised that information contained hereon reflects the Company's findings at the time of its intervention only and within the limits of Client's instructions, if any. The Company's sole responsibility is to its Client and this document does not exonerate parties to a transaction from exercising all their rights and obligations under the transaction documents. This document cannot be reproduced except in full, without prior written approval of the Company. Any unauthorized alteration, forgery or falsification of the content or appearance of this document is unlawful and offenders may be prosecuted to the fullest extent of the law.

Date: 2020/7/21

Report No. :ES/2020/30005

LTE Band 42 (20MHz)_Head_Le Cheek_CH 43490_QPSK_1-99_LAT

Communication System: LTE; Frequency: 3590 MHz; Duty cycle= 1:1.59956

Medium parameters used: $f = 3590$ MHz; $\sigma = 2.978$ S/m; $\epsilon_r = 37.704$; $\rho = 1000$ kg/m³

Phantom section: Left Section

Ambient temperature: 22.0°C; Liquid temperature: 22.4°C

DASY5 Configuration:

- Probe: EX3DV4 - SN3770; ConvF(6.7, 6.7, 6.7) @ 3590 MHz; Calibrated: 2020/5/27
- Sensor-Surface: 2mm (Mechanical Surface Detection)
- Electronics: DAE4 Sn877; Calibrated: 2020/3/17
- Phantom: SAM
- DASY52 52.10.4(1527); SEMCAD X 14.6.14(7483)

Area Scan (91x181x1): Interpolated grid: dx=12 mm, dy=12 mm

Maximum value of SAR (interpolated) = 0.0982 W/kg

Zoom Scan (7x7x8)/Cube 0: Measurement grid: dx=5mm, dy=5mm, dz=4mm

Reference Value = 2.231 V/m; Power Drift = 0.05 dB

Peak SAR (extrapolated) = 0.127 W/kg

SAR(1 g) = 0.051 W/kg; SAR(10 g) = 0.016 W/kg

Smallest distance from peaks to all points 3 dB below: Larger than measurement grid

Ratio of SAR at M2 to SAR at M1 = 38.2%

Maximum value of SAR (measured) = 0.0928 W/kg

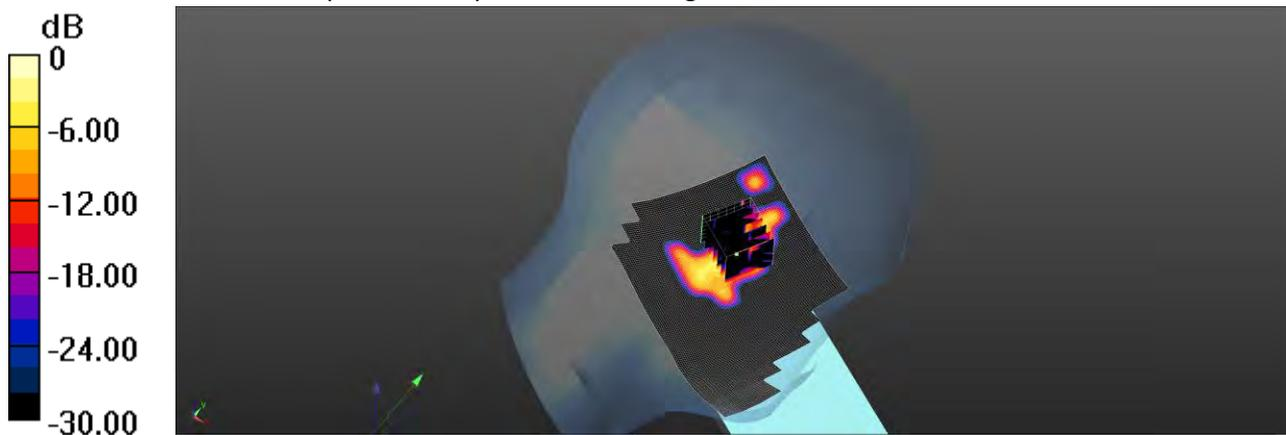

0 dB = 0.0928 W/kg = -10.32 dBW/kg

Unless otherwise stated the results shown in this test report refer only to the sample(s) tested and such sample(s) are retained for 90 days only.

除非另有說明，此報告結果僅對測試之樣品負責，同時此樣品僅保留90天。本報告未經本公司書面許可，不可部份複製。

This document is issued by the Company subject to its General Conditions of Service printed overleaf, available on request or accessible at <http://www.sgs.com.tw/Terms-and-Conditions> and for electronic format documents, subject to Terms and Conditions for Electronic Documents at <http://www.sgs.com.tw/Terms-and-Conditions>. Attention is drawn to the limitation of liability, indemnification and jurisdiction issues defined therein. Any holder of this document is advised that information contained hereon reflects the Company's findings at the time of its intervention only and within the limits of Client's instructions, if any. The Company's sole responsibility is to its Client and this document does not exonerate parties to a transaction from exercising all their rights and obligations under the transaction documents. This document cannot be reproduced except in full, without prior written approval of the Company. Any unauthorized alteration, forgery or falsification of the content or appearance of this document is unlawful and offenders may be prosecuted to the fullest extent of the law.

Date: 2020/7/21

Report No. :ES/2020/30005

LTE Band 48 (20MHz)_Head_Le Cheek_CH 55773_QPSK_1-0_LAT

Communication System: LTE; Frequency: 3603.3 MHz; Duty cycle= 1:1.59956

Medium parameters used: $f = 3603.3$ MHz; $\sigma = 2.983$ S/m; $\epsilon_r = 37.699$; $\rho = 1000$ kg/m³

Phantom section: Left Section

Ambient temperature: 22.0°C; Liquid temperature: 22.4°C

DASY5 Configuration:

- Probe: EX3DV4 - SN3770; ConvF(6.7, 6.7, 6.7) @ 3603.3 MHz; Calibrated: 2020/5/27
- Sensor-Surface: 2mm (Mechanical Surface Detection)
- Electronics: DAE4 Sn877; Calibrated: 2020/3/17
- Phantom: SAM
- DASY52 52.10.4(1527); SEMCAD X 14.6.14(7483)

Area Scan (91x181x1): Interpolated grid: dx=12 mm, dy=12 mm

Maximum value of SAR (interpolated) = 0.133 W/kg

Zoom Scan (7x7x8)/Cube 0: Measurement grid: dx=5mm, dy=5mm, dz=4mm

Reference Value = 1.971 V/m; Power Drift = 0.17 dB

Peak SAR (extrapolated) = 0.163 W/kg

SAR(1 g) = 0.069 W/kg; SAR(10 g) = 0.023 W/kg

Smallest distance from peaks to all points 3 dB below = 6.7 mm

Ratio of SAR at M2 to SAR at M1 = 41%

Maximum value of SAR (measured) = 0.118 W/kg

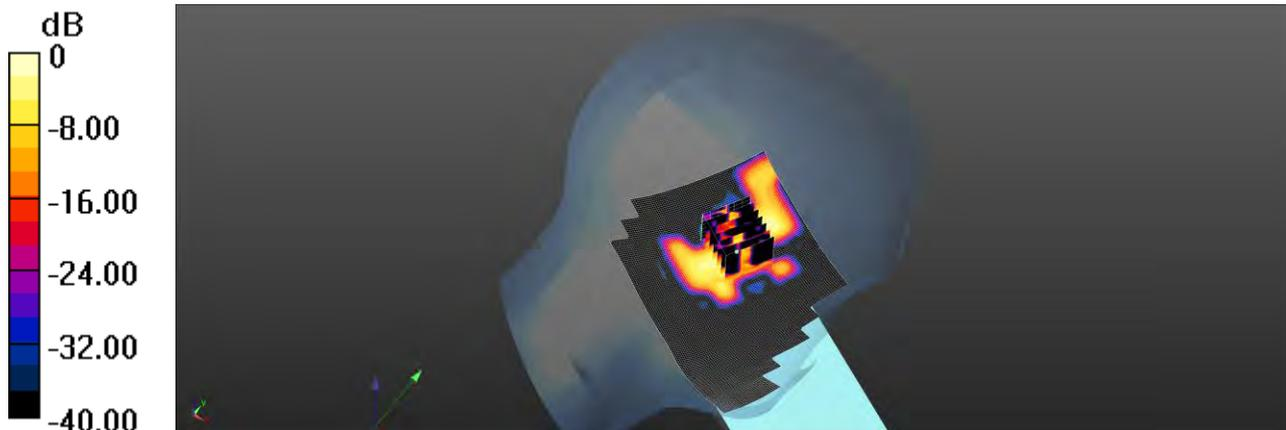

0 dB = 0.118 W/kg = -9.28 dBW/kg

Unless otherwise stated the results shown in this test report refer only to the sample(s) tested and such sample(s) are retained for 90 days only.

除非另有說明，此報告結果僅對測試之樣品負責，同時此樣品僅保留90天。本報告未經本公司書面許可，不可部份複製。

This document is issued by the Company subject to its General Conditions of Service printed overleaf, available on request or accessible at <http://www.sgs.com.tw/Terms-and-Conditions> and for electronic format documents, subject to Terms and Conditions for Electronic Documents at <http://www.sgs.com.tw/Terms-and-Conditions>. Attention is drawn to the limitation of liability, indemnification and jurisdiction issues defined therein. Any holder of this document is advised that information contained hereon reflects the Company's findings at the time of its intervention only and within the limits of Client's instructions, if any. The Company's sole responsibility is to its Client and this document does not exonerate parties to a transaction from exercising all their rights and obligations under the transaction documents. This document cannot be reproduced except in full, without prior written approval of the Company. Any unauthorized alteration, forgery or falsification of the content or appearance of this document is unlawful and offenders may be prosecuted to the fullest extent of the law.

Date: 2020/7/16

Report No. :ES/2020/30005

LTE Band 66 (20MHz)_Head_Le Cheek_CH 132572_QPSK_1-0_LAT

Communication System: LTE; Frequency: 1770 MHz; Duty cycle= 1:1

Medium parameters used: $f = 1770$ MHz; $\sigma = 1.388$ S/m; $\epsilon_r = 40.012$; $\rho = 1000$ kg/m³

Phantom section: Left Section

Ambient temperature: 22.5°C; Liquid temperature: 22.1°C

DASY5 Configuration:

- Probe: EX3DV4 - SN3770; ConvF(8.36, 8.36, 8.36) @ 1770 MHz; Calibrated: 2020/5/27
- Sensor-Surface: 2mm (Mechanical Surface Detection)
- Electronics: DAE4 Sn877; Calibrated: 2020/3/17
- Phantom: SAM
- DASY52 52.10.4(1527); SEMCAD X 14.6.14(7483)

Area Scan (71x141x1): Interpolated grid: dx=15 mm, dy=15 mm

Maximum value of SAR (interpolated) = 0.343 W/kg

Zoom Scan (5x5x7)/Cube 0: Measurement grid: dx=8mm, dy=8mm, dz=5mm

Reference Value = 5.324 V/m; Power Drift = 0.10 dB

Peak SAR (extrapolated) = 0.338 W/kg

SAR(1 g) = 0.269 W/kg; SAR(10 g) = 0.200 W/kg

Smallest distance from peaks to all points 3 dB below = 10.3 mm

Ratio of SAR at M2 to SAR at M1 = 84.5%

Maximum value of SAR (measured) = 0.308 W/kg

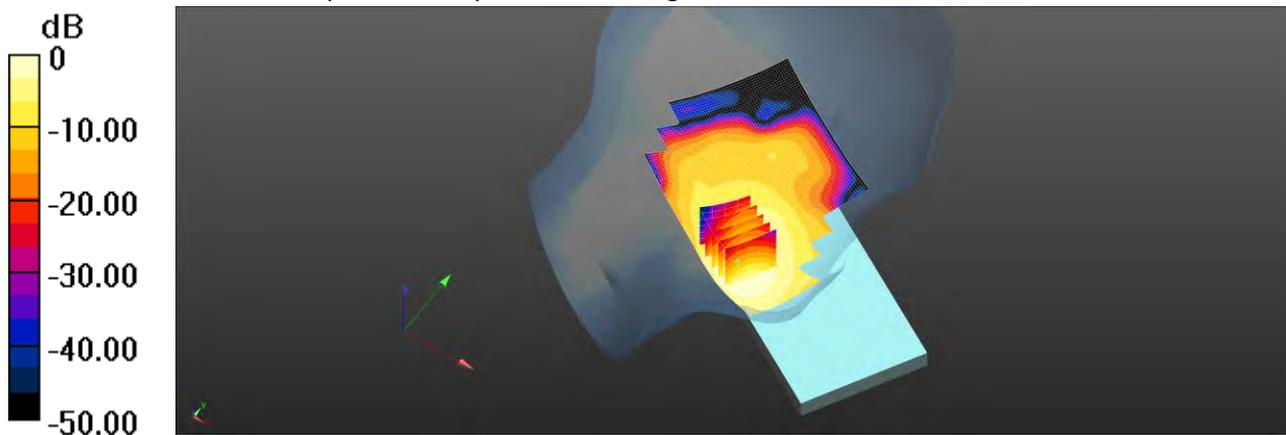

0 dB = 0.343 W/kg = -4.64 dBW/kg

Unless otherwise stated the results shown in this test report refer only to the sample(s) tested and such sample(s) are retained for 90 days only.

除非另有說明，此報告結果僅對測試之樣品負責，同時此樣品僅保留90天。本報告未經本公司書面許可，不可部份複製。

This document is issued by the Company subject to its General Conditions of Service printed overleaf, available on request or accessible at <http://www.sgs.com.tw/Terms-and-Conditions> and for electronic format documents, subject to Terms and Conditions for Electronic Documents at <http://www.sgs.com.tw/Terms-and-Conditions>. Attention is drawn to the limitation of liability, indemnification and jurisdiction issues defined therein. Any holder of this document is advised that information contained hereon reflects the Company's findings at the time of its intervention only and within the limits of Client's instructions, if any. The Company's sole responsibility is to its Client and this document does not exonerate parties to a transaction from exercising all their rights and obligations under the transaction documents. This document cannot be reproduced except in full, without prior written approval of the Company. Any unauthorized alteration, forgery or falsification of the content or appearance of this document is unlawful and offenders may be prosecuted to the fullest extent of the law.

Date: 2020/7/14

Report No. :ES/2020/30005

LTE Band 71 (20MHz)_Head_Re Cheek_CH 133222_QPSK_1-0_LAT

Communication System: LTE; Frequency: 673 MHz; Duty cycle= 1:1

Medium parameters used: $f = 673 \text{ MHz}$; $\sigma = 0.849 \text{ S/m}$; $\epsilon_r = 43.493$; $\rho = 1000 \text{ kg/m}^3$

Phantom section: Right Section

Ambient temperature: 21.3°C; Liquid temperature: 21.6°C

DASY5 Configuration:

- Probe: EX3DV4 - SN3770; ConvF(9.84, 9.84, 9.84) @ 673 MHz; Calibrated: 2020/5/27
- Sensor-Surface: 2mm (Mechanical Surface Detection)
- Electronics: DAE4 Sn877; Calibrated: 2020/3/17
- Phantom: SAM
- DASY52 52.10.4(1527); SEMCAD X 14.6.14(7483)

Area Scan (71x151x1): Interpolated grid: dx=15 mm, dy=15 mm

Maximum value of SAR (interpolated) = 0.123 W/kg

Zoom Scan (5x5x7)/Cube 0: Measurement grid: dx=8mm, dy=8mm, dz=5mm

Reference Value = 2.655 V/m; Power Drift = 0.16 dB

Peak SAR (extrapolated) = 0.146 W/kg

SAR(1 g) = 0.143 W/kg; SAR(10 g) = 0.132 W/kg

Smallest distance from peaks to all points 3 dB below = 8.3 mm

Ratio of SAR at M2 to SAR at M1 = 84.2%

Maximum value of SAR (measured) = 0.145 W/kg

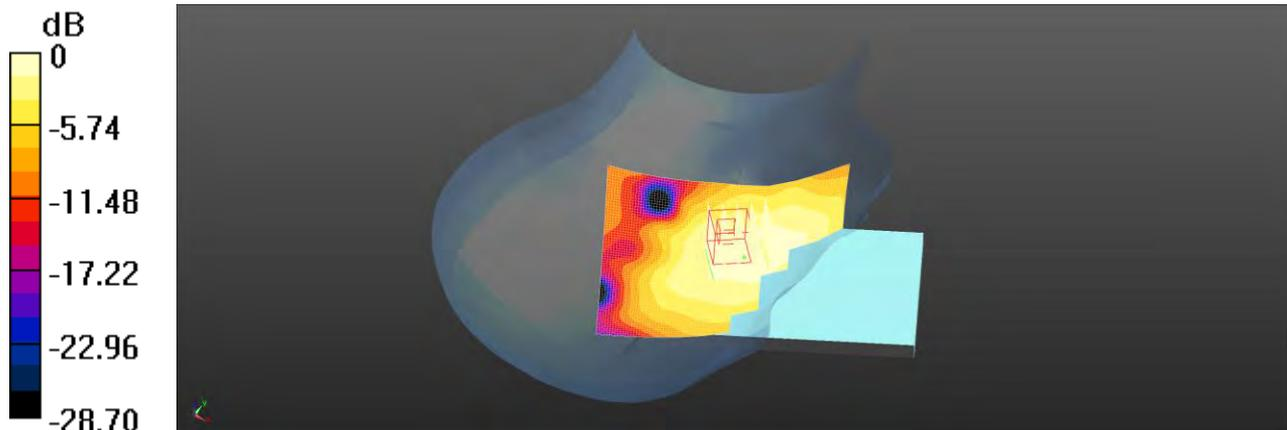

0 dB = 0.145 W/kg = -8.39 dBW/kg

Unless otherwise stated the results shown in this test report refer only to the sample(s) tested and such sample(s) are retained for 90 days only.

除非另有說明，此報告結果僅對測試之樣品負責，同時此樣品僅保留90天。本報告未經本公司書面許可，不可部份複製。

This document is issued by the Company subject to its General Conditions of Service printed overleaf, available on request or accessible at <http://www.sgs.com.tw/Terms-and-Conditions> and for electronic format documents, subject to Terms and Conditions for Electronic Documents at <http://www.sgs.com.tw/Terms-and-Conditions>. Attention is drawn to the limitation of liability, indemnification and jurisdiction issues defined therein. Any holder of this document is advised that information contained hereon reflects the Company's findings at the time of its intervention only and within the limits of Client's instructions, if any. The Company's sole responsibility is to its Client and this document does not exonerate parties to a transaction from exercising all their rights and obligations under the transaction documents. This document cannot be reproduced except in full, without prior written approval of the Company. Any unauthorized alteration, forgery or falsification of the content or appearance of this document is unlawful and offenders may be prosecuted to the fullest extent of the law.

Date: 2020/7/15

Report No. :ES/2020/30005

GPRS 850_Hotspot_Front side_CH 251_10mm_UAT

Communication System: GPRS (1Dn2Up); Frequency: 848.8 MHz; Duty cycle= 1:4.1

Medium parameters used: $f = 849$ MHz; $\sigma = 0.925$ S/m; $\epsilon_r = 41.847$; $\rho = 1000$ kg/m³

Phantom section: Flat Section

Ambient temperature: 21.9°C; Liquid temperature: 22.3°C

DASY5 Configuration:

- Probe: EX3DV4 - SN7509; ConvF(9.73, 9.73, 9.73) @ 848.8 MHz; Calibrated: 2020/03/25
- Sensor-Surface: 2mm (Mechanical Surface Detection)
- Electronics: DAE4 Sn558; Calibrated: 2019/10/11
- Phantom: SAM
- DASY52 52.10.4(1527); SEMCAD X 14.6.14(7483)

Area Scan (71x141x1): Interpolated grid: dx=15 mm, dy=15 mm

Maximum value of SAR (interpolated) = 0.429 W/kg

Zoom Scan (5x5x7)/Cube 0: Measurement grid: dx=8mm, dy=8mm, dz=5mm

Reference Value = 8.647 V/m; Power Drift = 0.11 dB

Peak SAR (extrapolated) = 0.451 W/kg

SAR(1 g) = 0.350 W/kg; SAR(10 g) = 0.253 W/kg

Smallest distance from peaks to all points 3 dB below = 12.5 mm

Ratio of SAR at M2 to SAR at M1 = 82.7%

Maximum value of SAR (measured) = 0.400 W/kg

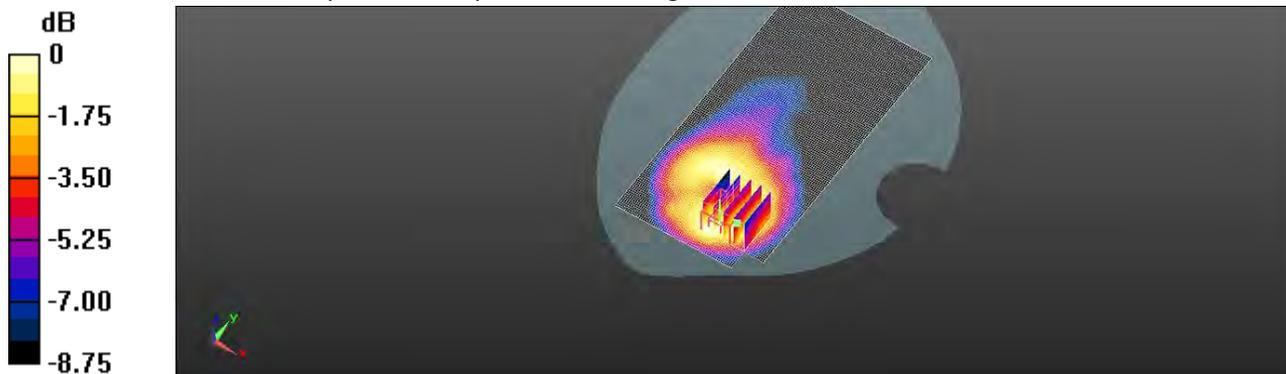

0 dB = 0.400 W/kg = -3.98 dBW/kg

Unless otherwise stated the results shown in this test report refer only to the sample(s) tested and such sample(s) are retained for 90 days only.

除非另有說明，此報告結果僅對測試之樣品負責，同時此樣品僅保留90天。本報告未經本公司書面許可，不可部份複製。

This document is issued by the Company subject to its General Conditions of Service printed overleaf, available on request or accessible at <http://www.sgs.com.tw/Terms-and-Conditions> and for electronic format documents, subject to Terms and Conditions for Electronic Documents at <http://www.sgs.com.tw/Terms-and-Conditions>. Attention is drawn to the limitation of liability, indemnification and jurisdiction issues defined therein. Any holder of this document is advised that information contained hereon reflects the Company's findings at the time of its intervention only and within the limits of Client's instructions, if any. The Company's sole responsibility is to its Client and this document does not exonerate parties to a transaction from exercising all their rights and obligations under the transaction documents. This document cannot be reproduced except in full, without prior written approval of the Company. Any unauthorized alteration, forgery or falsification of the content or appearance of this document is unlawful and offenders may be prosecuted to the fullest extent of the law.

Date: 2020/7/15

Report No. : ES/2020/30005

WCDMA Band V_Hotspot_Front side_CH 4183_10mm_UAT

Communication System: WCDMA; Frequency: 836.6 MHz; Duty cycle= 1:1

Medium parameters used: $f = 837$ MHz; $\sigma = 0.938$ S/m; $\epsilon_r = 41.793$; $\rho = 1000$ kg/m³

Phantom section: Flat Section

Ambient temperature: 21.9°C; Liquid temperature: 22.3°C

DASY5 Configuration:

- Probe: EX3DV4 - SN7509; ConvF(9.73, 9.73, 9.73) @ 836.6 MHz; Calibrated: 2020/03/25
- Sensor-Surface: 2mm (Mechanical Surface Detection)
- Electronics: DAE4 Sn558; Calibrated: 2019/10/11
- Phantom: SAM
- DASY52 52.10.4(1527); SEMCAD X 14.6.14(7483)

Area Scan (71x141x1): Interpolated grid: dx=15 mm, dy=15 mm

Maximum value of SAR (interpolated) = 0.269 W/kg

Zoom Scan (5x5x7)/Cube 0: Measurement grid: dx=8mm, dy=8mm, dz=5mm

Reference Value = 7.752 V/m; Power Drift = 0.13 dB

Peak SAR (extrapolated) = 0.286 W/kg

SAR(1 g) = 0.218 W/kg; SAR(10 g) = 0.157 W/kg

Smallest distance from peaks to all points 3 dB below = 12.5 mm

Ratio of SAR at M2 to SAR at M1 = 77%

Maximum value of SAR (measured) = 0.258 W/kg

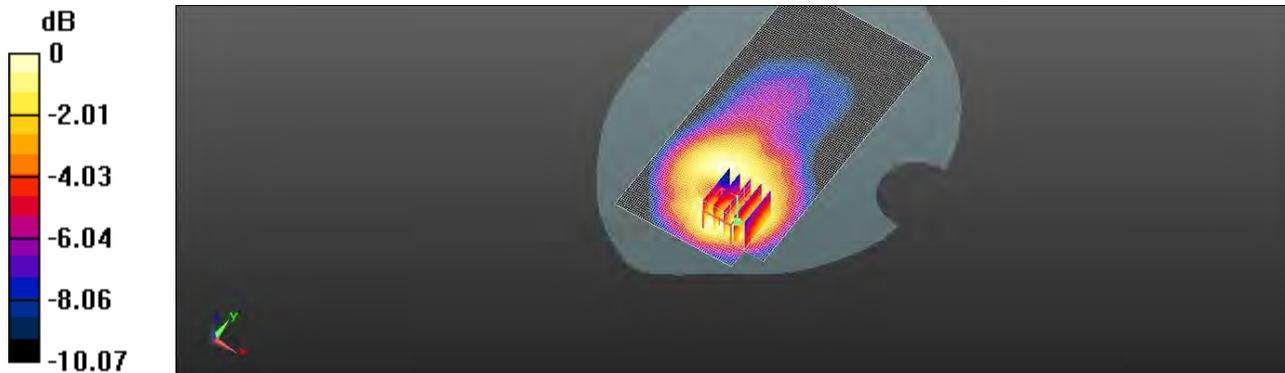

0 dB = 0.258 W/kg = -5.88 dBW/kg

Unless otherwise stated the results shown in this test report refer only to the sample(s) tested and such sample(s) are retained for 90 days only.

除非另有說明，此報告結果僅對測試之樣品負責，同時此樣品僅保留90天。本報告未經本公司書面許可，不可部份複製。

This document is issued by the Company subject to its General Conditions of Service printed overleaf, available on request or accessible at <http://www.sgs.com.tw/Terms-and-Conditions> and for electronic format documents, subject to Terms and Conditions for Electronic Documents at <http://www.sgs.com.tw/Terms-and-Conditions>. Attention is drawn to the limitation of liability, indemnification and jurisdiction issues defined therein. Any holder of this document is advised that information contained hereon reflects the Company's findings at the time of its intervention only and within the limits of Client's instructions, if any. The Company's sole responsibility is to its Client and this document does not exonerate parties to a transaction from exercising all their rights and obligations under the transaction documents. This document cannot be reproduced except in full, without prior written approval of the Company. Any unauthorized alteration, forgery or falsification of the content or appearance of this document is unlawful and offenders may be prosecuted to the fullest extent of the law.

Date: 2020/7/14

Report No. :ES/2020/30005

LTE Band 12 (10MHz)_Hotspot_Front side_CH 23060_QPSK_1-0_10mm_UAT

Communication System: LTE; Frequency: 704 MHz; Duty cycle= 1:1

Medium parameters used: $f = 704 \text{ MHz}$; $\sigma = 0.858 \text{ S/m}$; $\epsilon_r = 43.194$; $\rho = 1000 \text{ kg/m}^3$

Phantom section: Flat Section

Ambient temperature: 21.8°C; Liquid temperature: 22.3°C

DASY5 Configuration:

- Probe: EX3DV4 - SN7509; ConvF(9.94, 9.94, 9.94) @ 704 MHz; Calibrated: 2020/03/25
- Sensor-Surface: 2mm (Mechanical Surface Detection)
- Electronics: DAE4 Sn558; Calibrated: 2019/10/11
- Phantom: SAM
- DASY52 52.10.4(1527); SEMCAD X 14.6.14(7483)

Area Scan (71x141x1): Interpolated grid: dx=15 mm, dy=15 mm

Maximum value of SAR (interpolated) = 0.145 W/kg

Zoom Scan (5x5x7)/Cube 0: Measurement grid: dx=8mm, dy=8mm, dz=5mm

Reference Value = 7.285 V/m; Power Drift = 0.16 dB

Peak SAR (extrapolated) = 0.154 W/kg

SAR(1 g) = 0.118 W/kg; SAR(10 g) = 0.086 W/kg

Smallest distance from peaks to all points 3 dB below = 14.8 mm

Ratio of SAR at M2 to SAR at M1 = 75.5%

Maximum value of SAR (measured) = 0.139 W/kg

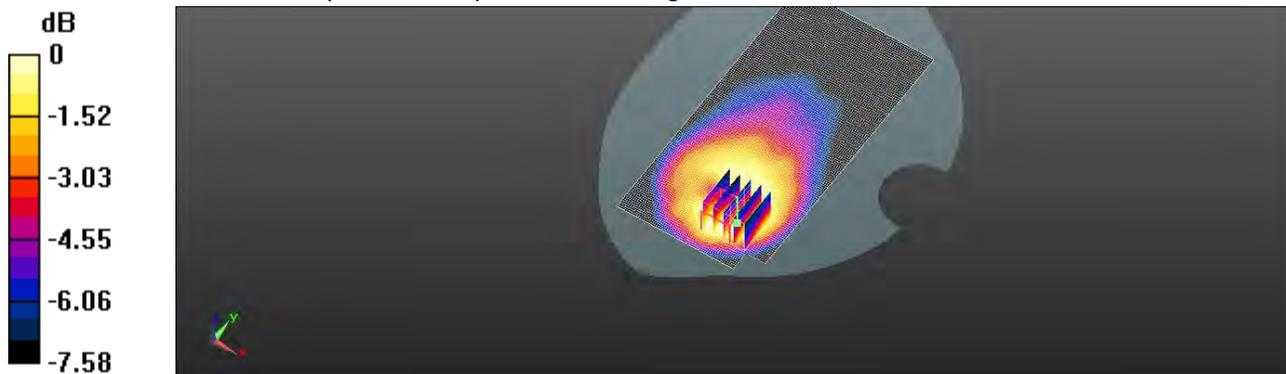

0 dB = 0.139 W/kg = -8.57 dBW/kg

Unless otherwise stated the results shown in this test report refer only to the sample(s) tested and such sample(s) are retained for 90 days only.

除非另有說明，此報告結果僅對測試之樣品負責，同時此樣品僅保留90天。本報告未經本公司書面許可，不可部份複製。

This document is issued by the Company subject to its General Conditions of Service printed overleaf, available on request or accessible at <http://www.sgs.com.tw/Terms-and-Conditions> and for electronic format documents, subject to Terms and Conditions for Electronic Documents at <http://www.sgs.com.tw/Terms-and-Conditions>. Attention is drawn to the limitation of liability, indemnification and jurisdiction issues defined therein. Any holder of this document is advised that information contained hereon reflects the Company's findings at the time of its intervention only and within the limits of Client's instructions, if any. The Company's sole responsibility is to its Client and this document does not exonerate parties to a transaction from exercising all their rights and obligations under the transaction documents. This document cannot be reproduced except in full, without prior written approval of the Company. Any unauthorized alteration, forgery or falsification of the content or appearance of this document is unlawful and offenders may be prosecuted to the fullest extent of the law.

Date: 2020/7/14

Report No. :ES/2020/30005

LTE Band 13 (10MHz)_Hotspot_Front side_CH 23230_QPSK_1-49_10mm_UAT

Communication System: LTE; Frequency: 782 MHz; Duty cycle= 1:1

Medium parameters used: $f = 782 \text{ MHz}$; $\sigma = 0.882 \text{ S/m}$; $\epsilon_r = 42.621$; $\rho = 1000 \text{ kg/m}^3$

Phantom section: Flat Section

Ambient temperature: 21.8°C; Liquid temperature: 22.3°C

DASY5 Configuration:

- Probe: EX3DV4 - SN7509; ConvF(9.94, 9.94, 9.94) @ 782 MHz; Calibrated: 2020/03/25
- Sensor-Surface: 2mm (Mechanical Surface Detection)
- Electronics: DAE4 Sn558; Calibrated: 2019/10/11
- Phantom: SAM
- DASY52 52.10.4(1527); SEMCAD X 14.6.14(7483)

Area Scan (71x141x1): Interpolated grid: dx=15 mm, dy=15 mm

Maximum value of SAR (interpolated) = 0.283 W/kg

Zoom Scan (5x5x7)/Cube 0: Measurement grid: dx=8mm, dy=8mm, dz=5mm

Reference Value = 8.520 V/m; Power Drift = 0.13 dB

Peak SAR (extrapolated) = 0.321 W/kg

SAR(1 g) = 0.244 W/kg; SAR(10 g) = 0.175 W/kg

Smallest distance from peaks to all points 3 dB below = 12.5 mm

Ratio of SAR at M2 to SAR at M1 = 76%

Maximum value of SAR (measured) = 0.286 W/kg

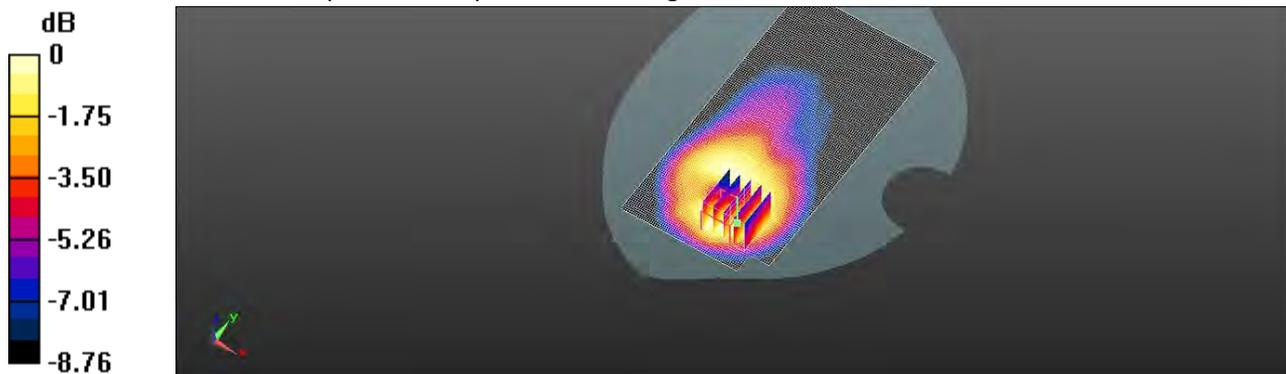

0 dB = 0.286 W/kg = -5.44 dBW/kg

Unless otherwise stated the results shown in this test report refer only to the sample(s) tested and such sample(s) are retained for 90 days only.

除非另有說明，此報告結果僅對測試之樣品負責，同時此樣品僅保留90天。本報告未經本公司書面許可，不可部份複製。

This document is issued by the Company subject to its General Conditions of Service printed overleaf, available on request or accessible at <http://www.sgs.com.tw/Terms-and-Conditions> and for electronic format documents, subject to Terms and Conditions for Electronic Documents at <http://www.sgs.com.tw/Terms-and-Conditions>. Attention is drawn to the limitation of liability, indemnification and jurisdiction issues defined therein. Any holder of this document is advised that information contained hereon reflects the Company's findings at the time of its intervention only and within the limits of Client's instructions, if any. The Company's sole responsibility is to its Client and this document does not exonerate parties to a transaction from exercising all their rights and obligations under the transaction documents. This document cannot be reproduced except in full, without prior written approval of the Company. Any unauthorized alteration, forgery or falsification of the content or appearance of this document is unlawful and offenders may be prosecuted to the fullest extent of the law.

Date: 2020/7/15

Report No. :ES/2020/30005

LTE Band 26 (15MHz)_Hotspot_Front side_CH 26765_QPSK_1-0_10mm_UAT

Communication System: LTE; Frequency: 821.5 MHz; Duty cycle= 1:1

Medium parameters used: $f = 821.5$ MHz; $\sigma = 0.884$ S/m; $\epsilon_r = 42.515$; $\rho = 1000$ kg/m³

Phantom section: Flat Section

Ambient temperature: 21.9°C; Liquid temperature: 22.3°C

DASY5 Configuration:

- Probe: EX3DV4 - SN7509; ConvF(9.73, 9.73, 9.73) @ 821.5 MHz; Calibrated: 2020/03/25
- Sensor-Surface: 2mm (Mechanical Surface Detection)
- Electronics: DAE4 Sn558; Calibrated: 2019/10/11
- Phantom: SAM
- DASY52 52.10.4(1527); SEMCAD X 14.6.14(7483)

Area Scan (71x141x1): Interpolated grid: dx=15 mm, dy=15 mm

Maximum value of SAR (interpolated) = 0.313 W/kg

Zoom Scan (5x5x7)/Cube 0: Measurement grid: dx=8mm, dy=8mm, dz=5mm

Reference Value = 8.313 V/m; Power Drift = 0.14 dB

Peak SAR (extrapolated) = 0.349 W/kg

SAR(1 g) = 0.271 W/kg; SAR(10 g) = 0.194 W/kg

Smallest distance from peaks to all points 3 dB below = 12.5 mm

Ratio of SAR at M2 to SAR at M1 = 76.9%

Maximum value of SAR (measured) = 0.315 W/kg

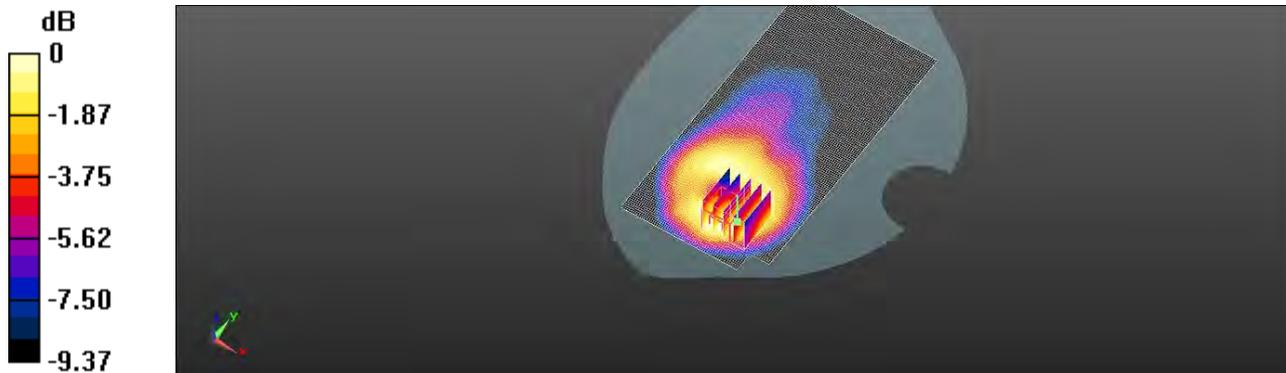

0 dB = 0.315 W/kg = -5.02 dBW/kg

Unless otherwise stated the results shown in this test report refer only to the sample(s) tested and such sample(s) are retained for 90 days only.

除非另有說明，此報告結果僅對測試之樣品負責，同時此樣品僅保留90天。本報告未經本公司書面許可，不可部份複製。

This document is issued by the Company subject to its General Conditions of Service printed overleaf, available on request or accessible at <http://www.sgs.com.tw/Terms-and-Conditions> and for electronic format documents, subject to Terms and Conditions for Electronic Documents at <http://www.sgs.com.tw/Terms-and-Conditions>. Attention is drawn to the limitation of liability, indemnification and jurisdiction issues defined therein. Any holder of this document is advised that information contained hereon reflects the Company's findings at the time of its intervention only and within the limits of Client's instructions, if any. The Company's sole responsibility is to its Client and this document does not exonerate parties to a transaction from exercising all their rights and obligations under the transaction documents. This document cannot be reproduced except in full, without prior written approval of the Company. Any unauthorized alteration, forgery or falsification of the content or appearance of this document is unlawful and offenders may be prosecuted to the fullest extent of the law.

Date: 2020/7/14

Report No. :ES/2020/30005

LTE Band 71 (20MHz)_Hotspot_Front side_CH 133372_QPSK_1-0_10mm_UAT

Communication System: LTE; Frequency: 688 MHz; Duty cycle= 1:1

Medium parameters used: $f = 688 \text{ MHz}$; $\sigma = 0.853 \text{ S/m}$; $\epsilon_r = 43.354$; $\rho = 1000 \text{ kg/m}^3$

Phantom section: Flat Section

Ambient temperature: 21.8°C; Liquid temperature: 22.3°C

DASY5 Configuration:

- Probe: EX3DV4 - SN7509; ConvF(9.94, 9.94, 9.94) @ 688 MHz; Calibrated: 2020/03/25
- Sensor-Surface: 2mm (Mechanical Surface Detection)
- Electronics: DAE4 Sn558; Calibrated: 2019/10/11
- Phantom: SAM
- DASY52 52.10.4(1527); SEMCAD X 14.6.14(7483)

Area Scan (71x141x1): Interpolated grid: dx=15 mm, dy=15 mm

Maximum value of SAR (interpolated) = 0.130 W/kg

Zoom Scan (5x5x7)/Cube 0: Measurement grid: dx=8mm, dy=8mm, dz=5mm

Reference Value = 6.993 V/m; Power Drift = 0.12 dB

Peak SAR (extrapolated) = 0.138 W/kg

SAR(1 g) = 0.108 W/kg; SAR(10 g) = 0.078 W/kg

Smallest distance from peaks to all points 3 dB below = 16 mm

Ratio of SAR at M2 to SAR at M1 = 75.2%

Maximum value of SAR (measured) = 0.123 W/kg

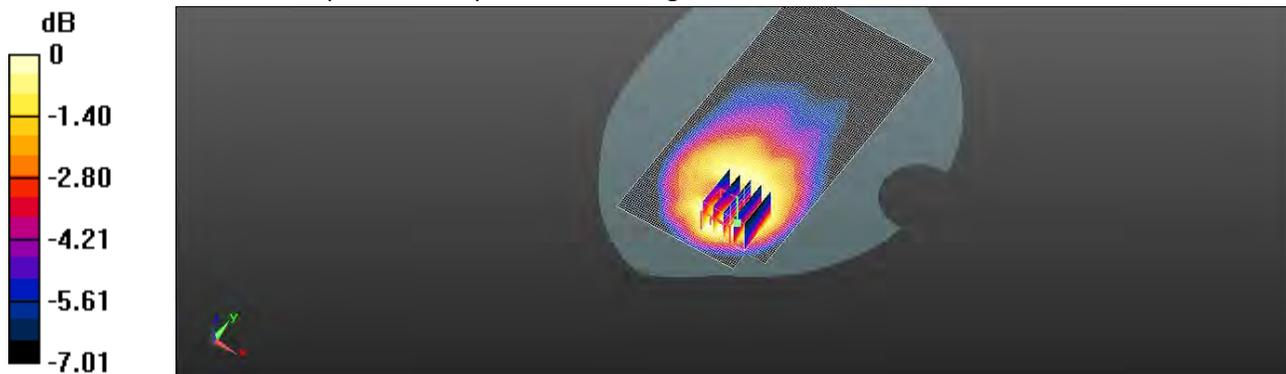

0 dB = 0.123 W/kg = -9.10 dBW/kg

Unless otherwise stated the results shown in this test report refer only to the sample(s) tested and such sample(s) are retained for 90 days only.

除非另有說明，此報告結果僅對測試之樣品負責，同時此樣品僅保留90天。本報告未經本公司書面許可，不可部份複製。

This document is issued by the Company subject to its General Conditions of Service printed overleaf, available on request or accessible at <http://www.sgs.com.tw/Terms-and-Conditions> and for electronic format documents, subject to Terms and Conditions for Electronic Documents at <http://www.sgs.com.tw/Terms-and-Conditions>. Attention is drawn to the limitation of liability, indemnification and jurisdiction issues defined therein. Any holder of this document is advised that information contained hereon reflects the Company's findings at the time of its intervention only and within the limits of Client's instructions, if any. The Company's sole responsibility is to its Client and this document does not exonerate parties to a transaction from exercising all their rights and obligations under the transaction documents. This document cannot be reproduced except in full, without prior written approval of the Company. Any unauthorized alteration, forgery or falsification of the content or appearance of this document is unlawful and offenders may be prosecuted to the fullest extent of the law.

Date: 2020/7/17

Report No. :ES/2020/30005

GPRS 1900_Hotspot_Bottom side_CH 810_10mm_LAT

Communication System: GPRS (1Dn2Up); Frequency: 1909.8 MHz; Duty cycle= 1:4.1

Medium parameters used: $f = 1910$ MHz; $\sigma = 1.444$ S/m; $\epsilon_r = 39.347$; $\rho = 1000$ kg/m³

Phantom section: Flat Section

Ambient temperature: 22.7°C; Liquid temperature: 21.6°C

DASY5 Configuration:

- Probe: EX3DV4 - SN7509; ConvF(8.07, 8.07, 8.07) @ 1910 MHz; Calibrated: 3/25/2020
- Sensor-Surface: 2mm (Mechanical Surface Detection)
- Electronics: DAE4 Sn558; Calibrated: 10/11/2019
- Phantom: SAM
- DASY52 52.10.4(1527); SEMCAD X 14.6.14(7483)

Area Scan (51x81x1): Interpolated grid: dx=15 mm, dy=15 mm

Maximum value of SAR (interpolated) = 1.33 W/kg

Zoom Scan (5x5x7)/Cube 0: Measurement grid: dx=8mm, dy=8mm, dz=5mm

Reference Value = 24.23 V/m; Power Drift = -0.12 dB

Peak SAR (extrapolated) = 1.33 W/kg

SAR(1 g) = 1.11 W/kg; SAR(10 g) = 0.770 W/kg

Smallest distance from peaks to all points 3 dB below = 13.1 mm

Ratio of SAR at M2 to SAR at M1 = 77%

Maximum value of SAR (measured) = 1.19 W/kg

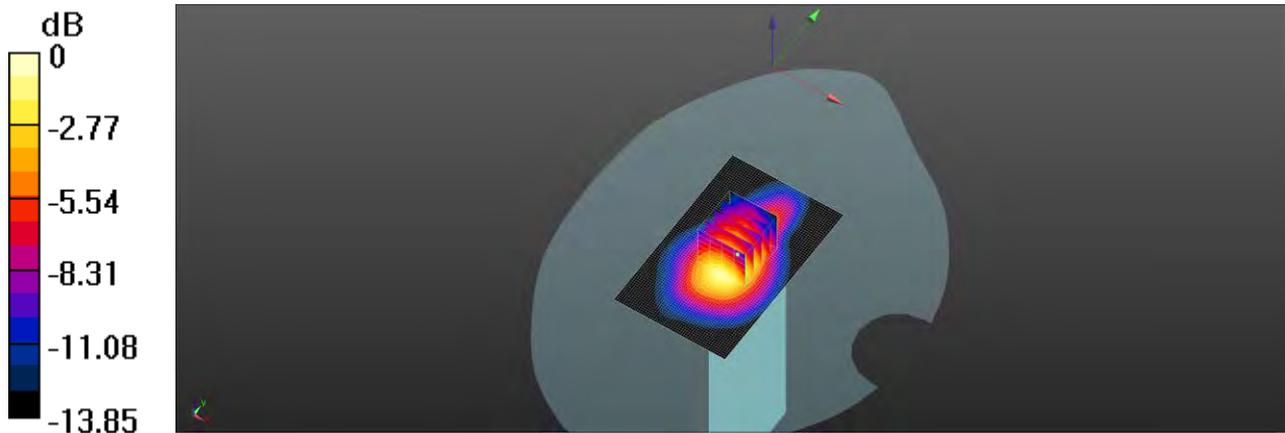

0 dB = 1.19 W/kg = 0.76 dBW/kg

Unless otherwise stated the results shown in this test report refer only to the sample(s) tested and such sample(s) are retained for 90 days only.

除非另有說明，此報告結果僅對測試之樣品負責，同時此樣品僅保留90天。本報告未經本公司書面許可，不可部份複製。

This document is issued by the Company subject to its General Conditions of Service printed overleaf, available on request or accessible at <http://www.sgs.com.tw/Terms-and-Conditions> and for electronic format documents, subject to Terms and Conditions for Electronic Documents at <http://www.sgs.com.tw/Terms-and-Conditions>. Attention is drawn to the limitation of liability, indemnification and jurisdiction issues defined therein. Any holder of this document is advised that information contained hereon reflects the Company's findings at the time of its intervention only and within the limits of Client's instructions, if any. The Company's sole responsibility is to its Client and this document does not exonerate parties to a transaction from exercising all their rights and obligations under the transaction documents. This document cannot be reproduced except in full, without prior written approval of the Company. Any unauthorized alteration, forgery or falsification of the content or appearance of this document is unlawful and offenders may be prosecuted to the fullest extent of the law.

Date: 2020/7/17

Report No. : ES/2020/30005

WCDMA Band II_Hotspot_Bottom side_CH 9538_10mm_LAT

Communication System: WCDMA; Frequency: 1907.6 MHz; Duty cycle= 1:1

Medium parameters used: $f = 1908$ MHz; $\sigma = 1.427$ S/m; $\epsilon_r = 39.371$; $\rho = 1000$ kg/m³

Phantom section: Flat Section

Ambient temperature: 22.3°C; Liquid temperature: 21.4°C

DASY5 Configuration:

- Probe: EX3DV4 - SN7509; ConvF(8.07, 8.07, 8.07) @ 1907.6 MHz; Calibrated: 3/25/2020
- Sensor-Surface: 2mm (Mechanical Surface Detection)
- Electronics: DAE4 Sn558; Calibrated: 10/11/2019
- Phantom: SAM
- DASY52 52.10.4(1527); SEMCAD X 14.6.14(7483)

Area Scan (51x81x1): Interpolated grid: dx=15 mm, dy=15 mm

Maximum value of SAR (interpolated) = 1.42 W/kg

Zoom Scan (5x5x7)/Cube 0: Measurement grid: dx=8mm, dy=8mm, dz=5mm

Reference Value = 30.28 V/m; Power Drift = -0.12 dB

Peak SAR (extrapolated) = 1.46 W/kg

SAR(1 g) = 1.13 W/kg; SAR(10 g) = 0.764 W/kg

Smallest distance from peaks to all points 3 dB below = 18.6 mm

Ratio of SAR at M2 to SAR at M1 = 74.7%

Maximum value of SAR (measured) = 1.30 W/kg

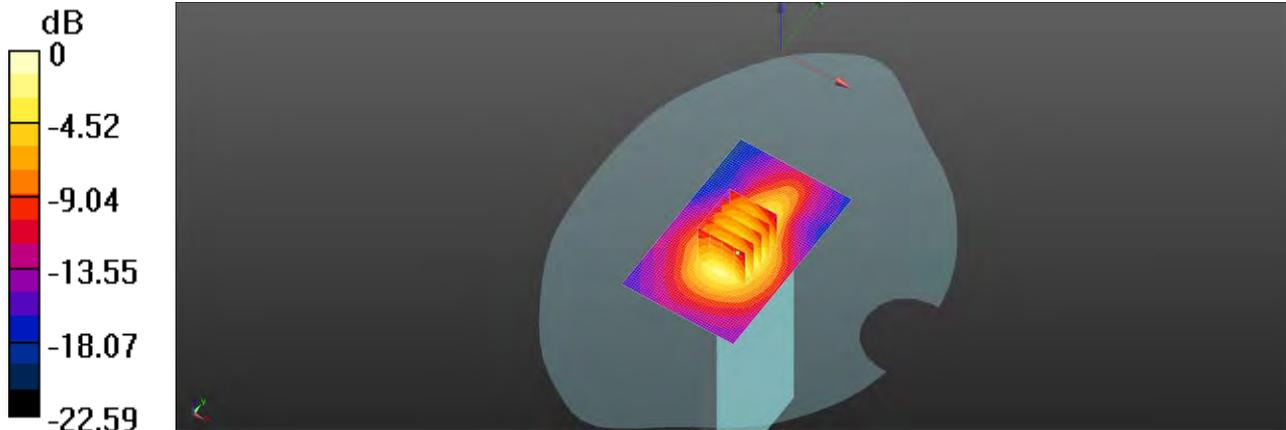

0 dB = 1.30 W/kg = 1.14 dBW/kg

Unless otherwise stated the results shown in this test report refer only to the sample(s) tested and such sample(s) are retained for 90 days only.

除非另有說明，此報告結果僅對測試之樣品負責，同時此樣品僅保留90天。本報告未經本公司書面許可，不可部份複製。

This document is issued by the Company subject to its General Conditions of Service printed overleaf, available on request or accessible at <http://www.sgs.com.tw/Terms-and-Conditions> and for electronic format documents, subject to Terms and Conditions for Electronic Documents at <http://www.sgs.com.tw/Terms-and-Conditions>. Attention is drawn to the limitation of liability, indemnification and jurisdiction issues defined therein. Any holder of this document is advised that information contained hereon reflects the Company's findings at the time of its intervention only and within the limits of Client's instructions, if any. The Company's sole responsibility is to its Client and this document does not exonerate parties to a transaction from exercising all their rights and obligations under the transaction documents. This document cannot be reproduced except in full, without prior written approval of the Company. Any unauthorized alteration, forgery or falsification of the content or appearance of this document is unlawful and offenders may be prosecuted to the fullest extent of the law.

Date: 2020/7/16

Report No. : ES/2020/30005

WCDMA Band IV_Hotspot_Bottom side_CH 1412_10mm_LAT

Communication System: WCDMA; Frequency: 1732.4 MHz; Duty cycle= 1:1

Medium parameters used: $f = 1732.4$ MHz; $\sigma = 1.315$ S/m; $\epsilon_r = 41.113$; $\rho = 1000$ kg/m³

Phantom section: Flat Section

Ambient temperature: 22.3°C; Liquid temperature: 21.4°C

DASY5 Configuration:

- Probe: EX3DV4 - SN7509; ConvF(8.34, 8.34, 8.34) @ 1732.4 MHz; Calibrated: 3/25/2020
- Sensor-Surface: 2mm (Mechanical Surface Detection)
- Electronics: DAE4 Sn558; Calibrated: 10/11/2019
- Phantom: SAM
- DASY52 52.10.4(1527); SEMCAD X 14.6.14(7483)

Area Scan (51x81x1): Interpolated grid: dx=15 mm, dy=15 mm

Maximum value of SAR (interpolated) = 1.41 W/kg

Zoom Scan (5x5x7)/Cube 0: Measurement grid: dx=8mm, dy=8mm, dz=5mm

Reference Value = 27.14 V/m; Power Drift = -0.06 dB

Peak SAR (extrapolated) = 1.44 W/kg

SAR(1 g) = 1.08 W/kg; SAR(10 g) = 0.753 W/kg

Smallest distance from peaks to all points 3 dB below = 12.8 mm

Ratio of SAR at M2 to SAR at M1 = 77.3%

Maximum value of SAR (measured) = 1.31 W/kg

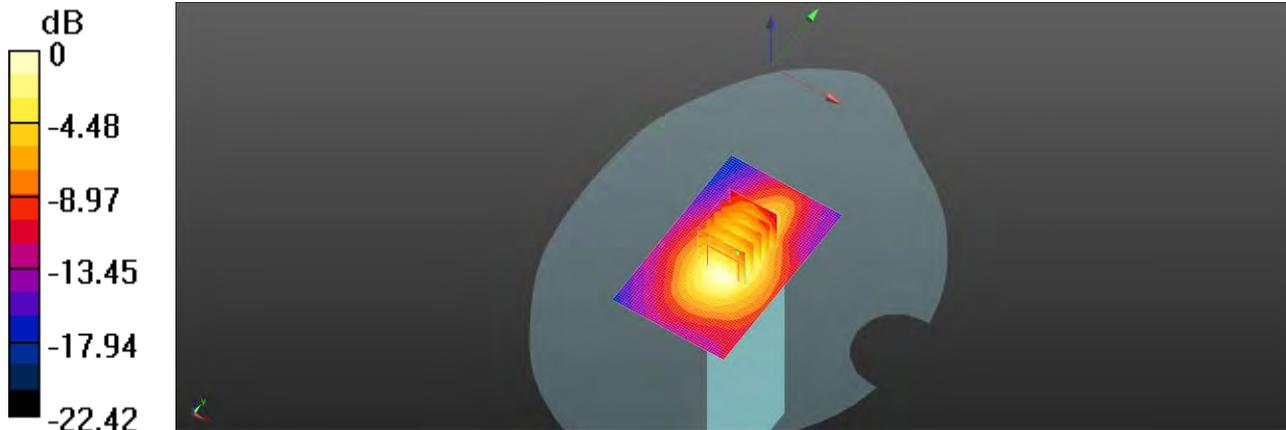

0 dB = 1.31 W/kg = 1.17 dBW/kg

Unless otherwise stated the results shown in this test report refer only to the sample(s) tested and such sample(s) are retained for 90 days only.

除非另有說明，此報告結果僅對測試之樣品負責，同時此樣品僅保留90天。本報告未經本公司書面許可，不可部份複製。

This document is issued by the Company subject to its General Conditions of Service printed overleaf, available on request or accessible at <http://www.sgs.com.tw/Terms-and-Conditions> and for electronic format documents, subject to Terms and Conditions for Electronic Documents at <http://www.sgs.com.tw/Terms-and-Conditions>. Attention is drawn to the limitation of liability, indemnification and jurisdiction issues defined therein. Any holder of this document is advised that information contained hereon reflects the Company's findings at the time of its intervention only and within the limits of Client's instructions, if any. The Company's sole responsibility is to its Client and this document does not exonerate parties to a transaction from exercising all their rights and obligations under the transaction documents. This document cannot be reproduced except in full, without prior written approval of the Company. Any unauthorized alteration, forgery or falsification of the content or appearance of this document is unlawful and offenders may be prosecuted to the fullest extent of the law.

Date: 2020/7/15

Report No. :ES/2020/30005

WCDMA Band V_Hotspot Front side_CH 4233_10mm_LAT

Communication System: WCDMA; Frequency: 846.6 MHz; Duty cycle= 1:1

Medium parameters used: $f = 847$ MHz; $\sigma = 0.913$ S/m; $\epsilon_r = 41.901$; $\rho = 1000$ kg/m³

Phantom section: Flat Section

Ambient temperature: 21.9°C; Liquid temperature: 22.3°C

DASY5 Configuration:

- Probe: EX3DV4 - SN7509; ConvF(9.73, 9.73, 9.73) @ 847 MHz; Calibrated: 3/25/2020
- Sensor-Surface: 2mm (Mechanical Surface Detection)
- Electronics: DAE4 Sn558; Calibrated: 10/11/2019
- Phantom: SAM
- DASY52 52.10.4(1527); SEMCAD X 14.6.14(7483)

Area Scan (71x141x1): Interpolated grid: dx=15 mm, dy=15 mm

Maximum value of SAR (interpolated) = 0.568 W/kg

Zoom Scan (5x5x7)/Cube 0: Measurement grid: dx=8mm, dy=8mm, dz=5mm

Reference Value = 11.98 V/m; Power Drift = 0.05 dB

Peak SAR (extrapolated) = 0.574 W/kg

SAR(1 g) = 0.517 W/kg; SAR(10 g) = 0.379 W/kg

Smallest distance from peaks to all points 3 dB below = 14.4 mm

Ratio of SAR at M2 to SAR at M1 = 91%

Maximum value of SAR (measured) = 0.560 W/kg

Zoom Scan (5x5x7)/Cube 1: Measurement grid: dx=8mm, dy=8mm, dz=5mm

Reference Value = 11.98 V/m; Power Drift = 0.05 dB

Peak SAR (extrapolated) = 0.512 W/kg

SAR(1 g) = 0.452 W/kg; SAR(10 g) = 0.389 W/kg

Smallest distance from peaks to all points 3 dB below: Larger than measurement grid

Ratio of SAR at M2 to SAR at M1 = 94.9%

Maximum value of SAR (measured) = 0.476 W/kg

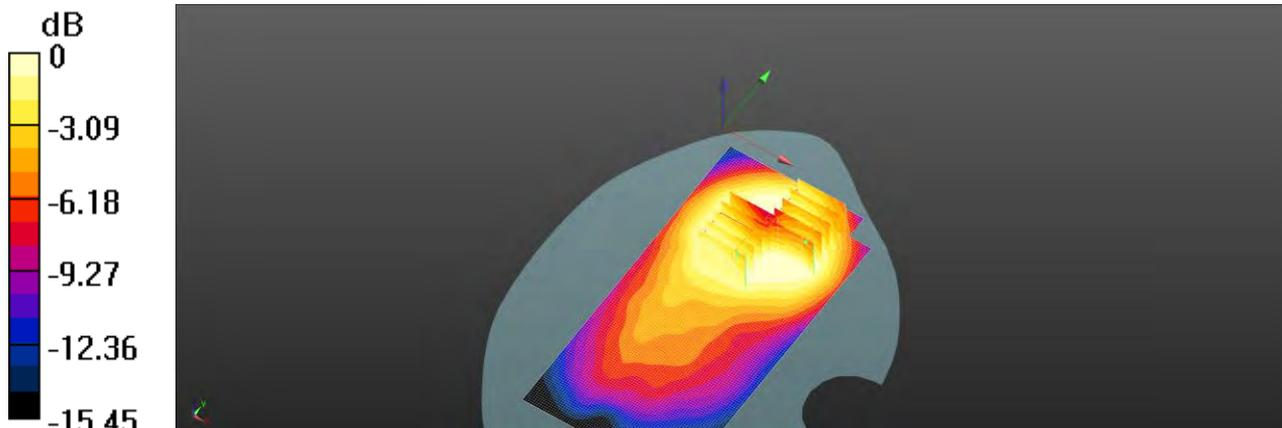

0 dB = 0.476 W/kg = -3.22 dBW/kg

Unless otherwise stated the results shown in this test report refer only to the sample(s) tested and such sample(s) are retained for 90 days only.

除非另有說明，此報告結果僅對測試之樣品負責，同時此樣品僅保留90天。本報告未經本公司書面許可，不可部份複製。

This document is issued by the Company subject to its General Conditions of Service printed overleaf, available on request or accessible at <http://www.sgs.com.tw/Terms-and-Conditions> and for electronic format documents, subject to Terms and Conditions for Electronic Documents at <http://www.sgs.com.tw/Terms-and-Conditions>. Attention is drawn to the limitation of liability, indemnification and jurisdiction issues defined therein. Any holder of this document is advised that information contained hereon reflects the Company's findings at the time of its intervention only and within the limits of Client's instructions, if any. The Company's sole responsibility is to its Client and this document does not exonerate parties to a transaction from exercising all their rights and obligations under the transaction documents. This document cannot be reproduced except in full, without prior written approval of the Company. Any unauthorized alteration, forgery or falsification of the content or appearance of this document is unlawful and offenders may be prosecuted to the fullest extent of the law.

Date: 2020/7/19

Report No. :ES/2020/30005

LTE Band 7 (20MHz)_Hotspot_Bottom side_CH 21350_QPSK_1-99_10mm_LAT

Communication System: LTE; Frequency: 2560 MHz; Duty cycle= 1:1

Medium parameters used: $f = 2560$ MHz; $\sigma = 1.904$ S/m; $\epsilon_r = 38.521$; $\rho = 1000$ kg/m³

Phantom section: Flat Section

Ambient temperature: 21.7°C; Liquid temperature: 22.3°C

DASY5 Configuration:

- Probe: EX3DV4 - SN7509; ConvF(7.23, 7.23, 7.23) @ 2560 MHz; Calibrated: 3/25/2020
- Sensor-Surface: 2mm (Mechanical Surface Detection)
- Electronics: DAE4 Sn558; Calibrated: 10/11/2019
- Phantom: SAM
- DASY52 52.10.4(1527); SEMCAD X 14.6.14(7483)

Area Scan (61x101x1): Interpolated grid: dx=12 mm, dy=12 mm

Maximum value of SAR (interpolated) = 1.01 W/kg

Zoom Scan (7x7x7)/Cube 0: Measurement grid: dx=5mm, dy=5mm, dz=5mm

Reference Value = 21.64 V/m; Power Drift = -0.13 dB

Peak SAR (extrapolated) = 1.12 W/kg

SAR(1 g) = 0.688 W/kg; SAR(10 g) = 0.383 W/kg

Smallest distance from peaks to all points 3 dB below = 11.4 mm

Ratio of SAR at M2 to SAR at M1 = 63.2%

Maximum value of SAR (measured) = 0.922 W/kg

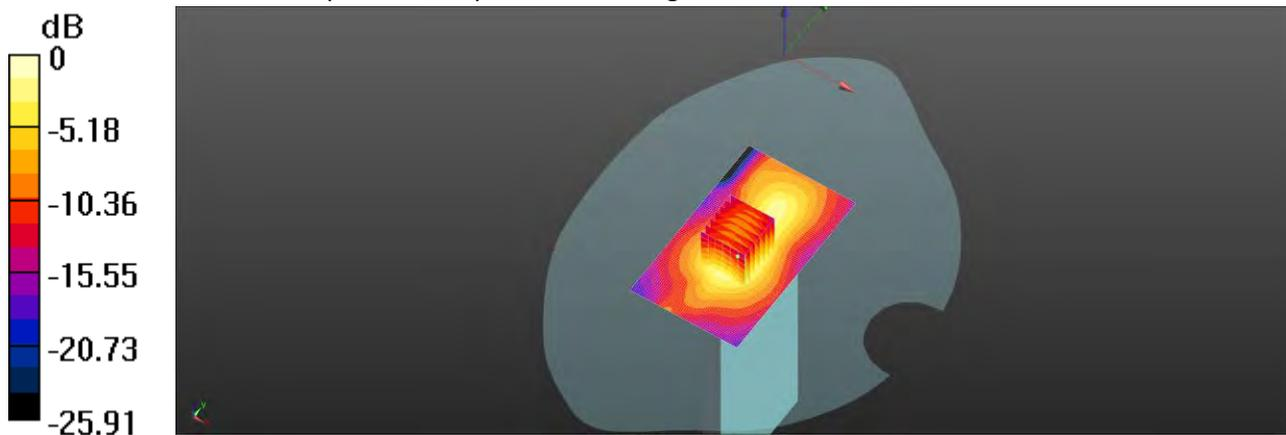

0 dB = 0.922 W/kg = -0.35 dBW/kg

Unless otherwise stated the results shown in this test report refer only to the sample(s) tested and such sample(s) are retained for 90 days only.

除非另有說明，此報告結果僅對測試之樣品負責，同時此樣品僅保留90天。本報告未經本公司書面許可，不可部份複製。

This document is issued by the Company subject to its General Conditions of Service printed overleaf, available on request or accessible at <http://www.sgs.com.tw/Terms-and-Conditions> and for electronic format documents, subject to Terms and Conditions for Electronic Documents at <http://www.sgs.com.tw/Terms-and-Conditions>. Attention is drawn to the limitation of liability, indemnification and jurisdiction issues defined therein. Any holder of this document is advised that information contained hereon reflects the Company's findings at the time of its intervention only and within the limits of Client's instructions, if any. The Company's sole responsibility is to its Client and this document does not exonerate parties to a transaction from exercising all their rights and obligations under the transaction documents. This document cannot be reproduced except in full, without prior written approval of the Company. Any unauthorized alteration, forgery or falsification of the content or appearance of this document is unlawful and offenders may be prosecuted to the fullest extent of the law.

Date: 2020/7/14

Report No. :ES/2020/30005

LTE Band 12 (10MHz)_Hotspot_Front side_CH 23060_QPSK_1-0_10mm_LAT

Communication System: LTE; Frequency: 704 MHz; Duty cycle= 1:1

Medium parameters used: $f = 704 \text{ MHz}$; $\sigma = 0.858 \text{ S/m}$; $\epsilon_r = 43.194$; $\rho = 1000 \text{ kg/m}^3$

Phantom section: Flat Section

Ambient temperature: 21.8°C; Liquid temperature: 22.3°C

DASY5 Configuration:

- Probe: EX3DV4 - SN7509; ConvF(9.94, 9.94, 9.94) @ 704 MHz; Calibrated: 3/25/2020
- Sensor-Surface: 2mm (Mechanical Surface Detection)
- Electronics: DAE4 Sn558; Calibrated: 10/11/2019
- Phantom: SAM
- DASY52 52.10.4(1527); SEMCAD X 14.6.14(7483)

Area Scan (71x141x1): Interpolated grid: dx=15 mm, dy=15 mm

Maximum value of SAR (interpolated) = 0.246 W/kg

Zoom Scan (5x5x7)/Cube 0: Measurement grid: dx=8mm, dy=8mm, dz=5mm

Reference Value = 12.18 V/m; Power Drift = -0.12 dB

Peak SAR (extrapolated) = 0.219 W/kg

SAR(1 g) = 0.195 W/kg; SAR(10 g) = 0.148 W/kg

Smallest distance from peaks to all points 3 dB below = 18.2 mm

Ratio of SAR at M2 to SAR at M1 = 91.9%

Maximum value of SAR (measured) = 0.208 W/kg

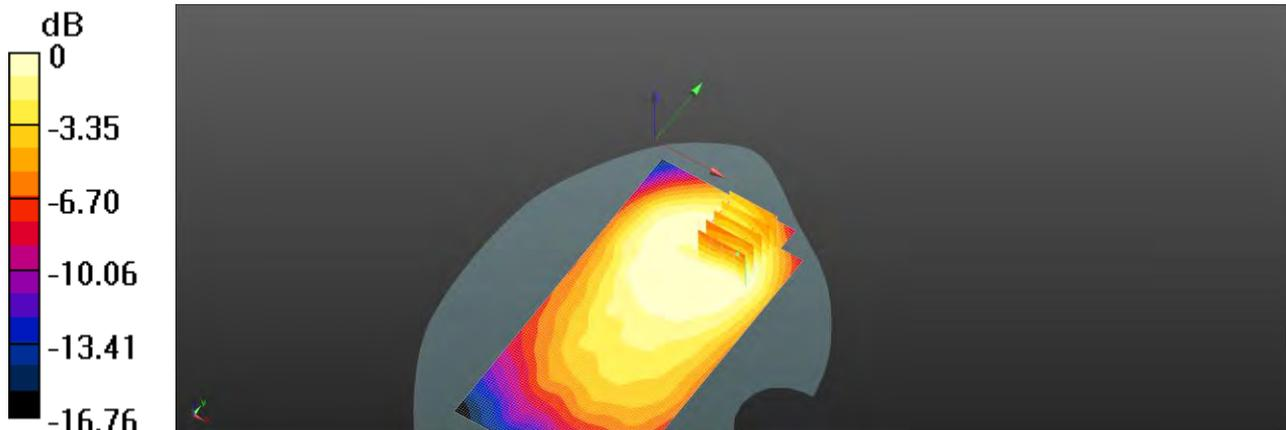

0 dB = 0.208 W/kg = -6.82 dBW/kg

Unless otherwise stated the results shown in this test report refer only to the sample(s) tested and such sample(s) are retained for 90 days only.

除非另有說明，此報告結果僅對測試之樣品負責，同時此樣品僅保留90天。本報告未經本公司書面許可，不可部份複製。

This document is issued by the Company subject to its General Conditions of Service printed overleaf, available on request or accessible at <http://www.sgs.com.tw/Terms-and-Conditions> and for electronic format documents, subject to Terms and Conditions for Electronic Documents at <http://www.sgs.com.tw/Terms-and-Conditions>. Attention is drawn to the limitation of liability, indemnification and jurisdiction issues defined therein. Any holder of this document is advised that information contained hereon reflects the Company's findings at the time of its intervention only and within the limits of Client's instructions, if any. The Company's sole responsibility is to its Client and this document does not exonerate parties to a transaction from exercising all their rights and obligations under the transaction documents. This document cannot be reproduced except in full, without prior written approval of the Company. Any unauthorized alteration, forgery or falsification of the content or appearance of this document is unlawful and offenders may be prosecuted to the fullest extent of the law.

Date: 2020/7/14

Report No. :ES/2020/30005

LTE Band 13 (10MHz)_Hotspot_Front side_CH 23230_QPSK_1-0_10mm_LAT

Communication System: LTE; Frequency: 782 MHz; Duty cycle= 1:1

Medium parameters used: $f = 782 \text{ MHz}$; $\sigma = 0.882 \text{ S/m}$; $\epsilon_r = 42.621$; $\rho = 1000 \text{ kg/m}^3$

Phantom section: Flat Section

Ambient temperature: 21.8°C; Liquid temperature: 22.3°C

DASY5 Configuration:

- Probe: EX3DV4 - SN7509; ConvF(9.94, 9.94, 9.94) @ 782 MHz; Calibrated: 3/25/2020
- Sensor-Surface: 2mm (Mechanical Surface Detection)
- Electronics: DAE4 Sn558; Calibrated: 10/11/2019
- Phantom: SAM
- DASY52 52.10.4(1527); SEMCAD X 14.6.14(7483)

Area Scan (71x141x1): Interpolated grid: dx=15 mm, dy=15 mm

Maximum value of SAR (interpolated) = 0.401 W/kg

Zoom Scan (5x5x7)/Cube 0: Measurement grid: dx=8mm, dy=8mm, dz=5mm

Reference Value = 13.58 V/m; Power Drift = 0.00 dB

Peak SAR (extrapolated) = 0.377 W/kg

SAR(1 g) = 0.332 W/kg; SAR(10 g) = 0.251 W/kg

Smallest distance from peaks to all points 3 dB below = 13.8 mm

Ratio of SAR at M2 to SAR at M1 = 91.5%

Maximum value of SAR (measured) = 0.352 W/kg

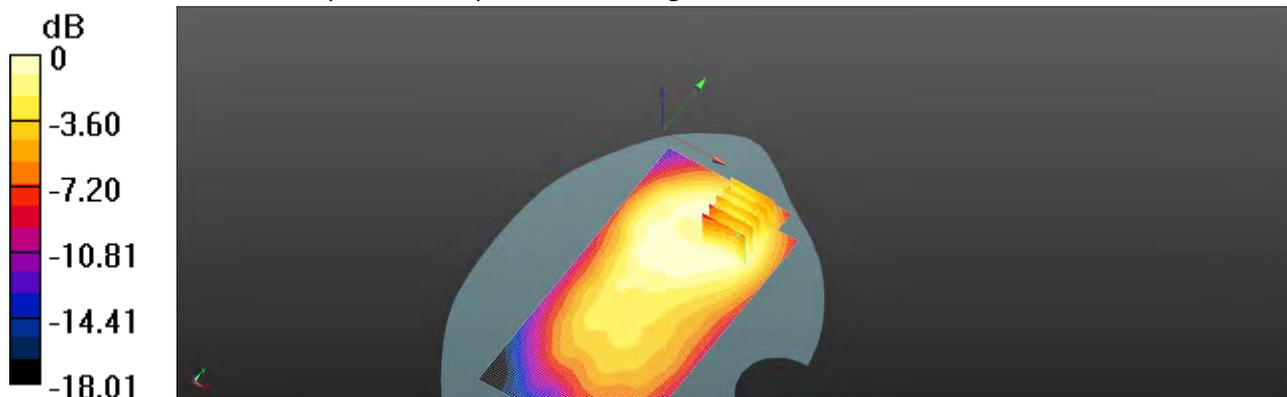

0 dB = 0.352 W/kg = -4.53 dBW/kg

Unless otherwise stated the results shown in this test report refer only to the sample(s) tested and such sample(s) are retained for 90 days only.

除非另有說明，此報告結果僅對測試之樣品負責，同時此樣品僅保留90天。本報告未經本公司書面許可，不可部份複製。

This document is issued by the Company subject to its General Conditions of Service printed overleaf, available on request or accessible at <http://www.sgs.com.tw/Terms-and-Conditions> and for electronic format documents, subject to Terms and Conditions for Electronic Documents at <http://www.sgs.com.tw/Terms-and-Conditions>. Attention is drawn to the limitation of liability, indemnification and jurisdiction issues defined therein. Any holder of this document is advised that information contained hereon reflects the Company's findings at the time of its intervention only and within the limits of Client's instructions, if any. The Company's sole responsibility is to its Client and this document does not exonerate parties to a transaction from exercising all their rights and obligations under the transaction documents. This document cannot be reproduced except in full, without prior written approval of the Company. Any unauthorized alteration, forgery or falsification of the content or appearance of this document is unlawful and offenders may be prosecuted to the fullest extent of the law.

Date: 2020/7/17

Report No. :ES/2020/30005

LTE Band 25 (20MHz)_Hotspot_Bottom side_CH 26590_QPSK_1-0_10mm_LAT

Communication System: LTE; Frequency: 1905 MHz; Duty cycle= 1:1

Medium parameters used: $f = 1905$ MHz; $\sigma = 1.421$ S/m; $\epsilon_r = 39.533$; $\rho = 1000$ kg/m³

Phantom section: Flat Section

Ambient temperature: 22.7°C; Liquid temperature: 21.6°C

DASY5 Configuration:

- Probe: EX3DV4 - SN7509; ConvF(8.07, 8.07, 8.07) @ 1905 MHz; Calibrated: 3/25/2020
- Sensor-Surface: 2mm (Mechanical Surface Detection)
- Electronics: DAE4 Sn558; Calibrated: 10/11/2019
- Phantom: SAM
- DASY52 52.10.4(1527); SEMCAD X 14.6.14(7483)

Area Scan (51x81x1): Interpolated grid: dx=15 mm, dy=15 mm

Maximum value of SAR (interpolated) = 1.40 W/kg

Zoom Scan (5x5x7)/Cube 0: Measurement grid: dx=8mm, dy=8mm, dz=5mm

Reference Value = 31.01 V/m; Power Drift = -0.18 dB

Peak SAR (extrapolated) = 1.43 W/kg

SAR(1 g) = 1.09 W/kg; SAR(10 g) = 0.776 W/kg

Smallest distance from peaks to all points 3 dB below = 12.2 mm

Ratio of SAR at M2 to SAR at M1 = 74.5%

Maximum value of SAR (measured) = 1.28 W/kg

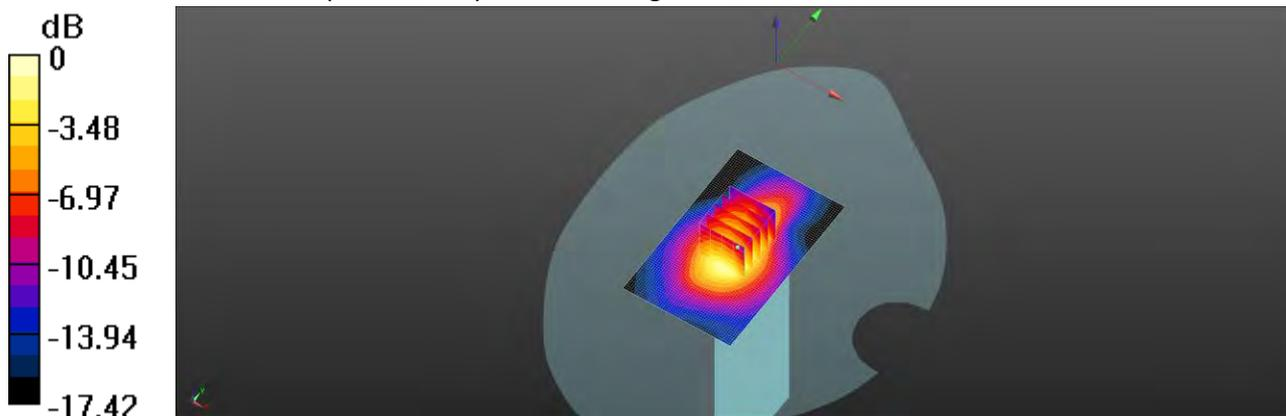

0 dB = 1.28 W/kg = 1.07 dBW/kg

Unless otherwise stated the results shown in this test report refer only to the sample(s) tested and such sample(s) are retained for 90 days only.

除非另有說明，此報告結果僅對測試之樣品負責，同時此樣品僅保留90天。本報告未經本公司書面許可，不可部份複製。

This document is issued by the Company subject to its General Conditions of Service printed overleaf, available on request or accessible at <http://www.sgs.com.tw/Terms-and-Conditions> and for electronic format documents, subject to Terms and Conditions for Electronic Documents at <http://www.sgs.com.tw/Terms-and-Conditions>. Attention is drawn to the limitation of liability, indemnification and jurisdiction issues defined therein. Any holder of this document is advised that information contained hereon reflects the Company's findings at the time of its intervention only and within the limits of Client's instructions, if any. The Company's sole responsibility is to its Client and this document does not exonerate parties to a transaction from exercising all their rights and obligations under the transaction documents. This document cannot be reproduced except in full, without prior written approval of the Company. Any unauthorized alteration, forgery or falsification of the content or appearance of this document is unlawful and offenders may be prosecuted to the fullest extent of the law.

Date: 2020/7/15

Report No. :ES/2020/30005

LTE Band 26 (15MHz)_Hotspot_Front side_CH 26765_QPSK_1-0_10mm_LAT

Communication System: LTE; Frequency: 821.5 MHz; Duty cycle= 1:1

Medium parameters used: $f = 821.5$ MHz; $\sigma = 0.884$ S/m; $\epsilon_r = 42.515$; $\rho = 1000$ kg/m³

Phantom section: Flat Section

Ambient temperature: 21.9°C; Liquid temperature: 22.3°C

DASY5 Configuration:

- Probe: EX3DV4 - SN7509; ConvF(9.73, 9.73, 9.73) @ 821.5 MHz; Calibrated: 3/25/2020
- Sensor-Surface: 2mm (Mechanical Surface Detection)
- Electronics: DAE4 Sn558; Calibrated: 10/11/2019
- Phantom: SAM
- DASY52 52.10.4(1527); SEMCAD X 14.6.14(7483)

Area Scan (71x141x1): Interpolated grid: dx=15 mm, dy=15 mm

Maximum value of SAR (interpolated) = 0.436 W/kg

Zoom Scan (5x5x7)/Cube 0: Measurement grid: dx=8mm, dy=8mm, dz=5mm

Reference Value = 11.23 V/m; Power Drift = 0.18 dB

Peak SAR (extrapolated) = 0.453 W/kg

SAR(1 g) = 0.401 W/kg; SAR(10 g) = 0.293 W/kg

Smallest distance from peaks to all points 3 dB below = 11.3 mm

Ratio of SAR at M2 to SAR at M1 = 91.8%

Maximum value of SAR (measured) = 0.426 W/kg

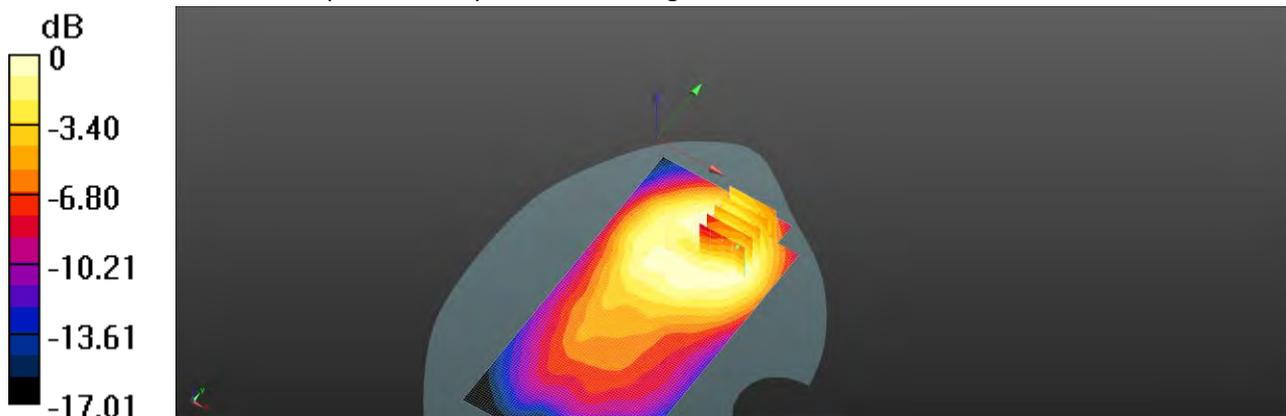

0 dB = 0.426 W/kg = -3.71 dBW/kg

Unless otherwise stated the results shown in this test report refer only to the sample(s) tested and such sample(s) are retained for 90 days only.

除非另有說明，此報告結果僅對測試之樣品負責，同時此樣品僅保留90天。本報告未經本公司書面許可，不可部份複製。

This document is issued by the Company subject to its General Conditions of Service printed overleaf, available on request or accessible at <http://www.sgs.com.tw/Terms-and-Conditions> and for electronic format documents, subject to Terms and Conditions for Electronic Documents at <http://www.sgs.com.tw/Terms-and-Conditions>. Attention is drawn to the limitation of liability, indemnification and jurisdiction issues defined therein. Any holder of this document is advised that information contained hereon reflects the Company's findings at the time of its intervention only and within the limits of Client's instructions, if any. The Company's sole responsibility is to its Client and this document does not exonerate parties to a transaction from exercising all their rights and obligations under the transaction documents. This document cannot be reproduced except in full, without prior written approval of the Company. Any unauthorized alteration, forgery or falsification of the content or appearance of this document is unlawful and offenders may be prosecuted to the fullest extent of the law.

Date: 2020/7/19

Report No. :ES/2020/30005

LTE Band 41 (20MHz)_Hotspot_Bottom side_CH 41490_QPSK_1-0_10mm_LAT

Communication System: LTE; Frequency: 2680 MHz; Duty cycle= 1:1.59956

Medium parameters used: $f = 2680$ MHz; $\sigma = 2.059$ S/m; $\epsilon_r = 38.252$; $\rho = 1000$ kg/m³

Phantom section: Flat Section

Ambient temperature: 21.7°C; Liquid temperature: 22.3°C

DASY5 Configuration:

- Probe: EX3DV4 - SN7509; ConvF(7.23, 7.23, 7.23) @ 2680 MHz; Calibrated: 3/25/2020
- Sensor-Surface: 2mm (Mechanical Surface Detection)
- Electronics: DAE4 Sn558; Calibrated: 10/11/2019
- Phantom: SAM
- DASY52 52.10.4(1527); SEMCAD X 14.6.14(7483)

Area Scan (61x101x1): Interpolated grid: dx=12 mm, dy=12 mm

Maximum value of SAR (interpolated) = 0.951 W/kg

Zoom Scan (7x7x7)/Cube 0: Measurement grid: dx=5mm, dy=5mm, dz=5mm

Reference Value = 14.93 V/m; Power Drift = -0.17 dB

Peak SAR (extrapolated) = 1.06 W/kg

SAR(1 g) = 0.637 W/kg; SAR(10 g) = 0.342 W/kg

Smallest distance from peaks to all points 3 dB below = 10.4 mm

Ratio of SAR at M2 to SAR at M1 = 61.7%

Maximum value of SAR (measured) = 0.875 W/kg

Zoom Scan (7x7x7)/Cube 1: Measurement grid: dx=5mm, dy=5mm, dz=5mm

Reference Value = 14.93 V/m; Power Drift = -0.17 dB

Peak SAR (extrapolated) = 0.833 W/kg

SAR(1 g) = 0.435 W/kg; SAR(10 g) = 0.214 W/kg

Smallest distance from peaks to all points 3 dB below = 10.2 mm

Ratio of SAR at M2 to SAR at M1 = 53.7%

Maximum value of SAR (measured) = 0.639 W/kg

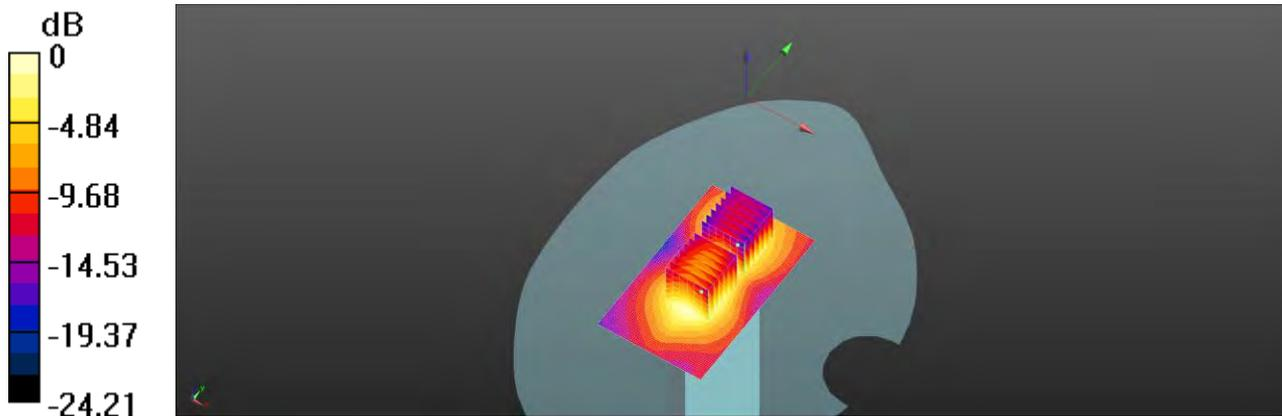

0 dB = 0.639 W/kg = -1.94 dBW/kg

Unless otherwise stated the results shown in this test report refer only to the sample(s) tested and such sample(s) are retained for 90 days only.

除非另有說明，此報告結果僅對測試之樣品負責，同時此樣品僅保留90天。本報告未經本公司書面許可，不可部份複製。

This document is issued by the Company subject to its General Conditions of Service printed overleaf, available on request or accessible at <http://www.sgs.com.tw/Terms-and-Conditions> and for electronic format documents, subject to Terms and Conditions for Electronic Documents at <http://www.sgs.com.tw/Terms-and-Conditions>. Attention is drawn to the limitation of liability, indemnification and jurisdiction issues defined therein. Any holder of this document is advised that information contained hereon reflects the Company's findings at the time of its intervention only and within the limits of Client's instructions, if any. The Company's sole responsibility is to its Client and this document does not exonerate parties to a transaction from exercising all their rights and obligations under the transaction documents. This document cannot be reproduced except in full, without prior written approval of the Company. Any unauthorized alteration, forgery or falsification of the content or appearance of this document is unlawful and offenders may be prosecuted to the fullest extent of the law.

Date: 2020/7/21

Report No. :ES/2020/30005

LTE Band 42 (20MHz)_Hotspot_Back side_CH 43490_QPSK_1-99_10mm_LAT

Communication System: LTE; Frequency: 3590 MHz; Duty cycle= 1:1.59956

Medium parameters used: $f = 3590$ MHz; $\sigma = 2.978$ S/m; $\epsilon_r = 37.704$; $\rho = 1000$ kg/m³

Phantom section: Flat Section

Ambient temperature: 21.8°C; Liquid temperature: 22.3°C

DASY5 Configuration:

- Probe: EX3DV4 - SN7509; ConvF(6.73, 6.73, 6.73) @ 3590 MHz; Calibrated: 3/25/2020
- Sensor-Surface: 2mm (Mechanical Surface Detection)
- Electronics: DAE4 Sn558; Calibrated: 10/11/2019
- Phantom: SAM
- DASY52 52.10.4(1527); SEMCAD X 14.6.14(7483)

Area Scan (91x181x1): Interpolated grid: dx=12 mm, dy=12 mm

Maximum value of SAR (interpolated) = 0.298 W/kg

Zoom Scan (7x7x8)/Cube 0: Measurement grid: dx=5mm, dy=5mm, dz=4mm

Reference Value = 2.924 V/m; Power Drift = -0.06 dB

Peak SAR (extrapolated) = 0.404 W/kg

SAR(1 g) = 0.192 W/kg; SAR(10 g) = 0.090 W/kg

Smallest distance from peaks to all points 3 dB below = 11.4 mm

Ratio of SAR at M2 to SAR at M1 = 53.3%

Maximum value of SAR (measured) = 0.290 W/kg

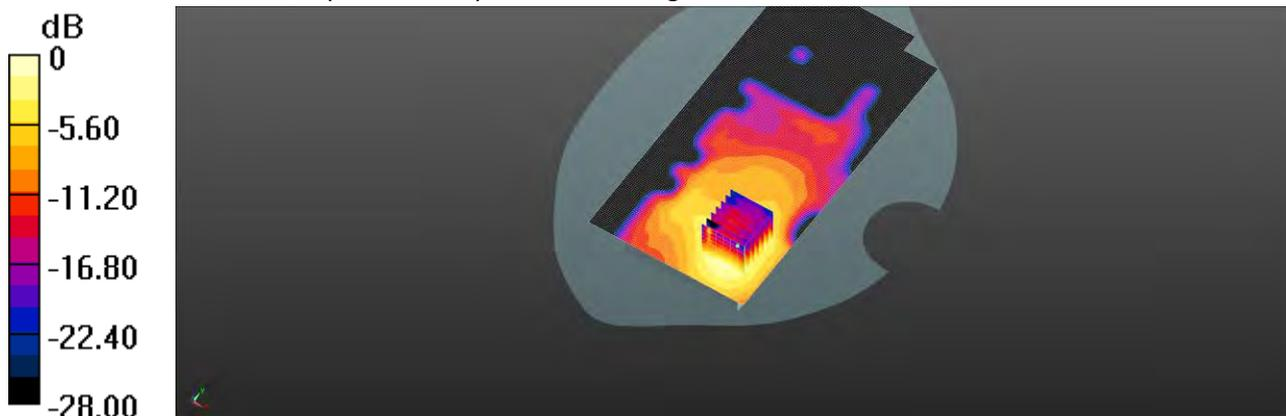

0 dB = 0.290 W/kg = -5.38 dBW/kg

Unless otherwise stated the results shown in this test report refer only to the sample(s) tested and such sample(s) are retained for 90 days only.

除非另有說明，此報告結果僅對測試之樣品負責，同時此樣品僅保留90天。本報告未經本公司書面許可，不可部份複製。

This document is issued by the Company subject to its General Conditions of Service printed overleaf, available on request or accessible at <http://www.sgs.com.tw/Terms-and-Conditions> and for electronic format documents, subject to Terms and Conditions for Electronic Documents at <http://www.sgs.com.tw/Terms-and-Conditions>. Attention is drawn to the limitation of liability, indemnification and jurisdiction issues defined therein. Any holder of this document is advised that information contained hereon reflects the Company's findings at the time of its intervention only and within the limits of Client's instructions, if any. The Company's sole responsibility is to its Client and this document does not exonerate parties to a transaction from exercising all their rights and obligations under the transaction documents. This document cannot be reproduced except in full, without prior written approval of the Company. Any unauthorized alteration, forgery or falsification of the content or appearance of this document is unlawful and offenders may be prosecuted to the fullest extent of the law.

Date: 2020/7/21

Report No. :ES/2020/30005

LTE Band 48 (20MHz)_Hotspot_Back side_CH 55773_QPSK_1-0_10mm_LAT

Communication System: LTE; Frequency: 3603.3 MHz; Duty cycle= 1:1.59956

Medium parameters used: $f = 3603.3$ MHz; $\sigma = 2.983$ S/m; $\epsilon_r = 37.699$; $\rho = 1000$ kg/m³

Phantom section: Flat Section

Ambient temperature: 22.5°C; Liquid temperature: 21.4°C

DASY5 Configuration:

- Probe: EX3DV4 - SN7509; ConvF(6.67, 6.67, 6.67) @ 3603.3 MHz; Calibrated: 2020/3/25
- Sensor-Surface: 2mm (Mechanical Surface Detection)
- Electronics: DAE4 Sn558; Calibrated: 2019/10/11
- Phantom: SAM
- DASY52 52.10.4(1527); SEMCAD X 14.6.14(7483)

Area Scan (91x181x1): Interpolated grid: dx=12 mm, dy=12 mm

Maximum value of SAR (interpolated) = 0.265 W/kg

Zoom Scan (7x7x8)/Cube 0: Measurement grid: dx=5mm, dy=5mm, dz=4mm

Reference Value = 2.341 V/m; Power Drift = 0.17 dB

Peak SAR (extrapolated) = 0.378 W/kg

SAR(1 g) = 0.178 W/kg; SAR(10 g) = 0.082 W/kg

Smallest distance from peaks to all points 3 dB below = 11.3 mm

Ratio of SAR at M2 to SAR at M1 = 54.3%

Maximum value of SAR (measured) = 0.274 W/kg

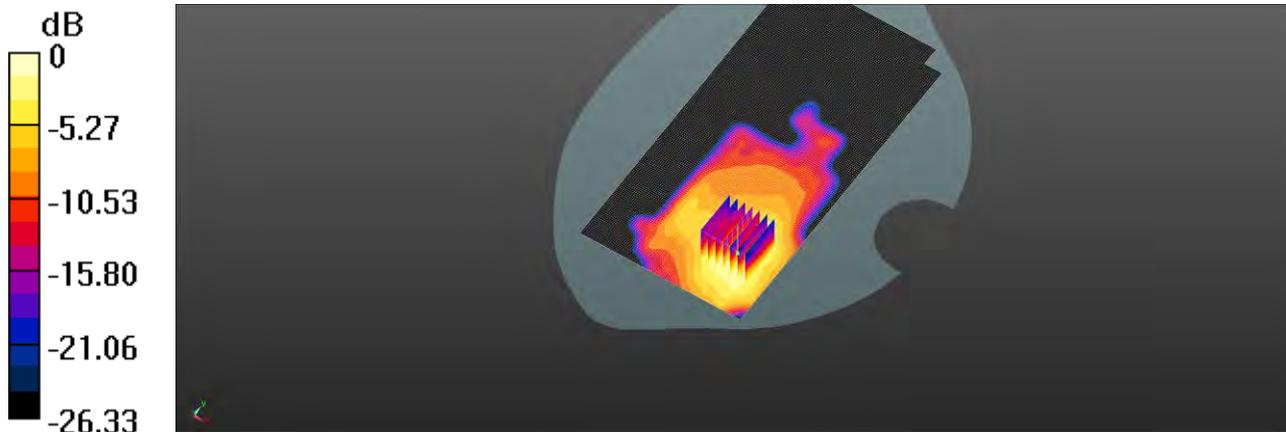

0 dB = 0.274 W/kg = -5.62 dBW/kg

Unless otherwise stated the results shown in this test report refer only to the sample(s) tested and such sample(s) are retained for 90 days only.

除非另有說明，此報告結果僅對測試之樣品負責，同時此樣品僅保留90天。本報告未經本公司書面許可，不可部份複製。

This document is issued by the Company subject to its General Conditions of Service printed overleaf, available on request or accessible at <http://www.sgs.com.tw/Terms-and-Conditions> and for electronic format documents, subject to Terms and Conditions for Electronic Documents at <http://www.sgs.com.tw/Terms-and-Conditions>. Attention is drawn to the limitation of liability, indemnification and jurisdiction issues defined therein. Any holder of this document is advised that information contained hereon reflects the Company's findings at the time of its intervention only and within the limits of Client's instructions, if any. The Company's sole responsibility is to its Client and this document does not exonerate parties to a transaction from exercising all their rights and obligations under the transaction documents. This document cannot be reproduced except in full, without prior written approval of the Company. Any unauthorized alteration, forgery or falsification of the content or appearance of this document is unlawful and offenders may be prosecuted to the fullest extent of the law.

Date: 2020/7/16

Report No. :ES/2020/30005

**LTE Band 66 (20MHz)_Hotspot_Bottom side_CH
132572_QPSK_1-0_10mm_LAT**

Communication System: LTE; Frequency: 1770 MHz; Duty cycle= 1:1

Medium parameters used: $f = 1770$ MHz; $\sigma = 1.388$ S/m; $\epsilon_r = 40.012$; $\rho = 1000$ kg/m³

Phantom section: Flat Section

Ambient temperature: 22.3°C; Liquid temperature: 21.4°C

DASY5 Configuration:

- Probe: EX3DV4 - SN7509; ConvF(8.34, 8.34, 8.34) @ 1770 MHz; Calibrated: 3/25/2020
- Sensor-Surface: 2mm (Mechanical Surface Detection)
- Electronics: DAE4 Sn558; Calibrated: 10/11/2019
- Phantom: SAM
- DASY52 52.10.4(1527); SEMCAD X 14.6.14(7483)

Area Scan (51x81x1): Interpolated grid: dx=15 mm, dy=15 mm

Maximum value of SAR (interpolated) = 1.45 W/kg

Zoom Scan (5x5x7)/Cube 0: Measurement grid: dx=8mm, dy=8mm, dz=5mm

Reference Value = 29.96 V/m; Power Drift = -0.17 dB

Peak SAR (extrapolated) = 1.46 W/kg

SAR(1 g) = 1.1 W/kg; SAR(10 g) = 0.788 W/kg

Smallest distance from peaks to all points 3 dB below = 12.8 mm

Ratio of SAR at M2 to SAR at M1 = 76.5%

Maximum value of SAR (measured) = 1.32 W/kg

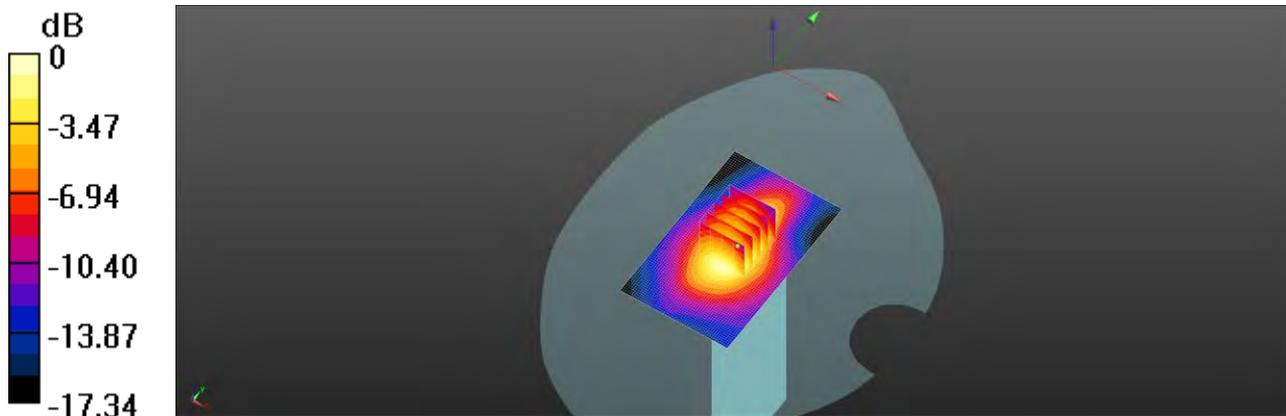

0 dB = 1.32 W/kg = 1.21 dBW/kg

Unless otherwise stated the results shown in this test report refer only to the sample(s) tested and such sample(s) are retained for 90 days only.

除非另有說明，此報告結果僅對測試之樣品負責，同時此樣品僅保留90天。本報告未經本公司書面許可，不可部份複製。

This document is issued by the Company subject to its General Conditions of Service printed overleaf, available on request or accessible at <http://www.sgs.com.tw/Terms-and-Conditions> and for electronic format documents, subject to Terms and Conditions for Electronic Documents at <http://www.sgs.com.tw/Terms-and-Conditions>. Attention is drawn to the limitation of liability, indemnification and jurisdiction issues defined therein. Any holder of this document is advised that information contained hereon reflects the Company's findings at the time of its intervention only and within the limits of Client's instructions, if any. The Company's sole responsibility is to its Client and this document does not exonerate parties to a transaction from exercising all their rights and obligations under the transaction documents. This document cannot be reproduced except in full, without prior written approval of the Company. Any unauthorized alteration, forgery or falsification of the content or appearance of this document is unlawful and offenders may be prosecuted to the fullest extent of the law.

Date: 2020/7/14

Report No. :ES/2020/30005

LTE Band 71 (20MHz)_Hotspot_Front side_CH 133372_QPSK_1-0_10mm_LAT

Communication System: LTE; Frequency: 688 MHz; Duty cycle= 1:1

Medium parameters used: $f = 688 \text{ MHz}$; $\sigma = 0.853 \text{ S/m}$; $\epsilon_r = 43.354$; $\rho = 1000 \text{ kg/m}^3$

Phantom section: Flat Section

Ambient temperature: 21.8°C; Liquid temperature: 22.3°C

DASY5 Configuration:

- Probe: EX3DV4 - SN7509; ConvF(9.94, 9.94, 9.94) @ 688 MHz; Calibrated: 3/25/2020
- Sensor-Surface: 2mm (Mechanical Surface Detection)
- Electronics: DAE4 Sn558; Calibrated: 10/11/2019
- Phantom: SAM
- DASY52 52.10.4(1527); SEMCAD X 14.6.14(7483)

Area Scan (71x141x1): Interpolated grid: dx=15 mm, dy=15 mm

Maximum value of SAR (interpolated) = 0.239 W/kg

Zoom Scan (5x5x7)/Cube 0: Measurement grid: dx=8mm, dy=8mm, dz=5mm

Reference Value = 11.58 V/m; Power Drift = 0.01 dB

Peak SAR (extrapolated) = 0.220 W/kg

SAR(1 g) = 0.197 W/kg; SAR(10 g) = 0.147 W/kg

Smallest distance from peaks to all points 3 dB below = 20 mm

Ratio of SAR at M2 to SAR at M1 = 91.4%

Maximum value of SAR (measured) = 0.211 W/kg

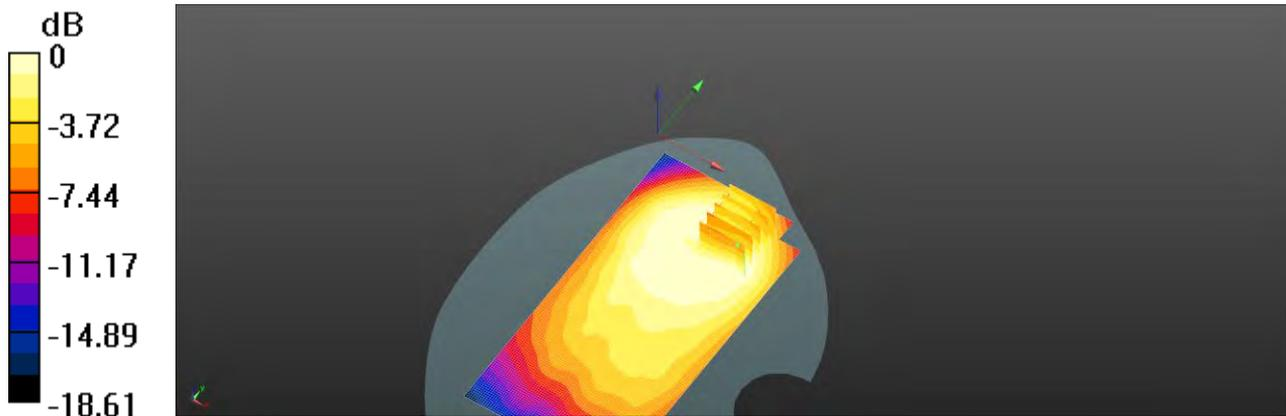

0 dB = 0.211 W/kg = -6.76 dBW/kg

Unless otherwise stated the results shown in this test report refer only to the sample(s) tested and such sample(s) are retained for 90 days only.

除非另有說明，此報告結果僅對測試之樣品負責，同時此樣品僅保留90天。本報告未經本公司書面許可，不可部份複製。

This document is issued by the Company subject to its General Conditions of Service printed overleaf, available on request or accessible at <http://www.sgs.com.tw/Terms-and-Conditions> and for electronic format documents, subject to Terms and Conditions for Electronic Documents at <http://www.sgs.com.tw/Terms-and-Conditions>. Attention is drawn to the limitation of liability, indemnification and jurisdiction issues defined therein. Any holder of this document is advised that information contained hereon reflects the Company's findings at the time of its intervention only and within the limits of Client's instructions, if any. The Company's sole responsibility is to its Client and this document does not exonerate parties to a transaction from exercising all their rights and obligations under the transaction documents. This document cannot be reproduced except in full, without prior written approval of the Company. Any unauthorized alteration, forgery or falsification of the content or appearance of this document is unlawful and offenders may be prosecuted to the fullest extent of the law.

Date: 2020/7/2

Report No. : ES/2020/30005

GSM 850_Head_Re Cheek_CH 251_UAT

Communication System: GSM; Frequency: 848.8 MHz; Duty cycle= 1:8.3

Medium parameters used: $f = 849$ MHz; $\sigma = 0.928$ S/m; $\epsilon_r = 41.757$; $\rho = 1000$ kg/m³

Phantom section: Right Section

Ambient temperature: 21.4°C; Liquid temperature: 21.8°C

DASY5 Configuration:

- Probe: EX3DV4 - SN3770; ConvF(9.5, 9.5, 9.5) @ 849 MHz; Calibrated: 2020/5/27
- Sensor-Surface: 2mm (Mechanical Surface Detection)
- Electronics: DAE4 Sn877; Calibrated: 2020/3/17
- Phantom: SAM
- DASY52 52.10.4(1527); SEMCAD X 14.6.14(7483)

Area Scan (71x151x1): Interpolated grid: dx=15 mm, dy=15 mm

Maximum value of SAR (interpolated) = 0.612 W/kg

Zoom Scan (5x5x7)/Cube 0: Measurement grid: dx=8mm, dy=8mm, dz=5mm

Reference Value = 21.64 V/m; Power Drift = 0.12 dB

Peak SAR (extrapolated) = 0.682 W/kg

SAR(1 g) = 0.502 W/kg; SAR(10 g) = 0.352 W/kg

Smallest distance from peaks to all points 3 dB below = 14.4 mm

Ratio of SAR at M2 to SAR at M1 = 73.4%

Maximum value of SAR (measured) = 0.589 W/kg

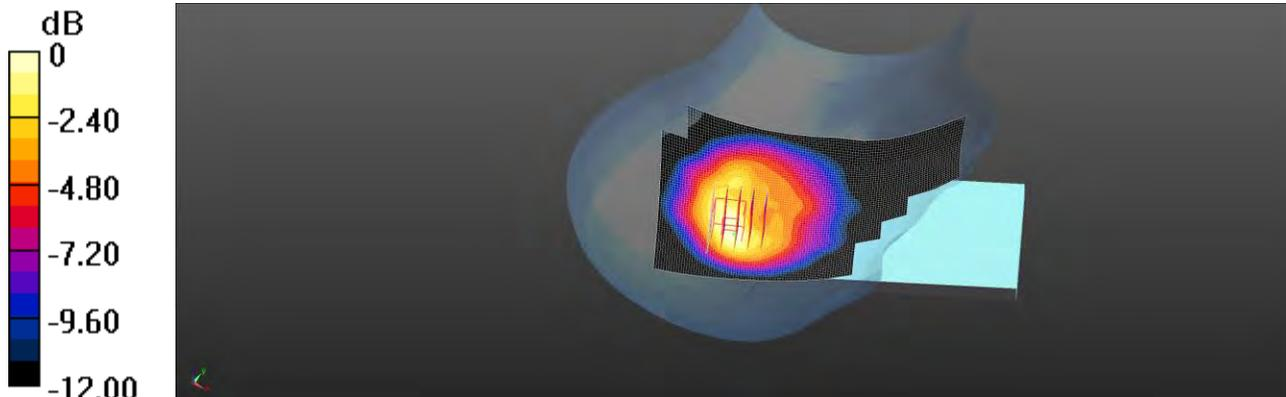

0 dB = 0.589 W/kg = -2.30 dBW/kg

Unless otherwise stated the results shown in this test report refer only to the sample(s) tested and such sample(s) are retained for 90 days only.

除非另有說明，此報告結果僅對測試之樣品負責，同時此樣品僅保留90天。本報告未經本公司書面許可，不可部份複製。

This document is issued by the Company subject to its General Conditions of Service printed overleaf, available on request or accessible at <http://www.sgs.com.tw/Terms-and-Conditions> and for electronic format documents, subject to Terms and Conditions for Electronic Documents at <http://www.sgs.com.tw/Terms-and-Conditions>. Attention is drawn to the limitation of liability, indemnification and jurisdiction issues defined therein. Any holder of this document is advised that information contained hereon reflects the Company's findings at the time of its intervention only and within the limits of Client's instructions, if any. The Company's sole responsibility is to its Client and this document does not exonerate parties to a transaction from exercising all their rights and obligations under the transaction documents. This document cannot be reproduced except in full, without prior written approval of the Company. Any unauthorized alteration, forgery or falsification of the content or appearance of this document is unlawful and offenders may be prosecuted to the fullest extent of the law.

Date: 2020/7/2

Report No. : ES/2020/30005

WCDMA Band V_Head_Re Cheek_CH 4183_UAT

Communication System: WCDMA; Frequency: 836.6 MHz; Duty cycle= 1:1

Medium parameters used: $f = 837 \text{ MHz}$; $\sigma = 0.912 \text{ S/m}$; $\epsilon_r = 41.943$; $\rho = 1000 \text{ kg/m}^3$

Phantom section: Right Section

Ambient temperature: 21.4°C; Liquid temperature: 21.8°C

DASY5 Configuration:

- Probe: EX3DV4 - SN3770; ConvF(9.5, 9.5, 9.5) @ 837 MHz; Calibrated: 2020/5/27
- Sensor-Surface: 2mm (Mechanical Surface Detection)
- Electronics: DAE4 Sn877; Calibrated: 2020/3/17
- Phantom: SAM
- DASY52 52.10.4(1527); SEMCAD X 14.6.14(7483)

Area Scan (71x151x1): Interpolated grid: dx=15 mm, dy=15 mm

Maximum value of SAR (interpolated) = 0.541 W/kg

Zoom Scan (5x5x7)/Cube 0: Measurement grid: dx=8mm, dy=8mm, dz=5mm

Reference Value = 27.35 V/m; Power Drift = -0.03 dB

Peak SAR (extrapolated) = 0.615 W/kg

SAR(1 g) = 0.444 W/kg; SAR(10 g) = 0.310 W/kg

Smallest distance from peaks to all points 3 dB below = 11.3 mm

Ratio of SAR at M2 to SAR at M1 = 70.4%

Maximum value of SAR (measured) = 0.533 W/kg

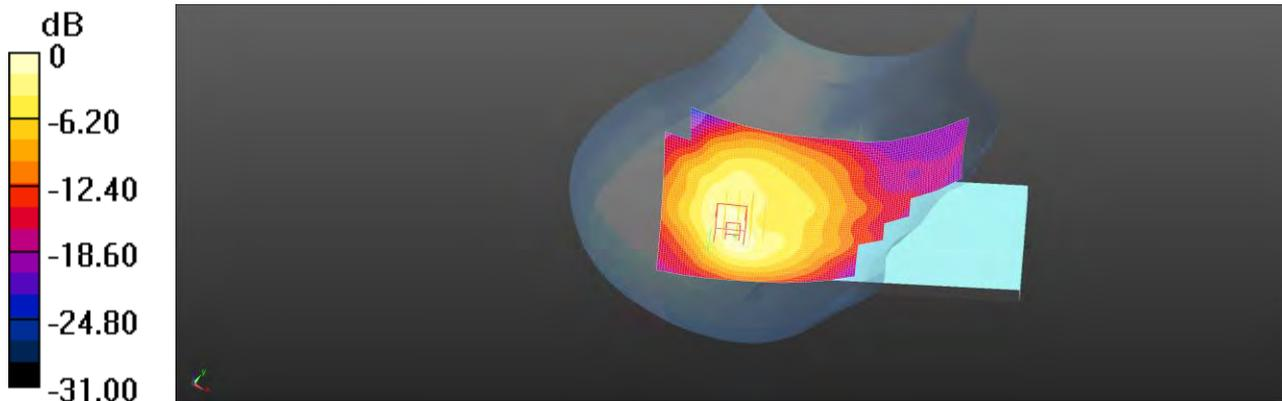

0 dB = 0.533 W/kg = -2.73 dBW/kg

Unless otherwise stated the results shown in this test report refer only to the sample(s) tested and such sample(s) are retained for 90 days only.

除非另有說明，此報告結果僅對測試之樣品負責，同時此樣品僅保留90天。本報告未經本公司書面許可，不可部份複製。

This document is issued by the Company subject to its General Conditions of Service printed overleaf, available on request or accessible at <http://www.sgs.com.tw/Terms-and-Conditions> and for electronic format documents, subject to Terms and Conditions for Electronic Documents at <http://www.sgs.com.tw/Terms-and-Conditions>. Attention is drawn to the limitation of liability, indemnification and jurisdiction issues defined therein. Any holder of this document is advised that information contained hereon reflects the Company's findings at the time of its intervention only and within the limits of Client's instructions, if any. The Company's sole responsibility is to its Client and this document does not exonerate parties to a transaction from exercising all their rights and obligations under the transaction documents. This document cannot be reproduced except in full, without prior written approval of the Company. Any unauthorized alteration, forgery or falsification of the content or appearance of this document is unlawful and offenders may be prosecuted to the fullest extent of the law.

Date: 2020/7/1

Report No. :ES/2020/30005

LTE Band 12 (10MHz)_Head_Re Cheek_CH 23060_QPSK_1-0_UAT

Communication System: LTE; Frequency: 704 MHz; Duty cycle= 1:1

Medium parameters used: $f = 704 \text{ MHz}$; $\sigma = 0.87 \text{ S/m}$; $\epsilon_r = 43.034$; $\rho = 1000 \text{ kg/m}^3$

Phantom section: Right Section

Ambient temperature: 21.3°C; Liquid temperature: 21.6°C

DASY5 Configuration:

- Probe: EX3DV4 - SN3770; ConvF(9.84, 9.84, 9.84) @ 704 MHz; Calibrated: 2020/5/27
- Sensor-Surface: 2mm (Mechanical Surface Detection)
- Electronics: DAE4 Sn877; Calibrated: 2020/3/17
- Phantom: SAM
- DASY52 52.10.4(1527); SEMCAD X 14.6.14(7483)

Area Scan (71x151x1): Interpolated grid: dx=15 mm, dy=15 mm

Maximum value of SAR (interpolated) = 0.420 W/kg

Zoom Scan (5x5x7)/Cube 0: Measurement grid: dx=8mm, dy=8mm, dz=5mm

Reference Value = 21.42 V/m; Power Drift = 0.06 dB

Peak SAR (extrapolated) = 0.423 W/kg

SAR(1 g) = 0.312 W/kg; SAR(10 g) = 0.235 W/kg

Smallest distance from peaks to all points 3 dB below = 12.1 mm

Ratio of SAR at M2 to SAR at M1 = 71.7%

Maximum value of SAR (measured) = 0.342 W/kg

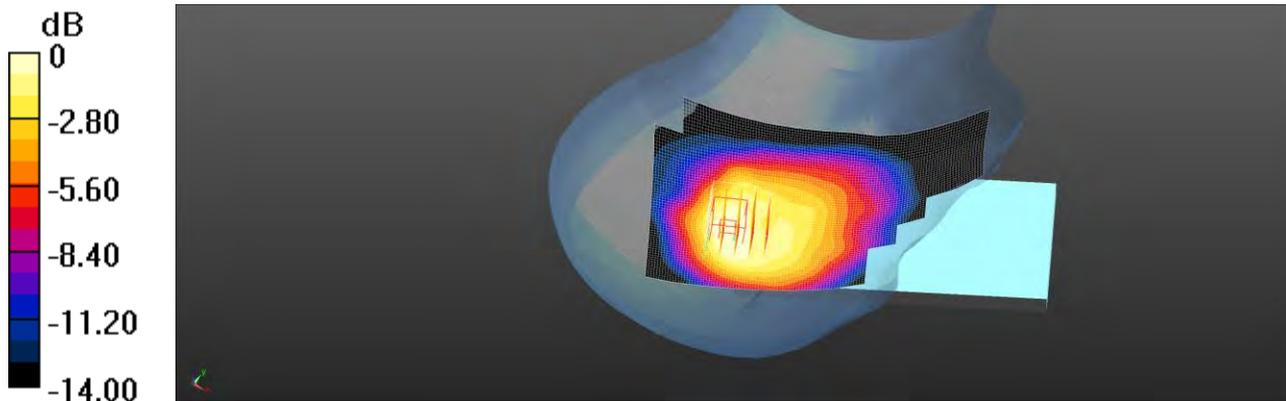

0 dB = 0.342 W/kg = -4.66 dBW/kg

Unless otherwise stated the results shown in this test report refer only to the sample(s) tested and such sample(s) are retained for 90 days only.

除非另有說明，此報告結果僅對測試之樣品負責，同時此樣品僅保留90天。本報告未經本公司書面許可，不可部份複製。

This document is issued by the Company subject to its General Conditions of Service printed overleaf, available on request or accessible at <http://www.sgs.com.tw/Terms-and-Conditions> and for electronic format documents, subject to Terms and Conditions for Electronic Documents at <http://www.sgs.com.tw/Terms-and-Conditions>. Attention is drawn to the limitation of liability, indemnification and jurisdiction issues defined therein. Any holder of this document is advised that information contained hereon reflects the Company's findings at the time of its intervention only and within the limits of Client's instructions, if any. The Company's sole responsibility is to its Client and this document does not exonerate parties to a transaction from exercising all their rights and obligations under the transaction documents. This document cannot be reproduced except in full, without prior written approval of the Company. Any unauthorized alteration, forgery or falsification of the content or appearance of this document is unlawful and offenders may be prosecuted to the fullest extent of the law.

Date: 2020/7/1

Report No. :ES/2020/30005

LTE Band 13 (10MHz)_Head_Re_Cheek_CH 23230_QPSK_1-0_UAT

Communication System: LTE; Frequency: 782 MHz; Duty cycle= 1:1

Medium parameters used: $f = 782 \text{ MHz}$; $\sigma = 0.896 \text{ S/m}$; $\epsilon_r = 42.491$; $\rho = 1000 \text{ kg/m}^3$

Phantom section: Right Section

Ambient temperature: 21.3°C; Liquid temperature: 21.6°C

DASY5 Configuration:

- Probe: EX3DV4 - SN3770; ConvF(9.84, 9.84, 9.84) @ 782 MHz; Calibrated: 2020/5/27
- Sensor-Surface: 2mm (Mechanical Surface Detection)
- Electronics: DAE4 Sn877; Calibrated: 2020/3/17
- Phantom: SAM
- DASY52 52.10.4(1527); SEMCAD X 14.6.14(7483)

Area Scan (71x151x1): Interpolated grid: dx=15 mm, dy=15 mm

Maximum value of SAR (interpolated) = 0.652 W/kg

Zoom Scan (5x5x7)/Cube 0: Measurement grid: dx=8mm, dy=8mm, dz=5mm

Reference Value = 20.49 V/m; Power Drift = -0.05 dB

Peak SAR (extrapolated) = 0.699 W/kg

SAR(1 g) = 0.492 W/kg; SAR(10 g) = 0.334 W/kg

Smallest distance from peaks to all points 3 dB below = 12.0 mm

Ratio of SAR at M2 to SAR at M1 = 68.5%

Maximum value of SAR (measured) = 0.579 W/kg

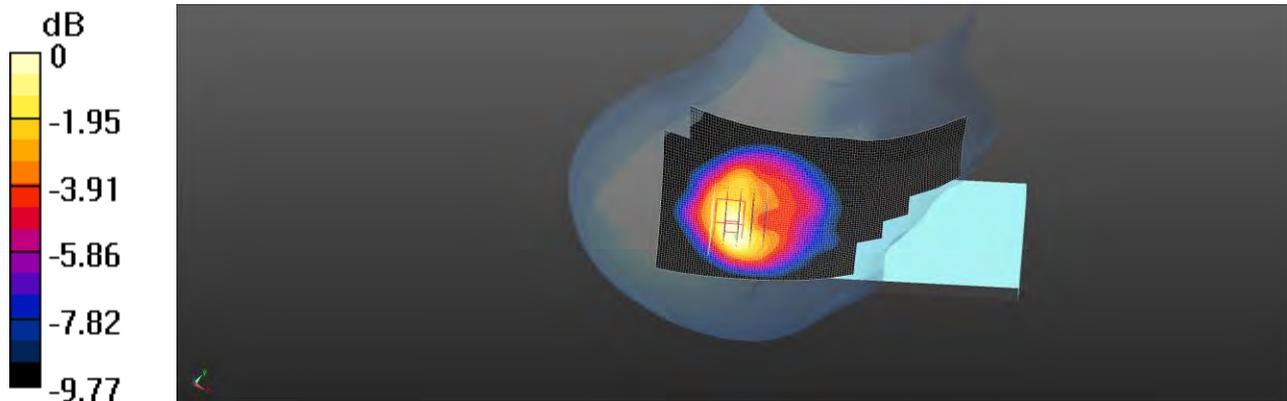

0 dB = 0.579 W/kg = -2.37 dBW/kg

Unless otherwise stated the results shown in this test report refer only to the sample(s) tested and such sample(s) are retained for 90 days only.

除非另有說明，此報告結果僅對測試之樣品負責，同時此樣品僅保留90天。本報告未經本公司書面許可，不可部份複製。

This document is issued by the Company subject to its General Conditions of Service printed overleaf, available on request or accessible at <http://www.sgs.com.tw/Terms-and-Conditions> and for electronic format documents, subject to Terms and Conditions for Electronic Documents at <http://www.sgs.com.tw/Terms-and-Conditions>. Attention is drawn to the limitation of liability, indemnification and jurisdiction issues defined therein. Any holder of this document is advised that information contained hereon reflects the Company's findings at the time of its intervention only and within the limits of Client's instructions, if any. The Company's sole responsibility is to its Client and this document does not exonerate parties to a transaction from exercising all their rights and obligations under the transaction documents. This document cannot be reproduced except in full, without prior written approval of the Company. Any unauthorized alteration, forgery or falsification of the content or appearance of this document is unlawful and offenders may be prosecuted to the fullest extent of the law.

Date: 2020/7/2

Report No. :ES/2020/30005

LTE Band 26 (15MHz)_Head_Re Cheek_CH 26765_QPSK_1-0_UAT

Communication System: LTE; Frequency: 821.5 MHz; Duty cycle= 1:1

Medium parameters used: $f = 821.5$ MHz; $\sigma = 0.897$ S/m; $\epsilon_r = 42.385$; $\rho = 1000$ kg/m³

Phantom section: Right Section

Ambient temperature: 21.4°C; Liquid temperature: 21.8°C

DASY5 Configuration:

- Probe: EX3DV4 - SN3770; ConvF(9.5, 9.5, 9.5) @ 821 MHz; Calibrated: 2020/5/27
- Sensor-Surface: 2mm (Mechanical Surface Detection)
- Electronics: DAE4 Sn877; Calibrated: 2020/3/17
- Phantom: SAM
- DASY52 52.10.4(1527); SEMCAD X 14.6.14(7483)

Area Scan (71x151x1): Interpolated grid: dx=15 mm, dy=15 mm

Maximum value of SAR (interpolated) = 0.565 W/kg

Zoom Scan (5x5x7)/Cube 0: Measurement grid: dx=8mm, dy=8mm, dz=5mm

Reference Value = 24.17 V/m; Power Drift = -0.04 dB

Peak SAR (extrapolated) = 0.601 W/kg

SAR(1 g) = 0.452 W/kg; SAR(10 g) = 0.320 W/kg

Smallest distance from peaks to all points 3 dB below = 11.3 mm

Ratio of SAR at M2 to SAR at M1 = 68.6%

Maximum value of SAR (measured) = 0.519 W/kg

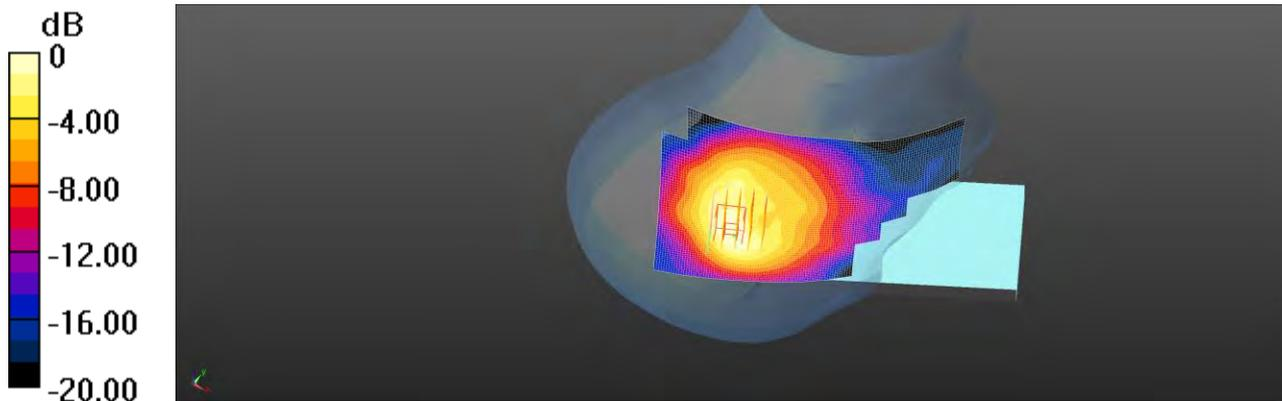

0 dB = 0.519 W/kg = -2.85 dBW/kg

Unless otherwise stated the results shown in this test report refer only to the sample(s) tested and such sample(s) are retained for 90 days only.

除非另有說明，此報告結果僅對測試之樣品負責，同時此樣品僅保留90天。本報告未經本公司書面許可，不可部份複製。

This document is issued by the Company subject to its General Conditions of Service printed overleaf, available on request or accessible at <http://www.sgs.com.tw/Terms-and-Conditions> and for electronic format documents, subject to Terms and Conditions for Electronic Documents at <http://www.sgs.com.tw/Terms-and-Conditions>. Attention is drawn to the limitation of liability, indemnification and jurisdiction issues defined therein. Any holder of this document is advised that information contained hereon reflects the Company's findings at the time of its intervention only and within the limits of Client's instructions, if any. The Company's sole responsibility is to its Client and this document does not exonerate parties to a transaction from exercising all their rights and obligations under the transaction documents. This document cannot be reproduced except in full, without prior written approval of the Company. Any unauthorized alteration, forgery or falsification of the content or appearance of this document is unlawful and offenders may be prosecuted to the fullest extent of the law.

Date: 2020/7/1

Report No. :ES/2020/30005

LTE Band 71 (20MHz)_Head_Re Cheek_CH 133372_QPSK_1-0_UAT

Communication System: LTE; Frequency: 688 MHz; Duty cycle= 1:1

Medium parameters used: $f = 688 \text{ MHz}$; $\sigma = 0.859 \text{ S/m}$; $\epsilon_r = 43.174$; $\rho = 1000 \text{ kg/m}^3$

Phantom section: Right Section

Ambient temperature: 21.3°C; Liquid temperature: 21.6°C

DASY5 Configuration:

- Probe: EX3DV4 - SN3770; ConvF(9.84, 9.84, 9.84) @ 688 MHz; Calibrated: 2020/5/27
- Sensor-Surface: 2mm (Mechanical Surface Detection)
- Electronics: DAE4 Sn877; Calibrated: 2020/3/17
- Phantom: SAM
- DASY52 52.10.4(1527); SEMCAD X 14.6.14(7483)

Area Scan (71x151x1): Interpolated grid: dx=15 mm, dy=15 mm

Maximum value of SAR (interpolated) = 0.364 W/kg

Zoom Scan (5x5x7)/Cube 0: Measurement grid: dx=8mm, dy=8mm, dz=5mm

Reference Value = 28.81 V/m; Power Drift = -0.05 dB

Peak SAR (extrapolated) = 0.357 W/kg

SAR(1 g) = 0.278 W/kg; SAR(10 g) = 0.213 W/kg

Smallest distance from peaks to all points 3 dB below = 10.2 mm

Ratio of SAR at M2 to SAR at M1 = 80.1%

Maximum value of SAR (measured) = 0.299 W/kg

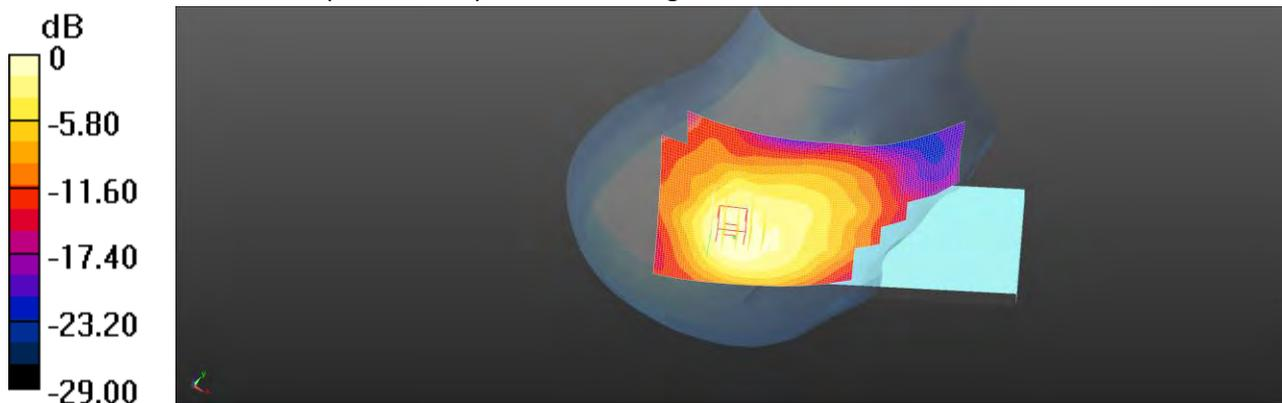

0 dB = 0.299 W/kg = -5.24 dBW/kg

Unless otherwise stated the results shown in this test report refer only to the sample(s) tested and such sample(s) are retained for 90 days only.

除非另有說明，此報告結果僅對測試之樣品負責，同時此樣品僅保留90天。本報告未經本公司書面許可，不可部份複製。

This document is issued by the Company subject to its General Conditions of Service printed overleaf, available on request or accessible at <http://www.sgs.com.tw/Terms-and-Conditions> and for electronic format documents, subject to Terms and Conditions for Electronic Documents at <http://www.sgs.com.tw/Terms-and-Conditions>. Attention is drawn to the limitation of liability, indemnification and jurisdiction issues defined therein. Any holder of this document is advised that information contained hereon reflects the Company's findings at the time of its intervention only and within the limits of Client's instructions, if any. The Company's sole responsibility is to its Client and this document does not exonerate parties to a transaction from exercising all their rights and obligations under the transaction documents. This document cannot be reproduced except in full, without prior written approval of the Company. Any unauthorized alteration, forgery or falsification of the content or appearance of this document is unlawful and offenders may be prosecuted to the fullest extent of the law.

Date: 2020/7/2

Report No. :ES/2020/30005

GPRS 850_Hotspot_Front side_CH 251_10mm_LAT

Communication System: GPRS (1Dn2Up); Frequency: 848.8 MHz; Duty cycle= 1:1

Medium parameters used: $f = 849$ MHz; $\sigma = 0.928$ S/m; $\epsilon_r = 41.757$; $\rho = 1000$ kg/m³

Phantom section: Flat Section

Ambient temperature: 21.4°C; Liquid temperature: 21.8°C

DASY5 Configuration:

- Probe: EX3DV4 - SN3770; ConvF(9.5, 9.5, 9.5) @ 849 MHz; Calibrated: 2020/5/27
- Sensor-Surface: 2mm (Mechanical Surface Detection)
- Electronics: DAE4 Sn877; Calibrated: 2020/3/17
- Phantom: SAM
- DASY52 52.10.4(1527); SEMCAD X 14.6.14(7483)

Area Scan (71x141x1): Interpolated grid: dx=15 mm, dy=15 mm

Maximum value of SAR (interpolated) = 0.841 W/kg

Zoom Scan (5x5x7)/Cube 0: Measurement grid: dx=8mm, dy=8mm, dz=5mm

Reference Value = 13.81 V/m; Power Drift = 0.16 dB

Peak SAR (extrapolated) = 0.723 W/kg

SAR(1 g) = 0.675 W/kg; SAR(10 g) = 0.529 W/kg

Smallest distance from peaks to all points 3 dB below = 13.8 mm

Ratio of SAR at M2 to SAR at M1 = 97.2%

Maximum value of SAR (measured) = 0.688 W/kg

Zoom Scan (5x5x7)/Cube 1: Measurement grid: dx=8mm, dy=8mm, dz=5mm

Reference Value = 13.81 V/m; Power Drift = 0.16 dB

Peak SAR (extrapolated) = 0.706 W/kg

SAR(1 g) = 0.660 W/kg; SAR(10 g) = 0.581 W/kg

Smallest distance from peaks to all points 3 dB below: Larger than measurement grid

Ratio of SAR at M2 to SAR at M1 = 92%

Maximum value of SAR (measured) = 0.680 W/kg

Zoom Scan (5x5x7)/Cube 2: Measurement grid: dx=8mm, dy=8mm, dz=5mm

Reference Value = 13.81 V/m; Power Drift = 0.16 dB

Peak SAR (extrapolated) = 0.707 W/kg

SAR(1 g) = 0.568 W/kg; SAR(10 g) = 0.431 W/kg

Smallest distance from peaks to all points 3 dB below = 27.2 mm

Ratio of SAR at M2 to SAR at M1 = 80.8%

Maximum value of SAR (measured) = 0.641 W/kg

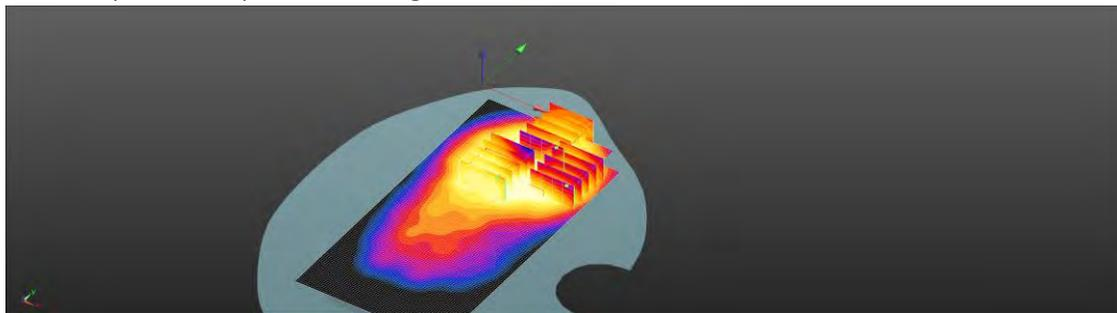
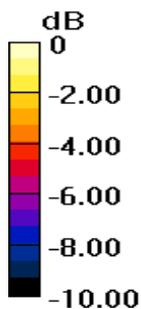

0 dB = 0.641 W/kg = -1.93 dBW/kg

Unless otherwise stated the results shown in this test report refer only to the sample(s) tested and such sample(s) are retained for 90 days only.

除非另有說明，此報告結果僅對測試之樣品負責，同時此樣品僅保留90天。本報告未經本公司書面許可，不可部份複製。

This document is issued by the Company subject to its General Conditions of Service printed overleaf, available on request or accessible at <http://www.sgs.com.tw/Terms-and-Conditions> and for electronic format documents, subject to Terms and Conditions for Electronic Documents at <http://www.sgs.com.tw/Terms-and-Conditions>. Attention is drawn to the limitation of liability, indemnification and jurisdiction issues defined therein. Any holder of this document is advised that information contained hereon reflects the Company's findings at the time of its intervention only and within the limits of Client's instructions, if any. The Company's sole responsibility is to its Client and this document does not exonerate parties to a transaction from exercising all their rights and obligations under the transaction documents. This document cannot be reproduced except in full, without prior written approval of the Company. Any unauthorized alteration, forgery or falsification of the content or appearance of this document is unlawful and offenders may be prosecuted to the fullest extent of the law.

Date: 2020/7/27

Report No. :ES/2020/30005

**LTE Band 30 (10MHz)_Hotspot_Bottom side_CH
27710_QPSK_1-49_10mm_LAT**

Communication System: LTE; Frequency: 2310 MHz; Duty cycle= 1:1

Medium parameters used: $f = 2310$ MHz; $\sigma = 1.682$ S/m; $\epsilon_r = 39.062$; $\rho = 1000$ kg/m³

Phantom section: Flat Section

Ambient temperature: 21.6°C; Liquid temperature: 21.9°C

DASY5 Configuration:

- Probe: EX3DV4 - SN3770; ConvF(7.67, 7.67, 7.67) @ 2310 MHz; Calibrated: 2020/5/27
- Sensor-Surface: 2mm (Mechanical Surface Detection)
- Electronics: DAE4 Sn877; Calibrated: 2020/3/17
- Phantom: SAM
- DASY52 52.10.4(1527); SEMCAD X 14.6.14(7483)

Area Scan (61x101x1): Interpolated grid: dx=12 mm, dy=12 mm

Maximum value of SAR (interpolated) = 1.14 W/kg

Zoom Scan (7x7x7)/Cube 0: Measurement grid: dx=5mm, dy=5mm, dz=5mm

Reference Value = 20.89 V/m; Power Drift = -0.13 dB

Peak SAR (extrapolated) = 1.30 W/kg

SAR(1 g) = 0.878 W/kg; SAR(10 g) = 0.529 W/kg

Smallest distance from peaks to all points 3 dB below = 13.2 mm

Ratio of SAR at M2 to SAR at M1 = 73%

Maximum value of SAR (measured) = 1.10 W/kg

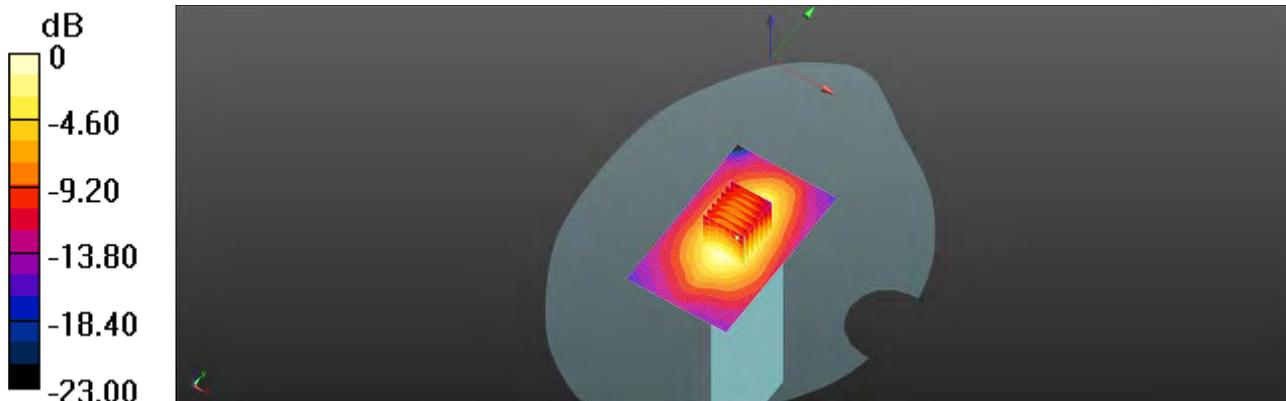

0 dB = 1.10 W/kg = 0.41 dBW/kg

Unless otherwise stated the results shown in this test report refer only to the sample(s) tested and such sample(s) are retained for 90 days only.

除非另有說明，此報告結果僅對測試之樣品負責，同時此樣品僅保留90天。本報告未經本公司書面許可，不可部份複製。

This document is issued by the Company subject to its General Conditions of Service printed overleaf, available on request or accessible at <http://www.sgs.com.tw/Terms-and-Conditions> and for electronic format documents, subject to Terms and Conditions for Electronic Documents at <http://www.sgs.com.tw/Terms-and-Conditions>. Attention is drawn to the limitation of liability, indemnification and jurisdiction issues defined therein. Any holder of this document is advised that information contained hereon reflects the Company's findings at the time of its intervention only and within the limits of Client's instructions, if any. The Company's sole responsibility is to its Client and this document does not exonerate parties to a transaction from exercising all their rights and obligations under the transaction documents. This document cannot be reproduced except in full, without prior written approval of the Company. Any unauthorized alteration, forgery or falsification of the content or appearance of this document is unlawful and offenders may be prosecuted to the fullest extent of the law.

Date: 2020/6/26

Report No. :ES/2020/30005

GPRS 850_Hotspot_Front side_CH 251_10mm_LAT

Communication System: GPRS (1Dn2Up); Frequency: 848.8 MHz; Duty cycle= 1:4.1

Medium parameters used: $f = 849$ MHz; $\sigma = 0.94$ S/m; $\epsilon_r = 41.567$; $\rho = 1000$ kg/m³

Phantom section: Flat Section

Ambient temperature: 21.6°C; Liquid temperature: 22.1°C

DASY5 Configuration:

- Probe: EX3DV4 - SN7509; ConvF(9.73, 9.73, 9.73) @ 849 MHz; Calibrated: 2020/3/25
- Sensor-Surface: 2mm (Mechanical Surface Detection)
- Electronics: DAE4 Sn558; Calibrated: 2019/10/11
- Phantom: SAM
- DASY52 52.10.4(1527); SEMCAD X 14.6.14(7483)

Area Scan (71x141x1): Interpolated grid: dx=15 mm, dy=15 mm

Maximum value of SAR (interpolated) = 0.572 W/kg

Zoom Scan (5x5x7)/Cube 0: Measurement grid: dx=8mm, dy=8mm, dz=5mm

Reference Value = 13.77 V/m; Power Drift = -0.03 dB

Peak SAR (extrapolated) = 0.535 W/kg

SAR(1 g) = 0.504 W/kg; SAR(10 g) = 0.413 W/kg

Smallest distance from peaks to all points 3 dB below = 19.1 mm

Ratio of SAR at M2 to SAR at M1 = 91.4%

Maximum value of SAR (measured) = 0.515 W/kg

Zoom Scan (5x5x7)/Cube 1: Measurement grid: dx=8mm, dy=8mm, dz=5mm

Reference Value = 13.77 V/m; Power Drift = -0.03 dB

Peak SAR (extrapolated) = 0.502 W/kg

SAR(1 g) = 0.444 W/kg; SAR(10 g) = 0.397 W/kg

Smallest distance from peaks to all points 3 dB below: Larger than measurement grid

Ratio of SAR at M2 to SAR at M1 = 85.1%

Maximum value of SAR (measured) = 0.464 W/kg

Zoom Scan (5x5x7)/Cube 2: Measurement grid: dx=8mm, dy=8mm, dz=5mm

Reference Value = 13.77 V/m; Power Drift = -0.03 dB

Peak SAR (extrapolated) = 0.495 W/kg

SAR(1 g) = 0.433 W/kg; SAR(10 g) = 0.353 W/kg

Smallest distance from peaks to all points 3 dB below = 13 mm

Ratio of SAR at M2 to SAR at M1 = 82.2%

Maximum value of SAR (measured) = 0.459 W/kg

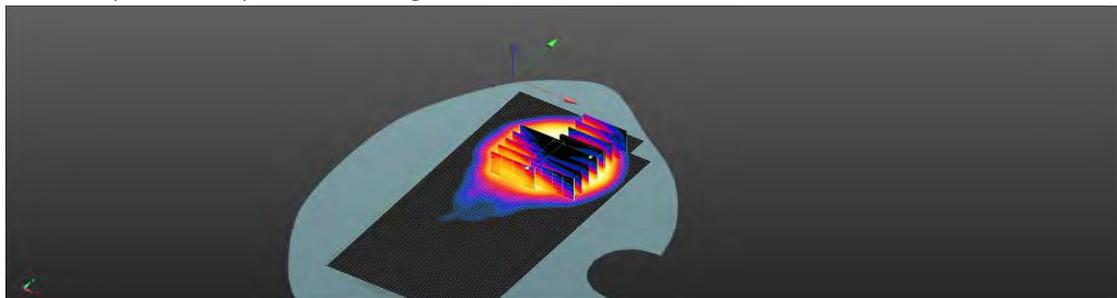
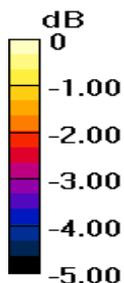

0 dB = 0.459 W/kg = -3.38 dBW/kg

Unless otherwise stated the results shown in this test report refer only to the sample(s) tested and such sample(s) are retained for 90 days only.

除非另有說明，此報告結果僅對測試之樣品負責，同時此樣品僅保留90天。本報告未經本公司書面許可，不可部份複製。

This document is issued by the Company subject to its General Conditions of Service printed overleaf, available on request or accessible at <http://www.sgs.com.tw/Terms-and-Conditions> and for electronic format documents, subject to Terms and Conditions for Electronic Documents at <http://www.sgs.com.tw/Terms-and-Conditions>. Attention is drawn to the limitation of liability, indemnification and jurisdiction issues defined therein. Any holder of this document is advised that information contained hereon reflects the Company's findings at the time of its intervention only and within the limits of Client's instructions, if any. The Company's sole responsibility is to its Client and this document does not exonerate parties to a transaction from exercising all their rights and obligations under the transaction documents. This document cannot be reproduced except in full, without prior written approval of the Company. Any unauthorized alteration, forgery or falsification of the content or appearance of this document is unlawful and offenders may be prosecuted to the fullest extent of the law.

Date: 2020/6/26

Report No. :ES/2020/30005

WCDMA Band V_Hotspot_Front side_CH 4233_10mm_LAT

Communication System: WCDMA; Frequency: 846.6 MHz; Duty cycle= 1:1

Medium parameters used: $f = 847$ MHz; $\sigma = 0.936$ S/m; $\epsilon_r = 41.793$; $\rho = 1000$ kg/m³

Phantom section: Flat Section

Ambient temperature: 21.6°C; Liquid temperature: 22.1°C

DASY5 Configuration:

- Probe: EX3DV4 - SN7509; ConvF(9.73, 9.73, 9.73) @ 846.6 MHz; Calibrated: 2020/3/25
- Sensor-Surface: 2mm (Mechanical Surface Detection)
- Electronics: DAE4 Sn558; Calibrated: 2019/10/11
- Phantom: SAM
- DASY52 52.10.4(1527); SEMCAD X 14.6.14(7483)

Area Scan (71x141x1): Interpolated grid: dx=15 mm, dy=15 mm

Maximum value of SAR (interpolated) = 0.616 W/kg

Zoom Scan (5x5x7)/Cube 0: Measurement grid: dx=8mm, dy=8mm, dz=5mm

Reference Value = 14.98 V/m; Power Drift = 0.05 dB

Peak SAR (extrapolated) = 0.623 W/kg

SAR(1 g) = 0.559 W/kg; SAR(10 g) = 0.401 W/kg

Smallest distance from peaks to all points 3 dB below = 12.7 mm

Ratio of SAR at M2 to SAR at M1 = 89%

Maximum value of SAR (measured) = 0.607 W/kg

Zoom Scan (5x5x7)/Cube 1: Measurement grid: dx=8mm, dy=8mm, dz=5mm

Reference Value = 14.98 V/m; Power Drift = 0.05 dB

Peak SAR (extrapolated) = 0.555 W/kg

SAR(1 g) = 0.488 W/kg; SAR(10 g) = 0.418 W/kg

Smallest distance from peaks to all points 3 dB below: Larger than measurement grid

Ratio of SAR at M2 to SAR at M1 = 91.3%

Maximum value of SAR (measured) = 0.516 W/kg

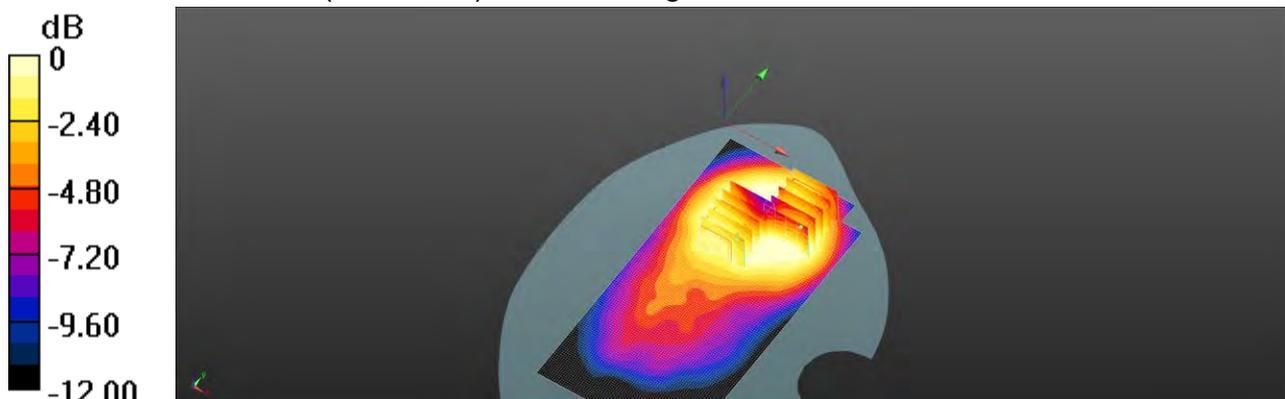

Unless otherwise stated the results shown in this test report refer only to the sample(s) tested and such sample(s) are retained for 90 days only.

除非另有說明，此報告結果僅對測試樣品負責。此報告結果僅對測試樣品負責。本報告僅在本公司管理系統中保存，不可部份複製。

This document is issued by the Company subject to its General Conditions of Service printed overleaf, available on request or accessible at <http://www.sgs.com.tw/Terms-and-Conditions> and for electronic format documents, subject to Terms and Conditions for Electronic Documents at <http://www.sgs.com.tw/Terms-and-Conditions>. Attention is drawn to the limitation of liability, indemnification and jurisdiction issues defined therein. Any holder of this document is advised that information contained hereon reflects the Company's findings at the time of its intervention only and within the limits of Client's instructions, if any. The Company's sole responsibility is to its Client and this document does not exonerate parties to a transaction from exercising all their rights and obligations under the transaction documents. This document cannot be reproduced except in full, without prior written approval of the Company. Any unauthorized alteration, forgery or falsification of the content or appearance of this document is unlawful and offenders may be prosecuted to the fullest extent of the law.

Date: 2020/7/22

Report No. :ES/2020/30005

**LTE Band 30 (10MHz)_Hotspot_Bottom side_CH
27710_QPSK_1-49_10mm_LAT**

Communication System: LTE; Frequency: 2310 MHz; Duty cycle= 1:1

Medium parameters used: $f = 2310$ MHz; $\sigma = 1.694$ S/m; $\epsilon_r = 39.114$; $\rho = 1000$ kg/m³

Phantom section: Flat Section

Ambient temperature: 22.4°C; Liquid temperature: 22.0°C

DASY5 Configuration:

- Probe: EX3DV4 - SN7509; ConvF(7.76, 7.76, 7.76) @ 2310 MHz; Calibrated: 2020/3/25
- Sensor-Surface: 2mm (Mechanical Surface Detection)
- Electronics: DAE4 Sn558; Calibrated: 2019/10/11
- Phantom: SAM
- DASY52 52.10.4(1527); SEMCAD X 14.6.14(7483)

Area Scan (61x101x1): Interpolated grid: dx=12 mm, dy=12 mm

Maximum value of SAR (interpolated) = 0.692 W/kg

Zoom Scan (7x7x7)/Cube 0: Measurement grid: dx=5mm, dy=5mm, dz=5mm

Reference Value = 12.09 V/m; Power Drift = -0.13 dB

Peak SAR (extrapolated) = 0.788 W/kg

SAR(1 g) = 0.564 W/kg; SAR(10 g) = 0.370 W/kg

Smallest distance from peaks to all points 3 dB below = 14.2 mm

Ratio of SAR at M2 to SAR at M1 = 72%

Maximum value of SAR (measured) = 0.668 W/kg

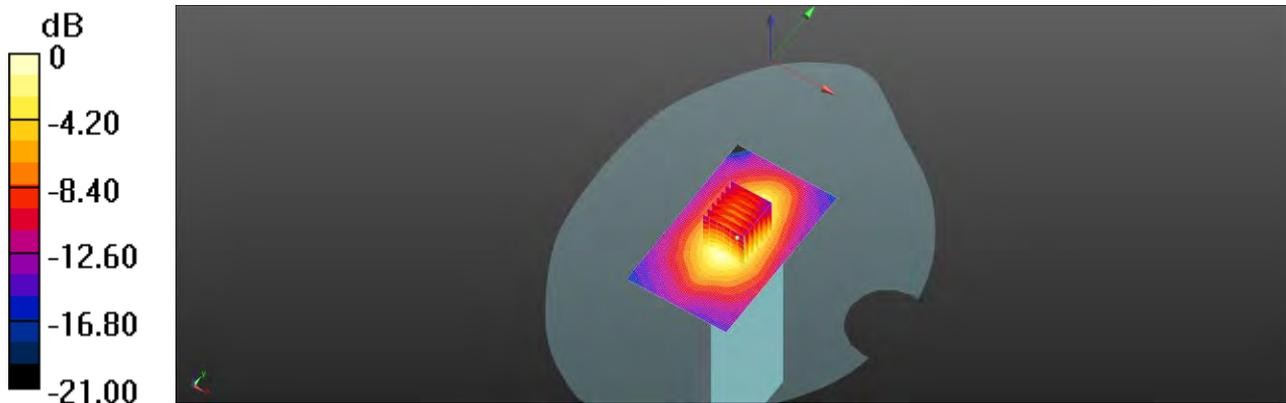

0 dB = 0.668 W/kg = -1.75 dBW/kg

Unless otherwise stated the results shown in this test report refer only to the sample(s) tested and such sample(s) are retained for 90 days only.

除非另有說明，此報告結果僅對測試之樣品負責，同時此樣品僅保留90天。本報告未經本公司書面許可，不可部份複製。

This document is issued by the Company subject to its General Conditions of Service printed overleaf, available on request or accessible at <http://www.sgs.com.tw/Terms-and-Conditions> and for electronic format documents, subject to Terms and Conditions for Electronic Documents at <http://www.sgs.com.tw/Terms-and-Conditions>. Attention is drawn to the limitation of liability, indemnification and jurisdiction issues defined therein. Any holder of this document is advised that information contained hereon reflects the Company's findings at the time of its intervention only and within the limits of Client's instructions, if any. The Company's sole responsibility is to its Client and this document does not exonerate parties to a transaction from exercising all their rights and obligations under the transaction documents. This document cannot be reproduced except in full, without prior written approval of the Company. Any unauthorized alteration, forgery or falsification of the content or appearance of this document is unlawful and offenders may be prosecuted to the fullest extent of the law.

Date: 2020/6/26

Report No. :ES/2020/30005

GPRS 850_Hotspot_Front side_CH 251_10mm_LAT

Communication System: GPRS (1Dn2Up); Frequency: 848.8 MHz; Duty cycle= 1:4.1

Medium parameters used: $f = 849$ MHz; $\sigma = 0.936$ S/m; $\epsilon_r = 41.717$; $\rho = 1000$ kg/m³

Phantom section: Flat Section

Ambient temperature: 21.6°C; Liquid temperature: 22.0°C

DASY5 Configuration:

- Probe: EX3DV4 - SN7509; ConvF(9.73, 9.73, 9.73) @ 848.8 MHz; Calibrated: 2020/3/25
- Sensor-Surface: 2mm (Mechanical Surface Detection)
- Electronics: DAE4 Sn558; Calibrated: 2019/10/11
- Phantom: SAM
- DASY52 52.10.4(1527); SEMCAD X 14.6.14(7483)

Area Scan (71x141x1): Interpolated grid: dx=15 mm, dy=15 mm

Maximum value of SAR (interpolated) = 0.572 W/kg

Zoom Scan (5x5x7)/Cube 0: Measurement grid: dx=8mm, dy=8mm, dz=5mm

Reference Value = 13.77 V/m; Power Drift = -0.03 dB

Peak SAR (extrapolated) = 0.535 W/kg

SAR(1 g) = 0.504 W/kg; SAR(10 g) = 0.413 W/kg

Smallest distance from peaks to all points 3 dB below = 19.1 mm

Ratio of SAR at M2 to SAR at M1 = 91.4%

Maximum value of SAR (measured) = 0.515 W/kg

Zoom Scan (5x5x7)/Cube 1: Measurement grid: dx=8mm, dy=8mm, dz=5mm

Reference Value = 13.77 V/m; Power Drift = -0.03 dB

Peak SAR (extrapolated) = 0.502 W/kg

SAR(1 g) = 0.444 W/kg; SAR(10 g) = 0.397 W/kg

Smallest distance from peaks to all points 3 dB below: Larger than measurement grid

Ratio of SAR at M2 to SAR at M1 = 85.1%

Maximum value of SAR (measured) = 0.464 W/kg

Zoom Scan (5x5x7)/Cube 2: Measurement grid: dx=8mm, dy=8mm, dz=5mm

Reference Value = 13.77 V/m; Power Drift = -0.03 dB

Peak SAR (extrapolated) = 0.495 W/kg

SAR(1 g) = 0.433 W/kg; SAR(10 g) = 0.353 W/kg

Smallest distance from peaks to all points 3 dB below = 13 mm

Ratio of SAR at M2 to SAR at M1 = 82.2%

Maximum value of SAR (measured) = 0.459 W/kg

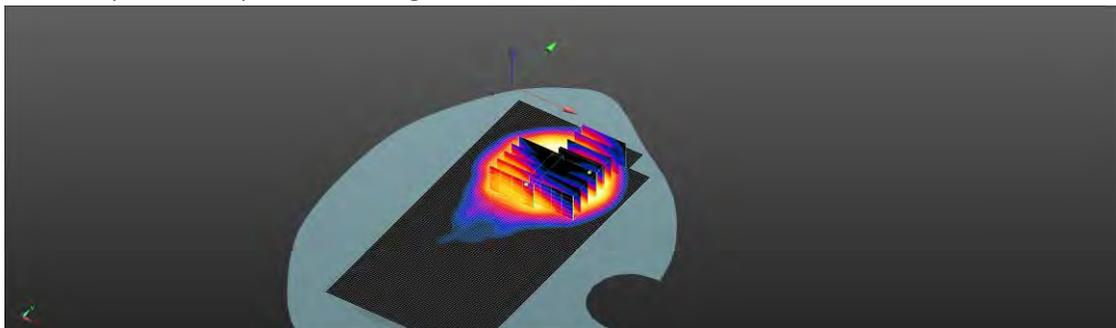
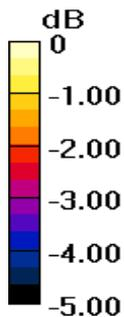

0 dB = 0.459 W/kg = -3.38 dBW/kg

Unless otherwise stated the results shown in this test report refer only to the sample(s) tested and such sample(s) are retained for 90 days only.

除非另有說明，此報告結果僅對測試之樣品負責，同時此樣品僅保留90天。本報告未經本公司書面許可，不可部份複製。

This document is issued by the Company subject to its General Conditions of Service printed overleaf, available on request or accessible at <http://www.sgs.com.tw/Terms-and-Conditions> and for electronic format documents, subject to Terms and Conditions for Electronic Documents at <http://www.sgs.com.tw/Terms-and-Conditions>. Attention is drawn to the limitation of liability, indemnification and jurisdiction issues defined therein. Any holder of this document is advised that information contained hereon reflects the Company's findings at the time of its intervention only and within the limits of Client's instructions, if any. The Company's sole responsibility is to its Client and this document does not exonerate parties to a transaction from exercising all their rights and obligations under the transaction documents. This document cannot be reproduced except in full, without prior written approval of the Company. Any unauthorized alteration, forgery or falsification of the content or appearance of this document is unlawful and offenders may be prosecuted to the fullest extent of the law.

Date: 2020/7/22

Report No. :ES/2020/30005

**LTE Band 30 (10MHz)_Hotspot_Bottom side_CH
27710_QPSK_1-49_10mm_LAT**

Communication System: LTE; Frequency: 2310 MHz; Duty cycle= 1:1

Medium parameters used: $f = 2310$ MHz; $\sigma = 1.694$ S/m; $\epsilon_r = 39.114$; $\rho = 1000$ kg/m³

Phantom section: Flat Section

Ambient temperature: 22.4°C; Liquid temperature: 22.0°C

DASY5 Configuration:

- Probe: EX3DV4 - SN7509; ConvF(7.76, 7.76, 7.76) @ 2310 MHz; Calibrated: 2020/3/25
- Sensor-Surface: 2mm (Mechanical Surface Detection)
- Electronics: DAE4 Sn558; Calibrated: 2019/10/11
- Phantom: SAM
- DASY52 52.10.4(1527); SEMCAD X 14.6.14(7483)

Area Scan (61x101x1): Interpolated grid: dx=12 mm, dy=12 mm

Maximum value of SAR (interpolated) = 0.692 W/kg

Zoom Scan (7x7x7)/Cube 0: Measurement grid: dx=5mm, dy=5mm, dz=5mm

Reference Value = 12.09 V/m; Power Drift = -0.13 dB

Peak SAR (extrapolated) = 0.788 W/kg

SAR(1 g) = 0.564 W/kg; SAR(10 g) = 0.370 W/kg

Smallest distance from peaks to all points 3 dB below = 14.2 mm

Ratio of SAR at M2 to SAR at M1 = 72%

Maximum value of SAR (measured) = 0.668 W/kg

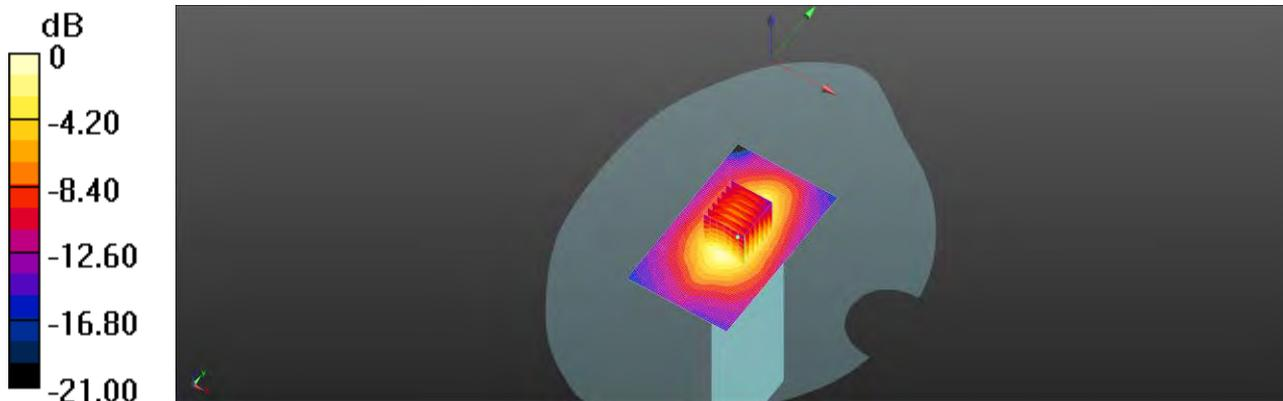

0 dB = 0.668 W/kg = -1.75 dBW/kg

Unless otherwise stated the results shown in this test report refer only to the sample(s) tested and such sample(s) are retained for 90 days only.

除非另有說明，此報告結果僅對測試之樣品負責，同時此樣品僅保留90天。本報告未經本公司書面許可，不可部份複製。

This document is issued by the Company subject to its General Conditions of Service printed overleaf, available on request or accessible at <http://www.sgs.com.tw/Terms-and-Conditions> and for electronic format documents, subject to Terms and Conditions for Electronic Documents at <http://www.sgs.com.tw/Terms-and-Conditions>. Attention is drawn to the limitation of liability, indemnification and jurisdiction issues defined therein. Any holder of this document is advised that information contained hereon reflects the Company's findings at the time of its intervention only and within the limits of Client's instructions, if any. The Company's sole responsibility is to its Client and this document does not exonerate parties to a transaction from exercising all their rights and obligations under the transaction documents. This document cannot be reproduced except in full, without prior written approval of the Company. Any unauthorized alteration, forgery or falsification of the content or appearance of this document is unlawful and offenders may be prosecuted to the fullest extent of the law.

Date: 2020/6/26

Report No. : ES/2020/30005

GPRS 850_Hotspot_Front side_CH 251_10mm_LAT

Communication System: GPRS (1Dn2Up); Frequency: 848.8 MHz; Duty cycle= 1:4.1

Medium parameters used: $f = 849$ MHz; $\sigma = 0.94$ S/m; $\epsilon_r = 41.567$; $\rho = 1000$ kg/m³

Phantom section: Flat Section

Ambient temperature: 21.6°C; Liquid temperature: 22.1°C

DASY5 Configuration:

- Probe: EX3DV4 - SN7509; ConvF(9.73, 9.73, 9.73) @ 849 MHz; Calibrated: 2020/3/25
- Sensor-Surface: 2mm (Mechanical Surface Detection)
- Electronics: DAE4 Sn558; Calibrated: 2019/10/11
- Phantom: SAM
- DASY52 52.10.4(1527); SEMCAD X 14.6.14(7483)

Area Scan (71x141x1): Interpolated grid: dx=15 mm, dy=15 mm

Maximum value of SAR (interpolated) = 0.572 W/kg

Zoom Scan (5x5x7)/Cube 0: Measurement grid: dx=8mm, dy=8mm, dz=5mm

Reference Value = 13.77 V/m; Power Drift = -0.03 dB

Peak SAR (extrapolated) = 0.535 W/kg

SAR(1 g) = 0.504 W/kg; SAR(10 g) = 0.413 W/kg

Smallest distance from peaks to all points 3 dB below = 19.1 mm

Ratio of SAR at M2 to SAR at M1 = 91.4%

Maximum value of SAR (measured) = 0.515 W/kg

Zoom Scan (5x5x7)/Cube 1: Measurement grid: dx=8mm, dy=8mm, dz=5mm

Reference Value = 13.77 V/m; Power Drift = -0.03 dB

Peak SAR (extrapolated) = 0.502 W/kg

SAR(1 g) = 0.444 W/kg; SAR(10 g) = 0.397 W/kg

Smallest distance from peaks to all points 3 dB below: Larger than measurement grid

Ratio of SAR at M2 to SAR at M1 = 85.1%

Maximum value of SAR (measured) = 0.464 W/kg

Zoom Scan (5x5x7)/Cube 2: Measurement grid: dx=8mm, dy=8mm, dz=5mm

Reference Value = 13.77 V/m; Power Drift = -0.03 dB

Peak SAR (extrapolated) = 0.495 W/kg

SAR(1 g) = 0.433 W/kg; SAR(10 g) = 0.353 W/kg

Smallest distance from peaks to all points 3 dB below = 13 mm

Ratio of SAR at M2 to SAR at M1 = 82.2%

Maximum value of SAR (measured) = 0.459 W/kg

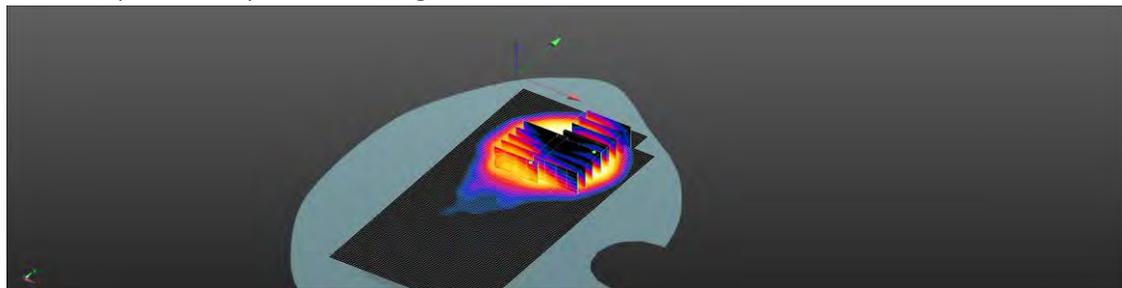
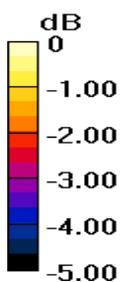

0 dB = 0.459 W/kg = -3.38 dBW/kg

Unless otherwise stated the results shown in this test report refer only to the sample(s) tested and such sample(s) are retained for 90 days only.

除非另有說明，此報告結果僅對測試之樣品負責，同時此樣品僅保留90天。本報告未經本公司書面許可，不可部份複製。

This document is issued by the Company subject to its General Conditions of Service printed overleaf, available on request or accessible at <http://www.sgs.com.tw/Terms-and-Conditions> and for electronic format documents, subject to Terms and Conditions for Electronic Documents at <http://www.sgs.com.tw/Terms-and-Conditions>. Attention is drawn to the limitation of liability, indemnification and jurisdiction issues defined therein. Any holder of this document is advised that information contained hereon reflects the Company's findings at the time of its intervention only and within the limits of Client's instructions, if any. The Company's sole responsibility is to its Client and this document does not exonerate parties to a transaction from exercising all their rights and obligations under the transaction documents. This document cannot be reproduced except in full, without prior written approval of the Company. Any unauthorized alteration, forgery or falsification of the content or appearance of this document is unlawful and offenders may be prosecuted to the fullest extent of the law.

Date: 2020/7/15

Report No. : ES/2020/30005

WCDMA Band V_Hotspot Front side_CH 4233_10mm_LAT

Communication System: WCDMA; Frequency: 846.6 MHz; Duty cycle= 1:1

Medium parameters used: $f = 847$ MHz; $\sigma = 0.913$ S/m; $\epsilon_r = 41.901$; $\rho = 1000$ kg/m³

Phantom section: Flat Section

Ambient temperature: 21.9°C; Liquid temperature: 22.3°C

DASY5 Configuration:

- Probe: EX3DV4 - SN7509; ConvF(9.73, 9.73, 9.73) @ 847 MHz; Calibrated: 3/25/2020
- Sensor-Surface: 2mm (Mechanical Surface Detection)
- Electronics: DAE4 Sn558; Calibrated: 10/11/2019
- Phantom: SAM
- DASY52 52.10.4(1527); SEMCAD X 14.6.14(7483)

Area Scan (71x141x1): Interpolated grid: dx=15 mm, dy=15 mm

Maximum value of SAR (interpolated) = 0.568 W/kg

Zoom Scan (5x5x7)/Cube 0: Measurement grid: dx=8mm, dy=8mm, dz=5mm

Reference Value = 11.98 V/m; Power Drift = 0.05 dB

Peak SAR (extrapolated) = 0.574 W/kg

SAR(1 g) = 0.517 W/kg; SAR(10 g) = 0.379 W/kg

Smallest distance from peaks to all points 3 dB below = 14.4 mm

Ratio of SAR at M2 to SAR at M1 = 91%

Maximum value of SAR (measured) = 0.560 W/kg

Zoom Scan (5x5x7)/Cube 1: Measurement grid: dx=8mm, dy=8mm, dz=5mm

Reference Value = 11.98 V/m; Power Drift = 0.05 dB

Peak SAR (extrapolated) = 0.512 W/kg

SAR(1 g) = 0.452 W/kg; SAR(10 g) = 0.389 W/kg

Smallest distance from peaks to all points 3 dB below: Larger than measurement grid

Ratio of SAR at M2 to SAR at M1 = 94.9%

Maximum value of SAR (measured) = 0.476 W/kg

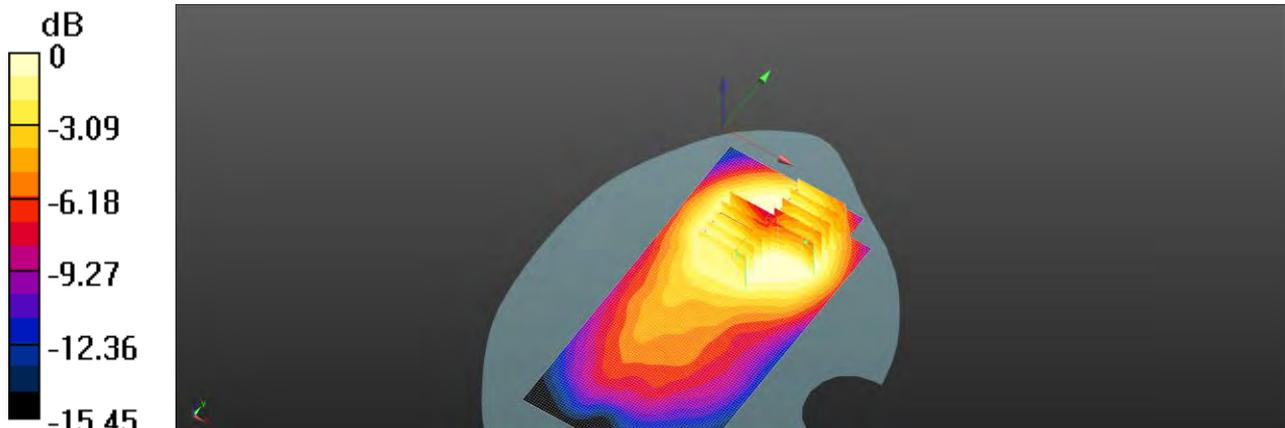

0 dB = 0.476 W/kg = -3.22 dBW/kg

Unless otherwise stated the results shown in this test report refer only to the sample(s) tested and such sample(s) are retained for 90 days only.

除非另有說明，此報告結果僅對測試之樣品負責，同時此樣品僅保留90天。本報告未經本公司書面許可，不可部份複製。

This document is issued by the Company subject to its General Conditions of Service printed overleaf, available on request or accessible at <http://www.sgs.com.tw/Terms-and-Conditions> and for electronic format documents, subject to Terms and Conditions for Electronic Documents at <http://www.sgs.com.tw/Terms-and-Conditions>. Attention is drawn to the limitation of liability, indemnification and jurisdiction issues defined therein. Any holder of this document is advised that information contained hereon reflects the Company's findings at the time of its intervention only and within the limits of Client's instructions, if any. The Company's sole responsibility is to its Client and this document does not exonerate parties to a transaction from exercising all their rights and obligations under the transaction documents. This document cannot be reproduced except in full, without prior written approval of the Company. Any unauthorized alteration, forgery or falsification of the content or appearance of this document is unlawful and offenders may be prosecuted to the fullest extent of the law.

Date: 2020/7/22

Report No. :ES/2020/30005

**LTE Band 30 (10MHz)_Hotspot_Bottom side_CH
27710_QPSK_1-49_10mm_LAT**

Communication System: LTE; Frequency: 2310 MHz; Duty cycle= 1:1

Medium parameters used: $f = 2310$ MHz; $\sigma = 1.694$ S/m; $\epsilon_r = 39.114$; $\rho = 1000$ kg/m³

Phantom section: Flat Section

Ambient temperature: 22.4°C; Liquid temperature: 22.0°C

DASY5 Configuration:

- Probe: EX3DV4 - SN7509; ConvF(7.76, 7.76, 7.76) @ 2310 MHz; Calibrated: 2020/3/25
- Sensor-Surface: 2mm (Mechanical Surface Detection)
- Electronics: DAE4 Sn558; Calibrated: 2019/10/11
- Phantom: SAM
- DASY52 52.10.4(1527); SEMCAD X 14.6.14(7483)

Area Scan (61x101x1): Interpolated grid: dx=12 mm, dy=12 mm

Maximum value of SAR (interpolated) = 0.692 W/kg

Zoom Scan (7x7x7)/Cube 0: Measurement grid: dx=5mm, dy=5mm, dz=5mm

Reference Value = 12.09 V/m; Power Drift = -0.13 dB

Peak SAR (extrapolated) = 0.788 W/kg

SAR(1 g) = 0.564 W/kg; SAR(10 g) = 0.370 W/kg

Smallest distance from peaks to all points 3 dB below = 14.2 mm

Ratio of SAR at M2 to SAR at M1 = 72%

Maximum value of SAR (measured) = 0.668 W/kg

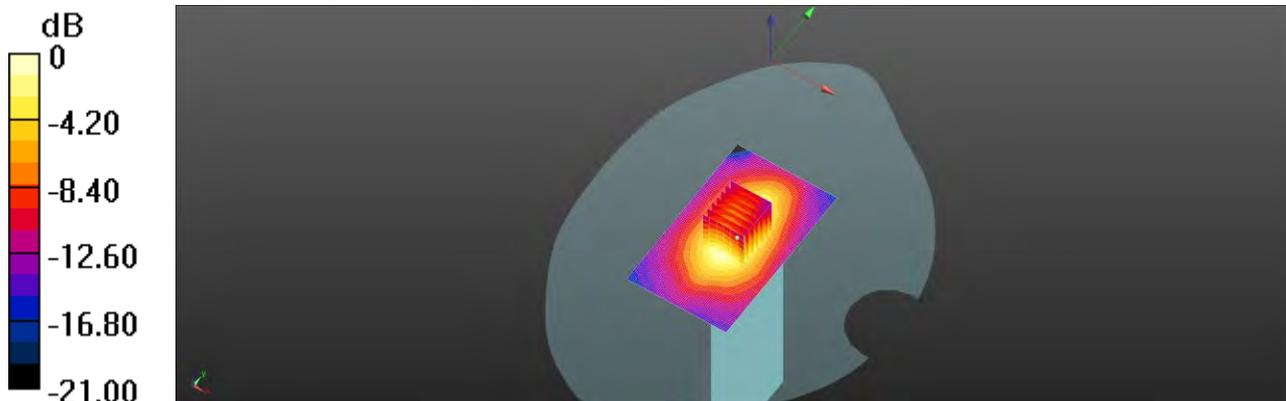

0 dB = 0.668 W/kg = -1.75 dBW/kg

Unless otherwise stated the results shown in this test report refer only to the sample(s) tested and such sample(s) are retained for 90 days only.

除非另有說明，此報告結果僅對測試之樣品負責，同時此樣品僅保留90天。本報告未經本公司書面許可，不可部份複製。

This document is issued by the Company subject to its General Conditions of Service printed overleaf, available on request or accessible at <http://www.sgs.com.tw/Terms-and-Conditions> and for electronic format documents, subject to Terms and Conditions for Electronic Documents at <http://www.sgs.com.tw/Terms-and-Conditions>. Attention is drawn to the limitation of liability, indemnification and jurisdiction issues defined therein. Any holder of this document is advised that information contained hereon reflects the Company's findings at the time of its intervention only and within the limits of Client's instructions, if any. The Company's sole responsibility is to its Client and this document does not exonerate parties to a transaction from exercising all their rights and obligations under the transaction documents. This document cannot be reproduced except in full, without prior written approval of the Company. Any unauthorized alteration, forgery or falsification of the content or appearance of this document is unlawful and offenders may be prosecuted to the fullest extent of the law.

Date: 2020/7/9

Report No. :ES/2020/30005

LTE Band 12 (10MHz)_Head_Re Cheek_CH 23060_QPSK_1-0_UAT

Communication System: LTE; Frequency: 704 MHz; Duty cycle= 1:1

Medium parameters used: $f = 704 \text{ MHz}$; $\sigma = 0.89 \text{ S/m}$; $\epsilon_r = 42.948$; $\rho = 1000 \text{ kg/m}^3$

Phantom section: Right Section

Ambient temperature: 21.5°C; Liquid temperature: 22.0°C

DASY5 Configuration:

- Probe: EX3DV4 - SN7509; ConvF(9.94, 9.94, 9.94) @ 704 MHz; Calibrated: 2020/3/25
- Sensor-Surface: 2mm (Mechanical Surface Detection)
- Electronics: DAE4 Sn558; Calibrated: 2019/10/11
- Phantom: SAM
- DASY52 52.10.4(1527); SEMCAD X 14.6.14(7483)

Area Scan (71x151x1): Interpolated grid: dx=15 mm, dy=15 mm

Maximum value of SAR (interpolated) = 0.469 W/kg

Zoom Scan (5x5x7)/Cube 0: Measurement grid: dx=8mm, dy=8mm, dz=5mm

Reference Value = 8.321 V/m; Power Drift = -0.03 dB

Peak SAR (extrapolated) = 0.472 W/kg

SAR(1 g) = 0.345 W/kg; SAR(10 g) = 0.257 W/kg

Smallest distance from peaks to all points 3 dB below = 9.3 mm

Ratio of SAR at M2 to SAR at M1 = 70.6%

Maximum value of SAR (measured) = 0.382 W/kg

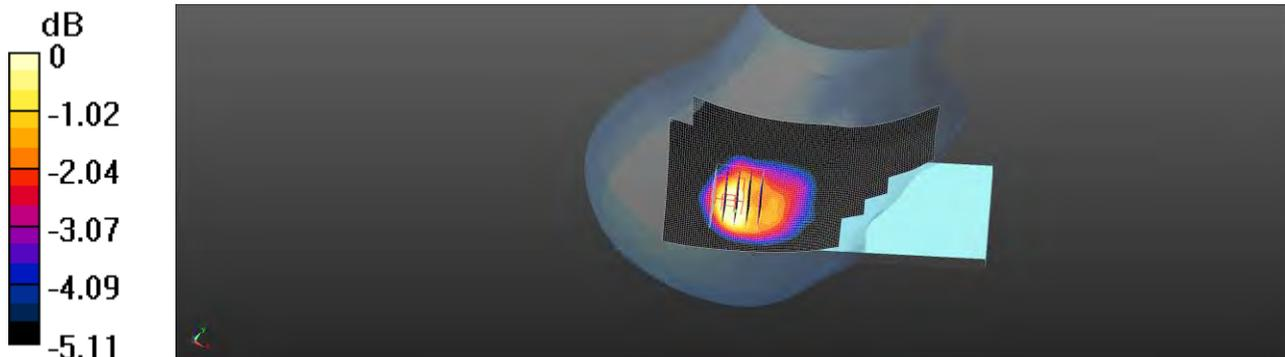

0 dB = 0.382 W/kg = -4.18 dBW/kg

Unless otherwise stated the results shown in this test report refer only to the sample(s) tested and such sample(s) are retained for 90 days only.

除非另有說明，此報告結果僅對測試之樣品負責，同時此樣品僅保留90天。本報告未經本公司書面許可，不可部份複製。

This document is issued by the Company subject to its General Conditions of Service printed overleaf, available on request or accessible at <http://www.sgs.com.tw/Terms-and-Conditions> and for electronic format documents, subject to Terms and Conditions for Electronic Documents at <http://www.sgs.com.tw/Terms-and-Conditions>. Attention is drawn to the limitation of liability, indemnification and jurisdiction issues defined therein. Any holder of this document is advised that information contained hereon reflects the Company's findings at the time of its intervention only and within the limits of Client's instructions, if any. The Company's sole responsibility is to its Client and this document does not exonerate parties to a transaction from exercising all their rights and obligations under the transaction documents. This document cannot be reproduced except in full, without prior written approval of the Company. Any unauthorized alteration, forgery or falsification of the content or appearance of this document is unlawful and offenders may be prosecuted to the fullest extent of the law.

Date: 2020/7/10

Report No. :ES/2020/30005

LTE Band 26 (15MHz)_Head_Re Cheek_CH 26765_QPSK_1-0_UAT

Communication System: LTE; Frequency: 821.5 MHz; Duty cycle= 1:1

Medium parameters used: $f = 821.5 \text{ MHz}$; $\sigma = 0.912 \text{ S/m}$; $\epsilon_r = 42.211$; $\rho = 1000 \text{ kg/m}^3$

Phantom section: Right Section

Ambient temperature: 22.2°C; Liquid temperature: 21.7°C

DASY5 Configuration:

- Probe: EX3DV4 - SN7509; ConvF(9.73, 9.73, 9.73) @ 821.5 MHz; Calibrated: 2020/3/25
- Sensor-Surface: 2mm (Mechanical Surface Detection)
- Electronics: DAE4 Sn558; Calibrated: 2019/10/11
- Phantom: SAM
- DASY52 52.10.4(1527); SEMCAD X 14.6.14(7483)

Area Scan (71x151x1): Interpolated grid: dx=15 mm, dy=15 mm

Maximum value of SAR (interpolated) = 0.649 W/kg

Zoom Scan (5x5x7)/Cube 0: Measurement grid: dx=8mm, dy=8mm, dz=5mm

Reference Value = 6.260 V/m; Power Drift = -0.02 dB

Peak SAR (extrapolated) = 0.689 W/kg

SAR(1 g) = 0.511 W/kg; SAR(10 g) = 0.357 W/kg

Smallest distance from peaks to all points 3 dB below = 8.5 mm

Ratio of SAR at M2 to SAR at M1 = 90.6%

Maximum value of SAR (measured) = 0.596 W/kg

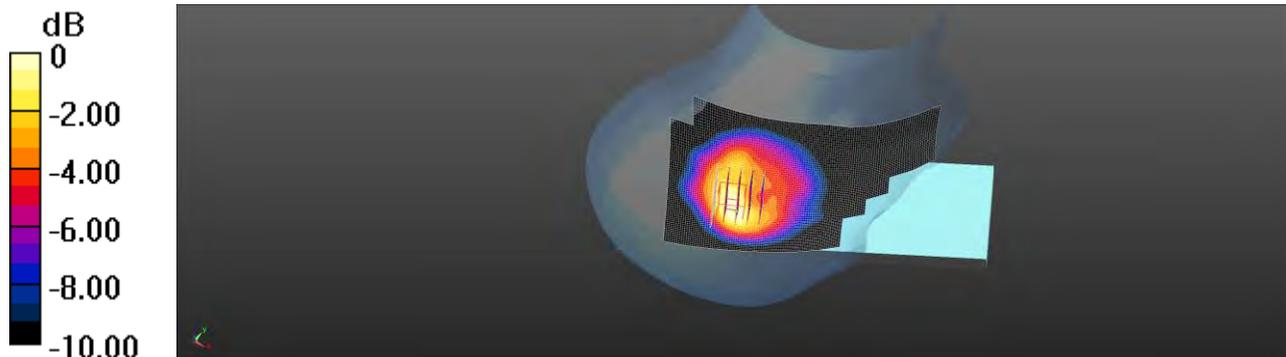

0 dB = 0.596 W/kg = -2.25 dBW/kg

Unless otherwise stated the results shown in this test report refer only to the sample(s) tested and such sample(s) are retained for 90 days only.

除非另有說明，此報告結果僅對測試之樣品負責，同時此樣品僅保留90天。本報告未經本公司書面許可，不可部份複製。

This document is issued by the Company subject to its General Conditions of Service printed overleaf, available on request or accessible at <http://www.sgs.com.tw/Terms-and-Conditions> and for electronic format documents, subject to Terms and Conditions for Electronic Documents at <http://www.sgs.com.tw/Terms-and-Conditions>. Attention is drawn to the limitation of liability, indemnification and jurisdiction issues defined therein. Any holder of this document is advised that information contained hereon reflects the Company's findings at the time of its intervention only and within the limits of Client's instructions, if any. The Company's sole responsibility is to its Client and this document does not exonerate parties to a transaction from exercising all their rights and obligations under the transaction documents. This document cannot be reproduced except in full, without prior written approval of the Company. Any unauthorized alteration, forgery or falsification of the content or appearance of this document is unlawful and offenders may be prosecuted to the fullest extent of the law.

Date: 2020/7/9

Report No. :ES/2020/30005

LTE Band 12 (10MHz)_Head_Re Cheek_CH 23060_QPSK_1-0_LAT

Communication System: LTE; Frequency: 704 MHz; Duty cycle= 1:1

Medium parameters used: $f = 704 \text{ MHz}$; $\sigma = 0.89 \text{ S/m}$; $\epsilon_r = 42.948$; $\rho = 1000 \text{ kg/m}^3$

Phantom section: Right Section

Ambient temperature: 21.5°C; Liquid temperature: 22.0°C

DASY5 Configuration:

- Probe: EX3DV4 - SN7509; ConvF(9.94, 9.94, 9.94) @ 704 MHz; Calibrated: 2020/10/11
- Sensor-Surface: 2mm (Mechanical Surface Detection)
- Electronics: DAE4 Sn558; Calibrated: 10/11/2019
- Phantom: SAM
- DASY52 52.10.4(1527); SEMCAD X 14.6.14(7483)

Area Scan (71x151x1): Interpolated grid: dx=15 mm, dy=15 mm

Maximum value of SAR (interpolated) = 0.0834 W/kg

Zoom Scan (5x5x7)/Cube 0: Measurement grid: dx=8mm, dy=8mm, dz=5mm

Reference Value = 8.382 V/m; Power Drift = 0.11 dB

Peak SAR (extrapolated) = 0.0840 W/kg

SAR(1 g) = 0.082 W/kg; SAR(10 g) = 0.076 W/kg

Smallest distance from peaks to all points 3 dB below= 8.9 mm

Ratio of SAR at M2 to SAR at M1 = 81.2%

Maximum value of SAR (measured) = 0.0830 W/kg

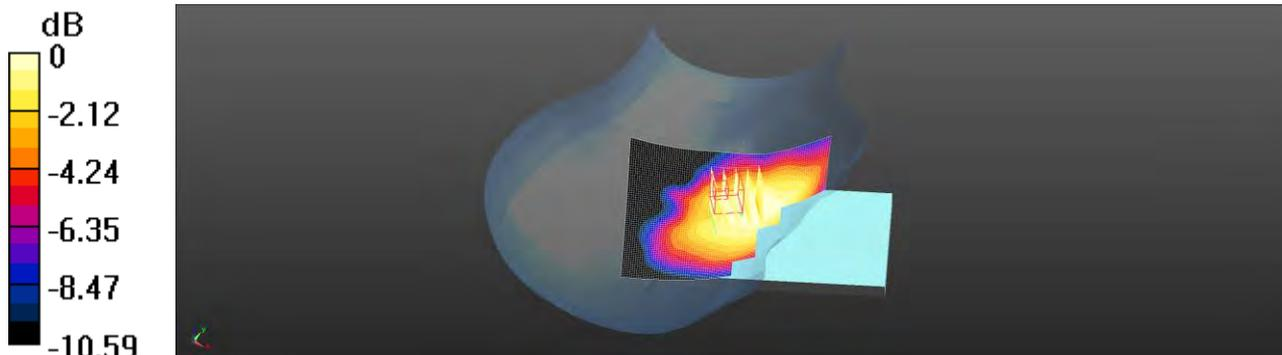

0 dB = 0.0830 W/kg = -10.81 dBW/kg

Unless otherwise stated the results shown in this test report refer only to the sample(s) tested and such sample(s) are retained for 90 days only.

除非另有說明，此報告結果僅對測試之樣品負責，同時此樣品僅保留90天。本報告未經本公司書面許可，不可部份複製。

This document is issued by the Company subject to its General Conditions of Service printed overleaf, available on request or accessible at <http://www.sgs.com.tw/Terms-and-Conditions> and for electronic format documents, subject to Terms and Conditions for Electronic Documents at <http://www.sgs.com.tw/Terms-and-Conditions>. Attention is drawn to the limitation of liability, indemnification and jurisdiction issues defined therein. Any holder of this document is advised that information contained hereon reflects the Company's findings at the time of its intervention only and within the limits of Client's instructions, if any. The Company's sole responsibility is to its Client and this document does not exonerate parties to a transaction from exercising all their rights and obligations under the transaction documents. This document cannot be reproduced except in full, without prior written approval of the Company. Any unauthorized alteration, forgery or falsification of the content or appearance of this document is unlawful and offenders may be prosecuted to the fullest extent of the law.

Date: 2020/7/12

Report No. :ES/2020/30005

LTE Band 25 (20MHz)_Head_Le Cheek_CH 26590_QPSK_1-0_LAT

Communication System: LTE; Frequency: 1905 MHz; Duty cycle= 1:1

Medium parameters used: $f = 1905$ MHz; $\sigma = 1.442$ S/m; $\epsilon_r = 39.151$; $\rho = 1000$ kg/m³

Phantom section: Left Section

Ambient temperature: 21.8°C; Liquid temperature: 21.3°C

DASY5 Configuration:

- Probe: EX3DV4 - SN7509; ConvF(8.07, 8.07, 8.07) @ 1905 MHz; Calibrated: 2020/10/11
- Sensor-Surface: 2mm (Mechanical Surface Detection)
- Electronics: DAE4 Sn558; Calibrated: 10/11/2019
- Phantom: SAM
- DASY52 52.10.4(1527); SEMCAD X 14.6.14(7483)

Area Scan (71x141x1): Interpolated grid: dx=15 mm, dy=15 mm

Maximum value of SAR (interpolated) = 0.215 W/kg

Zoom Scan (5x5x7)/Cube 0: Measurement grid: dx=8mm, dy=8mm, dz=5mm

Reference Value = 9.328 V/m; Power Drift = 0.04 dB

Peak SAR (extrapolated) = 0.212 W/kg

SAR(1 g) = 0.168 W/kg; SAR(10 g) = 0.127 W/kg

Smallest distance from peaks to all points 3 dB below = 10.8 mm

Ratio of SAR at M2 to SAR at M1 = 64.4%

Maximum value of SAR (measured) = 0.186 W/kg

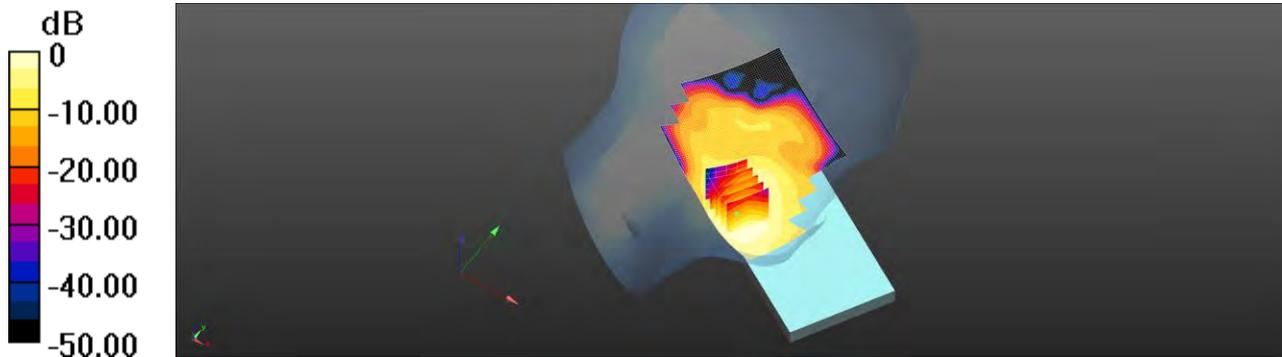

0 dB = 0.215 W/kg = -6.68 dBW/kg

Unless otherwise stated the results shown in this test report refer only to the sample(s) tested and such sample(s) are retained for 90 days only.

除非另有說明，此報告結果僅對測試之樣品負責，同時此樣品僅保留90天。本報告未經本公司書面許可，不可部份複製。

This document is issued by the Company subject to its General Conditions of Service printed overleaf, available on request or accessible at <http://www.sgs.com.tw/Terms-and-Conditions> and for electronic format documents, subject to Terms and Conditions for Electronic Documents at <http://www.sgs.com.tw/Terms-and-Conditions>. Attention is drawn to the limitation of liability, indemnification and jurisdiction issues defined therein. Any holder of this document is advised that information contained hereon reflects the Company's findings at the time of its intervention only and within the limits of Client's instructions, if any. The Company's sole responsibility is to its Client and this document does not exonerate parties to a transaction from exercising all their rights and obligations under the transaction documents. This document cannot be reproduced except in full, without prior written approval of the Company. Any unauthorized alteration, forgery or falsification of the content or appearance of this document is unlawful and offenders may be prosecuted to the fullest extent of the law.

Date: 2020/7/10

Report No. :ES/2020/30005

LTE Band 26 (15MHz)_Head_Re Cheek_CH 26765_QPSK_1-0_LAT

Communication System: LTE; Frequency: 821.5 MHz; Duty cycle= 1:1

Medium parameters used: $f = 821.5$ MHz; $\sigma = 0.912$ S/m; $\epsilon_r = 42.211$; $\rho = 1000$ kg/m³

Phantom section: Right Section

Ambient temperature: 22.2°C; Liquid temperature: 21.7°C

DASY5 Configuration:

- Probe: EX3DV4 - SN7509; ConvF(9.73, 9.73, 9.73) @ 821.5 MHz; Calibrated: 2020/10/11
- Sensor-Surface: 2mm (Mechanical Surface Detection)
- Electronics: DAE4 Sn558; Calibrated: 10/11/2019
- Phantom: SAM
- DASY52 52.10.4(1527); SEMCAD X 14.6.14(7483)

Area Scan (71x151x1): Interpolated grid: dx=15 mm, dy=15 mm

Maximum value of SAR (interpolated) = 0.0677 W/kg

Zoom Scan (5x5x7)/Cube 0: Measurement grid: dx=8mm, dy=8mm, dz=5mm

Reference Value = 2.643 V/m; Power Drift = -0.16 dB

Peak SAR (extrapolated) = 0.0720 W/kg

SAR(1 g) = 0.071 W/kg; SAR(10 g) = 0.067 W/kg

Smallest distance from peaks to all points 3 dB below = 10.3 mm

Ratio of SAR at M2 to SAR at M1 = 56.2%

Maximum value of SAR (measured) = 0.0721 W/kg

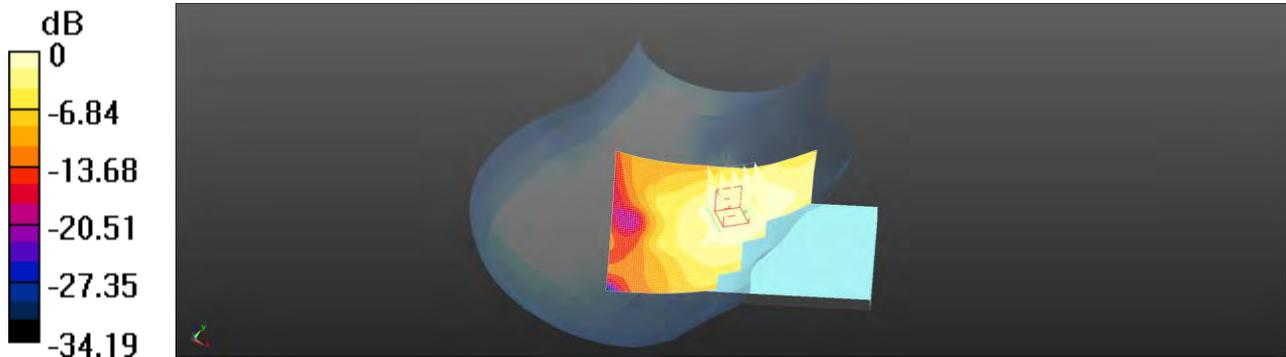

0 dB = 0.0721 W/kg = -11.42 dBW/kg

Unless otherwise stated the results shown in this test report refer only to the sample(s) tested and such sample(s) are retained for 90 days only.

除非另有說明，此報告結果僅對測試之樣品負責，同時此樣品僅保留90天。本報告未經本公司書面許可，不可部份複製。

This document is issued by the Company subject to its General Conditions of Service printed overleaf, available on request or accessible at <http://www.sgs.com.tw/Terms-and-Conditions> and for electronic format documents, subject to Terms and Conditions for Electronic Documents at <http://www.sgs.com.tw/Terms-and-Conditions>. Attention is drawn to the limitation of liability, indemnification and jurisdiction issues defined therein. Any holder of this document is advised that information contained hereon reflects the Company's findings at the time of its intervention only and within the limits of Client's instructions, if any. The Company's sole responsibility is to its Client and this document does not exonerate parties to a transaction from exercising all their rights and obligations under the transaction documents. This document cannot be reproduced except in full, without prior written approval of the Company. Any unauthorized alteration, forgery or falsification of the content or appearance of this document is unlawful and offenders may be prosecuted to the fullest extent of the law.

Date: 2020/7/11

Report No. :ES/2020/30005

LTE Band 66 (20MHz)_Head_Le Cheek_CH 132572_QPSK_1-0_LAT

Communication System: LTE; Frequency: 1770 MHz; Duty cycle= 1:1

Medium parameters used: $f = 1770$ MHz; $\sigma = 1.411$ S/m; $\epsilon_r = 39.774$; $\rho = 1000$ kg/m³

Phantom section: Left Section

Ambient temperature: 21.4°C; Liquid temperature: 21.8°C

DASY5 Configuration:

- Probe: EX3DV4 - SN7509; ConvF(8.34, 8.34, 8.34) @ 1770 MHz; Calibrated: 2020/10/11
- Sensor-Surface: 2mm (Mechanical Surface Detection)
- Electronics: DAE4 Sn558; Calibrated: 10/11/2019
- Phantom: SAM
- DASY52 52.10.4(1527); SEMCAD X 14.6.14(7483)

Area Scan (71x141x1): Interpolated grid: dx=15 mm, dy=15 mm

Maximum value of SAR (interpolated) = 0.211 W/kg

Zoom Scan (5x5x7)/Cube 0: Measurement grid: dx=8mm, dy=8mm, dz=5mm

Reference Value = 4.892 V/m; Power Drift = -0.10 dB

Peak SAR (extrapolated) = 0.207 W/kg

SAR(1 g) = 0.171 W/kg; SAR(10 g) = 0.134 W/kg

Smallest distance from peaks to all points 3 dB below = 9.3 mm

Ratio of SAR at M2 to SAR at M1 = 81.5%

Maximum value of SAR (measured) = 0.189 W/kg

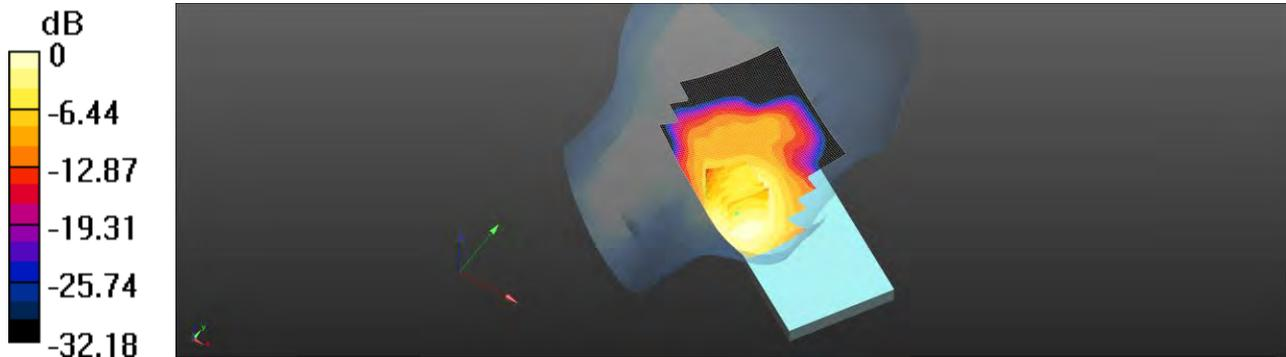

0 dB = 0.189 W/kg = -7.24 dBW/kg

Unless otherwise stated the results shown in this test report refer only to the sample(s) tested and such sample(s) are retained for 90 days only.

除非另有說明，此報告結果僅對測試之樣品負責，同時此樣品僅保留90天。本報告未經本公司書面許可，不可部份複製。

This document is issued by the Company subject to its General Conditions of Service printed overleaf, available on request or accessible at <http://www.sgs.com.tw/Terms-and-Conditions> and for electronic format documents, subject to Terms and Conditions for Electronic Documents at <http://www.sgs.com.tw/Terms-and-Conditions>. Attention is drawn to the limitation of liability, indemnification and jurisdiction issues defined therein. Any holder of this document is advised that information contained hereon reflects the Company's findings at the time of its intervention only and within the limits of Client's instructions, if any. The Company's sole responsibility is to its Client and this document does not exonerate parties to a transaction from exercising all their rights and obligations under the transaction documents. This document cannot be reproduced except in full, without prior written approval of the Company. Any unauthorized alteration, forgery or falsification of the content or appearance of this document is unlawful and offenders may be prosecuted to the fullest extent of the law.

Date: 2020/7/9

Report No. :ES/2020/30005

LTE Band 12 (10MHz)_Hotspot_Front side_CH 23060_QPSK_1-0_10mm_UAT

Communication System: LTE; Frequency: 704 MHz; Duty cycle= 1:1

Medium parameters used: $f = 704 \text{ MHz}$; $\sigma = 0.89 \text{ S/m}$; $\epsilon_r = 42.948$; $\rho = 1000 \text{ kg/m}^3$

Phantom section: Flat Section

Ambient temperature: 21.5°C; Liquid temperature: 22.0°C

DASY5 Configuration:

- Probe: EX3DV4 - SN7509; ConvF(9.94, 9.94, 9.94) @ 704 MHz; Calibrated: 2020/3/25
- Sensor-Surface: 2mm (Mechanical Surface Detection)
- Electronics: DAE4 Sn558; Calibrated: 2019/10/11
- Phantom: SAM
- DASY52 52.10.4(1527); SEMCAD X 14.6.14(7483)

Area Scan (71x141x1): Interpolated grid: dx=15 mm, dy=15 mm

Maximum value of SAR (interpolated) = 0.104 W/kg

Zoom Scan (5x5x7)/Cube 0: Measurement grid: dx=8mm, dy=8mm, dz=5mm

Reference Value = 7.285 V/m; Power Drift = 0.16 dB

Peak SAR (extrapolated) = 0.110 W/kg

SAR(1 g) = 0.087 W/kg; SAR(10 g) = 0.066 W/kg

Smallest distance from peaks to all points 3 dB below = 14.8 mm

Ratio of SAR at M2 to SAR at M1 = 75.5%

Maximum value of SAR (measured) = 0.0994 W/kg

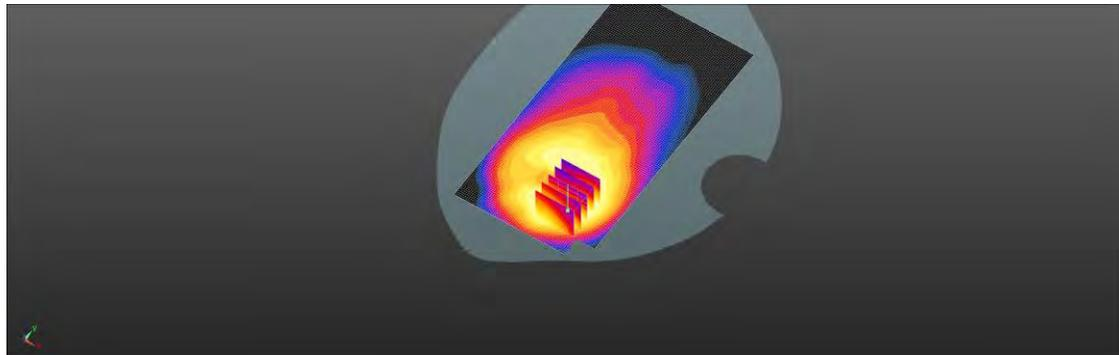
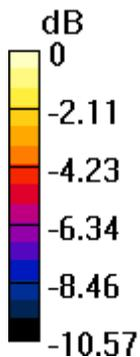

0 dB = 0.0994 W/kg = -10.03 dBW/kg

Unless otherwise stated the results shown in this test report refer only to the sample(s) tested and such sample(s) are retained for 90 days only.

除非另有說明，此報告結果僅對測試之樣品負責，同時此樣品僅保留90天。本報告未經本公司書面許可，不可部份複製。

This document is issued by the Company subject to its General Conditions of Service printed overleaf, available on request or accessible at <http://www.sgs.com.tw/Terms-and-Conditions> and for electronic format documents, subject to Terms and Conditions for Electronic Documents at <http://www.sgs.com.tw/Terms-and-Conditions>. Attention is drawn to the limitation of liability, indemnification and jurisdiction issues defined therein. Any holder of this document is advised that information contained hereon reflects the Company's findings at the time of its intervention only and within the limits of Client's instructions, if any. The Company's sole responsibility is to its Client and this document does not exonerate parties to a transaction from exercising all their rights and obligations under the transaction documents. This document cannot be reproduced except in full, without prior written approval of the Company. Any unauthorized alteration, forgery or falsification of the content or appearance of this document is unlawful and offenders may be prosecuted to the fullest extent of the law.

Date: 2020/7/10

Report No. :ES/2020/30005

LTE Band 26 (15MHz)_Hotspot_Front side_CH 26765_QPSK_1-0_10mm_UAT

Communication System: LTE; Frequency: 821.5 MHz; Duty cycle= 1:1

Medium parameters used: $f = 821.5$ MHz; $\sigma = 0.912$ S/m; $\epsilon_r = 42.211$; $\rho = 1000$ kg/m³

Phantom section: Flat Section

Ambient temperature: 22.2°C; Liquid temperature: 21.7°C

DASY5 Configuration:

- Probe: EX3DV4 - SN7509; ConvF(9.73, 9.73, 9.73) @ 821.5 MHz; Calibrated: 2020/3/25
- Sensor-Surface: 2mm (Mechanical Surface Detection)
- Electronics: DAE4 Sn558; Calibrated: 2019/10/11
- Phantom: SAM
- DASY52 52.10.4(1527); SEMCAD X 14.6.14(7483)

Area Scan (71x141x1): Interpolated grid: dx=15 mm, dy=15 mm

Maximum value of SAR (interpolated) = 0.177 W/kg

Zoom Scan (5x5x7)/Cube 0: Measurement grid: dx=8mm, dy=8mm, dz=5mm

Reference Value = 8.313 V/m; Power Drift = 0.14 dB

Peak SAR (extrapolated) = 0.197 W/kg

SAR(1 g) = 0.161 W/kg; SAR(10 g) = 0.123 W/kg

Smallest distance from peaks to all points 3 dB below = 12.5 mm

Ratio of SAR at M2 to SAR at M1 = 76.9%

Maximum value of SAR (measured) = 0.178 W/kg

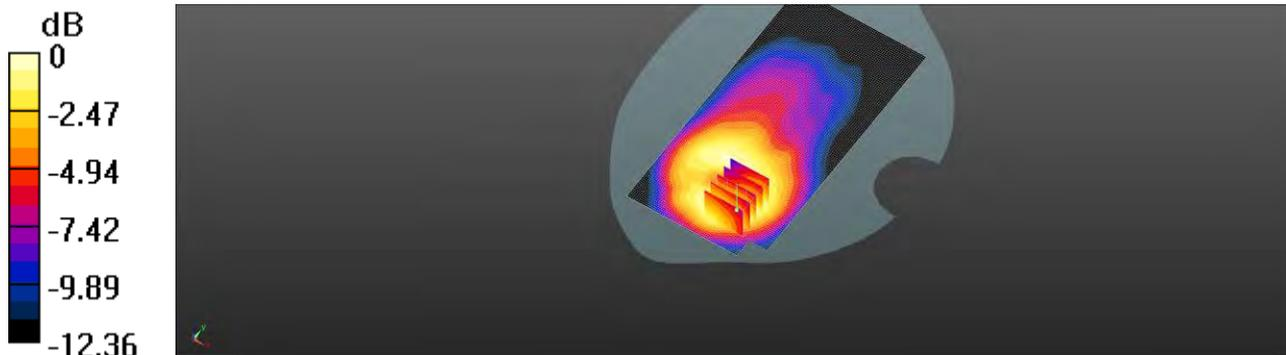

0 dB = 0.178 W/kg = -7.49 dBW/kg

Unless otherwise stated the results shown in this test report refer only to the sample(s) tested and such sample(s) are retained for 90 days only.

除非另有說明，此報告結果僅對測試之樣品負責，同時此樣品僅保留90天。本報告未經本公司書面許可，不可部份複製。

This document is issued by the Company subject to its General Conditions of Service printed overleaf, available on request or accessible at <http://www.sgs.com.tw/Terms-and-Conditions> and for electronic format documents, subject to Terms and Conditions for Electronic Documents at <http://www.sgs.com.tw/Terms-and-Conditions>. Attention is drawn to the limitation of liability, indemnification and jurisdiction issues defined therein. Any holder of this document is advised that information contained hereon reflects the Company's findings at the time of its intervention only and within the limits of Client's instructions, if any. The Company's sole responsibility is to its Client and this document does not exonerate parties to a transaction from exercising all their rights and obligations under the transaction documents. This document cannot be reproduced except in full, without prior written approval of the Company. Any unauthorized alteration, forgery or falsification of the content or appearance of this document is unlawful and offenders may be prosecuted to the fullest extent of the law.

Date: 2020/7/9

Report No. :ES/2020/30005

LTE Band 12 (10MHz)_Hotspot_Front side_CH 23060_QPSK_1-0_10mm_LAT

Communication System: LTE; Frequency: 704 MHz; Duty cycle= 1:1

Medium parameters used: $f = 704 \text{ MHz}$; $\sigma = 0.89 \text{ S/m}$; $\epsilon_r = 42.948$; $\rho = 1000 \text{ kg/m}^3$

Phantom section: Flat Section

Ambient temperature: 21.5°C; Liquid temperature: 22.0°C

DASY5 Configuration:

- Probe: EX3DV4 - SN7509; ConvF(9.94, 9.94, 9.94) @ 704 MHz; Calibrated: 2020/3/25
- Sensor-Surface: 2mm (Mechanical Surface Detection)
- Electronics: DAE4 Sn558; Calibrated: 2019/10/11
- Phantom: SAM
- DASY52 52.10.4(1527); SEMCAD X 14.6.14(7483)

Area Scan (71x141x1): Interpolated grid: dx=15 mm, dy=15 mm

Maximum value of SAR (interpolated) = 0.176 W/kg

Zoom Scan (5x5x7)/Cube 0: Measurement grid: dx=8mm, dy=8mm, dz=5mm

Reference Value = 12.18 V/m; Power Drift = -0.12 dB

Peak SAR (extrapolated) = 0.156 W/kg

SAR(1 g) = 0.142 W/kg; SAR(10 g) = 0.112 W/kg

Smallest distance from peaks to all points 3 dB below = 18.2 mm

Ratio of SAR at M2 to SAR at M1 = 91.9%

Maximum value of SAR (measured) = 0.148 W/kg

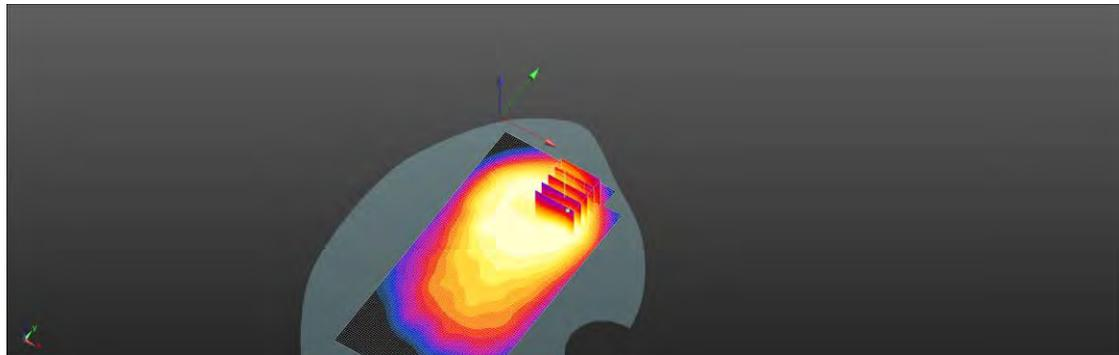
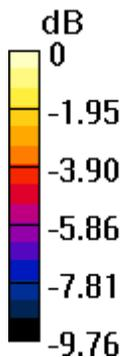

0 dB = 0.148 W/kg = -8.29 dBW/kg

Unless otherwise stated the results shown in this test report refer only to the sample(s) tested and such sample(s) are retained for 90 days only.

除非另有說明，此報告結果僅對測試之樣品負責，同時此樣品僅保留90天。本報告未經本公司書面許可，不可部份複製。

This document is issued by the Company subject to its General Conditions of Service printed overleaf, available on request or accessible at <http://www.sgs.com.tw/Terms-and-Conditions> and for electronic format documents, subject to Terms and Conditions for Electronic Documents at <http://www.sgs.com.tw/Terms-and-Conditions>. Attention is drawn to the limitation of liability, indemnification and jurisdiction issues defined therein. Any holder of this document is advised that information contained hereon reflects the Company's findings at the time of its intervention only and within the limits of Client's instructions, if any. The Company's sole responsibility is to its Client and this document does not exonerate parties to a transaction from exercising all their rights and obligations under the transaction documents. This document cannot be reproduced except in full, without prior written approval of the Company. Any unauthorized alteration, forgery or falsification of the content or appearance of this document is unlawful and offenders may be prosecuted to the fullest extent of the law.

Date: 2020/7/12

Report No. :ES/2020/30005

LTE Band 25 (20MHz)_Hotspot_Bottom side_CH 26590_QPSK_1-0_10mm_LAT

Communication System: LTE; Frequency: 1905 MHz; Duty cycle= 1:1

Medium parameters used: $f = 1905$ MHz; $\sigma = 1.442$ S/m; $\epsilon_r = 39.151$; $\rho = 1000$ kg/m³

Phantom section: Flat Section

Ambient temperature: 21.8°C; Liquid temperature: 21.3°C

DASY5 Configuration:

- Probe: EX3DV4 - SN7509; ConvF(8.07, 8.07, 8.07) @ 1905 MHz; Calibrated: 2020/3/25
- Sensor-Surface: 2mm (Mechanical Surface Detection)
- Electronics: DAE4 Sn558; Calibrated: 2019/10/11
- Phantom: SAM
- DASY52 52.10.4(1527); SEMCAD X 14.6.14(7483)

Area Scan (51x81x1): Interpolated grid: dx=15 mm, dy=15 mm

Maximum value of SAR (interpolated) = 0.873 W/kg

Zoom Scan (5x5x7)/Cube 0: Measurement grid: dx=8mm, dy=8mm, dz=5mm

Reference Value = 31.01 V/m; Power Drift = -0.18 dB

Peak SAR (extrapolated) = 0.891 W/kg

SAR(1 g) = 0.721 W/kg; SAR(10 g) = 0.535 W/kg

Smallest distance from peaks to all points 3 dB below = 12.2 mm

Ratio of SAR at M2 to SAR at M1 = 74.5%

Maximum value of SAR (measured) = 0.799 W/kg

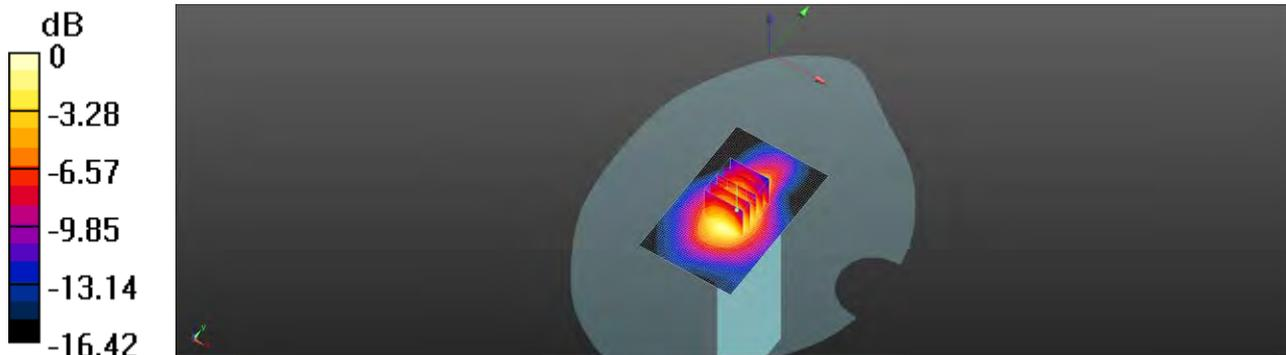

0 dB = 0.799 W/kg = -0.97 dBW/kg

Unless otherwise stated the results shown in this test report refer only to the sample(s) tested and such sample(s) are retained for 90 days only.

除非另有說明，此報告結果僅對測試之樣品負責，同時此樣品僅保留90天。本報告未經本公司書面許可，不可部份複製。

This document is issued by the Company subject to its General Conditions of Service printed overleaf, available on request or accessible at <http://www.sgs.com.tw/Terms-and-Conditions> and for electronic format documents, subject to Terms and Conditions for Electronic Documents at <http://www.sgs.com.tw/Terms-and-Conditions>. Attention is drawn to the limitation of liability, indemnification and jurisdiction issues defined therein. Any holder of this document is advised that information contained hereon reflects the Company's findings at the time of its intervention only and within the limits of Client's instructions, if any. The Company's sole responsibility is to its Client and this document does not exonerate parties to a transaction from exercising all their rights and obligations under the transaction documents. This document cannot be reproduced except in full, without prior written approval of the Company. Any unauthorized alteration, forgery or falsification of the content or appearance of this document is unlawful and offenders may be prosecuted to the fullest extent of the law.

Date: 2020/7/10

Report No. :ES/2020/30005

LTE Band 26 (15MHz)_Hotspot_Front side_CH 26765_QPSK_1-0_10mm_LAT

Communication System: LTE; Frequency: 821.5 MHz; Duty cycle= 1:1

Medium parameters used: $f = 821.5 \text{ MHz}$; $\sigma = 0.912 \text{ S/m}$; $\epsilon_r = 42.211$; $\rho = 1000 \text{ kg/m}^3$

Phantom section: Flat Section

Ambient temperature: 22.2°C; Liquid temperature: 21.7°C

DASY5 Configuration:

- Probe: EX3DV4 - SN7509; ConvF(9.73, 9.73, 9.73) @ 821.5 MHz; Calibrated: 2020/3/25
- Sensor-Surface: 2mm (Mechanical Surface Detection)
- Electronics: DAE4 Sn558; Calibrated: 2019/10/11
- Phantom: SAM
- DASY52 52.10.4(1527); SEMCAD X 14.6.14(7483)

Area Scan (71x141x1): Interpolated grid: dx=15 mm, dy=15 mm

Maximum value of SAR (interpolated) = 0.261 W/kg

Zoom Scan (5x5x7)/Cube 0: Measurement grid: dx=8mm, dy=8mm, dz=5mm

Reference Value = 11.23 V/m; Power Drift = 0.08 dB

Peak SAR (extrapolated) = 0.272 W/kg

SAR(1 g) = 0.249 W/kg; SAR(10 g) = 0.195 W/kg

Smallest distance from peaks to all points 3 dB below = 11.3 mm

Ratio of SAR at M2 to SAR at M1 = 91.8%

Maximum value of SAR (measured) = 0.255 W/kg

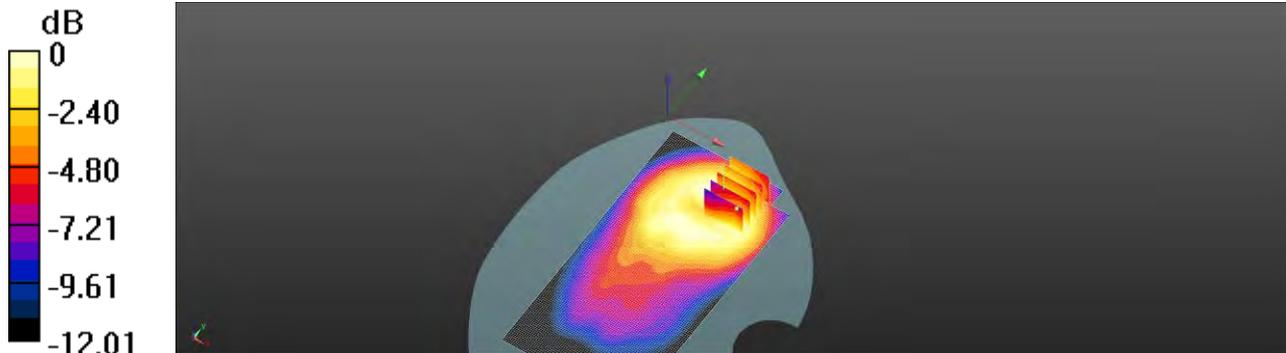

0 dB = 0.255 W/kg = -5.93 dBW/kg

Unless otherwise stated the results shown in this test report refer only to the sample(s) tested and such sample(s) are retained for 90 days only.

除非另有說明，此報告結果僅對測試之樣品負責，同時此樣品僅保留90天。本報告未經本公司書面許可，不可部份複製。

This document is issued by the Company subject to its General Conditions of Service printed overleaf, available on request or accessible at <http://www.sgs.com.tw/Terms-and-Conditions> and for electronic format documents, subject to Terms and Conditions for Electronic Documents at <http://www.sgs.com.tw/Terms-and-Conditions>. Attention is drawn to the limitation of liability, indemnification and jurisdiction issues defined therein. Any holder of this document is advised that information contained hereon reflects the Company's findings at the time of its intervention only and within the limits of Client's instructions, if any. The Company's sole responsibility is to its Client and this document does not exonerate parties to a transaction from exercising all their rights and obligations under the transaction documents. This document cannot be reproduced except in full, without prior written approval of the Company. Any unauthorized alteration, forgery or falsification of the content or appearance of this document is unlawful and offenders may be prosecuted to the fullest extent of the law.

Date: 2020/7/11

Report No. :ES/2020/30005

**LTE Band 66 (20MHz)_Hotspot_Bottom side_CH
132572_QPSK_1-0_10mm_LAT**

Communication System: LTE; Frequency: 1770 MHz; Duty cycle= 1:1

Medium parameters used: $f = 1770$ MHz; $\sigma = 1.411$ S/m; $\epsilon_r = 39.774$; $\rho = 1000$ kg/m³

Phantom section: Flat Section

Ambient temperature: 21.4°C; Liquid temperature: 21.8°C

DASY5 Configuration:

- Probe: EX3DV4 - SN7509; ConvF(8.34, 8.34, 8.34) @ 1770 MHz; Calibrated: 2020/3/25
- Sensor-Surface: 2mm (Mechanical Surface Detection)
- Electronics: DAE4 Sn558; Calibrated: 2019/10/11
- Phantom: SAM
- DASY52 52.10.4(1527); SEMCAD X 14.6.14(7483)

Area Scan (51x81x1): Interpolated grid: dx=15 mm, dy=15 mm

Maximum value of SAR (interpolated) = 0.884 W/kg

Zoom Scan (5x5x7)/Cube 0: Measurement grid: dx=8mm, dy=8mm, dz=5mm

Reference Value = 29.96 V/m; Power Drift = -0.17 dB

Peak SAR (extrapolated) = 0.889 W/kg

SAR(1 g) = 0.722 W/kg; SAR(10 g) = 0.535 W/kg

Smallest distance from peaks to all points 3 dB below = 12.8 mm

Ratio of SAR at M2 to SAR at M1 = 76.5%

Maximum value of SAR (measured) = 0.805 W/kg

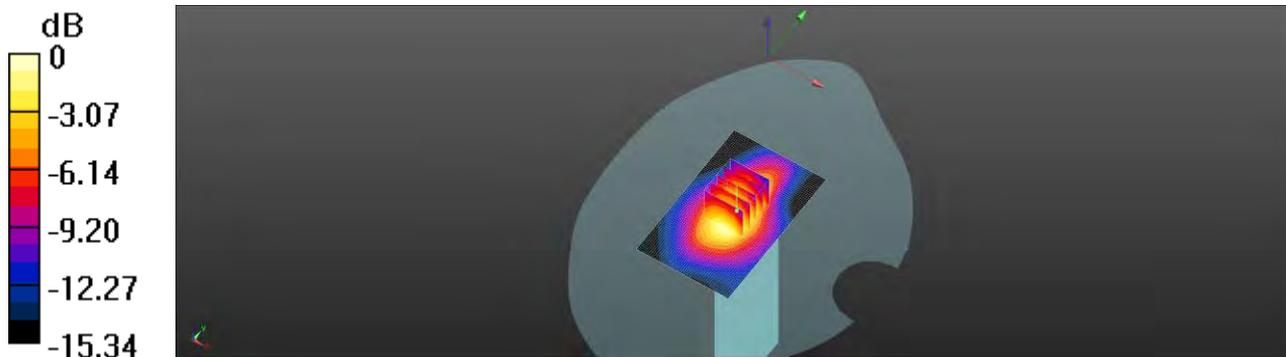

0 dB = 0.805 W/kg = -0.94 dBW/kg

Unless otherwise stated the results shown in this test report refer only to the sample(s) tested and such sample(s) are retained for 90 days only.

除非另有說明，此報告結果僅對測試之樣品負責，同時此樣品僅保留90天。本報告未經本公司書面許可，不可部份複製。

This document is issued by the Company subject to its General Conditions of Service printed overleaf, available on request or accessible at <http://www.sgs.com.tw/Terms-and-Conditions> and for electronic format documents, subject to Terms and Conditions for Electronic Documents at <http://www.sgs.com.tw/Terms-and-Conditions>. Attention is drawn to the limitation of liability, indemnification and jurisdiction issues defined therein. Any holder of this document is advised that information contained hereon reflects the Company's findings at the time of its intervention only and within the limits of Client's instructions, if any. The Company's sole responsibility is to its Client and this document does not exonerate parties to a transaction from exercising all their rights and obligations under the transaction documents. This document cannot be reproduced except in full, without prior written approval of the Company. Any unauthorized alteration, forgery or falsification of the content or appearance of this document is unlawful and offenders may be prosecuted to the fullest extent of the law.

Date: 2020/7/10

Report No. : ES/2020/30005

LTE Band 26 (15MHz)_Head_Re Cheek_CH 26765_QPSK_1-0_UAT

Communication System: LTE; Frequency: 821.5 MHz; Duty cycle= 1:1

Medium parameters used: $f = 821.5$ MHz; $\sigma = 0.912$ S/m; $\epsilon_r = 42.211$; $\rho = 1000$ kg/m³

Phantom section: Right Section

Ambient temperature: 22.2°C; Liquid temperature: 21.7°C

DASY5 Configuration:

- Probe: EX3DV4 - SN7509; ConvF(9.73, 9.73, 9.73) @ 821.5 MHz; Calibrated: 2020/3/25
- Sensor-Surface: 2mm (Mechanical Surface Detection)
- Electronics: DAE4 Sn558; Calibrated: 2019/10/11
- Phantom: SAM
- DASY52 52.10.4(1527); SEMCAD X 14.6.14(7483)

Area Scan (71x151x1): Interpolated grid: dx=15 mm, dy=15 mm

Maximum value of SAR (interpolated) = 0.499 W/kg

Zoom Scan (5x5x7)/Cube 0: Measurement grid: dx=8mm, dy=8mm, dz=5mm

Reference Value = 22.60 V/m; Power Drift = -0.12 dB

Peak SAR (extrapolated) = 0.530 W/kg

SAR(1 g) = 0.403 W/kg; SAR(10 g) = 0.290 W/kg

Smallest distance from peaks to all points 3 dB below = 10.7 mm

Ratio of SAR at M2 to SAR at M1 = 70.6%

Maximum value of SAR (measured) = 0.458 W/kg

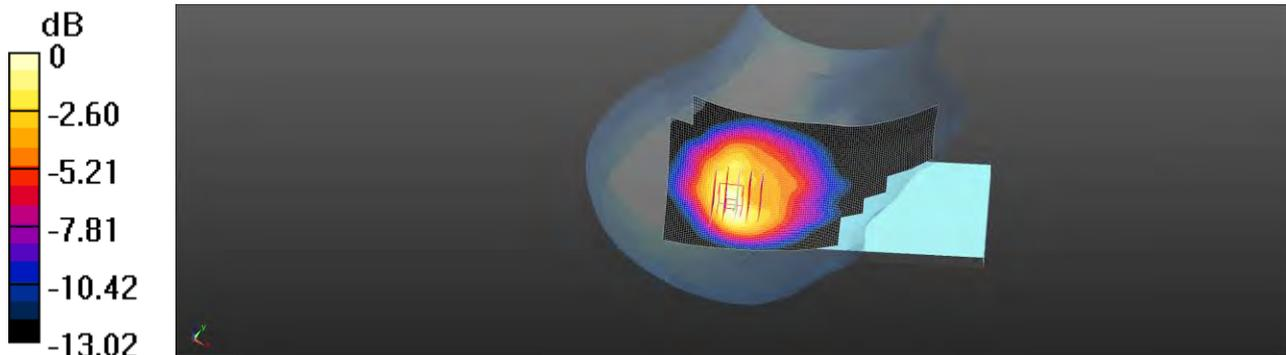

0 dB = 0.458 W/kg = -3.39 dBW/kg

Unless otherwise stated the results shown in this test report refer only to the sample(s) tested and such sample(s) are retained for 90 days only.

除非另有說明，此報告結果僅對測試之樣品負責，同時此樣品僅保留90天。本報告未經本公司書面許可，不可部份複製。

This document is issued by the Company subject to its General Conditions of Service printed overleaf, available on request or accessible at <http://www.sgs.com.tw/Terms-and-Conditions> and for electronic format documents, subject to Terms and Conditions for Electronic Documents at <http://www.sgs.com.tw/Terms-and-Conditions>. Attention is drawn to the limitation of liability, indemnification and jurisdiction issues defined therein. Any holder of this document is advised that information contained hereon reflects the Company's findings at the time of its intervention only and within the limits of Client's instructions, if any. The Company's sole responsibility is to its Client and this document does not exonerate parties to a transaction from exercising all their rights and obligations under the transaction documents. This document cannot be reproduced except in full, without prior written approval of the Company. Any unauthorized alteration, forgery or falsification of the content or appearance of this document is unlawful and offenders may be prosecuted to the fullest extent of the law.

Date: 2020/7/15

Report No. : ES/2020/30005

LTE Band 5 (10MHz)_Head_Re Cheek_CH 20450_QPSK_1-0_UAT

Communication System: LTE; Frequency: 829 MHz; Duty cycle= 1:1

Medium parameters used: $f = 829$ MHz; $\sigma = 0.89$ S/m; $\epsilon_r = 42.463$; $\rho = 1000$ kg/m³

Phantom section: Right Section

Ambient temperature: 21.9°C; Liquid temperature: 22.3°C

DASY5 Configuration:

- Probe: EX3DV4 - SN7509; ConvF(9.73, 9.73, 9.73) @ 829 MHz; Calibrated: 2020/03/25
- Sensor-Surface: 2mm (Mechanical Surface Detection)
- Electronics: DAE4 Sn558; Calibrated: 2019/10/11
- Phantom: SAM
- DASY52 52.10.4(1527); SEMCAD X 14.6.14(7483)

Area Scan (71x151x1): Interpolated grid: dx=15 mm, dy=15 mm

Maximum value of SAR (interpolated) = 0.647 W/kg

Zoom Scan (5x5x7)/Cube 0: Measurement grid: dx=8mm, dy=8mm, dz=5mm

Reference Value = 22.65 V/m; Power Drift = -0.16 dB

Peak SAR (extrapolated) = 0.686 W/kg

SAR(1 g) = 0.510 W/kg; SAR(10 g) = 0.357 W/kg

Smallest distance from peaks to all points 3 dB below = 10.7 mm

Ratio of SAR at M2 to SAR at M1 = 70.7%

Maximum value of SAR (measured) = 0.595 W/kg

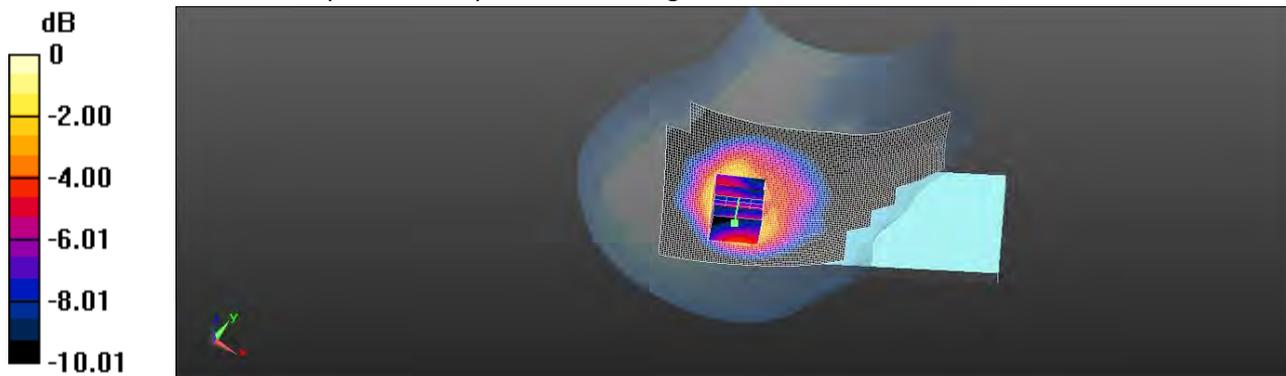

0 dB = 0.595 W/kg = -2.25 dBW/kg

Unless otherwise stated the results shown in this test report refer only to the sample(s) tested and such sample(s) are retained for 90 days only.

除非另有說明，此報告結果僅對測試之樣品負責，同時此樣品僅保留90天。本報告未經本公司書面許可，不可部份複製。

This document is issued by the Company subject to its General Conditions of Service printed overleaf, available on request or accessible at <http://www.sgs.com.tw/Terms-and-Conditions> and for electronic format documents, subject to Terms and Conditions for Electronic Documents at <http://www.sgs.com.tw/Terms-and-Conditions>. Attention is drawn to the limitation of liability, indemnification and jurisdiction issues defined therein. Any holder of this document is advised that information contained hereon reflects the Company's findings at the time of its intervention only and within the limits of Client's instructions, if any. The Company's sole responsibility is to its Client and this document does not exonerate parties to a transaction from exercising all their rights and obligations under the transaction documents. This document cannot be reproduced except in full, without prior written approval of the Company. Any unauthorized alteration, forgery or falsification of the content or appearance of this document is unlawful and offenders may be prosecuted to the fullest extent of the law.

Date: 2020/7/17

Report No. :ES/2020/30005

LTE Band 2 (20MHz)_Head_Le Cheek_CH 19100_QPSK_1-0_LAT

Communication System: LTE; Frequency: 1900 MHz; Duty cycle= 1:1

Medium parameters used: $f = 1900 \text{ MHz}$; $\sigma = 1.399 \text{ S/m}$; $\epsilon_r = 38.682$; $\rho = 1000 \text{ kg/m}^3$

Phantom section: Left Section

Ambient temperature: 22.7°C ; Liquid temperature: 21.6°C

DASY5 Configuration:

- Probe: EX3DV4 - SN7509; ConvF(8.07, 8.07, 8.07) @ 1900 MHz; Calibrated: 2020/03/25
- Sensor-Surface: 2mm (Mechanical Surface Detection)
- Electronics: DAE4 Sn558; Calibrated: 2019/10/11
- Phantom: SAM
- DASY52 52.10.4(1527); SEMCAD X 14.6.14(7483)

Area Scan (71x141x1): Interpolated grid: $dx=15 \text{ mm}$, $dy=15 \text{ mm}$

Maximum value of SAR (interpolated) = 0.163 W/kg

Zoom Scan (5x5x7)/Cube 0: Measurement grid: $dx=8\text{mm}$, $dy=8\text{mm}$, $dz=5\text{mm}$

Reference Value = 4.328 V/m ; Power Drift = 0.12 dB

Peak SAR (extrapolated) = 0.161 W/kg

SAR(1 g) = 0.131 W/kg ; SAR(10 g) = 0.101 W/kg

Smallest distance from peaks to all points 3 dB below = 10.8 mm

Ratio of SAR at M2 to SAR at M1 = 80.4%

Maximum value of SAR (measured) = 0.142 W/kg

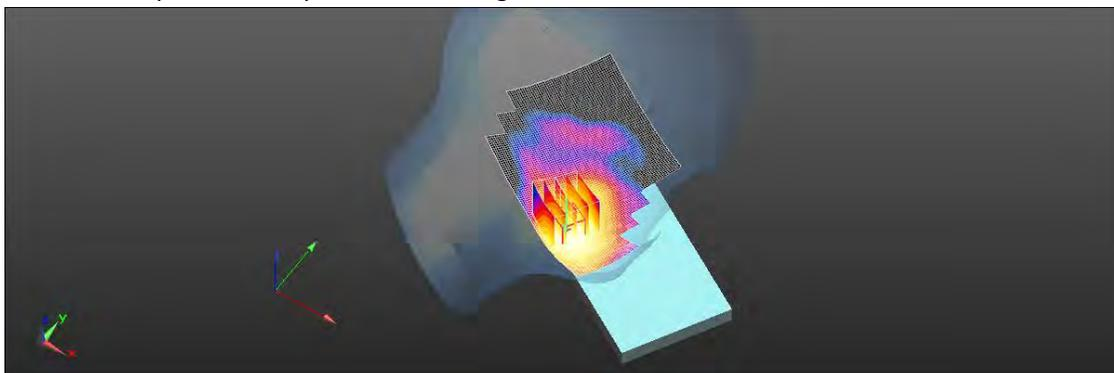
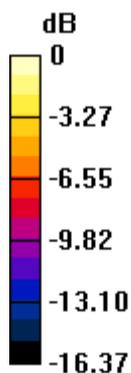

0 dB = 0.142 W/kg = -8.48 dBW/kg

Unless otherwise stated the results shown in this test report refer only to the sample(s) tested and such sample(s) are retained for 90 days only.

除非另有說明，此報告結果僅對測試之樣品負責，同時此樣品僅保留90天。本報告未經本公司書面許可，不可部份複製。

This document is issued by the Company subject to its General Conditions of Service printed overleaf, available on request or accessible at <http://www.sgs.com.tw/Terms-and-Conditions> and for electronic format documents, subject to Terms and Conditions for Electronic Documents at <http://www.sgs.com.tw/Terms-and-Conditions>. Attention is drawn to the limitation of liability, indemnification and jurisdiction issues defined therein. Any holder of this document is advised that information contained hereon reflects the Company's findings at the time of its intervention only and within the limits of Client's instructions, if any. The Company's sole responsibility is to its Client and this document does not exonerate parties to a transaction from exercising all their rights and obligations under the transaction documents. This document cannot be reproduced except in full, without prior written approval of the Company. Any unauthorized alteration, forgery or falsification of the content or appearance of this document is unlawful and offenders may be prosecuted to the fullest extent of the law.

Date: 2020/7/2

Report No. :ES/2020/30005

LTE Band 5 (10MHz)_Head_Re Cheek_CH 20450_QPSK_1-0_UAT

Communication System: LTE; Frequency: 829 MHz; Duty cycle= 1:1

Medium parameters used: $f = 829 \text{ MHz}$; $\sigma = 0.899 \text{ S/m}$; $\epsilon_r = 42.317$; $\rho = 1000 \text{ kg/m}^3$

Phantom section: Right Section

Ambient temperature: 21.4°C; Liquid temperature: 21.8°C

DASY5 Configuration:

- Probe: EX3DV4 - SN3770; ConvF(9.5, 9.5, 9.5) @ 829 MHz; Calibrated: 2020/5/27
- Sensor-Surface: 2mm (Mechanical Surface Detection)
- Electronics: DAE4 Sn877; Calibrated: 2020/3/17
- Phantom: SAM
- DASY52 52.10.4(1527); SEMCAD X 14.6.14(7483)

Area Scan (71x151x1): Interpolated grid: $dx=15 \text{ mm}$, $dy=15 \text{ mm}$

Maximum value of SAR (interpolated) = 0.431 W/kg

Zoom Scan (5x5x7)/Cube 0: Measurement grid: $dx=8\text{mm}$, $dy=8\text{mm}$, $dz=5\text{mm}$

Reference Value = 21.25 V/m; Power Drift = -0.11 dB

Peak SAR (extrapolated) = 0.458 W/kg

SAR(1 g) = 0.354 W/kg; SAR(10 g) = 0.259 W/kg

Smallest distance from peaks to all points 3 dB below = 11.5 mm

Ratio of SAR at M2 to SAR at M1 = 63.5%

Maximum value of SAR (measured) = 0.396 W/kg

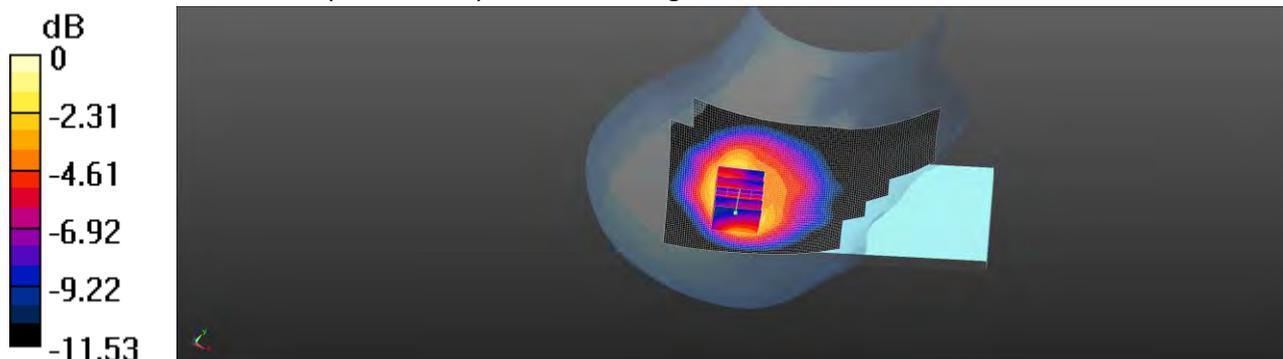

0 dB = 0.396 W/kg = -4.02 dBW/kg

Unless otherwise stated the results shown in this test report refer only to the sample(s) tested and such sample(s) are retained for 90 days only.

除非另有說明，此報告結果僅對測試之樣品負責，同時此樣品僅保留90天。本報告未經本公司書面許可，不可部份複製。

This document is issued by the Company subject to its General Conditions of Service printed overleaf, available on request or accessible at <http://www.sgs.com.tw/Terms-and-Conditions> and for electronic format documents, subject to Terms and Conditions for Electronic Documents at <http://www.sgs.com.tw/Terms-and-Conditions>. Attention is drawn to the limitation of liability, indemnification and jurisdiction issues defined therein. Any holder of this document is advised that information contained hereon reflects the Company's findings at the time of its intervention only and within the limits of Client's instructions, if any. The Company's sole responsibility is to its Client and this document does not exonerate parties to a transaction from exercising all their rights and obligations under the transaction documents. This document cannot be reproduced except in full, without prior written approval of the Company. Any unauthorized alteration, forgery or falsification of the content or appearance of this document is unlawful and offenders may be prosecuted to the fullest extent of the law.

Date: 2020/7/4

Report No. : ES/2020/30005
LTE Band 2 (20MHz)_Head_Le Cheek_CH 19100_QPSK_1-0_LAT

Communication System: LTE; Frequency: 1900 MHz; Duty cycle= 1:1

 Medium parameters used: $f = 1900 \text{ MHz}$; $\sigma = 1.411 \text{ S/m}$; $\epsilon_r = 39.542$; $\rho = 1000 \text{ kg/m}^3$

Phantom section: Left Section

Ambient temperature: 22.1°C; Liquid temperature: 22.4°C

DASY5 Configuration:

- Probe: EX3DV4 - SN3770; ConvF(8.03, 8.03, 8.03) @ 1900 MHz; Calibrated: 2020/5/27
- Sensor-Surface: 2mm (Mechanical Surface Detection)
- Electronics: DAE4 Sn877; Calibrated: 2020/3/17
- Phantom: SAM
- DASY52 52.10.4(1527); SEMCAD X 14.6.14(7483)

Area Scan (71x141x1): Interpolated grid: dx=15 mm, dy=15 mm

Maximum value of SAR (interpolated) = 0.0791 W/kg

Zoom Scan (5x5x7)/Cube 0: Measurement grid: dx=8mm, dy=8mm, dz=5mm

Reference Value = 4.324 V/m; Power Drift = 0.12 dB

Peak SAR (extrapolated) = 0.0780 W/kg

SAR(1 g) = 0.066 W/kg; SAR(10 g) = 0.054 W/kg

Smallest distance from peaks to all points 3 dB below: Larger than measurement grid

Ratio of SAR at M2 to SAR at M1 = 80.4%

Maximum value of SAR (measured) = 0.0686 W/kg

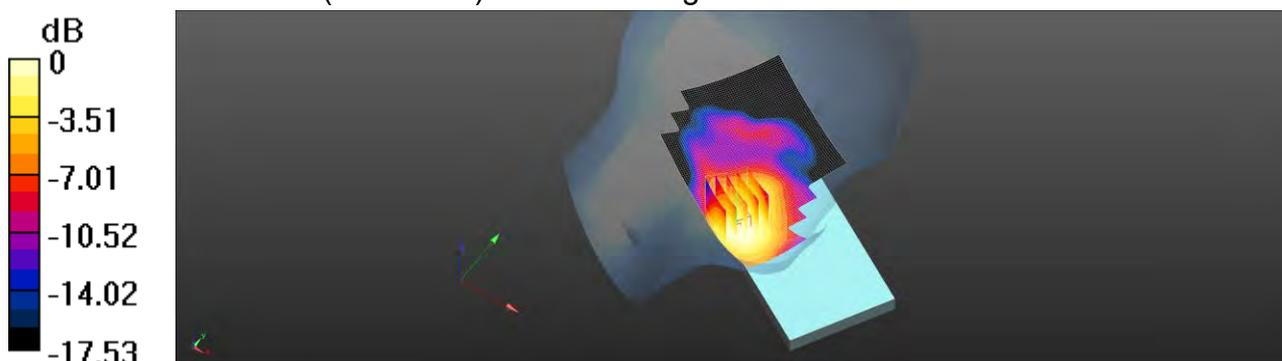

0 dB = 0.0686 W/kg = -11.64 dBW/kg

Unless otherwise stated the results shown in this test report refer only to the sample(s) tested and such sample(s) are retained for 90 days only.

除非另有說明，此報告結果僅對測試之樣品負責，同時此樣品僅保留90天。本報告未經本公司書面許可，不可部份複製。

 This document is issued by the Company subject to its General Conditions of Service printed overleaf, available on request or accessible at <http://www.sgs.com.tw/Terms-and-Conditions> and for electronic format documents, subject to Terms and Conditions for Electronic Documents at <http://www.sgs.com.tw/Terms-and-Conditions>. Attention is drawn to the limitation of liability, indemnification and jurisdiction issues defined therein. Any holder of this document is advised that information contained hereon reflects the Company's findings at the time of its intervention only and within the limits of Client's instructions, if any. The Company's sole responsibility is to its Client and this document does not exonerate parties to a transaction from exercising all their rights and obligations under the transaction documents. This document cannot be reproduced except in full, without prior written approval of the Company. Any unauthorized alteration, forgery or falsification of the content or appearance of this document is unlawful and offenders may be prosecuted to the fullest extent of the law.

Date: 2020/7/2

Report No. : ES/2020/30005

LTE Band 5 (10MHz)_Hotspot_Front side_CH 20450_QPSK_1-0_10mm_UAT

Communication System: LTE; Frequency: 821.5 MHz; Duty cycle= 1:1

Medium parameters used: $f = 821 \text{ MHz}$; $\sigma = 0.897 \text{ S/m}$; $\epsilon_r = 42.385$; $\rho = 1000 \text{ kg/m}^3$

Phantom section: Flat Section

Ambient temperature: 21.4°C ; Liquid temperature: 21.8°C

DASY5 Configuration:

- Probe: EX3DV4 - SN3770; ConvF(9.5, 9.5, 9.5) @ 821 MHz; Calibrated: 2020/5/27
- Sensor-Surface: 2mm (Mechanical Surface Detection)
- Electronics: DAE4 Sn877; Calibrated: 2020/3/17
- Phantom: SAM
- DASY52 52.10.4(1527); SEMCAD X 14.6.14(7483)

Area Scan (71x141x1): Interpolated grid: $dx=15 \text{ mm}$, $dy=15 \text{ mm}$

Maximum value of SAR (interpolated) = 0.281 W/kg

Zoom Scan (5x5x7)/Cube 0: Measurement grid: $dx=8\text{mm}$, $dy=8\text{mm}$, $dz=5\text{mm}$

Reference Value = 8.313 V/m; Power Drift = 0.14 dB

Peak SAR (extrapolated) = 0.312 W/kg

SAR(1 g) = 0.245 W/kg; SAR(10 g) = 0.177 W/kg

Smallest distance from peaks to all points 3 dB below = 12.5 mm

Ratio of SAR at M2 to SAR at M1 = 76.9%

Maximum value of SAR (measured) = 0.282 W/kg

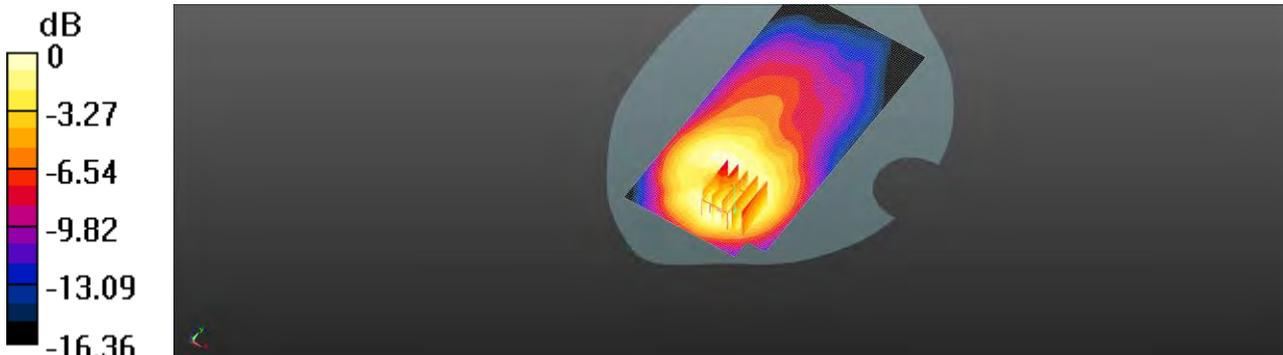

0 dB = 0.282 W/kg = -5.50 dBW/kg

Unless otherwise stated the results shown in this test report refer only to the sample(s) tested and such sample(s) are retained for 90 days only.

除非另有說明，此報告結果僅對測試之樣品負責，同時此樣品僅保留90天。本報告未經本公司書面許可，不可部份複製。

This document is issued by the Company subject to its General Conditions of Service printed overleaf, available on request or accessible at <http://www.sgs.com.tw/Terms-and-Conditions> and for electronic format documents, subject to Terms and Conditions for Electronic Documents at <http://www.sgs.com.tw/Terms-and-Conditions>. Attention is drawn to the limitation of liability, indemnification and jurisdiction issues defined therein. Any holder of this document is advised that information contained hereon reflects the Company's findings at the time of its intervention only and within the limits of Client's instructions, if any. The Company's sole responsibility is to its Client and this document does not exonerate parties to a transaction from exercising all their rights and obligations under the transaction documents. This document cannot be reproduced except in full, without prior written approval of the Company. Any unauthorized alteration, forgery or falsification of the content or appearance of this document is unlawful and offenders may be prosecuted to the fullest extent of the law.

Date: 2020/7/10

Report No. : ES/2020/30005

LTE Band 5 (10MHz)_Hotspot_Front side_CH 20450_QPSK_1-0_10mm_UAT

Communication System: LTE; Frequency: 821.5 MHz; Duty cycle= 1:1

Medium parameters used: $f = 821.5 \text{ MHz}$; $\sigma = 0.912 \text{ S/m}$; $\epsilon_r = 42.211$; $\rho = 1000 \text{ kg/m}^3$

Phantom section: Flat Section

Ambient temperature: 21.5°C; Liquid temperature: 22.0°C

DASY5 Configuration:

- Probe: EX3DV4 - SN7509; ConvF(9.73, 9.73, 9.73) @ 821.5 MHz; Calibrated: 3/25/2020
- Sensor-Surface: 2mm (Mechanical Surface Detection)
- Electronics: DAE4 Sn558; Calibrated: 10/11/2019
- Phantom: SAM
- DASY52 52.10.4(1527); SEMCAD X 14.6.14(7483)

Area Scan (71x141x1): Interpolated grid: dx=15 mm, dy=15 mm

Maximum value of SAR (interpolated) = 0.170 W/kg

Zoom Scan (5x5x7)/Cube 0: Measurement grid: dx=8mm, dy=8mm, dz=5mm

Reference Value = 8.313 V/m; Power Drift = 0.14 dB

Peak SAR (extrapolated) = 0.189 W/kg

SAR(1 g) = 0.155 W/kg; SAR(10 g) = 0.118 W/kg

Smallest distance from peaks to all points 3 dB below = 12.5 mm

Ratio of SAR at M2 to SAR at M1 = 76.9%

Maximum value of SAR (measured) = 0.171 W/kg

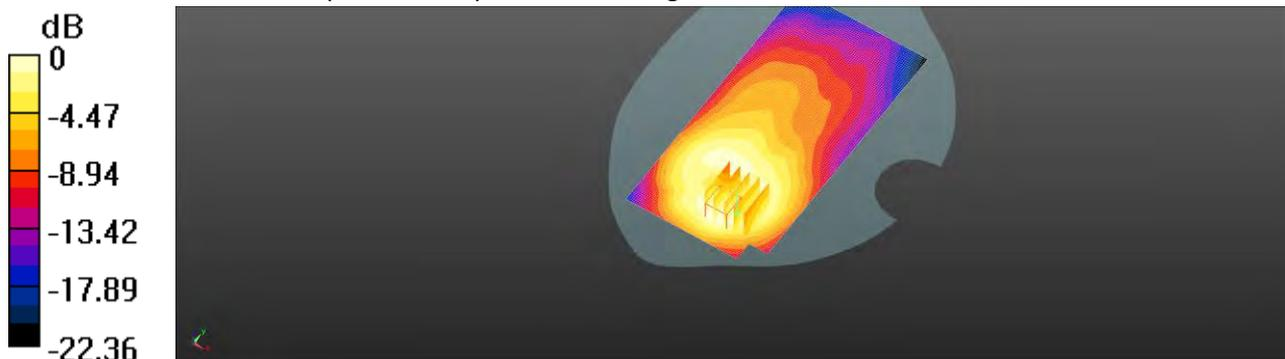

0 dB = 0.171 W/kg = -7.67 dBW/kg

Unless otherwise stated the results shown in this test report refer only to the sample(s) tested and such sample(s) are retained for 90 days only.

除非另有說明，此報告結果僅對測試之樣品負責，同時此樣品僅保留90天。本報告未經本公司書面許可，不可部份複製。

This document is issued by the Company subject to its General Conditions of Service printed overleaf, available on request or accessible at <http://www.sgs.com.tw/Terms-and-Conditions> and for electronic format documents, subject to Terms and Conditions for Electronic Documents at <http://www.sgs.com.tw/Terms-and-Conditions>. Attention is drawn to the limitation of liability, indemnification and jurisdiction issues defined therein. Any holder of this document is advised that information contained hereon reflects the Company's findings at the time of its intervention only and within the limits of Client's instructions, if any. The Company's sole responsibility is to its Client and this document does not exonerate parties to a transaction from exercising all their rights and obligations under the transaction documents. This document cannot be reproduced except in full, without prior written approval of the Company. Any unauthorized alteration, forgery or falsification of the content or appearance of this document is unlawful and offenders may be prosecuted to the fullest extent of the law.

Date: 2020/7/22

Report No. : ES/2020/30005**LTE Band 5 (10MHz)_Hotspot_Front side_CH 20450_QPSK_1-0_10mm_UAT**

Communication System: LTE; Frequency: 821.5 MHz; Duty cycle= 1:1

Medium parameters used: $f = 821.5$ MHz; $\sigma = 0.901$ S/m; $\epsilon_r = 42.375$; $\rho = 1000$ kg/m³

Phantom section: Flat Section

Ambient temperature: 21.6°C; Liquid temperature: 22.0°C

DASY5 Configuration:

- Probe: EX3DV4 - SN7509; ConvF(9.73, 9.73, 9.73) @ 821.5 MHz; Calibrated: 2020/3/25
- Sensor-Surface: 2mm (Mechanical Surface Detection)
- Electronics: DAE4 Sn558; Calibrated: 2019/10/11
- Phantom: SAM
- DASY52 52.10.4(1527); SEMCAD X 14.6.14(7483)

Area Scan (71x141x1): Interpolated grid: dx=15 mm, dy=15 mm

Maximum value of SAR (interpolated) = 0.235 W/kg

Zoom Scan (5x5x7)/Cube 0: Measurement grid: dx=8mm, dy=8mm, dz=5mm

Reference Value = 8.313 V/m; Power Drift = 0.14 dB

Peak SAR (extrapolated) = 0.261 W/kg

SAR(1 g) = 0.208 W/kg; SAR(10 g) = 0.154 W/kg

Smallest distance from peaks to all points 3 dB below = 12.5 mm

Ratio of SAR at M2 to SAR at M1 = 76.9%

Maximum value of SAR (measured) = 0.236 W/kg

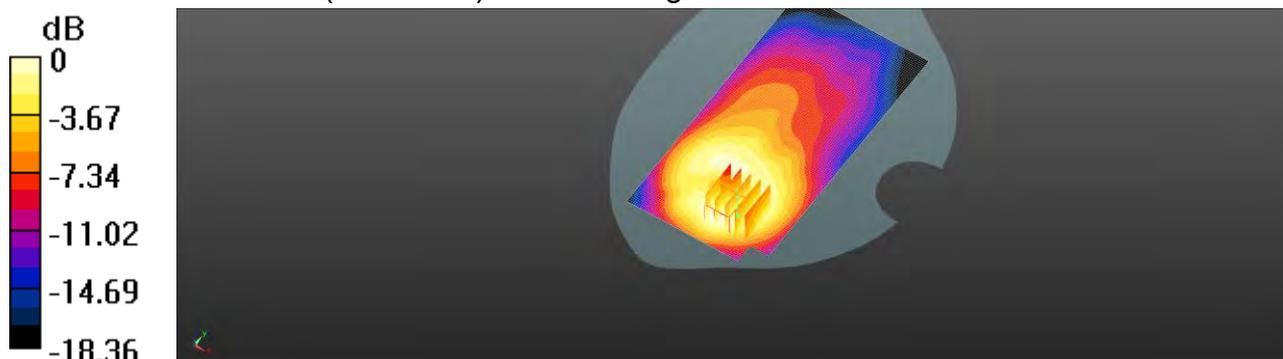

Unless otherwise stated the results shown in this test report refer only to the sample(s) tested and such sample(s) are retained for 90 days only.

除非另有說明，此報告結果僅對測試之樣品負責，同時此樣品僅保留90天。本報告未經本公司書面許可，不可部份複製。

This document is issued by the Company subject to its General Conditions of Service printed overleaf, available on request or accessible at <http://www.sgs.com.tw/Terms-and-Conditions> and for electronic format documents, subject to Terms and Conditions for Electronic Documents at <http://www.sgs.com.tw/Terms-and-Conditions>. Attention is drawn to the limitation of liability, indemnification and jurisdiction issues defined therein. Any holder of this document is advised that information contained hereon reflects the Company's findings at the time of its intervention only and within the limits of Client's instructions, if any. The Company's sole responsibility is to its Client and this document does not exonerate parties to a transaction from exercising all their rights and obligations under the transaction documents. This document cannot be reproduced except in full, without prior written approval of the Company. Any unauthorized alteration, forgery or falsification of the content or appearance of this document is unlawful and offenders may be prosecuted to the fullest extent of the law.

Date: 2020/7/10

Report No. : ES/2020/30005**LTE Band 5 (10MHz)_Hotspot_Front side_CH 20450_QPSK_1-0_10mm_LAT**

Communication System: LTE; Frequency: 829 MHz; Duty cycle= 1:1

Medium parameters used: $f = 829$ MHz; $\sigma = 0.918$ S/m; $\epsilon_r = 42.137$; $\rho = 1000$ kg/m³

Phantom section: Flat Section

Ambient temperature: 22.2°C; Liquid temperature: 21.7°C

DASY5 Configuration:

- Probe: EX3DV4 - SN7509; ConvF(9.73, 9.73, 9.73) @ 829 MHz; Calibrated: 2020/3/25
- Sensor-Surface: 2mm (Mechanical Surface Detection)
- Electronics: DAE4 Sn558; Calibrated: 10/11/2019
- Phantom: SAM
- DASY52 52.10.4(1527); SEMCAD X 14.6.14(7483)

Area Scan (71x141x1): Interpolated grid: dx=15 mm, dy=15 mm

Maximum value of SAR (interpolated) = 0.215 W/kg

Zoom Scan (5x5x7)/Cube 0: Measurement grid: dx=8mm, dy=8mm, dz=5mm

Reference Value = 11.24 V/m; Power Drift = 0.18 dB

Peak SAR (extrapolated) = 0.223 W/kg

SAR(1 g) = 0.206 W/kg; SAR(10 g) = 0.166 W/kg

Smallest distance from peaks to all points 3 dB below = 11.3 mm

Ratio of SAR at M2 to SAR at M1 = 91.8%

Maximum value of SAR (measured) = 0.210 W/kg

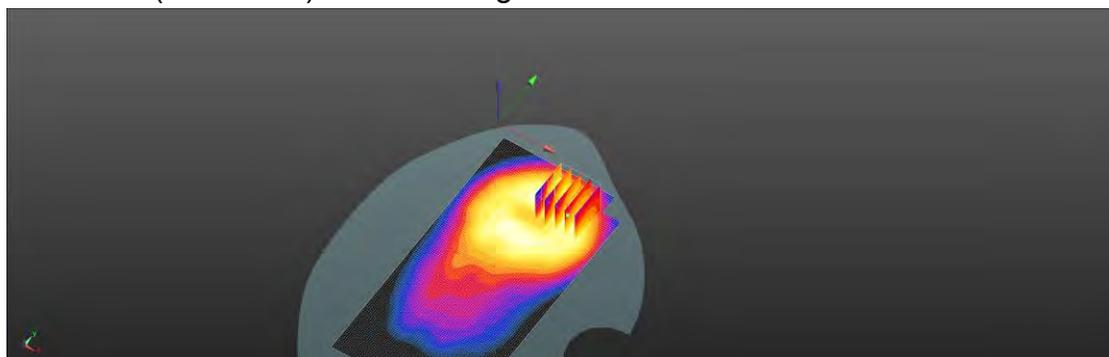
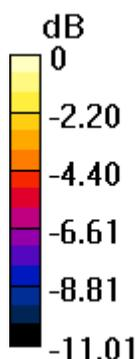

0 dB = 0.210 W/kg = -6.78 dBW/kg

Unless otherwise stated the results shown in this test report refer only to the sample(s) tested and such sample(s) are retained for 90 days only.

除非另有說明，此報告結果僅對測試之樣品負責，同時此樣品僅保留90天。本報告未經本公司書面許可，不可部份複製。

This document is issued by the Company subject to its General Conditions of Service printed overleaf, available on request or accessible at <http://www.sgs.com.tw/Terms-and-Conditions> and for electronic format documents, subject to Terms and Conditions for Electronic Documents at <http://www.sgs.com.tw/Terms-and-Conditions>. Attention is drawn to the limitation of liability, indemnification and jurisdiction issues defined therein. Any holder of this document is advised that information contained hereon reflects the Company's findings at the time of its intervention only and within the limits of Client's instructions, if any. The Company's sole responsibility is to its Client and this document does not exonerate parties to a transaction from exercising all their rights and obligations under the transaction documents. This document cannot be reproduced except in full, without prior written approval of the Company. Any unauthorized alteration, forgery or falsification of the content or appearance of this document is unlawful and offenders may be prosecuted to the fullest extent of the law.

Date: 2020/6/26

Report No. : ES/2020/30005**LTE Band 5 (10MHz)_Hotspot_Front side_CH 20450_QPSK_1-0_10mm_LAT**

Communication System: LTE; Frequency: 829 MHz; Duty cycle= 1:1

Medium parameters used: $f = 829$ MHz; $\sigma = 0.911$ S/m; $\epsilon_r = 42.234$; $\rho = 1000$ kg/m³

Phantom section: Flat Section

Ambient temperature: 21.6°C; Liquid temperature: 22.1°C

DASY5 Configuration:

- Probe: EX3DV4 - SN7509; ConvF(9.73, 9.73, 9.73) @ 829 MHz; Calibrated: 2020/3/25
- Sensor-Surface: 2mm (Mechanical Surface Detection)
- Electronics: DAE4 Sn558; Calibrated: 2019/10/11
- Phantom: SAM
- DASY52 52.10.4(1527); SEMCAD X 14.6.14(7483)

Area Scan (71x141x1): Interpolated grid: dx=15 mm, dy=15 mm

Maximum value of SAR (interpolated) = 0.152 W/kg

Zoom Scan (5x5x7)/Cube 0: Measurement grid: dx=8mm, dy=8mm, dz=5mm

Reference Value = 11.24 V/m; Power Drift = 0.14 dB

Peak SAR (extrapolated) = 0.158 W/kg

SAR(1 g) = 0.148 W/kg; SAR(10 g) = 0.124 W/kg

Smallest distance from peaks to all points 3 dB below = 11.3 mm

Ratio of SAR at M2 to SAR at M1 = 91.8%

Maximum value of SAR (measured) = 0.148 W/kg

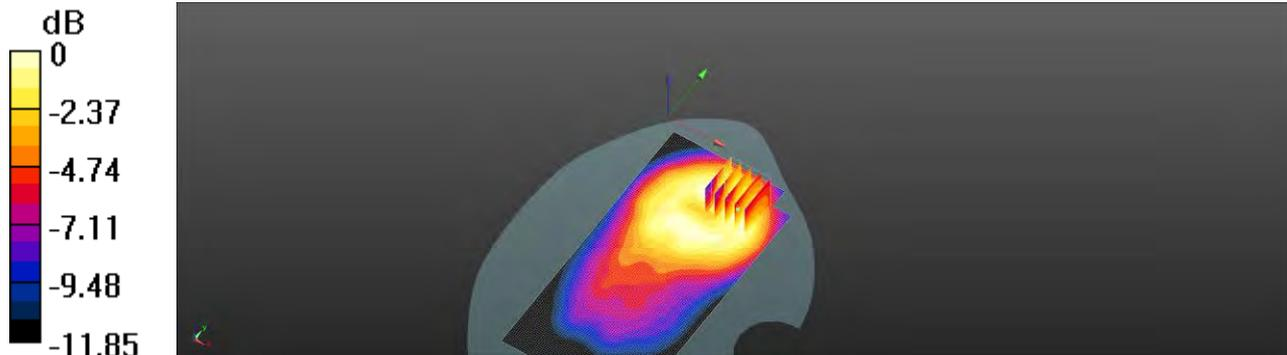

0 dB = 0.148 W/kg = -8.30 dBW/kg

Unless otherwise stated the results shown in this test report refer only to the sample(s) tested and such sample(s) are retained for 90 days only.

除非另有說明，此報告結果僅對測試之樣品負責，同時此樣品僅保留90天。本報告未經本公司書面許可，不可部份複製。

This document is issued by the Company subject to its General Conditions of Service printed overleaf, available on request or accessible at <http://www.sgs.com.tw/Terms-and-Conditions> and for electronic format documents, subject to Terms and Conditions for Electronic Documents at <http://www.sgs.com.tw/Terms-and-Conditions>. Attention is drawn to the limitation of liability, indemnification and jurisdiction issues defined therein. Any holder of this document is advised that information contained hereon reflects the Company's findings at the time of its intervention only and within the limits of Client's instructions, if any. The Company's sole responsibility is to its Client and this document does not exonerate parties to a transaction from exercising all their rights and obligations under the transaction documents. This document cannot be reproduced except in full, without prior written approval of the Company. Any unauthorized alteration, forgery or falsification of the content or appearance of this document is unlawful and offenders may be prosecuted to the fullest extent of the law.

Date: 2020/7/22

Report No. : ES/2020/30005

LTE Band 5 (10MHz)_Hotspot_Front side_CH 20450_QPSK_1-0_10mm_LAT

Communication System: LTE; Frequency: 829 MHz; Duty cycle= 1:1

Medium parameters used: $f = 829$ MHz; $\sigma = 0.91$ S/m; $\epsilon_r = 42.226$; $\rho = 1000$ kg/m³

Phantom section: Flat Section

Ambient temperature: 21.6°C; Liquid temperature: 22.0°C

DASY5 Configuration:

- Probe: EX3DV4 - SN7509; ConvF(9.73, 9.73, 9.73) @ 829 MHz; Calibrated: 2020/3/25
- Sensor-Surface: 2mm (Mechanical Surface Detection)
- Electronics: DAE4 Sn558; Calibrated: 2019/10/11
- Phantom: SAM
- DASY52 52.10.4(1527); SEMCAD X 14.6.14(7483)

Area Scan (71x141x1): Interpolated grid: dx=15 mm, dy=15 mm

Maximum value of SAR (interpolated) = 0.197 W/kg

Zoom Scan (5x5x7)/Cube 0: Measurement grid: dx=8mm, dy=8mm, dz=5mm

Reference Value = 11.24 V/m; Power Drift = 0.18 dB

Peak SAR (extrapolated) = 0.204 W/kg

SAR(1 g) = 0.189 W/kg; SAR(10 g) = 0.154 W/kg

Smallest distance from peaks to all points 3 dB below = 11.6 mm

Ratio of SAR at M2 to SAR at M1 = 93.8%

Maximum value of SAR (measured) = 0.192 W/kg

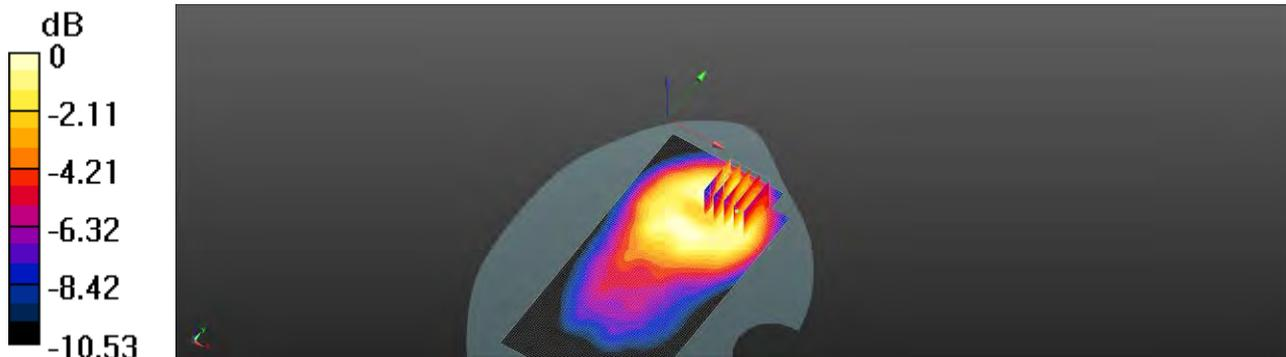

0 dB = 0.192 W/kg = -7.17 dBW/kg

Unless otherwise stated the results shown in this test report refer only to the sample(s) tested and such sample(s) are retained for 90 days only.

除非另有說明，此報告結果僅對測試之樣品負責，同時此樣品僅保留90天。本報告未經本公司書面許可，不可部份複製。

This document is issued by the Company subject to its General Conditions of Service printed overleaf, available on request or accessible at <http://www.sgs.com.tw/Terms-and-Conditions> and for electronic format documents, subject to Terms and Conditions for Electronic Documents at <http://www.sgs.com.tw/Terms-and-Conditions>. Attention is drawn to the limitation of liability, indemnification and jurisdiction issues defined therein. Any holder of this document is advised that information contained hereon reflects the Company's findings at the time of its intervention only and within the limits of Client's instructions, if any. The Company's sole responsibility is to its Client and this document does not exonerate parties to a transaction from exercising all their rights and obligations under the transaction documents. This document cannot be reproduced except in full, without prior written approval of the Company. Any unauthorized alteration, forgery or falsification of the content or appearance of this document is unlawful and offenders may be prosecuted to the fullest extent of the law.

Date: 2020/7/19

Report No. :ES/2020/30005

5G NR n41 (100MHz)_Head_Re Cheek_CH 513900_QPSK_1-1_UAT

Communication System: 5G NR(100MHz,QPSK,30k); Frequency: 2569.5 MHz; Duty cycle= 1:1

Medium parameters used: $f = 2569.5 \text{ MHz}$; $\sigma = 1.913 \text{ S/m}$; $\epsilon_r = 38.455$; $\rho = 1000 \text{ kg/m}^3$

Phantom section: Right Section

Ambient temperature: 21.7°C; Liquid temperature: 22.3°C

DASY5 Configuration:

- Probe: EX3DV4 - SN3770; ConvF(7.21, 7.21, 7.21) @ 2569.5 MHz; Calibrated: 2020/05/27
- Sensor-Surface: 2mm (Mechanical Surface Detection)
- Electronics: DAE4 Sn877; Calibrated: 2020/03/17
- Phantom: SAM
- DASY52 52.10.4(1527); SEMCAD X 14.6.14(7483)

Area Scan (101x171x1): Interpolated grid: $dx=12 \text{ mm}$, $dy=12 \text{ mm}$

Maximum value of SAR (interpolated) = 0.134 W/kg

Zoom Scan (7x7x7)/Cube 0: Measurement grid: $dx=5\text{mm}$, $dy=5\text{mm}$, $dz=5\text{mm}$

Reference Value = 3.885 V/m; Power Drift = 0.07 dB

Peak SAR (extrapolated) = 0.0830 W/kg

SAR(1 g) = 0.044 W/kg; SAR(10 g) = 0.021 W/kg

Smallest distance from peaks to all points 3 dB below: Larger than measurement grid

Ratio of SAR at M2 to SAR at M1 = 35.1%

Maximum value of SAR (measured) = 0.0643 W/kg

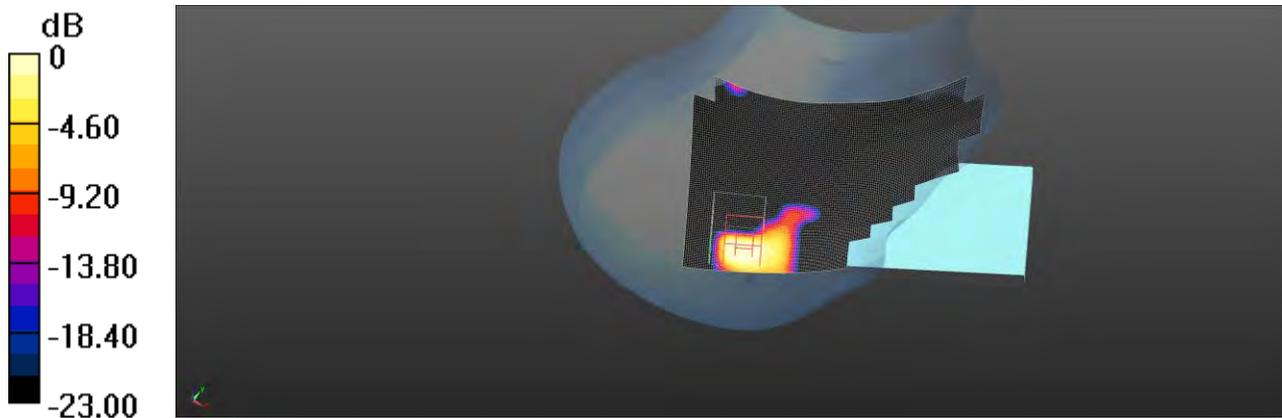

0 dB = 0.0643 W/kg = -11.92 dBW/kg

Unless otherwise stated the results shown in this test report refer only to the sample(s) tested and such sample(s) are retained for 90 days only.

除非另有說明，此報告結果僅對測試之樣品負責，同時此樣品僅保留90天。本報告未經本公司書面許可，不可部份複製。

This document is issued by the Company subject to its General Conditions of Service printed overleaf, available on request or accessible at <http://www.sgs.com.tw/Terms-and-Conditions> and for electronic format documents, subject to Terms and Conditions for Electronic Documents at <http://www.sgs.com.tw/Terms-and-Conditions>. Attention is drawn to the limitation of liability, indemnification and jurisdiction issues defined therein. Any holder of this document is advised that information contained hereon reflects the Company's findings at the time of its intervention only and within the limits of Client's instructions, if any. The Company's sole responsibility is to its Client and this document does not exonerate parties to a transaction from exercising all their rights and obligations under the transaction documents. This document cannot be reproduced except in full, without prior written approval of the Company. Any unauthorized alteration, forgery or falsification of the content or appearance of this document is unlawful and offenders may be prosecuted to the fullest extent of the law.

Date: 2020/7/19

Report No. :ES/2020/30005

5G NR n41 (100MHz)_Head_Re Cheek_CH 513900_QPSK_1-1_LAT

Communication System: 5G NR(100MHz,QPSK,30k); Frequency: 2569.5 MHz; Duty cycle= 1:1

Medium parameters used: $f = 2569.5$ MHz; $\sigma = 1.913$ S/m; $\epsilon_r = 38.455$; $\rho = 1000$ kg/m³

Phantom section: Right Section

Ambient temperature: 21.7°C; Liquid temperature: 22.3°C

DASY5 Configuration:

- Probe: EX3DV4 - SN3770; ConvF(7.21, 7.21, 7.21) @ 2569.5 MHz; Calibrated: 2020/05/27
- Sensor-Surface: 2mm (Mechanical Surface Detection)
- Electronics: DAE4 Sn877; Calibrated: 2020/03/17
- Phantom: SAM
- DASY52 52.10.4(1527); SEMCAD X 14.6.14(7483)

Area Scan (101x171x1): Interpolated grid: dx=12 mm, dy=12 mm

Maximum value of SAR (interpolated) = 0.0690 W/kg

Zoom Scan (7x7x7)/Cube 0: Measurement grid: dx=5mm, dy=5mm, dz=5mm

Reference Value = 1.503 V/m; Power Drift = -0.03 dB

Peak SAR (extrapolated) = 0.0470 W/kg

SAR(1 g) = 0.021 W/kg; SAR(10 g) = 0.013 W/kg

Smallest distance from peaks to all points 3 dB below: Larger than measurement grid

Ratio of SAR at M2 to SAR at M1 = 88.4%

Maximum value of SAR (measured) = 0.0244 W/kg

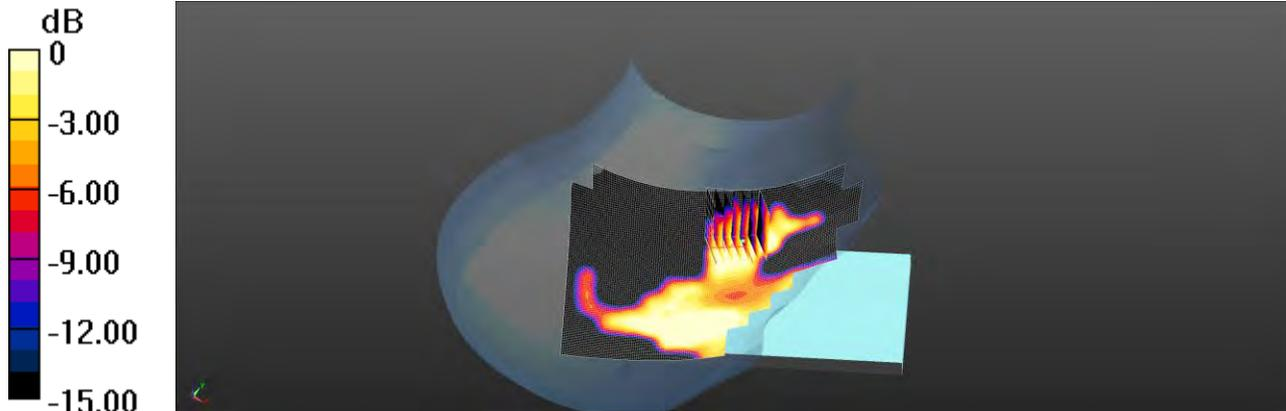

Unless otherwise stated the results shown in this test report refer only to the sample(s) tested and such sample(s) are retained for 90 days only.

除非另有說明，此報告結果僅對測試之樣品負責，同時此樣品僅保留90天。本報告未經本公司書面許可，不可部份複製。

This document is issued by the Company subject to its General Conditions of Service printed overleaf, available on request or accessible at <http://www.sgs.com.tw/Terms-and-Conditions> and for electronic format documents, subject to Terms and Conditions for Electronic Documents at <http://www.sgs.com.tw/Terms-and-Conditions>. Attention is drawn to the limitation of liability, indemnification and jurisdiction issues defined therein. Any holder of this document is advised that information contained hereon reflects the Company's findings at the time of its intervention only and within the limits of Client's instructions, if any. The Company's sole responsibility is to its Client and this document does not exonerate parties to a transaction from exercising all their rights and obligations under the transaction documents. This document cannot be reproduced except in full, without prior written approval of the Company. Any unauthorized alteration, forgery or falsification of the content or appearance of this document is unlawful and offenders may be prosecuted to the fullest extent of the law.

Date: 2020/7/19

Report No. :ES/2020/30005

5G NR n41 (100MHz)_Hotspot_Back side_CH 509202_QPSK_1-1_10mm_LAT

Communication System: 5G NR(100MHz,QPSK,30k); Frequency: 2546.01 MHz; Duty cycle=1:1

Medium parameters used: $f = 2546.01$ MHz; $\sigma = 1.879$ S/m; $\epsilon_r = 38.673$; $\rho = 1000$ kg/m³

Phantom section: Flat Section

Ambient temperature: 21.7°C; Liquid temperature: 22.3°C

DASY5 Configuration:

- Probe: EX3DV4 - SN3770; ConvF(7.21, 7.21, 7.21) @ 2546.01 MHz; Calibrated: 2020/05/27
- Sensor-Surface: 2mm (Mechanical Surface Detection)
- Electronics: DAE4 Sn877; Calibrated: 2020/03/17
- Phantom: SAM
- DASY52 52.10.4(1527); SEMCAD X 14.6.14(7483)

Area Scan (101x171x1): Interpolated grid: dx=12 mm, dy=12 mm

Maximum value of SAR (interpolated) = 0.354 W/kg

Zoom Scan (7x7x7)/Cube 0: Measurement grid: dx=5mm, dy=5mm, dz=5mm

Reference Value = 2.392 V/m; Power Drift = 0.10 dB

Peak SAR (extrapolated) = 0.377 W/kg

SAR(1 g) = 0.195 W/kg; SAR(10 g) = 0.091 W/kg

Smallest distance from peaks to all points 3 dB below = 7.1 mm

Ratio of SAR at M2 to SAR at M1 = 75.6%

Maximum value of SAR (measured) = 0.279 W/kg

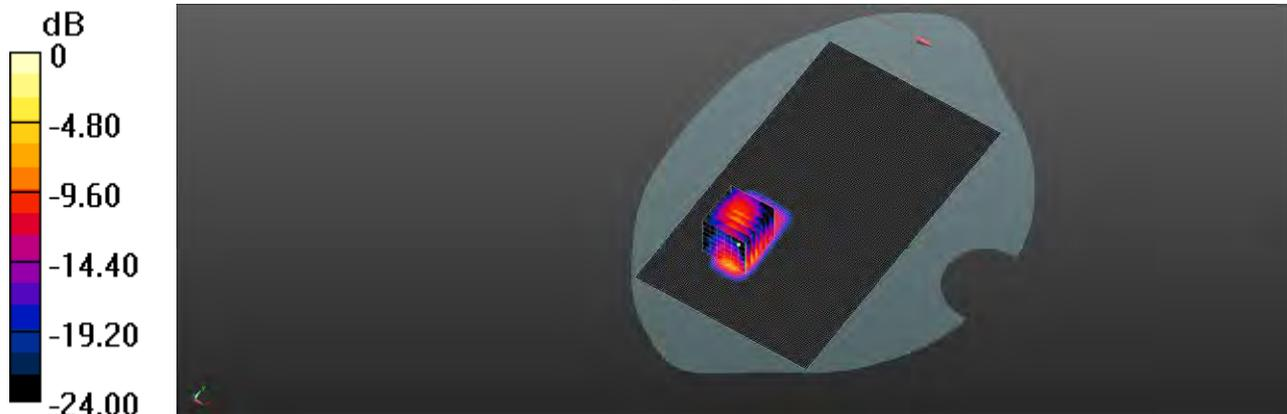

0 dB = 0.279 W/kg = -5.54 dBW/kg

Unless otherwise stated the results shown in this test report refer only to the sample(s) tested and such sample(s) are retained for 90 days only.

除非另有說明，此報告結果僅對測試之樣品負責，同時此樣品僅保留90天。本報告未經本公司書面許可，不可部份複製。

This document is issued by the Company subject to its General Conditions of Service printed overleaf, available on request or accessible at <http://www.sgs.com.tw/Terms-and-Conditions> and for electronic format documents, subject to Terms and Conditions for Electronic Documents at <http://www.sgs.com.tw/Terms-and-Conditions>. Attention is drawn to the limitation of liability, indemnification and jurisdiction issues defined therein. Any holder of this document is advised that information contained hereon reflects the Company's findings at the time of its intervention only and within the limits of Client's instructions, if any. The Company's sole responsibility is to its Client and this document does not exonerate parties to a transaction from exercising all their rights and obligations under the transaction documents. This document cannot be reproduced except in full, without prior written approval of the Company. Any unauthorized alteration, forgery or falsification of the content or appearance of this document is unlawful and offenders may be prosecuted to the fullest extent of the law.

SGS Taiwan Ltd.

No.134,Wu Kung Road, New Taipei Industrial Park, Wuku District, New Taipei City, Taiwan/新北市五股區新北產業園區五工路 134 號

台灣檢驗科技股份有限公司

t (886-2) 2299-3279

f (886-2) 2298-0488

www.sgs.com.tw

Member of SGS Group

Date: 2020/7/19

Report No. :ES/2020/30005

5G NR n41 (100MHz)_Hotspot_Back side_CH 509202_QPSK_1-137_10mm_LAT

Communication System: 5G NR (100 MHz, QPSK, 30 kHz); Frequency: 2546.01 MHz; Duty cycle= 1:1

Medium parameters used: $f = 2546.01$ MHz; $\sigma = 1.879$ S/m; $\epsilon_r = 38.673$; $\rho = 1000$ kg/m³

Phantom section: Flat Section

Ambient temperature: 21.7°C; Liquid temperature: 22.3°C

DASY5 Configuration:

- Probe: EX3DV4 - SN3770; ConvF(7.21, 7.21, 7.21) @ 2546.01 MHz; Calibrated: 2020/5/27
- Sensor-Surface: 2mm (Mechanical Surface Detection)
- Electronics: DAE4 Sn877; Calibrated: 2020/3/17
- Phantom: SAM
- DASY52 52.10.4(1527); SEMCAD X 14.6.14(7483)

Area Scan (91x171x1): Interpolated grid: dx=12 mm, dy=12 mm

Maximum value of SAR (interpolated) = 1.44 W/kg

Zoom Scan (7x7x7)/Cube 0: Measurement grid: dx=5mm, dy=5mm, dz=5mm

Reference Value = 4.858 V/m; Power Drift = -0.01 dB

Peak SAR (extrapolated) = 1.96 W/kg

SAR(1 g) = 1.01 W/kg; SAR(10 g) = 0.528 W/kg

Smallest distance from peaks to all points 3 dB below = 9.2 mm

Ratio of SAR at M2 to SAR at M1 = 82.1%

Maximum value of SAR (measured) = 1.50 W/kg

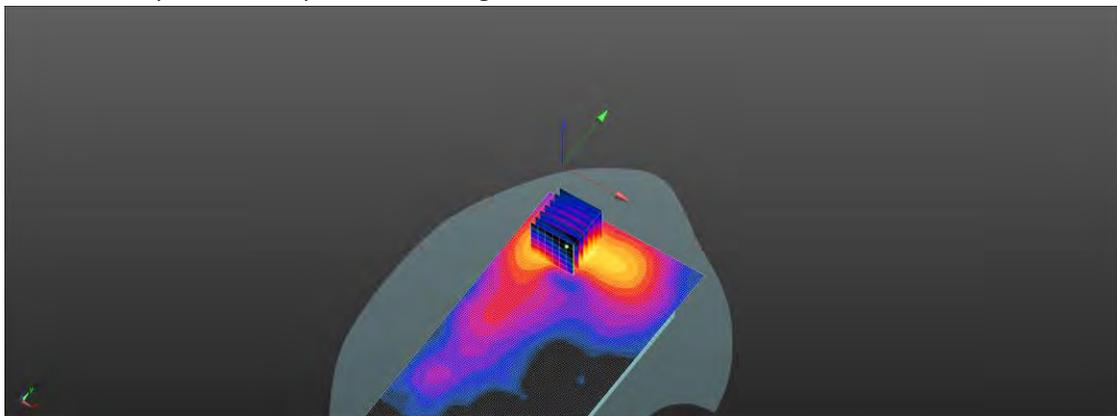
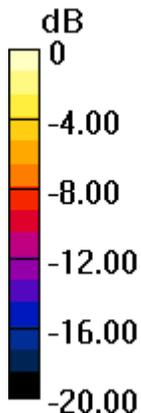

0 dB = 1.50 W/kg = 1.76 dBW/kg

Unless otherwise stated the results shown in this test report refer only to the sample(s) tested and such sample(s) are retained for 90 days only.

除非另有說明，此報告結果僅對測試之樣品負責，同時此樣品僅保留90天。本報告未經本公司書面許可，不可部份複製。

This document is issued by the Company subject to its General Conditions of Service printed overleaf, available on request or accessible at <http://www.sgs.com.tw/Terms-and-Conditions> and for electronic format documents, subject to Terms and Conditions for Electronic Documents at <http://www.sgs.com.tw/Terms-and-Conditions>. Attention is drawn to the limitation of liability, indemnification and jurisdiction issues defined therein. Any holder of this document is advised that information contained hereon reflects the Company's findings at the time of its intervention only and within the limits of Client's instructions, if any. The Company's sole responsibility is to its Client and this document does not exonerate parties to a transaction from exercising all their rights and obligations under the transaction documents. This document cannot be reproduced except in full, without prior written approval of the Company. Any unauthorized alteration, forgery or falsification of the content or appearance of this document is unlawful and offenders may be prosecuted to the fullest extent of the law.

Date: 2020/7/26

Report No. : ES/2020/30005**5G NR n41 (100MHz)_Hotspot_Back side_CH 509202_QPSK_1-137_10mm_LAT**

Communication System: 5G NR (100 MHz, QPSK, 30 kHz); Frequency: 2546.01 MHz; Duty cycle= 1:1

Medium parameters used: $f = 2546.01 \text{ MHz}$; $\sigma = 1.893 \text{ S/m}$; $\epsilon_r = 38.484$; $\rho = 1000 \text{ kg/m}^3$

Phantom section: Flat Section

Ambient temperature: 21.9°C; Liquid temperature: 22.2°C

DASY5 Configuration:

- Probe: EX3DV4 - SN7509; ConvF(7.23, 7.23, 7.23) @ 2546.01 MHz; Calibrated: 2020/3/25
- Sensor-Surface: 2mm (Mechanical Surface Detection)
- Electronics: DAE4 Sn558; Calibrated: 2019/10/11
- Phantom: SAM
- DASY52 52.10.4(1527); SEMCAD X 14.6.14(7483)

Area Scan (91x171x1): Interpolated grid: $dx=12 \text{ mm}$, $dy=12 \text{ mm}$

Maximum value of SAR (interpolated) = 0.863 W/kg

Zoom Scan (7x7x7)/Cube 0: Measurement grid: $dx=5\text{mm}$, $dy=5\text{mm}$, $dz=5\text{mm}$

Reference Value = 4.642 V/m; Power Drift = -0.09 dB

Peak SAR (extrapolated) = 1.18 W/kg

SAR(1 g) = 0.711 W/kg; SAR(10 g) = 0.389 W/kg

Smallest distance from peaks to all points 3 dB below = 8.7 mm

Ratio of SAR at M2 to SAR at M1 = 45.7%

Maximum value of SAR (measured) = 0.900 W/kg

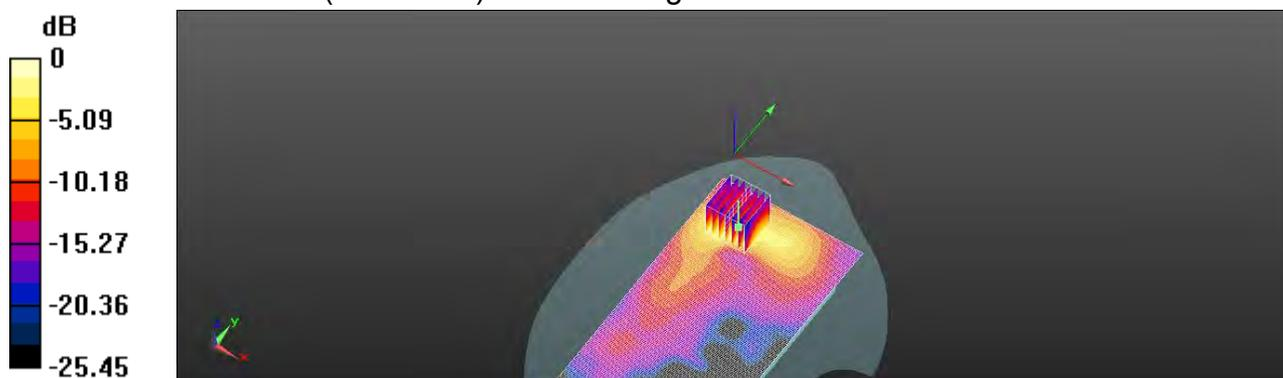

Unless otherwise stated the results shown in this test report refer only to the sample(s) tested and such sample(s) are retained for 90 days only.

除非另有說明，此報告結果僅對測試之樣品負責，同時此樣品僅保留90天。本報告未經本公司書面許可，不可部份複製。

This document is issued by the Company subject to its General Conditions of Service printed overleaf, available on request or accessible at <http://www.sgs.com.tw/Terms-and-Conditions> and for electronic format documents, subject to Terms and Conditions for Electronic Documents at <http://www.sgs.com.tw/Terms-and-Conditions>. Attention is drawn to the limitation of liability, indemnification and jurisdiction issues defined therein. Any holder of this document is advised that information contained hereon reflects the Company's findings at the time of its intervention only and within the limits of Client's instructions, if any. The Company's sole responsibility is to its Client and this document does not exonerate parties to a transaction from exercising all their rights and obligations under the transaction documents. This document cannot be reproduced except in full, without prior written approval of the Company. Any unauthorized alteration, forgery or falsification of the content or appearance of this document is unlawful and offenders may be prosecuted to the fullest extent of the law.

Date: 2020/6/30

Report No. :ES/2020/30005
5G NR n41 (100MHz)_Hotspot_Back side_CH 509202_QPSK_1-137_10mm_LAT

Communication System: 5G NR (100 MHz, QPSK, 30 kHz); Frequency: 2546.01 MHz; Duty cycle= 1:1

 Medium parameters used: $f = 2546.01$ MHz; $\sigma = 1.89$ S/m; $\epsilon_r = 38.478$; $\rho = 1000$ kg/m³

Phantom section: Flat Section

Ambient temperature: 21.4°C; Liquid temperature: 21.7°C

DASY5 Configuration:

- Probe: EX3DV4 - SN7509; ConvF(7.23, 7.23, 7.23) @ 2546.01 MHz; Calibrated: 2020/3/25
- Sensor-Surface: 2mm (Mechanical Surface Detection)
- Electronics: DAE4 Sn558; Calibrated: 2019/10/11
- Phantom: SAM
- DASY52 52.8.8(1258); SEMCAD X 14.6.14(7483)

Area Scan (91x171x1): Interpolated grid: dx=12 mm, dy=12 mm

Maximum value of SAR (interpolated) = 0.569 W/kg

Zoom Scan (7x7x7)/Cube 0: Measurement grid: dx=5mm, dy=5mm, dz=5mm

Reference Value = 4.561 V/m; Power Drift = -0.18 dB

Peak SAR (extrapolated) = 0.778 W/kg

SAR(1 g) = 0.501 W/kg; SAR(10 g) = 0.296 W/kg

Smallest distance from peaks to all points 3 dB below = 8.3 mm

Ratio of SAR at M2 to SAR at M1 = 55.3%

Maximum value of SAR (measured) = 0.593 W/kg

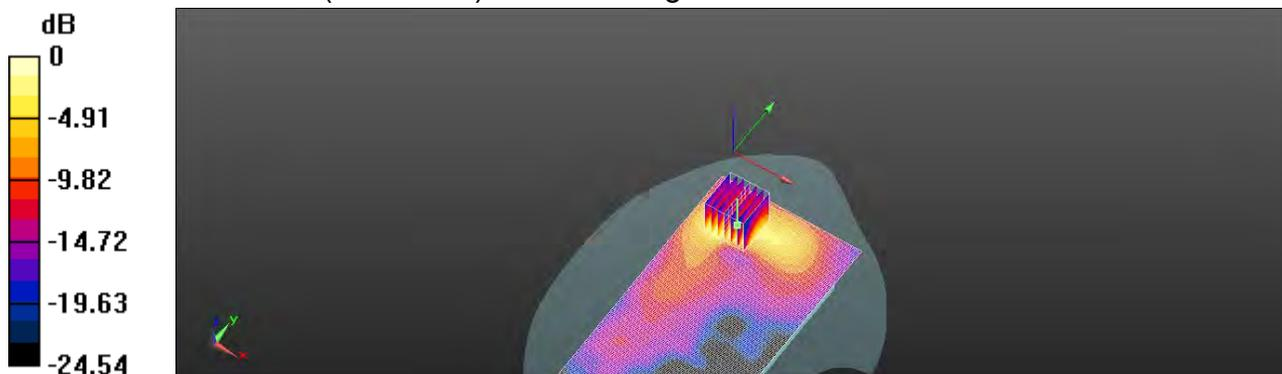

0 dB = 0.593 W/kg = -2.27 dBW/kg

Unless otherwise stated the results shown in this test report refer only to the sample(s) tested and such sample(s) are retained for 90 days only.

除非另有說明，此報告結果僅對測試之樣品負責，同時此樣品僅保留90天。本報告未經本公司書面許可，不可部份複製。

 This document is issued by the Company subject to its General Conditions of Service printed overleaf, available on request or accessible at <http://www.sgs.com.tw/Terms-and-Conditions> and for electronic format documents, subject to Terms and Conditions for Electronic Documents at <http://www.sgs.com.tw/Terms-and-Conditions>. Attention is drawn to the limitation of liability, indemnification and jurisdiction issues defined therein. Any holder of this document is advised that information contained hereon reflects the Company's findings at the time of its intervention only and within the limits of Client's instructions, if any. The Company's sole responsibility is to its Client and this document does not exonerate parties to a transaction from exercising all their rights and obligations under the transaction documents. This document cannot be reproduced except in full, without prior written approval of the Company. Any unauthorized alteration, forgery or falsification of the content or appearance of this document is unlawful and offenders may be prosecuted to the fullest extent of the law.

SGS Taiwan Ltd.

No.134,Wu Kung Road, New Taipei Industrial Park, Wuku District, New Taipei City, Taiwan/新北市五股區新北產業園區五工路 134 號

台灣檢驗科技股份有限公司

t (886-2) 2299-3279

f (886-2) 2298-0488

www.sgs.com.tw

Member of SGS Group

Date: 2020/7/14

Report No. :ES/2020/30005

5G NR n41 (100MHz)_Hotspot_Back side_CH 509202_QPSK_1-137_10mm_LAT

Communication System: 5G NR(100MHz,QPSK,30k); Frequency: 2546.01 MHz; Duty cycle= 1:1

Medium parameters used: $f = 2546.01 \text{ MHz}$; $\sigma = 1.904 \text{ S/m}$; $\epsilon_r = 38.363$; $\rho = 1000 \text{ kg/m}^3$

Phantom section: Flat Section

Ambient temperature: 22.2°C ; Liquid temperature: 22.4°C

DASY5 Configuration:

- Probe: EX3DV4 - SN7509; ConvF(7.23, 7.23, 7.23) @ 2546.01 MHz; Calibrated: 2020/3/25
- Sensor-Surface: 2mm (Mechanical Surface Detection)
- Electronics: DAE4 Sn558; Calibrated: 2019/10/11
- Phantom: SAM
- DASY52 52.10.4(1527); SEMCAD X 14.6.14(7483)

Area Scan (81x181x1): Interpolated grid: dx=12 mm, dy=12 mm

Maximum value of SAR (interpolated) = 0.832 W/kg

Zoom Scan (7x7x7)/Cube 0: Measurement grid: dx=5mm, dy=5mm, dz=5mm

Reference Value = 1.088 V/m; Power Drift = 0.09 dB

Peak SAR (extrapolated) = 0.921 W/kg

SAR(1 g) = 0.568 W/kg; SAR(10 g) = 0.323 W/kg

Smallest distance from peaks to all points 3 dB below = 16.8 mm

Ratio of SAR at M2 to SAR at M1 = 83.7%

Maximum value of SAR (measured) = 0.805 W/kg

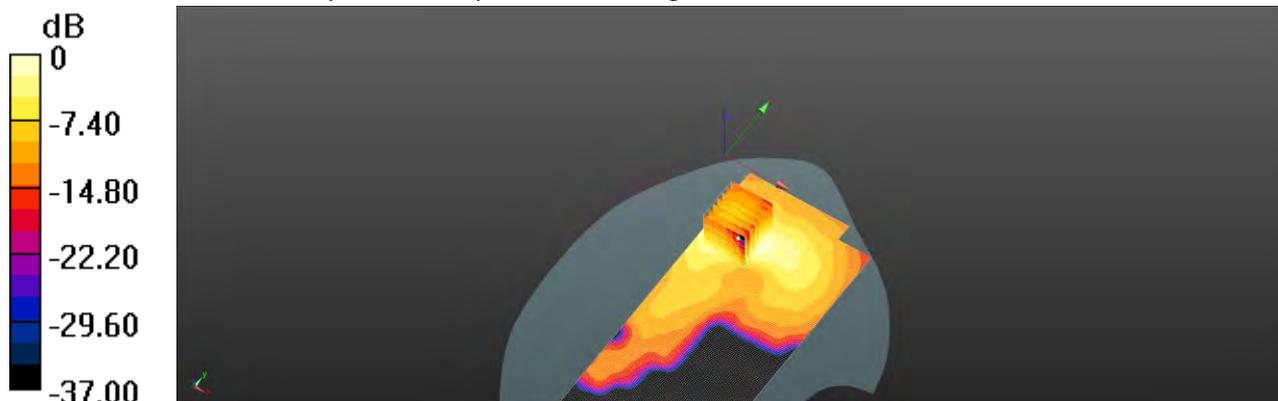

0 dB = 0.805 W/kg = -0.94 dBW/kg

Unless otherwise stated the results shown in this test report refer only to the sample(s) tested and such sample(s) are retained for 90 days only.
除非另有說明，此報告結果僅對測試之樣品負責，同時此樣品僅保留90天。本報告未經本公司書面許可，不可部份複製。

This document is issued by the Company subject to its General Conditions of Service printed overleaf, available on request or accessible at <http://www.sgs.com.tw/Terms-and-Conditions> and for electronic format documents, subject to Terms and Conditions for Electronic Documents at <http://www.sgs.com.tw/Terms-and-Conditions>. Attention is drawn to the limitation of liability, indemnification and jurisdiction issues defined therein. Any holder of this document is advised that information contained hereon reflects the Company's findings at the time of its intervention only and within the limits of Client's instructions, if any. The Company's sole responsibility is to its Client and this document does not exonerate parties to a transaction from exercising all their rights and obligations under the transaction documents. This document cannot be reproduced except in full, without prior written approval of the Company. Any unauthorized alteration, forgery or falsification of the content or appearance of this document is unlawful and offenders may be prosecuted to the fullest extent of the law.

Date: 2020/7/4

Report No. : ES/2020/30005

5G NR n2 (20MHz)_Head_Re Cheek_CH 376000_QPSK_1-53_LAT

Communication System: 5G NR(20MHz, QPSK, 15kHz); Frequency: 1880 MHz; Duty cycle=1:1

Medium parameters used: $f = 1880 \text{ MHz}$; $\sigma = 1.404 \text{ S/m}$; $\epsilon_r = 39.768$; $\rho = 1000 \text{ kg/m}^3$

Phantom section: Right Section

Ambient temperature: 22.1°C; Liquid temperature: 22.4°C

DASY5 Configuration:

- Probe: EX3DV4 - SN3770; ConvF(8.03, 8.03, 8.03) @ 1880 MHz; Calibrated: 2020/5/27
- Sensor-Surface: 2mm (Mechanical Surface Detection)
- Electronics: DAE4 Sn877; Calibrated: 2020/3/17
- Phantom: SAM
- DASY52 52.10.4(1527); SEMCAD X 14.6.14(7483)

Area Scan (81x131x1): Interpolated grid: $dx=15 \text{ mm}$, $dy=15 \text{ mm}$

Maximum value of SAR (interpolated) = 0.0303 W/kg

Zoom Scan (5x5x7)/Cube 0: Measurement grid: $dx=8\text{mm}$, $dy=8\text{mm}$, $dz=5\text{mm}$

Reference Value = 3.034 V/m; Power Drift = 0.07 dB

Peak SAR (extrapolated) = 0.0330 W/kg

SAR(1 g) = 0.028 W/kg; SAR(10 g) = 0.023 W/kg

Smallest distance from peaks to all points 3 dB below: Larger than measurement grid

Ratio of SAR at M2 to SAR at M1 = 88.1%

Maximum value of SAR (measured) = 0.0294 W/kg

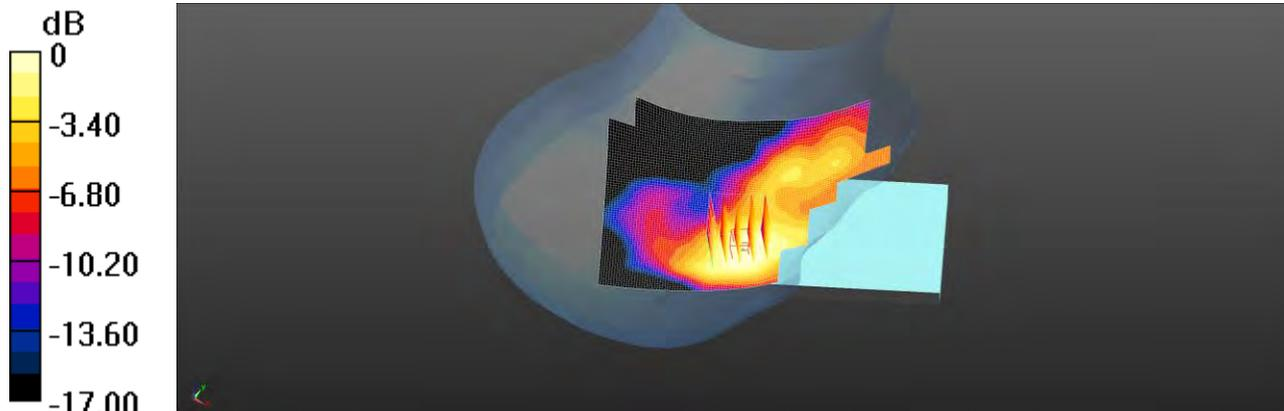

0 dB = 0.0294 W/kg = -15.32 dBW/kg

Unless otherwise stated the results shown in this test report refer only to the sample(s) tested and such sample(s) are retained for 90 days only.

除非另有說明，此報告結果僅對測試之樣品負責，同時此樣品僅保留90天。本報告未經本公司書面許可，不可部份複製。

This document is issued by the Company subject to its General Conditions of Service printed overleaf, available on request or accessible at <http://www.sgs.com.tw/Terms-and-Conditions> and for electronic format documents, subject to Terms and Conditions for Electronic Documents at <http://www.sgs.com.tw/Terms-and-Conditions>. Attention is drawn to the limitation of liability, indemnification and jurisdiction issues defined therein. Any holder of this document is advised that information contained hereon reflects the Company's findings at the time of its intervention only and within the limits of Client's instructions, if any. The Company's sole responsibility is to its Client and this document does not exonerate parties to a transaction from exercising all their rights and obligations under the transaction documents. This document cannot be reproduced except in full, without prior written approval of the Company. Any unauthorized alteration, forgery or falsification of the content or appearance of this document is unlawful and offenders may be prosecuted to the fullest extent of the law.

Date: 2020/7/6

Report No. :ES/2020/30005

5G NR n41 (100MHz)_Head_Re Cheek_CH 513900_QPSK_1-1_LAT

Communication System: 5G NR(100MHz,QPSK,30k); Frequency: 2569.5 MHz; Duty cycle= 1:1

Medium parameters used: f = 2569.5 MHz; $\sigma = 1.919$ S/m; $\epsilon_r = 38.295$; $\rho = 1000$ kg/m³

Phantom section: Right Section

Ambient temperature: 22.1°C; Liquid temperature: 21.8°C

DASY5 Configuration:

- Probe: EX3DV4 - SN3770; ConvF(7.21, 7.21, 7.21) @ 2569.5 MHz; Calibrated: 2020/5/27
- Sensor-Surface: 2mm (Mechanical Surface Detection)
- Electronics: DAE4 Sn877; Calibrated: 2020/3/17
- Phantom: SAM
- DASY52 52.10.4(1527); SEMCAD X 14.6.14(7483)

Area Scan (101x171x1): Interpolated grid: dx=12 mm, dy=12 mm

Maximum value of SAR (interpolated) = 0.0300 W/kg

Zoom Scan (7x7x7)/Cube 0: Measurement grid: dx=5mm, dy=5mm, dz=5mm

Reference Value = 1.503 V/m; Power Drift = -0.13 dB

Peak SAR (extrapolated) = 0.0200 W/kg

SAR(1 g) = 0.009 W/kg; SAR(10 g) = 0.007 W/kg

Smallest distance from peaks to all points 3 dB below: Larger than measurement grid

Ratio of SAR at M2 to SAR at M1 = 85.4%

Maximum value of SAR (measured) = 0.0106 W/kg

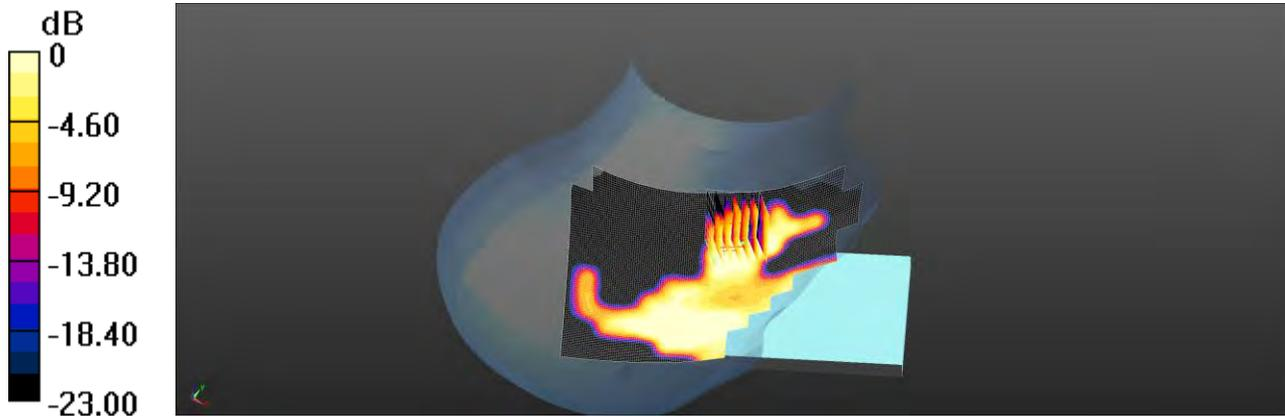

0 dB = 0.0106 W/kg = -19.75 dBW/kg

Unless otherwise stated the results shown in this test report refer only to the sample(s) tested and such sample(s) are retained for 90 days only.

除非另有說明，此報告結果僅對測試之樣品負責，同時此樣品僅保留90天。本報告未經本公司書面許可，不可部份複製。

This document is issued by the Company subject to its General Conditions of Service printed overleaf, available on request or accessible at <http://www.sgs.com.tw/Terms-and-Conditions> and for electronic format documents, subject to Terms and Conditions for Electronic Documents at <http://www.sgs.com.tw/Terms-and-Conditions>. Attention is drawn to the limitation of liability, indemnification and jurisdiction issues defined therein. Any holder of this document is advised that information contained hereon reflects the Company's findings at the time of its intervention only and within the limits of Client's instructions, if any. The Company's sole responsibility is to its Client and this document does not exonerate parties to a transaction from exercising all their rights and obligations under the transaction documents. This document cannot be reproduced except in full, without prior written approval of the Company. Any unauthorized alteration, forgery or falsification of the content or appearance of this document is unlawful and offenders may be prosecuted to the fullest extent of the law.

Date: 2020/7/3

Report No. :ES/2020/30005

5G NR n66 (40MHz)_Head_Re Cheek_CH 346000_QPSK_1-1_LAT

Communication System: 5G NR(20MHz, QPSK, 15kHz); Frequency: 1730 MHz; Duty cycle= 1:1

Medium parameters used: $f = 1730 \text{ MHz}$; $\sigma = 1.354 \text{ S/m}$; $\epsilon_r = 41.078$; $\rho = 1000 \text{ kg/m}^3$

Phantom section: Right Section

Ambient temperature: 22.5°C; Liquid temperature: 22.1°C

DASY5 Configuration:

- Probe: EX3DV4 - SN3770; ConvF(8.36, 8.36, 8.36) @ 1730 MHz; Calibrated: 2020/5/27
- Sensor-Surface: 2mm (Mechanical Surface Detection)
- Electronics: DAE4 Sn877; Calibrated: 2020/3/17
- Phantom: SAM
- DASY52 52.10.4(1527); SEMCAD X 14.6.14(7483)

Area Scan (81x131x1): Interpolated grid: $dx=15 \text{ mm}$, $dy=15 \text{ mm}$

Maximum value of SAR (interpolated) = 0.0398 W/kg

Zoom Scan (5x5x7)/Cube 0: Measurement grid: $dx=8\text{mm}$, $dy=8\text{mm}$, $dz=5\text{mm}$

Reference Value = 3.517 V/m; Power Drift = 0.13 dB

Peak SAR (extrapolated) = 0.0430 W/kg

SAR(1 g) = 0.036 W/kg; SAR(10 g) = 0.029 W/kg

Smallest distance from peaks to all points 3 dB below: Larger than measurement grid

Ratio of SAR at M2 to SAR at M1 = 86.7%

Maximum value of SAR (measured) = 0.0388 W/kg

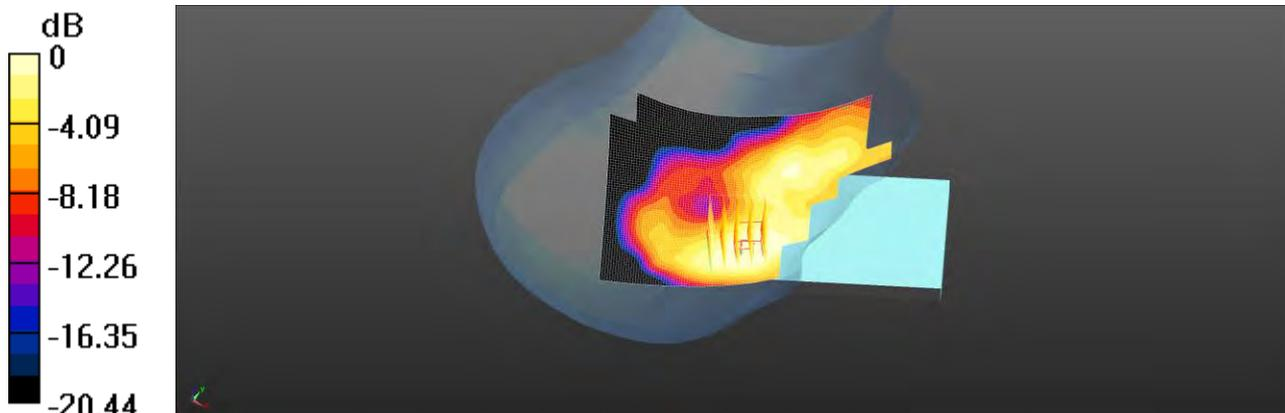

0 dB = 0.0388 W/kg = -14.11 dBW/kg

Unless otherwise stated the results shown in this test report refer only to the sample(s) tested and such sample(s) are retained for 90 days only.

除非另有說明，此報告結果僅對測試之樣品負責，同時此樣品僅保留90天。本報告未經本公司書面許可，不可部份複製。

This document is issued by the Company subject to its General Conditions of Service printed overleaf, available on request or accessible at <http://www.sgs.com.tw/Terms-and-Conditions> and for electronic format documents, subject to Terms and Conditions for Electronic Documents at <http://www.sgs.com.tw/Terms-and-Conditions>. Attention is drawn to the limitation of liability, indemnification and jurisdiction issues defined therein. Any holder of this document is advised that information contained hereon reflects the Company's findings at the time of its intervention only and within the limits of Client's instructions, if any. The Company's sole responsibility is to its Client and this document does not exonerate parties to a transaction from exercising all their rights and obligations under the transaction documents. This document cannot be reproduced except in full, without prior written approval of the Company. Any unauthorized alteration, forgery or falsification of the content or appearance of this document is unlawful and offenders may be prosecuted to the fullest extent of the law.

Date: 2020/7/1

Report No. : ES/2020/30005

5G NR n71 (20MHz)_Head_Re Cheek_CH 134600_QPSK_1-1_LAT

Communication System: 5G NR(20MHz, QPSK, 15kHz); Frequency: 673 MHz; Duty cycle= 1:1

Medium parameters used: $f = 673 \text{ MHz}$; $\sigma = 0.847 \text{ S/m}$; $\epsilon_r = 43.443$; $\rho = 1000 \text{ kg/m}^3$

Phantom section: Right Section

Ambient temperature: 21.3°C; Liquid temperature: 21.6°C

DASY5 Configuration:

- Probe: EX3DV4 - SN3770; ConvF(9.84, 9.84, 9.84) @ 673 MHz; Calibrated: 2020/5/27
- Sensor-Surface: 2mm (Mechanical Surface Detection)
- Electronics: DAE4 Sn877; Calibrated: 2020/3/17
- Phantom: SAM
- DASY52 52.10.4(1527); SEMCAD X 14.6.14(7483)

Area Scan (81x131x1): Interpolated grid: dx=15 mm, dy=15 mm

Maximum value of SAR (interpolated) = 0.00875 W/kg

Zoom Scan (5x5x7)/Cube 0: Measurement grid: dx=8mm, dy=8mm, dz=5mm

Reference Value = 1.001 V/m; Power Drift = 0.09 dB

Peak SAR (extrapolated) = 0.0110 W/kg

SAR(1 g) = 0.010 W/kg; SAR(10 g) = 0.00939 W/kg

Smallest distance from peaks to all points 3 dB below: Larger than measurement grid

Ratio of SAR at M2 to SAR at M1 = 72.7%

Maximum value of SAR (measured) = 0.0105 W/kg

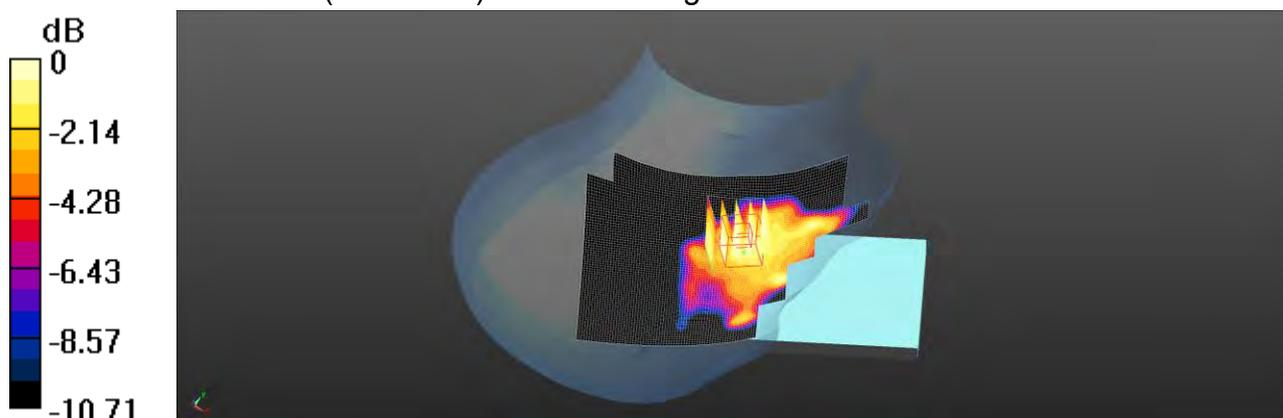

0 dB = 0.0105 W/kg = -19.79 dBW/kg

Unless otherwise stated the results shown in this test report refer only to the sample(s) tested and such sample(s) are retained for 90 days only.

除非另有說明，此報告結果僅對測試之樣品負責，同時此樣品僅保留90天。本報告未經本公司書面許可，不可部份複製。

This document is issued by the Company subject to its General Conditions of Service printed overleaf, available on request or accessible at <http://www.sgs.com.tw/Terms-and-Conditions> and for electronic format documents, subject to Terms and Conditions for Electronic Documents at <http://www.sgs.com.tw/Terms-and-Conditions>. Attention is drawn to the limitation of liability, indemnification and jurisdiction issues defined therein. Any holder of this document is advised that information contained hereon reflects the Company's findings at the time of its intervention only and within the limits of Client's instructions, if any. The Company's sole responsibility is to its Client and this document does not exonerate parties to a transaction from exercising all their rights and obligations under the transaction documents. This document cannot be reproduced except in full, without prior written approval of the Company. Any unauthorized alteration, forgery or falsification of the content or appearance of this document is unlawful and offenders may be prosecuted to the fullest extent of the law.

SGS Taiwan Ltd.

No.134,Wu Kung Road, New Taipei Industrial Park, Wuku District, New Taipei City, Taiwan/新北市五股區新北產業園區五工路 134 號

台灣檢驗科技股份有限公司

t (886-2) 2299-3279

f (886-2) 2298-0488

www.sgs.com.tw

Member of SGS Group

Date: 2020/7/24

Report No. :ES/2020/30005

5G NR n2 (20MHz)_Hotspot_Bottom side_CH 376000_QPSK_1-53_10mm_LAT

Communication System: 5G NR(20MHz,QPSK,15kHz); Frequency: 1880 MHz; Duty cycle= 1:1

Medium parameters used: $f = 1880 \text{ MHz}$; $\sigma = 1.419 \text{ S/m}$; $\epsilon_r = 39.738$; $\rho = 1000 \text{ kg/m}^3$

Phantom section: Flat Section

Ambient temperature: 22.4°C; Liquid temperature: 22.1°C

DASY5 Configuration:

- Probe: EX3DV4 - SN7509; ConvF(8.07, 8.07, 8.07) @ 1880 MHz; Calibrated: 2020/3/25
- Sensor-Surface: 2mm (Mechanical Surface Detection)
- Electronics: DAE4 Sn558; Calibrated: 2019/10/11
- Phantom: SAM
- DASY52 52.10.4(1527); SEMCAD X 14.6.14(7483)

Area Scan (51x91x1): Interpolated grid: dx=15 mm, dy=15 mm

Maximum value of SAR (interpolated) = 0.468 W/kg

Zoom Scan (5x5x7)/Cube 0: Measurement grid: dx=8mm, dy=8mm, dz=5mm

Reference Value = 43.23 V/m; Power Drift = 0.09 dB

Peak SAR (extrapolated) = 0.544 W/kg

SAR(1 g) = 0.411 W/kg; SAR(10 g) = 0.298 W/kg

Smallest distance from peaks to all points 3 dB below = 7.2 mm

Ratio of SAR at M2 to SAR at M1 = 83.7%

Maximum value of SAR (measured) = 0.451 W/kg

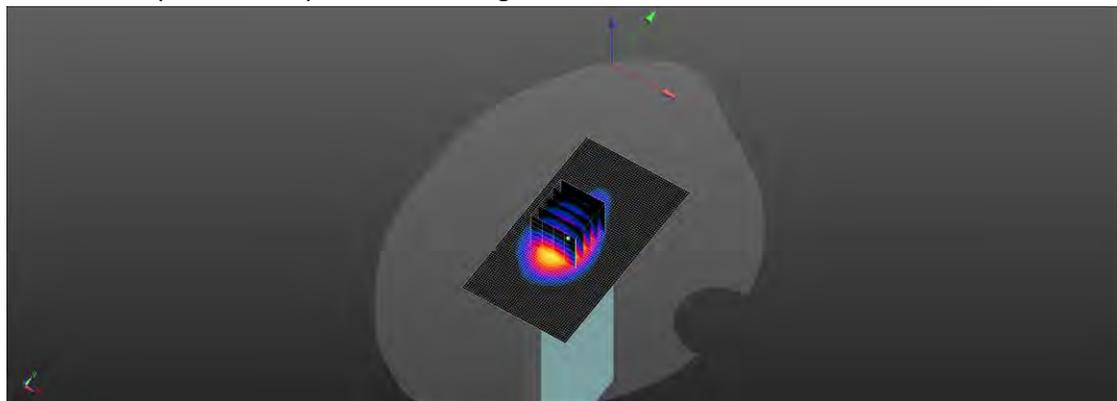
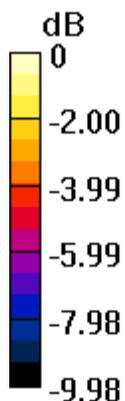

0 dB = 0.451 W/kg = -3.46 dBW/kg

Unless otherwise stated the results shown in this test report refer only to the sample(s) tested and such sample(s) are retained for 90 days only.
除非另有說明，此報告結果僅對測試之樣品負責，同時此樣品僅保留90天。本報告未經本公司書面許可，不可部份複製。

This document is issued by the Company subject to its General Conditions of Service printed overleaf, available on request or accessible at <http://www.sgs.com.tw/Terms-and-Conditions> and for electronic format documents, subject to Terms and Conditions for Electronic Documents at <http://www.sgs.com.tw/Terms-and-Conditions>. Attention is drawn to the limitation of liability, indemnification and jurisdiction issues defined therein. Any holder of this document is advised that information contained hereon reflects the Company's findings at the time of its intervention only and within the limits of Client's instructions, if any. The Company's sole responsibility is to its Client and this document does not exonerate parties to a transaction from exercising all their rights and obligations under the transaction documents. This document cannot be reproduced except in full, without prior written approval of the Company. Any unauthorized alteration, forgery or falsification of the content or appearance of this document is unlawful and offenders may be prosecuted to the fullest extent of the law.

Date: 2020/7/22

Report No. :ES/2020/30005

5G NR n5 (20MHz)_Hotspot_Front side_CH 167300_QPSK_1-53_10mm_LAT

Communication System: 5G NR(20MHz, QPSK, 15kHz); Frequency: 836.5 MHz; Duty cycle= 1:1

Medium parameters used: f = 836.5 MHz; $\sigma = 0.915$ S/m; $\epsilon_r = 41.937$; $\rho = 1000$ kg/m³

Phantom section: Flat Section

Ambient temperature: 21.6°C; Liquid temperature: 22.0°C

DASY5 Configuration:

- Probe: EX3DV4 - SN7509; ConvF(9.73, 9.73, 9.73) @ 836.5 MHz; Calibrated: 2020/03/25
- Sensor-Surface: 2mm (Mechanical Surface Detection)
- Electronics: DAE4 Sn558; Calibrated: 2019/10/11
- Phantom: SAM
- DASY52 52.10.4(1527); SEMCAD X 14.6.14(7483)

Area Scan (71x141x1): Interpolated grid: dx=15 mm, dy=15 mm

Maximum value of SAR (interpolated) = 0.0855 W/kg

Zoom Scan (5x5x7)/Cube 0: Measurement grid: dx=8mm, dy=8mm, dz=5mm

Reference Value = 3.656 V/m; Power Drift = 0.13 dB

Peak SAR (extrapolated) = 0.0910 W/kg

SAR(1 g) = 0.080 W/kg; SAR(10 g) = 0.056 W/kg

Smallest distance from peaks to all points 3 dB below: Larger than measurement grid

Ratio of SAR at M2 to SAR at M1 = 89.6%

Maximum value of SAR (measured) = 0.0869 W/kg

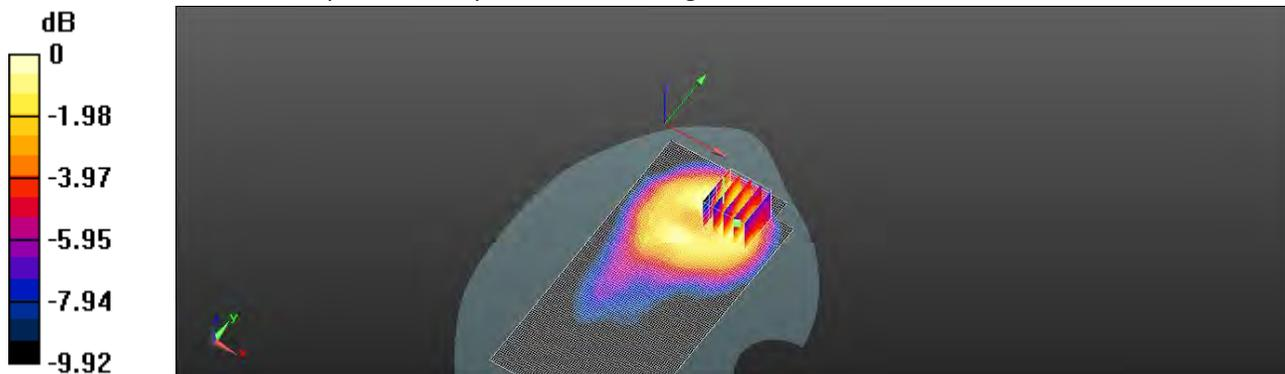

0 dB = 0.0869 W/kg = -10.61 dBW/kg

Unless otherwise stated the results shown in this test report refer only to the sample(s) tested and such sample(s) are retained for 90 days only.

除非另有說明，此報告結果僅對測試之樣品負責，同時此樣品僅保留90天。本報告未經本公司書面許可，不可部份複製。

This document is issued by the Company subject to its General Conditions of Service printed overleaf, available on request or accessible at <http://www.sgs.com.tw/Terms-and-Conditions> and for electronic format documents, subject to Terms and Conditions for Electronic Documents at <http://www.sgs.com.tw/Terms-and-Conditions>. Attention is drawn to the limitation of liability, indemnification and jurisdiction issues defined therein. Any holder of this document is advised that information contained hereon reflects the Company's findings at the time of its intervention only and within the limits of Client's instructions, if any. The Company's sole responsibility is to its Client and this document does not exonerate parties to a transaction from exercising all their rights and obligations under the transaction documents. This document cannot be reproduced except in full, without prior written approval of the Company. Any unauthorized alteration, forgery or falsification of the content or appearance of this document is unlawful and offenders may be prosecuted to the fullest extent of the law.

SGS Taiwan Ltd.

台灣檢驗科技股份有限公司

No.134,Wu Kung Road, New Taipei Industrial Park, Wuku District, New Taipei City, Taiwan/新北市五股區新北產業園區五工路 134 號

t (886-2) 2299-3279

f (886-2) 2298-0488

www.sgs.com.tw

Member of SGS Group

Date:2020/7/21

Report No. :ES/2020/30005

5G NR n71 (20MHz)_Hotspot_Front side_CH 134600_QPSK_1-1_10mm_LAT

Communication System: 5G NR(20MHz, QPSK, 15kHz); Frequency: 673 MHz; Duty cycle= 1:1

Medium parameters used: $f = 673$ MHz; $\sigma = 0.866$ S/m; $\epsilon_r = 43.373$; $\rho = 1000$ kg/m³

Phantom section: Flat Section

Ambient temperature: 21.8°C; Liquid temperature: 22.2°C

DASY5 Configuration:

- Probe: EX3DV4 - SN7509; ConvF(9.94, 9.94, 9.94) @ 673 MHz; Calibrated: 2020/03/25
- Sensor-Surface: 2mm (Mechanical Surface Detection)
- Electronics: DAE4 Sn558; Calibrated: 2019/10/11
- Phantom: SAM
- DASY52 52.10.4(1527); SEMCAD X 14.6.14(7483)

Area Scan (71x131x1): Interpolated grid: dx=15 mm, dy=15 mm

Maximum value of SAR (interpolated) = 0.0355 W/kg

Zoom Scan (5x5x7)/Cube 0: Measurement grid: dx=8mm, dy=8mm, dz=5mm

Reference Value = 3.206 V/m; Power Drift = 0.12 dB

Peak SAR (extrapolated) = 0.0320 W/kg

SAR(1 g) = 0.026 W/kg; SAR(10 g) = 0.018 W/kg

Smallest distance from peaks to all points 3 dB below: Larger than measurement grid

Ratio of SAR at M2 to SAR at M1 = 77.4%

Maximum value of SAR (measured) = 0.0285 W/kg

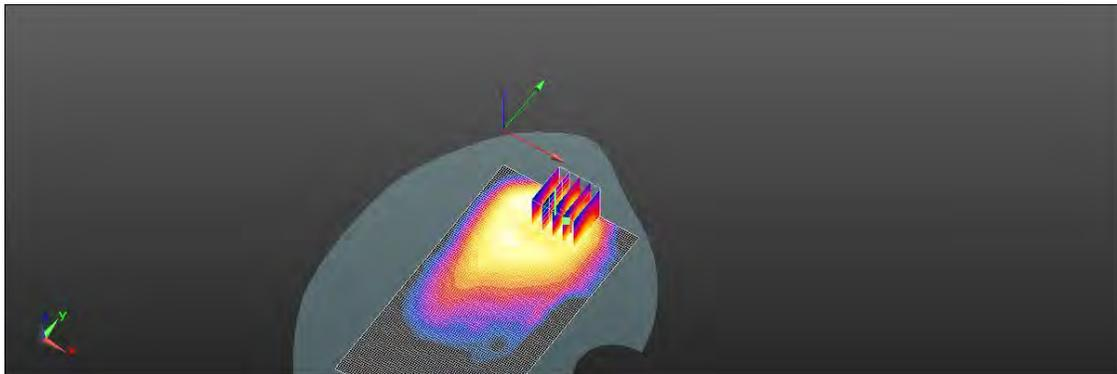
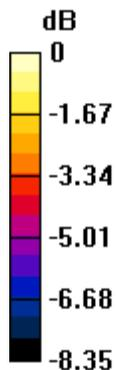

0 dB = 0.0285 W/kg = -15.45 dBW/kg

Unless otherwise stated the results shown in this test report refer only to the sample(s) tested and such sample(s) are retained for 90 days only.

除非另有說明，此報告結果僅對測試之樣品負責，同時此樣品僅保留90天。本報告未經本公司書面許可，不可部份複製。

This document is issued by the Company subject to its General Conditions of Service printed overleaf, available on request or accessible at <http://www.sgs.com.tw/Terms-and-Conditions> and for electronic format documents, subject to Terms and Conditions for Electronic Documents at <http://www.sgs.com.tw/Terms-and-Conditions>. Attention is drawn to the limitation of liability, indemnification and jurisdiction issues defined therein. Any holder of this document is advised that information contained hereon reflects the Company's findings at the time of its intervention only and within the limits of Client's instructions, if any. The Company's sole responsibility is to its Client and this document does not exonerate parties to a transaction from exercising all their rights and obligations under the transaction documents. This document cannot be reproduced except in full, without prior written approval of the Company. Any unauthorized alteration, forgery or falsification of the content or appearance of this document is unlawful and offenders may be prosecuted to the fullest extent of the law.

Date: 2020/6/30

Report No. : ES/2020/30005

5G NR n41 (100MHz)_Hotspot_Back side_CH 509202_QPSK_1-137_10mm_LAT

Communication System: 5G NR(100MHz,QPSK,30k); Frequency: 2546.01 MHz; Duty cycle= 1:1

Medium parameters used: $f = 2546.01$ MHz; $\sigma = 1.89$ S/m; $\epsilon_r = 38.478$; $\rho = 1000$ kg/m³

Phantom section: Flat Section

Ambient temperature: 21.4°C; Liquid temperature: 21.7°C

DASY5 Configuration:

- Probe: EX3DV4 - SN7509; ConvF(7.23, 7.23, 7.23) @ 2546.01 MHz; Calibrated: 2020/3/25
- Sensor-Surface: 2mm (Mechanical Surface Detection)
- Electronics: DAE4 Sn558; Calibrated: 2019/10/11
- Phantom: SAM
- DASY52 52.10.4(1527); SEMCAD X 14.6.14(7483)

Area Scan (81x181x1): Interpolated grid: dx=12 mm, dy=12 mm

Maximum value of SAR (interpolated) = 0.462 W/kg

Zoom Scan (7x7x7)/Cube 0: Measurement grid: dx=5mm, dy=5mm, dz=5mm

Reference Value = 3.178 V/m; Power Drift = 0.02 dB

Peak SAR (extrapolated) = 0.511 W/kg

SAR(1 g) = 0.346 W/kg; SAR(10 g) = 0.218 W/kg

Smallest distance from peaks to all points 3 dB below = 19.8 mm

Ratio of SAR at M2 to SAR at M1 = 84.7%

Maximum value of SAR (measured) = 0.447 W/kg

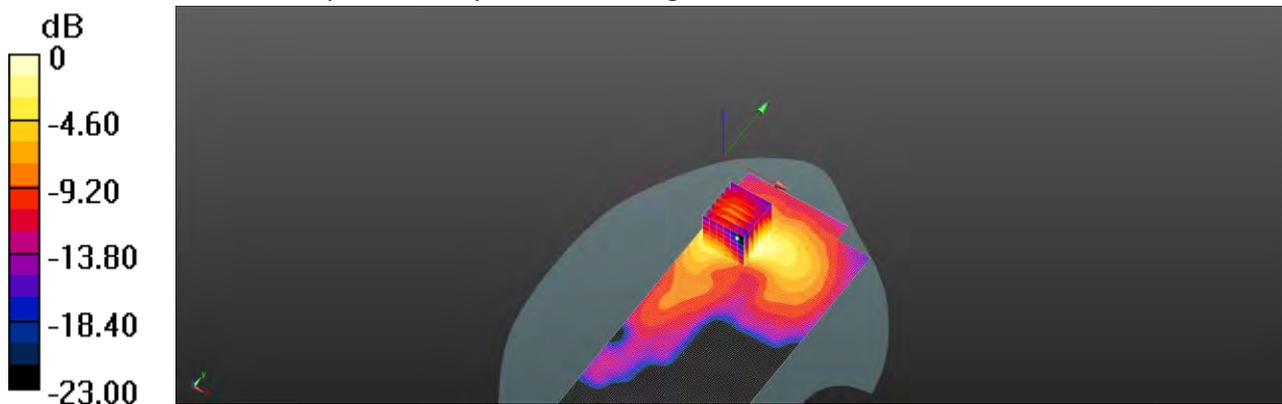

0 dB = 0.447 W/kg = -3.50 dBW/kg

Unless otherwise stated the results shown in this test report refer only to the sample(s) tested and such sample(s) are retained for 90 days only.

除非另有說明，此報告結果僅對測試之樣品負責，同時此樣品僅保留90天。本報告未經本公司書面許可，不可部份複製。

This document is issued by the Company subject to its General Conditions of Service printed overleaf, available on request or accessible at <http://www.sgs.com.tw/Terms-and-Conditions> and for electronic format documents, subject to Terms and Conditions for Electronic Documents at <http://www.sgs.com.tw/Terms-and-Conditions>. Attention is drawn to the limitation of liability, indemnification and jurisdiction issues defined therein. Any holder of this document is advised that information contained hereon reflects the Company's findings at the time of its intervention only and within the limits of Client's instructions, if any. The Company's sole responsibility is to its Client and this document does not exonerate parties to a transaction from exercising all their rights and obligations under the transaction documents. This document cannot be reproduced except in full, without prior written approval of the Company. Any unauthorized alteration, forgery or falsification of the content or appearance of this document is unlawful and offenders may be prosecuted to the fullest extent of the law.

Date: 2020/7/29

Report No. :ES/2020/30005

**LTE Band 13 (10MHz)_Product specific 10g-SAR_Front side_CH
23230_QPSK_1-49_0mm_UAT**

Communication System: LTE; Frequency: 782 MHz; Duty cycle= 1:1

Medium parameters used: $f = 782 \text{ MHz}$; $\sigma = 0.885 \text{ S/m}$; $\epsilon_r = 42.477$; $\rho = 1000 \text{ kg/m}^3$

Phantom section: Flat Section

Ambient temperature: 22.2°C; Liquid temperature: 22.4°C

DASY5 Configuration:

- Probe: EX3DV4 - SN3770; ConvF(9.84, 9.84, 9.84) @ 782 MHz; Calibrated: 2020/05/27
- Sensor-Surface: 2mm (Mechanical Surface Detection)
- Electronics: DAE4 Sn558; Calibrated: 2019/10/11
- Phantom: SAM
- DASY52 52.10.4(1527); SEMCAD X 14.6.14(7483)

Area Scan (71x141x1): Interpolated grid: dx=15 mm, dy=15 mm

Maximum value of SAR (interpolated) = 2.36 W/kg

Zoom Scan (5x5x7)/Cube 0: Measurement grid: dx=8mm, dy=8mm, dz=5mm

Reference Value = 8.105 V/m; Power Drift = 0.19 dB

Peak SAR (extrapolated) = 3.13 W/kg

SAR(1 g) = 1.48 W/kg; SAR(10 g) = 0.759 W/kg

Smallest distance from peaks to all points 3 dB below = 9.1 mm

Ratio of SAR at M2 to SAR at M1 = 48.2%

Maximum value of SAR (measured) = 2.21 W/kg

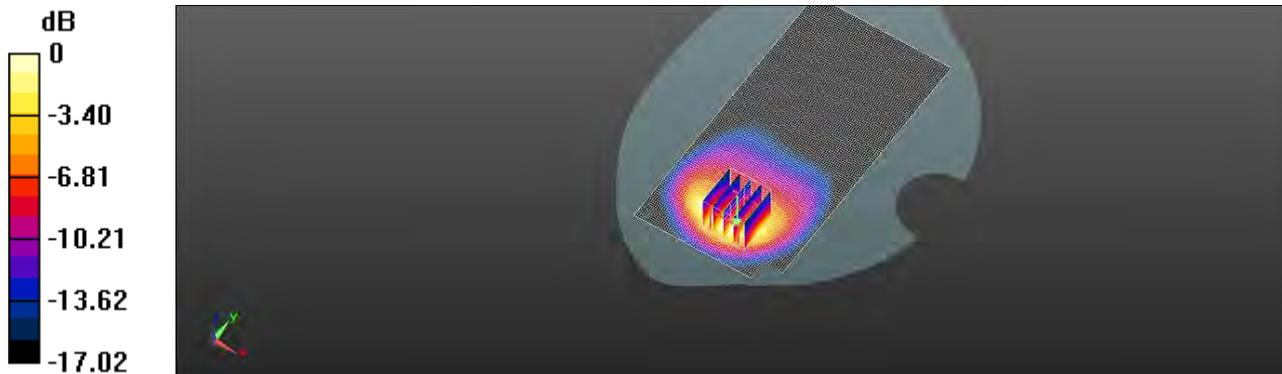

0 dB = 2.21 W/kg = 3.44 dBW/kg

Unless otherwise stated the results shown in this test report refer only to the sample(s) tested and such sample(s) are retained for 90 days only.

除非另有說明，此報告結果僅對測試之樣品負責，同時此樣品僅保留90天。本報告未經本公司書面許可，不可部份複製。

This document is issued by the Company subject to its General Conditions of Service printed overleaf, available on request or accessible at <http://www.sgs.com.tw/Terms-and-Conditions> and for electronic format documents, subject to Terms and Conditions for Electronic Documents at <http://www.sgs.com.tw/Terms-and-Conditions>. Attention is drawn to the limitation of liability, indemnification and jurisdiction issues defined therein. Any holder of this document is advised that information contained hereon reflects the Company's findings at the time of its intervention only and within the limits of Client's instructions, if any. The Company's sole responsibility is to its Client and this document does not exonerate parties to a transaction from exercising all their rights and obligations under the transaction documents. This document cannot be reproduced except in full, without prior written approval of the Company. Any unauthorized alteration, forgery or falsification of the content or appearance of this document is unlawful and offenders may be prosecuted to the fullest extent of the law.

Date: 2020/7/30

Report No. :ES/2020/30005

**LTE Band 26 (15MHz)_Product specific 10g-SAR_Front side_CH
26765_QPSK_1-0_0mm_UAT**

Communication System: LTE; Frequency: 821.5 MHz; Duty cycle= 1:1

Medium parameters used: $f = 821.5 \text{ MHz}$; $\sigma = 0.887 \text{ S/m}$; $\epsilon_r = 42.382$; $\rho = 1000 \text{ kg/m}^3$

Phantom section: Flat Section

Ambient temperature: 22.3°C; Liquid temperature: 22.1°C

DASY5 Configuration:

- Probe: EX3DV4 - SN3770; ConvF(9.5, 9.5, 9.5) @ 821.5 MHz; Calibrated: 2020/05/27
- Sensor-Surface: 2mm (Mechanical Surface Detection)
- Electronics: DAE4 Sn558; Calibrated: 2019/10/11
- Phantom: SAM
- DASY52 52.10.4(1527); SEMCAD X 14.6.14(7483)

Area Scan (71x141x1): Interpolated grid: dx=15 mm, dy=15 mm

Maximum value of SAR (interpolated) = 2.28 W/kg

Zoom Scan (5x5x7)/Cube 0: Measurement grid: dx=8mm, dy=8mm, dz=5mm

Reference Value = 12.72 V/m; Power Drift = 0.03 dB

Peak SAR (extrapolated) = 2.99 W/kg

SAR(1 g) = 1.42 W/kg; SAR(10 g) = 0.716 W/kg

Smallest distance from peaks to all points 3 dB below = 9.8 mm

Ratio of SAR at M2 to SAR at M1 = 47.2%

Maximum value of SAR (measured) = 2.22 W/kg

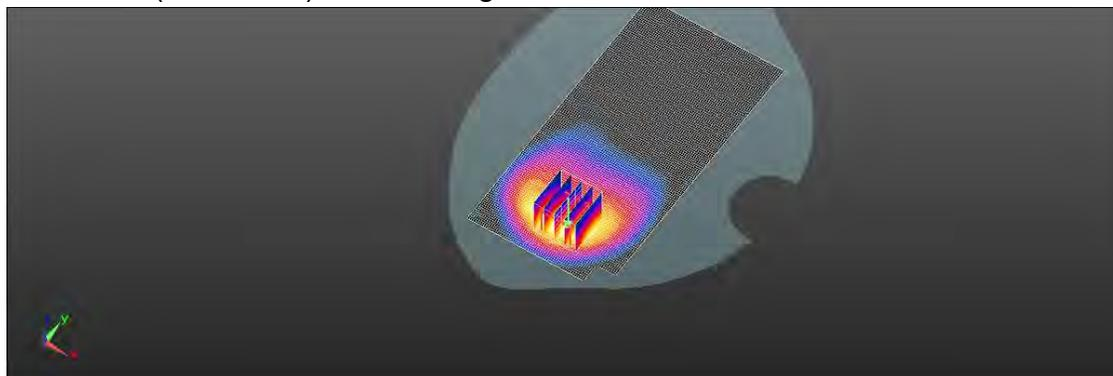
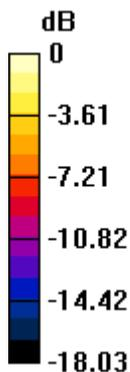

0 dB = 2.22 W/kg = 3.46 dBW/kg

Unless otherwise stated the results shown in this test report refer only to the sample(s) tested and such sample(s) are retained for 90 days only.

除非另有說明，此報告結果僅對測試之樣品負責，同時此樣品僅保留90天。本報告未經本公司書面許可，不可部份複製。

This document is issued by the Company subject to its General Conditions of Service printed overleaf, available on request or accessible at <http://www.sgs.com.tw/Terms-and-Conditions> and for electronic format documents, subject to Terms and Conditions for Electronic Documents at <http://www.sgs.com.tw/Terms-and-Conditions>. Attention is drawn to the limitation of liability, indemnification and jurisdiction issues defined therein. Any holder of this document is advised that information contained hereon reflects the Company's findings at the time of its intervention only and within the limits of Client's instructions, if any. The Company's sole responsibility is to its Client and this document does not exonerate parties to a transaction from exercising all their rights and obligations under the transaction documents. This document cannot be reproduced except in full, without prior written approval of the Company. Any unauthorized alteration, forgery or falsification of the content or appearance of this document is unlawful and offenders may be prosecuted to the fullest extent of the law.

Date: 2020/7/29

Report No. :ES/2020/30005

**LTE Band 71 (20MHz)_Product specific 10g-SAR_Front side_CH
133372_QPSK_1-0_0mm_UAT**

Communication System: LTE; Frequency: 688 MHz; Duty cycle= 1:1

Medium parameters used: $f = 688$ MHz; $\sigma = 0.858$ S/m; $\epsilon_r = 43.165$; $\rho = 1000$ kg/m³

Phantom section: Flat Section

Ambient temperature: 22.2°C; Liquid temperature: 22.4°C

DASY5 Configuration:

- Probe: EX3DV4 - SN3770; ConvF(9.84, 9.84, 9.84) @ 688 MHz; Calibrated: 2020/05/27
- Sensor-Surface: 2mm (Mechanical Surface Detection)
- Electronics: DAE4 Sn558; Calibrated: 2019/10/11
- Phantom: SAM
- DASY52 52.10.4(1527); SEMCAD X 14.6.14(7483)

Area Scan (71x141x1): Interpolated grid: $dx=15$ mm, $dy=15$ mm

Maximum value of SAR (interpolated) = 1.36 W/kg

Zoom Scan (5x5x7)/Cube 0: Measurement grid: $dx=8$ mm, $dy=8$ mm, $dz=5$ mm

Reference Value = 8.059 V/m; Power Drift = -0.03 dB

Peak SAR (extrapolated) = 1.92 W/kg

SAR(1 g) = 0.814 W/kg; SAR(10 g) = 0.411 W/kg

Smallest distance from peaks to all points 3 dB below = 11.3 mm

Ratio of SAR at M2 to SAR at M1 = 44.6%

Maximum value of SAR (measured) = 1.37 W/kg

Zoom Scan (5x5x7)/Cube 1: Measurement grid: $dx=8$ mm, $dy=8$ mm, $dz=5$ mm

Reference Value = 8.059 V/m; Power Drift = -0.03 dB

Peak SAR (extrapolated) = 1.33 W/kg

SAR(1 g) = 0.632 W/kg; SAR(10 g) = 0.308 W/kg

Smallest distance from peaks to all points 3 dB below = 11.2 mm

Ratio of SAR at M2 to SAR at M1 = 47%

Maximum value of SAR (measured) = 0.954 W/kg

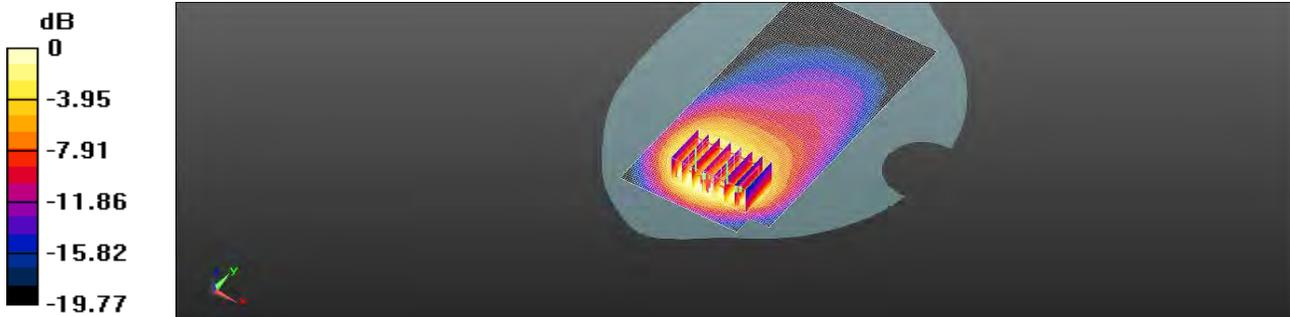

0 dB = 0.954 W/kg = -0.20 dBW/kg

Unless otherwise stated the results shown in this test report refer only to the sample(s) tested and such sample(s) are retained for 90 days only.

除非另有說明，此報告結果僅對測試之樣品負責，同時此樣品僅保留90天。本報告未經本公司書面許可，不可部份複製。

This document is issued by the Company subject to its General Conditions of Service printed overleaf, available on request or accessible at <http://www.sgs.com.tw/Terms-and-Conditions> and for electronic format documents, subject to Terms and Conditions for Electronic Documents at <http://www.sgs.com.tw/Terms-and-Conditions>. Attention is drawn to the limitation of liability, indemnification and jurisdiction issues defined therein. Any holder of this document is advised that information contained hereon reflects the Company's findings at the time of its intervention only and within the limits of Client's instructions, if any. The Company's sole responsibility is to its Client and this document does not exonerate parties to a transaction from exercising all their rights and obligations under the transaction documents. This document cannot be reproduced except in full, without prior written approval of the Company. Any unauthorized alteration, forgery or falsification of the content or appearance of this document is unlawful and offenders may be prosecuted to the fullest extent of the law.

Date: 2020/7/30

Report No. :ES/2020/30005

GPRS 850_Product specific 10g-SAR_Front side_CH 251_0mm_LAT

Communication System: GPRS (1Dn2Up); Frequency: 848.8 MHz; Duty cycle= 1:4.1

Medium parameters used: $f = 848.8$ MHz; $\sigma = 0.916$ S/m; $\epsilon_r = 41.744$; $\rho = 1000$ kg/m³

Phantom section: Flat Section

Ambient temperature: 22.3°C; Liquid temperature: 22.1°C

DASY5 Configuration:

- Probe: EX3DV4 - SN3770; ConvF(9.5, 9.5, 9.5) @ 848.8 MHz; Calibrated: 2020/05/27
- Sensor-Surface: 2mm (Mechanical Surface Detection)
- Electronics: DAE4 Sn558; Calibrated: 2019/10/11
- Phantom: SAM
- DASY52 52.10.4(1527); SEMCAD X 14.6.14(7483)

Area Scan (71x141x1): Interpolated grid: dx=15 mm, dy=15 mm

Maximum value of SAR (interpolated) = 6.50 W/kg

Zoom Scan (5x5x7)/Cube 0: Measurement grid: dx=8mm, dy=8mm, dz=5mm

Reference Value = 11.35 V/m; Power Drift = -0.04 dB

Peak SAR (extrapolated) = 8.45 W/kg

SAR(1 g) = 4.1 W/kg; SAR(10 g) = 2.09 W/kg

Smallest distance from peaks to all points 3 dB below = 8.5 mm

Ratio of SAR at M2 to SAR at M1 = 56.4%

Maximum value of SAR (measured) = 6.45 W/kg

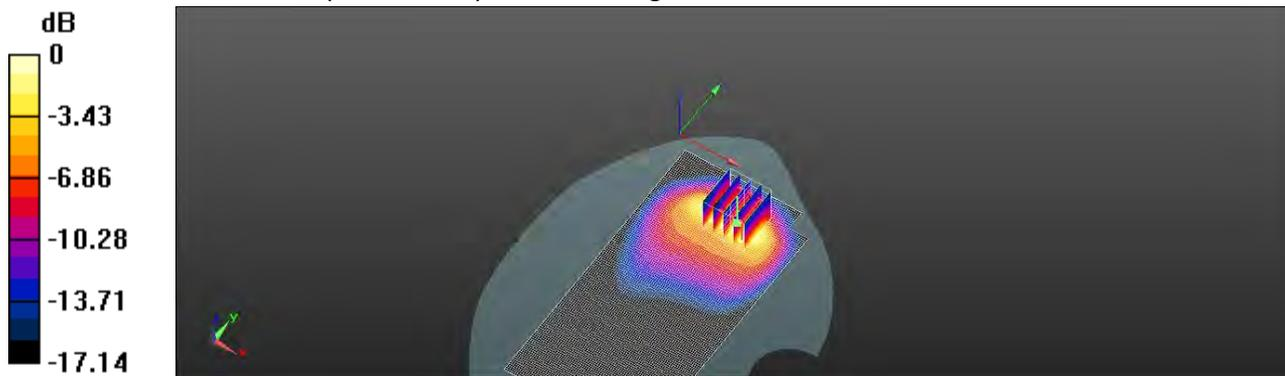

0 dB = 6.45 W/kg = 8.10 dBW/kg

Unless otherwise stated the results shown in this test report refer only to the sample(s) tested and such sample(s) are retained for 90 days only.

除非另有說明，此報告結果僅對測試之樣品負責，同時此樣品僅保留90天。本報告未經本公司書面許可，不可部份複製。

This document is issued by the Company subject to its General Conditions of Service printed overleaf, available on request or accessible at <http://www.sgs.com.tw/Terms-and-Conditions> and for electronic format documents, subject to Terms and Conditions for Electronic Documents at <http://www.sgs.com.tw/Terms-and-Conditions>. Attention is drawn to the limitation of liability, indemnification and jurisdiction issues defined therein. Any holder of this document is advised that information contained hereon reflects the Company's findings at the time of its intervention only and within the limits of Client's instructions, if any. The Company's sole responsibility is to its Client and this document does not exonerate parties to a transaction from exercising all their rights and obligations under the transaction documents. This document cannot be reproduced except in full, without prior written approval of the Company. Any unauthorized alteration, forgery or falsification of the content or appearance of this document is unlawful and offenders may be prosecuted to the fullest extent of the law.

Date: 2020/7/17

Report No. : ES/2020/30005

GPRS 1900_product specific 10g-SAR_Bottom side_CH 810_0mm_LAT

Communication System: GPRS (1Dn2Up); Frequency: 1909.8 MHz; Duty cycle= 1:4.1

Medium parameters used: $f = 1910$ MHz; $\sigma = 1.444$ S/m; $\epsilon_r = 39.347$; $\rho = 1000$ kg/m³

Phantom section: Flat Section

Ambient temperature: 22.7°C; Liquid temperature: 21.6°C

DASY5 Configuration:

- Probe: EX3DV4 - SN3770; ConvF(8.03, 8.03, 8.03) @ 1910 MHz; Calibrated: 2020/05/27
- Sensor-Surface: 2mm (Mechanical Surface Detection)
- Electronics: DAE4 Sn877; Calibrated: 2020/03/17
- Phantom: SAM
- DASY52 52.10.4(1527); SEMCAD X 14.6.14(7483)

Area Scan (61x91x1): Interpolated grid: dx=15 mm, dy=15 mm

Maximum value of SAR (interpolated) = 10.9 W/kg

Zoom Scan (5x5x7)/Cube 0: Measurement grid: dx=8mm, dy=8mm, dz=5mm

Reference Value = 49.12 V/m; Power Drift = 0.12 dB

Peak SAR (extrapolated) = 12.9 W/kg

SAR(1 g) = 4.87 W/kg; SAR(10 g) = 1.88 W/kg

Smallest distance from peaks to all points 3 dB below = 9.8 mm

Ratio of SAR at M2 to SAR at M1 = 39%

Maximum value of SAR (measured) = 9.13 W/kg

Zoom Scan (5x5x7)/Cube 1: Measurement grid: dx=8mm, dy=8mm, dz=5mm

Reference Value = 49.12 V/m; Power Drift = 0.12 dB

Peak SAR (extrapolated) = 9.68 W/kg

SAR(1 g) = 5.16 W/kg; SAR(10 g) = 2.51 W/kg

Smallest distance from peaks to all points 3 dB below = 8.2 mm

Ratio of SAR at M2 to SAR at M1 = 53.4%

Maximum value of SAR (measured) = 7.75 W/kg

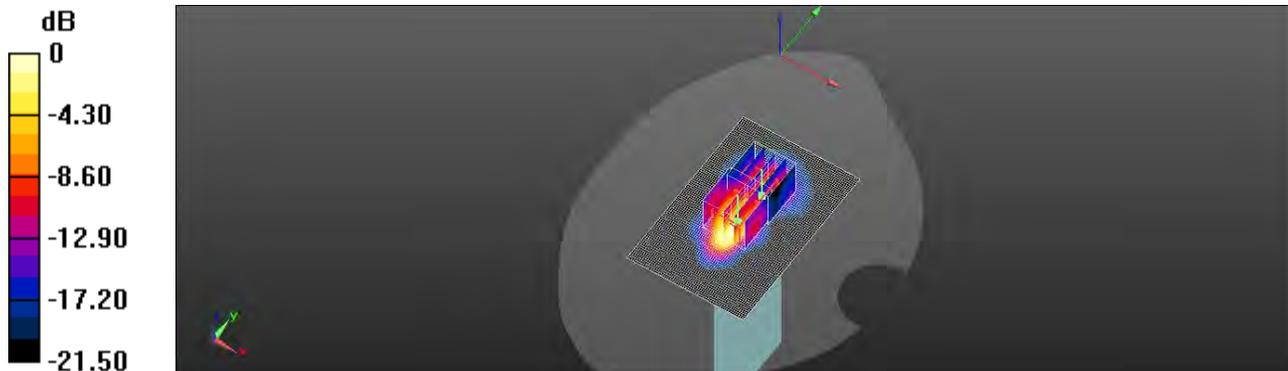

0 dB = 7.75 W/kg = 8.89 dBW/kg

Unless otherwise stated the results shown in this test report refer only to the sample(s) tested and such sample(s) are retained for 90 days only.

除非另有說明，此報告結果僅對測試之樣品負責，同時此樣品僅保留90天。本報告未經本公司書面許可，不可部份複製。

This document is issued by the Company subject to its General Conditions of Service printed overleaf, available on request or accessible at <http://www.sgs.com.tw/Terms-and-Conditions> and for electronic format documents, subject to Terms and Conditions for Electronic Documents at <http://www.sgs.com.tw/Terms-and-Conditions>. Attention is drawn to the limitation of liability, indemnification and jurisdiction issues defined therein. Any holder of this document is advised that information contained hereon reflects the Company's findings at the time of its intervention only and within the limits of Client's instructions, if any. The Company's sole responsibility is to its Client and this document does not exonerate parties to a transaction from exercising all their rights and obligations under the transaction documents. This document cannot be reproduced except in full, without prior written approval of the Company. Any unauthorized alteration, forgery or falsification of the content or appearance of this document is unlawful and offenders may be prosecuted to the fullest extent of the law.

Date: 2020/7/17

Report No. : ES/2020/30005

WCDMA Band II_product specific 10g-SAR_Bottom side_CH 9538_0mm_LAT

Communication System: WCDMA; Frequency: 1907.6 MHz; Duty cycle= 1:1

Medium parameters used: $f = 1908$ MHz; $\sigma = 1.427$ S/m; $\epsilon_r = 39.371$; $\rho = 1000$ kg/m³

Phantom section: Flat Section

Ambient temperature: 22.7°C; Liquid temperature: 21.6°C

DASY5 Configuration:

- Probe: EX3DV4 - SN3770; ConvF(8.03, 8.03, 8.03) @ 1908 MHz; Calibrated: 2020/05/27
- Sensor-Surface: 2mm (Mechanical Surface Detection)
- Electronics: DAE4 Sn877; Calibrated: 2020/03/17
- Phantom: SAM
- DASY52 52.10.4(1527); SEMCAD X 14.6.14(7483)

Area Scan (61x91x1): Interpolated grid: dx=15 mm, dy=15 mm

Maximum value of SAR (interpolated) = 4.57 W/kg

Zoom Scan (5x5x7)/Cube 0: Measurement grid: dx=8mm, dy=8mm, dz=5mm

Reference Value = 44.53 V/m; Power Drift = 0.17 dB

Peak SAR (extrapolated) = 6.47 W/kg

SAR(1 g) = 2.93 W/kg; SAR(10 g) = 1.27 W/kg

Smallest distance from peaks to all points 3 dB below = 9.5 mm

Ratio of SAR at M2 to SAR at M1 = 35.1%

Maximum value of SAR (measured) = 4.28 W/kg

Zoom Scan (5x5x7)/Cube 1: Measurement grid: dx=8mm, dy=8mm, dz=5mm

Reference Value = 44.53 V/m; Power Drift = 0.17 dB

Peak SAR (extrapolated) = 4.64 W/kg

SAR(1 g) = 2.84 W/kg; SAR(10 g) = 1.58 W/kg

Smallest distance from peaks to all points 3 dB below = 8.6 mm

Ratio of SAR at M2 to SAR at M1 = 53.6%

Maximum value of SAR (measured) = 3.62 W/kg

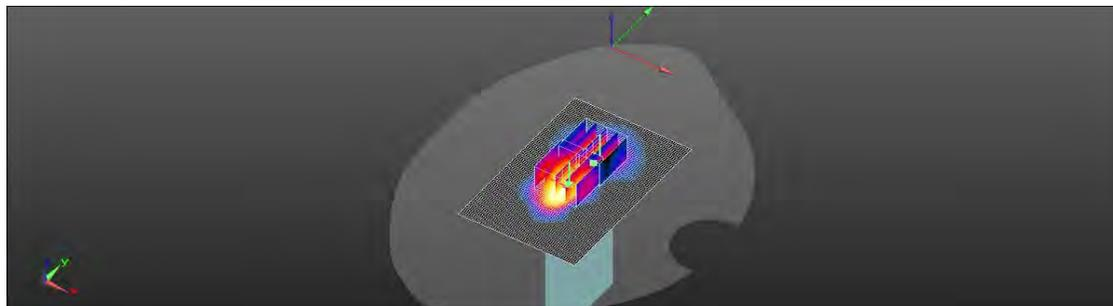
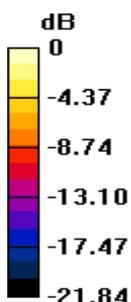

0 dB = 3.62 W/kg = 5.59 dBW/kg

Unless otherwise stated the results shown in this test report refer only to the sample(s) tested and such sample(s) are retained for 90 days only.

除非另有說明，此報告結果僅對測試之樣品負責，同時此樣品僅保留90天。本報告未經本公司書面許可，不可部份複製。

This document is issued by the Company subject to its General Conditions of Service printed overleaf, available on request or accessible at <http://www.sgs.com.tw/Terms-and-Conditions> and for electronic format documents, subject to Terms and Conditions for Electronic Documents at <http://www.sgs.com.tw/Terms-and-Conditions>. Attention is drawn to the limitation of liability, indemnification and jurisdiction issues defined therein. Any holder of this document is advised that information contained hereon reflects the Company's findings at the time of its intervention only and within the limits of Client's instructions, if any. The Company's sole responsibility is to its Client and this document does not exonerate parties to a transaction from exercising all their rights and obligations under the transaction documents. This document cannot be reproduced except in full, without prior written approval of the Company. Any unauthorized alteration, forgery or falsification of the content or appearance of this document is unlawful and offenders may be prosecuted to the fullest extent of the law.

Date: 2020/7/16

Report No. :ES/2020/30005

WCDMA Band IV_product specific 10g-SAR_Bottom side_CH 1412_0mm_LAT

Communication System: WCDMA; Frequency: 1732.4 MHz; Duty cycle= 1:1

Medium parameters used: f = 1732.4 MHz; $\sigma = 1.343$ S/m; $\epsilon_r = 41.113$; $\rho = 1000$ kg/m³

Phantom section: Flat Section

Ambient temperature: 22.3°C; Liquid temperature: 21.4°C

DASY5 Configuration:

- Probe: EX3DV4 - SN3770; ConvF(8.36, 8.36, 8.36) @ 1732.4 MHz; Calibrated: 2020/05/27
- Sensor-Surface: 2mm (Mechanical Surface Detection)
- Electronics: DAE4 Sn877; Calibrated: 2020/03/17
- Phantom: SAM
- DASY52 52.10.4(1527); SEMCAD X 14.6.14(7483)

Area Scan (61x91x1): Interpolated grid: dx=15 mm, dy=15 mm

Maximum value of SAR (interpolated) = 12.8 W/kg

Zoom Scan (5x5x7)/Cube 0: Measurement grid: dx=8mm, dy=8mm, dz=5mm

Reference Value = 61.43 V/m; Power Drift = 0.13 dB

Peak SAR (extrapolated) = 18.6 W/kg

SAR(1 g) = 6.61 W/kg; SAR(10 g) = 3.02 W/kg

Smallest distance from peaks to all points 3 dB below = 9.6 mm

Ratio of SAR at M2 to SAR at M1 = 38.7%

Maximum value of SAR (measured) = 12.9 W/kg

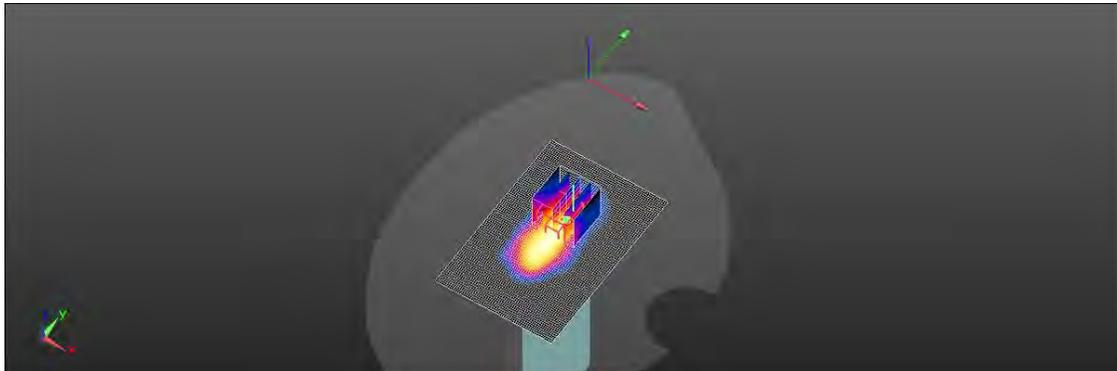
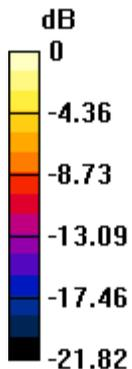

0 dB = 12.9 W/kg = 11.09 dBW/kg

Unless otherwise stated the results shown in this test report refer only to the sample(s) tested and such sample(s) are retained for 90 days only.

除非另有說明，此報告結果僅對測試之樣品負責，同時此樣品僅保留90天。本報告未經本公司書面許可，不可部份複製。

This document is issued by the Company subject to its General Conditions of Service printed overleaf, available on request or accessible at <http://www.sgs.com.tw/Terms-and-Conditions> and for electronic format documents, subject to Terms and Conditions for Electronic Documents at <http://www.sgs.com.tw/Terms-and-Conditions>. Attention is drawn to the limitation of liability, indemnification and jurisdiction issues defined therein. Any holder of this document is advised that information contained hereon reflects the Company's findings at the time of its intervention only and within the limits of Client's instructions, if any. The Company's sole responsibility is to its Client and this document does not exonerate parties to a transaction from exercising all their rights and obligations under the transaction documents. This document cannot be reproduced except in full, without prior written approval of the Company. Any unauthorized alteration, forgery or falsification of the content or appearance of this document is unlawful and offenders may be prosecuted to the fullest extent of the law.

Date: 2020/7/15

Report No. : ES/2020/30005

WCDMA Band V_Product specific 10g-SAR_Front side_CH 4233_0mm_LAT

Communication System: WCDMA; Frequency: 846.6 MHz; Duty cycle= 1:1

Medium parameters used: $f = 846.6$ MHz; $\sigma = 0.908$ S/m; $\epsilon_r = 41.823$; $\rho = 1000$ kg/m³

Phantom section: Flat Section

Ambient temperature: 21.9°C; Liquid temperature: 22.3°C

DASY5 Configuration:

- Probe: EX3DV4 - SN3770; ConvF(9.5, 9.5, 9.5) @ 846.6 MHz; Calibrated: 2020/05/27
- Sensor-Surface: 2mm (Mechanical Surface Detection)
- Electronics: DAE4 Sn877; Calibrated: 2020/03/17
- Phantom: SAM
- DASY52 52.10.4(1527); SEMCAD X 14.6.14(7483)

Area Scan (71x141x1): Interpolated grid: dx=15 mm, dy=15 mm

Maximum value of SAR (interpolated) = 3.70 W/kg

Zoom Scan (5x5x7)/Cube 0: Measurement grid: dx=8mm, dy=8mm, dz=5mm

Reference Value = 6.254 V/m; Power Drift = 0.02 dB

Peak SAR (extrapolated) = 4.92 W/kg

SAR(1 g) = 2.3 W/kg; SAR(10 g) = 1.16 W/kg

Smallest distance from peaks to all points 3 dB below = 9.6 mm

Ratio of SAR at M2 to SAR at M1 = 46.3%

Maximum value of SAR (measured) = 3.63 W/kg

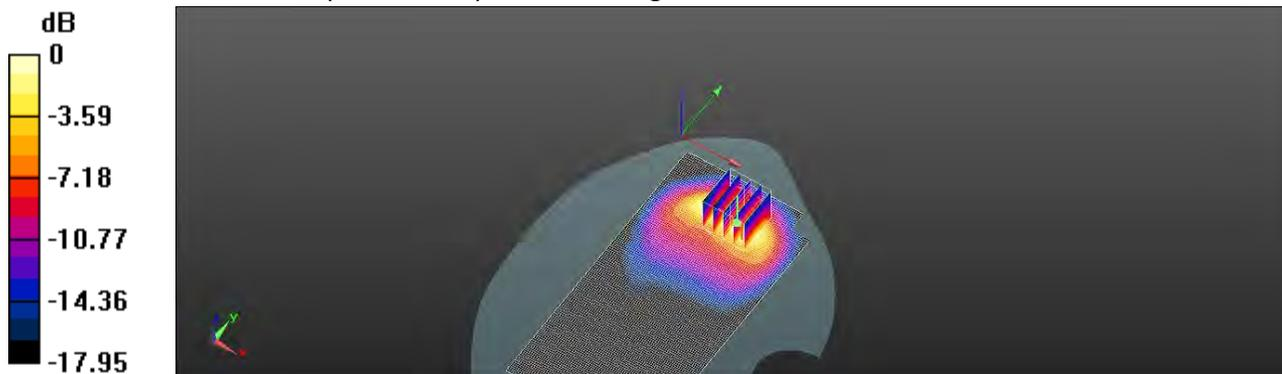

0 dB = 3.63 W/kg = 5.60 dBW/kg

Unless otherwise stated the results shown in this test report refer only to the sample(s) tested and such sample(s) are retained for 90 days only.

除非另有說明，此報告結果僅對測試之樣品負責，同時此樣品僅保留90天。本報告未經本公司書面許可，不可部份複製。

This document is issued by the Company subject to its General Conditions of Service printed overleaf, available on request or accessible at <http://www.sgs.com.tw/Terms-and-Conditions> and for electronic format documents, subject to Terms and Conditions for Electronic Documents at <http://www.sgs.com.tw/Terms-and-Conditions>. Attention is drawn to the limitation of liability, indemnification and jurisdiction issues defined therein. Any holder of this document is advised that information contained hereon reflects the Company's findings at the time of its intervention only and within the limits of Client's instructions, if any. The Company's sole responsibility is to its Client and this document does not exonerate parties to a transaction from exercising all their rights and obligations under the transaction documents. This document cannot be reproduced except in full, without prior written approval of the Company. Any unauthorized alteration, forgery or falsification of the content or appearance of this document is unlawful and offenders may be prosecuted to the fullest extent of the law.

Date: 2020/8/3

Report No. :ES/2020/30005

**LTE Band 7 (20MHz)_Product specific 10g-SAR_Bottom side_CH
21350_QPSK_1-99_0mm_LAT**

Communication System: LTE; Frequency: 2560 MHz; Duty cycle= 1:1

Medium parameters used: $f = 2560$ MHz; $\sigma = 1.905$ S/m; $\epsilon_r = 38.355$; $\rho = 1000$ kg/m³

Phantom section: Flat Section

Ambient temperature: 22.2°C; Liquid temperature: 22.5°C

DASY5 Configuration:

- Probe: EX3DV4 - SN3770; ConvF(7.21, 7.21, 7.21) @ 2560 MHz; Calibrated: 2020/05/27
- Sensor-Surface: 2mm (Mechanical Surface Detection)
- Electronics: DAE4 Sn558; Calibrated: 2019/10/11
- Phantom: SAM
- DASY52 52.10.4(1527); SEMCAD X 14.6.14(7483)

Area Scan (61x101x1): Interpolated grid: dx=12 mm, dy=12 mm

Maximum value of SAR (interpolated) = 4.64 W/kg

Zoom Scan (7x7x7)/Cube 0: Measurement grid: dx=5mm, dy=5mm, dz=5mm

Reference Value = 28.11 V/m; Power Drift = 0.16 dB

Peak SAR (extrapolated) = 10.2 W/kg

SAR(1 g) = 3.9 W/kg; SAR(10 g) = 1.6 W/kg

Smallest distance from peaks to all points 3 dB below = 6.1 mm

Ratio of SAR at M2 to SAR at M1 = 31.5%

Maximum value of SAR (measured) = 5.99 W/kg

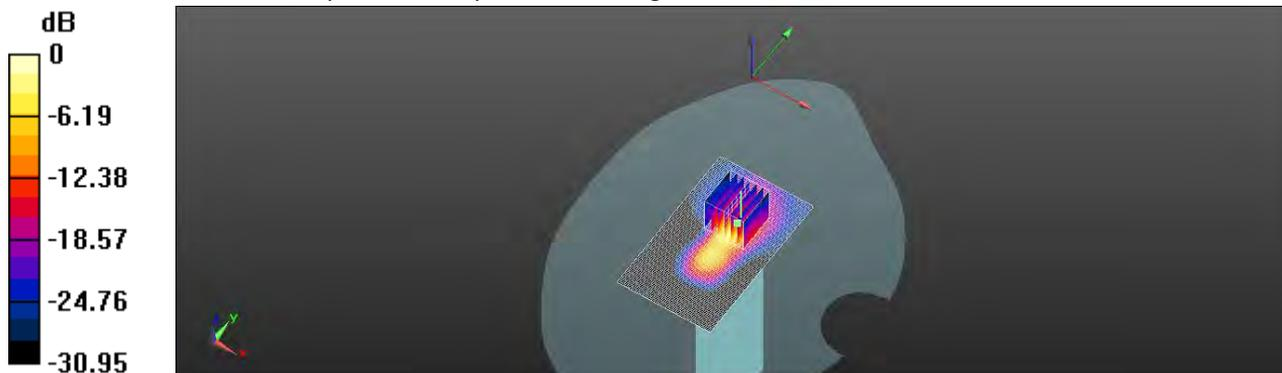

0 dB = 5.99 W/kg = 7.77 dBW/kg

Unless otherwise stated the results shown in this test report refer only to the sample(s) tested and such sample(s) are retained for 90 days only.

除非另有說明，此報告結果僅對測試之樣品負責，同時此樣品僅保留90天。本報告未經本公司書面許可，不可部份複製。

This document is issued by the Company subject to its General Conditions of Service printed overleaf, available on request or accessible at <http://www.sgs.com.tw/Terms-and-Conditions> and for electronic format documents, subject to Terms and Conditions for Electronic Documents at <http://www.sgs.com.tw/Terms-and-Conditions>. Attention is drawn to the limitation of liability, indemnification and jurisdiction issues defined therein. Any holder of this document is advised that information contained hereon reflects the Company's findings at the time of its intervention only and within the limits of Client's instructions, if any. The Company's sole responsibility is to its Client and this document does not exonerate parties to a transaction from exercising all their rights and obligations under the transaction documents. This document cannot be reproduced except in full, without prior written approval of the Company. Any unauthorized alteration, forgery or falsification of the content or appearance of this document is unlawful and offenders may be prosecuted to the fullest extent of the law.

Date: 2020/7/29

Report No. :ES/2020/30005

**LTE Band 12 (10MHz)_Product specific 10g-SAR_Front_CH
23060_QPSK_1-0_0mm_LAT**

Communication System: LTE; Frequency: 704 MHz; Duty cycle= 1:1

Medium parameters used: $f = 704$ MHz; $\sigma = 0.861$ S/m; $\epsilon_r = 43.030$; $\rho = 1000$ kg/m³

Phantom section: Flat Section

Ambient temperature: 22.2°C; Liquid temperature: 22.4°C

DASY5 Configuration:

- Probe: EX3DV4 - SN3770; ConvF(9.84, 9.84, 9.84) @ 704 MHz; Calibrated: 2020/05/27
- Sensor-Surface: 2mm (Mechanical Surface Detection)
- Electronics: DAE4 Sn558; Calibrated: 2019/10/11
- Phantom: SAM
- DASY52 52.10.4(1527); SEMCAD X 14.6.14(7483)

Area Scan (71x141x1): Interpolated grid: dx=15 mm, dy=15 mm

Maximum value of SAR (interpolated) = 2.20 W/kg

Zoom Scan (5x5x7)/Cube 0: Measurement grid: dx=8mm, dy=8mm, dz=5mm

Reference Value = 22.89 V/m; Power Drift = 0.09 dB

Peak SAR (extrapolated) = 3.25 W/kg

SAR(1 g) = 1.39 W/kg; SAR(10 g) = 0.702 W/kg

Smallest distance from peaks to all points 3 dB below = 8.5 mm

Ratio of SAR at M2 to SAR at M1 = 42.4%

Maximum value of SAR (measured) = 2.28 W/kg

Zoom Scan (5x5x7)/Cube 1: Measurement grid: dx=8mm, dy=8mm, dz=5mm

Reference Value = 22.89 V/m; Power Drift = 0.09 dB

Peak SAR (extrapolated) = 2.98 W/kg

SAR(1 g) = 1.2 W/kg; SAR(10 g) = 0.596 W/kg

Smallest distance from peaks to all points 3 dB below = 9.6 mm

Ratio of SAR at M2 to SAR at M1 = 42.9%

Maximum value of SAR (measured) = 2.09 W/kg

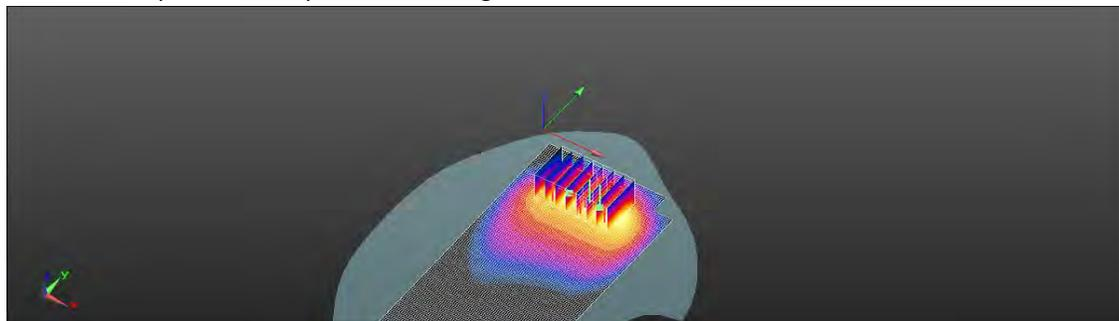
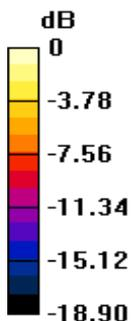

0 dB = 2.09 W/kg = 3.20 dBW/kg

Unless otherwise stated the results shown in this test report refer only to the sample(s) tested and such sample(s) are retained for 90 days only.

除非另有說明，此報告結果僅對測試之樣品負責，同時此樣品僅保留90天。本報告未經本公司書面許可，不可部份複製。

This document is issued by the Company subject to its General Conditions of Service printed overleaf, available on request or accessible at <http://www.sgs.com.tw/Terms-and-Conditions> and for electronic format documents, subject to Terms and Conditions for Electronic Documents at <http://www.sgs.com.tw/Terms-and-Conditions>. Attention is drawn to the limitation of liability, indemnification and jurisdiction issues defined therein. Any holder of this document is advised that information contained hereon reflects the Company's findings at the time of its intervention only and within the limits of Client's instructions, if any. The Company's sole responsibility is to its Client and this document does not exonerate parties to a transaction from exercising all their rights and obligations under the transaction documents. This document cannot be reproduced except in full, without prior written approval of the Company. Any unauthorized alteration, forgery or falsification of the content or appearance of this document is unlawful and offenders may be prosecuted to the fullest extent of the law.

Date: 2020/7/29

Report No. : ES/2020/30005

**LTE Band 13 (10MHz)_Product specific 10g-SAR_Front_CH
23230_QPSK_1-0_0mm_LAT**

Communication System: LTE; Frequency: 782 MHz; Duty cycle= 1:1

Medium parameters used: $f = 782 \text{ MHz}$; $\sigma = 0.885 \text{ S/m}$; $\epsilon_r = 42.477$; $\rho = 1000 \text{ kg/m}^3$

Phantom section: Flat Section

Ambient temperature: 22.2°C; Liquid temperature: 22.4°C

DASY5 Configuration:

- Probe: EX3DV4 - SN3770; ConvF(9.84, 9.84, 9.84) @ 782 MHz; Calibrated: 2020/05/27
- Sensor-Surface: 2mm (Mechanical Surface Detection)
- Electronics: DAE4 Sn558; Calibrated: 2019/10/11
- Phantom: SAM
- DASY52 52.10.4(1527); SEMCAD X 14.6.14(7483)

Area Scan (71x141x1): Interpolated grid: dx=15 mm, dy=15 mm

Maximum value of SAR (interpolated) = 2.73 W/kg

Zoom Scan (5x5x7)/Cube 0: Measurement grid: dx=8mm, dy=8mm, dz=5mm

Reference Value = 9.621 V/m; Power Drift = 0.17 dB

Peak SAR (extrapolated) = 3.85 W/kg

SAR(1 g) = 1.69 W/kg; SAR(10 g) = 0.845 W/kg

Smallest distance from peaks to all points 3 dB below = 8.8 mm

Ratio of SAR at M2 to SAR at M1 = 43.1%

Maximum value of SAR (measured) = 2.74 W/kg

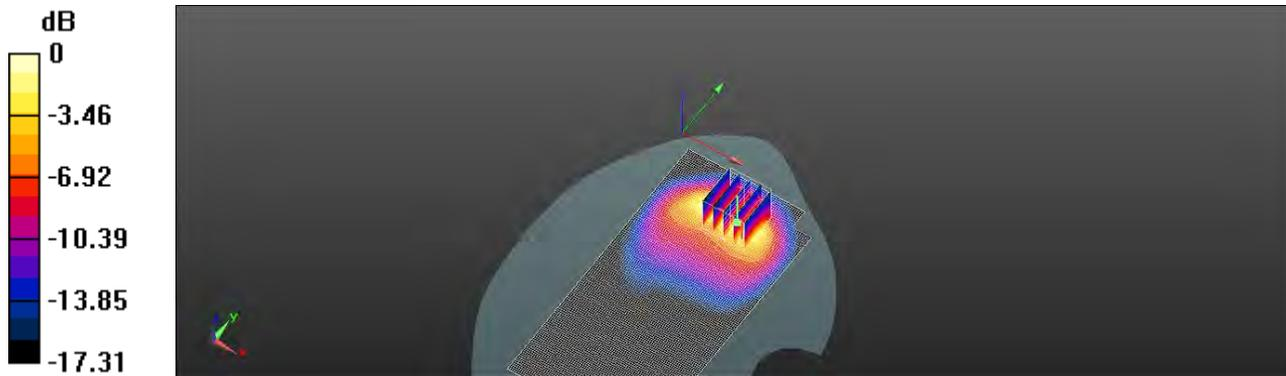

0 dB = 2.74 W/kg = 4.38 dBW/kg

Unless otherwise stated the results shown in this test report refer only to the sample(s) tested and such sample(s) are retained for 90 days only.

除非另有說明，此報告結果僅對測試之樣品負責，同時此樣品僅保留90天。本報告未經本公司書面許可，不可部份複製。

This document is issued by the Company subject to its General Conditions of Service printed overleaf, available on request or accessible at <http://www.sgs.com.tw/Terms-and-Conditions> and for electronic format documents, subject to Terms and Conditions for Electronic Documents at <http://www.sgs.com.tw/Terms-and-Conditions>. Attention is drawn to the limitation of liability, indemnification and jurisdiction issues defined therein. Any holder of this document is advised that information contained hereon reflects the Company's findings at the time of its intervention only and within the limits of Client's instructions, if any. The Company's sole responsibility is to its Client and this document does not exonerate parties to a transaction from exercising all their rights and obligations under the transaction documents. This document cannot be reproduced except in full, without prior written approval of the Company. Any unauthorized alteration, forgery or falsification of the content or appearance of this document is unlawful and offenders may be prosecuted to the fullest extent of the law.

Date: 2020/7/17

Report No. :ES/2020/30005

**LTE Band 25 (20MHz)_product specific 10g-SAR_Bottom side_CH
26590_QPSK_1-0_0mm_LAT**

Communication System: LTE; Frequency: 1905 MHz; Duty cycle= 1:1

Medium parameters used: $f = 1905 \text{ MHz}$; $\sigma = 1.421 \text{ S/m}$; $\epsilon_r = 39.533$; $\rho = 1000 \text{ kg/m}^3$

Phantom section: Flat Section

Ambient temperature: 22.7°C ; Liquid temperature: 21.6°C

DASY5 Configuration:

- Probe: EX3DV4 - SN3770; ConvF(8.03, 8.03, 8.03) @ 1905 MHz; Calibrated: 2020/05/27
- Sensor-Surface: 2mm (Mechanical Surface Detection)
- Electronics: DAE4 Sn877; Calibrated: 2020/03/17
- Phantom: SAM
- DASY52 52.10.4(1527); SEMCAD X 14.6.14(7483)

Area Scan (61x101x1): Interpolated grid: $dx=15 \text{ mm}$, $dy=15 \text{ mm}$

Maximum value of SAR (interpolated) = 7.59 W/kg

Zoom Scan (5x5x7)/Cube 0: Measurement grid: $dx=8\text{mm}$, $dy=8\text{mm}$, $dz=5\text{mm}$

Reference Value = 47.84 V/m ; Power Drift = 0.09 dB

Peak SAR (extrapolated) = 10.7 W/kg

SAR(1 g) = 4 W/kg ; SAR(10 g) = 1.61 W/kg

Smallest distance from peaks to all points 3 dB below = 8.5 mm

Ratio of SAR at M2 to SAR at M1 = 39.8%

Maximum value of SAR (measured) = 7.77 W/kg

Zoom Scan (5x5x7)/Cube 1: Measurement grid: $dx=8\text{mm}$, $dy=8\text{mm}$, $dz=5\text{mm}$

Reference Value = 47.84 V/m ; Power Drift = 0.09 dB

Peak SAR (extrapolated) = 6.30 W/kg

SAR(1 g) = 3.76 W/kg ; SAR(10 g) = 2.05 W/kg

Smallest distance from peaks to all points 3 dB below = 9.6 mm

Ratio of SAR at M2 to SAR at M1 = 53.1%

Maximum value of SAR (measured) = 4.98 W/kg

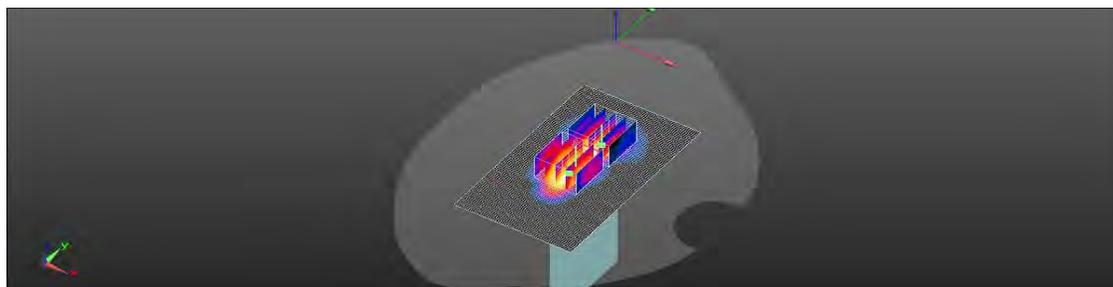
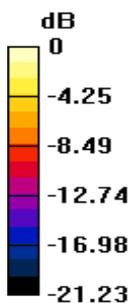

0 dB = $4.98 \text{ W/kg} = 6.97 \text{ dBW/kg}$

Unless otherwise stated the results shown in this test report refer only to the sample(s) tested and such sample(s) are retained for 90 days only.

除非另有說明，此報告結果僅對測試之樣品負責，同時此樣品僅保留90天。本報告未經本公司書面許可，不可部份複製。

This document is issued by the Company subject to its General Conditions of Service printed overleaf, available on request or accessible at <http://www.sgs.com.tw/Terms-and-Conditions> and for electronic format documents, subject to Terms and Conditions for Electronic Documents at <http://www.sgs.com.tw/Terms-and-Conditions>. Attention is drawn to the limitation of liability, indemnification and jurisdiction issues defined therein. Any holder of this document is advised that information contained hereon reflects the Company's findings at the time of its intervention only and within the limits of Client's instructions, if any. The Company's sole responsibility is to its Client and this document does not exonerate parties to a transaction from exercising all their rights and obligations under the transaction documents. This document cannot be reproduced except in full, without prior written approval of the Company. Any unauthorized alteration, forgery or falsification of the content or appearance of this document is unlawful and offenders may be prosecuted to the fullest extent of the law.

Date: 2020/7/30

Report No. :ES/2020/30005

**LTE Band 26 (15MHz)_Product specific 10g-SAR_Front_CH
26765_QPSK_1-0_0mm_LAT**

Communication System: LTE; Frequency: 821.5 MHz; Duty cycle= 1:1

Medium parameters used: $f = 821.5 \text{ MHz}$; $\sigma = 0.887 \text{ S/m}$; $\epsilon_r = 42.382$; $\rho = 1000 \text{ kg/m}^3$

Phantom section: Flat Section

Ambient temperature: 22.3°C; Liquid temperature: 22.1°C

DASY5 Configuration:

- Probe: EX3DV4 - SN3770; ConvF(9.5, 9.5, 9.5) @ 821.5 MHz; Calibrated: 2020/05/27
- Sensor-Surface: 2mm (Mechanical Surface Detection)
- Electronics: DAE4 Sn558; Calibrated: 2019/10/11
- Phantom: SAM
- DASY52 52.10.4(1527); SEMCAD X 14.6.14(7483)

Area Scan (71x141x1): Interpolated grid: dx=15 mm, dy=15 mm

Maximum value of SAR (interpolated) = 3.73 W/kg

Zoom Scan (5x5x7)/Cube 0: Measurement grid: dx=8mm, dy=8mm, dz=5mm

Reference Value = 6.971 V/m; Power Drift = -0.03 dB

Peak SAR (extrapolated) = 5.00 W/kg

SAR(1 g) = 2.37 W/kg; SAR(10 g) = 1.22 W/kg

Smallest distance from peaks to all points 3 dB below = 9.4 mm

Ratio of SAR at M2 to SAR at M1 = 47.6%

Maximum value of SAR (measured) = 3.74 W/kg

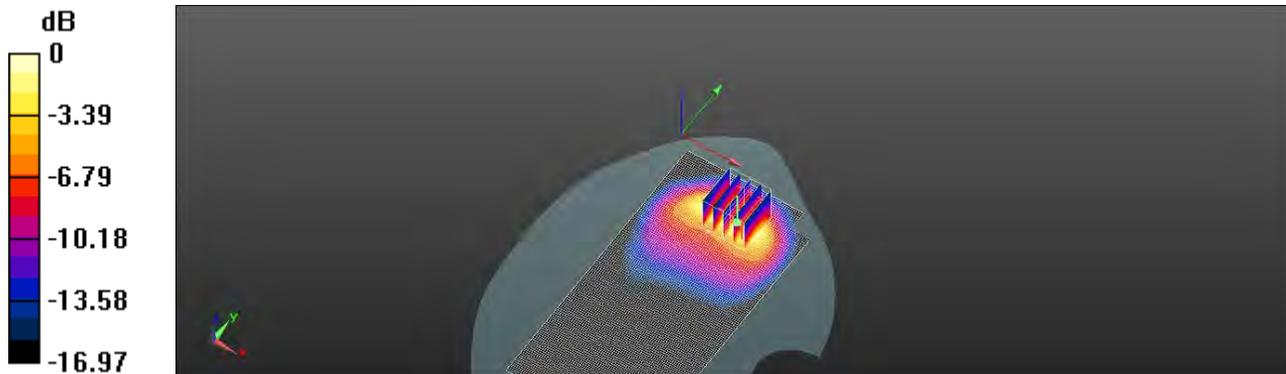

0 dB = 3.74 W/kg = 5.73 dBW/kg

Unless otherwise stated the results shown in this test report refer only to the sample(s) tested and such sample(s) are retained for 90 days only.

除非另有說明，此報告結果僅對測試之樣品負責，同時此樣品僅保留90天。本報告未經本公司書面許可，不可部份複製。

This document is issued by the Company subject to its General Conditions of Service printed overleaf, available on request or accessible at <http://www.sgs.com.tw/Terms-and-Conditions> and for electronic format documents, subject to Terms and Conditions for Electronic Documents at <http://www.sgs.com.tw/Terms-and-Conditions>. Attention is drawn to the limitation of liability, indemnification and jurisdiction issues defined therein. Any holder of this document is advised that information contained hereon reflects the Company's findings at the time of its intervention only and within the limits of Client's instructions, if any. The Company's sole responsibility is to its Client and this document does not exonerate parties to a transaction from exercising all their rights and obligations under the transaction documents. This document cannot be reproduced except in full, without prior written approval of the Company. Any unauthorized alteration, forgery or falsification of the content or appearance of this document is unlawful and offenders may be prosecuted to the fullest extent of the law.

Date: 2020/7/27

Report No. :ES/2020/30005

**LTE Band 30 (10MHz)_product specific 10g-SAR_Bottom side_CH
27710_QPSK_1-49_0mm_LAT**

Communication System: LTE; Frequency: 2310 MHz; Duty cycle= 1:1

Medium parameters used: $f = 2310$ MHz; $\sigma = 1.678$ S/m; $\epsilon_r = 39.212$; $\rho = 1000$ kg/m³

Phantom section: Flat Section

Ambient temperature: 22.7°C; Liquid temperature: 21.8°C

DASY5 Configuration:

- Probe: EX3DV4 - SN3770; ConvF(7.67, 7.67, 7.67) @ 2310 MHz; Calibrated: 2020/05/27
- Sensor-Surface: 2mm (Mechanical Surface Detection)
- Electronics: DAE4 Sn877; Calibrated: 2020/03/17
- Phantom: SAM
- DASY52 52.10.4(1527); SEMCAD X 14.6.14(7483)

Area Scan (61x101x1): Interpolated grid: dx=12 mm, dy=12 mm

Maximum value of SAR (interpolated) = 15.6 W/kg

Zoom Scan (7x7x7)/Cube 0: Measurement grid: dx=5mm, dy=5mm, dz=5mm

Reference Value = 38.83 V/m; Power Drift = 0.15 dB

Peak SAR (extrapolated) = 27.9 W/kg

SAR(1 g) = 8.45 W/kg; SAR(10 g) = 3.17 W/kg

Smallest distance from peaks to all points 3 dB below = 5.1 mm

Ratio of SAR at M2 to SAR at M1 = 32.6%

Maximum value of SAR (measured) = 17.6 W/kg

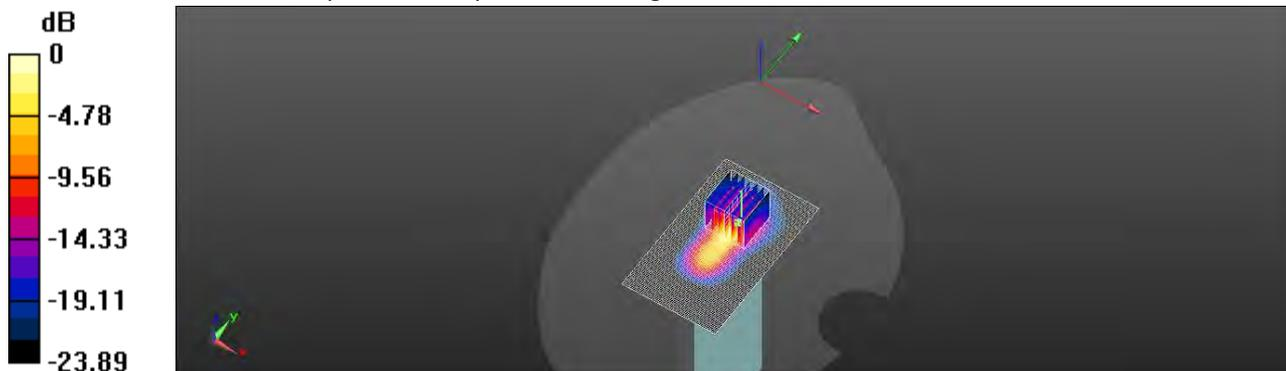

0 dB = 17.6 W/kg = 12.46 dBW/kg

Unless otherwise stated the results shown in this test report refer only to the sample(s) tested and such sample(s) are retained for 90 days only.

除非另有說明，此報告結果僅對測試之樣品負責，同時此樣品僅保留90天。本報告未經本公司書面許可，不可部份複製。

This document is issued by the Company subject to its General Conditions of Service printed overleaf, available on request or accessible at <http://www.sgs.com.tw/Terms-and-Conditions> and for electronic format documents, subject to Terms and Conditions for Electronic Documents at <http://www.sgs.com.tw/Terms-and-Conditions>. Attention is drawn to the limitation of liability, indemnification and jurisdiction issues defined therein. Any holder of this document is advised that information contained hereon reflects the Company's findings at the time of its intervention only and within the limits of Client's instructions, if any. The Company's sole responsibility is to its Client and this document does not exonerate parties to a transaction from exercising all their rights and obligations under the transaction documents. This document cannot be reproduced except in full, without prior written approval of the Company. Any unauthorized alteration, forgery or falsification of the content or appearance of this document is unlawful and offenders may be prosecuted to the fullest extent of the law.

Date: 2020/8/3

Report No. :ES/2020/30005

**LTE Band 41 (20MHz)_Product specific 10g-SAR_Bottom side_CH
41490_QPSK_1-0_0mm_LAT**

Communication System: LTE; Frequency: 2680 MHz; Duty cycle= 1:1.59956

Medium parameters used: $f = 2680$ MHz; $\sigma = 2.061$ S/m; $\epsilon_r = 38.170$; $\rho = 1000$ kg/m³

Phantom section: Flat Section

Ambient temperature: 22.2°C; Liquid temperature: 22.5°C

DASY5 Configuration:

- Probe: EX3DV4 - SN3770; ConvF(7.21, 7.21, 7.21) @ 2680 MHz; Calibrated: 2020/05/27
- Sensor-Surface: 2mm (Mechanical Surface Detection)
- Electronics: DAE4 Sn558; Calibrated: 2019/10/11
- Phantom: SAM
- DASY52 52.10.4(1527); SEMCAD X 14.6.14(7483)

Area Scan (61x101x1): Interpolated grid: dx=12 mm, dy=12 mm

Maximum value of SAR (interpolated) = 5.61 W/kg

Zoom Scan (7x7x7)/Cube 0: Measurement grid: dx=5mm, dy=5mm, dz=5mm

Reference Value = 19.75 V/m; Power Drift = 0.11 dB

Peak SAR (extrapolated) = 13.1 W/kg

SAR(1 g) = 3.79 W/kg; SAR(10 g) = 1.23 W/kg

Smallest distance from peaks to all points 3 dB below = 6.9 mm

Ratio of SAR at M2 to SAR at M1 = 69.4%

Maximum value of SAR (measured) = 7.94 W/kg

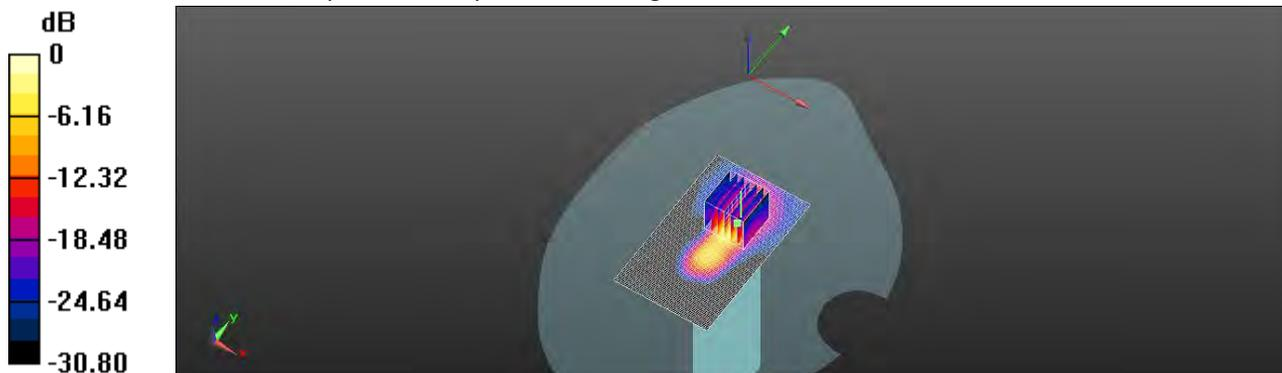

0 dB = 7.94 W/kg = 9.00 dBW/kg

Unless otherwise stated the results shown in this test report refer only to the sample(s) tested and such sample(s) are retained for 90 days only.

除非另有說明，此報告結果僅對測試之樣品負責，同時此樣品僅保留90天。本報告未經本公司書面許可，不可部份複製。

This document is issued by the Company subject to its General Conditions of Service printed overleaf, available on request or accessible at <http://www.sgs.com.tw/Terms-and-Conditions> and for electronic format documents, subject to Terms and Conditions for Electronic Documents at <http://www.sgs.com.tw/Terms-and-Conditions>. Attention is drawn to the limitation of liability, indemnification and jurisdiction issues defined therein. Any holder of this document is advised that information contained hereon reflects the Company's findings at the time of its intervention only and within the limits of Client's instructions, if any. The Company's sole responsibility is to its Client and this document does not exonerate parties to a transaction from exercising all their rights and obligations under the transaction documents. This document cannot be reproduced except in full, without prior written approval of the Company. Any unauthorized alteration, forgery or falsification of the content or appearance of this document is unlawful and offenders may be prosecuted to the fullest extent of the law.

Date: 2020/8/5

Report No. :ES/2020/30005

**LTE Band 42 (20MHz)_Product specific 10g-SAR_Back side_CH
43490_QPSK_1-99_0mm_LAT**

Communication System: LTE; Frequency: 3590 MHz; Duty cycle= 1:1.59956

Medium parameters used: $f = 3590$ MHz; $\sigma = 2.976$ S/m; $\epsilon_r = 37.530$; $\rho = 1000$ kg/m³

Phantom section: Flat Section

Ambient temperature: 22.2°C; Liquid temperature: 21.8°C

DASY5 Configuration:

- Probe: EX3DV4 - SN3770; ConvF(6.7, 6.7, 6.7) @ 3590 MHz; Calibrated: 2020/05/27
- Sensor-Surface: 2mm (Mechanical Surface Detection)
- Electronics: DAE4 Sn558; Calibrated: 2019/10/11
- Phantom: SAM
- DASY52 52.10.4(1527); SEMCAD X 14.6.14(7483)

Area Scan (91x181x1): Interpolated grid: dx=12 mm, dy=12 mm

Maximum value of SAR (interpolated) = 4.06 W/kg

Zoom Scan (7x7x10)/Cube 0: Measurement grid: dx=5mm, dy=5mm, dz=3mm

Reference Value = 6.518 V/m; Power Drift = -0.08 dB

Peak SAR (extrapolated) = 6.78 W/kg

SAR(1 g) = 2.25 W/kg; SAR(10 g) = 0.808 W/kg

Smallest distance from peaks to all points 3 dB below = 6.1 mm

Ratio of SAR at M2 to SAR at M1 = 58.5%

Maximum value of SAR (measured) = 3.74 W/kg

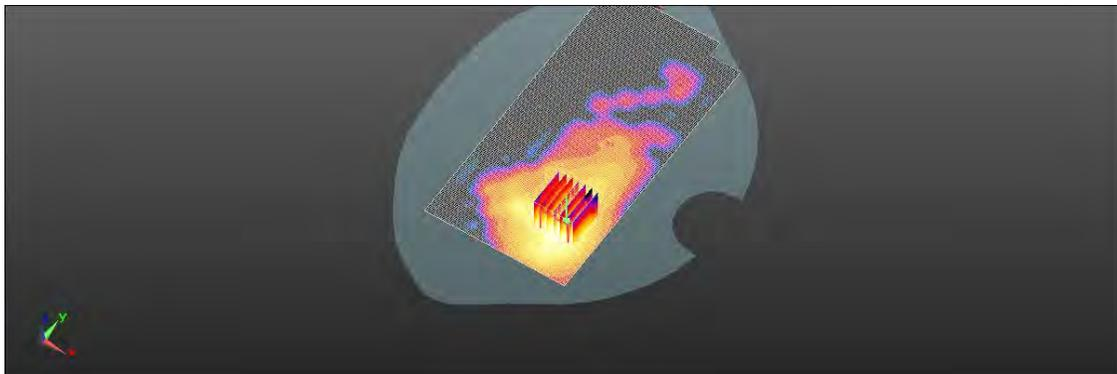
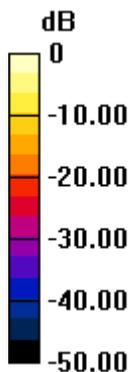

0 dB = 3.74 W/kg = 5.73 dBW/kg

Unless otherwise stated the results shown in this test report refer only to the sample(s) tested and such sample(s) are retained for 90 days only.

除非另有說明，此報告結果僅對測試之樣品負責，同時此樣品僅保留90天。本報告未經本公司書面許可，不可部份複製。

This document is issued by the Company subject to its General Conditions of Service printed overleaf, available on request or accessible at <http://www.sgs.com.tw/Terms-and-Conditions> and for electronic format documents, subject to Terms and Conditions for Electronic Documents at <http://www.sgs.com.tw/Terms-and-Conditions>. Attention is drawn to the limitation of liability, indemnification and jurisdiction issues defined therein. Any holder of this document is advised that information contained hereon reflects the Company's findings at the time of its intervention only and within the limits of Client's instructions, if any. The Company's sole responsibility is to its Client and this document does not exonerate parties to a transaction from exercising all their rights and obligations under the transaction documents. This document cannot be reproduced except in full, without prior written approval of the Company. Any unauthorized alteration, forgery or falsification of the content or appearance of this document is unlawful and offenders may be prosecuted to the fullest extent of the law.

Date: 2020/8/6

Report No. :ES/2020/30005

**LTE Band 48 (20MHz)_Product specific 10g-SAR_Back side_CH
55773_QPSK_1-0_0mm_LAT**

Communication System: LTE; Frequency: 3603.3 MHz; Duty cycle= 1:1.59956

Medium parameters used: $f = 3600$ MHz; $\sigma = 2.978$ S/m; $\epsilon_r = 37.512$; $\rho = 1000$ kg/m³

Phantom section: Flat Section

Ambient temperature: 21.7°C; Liquid temperature: 21.9°C

DASY5 Configuration:

- Probe: EX3DV4 - SN3770; ConvF(6.6, 6.6, 6.6) @ 3603.3 MHz; Calibrated: 2020/05/27
- Sensor-Surface: 2mm (Mechanical Surface Detection)
- Electronics: DAE4 Sn558; Calibrated: 2019/10/11
- Phantom: SAM
- DASY52 52.10.4(1527); SEMCAD X 14.6.14(7483)

Area Scan (91x181x1): Interpolated grid: dx=12 mm, dy=12 mm

Maximum value of SAR (interpolated) = 3.96 W/kg

Zoom Scan (7x7x8)/Cube 0: Measurement grid: dx=5mm, dy=5mm, dz=4mm

Reference Value = 29.61 V/m; Power Drift = 0.15 dB

Peak SAR (extrapolated) = 6.50 W/kg

SAR(1 g) = 2.18 W/kg; SAR(10 g) = 0.795 W/kg

Smallest distance from peaks to all points 3 dB below = 7.2 mm

Ratio of SAR at M2 to SAR at M1 = 42.6%

Maximum value of SAR (measured) = 3.86 W/kg

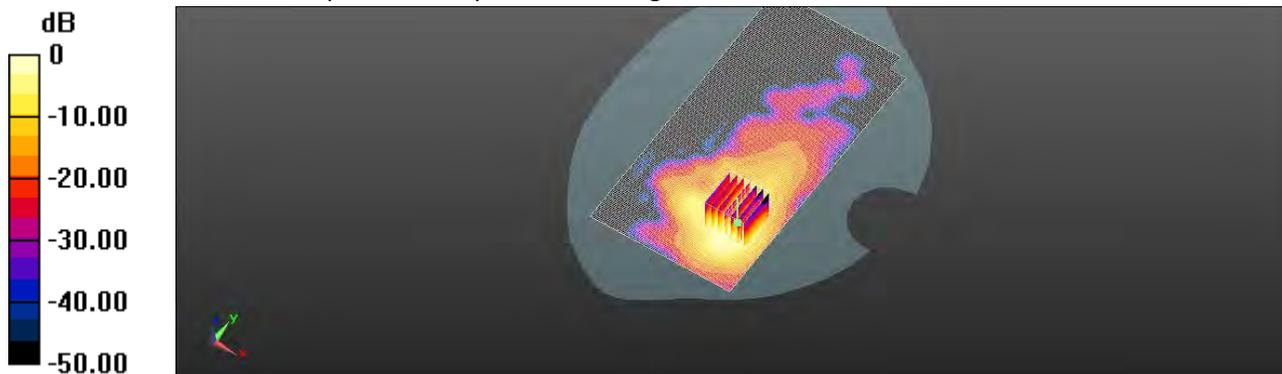

0 dB = 3.86 W/kg = 5.87 dBW/kg

Unless otherwise stated the results shown in this test report refer only to the sample(s) tested and such sample(s) are retained for 90 days only.

除非另有說明，此報告結果僅對測試之樣品負責，同時此樣品僅保留90天。本報告未經本公司書面許可，不可部份複製。

This document is issued by the Company subject to its General Conditions of Service printed overleaf, available on request or accessible at <http://www.sgs.com.tw/Terms-and-Conditions> and for electronic format documents, subject to Terms and Conditions for Electronic Documents at <http://www.sgs.com.tw/Terms-and-Conditions>. Attention is drawn to the limitation of liability, indemnification and jurisdiction issues defined therein. Any holder of this document is advised that information contained hereon reflects the Company's findings at the time of its intervention only and within the limits of Client's instructions, if any. The Company's sole responsibility is to its Client and this document does not exonerate parties to a transaction from exercising all their rights and obligations under the transaction documents. This document cannot be reproduced except in full, without prior written approval of the Company. Any unauthorized alteration, forgery or falsification of the content or appearance of this document is unlawful and offenders may be prosecuted to the fullest extent of the law.

Date: 2020/7/16

Report No. :ES/2020/30005

**LTE Band 66 (20MHz)_product specific 10g-SAR_Bottom side_CH
132572_QPSK_1-0_0mm_LAT**

Communication System: LTE; Frequency: 1770 MHz; Duty cycle= 1:1

Medium parameters used: $f = 1770$ MHz; $\sigma = 1.388$ S/m; $\epsilon_r = 40.012$; $\rho = 1000$ kg/m³

Phantom section: Flat Section

Ambient temperature: 22.3°C; Liquid temperature: 21.4°C

DASY5 Configuration:

- Probe: EX3DV4 - SN3770; ConvF(8.36, 8.36, 8.36) @ 1770 MHz; Calibrated: 2020/05/27
- Sensor-Surface: 2mm (Mechanical Surface Detection)
- Electronics: DAE4 Sn877; Calibrated: 2020/03/17
- Phantom: SAM
- DASY52 52.10.4(1527); SEMCAD X 14.6.14(7483)

Area Scan (61x101x1): Interpolated grid: dx=15 mm, dy=15 mm

Maximum value of SAR (interpolated) = 6.25 W/kg

Zoom Scan (5x5x7)/Cube 0: Measurement grid: dx=8mm, dy=8mm, dz=5mm

Reference Value = 59.50 V/m; Power Drift = 0.16 dB

Peak SAR (extrapolated) = 8.90 W/kg

SAR(1 g) = 3.67 W/kg; SAR(10 g) = 1.73 W/kg

Smallest distance from peaks to all points 3 dB below = 8.8 mm

Ratio of SAR at M2 to SAR at M1 = 31.7%

Maximum value of SAR (measured) = 6.12 W/kg

Zoom Scan (5x5x7)/Cube 1: Measurement grid: dx=8mm, dy=8mm, dz=5mm

Reference Value = 59.50 V/m; Power Drift = 0.16 dB

Peak SAR (extrapolated) = 6.75 W/kg

SAR(1 g) = 4.14 W/kg; SAR(10 g) = 2.39 W/kg

Smallest distance from peaks to all points 3 dB below = 9.4 mm

Ratio of SAR at M2 to SAR at M1 = 53.7%

Maximum value of SAR (measured) = 5.56 W/kg

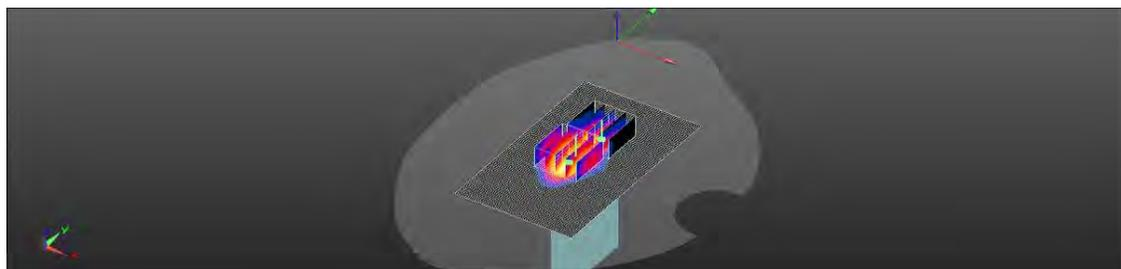
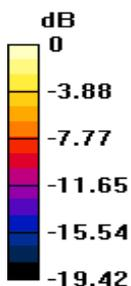

0 dB = 5.56 W/kg = 7.45 dBW/kg

Unless otherwise stated the results shown in this test report refer only to the sample(s) tested and such sample(s) are retained for 90 days only.

除非另有說明，此報告結果僅對測試之樣品負責，同時此樣品僅保留90天。本報告未經本公司書面許可，不可部份複製。

This document is issued by the Company subject to its General Conditions of Service printed overleaf, available on request or accessible at <http://www.sgs.com.tw/Terms-and-Conditions> and for electronic format documents, subject to Terms and Conditions for Electronic Documents at <http://www.sgs.com.tw/Terms-and-Conditions>. Attention is drawn to the limitation of liability, indemnification and jurisdiction issues defined therein. Any holder of this document is advised that information contained hereon reflects the Company's findings at the time of its intervention only and within the limits of Client's instructions, if any. The Company's sole responsibility is to its Client and this document does not exonerate parties to a transaction from exercising all their rights and obligations under the transaction documents. This document cannot be reproduced except in full, without prior written approval of the Company. Any unauthorized alteration, forgery or falsification of the content or appearance of this document is unlawful and offenders may be prosecuted to the fullest extent of the law.

Date: 2020/7/29

Report No. : ES/2020/30005

**LTE Band 71 (20MHz)_Product specific 10g-SAR_Front_CH
133222_QPSK_1-0_0mm_LAT**

Communication System: LTE; Frequency: 673 MHz; Duty cycle= 1:1

Medium parameters used: $f = 673 \text{ MHz}$; $\sigma = 0.848 \text{ S/m}$; $\epsilon_r = 43.438$; $\rho = 1000 \text{ kg/m}^3$

Phantom section: Flat Section

Ambient temperature: 22.2°C; Liquid temperature: 22.4°C

DASY5 Configuration:

- Probe: EX3DV4 - SN3770; ConvF(9.84, 9.84, 9.84) @ 673 MHz; Calibrated: 2020/05/27
- Sensor-Surface: 2mm (Mechanical Surface Detection)
- Electronics: DAE4 Sn558; Calibrated: 2019/10/11
- Phantom: SAM
- DASY52 52.10.4(1527); SEMCAD X 14.6.14(7483)

Area Scan (71x141x1): Interpolated grid: $dx=15 \text{ mm}$, $dy=15 \text{ mm}$

Maximum value of SAR (interpolated) = 1.71 W/kg

Zoom Scan (5x5x7)/Cube 0: Measurement grid: $dx=8\text{mm}$, $dy=8\text{mm}$, $dz=5\text{mm}$

Reference Value = 6.666 V/m; Power Drift = 0.04 dB

Peak SAR (extrapolated) = 2.57 W/kg

SAR(1 g) = 1.08 W/kg; SAR(10 g) = 0.543 W/kg

Smallest distance from peaks to all points 3 dB below = 8.9 mm

Ratio of SAR at M2 to SAR at M1 = 41%

Maximum value of SAR (measured) = 1.76 W/kg

Zoom Scan (5x5x7)/Cube 1: Measurement grid: $dx=8\text{mm}$, $dy=8\text{mm}$, $dz=5\text{mm}$

Reference Value = 6.666 V/m; Power Drift = 0.04 dB

Peak SAR (extrapolated) = 2.46 W/kg

SAR(1 g) = 0.933 W/kg; SAR(10 g) = 0.465 W/kg

Smallest distance from peaks to all points 3 dB below = 9.6 mm

Ratio of SAR at M2 to SAR at M1 = 41.2%

Maximum value of SAR (measured) = 1.64 W/kg

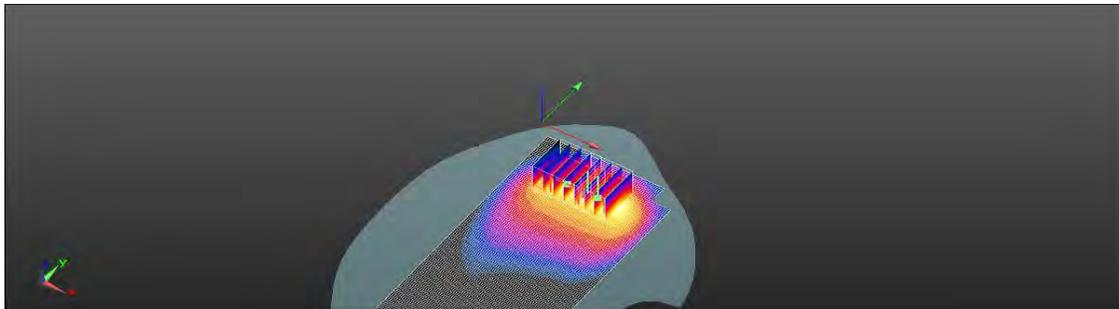
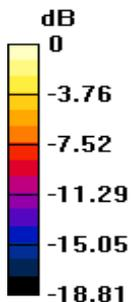

0 dB = 1.64 W/kg = 2.15 dBW/kg

Unless otherwise stated the results shown in this test report refer only to the sample(s) tested and such sample(s) are retained for 90 days only.

除非另有說明，此報告結果僅對測試之樣品負責，同時此樣品僅保留90天。本報告未經本公司書面許可，不可部份複製。

This document is issued by the Company subject to its General Conditions of Service printed overleaf, available on request or accessible at <http://www.sgs.com.tw/Terms-and-Conditions> and for electronic format documents, subject to Terms and Conditions for Electronic Documents at <http://www.sgs.com.tw/Terms-and-Conditions>. Attention is drawn to the limitation of liability, indemnification and jurisdiction issues defined therein. Any holder of this document is advised that information contained hereon reflects the Company's findings at the time of its intervention only and within the limits of Client's instructions, if any. The Company's sole responsibility is to its Client and this document does not exonerate parties to a transaction from exercising all their rights and obligations under the transaction documents. This document cannot be reproduced except in full, without prior written approval of the Company. Any unauthorized alteration, forgery or falsification of the content or appearance of this document is unlawful and offenders may be prosecuted to the fullest extent of the law.

Date: 2020/8/3

Report No. :ES/2020/30005

**5G NR n41 (100MHz)_Product specific 10g-SAR_Back side_CH
513900_QPSK_1-137_0mm_UAT**

Communication System: 5G NR(100MHz,QPSK,30k); Frequency: 2569.5 MHz; Duty cycle= 1:1
Medium parameters used: $f = 2569.5$ MHz; $\sigma = 1.909$ S/m; $\epsilon_r = 38.287$; $\rho = 1000$ kg/m³
Phantom section: Flat Section
Ambient temperature: 22.2°C; Liquid temperature: 22.5°C

DASY5 Configuration:

- Probe: EX3DV4 - SN3770; ConvF(7.21, 7.21, 7.21) @ 2569.5 MHz; Calibrated: 2020/05/27
- Sensor-Surface: 2mm (Mechanical Surface Detection)
- Electronics: DAE4 Sn558; Calibrated: 2019/10/11
- Phantom: SAM
- DASY52 52.10.4(1527); SEMCAD X 14.6.14(7483)

Area Scan (81x181x1): Interpolated grid: dx=12 mm, dy=12 mm

Maximum value of SAR (interpolated) = 10.2 W/kg

Zoom Scan (7x7x7)/Cube 0: Measurement grid: dx=5mm, dy=5mm, dz=5mm

Reference Value = 10.38 V/m; Power Drift = 0.14 dB

Peak SAR (extrapolated) = 19.3 W/kg

SAR(1 g) = 5.35 W/kg; SAR(10 g) = 1.66 W/kg

Smallest distance from peaks to all points 3 dB below = 6.5 mm

Ratio of SAR at M2 to SAR at M1 = 40.4%

Maximum value of SAR (measured) = 10.0 W/kg

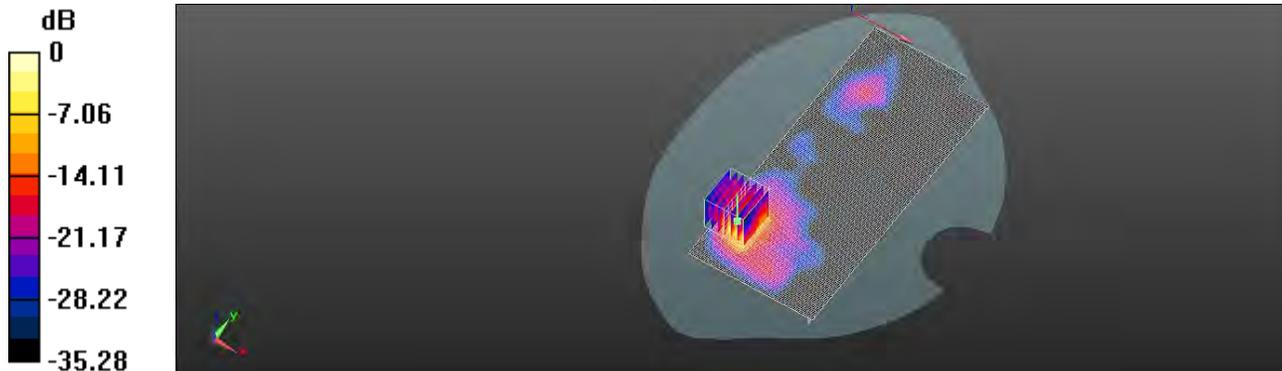

0 dB = 10.0 W/kg = 10.00 dBW/kg

Unless otherwise stated the results shown in this test report refer only to the sample(s) tested and such sample(s) are retained for 90 days only.

除非另有說明，此報告結果僅對測試之樣品負責，同時此樣品僅保留90天。本報告未經本公司書面許可，不可部份複製。

This document is issued by the Company subject to its General Conditions of Service printed overleaf, available on request or accessible at <http://www.sgs.com.tw/Terms-and-Conditions> and for electronic format documents, subject to Terms and Conditions for Electronic Documents at <http://www.sgs.com.tw/Terms-and-Conditions>. Attention is drawn to the limitation of liability, indemnification and jurisdiction issues defined therein. Any holder of this document is advised that information contained hereon reflects the Company's findings at the time of its intervention only and within the limits of Client's instructions, if any. The Company's sole responsibility is to its Client and this document does not exonerate parties to a transaction from exercising all their rights and obligations under the transaction documents. This document cannot be reproduced except in full, without prior written approval of the Company. Any unauthorized alteration, forgery or falsification of the content or appearance of this document is unlawful and offenders may be prosecuted to the fullest extent of the law.

Date: 2020/8/3

Report No. :ES/2020/30005

5G NR n41 (100MHz)_Body_Back side_CH 509202_QPSK_1-137_0mm_LAT

Communication System: 5G NR(100MHz,QPSK,30k); Frequency: 2546.01 MHz; Duty cycle= 1:1

Medium parameters used: $f = 2546.01$ MHz; $\sigma = 1.877$ S/m; $\epsilon_r = 38.548$ $\rho = 1000$ kg/m³

Phantom section: Flat Section

Ambient temperature: 22.2°C; Liquid temperature: 22.5°C

DASY5 Configuration:

- Probe: EX3DV4 – SN3770; ConvF(7.23, 7.23, 7.23) @ 2546.01 MHz; Calibrated: 2020/05/27
- Sensor-Surface: 2mm (Mechanical Surface Detection)
- Electronics: DAE4 Sn558; Calibrated: 2019/10/11
- Phantom: SAM
- DASY52 52.10.4(1527); SEMCAD X 14.6.14(7483)

Area Scan (81x181x1): Interpolated grid: dx=12 mm, dy=12 mm

Maximum value of SAR (interpolated) = 10.4 W/kg

Zoom Scan (7x7x7)/Cube 0: Measurement grid: dx=5mm, dy=5mm, dz=5mm

Reference Value = 9.853 V/m; Power Drift = 0.14 dB

Peak SAR (extrapolated) = 17.7 W/kg

SAR(1 g) = 7.87 W/kg; SAR(10 g) = 3.51 W/kg

Smallest distance from peaks to all points 3 dB below = 7.1 mm

Ratio of SAR at M2 to SAR at M1 = 53.9%

Maximum value of SAR (measured) = 10.6 W/kg

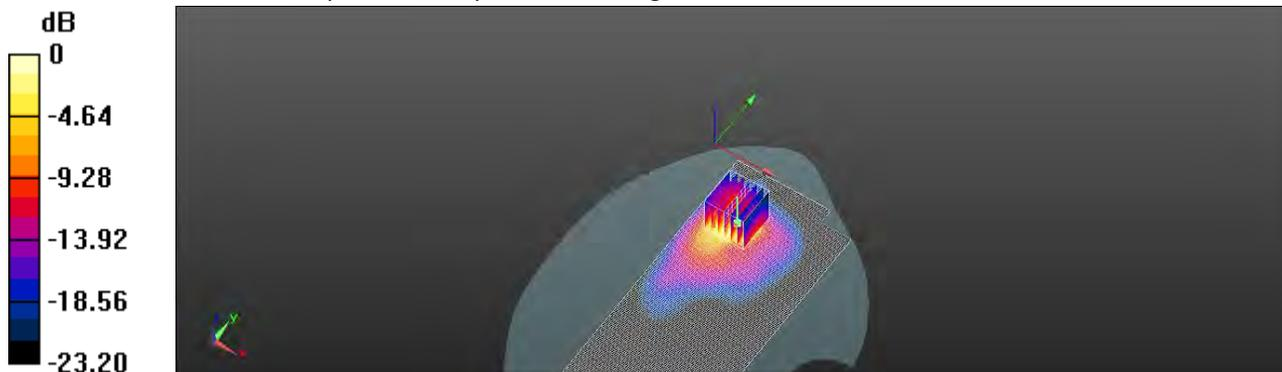

0 dB = 10.6 W/kg = 10.25 dBW/kg

Unless otherwise stated the results shown in this test report refer only to the sample(s) tested and such sample(s) are retained for 90 days only.

除非另有說明，此報告結果僅對測試之樣品負責，同時此樣品僅保留90天。本報告未經本公司書面許可，不可部份複製。

This document is issued by the Company subject to its General Conditions of Service printed overleaf, available on request or accessible at <http://www.sgs.com.tw/Terms-and-Conditions> and for electronic format documents, subject to Terms and Conditions for Electronic Documents at <http://www.sgs.com.tw/Terms-and-Conditions>. Attention is drawn to the limitation of liability, indemnification and jurisdiction issues defined therein. Any holder of this document is advised that information contained hereon reflects the Company's findings at the time of its intervention only and within the limits of Client's instructions, if any. The Company's sole responsibility is to its Client and this document does not exonerate parties to a transaction from exercising all their rights and obligations under the transaction documents. This document cannot be reproduced except in full, without prior written approval of the Company. Any unauthorized alteration, forgery or falsification of the content or appearance of this document is unlawful and offenders may be prosecuted to the fullest extent of the law.

Date: 2020/7/9

Report No. :ES/2020/30005

LTE Band 12 (10MHz)_Hotspot_Front side_CH 23060_QPSK_1-0_10mm_UAT

Communication System: LTE; Frequency: 704 MHz; Duty cycle= 1:1

Medium parameters used: $f = 704 \text{ MHz}$; $\sigma = 0.89 \text{ S/m}$; $\epsilon_r = 42.948$; $\rho = 1000 \text{ kg/m}^3$

Phantom section: Flat Section

Ambient temperature: 21.5°C; Liquid temperature: 22.0°C

DASY5 Configuration:

- Probe: EX3DV4 - SN7509; ConvF(9.94, 9.94, 9.94) @ 704 MHz; Calibrated: 2020/3/25
- Sensor-Surface: 2mm (Mechanical Surface Detection)
- Electronics: DAE4 Sn558; Calibrated: 2019/10/11
- Phantom: SAM
- DASY52 52.10.4(1527); SEMCAD X 14.6.14(7483)

Area Scan (71x141x1): Interpolated grid: dx=15 mm, dy=15 mm

Maximum value of SAR (interpolated) = 0.104 W/kg

Zoom Scan (5x5x7)/Cube 0: Measurement grid: dx=8mm, dy=8mm, dz=5mm

Reference Value = 7.285 V/m; Power Drift = 0.16 dB

Peak SAR (extrapolated) = 0.110 W/kg

SAR(1 g) = 0.087 W/kg; SAR(10 g) = 0.066 W/kg

Smallest distance from peaks to all points 3 dB below = 14.8 mm

Ratio of SAR at M2 to SAR at M1 = 75.5%

Maximum value of SAR (measured) = 0.0994 W/kg

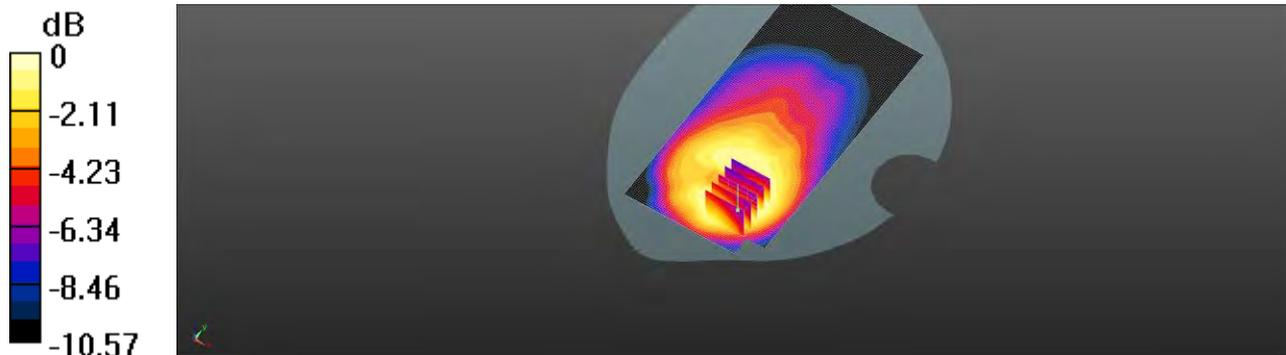

0 dB = 0.0994 W/kg = -10.03 dBW/kg

Unless otherwise stated the results shown in this test report refer only to the sample(s) tested and such sample(s) are retained for 90 days only.

除非另有說明，此報告結果僅對測試之樣品負責，同時此樣品僅保留90天。本報告未經本公司書面許可，不可部份複製。

This document is issued by the Company subject to its General Conditions of Service printed overleaf, available on request or accessible at <http://www.sgs.com.tw/Terms-and-Conditions> and for electronic format documents, subject to Terms and Conditions for Electronic Documents at <http://www.sgs.com.tw/Terms-and-Conditions>. Attention is drawn to the limitation of liability, indemnification and jurisdiction issues defined therein. Any holder of this document is advised that information contained hereon reflects the Company's findings at the time of its intervention only and within the limits of Client's instructions, if any. The Company's sole responsibility is to its Client and this document does not exonerate parties to a transaction from exercising all their rights and obligations under the transaction documents. This document cannot be reproduced except in full, without prior written approval of the Company. Any unauthorized alteration, forgery or falsification of the content or appearance of this document is unlawful and offenders may be prosecuted to the fullest extent of the law.

Date: 2020/7/10

Report No. :ES/2020/30005

LTE Band 26 (15MHz)_Hotspot_Front side_CH 26765_QPSK_1-0_10mm_UAT

Communication System: LTE; Frequency: 821.5 MHz; Duty cycle= 1:1

Medium parameters used: $f = 821.5$ MHz; $\sigma = 0.912$ S/m; $\epsilon_r = 42.211$; $\rho = 1000$ kg/m³

Phantom section: Flat Section

Ambient temperature: 22.2°C; Liquid temperature: 21.7°C

DASY5 Configuration:

- Probe: EX3DV4 - SN7509; ConvF(9.73, 9.73, 9.73) @ 821.5 MHz; Calibrated: 2020/3/25
- Sensor-Surface: 2mm (Mechanical Surface Detection)
- Electronics: DAE4 Sn558; Calibrated: 2019/10/11
- Phantom: SAM
- DASY52 52.10.4(1527); SEMCAD X 14.6.14(7483)

Area Scan (71x141x1): Interpolated grid: dx=15 mm, dy=15 mm

Maximum value of SAR (interpolated) = 0.177 W/kg

Zoom Scan (5x5x7)/Cube 0: Measurement grid: dx=8mm, dy=8mm, dz=5mm

Reference Value = 8.313 V/m; Power Drift = 0.14 dB

Peak SAR (extrapolated) = 0.197 W/kg

SAR(1 g) = 0.161 W/kg; SAR(10 g) = 0.123 W/kg

Smallest distance from peaks to all points 3 dB below = 12.5 mm

Ratio of SAR at M2 to SAR at M1 = 76.9%

Maximum value of SAR (measured) = 0.178 W/kg

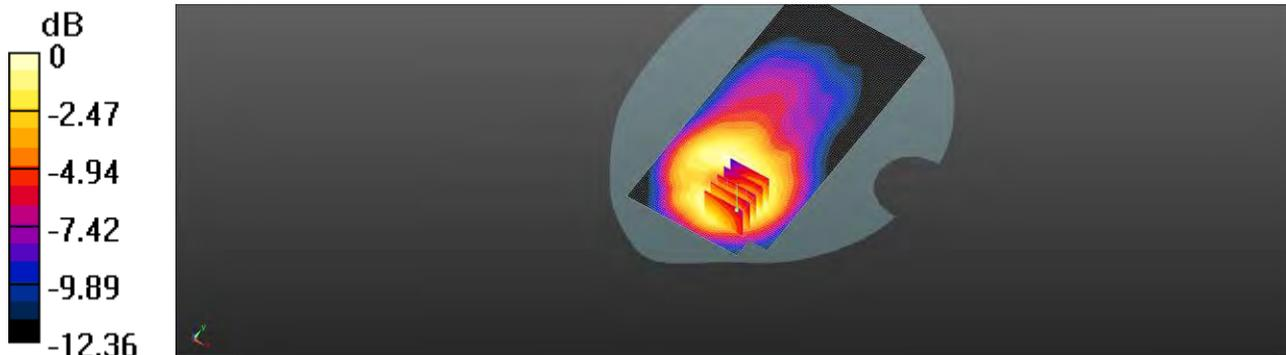

0 dB = 0.178 W/kg = -7.49 dBW/kg

Unless otherwise stated the results shown in this test report refer only to the sample(s) tested and such sample(s) are retained for 90 days only.

除非另有說明，此報告結果僅對測試之樣品負責，同時此樣品僅保留90天。本報告未經本公司書面許可，不可部份複製。

This document is issued by the Company subject to its General Conditions of Service printed overleaf, available on request or accessible at <http://www.sgs.com.tw/Terms-and-Conditions> and for electronic format documents, subject to Terms and Conditions for Electronic Documents at <http://www.sgs.com.tw/Terms-and-Conditions>. Attention is drawn to the limitation of liability, indemnification and jurisdiction issues defined therein. Any holder of this document is advised that information contained hereon reflects the Company's findings at the time of its intervention only and within the limits of Client's instructions, if any. The Company's sole responsibility is to its Client and this document does not exonerate parties to a transaction from exercising all their rights and obligations under the transaction documents. This document cannot be reproduced except in full, without prior written approval of the Company. Any unauthorized alteration, forgery or falsification of the content or appearance of this document is unlawful and offenders may be prosecuted to the fullest extent of the law.

Date: 2020/7/9

Report No. :ES/2020/30005

**LTE Band 12 (10MHz)_Body- worn_Back side_CH
23060_QPSK_1-0_15mm_LAT**

Communication System: LTE; Frequency: 704 MHz; Duty cycle= 1:1

Medium parameters used: $f = 704 \text{ MHz}$; $\sigma = 0.89 \text{ S/m}$; $\epsilon_r = 42.948$; $\rho = 1000 \text{ kg/m}^3$

Phantom section: Flat Section

Ambient temperature: 21.5°C; Liquid temperature: 22.0°C

DASY5 Configuration:

- Probe: EX3DV4 - SN7509; ConvF(9.94, 9.94, 9.94) @ 704 MHz; Calibrated: 2020/3/25
- Sensor-Surface: 2mm (Mechanical Surface Detection)
- Electronics: DAE4 Sn558; Calibrated: 2019/10/11
- Phantom: SAM
- DASY52 52.10.4(1527); SEMCAD X 14.6.14(7483)

Area Scan (71x141x1): Interpolated grid: dx=15 mm, dy=15 mm

Maximum value of SAR (interpolated) = 0.152 W/kg

Zoom Scan (5x5x7)/Cube 0: Measurement grid: dx=8mm, dy=8mm, dz=5mm

Reference Value = 14.00 V/m; Power Drift = -0.13 dB

Peak SAR (extrapolated) = 0.154 W/kg

SAR(1 g) = 0.152 W/kg; SAR(10 g) = 0.143 W/kg

Smallest distance from peaks to all points 3 dB below: Larger than measurement grid

Ratio of SAR at M2 to SAR at M1 = 97.2%

Maximum value of SAR (measured) = 0.154 W/kg

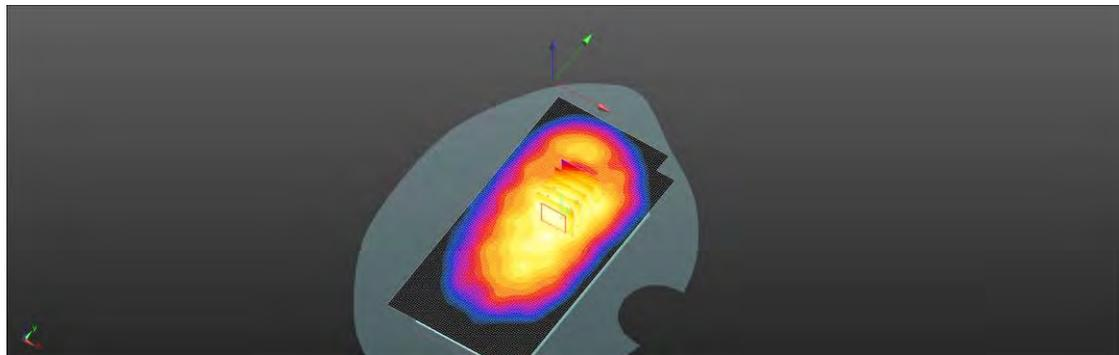
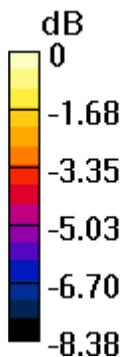

0 dB = 0.154 W/kg = -8.12 dBW/kg

Unless otherwise stated the results shown in this test report refer only to the sample(s) tested and such sample(s) are retained for 90 days only.

除非另有說明，此報告結果僅對測試之樣品負責，同時此樣品僅保留90天。本報告未經本公司書面許可，不可部份複製。

This document is issued by the Company subject to its General Conditions of Service printed overleaf, available on request or accessible at <http://www.sgs.com.tw/Terms-and-Conditions> and for electronic format documents, subject to Terms and Conditions for Electronic Documents at <http://www.sgs.com.tw/Terms-and-Conditions>. Attention is drawn to the limitation of liability, indemnification and jurisdiction issues defined therein. Any holder of this document is advised that information contained hereon reflects the Company's findings at the time of its intervention only and within the limits of Client's instructions, if any. The Company's sole responsibility is to its Client and this document does not exonerate parties to a transaction from exercising all their rights and obligations under the transaction documents. This document cannot be reproduced except in full, without prior written approval of the Company. Any unauthorized alteration, forgery or falsification of the content or appearance of this document is unlawful and offenders may be prosecuted to the fullest extent of the law.

Date: 2020/7/12

Report No. :ES/2020/30005

**LTE Band 25 (20MHz)_Body-worn_Back side_CH
26140_QPSK_1-0_15mm_LAT**

Communication System: LTE; Frequency: 1860 MHz; Duty cycle= 1:1

Medium parameters used: $f = 1860$ MHz; $\sigma = 1.429$ S/m; $\epsilon_r = 39.721$; $\rho = 1000$ kg/m³

Phantom section: Flat Section

Ambient temperature: 21.8°C; Liquid temperature: 21.3°C

DASY5 Configuration:

- Probe: EX3DV4 - SN7509; ConvF(8.07, 8.07, 8.07) @ 1860 MHz; Calibrated: 2020/3/25
- Sensor-Surface: 2mm (Mechanical Surface Detection)
- Electronics: DAE4 Sn558; Calibrated: 2019/10/11
- Phantom: SAM
- DASY52 52.10.4(1527); SEMCAD X 14.6.14(7483)

Area Scan (71x141x1): Interpolated grid: dx=15 mm, dy=15 mm

Maximum value of SAR (interpolated) = 0.379 W/kg

Zoom Scan (5x5x7)/Cube 0: Measurement grid: dx=8mm, dy=8mm, dz=5mm

Reference Value = 10.16 V/m; Power Drift = 0.06 dB

Peak SAR (extrapolated) = 0.334 W/kg

SAR(1 g) = 0.307 W/kg; SAR(10 g) = 0.245 W/kg

Smallest distance from peaks to all points 3 dB below = 16.1 mm

Ratio of SAR at M2 to SAR at M1 = 89.5%

Maximum value of SAR (measured) = 0.319 W/kg

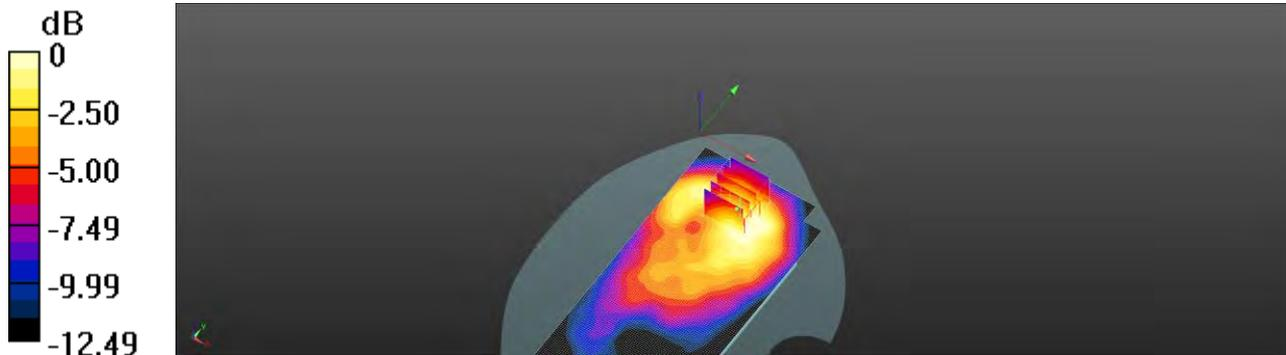

0 dB = 0.319 W/kg = -4.97 dBW/kg

Unless otherwise stated the results shown in this test report refer only to the sample(s) tested and such sample(s) are retained for 90 days only.

除非另有說明，此報告結果僅對測試之樣品負責，同時此樣品僅保留90天。本報告未經本公司書面許可，不可部份複製。

This document is issued by the Company subject to its General Conditions of Service printed overleaf, available on request or accessible at <http://www.sgs.com.tw/Terms-and-Conditions> and for electronic format documents, subject to Terms and Conditions for Electronic Documents at <http://www.sgs.com.tw/Terms-and-Conditions>. Attention is drawn to the limitation of liability, indemnification and jurisdiction issues defined therein. Any holder of this document is advised that information contained hereon reflects the Company's findings at the time of its intervention only and within the limits of Client's instructions, if any. The Company's sole responsibility is to its Client and this document does not exonerate parties to a transaction from exercising all their rights and obligations under the transaction documents. This document cannot be reproduced except in full, without prior written approval of the Company. Any unauthorized alteration, forgery or falsification of the content or appearance of this document is unlawful and offenders may be prosecuted to the fullest extent of the law.

Date: 2020/7/10

Report No. :ES/2020/30005

**LTE Band 26 (15MHz)_Body-worn_Back side_CH
26765_QPSK_1-0_15mm_LAT**

Communication System: LTE; Frequency: 821.5 MHz; Duty cycle= 1:1

Medium parameters used: $f = 821.5 \text{ MHz}$; $\sigma = 0.912 \text{ S/m}$; $\epsilon_r = 42.211$; $\rho = 1000 \text{ kg/m}^3$

Phantom section: Flat Section

Ambient temperature: 22.2°C; Liquid temperature: 21.7°C

DASY5 Configuration:

- Probe: EX3DV4 - SN7509; ConvF(9.73, 9.73, 9.73) @ 821.5 MHz; Calibrated: 2020/3/25
- Sensor-Surface: 2mm (Mechanical Surface Detection)
- Electronics: DAE4 Sn558; Calibrated: 2019/10/11
- Phantom: SAM
- DASY52 52.10.4(1527); SEMCAD X 14.6.14(7483)

Area Scan (71x141x1): Interpolated grid: dx=15 mm, dy=15 mm

Maximum value of SAR (interpolated) = 0.197 W/kg

Zoom Scan (5x5x7)/Cube 0: Measurement grid: dx=8mm, dy=8mm, dz=5mm

Reference Value = 13.30 V/m; Power Drift = -0.19 dB

Peak SAR (extrapolated) = 0.188 W/kg

SAR(1 g) = 0.184 W/kg; SAR(10 g) = 0.166 W/kg

Smallest distance from peaks to all points 3 dB below: Larger than measurement grid

Ratio of SAR at M2 to SAR at M1 = 91.8%

Maximum value of SAR (measured) = 0.186 W/kg

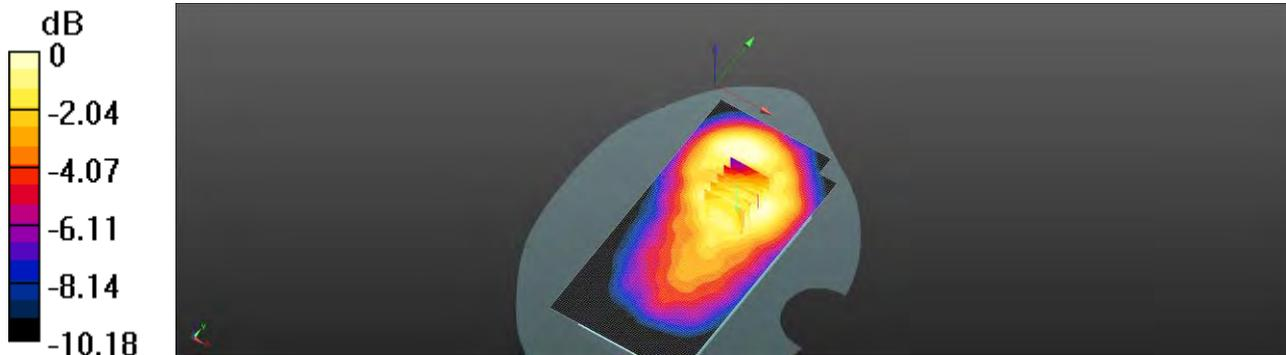

0 dB = 0.186 W/kg = -7.31 dBW/kg

Unless otherwise stated the results shown in this test report refer only to the sample(s) tested and such sample(s) are retained for 90 days only.

除非另有說明，此報告結果僅對測試之樣品負責，同時此樣品僅保留90天。本報告未經本公司書面許可，不可部份複製。

This document is issued by the Company subject to its General Conditions of Service printed overleaf, available on request or accessible at <http://www.sgs.com.tw/Terms-and-Conditions> and for electronic format documents, subject to Terms and Conditions for Electronic Documents at <http://www.sgs.com.tw/Terms-and-Conditions>. Attention is drawn to the limitation of liability, indemnification and jurisdiction issues defined therein. Any holder of this document is advised that information contained hereon reflects the Company's findings at the time of its intervention only and within the limits of Client's instructions, if any. The Company's sole responsibility is to its Client and this document does not exonerate parties to a transaction from exercising all their rights and obligations under the transaction documents. This document cannot be reproduced except in full, without prior written approval of the Company. Any unauthorized alteration, forgery or falsification of the content or appearance of this document is unlawful and offenders may be prosecuted to the fullest extent of the law.

Date: 2020/7/11

Report No. :ES/2020/30005

**LTE Band 66 (20MHz)_Body-worn_Back side_CH
132322_QPSK_1-0_15mm_LAT**

Communication System: LTE; Frequency: 1745 MHz; Duty cycle= 1:1

Medium parameters used: $f = 1745 \text{ MHz}$; $\sigma = 1.388 \text{ S/m}$; $\epsilon_r = 40.806$; $\rho = 1000 \text{ kg/m}^3$

Phantom section: Flat Section

Ambient temperature: 21.4°C; Liquid temperature: 21.8°C

DASY5 Configuration:

- Probe: EX3DV4 - SN7509; ConvF(8.34, 8.34, 8.34) @ 1745 MHz; Calibrated: 2020/3/25
- Sensor-Surface: 2mm (Mechanical Surface Detection)
- Electronics: DAE4 Sn558; Calibrated: 2019/10/11
- Phantom: SAM
- DASY52 52.10.4(1527); SEMCAD X 14.6.14(7483)

Area Scan (71x141x1): Interpolated grid: dx=15 mm, dy=15 mm

Maximum value of SAR (interpolated) = 0.163 W/kg

Zoom Scan (5x5x7)/Cube 0: Measurement grid: dx=8mm, dy=8mm, dz=5mm

Reference Value = 8.045 V/m; Power Drift = -0.12 dB

Peak SAR (extrapolated) = 0.171 W/kg

SAR(1 g) = 0.136 W/kg; SAR(10 g) = 0.099 W/kg

Smallest distance from peaks to all points 3 dB below = 15.1 mm

Ratio of SAR at M2 to SAR at M1 = 74.7%

Maximum value of SAR (measured) = 0.154 W/kg

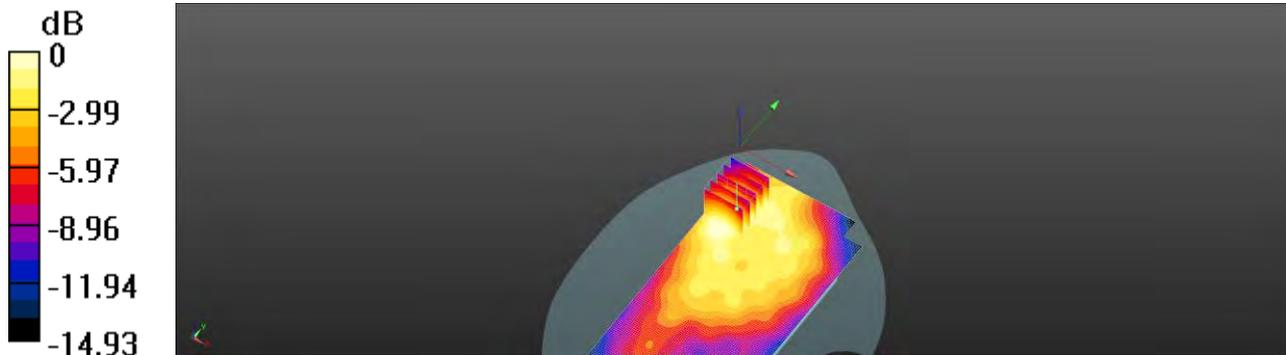

0 dB = 0.154 W/kg = -8.11 dBW/kg

Unless otherwise stated the results shown in this test report refer only to the sample(s) tested and such sample(s) are retained for 90 days only.

除非另有說明，此報告結果僅對測試之樣品負責，同時此樣品僅保留90天。本報告未經本公司書面許可，不可部份複製。

This document is issued by the Company subject to its General Conditions of Service printed overleaf, available on request or accessible at <http://www.sgs.com.tw/Terms-and-Conditions> and for electronic format documents, subject to Terms and Conditions for Electronic Documents at <http://www.sgs.com.tw/Terms-and-Conditions>. Attention is drawn to the limitation of liability, indemnification and jurisdiction issues defined therein. Any holder of this document is advised that information contained hereon reflects the Company's findings at the time of its intervention only and within the limits of Client's instructions, if any. The Company's sole responsibility is to its Client and this document does not exonerate parties to a transaction from exercising all their rights and obligations under the transaction documents. This document cannot be reproduced except in full, without prior written approval of the Company. Any unauthorized alteration, forgery or falsification of the content or appearance of this document is unlawful and offenders may be prosecuted to the fullest extent of the law.

Date: 2020/7/29

Report No. :ES/2020/30005

**LTE Band 12 (10MHz)_Product specific 10g-SAR_Front side_CH
23060_QPSK_1-0_0mm_UAT**

Communication System: LTE; Frequency: 704 MHz; Duty cycle= 1:1

Medium parameters used: $f = 704 \text{ MHz}$; $\sigma = 0.861 \text{ S/m}$; $\epsilon_r = 43.03$; $\rho = 1000 \text{ kg/m}^3$

Phantom section: Flat Section

Ambient temperature: 22.2°C; Liquid temperature: 22.4°C

DASY5 Configuration:

- Probe: EX3DV4 - SN3770; ConvF(9.84, 9.84, 9.84) @ 704 MHz; Calibrated: 2020/05/27
- Sensor-Surface: 2mm (Mechanical Surface Detection)
- Electronics: DAE4 Sn558; Calibrated: 2019/10/11
- Phantom: SAM
- DASY52 52.10.4(1527); SEMCAD X 14.6.14(7483)

Area Scan (71x141x1): Interpolated grid: $dx=15 \text{ mm}$, $dy=15 \text{ mm}$

Maximum value of SAR (interpolated) = 0.900 W/kg

Zoom Scan (5x5x7)/Cube 0: Measurement grid: $dx=8\text{mm}$, $dy=8\text{mm}$, $dz=5\text{mm}$

Reference Value = 5.355 V/m; Power Drift = 0.12 dB

Peak SAR (extrapolated) = 1.28 W/kg

SAR(1 g) = 0.641 W/kg; SAR(10 g) = 0.352 W/kg

Smallest distance from peaks to all points 3 dB below = 10.1 mm

Ratio of SAR at M2 to SAR at M1 = 43.7%

Maximum value of SAR (measured) = 0.895 W/kg

Zoom Scan (5x5x7)/Cube 1: Measurement grid: $dx=8\text{mm}$, $dy=8\text{mm}$, $dz=5\text{mm}$

Reference Value = 5.355 V/m; Power Drift = 0.12 dB

Peak SAR (extrapolated) = 1.07 W/kg

SAR(1 g) = 0.538 W/kg; SAR(10 g) = 0.290 W/kg

Smallest distance from peaks to all points 3 dB below = 9.6 mm

Ratio of SAR at M2 to SAR at M1 = 41.6%

Maximum value of SAR (measured) = 0.779 W/kg

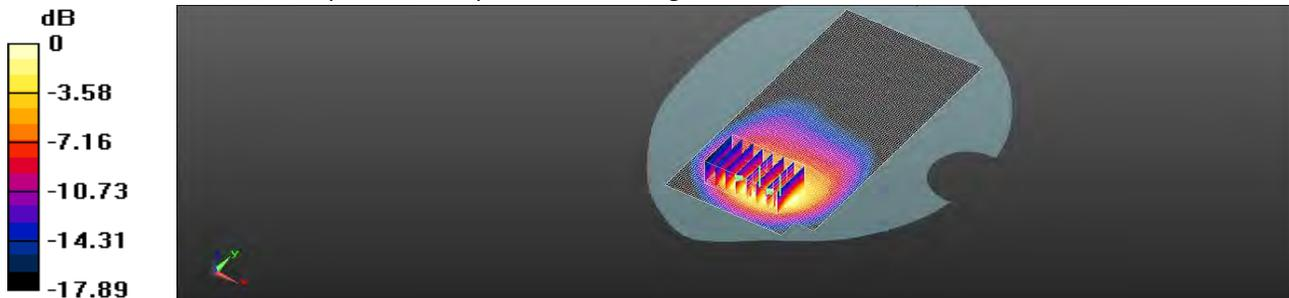

0 dB = 0.779 W/kg = -1.08 dBW/kg

Unless otherwise stated the results shown in this test report refer only to the sample(s) tested and such sample(s) are retained for 90 days only.

除非另有說明，此報告結果僅對測試之樣品負責，同時此樣品僅保留90天。本報告未經本公司書面許可，不可部份複製。

This document is issued by the Company subject to its General Conditions of Service printed overleaf, available on request or accessible at <http://www.sgs.com.tw/Terms-and-Conditions> and for electronic format documents, subject to Terms and Conditions for Electronic Documents at <http://www.sgs.com.tw/Terms-and-Conditions>. Attention is drawn to the limitation of liability, indemnification and jurisdiction issues defined therein. Any holder of this document is advised that information contained hereon reflects the Company's findings at the time of its intervention only and within the limits of Client's instructions, if any. The Company's sole responsibility is to its Client and this document does not exonerate parties to a transaction from exercising all their rights and obligations under the transaction documents. This document cannot be reproduced except in full, without prior written approval of the Company. Any unauthorized alteration, forgery or falsification of the content or appearance of this document is unlawful and offenders may be prosecuted to the fullest extent of the law.

Date: 2020/7/30

Report No. :ES/2020/30005

**LTE Band 26 (15MHz)_Product specific 10g-SAR_Front side_CH
26765_QPSK_1-0_0mm_UAT**

Communication System: LTE; Frequency: 821.5 MHz; Duty cycle= 1:1

Medium parameters used: $f = 821.5 \text{ MHz}$; $\sigma = 0.887 \text{ S/m}$; $\epsilon_r = 42.382$; $\rho = 1000 \text{ kg/m}^3$

Phantom section: Flat Section

Ambient temperature: 22.3°C; Liquid temperature: 22.1°C

DASY5 Configuration:

- Probe: EX3DV4 - SN3770; ConvF(9.5, 9.5, 9.5) @ 821.5 MHz; Calibrated: 2020/05/27
- Sensor-Surface: 2mm (Mechanical Surface Detection)
- Electronics: DAE4 Sn558; Calibrated: 2019/10/11
- Phantom: SAM
- DASY52 52.10.4(1527); SEMCAD X 14.6.14(7483)

Area Scan (71x141x1): Interpolated grid: dx=15 mm, dy=15 mm

Maximum value of SAR (interpolated) = 1.00 W/kg

Zoom Scan (5x5x7)/Cube 0: Measurement grid: dx=8mm, dy=8mm, dz=5mm

Reference Value = 4.772 V/m; Power Drift = 0.13 dB

Peak SAR (extrapolated) = 1.32 W/kg

SAR(1 g) = 0.738 W/kg; SAR(10 g) = 0.419 W/kg

Smallest distance from peaks to all points 3 dB below = 9.8 mm

Ratio of SAR at M2 to SAR at M1 = 47.2%

Maximum value of SAR (measured) = 0.978 W/kg

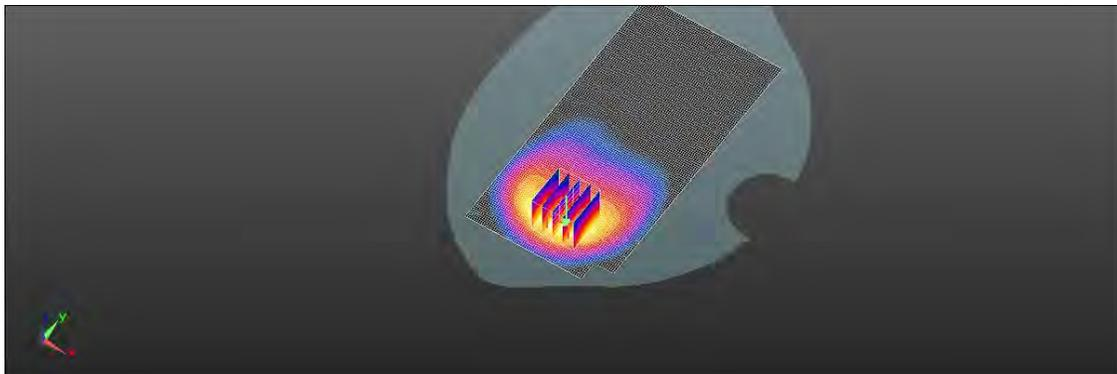
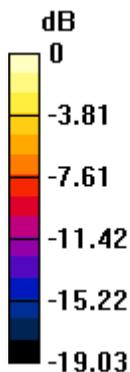

0 dB = 0.978 W/kg = -0.10 dBW/kg

Unless otherwise stated the results shown in this test report refer only to the sample(s) tested and such sample(s) are retained for 90 days only.

除非另有說明，此報告結果僅對測試之樣品負責，同時此樣品僅保留90天。本報告未經本公司書面許可，不可部份複製。

This document is issued by the Company subject to its General Conditions of Service printed overleaf, available on request or accessible at <http://www.sgs.com.tw/Terms-and-Conditions> and for electronic format documents, subject to Terms and Conditions for Electronic Documents at <http://www.sgs.com.tw/Terms-and-Conditions>. Attention is drawn to the limitation of liability, indemnification and jurisdiction issues defined therein. Any holder of this document is advised that information contained hereon reflects the Company's findings at the time of its intervention only and within the limits of Client's instructions, if any. The Company's sole responsibility is to its Client and this document does not exonerate parties to a transaction from exercising all their rights and obligations under the transaction documents. This document cannot be reproduced except in full, without prior written approval of the Company. Any unauthorized alteration, forgery or falsification of the content or appearance of this document is unlawful and offenders may be prosecuted to the fullest extent of the law.

Date: 2020/7/29

Report No. :ES/2020/30005

**LTE Band 12 (10MHz)_Product specific 10g-SAR_Front_CH
23060_QPSK_1-0_0mm_LAT**

Communication System: LTE; Frequency: 704 MHz; Duty cycle= 1:1

Medium parameters used: $f = 704 \text{ MHz}$; $\sigma = 0.861 \text{ S/m}$; $\epsilon_r = 43.03$; $\rho = 1000 \text{ kg/m}^3$

Phantom section: Flat Section

Ambient temperature: 22.2°C ; Liquid temperature: 22.4°C

DASY5 Configuration:

- Probe: EX3DV4 - SN3770; ConvF(9.84, 9.84, 9.84) @ 704 MHz; Calibrated: 2020/05/27
- Sensor-Surface: 2mm (Mechanical Surface Detection)
- Electronics: DAE4 Sn558; Calibrated: 2019/10/11
- Phantom: SAM
- DASY52 52.10.4(1527); SEMCAD X 14.6.14(7483)

Area Scan (71x141x1): Interpolated grid: $dx=15 \text{ mm}$, $dy=15 \text{ mm}$

Maximum value of SAR (interpolated) = 1.32 W/kg

Zoom Scan (5x5x7)/Cube 0: Measurement grid: $dx=8\text{mm}$, $dy=8\text{mm}$, $dz=5\text{mm}$

Reference Value = 7.289 V/m ; Power Drift = 0.15 dB

Peak SAR (extrapolated) = 1.94 W/kg

SAR(1 g) = 0.935 W/kg ; SAR(10 g) = 0.503 W/kg

Smallest distance from peaks to all points 3 dB below = 8.3 mm

Ratio of SAR at M2 to SAR at M1 = 42.4%

Maximum value of SAR (measured) = 1.36 W/kg

Zoom Scan (5x5x7)/Cube 1: Measurement grid: $dx=8\text{mm}$, $dy=8\text{mm}$, $dz=5\text{mm}$

Reference Value = 7.289 V/m ; Power Drift = 0.15 dB

Peak SAR (extrapolated) = 1.78 W/kg

SAR(1 g) = 0.813 W/kg ; SAR(10 g) = 0.428 W/kg

Smallest distance from peaks to all points 3 dB below = 9.6 mm

Ratio of SAR at M2 to SAR at M1 = 40.9%

Maximum value of SAR (measured) = 1.25 W/kg

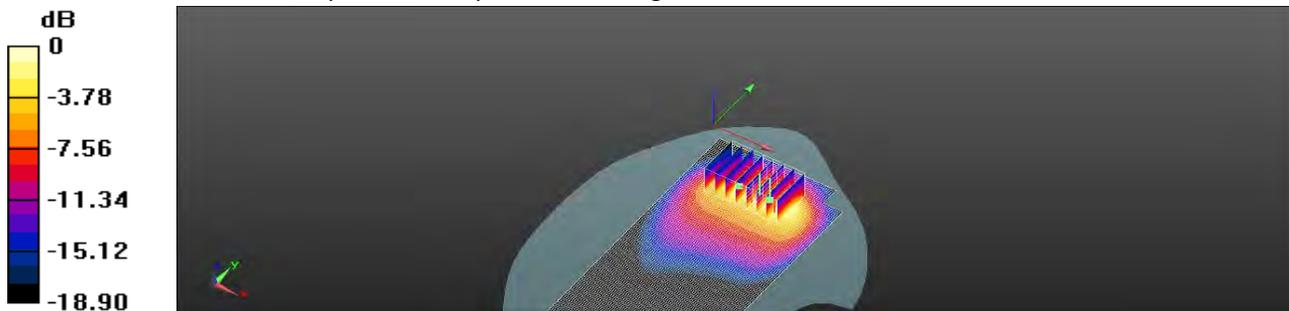

$0 \text{ dB} = 1.25 \text{ W/kg} = 0.97 \text{ dBW/kg}$

Unless otherwise stated the results shown in this test report refer only to the sample(s) tested and such sample(s) are retained for 90 days only.

除非另有說明，此報告結果僅對測試之樣品負責，同時此樣品僅保留90天。本報告未經本公司書面許可，不可部份複製。

This document is issued by the Company subject to its General Conditions of Service printed overleaf, available on request or accessible at <http://www.sgs.com.tw/Terms-and-Conditions> and for electronic format documents, subject to Terms and Conditions for Electronic Documents at <http://www.sgs.com.tw/Terms-and-Conditions>. Attention is drawn to the limitation of liability, indemnification and jurisdiction issues defined therein. Any holder of this document is advised that information contained hereon reflects the Company's findings at the time of its intervention only and within the limits of Client's instructions, if any. The Company's sole responsibility is to its Client and this document does not exonerate parties to a transaction from exercising all their rights and obligations under the transaction documents. This document cannot be reproduced except in full, without prior written approval of the Company. Any unauthorized alteration, forgery or falsification of the content or appearance of this document is unlawful and offenders may be prosecuted to the fullest extent of the law.

Date: 2020/8/1

Report No. :ES/2020/30005

**LTE Band 25 (20MHz)_Product specific 10g-SAR_Bottom side_CH
26590_QPSK_1-0_0mm_LAT**

Communication System: LTE; Frequency: 1905 MHz; Duty cycle= 1:1

Medium parameters used: $f = 1905$ MHz; $\sigma = 1.424$ S/m; $\epsilon_r = 39.355$; $\rho = 1000$ kg/m³

Phantom section: Flat Section

Ambient temperature: 22.4°C; Liquid temperature: 22.6°C

DASY5 Configuration:

- Probe: EX3DV4 - SN3770; ConvF(8.03, 8.03, 8.03) @ 1905 MHz; Calibrated: 2020/05/27
- Sensor-Surface: 2mm (Mechanical Surface Detection)
- Electronics: DAE4 Sn558; Calibrated: 2019/10/11
- Phantom: SAM
- DASY52 52.10.4(1527); SEMCAD X 14.6.14(7483)

Area Scan (61x101x1): Interpolated grid: dx=15 mm, dy=15 mm

Maximum value of SAR (interpolated) = 3.60 W/kg

Zoom Scan (5x5x7)/Cube 0: Measurement grid: dx=8mm, dy=8mm, dz=5mm

Reference Value = 47.67 V/m; Power Drift = 0.12 dB

Peak SAR (extrapolated) = 5.07 W/kg

SAR(1 g) = 2.37 W/kg; SAR(10 g) = 1.06 W/kg

Smallest distance from peaks to all points 3 dB below = 8.5 mm

Ratio of SAR at M2 to SAR at M1 = 31.8%

Maximum value of SAR (measured) = 3.68 W/kg

Zoom Scan (5x5x7)/Cube 1: Measurement grid: dx=8mm, dy=8mm, dz=5mm

Reference Value = 47.67 V/m; Power Drift = 0.12 dB

Peak SAR (extrapolated) = 2.98 W/kg

SAR(1 g) = 2.01 W/kg; SAR(10 g) = 1.23 W/kg

Smallest distance from peaks to all points 3 dB below = 9.4 mm

Ratio of SAR at M2 to SAR at M1 = 53.1%

Maximum value of SAR (measured) = 2.36 W/kg

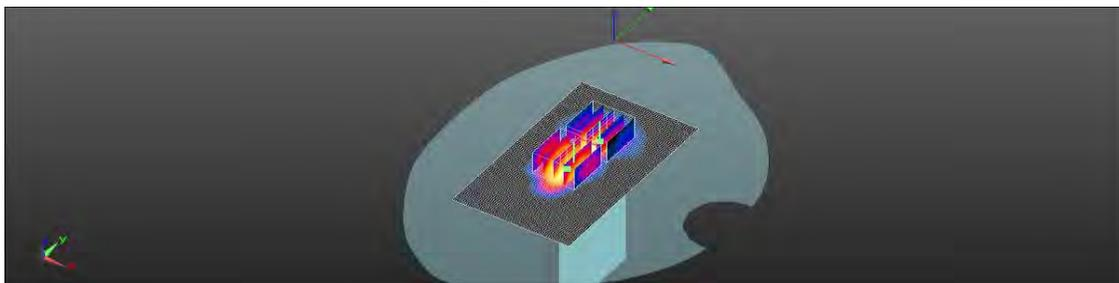
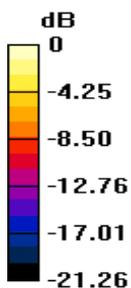

0 dB = 2.36 W/kg = 3.73 dBW/kg

Unless otherwise stated the results shown in this test report refer only to the sample(s) tested and such sample(s) are retained for 90 days only.

除非另有說明，此報告結果僅對測試之樣品負責，同時此樣品僅保留90天。本報告未經本公司書面許可，不可部份複製。

This document is issued by the Company subject to its General Conditions of Service printed overleaf, available on request or accessible at <http://www.sgs.com.tw/Terms-and-Conditions> and for electronic format documents, subject to Terms and Conditions for Electronic Documents at <http://www.sgs.com.tw/Terms-and-Conditions>. Attention is drawn to the limitation of liability, indemnification and jurisdiction issues defined therein. Any holder of this document is advised that information contained hereon reflects the Company's findings at the time of its intervention only and within the limits of Client's instructions, if any. The Company's sole responsibility is to its Client and this document does not exonerate parties to a transaction from exercising all their rights and obligations under the transaction documents. This document cannot be reproduced except in full, without prior written approval of the Company. Any unauthorized alteration, forgery or falsification of the content or appearance of this document is unlawful and offenders may be prosecuted to the fullest extent of the law.

Date: 2020/7/30

Report No. :ES/2020/30005

**LTE Band 26 (15MHz)_Product specific 10g-SAR_Front_CH
26765_QPSK_1-0_0mm_LAT**

Communication System: LTE; Frequency: 821.5 MHz; Duty cycle= 1:1

Medium parameters used: $f = 821.5 \text{ MHz}$; $\sigma = 0.887 \text{ S/m}$; $\epsilon_r = 42.382$; $\rho = 1000 \text{ kg/m}^3$

Phantom section: Flat Section

Ambient temperature: 22.3°C; Liquid temperature: 22.1°C

DASY5 Configuration:

- Probe: EX3DV4 - SN3770; ConvF(9.5, 9.5, 9.5) @ 821.5 MHz; Calibrated: 2020/05/27
- Sensor-Surface: 2mm (Mechanical Surface Detection)
- Electronics: DAE4 Sn558; Calibrated: 2019/10/11
- Phantom: SAM
- DASY52 52.10.4(1527); SEMCAD X 14.6.14(7483)

Area Scan (71x141x1): Interpolated grid: dx=15 mm, dy=15 mm

Maximum value of SAR (interpolated) = 1.71 W/kg

Zoom Scan (5x5x7)/Cube 0: Measurement grid: dx=8mm, dy=8mm, dz=5mm

Reference Value = 6.971 V/m; Power Drift = 0.03 dB

Peak SAR (extrapolated) = 2.29 W/kg

SAR(1 g) = 1.27 W/kg; SAR(10 g) = 0.726 W/kg

Smallest distance from peaks to all points 3 dB below = 8 mm

Ratio of SAR at M2 to SAR at M1 = 47.6%

Maximum value of SAR (measured) = 1.71 W/kg

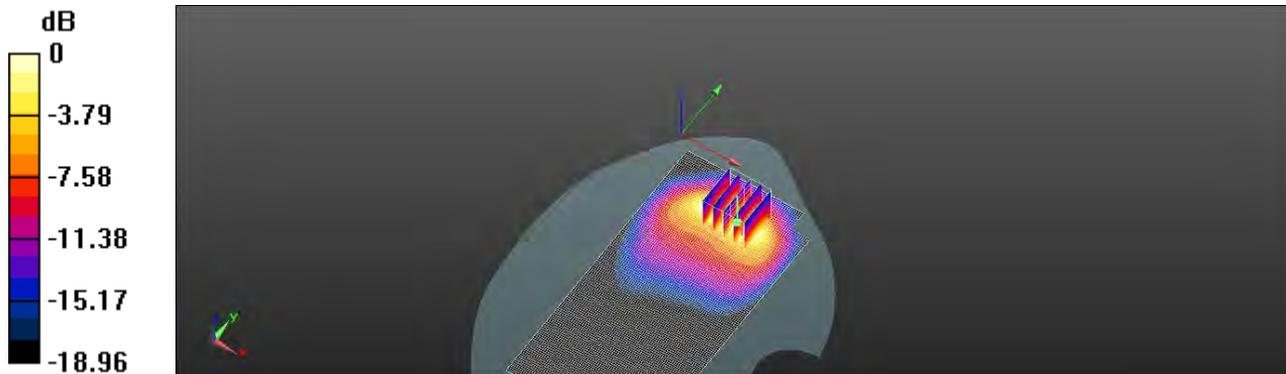

0 dB = 1.71 W/kg = 2.33 dBW/kg

Unless otherwise stated the results shown in this test report refer only to the sample(s) tested and such sample(s) are retained for 90 days only.

除非另有說明，此報告結果僅對測試之樣品負責，同時此樣品僅保留90天。本報告未經本公司書面許可，不可部份複製。

This document is issued by the Company subject to its General Conditions of Service printed overleaf, available on request or accessible at <http://www.sgs.com.tw/Terms-and-Conditions> and for electronic format documents, subject to Terms and Conditions for Electronic Documents at <http://www.sgs.com.tw/Terms-and-Conditions>. Attention is drawn to the limitation of liability, indemnification and jurisdiction issues defined therein. Any holder of this document is advised that information contained hereon reflects the Company's findings at the time of its intervention only and within the limits of Client's instructions, if any. The Company's sole responsibility is to its Client and this document does not exonerate parties to a transaction from exercising all their rights and obligations under the transaction documents. This document cannot be reproduced except in full, without prior written approval of the Company. Any unauthorized alteration, forgery or falsification of the content or appearance of this document is unlawful and offenders may be prosecuted to the fullest extent of the law.

Date: 2020/7/31

Report No. : ES/2020/30005

**LTE Band 66 (20MHz)_Product specific 10g-SAR_Bottom side_CH
132572_QPSK_1-0_0mm_LAT**

Communication System: LTE; Frequency: 1770 MHz; Duty cycle= 1:1

Medium parameters used: $f = 1770$ MHz; $\sigma = 1.383$ S/m; $\epsilon_r = 39.928$; $\rho = 1000$ kg/m³

Phantom section: Flat Section

Ambient temperature: 21.8°C; Liquid temperature: 22.1°C

DASY5 Configuration:

- Probe: EX3DV4 - SN3770; ConvF(8.36, 8.36, 8.36) @ 1770 MHz; Calibrated: 2020/05/27
- Sensor-Surface: 2mm (Mechanical Surface Detection)
- Electronics: DAE4 Sn558; Calibrated: 2019/10/11
- Phantom: SAM
- DASY52 52.10.4(1527); SEMCAD X 14.6.14(7483)

Area Scan (61x101x1): Interpolated grid: dx=15 mm, dy=15 mm

Maximum value of SAR (interpolated) = 2.99 W/kg

Zoom Scan (5x5x7)/Cube 0: Measurement grid: dx=8mm, dy=8mm, dz=5mm

Reference Value = 59.37 V/m; Power Drift = 0.09 dB

Peak SAR (extrapolated) = 4.25 W/kg

SAR(1 g) = 2.14 W/kg; SAR(10 g) = 1.08 W/kg

Smallest distance from peaks to all points 3 dB below = 8.8 mm

Ratio of SAR at M2 to SAR at M1 = 31.7%

Maximum value of SAR (measured) = 2.92 W/kg

Zoom Scan (5x5x7)/Cube 1: Measurement grid: dx=8mm, dy=8mm, dz=5mm

Reference Value = 59.37 V/m; Power Drift = 0.09 dB

Peak SAR (extrapolated) = 3.22 W/kg

SAR(1 g) = 2.22 W/kg; SAR(10 g) = 1.42 W/kg

Smallest distance from peaks to all points 3 dB below = 9.4 mm

Ratio of SAR at M2 to SAR at M1 = 53.7%

Maximum value of SAR (measured) = 2.66 W/kg

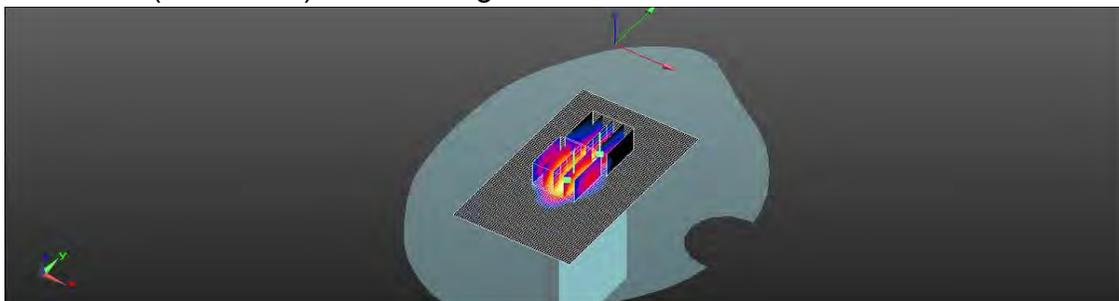
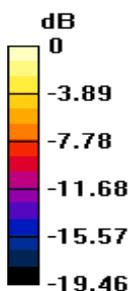

0 dB = 2.66 W/kg = 4.25 dBW/kg

Unless otherwise stated the results shown in this test report refer only to the sample(s) tested and such sample(s) are retained for 90 days only.

除非另有說明，此報告結果僅對測試之樣品負責，同時此樣品僅保留90天。本報告未經本公司書面許可，不可部份複製。

This document is issued by the Company subject to its General Conditions of Service printed overleaf, available on request or accessible at <http://www.sgs.com.tw/Terms-and-Conditions> and for electronic format documents, subject to Terms and Conditions for Electronic Documents at <http://www.sgs.com.tw/Terms-and-Conditions>. Attention is drawn to the limitation of liability, indemnification and jurisdiction issues defined therein. Any holder of this document is advised that information contained hereon reflects the Company's findings at the time of its intervention only and within the limits of Client's instructions, if any. The Company's sole responsibility is to its Client and this document does not exonerate parties to a transaction from exercising all their rights and obligations under the transaction documents. This document cannot be reproduced except in full, without prior written approval of the Company. Any unauthorized alteration, forgery or falsification of the content or appearance of this document is unlawful and offenders may be prosecuted to the fullest extent of the law.

Date: 2020/7/15

Report No. :ES/2020/30005

LTE Band 26 (15MHz)_Hotspot_Front side_CH 26765_QPSK_1-0_10mm_UAT

Communication System: LTE; Frequency: 821.5 MHz; Duty cycle= 1:1

Medium parameters used: $f = 821.5$ MHz; $\sigma = 0.884$ S/m; $\epsilon_r = 42.515$; $\rho = 1000$ kg/m³

Phantom section: Flat Section

Ambient temperature: 21.9°C; Liquid temperature: 22.3°C

DASY5 Configuration:

- Probe: EX3DV4 - SN7509; ConvF(9.73, 9.73, 9.73) @ 821.5 MHz; Calibrated: 2020/03/25
- Sensor-Surface: 2mm (Mechanical Surface Detection)
- Electronics: DAE4 Sn558; Calibrated: 2019/10/11
- Phantom: SAM
- DASY52 52.10.4(1527); SEMCAD X 14.6.14(7483)

Area Scan (71x141x1): Interpolated grid: dx=15 mm, dy=15 mm

Maximum value of SAR (interpolated) = 0.313 W/kg

Zoom Scan (5x5x7)/Cube 0: Measurement grid: dx=8mm, dy=8mm, dz=5mm

Reference Value = 8.313 V/m; Power Drift = 0.14 dB

Peak SAR (extrapolated) = 0.349 W/kg

SAR(1 g) = 0.271 W/kg; SAR(10 g) = 0.194 W/kg

Smallest distance from peaks to all points 3 dB below = 12.5 mm

Ratio of SAR at M2 to SAR at M1 = 76.9%

Maximum value of SAR (measured) = 0.315 W/kg

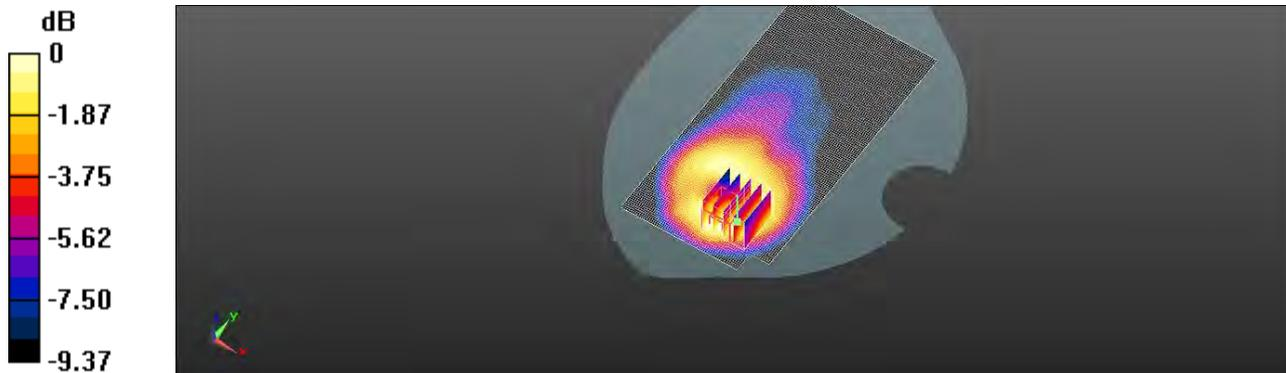

0 dB = 0.315 W/kg = -5.02 dBW/kg

Unless otherwise stated the results shown in this test report refer only to the sample(s) tested and such sample(s) are retained for 90 days only.

除非另有說明，此報告結果僅對測試之樣品負責，同時此樣品僅保留90天。本報告未經本公司書面許可，不可部份複製。

This document is issued by the Company subject to its General Conditions of Service printed overleaf, available on request or accessible at <http://www.sgs.com.tw/Terms-and-Conditions> and for electronic format documents, subject to Terms and Conditions for Electronic Documents at <http://www.sgs.com.tw/Terms-and-Conditions>. Attention is drawn to the limitation of liability, indemnification and jurisdiction issues defined therein. Any holder of this document is advised that information contained hereon reflects the Company's findings at the time of its intervention only and within the limits of Client's instructions, if any. The Company's sole responsibility is to its Client and this document does not exonerate parties to a transaction from exercising all their rights and obligations under the transaction documents. This document cannot be reproduced except in full, without prior written approval of the Company. Any unauthorized alteration, forgery or falsification of the content or appearance of this document is unlawful and offenders may be prosecuted to the fullest extent of the law.

Date: 2020/7/17

Report No. :ES/2020/30005

LTE Band 2 (20MHz)_Body-worn_Back side_CH 18700_QPSK_1-0_15mm_LAT

Communication System: LTE; Frequency: 1860 MHz; Duty cycle= 1:1

Medium parameters used: $f = 1860$ MHz; $\sigma = 1.39$ S/m; $\epsilon_r = 39.914$; $\rho = 1000$ kg/m³

Phantom section: Flat Section

Ambient temperature: 22.0°C; Liquid temperature: 22.0°C

DASY5 Configuration:

- Probe: EX3DV4 - SN7509; ConvF(8.07, 8.07, 8.07) @ 1860 MHz; Calibrated: 2020/03/25
- Sensor-Surface: 2mm (Mechanical Surface Detection)
- Electronics: DAE4 Sn558; Calibrated: 2019/10/11
- Phantom: SAM
- DASY52 52.10.4(1527); SEMCAD X 14.6.14(7483)

Area Scan (71x141x1): Interpolated grid: dx=15 mm, dy=15 mm

Maximum value of SAR (interpolated) = 0.556 W/kg

Zoom Scan (5x5x7)/Cube 0: Measurement grid: dx=8mm, dy=8mm, dz=5mm

Reference Value = 10.16 V/m; Power Drift = 0.06 dB

Peak SAR (extrapolated) = 0.490 W/kg

SAR(1 g) = 0.441 W/kg; SAR(10 g) = 0.336 W/kg

Smallest distance from peaks to all points 3 dB below = 16.1 mm

Ratio of SAR at M2 to SAR at M1 = 89.5%

Maximum value of SAR (measured) = 0.468 W/kg

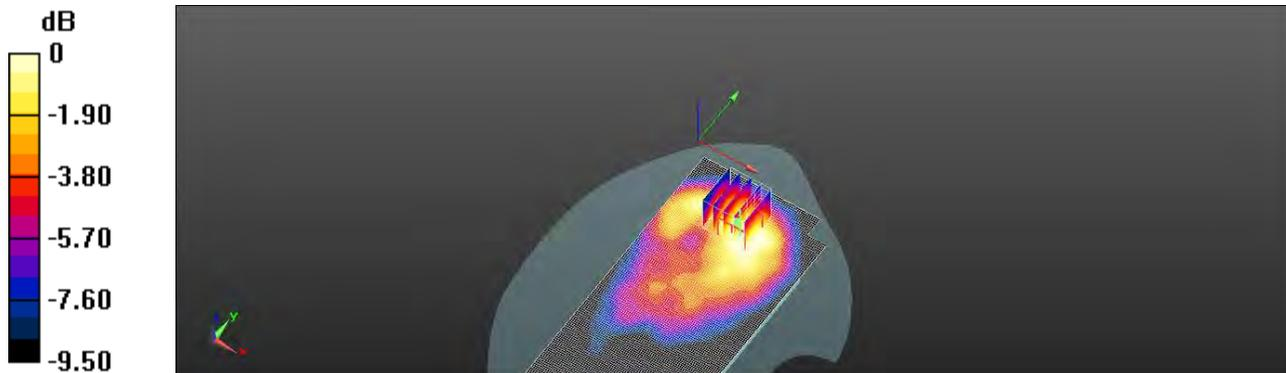

0 dB = 0.468 W/kg = -3.30 dBW/kg

Unless otherwise stated the results shown in this test report refer only to the sample(s) tested and such sample(s) are retained for 90 days only.

除非另有說明，此報告結果僅對測試之樣品負責，同時此樣品僅保留90天。本報告未經本公司書面許可，不可部份複製。

This document is issued by the Company subject to its General Conditions of Service printed overleaf, available on request or accessible at <http://www.sgs.com.tw/Terms-and-Conditions> and for electronic format documents, subject to Terms and Conditions for Electronic Documents at <http://www.sgs.com.tw/Terms-and-Conditions>. Attention is drawn to the limitation of liability, indemnification and jurisdiction issues defined therein. Any holder of this document is advised that information contained hereon reflects the Company's findings at the time of its intervention only and within the limits of Client's instructions, if any. The Company's sole responsibility is to its Client and this document does not exonerate parties to a transaction from exercising all their rights and obligations under the transaction documents. This document cannot be reproduced except in full, without prior written approval of the Company. Any unauthorized alteration, forgery or falsification of the content or appearance of this document is unlawful and offenders may be prosecuted to the fullest extent of the law.