

Band38\_15MHz\_QPSK\_75\_0\_Main\_LowCH37825-2577.5

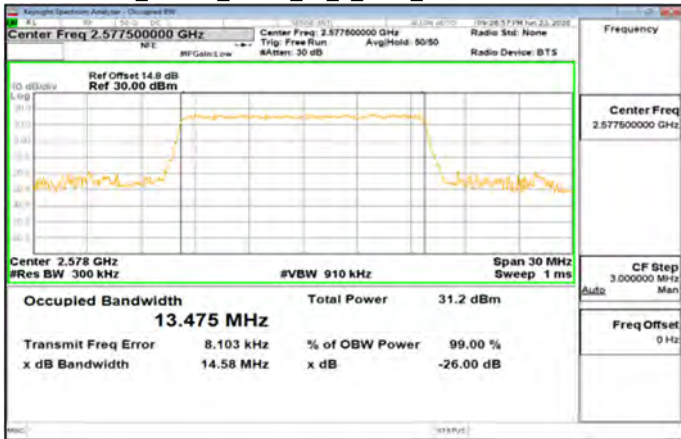

Band38\_15MHz\_16QAM\_75\_0\_Main\_LowCH37825-2577.5

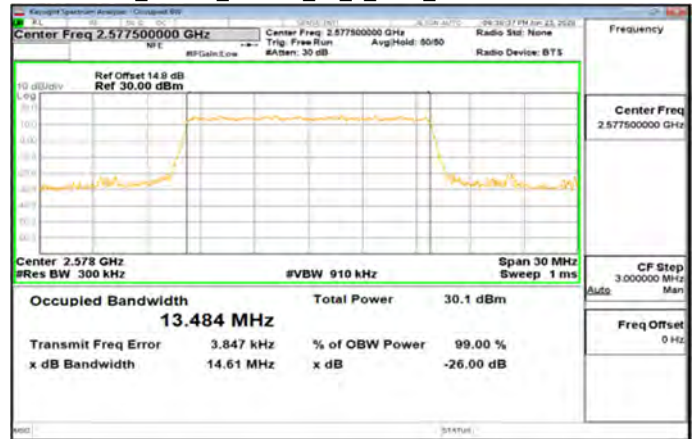

Band38\_15MHz\_QPSK\_75\_0\_Main\_MidCH38000-2595

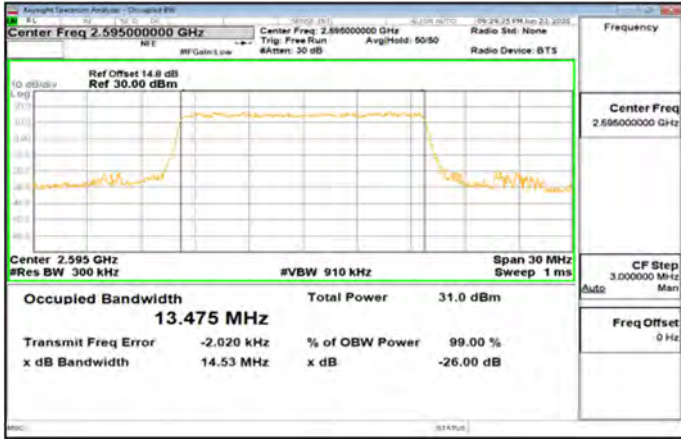

Band38\_15MHz\_16QAM\_75\_0\_Main\_MidCH38000-2595

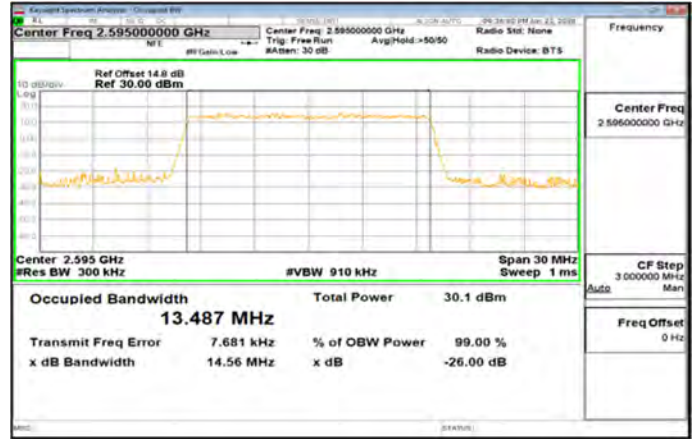

Band38\_15MHz\_QPSK\_75\_0\_Main\_HighCH38175-2612.5

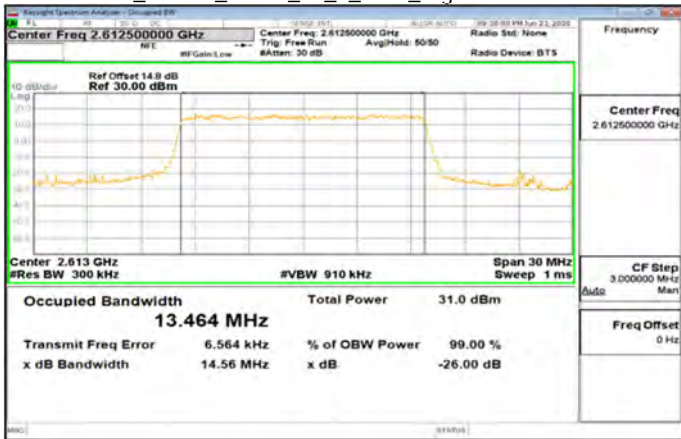

Band38\_15MHz\_16QAM\_75\_0\_Main\_HighCH38175-2612.5

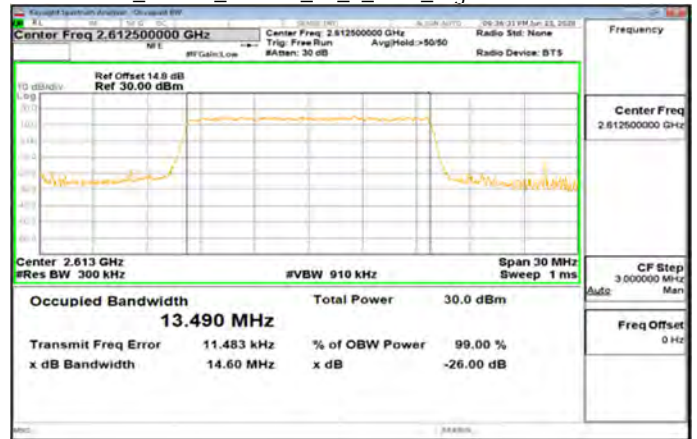

Unless otherwise stated the results shown in this test report refer only to the sample(s) tested and such sample(s) are retained for 90 days only.

除非另有說明，此報告結果僅對測試之樣品負責，同時此樣品僅保留90天。本報告未經本公司書面許可，不可部份複製。

This document is issued by the Company subject to its General Conditions of Service printed overleaf, available on request or accessible at <http://www.sgs.com.tw/Terms-and-Conditions> and for electronic format documents, subject to Terms and Conditions for Electronic Documents at <http://www.sgs.com.tw/Terms-and-Conditions>. Attention is drawn to the limitation of liability, indemnification and jurisdiction issues defined therein. Any holder of this document is advised that information contained hereon reflects the Company's findings at the time of its intervention only and within the limits of Client's instructions, if any. The Company's sole responsibility is to its Client and this document does not exonerate parties to a transaction from exercising all their rights and obligations under the transaction documents. This document cannot be reproduced except in full, without prior written approval of the Company. Any unauthorized alteration, forgery or falsification of the content or appearance of this document is unlawful and offenders may be prosecuted to the fullest extent of the law.

Band38\_15MHz\_64QAM\_75\_0\_Main\_LowCH37825-2577.5

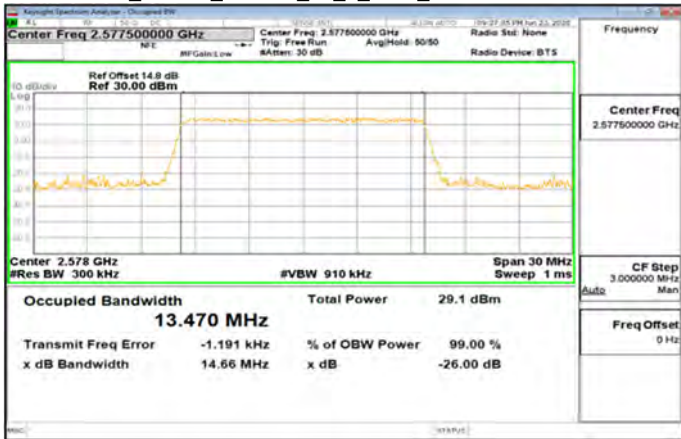

Band38\_15MHz\_256QAM\_75\_0\_Main\_LowCH37825-2577.5

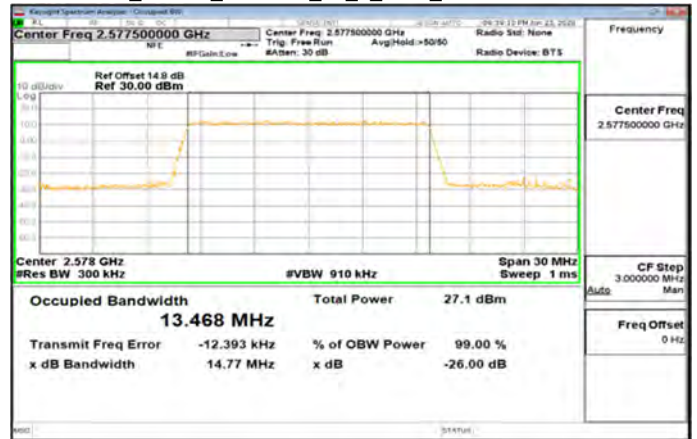

Band38\_15MHz\_64QAM\_75\_0\_Main\_MidCH38000-2595

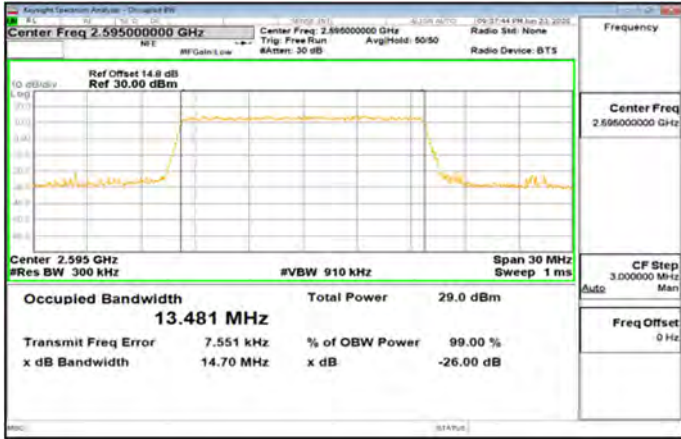

Band38\_15MHz\_256QAM\_75\_0\_Main\_MidCH38000-2595

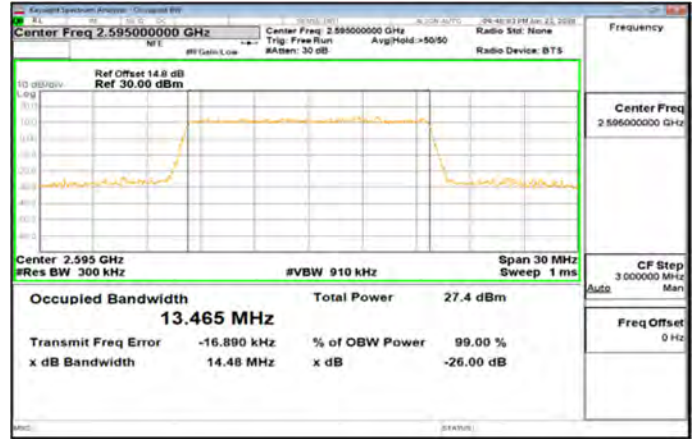

Band38\_15MHz\_64QAM\_75\_0\_Main\_HighCH38175-2612.5

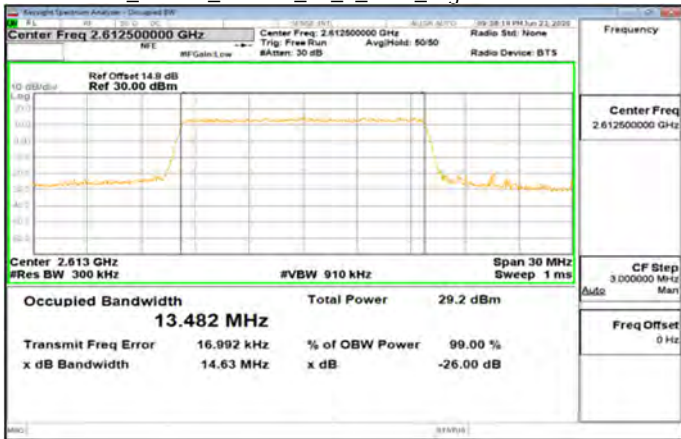

Band38\_15MHz\_256QAM\_75\_0\_Main\_HighCH38175-2612.5

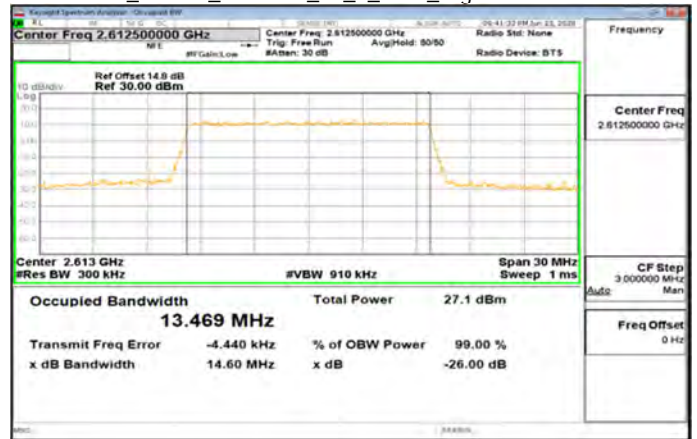

Unless otherwise stated the results shown in this test report refer only to the sample(s) tested and such sample(s) are retained for 90 days only.

除非另有說明，此報告結果僅對測試之樣品負責，同時此樣品僅保留90天。本報告未經本公司書面許可，不可部份複製。

This document is issued by the Company subject to its General Conditions of Service printed overleaf, available on request or accessible at <http://www.sgs.com.tw/Terms-and-Conditions> and for electronic format documents, subject to Terms and Conditions for Electronic Documents at <http://www.sgs.com.tw/Terms-and-Conditions>. Attention is drawn to the limitation of liability, indemnification and jurisdiction issues defined therein. Any holder of this document is advised that information contained hereon reflects the Company's findings at the time of its intervention only and within the limits of Client's instructions, if any. The Company's sole responsibility is to its Client and this document does not exonerate parties to a transaction from exercising all their rights and obligations under the transaction documents. This document cannot be reproduced except in full, without prior written approval of the Company. Any unauthorized alteration, forgery or falsification of the content or appearance of this document is unlawful and offenders may be prosecuted to the fullest extent of the law.









Band41\_5MHz\_QPSK\_25\_0\_Main\_LowCH39675-2498.5

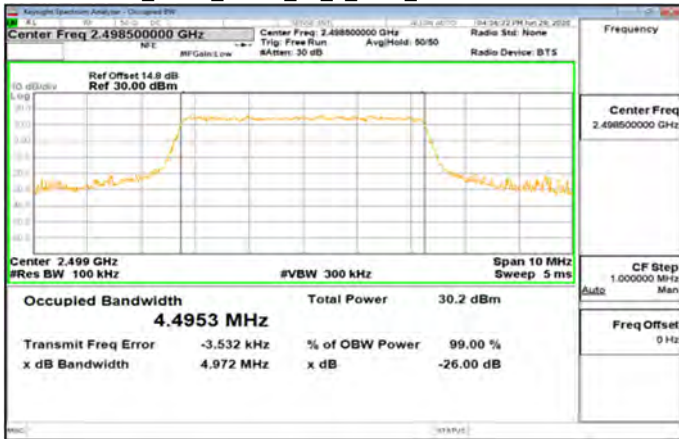

Band41\_5MHz\_16QAM\_25\_0\_Main\_LowCH39675-2498.5

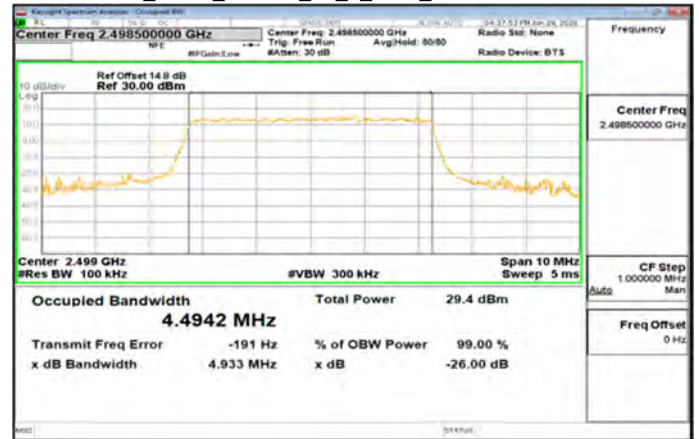

Band41\_5MHz\_QPSK\_25\_0\_Main\_MidCH40620-2593

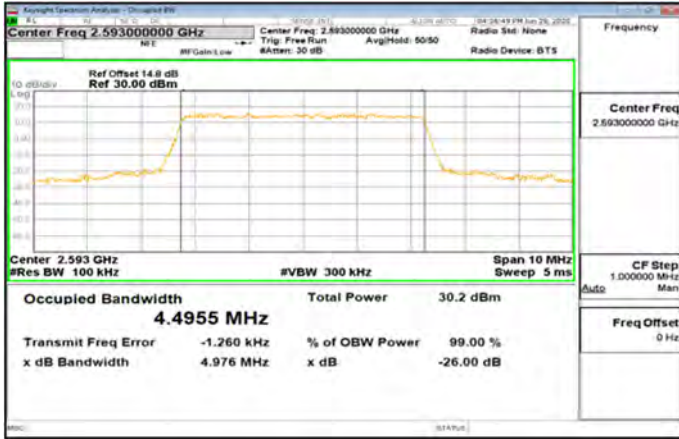

Band41\_5MHz\_16QAM\_25\_0\_Main\_MidCH40620-2593

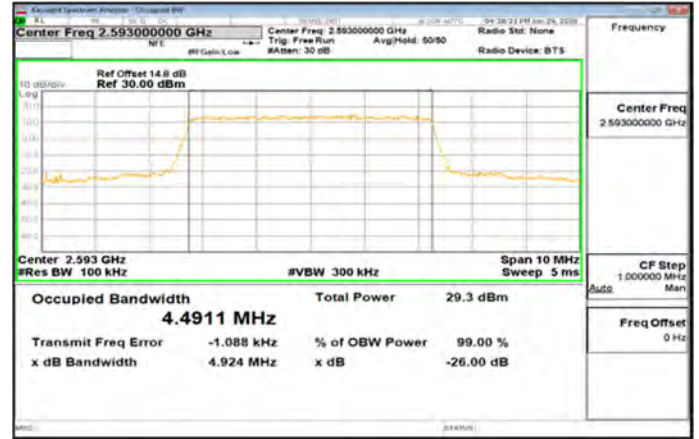

Band41\_5MHz\_QPSK\_25\_0\_Main\_HighCH41565-2687.5

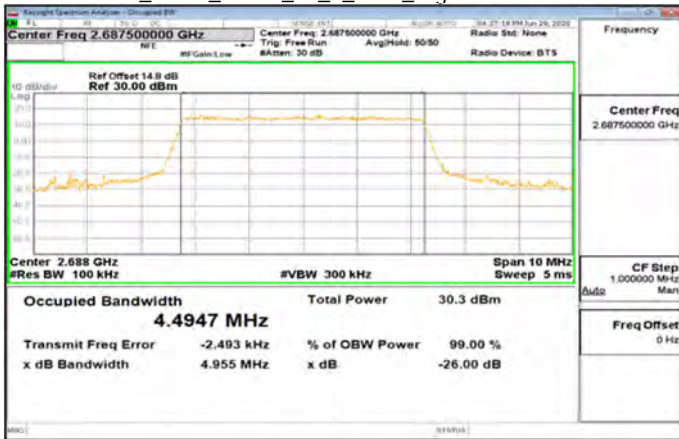

Band41\_5MHz\_16QAM\_25\_0\_Main\_HighCH41565-2687.5

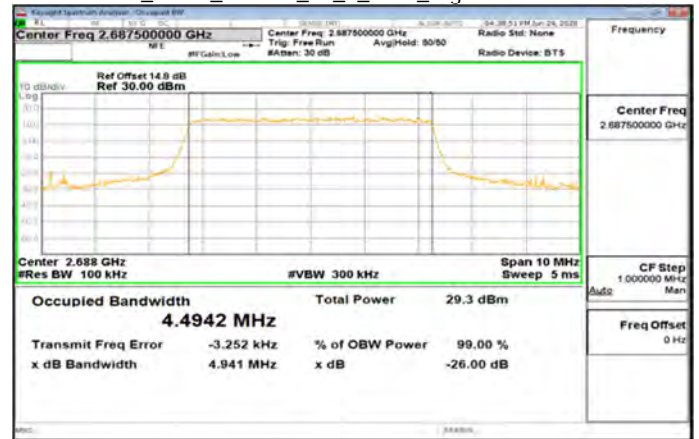

Unless otherwise stated the results shown in this test report refer only to the sample(s) tested and such sample(s) are retained for 90 days only.

除非另有說明，此報告結果僅對測試之樣品負責，同時此樣品僅保留90天。本報告未經本公司書面許可，不可部份複製。

This document is issued by the Company subject to its General Conditions of Service printed overleaf, available on request or accessible at <http://www.sgs.com.tw/Terms-and-Conditions> and for electronic format documents, subject to Terms and Conditions for Electronic Documents at <http://www.sgs.com.tw/Terms-and-Conditions>. Attention is drawn to the limitation of liability, indemnification and jurisdiction issues defined therein. Any holder of this document is advised that information contained hereon reflects the Company's findings at the time of its intervention only and within the limits of Client's instructions, if any. The Company's sole responsibility is to its Client and this document does not exonerate parties to a transaction from exercising all their rights and obligations under the transaction documents. This document cannot be reproduced except in full, without prior written approval of the Company. Any unauthorized alteration, forgery or falsification of the content or appearance of this document is unlawful and offenders may be prosecuted to the fullest extent of the law.

Band41\_5MHz\_64QAM\_25\_0\_Main\_LowCH39675-2498.5

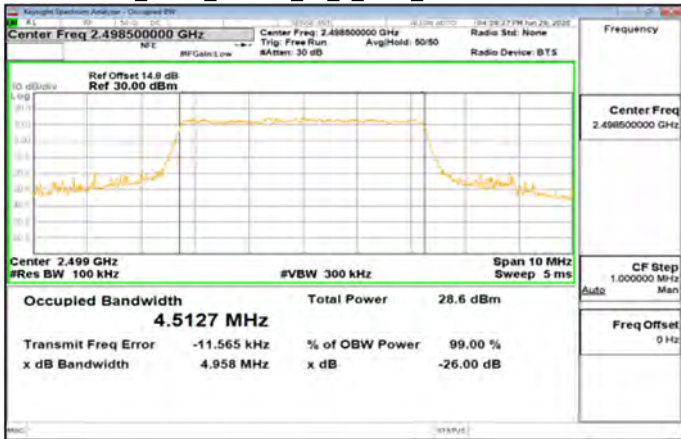

Band41\_5MHz\_256QAM\_25\_0\_Main\_LowCH39675-2498.5

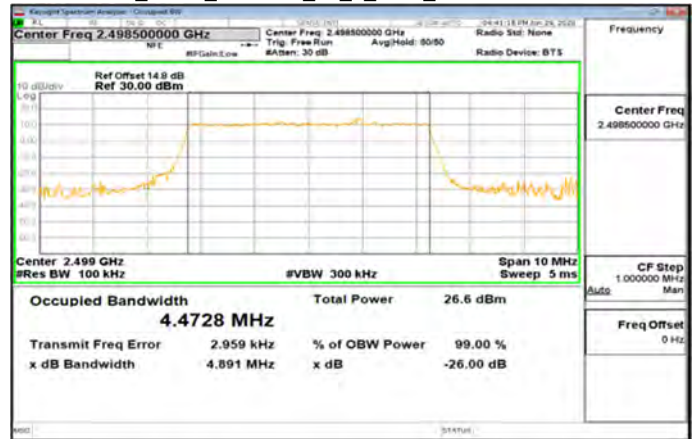

Band41\_5MHz\_64QAM\_25\_0\_Main\_MidCH40620-2593

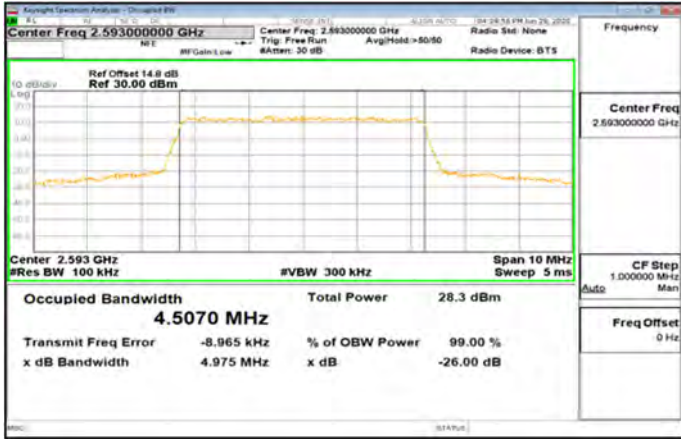

Band41\_5MHz\_256QAM\_25\_0\_Main\_MidCH40620-2593

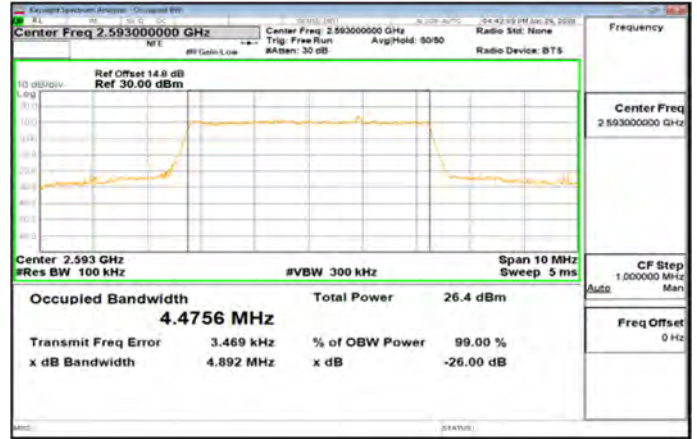

Band41\_5MHz\_64QAM\_25\_0\_Main\_HighCH41565-2687.5

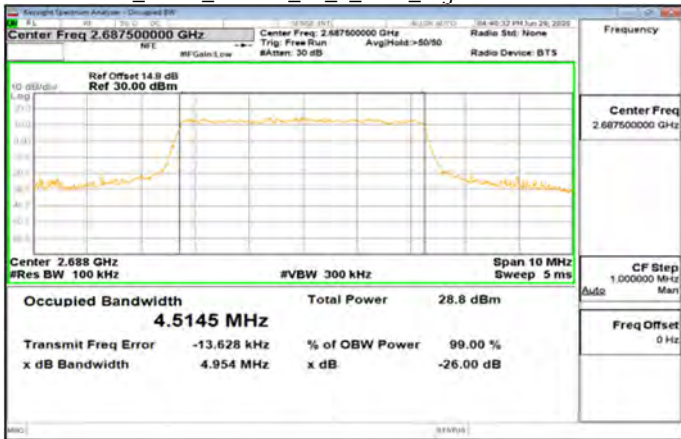

Band41\_5MHz\_256QAM\_25\_0\_Main\_HighCH41565-2687.5

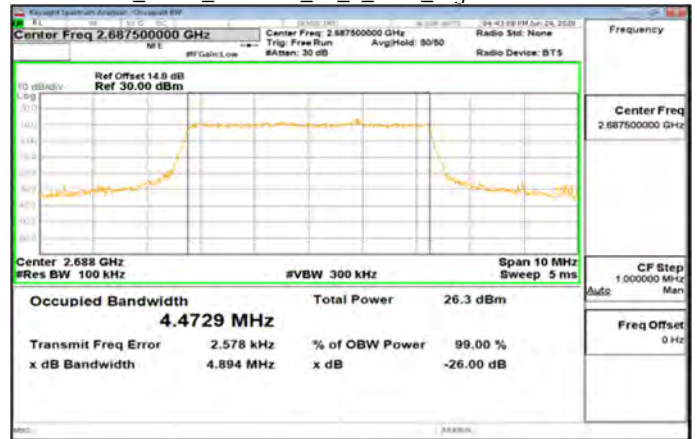

Unless otherwise stated the results shown in this test report refer only to the sample(s) tested and such sample(s) are retained for 90 days only.

除非另有說明，此報告結果僅對測試之樣品負責，同時此樣品僅保留90天。本報告未經本公司書面許可，不可部份複製。

This document is issued by the Company subject to its General Conditions of Service printed overleaf, available on request or accessible at <http://www.sgs.com.tw/Terms-and-Conditions> and for electronic format documents, subject to Terms and Conditions for Electronic Documents at <http://www.sgs.com.tw/Terms-and-Conditions>. Attention is drawn to the limitation of liability, indemnification and jurisdiction issues defined therein. Any holder of this document is advised that information contained hereon reflects the Company's findings at the time of its intervention only and within the limits of Client's instructions, if any. The Company's sole responsibility is to its Client and this document does not exonerate parties to a transaction from exercising all their rights and obligations under the transaction documents. This document cannot be reproduced except in full, without prior written approval of the Company. Any unauthorized alteration, forgery or falsification of the content or appearance of this document is unlawful and offenders may be prosecuted to the fullest extent of the law.



Band41\_10MHz\_QPSK\_50\_0\_Main\_LowCH39700-2501

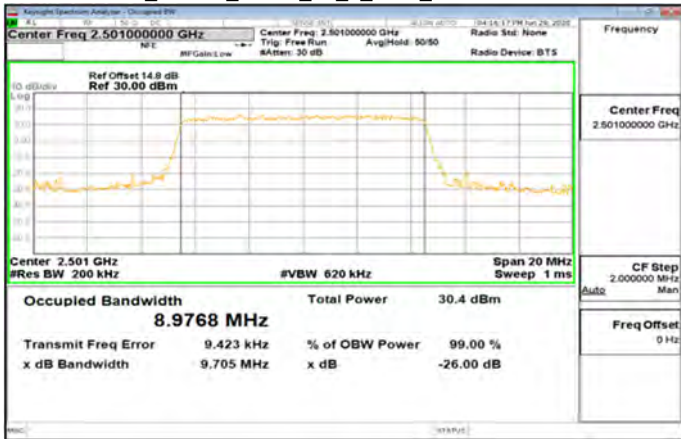

Band41\_10MHz\_16QAM\_50\_0\_Main\_LowCH39700-2501

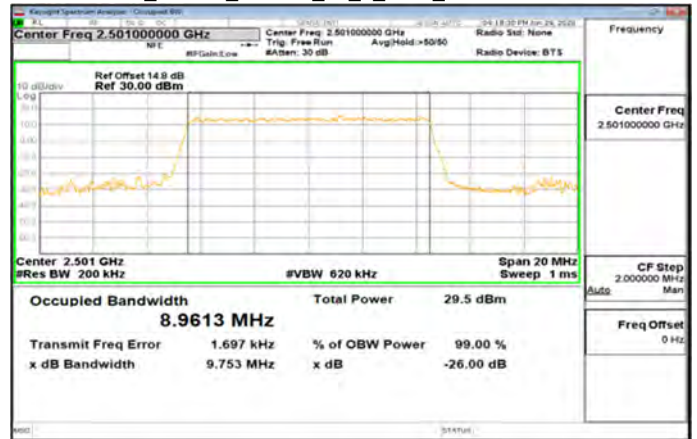

Band41\_10MHz\_QPSK\_50\_0\_Main\_MidCH40620-2593

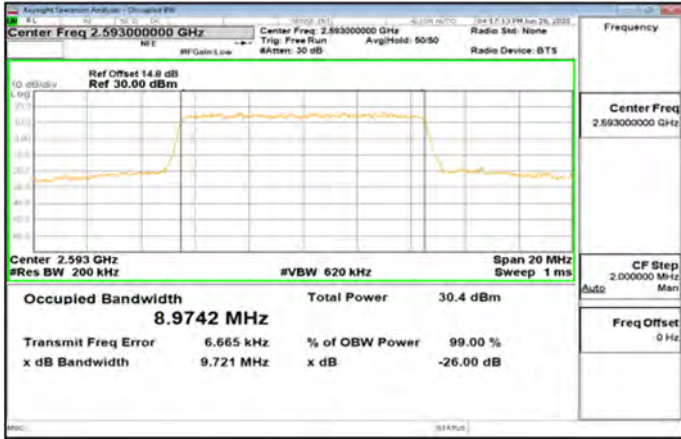

Band41\_10MHz\_16QAM\_50\_0\_Main\_MidCH40620-2593

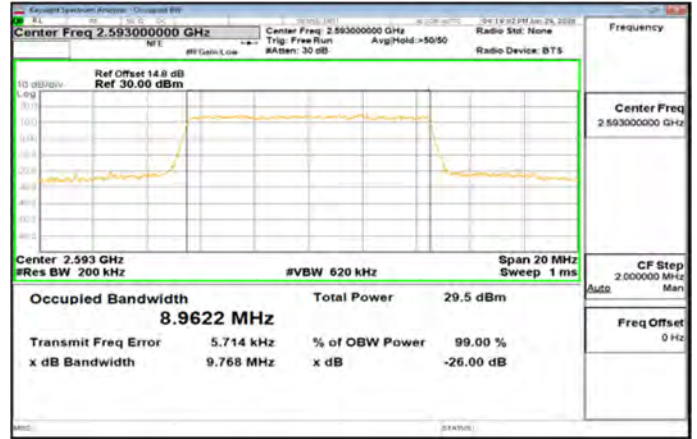

Band41\_10MHz\_QPSK\_50\_0\_Main\_HighCH41540-2685

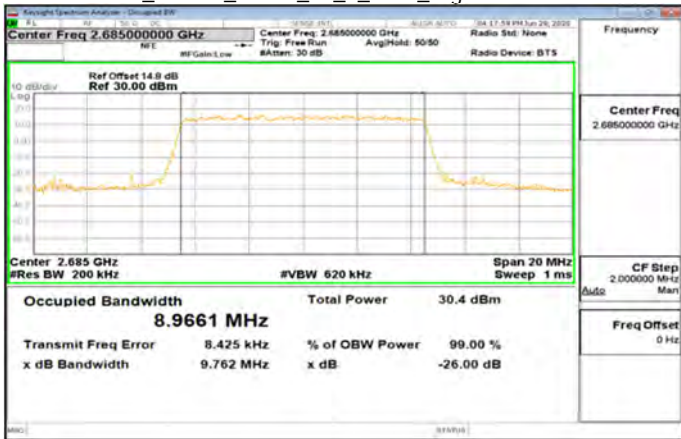

Band41\_10MHz\_16QAM\_50\_0\_Main\_HighCH41540-2685

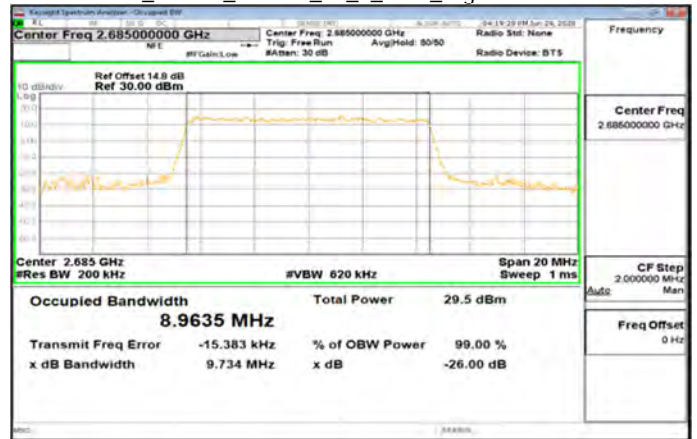

Unless otherwise stated the results shown in this test report refer only to the sample(s) tested and such sample(s) are retained for 90 days only.

除非另有說明，此報告結果僅對測試之樣品負責，同時此樣品僅保留90天。本報告未經本公司書面許可，不可部份複製。

This document is issued by the Company subject to its General Conditions of Service printed overleaf, available on request or accessible at <http://www.sgs.com.tw/Terms-and-Conditions> and for electronic format documents, subject to Terms and Conditions for Electronic Documents at <http://www.sgs.com.tw/Terms-and-Conditions>. Attention is drawn to the limitation of liability, indemnification and jurisdiction issues defined therein. Any holder of this document is advised that information contained hereon reflects the Company's findings at the time of its intervention only and within the limits of Client's instructions, if any. The Company's sole responsibility is to its Client and this document does not exonerate parties to a transaction from exercising all their rights and obligations under the transaction documents. This document cannot be reproduced except in full, without prior written approval of the Company. Any unauthorized alteration, forgery or falsification of the content or appearance of this document is unlawful and offenders may be prosecuted to the fullest extent of the law.

Band41\_10MHz\_64QAM\_50\_0\_Main\_LowCH39700-2501

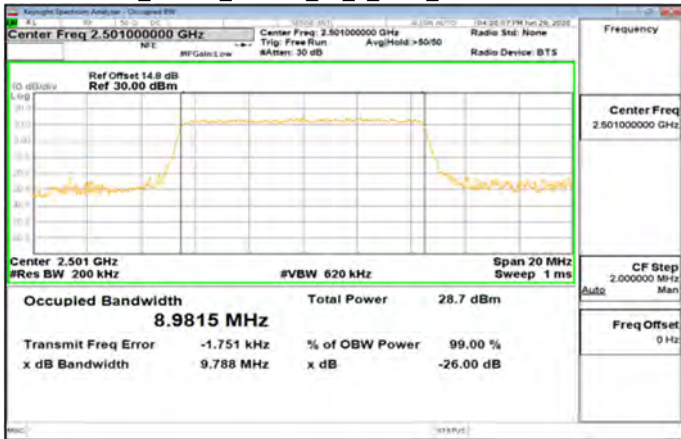

Band41\_10MHz\_256QAM\_50\_0\_Main\_LowCH39700-2501

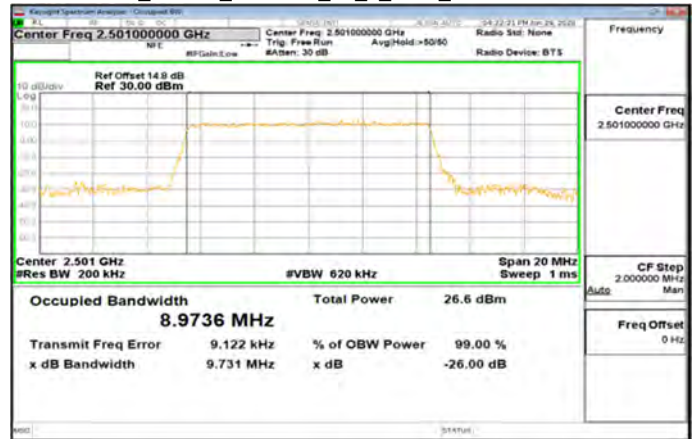

Band41\_10MHz\_64QAM\_50\_0\_Main\_MidCH40620-2593

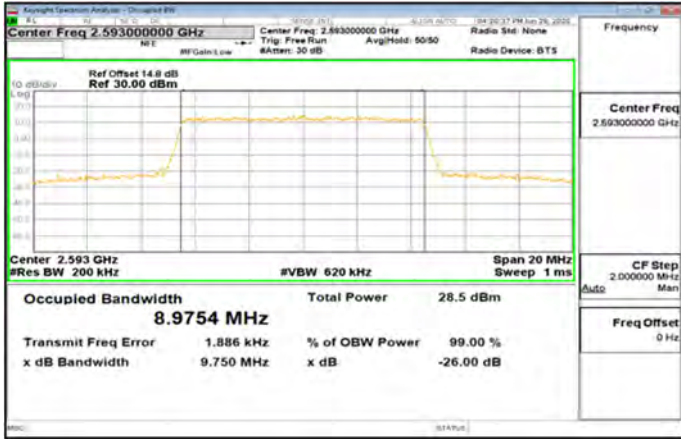

Band41\_10MHz\_256QAM\_50\_0\_Main\_MidCH40620-2593

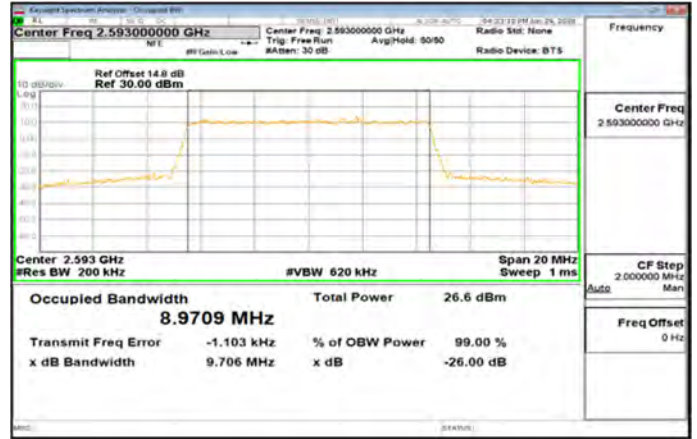

Band41\_10MHz\_64QAM\_50\_0\_Main\_HighCH41540-2685

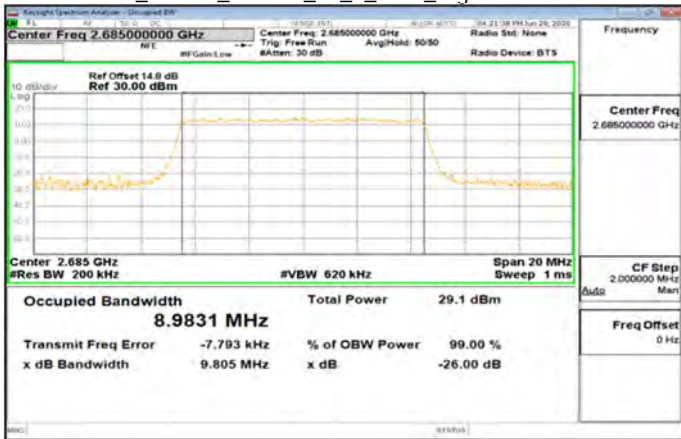

Band41\_10MHz\_256QAM\_50\_0\_Main\_HighCH41540-2685

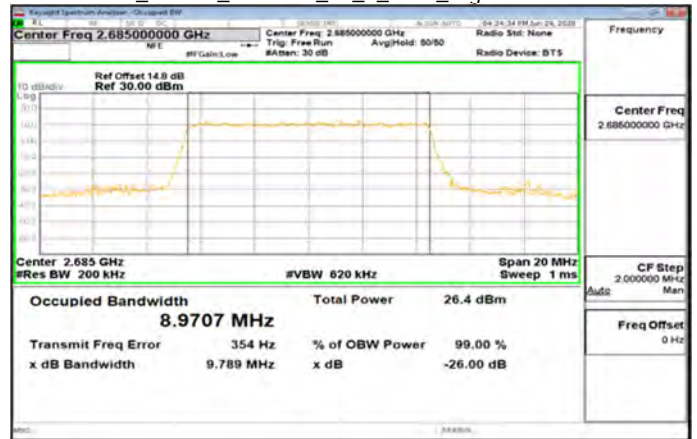

Unless otherwise stated the results shown in this test report refer only to the sample(s) tested and such sample(s) are retained for 90 days only.

除非另有說明，此報告結果僅對測試之樣品負責，同時此樣品僅保留90天。本報告未經本公司書面許可，不可部份複製。

This document is issued by the Company subject to its General Conditions of Service printed overleaf, available on request or accessible at <http://www.sgs.com.tw/Terms-and-Conditions> and for electronic format documents, subject to Terms and Conditions for Electronic Documents at <http://www.sgs.com.tw/Terms-and-Conditions>. Attention is drawn to the limitation of liability, indemnification and jurisdiction issues defined therein. Any holder of this document is advised that information contained hereon reflects the Company's findings at the time of its intervention only and within the limits of Client's instructions, if any. The Company's sole responsibility is to its Client and this document does not exonerate parties to a transaction from exercising all their rights and obligations under the transaction documents. This document cannot be reproduced except in full, without prior written approval of the Company. Any unauthorized alteration, forgery or falsification of the content or appearance of this document is unlawful and offenders may be prosecuted to the fullest extent of the law.



Band41\_15MHz\_QPSK\_75\_0\_Main\_LowCH39725-2503.5

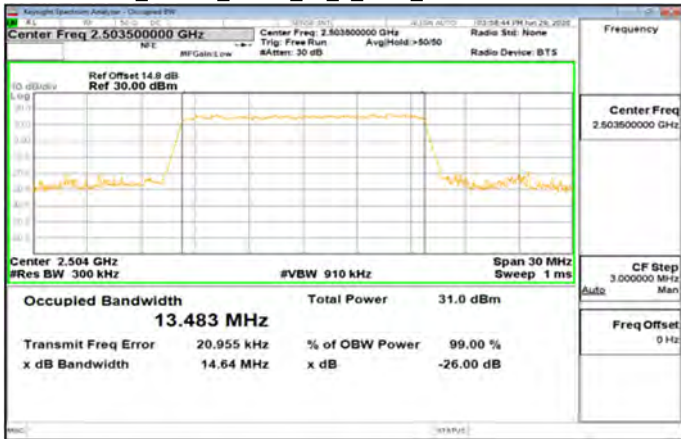

Band41\_15MHz\_16QAM\_75\_0\_Main\_LowCH39725-2503.5

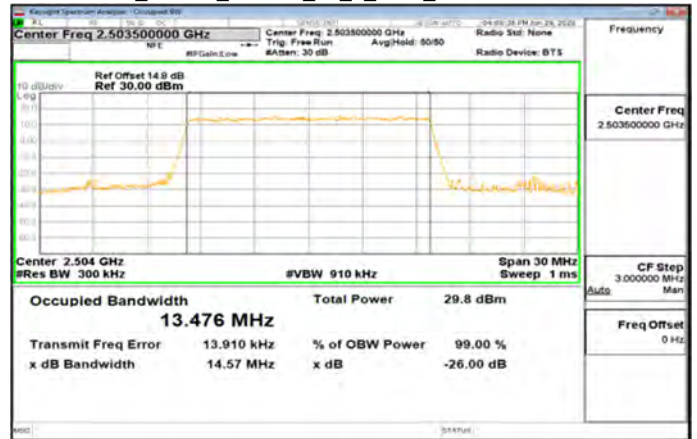

Band41\_15MHz\_QPSK\_75\_0\_Main\_MidCH40620-2593

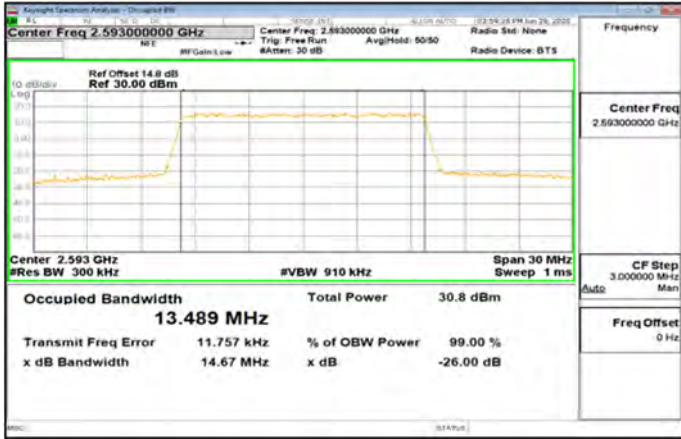

Band41\_15MHz\_16QAM\_75\_0\_Main\_MidCH40620-2593

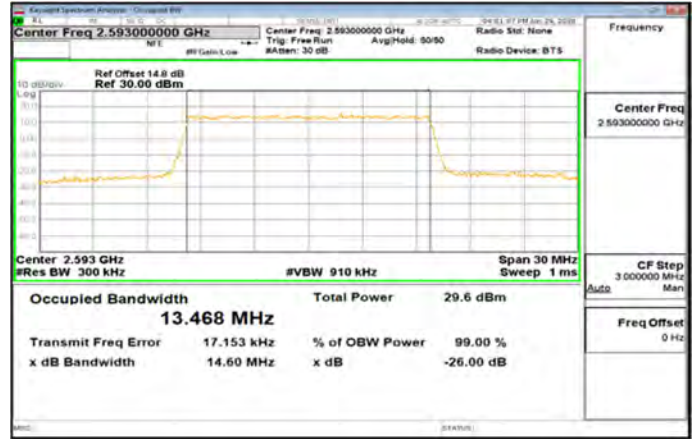

Band41\_15MHz\_QPSK\_75\_0\_Main\_HighCH41515-2682.5

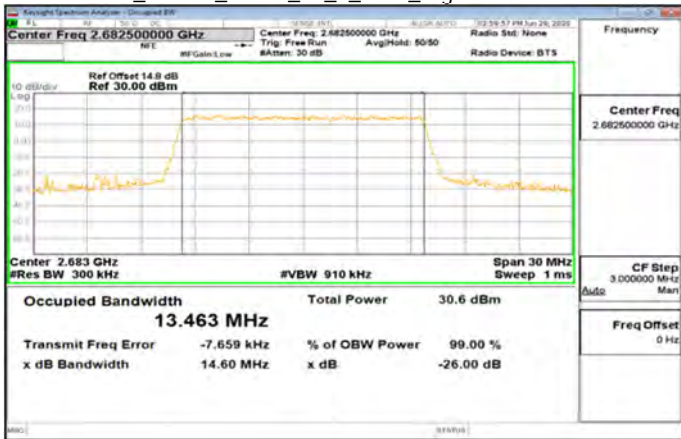

Band41\_15MHz\_16QAM\_75\_0\_Main\_HighCH41515-2682.5

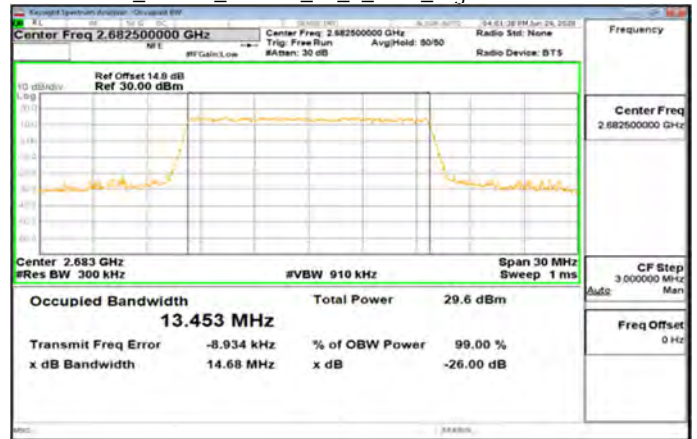

Unless otherwise stated the results shown in this test report refer only to the sample(s) tested and such sample(s) are retained for 90 days only.

除非另有說明，此報告結果僅對測試之樣品負責，同時此樣品僅保留90天。本報告未經本公司書面許可，不可部份複製。

This document is issued by the Company subject to its General Conditions of Service printed overleaf, available on request or accessible at <http://www.sgs.com.tw/Terms-and-Conditions> and for electronic format documents, subject to Terms and Conditions for Electronic Documents at <http://www.sgs.com.tw/Terms-and-Conditions>. Attention is drawn to the limitation of liability, indemnification and jurisdiction issues defined therein. Any holder of this document is advised that information contained hereon reflects the Company's findings at the time of its intervention only and within the limits of Client's instructions, if any. The Company's sole responsibility is to its Client and this document does not exonerate parties to a transaction from exercising all their rights and obligations under the transaction documents. This document cannot be reproduced except in full, without prior written approval of the Company. Any unauthorized alteration, forgery or falsification of the content or appearance of this document is unlawful and offenders may be prosecuted to the fullest extent of the law.

Band41\_15MHz\_64QAM\_75\_0\_Main\_LowCH39725-2503.5

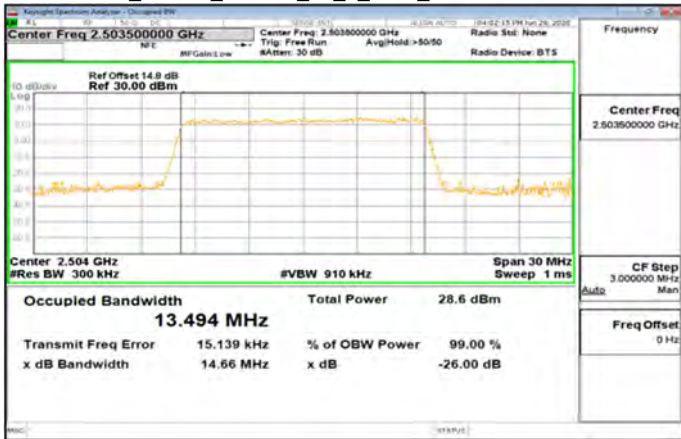

Band41\_15MHz\_256QAM\_75\_0\_Main\_LowCH39725-2503.5

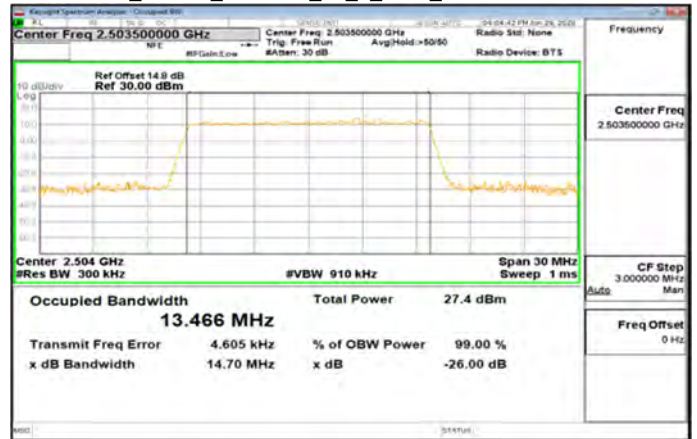

Band41\_15MHz\_64QAM\_75\_0\_Main\_MidCH40620-2593

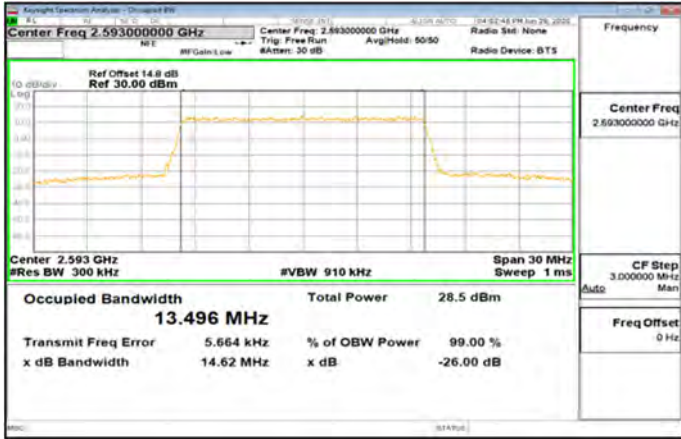

Band41\_15MHz\_256QAM\_75\_0\_Main\_MidCH40620-2593

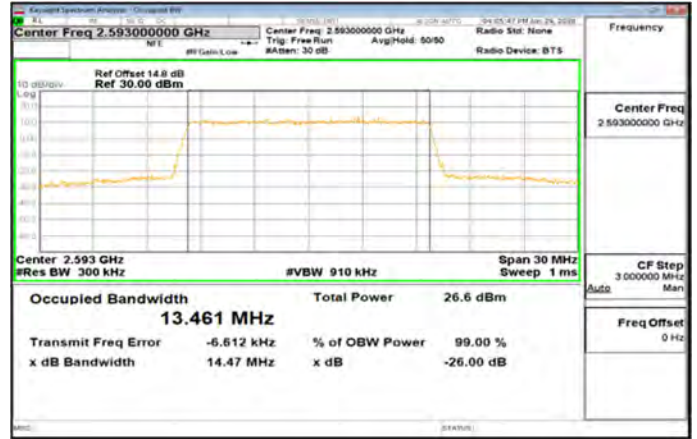

Band41\_15MHz\_64QAM\_75\_0\_Main\_HighCH41515-2682.5

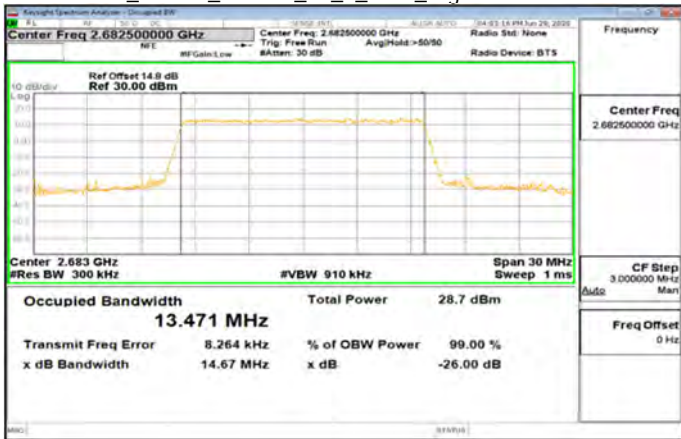

Band41\_15MHz\_256QAM\_75\_0\_Main\_HighCH41515-2682.5

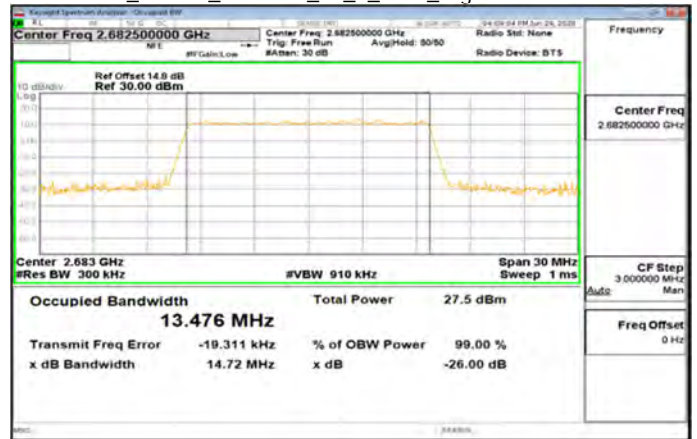

Unless otherwise stated the results shown in this test report refer only to the sample(s) tested and such sample(s) are retained for 90 days only.

除非另有說明，此報告結果僅對測試之樣品負責，同時此樣品僅保留90天。本報告未經本公司書面許可，不可部份複製。

This document is issued by the Company subject to its General Conditions of Service printed overleaf, available on request or accessible at <http://www.sgs.com.tw/Terms-and-Conditions> and for electronic format documents, subject to Terms and Conditions for Electronic Documents at <http://www.sgs.com.tw/Terms-and-Conditions>. Attention is drawn to the limitation of liability, indemnification and jurisdiction issues defined therein. Any holder of this document is advised that information contained hereon reflects the Company's findings at the time of its intervention only and within the limits of Client's instructions, if any. The Company's sole responsibility is to its Client and this document does not exonerate parties to a transaction from exercising all their rights and obligations under the transaction documents. This document cannot be reproduced except in full, without prior written approval of the Company. Any unauthorized alteration, forgery or falsification of the content or appearance of this document is unlawful and offenders may be prosecuted to the fullest extent of the law.



Band41\_20MHz\_QPSK\_100\_0\_Main\_LowCH39750-2506

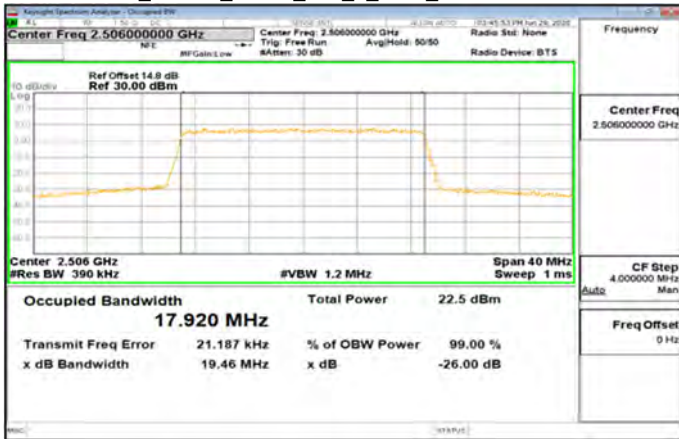

Band41\_20MHz\_16QAM\_100\_0\_Main\_LowCH39750-2506

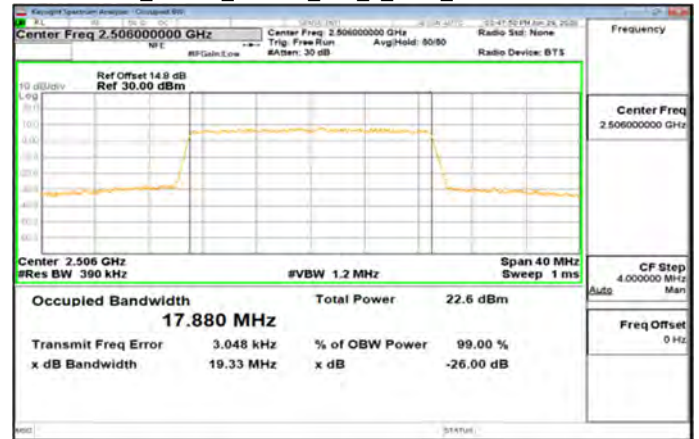

Band41\_20MHz\_QPSK\_100\_0\_Main\_MidCH40620-2593

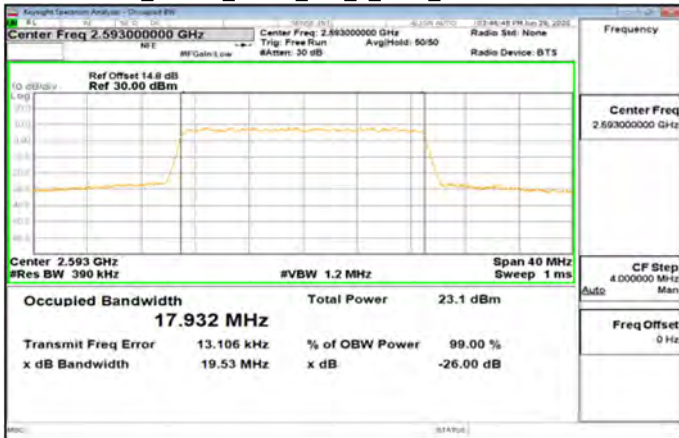

Band41\_20MHz\_16QAM\_100\_0\_Main\_MidCH40620-2593

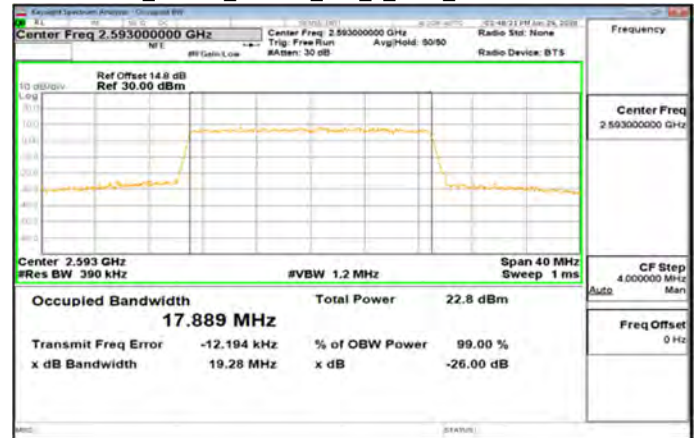

Band41\_20MHz\_QPSK\_100\_0\_Main\_HighCH41490-2680

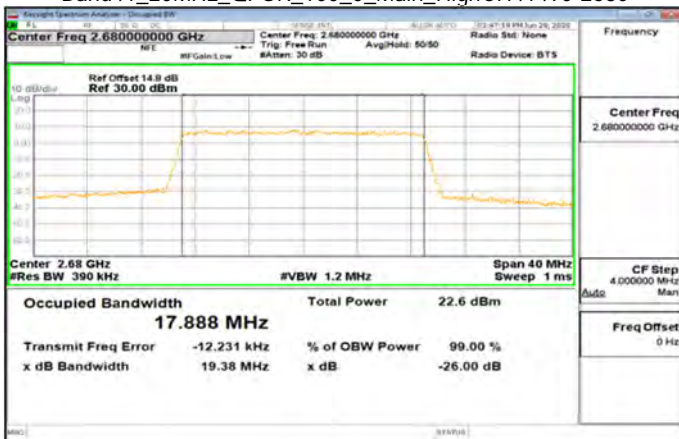

Band41\_20MHz\_16QAM\_100\_0\_Main\_HighCH41490-2680

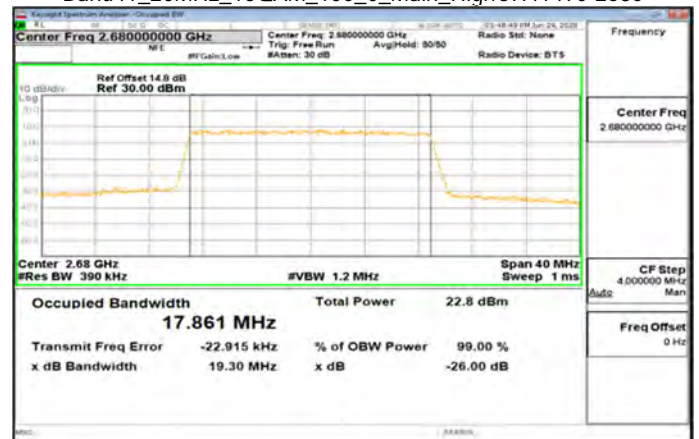

Unless otherwise stated the results shown in this test report refer only to the sample(s) tested and such sample(s) are retained for 90 days only.

除非另有說明，此報告結果僅對測試之樣品負責，同時此樣品僅保留90天。本報告未經本公司書面許可，不可部份複製。

This document is issued by the Company subject to its General Conditions of Service printed overleaf, available on request or accessible at <http://www.sgs.com.tw/Terms-and-Conditions> and for electronic format documents, subject to Terms and Conditions for Electronic Documents at <http://www.sgs.com.tw/Terms-and-Conditions>. Attention is drawn to the limitation of liability, indemnification and jurisdiction issues defined therein. Any holder of this document is advised that information contained hereon reflects the Company's findings at the time of its intervention only and within the limits of Client's instructions, if any. The Company's sole responsibility is to its Client and this document does not exonerate parties to a transaction from exercising all their rights and obligations under the transaction documents. This document cannot be reproduced except in full, without prior written approval of the Company. Any unauthorized alteration, forgery or falsification of the content or appearance of this document is unlawful and offenders may be prosecuted to the fullest extent of the law.

Band41\_20MHz\_64QAM\_100\_0\_Main\_LowCH39750-2506

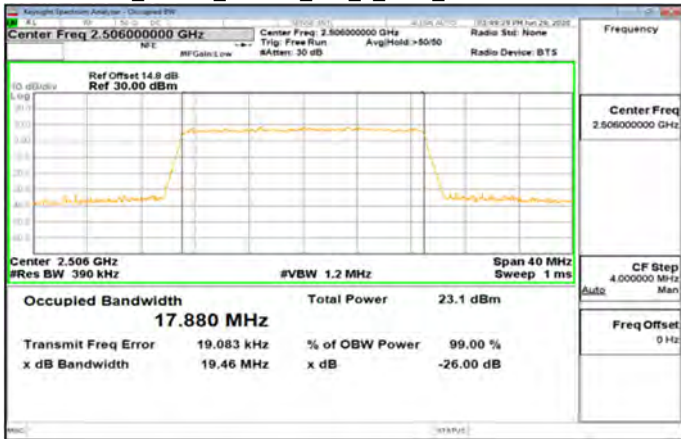

Band41\_20MHz\_256QAM\_100\_0\_Main\_LowCH39750-2506

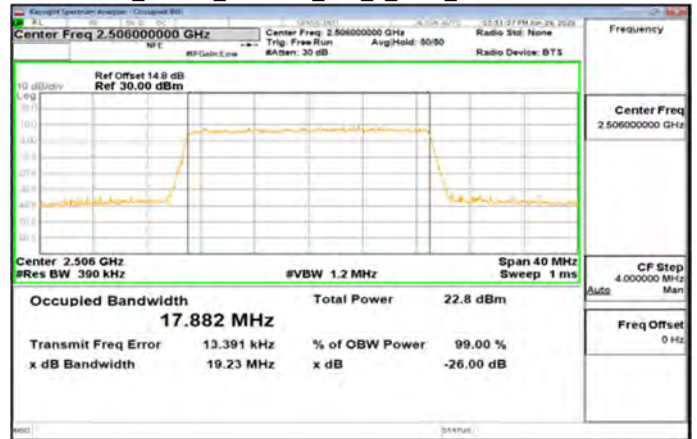

Band41\_20MHz\_64QAM\_100\_0\_Main\_MidCH40620-2593

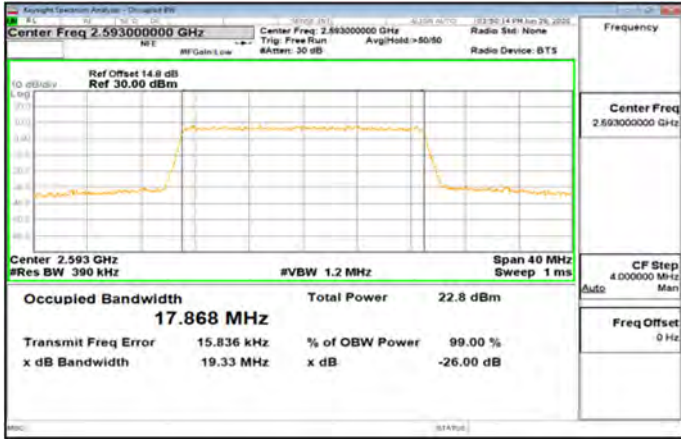

Band41\_20MHz\_256QAM\_100\_0\_Main\_MidCH40620-2593

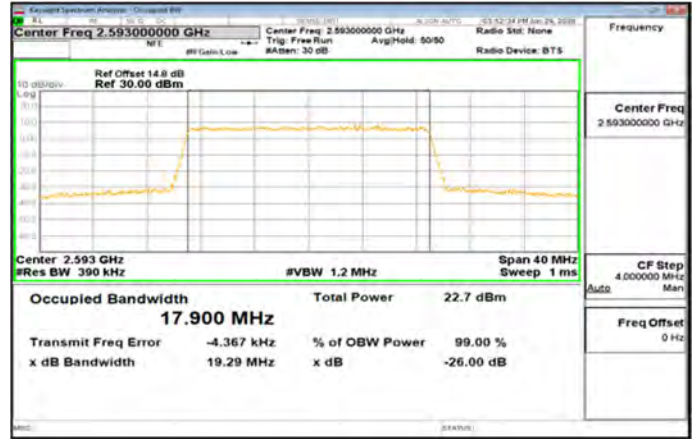

Band41\_20MHz\_64QAM\_100\_0\_Main\_HighCH41490-2680

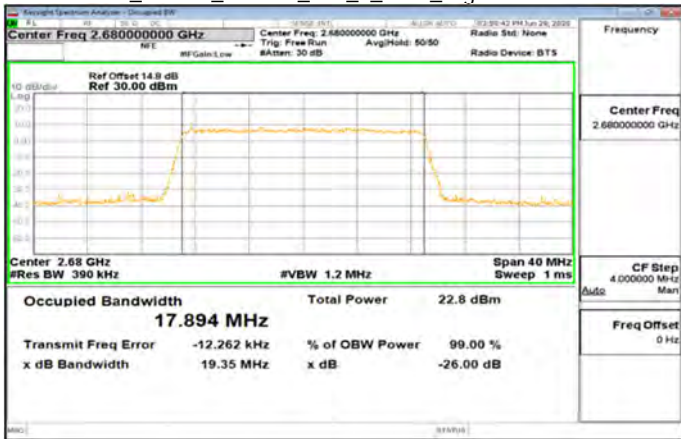

Band41\_20MHz\_256QAM\_100\_0\_Main\_HighCH41490-2680

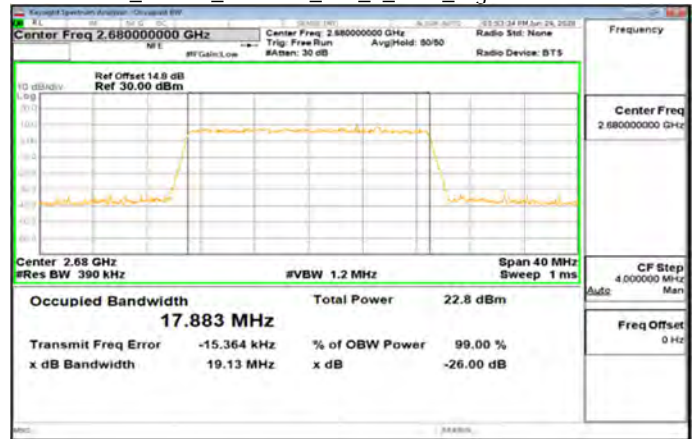

Unless otherwise stated the results shown in this test report refer only to the sample(s) tested and such sample(s) are retained for 90 days only.

除非另有說明，此報告結果僅對測試之樣品負責，同時此樣品僅保留90天。本報告未經本公司書面許可，不可部份複製。

This document is issued by the Company subject to its General Conditions of Service printed overleaf, available on request or accessible at <http://www.sgs.com.tw/Terms-and-Conditions> and for electronic format documents, subject to Terms and Conditions for Electronic Documents at <http://www.sgs.com.tw/Terms-and-Conditions>. Attention is drawn to the limitation of liability, indemnification and jurisdiction issues defined therein. Any holder of this document is advised that information contained hereon reflects the Company's findings at the time of its intervention only and within the limits of Client's instructions, if any. The Company's sole responsibility is to its Client and this document does not exonerate parties to a transaction from exercising all their rights and obligations under the transaction documents. This document cannot be reproduced except in full, without prior written approval of the Company. Any unauthorized alteration, forgery or falsification of the content or appearance of this document is unlawful and offenders may be prosecuted to the fullest extent of the law.



Band66\_1\_4MHz\_QPSK\_6\_0\_Main\_LowCH131979-1710.7

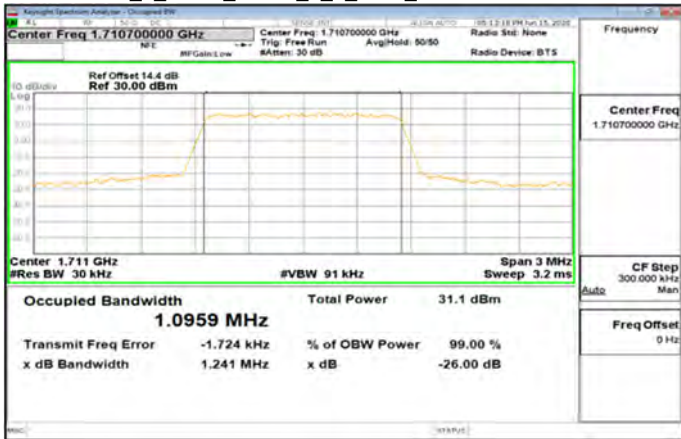

Band66\_1\_4MHz\_16QAM\_6\_0\_Main\_LowCH131979-1710.7

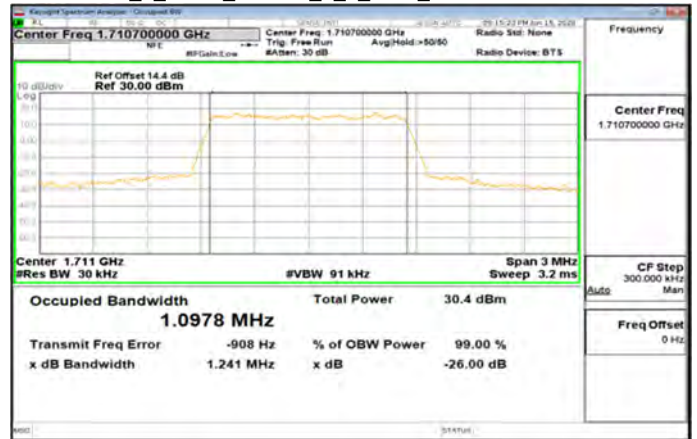

Band66\_1\_4MHz\_QPSK\_6\_0\_Main\_MidCH132322-1745

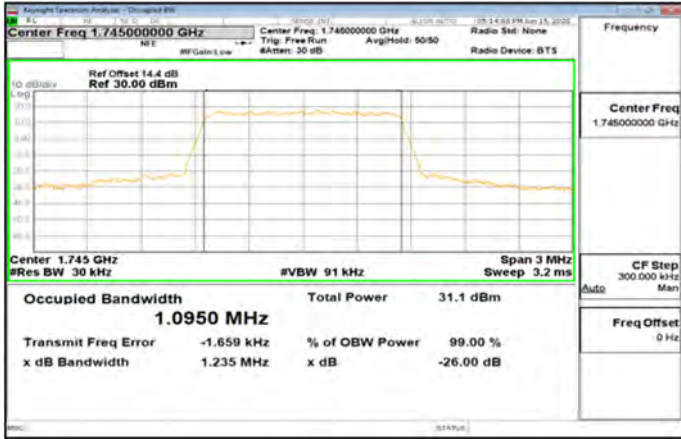

Band66\_1\_4MHz\_16QAM\_6\_0\_Main\_MidCH132322-1745

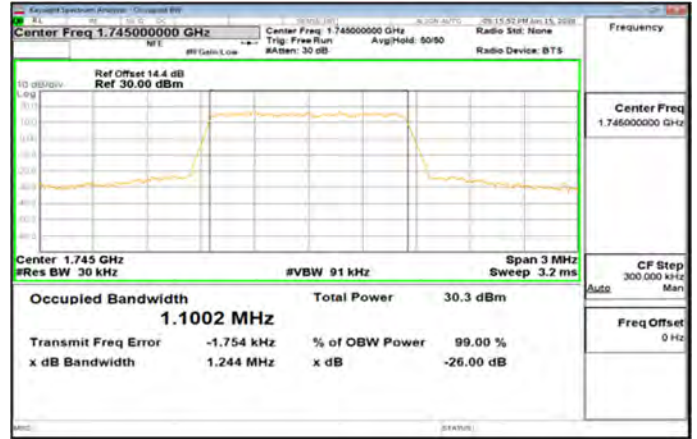

Band66\_1\_4MHz\_QPSK\_6\_0\_Main\_HighCH132665-1779.3

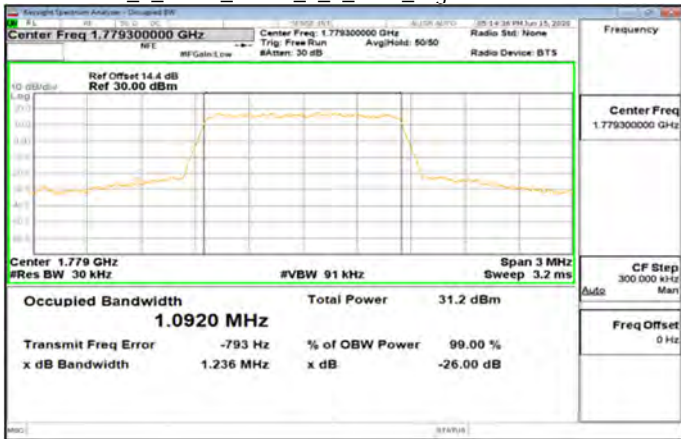

Band66\_1\_4MHz\_16QAM\_6\_0\_Main\_HighCH132665-1779.3

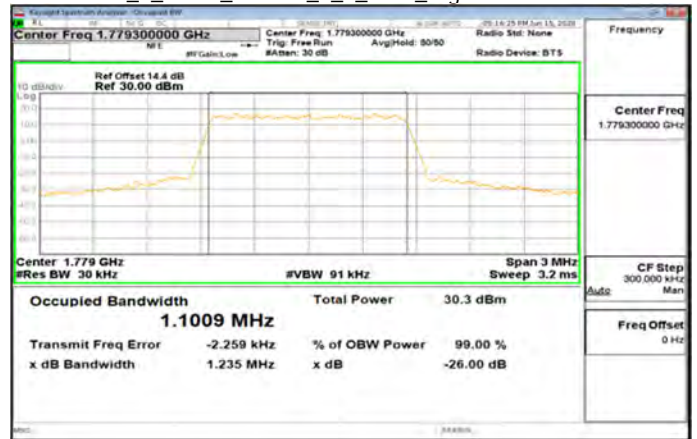

Unless otherwise stated the results shown in this test report refer only to the sample(s) tested and such sample(s) are retained for 90 days only.

除非另有說明，此報告結果僅對測試之樣品負責，同時此樣品僅保留90天。本報告未經本公司書面許可，不可部份複製。

This document is issued by the Company subject to its General Conditions of Service printed overleaf, available on request or accessible at <http://www.sgs.com.tw/Terms-and-Conditions> and for electronic format documents, subject to Terms and Conditions for Electronic Documents at <http://www.sgs.com.tw/Terms-and-Conditions>. Attention is drawn to the limitation of liability, indemnification and jurisdiction issues defined therein. Any holder of this document is advised that information contained hereon reflects the Company's findings at the time of its intervention only and within the limits of Client's instructions, if any. The Company's sole responsibility is to its Client and this document does not exonerate parties to a transaction from exercising all their rights and obligations under the transaction documents. This document cannot be reproduced except in full, without prior written approval of the Company. Any unauthorized alteration, forgery or falsification of the content or appearance of this document is unlawful and offenders may be prosecuted to the fullest extent of the law.

Band66\_1\_4MHz\_64QAM\_6\_0\_Main\_LowCH131979-1710.7

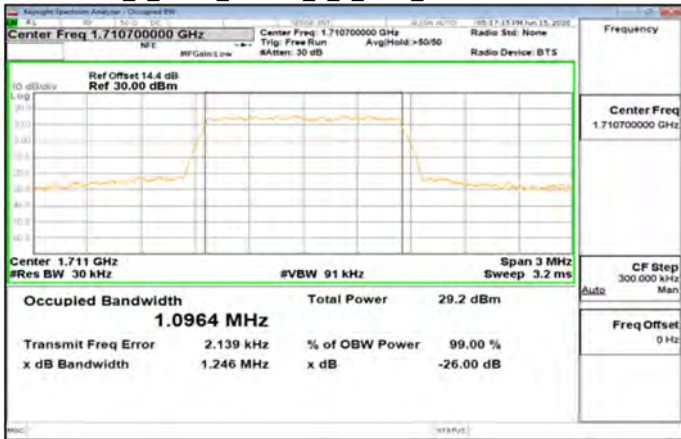

Band66\_1\_4MHz\_256QAM\_6\_0\_Main\_LowCH131979-1710.7

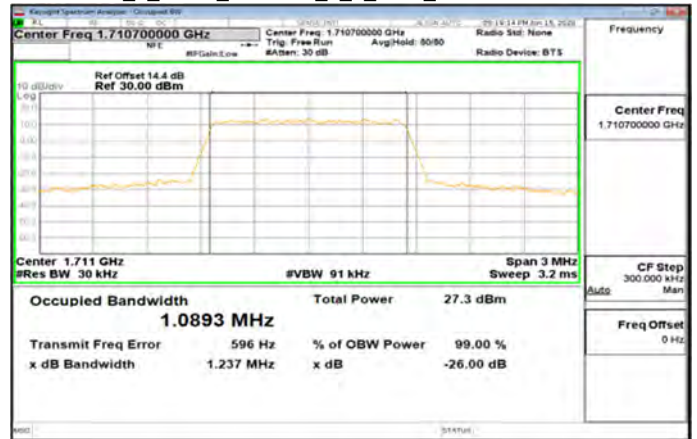

Band66\_1\_4MHz\_64QAM\_6\_0\_Main\_MidCH132322-1745

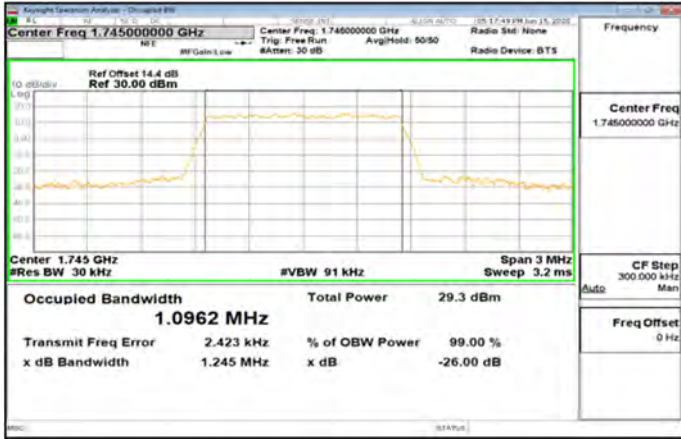

Band66\_1\_4MHz\_256QAM\_6\_0\_Main\_MidCH132322-1745

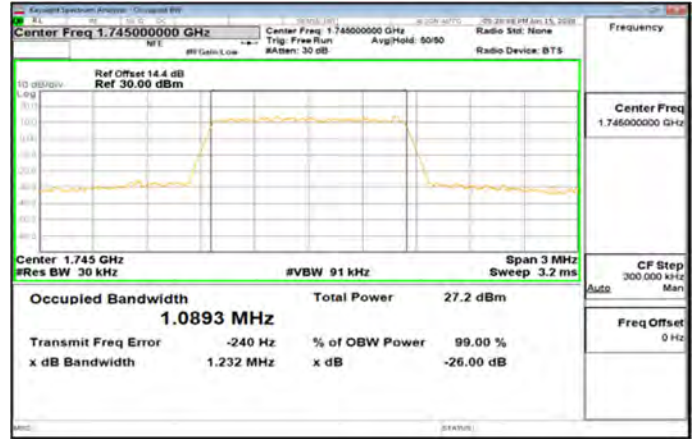

Band66\_1\_4MHz\_64QAM\_6\_0\_Main\_HighCH132665-1779.3

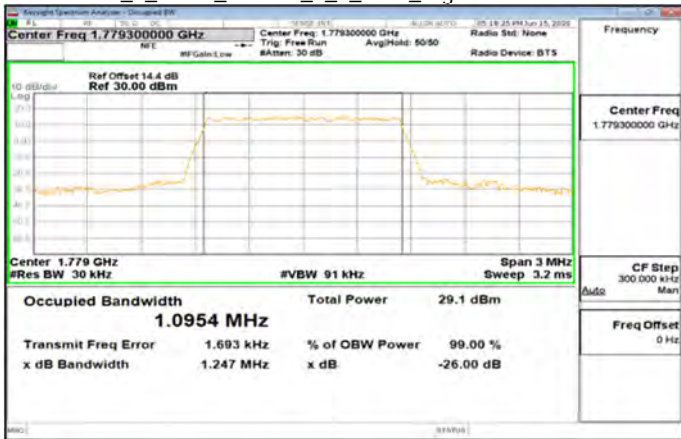

Band66\_1\_4MHz\_256QAM\_6\_0\_Main\_HighCH132665-1779.3

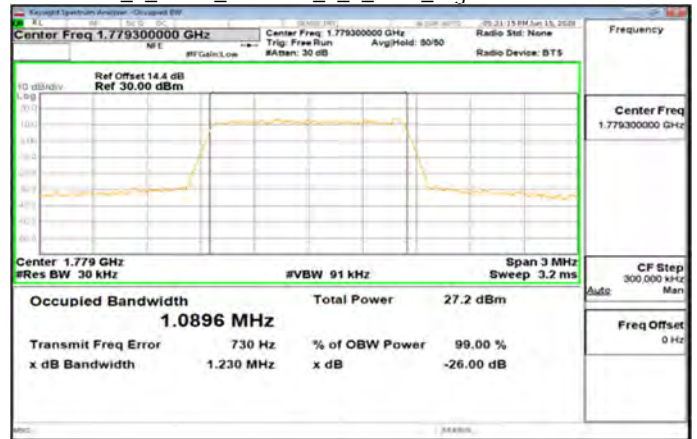

Unless otherwise stated the results shown in this test report refer only to the sample(s) tested and such sample(s) are retained for 90 days only.

除非另有說明，此報告結果僅對測試之樣品負責，同時此樣品僅保留90天。本報告未經本公司書面許可，不可部份複製。

This document is issued by the Company subject to its General Conditions of Service printed overleaf, available on request or accessible at <http://www.sgs.com.tw/Terms-and-Conditions> and for electronic format documents, subject to Terms and Conditions for Electronic Documents at <http://www.sgs.com.tw/Terms-and-Conditions>. Attention is drawn to the limitation of liability, indemnification and jurisdiction issues defined therein. Any holder of this document is advised that information contained hereon reflects the Company's findings at the time of its intervention only and within the limits of Client's instructions, if any. The Company's sole responsibility is to its Client and this document does not exonerate parties to a transaction from exercising all their rights and obligations under the transaction documents. This document cannot be reproduced except in full, without prior written approval of the Company. Any unauthorized alteration, forgery or falsification of the content or appearance of this document is unlawful and offenders may be prosecuted to the fullest extent of the law.



Band66\_3MHz\_QPSK\_15\_0\_Main\_LowCH131987-1711.5

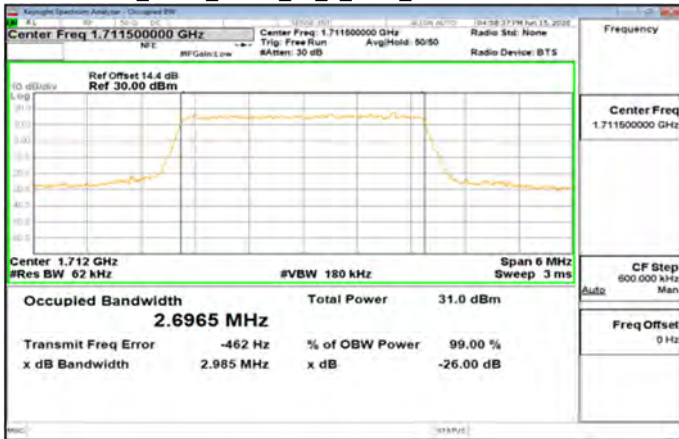

Band66\_3MHz\_16QAM\_15\_0\_Main\_LowCH131987-1711.5

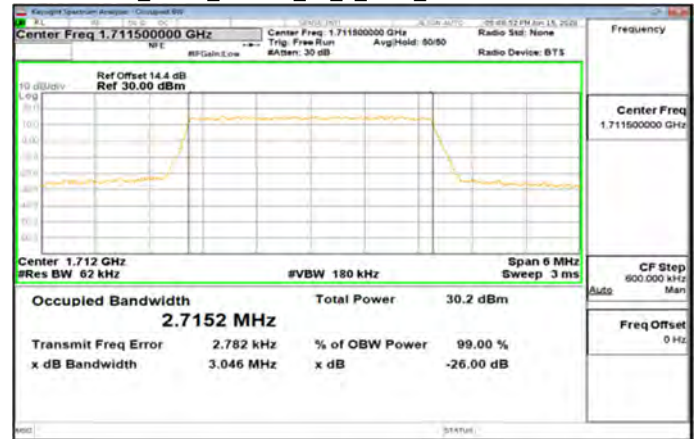

Band66\_3MHz\_QPSK\_15\_0\_Main\_MidCH132322-1745

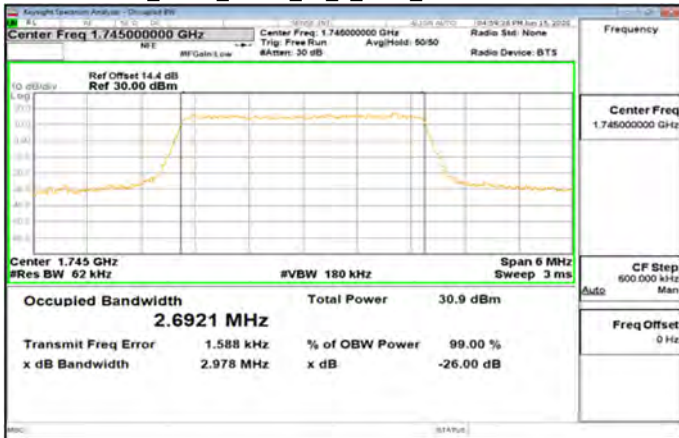

Band66\_3MHz\_16QAM\_15\_0\_Main\_MidCH132322-1745

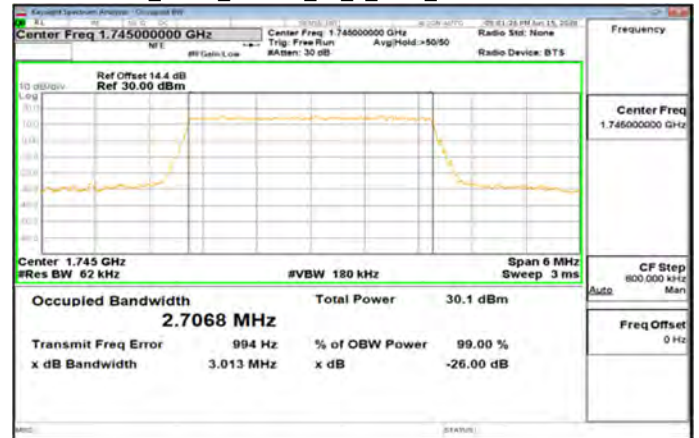

Band66\_3MHz\_QPSK\_15\_0\_Main\_HighCH132657-1778.5

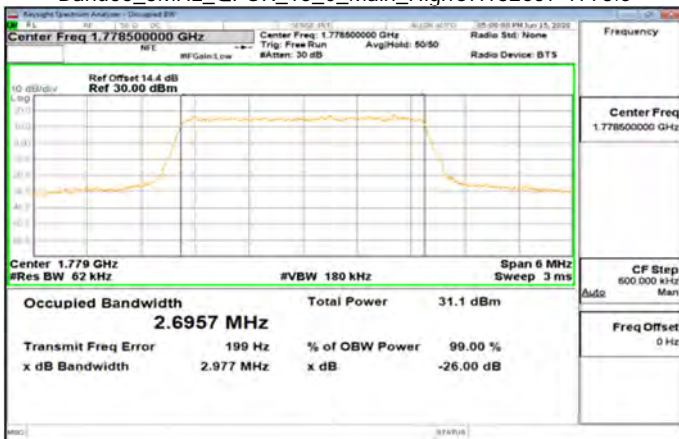

Band66\_3MHz\_16QAM\_15\_0\_Main\_HighCH132657-1778.5

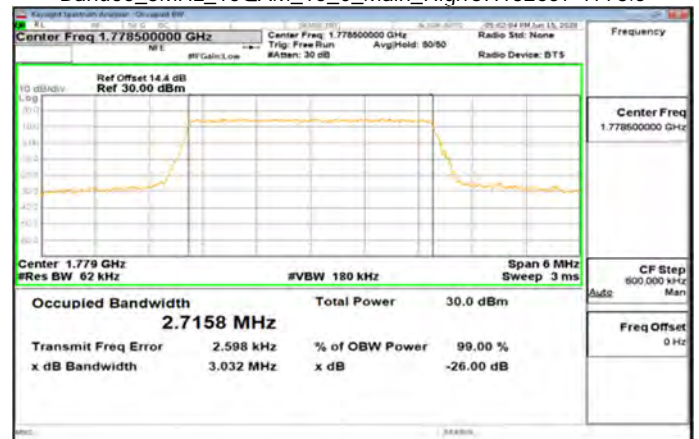

Unless otherwise stated the results shown in this test report refer only to the sample(s) tested and such sample(s) are retained for 90 days only.

除非另有說明，此報告結果僅對測試之樣品負責，同時此樣品僅保留90天。本報告未經本公司書面許可，不可部份複製。

This document is issued by the Company subject to its General Conditions of Service printed overleaf, available on request or accessible at <http://www.sgs.com.tw/Terms-and-Conditions> and for electronic format documents, subject to Terms and Conditions for Electronic Documents at <http://www.sgs.com.tw/Terms-and-Conditions>. Attention is drawn to the limitation of liability, indemnification and jurisdiction issues defined therein. Any holder of this document is advised that information contained hereon reflects the Company's findings at the time of its intervention only and within the limits of Client's instructions, if any. The Company's sole responsibility is to its Client and this document does not exonerate parties to a transaction from exercising all their rights and obligations under the transaction documents. This document cannot be reproduced except in full, without prior written approval of the Company. Any unauthorized alteration, forgery or falsification of the content or appearance of this document is unlawful and offenders may be prosecuted to the fullest extent of the law.

Band66\_3MHz\_64QAM\_15\_0\_Main\_LowCH131987-1711.5

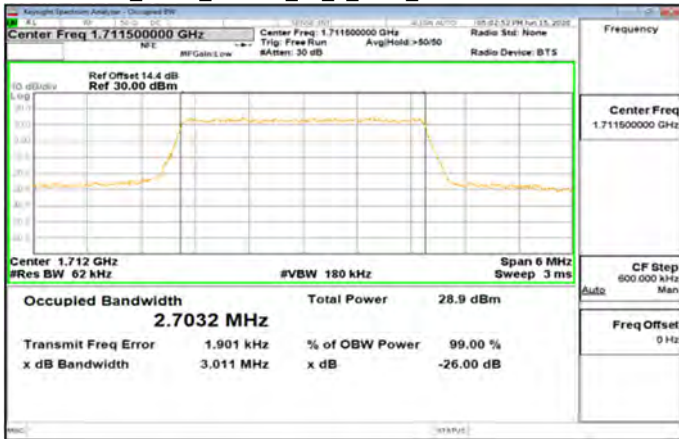

Band66\_3MHz\_256QAM\_15\_0\_Main\_LowCH131987-1711.5

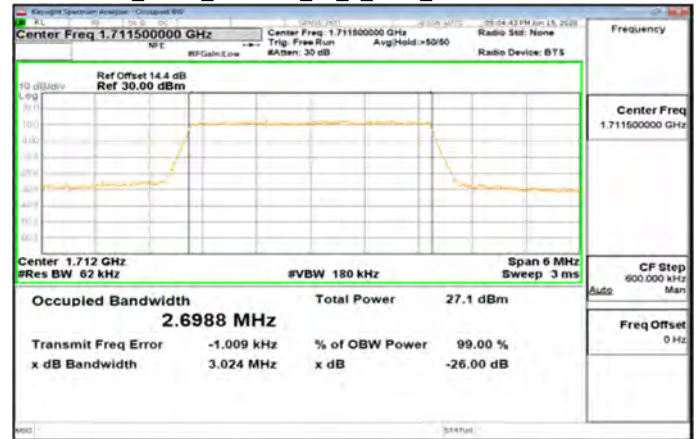

Band66\_3MHz\_64QAM\_15\_0\_Main\_MidCH132322-1745

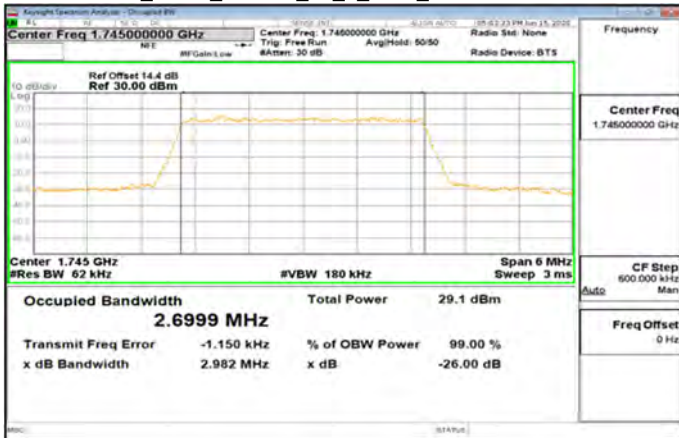

Band66\_3MHz\_256QAM\_15\_0\_Main\_MidCH132322-1745

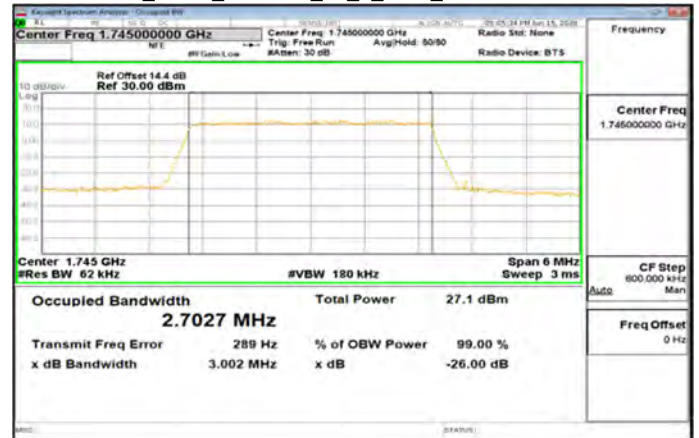

Band66\_3MHz\_64QAM\_15\_0\_Main\_HighCH132657-1778.5

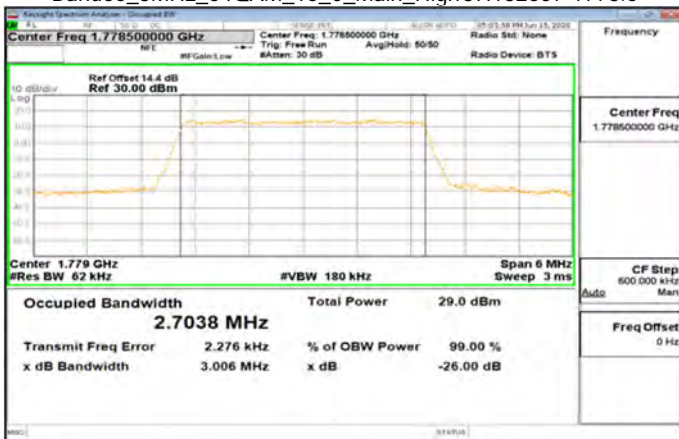

Band66\_3MHz\_256QAM\_15\_0\_Main\_HighCH132657-1778.5

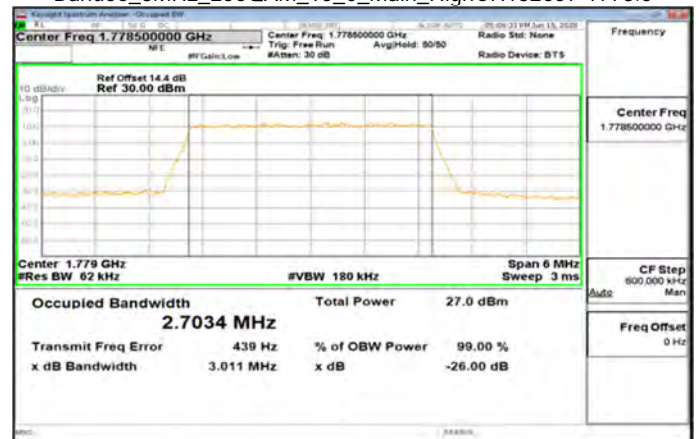

Unless otherwise stated the results shown in this test report refer only to the sample(s) tested and such sample(s) are retained for 90 days only.

除非另有說明，此報告結果僅對測試之樣品負責，同時此樣品僅保留90天。本報告未經本公司書面許可，不可部份複製。

This document is issued by the Company subject to its General Conditions of Service printed overleaf, available on request or accessible at <http://www.sgs.com.tw/Terms-and-Conditions> and for electronic format documents, subject to Terms and Conditions for Electronic Documents at <http://www.sgs.com.tw/Terms-and-Conditions>. Attention is drawn to the limitation of liability, indemnification and jurisdiction issues defined therein. Any holder of this document is advised that information contained hereon reflects the Company's findings at the time of its intervention only and within the limits of Client's instructions, if any. The Company's sole responsibility is to its Client and this document does not exonerate parties to a transaction from exercising all their rights and obligations under the transaction documents. This document cannot be reproduced except in full, without prior written approval of the Company. Any unauthorized alteration, forgery or falsification of the content or appearance of this document is unlawful and offenders may be prosecuted to the fullest extent of the law.



Band66\_5MHz\_QPSK\_25\_0\_Main\_LowCH131997-1712.5

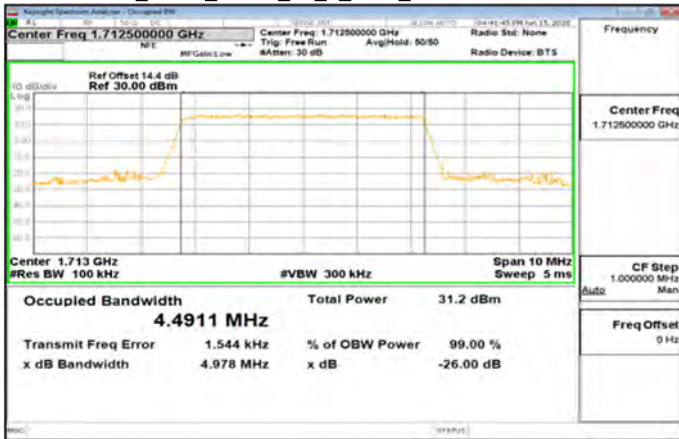

Band66\_5MHz\_16QAM\_25\_0\_Main\_LowCH131997-1712.5

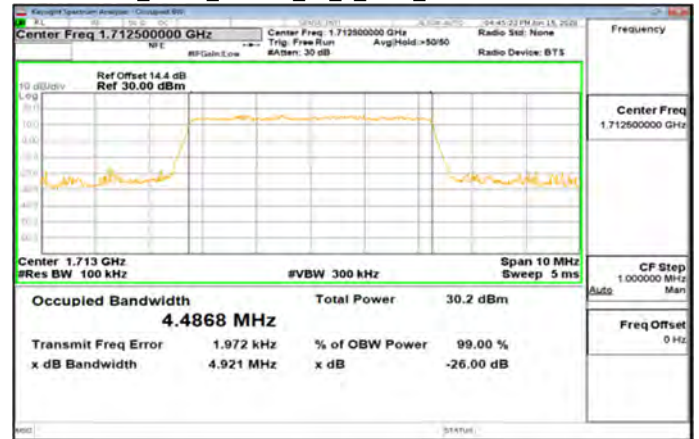

Band66\_5MHz\_QPSK\_25\_0\_Main\_MidCH132322-1745

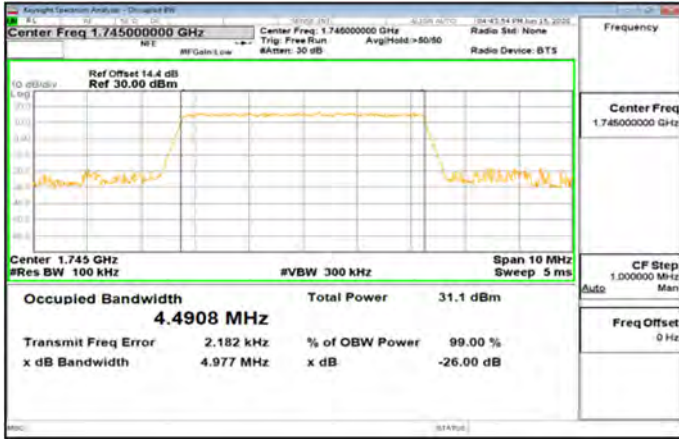

Band66\_5MHz\_16QAM\_25\_0\_Main\_MidCH132322-1745

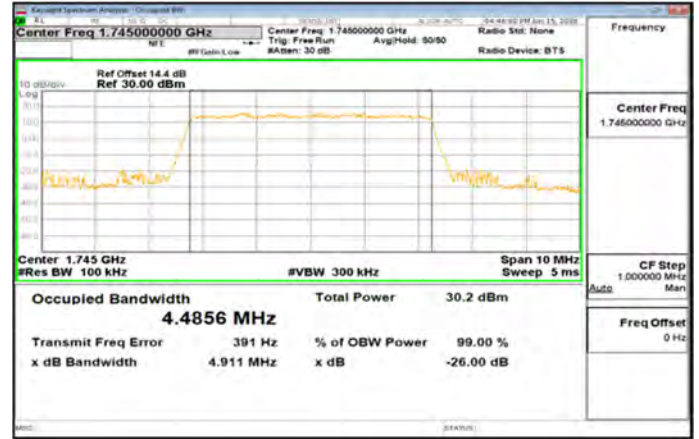

Band66\_5MHz\_QPSK\_25\_0\_Main\_HighCH132647-1777.5

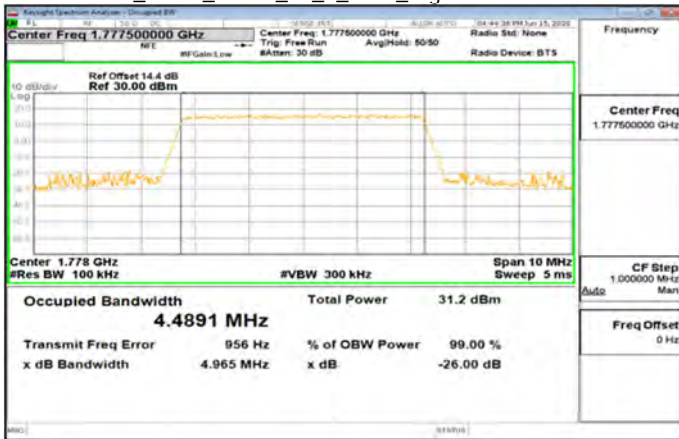

Band66\_5MHz\_16QAM\_25\_0\_Main\_HighCH132647-1777.5

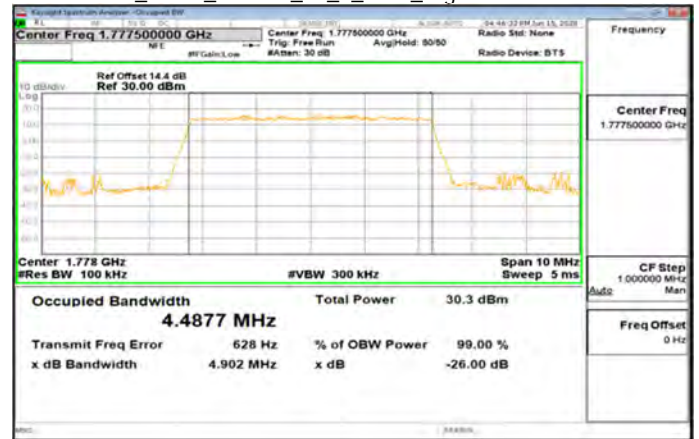

Unless otherwise stated the results shown in this test report refer only to the sample(s) tested and such sample(s) are retained for 90 days only.

除非另有說明，此報告結果僅對測試之樣品負責，同時此樣品僅保留90天。本報告未經本公司書面許可，不可部份複製。

This document is issued by the Company subject to its General Conditions of Service printed overleaf, available on request or accessible at <http://www.sgs.com.tw/Terms-and-Conditions> and for electronic format documents, subject to Terms and Conditions for Electronic Documents at <http://www.sgs.com.tw/Terms-and-Conditions>. Attention is drawn to the limitation of liability, indemnification and jurisdiction issues defined therein. Any holder of this document is advised that information contained hereon reflects the Company's findings at the time of its intervention only and within the limits of Client's instructions, if any. The Company's sole responsibility is to its Client and this document does not exonerate parties to a transaction from exercising all their rights and obligations under the transaction documents. This document cannot be reproduced except in full, without prior written approval of the Company. Any unauthorized alteration, forgery or falsification of the content or appearance of this document is unlawful and offenders may be prosecuted to the fullest extent of the law.

Band66\_5MHz\_64QAM\_25\_0\_Main\_LowCH131997-1712.5

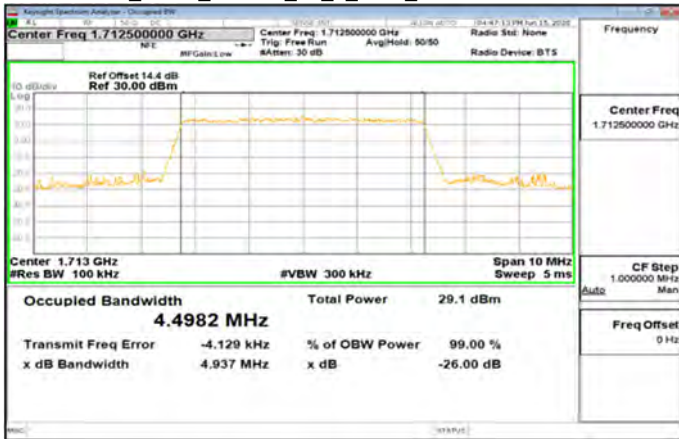

Band66\_5MHz\_256QAM\_25\_0\_Main\_LowCH131997-1712.5

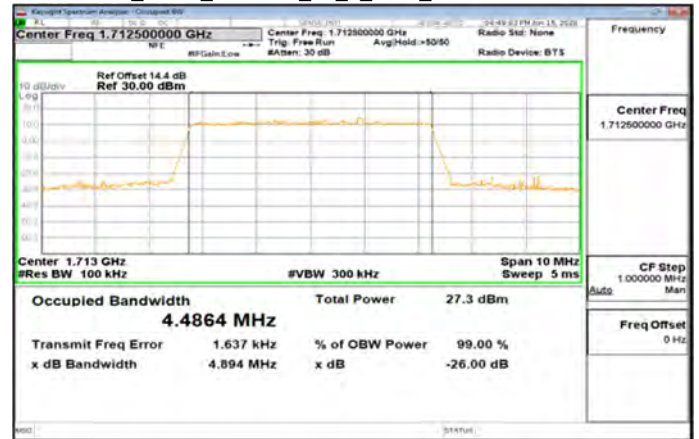

Band66\_5MHz\_64QAM\_25\_0\_Main\_MidCH132322-1745

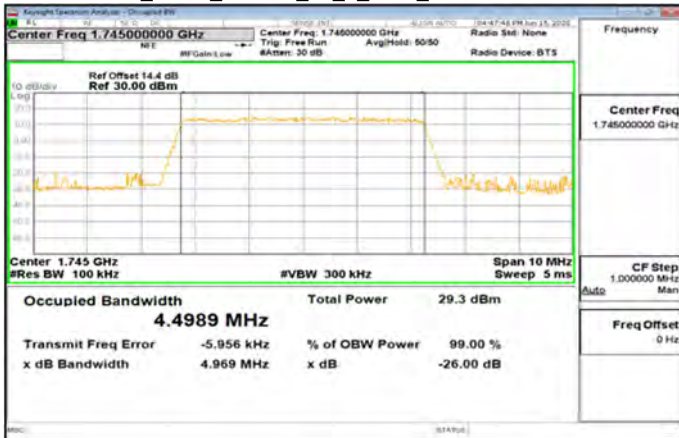

Band66\_5MHz\_256QAM\_25\_0\_Main\_MidCH132322-1745

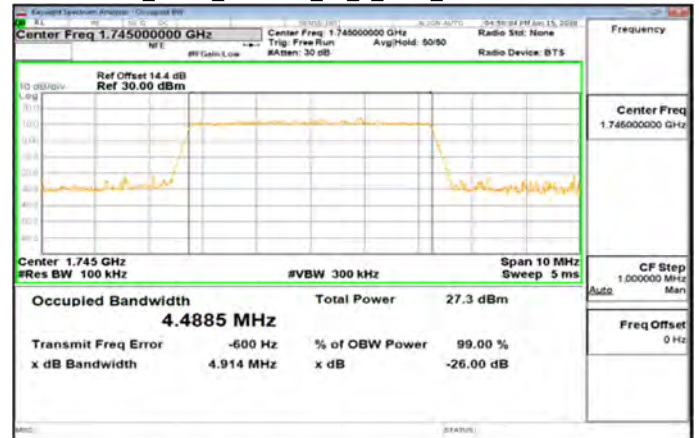

Band66\_5MHz\_64QAM\_25\_0\_Main\_HighCH132647-1777.5

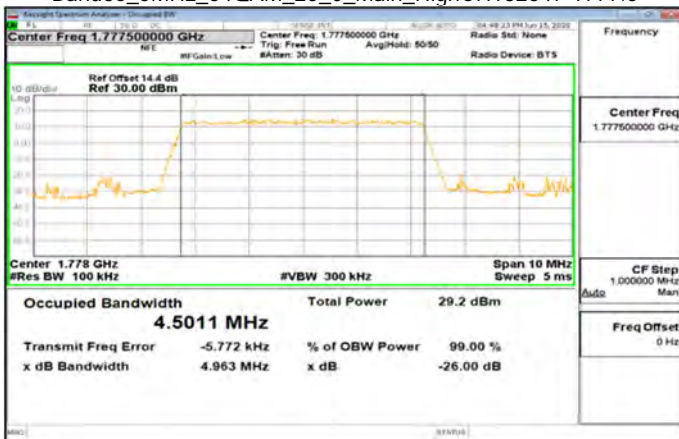

Band66\_5MHz\_256QAM\_25\_0\_Main\_HighCH132647-1777.5



Unless otherwise stated the results shown in this test report refer only to the sample(s) tested and such sample(s) are retained for 90 days only.

除非另有說明，此報告結果僅對測試之樣品負責，同時此樣品僅保留90天。本報告未經本公司書面許可，不可部份複製。

This document is issued by the Company subject to its General Conditions of Service printed overleaf, available on request or accessible at <http://www.sgs.com.tw/Terms-and-Conditions> and for electronic format documents, subject to Terms and Conditions for Electronic Documents at <http://www.sgs.com.tw/Terms-and-Conditions>. Attention is drawn to the limitation of liability, indemnification and jurisdiction issues defined therein. Any holder of this document is advised that information contained hereon reflects the Company's findings at the time of its intervention only and within the limits of Client's instructions, if any. The Company's sole responsibility is to its Client and this document does not exonerate parties to a transaction from exercising all their rights and obligations under the transaction documents. This document cannot be reproduced except in full, without prior written approval of the Company. Any unauthorized alteration, forgery or falsification of the content or appearance of this document is unlawful and offenders may be prosecuted to the fullest extent of the law.



Band66\_10MHz\_QPSK\_50\_0\_Main\_LowCH132022-1715

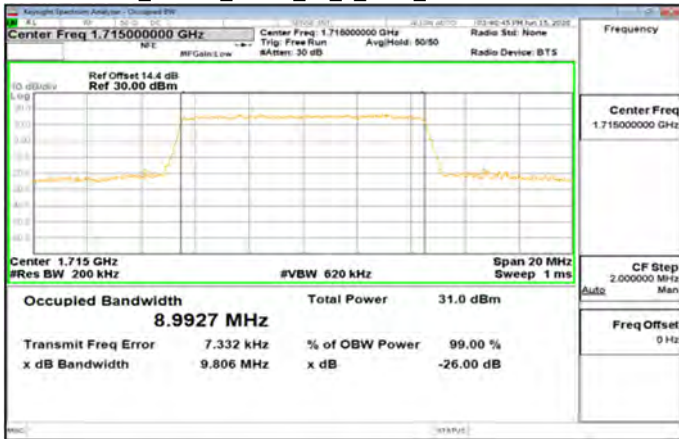

Band66\_10MHz\_16QAM\_50\_0\_Main\_LowCH132022-1715

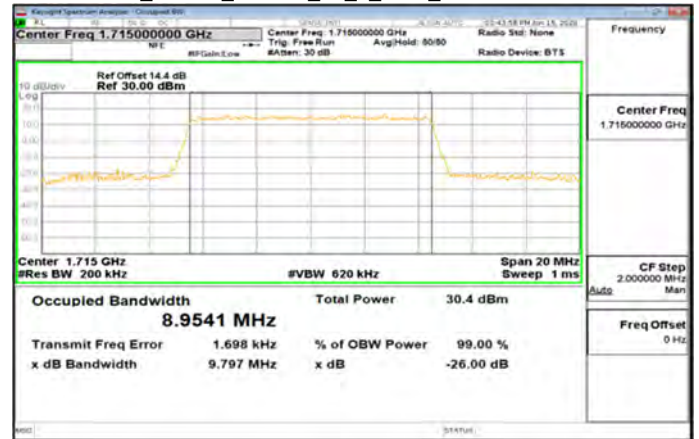

Band66\_10MHz\_QPSK\_50\_0\_Main\_MidCH132322-1745

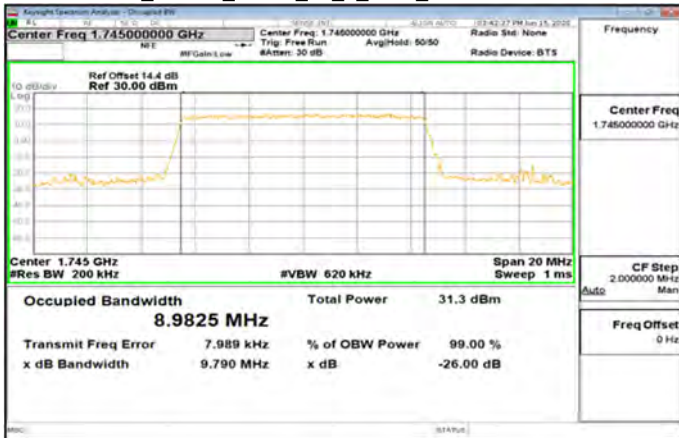

Band66\_10MHz\_16QAM\_50\_0\_Main\_MidCH132322-1745

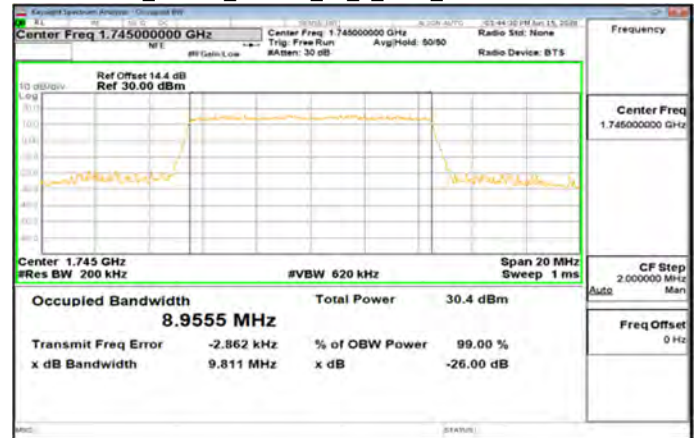

Band66\_10MHz\_QPSK\_50\_0\_Main\_HighCH132622-1775

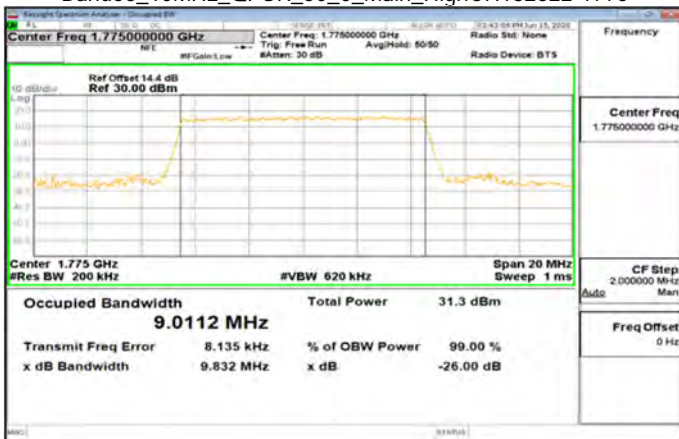

Band66\_10MHz\_16QAM\_50\_0\_Main\_HighCH132622-1775

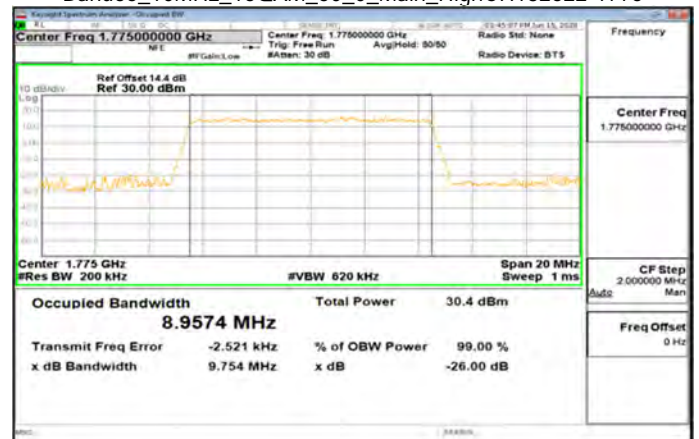

Unless otherwise stated the results shown in this test report refer only to the sample(s) tested and such sample(s) are retained for 90 days only.

除非另有說明，此報告結果僅對測試之樣品負責，同時此樣品僅保留90天。本報告未經本公司書面許可，不可部份複製。

This document is issued by the Company subject to its General Conditions of Service printed overleaf, available on request or accessible at <http://www.sgs.com.tw/Terms-and-Conditions> and for electronic format documents, subject to Terms and Conditions for Electronic Documents at <http://www.sgs.com.tw/Terms-and-Conditions>. Attention is drawn to the limitation of liability, indemnification and jurisdiction issues defined therein. Any holder of this document is advised that information contained hereon reflects the Company's findings at the time of its intervention only and within the limits of Client's instructions, if any. The Company's sole responsibility is to its Client and this document does not exonerate parties to a transaction from exercising all their rights and obligations under the transaction documents. This document cannot be reproduced except in full, without prior written approval of the Company. Any unauthorized alteration, forgery or falsification of the content or appearance of this document is unlawful and offenders may be prosecuted to the fullest extent of the law.

Band66\_10MHz\_64QAM\_50\_0\_Main\_LowCH132022-1715

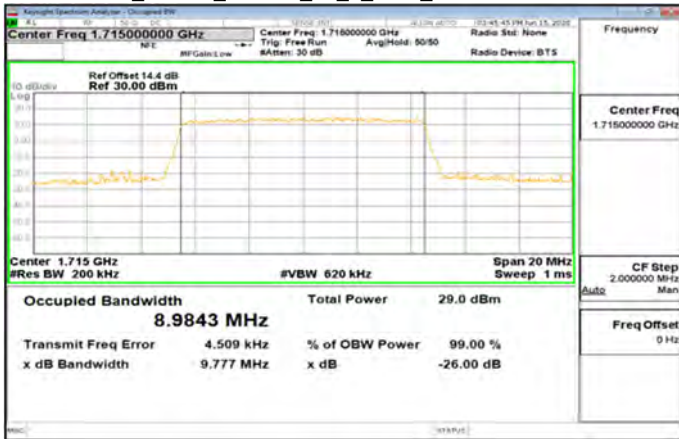

Band66\_10MHz\_256QAM\_50\_0\_Main\_LowCH132022-1715

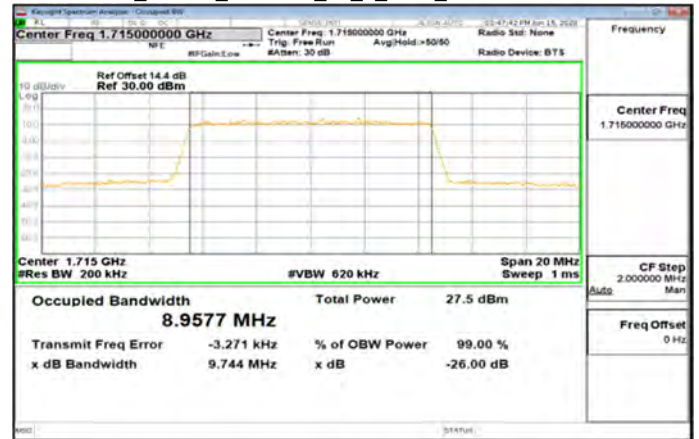

Band66\_10MHz\_64QAM\_50\_0\_Main\_MidCH132322-1745

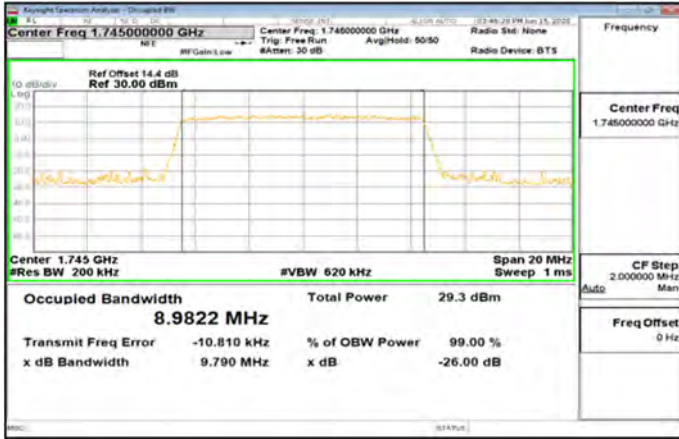

Band66\_10MHz\_256QAM\_50\_0\_Main\_MidCH132322-1745

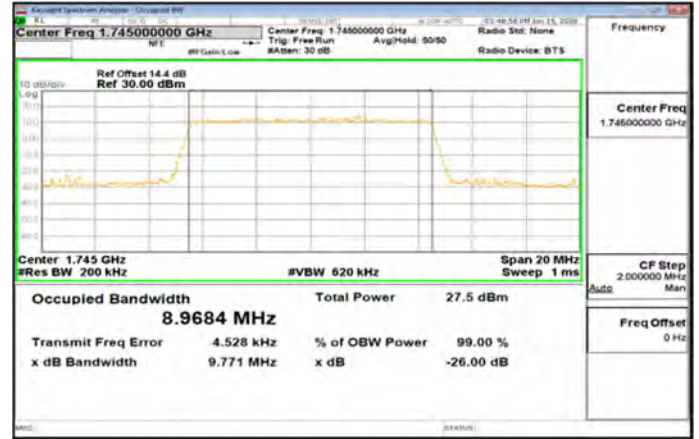

Band66\_10MHz\_64QAM\_50\_0\_Main\_HighCH132622-1775

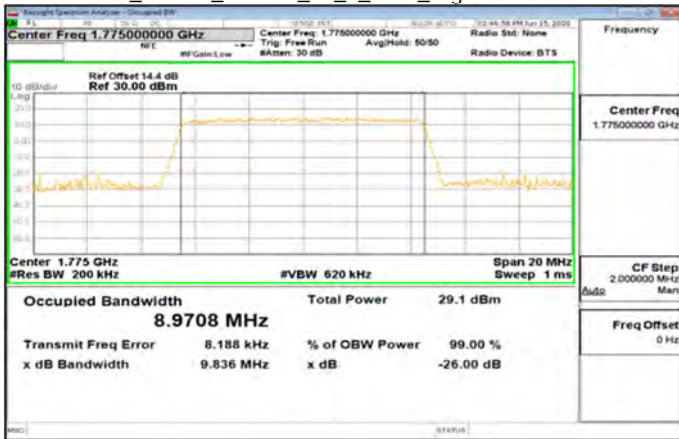

Band66\_10MHz\_256QAM\_50\_0\_Main\_HighCH132622-1775

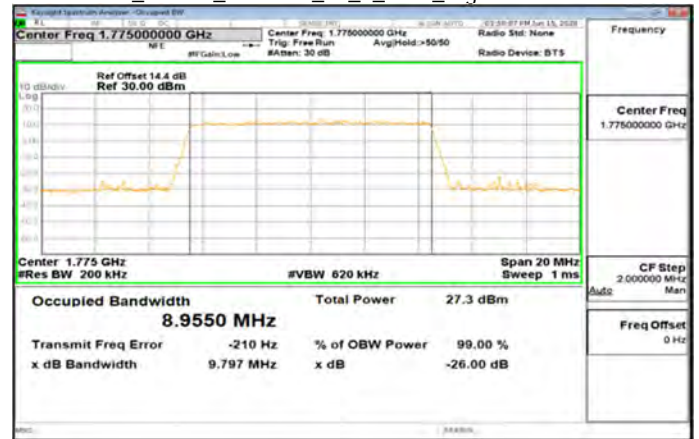

Unless otherwise stated the results shown in this test report refer only to the sample(s) tested and such sample(s) are retained for 90 days only.

除非另有說明，此報告結果僅對測試之樣品負責，同時此樣品僅保留90天。本報告未經本公司書面許可，不可部份複製。

This document is issued by the Company subject to its General Conditions of Service printed overleaf, available on request or accessible at <http://www.sgs.com.tw/Terms-and-Conditions> and for electronic format documents, subject to Terms and Conditions for Electronic Documents at <http://www.sgs.com.tw/Terms-and-Conditions>. Attention is drawn to the limitation of liability, indemnification and jurisdiction issues defined therein. Any holder of this document is advised that information contained hereon reflects the Company's findings at the time of its intervention only and within the limits of Client's instructions, if any. The Company's sole responsibility is to its Client and this document does not exonerate parties to a transaction from exercising all their rights and obligations under the transaction documents. This document cannot be reproduced except in full, without prior written approval of the Company. Any unauthorized alteration, forgery or falsification of the content or appearance of this document is unlawful and offenders may be prosecuted to the fullest extent of the law.



Band66\_15MHz\_QPSK\_75\_0\_Main\_LowCH132047-1717.5

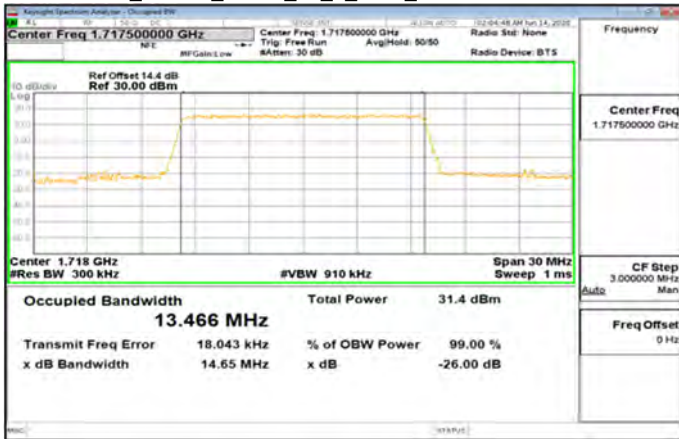

Band66\_15MHz\_16QAM\_75\_0\_Main\_LowCH132047-1717.5

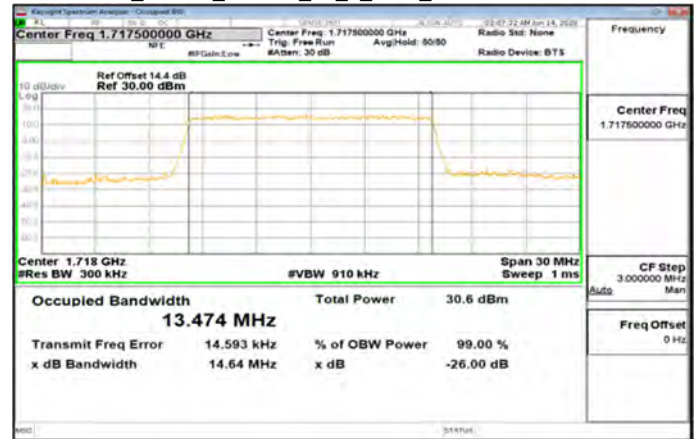

Band66\_15MHz\_QPSK\_75\_0\_Main\_MidCH132322-1745

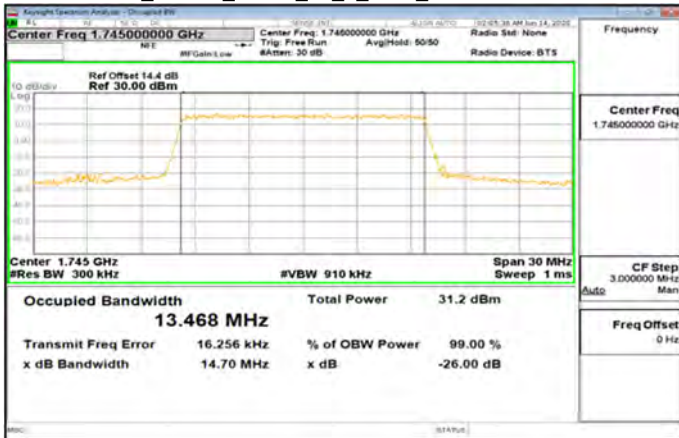

Band66\_15MHz\_16QAM\_75\_0\_Main\_MidCH132322-1745

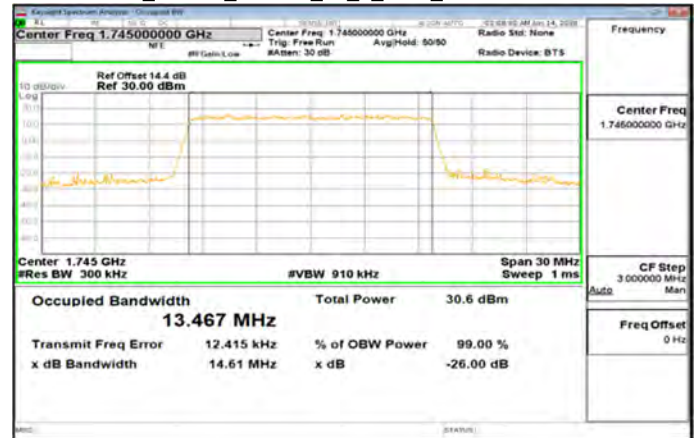

Band66\_15MHz\_QPSK\_75\_0\_Main\_HighCH132597-1772.5

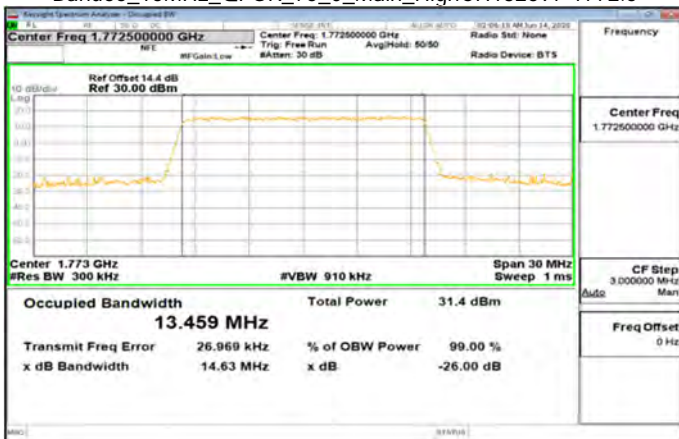

Band66\_15MHz\_16QAM\_75\_0\_Main\_HighCH132597-1772.5

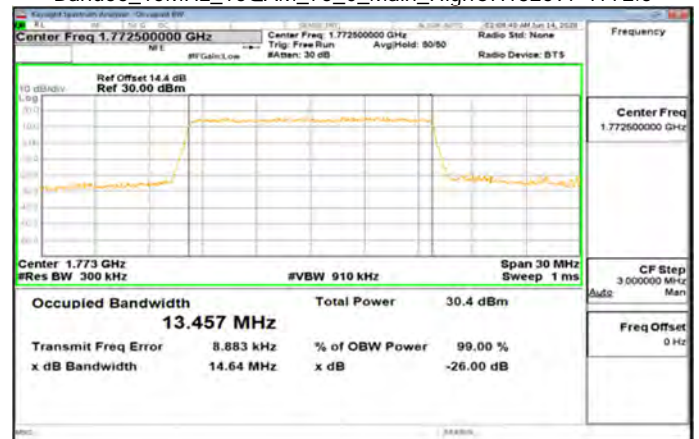

Unless otherwise stated the results shown in this test report refer only to the sample(s) tested and such sample(s) are retained for 90 days only.

除非另有說明，此報告結果僅對測試之樣品負責，同時此樣品僅保留90天。本報告未經本公司書面許可，不可部份複製。

This document is issued by the Company subject to its General Conditions of Service printed overleaf, available on request or accessible at <http://www.sgs.com.tw/Terms-and-Conditions> and for electronic format documents, subject to Terms and Conditions for Electronic Documents at <http://www.sgs.com.tw/Terms-and-Conditions>. Attention is drawn to the limitation of liability, indemnification and jurisdiction issues defined therein. Any holder of this document is advised that information contained hereon reflects the Company's findings at the time of its intervention only and within the limits of Client's instructions, if any. The Company's sole responsibility is to its Client and this document does not exonerate parties to a transaction from exercising all their rights and obligations under the transaction documents. This document cannot be reproduced except in full, without prior written approval of the Company. Any unauthorized alteration, forgery or falsification of the content or appearance of this document is unlawful and offenders may be prosecuted to the fullest extent of the law.

Band66\_15MHz\_64QAM\_75\_0\_Main\_LowCH132047-1717.5

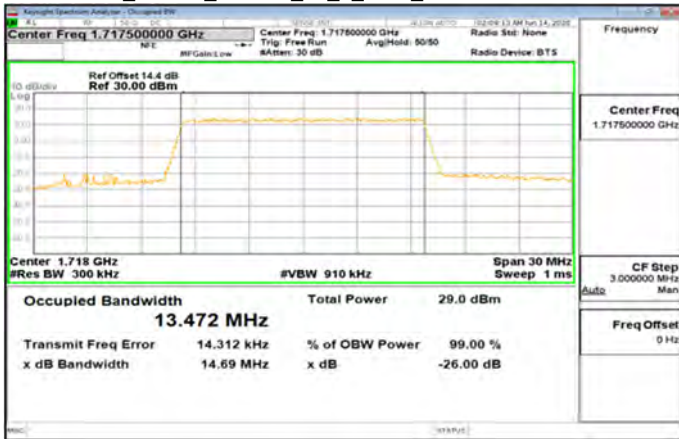

Band66\_15MHz\_256QAM\_75\_0\_Main\_LowCH132047-1717.5

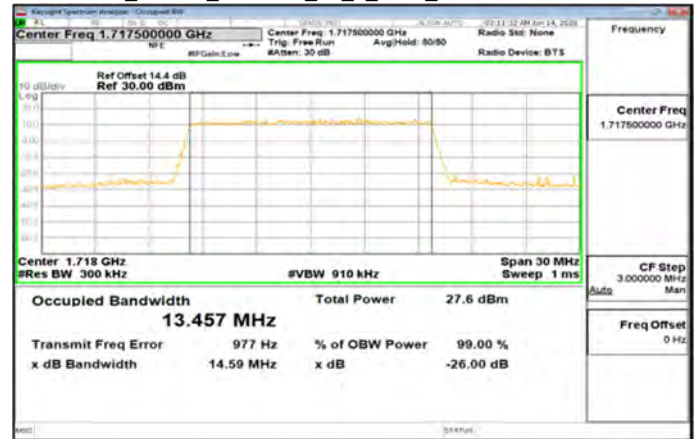

Band66\_15MHz\_64QAM\_75\_0\_Main\_MidCH132322-1745

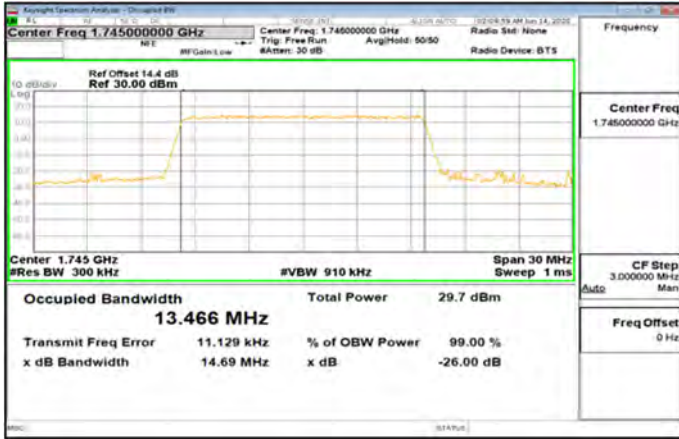

Band66\_15MHz\_256QAM\_75\_0\_Main\_MidCH132322-1745

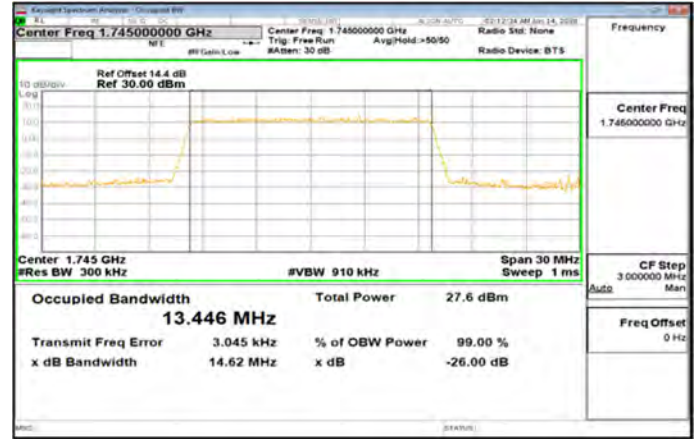

Band66\_15MHz\_64QAM\_75\_0\_Main\_HighCH132597-1772.5

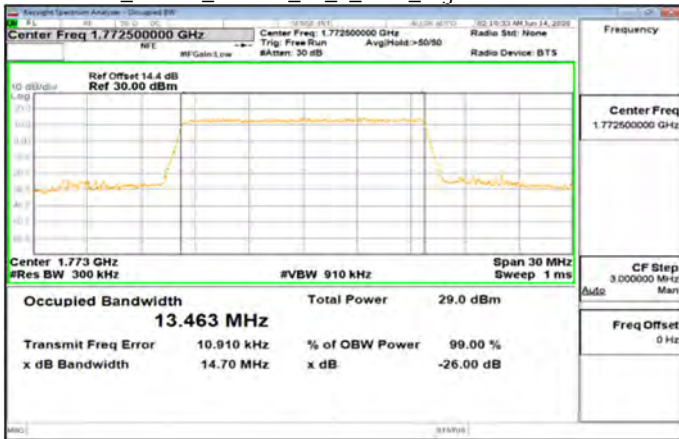

Band66\_15MHz\_256QAM\_75\_0\_Main\_HighCH132597-1772.5

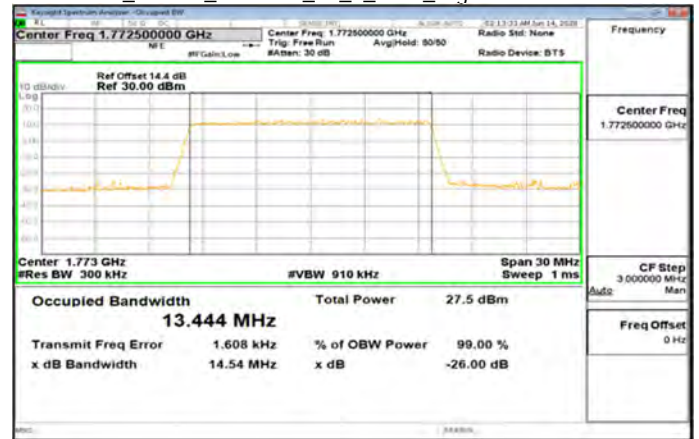

Unless otherwise stated the results shown in this test report refer only to the sample(s) tested and such sample(s) are retained for 90 days only.

除非另有說明，此報告結果僅對測試之樣品負責，同時此樣品僅保留90天。本報告未經本公司書面許可，不可部份複製。

This document is issued by the Company subject to its General Conditions of Service printed overleaf, available on request or accessible at <http://www.sgs.com.tw/Terms-and-Conditions> and for electronic format documents, subject to Terms and Conditions for Electronic Documents at <http://www.sgs.com.tw/Terms-and-Conditions>. Attention is drawn to the limitation of liability, indemnification and jurisdiction issues defined therein. Any holder of this document is advised that information contained hereon reflects the Company's findings at the time of its intervention only and within the limits of Client's instructions, if any. The Company's sole responsibility is to its Client and this document does not exonerate parties to a transaction from exercising all their rights and obligations under the transaction documents. This document cannot be reproduced except in full, without prior written approval of the Company. Any unauthorized alteration, forgery or falsification of the content or appearance of this document is unlawful and offenders may be prosecuted to the fullest extent of the law.









Band71\_5MHz\_QPSK\_25\_0\_Main\_LowCH133147-665.5

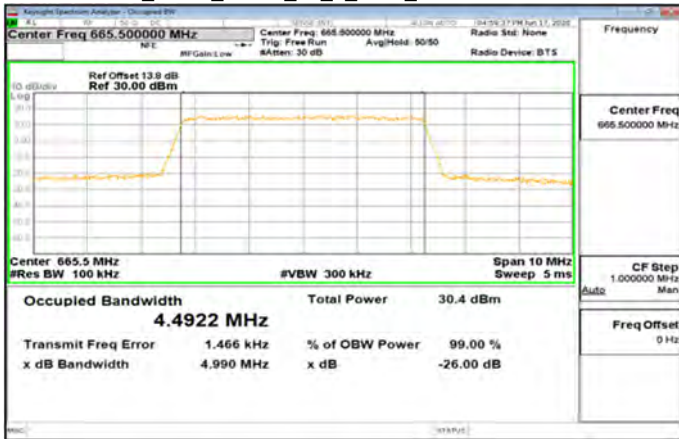

Band71\_5MHz\_16QAM\_25\_0\_Main\_LowCH133147-665.5

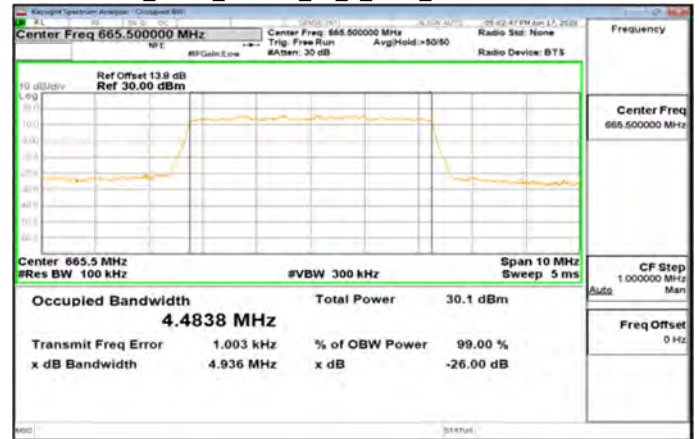

Band71\_5MHz\_QPSK\_25\_0\_Main\_MidCH133297-680.5

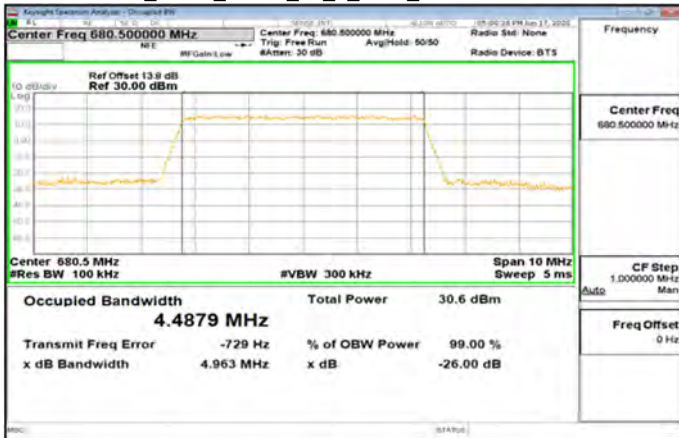

Band71\_5MHz\_16QAM\_25\_0\_Main\_MidCH133297-680.5

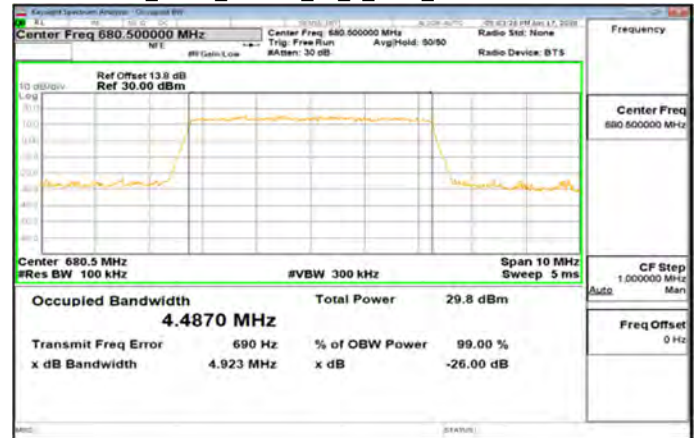

Band71\_5MHz\_QPSK\_25\_0\_Main\_HighCH133447-695.5

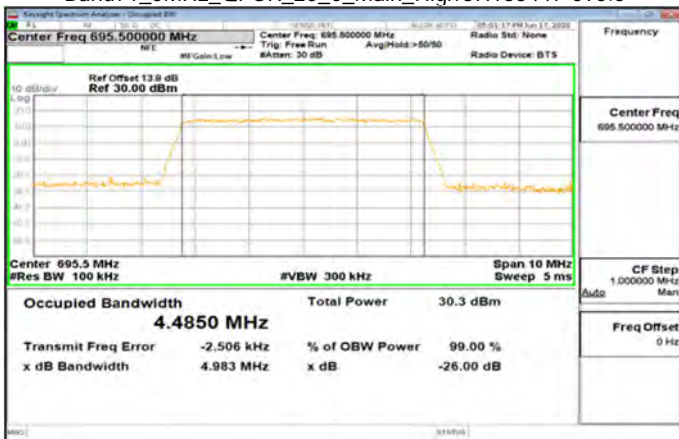

Band71\_5MHz\_16QAM\_25\_0\_Main\_HighCH133447-695.5

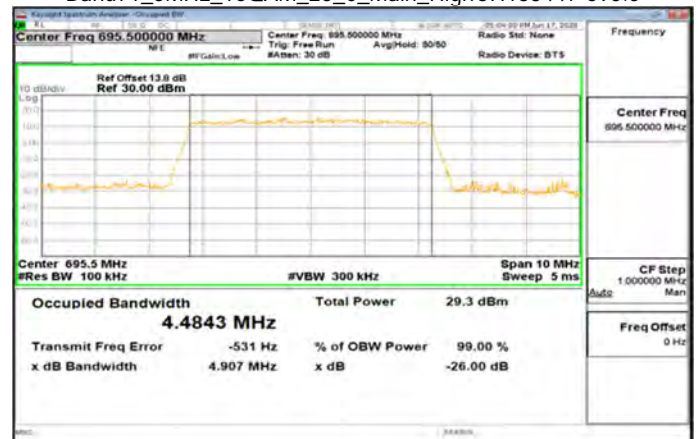

Unless otherwise stated the results shown in this test report refer only to the sample(s) tested and such sample(s) are retained for 90 days only.

除非另有說明，此報告結果僅對測試之樣品負責，同時此樣品僅保留90天。本報告未經本公司書面許可，不可部份複製。

This document is issued by the Company subject to its General Conditions of Service printed overleaf, available on request or accessible at <http://www.sgs.com.tw/Terms-and-Conditions> and for electronic format documents, subject to Terms and Conditions for Electronic Documents at <http://www.sgs.com.tw/Terms-and-Conditions>. Attention is drawn to the limitation of liability, indemnification and jurisdiction issues defined therein. Any holder of this document is advised that information contained hereon reflects the Company's findings at the time of its intervention only and within the limits of Client's instructions, if any. The Company's sole responsibility is to its Client and this document does not exonerate parties to a transaction from exercising all their rights and obligations under the transaction documents. This document cannot be reproduced except in full, without prior written approval of the Company. Any unauthorized alteration, forgery or falsification of the content or appearance of this document is unlawful and offenders may be prosecuted to the fullest extent of the law.

Band71\_5MHz\_64QAM\_25\_0\_Main\_LowCH133147-665.5

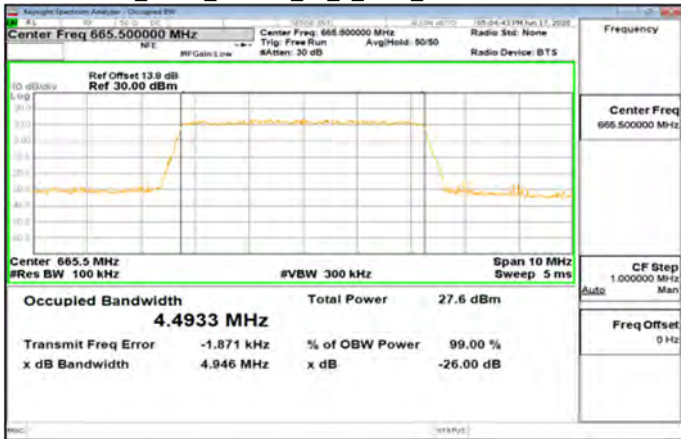

Band71\_5MHz\_256QAM\_25\_0\_Main\_LowCH133147-665.5

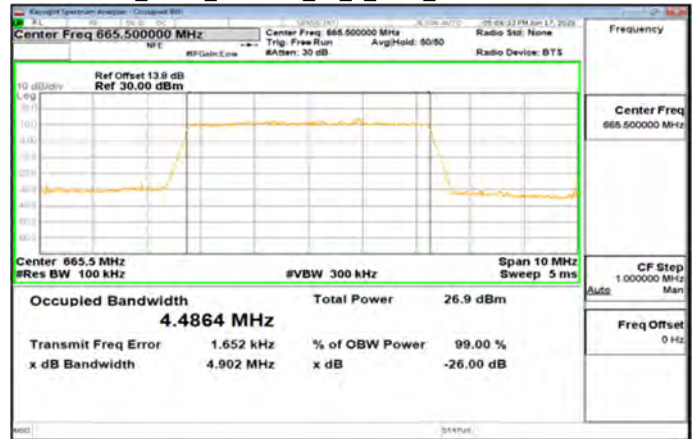

Band71\_5MHz\_64QAM\_25\_0\_Main\_MidCH133297-680.5

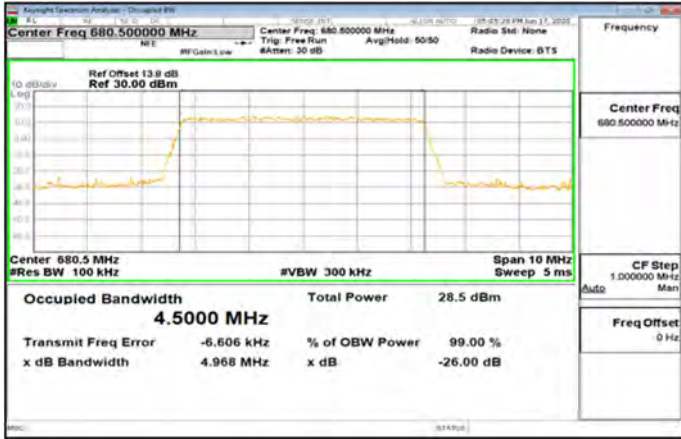

Band71\_5MHz\_256QAM\_25\_0\_Main\_MidCH133297-680.5

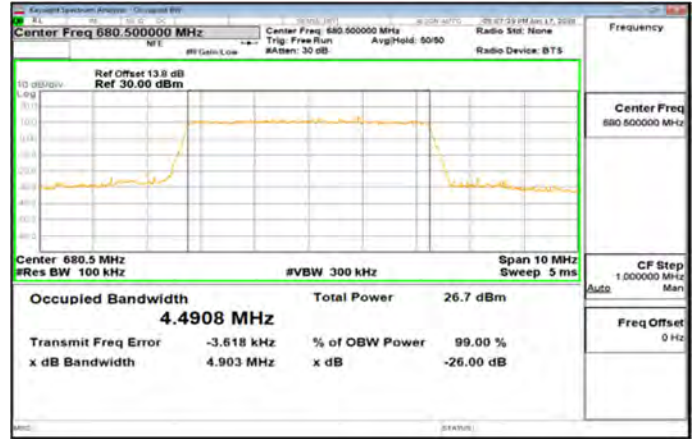

Band71\_5MHz\_64QAM\_25\_0\_Main\_HighCH133447-695.5

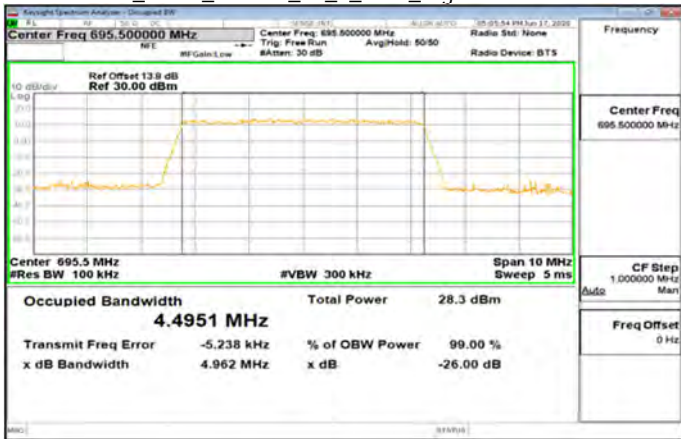

Band71\_5MHz\_256QAM\_25\_0\_Main\_HighCH133447-695.5

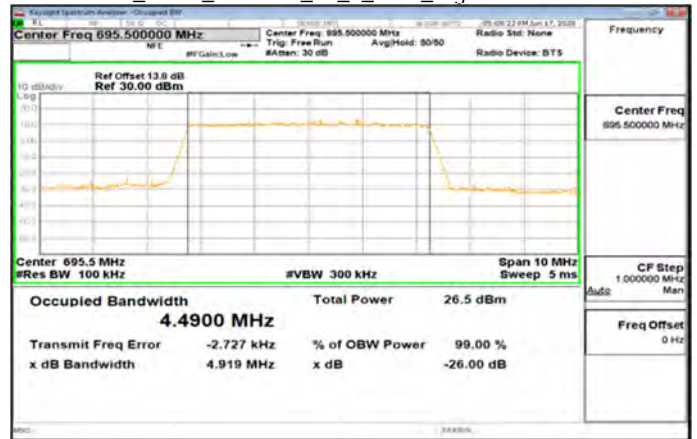

Unless otherwise stated the results shown in this test report refer only to the sample(s) tested and such sample(s) are retained for 90 days only.

除非另有說明，此報告結果僅對測試之樣品負責，同時此樣品僅保留90天。本報告未經本公司書面許可，不可部份複製。

This document is issued by the Company subject to its General Conditions of Service printed overleaf, available on request or accessible at <http://www.sgs.com.tw/Terms-and-Conditions> and for electronic format documents, subject to Terms and Conditions for Electronic Documents at <http://www.sgs.com.tw/Terms-and-Conditions>. Attention is drawn to the limitation of liability, indemnification and jurisdiction issues defined therein. Any holder of this document is advised that information contained hereon reflects the Company's findings at the time of its intervention only and within the limits of Client's instructions, if any. The Company's sole responsibility is to its Client and this document does not exonerate parties to a transaction from exercising all their rights and obligations under the transaction documents. This document cannot be reproduced except in full, without prior written approval of the Company. Any unauthorized alteration, forgery or falsification of the content or appearance of this document is unlawful and offenders may be prosecuted to the fullest extent of the law.



Band71\_10MHz\_QPSK\_50\_0\_Main\_LowCH133172-668

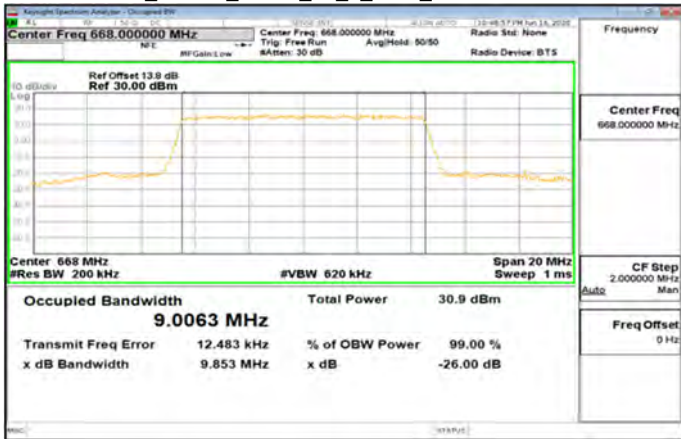

Band71\_10MHz\_16QAM\_50\_0\_Main\_LowCH133172-668

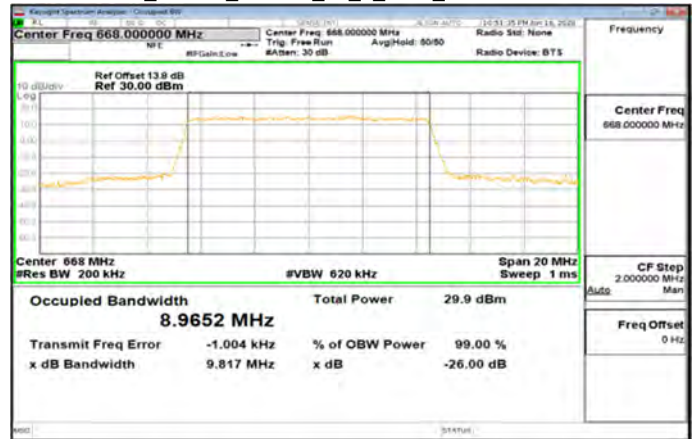

Band71\_10MHz\_QPSK\_50\_0\_Main\_MidCH133297-680.5

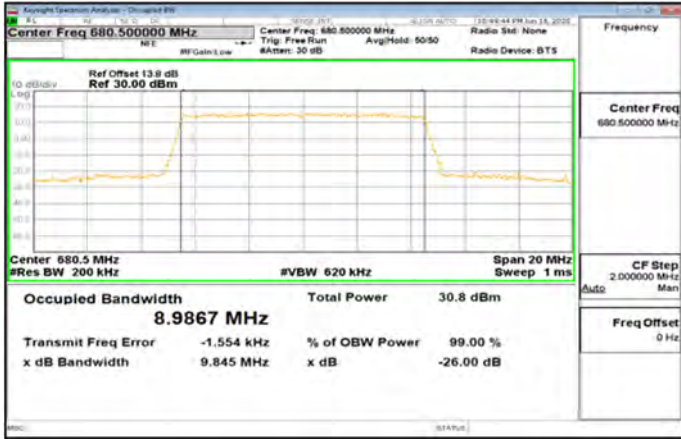

Band71\_10MHz\_16QAM\_50\_0\_Main\_MidCH133297-680.5

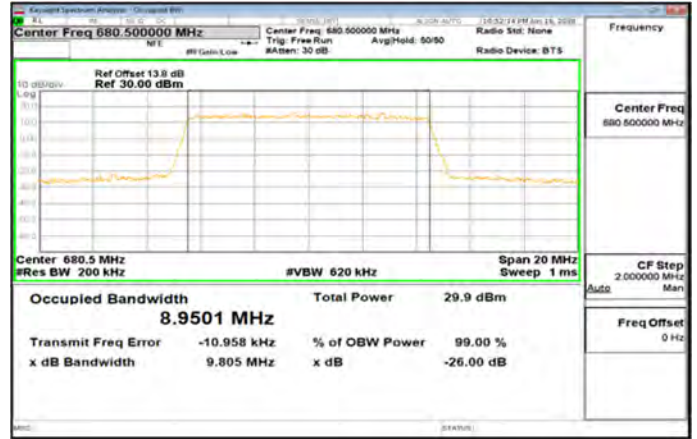

Band71\_10MHz\_QPSK\_50\_0\_Main\_HighCH133422-693

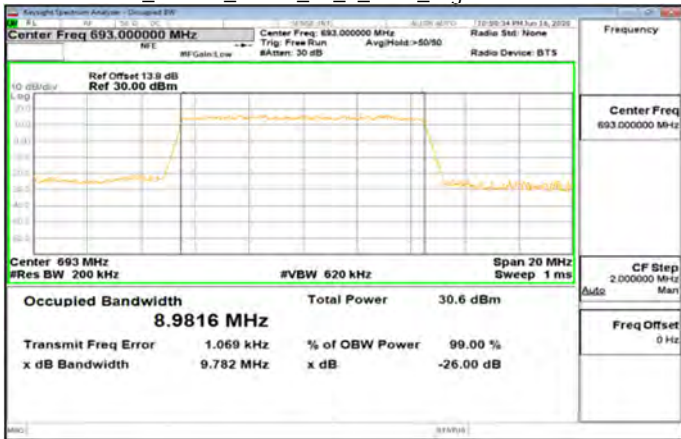

Band71\_10MHz\_16QAM\_50\_0\_Main\_HighCH133422-693

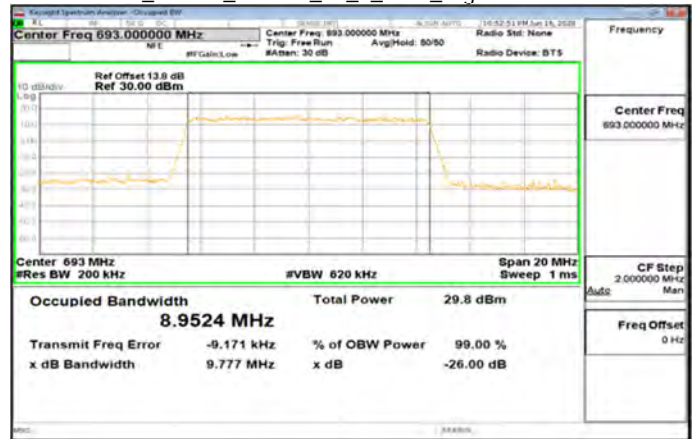

Unless otherwise stated the results shown in this test report refer only to the sample(s) tested and such sample(s) are retained for 90 days only.

除非另有說明，此報告結果僅對測試之樣品負責，同時此樣品僅保留90天。本報告未經本公司書面許可，不可部份複製。

This document is issued by the Company subject to its General Conditions of Service printed overleaf, available on request or accessible at <http://www.sgs.com.tw/Terms-and-Conditions> and for electronic format documents, subject to Terms and Conditions for Electronic Documents at <http://www.sgs.com.tw/Terms-and-Conditions>. Attention is drawn to the limitation of liability, indemnification and jurisdiction issues defined therein. Any holder of this document is advised that information contained hereon reflects the Company's findings at the time of its intervention only and within the limits of Client's instructions, if any. The Company's sole responsibility is to its Client and this document does not exonerate parties to a transaction from exercising all their rights and obligations under the transaction documents. This document cannot be reproduced except in full, without prior written approval of the Company. Any unauthorized alteration, forgery or falsification of the content or appearance of this document is unlawful and offenders may be prosecuted to the fullest extent of the law.

Band71\_10MHz\_64QAM\_50\_0\_Main\_LowCH133172-668

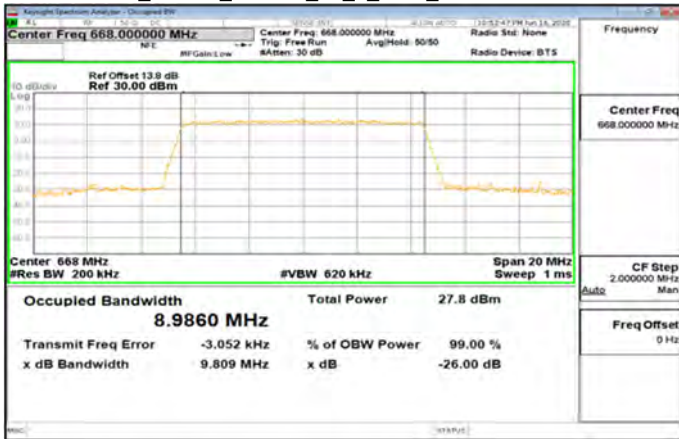

Band71\_10MHz\_256QAM\_50\_0\_Main\_LowCH133172-668

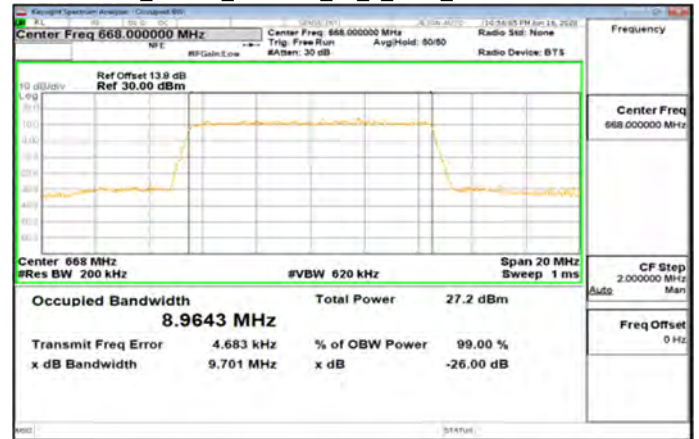

Band71\_10MHz\_64QAM\_50\_0\_Main\_MidCH133297-680.5

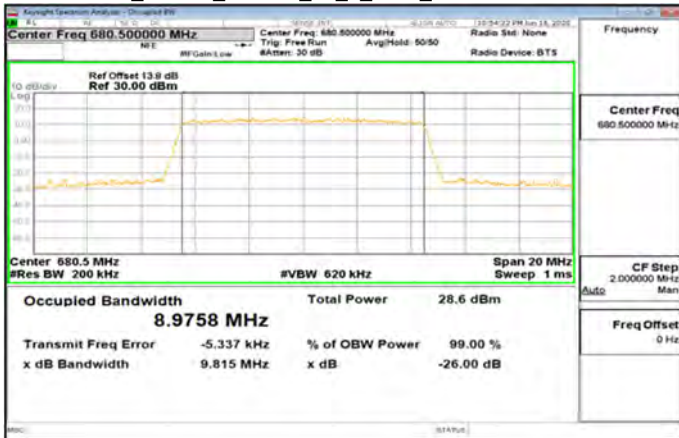

Band71\_10MHz\_256QAM\_50\_0\_Main\_MidCH133297-680.5

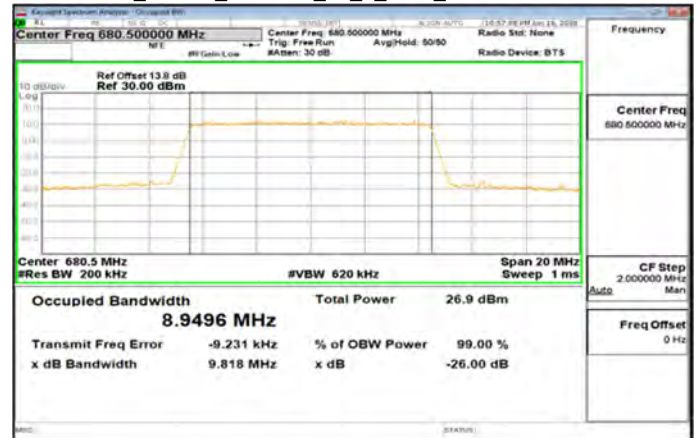

Band71\_10MHz\_64QAM\_50\_0\_Main\_HighCH133422-693

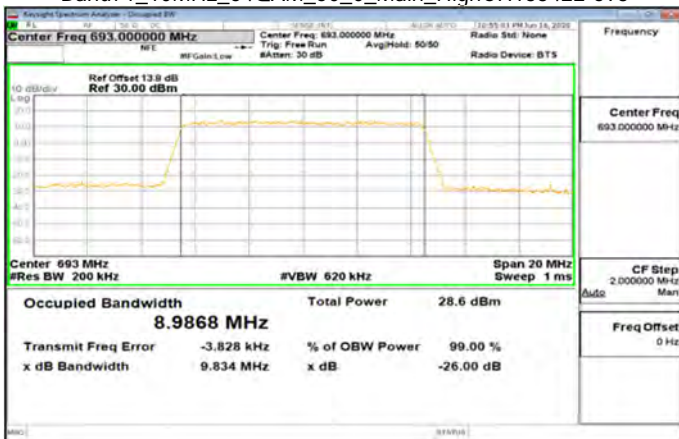

Band71\_10MHz\_256QAM\_50\_0\_Main\_HighCH133422-693

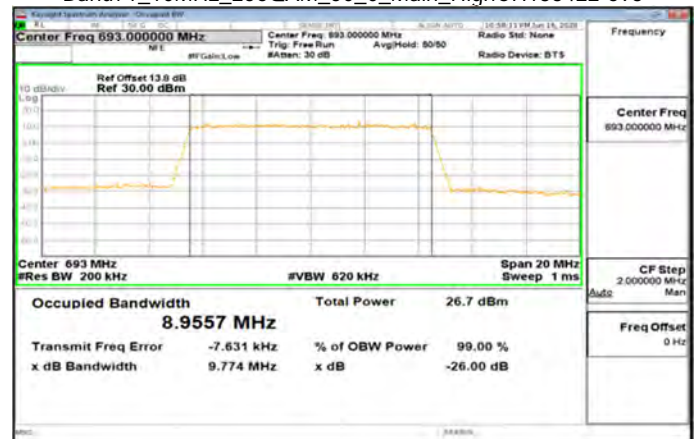

Unless otherwise stated the results shown in this test report refer only to the sample(s) tested and such sample(s) are retained for 90 days only.

除非另有說明，此報告結果僅對測試之樣品負責，同時此樣品僅保留90天。本報告未經本公司書面許可，不可部份複製。

This document is issued by the Company subject to its General Conditions of Service printed overleaf, available on request or accessible at <http://www.sgs.com.tw/Terms-and-Conditions> and for electronic format documents, subject to Terms and Conditions for Electronic Documents at <http://www.sgs.com.tw/Terms-and-Conditions>. Attention is drawn to the limitation of liability, indemnification and jurisdiction issues defined therein. Any holder of this document is advised that information contained hereon reflects the Company's findings at the time of its intervention only and within the limits of Client's instructions, if any. The Company's sole responsibility is to its Client and this document does not exonerate parties to a transaction from exercising all their rights and obligations under the transaction documents. This document cannot be reproduced except in full, without prior written approval of the Company. Any unauthorized alteration, forgery or falsification of the content or appearance of this document is unlawful and offenders may be prosecuted to the fullest extent of the law.



Band71\_15MHz\_QPSK\_75\_0\_Main\_LowCH133197-670.5

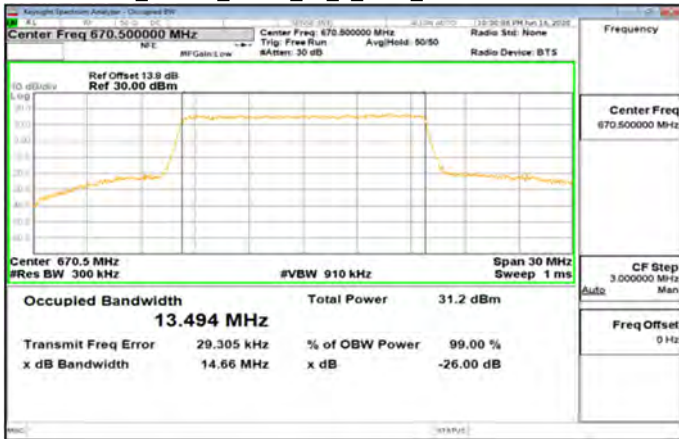

Band71\_15MHz\_16QAM\_75\_0\_Main\_LowCH133197-670.5

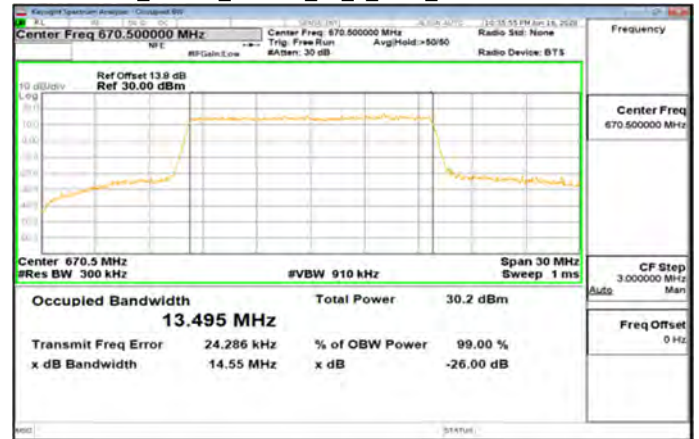

Band71\_15MHz\_QPSK\_75\_0\_Main\_MidCH133297-680.5

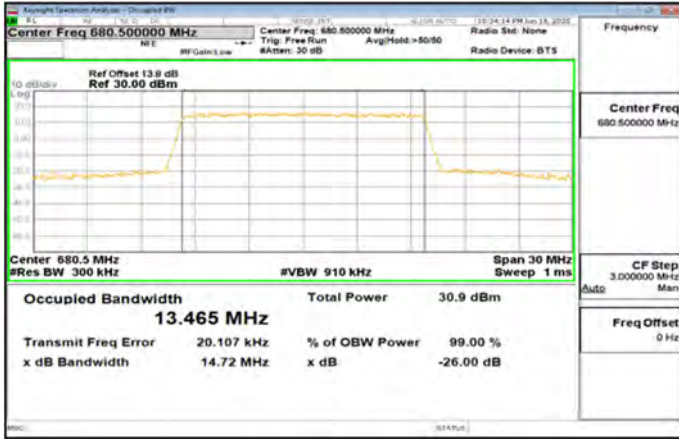

Band71\_15MHz\_16QAM\_75\_0\_Main\_MidCH133297-680.5

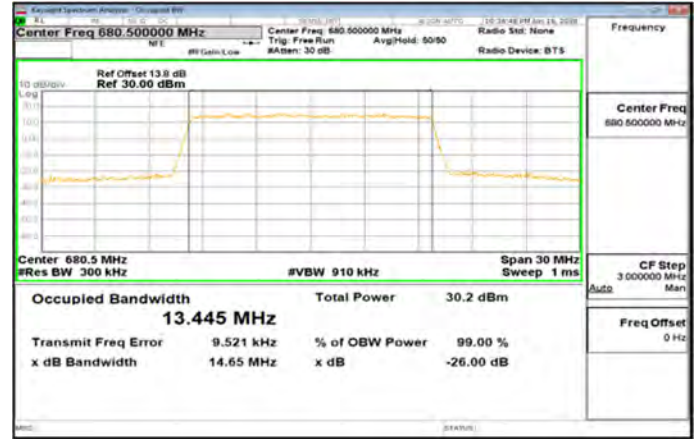

Band71\_15MHz\_QPSK\_75\_0\_Main\_HighCH133397-690.5

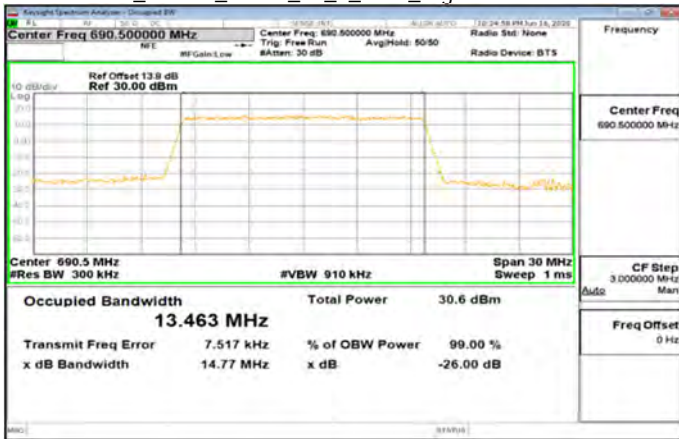

Band71\_15MHz\_16QAM\_75\_0\_Main\_HighCH133397-690.5

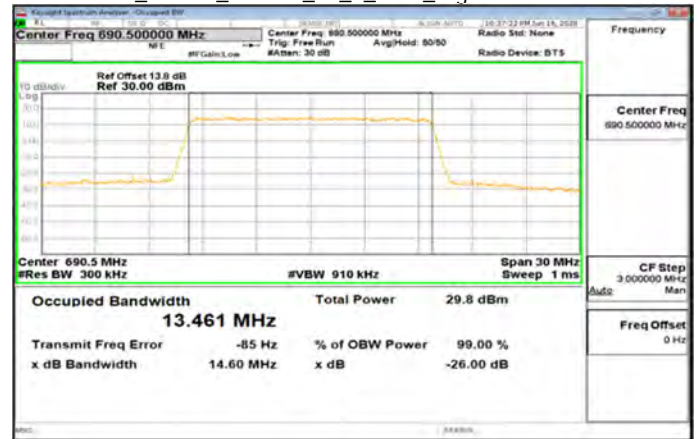

Unless otherwise stated the results shown in this test report refer only to the sample(s) tested and such sample(s) are retained for 90 days only.

除非另有說明，此報告結果僅對測試之樣品負責，同時此樣品僅保留90天。本報告未經本公司書面許可，不可部份複製。

This document is issued by the Company subject to its General Conditions of Service printed overleaf, available on request or accessible at <http://www.sgs.com.tw/Terms-and-Conditions> and for electronic format documents, subject to Terms and Conditions for Electronic Documents at <http://www.sgs.com.tw/Terms-and-Conditions>. Attention is drawn to the limitation of liability, indemnification and jurisdiction issues defined therein. Any holder of this document is advised that information contained hereon reflects the Company's findings at the time of its intervention only and within the limits of Client's instructions, if any. The Company's sole responsibility is to its Client and this document does not exonerate parties to a transaction from exercising all their rights and obligations under the transaction documents. This document cannot be reproduced except in full, without prior written approval of the Company. Any unauthorized alteration, forgery or falsification of the content or appearance of this document is unlawful and offenders may be prosecuted to the fullest extent of the law.

Band71\_15MHz\_64QAM\_75\_0\_Main\_LowCH133197-670.5

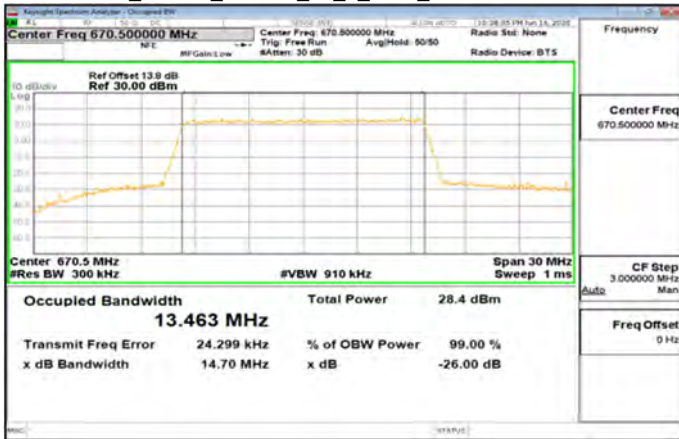

Band71\_15MHz\_256QAM\_75\_0\_Main\_LowCH133197-670.5

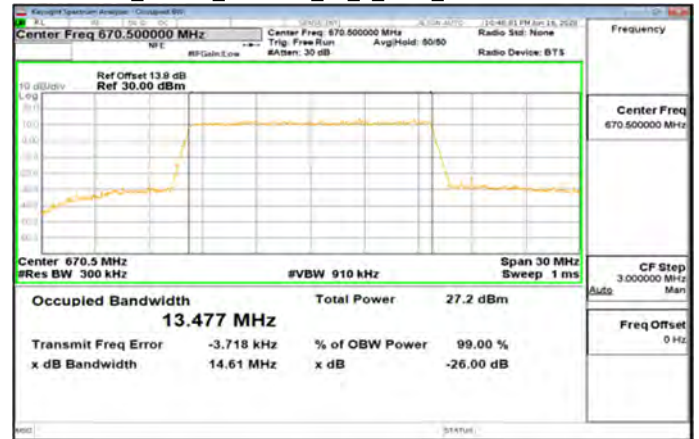

Band71\_15MHz\_64QAM\_75\_0\_Main\_MidCH133297-680.5

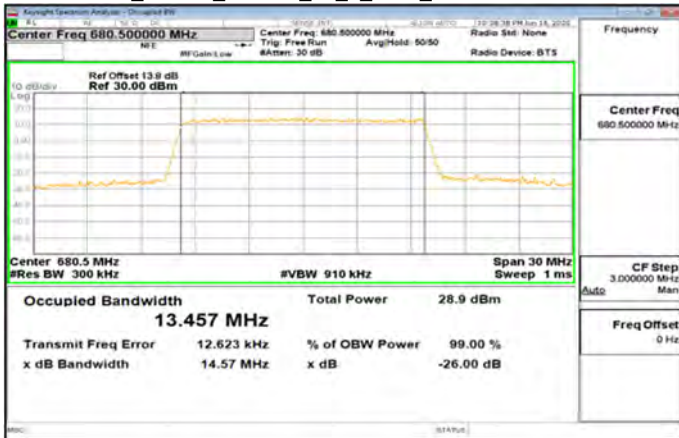

Band71\_15MHz\_256QAM\_75\_0\_Main\_MidCH133297-680.5

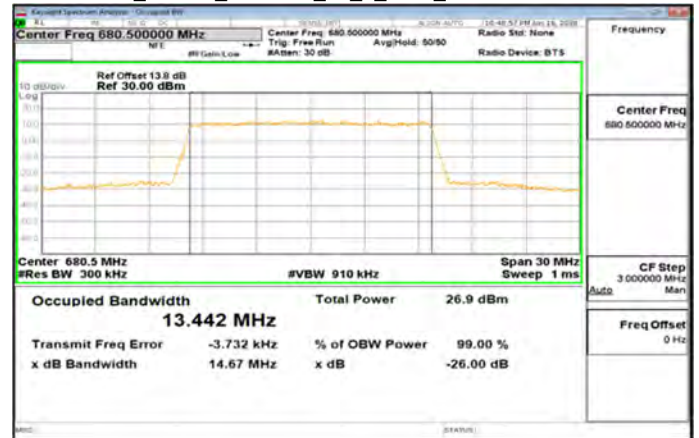

Band71\_15MHz\_64QAM\_75\_0\_Main\_HighCH133397-690.5

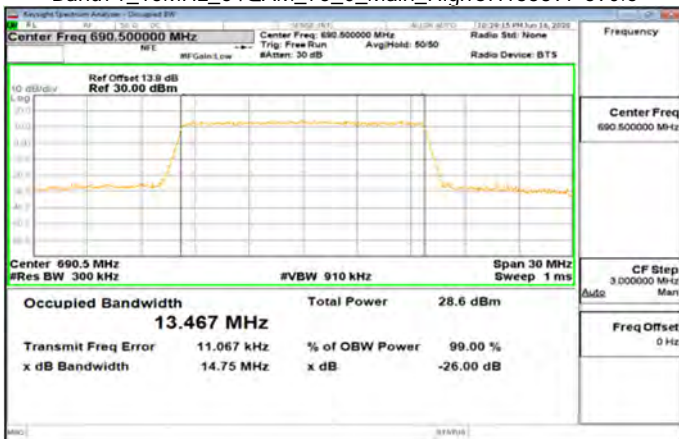

Band71\_15MHz\_256QAM\_75\_0\_Main\_HighCH133397-690.5

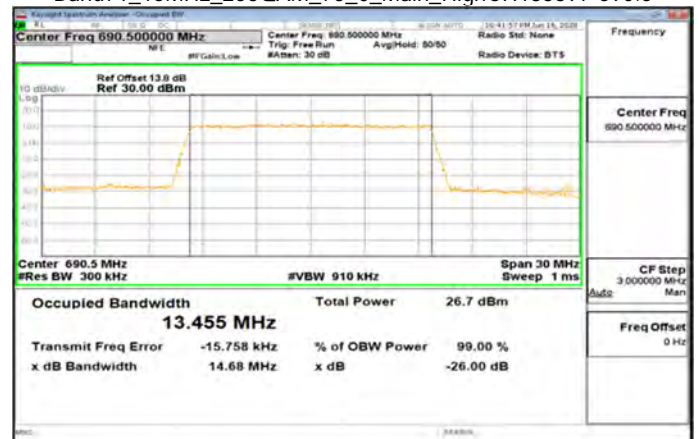

Unless otherwise stated the results shown in this test report refer only to the sample(s) tested and such sample(s) are retained for 90 days only.

除非另有說明，此報告結果僅對測試之樣品負責，同時此樣品僅保留90天。本報告未經本公司書面許可，不可部份複製。

This document is issued by the Company subject to its General Conditions of Service printed overleaf, available on request or accessible at <http://www.sgs.com.tw/Terms-and-Conditions> and for electronic format documents, subject to Terms and Conditions for Electronic Documents at <http://www.sgs.com.tw/Terms-and-Conditions>. Attention is drawn to the limitation of liability, indemnification and jurisdiction issues defined therein. Any holder of this document is advised that information contained hereon reflects the Company's findings at the time of its intervention only and within the limits of Client's instructions, if any. The Company's sole responsibility is to its Client and this document does not exonerate parties to a transaction from exercising all their rights and obligations under the transaction documents. This document cannot be reproduced except in full, without prior written approval of the Company. Any unauthorized alteration, forgery or falsification of the content or appearance of this document is unlawful and offenders may be prosecuted to the fullest extent of the law.



Band71\_20MHz\_QPSK\_100\_0\_Main\_LowCH133222-673

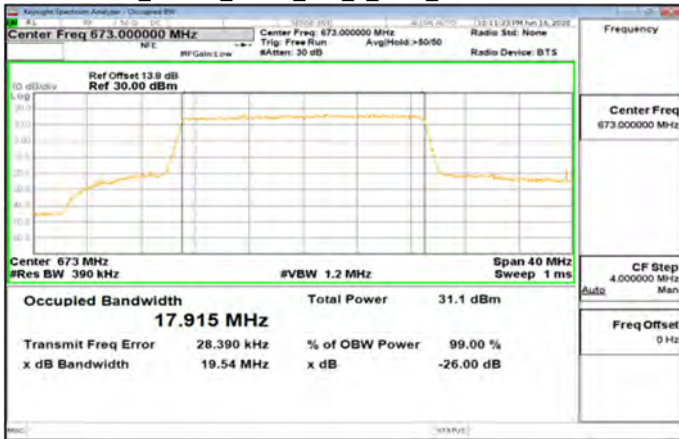

Band71\_20MHz\_16QAM\_100\_0\_Main\_LowCH133222-673

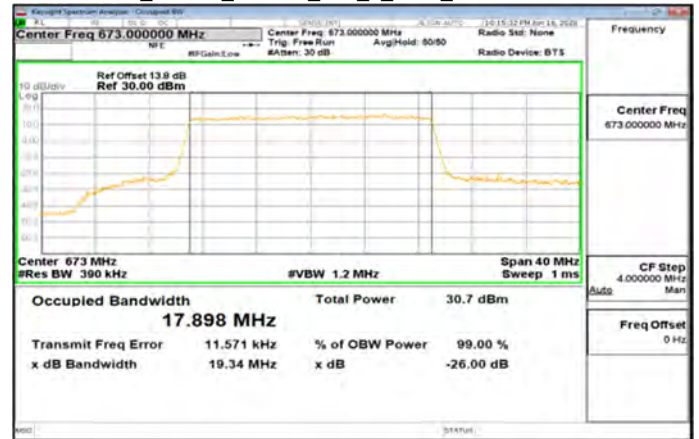

Band71\_20MHz\_QPSK\_100\_0\_Main\_MidCH133297-680.5

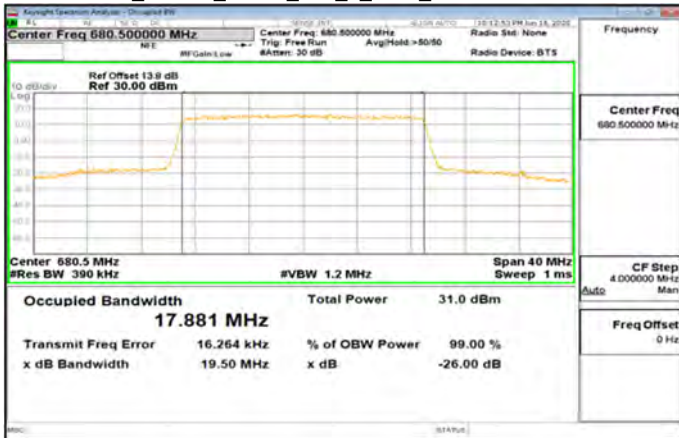

Band71\_20MHz\_16QAM\_100\_0\_Main\_MidCH133297-680.5

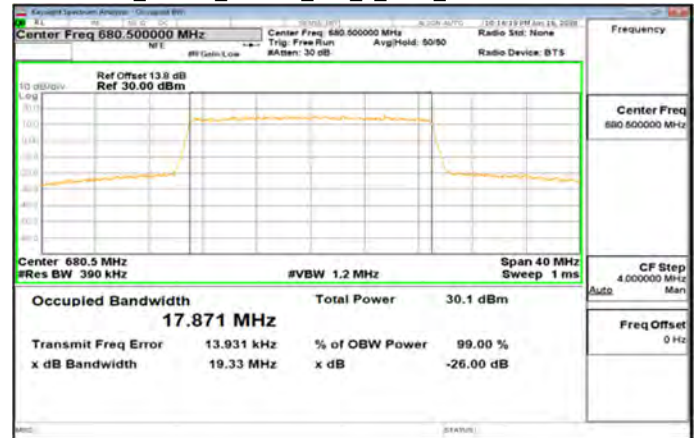

Band71\_20MHz\_QPSK\_100\_0\_Main\_HighCH133372-688

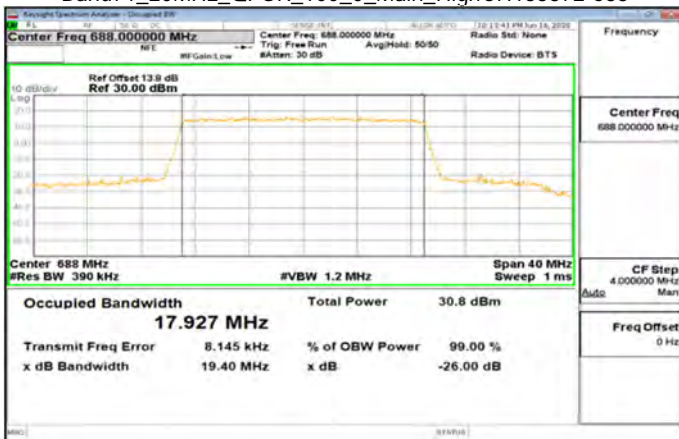

Band71\_20MHz\_16QAM\_100\_0\_Main\_HighCH133372-688

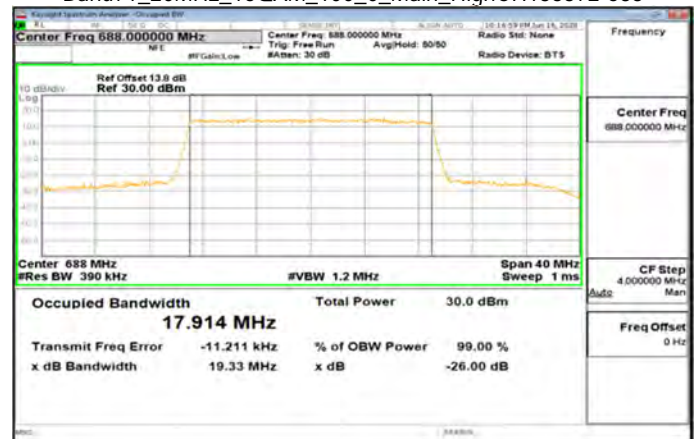

Unless otherwise stated the results shown in this test report refer only to the sample(s) tested and such sample(s) are retained for 90 days only.

除非另有說明，此報告結果僅對測試之樣品負責，同時此樣品僅保留90天。本報告未經本公司書面許可，不可部份複製。

This document is issued by the Company subject to its General Conditions of Service printed overleaf, available on request or accessible at <http://www.sgs.com.tw/Terms-and-Conditions> and for electronic format documents, subject to Terms and Conditions for Electronic Documents at <http://www.sgs.com.tw/Terms-and-Conditions>. Attention is drawn to the limitation of liability, indemnification and jurisdiction issues defined therein. Any holder of this document is advised that information contained hereon reflects the Company's findings at the time of its intervention only and within the limits of Client's instructions, if any. The Company's sole responsibility is to its Client and this document does not exonerate parties to a transaction from exercising all their rights and obligations under the transaction documents. This document cannot be reproduced except in full, without prior written approval of the Company. Any unauthorized alteration, forgery or falsification of the content or appearance of this document is unlawful and offenders may be prosecuted to the fullest extent of the law.

Band71\_20MHz\_64QAM\_100\_0\_Main\_LowCH133222-673

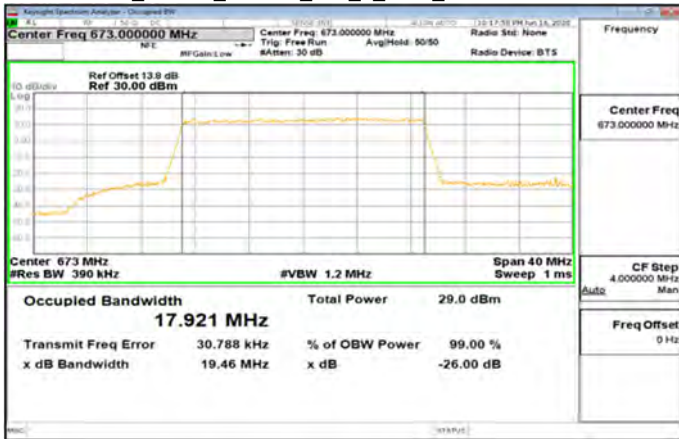

Band71\_20MHz\_256QAM\_100\_0\_Main\_LowCH133222-673

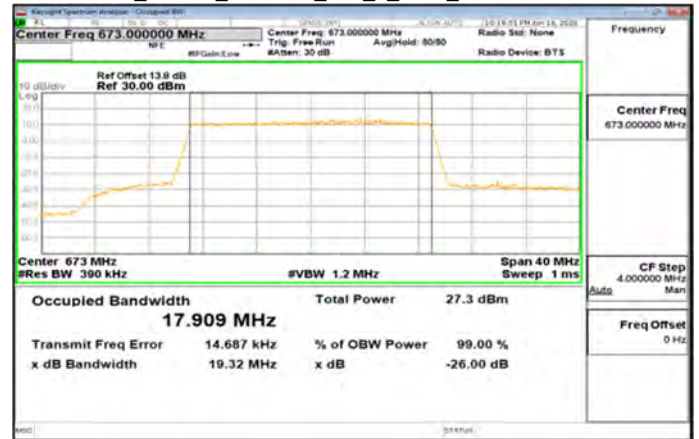

Band71\_20MHz\_64QAM\_100\_0\_Main\_MidCH133297-680.5

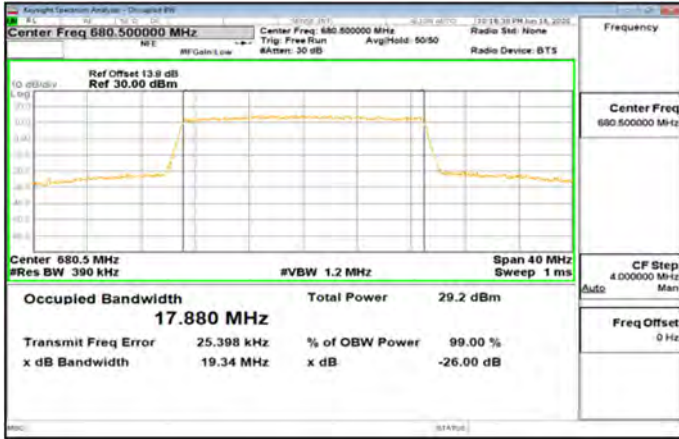

Band71\_20MHz\_256QAM\_100\_0\_Main\_MidCH133297-680.5

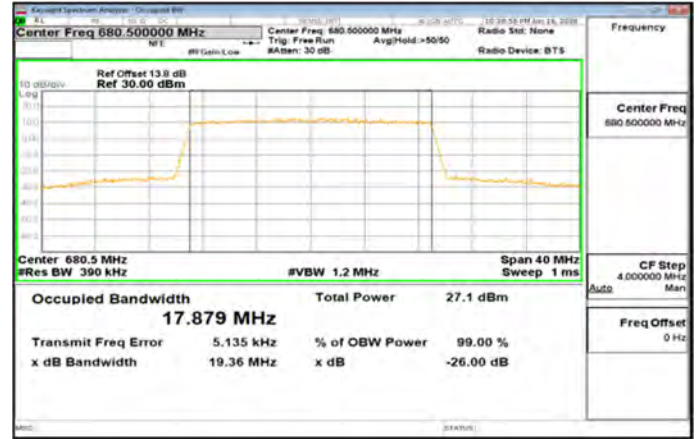

Band71\_20MHz\_64QAM\_100\_0\_Main\_HighCH133372-688

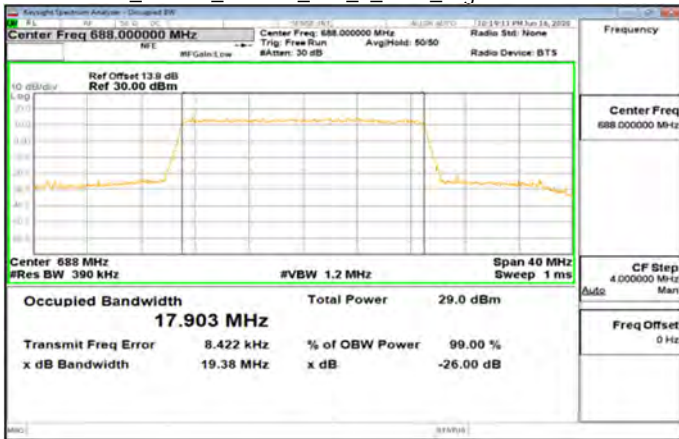

Band71\_20MHz\_256QAM\_100\_0\_Main\_HighCH133372-688

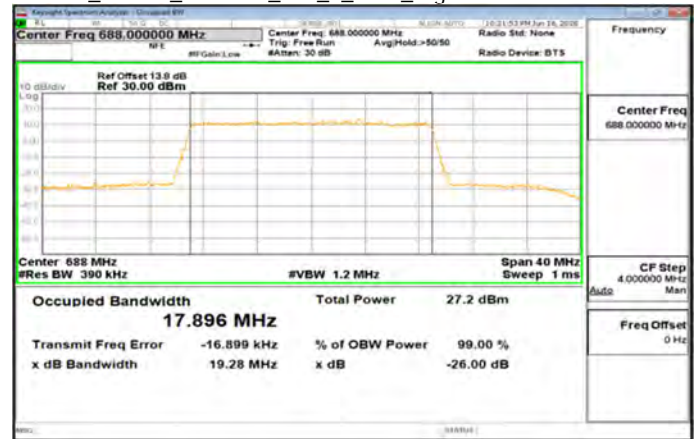

Unless otherwise stated the results shown in this test report refer only to the sample(s) tested and such sample(s) are retained for 90 days only.

除非另有說明，此報告結果僅對測試之樣品負責，同時此樣品僅保留90天。本報告未經本公司書面許可，不可部份複製。

This document is issued by the Company subject to its General Conditions of Service printed overleaf, available on request or accessible at <http://www.sgs.com.tw/Terms-and-Conditions> and for electronic format documents, subject to Terms and Conditions for Electronic Documents at <http://www.sgs.com.tw/Terms-and-Conditions>. Attention is drawn to the limitation of liability, indemnification and jurisdiction issues defined therein. Any holder of this document is advised that information contained hereon reflects the Company's findings at the time of its intervention only and within the limits of Client's instructions, if any. The Company's sole responsibility is to its Client and this document does not exonerate parties to a transaction from exercising all their rights and obligations under the transaction documents. This document cannot be reproduced except in full, without prior written approval of the Company. Any unauthorized alteration, forgery or falsification of the content or appearance of this document is unlawful and offenders may be prosecuted to the fullest extent of the law.



## 8 OUT OF BAND EMISSION AT ANTENNA TERMINALS

### 8.1 Standard Applicable

**FCC §22.917(a), §24.238(a), §27.53(h), §90.691**

**RSS-130 §4.7, RSS-132 §5.5, RSS-133 §6.5.1, RSS-139 §6.5, RSS-195 §5.6, RSS-199 §4.5**

Out of band emissions. The power of any emission outside of the authorized operating frequency ranges must be attenuated below the transmitting power (P) by a factor of at least  $43 + 10 \log(P)$  dB.

#### **FCC §27.53(a) for LTE B30**

For operations in the 2305-2320 MHz band and the 2345-2360 MHz band, the power of any emission outside a licensee's frequency band(s) of operation shall be attenuated below the transmitter power P (with averaging performed only during periods of transmission) within the licensed band(s) of operation, in watts, by the following amounts:

(4) For mobile and portable stations operating in the 2305-2315 MHz and 2350-2360 MHz bands:

#### **FCC §27.53(c) for LTE B13**

For operations in the 746-758 MHz band and the 776-788 MHz band, the power of any emission outside the licensee's frequency band(s) of operation shall be attenuated below the transmitter power (P) within the licensed band(s) of operation, measured in watts, in accordance with the following:

(2) On any frequency outside the 776-788 MHz band, the power of any emission shall be attenuated outside the band below the transmitter power (P) by at least  $43 + 10 \log(P)$  dB (-13dBm)

(4) On all frequencies between 763-775 MHz and 793-805 MHz, by a factor not less than  $65 + 10 \log(P)$  dB in a 6.25 kHz band segment, for mobile and portable stations;

#### **FCC §27.53(c) (5) & FCC §27.53(g) for LTE B12, 13, 71**

Compliance for operations in the 600 MHz, 698-746 MHz, 746-758 MHz and the 776-788 MHz band with this provision is based on the use of measurement instrumentation employing a resolution bandwidth of 100 kilohertz or greater. However, in the 100 kilohertz bands immediately outside and adjacent to a licensee's frequency block, a resolution bandwidth of at least 30 kHz may be employed.

#### **ISED RSS-130 §4.7.1 for LTE B12, 13, 71**

Compliance for operations in the 617-652 MHz, 663-698 MHz, 698-756 MHz and the 777-787 MHz band, the unwanted emissions in any 100 kHz bandwidth on any frequency outside the low frequency edge and the high frequency edge of each frequency block range(s), shall be attenuated below the transmitter power, P (dBW), by at least  $43 + 10 \log_{10} p$  (watts), dB. However, in the 100 kHz band immediately outside of the equipment's frequency block range, a resolution bandwidth of 30 kHz may be employed.

#### **ISED RSS-130 §4.7.2 for LTE B13**

In addition to the limit outlined in section 4.7.1 above, equipment operating in the frequency bands 746-756 MHz and 777-787 MHz shall also comply with the following restrictions:

the power of any unwanted emissions in any 6.25 kHz bandwidth for all frequencies between 763-775 MHz and 793-806 MHz shall be attenuated below the transmitter power, P (dBW), by at least:

$76 + 10 \log_{10} p$  (watts), dB, for base and fixed equipment and

$65 + 10 \log_{10} p$  (watts), dB, for mobile and portable equipment

the e.i.r.p. in the band 1559-1610 MHz shall not exceed  $-70$  dBW/MHz for wideband signal and  $-80$  dBW for discrete emission with bandwidth less than 700 Hz.

Unless otherwise stated the results shown in this test report refer only to the sample(s) tested and such sample(s) are retained for 90 days only.

除非另有說明，此報告結果僅對測試之樣品負責，同時此樣品僅保留90天。本報告未經本公司書面許可，不可部份複製。

This document is issued by the Company subject to its General Conditions of Service printed overleaf, available on request or accessible at <http://www.sgs.com.tw/Terms-and-Conditions> and for electronic format documents, subject to Terms and Conditions for Electronic Documents at <http://www.sgs.com.tw/Terms-and-Conditions>. Attention is drawn to the limitation of liability, indemnification and jurisdiction issues defined therein. Any holder of this document is advised that information contained hereon reflects the Company's findings at the time of its intervention only and within the limits of Client's instructions, if any. The Company's sole responsibility is to its Client and this document does not exonerate parties to a transaction from exercising all their rights and obligations under the transaction documents. This document cannot be reproduced except in full, without prior written approval of the Company. Any unauthorized alteration, forgery or falsification of the content or appearance of this document is unlawful and offenders may be prosecuted to the fullest extent of the law.

**FCC §27.53(h)(3) for LTE B4, 66**

Compliance with this provision is based on the use of measurement instrumentation employing a resolution bandwidth of 1 megahertz or greater. However, in the 1 megahertz bands immediately outside and adjacent to the licensee's frequency block, a resolution bandwidth of at least one percent of the emission bandwidth of the fundamental emission of the transmitter may be employed. The emission bandwidth is defined as the width of the signal between two points, one below the carrier center frequency and one above the carrier center frequency, outside of which all emissions are attenuated at least 26 dB below the transmitter power.

**RSS-139 §6.6 for LTE B4, 66**

In the first 1.0 MHz bands immediately outside and adjacent to the equipment's smallest operating frequency block, Footnote 2 which can contain the equipment's occupied bandwidth, the emission power per any 1% of the emission bandwidth shall be attenuated below the transmitter output power P (in dBW) by at least  $43 + 10 \log_{10} p$  (watts) dB.

After the first 1.0 MHz outside the equipment's smallest operating frequency block, which can contain the equipment's occupied bandwidth, the emission power in any 1 MHz bandwidth shall be attenuated below the transmitter output power P (in dBW) by at least  $43 + 10 \log_{10} p$  (watts) dB.

**FCC §27.53(m) (4) (6) for LTE B7, 38, 41**

For mobile digital stations, the attenuation factor shall be not less than  $40 + 10 \log(P)$  dB on all frequencies between the channel edge and 5 megahertz from the channel edge,  $43 + 10 \log(P)$  dB on all frequencies between 5 megahertz and X megahertz from the channel edge, and  $55 + 10 \log(P)$  dB on all frequencies more than X megahertz from the channel edge, where X is the greater of 6 megahertz or the actual emission bandwidth as defined in paragraph (m)(6) of this section. In addition, the attenuation factor shall not be less than  $43 + 10 \log(P)$  dB on all frequencies between 2490.5 MHz and 2496 MHz and  $55 + 10 \log(P)$  dB at or below 2490.5 MHz. Mobile Satellite Service licensees operating on frequencies below 2495 MHz may also submit a documented interference complaint against BRS licensees operating on channel BRS Channel 1 on the same terms and conditions as adjacent channel BRS or EBS licensees.

Measurement procedure. Compliance with these rules is based on the use of measurement instrumentation employing a resolution bandwidth of 1 megahertz or greater. However, in the 1 MHz bands immediately outside and adjacent to the frequency block a resolution bandwidth of at least one percent of the emission bandwidth of the fundamental emission of the transmitter may be employed; for mobile digital stations, in the 1 megahertz bands immediately outside and adjacent to the frequency block a resolution bandwidth of at least two percent may be employed, except when the 1 megahertz band is 2495-2496 MHz, in which case a resolution bandwidth of at least one percent may be employed. A narrower resolution bandwidth is permitted in all cases to improve measurement accuracy provided the measured power is integrated over the full required measurement bandwidth (i.e. 1 megahertz or 1 percent of emission bandwidth, as specified; or 1 megahertz or 2 percent for mobile digital stations, except in the band 2495-2496 MHz). The emission bandwidth is defined as the width of the signal between two points, one below the carrier center frequency and one above the carrier center frequency, outside of which all emissions are attenuated at least 26 dB below the transmitter power. With respect to television operations, measurements must be made of the separate visual and aural operating powers at sufficiently frequent intervals to ensure compliance with the rules.

Unless otherwise stated the results shown in this test report refer only to the sample(s) tested and such sample(s) are retained for 90 days only.

除非另有說明，此報告結果僅對測試之樣品負責，同時此樣品僅保留90天。本報告未經本公司書面許可，不可部份複製。

This document is issued by the Company subject to its General Conditions of Service printed overleaf, available on request or accessible at <http://www.sgs.com.tw/Terms-and-Conditions> and for electronic format documents, subject to Terms and Conditions for Electronic Documents at <http://www.sgs.com.tw/Terms-and-Conditions>. Attention is drawn to the limitation of liability, indemnification and jurisdiction issues defined therein. Any holder of this document is advised that information contained hereon reflects the Company's findings at the time of its intervention only and within the limits of Client's instructions, if any. The Company's sole responsibility is to its Client and this document does not exonerate parties to a transaction from exercising all their rights and obligations under the transaction documents. This document cannot be reproduced except in full, without prior written approval of the Company. Any unauthorized alteration, forgery or falsification of the content or appearance of this document is unlawful and offenders may be prosecuted to the fullest extent of the law.



**RSS-199 §4.5 for LTE B7, 38, 41**

In the 1 MHz band immediately outside and adjacent to the channel edge, the unwanted emission power shall be measured with a resolution bandwidth of at least 1% of the occupied bandwidth for base station and fixed subscriber equipment, and 2% for mobile subscriber equipment. Beyond the 1 MHz band, a resolution bandwidth of 1 MHz shall be used. A narrower resolution bandwidth can be used, provided that the measured power is integrated over the full required measurement bandwidth of 1 MHz, or 1% or 2% of the occupied bandwidth, as applicable.

Equipment shall comply with the following unwanted emission limits:

for base station and fixed subscriber equipment, the power of any unwanted emissions measured as above shall be attenuated (in dB) below the transmitter power, P (dBW), by at least  $43 + 10 \log_{10} p$  for mobile subscriber equipment, the power of any unwanted emissions measured as above shall be attenuated (in dB) below the transmitter power, P (dBW), by at least:

$40 + 10 \log_{10} p$  from the channel edges to 5 MHz away

$43 + 10 \log_{10} p$  between 5 MHz and X MHz from the channel edges, and

$55 + 10 \log_{10} p$  at X MHz and beyond from the channel edges

In addition, the attenuation shall not be less than  $43 + 10 \log_{10} p$  on all frequencies between 2490.5 MHz and 2496 MHz, and  $55 + 10 \log_{10} p$  at or below 2490.5 MHz.

In (a) and (b), p is the transmitter power measured in watts and X is 6 MHz or the equipment occupied bandwidth, whichever is greater.

**FCC §90.543 (e) for LTE B30**

For operations in the 758-768 MHz and the 788-798 MHz bands, the power of any emission outside the licensee's frequency band(s) of operation shall be attenuated below the transmitter power (P) within the licensed band(s) of operation, measured in watts, in accordance with the following:

(1) On all frequencies between 769-775 MHz and 799-805 MHz, by a factor not less than  $76 + 10 \log (P)$  dB in a 6.25 kHz band segment, for base and fixed stations.

(2) On all frequencies between 769-775 MHz and 799-805 MHz, by a factor not less than  $65 + 10 \log (P)$  dB in a 6.25 kHz band segment, for mobile and portable stations.

(3) On any frequency between 775-788 MHz, above 805 MHz, and below 758 MHz, by at least  $43 + 10 \log (P)$  dB.

**FCC §90.691 Emission mask requirements for EA-based systems for LTE B26**

(a) Out-of-band emission requirement shall apply only to the "outer" channels included in an EA license and to spectrum adjacent to interior channels used by incumbent licensees. The emission limits are as follows:

(1) For any frequency removed from the EA licensee's frequency block by up to and including 37.5 kHz, the power of any emission shall be attenuated below the transmitter power (P) in watts by at least  $116 \log_{10}(f/6.1)$  decibels or  $50 + 10 \log_{10}(P)$  decibels or 80 decibels, whichever is the lesser attenuation, where f is the frequency removed from the center of the outer channel in the block in kilohertz and where f is greater than 12.5 kHz.

(2) For any frequency removed from the EA licensee's frequency block greater than 37.5 kHz, the power of any emission shall be attenuated below the transmitter power (P) in watts by at least  $43 + 10 \log_{10}(P)$  decibels or 80 decibels, whichever is the lesser attenuation, where f is the frequency removed from the center of the outer channel in the block in kilohertz and where f is greater than 37.5 kHz.

Unless otherwise stated the results shown in this test report refer only to the sample(s) tested and such sample(s) are retained for 90 days only.

除非另有說明，此報告結果僅對測試之樣品負責，同時此樣品僅保留90天。本報告未經本公司書面許可，不可部份複製。

This document is issued by the Company subject to its General Conditions of Service printed overleaf, available on request or accessible at <http://www.sgs.com.tw/Terms-and-Conditions> and for electronic format documents, subject to Terms and Conditions for Electronic Documents at <http://www.sgs.com.tw/Terms-and-Conditions>. Attention is drawn to the limitation of liability, indemnification and jurisdiction issues defined therein. Any holder of this document is advised that information contained hereon reflects the Company's findings at the time of its intervention only and within the limits of Client's instructions, if any. The Company's sole responsibility is to its Client and this document does not exonerate parties to a transaction from exercising all their rights and obligations under the transaction documents. This document cannot be reproduced except in full, without prior written approval of the Company. Any unauthorized alteration, forgery or falsification of the content or appearance of this document is unlawful and offenders may be prosecuted to the fullest extent of the law.

## 8.2 Test SET-UP

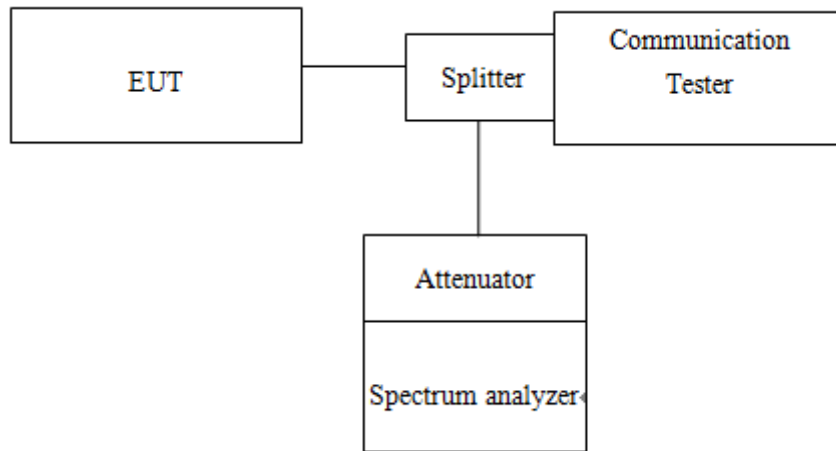

## 8.3 Measurement Procedure

### 8.3.1 Conducted Emission

The RF output of the transceiver was connected to a spectrum analyzer through appropriate attenuation. The resolution bandwidth of the spectrum analyzer was set at 1MHz, sufficient scans were taken to show the out of band Emissions if any up to 10th harmonic.

1. To connect Antenna Port of EUT to Spectrum.
2. Set RBW = 1MHz & VBW = 1MHz on Spectrum.
3. Allow trace to fully stabilize
4. Repeat above procedures until all default test channel measured were complete.

### 8.3.2 Band Edge

1. To connect Antenna Port of EUT to Spectrum.
2. The band edge of low and high channels for the highest RF powers was measured. Setting  $RBW \geq 1\% EBW$ .
3. Allow trace to fully stabilize
4. Repeat above procedures until all default test channel measured were complete.

Unless otherwise stated the results shown in this test report refer only to the sample(s) tested and such sample(s) are retained for 90 days only.  
除非另有說明，此報告結果僅對測試之樣品負責，同時此樣品僅保留90天。本報告未經本公司書面許可，不可部份複製。

This document is issued by the Company subject to its General Conditions of Service printed overleaf, available on request or accessible at <http://www.sgs.com.tw/Terms-and-Conditions> and for electronic format documents, subject to Terms and Conditions for Electronic Documents at <http://www.sgs.com.tw/Terms-and-Conditions>. Attention is drawn to the limitation of liability, indemnification and jurisdiction issues defined therein. Any holder of this document is advised that information contained hereon reflects the Company's findings at the time of its intervention only and within the limits of Client's instructions, if any. The Company's sole responsibility is to its Client and this document does not exonerate parties to a transaction from exercising all their rights and obligations under the transaction documents. This document cannot be reproduced except in full, without prior written approval of the Company. Any unauthorized alteration, forgery or falsification of the content or appearance of this document is unlawful and offenders may be prosecuted to the fullest extent of the law.



#### 8.4 Measurement Equipment Used 2/3G

Conducted Emission (measured at antenna port) Test Site					
EQUIPMENT TYPE	MFR	MODEL NUMBER	SERIAL NUMBER	LAST CAL.	CAL DUE.
PXA Spectrum Analyzer	Agilent	N9030A	MY53120760	04/21/2020	04/20/2021
DC Power Supply	Agilent	E3640A	MY40000811	12/23/2019	12/22/2020
Radio Communication Analyzer	Anritsu	MT8815B	6200711454	04/01/2020	03/31/2021
Attenuator	Mini-Circuit	BW-S10W2+	2	01/02/2020	01/01/2021
DC Block	Mini-Circuits	BLK-18-S+	1	01/02/2020	01/01/2021
Splitter	RF-LAMBAD	RFLT2W1G18G	11-JSPF412-018	01/02/2020	01/01/2021

#### 4G

Conducted Emission (measured at antenna port) Test Site					
EQUIPMENT TYPE	MFR	MODEL NUMBER	SERIAL NUMBER	LAST CAL.	CAL DUE.
PXA Spectrum Analyzer	Agilent	N9030A	MY53120760	04/21/2020	04/20/2021
Radio Communication Analyzer	Anritsu	MT8821C	6261786084	01/18/2020	01/17/2021
Attenuator	Mini-Circuit	BW-S10W2+	2	01/02/2020	01/01/2021
DC Block	Mini-Circuits	BLK-18-S+	1	01/02/2020	01/01/2021
Splitter	RF-LAMBAD	RFLT2W1G18G	11-JSPF412-018	01/02/2020	01/01/2021

#### 8.5 Measurement Result:

Refer to next pages.

Unless otherwise stated the results shown in this test report refer only to the sample(s) tested and such sample(s) are retained for 90 days only.

除非另有說明，此報告結果僅對測試之樣品負責，同時此樣品僅保留90天。本報告未經本公司書面許可，不可部份複製。

This document is issued by the Company subject to its General Conditions of Service printed overleaf, available on request or accessible at <http://www.sgs.com.tw/Terms-and-Conditions> and for electronic format documents, subject to Terms and Conditions for Electronic Documents at <http://www.sgs.com.tw/Terms-and-Conditions>. Attention is drawn to the limitation of liability, indemnification and jurisdiction issues defined therein. Any holder of this document is advised that information contained hereon reflects the Company's findings at the time of its intervention only and within the limits of Client's instructions, if any. The Company's sole responsibility is to its Client and this document does not exonerate parties to a transaction from exercising all their rights and obligations under the transaction documents. This document cannot be reproduced except in full, without prior written approval of the Company. Any unauthorized alteration, forgery or falsification of the content or appearance of this document is unlawful and offenders may be prosecuted to the fullest extent of the law.

Band Edge  
GSM\_850MHz\_LowCH128-824.2

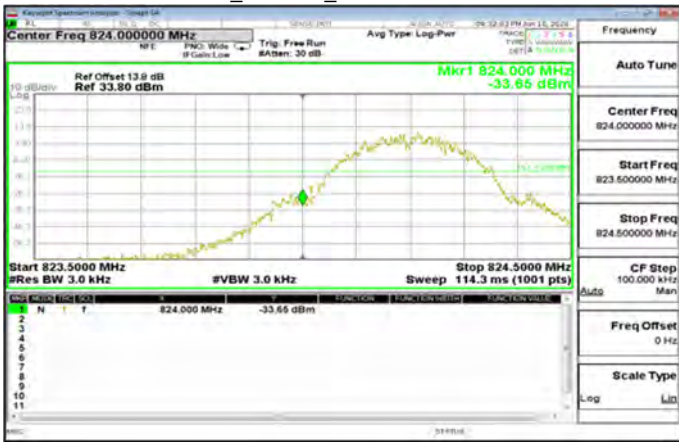

GPRS\_850MHz\_HighCH251-848.8

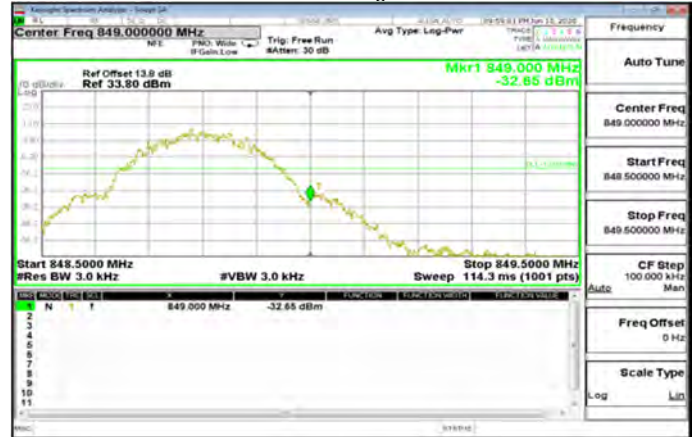

GSM\_850MHz\_HighCH251-848.8

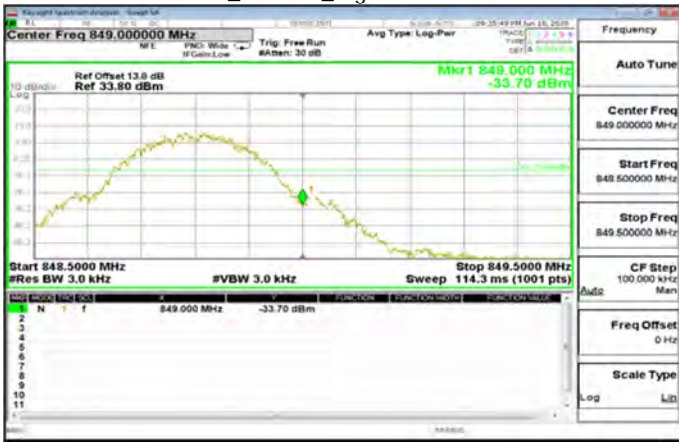

EDGE\_850MHz\_LowCH128-824.2



GPRS\_850MHz\_LowCH128-824.2



EDGE\_850MHz\_HighCH251-848.8



Unless otherwise stated the results shown in this test report refer only to the sample(s) tested and such sample(s) are retained for 90 days only.

除非另有說明，此報告結果僅對測試之樣品負責，同時此樣品僅保留90天。本報告未經本公司書面許可，不可部份複製。

This document is issued by the Company subject to its General Conditions of Service printed overleaf, available on request or accessible at <http://www.sgs.com.tw/Terms-and-Conditions> and for electronic format documents, subject to Terms and Conditions for Electronic Documents at <http://www.sgs.com.tw/Terms-and-Conditions>. Attention is drawn to the limitation of liability, indemnification and jurisdiction issues defined therein. Any holder of this document is advised that information contained hereon reflects the Company's findings at the time of its intervention only and within the limits of Client's instructions, if any. The Company's sole responsibility is to its Client and this document does not exonerate parties to a transaction from exercising all their rights and obligations under the transaction documents. This document cannot be reproduced except in full, without prior written approval of the Company. Any unauthorized alteration, forgery or falsification of the content or appearance of this document is unlawful and offenders may be prosecuted to the fullest extent of the law.



GSM\_1900MHz\_LowCH512-1850.2



GPRS\_1900MHz\_HighCH810-1909.8



GSM\_1900MHz\_HighCH810-1909.8



EDGE\_1900MHz\_LowCH512-1850.2



GPRS\_1900MHz\_LowCH512-1850.2



EDGE\_1900MHz\_HighCH810-1909.8



Unless otherwise stated the results shown in this test report refer only to the sample(s) tested and such sample(s) are retained for 90 days only.

除非另有說明，此報告結果僅對測試之樣品負責，同時此樣品僅保留90天。本報告未經本公司書面許可，不可部份複製。

This document is issued by the Company subject to its General Conditions of Service printed overleaf, available on request or accessible at <http://www.sgs.com.tw/Terms-and-Conditions> and for electronic format documents, subject to Terms and Conditions for Electronic Documents at <http://www.sgs.com.tw/Terms-and-Conditions>. Attention is drawn to the limitation of liability, indemnification and jurisdiction issues defined therein. Any holder of this document is advised that information contained hereon reflects the Company's findings at the time of its intervention only and within the limits of Client's instructions, if any. The Company's sole responsibility is to its Client and this document does not exonerate parties to a transaction from exercising all their rights and obligations under the transaction documents. This document cannot be reproduced except in full, without prior written approval of the Company. Any unauthorized alteration, forgery or falsification of the content or appearance of this document is unlawful and offenders may be prosecuted to the fullest extent of the law.

WCDMA\_B2\_LowCH9262-1852.4

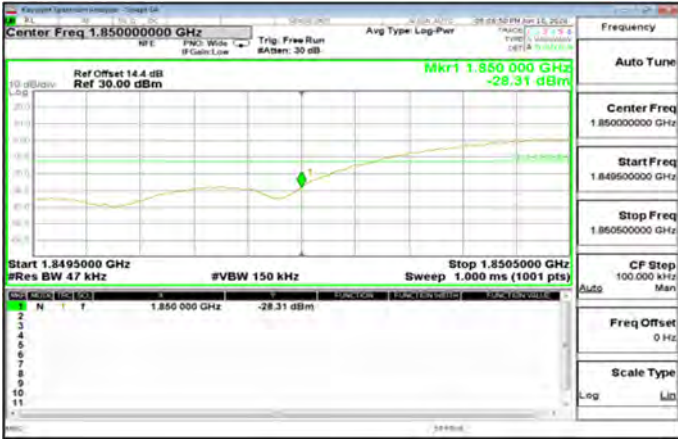

HSDPA\_B2\_HighCH9538-1907.6

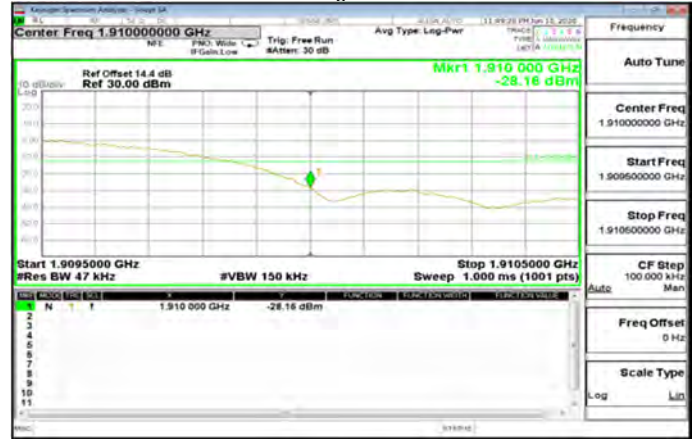

WCDMA\_B2\_HighCH9538-1907.6

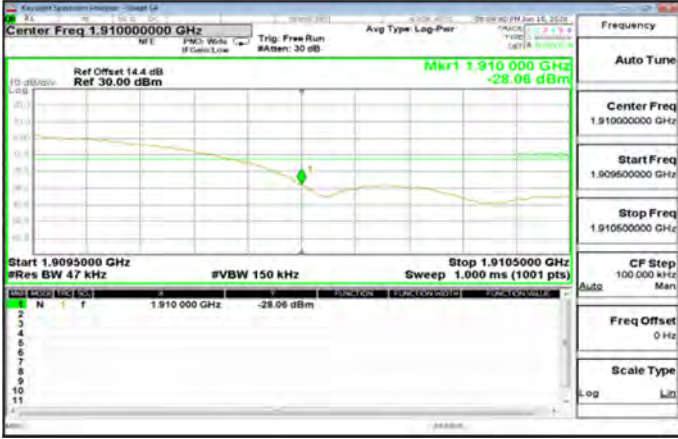

HSUPA\_B2\_LowCH9262-1852.4

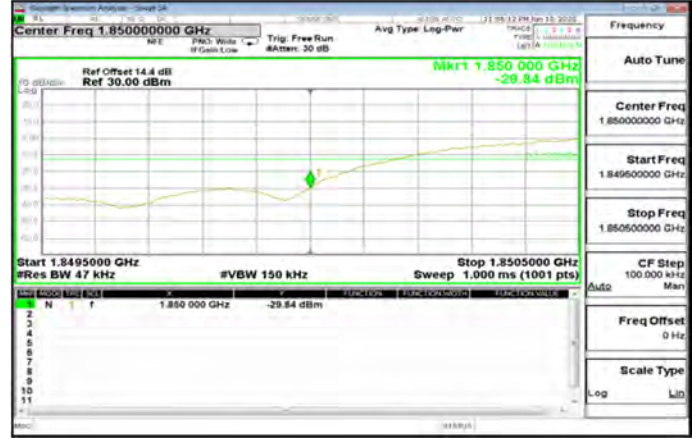

HSDPA\_B2\_LowCH9262-1852.4



HSUPA\_B2\_HighCH9538-1907.6

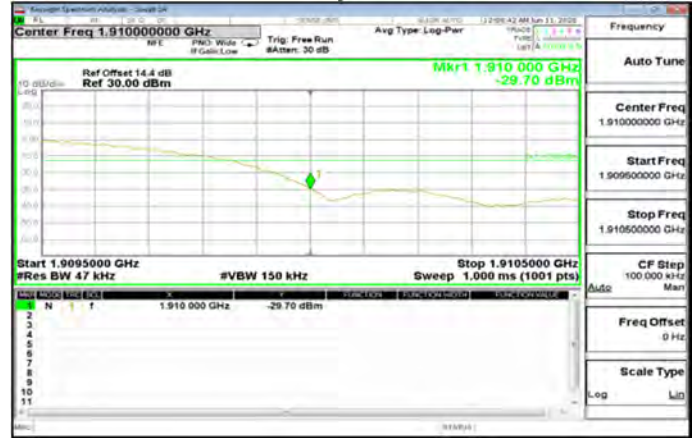

Unless otherwise stated the results shown in this test report refer only to the sample(s) tested and such sample(s) are retained for 90 days only.

除非另有說明，此報告結果僅對測試之樣品負責，同時此樣品僅保留90天。本報告未經本公司書面許可，不可部份複製。

This document is issued by the Company subject to its General Conditions of Service printed overleaf, available on request or accessible at <http://www.sgs.com.tw/Terms-and-Conditions> and for electronic format documents, subject to Terms and Conditions for Electronic Documents at <http://www.sgs.com.tw/Terms-and-Conditions>. Attention is drawn to the limitation of liability, indemnification and jurisdiction issues defined therein. Any holder of this document is advised that information contained hereon reflects the Company's findings at the time of its intervention only and within the limits of Client's instructions, if any. The Company's sole responsibility is to its Client and this document does not exonerate parties to a transaction from exercising all their rights and obligations under the transaction documents. This document cannot be reproduced except in full, without prior written approval of the Company. Any unauthorized alteration, forgery or falsification of the content or appearance of this document is unlawful and offenders may be prosecuted to the fullest extent of the law.



WCDMA\_B4\_LowCH1312-1712.4

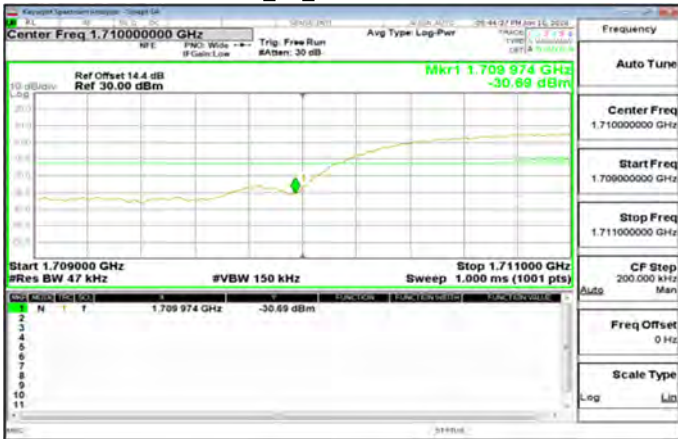

HSDPA\_B4\_HighCH1513-1752.6

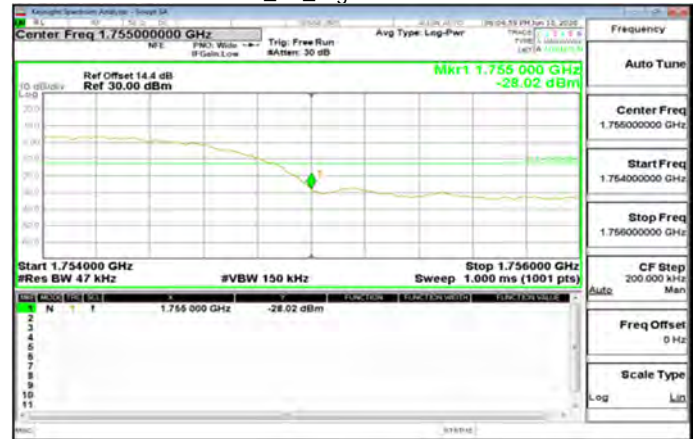

WCDMA\_B4\_HighCH1513-1752.6



HSUPA\_B4\_LowCH1312-1712.4



HSDPA\_B4\_LowCH1312-1712.4

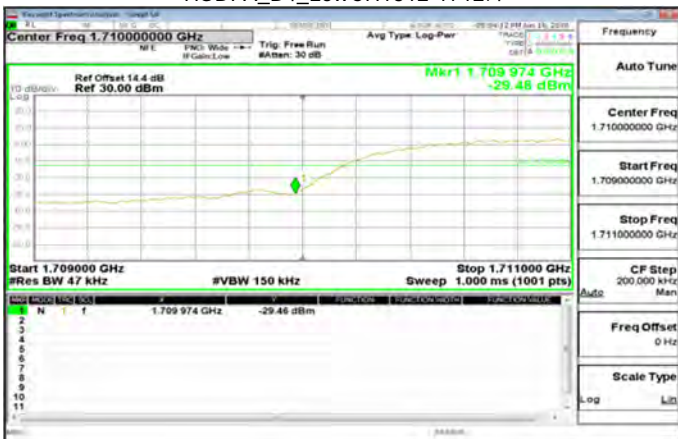

HSUPA\_B4\_HighCH1513-1752.6



Unless otherwise stated the results shown in this test report refer only to the sample(s) tested and such sample(s) are retained for 90 days only.

除非另有說明，此報告結果僅對測試之樣品負責，同時此樣品僅保留90天。本報告未經本公司書面許可，不可部份複製。

This document is issued by the Company subject to its General Conditions of Service printed overleaf, available on request or accessible at <http://www.sgs.com.tw/Terms-and-Conditions> and for electronic format documents, subject to Terms and Conditions for Electronic Documents at <http://www.sgs.com.tw/Terms-and-Conditions>. Attention is drawn to the limitation of liability, indemnification and jurisdiction issues defined therein. Any holder of this document is advised that information contained hereon reflects the Company's findings at the time of its intervention only and within the limits of Client's instructions, if any. The Company's sole responsibility is to its Client and this document does not exonerate parties to a transaction from exercising all their rights and obligations under the transaction documents. This document cannot be reproduced except in full, without prior written approval of the Company. Any unauthorized alteration, forgery or falsification of the content or appearance of this document is unlawful and offenders may be prosecuted to the fullest extent of the law.

WCDMA\_B5\_LowCH4132-826.4

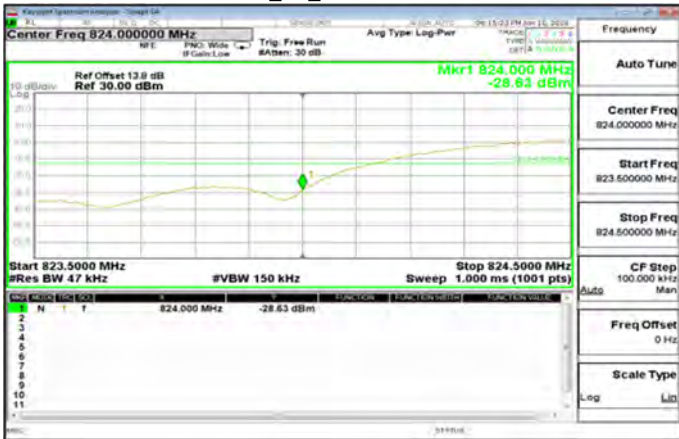

HSDPA\_B5\_HighCH4233-846.6

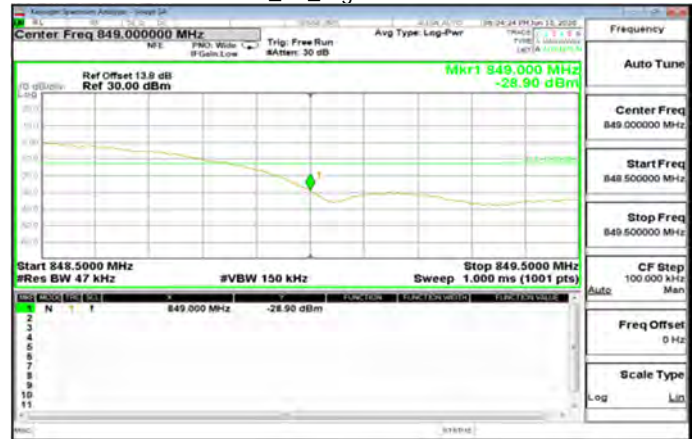

WCDMA\_B5\_HighCH4233-846.6

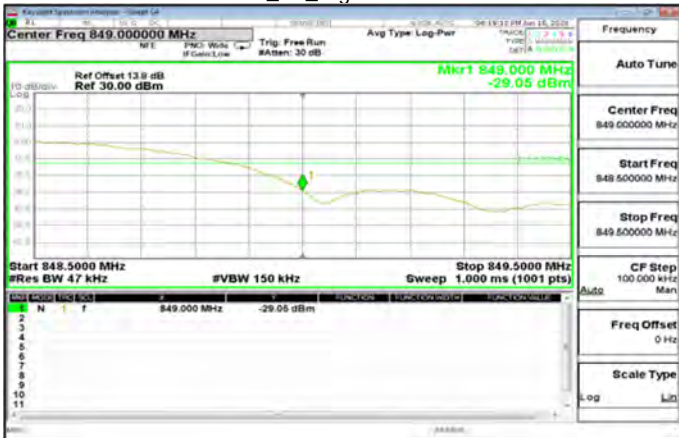

HSUPA\_B5\_LowCH4132-826.4



HSDPA\_B5\_LowCH4132-826.4

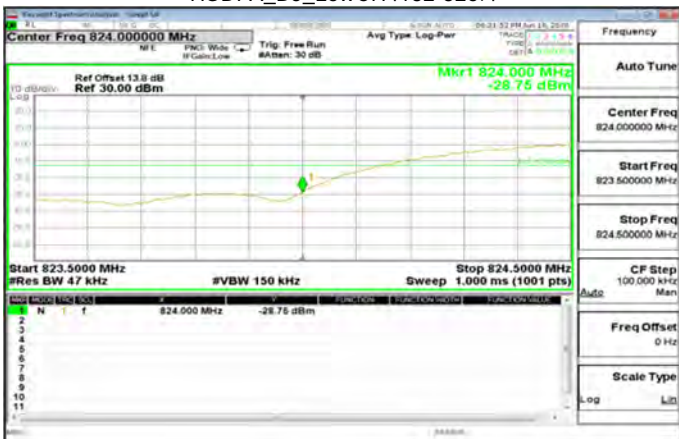

HSUPA\_B5\_HighCH4233-846.6

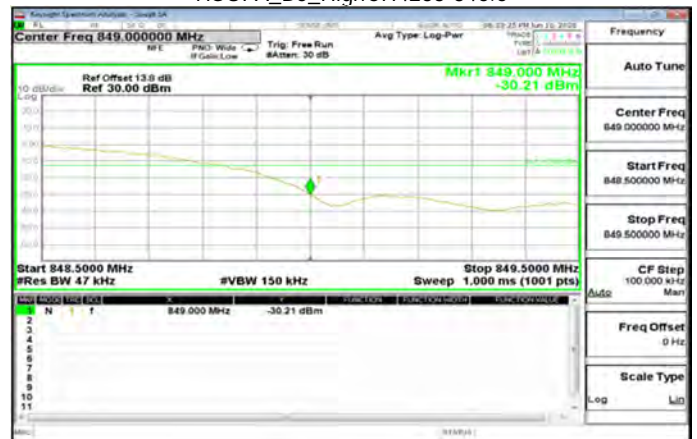

Unless otherwise stated the results shown in this test report refer only to the sample(s) tested and such sample(s) are retained for 90 days only.

除非另有說明，此報告結果僅對測試之樣品負責，同時此樣品僅保留90天。本報告未經本公司書面許可，不可部份複製。

This document is issued by the Company subject to its General Conditions of Service printed overleaf, available on request or accessible at <http://www.sgs.com.tw/Terms-and-Conditions> and for electronic format documents, subject to Terms and Conditions for Electronic Documents at <http://www.sgs.com.tw/Terms-and-Conditions>. Attention is drawn to the limitation of liability, indemnification and jurisdiction issues defined therein. Any holder of this document is advised that information contained hereon reflects the Company's findings at the time of its intervention only and within the limits of Client's instructions, if any. The Company's sole responsibility is to its Client and this document does not exonerate parties to a transaction from exercising all their rights and obligations under the transaction documents. This document cannot be reproduced except in full, without prior written approval of the Company. Any unauthorized alteration, forgery or falsification of the content or appearance of this document is unlawful and offenders may be prosecuted to the fullest extent of the law.



LTE\Band2\_1\_4MHz\_QPSK\_1\_0\_LowCH18607-1850.7

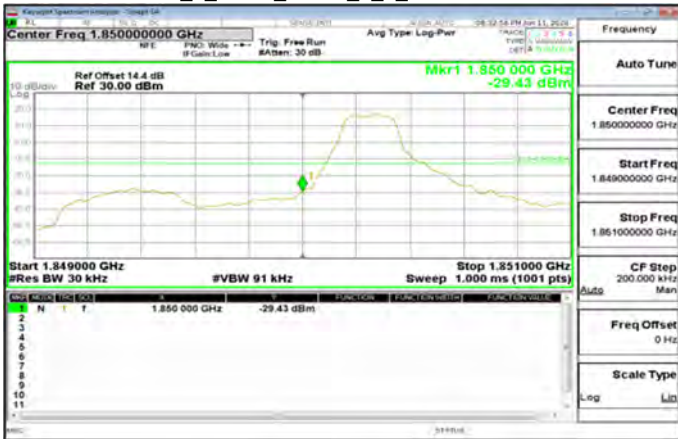

LTE\Band2\_1\_4MHz\_QPSK\_6\_0\_HighCH19193-1909.3



LTE\Band2\_1\_4MHz\_QPSK\_1\_5\_HighCH19193-1909.3



LTE\Band2\_3MHz\_QPSK\_1\_0\_LowCH18615-1851.5



LTE\Band2\_1\_4MHz\_QPSK\_6\_0\_LowCH18607-1850.7

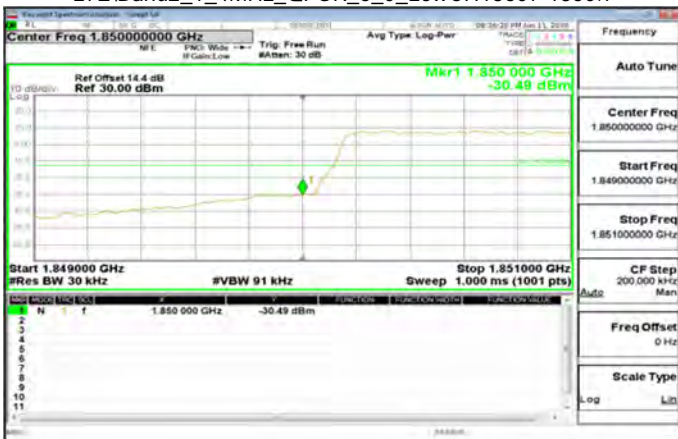

LTE\Band2\_3MHz\_QPSK\_1\_14\_HighCH19185-1908.5



Unless otherwise stated the results shown in this test report refer only to the sample(s) tested and such sample(s) are retained for 90 days only.

除非另有說明，此報告結果僅對測試之樣品負責，同時此樣品僅保留90天。本報告未經本公司書面許可，不可部份複製。

This document is issued by the Company subject to its General Conditions of Service printed overleaf, available on request or accessible at <http://www.sgs.com.tw/Terms-and-Conditions> and for electronic format documents, subject to Terms and Conditions for Electronic Documents at <http://www.sgs.com.tw/Terms-and-Conditions>. Attention is drawn to the limitation of liability, indemnification and jurisdiction issues defined therein. Any holder of this document is advised that information contained hereon reflects the Company's findings at the time of its intervention only and within the limits of Client's instructions, if any. The Company's sole responsibility is to its Client and this document does not exonerate parties to a transaction from exercising all their rights and obligations under the transaction documents. This document cannot be reproduced except in full, without prior written approval of the Company. Any unauthorized alteration, forgery or falsification of the content or appearance of this document is unlawful and offenders may be prosecuted to the fullest extent of the law.

LTE\Band2\_3MHz\_QPSK\_15\_0\_LowCH18615-1851.5

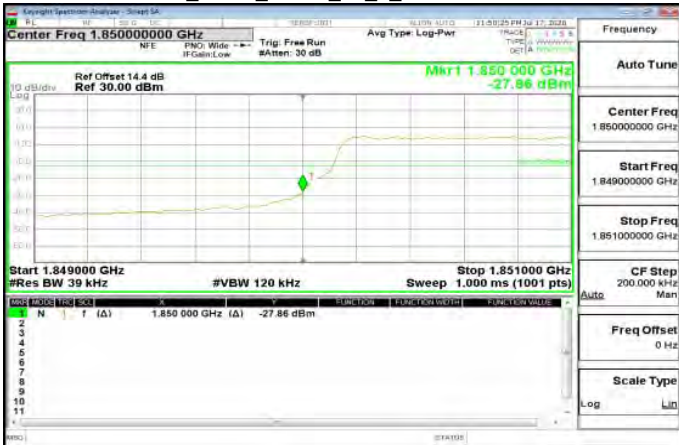

LTE\Band2\_5MHz\_QPSK\_1\_24\_HighCH19175-1907.5



LTE\Band2\_3MHz\_QPSK\_15\_0\_HighCH19185-1908.5

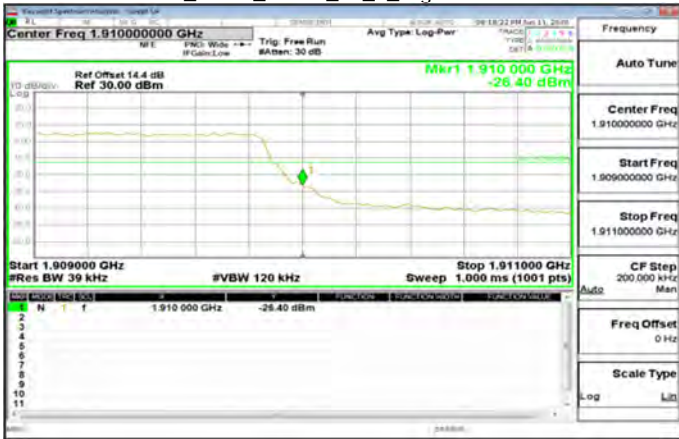

LTE\Band2\_5MHz\_QPSK\_25\_0\_LowCH18625-1852.5

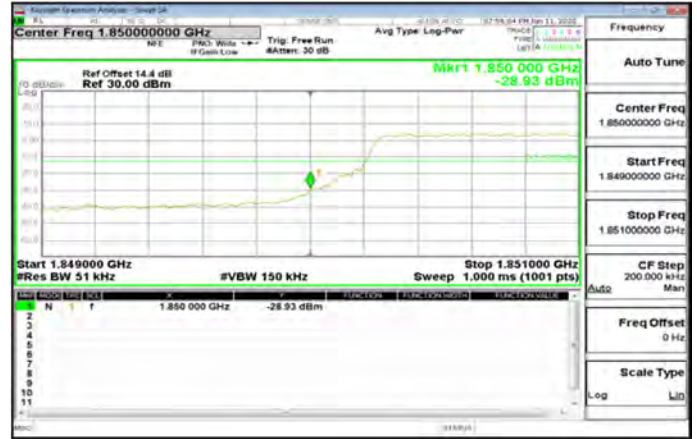

LTE\Band2\_5MHz\_QPSK\_1\_0\_LowCH18625-1852.5

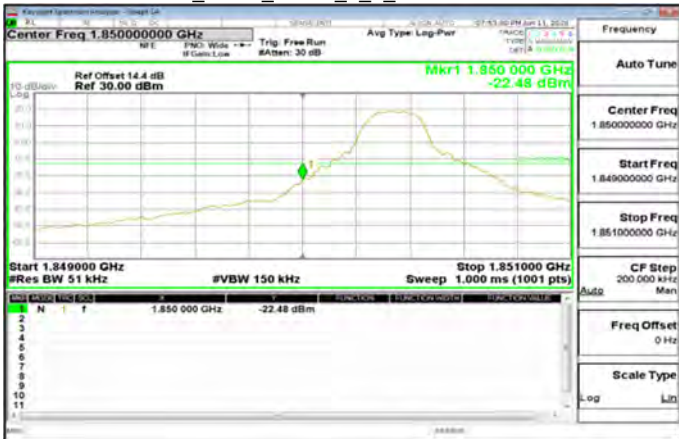

LTE\Band2\_5MHz\_QPSK\_25\_0\_HighCH19175-1907.5



Unless otherwise stated the results shown in this test report refer only to the sample(s) tested and such sample(s) are retained for 90 days only.

除非另有說明，此報告結果僅對測試之樣品負責，同時此樣品僅保留90天。本報告未經本公司書面許可，不可部份複製。

This document is issued by the Company subject to its General Conditions of Service printed overleaf, available on request or accessible at <http://www.sgs.com.tw/Terms-and-Conditions> and for electronic format documents, subject to Terms and Conditions for Electronic Documents at <http://www.sgs.com.tw/Terms-and-Conditions>. Attention is drawn to the limitation of liability, indemnification and jurisdiction issues defined therein. Any holder of this document is advised that information contained hereon reflects the Company's findings at the time of its intervention only and within the limits of Client's instructions, if any. The Company's sole responsibility is to its Client and this document does not exonerate parties to a transaction from exercising all their rights and obligations under the transaction documents. This document cannot be reproduced except in full, without prior written approval of the Company. Any unauthorized alteration, forgery or falsification of the content or appearance of this document is unlawful and offenders may be prosecuted to the fullest extent of the law.



LTE\Band2\_10MHz\_QPSK\_1\_0\_LowCH18650-1855

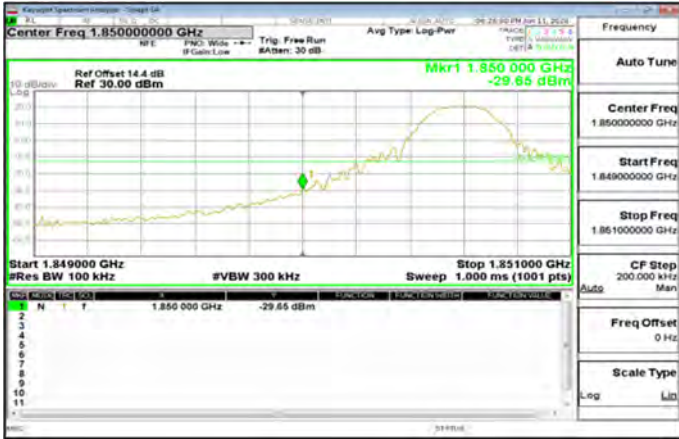

LTE\Band2\_10MHz\_QPSK\_50\_0\_HighCH19150-1905

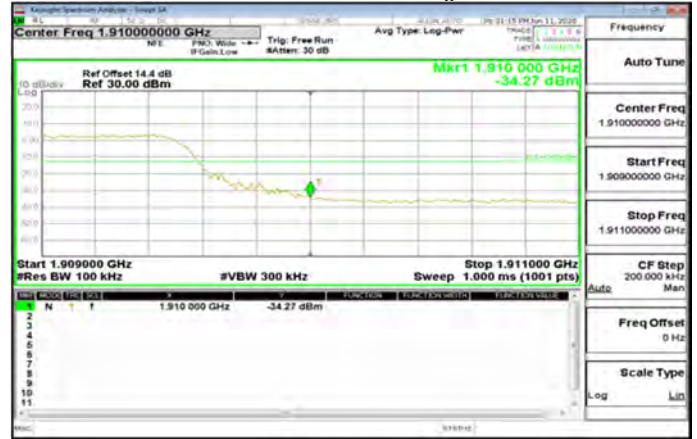

LTE\Band2\_10MHz\_QPSK\_1\_49\_HighCH19150-1905

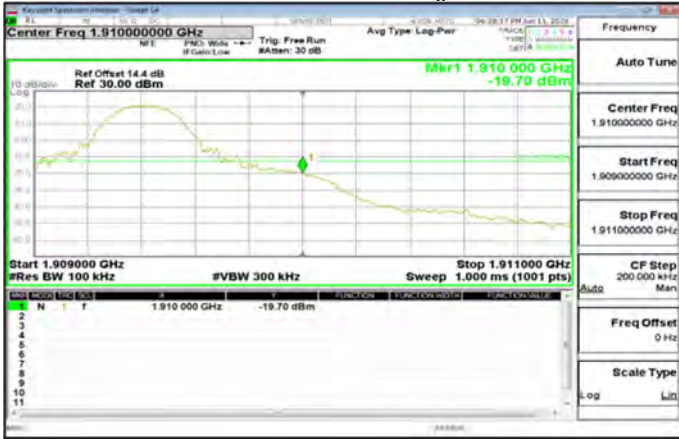

LTE\Band2\_15MHz\_QPSK\_1\_0\_LowCH18675-1857.5

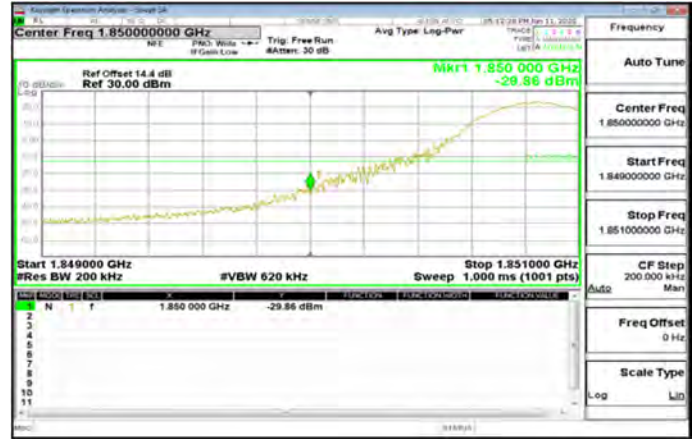

LTE\Band2\_10MHz\_QPSK\_50\_0\_LowCH18650-1855



LTE\Band2\_15MHz\_QPSK\_1\_74\_HighCH19125-1902.5



Unless otherwise stated the results shown in this test report refer only to the sample(s) tested and such sample(s) are retained for 90 days only.

除非另有說明，此報告結果僅對測試之樣品負責，同時此樣品僅保留90天。本報告未經本公司書面許可，不可部份複製。

This document is issued by the Company subject to its General Conditions of Service printed overleaf, available on request or accessible at <http://www.sgs.com.tw/Terms-and-Conditions> and for electronic format documents, subject to Terms and Conditions for Electronic Documents at <http://www.sgs.com.tw/Terms-and-Conditions>. Attention is drawn to the limitation of liability, indemnification and jurisdiction issues defined therein. Any holder of this document is advised that information contained hereon reflects the Company's findings at the time of its intervention only and within the limits of Client's instructions, if any. The Company's sole responsibility is to its Client and this document does not exonerate parties to a transaction from exercising all their rights and obligations under the transaction documents. This document cannot be reproduced except in full, without prior written approval of the Company. Any unauthorized alteration, forgery or falsification of the content or appearance of this document is unlawful and offenders may be prosecuted to the fullest extent of the law.

LTE\Band2\_15MHz\_QPSK\_75\_0\_LowCH18675-1857.5

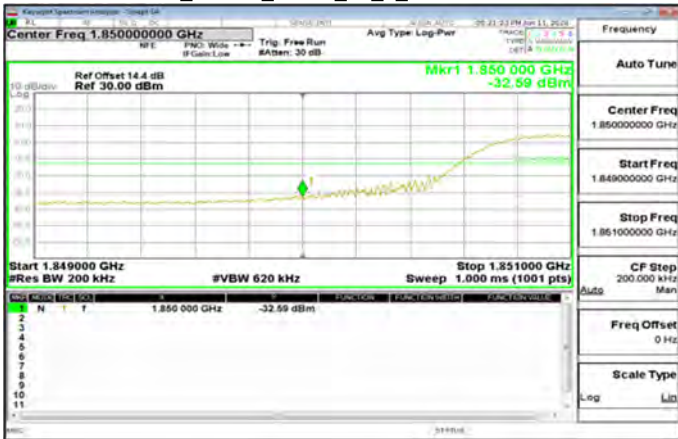

LTE\Band2\_20MHz\_QPSK\_1\_99\_HighCH19100-1900



LTE\Band2\_15MHz\_QPSK\_75\_0\_HighCH19125-1902.5



LTE\Band2\_20MHz\_QPSK\_100\_0\_LowCH18700-1860



LTE\Band2\_20MHz\_QPSK\_1\_0\_LowCH18700-1860

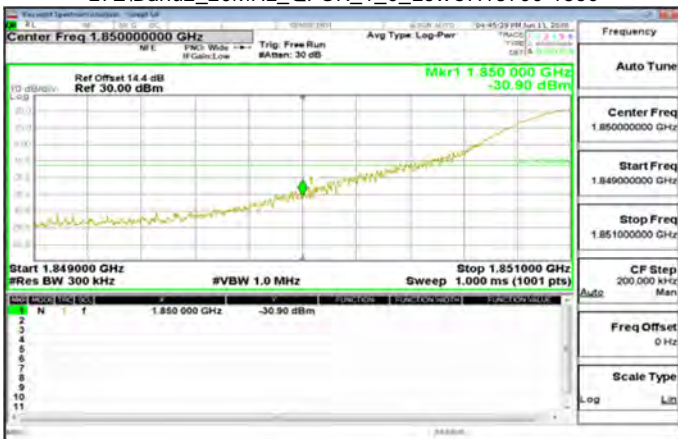

LTE\Band2\_20MHz\_QPSK\_100\_0\_HighCH19100-1900



Unless otherwise stated the results shown in this test report refer only to the sample(s) tested and such sample(s) are retained for 90 days only.

除非另有說明，此報告結果僅對測試之樣品負責，同時此樣品僅保留90天。本報告未經本公司書面許可，不可部份複製。

This document is issued by the Company subject to its General Conditions of Service printed overleaf, available on request or accessible at <http://www.sgs.com.tw/Terms-and-Conditions> and for electronic format documents, subject to Terms and Conditions for Electronic Documents at <http://www.sgs.com.tw/Terms-and-Conditions>. Attention is drawn to the limitation of liability, indemnification and jurisdiction issues defined therein. Any holder of this document is advised that information contained hereon reflects the Company's findings at the time of its intervention only and within the limits of Client's instructions, if any. The Company's sole responsibility is to its Client and this document does not exonerate parties to a transaction from exercising all their rights and obligations under the transaction documents. This document cannot be reproduced except in full, without prior written approval of the Company. Any unauthorized alteration, forgery or falsification of the content or appearance of this document is unlawful and offenders may be prosecuted to the fullest extent of the law.



LTE\Band4\_1\_4MHz\_QPSK\_1\_0\_LowCH19957-1710.7

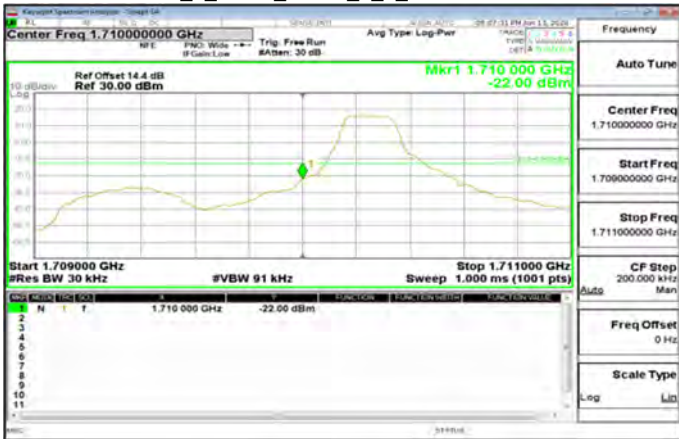

LTE\Band4\_1\_4MHz\_QPSK\_6\_0\_HighCH20393-1754.3

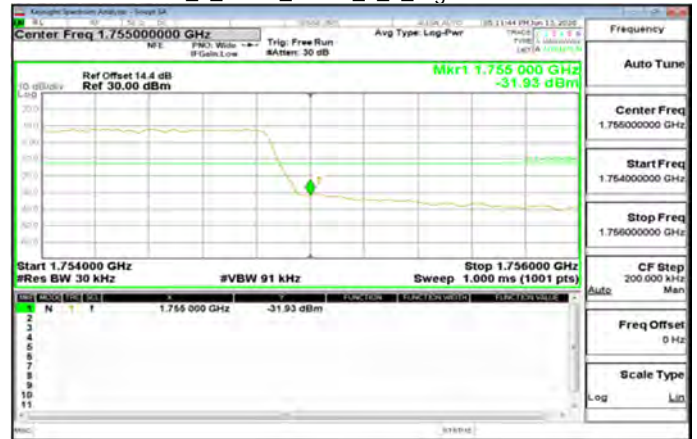

LTE\Band4\_1\_4MHz\_QPSK\_1\_5\_HighCH20393-1754.3



LTE\Band4\_3MHz\_QPSK\_1\_0\_LowCH19965-1711.5

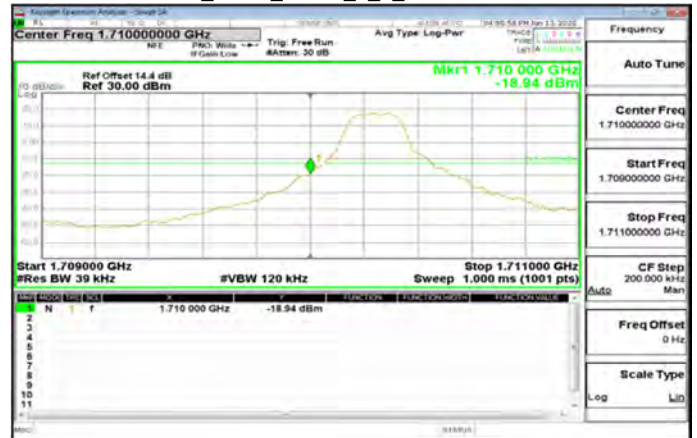

LTE\Band4\_1\_4MHz\_QPSK\_6\_0\_LowCH19957-1710.7

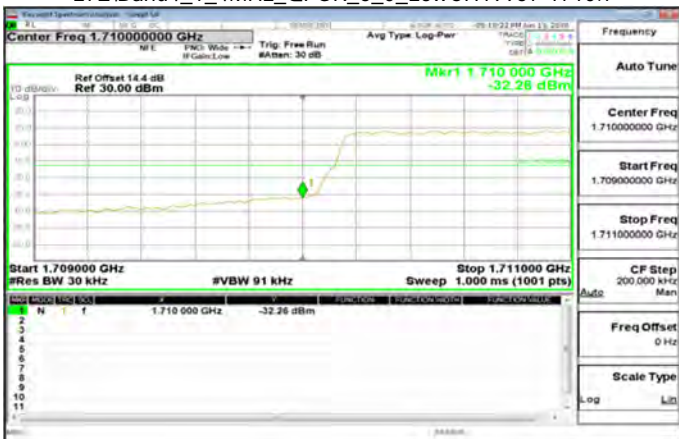

LTE\Band4\_3MHz\_QPSK\_1\_14\_HighCH20385-1753.5



Unless otherwise stated the results shown in this test report refer only to the sample(s) tested and such sample(s) are retained for 90 days only.

除非另有說明，此報告結果僅對測試之樣品負責，同時此樣品僅保留90天。本報告未經本公司書面許可，不可部份複製。

This document is issued by the Company subject to its General Conditions of Service printed overleaf, available on request or accessible at <http://www.sgs.com.tw/Terms-and-Conditions> and for electronic format documents, subject to Terms and Conditions for Electronic Documents at <http://www.sgs.com.tw/Terms-and-Conditions>. Attention is drawn to the limitation of liability, indemnification and jurisdiction issues defined therein. Any holder of this document is advised that information contained hereon reflects the Company's findings at the time of its intervention only and within the limits of Client's instructions, if any. The Company's sole responsibility is to its Client and this document does not exonerate parties to a transaction from exercising all their rights and obligations under the transaction documents. This document cannot be reproduced except in full, without prior written approval of the Company. Any unauthorized alteration, forgery or falsification of the content or appearance of this document is unlawful and offenders may be prosecuted to the fullest extent of the law.

LTE\Band4\_3MHz\_QPSK\_15\_0\_LowCH19965-1711.5



LTE\Band4\_5MHz\_QPSK\_1\_24\_HighCH20375-1752.5

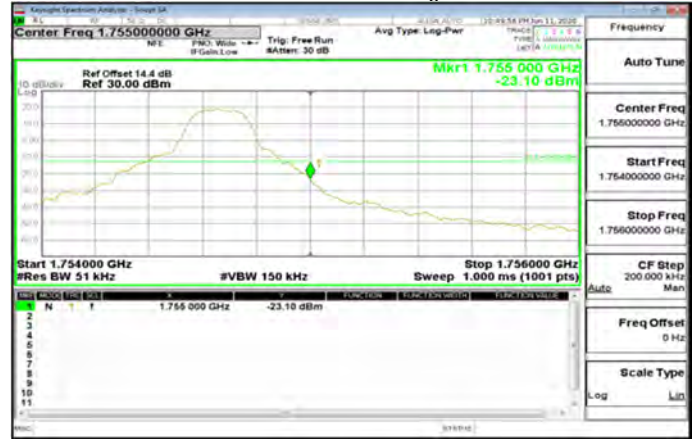

LTE\Band4\_3MHz\_QPSK\_15\_0\_HighCH20385-1753.5



LTE\Band4\_5MHz\_QPSK\_25\_0\_LowCH19975-1712.5

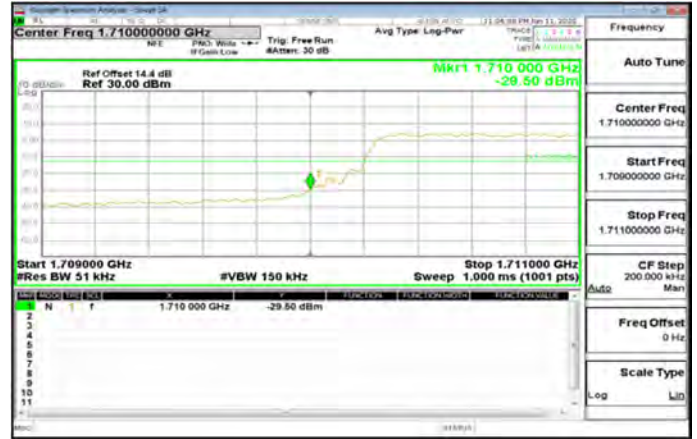

LTE\Band4\_5MHz\_QPSK\_1\_0\_LowCH19975-1712.5

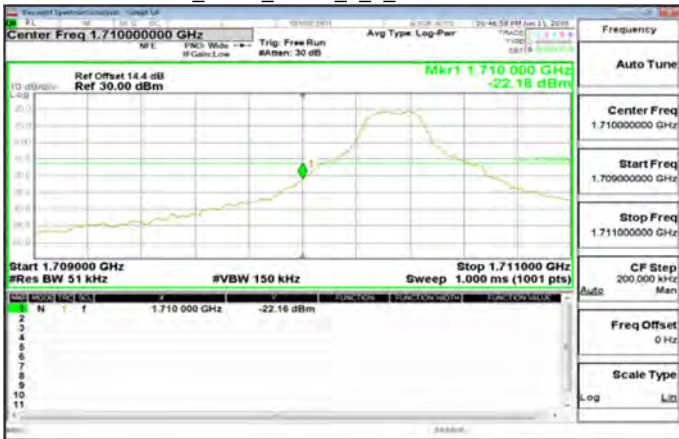

LTE\Band4\_5MHz\_QPSK\_25\_0\_HighCH20375-1752.5



Unless otherwise stated the results shown in this test report refer only to the sample(s) tested and such sample(s) are retained for 90 days only.

除非另有說明，此報告結果僅對測試之樣品負責，同時此樣品僅保留90天。本報告未經本公司書面許可，不可部份複製。

This document is issued by the Company subject to its General Conditions of Service printed overleaf, available on request or accessible at <http://www.sgs.com.tw/Terms-and-Conditions> and for electronic format documents, subject to Terms and Conditions for Electronic Documents at <http://www.sgs.com.tw/Terms-and-Conditions>. Attention is drawn to the limitation of liability, indemnification and jurisdiction issues defined therein. Any holder of this document is advised that information contained hereon reflects the Company's findings at the time of its intervention only and within the limits of Client's instructions, if any. The Company's sole responsibility is to its Client and this document does not exonerate parties to a transaction from exercising all their rights and obligations under the transaction documents. This document cannot be reproduced except in full, without prior written approval of the Company. Any unauthorized alteration, forgery or falsification of the content or appearance of this document is unlawful and offenders may be prosecuted to the fullest extent of the law.



LTE\Band4\_10MHz\_QPSK\_1\_0\_LowCH2000-1715

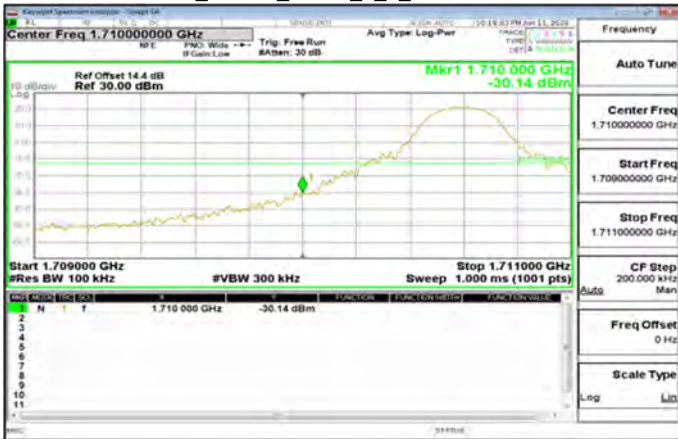

LTE\Band4\_10MHz\_QPSK\_50\_0\_HighCH20350-1750

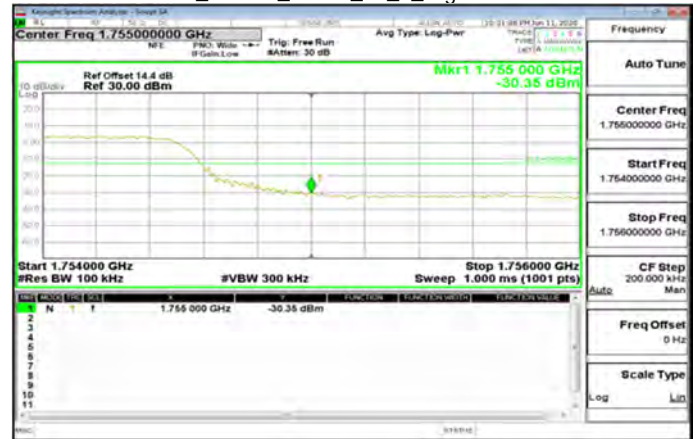

LTE\Band4\_10MHz\_QPSK\_1\_49\_HighCH20350-1750



LTE\Band4\_15MHz\_QPSK\_1\_0\_LowCH20025-1717.5

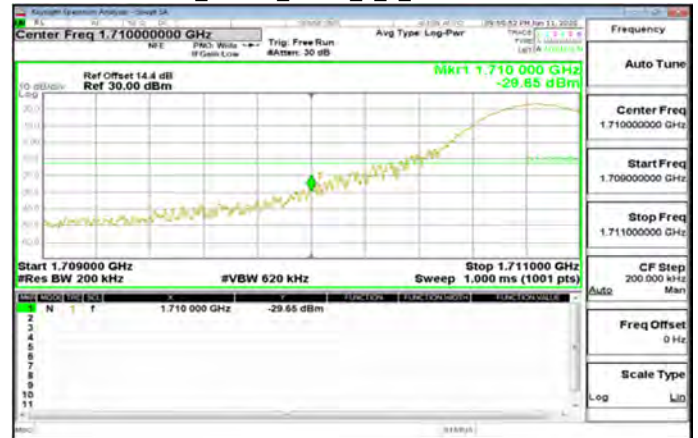

LTE\Band4\_10MHz\_QPSK\_50\_0\_LowCH2000-1715

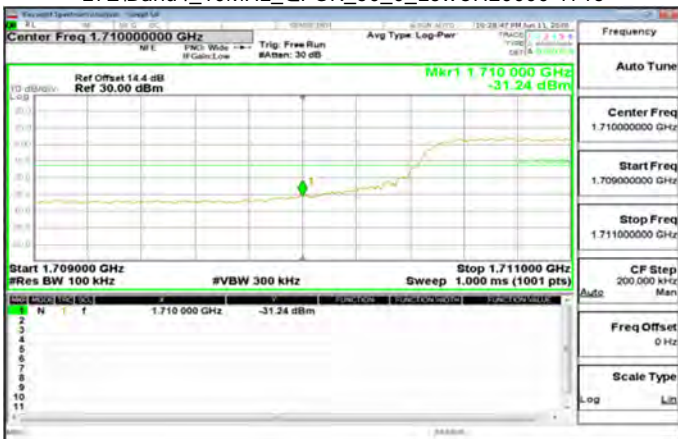

LTE\Band4\_15MHz\_QPSK\_1\_74\_HighCH20325-1747.5

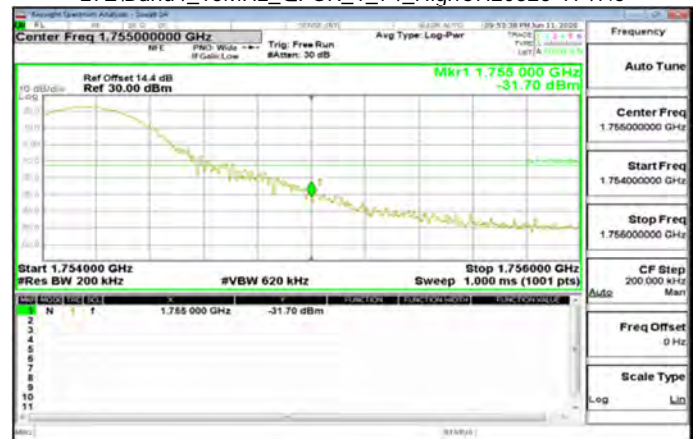

Unless otherwise stated the results shown in this test report refer only to the sample(s) tested and such sample(s) are retained for 90 days only.

除非另有說明，此報告結果僅對測試之樣品負責，同時此樣品僅保留90天。本報告未經本公司書面許可，不可部份複製。

This document is issued by the Company subject to its General Conditions of Service printed overleaf, available on request or accessible at <http://www.sgs.com.tw/Terms-and-Conditions> and for electronic format documents, subject to Terms and Conditions for Electronic Documents at <http://www.sgs.com.tw/Terms-and-Conditions>. Attention is drawn to the limitation of liability, indemnification and jurisdiction issues defined therein. Any holder of this document is advised that information contained hereon reflects the Company's findings at the time of its intervention only and within the limits of Client's instructions, if any. The Company's sole responsibility is to its Client and this document does not exonerate parties to a transaction from exercising all their rights and obligations under the transaction documents. This document cannot be reproduced except in full, without prior written approval of the Company. Any unauthorized alteration, forgery or falsification of the content or appearance of this document is unlawful and offenders may be prosecuted to the fullest extent of the law.

LTE\Band4\_15MHz\_QPSK\_75\_0\_LowCH20025-1717.5

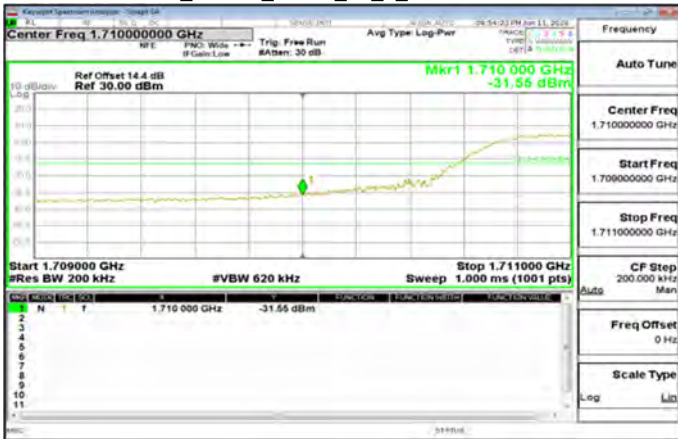

LTE\Band4\_20MHz\_QPSK\_1\_99\_HighCH20300-1745



LTE\Band4\_15MHz\_QPSK\_75\_0\_HighCH20325-1747.5

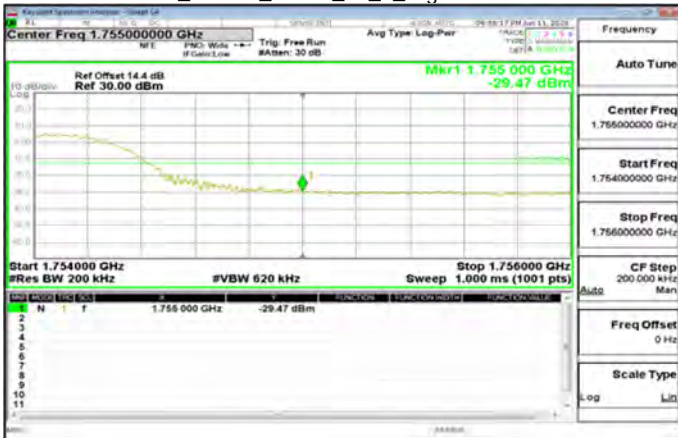

LTE\Band4\_20MHz\_QPSK\_100\_0\_LowCH20050-1720

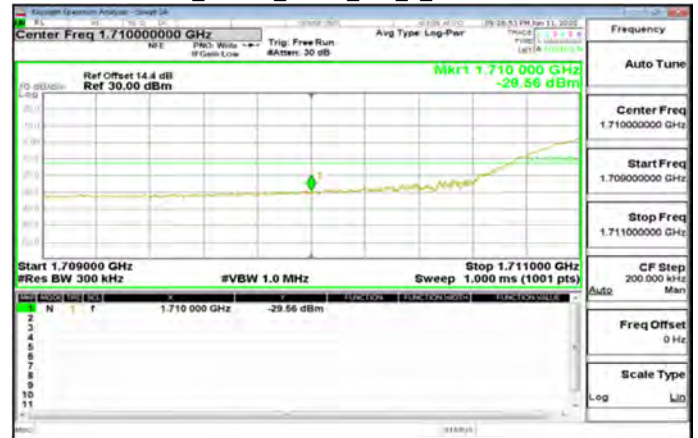

LTE\Band4\_20MHz\_QPSK\_1\_0\_LowCH20050-1720

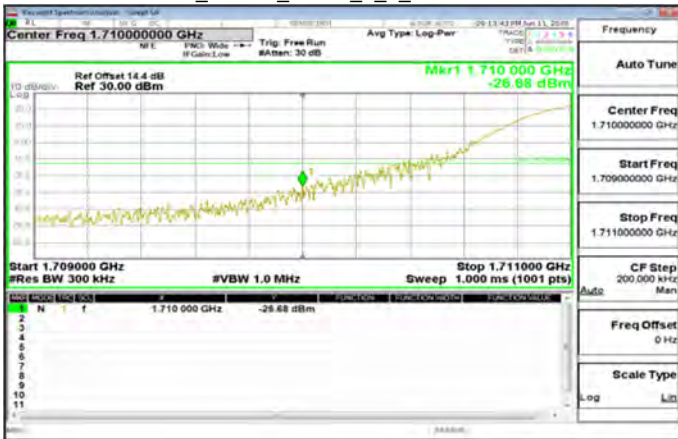

LTE\Band4\_20MHz\_QPSK\_100\_0\_HighCH20300-1745



Unless otherwise stated the results shown in this test report refer only to the sample(s) tested and such sample(s) are retained for 90 days only.

除非另有說明，此報告結果僅對測試之樣品負責，同時此樣品僅保留90天。本報告未經本公司書面許可，不可部份複製。

This document is issued by the Company subject to its General Conditions of Service printed overleaf, available on request or accessible at <http://www.sgs.com.tw/Terms-and-Conditions> and for electronic format documents, subject to Terms and Conditions for Electronic Documents at <http://www.sgs.com.tw/Terms-and-Conditions>. Attention is drawn to the limitation of liability, indemnification and jurisdiction issues defined therein. Any holder of this document is advised that information contained hereon reflects the Company's findings at the time of its intervention only and within the limits of Client's instructions, if any. The Company's sole responsibility is to its Client and this document does not exonerate parties to a transaction from exercising all their rights and obligations under the transaction documents. This document cannot be reproduced except in full, without prior written approval of the Company. Any unauthorized alteration, forgery or falsification of the content or appearance of this document is unlawful and offenders may be prosecuted to the fullest extent of the law.



LTE\Band5\_1\_4MHz\_QPSK\_1\_0\_LowCH20407-824.7

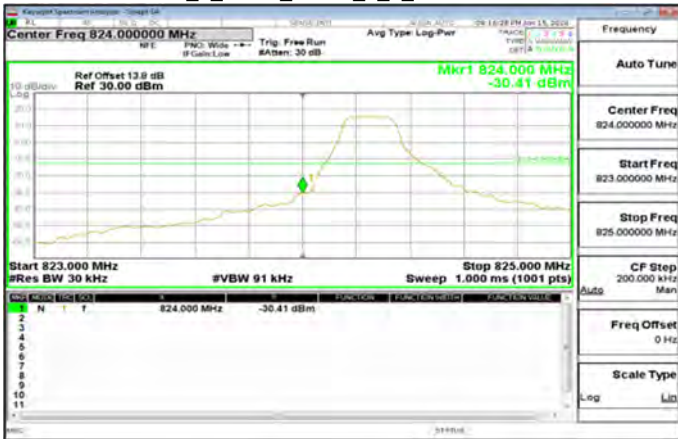

LTE\Band5\_1\_4MHz\_QPSK\_6\_0\_HighCH20643-848.3

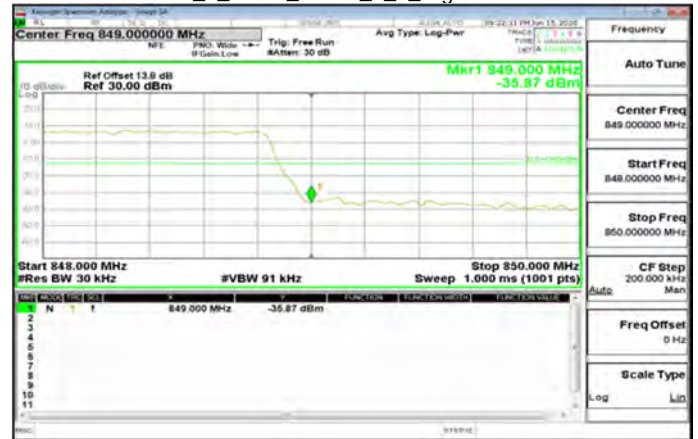

LTE\Band5\_1\_4MHz\_QPSK\_1\_5\_HighCH20643-848.3



LTE\Band5\_3MHz\_QPSK\_1\_0\_LowCH20415-825.5



LTE\Band5\_1\_4MHz\_QPSK\_6\_0\_LowCH20407-824.7



LTE\Band5\_3MHz\_QPSK\_1\_14\_HighCH20635-847.5

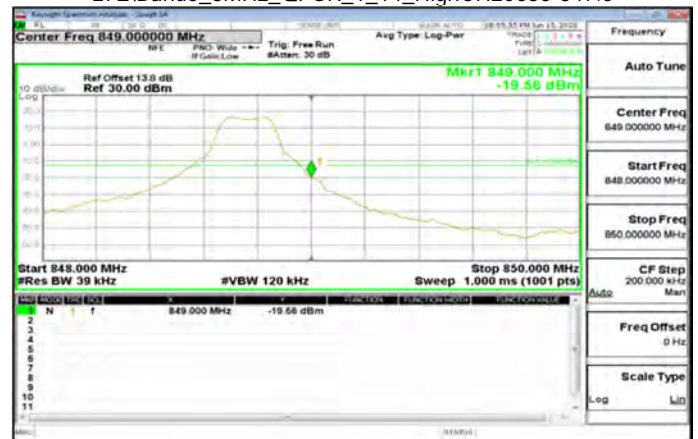

Unless otherwise stated the results shown in this test report refer only to the sample(s) tested and such sample(s) are retained for 90 days only.

除非另有說明，此報告結果僅對測試之樣品負責，同時此樣品僅保留90天。本報告未經本公司書面許可，不可部份複製。

This document is issued by the Company subject to its General Conditions of Service printed overleaf, available on request or accessible at <http://www.sgs.com.tw/Terms-and-Conditions> and for electronic format documents, subject to Terms and Conditions for Electronic Documents at <http://www.sgs.com.tw/Terms-and-Conditions>. Attention is drawn to the limitation of liability, indemnification and jurisdiction issues defined therein. Any holder of this document is advised that information contained hereon reflects the Company's findings at the time of its intervention only and within the limits of Client's instructions, if any. The Company's sole responsibility is to its Client and this document does not exonerate parties to a transaction from exercising all their rights and obligations under the transaction documents. This document cannot be reproduced except in full, without prior written approval of the Company. Any unauthorized alteration, forgery or falsification of the content or appearance of this document is unlawful and offenders may be prosecuted to the fullest extent of the law.

LTE\Band5\_3MHz\_QPSK\_15\_0\_LowCH20415-825.5

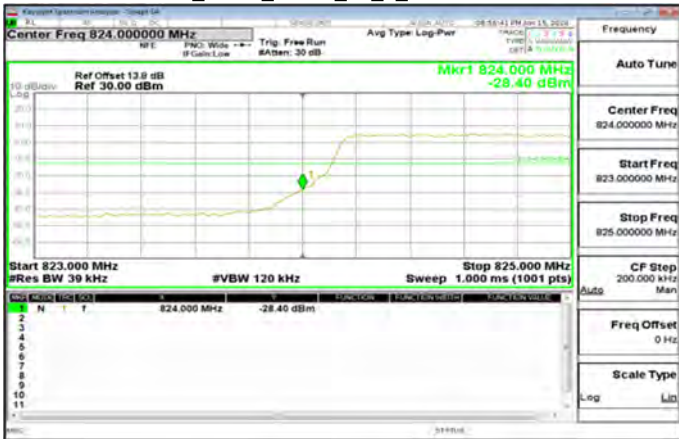

LTE\Band5\_5MHz\_QPSK\_1\_24\_HighCH20625-846.5

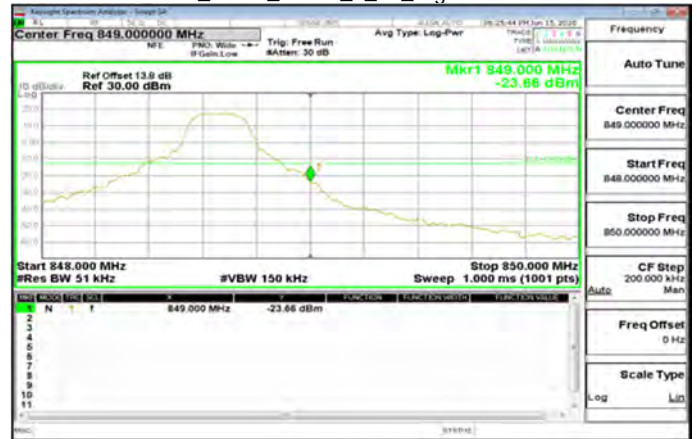

LTE\Band5\_3MHz\_QPSK\_15\_0\_HighCH20635-847.5

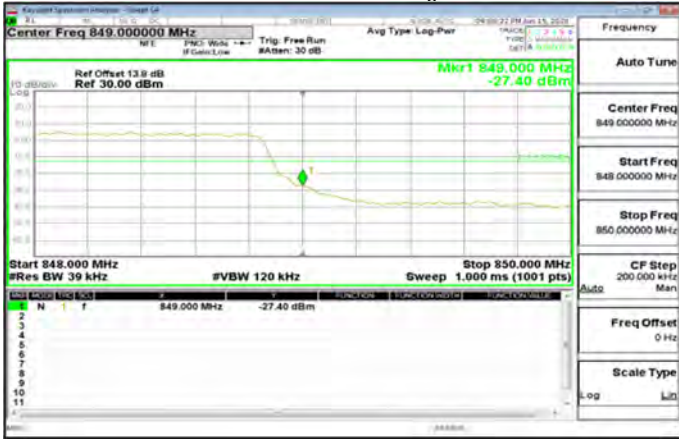

LTE\Band5\_5MHz\_QPSK\_25\_0\_LowCH20425-826.5

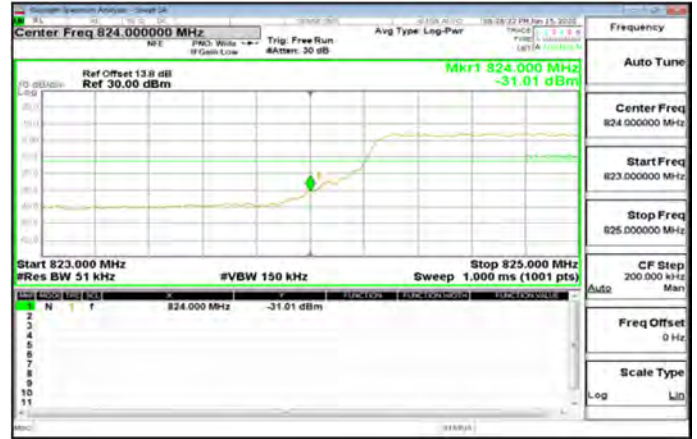

LTE\Band5\_5MHz\_QPSK\_1\_0\_LowCH20425-826.5



LTE\Band5\_5MHz\_QPSK\_25\_0\_HighCH20625-846.5



Unless otherwise stated the results shown in this test report refer only to the sample(s) tested and such sample(s) are retained for 90 days only.

除非另有說明，此報告結果僅對測試之樣品負責，同時此樣品僅保留90天。本報告未經本公司書面許可，不可部份複製。

This document is issued by the Company subject to its General Conditions of Service printed overleaf, available on request or accessible at <http://www.sgs.com.tw/Terms-and-Conditions> and for electronic format documents, subject to Terms and Conditions for Electronic Documents at <http://www.sgs.com.tw/Terms-and-Conditions>. Attention is drawn to the limitation of liability, indemnification and jurisdiction issues defined therein. Any holder of this document is advised that information contained hereon reflects the Company's findings at the time of its intervention only and within the limits of Client's instructions, if any. The Company's sole responsibility is to its Client and this document does not exonerate parties to a transaction from exercising all their rights and obligations under the transaction documents. This document cannot be reproduced except in full, without prior written approval of the Company. Any unauthorized alteration, forgery or falsification of the content or appearance of this document is unlawful and offenders may be prosecuted to the fullest extent of the law.



LTE\Band5\_10MHz\_QPSK\_1\_0\_LowCH20450-829



LTE\Band5\_10MHz\_QPSK\_50\_0\_HighCH20600-844

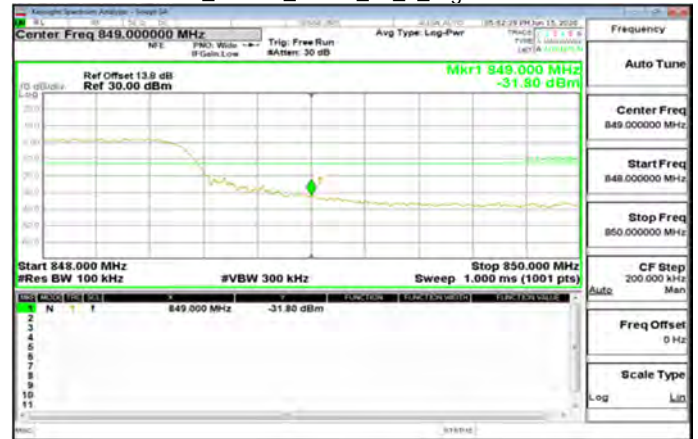

LTE\Band5\_10MHz\_QPSK\_1\_49\_HighCH20600-844



LTE\Band12\_1\_4MHz\_QPSK\_1\_0\_LowCH23017-699.7



LTE\Band5\_10MHz\_QPSK\_50\_0\_LowCH20450-829

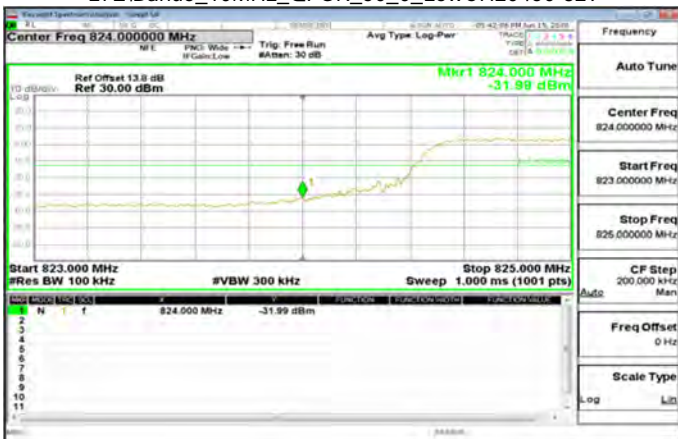

LTE\Band12\_1\_4MHz\_QPSK\_1\_5\_HighCH23173-715.3

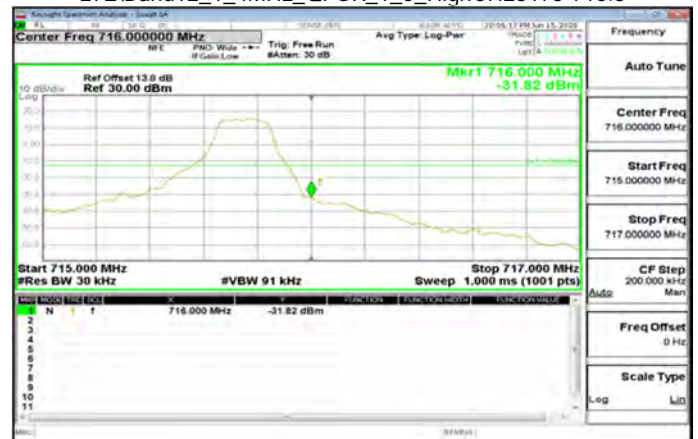

Unless otherwise stated the results shown in this test report refer only to the sample(s) tested and such sample(s) are retained for 90 days only.

除非另有說明，此報告結果僅對測試之樣品負責，同時此樣品僅保留90天。本報告未經本公司書面許可，不可部份複製。

This document is issued by the Company subject to its General Conditions of Service printed overleaf, available on request or accessible at <http://www.sgs.com.tw/Terms-and-Conditions> and for electronic format documents, subject to Terms and Conditions for Electronic Documents at <http://www.sgs.com.tw/Terms-and-Conditions>. Attention is drawn to the limitation of liability, indemnification and jurisdiction issues defined therein. Any holder of this document is advised that information contained hereon reflects the Company's findings at the time of its intervention only and within the limits of Client's instructions, if any. The Company's sole responsibility is to its Client and this document does not exonerate parties to a transaction from exercising all their rights and obligations under the transaction documents. This document cannot be reproduced except in full, without prior written approval of the Company. Any unauthorized alteration, forgery or falsification of the content or appearance of this document is unlawful and offenders may be prosecuted to the fullest extent of the law.

LTE\Band12\_1\_4MHz\_QPSK\_6\_0\_LowCH23017-699.7

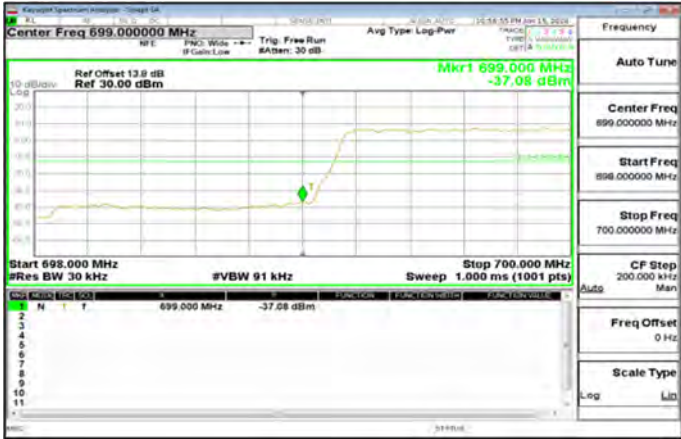

LTE\Band12\_3MHz\_QPSK\_1\_14\_HighCH23165-714.5



LTE\Band12\_1\_4MHz\_QPSK\_6\_0\_HighCH23173-715.3



LTE\Band12\_3MHz\_QPSK\_15\_0\_LowCH23025-700.5



LTE\Band12\_3MHz\_QPSK\_1\_0\_LowCH23025-700.5

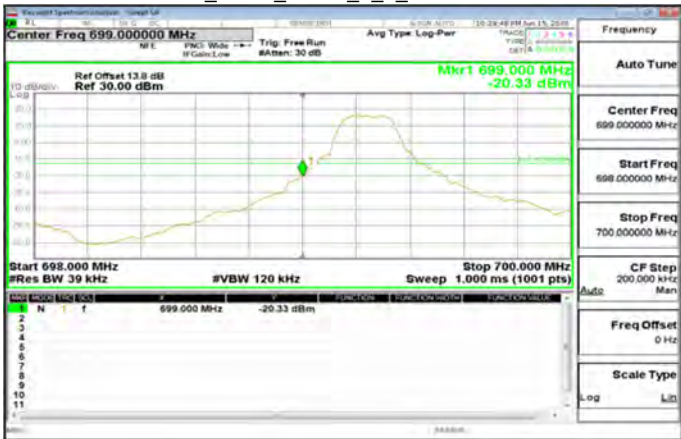

LTE\Band12\_3MHz\_QPSK\_15\_0\_HighCH23165-714.5



Unless otherwise stated the results shown in this test report refer only to the sample(s) tested and such sample(s) are retained for 90 days only.

除非另有說明，此報告結果僅對測試之樣品負責，同時此樣品僅保留90天。本報告未經本公司書面許可，不可部份複製。

This document is issued by the Company subject to its General Conditions of Service printed overleaf, available on request or accessible at <http://www.sgs.com.tw/Terms-and-Conditions> and for electronic format documents, subject to Terms and Conditions for Electronic Documents at <http://www.sgs.com.tw/Terms-and-Conditions>. Attention is drawn to the limitation of liability, indemnification and jurisdiction issues defined therein. Any holder of this document is advised that information contained hereon reflects the Company's findings at the time of its intervention only and within the limits of Client's instructions, if any. The Company's sole responsibility is to its Client and this document does not exonerate parties to a transaction from exercising all their rights and obligations under the transaction documents. This document cannot be reproduced except in full, without prior written approval of the Company. Any unauthorized alteration, forgery or falsification of the content or appearance of this document is unlawful and offenders may be prosecuted to the fullest extent of the law.



LTE\Band12\_5MHz\_QPSK\_1\_0\_LowCH23035-701.5

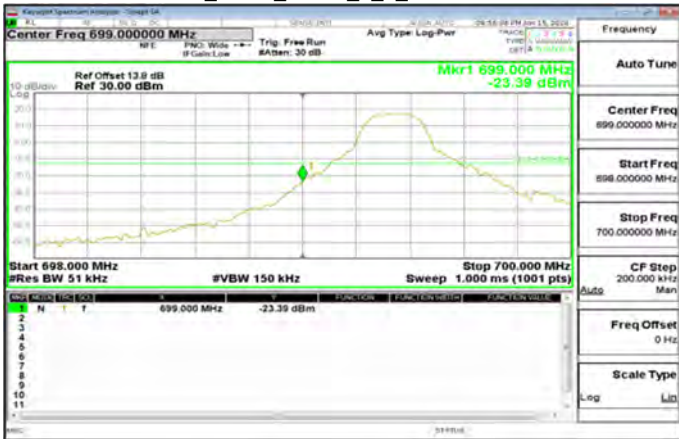

LTE\Band12\_5MHz\_QPSK\_25\_0\_HighCH23155-713.5



LTE\Band12\_5MHz\_QPSK\_1\_24\_HighCH23155-713.5

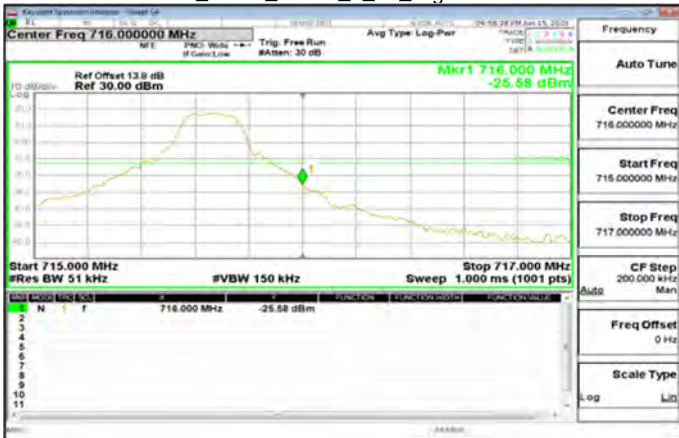

LTE\Band12\_10MHz\_QPSK\_1\_0\_LowCH23060-704



LTE\Band12\_5MHz\_QPSK\_25\_0\_LowCH23035-701.5

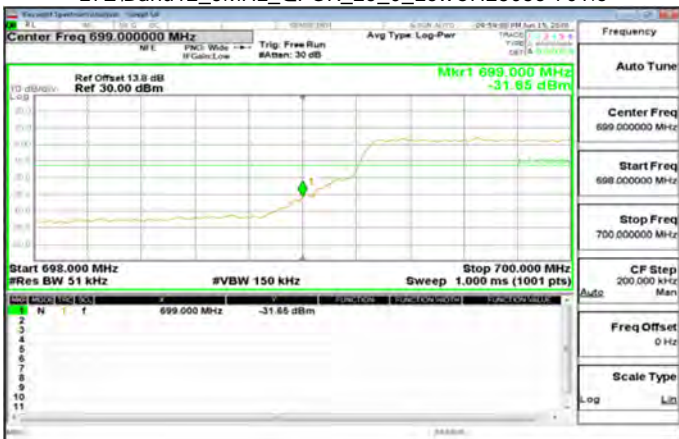

LTE\Band12\_10MHz\_QPSK\_1\_49\_HighCH23130-711



Unless otherwise stated the results shown in this test report refer only to the sample(s) tested and such sample(s) are retained for 90 days only.

除非另有說明，此報告結果僅對測試之樣品負責，同時此樣品僅保留90天。本報告未經本公司書面許可，不可部份複製。

This document is issued by the Company subject to its General Conditions of Service printed overleaf, available on request or accessible at <http://www.sgs.com.tw/Terms-and-Conditions> and for electronic format documents, subject to Terms and Conditions for Electronic Documents at <http://www.sgs.com.tw/Terms-and-Conditions>. Attention is drawn to the limitation of liability, indemnification and jurisdiction issues defined therein. Any holder of this document is advised that information contained hereon reflects the Company's findings at the time of its intervention only and within the limits of Client's instructions, if any. The Company's sole responsibility is to its Client and this document does not exonerate parties to a transaction from exercising all their rights and obligations under the transaction documents. This document cannot be reproduced except in full, without prior written approval of the Company. Any unauthorized alteration, forgery or falsification of the content or appearance of this document is unlawful and offenders may be prosecuted to the fullest extent of the law.

LTE\Band12\_10MHz\_QPSK\_50\_0\_LowCH23060-704

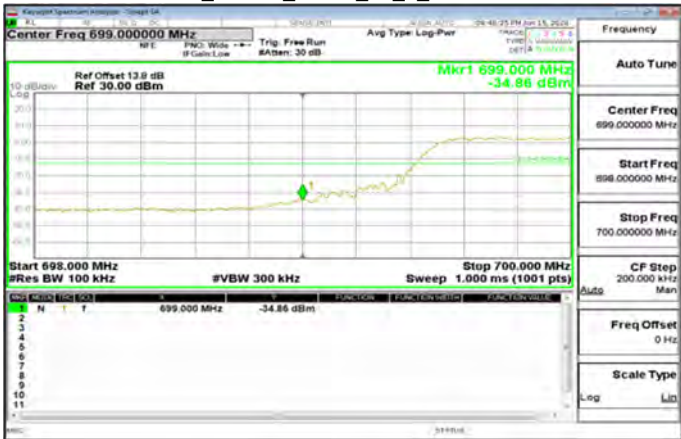

LTE\Band17\_5MHz\_QPSK\_1\_24\_HighCH23825-713.5



LTE\Band12\_10MHz\_QPSK\_50\_0\_HighCH23130-711

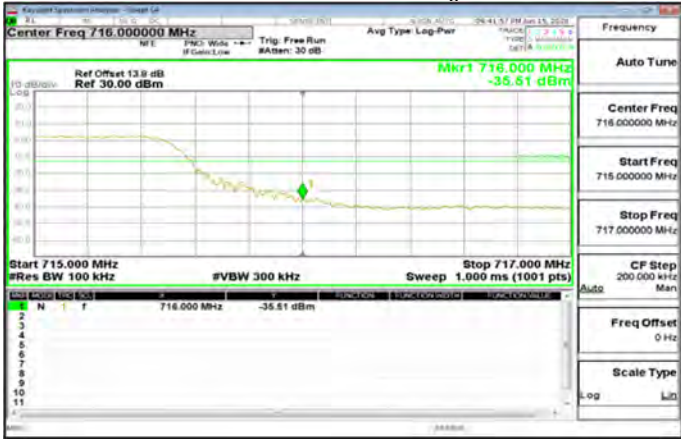

LTE\Band17\_5MHz\_QPSK\_25\_0\_LowCH23755-706.5



LTE\Band17\_5MHz\_QPSK\_1\_0\_LowCH23755-706.5



LTE\Band17\_5MHz\_QPSK\_25\_0\_HighCH23825-713.5



Unless otherwise stated the results shown in this test report refer only to the sample(s) tested and such sample(s) are retained for 90 days only.

除非另有說明，此報告結果僅對測試之樣品負責，同時此樣品僅保留90天。本報告未經本公司書面許可，不可部份複製。

This document is issued by the Company subject to its General Conditions of Service printed overleaf, available on request or accessible at <http://www.sgs.com.tw/Terms-and-Conditions> and for electronic format documents, subject to Terms and Conditions for Electronic Documents at <http://www.sgs.com.tw/Terms-and-Conditions>. Attention is drawn to the limitation of liability, indemnification and jurisdiction issues defined therein. Any holder of this document is advised that information contained hereon reflects the Company's findings at the time of its intervention only and within the limits of Client's instructions, if any. The Company's sole responsibility is to its Client and this document does not exonerate parties to a transaction from exercising all their rights and obligations under the transaction documents. This document cannot be reproduced except in full, without prior written approval of the Company. Any unauthorized alteration, forgery or falsification of the content or appearance of this document is unlawful and offenders may be prosecuted to the fullest extent of the law.



LTE\Band17\_10MHz\_QPSK\_1\_0\_LowCH23780-709



LTE\Band17\_10MHz\_QPSK\_50\_0\_HighCH23800-711



LTE\Band17\_10MHz\_QPSK\_1\_49\_HighCH23800-711



LTE\Band25\_1\_4MHz\_QPSK\_1\_0\_LowCH26047-1850.7

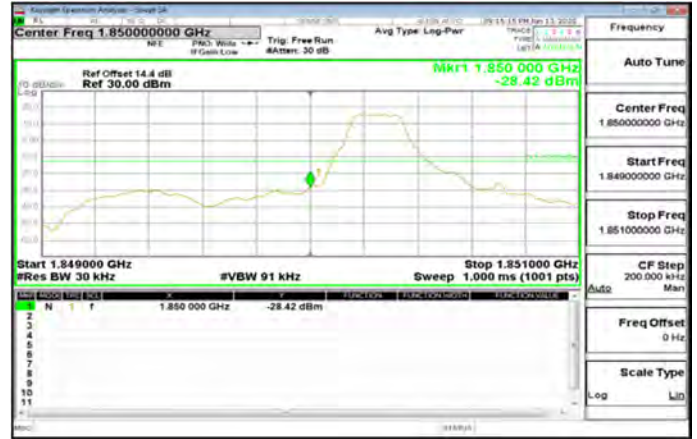

LTE\Band17\_10MHz\_QPSK\_50\_0\_LowCH23780-709

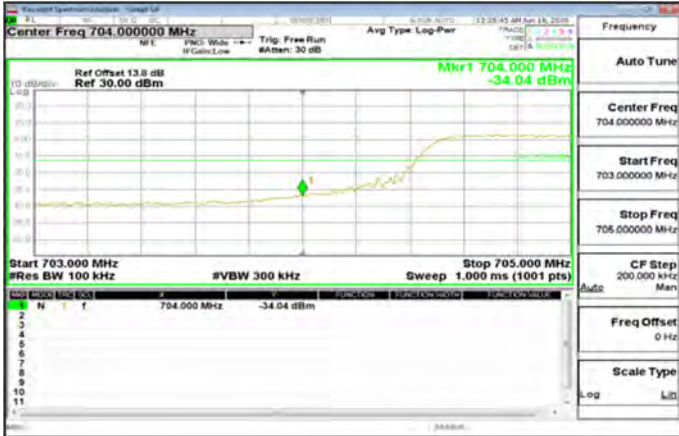

LTE\Band25\_1\_4MHz\_QPSK\_1\_5\_HighCH26683-1914.3

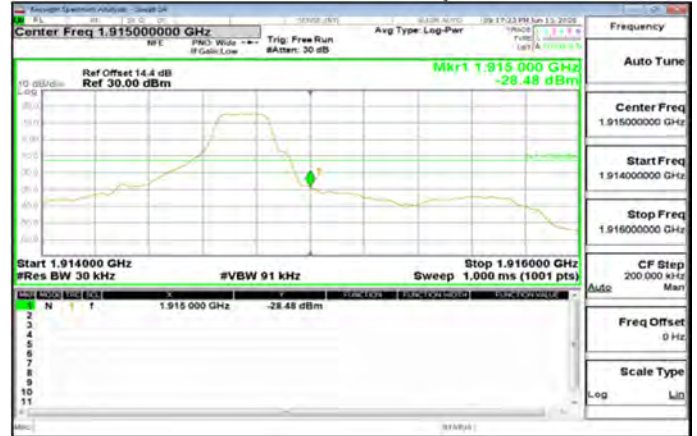

Unless otherwise stated the results shown in this test report refer only to the sample(s) tested and such sample(s) are retained for 90 days only.

除非另有說明，此報告結果僅對測試之樣品負責，同時此樣品僅保留90天。本報告未經本公司書面許可，不可部份複製。

This document is issued by the Company subject to its General Conditions of Service printed overleaf, available on request or accessible at <http://www.sgs.com.tw/Terms-and-Conditions> and for electronic format documents, subject to Terms and Conditions for Electronic Documents at <http://www.sgs.com.tw/Terms-and-Conditions>. Attention is drawn to the limitation of liability, indemnification and jurisdiction issues defined therein. Any holder of this document is advised that information contained hereon reflects the Company's findings at the time of its intervention only and within the limits of Client's instructions, if any. The Company's sole responsibility is to its Client and this document does not exonerate parties to a transaction from exercising all their rights and obligations under the transaction documents. This document cannot be reproduced except in full, without prior written approval of the Company. Any unauthorized alteration, forgery or falsification of the content or appearance of this document is unlawful and offenders may be prosecuted to the fullest extent of the law.