

Date: 2020/7/19

Report No. :ES/2020/30005

**LTE Band 7 (20MHz)_Body-worn_Back side_CH
21350_QPSK_1-99_15mm_LAT**

Communication System: LTE; Frequency: 2560 MHz; Duty cycle= 1:1

Medium parameters used: $f = 2560$ MHz; $\sigma = 1.904$ S/m; $\epsilon_r = 38.521$; $\rho = 1000$ kg/m³

Phantom section: Flat Section

Ambient temperature: 21.7°C; Liquid temperature: 22.3°C

DASY5 Configuration:

- Probe: EX3DV4 - SN3770; ConvF(7.21, 7.21, 7.21) @ 2560 MHz; Calibrated: 2020/05/27
- Sensor-Surface: 2mm (Mechanical Surface Detection)
- Electronics: DAE4 Sn877; Calibrated: 2020/03/17
- Phantom: SAM
- DASY52 52.10.4(1527); SEMCAD X 14.6.14(7483)

Area Scan (101x171x1): Interpolated grid: dx=12 mm, dy=12 mm

Maximum value of SAR (interpolated) = 0.313 W/kg

Zoom Scan (7x7x7)/Cube 0: Measurement grid: dx=5mm, dy=5mm, dz=5mm

Reference Value = 2.584 V/m; Power Drift = 0.19 dB

Peak SAR (extrapolated) = 0.379 W/kg

SAR(1 g) = 0.240 W/kg; SAR(10 g) = 0.139 W/kg

Smallest distance from peaks to all points 3 dB below = 11.3 mm

Ratio of SAR at M2 to SAR at M1 = 68.9%

Maximum value of SAR (measured) = 0.327 W/kg

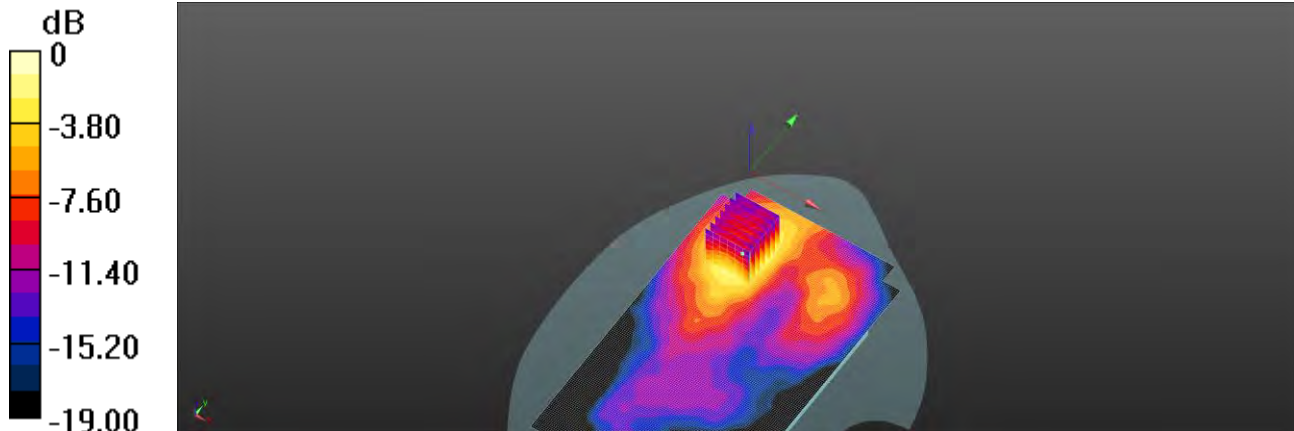

0 dB = 0.327 W/kg = -4.85 dBW/kg

Unless otherwise stated the results shown in this test report refer only to the sample(s) tested and such sample(s) are retained for 90 days only.

除非另有說明，此報告結果僅對測試之樣品負責，同時此樣品僅保留90天。本報告未經本公司書面許可，不可部份複製。

This document is issued by the Company subject to its General Conditions of Service printed overleaf, available on request or accessible at <http://www.sgs.com.tw/Terms-and-Conditions> and for electronic format documents, subject to Terms and Conditions for Electronic Documents at <http://www.sgs.com.tw/Terms-and-Conditions>. Attention is drawn to the limitation of liability, indemnification and jurisdiction issues defined therein. Any holder of this document is advised that information contained hereon reflects the Company's findings at the time of its intervention only and within the limits of Client's instructions, if any. The Company's sole responsibility is to its Client and this document does not exonerate parties to a transaction from exercising all their rights and obligations under the transaction documents. This document cannot be reproduced except in full, without prior written approval of the Company. Any unauthorized alteration, forgery or falsification of the content or appearance of this document is unlawful and offenders may be prosecuted to the fullest extent of the law.

Date: 2020/7/15

Report No. :ES/2020/30005

**LTE Band 26 (15MHz)_Body-worn_Back side_CH
26765_QPSK_1-0_15mm_LAT**

Communication System: LTE; Frequency: 821.5 MHz; Duty cycle= 1:1

Medium parameters used: $f = 821.5 \text{ MHz}$; $\sigma = 0.884 \text{ S/m}$; $\epsilon_r = 42.515$; $\rho = 1000 \text{ kg/m}^3$

Phantom section: Flat Section

Ambient temperature: 21.9°C; Liquid temperature: 22.3°C

DASY5 Configuration:

- Probe: EX3DV4 - SN3770; ConvF(9.5, 9.5, 9.5) @ 821.5 MHz; Calibrated: 2020/05/27
- Sensor-Surface: 2mm (Mechanical Surface Detection)
- Electronics: DAE4 Sn877; Calibrated: 2020/03/17
- Phantom: SAM
- DASY52 52.10.4(1527); SEMCAD X 14.6.14(7483)

Area Scan (71x141x1): Interpolated grid: dx=15 mm, dy=15 mm

Maximum value of SAR (interpolated) = 0.329 W/kg

Zoom Scan (5x5x7)/Cube 0: Measurement grid: dx=8mm, dy=8mm, dz=5mm

Reference Value = 19.30 V/m; Power Drift = -0.19 dB

Peak SAR (extrapolated) = 0.314 W/kg

SAR(1 g) = 0.304 W/kg; SAR(10 g) = 0.264 W/kg

Smallest distance from peaks to all points 3 dB below = 15.6 mm

Ratio of SAR at M2 to SAR at M1 = 94.3%

Maximum value of SAR (measured) = 0.310 W/kg

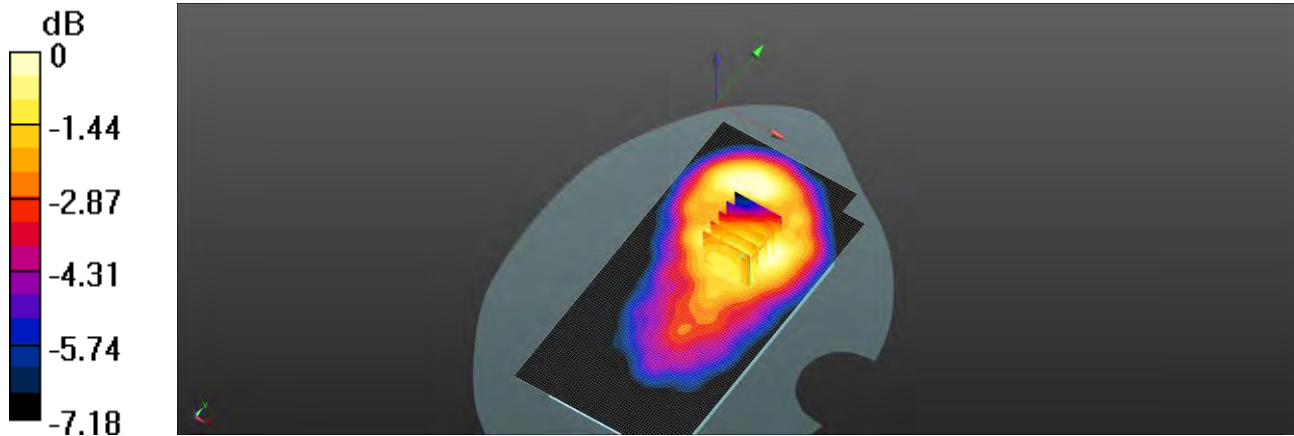

0 dB = 0.310 W/kg = -5.09 dBW/kg

Unless otherwise stated the results shown in this test report refer only to the sample(s) tested and such sample(s) are retained for 90 days only.

除非另有說明，此報告結果僅對測試之樣品負責，同時此樣品僅保留90天。本報告未經本公司書面許可，不可部份複製。

This document is issued by the Company subject to its General Conditions of Service printed overleaf, available on request or accessible at <http://www.sgs.com.tw/Terms-and-Conditions> and for electronic format documents, subject to Terms and Conditions for Electronic Documents at <http://www.sgs.com.tw/Terms-and-Conditions>. Attention is drawn to the limitation of liability, indemnification and jurisdiction issues defined therein. Any holder of this document is advised that information contained hereon reflects the Company's findings at the time of its intervention only and within the limits of Client's instructions, if any. The Company's sole responsibility is to its Client and this document does not exonerate parties to a transaction from exercising all their rights and obligations under the transaction documents. This document cannot be reproduced except in full, without prior written approval of the Company. Any unauthorized alteration, forgery or falsification of the content or appearance of this document is unlawful and offenders may be prosecuted to the fullest extent of the law.

Date: 2020/7/19

Report No. :ES/2020/30005

LTE Band 41 (20MHz)_Body-wor_Back side_CH 41490_QPSK_1-0_15mm_LAT

Communication System: LTE; Frequency: 2680 MHz; Duty cycle= 1:1.59956

Medium parameters used: $f = 2680$ MHz; $\sigma = 2.059$ S/m; $\epsilon_r = 38.252$; $\rho = 1000$ kg/m³

Phantom section: Flat Section

Ambient temperature: 21.7°C; Liquid temperature: 22.3°C

DASY5 Configuration:

- Probe: EX3DV4 - SN3770; ConvF(7.21, 7.21, 7.21) @ 2680 MHz; Calibrated: 2020/05/27
- Sensor-Surface: 2mm (Mechanical Surface Detection)
- Electronics: DAE4 Sn877; Calibrated: 2020/03/17
- Phantom: SAM
- DASY52 52.10.4(1527); SEMCAD X 14.6.14(7483)

Area Scan (101x171x1): Interpolated grid: dx=12 mm, dy=12 mm

Maximum value of SAR (interpolated) = 0.250 W/kg

Zoom Scan (7x7x7)/Cube 0: Measurement grid: dx=5mm, dy=5mm, dz=5mm

Reference Value = 2.505 V/m; Power Drift = 0.07 dB

Peak SAR (extrapolated) = 0.287 W/kg

SAR(1 g) = 0.174 W/kg; SAR(10 g) = 0.101 W/kg

Smallest distance from peaks to all points 3 dB below = 12.6 mm

Ratio of SAR at M2 to SAR at M1 = 51.8%

Maximum value of SAR (measured) = 0.232 W/kg

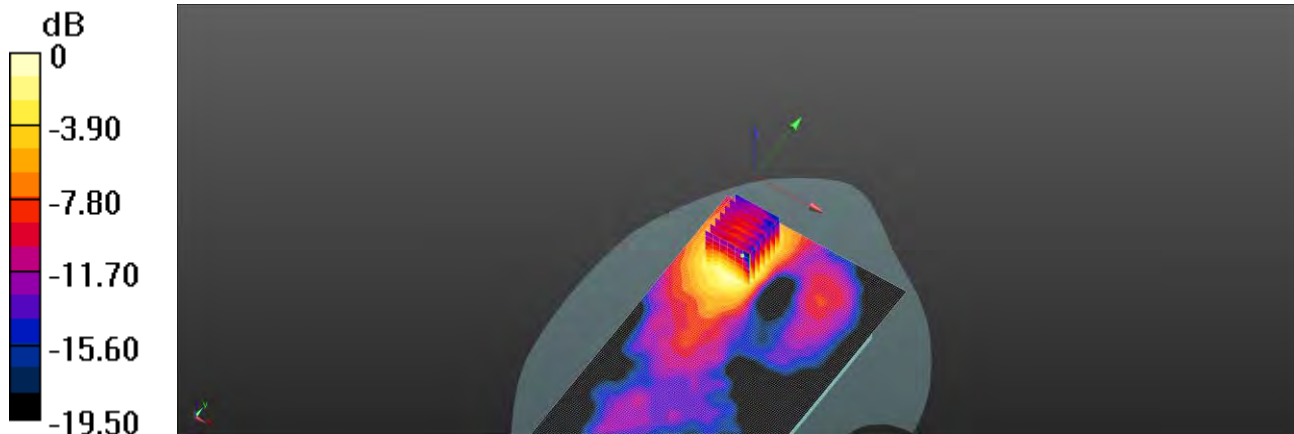

0 dB = 0.232 W/kg = -6.35 dBW/kg

Unless otherwise stated the results shown in this test report refer only to the sample(s) tested and such sample(s) are retained for 90 days only.

除非另有說明，此報告結果僅對測試之樣品負責，同時此樣品僅保留90天。本報告未經本公司書面許可，不可部份複製。

This document is issued by the Company subject to its General Conditions of Service printed overleaf, available on request or accessible at <http://www.sgs.com.tw/Terms-and-Conditions> and for electronic format documents, subject to Terms and Conditions for Electronic Documents at <http://www.sgs.com.tw/Terms-and-Conditions>. Attention is drawn to the limitation of liability, indemnification and jurisdiction issues defined therein. Any holder of this document is advised that information contained hereon reflects the Company's findings at the time of its intervention only and within the limits of Client's instructions, if any. The Company's sole responsibility is to its Client and this document does not exonerate parties to a transaction from exercising all their rights and obligations under the transaction documents. This document cannot be reproduced except in full, without prior written approval of the Company. Any unauthorized alteration, forgery or falsification of the content or appearance of this document is unlawful and offenders may be prosecuted to the fullest extent of the law.

Date: 2020/7/19

Report No. :ES/2020/30005

5G NR n41 (100MHz)_Hotspot_Back side_CH 509202_QPSK_1-1_10mm_LAT

Communication System: 5G NR(100MHz,QPSK,30k); Frequency: 2546.01 MHz; Duty cycle= 1:1

Medium parameters used: $f = 2546.01$ MHz; $\sigma = 1.879$ S/m; $\epsilon_r = 38.673$; $\rho = 1000$ kg/m³

Phantom section: Flat Section

Ambient temperature: 21.7°C; Liquid temperature: 22.3°C

DASY5 Configuration:

- Probe: EX3DV4 - SN3770; ConvF(7.21, 7.21, 7.21) @ 2546.01 MHz; Calibrated: 2020/05/27
- Sensor-Surface: 2mm (Mechanical Surface Detection)
- Electronics: DAE4 Sn877; Calibrated: 2020/03/17
- Phantom: SAM
- DASY52 52.10.4(1527); SEMCAD X 14.6.14(7483)

Area Scan (101x171x1): Interpolated grid: dx=12 mm, dy=12 mm

Maximum value of SAR (interpolated) = 0.354 W/kg

Zoom Scan (7x7x7)/Cube 0: Measurement grid: dx=5mm, dy=5mm, dz=5mm

Reference Value = 2.392 V/m; Power Drift = 0.10 dB

Peak SAR (extrapolated) = 0.377 W/kg

SAR(1 g) = 0.195 W/kg; SAR(10 g) = 0.091 W/kg

Smallest distance from peaks to all points 3 dB below = 7.1 mm

Ratio of SAR at M2 to SAR at M1 = 75.6%

Maximum value of SAR (measured) = 0.279 W/kg

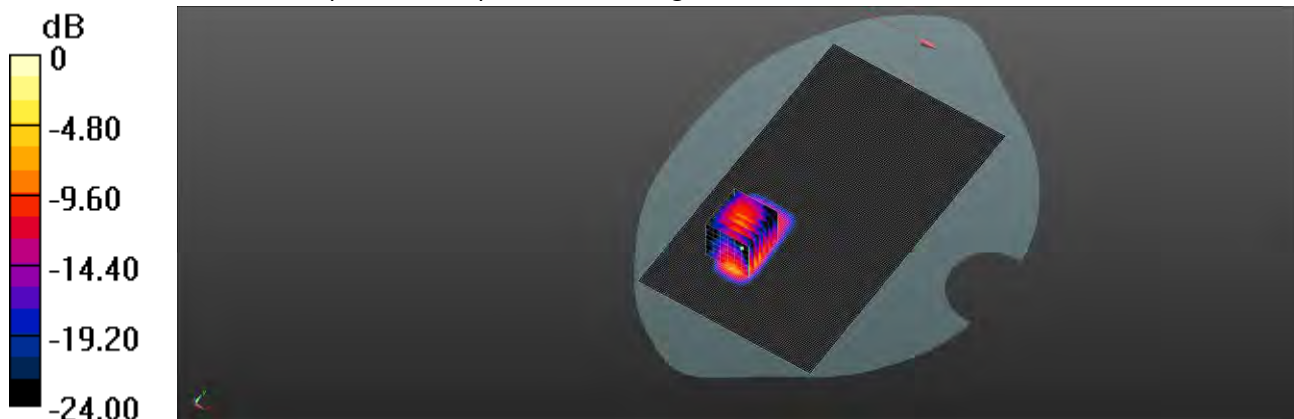

0 dB = 0.279 W/kg = -5.54 dBW/kg

Unless otherwise stated the results shown in this test report refer only to the sample(s) tested and such sample(s) are retained for 90 days only.

除非另有說明，此報告結果僅對測試之樣品負責，同時此樣品僅保留90天。本報告未經本公司書面許可，不可部份複製。

This document is issued by the Company subject to its General Conditions of Service printed overleaf, available on request or accessible at <http://www.sgs.com.tw/Terms-and-Conditions> and for electronic format documents, subject to Terms and Conditions for Electronic Documents at <http://www.sgs.com.tw/Terms-and-Conditions>. Attention is drawn to the limitation of liability, indemnification and jurisdiction issues defined therein. Any holder of this document is advised that information contained hereon reflects the Company's findings at the time of its intervention only and within the limits of Client's instructions, if any. The Company's sole responsibility is to its Client and this document does not exonerate parties to a transaction from exercising all their rights and obligations under the transaction documents. This document cannot be reproduced except in full, without prior written approval of the Company. Any unauthorized alteration, forgery or falsification of the content or appearance of this document is unlawful and offenders may be prosecuted to the fullest extent of the law.

Date: 2020/7/17

Report No. :ES/2020/30005

5G NR n2 (20MHz)_Body worn_Back side_CH 376000_QPSK_1-53_15mm_LAT

Communication System: 5G NR(20MHz,QPSK,15kHz); Frequency: 1880 MHz; Duty cycle= 1:1

Medium parameters used: $f = 1880 \text{ MHz}$; $\sigma = 1.394 \text{ S/m}$; $\epsilon_r = 39.878$; $\rho = 1000 \text{ kg/m}^3$

Phantom section: Flat Section

Ambient temperature: 22.7°C; Liquid temperature: 21.6°C

DASY5 Configuration:

- Probe: EX3DV4 - SN3770; ConvF(8.03, 8.03, 8.03) @ 1880 MHz; Calibrated: 2020/5/27
- Sensor-Surface: 2mm (Mechanical Surface Detection)
- Electronics: DAE4 Sn877; Calibrated: 2020/3/17
- Phantom: SAM
- DASY52 52.10.4(1527); SEMCAD X 14.6.14(7483)

Area Scan (71x141x1): Interpolated grid: dx=15 mm, dy=15 mm

Maximum value of SAR (interpolated) = 0.337 W/kg

Zoom Scan (5x5x7)/Cube 0: Measurement grid: dx=8mm, dy=8mm, dz=5mm

Reference Value = 10.97 V/m; Power Drift = -0.04 dB

Peak SAR (extrapolated) = 0.384 W/kg

SAR(1 g) = 0.273 W/kg; SAR(10 g) = 0.188 W/kg

Smallest distance from peaks to all points 3 dB below = 18.1 mm

Ratio of SAR at M2 to SAR at M1 = 70.2%

Maximum value of SAR (measured) = 0.330 W/kg

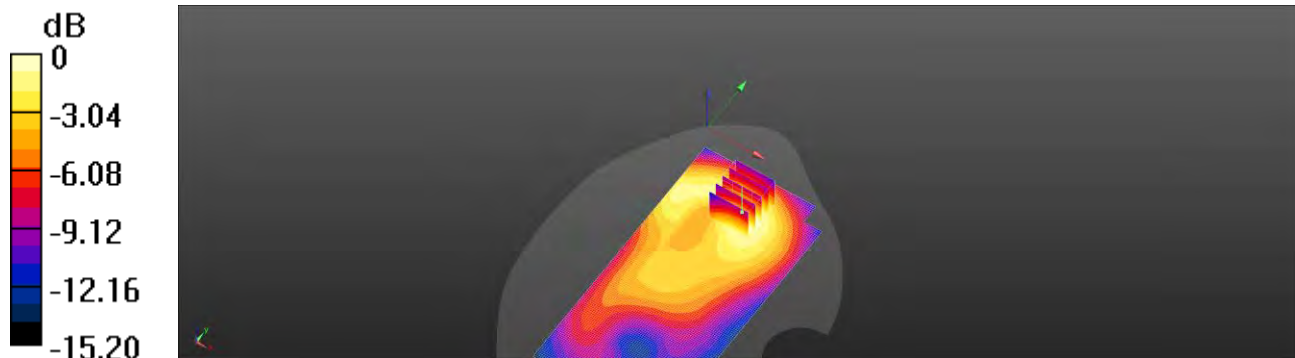

0 dB = 0.330 W/kg = -4.81 dBW/kg

Unless otherwise stated the results shown in this test report refer only to the sample(s) tested and such sample(s) are retained for 90 days only.

除非另有說明，此報告結果僅對測試之樣品負責，同時此樣品僅保留90天。本報告未經本公司書面許可，不可部份複製。

This document is issued by the Company subject to its General Conditions of Service printed overleaf, available on request or accessible at <http://www.sgs.com.tw/Terms-and-Conditions> and for electronic format documents, subject to Terms and Conditions for Electronic Documents at <http://www.sgs.com.tw/Terms-and-Conditions>. Attention is drawn to the limitation of liability, indemnification and jurisdiction issues defined therein. Any holder of this document is advised that information contained hereon reflects the Company's findings at the time of its intervention only and within the limits of Client's instructions, if any. The Company's sole responsibility is to its Client and this document does not exonerate parties to a transaction from exercising all their rights and obligations under the transaction documents. This document cannot be reproduced except in full, without prior written approval of the Company. Any unauthorized alteration, forgery or falsification of the content or appearance of this document is unlawful and offenders may be prosecuted to the fullest extent of the law.

Date: 2020/7/15

Report No. :ES/2020/30005

5G NR n5 (20MHz)_Body worn_Front side_CH 167300_QPSK_1-53_15mm_LAT

Communication System: 5G NR(20MHz,QPSK,15kHz); Frequency: 836.5 MHz; Duty cycle= 1:1

Medium parameters used: $f = 836.5 \text{ MHz}$; $\sigma = 0.903 \text{ S/m}$; $\epsilon_r = 42.087$; $\rho = 1000 \text{ kg/m}^3$

Phantom section: Flat Section

Ambient temperature: 21.9°C; Liquid temperature: 22.3°C

DASY5 Configuration:

- Probe: EX3DV4 - SN3770; ConvF(9.5, 9.5, 9.5) @ 836.5 MHz; Calibrated: 2020/5/27
- Sensor-Surface: 2mm (Mechanical Surface Detection)
- Electronics: DAE4 Sn877; Calibrated: 2020/3/17
- Phantom: SAM
- DASY52 52.10.4(1527); SEMCAD X 14.6.14(7483)

Area Scan (71x141x1): Interpolated grid: dx=15 mm, dy=15 mm

Maximum value of SAR (interpolated) = 0.0403 W/kg

Zoom Scan (5x5x7)/Cube 0: Measurement grid: dx=8mm, dy=8mm, dz=5mm

Reference Value = 3.765 V/m; Power Drift = -0.15 dB

Peak SAR (extrapolated) = 0.0400 W/kg

SAR(1 g) = 0.029 W/kg; SAR(10 g) = 0.021 W/kg

Smallest distance from peaks to all points 3 dB below = 11.9 mm

Ratio of SAR at M2 to SAR at M1 = 89.5%

Maximum value of SAR (measured) = 0.0343 W/kg

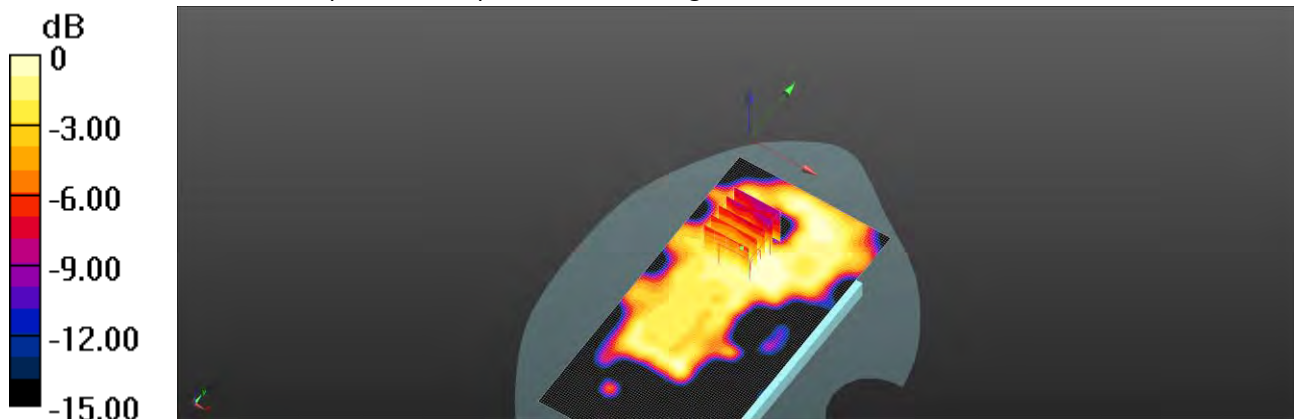

0 dB = 0.0343 W/kg = -14.65 dBW/kg

Unless otherwise stated the results shown in this test report refer only to the sample(s) tested and such sample(s) are retained for 90 days only.

除非另有說明，此報告結果僅對測試之樣品負責，同時此樣品僅保留90天。本報告未經本公司書面許可，不可部份複製。

This document is issued by the Company subject to its General Conditions of Service printed overleaf, available on request or accessible at <http://www.sgs.com.tw/Terms-and-Conditions> and for electronic format documents, subject to Terms and Conditions for Electronic Documents at <http://www.sgs.com.tw/Terms-and-Conditions>. Attention is drawn to the limitation of liability, indemnification and jurisdiction issues defined therein. Any holder of this document is advised that information contained hereon reflects the Company's findings at the time of its intervention only and within the limits of Client's instructions, if any. The Company's sole responsibility is to its Client and this document does not exonerate parties to a transaction from exercising all their rights and obligations under the transaction documents. This document cannot be reproduced except in full, without prior written approval of the Company. Any unauthorized alteration, forgery or falsification of the content or appearance of this document is unlawful and offenders may be prosecuted to the fullest extent of the law.

Date: 2020/7/19

Report No. : ES/2020/30005

5G NR n41 (100MHz)_Body worn_Back side_CH

509202_QPSK_1-137_15mm_LAT

Communication System: 5G NR (100 MHz, QPSK, 30 kHz); Frequency: 2546.01 MHz; Duty cycle= 1:1

Medium parameters used: $f = 2546.01$ MHz; $\sigma = 1.879$ S/m; $\epsilon_r = 38.673$; $\rho = 1000$ kg/m³

Phantom section: Flat Section

Ambient temperature: 21.7°C; Liquid temperature: 22.3°C

DASY5 Configuration:

- Probe: EX3DV4 - SN3770; ConvF(7.21, 7.21, 7.21) @ 2546.01 MHz; Calibrated: 2020/5/27
- Sensor-Surface: 2mm (Mechanical Surface Detection)
- Electronics: DAE4 Sn877; Calibrated: 2020/3/17
- Phantom: SAM
- DASY52 52.10.4(1527); SEMCAD X 14.6.14(7483)

Area Scan (91x171x1): Interpolated grid: dx=12 mm, dy=12 mm

Maximum value of SAR (interpolated) = 0.116 W/kg

Zoom Scan (7x7x7)/Cube 0: Measurement grid: dx=5mm, dy=5mm, dz=5mm

Reference Value = 4.345 V/m; Power Drift = 0.02 dB

Peak SAR (extrapolated) = 0.149 W/kg

SAR(1 g) = 0.103 W/kg; SAR(10 g) = 0.070 W/kg

Smallest distance from peaks to all points 3 dB below = 13.9 mm

Ratio of SAR at M2 to SAR at M1 = 56.7%

Maximum value of SAR (measured) = 0.116 W/kg

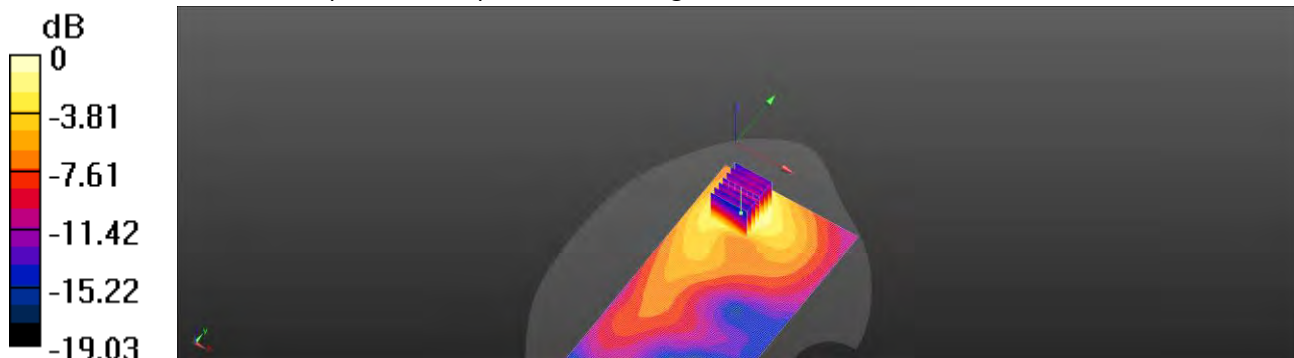

0 dB = 0.116 W/kg = -9.34 dBW/kg

Unless otherwise stated the results shown in this test report refer only to the sample(s) tested and such sample(s) are retained for 90 days only.

除非另有說明，此報告結果僅對測試之樣品負責，同時此樣品僅保留90天。本報告未經本公司書面許可，不可部份複製。

This document is issued by the Company subject to its General Conditions of Service printed overleaf, available on request or accessible at <http://www.sgs.com.tw/Terms-and-Conditions> and for electronic format documents, subject to Terms and Conditions for Electronic Documents at <http://www.sgs.com.tw/Terms-and-Conditions>. Attention is drawn to the limitation of liability, indemnification and jurisdiction issues defined therein. Any holder of this document is advised that information contained hereon reflects the Company's findings at the time of its intervention only and within the limits of Client's instructions, if any. The Company's sole responsibility is to its Client and this document does not exonerate parties to a transaction from exercising all their rights and obligations under the transaction documents. This document cannot be reproduced except in full, without prior written approval of the Company. Any unauthorized alteration, forgery or falsification of the content or appearance of this document is unlawful and offenders may be prosecuted to the fullest extent of the law.

Date: 2020/7/16

Report No. :ES/2020/30005

5G NR n66 (40MHz)_Body worn_Front side_CH 346000_QPSK_1-1_15mm_LAT

Communication System: 5G NR(20MHz, QPSK, 15kHz); Frequency: 1730 MHz; Duty cycle= 1:1

Medium parameters used: $f = 1730$ MHz; $\sigma = 1.342$ S/m; $\epsilon_r = 41.208$; $\rho = 1000$ kg/m³

Phantom section: Flat Section

Ambient temperature: 22.3°C; Liquid temperature: 21.4°C

DASY5 Configuration:

- Probe: EX3DV4 - SN7509; ConvF(8.34, 8.34, 8.34) @ 1730 MHz; Calibrated: 2020/3/25
- Sensor-Surface: 2mm (Mechanical Surface Detection)
- Electronics: DAE4 Sn558; Calibrated: 2019/10/11
- Phantom: SAM
- DASY52 52.10.4(1527); SEMCAD X 14.6.14(7483)

Area Scan (71x151x1): Interpolated grid: dx=15 mm, dy=15 mm

Maximum value of SAR (interpolated) = 0.175 W/kg

Zoom Scan (5x5x7)/Cube 0: Measurement grid: dx=8mm, dy=8mm, dz=5mm

Reference Value = 7.440 V/m; Power Drift = 0.14 dB

Peak SAR (extrapolated) = 0.174 W/kg

SAR(1 g) = 0.151 W/kg; SAR(10 g) = 0.121 W/kg

Smallest distance from peaks to all points 3 dB below = 23.1 mm

Ratio of SAR at M2 to SAR at M1 = 82.6%

Maximum value of SAR (measured) = 0.161 W/kg

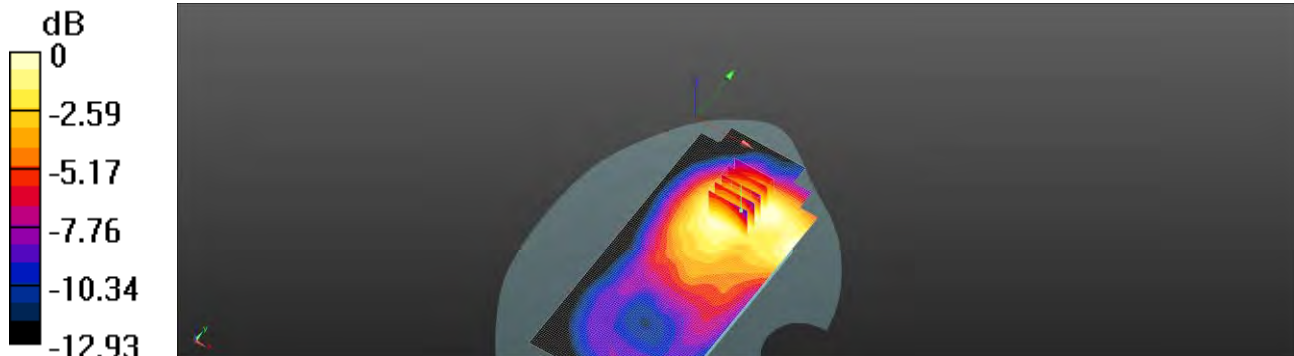

0 dB = 0.161 W/kg = -7.93 dBW/kg

Unless otherwise stated the results shown in this test report refer only to the sample(s) tested and such sample(s) are retained for 90 days only.

除非另有說明，此報告結果僅對測試之樣品負責，同時此樣品僅保留90天。本報告未經本公司書面許可，不可部份複製。

This document is issued by the Company subject to its General Conditions of Service printed overleaf, available on request or accessible at <http://www.sgs.com.tw/Terms-and-Conditions> and for electronic format documents, subject to Terms and Conditions for Electronic Documents at <http://www.sgs.com.tw/Terms-and-Conditions>. Attention is drawn to the limitation of liability, indemnification and jurisdiction issues defined therein. Any holder of this document is advised that information contained hereon reflects the Company's findings at the time of its intervention only and within the limits of Client's instructions, if any. The Company's sole responsibility is to its Client and this document does not exonerate parties to a transaction from exercising all their rights and obligations under the transaction documents. This document cannot be reproduced except in full, without prior written approval of the Company. Any unauthorized alteration, forgery or falsification of the content or appearance of this document is unlawful and offenders may be prosecuted to the fullest extent of the law.

Date: 2020/7/14

Report No. :ES/2020/30005

5G NR n71 (20MHz)_Body worn_Front side_CH 167300_QPSK_1-1_15mm_LAT

Communication System: 5G NR(20MHz,QPSK,15kHz); Frequency: 673 MHz; Duty cycle= 1:1

Medium parameters used: $f = 673 \text{ MHz}$; $\sigma = 0.849 \text{ S/m}$; $\epsilon_r = 43.493$; $\rho = 1000 \text{ kg/m}^3$

Phantom section: Flat Section

Ambient temperature: 21.8°C; Liquid temperature: 22.3°C

DASY5 Configuration:

- Probe: EX3DV4 - SN3770; ConvF(9.84, 9.84, 9.84) @ 673 MHz; Calibrated: 2020/5/27
- Sensor-Surface: 2mm (Mechanical Surface Detection)
- Electronics: DAE4 Sn877; Calibrated: 2020/3/17
- Phantom: SAM
- DASY52 52.10.4(1527); SEMCAD X 14.6.14(7483)

Area Scan (71x141x1): Interpolated grid: dx=15 mm, dy=15 mm

Maximum value of SAR (interpolated) = 0.0235 W/kg

Zoom Scan (5x5x7)/Cube 0: Measurement grid: dx=8mm, dy=8mm, dz=5mm

Reference Value = 2.562 V/m; Power Drift = -0.16 dB

Peak SAR (extrapolated) = 0.0240 W/kg

SAR(1 g) = 0.022 W/kg; SAR(10 g) = 0.019 W/kg

Smallest distance from peaks to all points 3 dB below = 7.9 mm

Ratio of SAR at M2 to SAR at M1 = 93.5%

Maximum value of SAR (measured) = 0.0235 W/kg

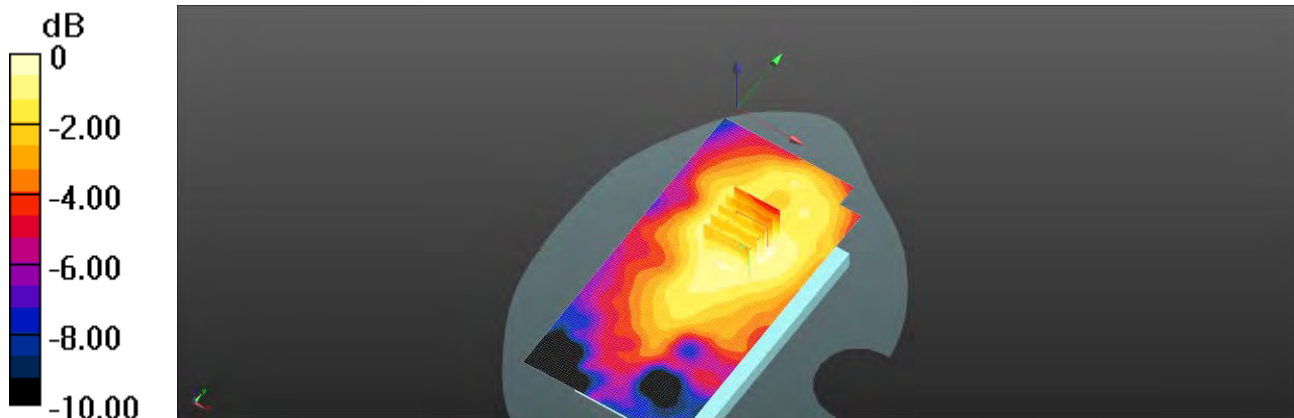

0 dB = 0.0235 W/kg = -16.29 dBW/kg

Unless otherwise stated the results shown in this test report refer only to the sample(s) tested and such sample(s) are retained for 90 days only.

除非另有說明，此報告結果僅對測試之樣品負責，同時此樣品僅保留90天。本報告未經本公司書面許可，不可部份複製。

This document is issued by the Company subject to its General Conditions of Service printed overleaf, available on request or accessible at <http://www.sgs.com.tw/Terms-and-Conditions> and for electronic format documents, subject to Terms and Conditions for Electronic Documents at <http://www.sgs.com.tw/Terms-and-Conditions>. Attention is drawn to the limitation of liability, indemnification and jurisdiction issues defined therein. Any holder of this document is advised that information contained hereon reflects the Company's findings at the time of its intervention only and within the limits of Client's instructions, if any. The Company's sole responsibility is to its Client and this document does not exonerate parties to a transaction from exercising all their rights and obligations under the transaction documents. This document cannot be reproduced except in full, without prior written approval of the Company. Any unauthorized alteration, forgery or falsification of the content or appearance of this document is unlawful and offenders may be prosecuted to the fullest extent of the law.

Date: 2020/7/30

Report No. :ES/2020/30005

**LTE Band 26 (15MHz)_Product specific 10g-SAR_Front side_CH
26765_QPSK_1-0_0mm_UAT**

Communication System: LTE; Frequency: 821.5 MHz; Duty cycle= 1:1

Medium parameters used: $f = 821.5 \text{ MHz}$; $\sigma = 0.887 \text{ S/m}$; $\epsilon_r = 42.382$; $\rho = 1000 \text{ kg/m}^3$

Phantom section: Flat Section

Ambient temperature: 22.3°C; Liquid temperature: 22.1°C

DASY5 Configuration:

- Probe: EX3DV4 - SN3770; ConvF(9.5, 9.5, 9.5) @ 821.5 MHz; Calibrated: 2020/05/27
- Sensor-Surface: 2mm (Mechanical Surface Detection)
- Electronics: DAE4 Sn558; Calibrated: 2019/10/11
- Phantom: SAM
- DASY52 52.10.4(1527); SEMCAD X 14.6.14(7483)

Area Scan (71x141x1): Interpolated grid: dx=15 mm, dy=15 mm

Maximum value of SAR (interpolated) = 2.28 W/kg

Zoom Scan (5x5x7)/Cube 0: Measurement grid: dx=8mm, dy=8mm, dz=5mm

Reference Value = 12.72 V/m; Power Drift = 0.03 dB

Peak SAR (extrapolated) = 2.99 W/kg

SAR(1 g) = 1.42 W/kg; SAR(10 g) = 0.716 W/kg

Smallest distance from peaks to all points 3 dB below = 9.8 mm

Ratio of SAR at M2 to SAR at M1 = 47.2%

Maximum value of SAR (measured) = 2.22 W/kg

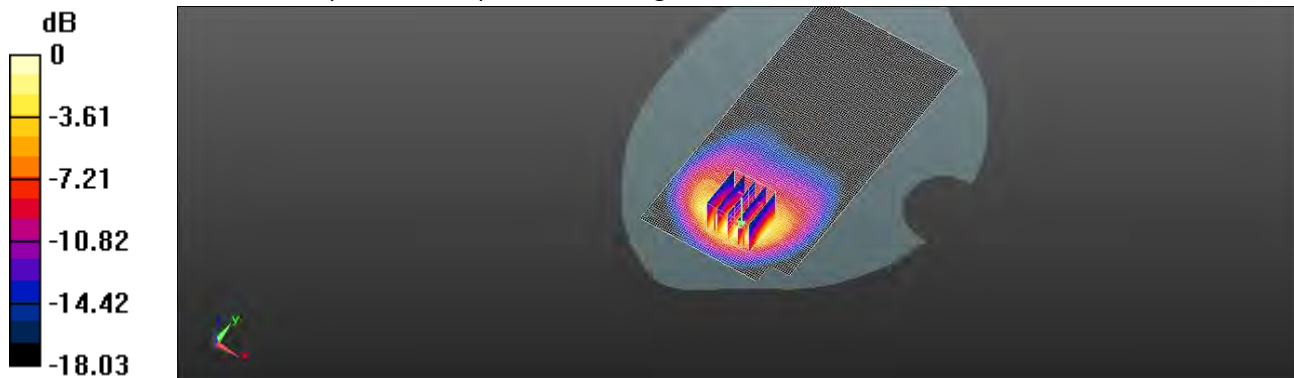

0 dB = 2.22 W/kg = 3.46 dBW/kg

Unless otherwise stated the results shown in this test report refer only to the sample(s) tested and such sample(s) are retained for 90 days only.

除非另有說明，此報告結果僅對測試之樣品負責，同時此樣品僅保留90天。本報告未經本公司書面許可，不可部份複製。

This document is issued by the Company subject to its General Conditions of Service printed overleaf, available on request or accessible at <http://www.sgs.com.tw/Terms-and-Conditions> and for electronic format documents, subject to Terms and Conditions for Electronic Documents at <http://www.sgs.com.tw/Terms-and-Conditions>. Attention is drawn to the limitation of liability, indemnification and jurisdiction issues defined therein. Any holder of this document is advised that information contained hereon reflects the Company's findings at the time of its intervention only and within the limits of Client's instructions, if any. The Company's sole responsibility is to its Client and this document does not exonerate parties to a transaction from exercising all their rights and obligations under the transaction documents. This document cannot be reproduced except in full, without prior written approval of the Company. Any unauthorized alteration, forgery or falsification of the content or appearance of this document is unlawful and offenders may be prosecuted to the fullest extent of the law.

Date: 2020/8/1

Report No. :ES/2020/30005

**LTE Band 2 (20MHz)_Product specific 10g-SAR_Bottom side_CH
19100_QPSK_1-0_0mm_LAT**

Communication System: LTE; Frequency: 1900 MHz; Duty cycle= 1:1

Medium parameters used: $f = 1900$ MHz; $\sigma = 1.401$ S/m; $\epsilon_r = 39.533$; $\rho = 1000$ kg/m³

Phantom section: Flat Section

Ambient temperature: 22.4°C; Liquid temperature: 22.6°C

DASY5 Configuration:

- Probe: EX3DV4 - SN3770; ConvF(8.03, 8.03, 8.03) @ 1900 MHz; Calibrated: 2020/05/27
- Sensor-Surface: 2mm (Mechanical Surface Detection)
- Electronics: DAE4 Sn558; Calibrated: 2019/10/11
- Phantom: SAM
- DASY52 52.10.4(1527); SEMCAD X 14.6.14(7483)

Area Scan (61x101x1): Interpolated grid: dx=15 mm, dy=15 mm

Maximum value of SAR (interpolated) = 2.67 W/kg

Zoom Scan (5x5x7)/Cube 0: Measurement grid: dx=8mm, dy=8mm, dz=5mm

Reference Value = 47.83 V/m; Power Drift = 0.14 dB

Peak SAR (extrapolated) = 3.76 W/kg

SAR(1 g) = 1.91 W/kg; SAR(10 g) = 0.887 W/kg

Smallest distance from peaks to all points 3 dB below = 8.5 mm

Ratio of SAR at M2 to SAR at M1 = 31.8%

Maximum value of SAR (measured) = 2.74 W/kg

Zoom Scan (5x5x7)/Cube 1: Measurement grid: dx=8mm, dy=8mm, dz=5mm

Reference Value = 47.83 V/m; Power Drift = 0.14 dB

Peak SAR (extrapolated) = 2.22 W/kg

SAR(1 g) = 1.56 W/kg; SAR(10 g) = 0.997 W/kg

Smallest distance from peaks to all points 3 dB below = 9.4 mm

Ratio of SAR at M2 to SAR at M1 = 56.1%

Maximum value of SAR (measured) = 1.75 W/kg

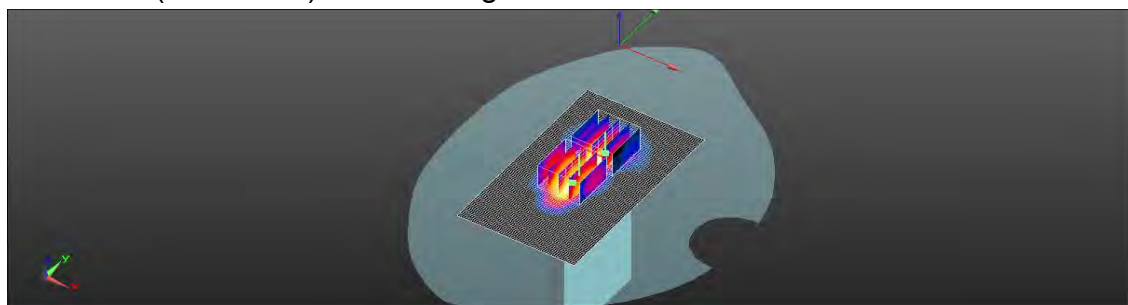
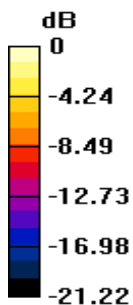

0 dB = 1.75 W/kg = 2.43 dBW/kg

Unless otherwise stated the results shown in this test report refer only to the sample(s) tested and such sample(s) are retained for 90 days only.

除非另有說明，此報告結果僅對測試之樣品負責，同時此樣品僅保留90天。本報告未經本公司書面許可，不可部份複製。

This document is issued by the Company subject to its General Conditions of Service printed overleaf, available on request or accessible at <http://www.sgs.com.tw/Terms-and-Conditions> and for electronic format documents, subject to Terms and Conditions for Electronic Documents at <http://www.sgs.com.tw/Terms-and-Conditions>. Attention is drawn to the limitation of liability, indemnification and jurisdiction issues defined therein. Any holder of this document is advised that information contained hereon reflects the Company's findings at the time of its intervention only and within the limits of Client's instructions, if any. The Company's sole responsibility is to its Client and this document does not exonerate parties to a transaction from exercising all their rights and obligations under the transaction documents. This document cannot be reproduced except in full, without prior written approval of the Company. Any unauthorized alteration, forgery or falsification of the content or appearance of this document is unlawful and offenders may be prosecuted to the fullest extent of the law.

Date: 2020/8/3

Report No. :ES/2020/30005

**LTE Band 7 (20MHz)_Product specific 10g-SAR_Bottom side_CH
21350_QPSK_1-99_0mm_LAT**

Communication System: LTE; Frequency: 2560 MHz; Duty cycle= 1:1

Medium parameters used: $f = 2560$ MHz; $\sigma = 1.905$ S/m; $\epsilon_r = 38.355$; $\rho = 1000$ kg/m³

Phantom section: Flat Section

Ambient temperature: 22.2°C; Liquid temperature: 22.5°C

DASY5 Configuration:

- Probe: EX3DV4 - SN3770; ConvF(7.21, 7.21, 7.21) @ 2560 MHz; Calibrated: 2020/05/27
- Sensor-Surface: 2mm (Mechanical Surface Detection)
- Electronics: DAE4 Sn558; Calibrated: 2019/10/11
- Phantom: SAM
- DASY52 52.10.4(1527); SEMCAD X 14.6.14(7483)

Area Scan (61x101x1): Interpolated grid: dx=12 mm, dy=12 mm

Maximum value of SAR (interpolated) = 4.64 W/kg

Zoom Scan (7x7x7)/Cube 0: Measurement grid: dx=5mm, dy=5mm, dz=5mm

Reference Value = 28.11 V/m; Power Drift = 0.16 dB

Peak SAR (extrapolated) = 10.2 W/kg

SAR(1 g) = 3.9 W/kg; SAR(10 g) = 1.6 W/kg

Smallest distance from peaks to all points 3 dB below = 6.1 mm

Ratio of SAR at M2 to SAR at M1 = 31.5%

Maximum value of SAR (measured) = 5.99 W/kg

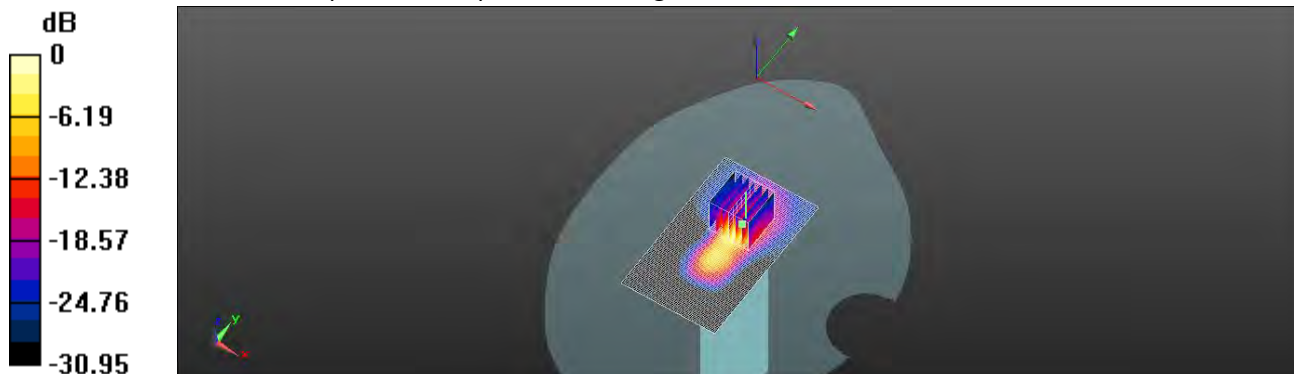

0 dB = 5.99 W/kg = 7.77 dBW/kg

Unless otherwise stated the results shown in this test report refer only to the sample(s) tested and such sample(s) are retained for 90 days only.

除非另有說明，此報告結果僅對測試之樣品負責，同時此樣品僅保留90天。本報告未經本公司書面許可，不可部份複製。

This document is issued by the Company subject to its General Conditions of Service printed overleaf, available on request or accessible at <http://www.sgs.com.tw/Terms-and-Conditions> and for electronic format documents, subject to Terms and Conditions for Electronic Documents at <http://www.sgs.com.tw/Terms-and-Conditions>. Attention is drawn to the limitation of liability, indemnification and jurisdiction issues defined therein. Any holder of this document is advised that information contained hereon reflects the Company's findings at the time of its intervention only and within the limits of Client's instructions, if any. The Company's sole responsibility is to its Client and this document does not exonerate parties to a transaction from exercising all their rights and obligations under the transaction documents. This document cannot be reproduced except in full, without prior written approval of the Company. Any unauthorized alteration, forgery or falsification of the content or appearance of this document is unlawful and offenders may be prosecuted to the fullest extent of the law.

Date: 2020/7/30

Report No. :ES/2020/30005

**LTE Band 26 (15MHz)_Product specific 10g-SAR_Front_CH
26765_QPSK_1-0_0mm_LAT**

Communication System: LTE; Frequency: 821.5 MHz; Duty cycle= 1:1

Medium parameters used: $f = 821.5 \text{ MHz}$; $\sigma = 0.887 \text{ S/m}$; $\epsilon_r = 42.382$; $\rho = 1000 \text{ kg/m}^3$

Phantom section: Flat Section

Ambient temperature: 22.3°C; Liquid temperature: 22.1°C

DASY5 Configuration:

- Probe: EX3DV4 - SN3770; ConvF(9.5, 9.5, 9.5) @ 821.5 MHz; Calibrated: 2020/05/27
- Sensor-Surface: 2mm (Mechanical Surface Detection)
- Electronics: DAE4 Sn558; Calibrated: 2019/10/11
- Phantom: SAM
- DASY52 52.10.4(1527); SEMCAD X 14.6.14(7483)

Area Scan (71x141x1): Interpolated grid: dx=15 mm, dy=15 mm

Maximum value of SAR (interpolated) = 3.73 W/kg

Zoom Scan (5x5x7)/Cube 0: Measurement grid: dx=8mm, dy=8mm, dz=5mm

Reference Value = 6.971 V/m; Power Drift = -0.03 dB

Peak SAR (extrapolated) = 5.00 W/kg

SAR(1 g) = 2.37 W/kg; SAR(10 g) = 1.22 W/kg

Smallest distance from peaks to all points 3 dB below = 9.4 mm

Ratio of SAR at M2 to SAR at M1 = 47.6%

Maximum value of SAR (measured) = 3.74 W/kg

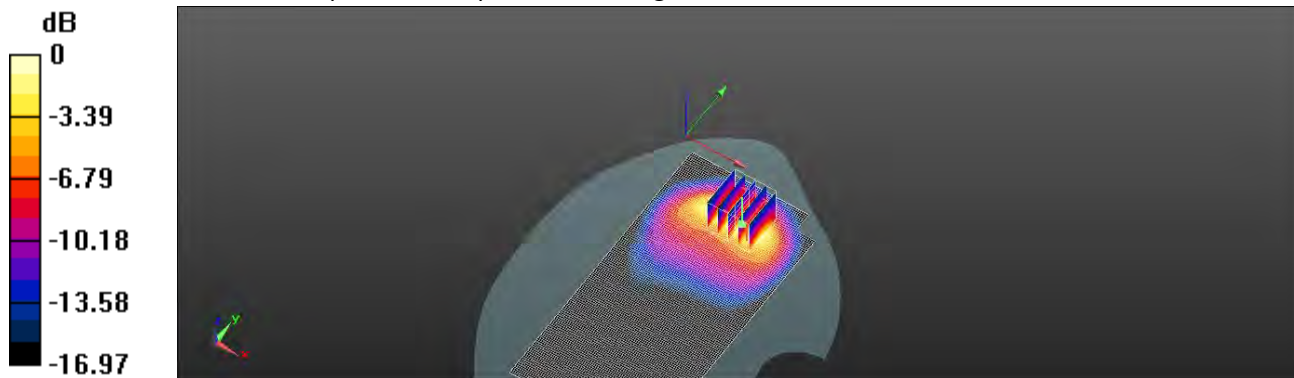

0 dB = 3.74 W/kg = 5.73 dBW/kg

Unless otherwise stated the results shown in this test report refer only to the sample(s) tested and such sample(s) are retained for 90 days only.

除非另有說明，此報告結果僅對測試之樣品負責，同時此樣品僅保留90天。本報告未經本公司書面許可，不可部份複製。

This document is issued by the Company subject to its General Conditions of Service printed overleaf, available on request or accessible at <http://www.sgs.com.tw/Terms-and-Conditions> and for electronic format documents, subject to Terms and Conditions for Electronic Documents at <http://www.sgs.com.tw/Terms-and-Conditions>. Attention is drawn to the limitation of liability, indemnification and jurisdiction issues defined therein. Any holder of this document is advised that information contained hereon reflects the Company's findings at the time of its intervention only and within the limits of Client's instructions, if any. The Company's sole responsibility is to its Client and this document does not exonerate parties to a transaction from exercising all their rights and obligations under the transaction documents. This document cannot be reproduced except in full, without prior written approval of the Company. Any unauthorized alteration, forgery or falsification of the content or appearance of this document is unlawful and offenders may be prosecuted to the fullest extent of the law.

Date: 2020/8/3

Report No. :ES/2020/30005

**LTE Band 41 (20MHz)_Product specific 10g-SAR_Bottom side_CH
41490_QPSK_1-0_0mm_LAT**

Communication System: LTE; Frequency: 2680 MHz; Duty cycle= 1:1.59956

Medium parameters used: $f = 2680$ MHz; $\sigma = 2.061$ S/m; $\epsilon_r = 38.170$; $\rho = 1000$ kg/m³

Phantom section: Flat Section

Ambient temperature: 22.2°C; Liquid temperature: 22.5°C

DASY5 Configuration:

- Probe: EX3DV4 - SN3770; ConvF(7.21, 7.21, 7.21) @ 2680 MHz; Calibrated: 2020/05/27
- Sensor-Surface: 2mm (Mechanical Surface Detection)
- Electronics: DAE4 Sn558; Calibrated: 2019/10/11
- Phantom: SAM
- DASY52 52.10.4(1527); SEMCAD X 14.6.14(7483)

Area Scan (61x101x1): Interpolated grid: dx=12 mm, dy=12 mm

Maximum value of SAR (interpolated) = 5.61 W/kg

Zoom Scan (7x7x7)/Cube 0: Measurement grid: dx=5mm, dy=5mm, dz=5mm

Reference Value = 19.75 V/m; Power Drift = 0.11 dB

Peak SAR (extrapolated) = 13.1 W/kg

SAR(1 g) = 3.79 W/kg; SAR(10 g) = 1.23 W/kg

Smallest distance from peaks to all points 3 dB below = 6.9 mm

Ratio of SAR at M2 to SAR at M1 = 69.4%

Maximum value of SAR (measured) = 7.94 W/kg

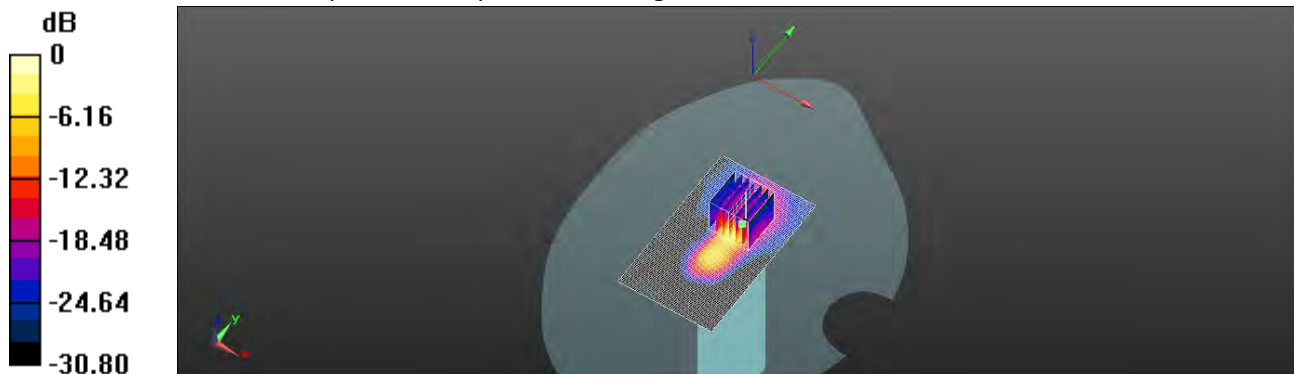

0 dB = 7.94 W/kg = 9.00 dBW/kg

Unless otherwise stated the results shown in this test report refer only to the sample(s) tested and such sample(s) are retained for 90 days only.

除非另有說明，此報告結果僅對測試之樣品負責，同時此樣品僅保留90天。本報告未經本公司書面許可，不可部份複製。

This document is issued by the Company subject to its General Conditions of Service printed overleaf, available on request or accessible at <http://www.sgs.com.tw/Terms-and-Conditions> and for electronic format documents, subject to Terms and Conditions for Electronic Documents at <http://www.sgs.com.tw/Terms-and-Conditions>. Attention is drawn to the limitation of liability, indemnification and jurisdiction issues defined therein. Any holder of this document is advised that information contained hereon reflects the Company's findings at the time of its intervention only and within the limits of Client's instructions, if any. The Company's sole responsibility is to its Client and this document does not exonerate parties to a transaction from exercising all their rights and obligations under the transaction documents. This document cannot be reproduced except in full, without prior written approval of the Company. Any unauthorized alteration, forgery or falsification of the content or appearance of this document is unlawful and offenders may be prosecuted to the fullest extent of the law.

Date: 2020/8/3

Report No. :ES/2020/30005

**5G NR n41 (100MHz)_Product specific 10g-SAR_Back side_CH
513900_QPSK_1-137_0mm_UAT**

Communication System: 5G NR(100MHz,QPSK,30k); Frequency: 2569.5 MHz; Duty cycle= 1:1
Medium parameters used: $f = 2569.5 \text{ MHz}$; $\sigma = 1.909 \text{ S/m}$; $\epsilon_r = 38.287$; $\rho = 1000 \text{ kg/m}^3$
Phantom section: Flat Section
Ambient temperature: 22.2°C; Liquid temperature: 22.5°C

DASY5 Configuration:

- Probe: EX3DV4 - SN3770; ConvF(7.21, 7.21, 7.21) @ 2569.5 MHz; Calibrated: 2020/05/27
- Sensor-Surface: 2mm (Mechanical Surface Detection)
- Electronics: DAE4 Sn558; Calibrated: 2019/10/11
- Phantom: SAM
- DASY52 52.10.4(1527); SEMCAD X 14.6.14(7483)

Area Scan (81x181x1): Interpolated grid: dx=12 mm, dy=12 mm

Maximum value of SAR (interpolated) = 10.2 W/kg

Zoom Scan (7x7x7)/Cube 0: Measurement grid: dx=5mm, dy=5mm, dz=5mm

Reference Value = 10.38 V/m; Power Drift = 0.14 dB

Peak SAR (extrapolated) = 19.3 W/kg

SAR(1 g) = 5.35 W/kg; SAR(10 g) = 1.66 W/kg

Smallest distance from peaks to all points 3 dB below = 6.5 mm

Ratio of SAR at M2 to SAR at M1 = 40.4%

Maximum value of SAR (measured) = 10.0 W/kg

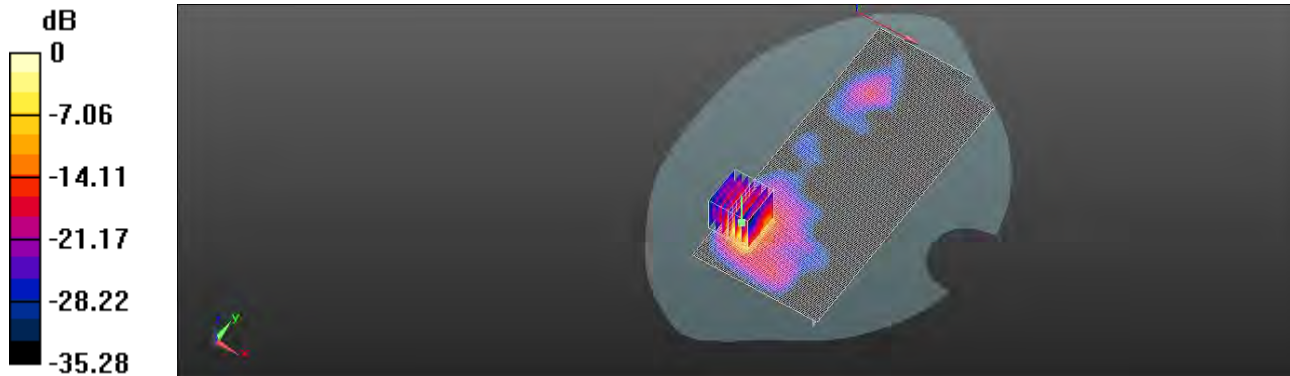

0 dB = 10.0 W/kg = 10.00 dBW/kg

Unless otherwise stated the results shown in this test report refer only to the sample(s) tested and such sample(s) are retained for 90 days only.

除非另有說明，此報告結果僅對測試之樣品負責，同時此樣品僅保留90天。本報告未經本公司書面許可，不可部份複製。

This document is issued by the Company subject to its General Conditions of Service printed overleaf, available on request or accessible at <http://www.sgs.com.tw/Terms-and-Conditions> and for electronic format documents, subject to Terms and Conditions for Electronic Documents at <http://www.sgs.com.tw/Terms-and-Conditions>. Attention is drawn to the limitation of liability, indemnification and jurisdiction issues defined therein. Any holder of this document is advised that information contained hereon reflects the Company's findings at the time of its intervention only and within the limits of Client's instructions, if any. The Company's sole responsibility is to its Client and this document does not exonerate parties to a transaction from exercising all their rights and obligations under the transaction documents. This document cannot be reproduced except in full, without prior written approval of the Company. Any unauthorized alteration, forgery or falsification of the content or appearance of this document is unlawful and offenders may be prosecuted to the fullest extent of the law.

Date: 2020/7/17

Report No. :ES/2020/30005

**5G NR n2 (20MHz)_Product specific 10g-SAR_Bottom side_CH
376000_QPSK_1-53_0mm_LAT**

Communication System: 5G NR(20MHz, QPSK, 15kHz); Frequency: 1880 MHz; Duty cycle= 1:1

Medium parameters used: $f = 1880$ MHz; $\sigma = 1.394$ S/m; $\epsilon_r = 39.878$; $\rho = 1000$ kg/m³

Phantom section: Flat Section

Ambient temperature: 22.7°C; Liquid temperature: 21.6°C

DASY5 Configuration:

- Probe: EX3DV4 - SN3770; ConvF(8.03, 8.03, 8.03) @ 1880 MHz; Calibrated: 2020/05/27
- Sensor-Surface: 2mm (Mechanical Surface Detection)
- Electronics: DAE4 Sn877; Calibrated: 2020/03/17
- Phantom: SAM
- DASY52 52.10.4(1527); SEMCAD X 14.6.14(7483)

Area Scan (51x81x1): Interpolated grid: dx=15 mm, dy=15 mm

Maximum value of SAR (interpolated) = 7.06 W/kg

Zoom Scan (5x5x7)/Cube 0: Measurement grid: dx=8mm, dy=8mm, dz=5mm

Reference Value = 33.53 V/m; Power Drift = -0.04 dB

Peak SAR (extrapolated) = 7.52 W/kg

SAR(1 g) = 3.8 W/kg; SAR(10 g) = 1.78 W/kg

Smallest distance from peaks to all points 3 dB below = 8.8 mm

Ratio of SAR at M2 to SAR at M1 = 38.5%

Maximum value of SAR (measured) = 5.20 W/kg

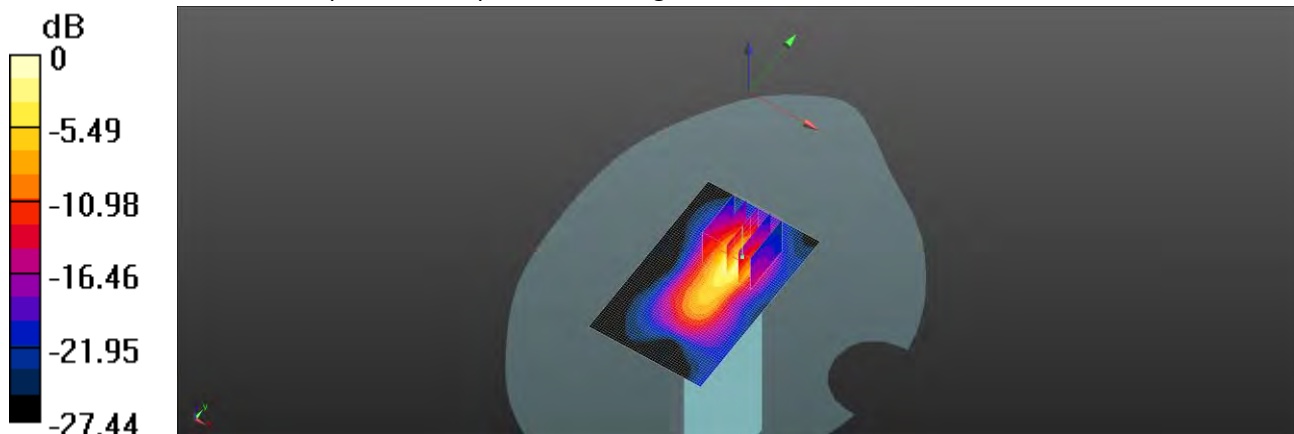

0 dB = 5.20 W/kg = 7.16 dBW/kg

Unless otherwise stated the results shown in this test report refer only to the sample(s) tested and such sample(s) are retained for 90 days only.

除非另有說明，此報告結果僅對測試之樣品負責，同時此樣品僅保留90天。本報告未經本公司書面許可，不可部份複製。

This document is issued by the Company subject to its General Conditions of Service printed overleaf, available on request or accessible at <http://www.sgs.com.tw/Terms-and-Conditions> and for electronic format documents, subject to Terms and Conditions for Electronic Documents at <http://www.sgs.com.tw/Terms-and-Conditions>. Attention is drawn to the limitation of liability, indemnification and jurisdiction issues defined therein. Any holder of this document is advised that information contained hereon reflects the Company's findings at the time of its intervention only and within the limits of Client's instructions, if any. The Company's sole responsibility is to its Client and this document does not exonerate parties to a transaction from exercising all their rights and obligations under the transaction documents. This document cannot be reproduced except in full, without prior written approval of the Company. Any unauthorized alteration, forgery or falsification of the content or appearance of this document is unlawful and offenders may be prosecuted to the fullest extent of the law.

Date: 2020/7/30

Report No. :ES/2020/30005

**5G NR n5 (20MHz)_Product specific 10g-SAR_Front side_CH
167300_QPSK_1-53_0mm_LAT**

Communication System: 5G NR(20MHz, QPSK, 15kHz); Frequency: 836.5 MHz; Duty cycle= 1:1

Medium parameters used: $f = 836.5$ MHz; $\sigma = 0.898$ S/m; $\epsilon_r = 42.008$; $\rho = 1000$ kg/m³

Phantom section: Flat Section

Ambient temperature: 22.3°C; Liquid temperature: 22.1°C

DASY5 Configuration:

- Probe: EX3DV4 - SN3770; ConvF(9.5, 9.5, 9.5) @ 836.5 MHz; Calibrated: 2020/05/27
- Sensor-Surface: 2mm (Mechanical Surface Detection)
- Electronics: DAE4 Sn558; Calibrated: 2019/10/11
- Phantom: SAM
- DASY52 52.10.4(1527); SEMCAD X 14.6.14(7483)

Area Scan (71x141x1): Interpolated grid: dx=15 mm, dy=15 mm

Maximum value of SAR (interpolated) = 0.646 W/kg

Zoom Scan (5x5x7)/Cube 0: Measurement grid: dx=8mm, dy=8mm, dz=5mm

Reference Value = 2.183 V/m; Power Drift = 0.11 dB

Peak SAR (extrapolated) = 0.860 W/kg

SAR(1 g) = 0.395 W/kg; SAR(10 g) = 0.196 W/kg

Smallest distance from peaks to all points 3 dB below = 8.6 mm

Ratio of SAR at M2 to SAR at M1 = 45.8%

Maximum value of SAR (measured) = 0.637 W/kg

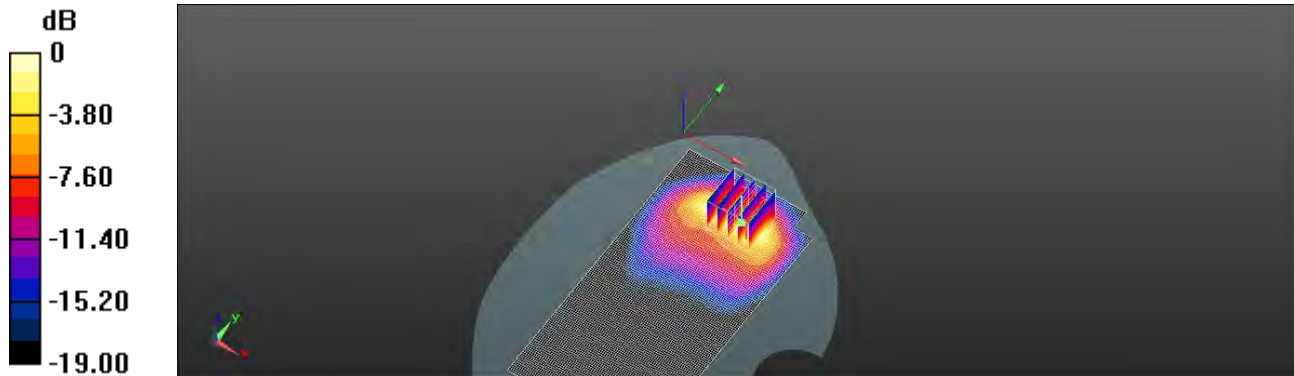

0 dB = 0.637 W/kg = -1.96 dBW/kg

Unless otherwise stated the results shown in this test report refer only to the sample(s) tested and such sample(s) are retained for 90 days only.

除非另有說明，此報告結果僅對測試之樣品負責，同時此樣品僅保留90天。本報告未經本公司書面許可，不可部份複製。

This document is issued by the Company subject to its General Conditions of Service printed overleaf, available on request or accessible at <http://www.sgs.com.tw/Terms-and-Conditions> and for electronic format documents, subject to Terms and Conditions for Electronic Documents at <http://www.sgs.com.tw/Terms-and-Conditions>. Attention is drawn to the limitation of liability, indemnification and jurisdiction issues defined therein. Any holder of this document is advised that information contained hereon reflects the Company's findings at the time of its intervention only and within the limits of Client's instructions, if any. The Company's sole responsibility is to its Client and this document does not exonerate parties to a transaction from exercising all their rights and obligations under the transaction documents. This document cannot be reproduced except in full, without prior written approval of the Company. Any unauthorized alteration, forgery or falsification of the content or appearance of this document is unlawful and offenders may be prosecuted to the fullest extent of the law.

Date: 2020/7/19

Report No. :ES/2020/30005

**5G NR n41 (100MHz)_Product specific 10g-SAR_Back side_CH
509202_QPSK_1-137_0mm_LAT**

Communication System: 5G NR(100MHz,QPSK,30k); Frequency: 2546.01 MHz; Duty cycle= 1:1

Medium parameters used: $f = 2546.01$ MHz; $\sigma = 1.879$ S/m; $\epsilon_r = 38.673$; $\rho = 1000$ kg/m³

Phantom section: Flat Section

Ambient temperature: 21.7°C; Liquid temperature: 22.3°C

DASY5 Configuration:

- Probe: EX3DV4 - SN3770; ConvF(7.21, 7.21, 7.21) @ 2546.01 MHz; Calibrated: 2020/05/27
- Sensor-Surface: 2mm (Mechanical Surface Detection)
- Electronics: DAE4 Sn877; Calibrated: 2020/03/17
- Phantom: SAM
- DASY52 52.10.4(1527); SEMCAD X 14.6.14(7483)

Area Scan (81x181x1): Interpolated grid: dx=12 mm, dy=12 mm

Maximum value of SAR (interpolated) = 3.16 W/kg

Zoom Scan (7x7x7)/Cube 0: Measurement grid: dx=5mm, dy=5mm, dz=5mm

Reference Value = 4.283 V/m; Power Drift = 0.17 dB

Peak SAR (extrapolated) = 5.35 W/kg

SAR(1 g) = 3.03 W/kg; SAR(10 g) = 1.73 W/kg

Smallest distance from peaks to all points 3 dB below = 7.7 mm

Ratio of SAR at M2 to SAR at M1 = 46.7%

Maximum value of SAR (measured) = 3.22 W/kg

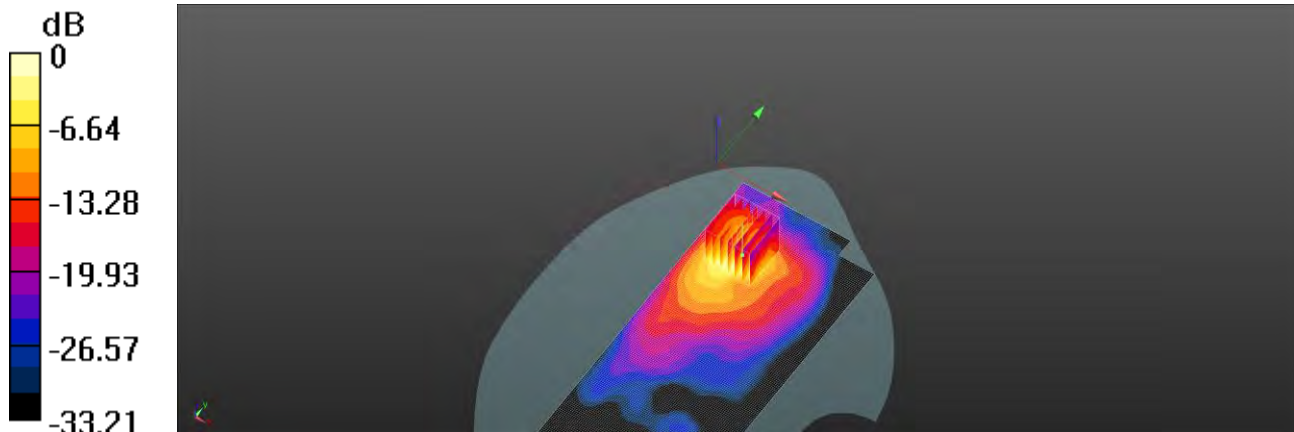

0 dB = 3.22 W/kg = 5.08 dBW/kg

Unless otherwise stated the results shown in this test report refer only to the sample(s) tested and such sample(s) are retained for 90 days only.

除非另有說明，此報告結果僅對測試之樣品負責，同時此樣品僅保留90天。本報告未經本公司書面許可，不可部份複製。

This document is issued by the Company subject to its General Conditions of Service printed overleaf, available on request or accessible at <http://www.sgs.com.tw/Terms-and-Conditions> and for electronic format documents, subject to Terms and Conditions for Electronic Documents at <http://www.sgs.com.tw/Terms-and-Conditions>. Attention is drawn to the limitation of liability, indemnification and jurisdiction issues defined therein. Any holder of this document is advised that information contained hereon reflects the Company's findings at the time of its intervention only and within the limits of Client's instructions, if any. The Company's sole responsibility is to its Client and this document does not exonerate parties to a transaction from exercising all their rights and obligations under the transaction documents. This document cannot be reproduced except in full, without prior written approval of the Company. Any unauthorized alteration, forgery or falsification of the content or appearance of this document is unlawful and offenders may be prosecuted to the fullest extent of the law.

Date: 2020/7/16

Report No. :ES/2020/30005

**5G NR n66 (40MHz)_Product specific 10g-SAR_Bottom side_CH
346000_QPSK_1-1_0mm_LAT**

Communication System: 5G NR(20MHz, QPSK, 15kHz); Frequency: 1730 MHz; Duty cycle= 1:1

Medium parameters used: $f = 1730 \text{ MHz}$; $\sigma = 1.313 \text{ S/m}$; $\epsilon_r = 39.335$; $\rho = 1000 \text{ kg/m}^3$

Phantom section: Flat Section

Ambient temperature: 22.3°C; Liquid temperature: 21.4°C

DASY5 Configuration:

- Probe: EX3DV4 - SN3770; ConvF(8.36, 8.36, 8.36) @ 1730 MHz; Calibrated: 2020/5/27
- Sensor-Surface: 2mm (Mechanical Surface Detection)
- Electronics: DAE4 Sn877; Calibrated: 2020/3/17
- Phantom: SAM
- DASY52 52.10.4(1527); SEMCAD X 14.6.14(7483)

Area Scan (51x81x1): Interpolated grid: $dx=15 \text{ mm}$, $dy=15 \text{ mm}$

Maximum value of SAR (interpolated) = 4.03 W/kg

Zoom Scan (5x5x7)/Cube 0: Measurement grid: $dx=8\text{mm}$, $dy=8\text{mm}$, $dz=5\text{mm}$

Reference Value = 48.82 V/m; Power Drift = 0.15 dB

Peak SAR (extrapolated) = 5.57 W/kg

SAR(1 g) = 3.16 W/kg; SAR(10 g) = 1.83 W/kg

Smallest distance from peaks to all points 3 dB below = 9.2 mm

Ratio of SAR at M2 to SAR at M1 = 46.2%

Maximum value of SAR (measured) = 1.78 W/kg

Zoom Scan (5x5x7)/Cube 1: Measurement grid: $dx=8\text{mm}$, $dy=8\text{mm}$, $dz=5\text{mm}$

Reference Value = 48.82 V/m; Power Drift = 0.15 dB

Peak SAR (extrapolated) = 9.12 W/kg

SAR(1 g) = 3.41 W/kg; SAR(10 g) = 1.44 W/kg

Smallest distance from peaks to all points 3 dB below = 9.7 mm

Ratio of SAR at M2 to SAR at M1 = 38.2%

Maximum value of SAR (measured) = 5.85 W/kg

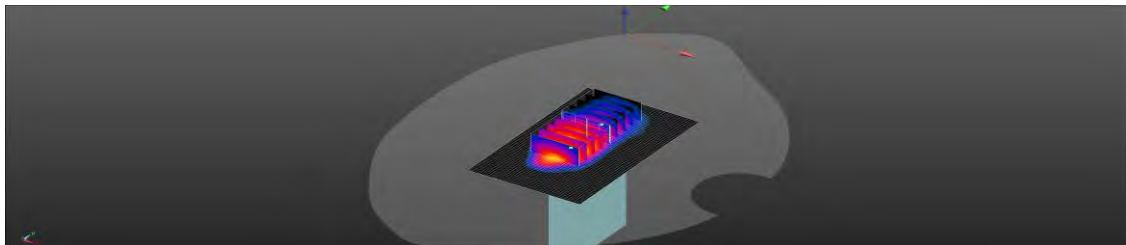
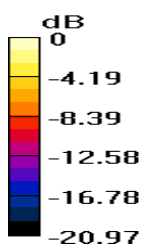

0 dB = 5.85 W/kg = 7.67 dBW/kg

Unless otherwise stated the results shown in this test report refer only to the sample(s) tested and such sample(s) are retained for 90 days only.

除非另有說明，此報告結果僅對測試之樣品負責，同時此樣品僅保留90天。本報告未經本公司書面許可，不可部份複製。

This document is issued by the Company subject to its General Conditions of Service printed overleaf, available on request or accessible at <http://www.sgs.com.tw/Terms-and-Conditions> and for electronic format documents, subject to Terms and Conditions for Electronic Documents at <http://www.sgs.com.tw/Terms-and-Conditions>. Attention is drawn to the limitation of liability, indemnification and jurisdiction issues defined therein. Any holder of this document is advised that information contained hereon reflects the Company's findings at the time of its intervention only and within the limits of Client's instructions, if any. The Company's sole responsibility is to its Client and this document does not exonerate parties to a transaction from exercising all their rights and obligations under the transaction documents. This document cannot be reproduced except in full, without prior written approval of the Company. Any unauthorized alteration, forgery or falsification of the content or appearance of this document is unlawful and offenders may be prosecuted to the fullest extent of the law.

Date: 2020/7/29

Report No. :ES/2020/30005

**5G NR n71 (20MHz)_Product specific 10g-SAR_Front side_CH
134600_QPSK_1-1_0mm_LAT**

Communication System: 5G NR(20MHz, QPSK, 15kHz); Frequency: 673 MHz; Duty cycle= 1:1
Medium parameters used: $f = 673 \text{ MHz}$; $\sigma = 0.848 \text{ S/m}$; $\epsilon_r = 43.438$; $\rho = 1000 \text{ kg/m}^3$
Phantom section: Flat Section
Ambient temperature: 22.2°C; Liquid temperature: 22.4°C

DASY5 Configuration:

- Probe: EX3DV4 - SN3770; ConvF(9.84, 9.84, 9.84) @ 673 MHz; Calibrated: 2020/05/27
- Sensor-Surface: 2mm (Mechanical Surface Detection)
- Electronics: DAE4 Sn558; Calibrated: 2019/10/11
- Phantom: SAM
- DASY52 52.10.4(1527); SEMCAD X 14.6.14(7483)

Area Scan (71x141x1): Interpolated grid: dx=15 mm, dy=15 mm
Maximum value of SAR (interpolated) = 0.179 W/kg

Zoom Scan (5x5x7)/Cube 0: Measurement grid: dx=8mm, dy=8mm, dz=5mm
Reference Value = 1.756 V/m; Power Drift = 0.17 dB
Peak SAR (extrapolated) = 0.258 W/kg
SAR(1 g) = 0.105 W/kg; SAR(10 g) = 0.052 W/kg
Smallest distance from peaks to all points 3 dB below = 9.4 mm
Ratio of SAR at M2 to SAR at M1 = 39.1%
Maximum value of SAR (measured) = 0.175 W/kg

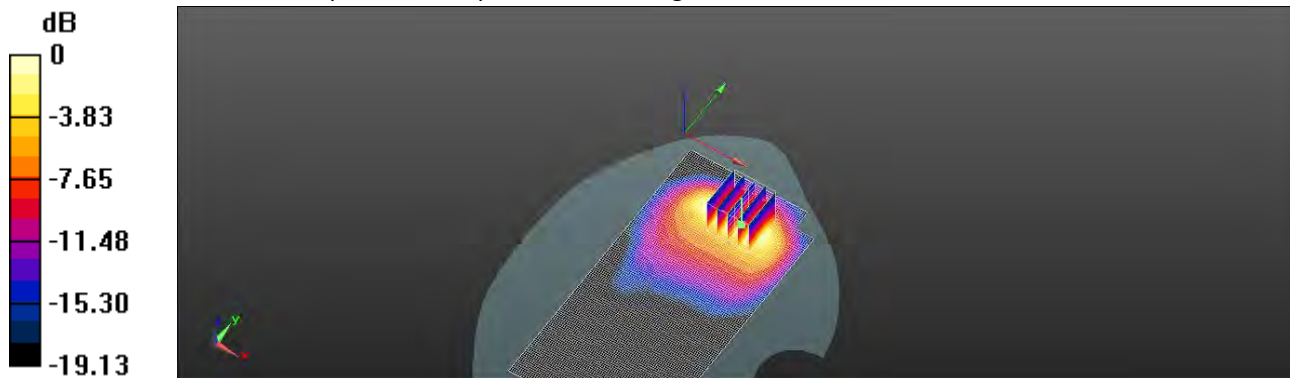

0 dB = 0.175 W/kg = -7.57 dBW/kg

Unless otherwise stated the results shown in this test report refer only to the sample(s) tested and such sample(s) are retained for 90 days only.

除非另有說明，此報告結果僅對測試之樣品負責，同時此樣品僅保留90天。本報告未經本公司書面許可，不可部份複製。

This document is issued by the Company subject to its General Conditions of Service printed overleaf, available on request or accessible at <http://www.sgs.com.tw/Terms-and-Conditions> and for electronic format documents, subject to Terms and Conditions for Electronic Documents at <http://www.sgs.com.tw/Terms-and-Conditions>. Attention is drawn to the limitation of liability, indemnification and jurisdiction issues defined therein. Any holder of this document is advised that information contained hereon reflects the Company's findings at the time of its intervention only and within the limits of Client's instructions, if any. The Company's sole responsibility is to its Client and this document does not exonerate parties to a transaction from exercising all their rights and obligations under the transaction documents. This document cannot be reproduced except in full, without prior written approval of the Company. Any unauthorized alteration, forgery or falsification of the content or appearance of this document is unlawful and offenders may be prosecuted to the fullest extent of the law.

Date: 2020/7/5

Report No. :ES/2020/30005

WLAN 802.11b_Head_Left Cheek_CH 1_Chain 0_Ant4

Communication System: Wi-Fi; Frequency: 2412 MHz; Duty cycle= 1:1

Medium parameters used: $f = 2412$ MHz; $\sigma = 1.706$ S/m; $\epsilon_r = 38.952$; $\rho = 1000$ kg/m³

Phantom section: Left Section

Ambient temperature: 22.3°C; Liquid temperature: 22.0°C

DASY5 Configuration:

- Probe: EX3DV4 - SN3770; ConvF(7.4, 7.4, 7.4) @ 2412 MHz; Calibrated: 2020/5/27
- Sensor-Surface: 2mm (Mechanical Surface Detection)
- Electronics: DAE4 Sn877; Calibrated: 2020/3/17
- Phantom: SAM
- DASY52 52.10.4(1527); SEMCAD X 14.6.14(7483)

Area Scan (111x171x1): Interpolated grid: dx=12 mm, dy=12 mm

Maximum value of SAR (interpolated) = 1.77 W/kg

Zoom Scan (7x7x7)/Cube 0: Measurement grid: dx=5mm, dy=5mm, dz=5mm

Reference Value = 18.45 V/m; Power Drift = 0.19 dB

Peak SAR (extrapolated) = 2.36 W/kg

SAR(1 g) = 1.04 W/kg; SAR(10 g) = 0.460 W/kg

Smallest distance from peaks to all points 3 dB below = 7.4 mm

Ratio of SAR at M2 to SAR at M1 = 45.5%

Maximum value of SAR (measured) = 1.68 W/kg

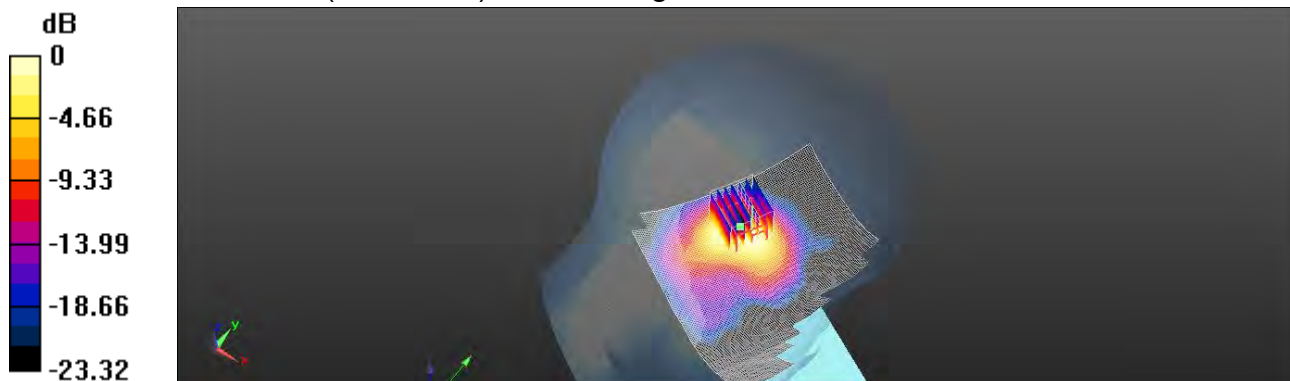

0 dB = 1.68 W/kg = 2.25 dBW/kg

Unless otherwise stated the results shown in this test report refer only to the sample(s) tested and such sample(s) are retained for 90 days only.

除非另有說明，此報告結果僅對測試之樣品負責，同時此樣品僅保留90天。本報告未經本公司書面許可，不可部份複製。

This document is issued by the Company subject to its General Conditions of Service printed overleaf, available on request or accessible at <http://www.sgs.com.tw/Terms-and-Conditions> and for electronic format documents, subject to Terms and Conditions for Electronic Documents at <http://www.sgs.com.tw/Terms-and-Conditions>. Attention is drawn to the limitation of liability, indemnification and jurisdiction issues defined therein. Any holder of this document is advised that information contained hereon reflects the Company's findings at the time of its intervention only and within the limits of Client's instructions, if any. The Company's sole responsibility is to its Client and this document does not exonerate parties to a transaction from exercising all their rights and obligations under the transaction documents. This document cannot be reproduced except in full, without prior written approval of the Company. Any unauthorized alteration, forgery or falsification of the content or appearance of this document is unlawful and offenders may be prosecuted to the fullest extent of the law.

Date: 2020/7/5

Report No. :ES/2020/30005

BLE_1M_Head_Le Cheek_CH 18_Chain0_Ant4

Communication System: Bluetooth; Frequency: 2442 MHz; Duty cycle= 1:1

Medium parameters used: $f = 2442 \text{ MHz}$; $\sigma = 1.741 \text{ S/m}$; $\epsilon_r = 38.897$; $\rho = 1000 \text{ kg/m}^3$

Phantom section: Left Section

Ambient temperature: 22.3°C; Liquid temperature: 22.0°C

DASY5 Configuration:

- Probe: EX3DV4 - SN7509; ConvF(7.51, 7.51, 7.51) @ 2442 MHz; Calibrated: 2020/03/25
- Sensor-Surface: 2mm (Mechanical Surface Detection)
- Electronics: DAE4 Sn558; Calibrated: 2019/10/11
- Phantom: SAM
- DASY52 52.10.4(1527); SEMCAD X 14.6.14(7483)

Area Scan (91x181x1): Interpolated grid: dx=12 mm, dy=12 mm

Maximum value of SAR (interpolated) = 0.972 W/kg

Zoom Scan (7x7x7)/Cube 0: Measurement grid: dx=5mm, dy=5mm, dz=5mm

Reference Value = 14.66 V/m; Power Drift = -0.13 dB

Peak SAR (extrapolated) = 1.09 W/kg

SAR(1 g) = 0.469 W/kg; SAR(10 g) = 0.198 W/kg

Smallest distance from peaks to all points 3 dB below = 7.6 mm

Ratio of SAR at M2 to SAR at M1 = 56.8%

Maximum value of SAR (measured) = 0.846 W/kg

Zoom Scan (7x7x7)/Cube 1: Measurement grid: dx=5mm, dy=5mm, dz=5mm

Reference Value = 14.66 V/m; Power Drift = -0.13 dB

Peak SAR (extrapolated) = 1.06 W/kg

SAR(1 g) = 0.527 W/kg; SAR(10 g) = 0.284 W/kg

Smallest distance from peaks to all points 3 dB below = 7.8 mm

Ratio of SAR at M2 to SAR at M1 = 57.1%

Maximum value of SAR (measured) = 0.831 W/kg

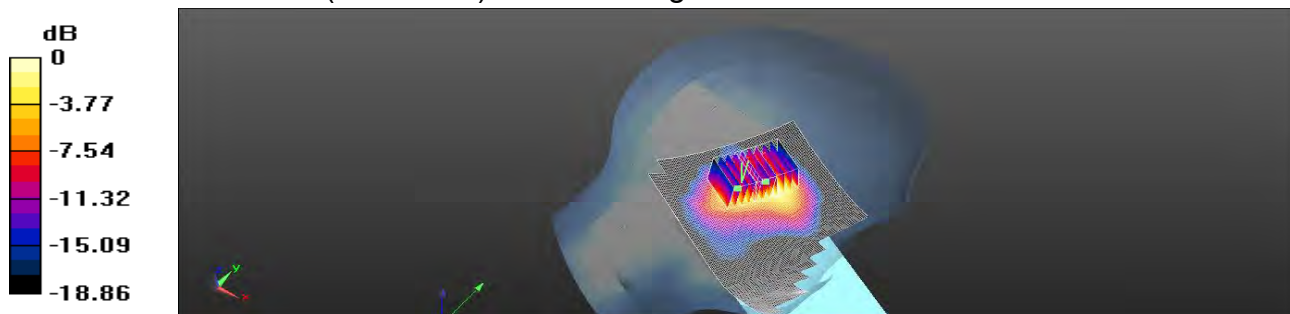

0 dB = 0.831 W/kg = -0.80 dBW/kg

Unless otherwise stated the results shown in this test report refer only to the sample(s) tested and such sample(s) are retained for 90 days only.

除非另有說明，此報告結果僅對測試之樣品負責，同時此樣品僅保留90天。本報告未經本公司書面許可，不可部份複製。

This document is issued by the Company subject to its General Conditions of Service printed overleaf, available on request or accessible at <http://www.sgs.com.tw/Terms-and-Conditions> and for electronic format documents, subject to Terms and Conditions for Electronic Documents at <http://www.sgs.com.tw/Terms-and-Conditions>. Attention is drawn to the limitation of liability, indemnification and jurisdiction issues defined therein. Any holder of this document is advised that information contained hereon reflects the Company's findings at the time of its intervention only and within the limits of Client's instructions, if any. The Company's sole responsibility is to its Client and this document does not exonerate parties to a transaction from exercising all their rights and obligations under the transaction documents. This document cannot be reproduced except in full, without prior written approval of the Company. Any unauthorized alteration, forgery or falsification of the content or appearance of this document is unlawful and offenders may be prosecuted to the fullest extent of the law.

Date: 2020/7/10

Report No. : ES/2020/30005

WLAN 802.11n(40M) 5.2G_Head_Left Cheek_CH 46_Chain 0_Ant4

Communication System: Wi-Fi; Frequency: 5230 MHz; Duty cycle= 1:1

Medium parameters used: $f = 5230 \text{ MHz}$; $\sigma = 4.734 \text{ S/m}$; $\epsilon_r = 35.583$; $\rho = 1000 \text{ kg/m}^3$

Phantom section: Left Section

Ambient temperature: 22.1°C; Liquid temperature: 21.8°C

DASY5 Configuration:

- Probe: EX3DV4 - SN3770; ConvF(5.4, 5.4, 5.4) @ 5230 MHz; Calibrated: 2020/5/27
- Sensor-Surface: 2mm (Mechanical Surface Detection)
- Electronics: DAE4 Sn877; Calibrated: 2020/3/17
- Phantom: SAM
- DASY52 52.10.4(1527); SEMCAD X 14.6.14(7483)

Area Scan (121x201x1): Interpolated grid: dx=10 mm, dy=10 mm

Maximum value of SAR (interpolated) = 2.29 W/kg

Zoom Scan (7x7x12)/Cube 0: Measurement grid: dx=4mm, dy=4mm, dz=2mm

Reference Value = 7.403 V/m; Power Drift = 0.16 dB

Peak SAR (extrapolated) = 4.71 W/kg

SAR(1 g) = 1.16 W/kg; SAR(10 g) = 0.369 W/kg

Smallest distance from peaks to all points 3 dB below = 7.5 mm

Ratio of SAR at M2 to SAR at M1 = 54.5%

Maximum value of SAR (measured) = 2.25 W/kg

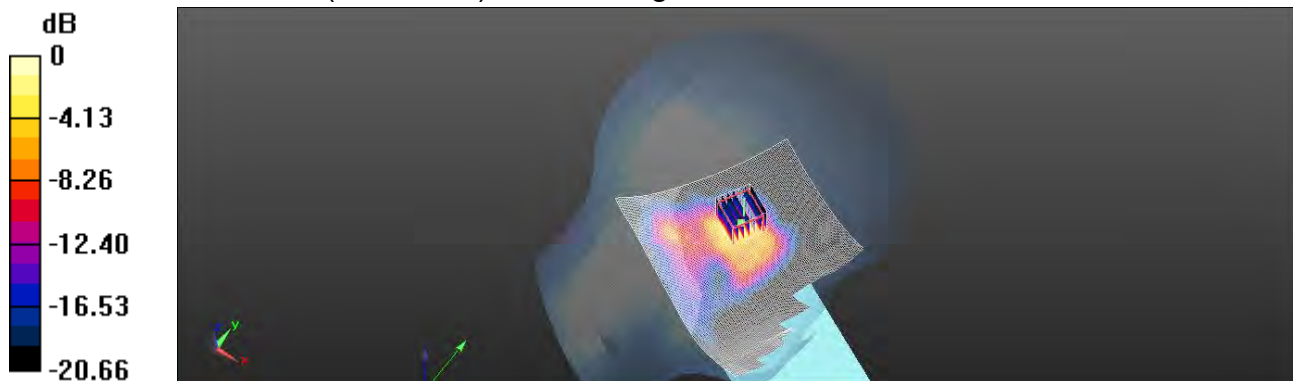

0 dB = 2.25 W/kg = 3.52 dBW/kg

Unless otherwise stated the results shown in this test report refer only to the sample(s) tested and such sample(s) are retained for 90 days only.

除非另有說明，此報告結果僅對測試之樣品負責，同時此樣品僅保留90天。本報告未經本公司書面許可，不可部份複製。

This document is issued by the Company subject to its General Conditions of Service printed overleaf, available on request or accessible at <http://www.sgs.com.tw/Terms-and-Conditions> and for electronic format documents, subject to Terms and Conditions for Electronic Documents at <http://www.sgs.com.tw/Terms-and-Conditions>. Attention is drawn to the limitation of liability, indemnification and jurisdiction issues defined therein. Any holder of this document is advised that information contained hereon reflects the Company's findings at the time of its intervention only and within the limits of Client's instructions, if any. The Company's sole responsibility is to its Client and this document does not exonerate parties to a transaction from exercising all their rights and obligations under the transaction documents. This document cannot be reproduced except in full, without prior written approval of the Company. Any unauthorized alteration, forgery or falsification of the content or appearance of this document is unlawful and offenders may be prosecuted to the fullest extent of the law.

Date: 2020/7/11

Report No. :ES/2020/30005

WLAN 802.11a 5.3G_Head_Left Cheek_CH 52_Chain 0_Ant4

Communication System: Wi-Fi; Frequency: 5260 MHz; Duty cycle= 1:1

Medium parameters used: $f = 5260$ MHz; $\sigma = 4.787$ S/m; $\epsilon_r = 35.478$; $\rho = 1000$ kg/m³

Phantom section: Left Section

Ambient temperature: 21.5°C; Liquid temperature: 22.1°C

DASY5 Configuration:

- Probe: EX3DV4 - SN3770; ConvF(5.4, 5.4, 5.4) @ 5260 MHz; Calibrated: 2020/5/27
- Sensor-Surface: 2mm (Mechanical Surface Detection)
- Electronics: DAE4 Sn877; Calibrated: 2020/3/17
- Phantom: SAM
- DASY52 52.10.4(1527); SEMCAD X 14.6.14(7483)

Area Scan (121x201x1): Interpolated grid: dx=10 mm, dy=10 mm

Maximum value of SAR (interpolated) = 1.50 W/kg

Zoom Scan (7x7x12)/Cube 0: Measurement grid: dx=4mm, dy=4mm, dz=2mm

Reference Value = 9.382 V/m; Power Drift = 0.14 dB

Peak SAR (extrapolated) = 3.24 W/kg

SAR(1 g) = 1.11 W/kg; SAR(10 g) = 0.414 W/kg

Smallest distance from peaks to all points 3 dB below = 5.4 mm

Ratio of SAR at M2 to SAR at M1 = 53.5%

Maximum value of SAR (measured) = 1.52 W/kg

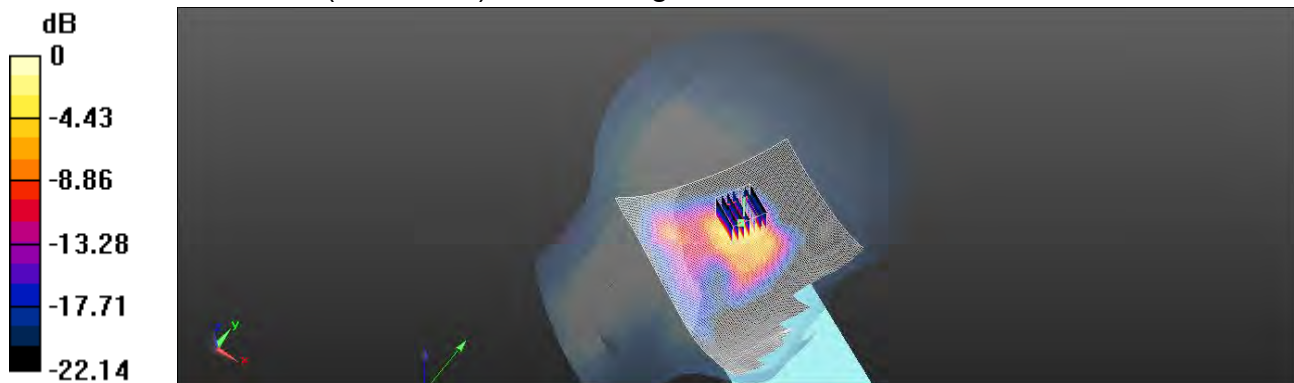

0 dB = 1.52 W/kg = 1.82 dBW/kg

Unless otherwise stated the results shown in this test report refer only to the sample(s) tested and such sample(s) are retained for 90 days only.

除非另有說明，此報告結果僅對測試之樣品負責，同時此樣品僅保留90天。本報告未經本公司書面許可，不可部份複製。

This document is issued by the Company subject to its General Conditions of Service printed overleaf, available on request or accessible at <http://www.sgs.com.tw/Terms-and-Conditions> and for electronic format documents, subject to Terms and Conditions for Electronic Documents at <http://www.sgs.com.tw/Terms-and-Conditions>. Attention is drawn to the limitation of liability, indemnification and jurisdiction issues defined therein. Any holder of this document is advised that information contained hereon reflects the Company's findings at the time of its intervention only and within the limits of Client's instructions, if any. The Company's sole responsibility is to its Client and this document does not exonerate parties to a transaction from exercising all their rights and obligations under the transaction documents. This document cannot be reproduced except in full, without prior written approval of the Company. Any unauthorized alteration, forgery or falsification of the content or appearance of this document is unlawful and offenders may be prosecuted to the fullest extent of the law.

Date: 2020/7/12

Report No. : ES/2020/30005

WLAN 802.11ac(80M) 5.6G_Head_Le Cheek_CH 138_Chain 0_Ant4

Communication System: WLAN 5G; Frequency: 5690 MHz; Duty cycle= 1:1

Medium parameters used: $f = 5690$ MHz; $\sigma = 5.234$ S/m; $\epsilon_r = 34.835$; $\rho = 1000$ kg/m³

Phantom section: Left Section

Ambient temperature: 21.9°C; Liquid temperature: 21.5°C

DASY5 Configuration:

- Probe: EX3DV4 - SN3770; ConvF(4.79, 4.79, 4.79) @ 5690 MHz; Calibrated: 2020/5/27
- Sensor-Surface: 2mm (Mechanical Surface Detection)
- Electronics: DAE4 Sn877; Calibrated: 2020/3/17
- Phantom: SAM
- DASY52 52.10.4(1527); SEMCAD X 14.6.14(7483)

Area Scan (121x201x1): Interpolated grid: dx=10 mm, dy=10 mm

Maximum value of SAR (interpolated) = 1.32 W/kg

Zoom Scan (7x7x12)/Cube 0: Measurement grid: dx=4mm, dy=4mm, dz=2mm

Reference Value = 9.107 V/m; Power Drift = 0.13 dB

Peak SAR (extrapolated) = 2.56 W/kg

SAR(1 g) = 1.17 W/kg; SAR(10 g) = 0.562 W/kg

Smallest distance from peaks to all points 3 dB below =6.4 mm

Ratio of SAR at M2 to SAR at M1 = 55.8%

Maximum value of SAR (measured) = 1.26 W/kg

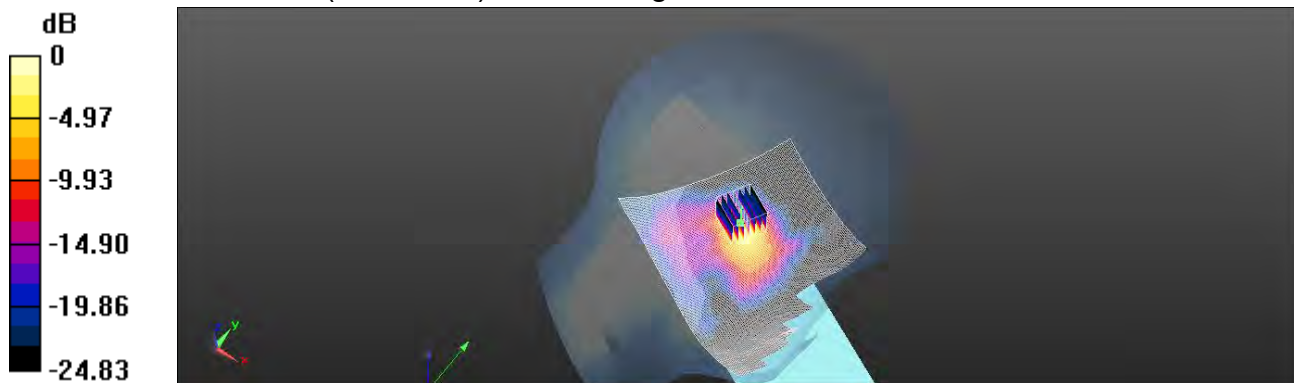

0 dB = 1.26 W/kg = 1.00 dBW/kg

Unless otherwise stated the results shown in this test report refer only to the sample(s) tested and such sample(s) are retained for 90 days only.

除非另有說明，此報告結果僅對測試之樣品負責，同時此樣品僅保留90天。本報告未經本公司書面許可，不可部份複製。

This document is issued by the Company subject to its General Conditions of Service printed overleaf, available on request or accessible at <http://www.sgs.com.tw/Terms-and-Conditions> and for electronic format documents, subject to Terms and Conditions for Electronic Documents at <http://www.sgs.com.tw/Terms-and-Conditions>. Attention is drawn to the limitation of liability, indemnification and jurisdiction issues defined therein. Any holder of this document is advised that information contained hereon reflects the Company's findings at the time of its intervention only and within the limits of Client's instructions, if any. The Company's sole responsibility is to its Client and this document does not exonerate parties to a transaction from exercising all their rights and obligations under the transaction documents. This document cannot be reproduced except in full, without prior written approval of the Company. Any unauthorized alteration, forgery or falsification of the content or appearance of this document is unlawful and offenders may be prosecuted to the fullest extent of the law.

Date: 2020/7/13

Report No. :ES/2020/30005

WLAN 802.11ac(80M) 5.8G _Head_ Left Cheek_ CH 155_Chain 0_Ant4

Communication System: Wi-Fi; Frequency: 5775 MHz; Duty cycle= 1:1

Medium parameters used: $f = 5775 \text{ MHz}$; $\sigma = 5.308 \text{ S/m}$; $\epsilon_r = 34.656$; $\rho = 1000 \text{ kg/m}^3$

Phantom section: Left Section

Ambient temperature: 21.4°C; Liquid temperature: 21.7°C

DASY5 Configuration:

- Probe: EX3DV4 - SN3770; ConvF(4.9, 4.9, 4.9) @ 5775 MHz; Calibrated: 2020/5/27
- Sensor-Surface: 2mm (Mechanical Surface Detection)
- Electronics: DAE4 Sn877; Calibrated: 2020/3/17
- Phantom: SAM
- DASY52 52.10.4(1527); SEMCAD X 14.6.14(7483)

Area Scan (121x201x1): Interpolated grid: dx=10 mm, dy=10 mm

Maximum value of SAR (interpolated) = 1.58 W/kg

Zoom Scan (7x7x12)/Cube 0: Measurement grid: dx=4mm, dy=4mm, dz=2mm

Reference Value = 8.461 V/m; Power Drift = -0.19 dB

Peak SAR (extrapolated) = 2.64 W/kg

SAR(1 g) = 1.03 W/kg; SAR(10 g) = 0.450 W/kg

Smallest distance from peaks to all points 3 dB below = 6.6 mm

Ratio of SAR at M2 to SAR at M1 = 56.3%

Maximum value of SAR (measured) = 1.24 W/kg

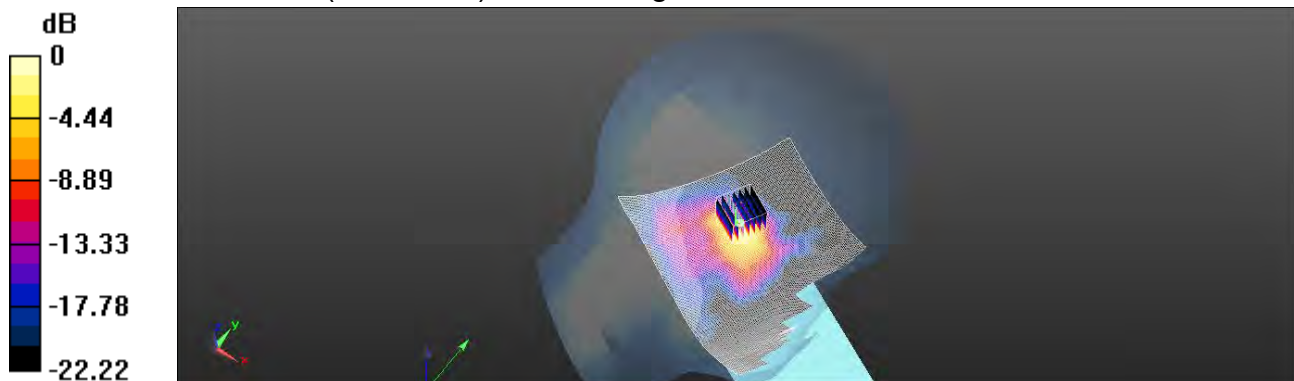

0 dB = 1.24 W/kg = 0.93 dBW/kg

Unless otherwise stated the results shown in this test report refer only to the sample(s) tested and such sample(s) are retained for 90 days only.

除非另有說明，此報告結果僅對測試之樣品負責，同時此樣品僅保留90天。本報告未經本公司書面許可，不可部份複製。

This document is issued by the Company subject to its General Conditions of Service printed overleaf, available on request or accessible at <http://www.sgs.com.tw/Terms-and-Conditions> and for electronic format documents, subject to Terms and Conditions for Electronic Documents at <http://www.sgs.com.tw/Terms-and-Conditions>. Attention is drawn to the limitation of liability, indemnification and jurisdiction issues defined therein. Any holder of this document is advised that information contained hereon reflects the Company's findings at the time of its intervention only and within the limits of Client's instructions, if any. The Company's sole responsibility is to its Client and this document does not exonerate parties to a transaction from exercising all their rights and obligations under the transaction documents. This document cannot be reproduced except in full, without prior written approval of the Company. Any unauthorized alteration, forgery or falsification of the content or appearance of this document is unlawful and offenders may be prosecuted to the fullest extent of the law.

Date: 2020/7/5

Report No. :ES/2020/30005

WLAN 802.11b_Head_Re Cheek_CH 6_Chain 1_Ant6

Communication System: WLAN 2.45G; Frequency: 2437 MHz; Duty cycle= 1:1

Medium parameters used: $f = 2437$ MHz; $\sigma = 1.725$ S/m; $\epsilon_r = 38.898$; $\rho = 1000$ kg/m³

Phantom section: Right Section

Ambient temperature: 22.3°C; Liquid temperature: 22.0°C

DASY5 Configuration:

- Probe: EX3DV4 - SN7509; ConvF(7.51, 7.51, 7.51) @ 2437 MHz; Calibrated: 2020/03/25
- Sensor-Surface: 2mm (Mechanical Surface Detection)
- Electronics: DAE4 Sn558; Calibrated: 2019/10/11
- Phantom: SAM
- DASY52 52.10.4(1527); SEMCAD X 14.6.14(7483)

Area Scan (91x181x1): Interpolated grid: dx=12 mm, dy=12 mm

Maximum value of SAR (interpolated) = 0.561 W/kg

Zoom Scan (7x7x7)/Cube 0: Measurement grid: dx=5mm, dy=5mm, dz=5mm

Reference Value = 2.918 V/m; Power Drift = 0.17 dB

Peak SAR (extrapolated) = 0.650 W/kg

SAR(1 g) = 0.398 W/kg; SAR(10 g) = 0.203 W/kg

Smallest distance from peaks to all points 3 dB below = 7.7 mm

Ratio of SAR at M2 to SAR at M1 = 66.3%

Maximum value of SAR (measured) = 0.537 W/kg

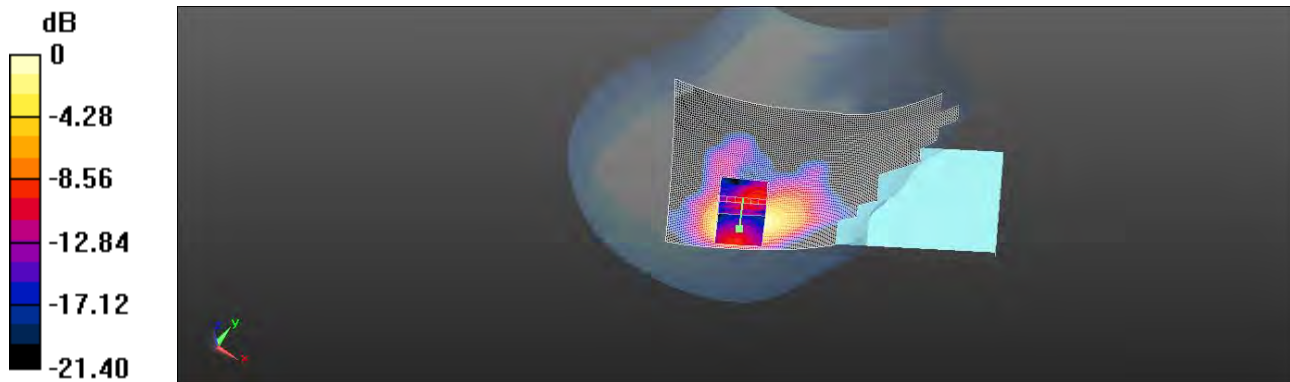

0 dB = 0.537 W/kg = -2.70 dBW/kg

Unless otherwise stated the results shown in this test report refer only to the sample(s) tested and such sample(s) are retained for 90 days only.

除非另有說明，此報告結果僅對測試之樣品負責，同時此樣品僅保留90天。本報告未經本公司書面許可，不可部份複製。

This document is issued by the Company subject to its General Conditions of Service printed overleaf, available on request or accessible at <http://www.sgs.com.tw/Terms-and-Conditions> and for electronic format documents, subject to Terms and Conditions for Electronic Documents at <http://www.sgs.com.tw/Terms-and-Conditions>. Attention is drawn to the limitation of liability, indemnification and jurisdiction issues defined therein. Any holder of this document is advised that information contained hereon reflects the Company's findings at the time of its intervention only and within the limits of Client's instructions, if any. The Company's sole responsibility is to its Client and this document does not exonerate parties to a transaction from exercising all their rights and obligations under the transaction documents. This document cannot be reproduced except in full, without prior written approval of the Company. Any unauthorized alteration, forgery or falsification of the content or appearance of this document is unlawful and offenders may be prosecuted to the fullest extent of the law.

Date: 2020/7/5

Report No. : ES/2020/30005

BLE_1M_Head_Re Cheek_CH 18_Chain0_Ant6

Communication System: Bluetooth; Frequency: 2442 MHz; Duty cycle= 1:1

Medium parameters used: $f = 2442 \text{ MHz}$; $\sigma = 1.741 \text{ S/m}$; $\epsilon_r = 38.897$; $\rho = 1000 \text{ kg/m}^3$

Phantom section: Right Section

Ambient temperature: 22.3°C; Liquid temperature: 22.0°C

DASY5 Configuration:

- Probe: EX3DV4 - SN7509; ConvF(7.51, 7.51, 7.51) @ 2442 MHz; Calibrated: 2020/03/25
- Sensor-Surface: 2mm (Mechanical Surface Detection)
- Electronics: DAE4 Sn558; Calibrated: 2019/10/11
- Phantom: SAM
- DASY52 52.10.4(1527); SEMCAD X 14.6.14(7483)

Area Scan (91x181x1): Interpolated grid: dx=12 mm, dy=12 mm

Maximum value of SAR (interpolated) = 0.153 W/kg

Zoom Scan (7x7x7)/Cube 0: Measurement grid: dx=5mm, dy=5mm, dz=5mm

Reference Value = 2.842 V/m; Power Drift = 0.17 dB

Peak SAR (extrapolated) = 0.165 W/kg

SAR(1 g) = 0.100 W/kg; SAR(10 g) = 0.049 W/kg

Smallest distance from peaks to all points 3 dB below = 7.1 mm

Ratio of SAR at M2 to SAR at M1 = 66.2%

Maximum value of SAR (measured) = 0.139 W/kg

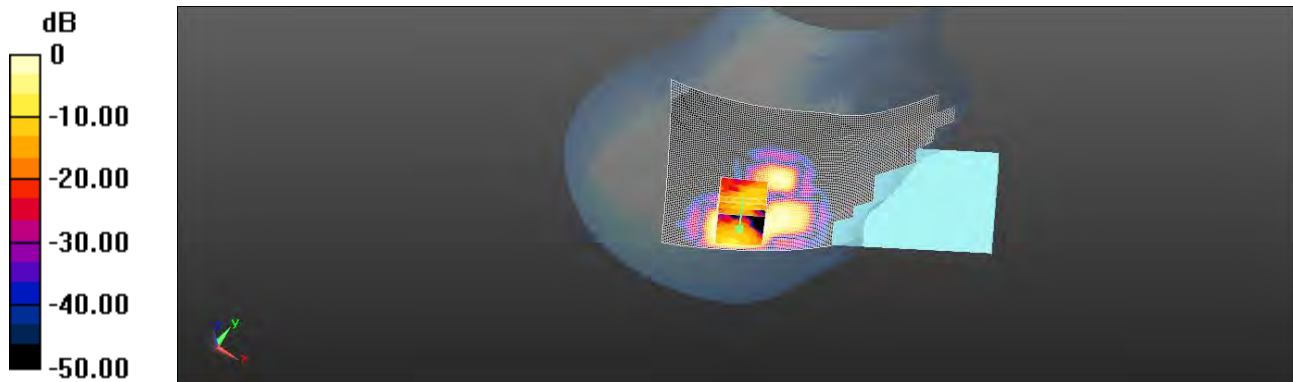

0 dB = 0.139 W/kg = -8.57 dBW/kg

Unless otherwise stated the results shown in this test report refer only to the sample(s) tested and such sample(s) are retained for 90 days only.

除非另有說明，此報告結果僅對測試之樣品負責，同時此樣品僅保留90天。本報告未經本公司書面許可，不可部份複製。

This document is issued by the Company subject to its General Conditions of Service printed overleaf, available on request or accessible at <http://www.sgs.com.tw/Terms-and-Conditions> and for electronic format documents, subject to Terms and Conditions for Electronic Documents at <http://www.sgs.com.tw/Terms-and-Conditions>. Attention is drawn to the limitation of liability, indemnification and jurisdiction issues defined therein. Any holder of this document is advised that information contained hereon reflects the Company's findings at the time of its intervention only and within the limits of Client's instructions, if any. The Company's sole responsibility is to its Client and this document does not exonerate parties to a transaction from exercising all their rights and obligations under the transaction documents. This document cannot be reproduced except in full, without prior written approval of the Company. Any unauthorized alteration, forgery or falsification of the content or appearance of this document is unlawful and offenders may be prosecuted to the fullest extent of the law.

Date: 2020/7/10

Report No. :ES/2020/30005

WLAN 802.11n(40M) 5.2G_Head_Right Cheek_CH 46_Chain 1_Ant6

Communication System: Wi-Fi; Frequency: 5230 MHz; Duty cycle= 1:1

Medium parameters used: $f = 5230 \text{ MHz}$; $\sigma = 4.734 \text{ S/m}$; $\epsilon_r = 35.583$; $\rho = 1000 \text{ kg/m}^3$

Phantom section: Right Section

Ambient temperature: 22.1°C; Liquid temperature: 21.8°C

DASY5 Configuration:

- Probe: EX3DV4 - SN7509; ConvF(5.33, 5.33, 5.33) @ 5230 MHz; Calibrated: 2020/03/25
- Sensor-Surface: 2mm (Mechanical Surface Detection)
- Electronics: DAE4 Sn558; Calibrated: 2019/10/11
- Phantom: SAM
- DASY52 52.10.4(1527); SEMCAD X 14.6.14(7483)

Area Scan (111x201x1): Interpolated grid: dx=10 mm, dy=10 mm

Maximum value of SAR (interpolated) = 0.133 W/kg

Zoom Scan (7x7x12)/Cube 0: Measurement grid: dx=4mm, dy=4mm, dz=2mm

Reference Value = 3.039 V/m; Power Drift = 0.19 dB

Peak SAR (extrapolated) = 0.379 W/kg

SAR(1 g) = 0.032 W/kg; SAR(10 g) = 0.00786 W/kg

Smallest distance from peaks to all points 3 dB below: Larger than measurement grid

Ratio of SAR at M2 to SAR at M1 = 55.2%

Maximum value of SAR (measured) = 0.0642 W/kg

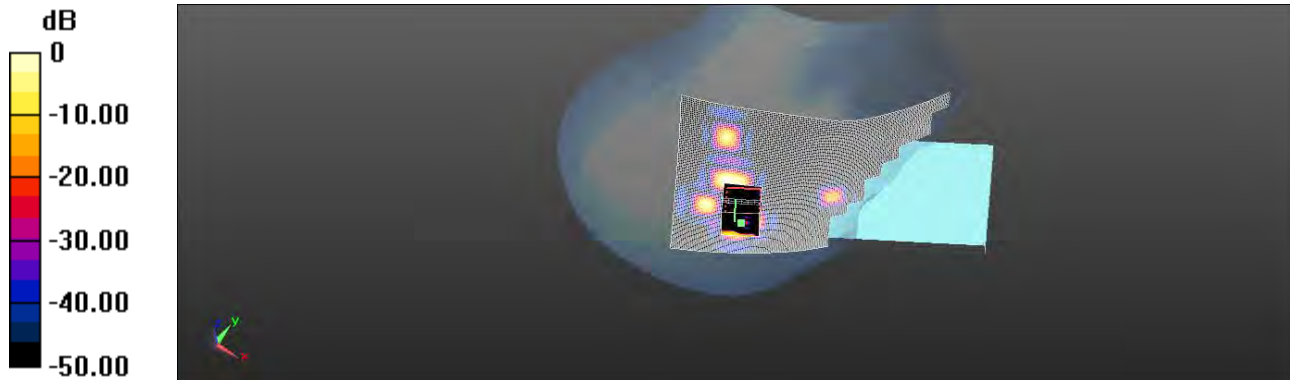

0 dB = 0.0642 W/kg = -11.92 dBW/kg

Unless otherwise stated the results shown in this test report refer only to the sample(s) tested and such sample(s) are retained for 90 days only.

除非另有說明，此報告結果僅對測試之樣品負責，同時此樣品僅保留90天。本報告未經本公司書面許可，不可部份複製。

This document is issued by the Company subject to its General Conditions of Service printed overleaf, available on request or accessible at <http://www.sgs.com.tw/Terms-and-Conditions> and for electronic format documents, subject to Terms and Conditions for Electronic Documents at <http://www.sgs.com.tw/Terms-and-Conditions>. Attention is drawn to the limitation of liability, indemnification and jurisdiction issues defined therein. Any holder of this document is advised that information contained hereon reflects the Company's findings at the time of its intervention only and within the limits of Client's instructions, if any. The Company's sole responsibility is to its Client and this document does not exonerate parties to a transaction from exercising all their rights and obligations under the transaction documents. This document cannot be reproduced except in full, without prior written approval of the Company. Any unauthorized alteration, forgery or falsification of the content or appearance of this document is unlawful and offenders may be prosecuted to the fullest extent of the law.

Date: 2020/7/11

Report No. : ES/2020/30005

WLAN 802.11n(20M) 5.3G_Head_Right Cheek_CH 52_Chain 1_Ant6

Communication System: Wi-Fi; Frequency: 5260 MHz; Duty cycle= 1:1

Medium parameters used: $f = 5260 \text{ MHz}$; $\sigma = 4.787 \text{ S/m}$; $\epsilon_r = 35.478$; $\rho = 1000 \text{ kg/m}^3$

Phantom section: Right Section

Ambient temperature: 21.5°C; Liquid temperature: 22.1°C

DASY5 Configuration:

- Probe: EX3DV4 - SN3770; ConvF(5.4, 5.4, 5.4) @ 5260 MHz; Calibrated: 2020/5/27
- Sensor-Surface: 2mm (Mechanical Surface Detection)
- Electronics: DAE4 Sn877; Calibrated: 2020/3/17
- Phantom: SAM
- DASY52 52.10.4(1527); SEMCAD X 14.6.14(7483)

Area Scan (111x201x1): Interpolated grid: dx=10 mm, dy=10 mm

Maximum value of SAR (interpolated) = 0.160 W/kg

Zoom Scan (7x7x12)/Cube 0: Measurement grid: dx=4mm, dy=4mm, dz=2mm

Reference Value = 3.794 V/m; Power Drift = 0.12 dB

Peak SAR (extrapolated) = 0.246 W/kg

SAR(1 g) = 0.067 W/kg; SAR(10 g) = 0.025 W/kg

Smallest distance from peaks to all points 3 dB below = 6.5 mm

Ratio of SAR at M2 to SAR at M1 = 62.9%

Maximum value of SAR (measured) = 0.129 W/kg

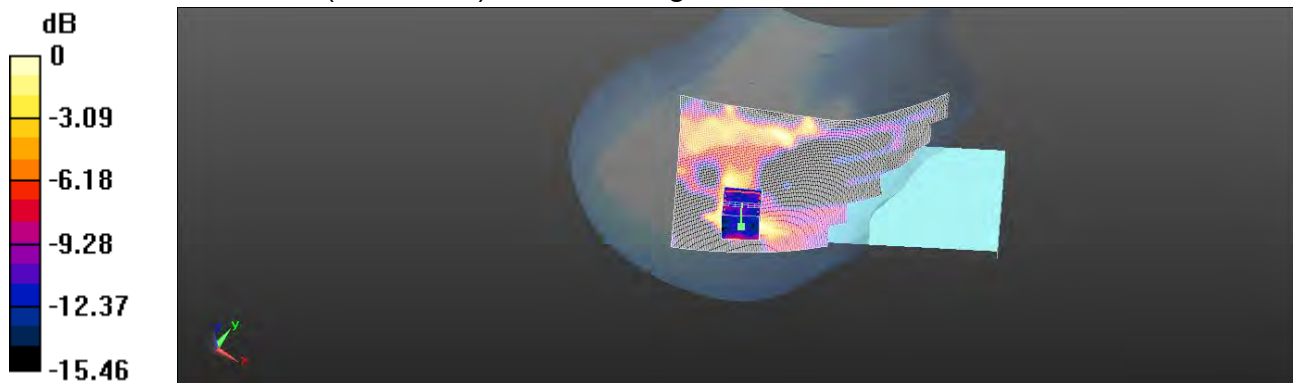

0 dB = 0.129 W/kg = -8.89 dBW/kg

Unless otherwise stated the results shown in this test report refer only to the sample(s) tested and such sample(s) are retained for 90 days only.

除非另有說明，此報告結果僅對測試之樣品負責，同時此樣品僅保留90天。本報告未經本公司書面許可，不可部份複製。

This document is issued by the Company subject to its General Conditions of Service printed overleaf, available on request or accessible at <http://www.sgs.com.tw/Terms-and-Conditions> and for electronic format documents, subject to Terms and Conditions for Electronic Documents at <http://www.sgs.com.tw/Terms-and-Conditions>. Attention is drawn to the limitation of liability, indemnification and jurisdiction issues defined therein. Any holder of this document is advised that information contained hereon reflects the Company's findings at the time of its intervention only and within the limits of Client's instructions, if any. The Company's sole responsibility is to its Client and this document does not exonerate parties to a transaction from exercising all their rights and obligations under the transaction documents. This document cannot be reproduced except in full, without prior written approval of the Company. Any unauthorized alteration, forgery or falsification of the content or appearance of this document is unlawful and offenders may be prosecuted to the fullest extent of the law.

Date: 2020/7/12

Report No. :ES/2020/30005

WLAN 802.11a 5.6G_Head_Right Cheek_CH 100_Chain 1_Ant6

Communication System: Wi-Fi; Frequency: 5500 MHz; Duty cycle= 1:1

Medium parameters used: $f = 5500$ MHz; $\sigma = 5.027$ S/m; $\epsilon_r = 35.407$; $\rho = 1000$ kg/m³

Phantom section: Right Section

Ambient temperature: 21.9°C; Liquid temperature: 21.5°C

DASY5 Configuration:

- Probe: EX3DV4 - SN3770; ConvF(4.79, 4.79, 4.79) @ 5500 MHz; Calibrated: 2020/5/27
- Sensor-Surface: 2mm (Mechanical Surface Detection)
- Electronics: DAE4 Sn877; Calibrated: 2020/3/17
- Phantom: SAM
- DASY52 52.10.4(1527); SEMCAD X 14.6.14(7483)

Area Scan (111x201x1): Interpolated grid: dx=10 mm, dy=10 mm

Maximum value of SAR (interpolated) = 0.313 W/kg

Zoom Scan (7x7x12)/Cube 0: Measurement grid: dx=4mm, dy=4mm, dz=2mm

Reference Value = 5.499 V/m; Power Drift = 0.03 dB

Peak SAR (extrapolated) = 0.482 W/kg

SAR(1 g) = 0.142 W/kg; SAR(10 g) = 0.059 W/kg

Smallest distance from peaks to all points 3 dB below = 9.1 mm

Ratio of SAR at M2 to SAR at M1 = 59.5%

Maximum value of SAR (measured) = 0.257 W/kg

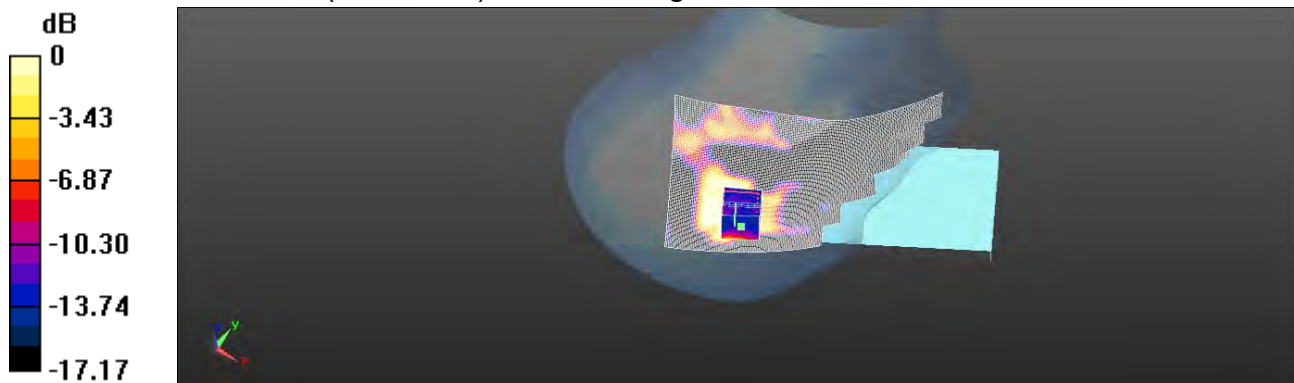

0 dB = 0.257 W/kg = -5.90 dBW/kg

Unless otherwise stated the results shown in this test report refer only to the sample(s) tested and such sample(s) are retained for 90 days only.

除非另有說明，此報告結果僅對測試之樣品負責，同時此樣品僅保留90天。本報告未經本公司書面許可，不可部份複製。

This document is issued by the Company subject to its General Conditions of Service printed overleaf, available on request or accessible at <http://www.sgs.com.tw/Terms-and-Conditions> and for electronic format documents, subject to Terms and Conditions for Electronic Documents at <http://www.sgs.com.tw/Terms-and-Conditions>. Attention is drawn to the limitation of liability, indemnification and jurisdiction issues defined therein. Any holder of this document is advised that information contained hereon reflects the Company's findings at the time of its intervention only and within the limits of Client's instructions, if any. The Company's sole responsibility is to its Client and this document does not exonerate parties to a transaction from exercising all their rights and obligations under the transaction documents. This document cannot be reproduced except in full, without prior written approval of the Company. Any unauthorized alteration, forgery or falsification of the content or appearance of this document is unlawful and offenders may be prosecuted to the fullest extent of the law.

Date: 2020/7/13

Report No. :ES/2020/30005

WLAN 802.11ac(80M) 5.8G_Head_Right Cheek_CH 155_Chain 1_Ant6

Communication System: Wi-Fi; Frequency: 5775 MHz; Duty cycle= 1:1

Medium parameters used: $f = 5775$ MHz; $\sigma = 5.308$ S/m; $\epsilon_r = 34.656$; $\rho = 1000$ kg/m³

Phantom section: Right Section

Ambient temperature: 21.4°C; Liquid temperature: 21.7°C

DASY5 Configuration:

- Probe: EX3DV4 - SN3770; ConvF(4.9, 4.9, 4.9) @ 5775 MHz; Calibrated: 2020/5/27
- Sensor-Surface: 2mm (Mechanical Surface Detection)
- Electronics: DAE4 Sn877; Calibrated: 2020/3/17
- Phantom: SAM
- DASY52 52.10.4(1527); SEMCAD X 14.6.14(7483)

Area Scan (111x201x1): Interpolated grid: dx=10 mm, dy=10 mm

Maximum value of SAR (interpolated) = 0.717 W/kg

Zoom Scan (7x7x12)/Cube 0: Measurement grid: dx=4mm, dy=4mm, dz=2mm

Reference Value = 6.404 V/m; Power Drift = 0.16 dB

Peak SAR (extrapolated) = 1.51 W/kg

SAR(1 g) = 0.358 W/kg; SAR(10 g) = 0.123 W/kg

Smallest distance from peaks to all points 3 dB below = 5.1 mm

Ratio of SAR at M2 to SAR at M1 = 55.4%

Maximum value of SAR (measured) = 0.714 W/kg

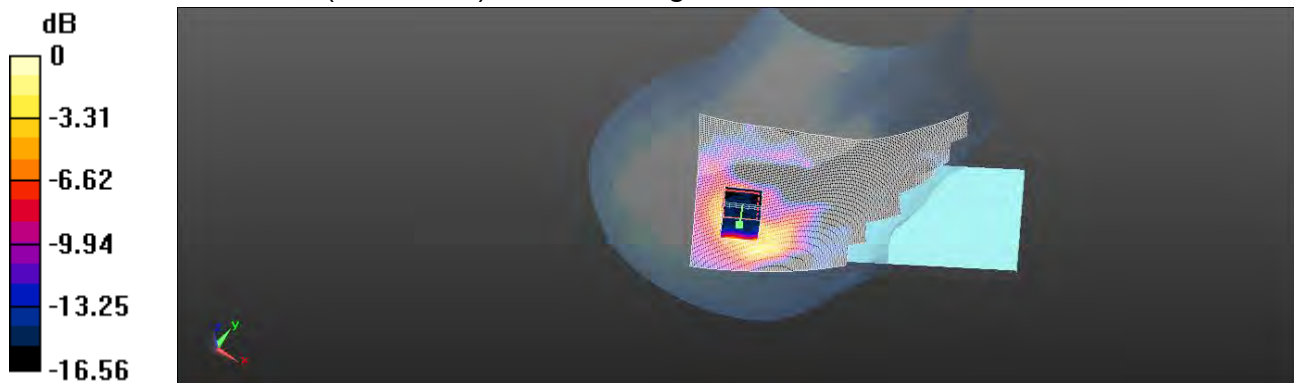

0 dB = 0.714 W/kg = -1.46 dBW/kg

Unless otherwise stated the results shown in this test report refer only to the sample(s) tested and such sample(s) are retained for 90 days only.

除非另有說明，此報告結果僅對測試之樣品負責，同時此樣品僅保留90天。本報告未經本公司書面許可，不可部份複製。

This document is issued by the Company subject to its General Conditions of Service printed overleaf, available on request or accessible at <http://www.sgs.com.tw/Terms-and-Conditions> and for electronic format documents, subject to Terms and Conditions for Electronic Documents at <http://www.sgs.com.tw/Terms-and-Conditions>. Attention is drawn to the limitation of liability, indemnification and jurisdiction issues defined therein. Any holder of this document is advised that information contained hereon reflects the Company's findings at the time of its intervention only and within the limits of Client's instructions, if any. The Company's sole responsibility is to its Client and this document does not exonerate parties to a transaction from exercising all their rights and obligations under the transaction documents. This document cannot be reproduced except in full, without prior written approval of the Company. Any unauthorized alteration, forgery or falsification of the content or appearance of this document is unlawful and offenders may be prosecuted to the fullest extent of the law.

Date: 2020/7/5

Report No. : ES/2020/30005

WLAN 802.11b_Body worn_Back side_CH 11_Chain0_Ant4_15mm

Communication System: WLAN 2.45G; Frequency: 2462 MHz; Duty cycle= 1:1

Medium parameters used: $f = 2462$ MHz; $\sigma = 1.783$ S/m; $\epsilon_r = 38.884$; $\rho = 1000$ kg/m³

Phantom section: Flat Section

Ambient temperature: 22.3°C; Liquid temperature: 22.0°C

DASY5 Configuration:

- Probe: EX3DV4 - SN7509; ConvF(7.51, 7.51, 7.51) @ 2462 MHz; Calibrated: 2020/03/25
- Sensor-Surface: 2mm (Mechanical Surface Detection)
- Electronics: DAE4 Sn558; Calibrated: 2019/10/11
- Phantom: SAM
- DASY52 52.10.4(1527); SEMCAD X 14.6.14(7483)

Area Scan (91x171x1): Interpolated grid: dx=12 mm, dy=12 mm

Maximum value of SAR (interpolated) = 0.201 W/kg

Zoom Scan (7x7x7)/Cube 0: Measurement grid: dx=5mm, dy=5mm, dz=5mm

Reference Value = 2.866 V/m; Power Drift = 0.16 dB

Peak SAR (extrapolated) = 0.224 W/kg

SAR(1 g) = 0.153 W/kg; SAR(10 g) = 0.096 W/kg

Smallest distance from peaks to all points 3 dB below = 13.2 mm

Ratio of SAR at M2 to SAR at M1 = 69.7%

Maximum value of SAR (measured) = 0.193 W/kg

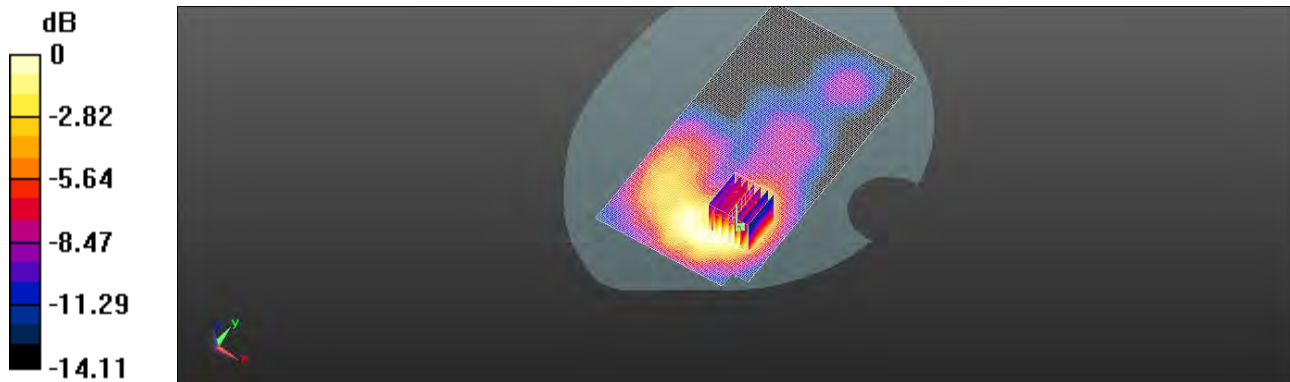

0 dB = 0.193 W/kg = -7.14 dBW/kg

Unless otherwise stated the results shown in this test report refer only to the sample(s) tested and such sample(s) are retained for 90 days only.

除非另有說明，此報告結果僅對測試之樣品負責，同時此樣品僅保留90天。本報告未經本公司書面許可，不可部份複製。

This document is issued by the Company subject to its General Conditions of Service printed overleaf, available on request or accessible at <http://www.sgs.com.tw/Terms-and-Conditions> and for electronic format documents, subject to Terms and Conditions for Electronic Documents at <http://www.sgs.com.tw/Terms-and-Conditions>. Attention is drawn to the limitation of liability, indemnification and jurisdiction issues defined therein. Any holder of this document is advised that information contained hereon reflects the Company's findings at the time of its intervention only and within the limits of Client's instructions, if any. The Company's sole responsibility is to its Client and this document does not exonerate parties to a transaction from exercising all their rights and obligations under the transaction documents. This document cannot be reproduced except in full, without prior written approval of the Company. Any unauthorized alteration, forgery or falsification of the content or appearance of this document is unlawful and offenders may be prosecuted to the fullest extent of the law.

Date: 2020/7/5

Report No. :ES/2020/30005

BLE_1M_Body worn_Back side_CH 18_Chain0_Ant4_15mm

Communication System: Bluetooth; Frequency: 2442 MHz; Duty cycle= 1:1

Medium parameters used: $f = 2442$ MHz; $\sigma = 1.741$ S/m; $\epsilon_r = 38.897$; $\rho = 1000$ kg/m³

Phantom section: Flat Section

Ambient temperature: 22.3°C; Liquid temperature: 22.0°C

DASY5 Configuration:

- Probe: EX3DV4 - SN7509; ConvF(7.51, 7.51, 7.51) @ 2442 MHz; Calibrated: 2020/03/25
- Sensor-Surface: 2mm (Mechanical Surface Detection)
- Electronics: DAE4 Sn558; Calibrated: 2019/10/11
- Phantom: SAM
- DASY52 52.10.4(1527); SEMCAD X 14.6.14(7483)

Area Scan (91x171x1): Interpolated grid: dx=12 mm, dy=12 mm

Maximum value of SAR (interpolated) = 0.0490 W/kg

Zoom Scan (7x7x7)/Cube 0: Measurement grid: dx=5mm, dy=5mm, dz=5mm

Reference Value = 1.938 V/m; Power Drift = 0.13 dB

Peak SAR (extrapolated) = 0.0400 W/kg

SAR(1 g) = 0.028 W/kg; SAR(10 g) = 0.017 W/kg

Smallest distance from peaks to all points 3 dB below: Larger than measurement grid

Ratio of SAR at M2 to SAR at M1 = 70%

Maximum value of SAR (measured) = 0.0356 W/kg

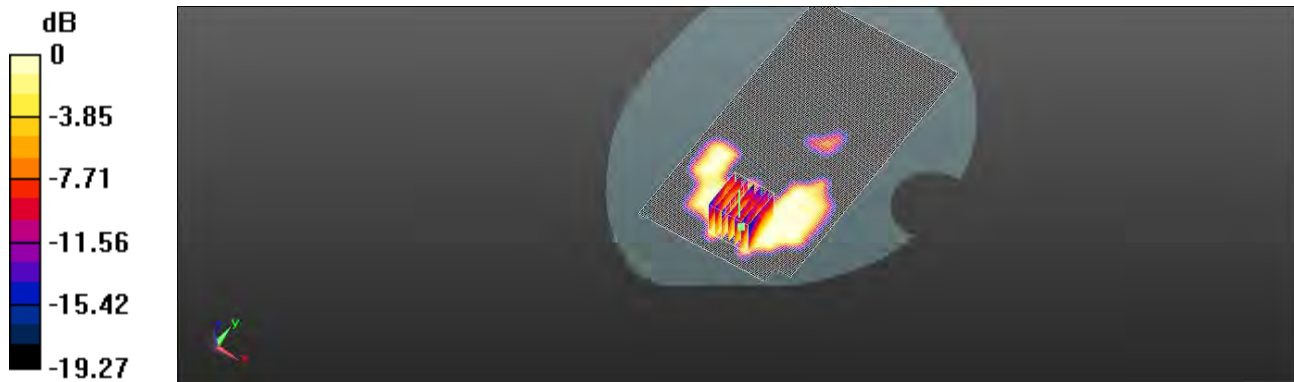

0 dB = 0.0356 W/kg = -14.49 dBW/kg

Unless otherwise stated the results shown in this test report refer only to the sample(s) tested and such sample(s) are retained for 90 days only.

除非另有說明，此報告結果僅對測試之樣品負責，同時此樣品僅保留90天。本報告未經本公司書面許可，不可部份複製。

This document is issued by the Company subject to its General Conditions of Service printed overleaf, available on request or accessible at <http://www.sgs.com.tw/Terms-and-Conditions> and for electronic format documents, subject to Terms and Conditions for Electronic Documents at <http://www.sgs.com.tw/Terms-and-Conditions>. Attention is drawn to the limitation of liability, indemnification and jurisdiction issues defined therein. Any holder of this document is advised that information contained hereon reflects the Company's findings at the time of its intervention only and within the limits of Client's instructions, if any. The Company's sole responsibility is to its Client and this document does not exonerate parties to a transaction from exercising all their rights and obligations under the transaction documents. This document cannot be reproduced except in full, without prior written approval of the Company. Any unauthorized alteration, forgery or falsification of the content or appearance of this document is unlawful and offenders may be prosecuted to the fullest extent of the law.

Date: 2020/7/10

Report No. : ES/2020/30005

WLAN 802.11n(40M) 5.2G_Body worn_Back side_CH 46_Chain0_Ant4_15mm

Communication System: WLAN 5G; Frequency: 5230 MHz; Duty cycle= 1:1

Medium parameters used: $f = 5230 \text{ MHz}$; $\sigma = 4.734 \text{ S/m}$; $\epsilon_r = 35.583$; $\rho = 1000 \text{ kg/m}^3$

Phantom section: Flat Section

Ambient temperature: 22.1°C; Liquid temperature: 21.8°C

DASY5 Configuration:

- Probe: EX3DV4 - SN7509; ConvF(5.33, 5.33, 5.33) @ 5230 MHz; Calibrated: 2020/03/25
- Sensor-Surface: 2mm (Mechanical Surface Detection)
- Electronics: DAE4 Sn558; Calibrated: 2019/10/11
- Phantom: SAM
- DASY52 52.10.4(1527); SEMCAD X 14.6.14(7483)

Area Scan (121x211x1): Interpolated grid: dx=10 mm, dy=10 mm

Maximum value of SAR (interpolated) = 0.373 W/kg

Zoom Scan (7x7x12)/Cube 0: Measurement grid: dx=4mm, dy=4mm, dz=2mm

Reference Value = 2.258 V/m; Power Drift = 0.15 dB

Peak SAR (extrapolated) = 0.489 W/kg

SAR(1 g) = 0.178 W/kg; SAR(10 g) = 0.070 W/kg

Smallest distance from peaks to all points 3 dB below = 9.6 mm

Ratio of SAR at M2 to SAR at M1 = 64.2%

Maximum value of SAR (measured) = 0.313 W/kg

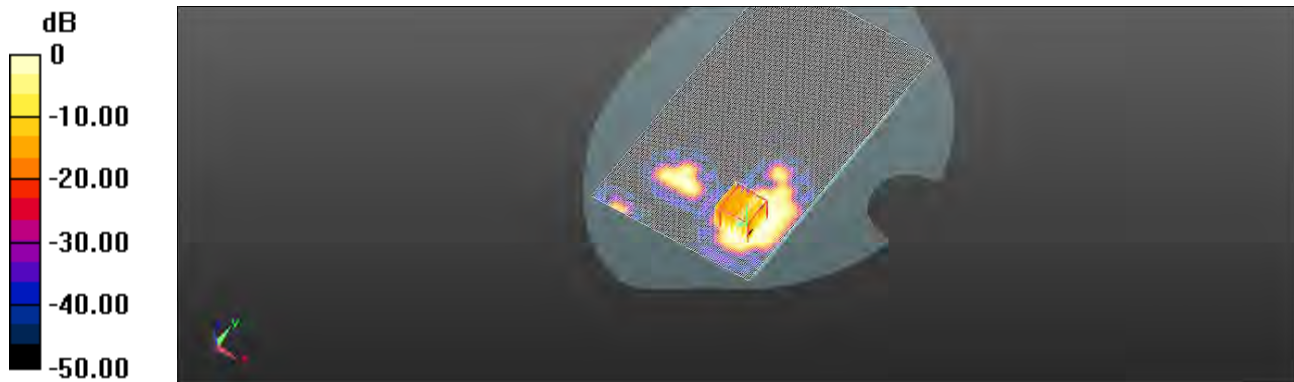

0 dB = 0.313 W/kg = -5.04 dBW/kg

Unless otherwise stated the results shown in this test report refer only to the sample(s) tested and such sample(s) are retained for 90 days only.

除非另有說明，此報告結果僅對測試之樣品負責，同時此樣品僅保留90天。本報告未經本公司書面許可，不可部份複製。

This document is issued by the Company subject to its General Conditions of Service printed overleaf, available on request or accessible at <http://www.sgs.com.tw/Terms-and-Conditions> and for electronic format documents, subject to Terms and Conditions for Electronic Documents at <http://www.sgs.com.tw/Terms-and-Conditions>. Attention is drawn to the limitation of liability, indemnification and jurisdiction issues defined therein. Any holder of this document is advised that information contained hereon reflects the Company's findings at the time of its intervention only and within the limits of Client's instructions, if any. The Company's sole responsibility is to its Client and this document does not exonerate parties to a transaction from exercising all their rights and obligations under the transaction documents. This document cannot be reproduced except in full, without prior written approval of the Company. Any unauthorized alteration, forgery or falsification of the content or appearance of this document is unlawful and offenders may be prosecuted to the fullest extent of the law.

Date: 2020/7/11

Report No. : ES/2020/30005

WLAN 802.11a 5.3G Body worn Back side CH 52 Chain0 Ant4 15mm

Communication System: Wi-Fi; Frequency: 5260 MHz; Duty cycle= 1:1

Medium parameters used: $f = 5260$ MHz; $\sigma = 4.787$ S/m; $\epsilon_r = 35.478$; $\rho = 1000$ kg/m³

Phantom section: Flat Section

Ambient temperature: 21.5°C; Liquid temperature: 22.1°C

DASY5 Configuration:

- Probe: EX3DV4 - SN7509; ConvF(5.23, 5.23, 5.23) @ 5260 MHz; Calibrated: 2020/03/25
- Sensor-Surface: 2mm (Mechanical Surface Detection)
- Electronics: DAE4 Sn558; Calibrated: 2019/10/11
- Phantom: SAM
- DASY52 52.10.4(1527); SEMCAD X 14.6.14(7483)

Area Scan (121x211x1): Interpolated grid: dx=10 mm, dy=10 mm

Maximum value of SAR (interpolated) = 0.240 W/kg

Zoom Scan (7x7x12)/Cube 0: Measurement grid: dx=4mm, dy=4mm, dz=2mm

Reference Value = 2.373 V/m; Power Drift = 0.15 dB

Peak SAR (extrapolated) = 0.353 W/kg

SAR(1 g) = 0.169 W/kg; SAR(10 g) = 0.083 W/kg

Smallest distance from peaks to all points 3 dB below = 12.2 mm

Ratio of SAR at M2 to SAR at M1 = 64.3%

Maximum value of SAR (measured) = 0.244 W/kg

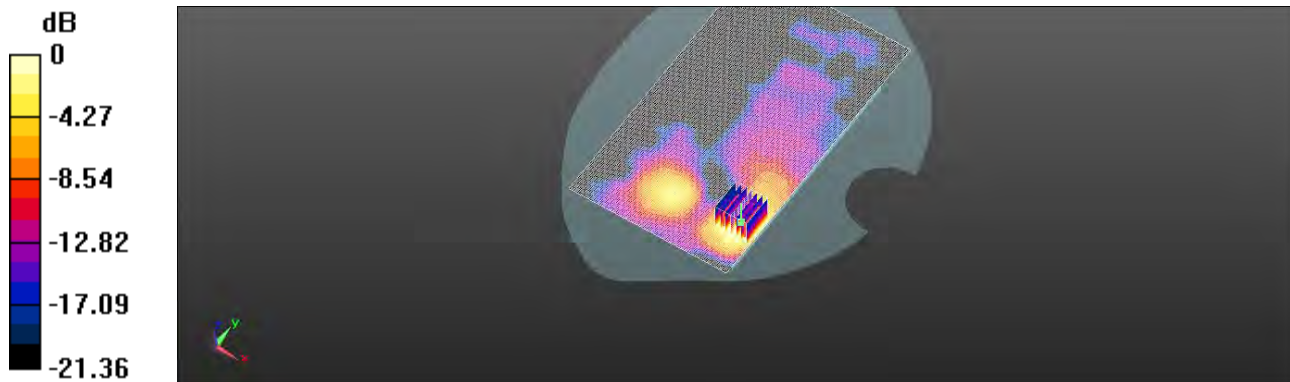

0 dB = 0.244 W/kg = -6.13 dBW/kg

Unless otherwise stated the results shown in this test report refer only to the sample(s) tested and such sample(s) are retained for 90 days only.

除非另有說明，此報告結果僅對測試之樣品負責，同時此樣品僅保留90天。本報告未經本公司書面許可，不可部份複製。

This document is issued by the Company subject to its General Conditions of Service printed overleaf, available on request or accessible at <http://www.sgs.com.tw/Terms-and-Conditions> and for electronic format documents, subject to Terms and Conditions for Electronic Documents at <http://www.sgs.com.tw/Terms-and-Conditions>. Attention is drawn to the limitation of liability, indemnification and jurisdiction issues defined therein. Any holder of this document is advised that information contained hereon reflects the Company's findings at the time of its intervention only and within the limits of Client's instructions, if any. The Company's sole responsibility is to its Client and this document does not exonerate parties to a transaction from exercising all their rights and obligations under the transaction documents. This document cannot be reproduced except in full, without prior written approval of the Company. Any unauthorized alteration, forgery or falsification of the content or appearance of this document is unlawful and offenders may be prosecuted to the fullest extent of the law.

Date: 2020/7/12

Report No. :ES/2020/30005

**WLAN 802.11ac(80M) 5.6G_Body worn_Back side_CH
138_Chain0_Ant4_15mm**

Communication System: Wi-Fi; Frequency: 5690 MHz; Duty cycle= 1:1

Medium parameters used: $f = 5690$ MHz; $\sigma = 5.234$ S/m; $\epsilon_r = 34.835$; $\rho = 1000$ kg/m³

Phantom section: Flat Section

Ambient temperature: 21.9°C; Liquid temperature: 21.5°C

DASY5 Configuration:

- Probe: EX3DV4 - SN3770; ConvF(4.79, 4.79, 4.79) @ 5690 MHz; Calibrated: 2020/5/27
- Sensor-Surface: 2mm (Mechanical Surface Detection)
- Electronics: DAE4 Sn877; Calibrated: 2020/3/17
- Phantom: SAM
- DASY52 52.10.4(1527); SEMCAD X 14.6.14(7483)

Area Scan (111x191x1): Interpolated grid: dx=10 mm, dy=10 mm

Maximum value of SAR (interpolated) = 0.215 W/kg

Zoom Scan (7x7x12)/Cube 0: Measurement grid: dx=4mm, dy=4mm, dz=2mm

Reference Value = 3.385 V/m; Power Drift = 0.16 dB

Peak SAR (extrapolated) = 0.335 W/kg

SAR(1 g) = 0.165 W/kg; SAR(10 g) = 0.090 W/kg

Smallest distance from peaks to all points 3 dB below = 11.6 mm

Ratio of SAR at M2 to SAR at M1 = 59.4%

Maximum value of SAR (measured) = 0.188 W/kg

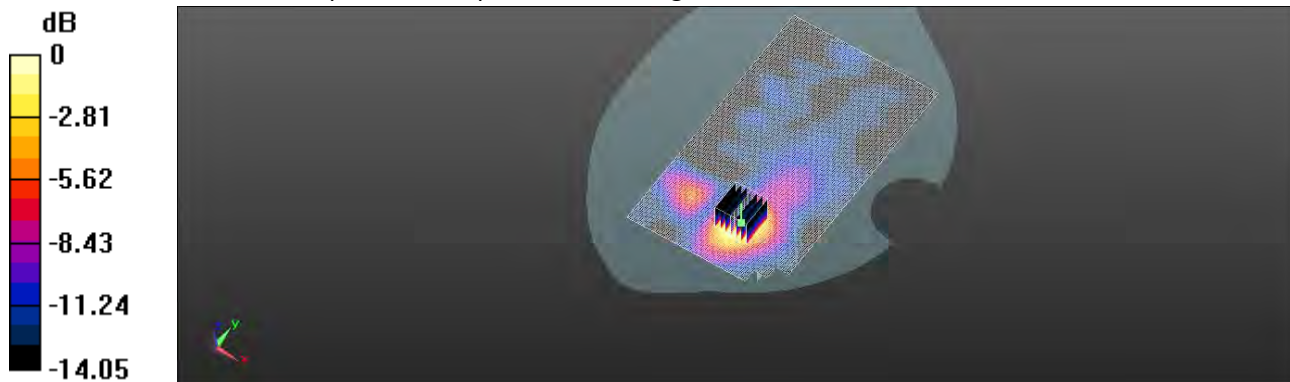

0 dB = 0.188 W/kg = -7.26 dBW/kg

Unless otherwise stated the results shown in this test report refer only to the sample(s) tested and such sample(s) are retained for 90 days only.

除非另有說明，此報告結果僅對測試之樣品負責，同時此樣品僅保留90天。本報告未經本公司書面許可，不可部份複製。

This document is issued by the Company subject to its General Conditions of Service printed overleaf, available on request or accessible at <http://www.sgs.com.tw/Terms-and-Conditions> and for electronic format documents, subject to Terms and Conditions for Electronic Documents at <http://www.sgs.com.tw/Terms-and-Conditions>. Attention is drawn to the limitation of liability, indemnification and jurisdiction issues defined therein. Any holder of this document is advised that information contained hereon reflects the Company's findings at the time of its intervention only and within the limits of Client's instructions, if any. The Company's sole responsibility is to its Client and this document does not exonerate parties to a transaction from exercising all their rights and obligations under the transaction documents. This document cannot be reproduced except in full, without prior written approval of the Company. Any unauthorized alteration, forgery or falsification of the content or appearance of this document is unlawful and offenders may be prosecuted to the fullest extent of the law.

Date: 2020/7/13

Report No. :ES/2020/30005

**WLAN 802.11ac(80M) 5.8G_Body worn_Back side_CH
155_Chain0_Ant4_15mm**

Communication System: WLAN 5G; Frequency: 5775 MHz; Duty cycle= 1:1

Medium parameters used: $f = 5775$ MHz; $\sigma = 5.308$ S/m; $\epsilon_r = 34.656$; $\rho = 1000$ kg/m³

Phantom section: Flat Section

Ambient temperature: 21.4°C; Liquid temperature: 21.7°C

DASY5 Configuration:

- Probe: EX3DV4 - SN7509; ConvF(4.85, 4.85, 4.85) @ 5775 MHz; Calibrated: 2020/03/25
- Sensor-Surface: 2mm (Mechanical Surface Detection)
- Electronics: DAE4 Sn558; Calibrated: 2019/10/11
- Phantom: SAM
- DASY52 52.10.4(1527); SEMCAD X 14.6.14(7483)

Area Scan (111x191x1): Interpolated grid: dx=10 mm, dy=10 mm

Maximum value of SAR (interpolated) = 0.215 W/kg

Zoom Scan (7x7x12)/Cube 0: Measurement grid: dx=4mm, dy=4mm, dz=2mm

Reference Value = 1.769 V/m; Power Drift = 0.11 dB

Peak SAR (extrapolated) = 0.344 W/kg

SAR(1 g) = 0.161 W/kg; SAR(10 g) = 0.081 W/kg

Smallest distance from peaks to all points 3 dB below = 11.5 mm

Ratio of SAR at M2 to SAR at M1 = 58.4%

Maximum value of SAR (measured) = 0.209 W/kg

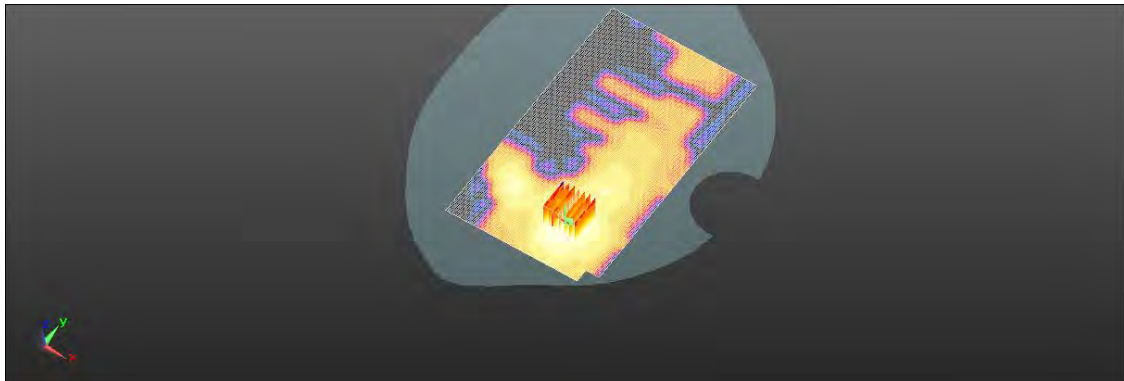
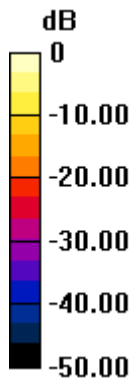

0 dB = 0.209 W/kg = -6.80 dBW/kg

Unless otherwise stated the results shown in this test report refer only to the sample(s) tested and such sample(s) are retained for 90 days only.

除非另有說明，此報告結果僅對測試之樣品負責，同時此樣品僅保留90天。本報告未經本公司書面許可，不可部份複製。

This document is issued by the Company subject to its General Conditions of Service printed overleaf, available on request or accessible at <http://www.sgs.com.tw/Terms-and-Conditions> and for electronic format documents, subject to Terms and Conditions for Electronic Documents at <http://www.sgs.com.tw/Terms-and-Conditions>. Attention is drawn to the limitation of liability, indemnification and jurisdiction issues defined therein. Any holder of this document is advised that information contained hereon reflects the Company's findings at the time of its intervention only and within the limits of Client's instructions, if any. The Company's sole responsibility is to its Client and this document does not exonerate parties to a transaction from exercising all their rights and obligations under the transaction documents. This document cannot be reproduced except in full, without prior written approval of the Company. Any unauthorized alteration, forgery or falsification of the content or appearance of this document is unlawful and offenders may be prosecuted to the fullest extent of the law.

Date: 2020/7/5

Report No. :ES/2020/30005

WLAN 802.11b_Body worn_Back side_CH 11_Chain1_Ant6_15mm

Communication System: WLAN 2.45G; Frequency: 2462 MHz; Duty cycle= 1:1

Medium parameters used: $f = 2462$ MHz; $\sigma = 1.783$ S/m; $\epsilon_r = 38.884$; $\rho = 1000$ kg/m³

Phantom section: Flat Section

Ambient temperature: 22.3°C; Liquid temperature: 22.0°C

DASY5 Configuration:

- Probe: EX3DV4 - SN7509; ConvF(7.51, 7.51, 7.51) @ 2462 MHz; Calibrated: 2020/03/25
- Sensor-Surface: 2mm (Mechanical Surface Detection)
- Electronics: DAE4 Sn558; Calibrated: 2019/10/11
- Phantom: SAM
- DASY52 52.10.4(1527); SEMCAD X 14.6.14(7483)

Area Scan (91x171x1): Interpolated grid: dx=12 mm, dy=12 mm

Maximum value of SAR (interpolated) = 0.0788 W/kg

Zoom Scan (7x7x7)/Cube 0: Measurement grid: dx=5mm, dy=5mm, dz=5mm

Reference Value = 3.443 V/m; Power Drift = 0.16 dB

Peak SAR (extrapolated) = 0.0940 W/kg

SAR(1 g) = 0.059 W/kg; SAR(10 g) = 0.036 W/kg

Smallest distance from peaks to all points 3 dB below: Larger than measurement grid

Ratio of SAR at M2 to SAR at M1 = 63.6%

Maximum value of SAR (measured) = 0.0768 W/kg

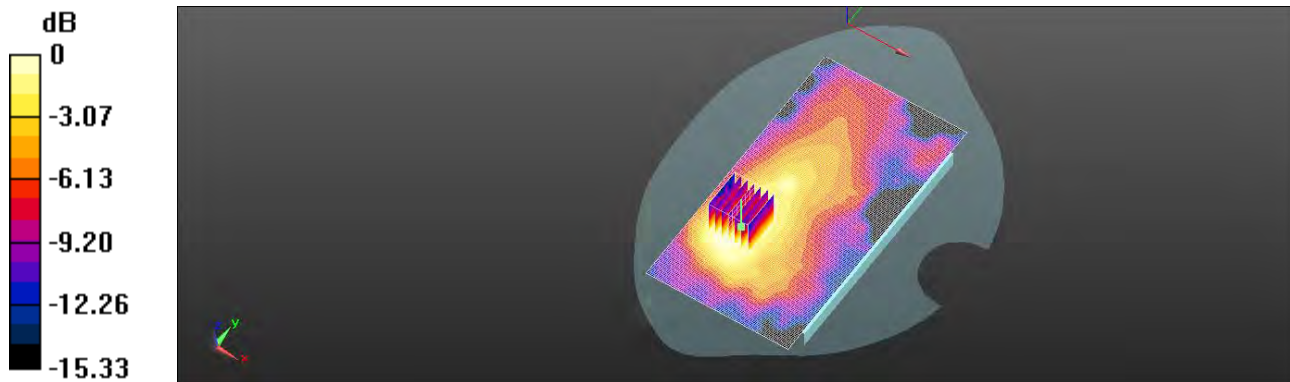

0 dB = 0.0768 W/kg = -11.15 dBW/kg

Unless otherwise stated the results shown in this test report refer only to the sample(s) tested and such sample(s) are retained for 90 days only.

除非另有說明，此報告結果僅對測試之樣品負責，同時此樣品僅保留90天。本報告未經本公司書面許可，不可部份複製。

This document is issued by the Company subject to its General Conditions of Service printed overleaf, available on request or accessible at <http://www.sgs.com.tw/Terms-and-Conditions> and for electronic format documents, subject to Terms and Conditions for Electronic Documents at <http://www.sgs.com.tw/Terms-and-Conditions>. Attention is drawn to the limitation of liability, indemnification and jurisdiction issues defined therein. Any holder of this document is advised that information contained hereon reflects the Company's findings at the time of its intervention only and within the limits of Client's instructions, if any. The Company's sole responsibility is to its Client and this document does not exonerate parties to a transaction from exercising all their rights and obligations under the transaction documents. This document cannot be reproduced except in full, without prior written approval of the Company. Any unauthorized alteration, forgery or falsification of the content or appearance of this document is unlawful and offenders may be prosecuted to the fullest extent of the law.

Date: 2020/7/5

Report No. :ES/2020/30005

BLE_1M_Body worn_Back side_CH 18_Chain1_Ant6_15mm

Communication System: Bluetooth; Frequency: 2442 MHz; Duty cycle= 1:1

Medium parameters used: $f = 2442$ MHz; $\sigma = 1.741$ S/m; $\epsilon_r = 38.897$; $\rho = 1000$ kg/m³

Phantom section: Flat Section

Ambient temperature: 22.3°C; Liquid temperature: 22.0°C

DASY5 Configuration:

- Probe: EX3DV4 - SN7509; ConvF(7.51, 7.51, 7.51) @ 2442 MHz; Calibrated: 2020/03/25
- Sensor-Surface: 2mm (Mechanical Surface Detection)
- Electronics: DAE4 Sn558; Calibrated: 2019/10/11
- Phantom: SAM
- DASY52 52.10.4(1527); SEMCAD X 14.6.14(7483)

Area Scan (91x171x1): Interpolated grid: dx=12 mm, dy=12 mm

Maximum value of SAR (interpolated) = 0.0162 W/kg

Zoom Scan (7x7x7)/Cube 0: Measurement grid: dx=5mm, dy=5mm, dz=5mm

Reference Value = 1.063 V/m; Power Drift = 0.17 dB

Peak SAR (extrapolated) = 0.0160 W/kg

SAR(1 g) = 0.010 W/kg; SAR(10 g) = 0.00483 W/kg

Smallest distance from peaks to all points 3 dB below: Larger than measurement grid

Ratio of SAR at M2 to SAR at M1 = 59.2%

Maximum value of SAR (measured) = 0.0133 W/kg

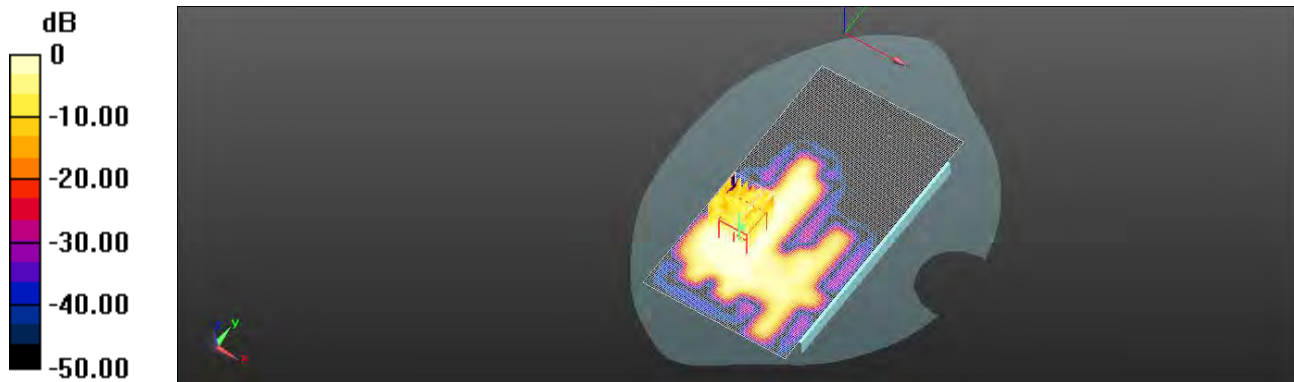

0 dB = 0.0133 W/kg = -18.76 dBW/kg

Unless otherwise stated the results shown in this test report refer only to the sample(s) tested and such sample(s) are retained for 90 days only.

除非另有說明，此報告結果僅對測試之樣品負責，同時此樣品僅保留90天。本報告未經本公司書面許可，不可部份複製。

This document is issued by the Company subject to its General Conditions of Service printed overleaf, available on request or accessible at <http://www.sgs.com.tw/Terms-and-Conditions> and for electronic format documents, subject to Terms and Conditions for Electronic Documents at <http://www.sgs.com.tw/Terms-and-Conditions>. Attention is drawn to the limitation of liability, indemnification and jurisdiction issues defined therein. Any holder of this document is advised that information contained hereon reflects the Company's findings at the time of its intervention only and within the limits of Client's instructions, if any. The Company's sole responsibility is to its Client and this document does not exonerate parties to a transaction from exercising all their rights and obligations under the transaction documents. This document cannot be reproduced except in full, without prior written approval of the Company. Any unauthorized alteration, forgery or falsification of the content or appearance of this document is unlawful and offenders may be prosecuted to the fullest extent of the law.

Date: 2020/7/10

Report No. :ES/2020/30005

WLAN 802.11n(40M) 5.2G_Body worn_Back side_CH 46_Chain1_Ant6_15mm

Communication System: Wi-Fi; Frequency: 5230 MHz; Duty cycle= 1:1

Medium parameters used: $f = 5230 \text{ MHz}$; $\sigma = 4.734 \text{ S/m}$; $\epsilon_r = 35.583$; $\rho = 1000 \text{ kg/m}^3$

Phantom section: Flat Section

Ambient temperature: 22.1°C; Liquid temperature: 21.8°C

DASY5 Configuration:

- Probe: EX3DV4 - SN7509; ConvF(5.33, 5.33, 5.33) @ 5230 MHz; Calibrated: 2020/03/25
- Sensor-Surface: 2mm (Mechanical Surface Detection)
- Electronics: DAE4 Sn558; Calibrated: 2019/10/11
- Phantom: SAM
- DASY52 52.10.4(1527); SEMCAD X 14.6.14(7483)

Area Scan (111x201x1): Interpolated grid: dx=10 mm, dy=10 mm

Maximum value of SAR (interpolated) = 0.394 W/kg

Zoom Scan (7x7x12)/Cube 0: Measurement grid: dx=4mm, dy=4mm, dz=2mm

Reference Value = 1.264 V/m; Power Drift = 0.14 dB

Peak SAR (extrapolated) = 0.611 W/kg

SAR(1 g) = 0.217 W/kg; SAR(10 g) = 0.078 W/kg

Smallest distance from peaks to all points 3 dB below = 8.9 mm

Ratio of SAR at M2 to SAR at M1 = 61.2%

Maximum value of SAR (measured) = 0.408 W/kg

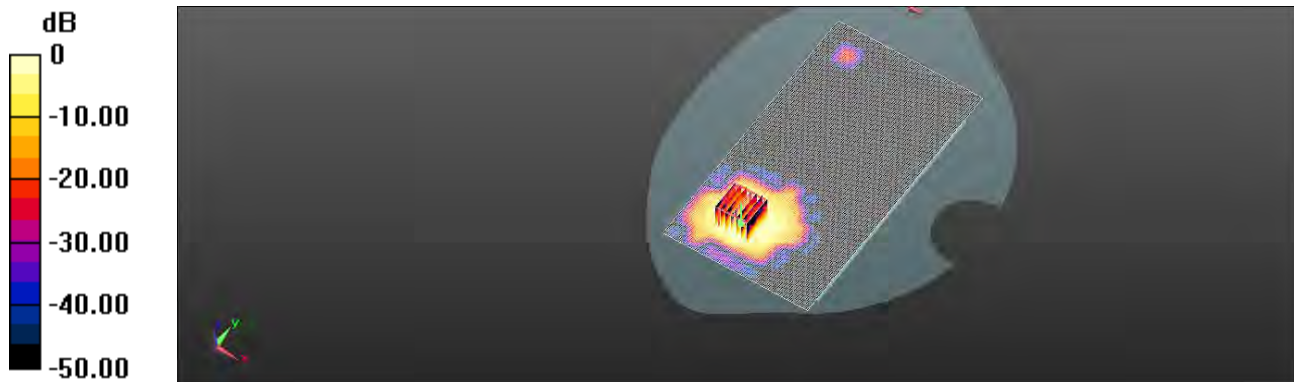

0 dB = 0.408 W/kg = -3.89 dBW/kg

Unless otherwise stated the results shown in this test report refer only to the sample(s) tested and such sample(s) are retained for 90 days only.

除非另有說明，此報告結果僅對測試之樣品負責，同時此樣品僅保留90天。本報告未經本公司書面許可，不可部份複製。

This document is issued by the Company subject to its General Conditions of Service printed overleaf, available on request or accessible at <http://www.sgs.com.tw/Terms-and-Conditions> and for electronic format documents, subject to Terms and Conditions for Electronic Documents at <http://www.sgs.com.tw/Terms-and-Conditions>. Attention is drawn to the limitation of liability, indemnification and jurisdiction issues defined therein. Any holder of this document is advised that information contained hereon reflects the Company's findings at the time of its intervention only and within the limits of Client's instructions, if any. The Company's sole responsibility is to its Client and this document does not exonerate parties to a transaction from exercising all their rights and obligations under the transaction documents. This document cannot be reproduced except in full, without prior written approval of the Company. Any unauthorized alteration, forgery or falsification of the content or appearance of this document is unlawful and offenders may be prosecuted to the fullest extent of the law.

Date: 2020/7/11

Report No. :ES/2020/30005

WLAN 802.11n(20M) 5.3G_Body worn_Back side_CH 60_Chain1_Ant6_15mm

Communication System: WLAN 5G; Frequency: 5300 MHz; Duty cycle= 1:1

Medium parameters used: $f = 5300 \text{ MHz}$; $\sigma = 4.835 \text{ S/m}$; $\epsilon_r = 35.425$; $\rho = 1000 \text{ kg/m}^3$

Phantom section: Flat Section

Ambient temperature: 21.5°C; Liquid temperature: 22.1°C

DASY5 Configuration:

- Probe: EX3DV4 - SN7509; ConvF(5.23, 5.23, 5.23) @ 5300 MHz; Calibrated: 2020/03/25
- Sensor-Surface: 2mm (Mechanical Surface Detection)
- Electronics: DAE4 Sn558; Calibrated: 2019/10/11
- Phantom: SAM
- DASY52 52.10.4(1527); SEMCAD X 14.6.14(7483)

Area Scan (111x201x1): Interpolated grid: dx=10 mm, dy=10 mm

Maximum value of SAR (interpolated) = 0.872 W/kg

Zoom Scan (7x7x12)/Cube 0: Measurement grid: dx=4mm, dy=4mm, dz=2mm

Reference Value = 1.134 V/m; Power Drift = 0.18 dB

Peak SAR (extrapolated) = 1.18 W/kg

SAR(1 g) = 0.485 W/kg; SAR(10 g) = 0.189 W/kg

Smallest distance from peaks to all points 3 dB below = 8.8 mm

Ratio of SAR at M2 to SAR at M1 = 67.2%

Maximum value of SAR (measured) = 0.844 W/kg

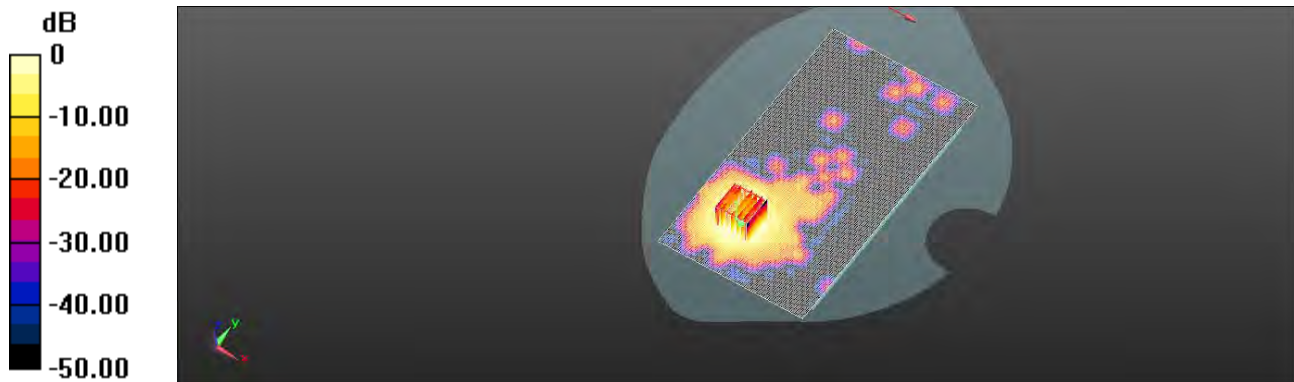

0 dB = 0.844 W/kg = -0.74 dBW/kg

Unless otherwise stated the results shown in this test report refer only to the sample(s) tested and such sample(s) are retained for 90 days only.

除非另有說明，此報告結果僅對測試之樣品負責，同時此樣品僅保留90天。本報告未經本公司書面許可，不可部份複製。

This document is issued by the Company subject to its General Conditions of Service printed overleaf, available on request or accessible at <http://www.sgs.com.tw/Terms-and-Conditions> and for electronic format documents, subject to Terms and Conditions for Electronic Documents at <http://www.sgs.com.tw/Terms-and-Conditions>. Attention is drawn to the limitation of liability, indemnification and jurisdiction issues defined therein. Any holder of this document is advised that information contained hereon reflects the Company's findings at the time of its intervention only and within the limits of Client's instructions, if any. The Company's sole responsibility is to its Client and this document does not exonerate parties to a transaction from exercising all their rights and obligations under the transaction documents. This document cannot be reproduced except in full, without prior written approval of the Company. Any unauthorized alteration, forgery or falsification of the content or appearance of this document is unlawful and offenders may be prosecuted to the fullest extent of the law.

Date: 2020/7/12

Report No. :ES/2020/30005

WLAN 802.11a 5.6G_Body worn_Back side_CH 100_Chain1_Ant6_15mm

Communication System: Wi-Fi; Frequency: 5500 MHz; Duty cycle= 1:1

Medium parameters used: $f = 5500 \text{ MHz}$; $\sigma = 5.027 \text{ S/m}$; $\epsilon_r = 35.407$; $\rho = 1000 \text{ kg/m}^3$

Phantom section: Flat Section

Ambient temperature: 21.9°C; Liquid temperature: 21.5°C

DASY5 Configuration:

- Probe: EX3DV4 - SN7509; ConvF(4.64, 4.64, 4.64) @ 5500 MHz; Calibrated: 2020/03/25
- Sensor-Surface: 2mm (Mechanical Surface Detection)
- Electronics: DAE4 Sn558; Calibrated: 2019/10/11
- Phantom: SAM
- DASY52 52.10.4(1527); SEMCAD X 14.6.14(7483)

Area Scan (111x201x1): Interpolated grid: dx=10 mm, dy=10 mm

Maximum value of SAR (interpolated) = 0.497 W/kg

Zoom Scan (7x7x12)/Cube 0: Measurement grid: dx=4mm, dy=4mm, dz=2mm

Reference Value = 1.148 V/m; Power Drift = -0.12 dB

Peak SAR (extrapolated) = 1.75 W/kg

SAR(1 g) = 0.204 W/kg; SAR(10 g) = 0.050 W/kg

Smallest distance from peaks to all points 3 dB below = 1.6 mm

Ratio of SAR at M2 to SAR at M1 = 67.5%

Maximum value of SAR (measured) = 0.575 W/kg

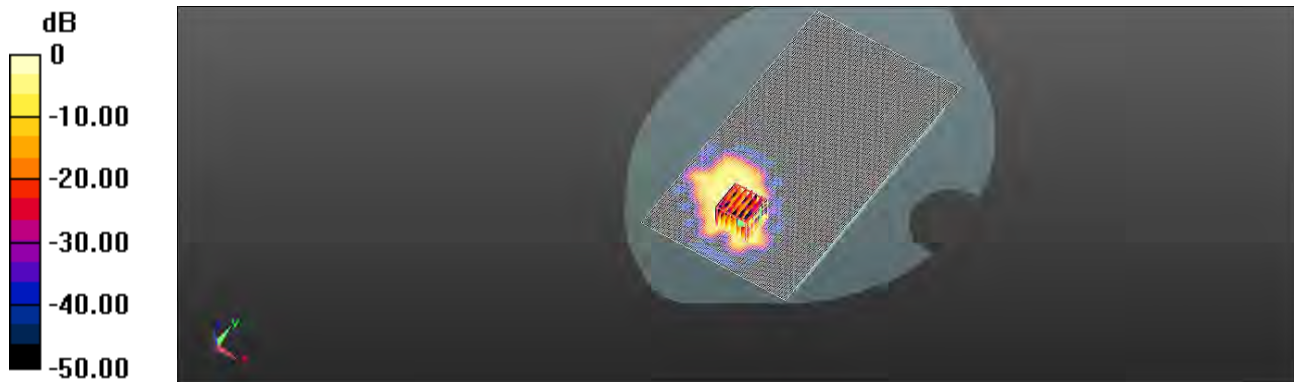

0 dB = 0.575 W/kg = -2.40 dBW/kg

Unless otherwise stated the results shown in this test report refer only to the sample(s) tested and such sample(s) are retained for 90 days only.

除非另有說明，此報告結果僅對測試之樣品負責，同時此樣品僅保留90天。本報告未經本公司書面許可，不可部份複製。

This document is issued by the Company subject to its General Conditions of Service printed overleaf, available on request or accessible at <http://www.sgs.com.tw/Terms-and-Conditions> and for electronic format documents, subject to Terms and Conditions for Electronic Documents at <http://www.sgs.com.tw/Terms-and-Conditions>. Attention is drawn to the limitation of liability, indemnification and jurisdiction issues defined therein. Any holder of this document is advised that information contained hereon reflects the Company's findings at the time of its intervention only and within the limits of Client's instructions, if any. The Company's sole responsibility is to its Client and this document does not exonerate parties to a transaction from exercising all their rights and obligations under the transaction documents. This document cannot be reproduced except in full, without prior written approval of the Company. Any unauthorized alteration, forgery or falsification of the content or appearance of this document is unlawful and offenders may be prosecuted to the fullest extent of the law.

Date: 2020/7/13

Report No. :ES/2020/30005

**WLAN 802.11ac(80M) 5.8G_Body worn_Back side_CH
155_Chain1_Ant6_15mm**

Communication System: Wi-Fi; Frequency: 5775 MHz; Duty cycle= 1:1

Medium parameters used: $f = 5775$ MHz; $\sigma = 5.308$ S/m; $\epsilon_r = 34.656$; $\rho = 1000$ kg/m³

Phantom section: Flat Section

Ambient temperature: 21.4°C; Liquid temperature: 21.7°C

DASY5 Configuration:

- Probe: EX3DV4 - SN7509; ConvF(4.85, 4.85, 4.85) @ 5775 MHz; Calibrated: 2020/03/25
- Sensor-Surface: 2mm (Mechanical Surface Detection)
- Electronics: DAE4 Sn558; Calibrated: 2019/10/11
- Phantom: SAM
- DASY52 52.10.4(1527); SEMCAD X 14.6.14(7483)

Area Scan (111x201x1): Interpolated grid: dx=10 mm, dy=10 mm

Maximum value of SAR (interpolated) = 0.549 W/kg

Zoom Scan (7x7x12)/Cube 0: Measurement grid: dx=4mm, dy=4mm, dz=2mm

Reference Value = 1.876 V/m; Power Drift = 0.16 dB

Peak SAR (extrapolated) = 0.650 W/kg

SAR(1 g) = 0.291 W/kg; SAR(10 g) = 0.108 W/kg

Smallest distance from peaks to all points 3 dB below = 7.4 mm

Ratio of SAR at M2 to SAR at M1 = 70.8%

Maximum value of SAR (measured) = 0.522 W/kg

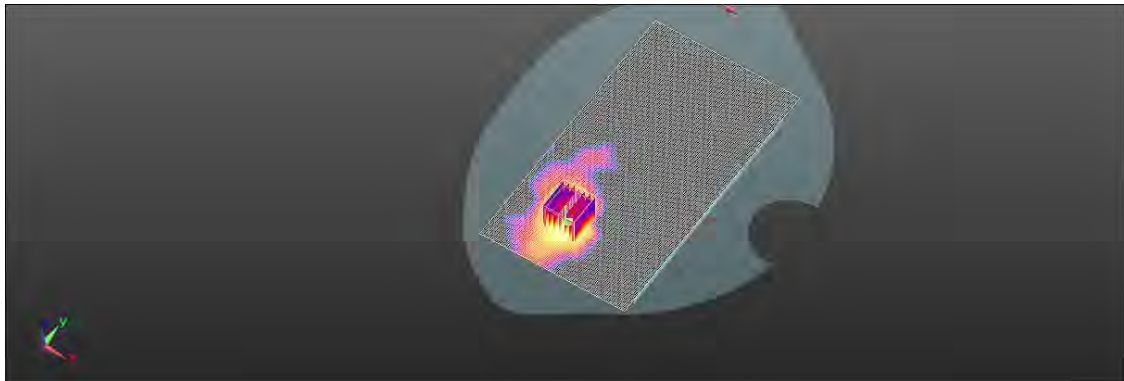
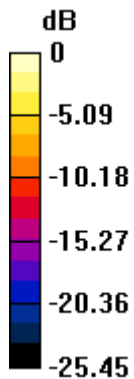

0 dB = 0.522 W/kg = -2.82 dBW/kg

Unless otherwise stated the results shown in this test report refer only to the sample(s) tested and such sample(s) are retained for 90 days only.

除非另有說明，此報告結果僅對測試之樣品負責，同時此樣品僅保留90天。本報告未經本公司書面許可，不可部份複製。

This document is issued by the Company subject to its General Conditions of Service printed overleaf, available on request or accessible at <http://www.sgs.com.tw/Terms-and-Conditions> and for electronic format documents, subject to Terms and Conditions for Electronic Documents at <http://www.sgs.com.tw/Terms-and-Conditions>. Attention is drawn to the limitation of liability, indemnification and jurisdiction issues defined therein. Any holder of this document is advised that information contained hereon reflects the Company's findings at the time of its intervention only and within the limits of Client's instructions, if any. The Company's sole responsibility is to its Client and this document does not exonerate parties to a transaction from exercising all their rights and obligations under the transaction documents. This document cannot be reproduced except in full, without prior written approval of the Company. Any unauthorized alteration, forgery or falsification of the content or appearance of this document is unlawful and offenders may be prosecuted to the fullest extent of the law.

Date: 2020/7/5

Report No. :ES/2020/30005

WLAN 802.11b_Body worn_Back side_CH 1_Chain0_Ant6_15mm

Communication System: Wi-Fi; Frequency: 2412 MHz; Duty cycle= 1:1

Medium parameters used: $f = 2412$ MHz; $\sigma = 1.706$ S/m; $\epsilon_r = 38.952$; $\rho = 1000$ kg/m³

Phantom section: Flat Section

Ambient temperature: 21.7°C; Liquid temperature: 22.1°C

DASY5 Configuration:

- Probe: EX3DV4 - SN7509; ConvF(7.51, 7.51, 7.51) @ 2412 MHz; Calibrated: 2020/03/25
- Sensor-Surface: 2mm (Mechanical Surface Detection)
- Electronics: DAE4 Sn558; Calibrated: 2019/10/11
- Phantom: SAM
- DASY52 52.10.4(1527); SEMCAD X 14.6.14(7483)

Area Scan (101x171x1): Interpolated grid: dx=12 mm, dy=12 mm

Maximum value of SAR (interpolated) = 0.0997 W/kg

Zoom Scan (7x7x7)/Cube 0: Measurement grid: dx=5mm, dy=5mm, dz=5mm

Reference Value = 3.733 V/m; Power Drift = 0.09 dB

Peak SAR (extrapolated) = 0.117 W/kg

SAR(1 g) = 0.072 W/kg; SAR(10 g) = 0.044 W/kg

Smallest distance from peaks to all points 3 dB below: Larger than measurement grid

Ratio of SAR at M2 to SAR at M1 = 60.5%

Maximum value of SAR (measured) = 0.0950 W/kg

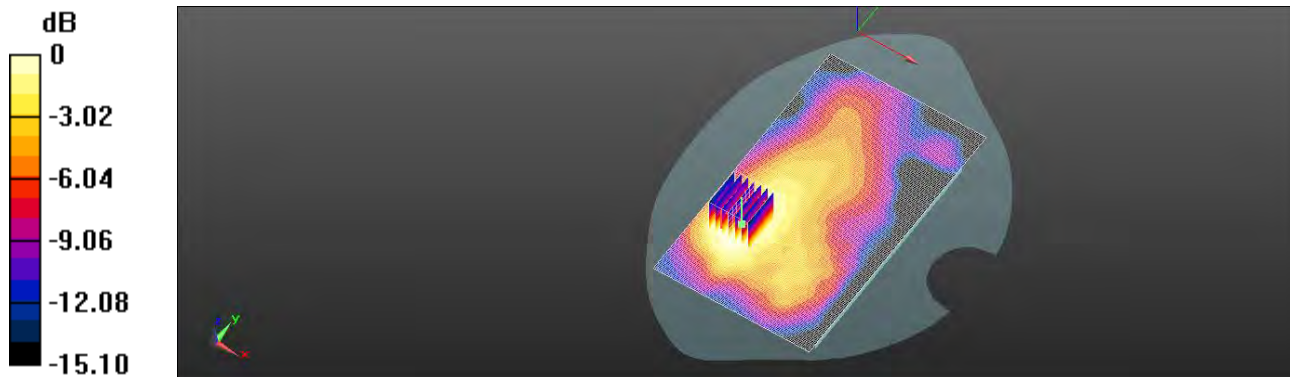

0 dB = 0.0950 W/kg = -10.22 dBW/kg

Unless otherwise stated the results shown in this test report refer only to the sample(s) tested and such sample(s) are retained for 90 days only.

除非另有說明，此報告結果僅對測試之樣品負責，同時此樣品僅保留90天。本報告未經本公司書面許可，不可部份複製。

This document is issued by the Company subject to its General Conditions of Service printed overleaf, available on request or accessible at <http://www.sgs.com.tw/Terms-and-Conditions> and for electronic format documents, subject to Terms and Conditions for Electronic Documents at <http://www.sgs.com.tw/Terms-and-Conditions>. Attention is drawn to the limitation of liability, indemnification and jurisdiction issues defined therein. Any holder of this document is advised that information contained hereon reflects the Company's findings at the time of its intervention only and within the limits of Client's instructions, if any. The Company's sole responsibility is to its Client and this document does not exonerate parties to a transaction from exercising all their rights and obligations under the transaction documents. This document cannot be reproduced except in full, without prior written approval of the Company. Any unauthorized alteration, forgery or falsification of the content or appearance of this document is unlawful and offenders may be prosecuted to the fullest extent of the law.

Date: 2020/7/5

Report No. :ES/2020/30005

BLE_1M_Body worn_Back side_CH 18_Chain0_Ant6_15mm

Communication System: Bluetooth; Frequency: 2442 MHz; Duty cycle= 1:1

Medium parameters used: $f = 2442 \text{ MHz}$; $\sigma = 1.741 \text{ S/m}$; $\epsilon_r = 38.897$; $\rho = 1000 \text{ kg/m}^3$

Phantom section: Flat Section

Ambient temperature: 21.7°C; Liquid temperature: 22.1°C

DASY5 Configuration:

- Probe: EX3DV4 - SN7509; ConvF(7.51, 7.51, 7.51) @ 2442 MHz; Calibrated: 2020/03/25
- Sensor-Surface: 2mm (Mechanical Surface Detection)
- Electronics: DAE4 Sn558; Calibrated: 2019/10/11
- Phantom: SAM
- DASY52 52.10.4(1527); SEMCAD X 14.6.14(7483)

Area Scan (101x171x1): Interpolated grid: $dx=12 \text{ mm}$, $dy=12 \text{ mm}$

Maximum value of SAR (interpolated) = 0.0202 W/kg

Zoom Scan (7x7x7)/Cube 0: Measurement grid: $dx=5\text{mm}$, $dy=5\text{mm}$, $dz=5\text{mm}$

Reference Value = 1.781 V/m; Power Drift = 0.18 dB

Peak SAR (extrapolated) = 0.0260 W/kg

SAR(1 g) = 0.016 W/kg; SAR(10 g) = 0.00858 W/kg

Smallest distance from peaks to all points 3 dB below: Larger than measurement grid

Ratio of SAR at M2 to SAR at M1 = 60.3%

Maximum value of SAR (measured) = 0.0208 W/kg

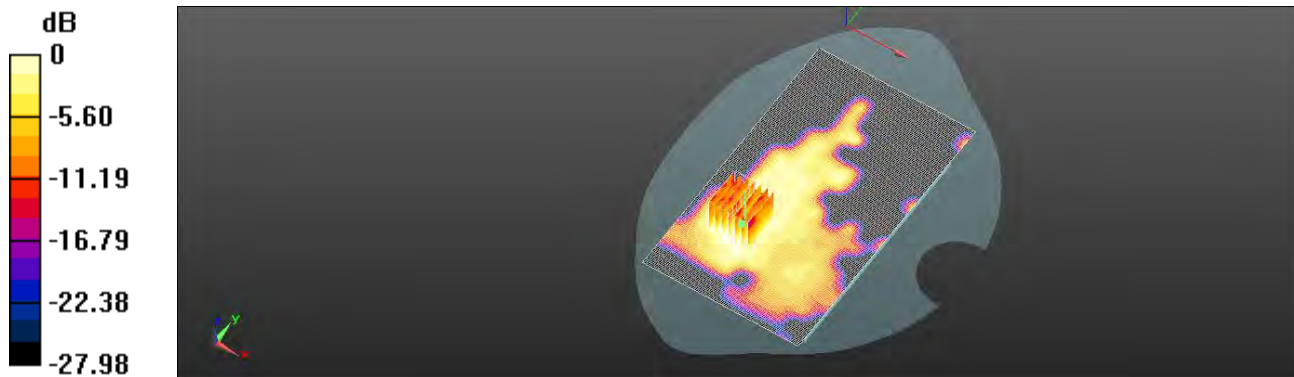

0 dB = 0.0208 W/kg = -16.82 dBW/kg

Unless otherwise stated the results shown in this test report refer only to the sample(s) tested and such sample(s) are retained for 90 days only.

除非另有說明，此報告結果僅對測試之樣品負責，同時此樣品僅保留90天。本報告未經本公司書面許可，不可部份複製。

This document is issued by the Company subject to its General Conditions of Service printed overleaf, available on request or accessible at <http://www.sgs.com.tw/Terms-and-Conditions> and for electronic format documents, subject to Terms and Conditions for Electronic Documents at <http://www.sgs.com.tw/Terms-and-Conditions>. Attention is drawn to the limitation of liability, indemnification and jurisdiction issues defined therein. Any holder of this document is advised that information contained hereon reflects the Company's findings at the time of its intervention only and within the limits of Client's instructions, if any. The Company's sole responsibility is to its Client and this document does not exonerate parties to a transaction from exercising all their rights and obligations under the transaction documents. This document cannot be reproduced except in full, without prior written approval of the Company. Any unauthorized alteration, forgery or falsification of the content or appearance of this document is unlawful and offenders may be prosecuted to the fullest extent of the law.

Date: 2020/7/10

Report No. :ES/2020/30005

WLAN 802.11n(40M) 5.2G_Body worn_Back side_CH 46_Chain0_Ant6_15mm

Communication System: Wi-Fi; Frequency: 5230 MHz; Duty cycle= 1:1

Medium parameters used: $f = 5230 \text{ MHz}$; $\sigma = 4.734 \text{ S/m}$; $\epsilon_r = 35.583$; $\rho = 1000 \text{ kg/m}^3$

Phantom section: Flat Section

Ambient temperature: 21.4°C; Liquid temperature: 21.8°C

DASY5 Configuration:

- Probe: EX3DV4 - SN7509; ConvF(5.33, 5.33, 5.33) @ 5230 MHz; Calibrated: 2020/03/25
- Sensor-Surface: 2mm (Mechanical Surface Detection)
- Electronics: DAE4 Sn558; Calibrated: 2019/10/11
- Phantom: SAM
- DASY52 52.10.4(1527); SEMCAD X 14.6.14(7483)

Area Scan (111x211x1): Interpolated grid: dx=10 mm, dy=10 mm

Maximum value of SAR (interpolated) = 0.658 W/kg

Zoom Scan (7x7x12)/Cube 0: Measurement grid: dx=4mm, dy=4mm, dz=2mm

Reference Value = 1.023 V/m; Power Drift = 0.03 dB

Peak SAR (extrapolated) = 0.923 W/kg

SAR(1 g) = 0.362 W/kg; SAR(10 g) = 0.136 W/kg

Smallest distance from peaks to all points 3 dB below = 9.7 mm

Ratio of SAR at M2 to SAR at M1 = 63.2%

Maximum value of SAR (measured) = 0.672 W/kg

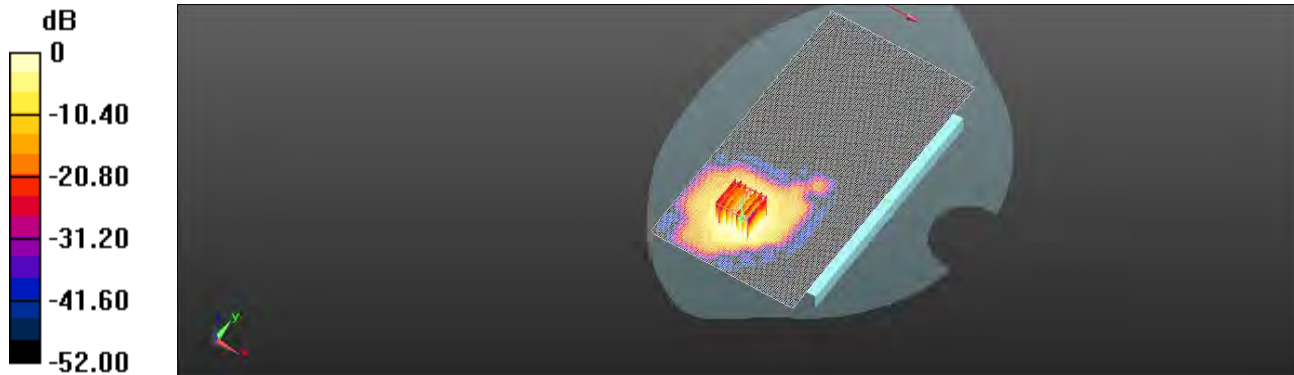

0 dB = 0.672 W/kg = -1.73 dBW/kg

Unless otherwise stated the results shown in this test report refer only to the sample(s) tested and such sample(s) are retained for 90 days only.

除非另有說明，此報告結果僅對測試之樣品負責，同時此樣品僅保留90天。本報告未經本公司書面許可，不可部份複製。

This document is issued by the Company subject to its General Conditions of Service printed overleaf, available on request or accessible at <http://www.sgs.com.tw/Terms-and-Conditions> and for electronic format documents, subject to Terms and Conditions for Electronic Documents at <http://www.sgs.com.tw/Terms-and-Conditions>. Attention is drawn to the limitation of liability, indemnification and jurisdiction issues defined therein. Any holder of this document is advised that information contained hereon reflects the Company's findings at the time of its intervention only and within the limits of Client's instructions, if any. The Company's sole responsibility is to its Client and this document does not exonerate parties to a transaction from exercising all their rights and obligations under the transaction documents. This document cannot be reproduced except in full, without prior written approval of the Company. Any unauthorized alteration, forgery or falsification of the content or appearance of this document is unlawful and offenders may be prosecuted to the fullest extent of the law.

Date: 2020/7/11

Report No. :ES/2020/30005

WLAN 802.11a 5.3G_Body worn_Back side_CH 52_Chain0_Ant6_15mm

Communication System: WLAN 5G; Frequency: 5260 MHz; Duty cycle= 1:1

Medium parameters used: $f = 5260$ MHz; $\sigma = 4.787$ S/m; $\epsilon_r = 35.478$; $\rho = 1000$ kg/m³

Phantom section: Flat Section

Ambient temperature: 22.0°C; Liquid temperature: 21.6°C

DASY5 Configuration:

- Probe: EX3DV4 - SN7509; ConvF(5.23, 5.23, 5.23) @ 5260 MHz; Calibrated: 2020/03/25
- Sensor-Surface: 2mm (Mechanical Surface Detection)
- Electronics: DAE4 Sn558; Calibrated: 2019/10/11
- Phantom: SAM
- DASY52 52.10.4(1527); SEMCAD X 14.6.14(7483)

Area Scan (111x211x1): Interpolated grid: dx=10 mm, dy=10 mm

Maximum value of SAR (interpolated) = 1.57 W/kg

Zoom Scan (7x7x12)/Cube 0: Measurement grid: dx=4mm, dy=4mm, dz=2mm

Reference Value = 1.791 V/m; Power Drift = 0.13 dB

Peak SAR (extrapolated) = 2.17 W/kg

SAR(1 g) = 0.880 W/kg; SAR(10 g) = 0.346 W/kg

Smallest distance from peaks to all points 3 dB below = 10.6 mm

Ratio of SAR at M2 to SAR at M1 = 66.5%

Maximum value of SAR (measured) = 1.56 W/kg

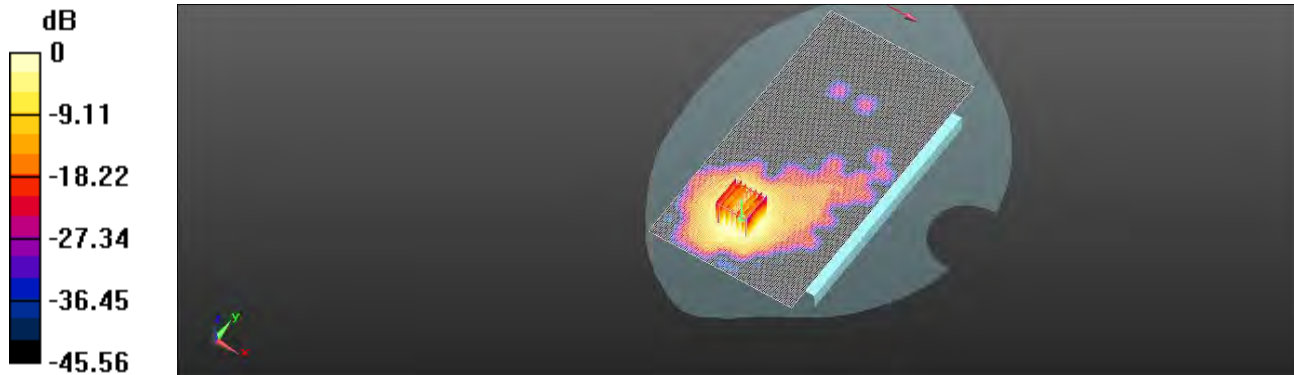

0 dB = 1.56 W/kg = 1.93 dBW/kg

Unless otherwise stated the results shown in this test report refer only to the sample(s) tested and such sample(s) are retained for 90 days only.

除非另有說明，此報告結果僅對測試之樣品負責，同時此樣品僅保留90天。本報告未經本公司書面許可，不可部份複製。

This document is issued by the Company subject to its General Conditions of Service printed overleaf, available on request or accessible at <http://www.sgs.com.tw/Terms-and-Conditions> and for electronic format documents, subject to Terms and Conditions for Electronic Documents at <http://www.sgs.com.tw/Terms-and-Conditions>. Attention is drawn to the limitation of liability, indemnification and jurisdiction issues defined therein. Any holder of this document is advised that information contained hereon reflects the Company's findings at the time of its intervention only and within the limits of Client's instructions, if any. The Company's sole responsibility is to its Client and this document does not exonerate parties to a transaction from exercising all their rights and obligations under the transaction documents. This document cannot be reproduced except in full, without prior written approval of the Company. Any unauthorized alteration, forgery or falsification of the content or appearance of this document is unlawful and offenders may be prosecuted to the fullest extent of the law.

Date: 2020/7/12

Report No. :ES/2020/30005

**WLAN 802.11ac(80M) 5.6G_Body worn_Back side_CH
138_Chain0_Ant6_15mm**

Communication System: WLAN 5G; Frequency: 5690 MHz; Duty cycle= 1:1
Medium parameters used: $f = 5690$ MHz; $\sigma = 5.234$ S/m; $\epsilon_r = 34.835$; $\rho = 1000$ kg/m³
Phantom section: Flat Section
Ambient temperature: 21.6°C; Liquid temperature: 22.1°C

DASY5 Configuration:

- Probe: EX3DV4 - SN7509; ConvF(4.64, 4.64, 4.64) @ 5690 MHz; Calibrated: 2020/03/25
- Sensor-Surface: 2mm (Mechanical Surface Detection)
- Electronics: DAE4 Sn558; Calibrated: 2019/10/11
- Phantom: SAM
- DASY52 52.10.4(1527); SEMCAD X 14.6.14(7483)

Area Scan (111x211x1): Interpolated grid: dx=10 mm, dy=10 mm

Maximum value of SAR (interpolated) = 0.512 W/kg

Zoom Scan (7x7x12)/Cube 0: Measurement grid: dx=4mm, dy=4mm, dz=2mm

Reference Value = 1.319 V/m; Power Drift = 0.13 dB

Peak SAR (extrapolated) = 0.681 W/kg

SAR(1 g) = 0.321 W/kg; SAR(10 g) = 0.132 W/kg

Smallest distance from peaks to all points 3 dB below = 7.7 mm

Ratio of SAR at M2 to SAR at M1 = 73.1%

Maximum value of SAR (measured) = 0.544 W/kg

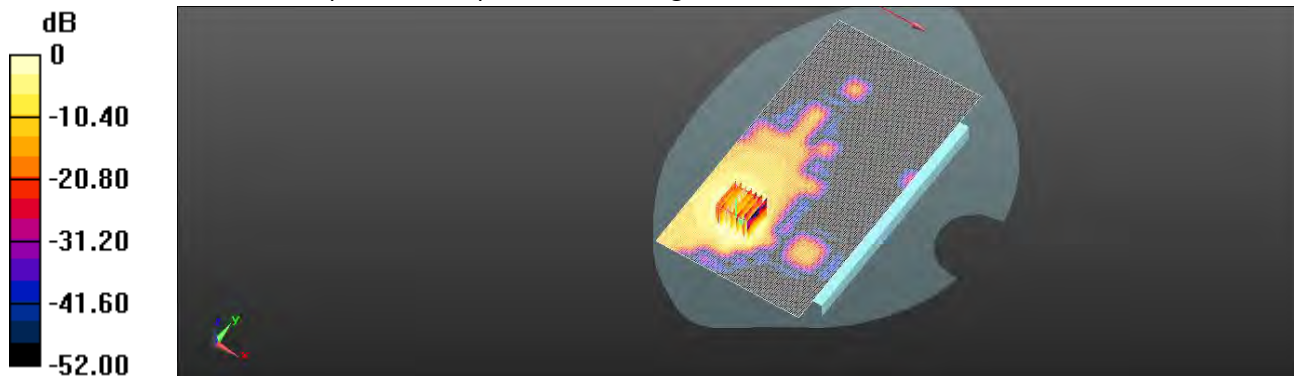

0 dB = 0.544 W/kg = -2.64 dBW/kg

Unless otherwise stated the results shown in this test report refer only to the sample(s) tested and such sample(s) are retained for 90 days only.

除非另有說明，此報告結果僅對測試之樣品負責，同時此樣品僅保留90天。本報告未經本公司書面許可，不可部份複製。

This document is issued by the Company subject to its General Conditions of Service printed overleaf, available on request or accessible at <http://www.sgs.com.tw/Terms-and-Conditions> and for electronic format documents, subject to Terms and Conditions for Electronic Documents at <http://www.sgs.com.tw/Terms-and-Conditions>. Attention is drawn to the limitation of liability, indemnification and jurisdiction issues defined therein. Any holder of this document is advised that information contained hereon reflects the Company's findings at the time of its intervention only and within the limits of Client's instructions, if any. The Company's sole responsibility is to its Client and this document does not exonerate parties to a transaction from exercising all their rights and obligations under the transaction documents. This document cannot be reproduced except in full, without prior written approval of the Company. Any unauthorized alteration, forgery or falsification of the content or appearance of this document is unlawful and offenders may be prosecuted to the fullest extent of the law.

Date: 2020/7/13

Report No. :ES/2020/30005

**WLAN 802.11ac(80M) 5.8G_Body worn_Back side_CH
155_Chain0_Ant6_15mm**

Communication System: WLAN 5G; Frequency: 5775 MHz; Duty cycle= 1:1

Medium parameters used: $f = 5775$ MHz; $\sigma = 5.308$ S/m; $\epsilon_r = 34.656$; $\rho = 1000$ kg/m³

Phantom section: Flat Section

Ambient temperature: 21.5°C; Liquid temperature: 21.9°C

DASY5 Configuration:

- Probe: EX3DV4 - SN7509; ConvF(4.85, 4.85, 4.85) @ 5775 MHz; Calibrated: 2020/03/25
- Sensor-Surface: 2mm (Mechanical Surface Detection)
- Electronics: DAE4 Sn558; Calibrated: 2019/10/11
- Phantom: SAM
- DASY52 52.10.4(1527); SEMCAD X 14.6.14(7483)

Area Scan (111x211x1): Interpolated grid: dx=10 mm, dy=10 mm

Maximum value of SAR (interpolated) = 0.656 W/kg

Zoom Scan (7x7x12)/Cube 0: Measurement grid: dx=4mm, dy=4mm, dz=2mm

Reference Value = 1.012 V/m; Power Drift = 0.06 dB

Peak SAR (extrapolated) = 0.912 W/kg

SAR(1 g) = 0.374 W/kg; SAR(10 g) = 0.144 W/kg

Smallest distance from peaks to all points 3 dB below = 8.7 mm

Ratio of SAR at M2 to SAR at M1 = 66.7%

Maximum value of SAR (measured) = 0.704 W/kg

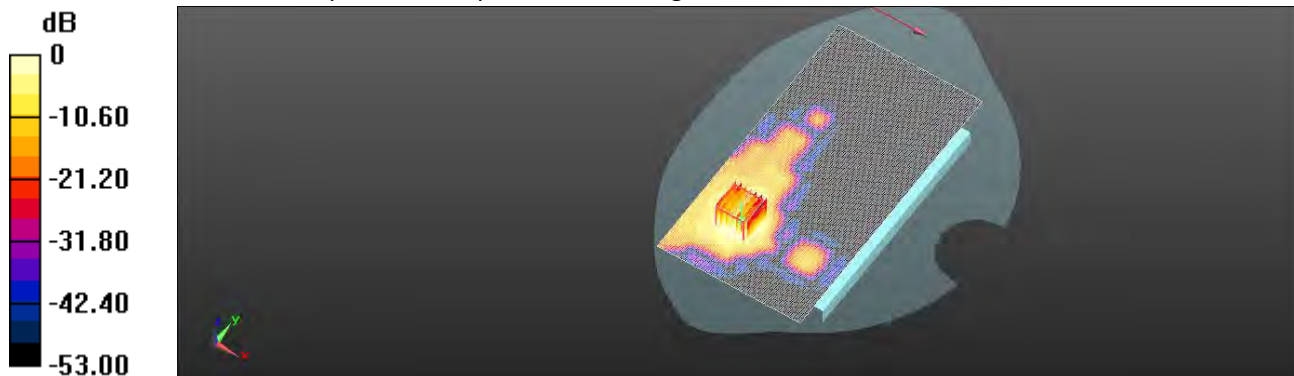

0 dB = 0.704 W/kg = -1.52 dBW/kg

Unless otherwise stated the results shown in this test report refer only to the sample(s) tested and such sample(s) are retained for 90 days only.

除非另有說明，此報告結果僅對測試之樣品負責，同時此樣品僅保留90天。本報告未經本公司書面許可，不可部份複製。

This document is issued by the Company subject to its General Conditions of Service printed overleaf, available on request or accessible at <http://www.sgs.com.tw/Terms-and-Conditions> and for electronic format documents, subject to Terms and Conditions for Electronic Documents at <http://www.sgs.com.tw/Terms-and-Conditions>. Attention is drawn to the limitation of liability, indemnification and jurisdiction issues defined therein. Any holder of this document is advised that information contained hereon reflects the Company's findings at the time of its intervention only and within the limits of Client's instructions, if any. The Company's sole responsibility is to its Client and this document does not exonerate parties to a transaction from exercising all their rights and obligations under the transaction documents. This document cannot be reproduced except in full, without prior written approval of the Company. Any unauthorized alteration, forgery or falsification of the content or appearance of this document is unlawful and offenders may be prosecuted to the fullest extent of the law.

Date: 2020/7/5

Report No. :ES/2020/30005

WLAN 802.11b_Body worn_Back side_CH 11_Chain 5_Ant5_15mm

Communication System: Wi-Fi; Frequency: 2462 MHz; Duty cycle= 1:1

Medium parameters used: $f = 2462$ MHz; $\sigma = 1.783$ S/m; $\epsilon_r = 38.884$; $\rho = 1000$ kg/m³

Phantom section: Flat Section

Ambient temperature: 21.7°C; Liquid temperature: 22.1°C

DASY5 Configuration:

- Probe: EX3DV4 - SN7509; ConvF(7.51, 7.51, 7.51) @ 2462 MHz; Calibrated: 2020/03/25
- Sensor-Surface: 2mm (Mechanical Surface Detection)
- Electronics: DAE4 Sn558; Calibrated: 2019/10/11
- Phantom: SAM
- DASY52 52.10.4(1527); SEMCAD X 14.6.14(7483)

Area Scan (91x171x1): Interpolated grid: dx=12 mm, dy=12 mm

Maximum value of SAR (interpolated) = 0.140 W/kg

Zoom Scan (7x7x7)/Cube 0: Measurement grid: dx=5mm, dy=5mm, dz=5mm

Reference Value = 3.856 V/m; Power Drift = 0.14 dB

Peak SAR (extrapolated) = 0.163 W/kg

SAR(1 g) = 0.104 W/kg; SAR(10 g) = 0.065 W/kg

Smallest distance from peaks to all points 3 dB below = 21.5 mm

Ratio of SAR at M2 to SAR at M1 = 64.7%

Maximum value of SAR (measured) = 0.135 W/kg

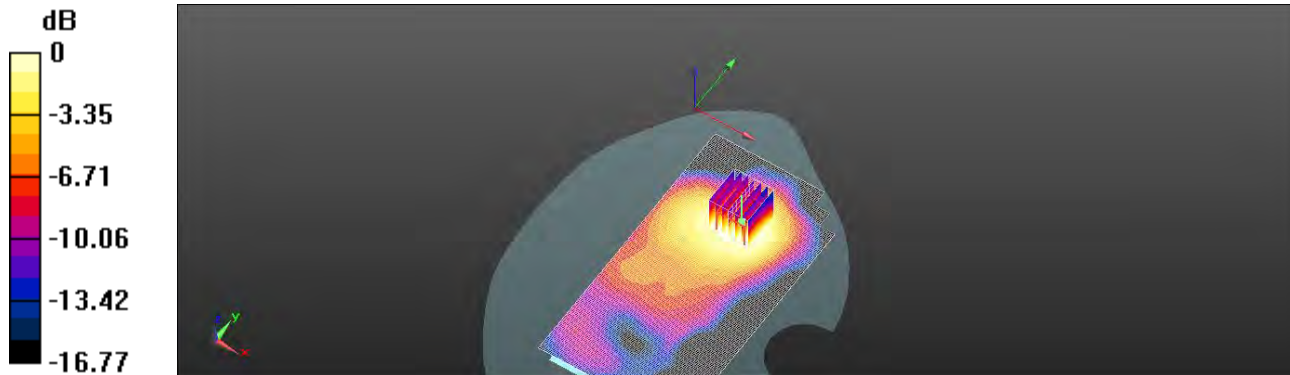

0 dB = 0.135 W/kg = -8.70 dBW/kg

Unless otherwise stated the results shown in this test report refer only to the sample(s) tested and such sample(s) are retained for 90 days only.

除非另有說明，此報告結果僅對測試之樣品負責，同時此樣品僅保留90天。本報告未經本公司書面許可，不可部份複製。

This document is issued by the Company subject to its General Conditions of Service printed overleaf, available on request or accessible at <http://www.sgs.com.tw/Terms-and-Conditions> and for electronic format documents, subject to Terms and Conditions for Electronic Documents at <http://www.sgs.com.tw/Terms-and-Conditions>. Attention is drawn to the limitation of liability, indemnification and jurisdiction issues defined therein. Any holder of this document is advised that information contained hereon reflects the Company's findings at the time of its intervention only and within the limits of Client's instructions, if any. The Company's sole responsibility is to its Client and this document does not exonerate parties to a transaction from exercising all their rights and obligations under the transaction documents. This document cannot be reproduced except in full, without prior written approval of the Company. Any unauthorized alteration, forgery or falsification of the content or appearance of this document is unlawful and offenders may be prosecuted to the fullest extent of the law.

Date: 2020/7/5

Report No. :ES/2020/30005

BLE_1M_Body worn_Back side_CH 18_Chain1_Ant5_15mm

Communication System: Bluetooth; Frequency: 2442 MHz; Duty cycle= 1:1

Medium parameters used: $f = 2442$ MHz; $\sigma = 1.741$ S/m; $\epsilon_r = 38.897$; $\rho = 1000$ kg/m³

Phantom section: Flat Section

Ambient temperature: 21.7°C; Liquid temperature: 22.1°C

DASY5 Configuration:

- Probe: EX3DV4 - SN7509; ConvF(7.51, 7.51, 7.51) @ 2442 MHz; Calibrated: 2020/03/25
- Sensor-Surface: 2mm (Mechanical Surface Detection)
- Electronics: DAE4 Sn558; Calibrated: 2019/10/11
- Phantom: SAM
- DASY52 52.10.4(1527); SEMCAD X 14.6.14(7483)

Area Scan (101x171x1): Interpolated grid: dx=12 mm, dy=12 mm

Maximum value of SAR (interpolated) = 0.256 W/kg

Zoom Scan (7x7x7)/Cube 0: Measurement grid: dx=5mm, dy=5mm, dz=5mm

Reference Value = 1.065 V/m; Power Drift = 0.05 dB

Peak SAR (extrapolated) = 0.365 W/kg

SAR(1 g) = 0.152 W/kg; SAR(10 g) = 0.074 W/kg

Smallest distance from peaks to all points 3 dB below = 10.2 mm

Ratio of SAR at M2 to SAR at M1 = 43.3%

Maximum value of SAR (measured) = 0.222 W/kg

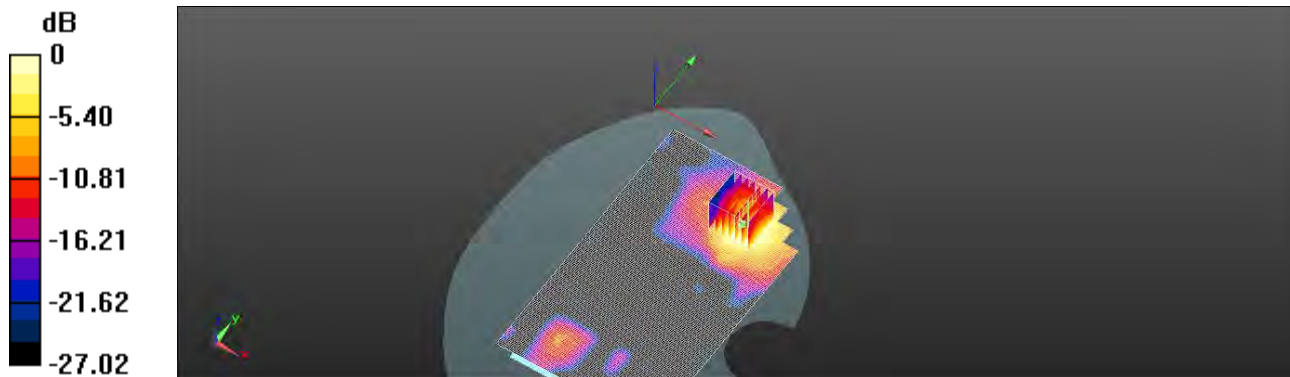

0 dB = 0.222 W/kg = -6.54 dBW/kg

Unless otherwise stated the results shown in this test report refer only to the sample(s) tested and such sample(s) are retained for 90 days only.

除非另有說明，此報告結果僅對測試之樣品負責，同時此樣品僅保留90天。本報告未經本公司書面許可，不可部份複製。

This document is issued by the Company subject to its General Conditions of Service printed overleaf, available on request or accessible at <http://www.sgs.com.tw/Terms-and-Conditions> and for electronic format documents, subject to Terms and Conditions for Electronic Documents at <http://www.sgs.com.tw/Terms-and-Conditions>. Attention is drawn to the limitation of liability, indemnification and jurisdiction issues defined therein. Any holder of this document is advised that information contained hereon reflects the Company's findings at the time of its intervention only and within the limits of Client's instructions, if any. The Company's sole responsibility is to its Client and this document does not exonerate parties to a transaction from exercising all their rights and obligations under the transaction documents. This document cannot be reproduced except in full, without prior written approval of the Company. Any unauthorized alteration, forgery or falsification of the content or appearance of this document is unlawful and offenders may be prosecuted to the fullest extent of the law.

Date: 2020/7/10

Report No. : ES/2020/30005

WLAN 802.11n(40M) 5.2G_Body worn_Back side_CH 46_Chain1_Ant5_15mm

Communication System: WLAN 5G; Frequency: 5230 MHz; Duty cycle= 1:1

Medium parameters used: $f = 5230$ MHz; $\sigma = 4.734$ S/m; $\epsilon_r = 35.583$; $\rho = 1000$ kg/m³

Phantom section: Flat Section

Ambient temperature: 21.4°C; Liquid temperature: 21.8°C

DASY5 Configuration:

- Probe: EX3DV4 - SN7509; ConvF(5.33, 5.33, 5.33) @ 5230 MHz; Calibrated: 2020/03/25
- Sensor-Surface: 2mm (Mechanical Surface Detection)
- Electronics: DAE4 Sn558; Calibrated: 2019/10/11
- Phantom: SAM
- DASY52 52.10.4(1527); SEMCAD X 14.6.14(7483)

Area Scan (111x191x1): Interpolated grid: dx=10 mm, dy=10 mm

Maximum value of SAR (interpolated) = 0.418 W/kg

Zoom Scan (7x7x12)/Cube 0: Measurement grid: dx=4mm, dy=4mm, dz=2mm

Reference Value = 1.006 V/m; Power Drift = 0.08 dB

Peak SAR (extrapolated) = 0.919 W/kg

SAR(1 g) = 0.142 W/kg; SAR(10 g) = 0.053 W/kg

Smallest distance from peaks to all points 3 dB below = 11.8 mm

Ratio of SAR at M2 to SAR at M1 = 62.4%

Maximum value of SAR (measured) = 0.259 W/kg

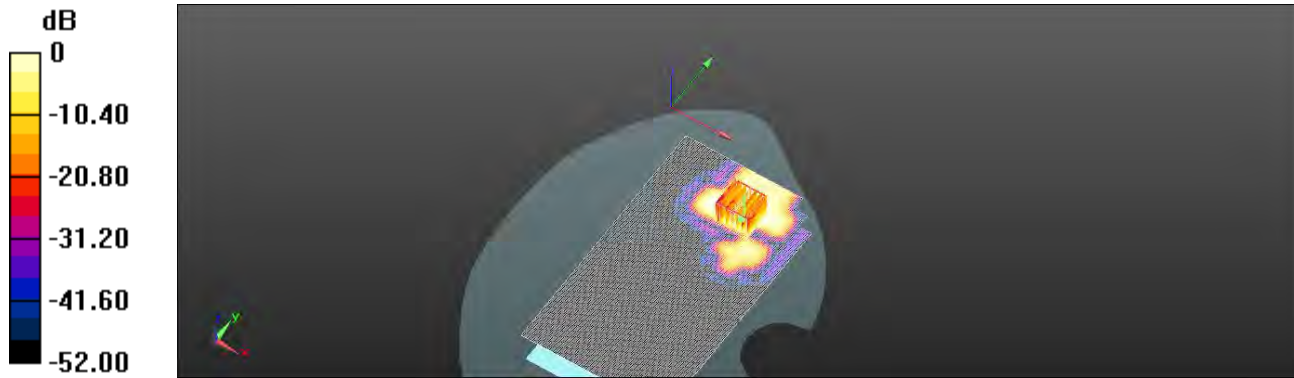

0 dB = 0.259 W/kg = -5.87 dBW/kg

Unless otherwise stated the results shown in this test report refer only to the sample(s) tested and such sample(s) are retained for 90 days only.

除非另有說明，此報告結果僅對測試之樣品負責，同時此樣品僅保留90天。本報告未經本公司書面許可，不可部份複製。

This document is issued by the Company subject to its General Conditions of Service printed overleaf, available on request or accessible at <http://www.sgs.com.tw/Terms-and-Conditions> and for electronic format documents, subject to Terms and Conditions for Electronic Documents at <http://www.sgs.com.tw/Terms-and-Conditions>. Attention is drawn to the limitation of liability, indemnification and jurisdiction issues defined therein. Any holder of this document is advised that information contained hereon reflects the Company's findings at the time of its intervention only and within the limits of Client's instructions, if any. The Company's sole responsibility is to its Client and this document does not exonerate parties to a transaction from exercising all their rights and obligations under the transaction documents. This document cannot be reproduced except in full, without prior written approval of the Company. Any unauthorized alteration, forgery or falsification of the content or appearance of this document is unlawful and offenders may be prosecuted to the fullest extent of the law.

Date: 2020/7/11

Report No. :ES/2020/30005

WLAN 802.11n(20M) 5.3G Body worn Back side CH60 Chain1 Ant5 15mm

Communication System: WLAN 5G; Frequency: 5300 MHz; Duty cycle= 1:1

Medium parameters used: $f = 5300$ MHz; $\sigma = 4.835$ S/m; $\epsilon_r = 35.425$; $\rho = 1000$ kg/m³

Phantom section: Flat Section

Ambient temperature: 22.0°C; Liquid temperature: 21.6°C

DASY5 Configuration:

- Probe: EX3DV4 - SN7509; ConvF(5.23, 5.23, 5.23) @ 5300 MHz; Calibrated: 2020/03/25
- Sensor-Surface: 2mm (Mechanical Surface Detection)
- Electronics: DAE4 Sn558; Calibrated: 2019/10/11
- Phantom: SAM
- DASY52 52.10.4(1527); SEMCAD X 14.6.14(7483)

Area Scan (111x191x1): Interpolated grid: dx=10 mm, dy=10 mm

Maximum value of SAR (interpolated) = 0.502 W/kg

Zoom Scan (7x7x12)/Cube 0: Measurement grid: dx=4mm, dy=4mm, dz=2mm

Reference Value = 1.779 V/m; Power Drift = 0.12 dB

Peak SAR (extrapolated) = 0.781 W/kg

SAR(1 g) = 0.276 W/kg; SAR(10 g) = 0.117 W/kg

Smallest distance from peaks to all points 3 dB below = 9.8 mm

Ratio of SAR at M2 to SAR at M1 = 63.9%

Maximum value of SAR (measured) = 0.474 W/kg

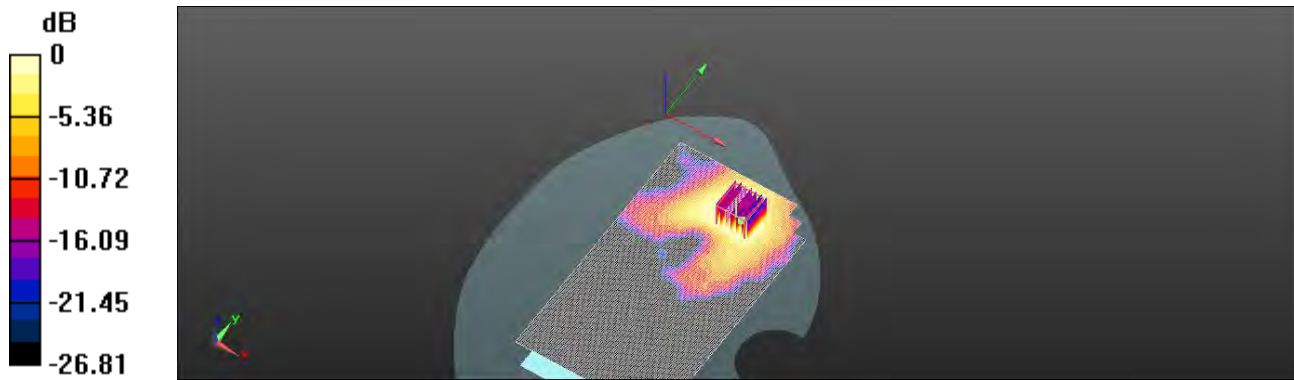

0 dB = 0.474 W/kg = -3.24 dBW/kg

Unless otherwise stated the results shown in this test report refer only to the sample(s) tested and such sample(s) are retained for 90 days only.

除非另有說明，此報告結果僅對測試之樣品負責，同時此樣品僅保留90天。本報告未經本公司書面許可，不可部份複製。

This document is issued by the Company subject to its General Conditions of Service printed overleaf, available on request or accessible at <http://www.sgs.com.tw/Terms-and-Conditions> and for electronic format documents, subject to Terms and Conditions for Electronic Documents at <http://www.sgs.com.tw/Terms-and-Conditions>. Attention is drawn to the limitation of liability, indemnification and jurisdiction issues defined therein. Any holder of this document is advised that information contained hereon reflects the Company's findings at the time of its intervention only and within the limits of Client's instructions, if any. The Company's sole responsibility is to its Client and this document does not exonerate parties to a transaction from exercising all their rights and obligations under the transaction documents. This document cannot be reproduced except in full, without prior written approval of the Company. Any unauthorized alteration, forgery or falsification of the content or appearance of this document is unlawful and offenders may be prosecuted to the fullest extent of the law.

Date: 2020/7/12

Report No. : ES/2020/30005

WLAN 802.11a 5.6G_Body worn_Back side_CH 100_Chain1_Ant5_15mm

Communication System: WLAN 5G; Frequency: 5500 MHz; Duty cycle= 1:1

Medium parameters used: $f = 5500$ MHz; $\sigma = 5.027$ S/m; $\epsilon_r = 35.407$; $\rho = 1000$ kg/m³

Phantom section: Flat Section

Ambient temperature: 21.6°C; Liquid temperature: 22.1°C

DASY5 Configuration:

- Probe: EX3DV4 - SN7509; ConvF(4.64, 4.64, 4.64) @ 5500 MHz; Calibrated: 2020/03/25
- Sensor-Surface: 2mm (Mechanical Surface Detection)
- Electronics: DAE4 Sn558; Calibrated: 2019/10/11
- Phantom: SAM
- DASY52 52.10.4(1527); SEMCAD X 14.6.14(7483)

Area Scan (111x191x1): Interpolated grid: dx=10 mm, dy=10 mm

Maximum value of SAR (interpolated) = 1.01 W/kg

Zoom Scan (7x7x12)/Cube 0: Measurement grid: dx=4mm, dy=4mm, dz=2mm

Reference Value = 1.636 V/m; Power Drift = 0.18 dB

Peak SAR (extrapolated) = 1.26 W/kg

SAR(1 g) = 0.594 W/kg; SAR(10 g) = 0.248 W/kg

Smallest distance from peaks to all points 3 dB below = 8.5 mm

Ratio of SAR at M2 to SAR at M1 = 74.5%

Maximum value of SAR (measured) = 1.04 W/kg

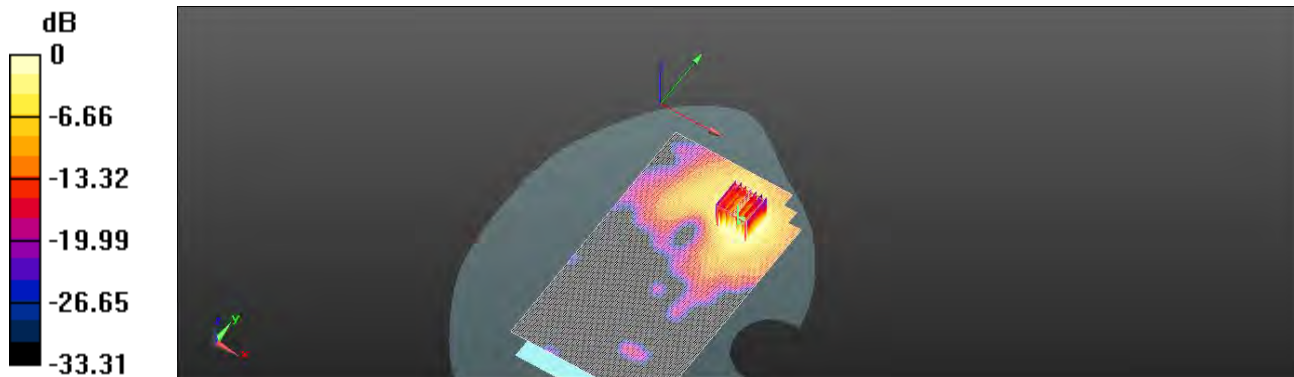

0 dB = 1.04 W/kg = 0.17 dBW/kg

Unless otherwise stated the results shown in this test report refer only to the sample(s) tested and such sample(s) are retained for 90 days only.

除非另有說明，此報告結果僅對測試之樣品負責，同時此樣品僅保留90天。本報告未經本公司書面許可，不可部份複製。

This document is issued by the Company subject to its General Conditions of Service printed overleaf, available on request or accessible at <http://www.sgs.com.tw/Terms-and-Conditions> and for electronic format documents, subject to Terms and Conditions for Electronic Documents at <http://www.sgs.com.tw/Terms-and-Conditions>. Attention is drawn to the limitation of liability, indemnification and jurisdiction issues defined therein. Any holder of this document is advised that information contained hereon reflects the Company's findings at the time of its intervention only and within the limits of Client's instructions, if any. The Company's sole responsibility is to its Client and this document does not exonerate parties to a transaction from exercising all their rights and obligations under the transaction documents. This document cannot be reproduced except in full, without prior written approval of the Company. Any unauthorized alteration, forgery or falsification of the content or appearance of this document is unlawful and offenders may be prosecuted to the fullest extent of the law.

Date: 2020/7/13

Report No. :ES/2020/30005

**WLAN 802.11ac(80M) 5.8G_Body worn_Back side_CH
155_Chain1_Ant5_15mm**

Communication System: Wi-Fi; Frequency: 5775 MHz; Duty cycle= 1:1

Medium parameters used: $f = 5775$ MHz; $\sigma = 5.308$ S/m; $\epsilon_r = 34.656$; $\rho = 1000$ kg/m³

Phantom section: Flat Section

Ambient temperature: 21.5°C; Liquid temperature: 21.9°C

DASY5 Configuration:

- Probe: EX3DV4 - SN7509; ConvF(4.85, 4.85, 4.85) @ 5775 MHz; Calibrated: 2020/03/25
- Sensor-Surface: 2mm (Mechanical Surface Detection)
- Electronics: DAE4 Sn558; Calibrated: 2019/10/11
- Phantom: SAM
- DASY52 52.10.4(1527); SEMCAD X 14.6.14(7483)

Area Scan (111x191x1): Interpolated grid: dx=10 mm, dy=10 mm

Maximum value of SAR (interpolated) = 0.865 W/kg

Zoom Scan (7x7x12)/Cube 0: Measurement grid: dx=4mm, dy=4mm, dz=2mm

Reference Value = 1.001 V/m; Power Drift = 0.03 dB

Peak SAR (extrapolated) = 0.990 W/kg

SAR(1 g) = 0.470 W/kg; SAR(10 g) = 0.170 W/kg

Smallest distance from peaks to all points 3 dB below = 8.3 mm

Ratio of SAR at M2 to SAR at M1 = 70.9%

Maximum value of SAR (measured) = 0.846 W/kg

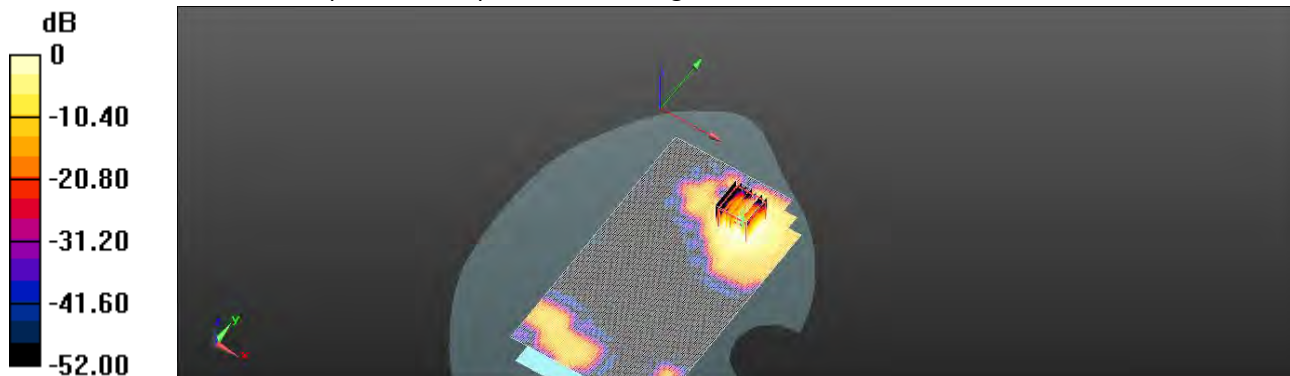

0 dB = 0.846 W/kg = -0.73 dBW/kg

Unless otherwise stated the results shown in this test report refer only to the sample(s) tested and such sample(s) are retained for 90 days only.

除非另有說明，此報告結果僅對測試之樣品負責，同時此樣品僅保留90天。本報告未經本公司書面許可，不可部份複製。

This document is issued by the Company subject to its General Conditions of Service printed overleaf, available on request or accessible at <http://www.sgs.com.tw/Terms-and-Conditions> and for electronic format documents, subject to Terms and Conditions for Electronic Documents at <http://www.sgs.com.tw/Terms-and-Conditions>. Attention is drawn to the limitation of liability, indemnification and jurisdiction issues defined therein. Any holder of this document is advised that information contained hereon reflects the Company's findings at the time of its intervention only and within the limits of Client's instructions, if any. The Company's sole responsibility is to its Client and this document does not exonerate parties to a transaction from exercising all their rights and obligations under the transaction documents. This document cannot be reproduced except in full, without prior written approval of the Company. Any unauthorized alteration, forgery or falsification of the content or appearance of this document is unlawful and offenders may be prosecuted to the fullest extent of the law.

Date: 2020/7/18

Report No. :ES/2020/30005

WLAN 802.11n(40M) 5.2G_Body worn_Back side_CH 46_Chain1_Ant7_15mm

Communication System: Wi-Fi; Frequency: 5230 MHz; Duty cycle= 1:1

Medium parameters used: $f = 5230 \text{ MHz}$; $\sigma = 4.753 \text{ S/m}$; $\epsilon_r = 35.363$; $\rho = 1000 \text{ kg/m}^3$

Phantom section: Flat Section

Ambient temperature: 22.2°C; Liquid temperature: 21.6°C

DASY5 Configuration:

- Probe: EX3DV4 - SN7509; ConvF(5.33, 5.33, 5.33) @ 5230 MHz; Calibrated: 2020/03/25
- Sensor-Surface: 2mm (Mechanical Surface Detection)
- Electronics: DAE4 Sn558; Calibrated: 2019/10/11
- Phantom: SAM
- DASY52 52.10.4(1527); SEMCAD X 14.6.14(7483)

Area Scan (111x191x1): Interpolated grid: dx=10 mm, dy=10 mm

Maximum value of SAR (interpolated) = 0.207 W/kg

Zoom Scan (7x7x12)/Cube 0: Measurement grid: dx=4mm, dy=4mm, dz=2mm

Reference Value = 1.023 V/m; Power Drift = 0.02 dB

Peak SAR (extrapolated) = 0.249 W/kg

SAR(1 g) = 0.124 W/kg; SAR(10 g) = 0.049 W/kg

Smallest distance from peaks to all points 3 dB below = 10.5 mm

Ratio of SAR at M2 to SAR at M1 = 74.9%

Maximum value of SAR (measured) = 0.222 W/kg

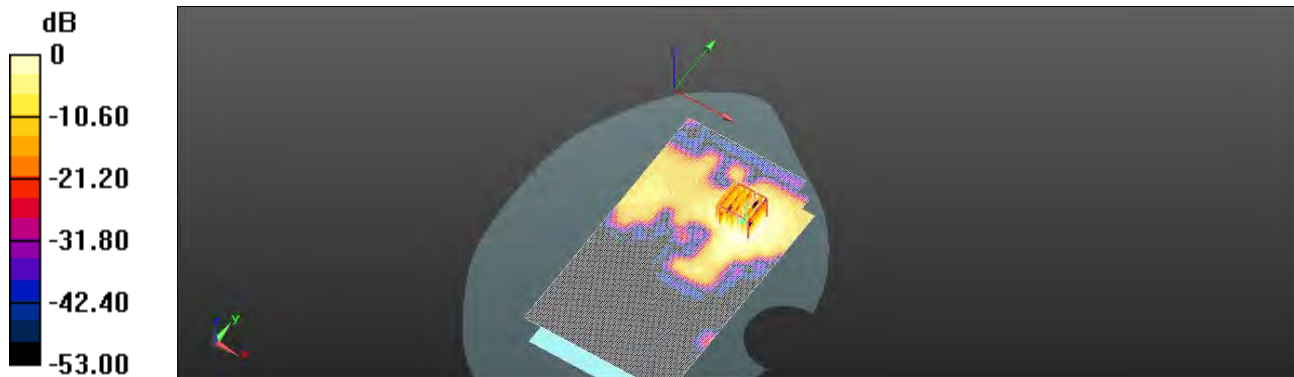

0 dB = 0.222 W/kg = -6.54 dBW/kg

Unless otherwise stated the results shown in this test report refer only to the sample(s) tested and such sample(s) are retained for 90 days only.

除非另有說明，此報告結果僅對測試之樣品負責，同時此樣品僅保留90天。本報告未經本公司書面許可，不可部份複製。

This document is issued by the Company subject to its General Conditions of Service printed overleaf, available on request or accessible at <http://www.sgs.com.tw/Terms-and-Conditions> and for electronic format documents, subject to Terms and Conditions for Electronic Documents at <http://www.sgs.com.tw/Terms-and-Conditions>. Attention is drawn to the limitation of liability, indemnification and jurisdiction issues defined therein. Any holder of this document is advised that information contained hereon reflects the Company's findings at the time of its intervention only and within the limits of Client's instructions, if any. The Company's sole responsibility is to its Client and this document does not exonerate parties to a transaction from exercising all their rights and obligations under the transaction documents. This document cannot be reproduced except in full, without prior written approval of the Company. Any unauthorized alteration, forgery or falsification of the content or appearance of this document is unlawful and offenders may be prosecuted to the fullest extent of the law.

Date: 2020/7/19

Report No. :ES/2020/30005

WLAN 802.11n(20M) 5.3G_Body worn_Back side_CH 60_Chain1_Ant7_15mm

Communication System: WLAN 5G; Frequency: 5300 MHz; Duty cycle= 1:1

Medium parameters used: $f = 5300 \text{ MHz}$; $\sigma = 4.84 \text{ S/m}$; $\epsilon_r = 35.215$; $\rho = 1000 \text{ kg/m}^3$

Phantom section: Flat Section

Ambient temperature: 21.4°C; Liquid temperature: 22.1°C

DASY5 Configuration:

- Probe: EX3DV4 - SN7509; ConvF(5.23, 5.23, 5.23) @ 5300 MHz; Calibrated: 2020/03/25
- Sensor-Surface: 2mm (Mechanical Surface Detection)
- Electronics: DAE4 Sn558; Calibrated: 2019/10/11
- Phantom: SAM
- DASY52 52.10.4(1527); SEMCAD X 14.6.14(7483)

Area Scan (111x191x1): Interpolated grid: dx=10 mm, dy=10 mm

Maximum value of SAR (interpolated) = 0.569 W/kg

Zoom Scan (7x7x12)/Cube 0: Measurement grid: dx=4mm, dy=4mm, dz=2mm

Reference Value = 1.025 V/m; Power Drift = 0.11 dB

Peak SAR (extrapolated) = 0.666 W/kg

SAR(1 g) = 0.338 W/kg; SAR(10 g) = 0.145 W/kg

Smallest distance from peaks to all points 3 dB below = 10.1 mm

Ratio of SAR at M2 to SAR at M1 = 73.6%

Maximum value of SAR (measured) = 0.597 W/kg

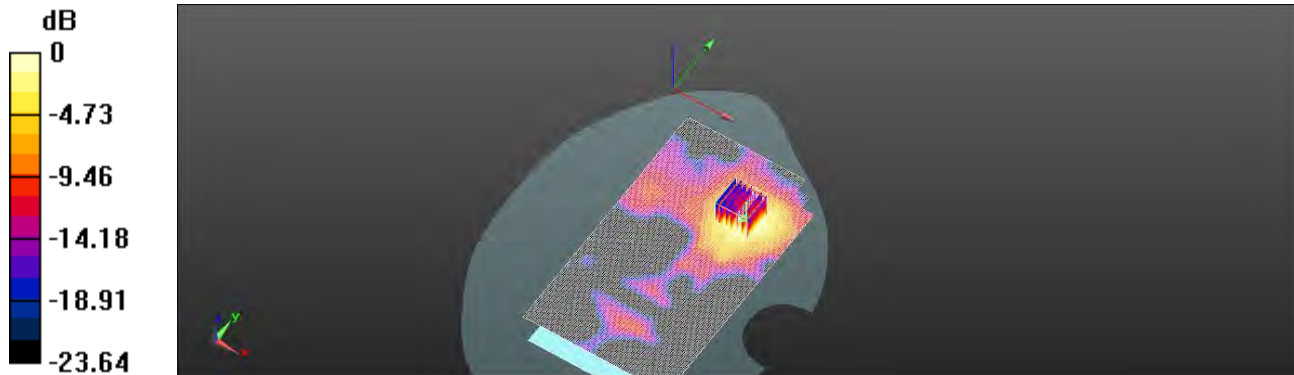

0 dB = 0.597 W/kg = -2.24 dBW/kg

Unless otherwise stated the results shown in this test report refer only to the sample(s) tested and such sample(s) are retained for 90 days only.

除非另有說明，此報告結果僅對測試之樣品負責，同時此樣品僅保留90天。本報告未經本公司書面許可，不可部份複製。

This document is issued by the Company subject to its General Conditions of Service printed overleaf, available on request or accessible at <http://www.sgs.com.tw/Terms-and-Conditions> and for electronic format documents, subject to Terms and Conditions for Electronic Documents at <http://www.sgs.com.tw/Terms-and-Conditions>. Attention is drawn to the limitation of liability, indemnification and jurisdiction issues defined therein. Any holder of this document is advised that information contained hereon reflects the Company's findings at the time of its intervention only and within the limits of Client's instructions, if any. The Company's sole responsibility is to its Client and this document does not exonerate parties to a transaction from exercising all their rights and obligations under the transaction documents. This document cannot be reproduced except in full, without prior written approval of the Company. Any unauthorized alteration, forgery or falsification of the content or appearance of this document is unlawful and offenders may be prosecuted to the fullest extent of the law.

Date: 2020/7/20

Report No. :ES/2020/30005

WLAN 802.11a 5.6G_Body worn_Back side_CH 100_Chain1_Ant7_15mm

Communication System: WLAN 5G; Frequency: 5500 MHz; Duty cycle= 1:1

Medium parameters used: $f = 5500$ MHz; $\sigma = 5.05$ S/m; $\epsilon_r = 35.097$; $\rho = 1000$ kg/m³

Phantom section: Flat Section

Ambient temperature: 21.8°C; Liquid temperature: 22.4°C

DASY5 Configuration:

- Probe: EX3DV4 - SN7509; ConvF(4.64, 4.64, 4.64) @ 5500 MHz; Calibrated: 2020/03/25
- Sensor-Surface: 2mm (Mechanical Surface Detection)
- Electronics: DAE4 Sn558; Calibrated: 2019/10/11
- Phantom: SAM
- DASY52 52.10.4(1527); SEMCAD X 14.6.14(7483)

Area Scan (111x191x1): Interpolated grid: dx=10 mm, dy=10 mm

Maximum value of SAR (interpolated) = 0.389 W/kg

Zoom Scan (7x7x12)/Cube 0: Measurement grid: dx=4mm, dy=4mm, dz=2mm

Reference Value = 1.281 V/m; Power Drift = 0.19 dB

Peak SAR (extrapolated) = 0.472 W/kg

SAR(1 g) = 0.224 W/kg; SAR(10 g) = 0.094 W/kg

Smallest distance from peaks to all points 3 dB below = 8.9 mm

Ratio of SAR at M2 to SAR at M1 = 76.2%

Maximum value of SAR (measured) = 0.392 W/kg

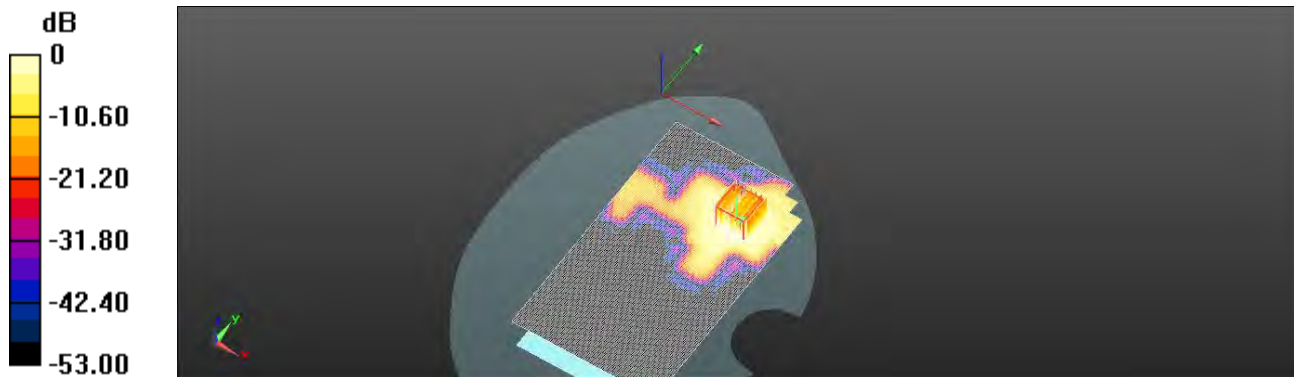

0 dB = 0.392 W/kg = -4.07 dBW/kg

Unless otherwise stated the results shown in this test report refer only to the sample(s) tested and such sample(s) are retained for 90 days only.

除非另有說明，此報告結果僅對測試之樣品負責，同時此樣品僅保留90天。本報告未經本公司書面許可，不可部份複製。

This document is issued by the Company subject to its General Conditions of Service printed overleaf, available on request or accessible at <http://www.sgs.com.tw/Terms-and-Conditions> and for electronic format documents, subject to Terms and Conditions for Electronic Documents at <http://www.sgs.com.tw/Terms-and-Conditions>. Attention is drawn to the limitation of liability, indemnification and jurisdiction issues defined therein. Any holder of this document is advised that information contained hereon reflects the Company's findings at the time of its intervention only and within the limits of Client's instructions, if any. The Company's sole responsibility is to its Client and this document does not exonerate parties to a transaction from exercising all their rights and obligations under the transaction documents. This document cannot be reproduced except in full, without prior written approval of the Company. Any unauthorized alteration, forgery or falsification of the content or appearance of this document is unlawful and offenders may be prosecuted to the fullest extent of the law.

Date: 2020/7/21

Report No. :ES/2020/30005

**WLAN 802.11ac(80M) 5.8G_Body worn_Back side_CH
155_Chain1_Ant7_15mm**

Communication System: WLAN 5G; Frequency: 5775 MHz; Duty cycle= 1:1

Medium parameters used: $f = 5775$ MHz; $\sigma = 5.328$ S/m; $\epsilon_r = 34.522$; $\rho = 1000$ kg/m³

Phantom section: Flat Section

Ambient temperature: 22.3°C; Liquid temperature: 21.5°C

DASY5 Configuration:

- Probe: EX3DV4 - SN7509; ConvF(4.85, 4.85, 4.85) @ 5775 MHz; Calibrated: 2020/03/25
- Sensor-Surface: 2mm (Mechanical Surface Detection)
- Electronics: DAE4 Sn558; Calibrated: 2019/10/11
- Phantom: SAM
- DASY52 52.10.4(1527); SEMCAD X 14.6.14(7483)

Area Scan (111x191x1): Interpolated grid: dx=10 mm, dy=10 mm

Maximum value of SAR (interpolated) = 0.758 W/kg

Zoom Scan (7x7x12)/Cube 0: Measurement grid: dx=4mm, dy=4mm, dz=2mm

Reference Value = 1.129 V/m; Power Drift = 0.13 dB

Peak SAR (extrapolated) = 0.915 W/kg

SAR(1 g) = 0.414 W/kg; SAR(10 g) = 0.177 W/kg

Smallest distance from peaks to all points 3 dB below = 11.5 mm

Ratio of SAR at M2 to SAR at M1 = 73.4%

Maximum value of SAR (measured) = 0.749 W/kg

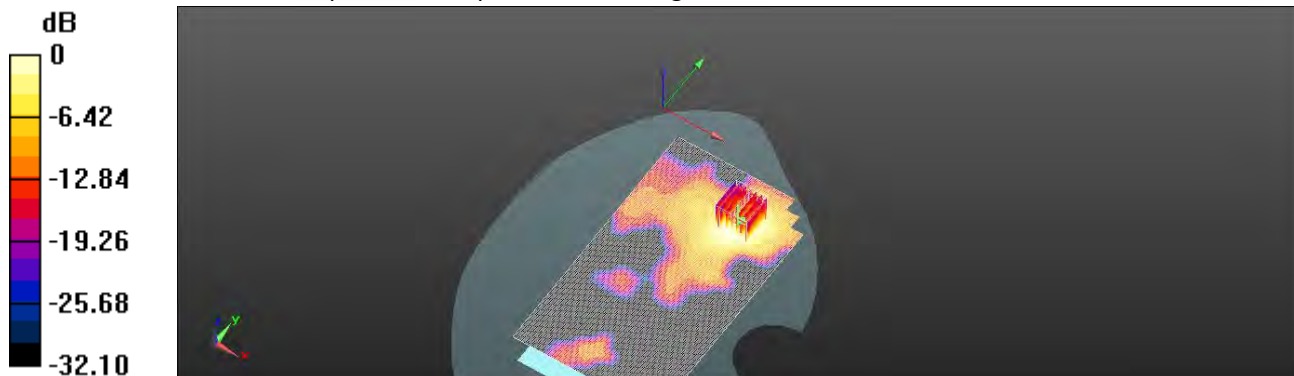

0 dB = 0.749 W/kg = -1.26 dBW/kg

Unless otherwise stated the results shown in this test report refer only to the sample(s) tested and such sample(s) are retained for 90 days only.

除非另有說明，此報告結果僅對測試之樣品負責，同時此樣品僅保留90天。本報告未經本公司書面許可，不可部份複製。

This document is issued by the Company subject to its General Conditions of Service printed overleaf, available on request or accessible at <http://www.sgs.com.tw/Terms-and-Conditions> and for electronic format documents, subject to Terms and Conditions for Electronic Documents at <http://www.sgs.com.tw/Terms-and-Conditions>. Attention is drawn to the limitation of liability, indemnification and jurisdiction issues defined therein. Any holder of this document is advised that information contained hereon reflects the Company's findings at the time of its intervention only and within the limits of Client's instructions, if any. The Company's sole responsibility is to its Client and this document does not exonerate parties to a transaction from exercising all their rights and obligations under the transaction documents. This document cannot be reproduced except in full, without prior written approval of the Company. Any unauthorized alteration, forgery or falsification of the content or appearance of this document is unlawful and offenders may be prosecuted to the fullest extent of the law.

Date: 2020/7/5

Report No. : ES/2020/30005

BLE_1M_Head_Le Cheek_CH 18_Chain0_Ant4

Communication System: Bluetooth; Frequency: 2442 MHz; Duty cycle= 1:1

Medium parameters used: $f = 2442$ MHz; $\sigma = 1.741$ S/m; $\epsilon_r = 38.897$; $\rho = 1000$ kg/m³

Phantom section: Left Section

Ambient temperature: 22.3°C; Liquid temperature: 22.0°C

DASY5 Configuration:

- Probe: EX3DV4 - SN7509; ConvF(7.51, 7.51, 7.51) @ 2442 MHz; Calibrated: 2020/03/25
- Sensor-Surface: 2mm (Mechanical Surface Detection)
- Electronics: DAE4 Sn558; Calibrated: 2019/10/11
- Phantom: SAM
- DASY52 52.10.4(1527); SEMCAD X 14.6.14(7483)

Area Scan (91x181x1): Interpolated grid: dx=12 mm, dy=12 mm

Maximum value of SAR (interpolated) = 0.397 W/kg

Zoom Scan (7x7x7)/Cube 0: Measurement grid: dx=5mm, dy=5mm, dz=5mm

Reference Value = 14.66 V/m; Power Drift = -0.13 dB

Peak SAR (extrapolated) = 0.444 W/kg

SAR(1 g) = 0.251 W/kg; SAR(10 g) = 0.141 W/kg

Smallest distance from peaks to all points 3 dB below = 7.6 mm

Ratio of SAR at M2 to SAR at M1 = 56.8%

Maximum value of SAR (measured) = 0.345 W/kg

Zoom Scan (7x7x7)/Cube 1: Measurement grid: dx=5mm, dy=5mm, dz=5mm

Reference Value = 14.66 V/m; Power Drift = -0.13 dB

Peak SAR (extrapolated) = 0.434 W/kg

SAR(1 g) = 0.262 W/kg; SAR(10 g) = 0.148 W/kg

Smallest distance from peaks to all points 3 dB below = 7.8 mm

Ratio of SAR at M2 to SAR at M1 = 57.1%

Maximum value of SAR (measured) = 0.339 W/kg

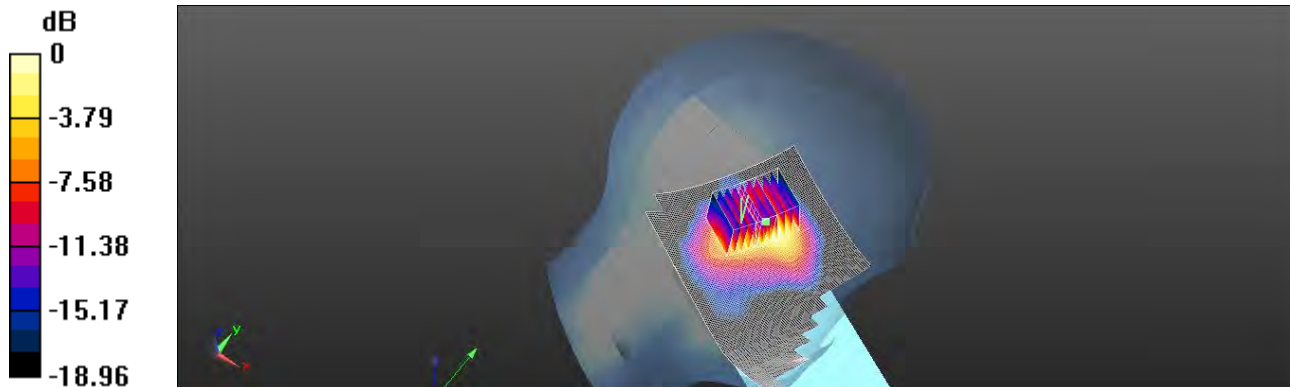

0 dB = 0.339 W/kg = -4.70 dBW/kg

Unless otherwise stated the results shown in this test report refer only to the sample(s) tested and such sample(s) are retained for 90 days only.

除非另有說明，此報告結果僅對測試之樣品負責，同時此樣品僅保留90天。本報告未經本公司書面許可，不可部份複製。
This document is issued by the Company subject to its General Conditions of Service printed overleaf, available on request or accessible at <http://www.sgs.com.tw/Terms-and-Conditions> and for electronic format documents, subject to Terms and Conditions for Electronic Documents at <http://www.sgs.com.tw/Terms-and-Conditions>. Attention is drawn to the limitation of liability, indemnification and jurisdiction issues defined therein. Any holder of this document is advised that information contained hereon reflects the Company's findings at the time of its intervention only and within the limits of Client's instructions, if any. The Company's sole responsibility is to its Client and this document does not exonerate parties to a transaction from exercising all their rights and obligations under the transaction documents. This document cannot be reproduced except in full, without prior written approval of the Company. Any unauthorized alteration, forgery or falsification of the content or appearance of this document is unlawful and offenders may be prosecuted to the fullest extent of the law.

Date: 2020/7/10

Report No. : ES/2020/30005

WLAN 802.11n(40M) 5.2G_Head_Le Cheek_CH 46_Chain 0_Ant4

Communication System: Wi-Fi; Frequency: 5230 MHz; Duty cycle= 1:1

Medium parameters used: $f = 5230 \text{ MHz}$; $\sigma = 4.734 \text{ S/m}$; $\epsilon_r = 35.583$; $\rho = 1000 \text{ kg/m}^3$

Phantom section: Left Section

Ambient temperature: 22.1°C; Liquid temperature: 21.8°C

DASY5 Configuration:

- Probe: EX3DV4 - SN3770; ConvF(5.4, 5.4, 5.4) @ 5230 MHz; Calibrated: 2020/5/27
- Sensor-Surface: 2mm (Mechanical Surface Detection)
- Electronics: DAE4 Sn877; Calibrated: 2020/3/17
- Phantom: SAM
- DASY52 52.10.4(1527); SEMCAD X 14.6.14(7483)

Area Scan (121x201x1): Interpolated grid: dx=10 mm, dy=10 mm

Maximum value of SAR (interpolated) = 1.33 W/kg

Zoom Scan (7x7x12)/Cube 0: Measurement grid: dx=4mm, dy=4mm, dz=2mm

Reference Value = 7.403 V/m; Power Drift = 0.16 dB

Peak SAR (extrapolated) = 2.73 W/kg

SAR(1 g) = 0.778 W/kg; SAR(10 g) = 0.286 W/kg

Smallest distance from peaks to all points 3 dB below = 7.5 mm

Ratio of SAR at M2 to SAR at M1 = 56.5%

Maximum value of SAR (measured) = 1.30 W/kg

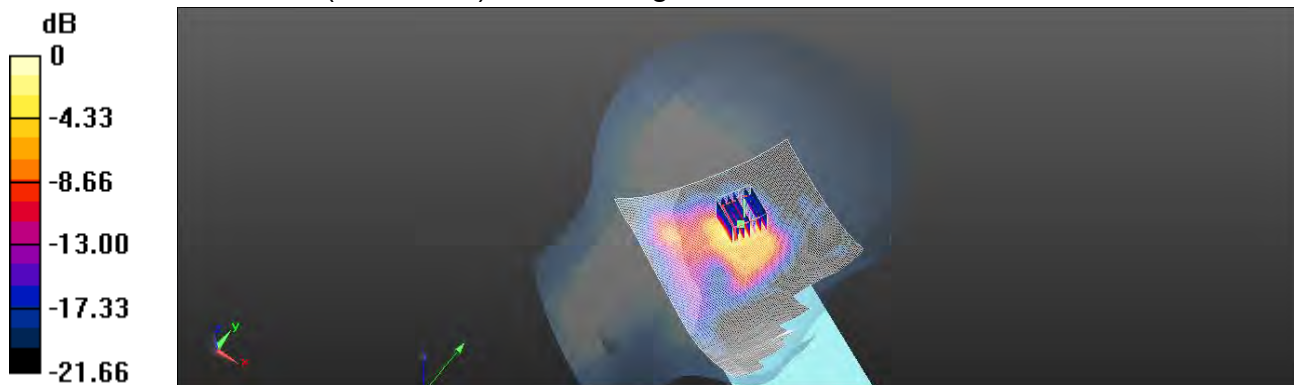

0 dB = 1.30 W/kg = 1.14 dBW/kg

Unless otherwise stated the results shown in this test report refer only to the sample(s) tested and such sample(s) are retained for 90 days only.

除非另有說明，此報告結果僅對測試之樣品負責，同時此樣品僅保留90天。本報告未經本公司書面許可，不可部份複製。

This document is issued by the Company subject to its General Conditions of Service printed overleaf, available on request or accessible at <http://www.sgs.com.tw/Terms-and-Conditions> and for electronic format documents, subject to Terms and Conditions for Electronic Documents at <http://www.sgs.com.tw/Terms-and-Conditions>. Attention is drawn to the limitation of liability, indemnification and jurisdiction issues defined therein. Any holder of this document is advised that information contained hereon reflects the Company's findings at the time of its intervention only and within the limits of Client's instructions, if any. The Company's sole responsibility is to its Client and this document does not exonerate parties to a transaction from exercising all their rights and obligations under the transaction documents. This document cannot be reproduced except in full, without prior written approval of the Company. Any unauthorized alteration, forgery or falsification of the content or appearance of this document is unlawful and offenders may be prosecuted to the fullest extent of the law.

Date: 2020/7/11

Report No. :ES/2020/30005

WLAN 802.11a 5.3G_Head_Le Cheek_CH 52_Chain 0_Ant4

Communication System: Wi-Fi; Frequency: 5260 MHz; Duty cycle= 1:1

Medium parameters used: $f = 5260$ MHz; $\sigma = 4.787$ S/m; $\epsilon_r = 35.478$; $\rho = 1000$ kg/m³

Phantom section: Left Section

Ambient temperature: 21.5°C; Liquid temperature: 22.1°C

DASY5 Configuration:

- Probe: EX3DV4 - SN3770; ConvF(5.4, 5.4, 5.4) @ 5260 MHz; Calibrated: 2020/5/27
- Sensor-Surface: 2mm (Mechanical Surface Detection)
- Electronics: DAE4 Sn877; Calibrated: 2020/3/17
- Phantom: SAM
- DASY52 52.10.4(1527); SEMCAD X 14.6.14(7483)

Area Scan (121x201x1): Interpolated grid: dx=10 mm, dy=10 mm

Maximum value of SAR (interpolated) = 0.938 W/kg

Zoom Scan (7x7x12)/Cube 0: Measurement grid: dx=4mm, dy=4mm, dz=2mm

Reference Value = 9.382 V/m; Power Drift = 0.14 dB

Peak SAR (extrapolated) = 2.03 W/kg

SAR(1 g) = 0.781 W/kg; SAR(10 g) = 0.331 W/kg

Smallest distance from peaks to all points 3 dB below = 6.9 mm

Ratio of SAR at M2 to SAR at M1 = 57.5%

Maximum value of SAR (measured) = 0.947 W/kg

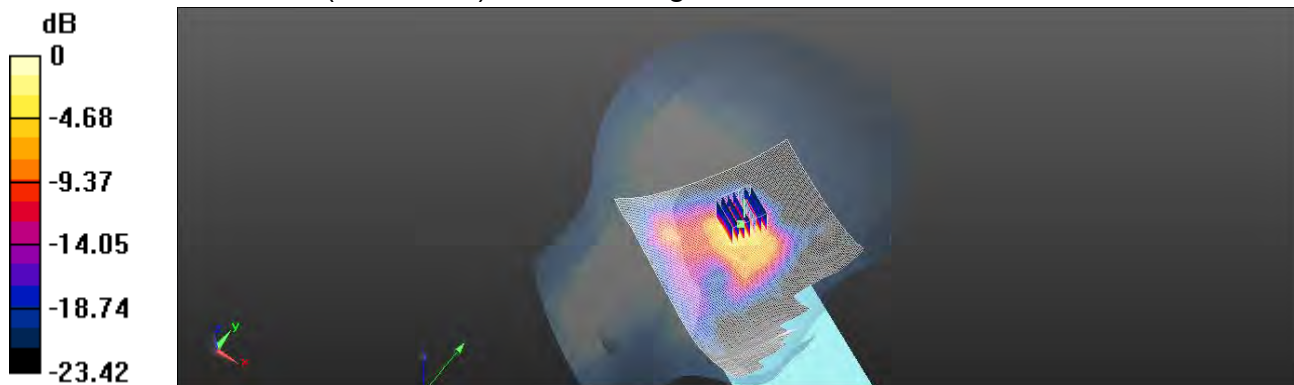

0 dB = 0.947 W/kg = -0.24 dBW/kg

Unless otherwise stated the results shown in this test report refer only to the sample(s) tested and such sample(s) are retained for 90 days only.

除非另有說明，此報告結果僅對測試之樣品負責，同時此樣品僅保留90天。本報告未經本公司書面許可，不可部份複製。

This document is issued by the Company subject to its General Conditions of Service printed overleaf, available on request or accessible at <http://www.sgs.com.tw/Terms-and-Conditions> and for electronic format documents, subject to Terms and Conditions for Electronic Documents at <http://www.sgs.com.tw/Terms-and-Conditions>. Attention is drawn to the limitation of liability, indemnification and jurisdiction issues defined therein. Any holder of this document is advised that information contained hereon reflects the Company's findings at the time of its intervention only and within the limits of Client's instructions, if any. The Company's sole responsibility is to its Client and this document does not exonerate parties to a transaction from exercising all their rights and obligations under the transaction documents. This document cannot be reproduced except in full, without prior written approval of the Company. Any unauthorized alteration, forgery or falsification of the content or appearance of this document is unlawful and offenders may be prosecuted to the fullest extent of the law.

Date: 2020/7/12

Report No. : ES/2020/30005

WLAN 802.11ac(80M) 5.6G_Head_Le Cheek_CH 138_Chain 0_Ant4

Communication System: WLAN 5G; Frequency: 5690 MHz; Duty cycle= 1:1

Medium parameters used: $f = 5690$ MHz; $\sigma = 5.234$ S/m; $\epsilon_r = 34.835$; $\rho = 1000$ kg/m³

Phantom section: Left Section

Ambient temperature: 21.9°C; Liquid temperature: 21.5°C

DASY5 Configuration:

- Probe: EX3DV4 - SN3770; ConvF(4.79, 4.79, 4.79) @ 5690 MHz; Calibrated: 2020/5/27
- Sensor-Surface: 2mm (Mechanical Surface Detection)
- Electronics: DAE4 Sn877; Calibrated: 2020/3/17
- Phantom: SAM
- DASY52 52.10.4(1527); SEMCAD X 14.6.14(7483)

Area Scan (121x201x1): Interpolated grid: dx=10 mm, dy=10 mm

Maximum value of SAR (interpolated) = 0.858 W/kg

Zoom Scan (7x7x12)/Cube 0: Measurement grid: dx=4mm, dy=4mm, dz=2mm

Reference Value = 9.107 V/m; Power Drift = 0.17 dB

Peak SAR (extrapolated) = 1.66 W/kg

SAR(1 g) = 0.831 W/kg; SAR(10 g) = 0.434 W/kg

Smallest distance from peaks to all points 3 dB below = 6.7 mm

Ratio of SAR at M2 to SAR at M1 = 53.8%

Maximum value of SAR (measured) = 0.818 W/kg

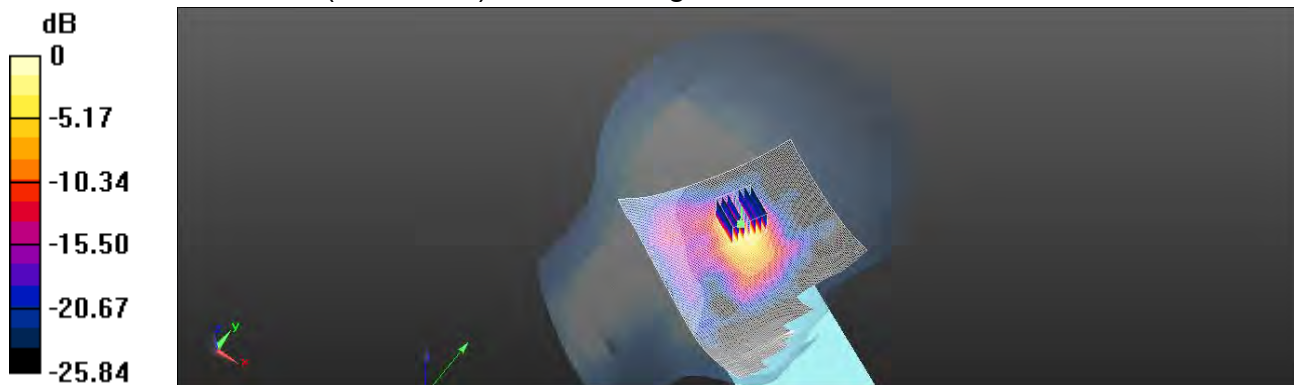

0 dB = 0.818 W/kg = -0.87 dBW/kg

Unless otherwise stated the results shown in this test report refer only to the sample(s) tested and such sample(s) are retained for 90 days only.

除非另有說明，此報告結果僅對測試之樣品負責，同時此樣品僅保留90天。本報告未經本公司書面許可，不可部份複製。

This document is issued by the Company subject to its General Conditions of Service printed overleaf, available on request or accessible at <http://www.sgs.com.tw/Terms-and-Conditions> and for electronic format documents, subject to Terms and Conditions for Electronic Documents at <http://www.sgs.com.tw/Terms-and-Conditions>. Attention is drawn to the limitation of liability, indemnification and jurisdiction issues defined therein. Any holder of this document is advised that information contained hereon reflects the Company's findings at the time of its intervention only and within the limits of Client's instructions, if any. The Company's sole responsibility is to its Client and this document does not exonerate parties to a transaction from exercising all their rights and obligations under the transaction documents. This document cannot be reproduced except in full, without prior written approval of the Company. Any unauthorized alteration, forgery or falsification of the content or appearance of this document is unlawful and offenders may be prosecuted to the fullest extent of the law.

Date: 2020/7/13

Report No. :ES/2020/30005

WLAN 802.11ac(80M) 5.8G _Head_ Le Cheek_ CH 155_ Chain 0_ Ant4

Communication System: Wi-Fi; Frequency: 5775 MHz; Duty cycle= 1:1

Medium parameters used: $f = 5775 \text{ MHz}$; $\sigma = 5.308 \text{ S/m}$; $\epsilon_r = 34.656$; $\rho = 1000 \text{ kg/m}^3$

Phantom section: Left Section

Ambient temperature: 21.4°C; Liquid temperature: 21.7°C

DASY5 Configuration:

- Probe: EX3DV4 - SN3770; ConvF(4.9, 4.9, 4.9) @ 5775 MHz; Calibrated: 2020/5/27
- Sensor-Surface: 2mm (Mechanical Surface Detection)
- Electronics: DAE4 Sn877; Calibrated: 2020/3/17
- Phantom: SAM
- DASY52 52.10.4(1527); SEMCAD X 14.6.14(7483)

Area Scan (121x201x1): Interpolated grid: dx=10 mm, dy=10 mm

Maximum value of SAR (interpolated) = 1.01 W/kg

Zoom Scan (7x7x12)/Cube 0: Measurement grid: dx=4mm, dy=4mm, dz=2mm

Reference Value = 8.462 V/m; Power Drift = -0.16 dB

Peak SAR (extrapolated) = 1.67 W/kg

SAR(1 g) = 0.732 W/kg; SAR(10 g) = 0.349 W/kg

Smallest distance from peaks to all points 3 dB below = 6.7 mm

Ratio of SAR at M2 to SAR at M1 = 54.3%

Maximum value of SAR (measured) = 0.788 W/kg

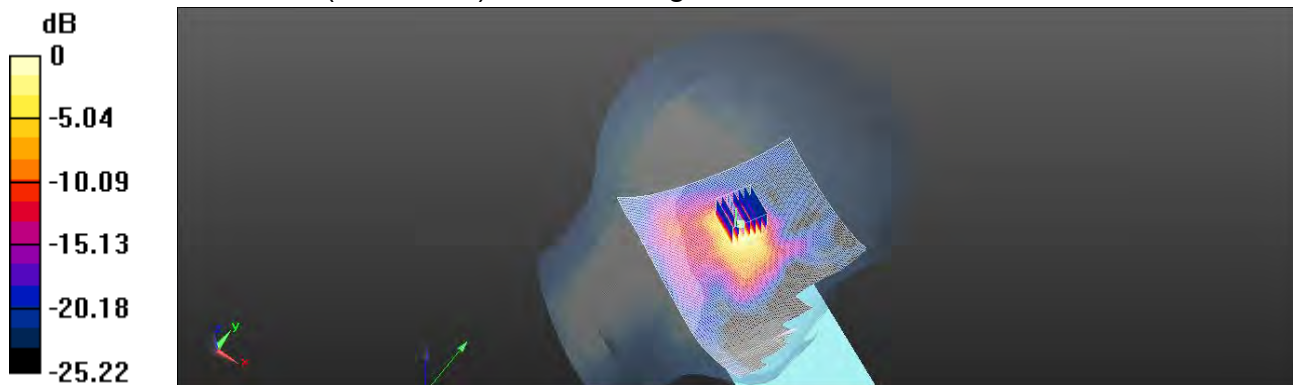

0 dB = 0.788 W/kg = -1.03 dBW/kg

Unless otherwise stated the results shown in this test report refer only to the sample(s) tested and such sample(s) are retained for 90 days only.

除非另有說明，此報告結果僅對測試之樣品負責，同時此樣品僅保留90天。本報告未經本公司書面許可，不可部份複製。

This document is issued by the Company subject to its General Conditions of Service printed overleaf, available on request or accessible at <http://www.sgs.com.tw/Terms-and-Conditions> and for electronic format documents, subject to Terms and Conditions for Electronic Documents at <http://www.sgs.com.tw/Terms-and-Conditions>. Attention is drawn to the limitation of liability, indemnification and jurisdiction issues defined therein. Any holder of this document is advised that information contained hereon reflects the Company's findings at the time of its intervention only and within the limits of Client's instructions, if any. The Company's sole responsibility is to its Client and this document does not exonerate parties to a transaction from exercising all their rights and obligations under the transaction documents. This document cannot be reproduced except in full, without prior written approval of the Company. Any unauthorized alteration, forgery or falsification of the content or appearance of this document is unlawful and offenders may be prosecuted to the fullest extent of the law.

Date: 2020/7/5

Report No. : ES/2020/30005

BLE_1M_Head_Re Cheek_CH 18_Chain0_Ant6

Communication System: Bluetooth; Frequency: 2442 MHz; Duty cycle= 1:1

Medium parameters used: $f = 2442$ MHz; $\sigma = 1.741$ S/m; $\epsilon_r = 38.897$; $\rho = 1000$ kg/m³

Phantom section: Right Section

Ambient temperature: 22.3°C; Liquid temperature: 22.0°C

DASY5 Configuration:

- Probe: EX3DV4 - SN7509; ConvF(7.51, 7.51, 7.51) @ 2442 MHz; Calibrated: 2020/03/25
- Sensor-Surface: 2mm (Mechanical Surface Detection)
- Electronics: DAE4 Sn558; Calibrated: 2019/10/11
- Phantom: SAM
- DASY52 52.10.4(1527); SEMCAD X 14.6.14(7483)

Area Scan (91x181x1): Interpolated grid: dx=12 mm, dy=12 mm

Maximum value of SAR (interpolated) = 0.0653 W/kg

Zoom Scan (7x7x7)/Cube 0: Measurement grid: dx=5mm, dy=5mm, dz=5mm

Reference Value = 1.842 V/m; Power Drift = 0.15 dB

Peak SAR (extrapolated) = 0.0700 W/kg

SAR(1 g) = 0.049 W/kg; SAR(10 g) = 0.029 W/kg

Smallest distance from peaks to all points 3 dB below: Larger than measurement grid

Ratio of SAR at M2 to SAR at M1 = 63.2%

Maximum value of SAR (measured) = 0.0591 W/kg

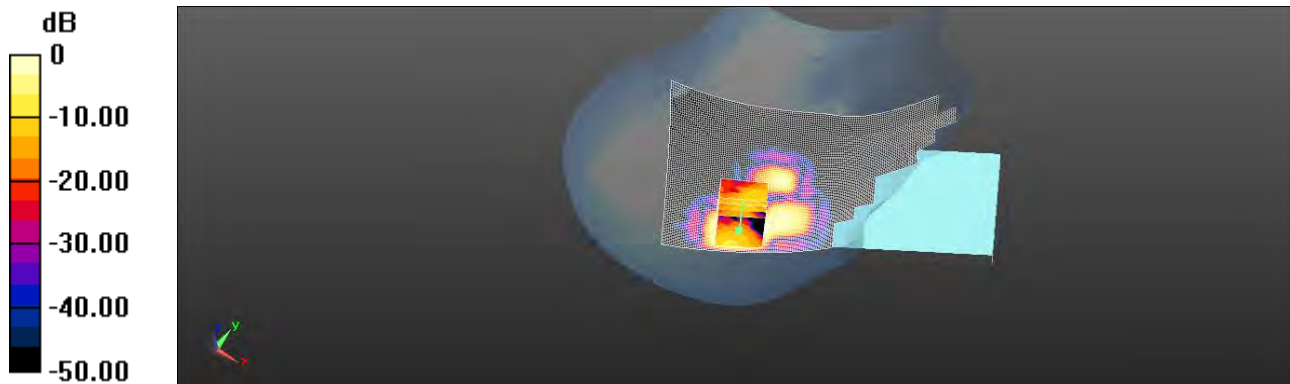

0 dB = 0.0591 W/kg = -12.28 dBW/kg

Unless otherwise stated the results shown in this test report refer only to the sample(s) tested and such sample(s) are retained for 90 days only.

除非另有說明，此報告結果僅對測試之樣品負責，同時此樣品僅保留90天。本報告未經本公司書面許可，不可部份複製。

This document is issued by the Company subject to its General Conditions of Service printed overleaf, available on request or accessible at <http://www.sgs.com.tw/Terms-and-Conditions> and for electronic format documents, subject to Terms and Conditions for Electronic Documents at <http://www.sgs.com.tw/Terms-and-Conditions>. Attention is drawn to the limitation of liability, indemnification and jurisdiction issues defined therein. Any holder of this document is advised that information contained hereon reflects the Company's findings at the time of its intervention only and within the limits of Client's instructions, if any. The Company's sole responsibility is to its Client and this document does not exonerate parties to a transaction from exercising all their rights and obligations under the transaction documents. This document cannot be reproduced except in full, without prior written approval of the Company. Any unauthorized alteration, forgery or falsification of the content or appearance of this document is unlawful and offenders may be prosecuted to the fullest extent of the law.

Date: 2020/7/11

Report No. : ES/2020/30005

WLAN 802.11n(20M) 5.3G_Head_Right Cheek_CH 52_Chain 1_Ant6

Communication System: Wi-Fi; Frequency: 5260 MHz; Duty cycle= 1:1

Medium parameters used: $f = 5260$ MHz; $\sigma = 4.787$ S/m; $\epsilon_r = 35.478$; $\rho = 1000$ kg/m³

Phantom section: Right Section

Ambient temperature: 21.5°C; Liquid temperature: 22.1°C

DASY5 Configuration:

- Probe: EX3DV4 - SN3770; ConvF(5.4, 5.4, 5.4) @ 5260 MHz; Calibrated: 2020/5/27
- Sensor-Surface: 2mm (Mechanical Surface Detection)
- Electronics: DAE4 Sn877; Calibrated: 2020/3/17
- Phantom: SAM
- DASY52 52.10.4(1527); SEMCAD X 14.6.14(7483)

Area Scan (111x201x1): Interpolated grid: dx=10 mm, dy=10 mm

Maximum value of SAR (interpolated) = 0.160 W/kg

Zoom Scan (7x7x12)/Cube 0: Measurement grid: dx=4mm, dy=4mm, dz=2mm

Reference Value = 3.794 V/m; Power Drift = 0.19 dB

Peak SAR (extrapolated) = 0.246 W/kg

SAR(1 g) = 0.067 W/kg; SAR(10 g) = 0.025 W/kg

Smallest distance from peaks to all points 3 dB below = 6.6 mm

Ratio of SAR at M2 to SAR at M1 = 63.9%

Maximum value of SAR (measured) = 0.129 W/kg

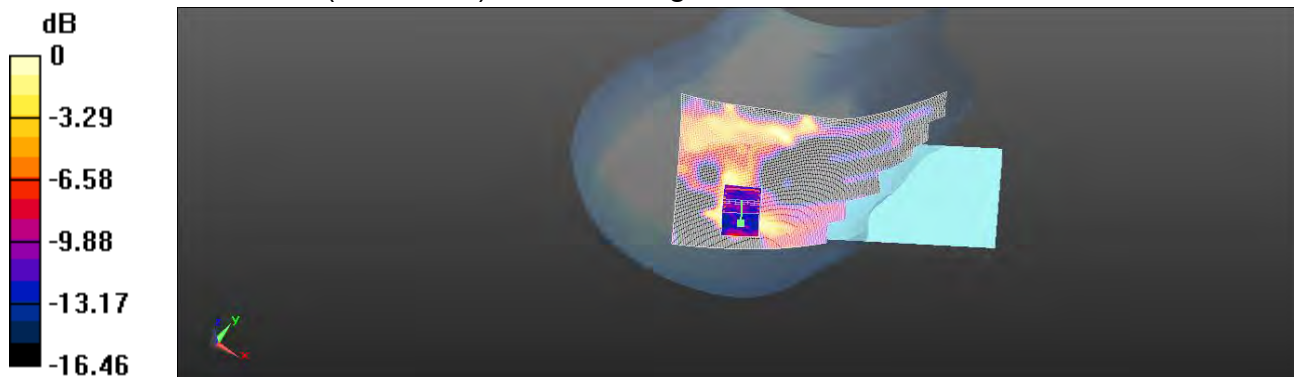

0 dB = 0.129 W/kg = -8.89 dBW/kg

Unless otherwise stated the results shown in this test report refer only to the sample(s) tested and such sample(s) are retained for 90 days only.

除非另有說明，此報告結果僅對測試之樣品負責，同時此樣品僅保留90天。本報告未經本公司書面許可，不可部份複製。

This document is issued by the Company subject to its General Conditions of Service printed overleaf, available on request or accessible at <http://www.sgs.com.tw/Terms-and-Conditions> and for electronic format documents, subject to Terms and Conditions for Electronic Documents at <http://www.sgs.com.tw/Terms-and-Conditions>. Attention is drawn to the limitation of liability, indemnification and jurisdiction issues defined therein. Any holder of this document is advised that information contained hereon reflects the Company's findings at the time of its intervention only and within the limits of Client's instructions, if any. The Company's sole responsibility is to its Client and this document does not exonerate parties to a transaction from exercising all their rights and obligations under the transaction documents. This document cannot be reproduced except in full, without prior written approval of the Company. Any unauthorized alteration, forgery or falsification of the content or appearance of this document is unlawful and offenders may be prosecuted to the fullest extent of the law.

Date: 2020/7/13

Report No. : ES/2020/30005

WLAN 802.11ac(80M) 5.8G_Head_Right Cheek_CH 155_Chain 1_Ant6

Communication System: Wi-Fi; Frequency: 5775 MHz; Duty cycle= 1:1

Medium parameters used: $f = 5775$ MHz; $\sigma = 5.308$ S/m; $\epsilon_r = 34.656$; $\rho = 1000$ kg/m³

Phantom section: Right Section

Ambient temperature: 21.4°C; Liquid temperature: 21.7°C

DASY5 Configuration:

- Probe: EX3DV4 - SN3770; ConvF(4.9, 4.9, 4.9) @ 5775 MHz; Calibrated: 2020/5/27
- Sensor-Surface: 2mm (Mechanical Surface Detection)
- Electronics: DAE4 Sn877; Calibrated: 2020/3/17
- Phantom: SAM
- DASY52 52.10.4(1527); SEMCAD X 14.6.14(7483)

Area Scan (111x201x1): Interpolated grid: dx=10 mm, dy=10 mm

Maximum value of SAR (interpolated) = 0.554 W/kg

Zoom Scan (7x7x12)/Cube 0: Measurement grid: dx=4mm, dy=4mm, dz=2mm

Reference Value = 6.404 V/m; Power Drift = 0.16 dB

Peak SAR (extrapolated) = 1.17 W/kg

SAR(1 g) = 0.305 W/kg; SAR(10 g) = 0.109 W/kg

Smallest distance from peaks to all points 3 dB below = 5.3 mm

Ratio of SAR at M2 to SAR at M1 = 56.4%

Maximum value of SAR (measured) = 0.551 W/kg

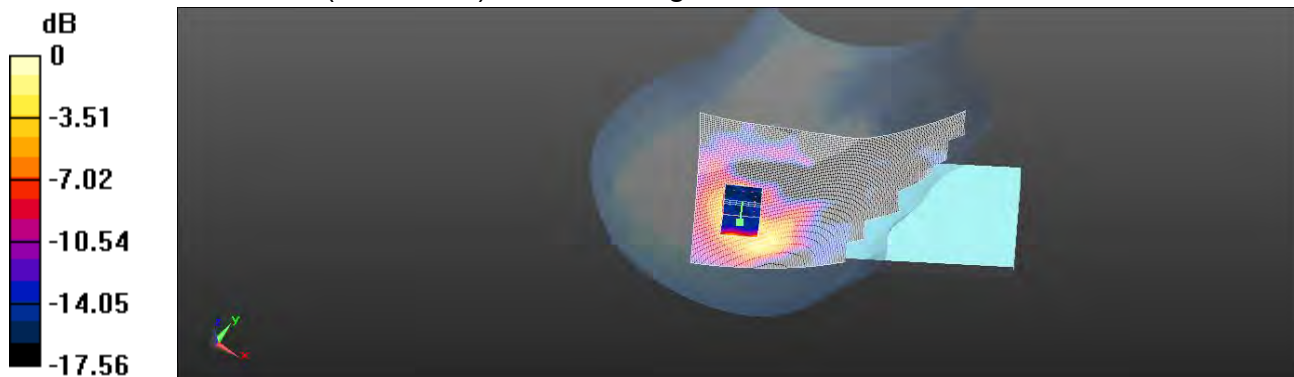

0 dB = 0.551 W/kg = -2.59 dBW/kg

Unless otherwise stated the results shown in this test report refer only to the sample(s) tested and such sample(s) are retained for 90 days only.

除非另有說明，此報告結果僅對測試之樣品負責，同時此樣品僅保留90天。本報告未經本公司書面許可，不可部份複製。

This document is issued by the Company subject to its General Conditions of Service printed overleaf, available on request or accessible at <http://www.sgs.com.tw/Terms-and-Conditions> and for electronic format documents, subject to Terms and Conditions for Electronic Documents at <http://www.sgs.com.tw/Terms-and-Conditions>. Attention is drawn to the limitation of liability, indemnification and jurisdiction issues defined therein. Any holder of this document is advised that information contained hereon reflects the Company's findings at the time of its intervention only and within the limits of Client's instructions, if any. The Company's sole responsibility is to its Client and this document does not exonerate parties to a transaction from exercising all their rights and obligations under the transaction documents. This document cannot be reproduced except in full, without prior written approval of the Company. Any unauthorized alteration, forgery or falsification of the content or appearance of this document is unlawful and offenders may be prosecuted to the fullest extent of the law.

Date: 2020/7/5

Report No. :ES/2020/30005

BLE_1M_Body worn_Back side_CH 18_Chain0_Ant4_15mm

Communication System: Bluetooth; Frequency: 2442 MHz; Duty cycle= 1:1

Medium parameters used: $f = 2442 \text{ MHz}$; $\sigma = 1.741 \text{ S/m}$; $\epsilon_r = 38.897$; $\rho = 1000 \text{ kg/m}^3$

Phantom section: Flat Section

Ambient temperature: 22.3°C; Liquid temperature: 22.0°C

DASY5 Configuration:

- Probe: EX3DV4 - SN7509; ConvF(7.51, 7.51, 7.51) @ 2442 MHz; Calibrated: 2020/03/25
- Sensor-Surface: 2mm (Mechanical Surface Detection)
- Electronics: DAE4 Sn558; Calibrated: 2019/10/11
- Phantom: SAM
- DASY52 52.10.4(1527); SEMCAD X 14.6.14(7483)

Area Scan (91x171x1): Interpolated grid: dx=12 mm, dy=12 mm

Maximum value of SAR (interpolated) = 0.0215 W/kg

Zoom Scan (7x7x7)/Cube 0: Measurement grid: dx=5mm, dy=5mm, dz=5mm

Reference Value = 1.938 V/m; Power Drift = 0.13 dB

Peak SAR (extrapolated) = 0.0170 W/kg

SAR(1 g) = 0.014 W/kg; SAR(10 g) = 0.00953 W/kg

Smallest distance from peaks to all points 3 dB below: Larger than measurement grid

Ratio of SAR at M2 to SAR at M1 = 70%

Maximum value of SAR (measured) = 0.0156 W/kg

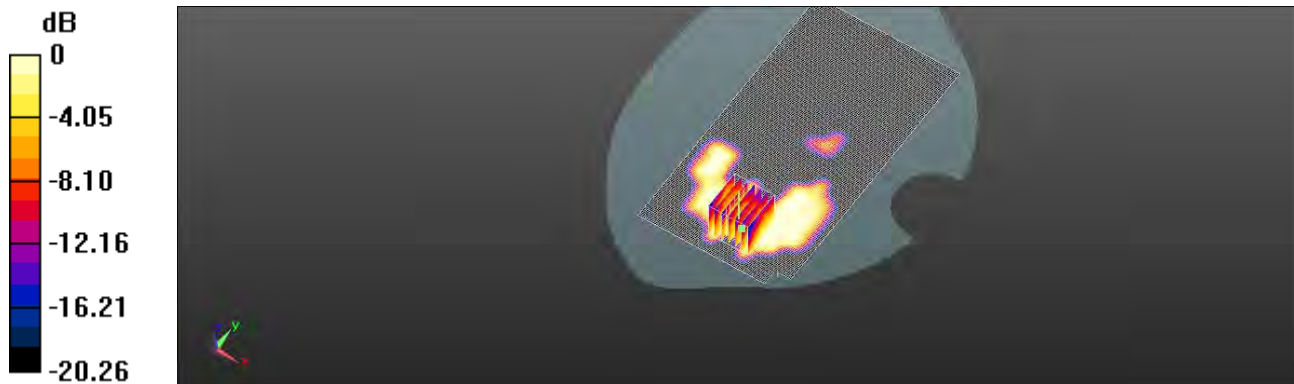

0 dB = 0.0156 W/kg = -18.07 dBW/kg

Unless otherwise stated the results shown in this test report refer only to the sample(s) tested and such sample(s) are retained for 90 days only.

除非另有說明，此報告結果僅對測試之樣品負責，同時此樣品僅保留90天。本報告未經本公司書面許可，不可部份複製。

This document is issued by the Company subject to its General Conditions of Service printed overleaf, available on request or accessible at <http://www.sgs.com.tw/Terms-and-Conditions> and for electronic format documents, subject to Terms and Conditions for Electronic Documents at <http://www.sgs.com.tw/Terms-and-Conditions>. Attention is drawn to the limitation of liability, indemnification and jurisdiction issues defined therein. Any holder of this document is advised that information contained hereon reflects the Company's findings at the time of its intervention only and within the limits of Client's instructions, if any. The Company's sole responsibility is to its Client and this document does not exonerate parties to a transaction from exercising all their rights and obligations under the transaction documents. This document cannot be reproduced except in full, without prior written approval of the Company. Any unauthorized alteration, forgery or falsification of the content or appearance of this document is unlawful and offenders may be prosecuted to the fullest extent of the law.

Date: 2020/7/10

Report No. : ES/2020/30005

WLAN 802.11n(40M) 5.2G_Body worn_Back side_CH 46_Chain0_Ant4_15mm

Communication System: WLAN 5G; Frequency: 5230 MHz; Duty cycle= 1:1

Medium parameters used: $f = 5230$ MHz; $\sigma = 4.734$ S/m; $\epsilon_r = 35.583$; $\rho = 1000$ kg/m³

Phantom section: Flat Section

Ambient temperature: 22.1°C; Liquid temperature: 21.8°C

DASY5 Configuration:

- Probe: EX3DV4 - SN7509; ConvF(5.33, 5.33, 5.33) @ 5230 MHz; Calibrated: 2020/03/25
- Sensor-Surface: 2mm (Mechanical Surface Detection)
- Electronics: DAE4 Sn558; Calibrated: 2019/10/11
- Phantom: SAM
- DASY52 52.10.4(1527); SEMCAD X 14.6.14(7483)

Area Scan (121x211x1): Interpolated grid: dx=10 mm, dy=10 mm

Maximum value of SAR (interpolated) = 0.230 W/kg

Zoom Scan (7x7x12)/Cube 0: Measurement grid: dx=4mm, dy=4mm, dz=2mm

Reference Value = 2.258 V/m; Power Drift = 0.15 dB

Peak SAR (extrapolated) = 0.302 W/kg

SAR(1 g) = 0.125 W/kg; SAR(10 g) = 0.057 W/kg

Smallest distance from peaks to all points 3 dB below = 9.6 mm

Ratio of SAR at M2 to SAR at M1 = 64.2%

Maximum value of SAR (measured) = 0.193 W/kg

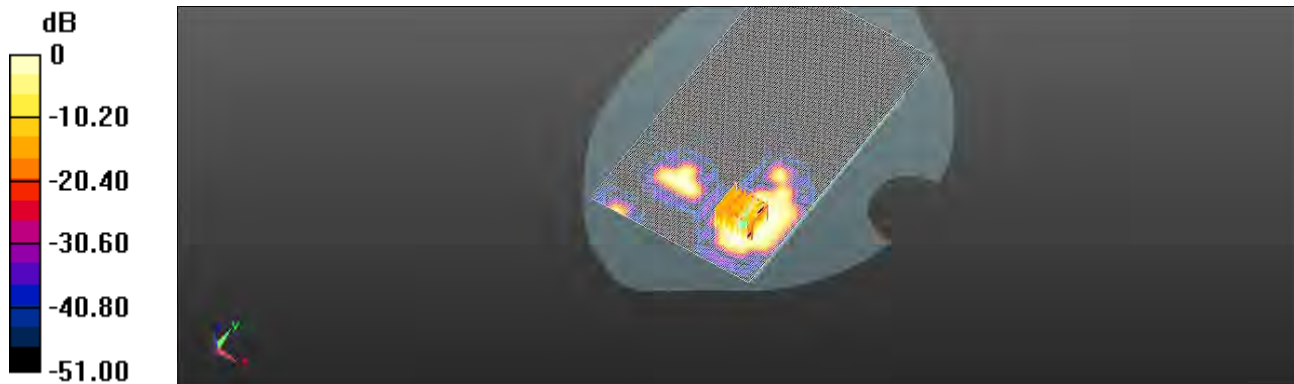

0 dB = 0.193 W/kg = -7.14 dBW/kg

Unless otherwise stated the results shown in this test report refer only to the sample(s) tested and such sample(s) are retained for 90 days only.

除非另有說明，此報告結果僅對測試之樣品負責，同時此樣品僅保留90天。本報告未經本公司書面許可，不可部份複製。

This document is issued by the Company subject to its General Conditions of Service printed overleaf, available on request or accessible at <http://www.sgs.com.tw/Terms-and-Conditions> and for electronic format documents, subject to Terms and Conditions for Electronic Documents at <http://www.sgs.com.tw/Terms-and-Conditions>. Attention is drawn to the limitation of liability, indemnification and jurisdiction issues defined therein. Any holder of this document is advised that information contained hereon reflects the Company's findings at the time of its intervention only and within the limits of Client's instructions, if any. The Company's sole responsibility is to its Client and this document does not exonerate parties to a transaction from exercising all their rights and obligations under the transaction documents. This document cannot be reproduced except in full, without prior written approval of the Company. Any unauthorized alteration, forgery or falsification of the content or appearance of this document is unlawful and offenders may be prosecuted to the fullest extent of the law.

Date: 2020/7/11

Report No. :ES/2020/30005

WLAN 802.11a 5.3G_Body worn_Back side_CH 52_Chain0_Ant4_15mm

Communication System: Wi-Fi; Frequency: 5260 MHz; Duty cycle= 1:1

Medium parameters used: $f = 5260$ MHz; $\sigma = 4.787$ S/m; $\epsilon_r = 35.478$; $\rho = 1000$ kg/m³

Phantom section: Flat Section

Ambient temperature: 21.5°C; Liquid temperature: 22.1°C

DASY5 Configuration:

- Probe: EX3DV4 - SN7509; ConvF(5.23, 5.23, 5.23) @ 5260 MHz; Calibrated: 2020/03/25
- Sensor-Surface: 2mm (Mechanical Surface Detection)
- Electronics: DAE4 Sn558; Calibrated: 2019/10/11
- Phantom: SAM
- DASY52 52.10.4(1527); SEMCAD X 14.6.14(7483)

Area Scan (121x211x1): Interpolated grid: dx=10 mm, dy=10 mm

Maximum value of SAR (interpolated) = 0.146 W/kg

Zoom Scan (7x7x12)/Cube 0: Measurement grid: dx=4mm, dy=4mm, dz=2mm

Reference Value = 2.373 V/m; Power Drift = 0.15 dB

Peak SAR (extrapolated) = 0.215 W/kg

SAR(1 g) = 0.115 W/kg; SAR(10 g) = 0.061 W/kg

Smallest distance from peaks to all points 3 dB below = 11.2 mm

Ratio of SAR at M2 to SAR at M1 = 62.3%

Maximum value of SAR (measured) = 0.148 W/kg

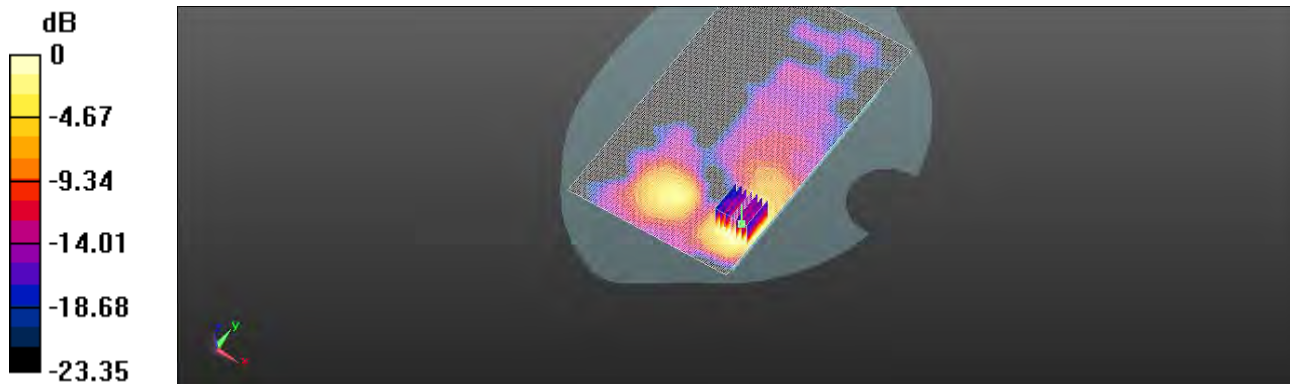

0 dB = 0.148 W/kg = -8.30 dBW/kg

Unless otherwise stated the results shown in this test report refer only to the sample(s) tested and such sample(s) are retained for 90 days only.

除非另有說明，此報告結果僅對測試之樣品負責，同時此樣品僅保留90天。本報告未經本公司書面許可，不可部份複製。

This document is issued by the Company subject to its General Conditions of Service printed overleaf, available on request or accessible at <http://www.sgs.com.tw/Terms-and-Conditions> and for electronic format documents, subject to Terms and Conditions for Electronic Documents at <http://www.sgs.com.tw/Terms-and-Conditions>. Attention is drawn to the limitation of liability, indemnification and jurisdiction issues defined therein. Any holder of this document is advised that information contained hereon reflects the Company's findings at the time of its intervention only and within the limits of Client's instructions, if any. The Company's sole responsibility is to its Client and this document does not exonerate parties to a transaction from exercising all their rights and obligations under the transaction documents. This document cannot be reproduced except in full, without prior written approval of the Company. Any unauthorized alteration, forgery or falsification of the content or appearance of this document is unlawful and offenders may be prosecuted to the fullest extent of the law.

Date: 2020/7/12

Report No. :ES/2020/30005

**WLAN 802.11ac(80M) 5.6G_Body worn_Back side_CH
138_Chain0_Ant4_15mm**

Communication System: Wi-Fi; Frequency: 5690 MHz; Duty cycle= 1:1

Medium parameters used: $f = 5690$ MHz; $\sigma = 5.234$ S/m; $\epsilon_r = 34.835$; $\rho = 1000$ kg/m³

Phantom section: Flat Section

Ambient temperature: 21.9°C; Liquid temperature: 21.5°C

DASY5 Configuration:

- Probe: EX3DV4 - SN3770; ConvF(4.79, 4.79, 4.79) @ 5610 MHz; Calibrated: 2020/5/27
- Sensor-Surface: 2mm (Mechanical Surface Detection)
- Electronics: DAE4 Sn877; Calibrated: 2020/3/17
- Phantom: SAM
- DASY52 52.10.4(1527); SEMCAD X 14.6.14(7483)

Area Scan (111x191x1): Interpolated grid: dx=10 mm, dy=10 mm

Maximum value of SAR (interpolated) = 0.133 W/kg

Zoom Scan (7x7x12)/Cube 0: Measurement grid: dx=4mm, dy=4mm, dz=2mm

Reference Value = 3.385 V/m; Power Drift = 0.16 dB

Peak SAR (extrapolated) = 0.208 W/kg

SAR(1 g) = 0.112 W/kg; SAR(10 g) = 0.065 W/kg

Smallest distance from peaks to all points 3 dB below = 11.3 mm

Ratio of SAR at M2 to SAR at M1 = 59.4%

Maximum value of SAR (measured) = 0.117 W/kg

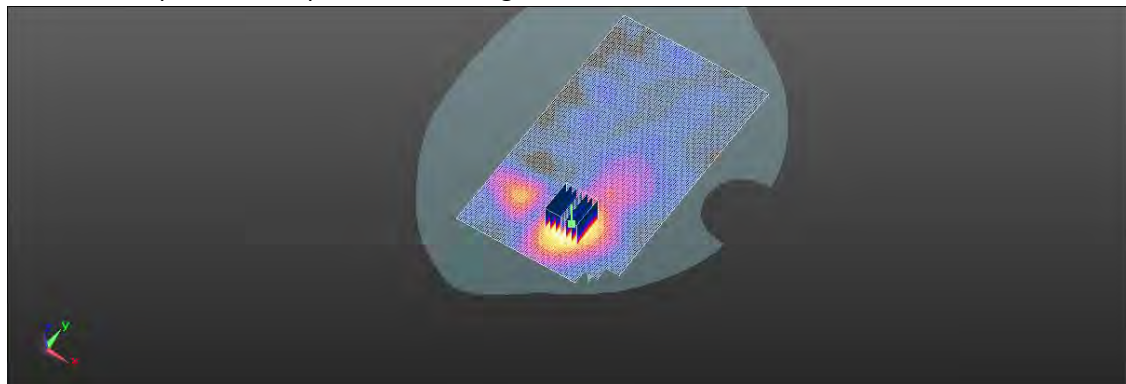
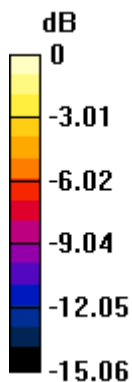

0 dB = 0.117 W/kg = -9.32 dBW/kg

Unless otherwise stated the results shown in this test report refer only to the sample(s) tested and such sample(s) are retained for 90 days only.

除非另有說明，此報告結果僅對測試之樣品負責，同時此樣品僅保留90天。本報告未經本公司書面許可，不可部份複製。

This document is issued by the Company subject to its General Conditions of Service printed overleaf, available on request or accessible at <http://www.sgs.com.tw/Terms-and-Conditions> and for electronic format documents, subject to Terms and Conditions for Electronic Documents at <http://www.sgs.com.tw/Terms-and-Conditions>. Attention is drawn to the limitation of liability, indemnification and jurisdiction issues defined therein. Any holder of this document is advised that information contained hereon reflects the Company's findings at the time of its intervention only and within the limits of Client's instructions, if any. The Company's sole responsibility is to its Client and this document does not exonerate parties to a transaction from exercising all their rights and obligations under the transaction documents. This document cannot be reproduced except in full, without prior written approval of the Company. Any unauthorized alteration, forgery or falsification of the content or appearance of this document is unlawful and offenders may be prosecuted to the fullest extent of the law.

Date: 2020/7/13

Report No. :ES/2020/30005

**WLAN 802.11ac(80M) 5.8G_Body worn_Back side_CH
155_Chain0_Ant4_15mm**

Communication System: WLAN 5G; Frequency: 5775 MHz; Duty cycle= 1:1

Medium parameters used: $f = 5775$ MHz; $\sigma = 5.308$ S/m; $\epsilon_r = 34.656$; $\rho = 1000$ kg/m³

Phantom section: Flat Section

Ambient temperature: 21.4°C; Liquid temperature: 21.7°C

DASY5 Configuration:

- Probe: EX3DV4 - SN7509; ConvF(4.85, 4.85, 4.85) @ 5775 MHz; Calibrated: 2020/03/25
- Sensor-Surface: 2mm (Mechanical Surface Detection)
- Electronics: DAE4 Sn558; Calibrated: 2019/10/11
- Phantom: SAM
- DASY52 52.10.4(1527); SEMCAD X 14.6.14(7483)

Area Scan (111x191x1): Interpolated grid: dx=10 mm, dy=10 mm

Maximum value of SAR (interpolated) = 0.125 W/kg

Zoom Scan (7x7x12)/Cube 0: Measurement grid: dx=4mm, dy=4mm, dz=2mm

Reference Value = 1.769 V/m; Power Drift =0.11 dB

Peak SAR (extrapolated) = 0.199 W/kg

SAR(1 g) = 0.105 W/kg; SAR(10 g) = 0.057 W/kg

Smallest distance from peaks to all points 3 dB below = 11.5 mm

Ratio of SAR at M2 to SAR at M1 = 52.4%

Maximum value of SAR (measured) = 0.121 W/kg

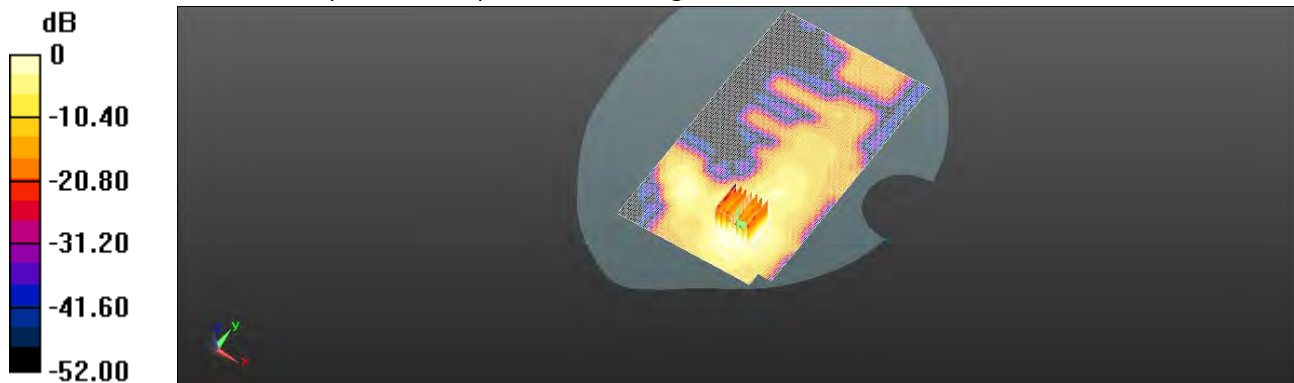

0 dB = 0.121 W/kg = -9.17 dBW/kg

Unless otherwise stated the results shown in this test report refer only to the sample(s) tested and such sample(s) are retained for 90 days only.

除非另有說明，此報告結果僅對測試之樣品負責，同時此樣品僅保留90天。本報告未經本公司書面許可，不可部份複製。

This document is issued by the Company subject to its General Conditions of Service printed overleaf, available on request or accessible at <http://www.sgs.com.tw/Terms-and-Conditions> and for electronic format documents, subject to Terms and Conditions for Electronic Documents at <http://www.sgs.com.tw/Terms-and-Conditions>. Attention is drawn to the limitation of liability, indemnification and jurisdiction issues defined therein. Any holder of this document is advised that information contained hereon reflects the Company's findings at the time of its intervention only and within the limits of Client's instructions, if any. The Company's sole responsibility is to its Client and this document does not exonerate parties to a transaction from exercising all their rights and obligations under the transaction documents. This document cannot be reproduced except in full, without prior written approval of the Company. Any unauthorized alteration, forgery or falsification of the content or appearance of this document is unlawful and offenders may be prosecuted to the fullest extent of the law.

Date: 2020/7/5

Report No. :ES/2020/30005

BLE_1M_Body worn_Back side_CH 18_Chain1_Ant6_15mm

Communication System: Bluetooth; Frequency: 2442 MHz; Duty cycle= 1:1

Medium parameters used: $f = 2442$ MHz; $\sigma = 1.741$ S/m; $\epsilon_r = 38.897$; $\rho = 1000$ kg/m³

Phantom section: Flat Section

Ambient temperature: 22.3°C; Liquid temperature: 22.0°C

DASY5 Configuration:

- Probe: EX3DV4 - SN3770; ConvF(7.4, 7.4, 7.4) @ 2442 MHz; Calibrated: 2020/5/27
- Sensor-Surface: 2mm (Mechanical Surface Detection)
- Electronics: DAE4 Sn877; Calibrated: 2020/3/17
- Phantom: SAM
- DASY52 52.10.4(1527); SEMCAD X 14.6.14(7483)

Area Scan (91x171x1): Interpolated grid: dx=12 mm, dy=12 mm

Maximum value of SAR (interpolated) = 0.00412 W/kg

Zoom Scan (7x7x7)/Cube 0: Measurement grid: dx=5mm, dy=5mm, dz=5mm

Reference Value = 1.063 V/m; Power Drift = 0.16 dB

Peak SAR (extrapolated) = 0.00415 W/kg

SAR(1 g) = 0.00322 W/kg; SAR(10 g) = 0.00216 W/kg

Smallest distance from peaks to all points 3 dB below: Larger than measurement grid

Ratio of SAR at M2 to SAR at M1 = 59.2%

Maximum value of SAR (measured) = 0.00338 W/kg

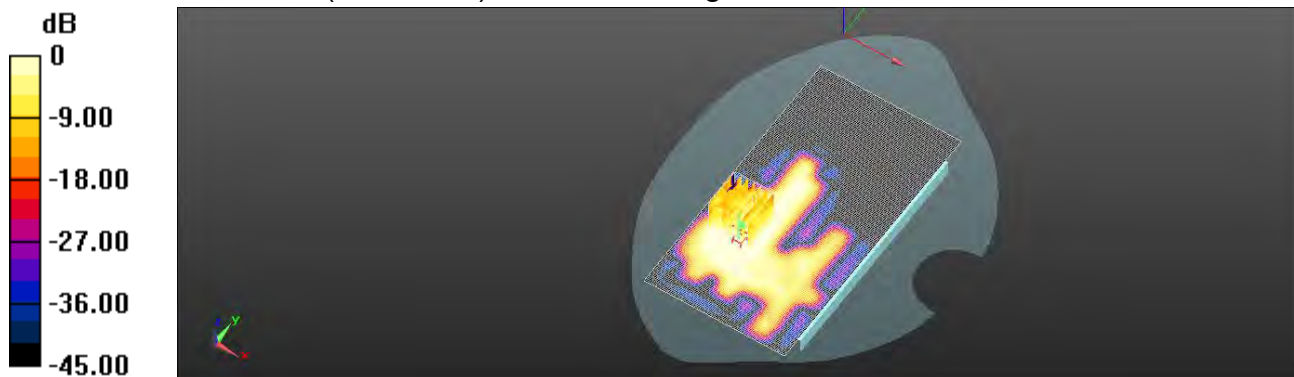

0 dB = 0.00338 W/kg = -24.71 dBW/kg

Unless otherwise stated the results shown in this test report refer only to the sample(s) tested and such sample(s) are retained for 90 days only.

除非另有說明，此報告結果僅對測試之樣品負責，同時此樣品僅保留90天。本報告未經本公司書面許可，不可部份複製。

This document is issued by the Company subject to its General Conditions of Service printed overleaf, available on request or accessible at <http://www.sgs.com.tw/Terms-and-Conditions> and for electronic format documents, subject to Terms and Conditions for Electronic Documents at <http://www.sgs.com.tw/Terms-and-Conditions>. Attention is drawn to the limitation of liability, indemnification and jurisdiction issues defined therein. Any holder of this document is advised that information contained hereon reflects the Company's findings at the time of its intervention only and within the limits of Client's instructions, if any. The Company's sole responsibility is to its Client and this document does not exonerate parties to a transaction from exercising all their rights and obligations under the transaction documents. This document cannot be reproduced except in full, without prior written approval of the Company. Any unauthorized alteration, forgery or falsification of the content or appearance of this document is unlawful and offenders may be prosecuted to the fullest extent of the law.

Date:2020/7/11

Report No. :ES/2020/30005

WLAN 802.11n(20M) 5.3G_Body worn_Back side_CH 60_Chain1_Ant6_15mm

Communication System: WLAN 5G; Frequency: 5300 MHz; Duty cycle= 1:1

Medium parameters used: $f = 5300$ MHz; $\sigma = 4.833$ S/m; $\epsilon_r = 36.141$; $\rho = 1000$ kg/m³

Phantom section: Flat Section

Ambient temperature: 21.5°C; Liquid temperature: 22.1°C

DASY5 Configuration:

- Probe: EX3DV4 - SN3770; ConvF(5.4, 5.4, 5.4) @ 5300 MHz; Calibrated: 2020/5/27
- Sensor-Surface: 2mm (Mechanical Surface Detection)
- Electronics: DAE4 Sn877; Calibrated: 2020/3/17
- Phantom: SAM
- DASY52 52.10.4(1527); SEMCAD X 14.6.14(7483)

Area Scan (111x201x1): Interpolated grid: dx=10 mm, dy=10 mm

Maximum value of SAR (interpolated) = 0.591 W/kg

Zoom Scan (7x7x12)/Cube 0: Measurement grid: dx=4mm, dy=4mm, dz=2mm

Reference Value = 1.134 V/m; Power Drift = 0.12 dB

Peak SAR (extrapolated) = 0.798 W/kg

SAR(1 g) = 0.367 W/kg; SAR(10 g) = 0.157 W/kg

Smallest distance from peaks to all points 3 dB below = 8.8 mm

Ratio of SAR at M2 to SAR at M1 = 66.2%

Maximum value of SAR (measured) = 0.572 W/kg

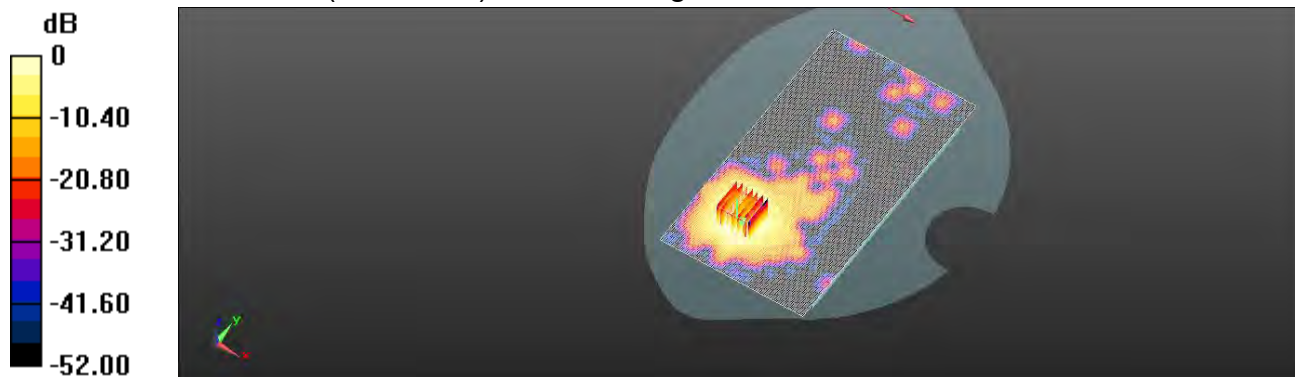

0 dB = 0.572 W/kg = -2.43 dBW/kg

Unless otherwise stated the results shown in this test report refer only to the sample(s) tested and such sample(s) are retained for 90 days only.

除非另有說明，此報告結果僅對測試之樣品負責，同時此樣品僅保留90天。本報告未經本公司書面許可，不可部份複製。

This document is issued by the Company subject to its General Conditions of Service printed overleaf, available on request or accessible at <http://www.sgs.com.tw/Terms-and-Conditions> and for electronic format documents, subject to Terms and Conditions for Electronic Documents at <http://www.sgs.com.tw/Terms-and-Conditions>. Attention is drawn to the limitation of liability, indemnification and jurisdiction issues defined therein. Any holder of this document is advised that information contained hereon reflects the Company's findings at the time of its intervention only and within the limits of Client's instructions, if any. The Company's sole responsibility is to its Client and this document does not exonerate parties to a transaction from exercising all their rights and obligations under the transaction documents. This document cannot be reproduced except in full, without prior written approval of the Company. Any unauthorized alteration, forgery or falsification of the content or appearance of this document is unlawful and offenders may be prosecuted to the fullest extent of the law.

Date: 2020/7/13

Report No. :ES/2020/30005

**WLAN 802.11ac(80M) 5.8G_Body worn_Back side_CH
155_Chain1_Ant6_15mm**

Communication System: Wi-Fi; Frequency: 5775 MHz; Duty cycle= 1:1

Medium parameters used: $f = 5775$ MHz; $\sigma = 5.308$ S/m; $\epsilon_r = 34.656$; $\rho = 1000$ kg/m³

Phantom section: Flat Section

Ambient temperature: 21.4°C; Liquid temperature: 21.7°C

DASY5 Configuration:

- Probe: EX3DV4 - SN3770; ConvF(4.9, 4.9, 4.9) @ 5775 MHz; Calibrated: 2020/5/27
- Sensor-Surface: 2mm (Mechanical Surface Detection)
- Electronics: DAE4 Sn877; Calibrated: 2020/3/17
- Phantom: SAM
- DASY52 52.10.4(1527); SEMCAD X 14.6.14(7483)

Area Scan (111x201x1): Interpolated grid: dx=10 mm, dy=10 mm

Maximum value of SAR (interpolated) = 0.422 W/kg

Zoom Scan (7x7x12)/Cube 0: Measurement grid: dx=4mm, dy=4mm, dz=2mm

Reference Value = 2.874 V/m; Power Drift = 0.15 dB

Peak SAR (extrapolated) = 0.500 W/kg

SAR(1 g) = 0.242 W/kg; SAR(10 g) = 0.096 W/kg

Smallest distance from peaks to all points 3 dB below = 7.4 mm

Ratio of SAR at M2 to SAR at M1 = 70.8%

Maximum value of SAR (measured) = 0.401 W/kg

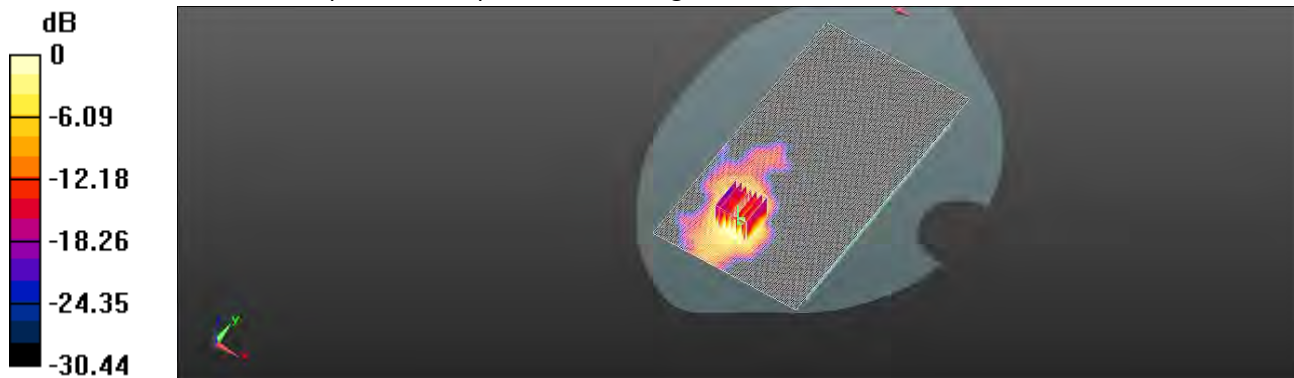

0 dB = 0.401 W/kg = -3.97 dBW/kg

Unless otherwise stated the results shown in this test report refer only to the sample(s) tested and such sample(s) are retained for 90 days only.

除非另有說明，此報告結果僅對測試之樣品負責，同時此樣品僅保留90天。本報告未經本公司書面許可，不可部份複製。

This document is issued by the Company subject to its General Conditions of Service printed overleaf, available on request or accessible at <http://www.sgs.com.tw/Terms-and-Conditions> and for electronic format documents, subject to Terms and Conditions for Electronic Documents at <http://www.sgs.com.tw/Terms-and-Conditions>. Attention is drawn to the limitation of liability, indemnification and jurisdiction issues defined therein. Any holder of this document is advised that information contained hereon reflects the Company's findings at the time of its intervention only and within the limits of Client's instructions, if any. The Company's sole responsibility is to its Client and this document does not exonerate parties to a transaction from exercising all their rights and obligations under the transaction documents. This document cannot be reproduced except in full, without prior written approval of the Company. Any unauthorized alteration, forgery or falsification of the content or appearance of this document is unlawful and offenders may be prosecuted to the fullest extent of the law.

Date: 2020/7/5

Report No. :ES/2020/30005

BLE_1M_Hotspot_Back side_CH 18_Chain0_Ant4_10mm

Communication System: Bluetooth; Frequency: 2442 MHz; Duty cycle= 1:1

Medium parameters used: $f = 2442$ MHz; $\sigma = 1.741$ S/m; $\epsilon_r = 38.897$; $\rho = 1000$ kg/m³

Phantom section: Flat Section

Ambient temperature: 22.3°C; Liquid temperature: 22.0°C

DASY5 Configuration:

- Probe: EX3DV4 - SN7509; ConvF(7.51, 7.51, 7.51) @ 2442 MHz; Calibrated: 2020/03/25
- Sensor-Surface: 2mm (Mechanical Surface Detection)
- Electronics: DAE4 Sn558; Calibrated: 2019/10/11
- Phantom: SAM
- DASY52 52.10.4(1527); SEMCAD X 14.6.14(7483)

Area Scan (91x171x1): Interpolated grid: dx=12 mm, dy=12 mm

Maximum value of SAR (interpolated) = 0.0513 W/kg

Zoom Scan (7x7x7)/Cube 0: Measurement grid: dx=5mm, dy=5mm, dz=5mm

Reference Value = 1.526 V/m; Power Drift = 0.11 dB

Peak SAR (extrapolated) = 0.0490 W/kg

SAR(1 g) = 0.038 W/kg; SAR(10 g) = 0.026 W/kg

Smallest distance from peaks to all points 3 dB below: Larger than measurement grid

Ratio of SAR at M2 to SAR at M1 = 70.3%

Maximum value of SAR (measured) = 0.0433 W/kg

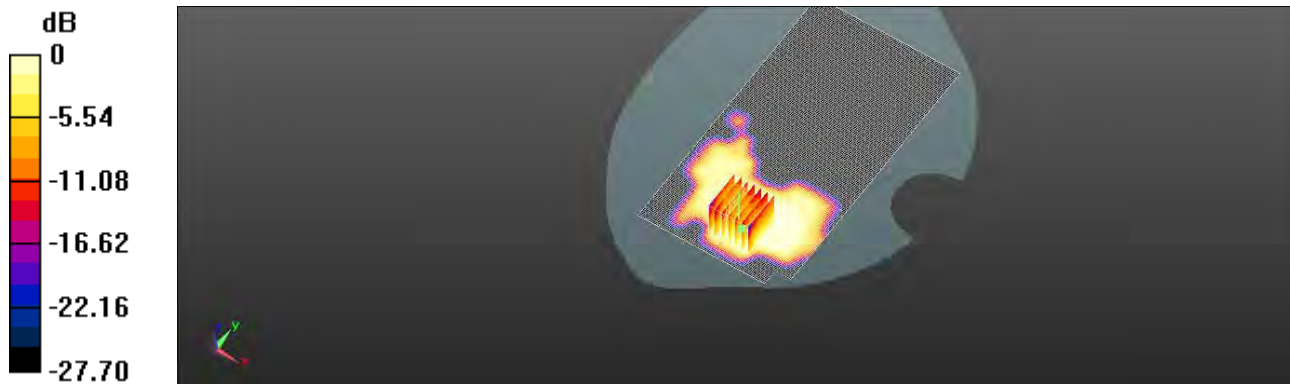

0 dB = 0.0433 W/kg = -13.64 dBW/kg

Unless otherwise stated the results shown in this test report refer only to the sample(s) tested and such sample(s) are retained for 90 days only.

除非另有說明，此報告結果僅對測試之樣品負責，同時此樣品僅保留90天。本報告未經本公司書面許可，不可部份複製。

This document is issued by the Company subject to its General Conditions of Service printed overleaf, available on request or accessible at <http://www.sgs.com.tw/Terms-and-Conditions> and for electronic format documents, subject to Terms and Conditions for Electronic Documents at <http://www.sgs.com.tw/Terms-and-Conditions>. Attention is drawn to the limitation of liability, indemnification and jurisdiction issues defined therein. Any holder of this document is advised that information contained hereon reflects the Company's findings at the time of its intervention only and within the limits of Client's instructions, if any. The Company's sole responsibility is to its Client and this document does not exonerate parties to a transaction from exercising all their rights and obligations under the transaction documents. This document cannot be reproduced except in full, without prior written approval of the Company. Any unauthorized alteration, forgery or falsification of the content or appearance of this document is unlawful and offenders may be prosecuted to the fullest extent of the law.

Date: 2020/7/10

Report No. : ES/2020/30005

WLAN 802.11n(40M) 5.2G_Hotspot_Back side_CH 46_Chain0_Ant4_10mm

Communication System: Wi-Fi; Frequency: 5230 MHz; Duty cycle= 1:1

Medium parameters used: $f = 5230 \text{ MHz}$; $\sigma = 4.734 \text{ S/m}$; $\epsilon_r = 35.583$; $\rho = 1000 \text{ kg/m}^3$

Phantom section: Flat Section

Ambient temperature: 22.1°C; Liquid temperature: 21.8°C

DASY5 Configuration:

- Probe: EX3DV4 - SN3770; ConvF(5.4, 5.4, 5.4) @ 5230 MHz; Calibrated: 2020/5/27
- Sensor-Surface: 2mm (Mechanical Surface Detection)
- Electronics: DAE4 Sn877; Calibrated: 2020/3/17
- Phantom: SAM
- DASY52 52.10.4(1527); SEMCAD X 14.6.14(7483)

Area Scan (121x211x1): Interpolated grid: dx=10 mm, dy=10 mm

Maximum value of SAR (interpolated) = 0.303 W/kg

Zoom Scan (7x7x12)/Cube 0: Measurement grid: dx=4mm, dy=4mm, dz=2mm

Reference Value = 2.065 V/m; Power Drift = 0.14 dB

Peak SAR (extrapolated) = 0.449 W/kg

SAR(1 g) = 0.171 W/kg; SAR(10 g) = 0.072 W/kg

Smallest distance from peaks to all points 3 dB below = 9.9 mm

Ratio of SAR at M2 to SAR at M1 = 60.3%

Maximum value of SAR (measured) = 0.263 W/kg

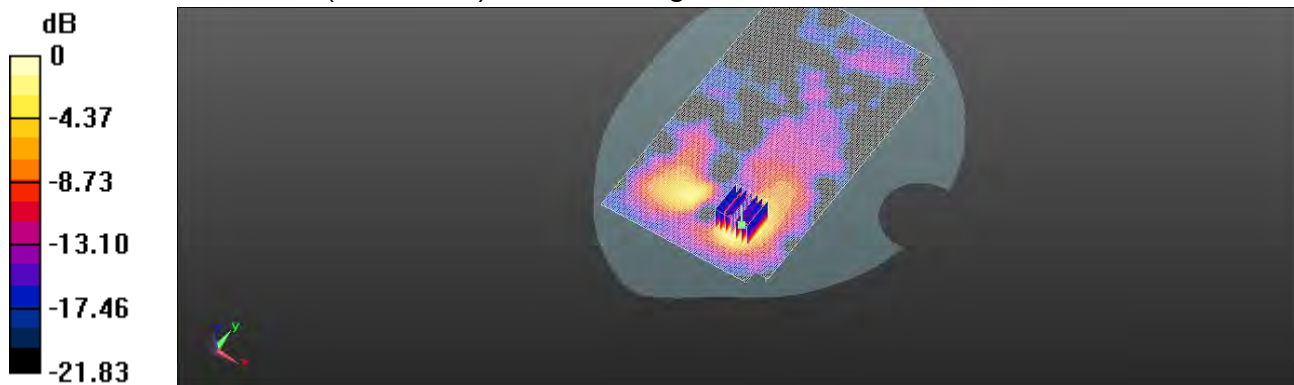

0 dB = 0.263 W/kg = -5.80 dBW/kg

Unless otherwise stated the results shown in this test report refer only to the sample(s) tested and such sample(s) are retained for 90 days only.

除非另有說明，此報告結果僅對測試之樣品負責，同時此樣品僅保留90天。本報告未經本公司書面許可，不可部份複製。

This document is issued by the Company subject to its General Conditions of Service printed overleaf, available on request or accessible at <http://www.sgs.com.tw/Terms-and-Conditions> and for electronic format documents, subject to Terms and Conditions for Electronic Documents at <http://www.sgs.com.tw/Terms-and-Conditions>. Attention is drawn to the limitation of liability, indemnification and jurisdiction issues defined therein. Any holder of this document is advised that information contained hereon reflects the Company's findings at the time of its intervention only and within the limits of Client's instructions, if any. The Company's sole responsibility is to its Client and this document does not exonerate parties to a transaction from exercising all their rights and obligations under the transaction documents. This document cannot be reproduced except in full, without prior written approval of the Company. Any unauthorized alteration, forgery or falsification of the content or appearance of this document is unlawful and offenders may be prosecuted to the fullest extent of the law.

Date: 2020/7/11

Report No. :ES/2020/30005

WLAN 802.11a 5.3G_Hotspot_Back side_CH 52_Chain0_Ant4_10mm

Communication System: Wi-Fi; Frequency: 5260 MHz; Duty cycle= 1:1

Medium parameters used: $f = 5260 \text{ MHz}$; $\sigma = 4.787 \text{ S/m}$; $\epsilon_r = 35.478$; $\rho = 1000 \text{ kg/m}^3$

Phantom section: Flat Section

Ambient temperature: 21.5°C; Liquid temperature: 22.1°C

DASY5 Configuration:

- Probe: EX3DV4 - SN3770; ConvF(5.4, 5.4, 5.4) @ 5260 MHz; Calibrated: 2020/5/27
- Sensor-Surface: 2mm (Mechanical Surface Detection)
- Electronics: DAE4 Sn877; Calibrated: 2020/3/17
- Phantom: SAM
- DASY52 52.10.4(1527); SEMCAD X 14.6.14(7483)

Area Scan (121x211x1): Interpolated grid: dx=10 mm, dy=10 mm

Maximum value of SAR (interpolated) = 0.241 W/kg

Zoom Scan (7x7x12)/Cube 0: Measurement grid: dx=4mm, dy=4mm, dz=2mm

Reference Value = 3.29 V/m; Power Drift = 0.18 dB

Peak SAR (extrapolated) = 0.374 W/kg

SAR(1 g) = 0.175 W/kg; SAR(10 g) = 0.086 W/kg

Smallest distance from peaks to all points 3 dB below = 9.7 mm

Ratio of SAR at M2 to SAR at M1 = 59.8%

Maximum value of SAR (measured) = 0.217 W/kg

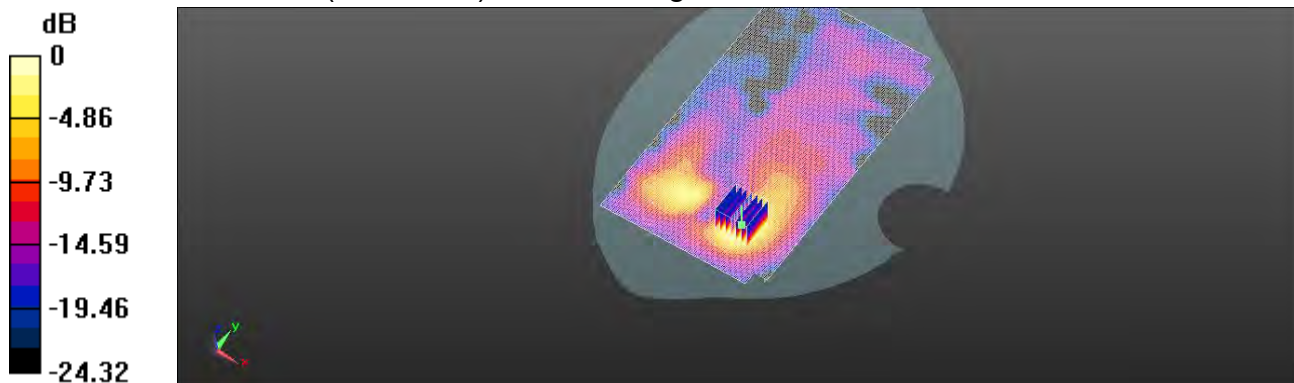

0 dB = 0.217 W/kg = -6.64 dBW/kg

Unless otherwise stated the results shown in this test report refer only to the sample(s) tested and such sample(s) are retained for 90 days only.

除非另有說明，此報告結果僅對測試之樣品負責，同時此樣品僅保留90天。本報告未經本公司書面許可，不可部份複製。

This document is issued by the Company subject to its General Conditions of Service printed overleaf, available on request or accessible at <http://www.sgs.com.tw/Terms-and-Conditions> and for electronic format documents, subject to Terms and Conditions for Electronic Documents at <http://www.sgs.com.tw/Terms-and-Conditions>. Attention is drawn to the limitation of liability, indemnification and jurisdiction issues defined therein. Any holder of this document is advised that information contained hereon reflects the Company's findings at the time of its intervention only and within the limits of Client's instructions, if any. The Company's sole responsibility is to its Client and this document does not exonerate parties to a transaction from exercising all their rights and obligations under the transaction documents. This document cannot be reproduced except in full, without prior written approval of the Company. Any unauthorized alteration, forgery or falsification of the content or appearance of this document is unlawful and offenders may be prosecuted to the fullest extent of the law.

Date: 2020/7/12

Report No. : ES/2020/30005

WLAN 802.11ac(80M) 5.6G_Hotspot_Back side_CH 138_Chain0_Ant4_10mm

Communication System: WLAN 5G; Frequency: 5690 MHz; Duty cycle= 1:1

Medium parameters used: $f = 5690$ MHz; $\sigma = 5.234$ S/m; $\epsilon_r = 34.835$; $\rho = 1000$ kg/m³

Phantom section: Flat Section

Ambient temperature: 21.9°C; Liquid temperature: 21.5°C

DASY5 Configuration:

- Probe: EX3DV4 - SN3770; ConvF(4.79, 4.79, 4.79) @ 5690 MHz; Calibrated: 2020/5/27
- Sensor-Surface: 2mm (Mechanical Surface Detection)
- Electronics: DAE4 Sn877; Calibrated: 2020/3/17
- Phantom: SAM
- DASY52 52.10.4(1527); SEMCAD X 14.6.14(7483)

Area Scan (121x211x1): Interpolated grid: dx=10 mm, dy=10 mm

Maximum value of SAR (interpolated) = 0.153 W/kg

Zoom Scan (7x7x12)/Cube 0: Measurement grid: dx=4mm, dy=4mm, dz=2mm

Reference Value = 3.416 V/m; Power Drift = 0.10 dB

Peak SAR (extrapolated) = 0.264 W/kg

SAR(1 g) = 0.139 W/kg; SAR(10 g) = 0.079 W/kg

Smallest distance from peaks to all points 3 dB below = 11.9 mm

Ratio of SAR at M2 to SAR at M1 = 57.4%

Maximum value of SAR (measured) = 0.141 W/kg

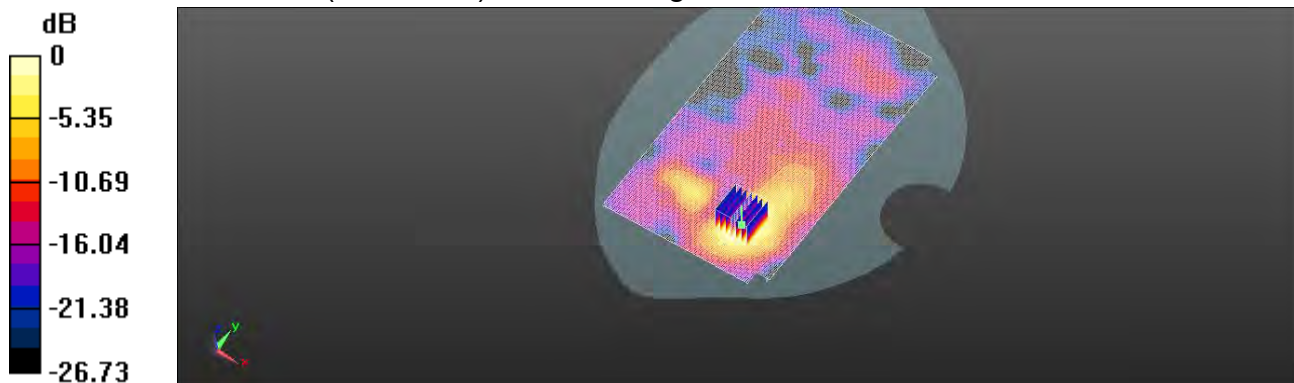

0 dB = 0.141 W/kg = -8.51 dBW/kg

Unless otherwise stated the results shown in this test report refer only to the sample(s) tested and such sample(s) are retained for 90 days only.

除非另有說明，此報告結果僅對測試之樣品負責，同時此樣品僅保留90天。本報告未經本公司書面許可，不可部份複製。

This document is issued by the Company subject to its General Conditions of Service printed overleaf, available on request or accessible at <http://www.sgs.com.tw/Terms-and-Conditions> and for electronic format documents, subject to Terms and Conditions for Electronic Documents at <http://www.sgs.com.tw/Terms-and-Conditions>. Attention is drawn to the limitation of liability, indemnification and jurisdiction issues defined therein. Any holder of this document is advised that information contained hereon reflects the Company's findings at the time of its intervention only and within the limits of Client's instructions, if any. The Company's sole responsibility is to its Client and this document does not exonerate parties to a transaction from exercising all their rights and obligations under the transaction documents. This document cannot be reproduced except in full, without prior written approval of the Company. Any unauthorized alteration, forgery or falsification of the content or appearance of this document is unlawful and offenders may be prosecuted to the fullest extent of the law.

Date: 2020/7/13

Report No. : ES/2020/30005

WLAN 802.11ac(80M) 5.8G_Hotspot_Back side_CH 155_Chain0_Ant4_10mm

Communication System: Wi-Fi; Frequency: 5775 MHz; Duty cycle= 1:1

Medium parameters used: $f = 5775 \text{ MHz}$; $\sigma = 5.308 \text{ S/m}$; $\epsilon_r = 34.656$; $\rho = 1000 \text{ kg/m}^3$

Phantom section: Flat Section

Ambient temperature: 21.4°C; Liquid temperature: 21.7°C

DASY5 Configuration:

- Probe: EX3DV4 - SN3770; ConvF(4.9, 4.9, 4.9) @ 5775 MHz; Calibrated: 2020/5/27
- Sensor-Surface: 2mm (Mechanical Surface Detection)
- Electronics: DAE4 Sn877; Calibrated: 2020/3/17
- Phantom: SAM
- DASY52 52.10.4(1527); SEMCAD X 14.6.14(7483)

Area Scan (111x201x1): Interpolated grid: dx=10 mm, dy=10 mm

Maximum value of SAR (interpolated) = 0.154 W/kg

Zoom Scan (7x7x12)/Cube 0: Measurement grid: dx=4mm, dy=4mm, dz=2mm

Reference Value = 1.698 V/m; Power Drift = 0.13 dB

Peak SAR (extrapolated) = 0.270 W/kg

SAR(1 g) = 0.125 W/kg; SAR(10 g) = 0.065 W/kg

Smallest distance from peaks to all points 3 dB below = 11.1 mm

Ratio of SAR at M2 to SAR at M1 = 52.1%

Maximum value of SAR (measured) = 0.143 W/kg

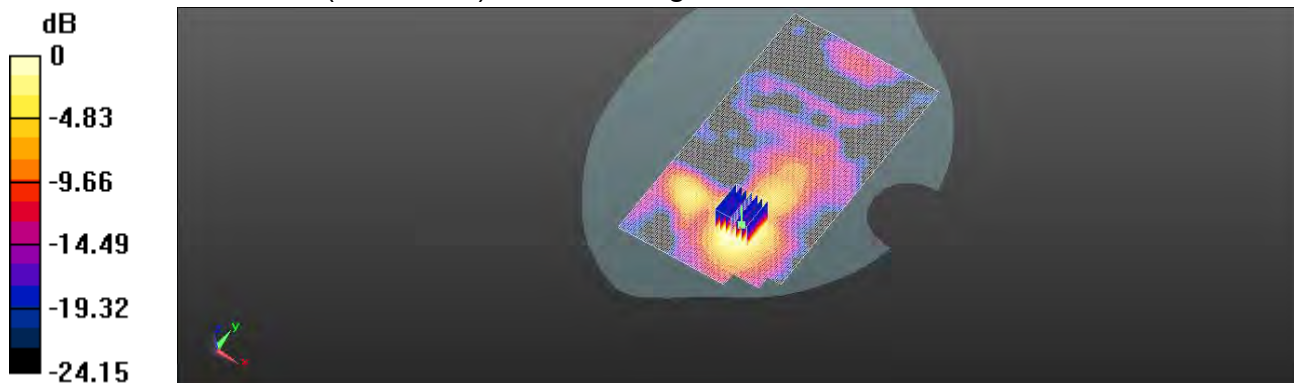

0 dB = 0.143 W/kg = -8.45 dBW/kg

Unless otherwise stated the results shown in this test report refer only to the sample(s) tested and such sample(s) are retained for 90 days only.

除非另有說明，此報告結果僅對測試之樣品負責，同時此樣品僅保留90天。本報告未經本公司書面許可，不可部份複製。

This document is issued by the Company subject to its General Conditions of Service printed overleaf, available on request or accessible at <http://www.sgs.com.tw/Terms-and-Conditions> and for electronic format documents, subject to Terms and Conditions for Electronic Documents at <http://www.sgs.com.tw/Terms-and-Conditions>. Attention is drawn to the limitation of liability, indemnification and jurisdiction issues defined therein. Any holder of this document is advised that information contained hereon reflects the Company's findings at the time of its intervention only and within the limits of Client's instructions, if any. The Company's sole responsibility is to its Client and this document does not exonerate parties to a transaction from exercising all their rights and obligations under the transaction documents. This document cannot be reproduced except in full, without prior written approval of the Company. Any unauthorized alteration, forgery or falsification of the content or appearance of this document is unlawful and offenders may be prosecuted to the fullest extent of the law.

Date: 2020/7/5

Report No. :ES/2020/30005

BLE_1M_Hotspot_Back side_CH 18_Chain1_Ant6_10mm

Communication System: Bluetooth; Frequency: 2442 MHz; Duty cycle= 1:1

Medium parameters used: $f = 2442 \text{ MHz}$; $\sigma = 1.741 \text{ S/m}$; $\epsilon_r = 38.897$; $\rho = 1000 \text{ kg/m}^3$

Phantom section: Flat Section

Ambient temperature: 22.3°C; Liquid temperature: 22.0°C

DASY5 Configuration:

- Probe: EX3DV4 - SN7509; ConvF(7.51, 7.51, 7.51) @ 2442 MHz; Calibrated: 2020/03/25
- Sensor-Surface: 2mm (Mechanical Surface Detection)
- Electronics: DAE4 Sn558; Calibrated: 2019/10/11
- Phantom: SAM
- DASY52 52.10.4(1527); SEMCAD X 14.6.14(7483)

Area Scan (91x171x1): Interpolated grid: dx=12 mm, dy=12 mm

Maximum value of SAR (interpolated) = 0.0205 W/kg

Zoom Scan (7x7x7)/Cube 0: Measurement grid: dx=5mm, dy=5mm, dz=5mm

Reference Value = 1.834 V/m; Power Drift = 0.14 dB

Peak SAR (extrapolated) = 0.0250 W/kg

SAR(1 g) = 0.016 W/kg; SAR(10 g) = 0.010 W/kg

Smallest distance from peaks to all points 3 dB below: Larger than measurement grid

Ratio of SAR at M2 to SAR at M1 = 53%

Maximum value of SAR (measured) = 0.0198 W/kg

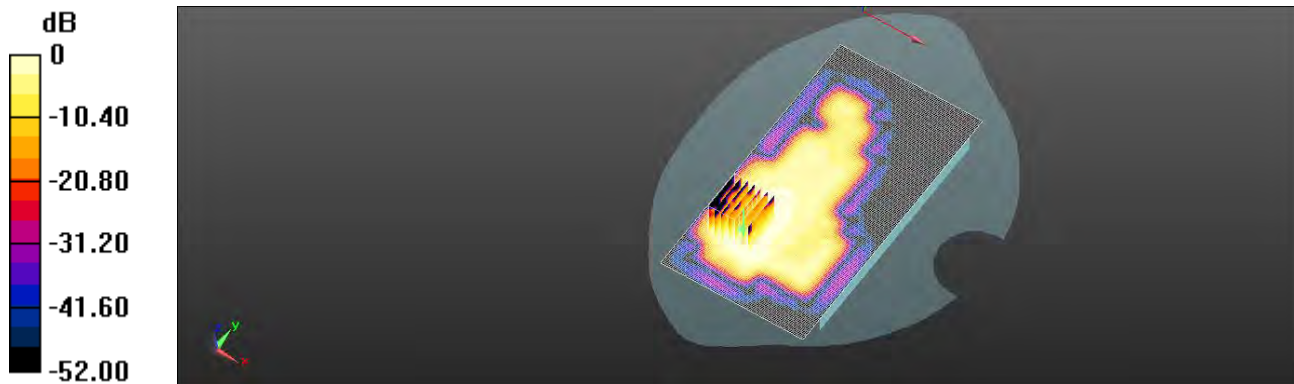

0 dB = 0.0198 W/kg = -17.03 dBW/kg

Unless otherwise stated the results shown in this test report refer only to the sample(s) tested and such sample(s) are retained for 90 days only.

除非另有說明，此報告結果僅對測試之樣品負責，同時此樣品僅保留90天。本報告未經本公司書面許可，不可部份複製。

This document is issued by the Company subject to its General Conditions of Service printed overleaf, available on request or accessible at <http://www.sgs.com.tw/Terms-and-Conditions> and for electronic format documents, subject to Terms and Conditions for Electronic Documents at <http://www.sgs.com.tw/Terms-and-Conditions>. Attention is drawn to the limitation of liability, indemnification and jurisdiction issues defined therein. Any holder of this document is advised that information contained hereon reflects the Company's findings at the time of its intervention only and within the limits of Client's instructions, if any. The Company's sole responsibility is to its Client and this document does not exonerate parties to a transaction from exercising all their rights and obligations under the transaction documents. This document cannot be reproduced except in full, without prior written approval of the Company. Any unauthorized alteration, forgery or falsification of the content or appearance of this document is unlawful and offenders may be prosecuted to the fullest extent of the law.

Date: 2020/7/11

Report No. : ES/2020/30005

WLAN 802.11n(20M) 5.3G_Hotspot_Back side_CH 60_Chain1_Ant6_10mm

Communication System: Wi-Fi; Frequency: 5300 MHz; Duty cycle= 1:1

Medium parameters used: $f = 5300$ MHz; $\sigma = 4.835$ S/m; $\epsilon_r = 35.425$; $\rho = 1000$ kg/m³

Phantom section: Flat Section

Ambient temperature: 21.5°C; Liquid temperature: 22.1°C

DASY5 Configuration:

- Probe: EX3DV4 - SN3770; ConvF(5.4, 5.4, 5.4) @ 5300 MHz; Calibrated: 2020/5/27
- Sensor-Surface: 2mm (Mechanical Surface Detection)
- Electronics: DAE4 Sn877; Calibrated: 2020/3/17
- Phantom: SAM
- DASY52 52.10.4(1527); SEMCAD X 14.6.14(7483)

Area Scan (111x201x1): Interpolated grid: dx=10 mm, dy=10 mm

Maximum value of SAR (interpolated) = 1.32 W/kg

Zoom Scan (7x7x12)/Cube 0: Measurement grid: dx=4mm, dy=4mm, dz=2mm

Reference Value = 1.529 V/m; Power Drift = 0.13 dB

Peak SAR (extrapolated) = 2.42 W/kg

SAR(1 g) = 0.817 W/kg; SAR(10 g) = 0.287 W/kg

Smallest distance from peaks to all points 3 dB below = 7.5 mm

Ratio of SAR at M2 to SAR at M1 = 57.8%

Maximum value of SAR (measured) = 1.32 W/kg

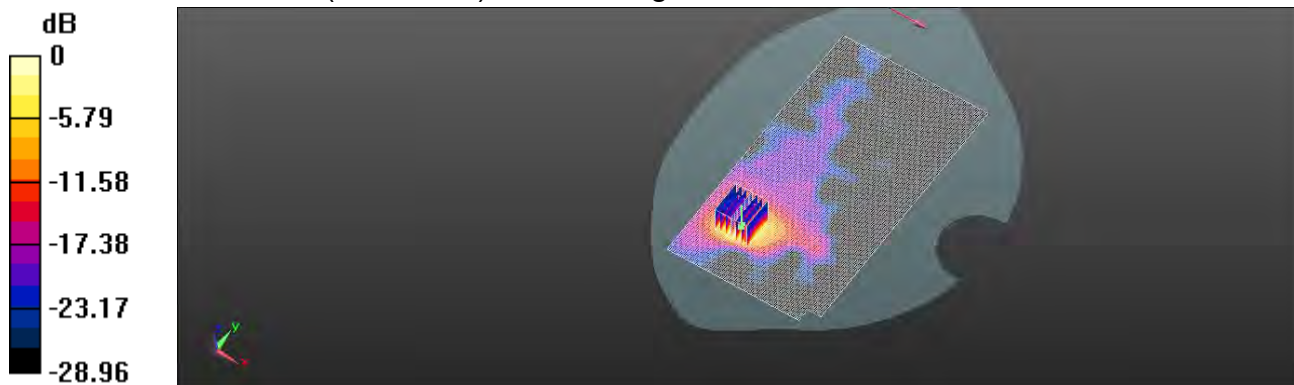

0 dB = 1.32 W/kg = 1.21 dBW/kg

Unless otherwise stated the results shown in this test report refer only to the sample(s) tested and such sample(s) are retained for 90 days only.

除非另有說明，此報告結果僅對測試之樣品負責，同時此樣品僅保留90天。本報告未經本公司書面許可，不可部份複製。

This document is issued by the Company subject to its General Conditions of Service printed overleaf, available on request or accessible at <http://www.sgs.com.tw/Terms-and-Conditions> and for electronic format documents, subject to Terms and Conditions for Electronic Documents at <http://www.sgs.com.tw/Terms-and-Conditions>. Attention is drawn to the limitation of liability, indemnification and jurisdiction issues defined therein. Any holder of this document is advised that information contained hereon reflects the Company's findings at the time of its intervention only and within the limits of Client's instructions, if any. The Company's sole responsibility is to its Client and this document does not exonerate parties to a transaction from exercising all their rights and obligations under the transaction documents. This document cannot be reproduced except in full, without prior written approval of the Company. Any unauthorized alteration, forgery or falsification of the content or appearance of this document is unlawful and offenders may be prosecuted to the fullest extent of the law.

Date: 2020/7/13

Report No. :ES/2020/30005

WLAN 802.11ac(80M) 5.8G_Hotspot_Back side_CH 155_Chain1_Ant6_10mm

Communication System: Wi-Fi; Frequency: 5775 MHz; Duty cycle= 1:1

Medium parameters used: $f = 5775$ MHz; $\sigma = 5.308$ S/m; $\epsilon_r = 34.656$; $\rho = 1000$ kg/m³

Phantom section: Flat Section

Ambient temperature: 21.4°C; Liquid temperature: 21.7°C

DASY5 Configuration:

- Probe: EX3DV4 - SN3770; ConvF(4.9, 4.9, 4.9) @ 5775 MHz; Calibrated: 2020/5/27
- Sensor-Surface: 2mm (Mechanical Surface Detection)
- Electronics: DAE4 Sn877; Calibrated: 2020/3/17
- Phantom: SAM
- DASY52 52.10.4(1527); SEMCAD X 14.6.14(7483)

Area Scan (111x201x1): Interpolated grid: dx=10 mm, dy=10 mm

Maximum value of SAR (interpolated) = 1.47 W/kg

Zoom Scan (7x7x12)/Cube 0: Measurement grid: dx=4mm, dy=4mm, dz=2mm

Reference Value = 1.254 V/m; Power Drift = 0.11dB

Peak SAR (extrapolated) = 2.83 W/kg

SAR(1 g) = 0.742 W/kg; SAR(10 g) = 0.221 W/kg

Smallest distance from peaks to all points 3 dB below = 7.2 mm

Ratio of SAR at M2 to SAR at M1 = 52.9%

Maximum value of SAR (measured) = 1.41 W/kg

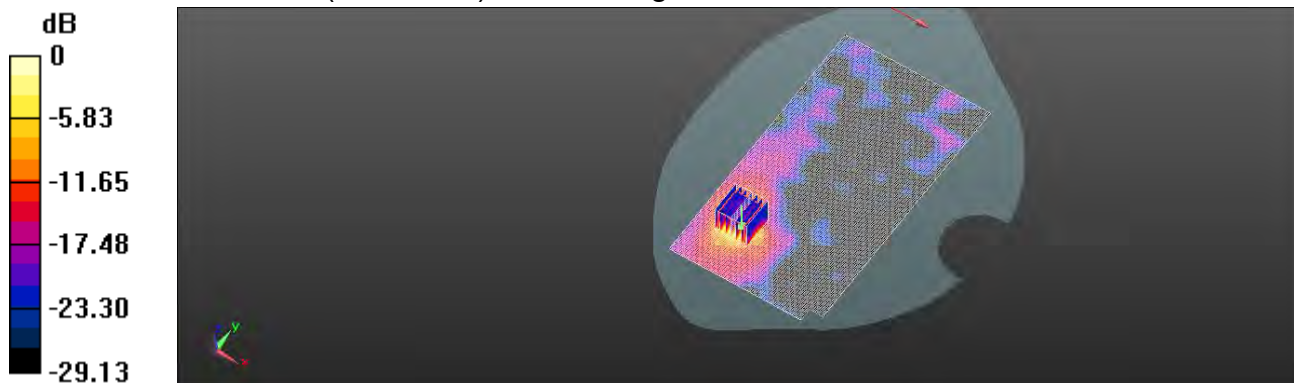

0 dB = 1.41 W/kg = 1.49 dBW/kg

Unless otherwise stated the results shown in this test report refer only to the sample(s) tested and such sample(s) are retained for 90 days only.

除非另有說明，此報告結果僅對測試之樣品負責，同時此樣品僅保留90天。本報告未經本公司書面許可，不可部份複製。

This document is issued by the Company subject to its General Conditions of Service printed overleaf, available on request or accessible at <http://www.sgs.com.tw/Terms-and-Conditions> and for electronic format documents, subject to Terms and Conditions for Electronic Documents at <http://www.sgs.com.tw/Terms-and-Conditions>. Attention is drawn to the limitation of liability, indemnification and jurisdiction issues defined therein. Any holder of this document is advised that information contained hereon reflects the Company's findings at the time of its intervention only and within the limits of Client's instructions, if any. The Company's sole responsibility is to its Client and this document does not exonerate parties to a transaction from exercising all their rights and obligations under the transaction documents. This document cannot be reproduced except in full, without prior written approval of the Company. Any unauthorized alteration, forgery or falsification of the content or appearance of this document is unlawful and offenders may be prosecuted to the fullest extent of the law.

Date: 2020/7/5

Report No. :ES/2020/30005

WLAN 802.11n(40M) 5.2G_Body worn_Back side_CH 46_Chain0_Ant6_15mm

Communication System: Wi-Fi; Frequency: 5230 MHz; Duty cycle= 1:1

Medium parameters used: $f = 5230 \text{ MHz}$; $\sigma = 4.748 \text{ S/m}$; $\epsilon_r = 35.528$; $\rho = 1000 \text{ kg/m}^3$

Phantom section: Flat Section

Ambient temperature: 21.4°C; Liquid temperature: 21.8°C

DASY5 Configuration:

- Probe: EX3DV4 - SN7509; ConvF(5.33, 5.33, 5.33) @ 5230 MHz; Calibrated: 2020/03/25
- Sensor-Surface: 2mm (Mechanical Surface Detection)
- Electronics: DAE4 Sn558; Calibrated: 2019/10/11
- Phantom: SAM
- DASY52 52.10.4(1527); SEMCAD X 14.6.14(7483)

Area Scan (111x211x1): Interpolated grid: dx=10 mm, dy=10 mm

Maximum value of SAR (interpolated) = 0.463 W/kg

Zoom Scan (7x7x12)/Cube 0: Measurement grid: dx=4mm, dy=4mm, dz=2mm

Reference Value = 1.567 V/m; Power Drift = 0.13 dB

Peak SAR (extrapolated) = 0.650 W/kg

SAR(1 g) = 0.283 W/kg; SAR(10 g) = 0.116 W/kg

Smallest distance from peaks to all points 3 dB below = 9.6 mm

Ratio of SAR at M2 to SAR at M1 = 66.2%

Maximum value of SAR (measured) = 0.473 W/kg

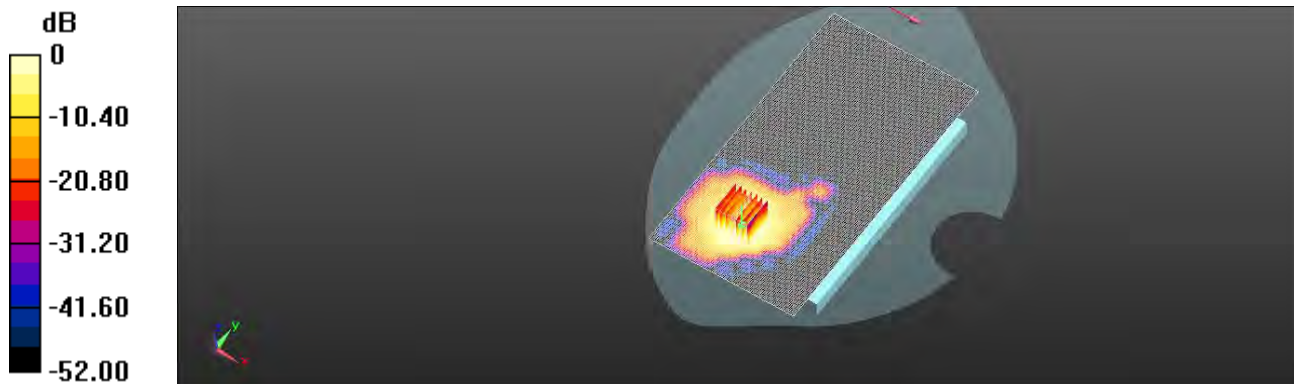

0 dB = 0.473 W/kg = -3.25 dBW/kg

Unless otherwise stated the results shown in this test report refer only to the sample(s) tested and such sample(s) are retained for 90 days only.

除非另有說明，此報告結果僅對測試之樣品負責，同時此樣品僅保留90天。本報告未經本公司書面許可，不可部份複製。

This document is issued by the Company subject to its General Conditions of Service printed overleaf, available on request or accessible at <http://www.sgs.com.tw/Terms-and-Conditions> and for electronic format documents, subject to Terms and Conditions for Electronic Documents at <http://www.sgs.com.tw/Terms-and-Conditions>. Attention is drawn to the limitation of liability, indemnification and jurisdiction issues defined therein. Any holder of this document is advised that information contained hereon reflects the Company's findings at the time of its intervention only and within the limits of Client's instructions, if any. The Company's sole responsibility is to its Client and this document does not exonerate parties to a transaction from exercising all their rights and obligations under the transaction documents. This document cannot be reproduced except in full, without prior written approval of the Company. Any unauthorized alteration, forgery or falsification of the content or appearance of this document is unlawful and offenders may be prosecuted to the fullest extent of the law.

Date: 2020/7/6

Report No. : ES/2020/30005

WLAN 802.11a 5.3G_Body worn_Back side_CH 52_Chain0_Ant6_15mm

Communication System: WLAN 5G; Frequency: 5260 MHz; Duty cycle= 1:1

Medium parameters used: $f = 5260$ MHz; $\sigma = 4.796$ S/m; $\epsilon_r = 35.513$; $\rho = 1000$ kg/m³

Phantom section: Flat Section

Ambient temperature: 22.0°C; Liquid temperature: 21.6°C

DASY5 Configuration:

- Probe: EX3DV4 - SN7509; ConvF(5.23, 5.23, 5.23) @ 5260 MHz; Calibrated: 2020/03/25
- Sensor-Surface: 2mm (Mechanical Surface Detection)
- Electronics: DAE4 Sn558; Calibrated: 2019/10/11
- Phantom: SAM
- DASY52 52.10.4(1527); SEMCAD X 14.6.14(7483)

Area Scan (111x211x1): Interpolated grid: dx=10 mm, dy=10 mm

Maximum value of SAR (interpolated) = 0.819 W/kg

Zoom Scan (7x7x12)/Cube 0: Measurement grid: dx=4mm, dy=4mm, dz=2mm

Reference Value = 1.791 V/m; Power Drift = 0.14 dB

Peak SAR (extrapolated) = 1.14 W/kg

SAR(1 g) = 0.551 W/kg; SAR(10 g) = 0.248 W/kg

Smallest distance from peaks to all points 3 dB below = 10.4 mm

Ratio of SAR at M2 to SAR at M1 = 66.5%

Maximum value of SAR (measured) = 0.819 W/kg

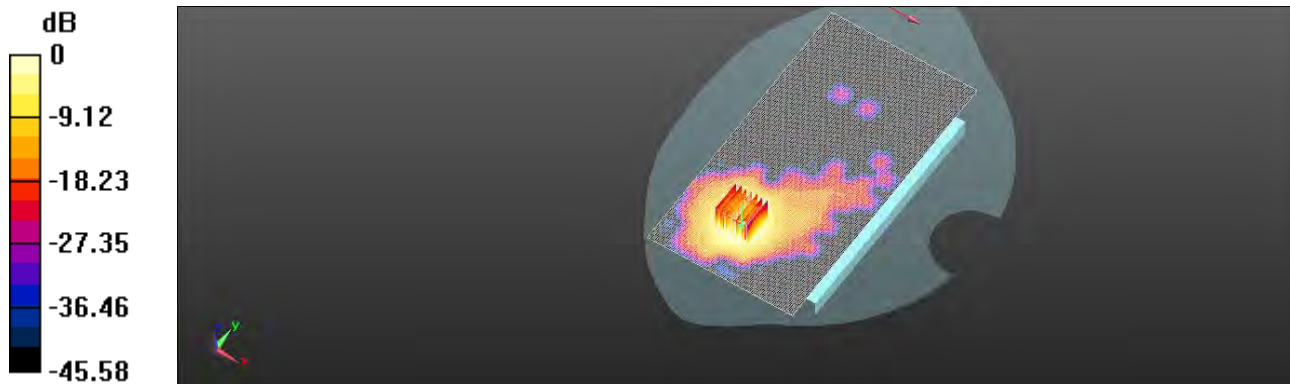

0 dB = 0.819 W/kg = -0.87 dBW/kg

Unless otherwise stated the results shown in this test report refer only to the sample(s) tested and such sample(s) are retained for 90 days only.

除非另有說明，此報告結果僅對測試之樣品負責，同時此樣品僅保留90天。本報告未經本公司書面許可，不可部份複製。

This document is issued by the Company subject to its General Conditions of Service printed overleaf, available on request or accessible at <http://www.sgs.com.tw/Terms-and-Conditions> and for electronic format documents, subject to Terms and Conditions for Electronic Documents at <http://www.sgs.com.tw/Terms-and-Conditions>. Attention is drawn to the limitation of liability, indemnification and jurisdiction issues defined therein. Any holder of this document is advised that information contained hereon reflects the Company's findings at the time of its intervention only and within the limits of Client's instructions, if any. The Company's sole responsibility is to its Client and this document does not exonerate parties to a transaction from exercising all their rights and obligations under the transaction documents. This document cannot be reproduced except in full, without prior written approval of the Company. Any unauthorized alteration, forgery or falsification of the content or appearance of this document is unlawful and offenders may be prosecuted to the fullest extent of the law.

Date: 2020/7/7

Report No. :ES/2020/30005

**WLAN 802.11ac(80M) 5.6G_Body worn_Back side_CH
138_Chain0_Ant6_15mm**

Communication System: WLAN 5G; Frequency: 5690 MHz; Duty cycle= 1:1

Medium parameters used: $f = 5690$ MHz; $\sigma = 5.233$ S/m; $\epsilon_r = 34.727$; $\rho = 1000$ kg/m³

Phantom section: Flat Section

Ambient temperature: 21.6°C; Liquid temperature: 22.1°C

DASY5 Configuration:

- Probe: EX3DV4 - SN7509; ConvF(4.64, 4.64, 4.64) @ 5690 MHz; Calibrated: 2020/03/25
- Sensor-Surface: 2mm (Mechanical Surface Detection)
- Electronics: DAE4 Sn558; Calibrated: 2019/10/11
- Phantom: SAM
- DASY52 52.10.4(1527); SEMCAD X 14.6.14(7483)

Area Scan (111x211x1): Interpolated grid: dx=10 mm, dy=10 mm

Maximum value of SAR (interpolated) = 0.353 W/kg

Zoom Scan (7x7x12)/Cube 0: Measurement grid: dx=4mm, dy=4mm, dz=2mm

Reference Value = 1.319 V/m; Power Drift = 0.12 dB

Peak SAR (extrapolated) = 0.469 W/kg

SAR(1 g) = 0.243 W/kg; SAR(10 g) = 0.110 W/kg

Smallest distance from peaks to all points 3 dB below = 7.9 mm

Ratio of SAR at M2 to SAR at M1 = 71.1%

Maximum value of SAR (measured) = 0.375 W/kg

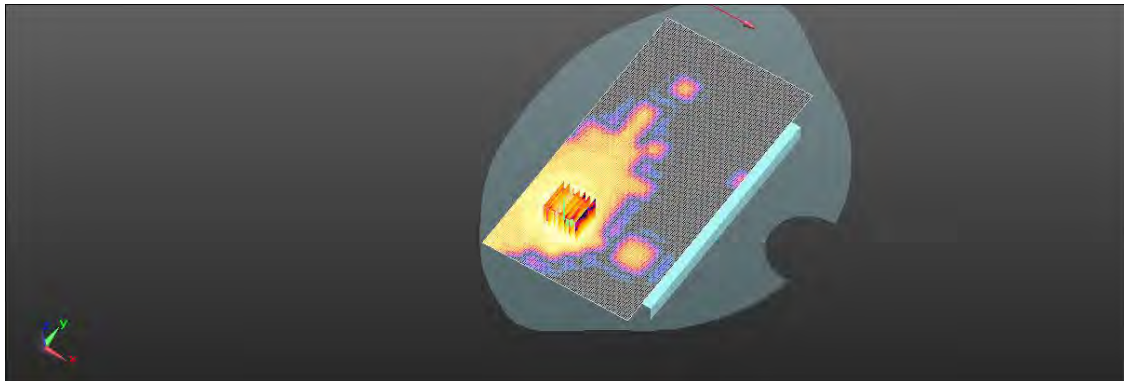
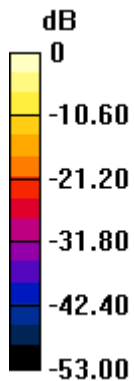

0 dB = 0.375 W/kg = -4.26 dBW/kg

Unless otherwise stated the results shown in this test report refer only to the sample(s) tested and such sample(s) are retained for 90 days only.

除非另有說明，此報告結果僅對測試之樣品負責，同時此樣品僅保留90天。本報告未經本公司書面許可，不可部份複製。

This document is issued by the Company subject to its General Conditions of Service printed overleaf, available on request or accessible at <http://www.sgs.com.tw/Terms-and-Conditions> and for electronic format documents, subject to Terms and Conditions for Electronic Documents at <http://www.sgs.com.tw/Terms-and-Conditions>. Attention is drawn to the limitation of liability, indemnification and jurisdiction issues defined therein. Any holder of this document is advised that information contained hereon reflects the Company's findings at the time of its intervention only and within the limits of Client's instructions, if any. The Company's sole responsibility is to its Client and this document does not exonerate parties to a transaction from exercising all their rights and obligations under the transaction documents. This document cannot be reproduced except in full, without prior written approval of the Company. Any unauthorized alteration, forgery or falsification of the content or appearance of this document is unlawful and offenders may be prosecuted to the fullest extent of the law.

Date: 2020/7/8

Report No. :ES/2020/30005

**WLAN 802.11ac(80M) 5.8G_Body worn_Back side_CH
155_Chain0_Ant6_15mm**

Communication System: WLAN 5G; Frequency: 5775 MHz; Duty cycle= 1:1

Medium parameters used: $f = 5775 \text{ MHz}$; $\sigma = 5.313 \text{ S/m}$; $\epsilon_r = 34.566$; $\rho = 1000 \text{ kg/m}^3$

Phantom section: Flat Section

Ambient temperature: 21.5°C; Liquid temperature: 21.9°C

DASY5 Configuration:

- Probe: EX3DV4 - SN7509; ConvF(4.85, 4.85, 4.85) @ 5775 MHz; Calibrated: 2020/03/25
- Sensor-Surface: 2mm (Mechanical Surface Detection)
- Electronics: DAE4 Sn558; Calibrated: 2019/10/11
- Phantom: SAM
- DASY52 52.10.4(1527); SEMCAD X 14.6.14(7483)

Area Scan (111x211x1): Interpolated grid: dx=10 mm, dy=10 mm

Maximum value of SAR (interpolated) = 0.393 W/kg

Zoom Scan (7x7x12)/Cube 0: Measurement grid: dx=4mm, dy=4mm, dz=2mm

Reference Value = 2.677 V/m; Power Drift = 0.16 dB

Peak SAR (extrapolated) = 0.546 W/kg

SAR(1 g) = 0.261 W/kg; SAR(10 g) = 0.113 W/kg

Smallest distance from peaks to all points 3 dB below = 8.6 mm

Ratio of SAR at M2 to SAR at M1 = 69.7%

Maximum value of SAR (measured) = 0.422 W/kg

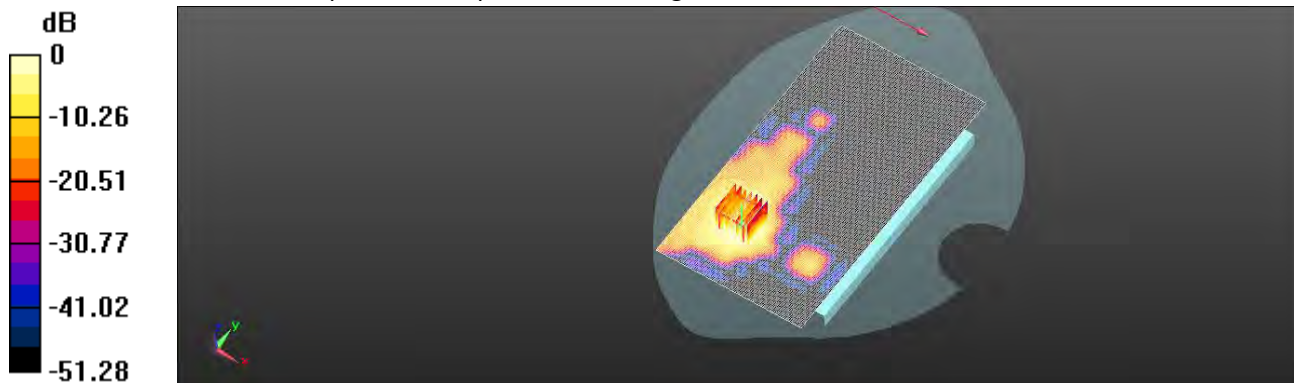

0 dB = 0.422 W/kg = -3.75 dBW/kg

Unless otherwise stated the results shown in this test report refer only to the sample(s) tested and such sample(s) are retained for 90 days only.

除非另有說明，此報告結果僅對測試之樣品負責，同時此樣品僅保留90天。本報告未經本公司書面許可，不可部份複製。

This document is issued by the Company subject to its General Conditions of Service printed overleaf, available on request or accessible at <http://www.sgs.com.tw/Terms-and-Conditions> and for electronic format documents, subject to Terms and Conditions for Electronic Documents at <http://www.sgs.com.tw/Terms-and-Conditions>. Attention is drawn to the limitation of liability, indemnification and jurisdiction issues defined therein. Any holder of this document is advised that information contained hereon reflects the Company's findings at the time of its intervention only and within the limits of Client's instructions, if any. The Company's sole responsibility is to its Client and this document does not exonerate parties to a transaction from exercising all their rights and obligations under the transaction documents. This document cannot be reproduced except in full, without prior written approval of the Company. Any unauthorized alteration, forgery or falsification of the content or appearance of this document is unlawful and offenders may be prosecuted to the fullest extent of the law.

Date: 2020/7/5

Report No. :ES/2020/30005

WLAN 802.11n(40M) 5.2G_Body worn_Back side_CH 46_Chain1_Ant5_15mm

Communication System: WLAN 5G; Frequency: 5230 MHz; Duty cycle= 1:1

Medium parameters used: $f = 5230 \text{ MHz}$; $\sigma = 4.748 \text{ S/m}$; $\epsilon_r = 35.528$; $\rho = 1000 \text{ kg/m}^3$

Phantom section: Flat Section

Ambient temperature: 21.4°C; Liquid temperature: 21.8°C

DASY5 Configuration:

- Probe: EX3DV4 - SN7509; ConvF(5.33, 5.33, 5.33) @ 5230 MHz; Calibrated: 2020/03/25
- Sensor-Surface: 2mm (Mechanical Surface Detection)
- Electronics: DAE4 Sn558; Calibrated: 2019/10/11
- Phantom: SAM
- DASY52 52.10.4(1527); SEMCAD X 14.6.14(7483)

Area Scan (111x191x1): Interpolated grid: dx=10 mm, dy=10 mm

Maximum value of SAR (interpolated) = 0.317 W/kg

Zoom Scan (7x7x12)/Cube 0: Measurement grid: dx=4mm, dy=4mm, dz=2mm

Reference Value = 1.257 V/m; Power Drift = 0.17 dB

Peak SAR (extrapolated) = 0.696 W/kg

SAR(1 g) = 0.117 W/kg; SAR(10 g) = 0.047 W/kg

Smallest distance from peaks to all points 3 dB below = 11.3 mm

Ratio of SAR at M2 to SAR at M1 = 60.4%

Maximum value of SAR (measured) = 0.196 W/kg

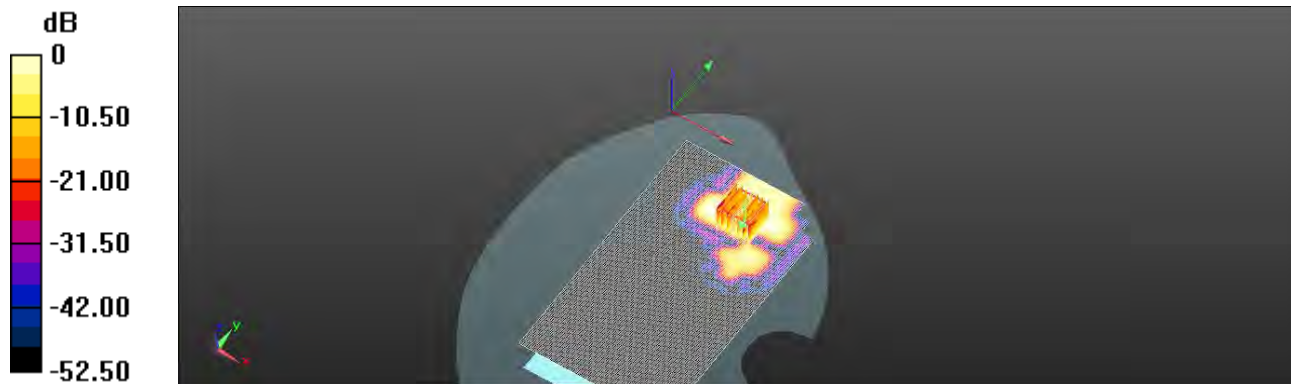

0 dB = 0.196 W/kg = -7.08 dBW/kg

Unless otherwise stated the results shown in this test report refer only to the sample(s) tested and such sample(s) are retained for 90 days only.

除非另有說明，此報告結果僅對測試之樣品負責，同時此樣品僅保留90天。本報告未經本公司書面許可，不可部份複製。

This document is issued by the Company subject to its General Conditions of Service printed overleaf, available on request or accessible at <http://www.sgs.com.tw/Terms-and-Conditions> and for electronic format documents, subject to Terms and Conditions for Electronic Documents at <http://www.sgs.com.tw/Terms-and-Conditions>. Attention is drawn to the limitation of liability, indemnification and jurisdiction issues defined therein. Any holder of this document is advised that information contained hereon reflects the Company's findings at the time of its intervention only and within the limits of Client's instructions, if any. The Company's sole responsibility is to its Client and this document does not exonerate parties to a transaction from exercising all their rights and obligations under the transaction documents. This document cannot be reproduced except in full, without prior written approval of the Company. Any unauthorized alteration, forgery or falsification of the content or appearance of this document is unlawful and offenders may be prosecuted to the fullest extent of the law.

Date: 2020/7/6

Report No. : ES/2020/30005

WLAN 802.11n(20M) 5.3G Body worn Back side CH60 Chain1 Ant5 15mm

Communication System: WLAN 5G; Frequency: 5300 MHz; Duty cycle= 1:1

Medium parameters used: $f = 5300 \text{ MHz}$; $\sigma = 4.821 \text{ S/m}$; $\epsilon_r = 35.335$; $\rho = 1000 \text{ kg/m}^3$

Phantom section: Flat Section

Ambient temperature: 22.0°C; Liquid temperature: 21.6°C

DASY5 Configuration:

- Probe: EX3DV4 - SN7509; ConvF(5.23, 5.23, 5.23) @ 5300 MHz; Calibrated: 2020/03/25
- Sensor-Surface: 2mm (Mechanical Surface Detection)
- Electronics: DAE4 Sn558; Calibrated: 2019/10/11
- Phantom: SAM
- DASY52 52.10.4(1527); SEMCAD X 14.6.14(7483)

Area Scan (111x191x1): Interpolated grid: dx=10 mm, dy=10 mm

Maximum value of SAR (interpolated) = 0.282 W/kg

Zoom Scan (7x7x12)/Cube 0: Measurement grid: dx=4mm, dy=4mm, dz=2mm

Reference Value = 1.779V/m; Power Drift = 0.12 dB

Peak SAR (extrapolated) = 0.439 W/kg

SAR(1 g) = 0.182 W/kg; SAR(10 g) = 0.085 W/kg

Smallest distance from peaks to all points 3 dB below = 9.1 mm

Ratio of SAR at M2 to SAR at M1 = 64.9%

Maximum value of SAR (measured) = 0.266 W/kg

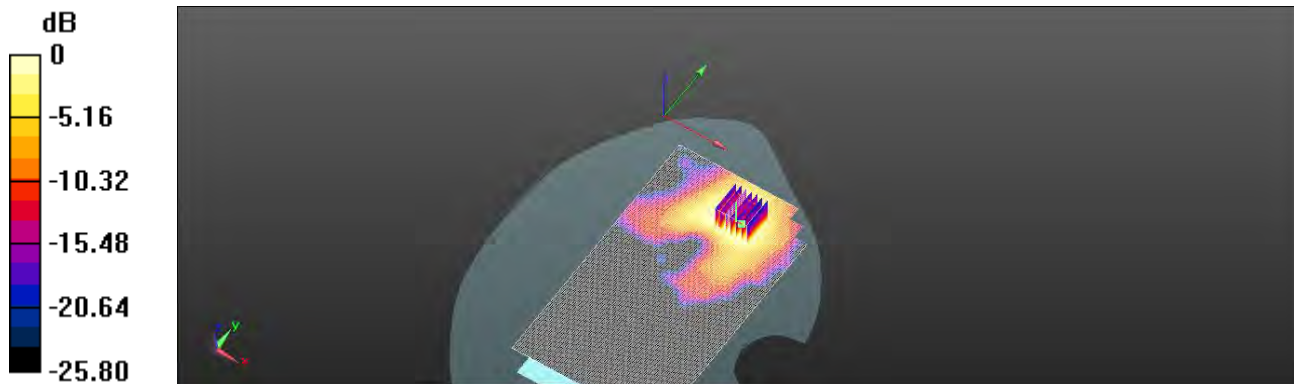

0 dB = 0.266 W/kg = -5.75 dBW/kg

Unless otherwise stated the results shown in this test report refer only to the sample(s) tested and such sample(s) are retained for 90 days only.

除非另有說明，此報告結果僅對測試之樣品負責，同時此樣品僅保留90天。本報告未經本公司書面許可，不可部份複製。

This document is issued by the Company subject to its General Conditions of Service printed overleaf, available on request or accessible at <http://www.sgs.com.tw/Terms-and-Conditions> and for electronic format documents, subject to Terms and Conditions for Electronic Documents at <http://www.sgs.com.tw/Terms-and-Conditions>. Attention is drawn to the limitation of liability, indemnification and jurisdiction issues defined therein. Any holder of this document is advised that information contained hereon reflects the Company's findings at the time of its intervention only and within the limits of Client's instructions, if any. The Company's sole responsibility is to its Client and this document does not exonerate parties to a transaction from exercising all their rights and obligations under the transaction documents. This document cannot be reproduced except in full, without prior written approval of the Company. Any unauthorized alteration, forgery or falsification of the content or appearance of this document is unlawful and offenders may be prosecuted to the fullest extent of the law.

Date: 2020/7/7

Report No. : ES/2020/30005

WLAN 802.11a 5.6G_Body worn_Back side_CH 100_Chain1_Ant5_15mm

Communication System: WLAN 5G; Frequency: 5500 MHz; Duty cycle= 1:1

Medium parameters used: $f = 5500$ MHz; $\sigma = 5.044$ S/m; $\epsilon_r = 35.227$; $\rho = 1000$ kg/m³

Phantom section: Flat Section

Ambient temperature: 21.6°C; Liquid temperature: 22.1°C

DASY5 Configuration:

- Probe: EX3DV4 - SN7509; ConvF(4.64, 4.64, 4.64) @ 5500 MHz; Calibrated: 2020/03/25
- Sensor-Surface: 2mm (Mechanical Surface Detection)
- Electronics: DAE4 Sn558; Calibrated: 2019/10/11
- Phantom: SAM
- DASY52 52.10.4(1527); SEMCAD X 14.6.14(7483)

Area Scan (111x191x1): Interpolated grid: dx=10 mm, dy=10 mm

Maximum value of SAR (interpolated) = 0.570 W/kg

Zoom Scan (7x7x12)/Cube 0: Measurement grid: dx=4mm, dy=4mm, dz=2mm

Reference Value = 1.634 V/m; Power Drift = 0.15 dB

Peak SAR (extrapolated) = 0.713 W/kg

SAR(1 g) = 0.391 W/kg; SAR(10 g) = 0.183 W/kg

Smallest distance from peaks to all points 3 dB below = 8.7 mm

Ratio of SAR at M2 to SAR at M1 = 71.5%

Maximum value of SAR (measured) = 0.589 W/kg

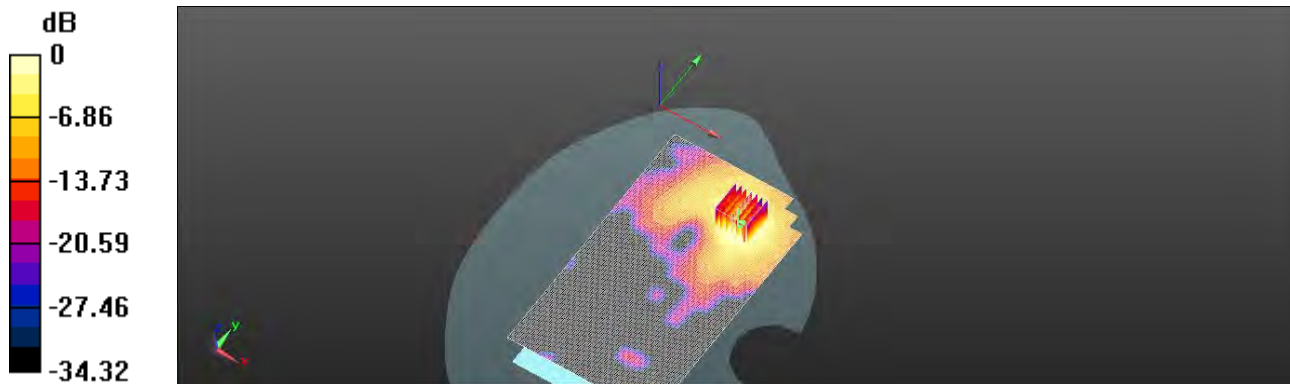

0 dB = 0.589 W/kg = -2.30 dBW/kg

Unless otherwise stated the results shown in this test report refer only to the sample(s) tested and such sample(s) are retained for 90 days only.

除非另有說明，此報告結果僅對測試之樣品負責，同時此樣品僅保留90天。本報告未經本公司書面許可，不可部份複製。

This document is issued by the Company subject to its General Conditions of Service printed overleaf, available on request or accessible at <http://www.sgs.com.tw/Terms-and-Conditions> and for electronic format documents, subject to Terms and Conditions for Electronic Documents at <http://www.sgs.com.tw/Terms-and-Conditions>. Attention is drawn to the limitation of liability, indemnification and jurisdiction issues defined therein. Any holder of this document is advised that information contained hereon reflects the Company's findings at the time of its intervention only and within the limits of Client's instructions, if any. The Company's sole responsibility is to its Client and this document does not exonerate parties to a transaction from exercising all their rights and obligations under the transaction documents. This document cannot be reproduced except in full, without prior written approval of the Company. Any unauthorized alteration, forgery or falsification of the content or appearance of this document is unlawful and offenders may be prosecuted to the fullest extent of the law.

Date: 2020/7/8

Report No. :ES/2020/30005

**WLAN 802.11ac(80M) 5.8G_Body worn_Back side_CH
155_Chain1_Ant5_15mm**

Communication System: Wi-Fi; Frequency: 5775 MHz; Duty cycle= 1:1

Medium parameters used: $f = 5775 \text{ MHz}$; $\sigma = 5.313 \text{ S/m}$; $\epsilon_r = 34.566$; $\rho = 1000 \text{ kg/m}^3$

Phantom section: Flat Section

Ambient temperature: 21.5°C; Liquid temperature: 21.9°C

DASY5 Configuration:

- Probe: EX3DV4 - SN7509; ConvF(4.85, 4.85, 4.85) @ 5775 MHz; Calibrated: 2020/03/25
- Sensor-Surface: 2mm (Mechanical Surface Detection)
- Electronics: DAE4 Sn558; Calibrated: 2019/10/11
- Phantom: SAM
- DASY52 52.10.4(1527); SEMCAD X 14.6.14(7483)

Area Scan (111x191x1): Interpolated grid: $dx=10 \text{ mm}$, $dy=10 \text{ mm}$

Maximum value of SAR (interpolated) = 0.512 W/kg

Zoom Scan (7x7x12)/Cube 0: Measurement grid: $dx=4\text{mm}$, $dy=4\text{mm}$, $dz=2\text{mm}$

Reference Value = 1.024 V/m; Power Drift = 0.09 dB

Peak SAR (extrapolated) = 0.586 W/kg

SAR(1 g) = 0.321 W/kg; SAR(10 g) = 0.139 W/kg

Smallest distance from peaks to all points 3 dB below = 8.3 mm

Ratio of SAR at M2 to SAR at M1 = 70.9%

Maximum value of SAR (measured) = 0.501 W/kg

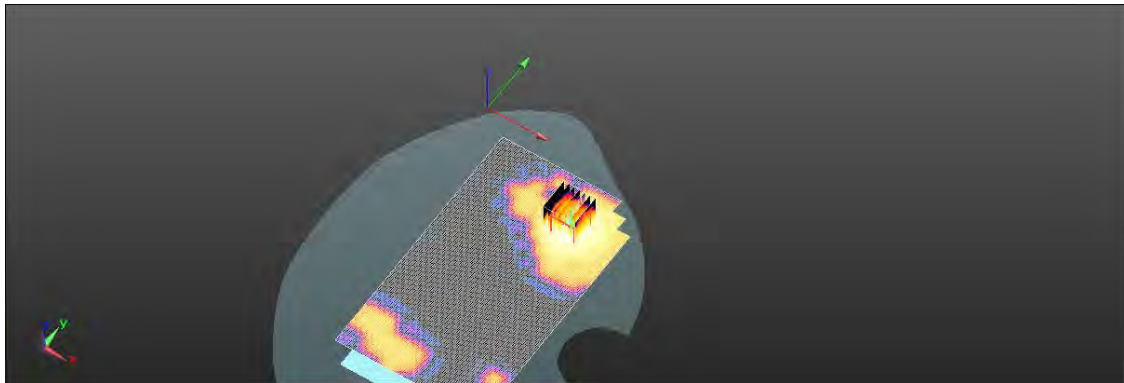
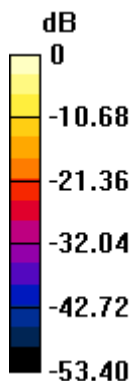

0 dB = 0.501 W/kg = -3.00 dBW/kg

Unless otherwise stated the results shown in this test report refer only to the sample(s) tested and such sample(s) are retained for 90 days only.

除非另有說明，此報告結果僅對測試之樣品負責，同時此樣品僅保留90天。本報告未經本公司書面許可，不可部份複製。

This document is issued by the Company subject to its General Conditions of Service printed overleaf, available on request or accessible at <http://www.sgs.com.tw/Terms-and-Conditions> and for electronic format documents, subject to Terms and Conditions for Electronic Documents at <http://www.sgs.com.tw/Terms-and-Conditions>. Attention is drawn to the limitation of liability, indemnification and jurisdiction issues defined therein. Any holder of this document is advised that information contained hereon reflects the Company's findings at the time of its intervention only and within the limits of Client's instructions, if any. The Company's sole responsibility is to its Client and this document does not exonerate parties to a transaction from exercising all their rights and obligations under the transaction documents. This document cannot be reproduced except in full, without prior written approval of the Company. Any unauthorized alteration, forgery or falsification of the content or appearance of this document is unlawful and offenders may be prosecuted to the fullest extent of the law.

Date: 2020/7/5

Report No. : ES/2020/30005

WLAN 802.11n(40M) 5.2G_Hotspot_Back side_CH 46_Chain0_Ant6_10mm

Communication System: Wi-Fi; Frequency: 5230 MHz; Duty cycle= 1:1

Medium parameters used: $f = 5230 \text{ MHz}$; $\sigma = 4.748 \text{ S/m}$; $\epsilon_r = 35.528$; $\rho = 1000 \text{ kg/m}^3$

Phantom section: Flat Section

Ambient temperature: 21.4°C; Liquid temperature: 21.8°C

DASY5 Configuration:

- Probe: EX3DV4 - SN7509; ConvF(5.33, 5.33, 5.33) @ 5230 MHz; Calibrated: 2020/03/25
- Sensor-Surface: 2mm (Mechanical Surface Detection)
- Electronics: DAE4 Sn558; Calibrated: 2019/10/11
- Phantom: SAM
- DASY52 52.10.4(1527); SEMCAD X 14.6.14(7483)

Area Scan (111x211x1): Interpolated grid: dx=10 mm, dy=10 mm

Maximum value of SAR (interpolated) = 1.19 W/kg

Zoom Scan (7x7x12)/Cube 0: Measurement grid: dx=4mm, dy=4mm, dz=2mm

Reference Value = 1.182 V/m; Power Drift = 0.17 dB

Peak SAR (extrapolated) = 2.15 W/kg

SAR(1 g) = 0.711 W/kg; SAR(10 g) = 0.241 W/kg

Smallest distance from peaks to all points 3 dB below = 7.4 mm

Ratio of SAR at M2 to SAR at M1 = 56.7%

Maximum value of SAR (measured) = 1.20 W/kg

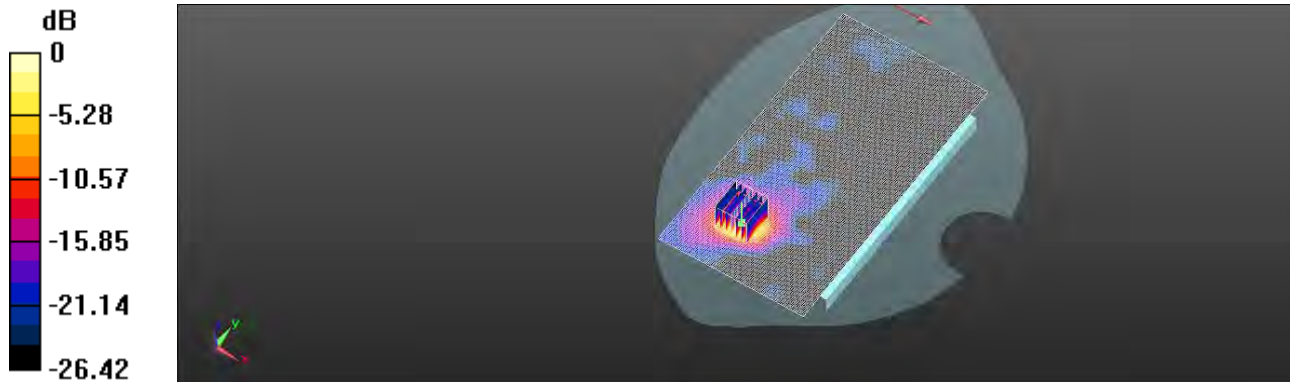

0 dB = 1.20 W/kg = 0.79 dBW/kg

Unless otherwise stated the results shown in this test report refer only to the sample(s) tested and such sample(s) are retained for 90 days only.

除非另有說明，此報告結果僅對測試之樣品負責，同時此樣品僅保留90天。本報告未經本公司書面許可，不可部份複製。

This document is issued by the Company subject to its General Conditions of Service printed overleaf, available on request or accessible at <http://www.sgs.com.tw/Terms-and-Conditions> and for electronic format documents, subject to Terms and Conditions for Electronic Documents at <http://www.sgs.com.tw/Terms-and-Conditions>. Attention is drawn to the limitation of liability, indemnification and jurisdiction issues defined therein. Any holder of this document is advised that information contained hereon reflects the Company's findings at the time of its intervention only and within the limits of Client's instructions, if any. The Company's sole responsibility is to its Client and this document does not exonerate parties to a transaction from exercising all their rights and obligations under the transaction documents. This document cannot be reproduced except in full, without prior written approval of the Company. Any unauthorized alteration, forgery or falsification of the content or appearance of this document is unlawful and offenders may be prosecuted to the fullest extent of the law.

Date: 2020/7/6

Report No. : ES/2020/30005

WLAN 802.11a 5.3G_Hotspot_Back side_CH 52_Chain0_Ant6_10mm

Communication System: Wi-Fi; Frequency: 5260 MHz; Duty cycle= 1:1

Medium parameters used: $f = 5260 \text{ MHz}$; $\sigma = 4.796 \text{ S/m}$; $\epsilon_r = 35.513$; $\rho = 1000 \text{ kg/m}^3$

Phantom section: Flat Section

Ambient temperature: 22.0°C; Liquid temperature: 21.6°C

DASY5 Configuration:

- Probe: EX3DV4 - SN7509; ConvF(5.23, 5.23, 5.23) @ 5260 MHz; Calibrated: 2020/03/25
- Sensor-Surface: 2mm (Mechanical Surface Detection)
- Electronics: DAE4 Sn558; Calibrated: 2019/10/11
- Phantom: SAM
- DASY52 52.10.4(1527); SEMCAD X 14.6.14(7483)

Area Scan (111x211x1): Interpolated grid: dx=10 mm, dy=10 mm

Maximum value of SAR (interpolated) = 1.09 W/kg

Zoom Scan (7x7x12)/Cube 0: Measurement grid: dx=4mm, dy=4mm, dz=2mm

Reference Value = 1.091 V/m; Power Drift = 0.15 dB

Peak SAR (extrapolated) = 2.03 W/kg

SAR(1 g) = 0.731 W/kg; SAR(10 g) = 0.273 W/kg

Smallest distance from peaks to all points 3 dB below = 7.6 mm

Ratio of SAR at M2 to SAR at M1 = 57.7%

Maximum value of SAR (measured) = 1.09 W/kg

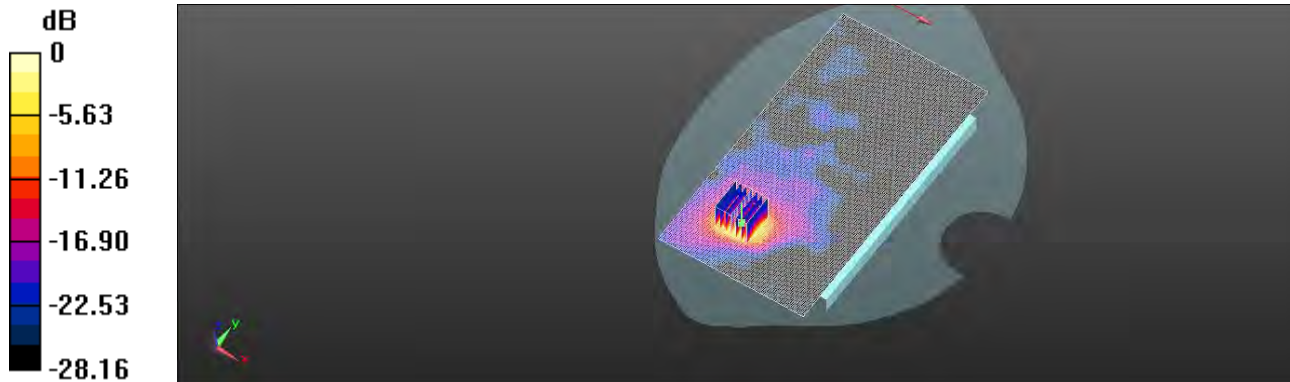

0 dB = 1.09 W/kg = 0.37 dBW/kg

Unless otherwise stated the results shown in this test report refer only to the sample(s) tested and such sample(s) are retained for 90 days only.

除非另有說明，此報告結果僅對測試之樣品負責，同時此樣品僅保留90天。本報告未經本公司書面許可，不可部份複製。

This document is issued by the Company subject to its General Conditions of Service printed overleaf, available on request or accessible at <http://www.sgs.com.tw/Terms-and-Conditions> and for electronic format documents, subject to Terms and Conditions for Electronic Documents at <http://www.sgs.com.tw/Terms-and-Conditions>. Attention is drawn to the limitation of liability, indemnification and jurisdiction issues defined therein. Any holder of this document is advised that information contained hereon reflects the Company's findings at the time of its intervention only and within the limits of Client's instructions, if any. The Company's sole responsibility is to its Client and this document does not exonerate parties to a transaction from exercising all their rights and obligations under the transaction documents. This document cannot be reproduced except in full, without prior written approval of the Company. Any unauthorized alteration, forgery or falsification of the content or appearance of this document is unlawful and offenders may be prosecuted to the fullest extent of the law.

Date: 2020/7/7

Report No. :ES/2020/30005

WLAN 802.11ac(80M) 5.6G_Hotspot_Back side_CH 138_Chain0_Ant6_10mm

Communication System: WLAN 5G; Frequency: 5690 MHz; Duty cycle= 1:1

Medium parameters used: $f = 5690$ MHz; $\sigma = 5.233$ S/m; $\epsilon_r = 34.727$; $\rho = 1000$ kg/m³

Phantom section: Flat Section

Ambient temperature: 21.6°C; Liquid temperature: 22.1°C

DASY5 Configuration:

- Probe: EX3DV4 - SN7509; ConvF(4.64, 4.64, 4.64) @ 5690 MHz; Calibrated: 2020/03/25
- Sensor-Surface: 2mm (Mechanical Surface Detection)
- Electronics: DAE4 Sn558; Calibrated: 2019/10/11
- Phantom: SAM
- DASY52 52.10.4(1527); SEMCAD X 14.6.14(7483)

Area Scan (111x211x1): Interpolated grid: dx=10 mm, dy=10 mm

Maximum value of SAR (interpolated) = 0.848 W/kg

Zoom Scan (7x7x12)/Cube 0: Measurement grid: dx=4mm, dy=4mm, dz=2mm

Reference Value = 1.081 V/m; Power Drift = 0.17 dB

Peak SAR (extrapolated) = 1.67 W/kg

SAR(1 g) = 0.578 W/kg; SAR(10 g) = 0.214 W/kg

Smallest distance from peaks to all points 3 dB below = 7.5 mm

Ratio of SAR at M2 to SAR at M1 = 57.8%

Maximum value of SAR (measured) = 0.860 W/kg

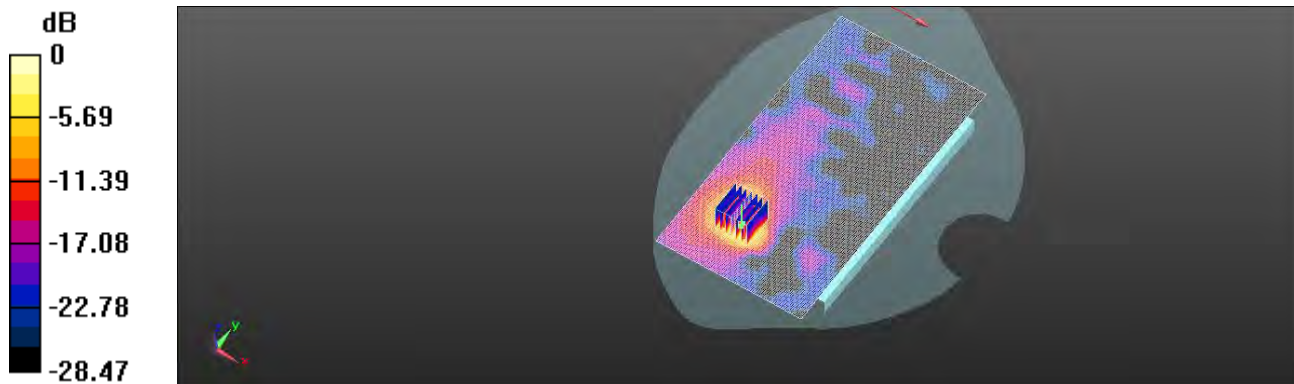

0 dB = 0.860 W/kg = -0.66 dBW/kg

Unless otherwise stated the results shown in this test report refer only to the sample(s) tested and such sample(s) are retained for 90 days only.

除非另有說明，此報告結果僅對測試之樣品負責，同時此樣品僅保留90天。本報告未經本公司書面許可，不可部份複製。

This document is issued by the Company subject to its General Conditions of Service printed overleaf, available on request or accessible at <http://www.sgs.com.tw/Terms-and-Conditions> and for electronic format documents, subject to Terms and Conditions for Electronic Documents at <http://www.sgs.com.tw/Terms-and-Conditions>. Attention is drawn to the limitation of liability, indemnification and jurisdiction issues defined therein. Any holder of this document is advised that information contained hereon reflects the Company's findings at the time of its intervention only and within the limits of Client's instructions, if any. The Company's sole responsibility is to its Client and this document does not exonerate parties to a transaction from exercising all their rights and obligations under the transaction documents. This document cannot be reproduced except in full, without prior written approval of the Company. Any unauthorized alteration, forgery or falsification of the content or appearance of this document is unlawful and offenders may be prosecuted to the fullest extent of the law.

Date: 2020/7/8

Report No. :ES/2020/30005

WLAN 802.11ac(80M)5.8G_Hotspot_Back side_CH 155_Chain0_Ant6_10mm

Communication System: Wi-Fi; Frequency: 5775 MHz; Duty cycle= 1:1

Medium parameters used: $f = 5775$ MHz; $\sigma = 5.313$ S/m; $\epsilon_r = 34.566$; $\rho = 1000$ kg/m³

Phantom section: Flat Section

Ambient temperature: 21.5°C; Liquid temperature: 21.9°C

DASY5 Configuration:

- Probe: EX3DV4 - SN7509; ConvF(4.85, 4.85, 4.85) @ 5775 MHz; Calibrated: 2020/03/25
- Sensor-Surface: 2mm (Mechanical Surface Detection)
- Electronics: DAE4 Sn558; Calibrated: 2019/10/11
- Phantom: SAM
- DASY52 52.10.4(1527); SEMCAD X 14.6.14(7483)

Area Scan (111x211x1): Interpolated grid: dx=10 mm, dy=10 mm

Maximum value of SAR (interpolated) = 1.06 W/kg

Zoom Scan (7x7x12)/Cube 0: Measurement grid: dx=4mm, dy=4mm, dz=2mm

Reference Value = 1.321 V/m; Power Drift = 0.12 dB

Peak SAR (extrapolated) = 2.10 W/kg

SAR(1 g) = 0.627 W/kg; SAR(10 g) = 0.208 W/kg

Smallest distance from peaks to all points 3 dB below = 6.9 mm

Ratio of SAR at M2 to SAR at M1 = 55.3%

Maximum value of SAR (measured) = 1.04 W/kg

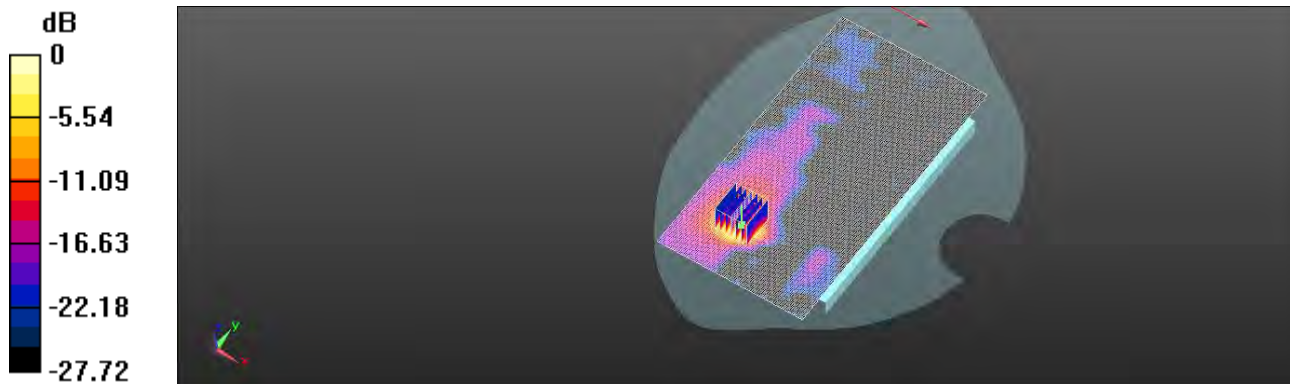

0 dB = 1.04 W/kg = 0.17 dBW/kg

Unless otherwise stated the results shown in this test report refer only to the sample(s) tested and such sample(s) are retained for 90 days only.

除非另有說明，此報告結果僅對測試之樣品負責，同時此樣品僅保留90天。本報告未經本公司書面許可，不可部份複製。

This document is issued by the Company subject to its General Conditions of Service printed overleaf, available on request or accessible at <http://www.sgs.com.tw/Terms-and-Conditions> and for electronic format documents, subject to Terms and Conditions for Electronic Documents at <http://www.sgs.com.tw/Terms-and-Conditions>. Attention is drawn to the limitation of liability, indemnification and jurisdiction issues defined therein. Any holder of this document is advised that information contained hereon reflects the Company's findings at the time of its intervention only and within the limits of Client's instructions, if any. The Company's sole responsibility is to its Client and this document does not exonerate parties to a transaction from exercising all their rights and obligations under the transaction documents. This document cannot be reproduced except in full, without prior written approval of the Company. Any unauthorized alteration, forgery or falsification of the content or appearance of this document is unlawful and offenders may be prosecuted to the fullest extent of the law.

Date: 2020/7/5

Report No. :ES/2020/30005

WLAN 802.11n(40M) 5.2G_Hotspot_Back side_CH 46_Chain1_Ant5_10mm

Communication System: Wi-Fi; Frequency: 5230 MHz; Duty cycle= 1:1

Medium parameters used: $f = 5230 \text{ MHz}$; $\sigma = 4.748 \text{ S/m}$; $\epsilon_r = 35.528$; $\rho = 1000 \text{ kg/m}^3$

Phantom section: Flat Section

Ambient temperature: 21.4°C; Liquid temperature: 21.8°C

DASY5 Configuration:

- Probe: EX3DV4 - SN7509; ConvF(5.33, 5.33, 5.33) @ 5230 MHz; Calibrated: 2020/03/25
- Sensor-Surface: 2mm (Mechanical Surface Detection)
- Electronics: DAE4 Sn558; Calibrated: 2019/10/11
- Phantom: SAM
- DASY52 52.10.4(1527); SEMCAD X 14.6.14(7483)

Area Scan (111x211x1): Interpolated grid: dx=10 mm, dy=10 mm

Maximum value of SAR (interpolated) = 0.319 W/kg

Zoom Scan (7x7x12)/Cube 0: Measurement grid: dx=4mm, dy=4mm, dz=2mm

Reference Value = 1.152 V/m; Power Drift = 0.19 dB

Peak SAR (extrapolated) = 0.574 W/kg

SAR(1 g) = 0.193 W/kg; SAR(10 g) = 0.079 W/kg

Smallest distance from peaks to all points 3 dB below = 7.1 mm

Ratio of SAR at M2 to SAR at M1 = 64.8%

Maximum value of SAR (measured) = 0.323 W/kg

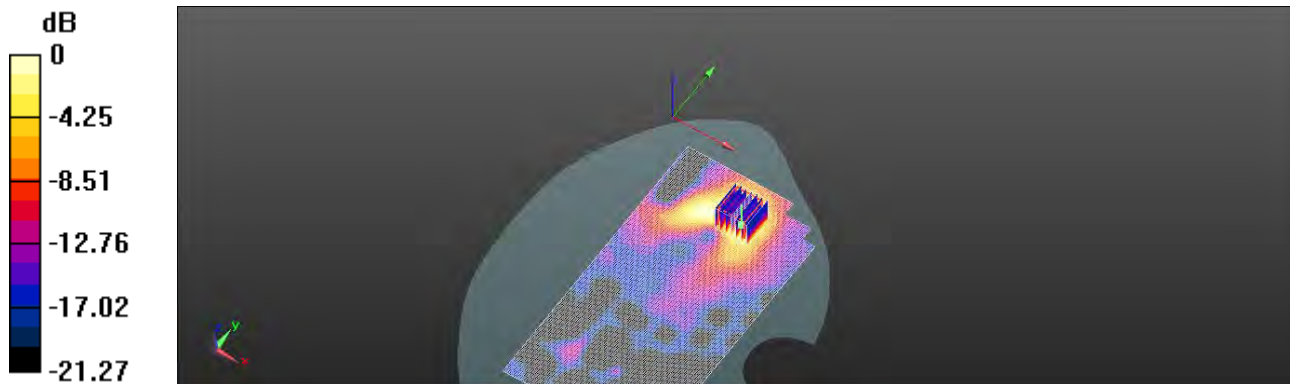

0 dB = 0.323 W/kg = -4.91 dBW/kg

Unless otherwise stated the results shown in this test report refer only to the sample(s) tested and such sample(s) are retained for 90 days only.

除非另有說明，此報告結果僅對測試之樣品負責，同時此樣品僅保留90天。本報告未經本公司書面許可，不可部份複製。

This document is issued by the Company subject to its General Conditions of Service printed overleaf, available on request or accessible at <http://www.sgs.com.tw/Terms-and-Conditions> and for electronic format documents, subject to Terms and Conditions for Electronic Documents at <http://www.sgs.com.tw/Terms-and-Conditions>. Attention is drawn to the limitation of liability, indemnification and jurisdiction issues defined therein. Any holder of this document is advised that information contained hereon reflects the Company's findings at the time of its intervention only and within the limits of Client's instructions, if any. The Company's sole responsibility is to its Client and this document does not exonerate parties to a transaction from exercising all their rights and obligations under the transaction documents. This document cannot be reproduced except in full, without prior written approval of the Company. Any unauthorized alteration, forgery or falsification of the content or appearance of this document is unlawful and offenders may be prosecuted to the fullest extent of the law.

Date: 2020/7/6

Report No. : ES/2020/30005

WLAN 802.11n(20M) 5.3G_Hotspot_Back side_CH 52_Chain1_Ant5_10mm

Communication System: Wi-Fi; Frequency: 5260 MHz; Duty cycle= 1:1

Medium parameters used: $f = 5260$ MHz; $\sigma = 4.796$ S/m; $\epsilon_r = 35.513$; $\rho = 1000$ kg/m³

Phantom section: Flat Section

Ambient temperature: 22.0°C; Liquid temperature: 21.6°C

DASY5 Configuration:

- Probe: EX3DV4 - SN7509; ConvF(5.23, 5.23, 5.23) @ 5260 MHz; Calibrated: 2020/03/25
- Sensor-Surface: 2mm (Mechanical Surface Detection)
- Electronics: DAE4 Sn558; Calibrated: 2019/10/11
- Phantom: SAM
- DASY52 52.10.4(1527); SEMCAD X 14.6.14(7483)

Area Scan (111x191x1): Interpolated grid: dx=10 mm, dy=10 mm

Maximum value of SAR (interpolated) = 0.402 W/kg

Zoom Scan (7x7x12)/Cube 0: Measurement grid: dx=4mm, dy=4mm, dz=2mm

Reference Value = 1.404 V/m; Power Drift = 0.17 dB

Peak SAR (extrapolated) = 0.703 W/kg

SAR(1 g) = 0.249 W/kg; SAR(10 g) = 0.104 W/kg

Smallest distance from peaks to all points 3 dB below = 8.6 mm

Ratio of SAR at M2 to SAR at M1 = 53.5%

Maximum value of SAR (measured) = 0.396 W/kg

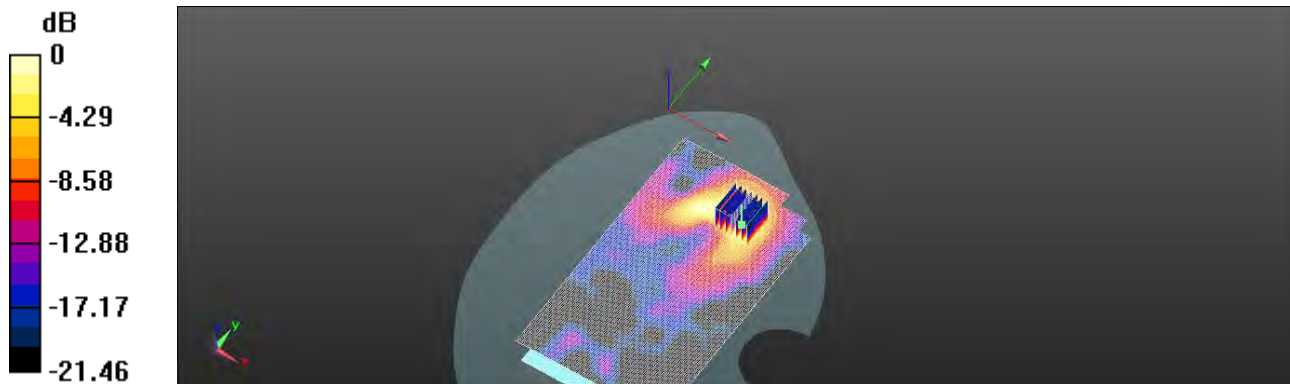

0 dB = 0.396 W/kg = -4.02 dBW/kg

Unless otherwise stated the results shown in this test report refer only to the sample(s) tested and such sample(s) are retained for 90 days only.

除非另有說明，此報告結果僅對測試之樣品負責，同時此樣品僅保留90天。本報告未經本公司書面許可，不可部份複製。

This document is issued by the Company subject to its General Conditions of Service printed overleaf, available on request or accessible at <http://www.sgs.com.tw/Terms-and-Conditions> and for electronic format documents, subject to Terms and Conditions for Electronic Documents at <http://www.sgs.com.tw/Terms-and-Conditions>. Attention is drawn to the limitation of liability, indemnification and jurisdiction issues defined therein. Any holder of this document is advised that information contained hereon reflects the Company's findings at the time of its intervention only and within the limits of Client's instructions, if any. The Company's sole responsibility is to its Client and this document does not exonerate parties to a transaction from exercising all their rights and obligations under the transaction documents. This document cannot be reproduced except in full, without prior written approval of the Company. Any unauthorized alteration, forgery or falsification of the content or appearance of this document is unlawful and offenders may be prosecuted to the fullest extent of the law.

Date: 2020/7/7

Report No. :ES/2020/30005

WLAN 802.11a 5.6G_Hotspot_Back side_CH 100_Chain1_Ant5_10mm

Communication System: Wi-Fi; Frequency: 5500 MHz; Duty cycle= 1:1

Medium parameters used: $f = 5500 \text{ MHz}$; $\sigma = 5.044 \text{ S/m}$; $\epsilon_r = 35.227$; $\rho = 1000 \text{ kg/m}^3$

Phantom section: Flat Section

Ambient temperature: 21.6°C; Liquid temperature: 22.1°C

DASY5 Configuration:

- Probe: EX3DV4 - SN7509; ConvF(4.64, 4.64, 4.64) @ 5500 MHz; Calibrated: 2020/03/25
- Sensor-Surface: 2mm (Mechanical Surface Detection)
- Electronics: DAE4 Sn558; Calibrated: 2019/10/11
- Phantom: SAM
- DASY52 52.10.4(1527); SEMCAD X 14.6.14(7483)

Area Scan (111x191x1): Interpolated grid: $dx=10 \text{ mm}$, $dy=10 \text{ mm}$

Maximum value of SAR (interpolated) = 1.19 W/kg

Zoom Scan (7x7x12)/Cube 0: Measurement grid: $dx=4\text{mm}$, $dy=4\text{mm}$, $dz=2\text{mm}$

Reference Value = 1.742 V/m; Power Drift = 0.15 dB

Peak SAR (extrapolated) = 2.16 W/kg

SAR(1 g) = 0.740 W/kg; SAR(10 g) = 0.278 W/kg

Smallest distance from peaks to all points 3 dB below = 7.9 mm

Ratio of SAR at M2 to SAR at M1 = 57.3%

Maximum value of SAR (measured) = 1.18 W/kg

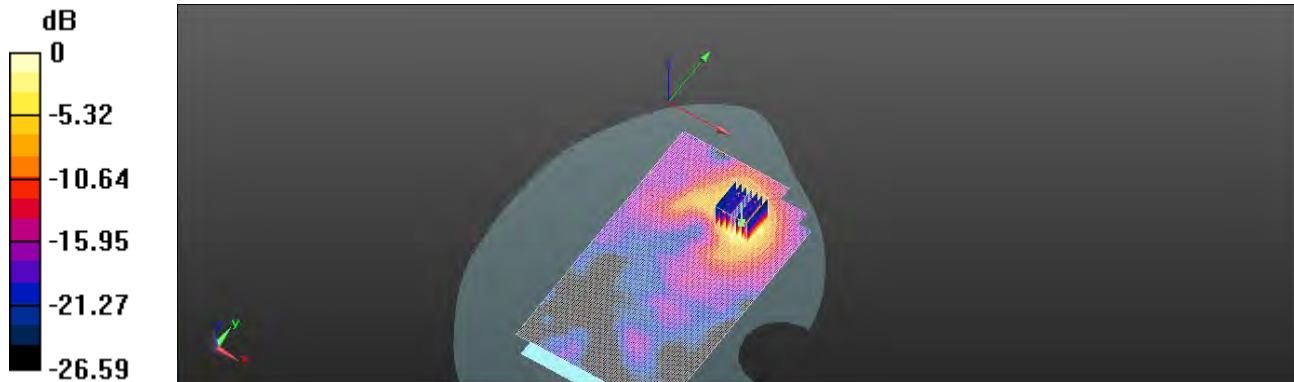

0 dB = 1.18 W/kg = 0.72 dBW/kg

Unless otherwise stated the results shown in this test report refer only to the sample(s) tested and such sample(s) are retained for 90 days only.

除非另有說明，此報告結果僅對測試之樣品負責，同時此樣品僅保留90天。本報告未經本公司書面許可，不可部份複製。

This document is issued by the Company subject to its General Conditions of Service printed overleaf, available on request or accessible at <http://www.sgs.com.tw/Terms-and-Conditions> and for electronic format documents, subject to Terms and Conditions for Electronic Documents at <http://www.sgs.com.tw/Terms-and-Conditions>. Attention is drawn to the limitation of liability, indemnification and jurisdiction issues defined therein. Any holder of this document is advised that information contained hereon reflects the Company's findings at the time of its intervention only and within the limits of Client's instructions, if any. The Company's sole responsibility is to its Client and this document does not exonerate parties to a transaction from exercising all their rights and obligations under the transaction documents. This document cannot be reproduced except in full, without prior written approval of the Company. Any unauthorized alteration, forgery or falsification of the content or appearance of this document is unlawful and offenders may be prosecuted to the fullest extent of the law.

Date: 2020/7/8

Report No. : ES/2020/30005

WLAN 802.11ac(80M) 5.8G_Hotspot_Back side_CH 155_Chain1_Ant5_10mm

Communication System: Wi-Fi; Frequency: 5775 MHz; Duty cycle= 1:1

Medium parameters used: $f = 5775 \text{ MHz}$; $\sigma = 5.313 \text{ S/m}$; $\epsilon_r = 34.566$; $\rho = 1000 \text{ kg/m}^3$

Phantom section: Flat Section

Ambient temperature: 21.5°C; Liquid temperature: 21.9°C

DASY5 Configuration:

- Probe: EX3DV4 - SN7509; ConvF(4.85, 4.85, 4.85) @ 5775 MHz; Calibrated: 2020/03/25
- Sensor-Surface: 2mm (Mechanical Surface Detection)
- Electronics: DAE4 Sn558; Calibrated: 2019/10/11
- Phantom: SAM
- DASY52 52.10.4(1527); SEMCAD X 14.6.14(7483)

Area Scan (111x191x1): Interpolated grid: dx=10 mm, dy=10 mm

Maximum value of SAR (interpolated) = 1.23 W/kg

Zoom Scan (7x7x12)/Cube 0: Measurement grid: dx=4mm, dy=4mm, dz=2mm

Reference Value = 1.101 V/m; Power Drift = 0.18 dB

Peak SAR (extrapolated) = 2.22 W/kg

SAR(1 g) = 0.765 W/kg; SAR(10 g) = 0.294 W/kg

Smallest distance from peaks to all points 3 dB below = 7.2 mm

Ratio of SAR at M2 to SAR at M1 = 54.3%

Maximum value of SAR (measured) = 1.14 W/kg

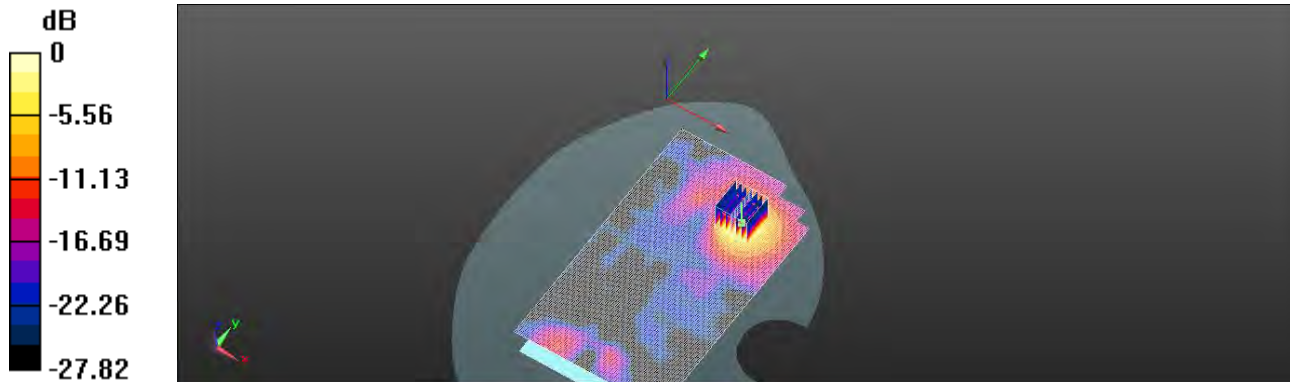

0 dB = 1.14 W/kg = 0.57 dBW/kg

Unless otherwise stated the results shown in this test report refer only to the sample(s) tested and such sample(s) are retained for 90 days only.

除非另有說明，此報告結果僅對測試之樣品負責，同時此樣品僅保留90天。本報告未經本公司書面許可，不可部份複製。

This document is issued by the Company subject to its General Conditions of Service printed overleaf, available on request or accessible at <http://www.sgs.com.tw/Terms-and-Conditions> and for electronic format documents, subject to Terms and Conditions for Electronic Documents at <http://www.sgs.com.tw/Terms-and-Conditions>. Attention is drawn to the limitation of liability, indemnification and jurisdiction issues defined therein. Any holder of this document is advised that information contained hereon reflects the Company's findings at the time of its intervention only and within the limits of Client's instructions, if any. The Company's sole responsibility is to its Client and this document does not exonerate parties to a transaction from exercising all their rights and obligations under the transaction documents. This document cannot be reproduced except in full, without prior written approval of the Company. Any unauthorized alteration, forgery or falsification of the content or appearance of this document is unlawful and offenders may be prosecuted to the fullest extent of the law.

Date: 2020/7/18

Report No. :ES/2020/30005

WLAN 802.11n 5.2G(40M)_Hotspot_Back side_CH 46_Chain1_Ant7_10mm

Communication System: Wi-Fi; Frequency: 5230 MHz; Duty cycle= 1:1

Medium parameters used: $f = 5230 \text{ MHz}$; $\sigma = 4.753 \text{ S/m}$; $\epsilon_r = 35.363$; $\rho = 1000 \text{ kg/m}^3$

Phantom section: Flat Section

Ambient temperature: 22.2°C; Liquid temperature: 21.6°C

DASY5 Configuration:

- Probe: EX3DV4 - SN7509; ConvF(5.33, 5.33, 5.33) @ 5230 MHz; Calibrated: 2020/03/25
- Sensor-Surface: 2mm (Mechanical Surface Detection)
- Electronics: DAE4 Sn558; Calibrated: 2019/10/11
- Phantom: SAM
- DASY52 52.10.4(1527); SEMCAD X 14.6.14(7483)

Area Scan (111x191x1): Interpolated grid: dx=10 mm, dy=10 mm

Maximum value of SAR (interpolated) = 0.403 W/kg

Zoom Scan (7x7x12)/Cube 0: Measurement grid: dx=4mm, dy=4mm, dz=2mm

Reference Value = 1.837 V/m; Power Drift = 0.19 dB

Peak SAR (extrapolated) = 0.681 W/kg

SAR(1 g) = 0.219 W/kg; SAR(10 g) = 0.083 W/kg

Smallest distance from peaks to all points 3 dB below = 9.9 mm

Ratio of SAR at M2 to SAR at M1 = 62.7%

Maximum value of SAR (measured) = 0.401 W/kg

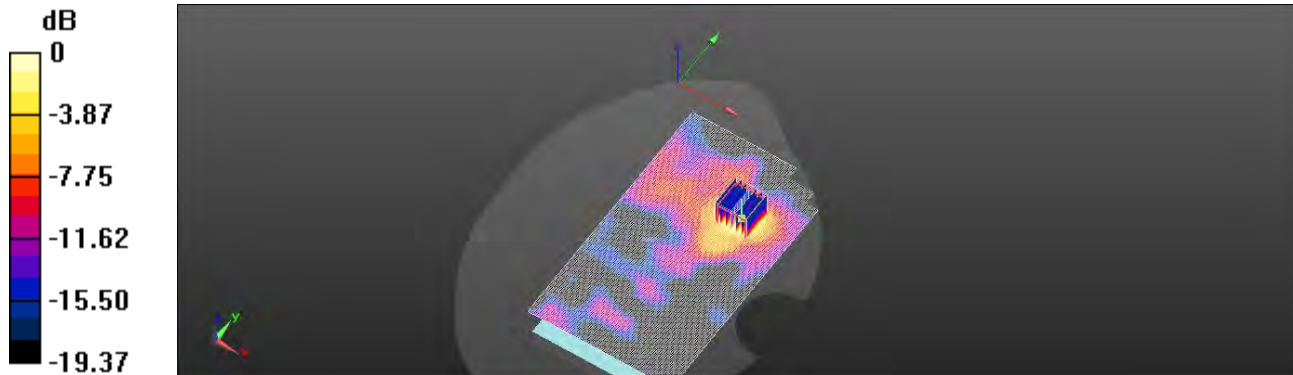

Unless otherwise stated the results shown in this test report refer only to the sample(s) tested and such sample(s) are retained for 90 days only.

除非另有說明，此報告結果僅對測試之樣品負責，同時此樣品僅保留90天。本報告未經本公司書面許可，不可部份複製。

This document is issued by the Company subject to its General Conditions of Service printed overleaf, available on request or accessible at <http://www.sgs.com.tw/Terms-and-Conditions> and for electronic format documents, subject to Terms and Conditions for Electronic Documents at <http://www.sgs.com.tw/Terms-and-Conditions>. Attention is drawn to the limitation of liability, indemnification and jurisdiction issues defined therein. Any holder of this document is advised that information contained hereon reflects the Company's findings at the time of its intervention only and within the limits of Client's instructions, if any. The Company's sole responsibility is to its Client and this document does not exonerate parties to a transaction from exercising all their rights and obligations under the transaction documents. This document cannot be reproduced except in full, without prior written approval of the Company. Any unauthorized alteration, forgery or falsification of the content or appearance of this document is unlawful and offenders may be prosecuted to the fullest extent of the law.

Date: 2020/7/19

Report No. :ES/2020/30005

WLAN 802.11n(20M) 5.3G_Hotspot_Back side_CH 60_Chain1_Ant7_10mm

Communication System: Wi-Fi; Frequency: 5300 MHz; Duty cycle= 1:1

Medium parameters used: $f = 5300 \text{ MHz}$; $\sigma = 4.84 \text{ S/m}$; $\epsilon_r = 35.215$; $\rho = 1000 \text{ kg/m}^3$

Phantom section: Flat Section

Ambient temperature: 21.4°C; Liquid temperature: 22.1°C

DASY5 Configuration:

- Probe: EX3DV4 - SN7509; ConvF(5.23, 5.23, 5.23) @ 5300 MHz; Calibrated: 2020/03/25
- Sensor-Surface: 2mm (Mechanical Surface Detection)
- Electronics: DAE4 Sn558; Calibrated: 2019/10/11
- Phantom: SAM
- DASY52 52.10.3(1513); SEMCAD X 14.6.14(7483)

Area Scan (111x191x1): Interpolated grid: $dx=10 \text{ mm}$, $dy=10 \text{ mm}$

Maximum value of SAR (interpolated) = 0.894 W/kg

Zoom Scan (7x7x12)/Cube 0: Measurement grid: $dx=4\text{mm}$, $dy=4\text{mm}$, $dz=2\text{mm}$

Reference Value = 2.652 V/m; Power Drift = 0.19 dB

Peak SAR (extrapolated) = 1.57 W/kg

SAR(1 g) = 0.488 W/kg; SAR(10 g) = 0.183 W/kg

Smallest distance from peaks to all points 3 dB below = 10.5 mm

Ratio of SAR at M2 to SAR at M1 = 58.7%

Maximum value of SAR (measured) = 0.897 W/kg

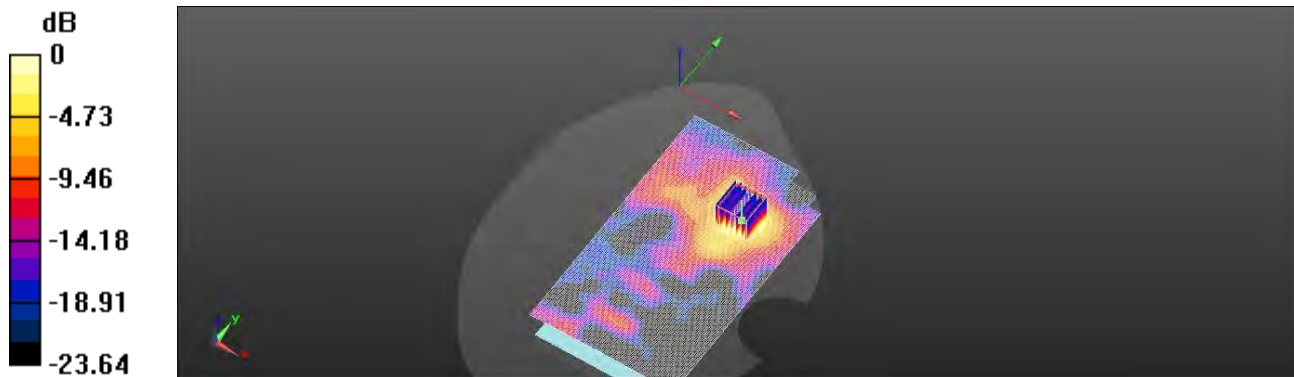

0 dB = 0.897 W/kg = -0.47 dBW/kg

Unless otherwise stated the results shown in this test report refer only to the sample(s) tested and such sample(s) are retained for 90 days only.

除非另有說明，此報告結果僅對測試之樣品負責，同時此樣品僅保留90天。本報告未經本公司書面許可，不可部份複製。

This document is issued by the Company subject to its General Conditions of Service printed overleaf, available on request or accessible at <http://www.sgs.com.tw/Terms-and-Conditions> and for electronic format documents, subject to Terms and Conditions for Electronic Documents at <http://www.sgs.com.tw/Terms-and-Conditions>. Attention is drawn to the limitation of liability, indemnification and jurisdiction issues defined therein. Any holder of this document is advised that information contained hereon reflects the Company's findings at the time of its intervention only and within the limits of Client's instructions, if any. The Company's sole responsibility is to its Client and this document does not exonerate parties to a transaction from exercising all their rights and obligations under the transaction documents. This document cannot be reproduced except in full, without prior written approval of the Company. Any unauthorized alteration, forgery or falsification of the content or appearance of this document is unlawful and offenders may be prosecuted to the fullest extent of the law.

Date: 2020/7/20

Report No. :ES/2020/30005

WLAN 802.11a 5.6G_Hotspot_Back side_CH 100_Chain1_Ant7_10mm

Communication System: Wi-Fi; Frequency: 5500 MHz; Duty cycle= 1:1

Medium parameters used: $f = 5500 \text{ MHz}$; $\sigma = 5.05 \text{ S/m}$; $\epsilon_r = 35.097$; $\rho = 1000 \text{ kg/m}^3$

Phantom section: Flat Section

Ambient temperature: 21.8°C; Liquid temperature: 22.4°C

DASY5 Configuration:

- Probe: EX3DV4 - SN7509; ConvF(4.64, 4.64, 4.64) @ 5500 MHz; Calibrated: 2020/03/25
- Sensor-Surface: 2mm (Mechanical Surface Detection)
- Electronics: DAE4 Sn558; Calibrated: 2019/10/11
- Phantom: SAM
- DASY52 52.10.3(1513); SEMCAD X 14.6.14(7483)

Area Scan (111x191x1): Interpolated grid: $dx=10 \text{ mm}$, $dy=10 \text{ mm}$

Maximum value of SAR (interpolated) = 0.602 W/kg

Zoom Scan (7x7x12)/Cube 0: Measurement grid: $dx=4\text{mm}$, $dy=4\text{mm}$, $dz=2\text{mm}$

Reference Value = 1.341 V/m; Power Drift = 0.18 dB

Peak SAR (extrapolated) = 1.05 W/kg

SAR(1 g) = 0.316 W/kg; SAR(10 g) = 0.118 W/kg

Smallest distance from peaks to all points 3 dB below = 9.8 mm

Ratio of SAR at M2 to SAR at M1 = 54.8%

Maximum value of SAR (measured) = 0.585 W/kg

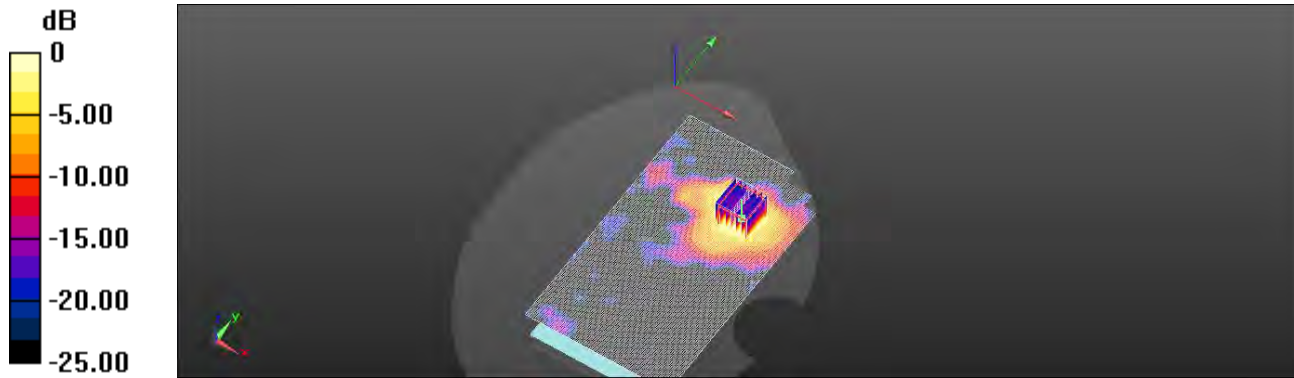

0 dB = 0.585 W/kg = -2.33 dBW/kg

Unless otherwise stated the results shown in this test report refer only to the sample(s) tested and such sample(s) are retained for 90 days only.

除非另有說明，此報告結果僅對測試之樣品負責，同時此樣品僅保留90天。本報告未經本公司書面許可，不可部份複製。

This document is issued by the Company subject to its General Conditions of Service printed overleaf, available on request or accessible at <http://www.sgs.com.tw/Terms-and-Conditions> and for electronic format documents, subject to Terms and Conditions for Electronic Documents at <http://www.sgs.com.tw/Terms-and-Conditions>. Attention is drawn to the limitation of liability, indemnification and jurisdiction issues defined therein. Any holder of this document is advised that information contained hereon reflects the Company's findings at the time of its intervention only and within the limits of Client's instructions, if any. The Company's sole responsibility is to its Client and this document does not exonerate parties to a transaction from exercising all their rights and obligations under the transaction documents. This document cannot be reproduced except in full, without prior written approval of the Company. Any unauthorized alteration, forgery or falsification of the content or appearance of this document is unlawful and offenders may be prosecuted to the fullest extent of the law.

Date: 2020/7/21

Report No. : ES/2020/30005

WLAN 802.11ac(80M) 5.8G_Hotspot_Back side_CH 155_Chain1_Ant7_10mm

Communication System: Wi-Fi; Frequency: 5775 MHz; Duty cycle= 1:1

Medium parameters used: $f = 5775 \text{ MHz}$; $\sigma = 5.328 \text{ S/m}$; $\epsilon_r = 34.522$; $\rho = 1000 \text{ kg/m}^3$

Phantom section: Flat Section

Ambient temperature: 22.3°C; Liquid temperature: 21.5°C

DASY5 Configuration:

- Probe: EX3DV4 - SN7509; ConvF(4.85, 4.85, 4.85) @ 5775 MHz; Calibrated: 2020/03/25
- Sensor-Surface: 2mm (Mechanical Surface Detection)
- Electronics: DAE4 Sn558; Calibrated: 2019/10/11
- Phantom: SAM
- DASY52 52.10.3(1513); SEMCAD X 14.6.14(7483)

Area Scan (111x191x1): Interpolated grid: dx=10 mm, dy=10 mm

Maximum value of SAR (interpolated) = 1.07 W/kg

Zoom Scan (7x7x12)/Cube 0: Measurement grid: dx=4mm, dy=4mm, dz=2mm

Reference Value = 2.339 V/m; Power Drift = 0.18 dB

Peak SAR (extrapolated) = 2.03 W/kg

SAR(1 g) = 0.552 W/kg; SAR(10 g) = 0.192 W/kg

Smallest distance from peaks to all points 3 dB below = 9.9 mm

Ratio of SAR at M2 to SAR at M1 = 56.8%

Maximum value of SAR (measured) = 1.07 W/kg

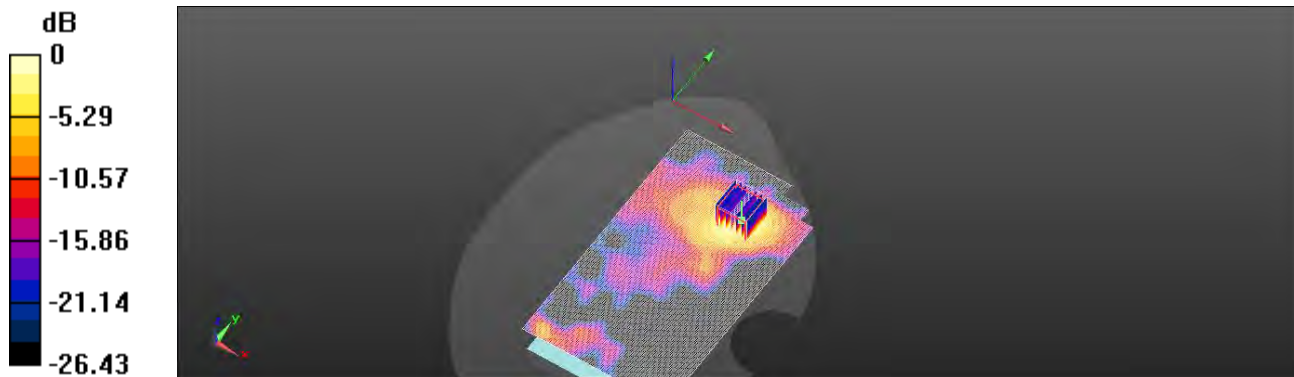

0 dB = 1.07 W/kg = 0.29 dBW/kg

Unless otherwise stated the results shown in this test report refer only to the sample(s) tested and such sample(s) are retained for 90 days only.

除非另有說明，此報告結果僅對測試之樣品負責，同時此樣品僅保留90天。本報告未經本公司書面許可，不可部份複製。

This document is issued by the Company subject to its General Conditions of Service printed overleaf, available on request or accessible at <http://www.sgs.com.tw/Terms-and-Conditions> and for electronic format documents, subject to Terms and Conditions for Electronic Documents at <http://www.sgs.com.tw/Terms-and-Conditions>. Attention is drawn to the limitation of liability, indemnification and jurisdiction issues defined therein. Any holder of this document is advised that information contained hereon reflects the Company's findings at the time of its intervention only and within the limits of Client's instructions, if any. The Company's sole responsibility is to its Client and this document does not exonerate parties to a transaction from exercising all their rights and obligations under the transaction documents. This document cannot be reproduced except in full, without prior written approval of the Company. Any unauthorized alteration, forgery or falsification of the content or appearance of this document is unlawful and offenders may be prosecuted to the fullest extent of the law.

Date: 2020/7/5

Report No. :ES/2020/30005

WLAN 802.11b_Head_Le Cheek_CH 1_Chain 0_Ant4

Communication System: Wi-Fi; Frequency: 2412 MHz; Duty cycle= 1:1

Medium parameters used: $f = 2412$ MHz; $\sigma = 1.706$ S/m; $\epsilon_r = 38.952$; $\rho = 1000$ kg/m³

Phantom section: Left Section

Ambient temperature: 22.3°C; Liquid temperature: 22.0°C

DASY5 Configuration:

- Probe: EX3DV4 - SN3770; ConvF(7.4, 7.4, 7.4) @ 2412 MHz; Calibrated: 2020/5/27
- Sensor-Surface: 2mm (Mechanical Surface Detection)
- Electronics: DAE4 Sn877; Calibrated: 2020/3/17
- Phantom: SAM
- DASY52 52.10.4(1527); SEMCAD X 14.6.14(7483)

Area Scan (111x171x1): Interpolated grid: dx=12 mm, dy=12 mm

Maximum value of SAR (interpolated) = 0.618 W/kg

Zoom Scan (7x7x7)/Cube 0: Measurement grid: dx=5mm, dy=5mm, dz=5mm

Reference Value = 18.45 V/m; Power Drift = 0.10 dB

Peak SAR (extrapolated) = 0.822 W/kg

SAR(1 g) = 0.461 W/kg; SAR(10 g) = 0.241 W/kg

Smallest distance from peaks to all points 3 dB below = 7 mm

Ratio of SAR at M2 to SAR at M1 = 45.5%

Maximum value of SAR (measured) = 0.585 W/kg

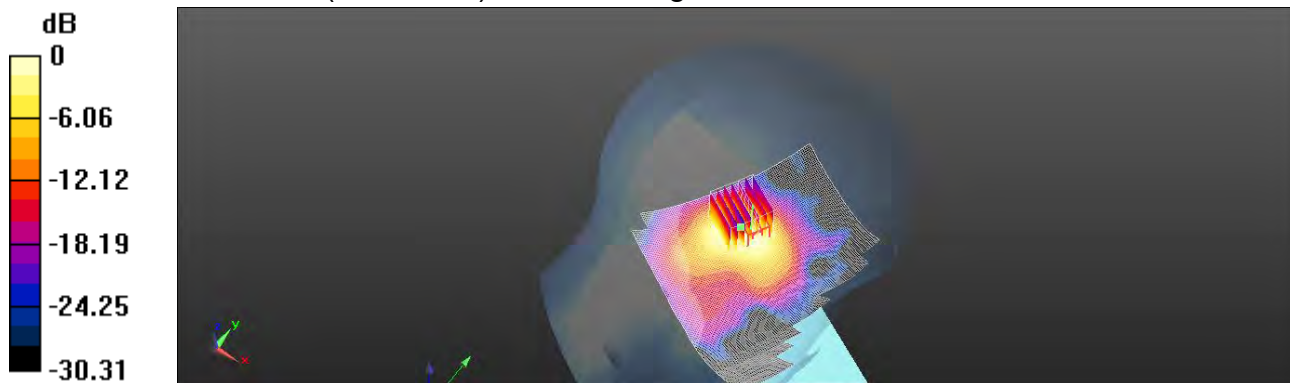

0 dB = 0.585 W/kg = -2.33 dBW/kg

Unless otherwise stated the results shown in this test report refer only to the sample(s) tested and such sample(s) are retained for 90 days only.

除非另有說明，此報告結果僅對測試之樣品負責，同時此樣品僅保留90天。本報告未經本公司書面許可，不可部份複製。

This document is issued by the Company subject to its General Conditions of Service printed overleaf, available on request or accessible at <http://www.sgs.com.tw/Terms-and-Conditions> and for electronic format documents, subject to Terms and Conditions for Electronic Documents at <http://www.sgs.com.tw/Terms-and-Conditions>. Attention is drawn to the limitation of liability, indemnification and jurisdiction issues defined therein. Any holder of this document is advised that information contained hereon reflects the Company's findings at the time of its intervention only and within the limits of Client's instructions, if any. The Company's sole responsibility is to its Client and this document does not exonerate parties to a transaction from exercising all their rights and obligations under the transaction documents. This document cannot be reproduced except in full, without prior written approval of the Company. Any unauthorized alteration, forgery or falsification of the content or appearance of this document is unlawful and offenders may be prosecuted to the fullest extent of the law.

Date: 2020/7/5

Report No. : ES/2020/30005

BLE_1M_Head_Le Cheek_CH 18_Chain0_Ant4

Communication System: Bluetooth; Frequency: 2442 MHz; Duty cycle= 1:1

Medium parameters used: $f = 2442$ MHz; $\sigma = 1.741$ S/m; $\epsilon_r = 38.897$; $\rho = 1000$ kg/m³

Phantom section: Left Section

Ambient temperature: 22.3°C; Liquid temperature: 22.0°C

DASY5 Configuration:

- Probe: EX3DV4 - SN7509; ConvF(7.51, 7.51, 7.51) @ 2442 MHz; Calibrated: 2020/03/25
- Sensor-Surface: 2mm (Mechanical Surface Detection)
- Electronics: DAE4 Sn558; Calibrated: 2019/10/11
- Phantom: SAM
- DASY52 52.10.4(1527); SEMCAD X 14.6.14(7483)

Area Scan (91x181x1): Interpolated grid: dx=12 mm, dy=12 mm

Maximum value of SAR (interpolated) = 0.324 W/kg

Zoom Scan (7x7x7)/Cube 0: Measurement grid: dx=5mm, dy=5mm, dz=5mm

Reference Value = 14.66 V/m; Power Drift = -0.12 dB

Peak SAR (extrapolated) = 0.363 W/kg

SAR(1 g) = 0.222 W/kg; SAR(10 g) = 0.128 W/kg

Smallest distance from peaks to all points 3 dB below = 7.8 mm

Ratio of SAR at M2 to SAR at M1 = 56.8%

Maximum value of SAR (measured) = 0.282 W/kg

Zoom Scan (7x7x7)/Cube 1: Measurement grid: dx=5mm, dy=5mm, dz=5mm

Reference Value = 14.66 V/m; Power Drift = -0.12 dB

Peak SAR (extrapolated) = 0.355 W/kg

SAR(1 g) = 0.232 W/kg; SAR(10 g) = 0.138 W/kg

Smallest distance from peaks to all points 3 dB below = 7.8 mm

Ratio of SAR at M2 to SAR at M1 = 57.1%

Maximum value of SAR (measured) = 0.277 W/kg

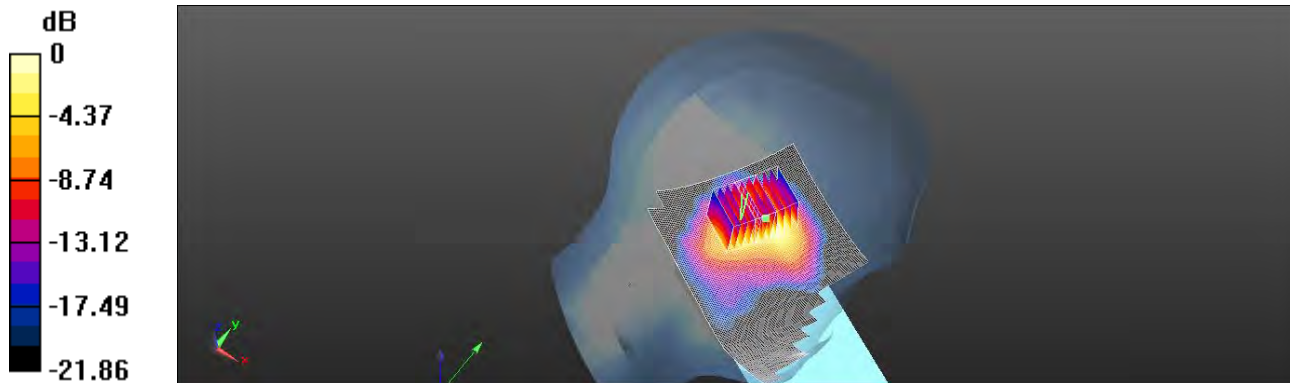

0 dB = 0.277 W/kg = -5.58 dBW/kg

Unless otherwise stated the results shown in this test report refer only to the sample(s) tested and such sample(s) are retained for 90 days only.

除非另有說明，此報告結果僅對測試之樣品負責，同時此樣品僅保留90天。本報告未經本公司書面許可，不可部份複製。

This document is issued by the Company subject to its General Conditions of Service printed overleaf, available on request or accessible at <http://www.sgs.com.tw/Terms-and-Conditions> and for electronic format documents, subject to Terms and Conditions for Electronic Documents at <http://www.sgs.com.tw/Terms-and-Conditions>. Attention is drawn to the limitation of liability, indemnification and jurisdiction issues defined therein. Any holder of this document is advised that information contained hereon reflects the Company's findings at the time of its intervention only and within the limits of Client's instructions, if any. The Company's sole responsibility is to its Client and this document does not exonerate parties to a transaction from exercising all their rights and obligations under the transaction documents. This document cannot be reproduced except in full, without prior written approval of the Company. Any unauthorized alteration, forgery or falsification of the content or appearance of this document is unlawful and offenders may be prosecuted to the fullest extent of the law.

Date: 2020/7/10

Report No. : ES/2020/30005

WLAN 802.11n(40M) 5.2G_Head_Le Cheek_CH 46_Chain 0_Ant4

Communication System: Wi-Fi; Frequency: 5230 MHz; Duty cycle= 1:1

Medium parameters used: $f = 5230$ MHz; $\sigma = 4.734$ S/m; $\epsilon_r = 35.583$; $\rho = 1000$ kg/m³

Phantom section: Left Section

Ambient temperature: 22.1°C; Liquid temperature: 21.8°C

DASY5 Configuration:

- Probe: EX3DV4 - SN3770; ConvF(5.4, 5.4, 5.4) @ 5230 MHz; Calibrated: 2020/5/27
- Sensor-Surface: 2mm (Mechanical Surface Detection)
- Electronics: DAE4 Sn877; Calibrated: 2020/3/17
- Phantom: SAM
- DASY52 52.10.4(1527); SEMCAD X 14.6.14(7483)

Area Scan (121x201x1): Interpolated grid: dx=10 mm, dy=10 mm

Maximum value of SAR (interpolated) = 0.542 W/kg

Zoom Scan (7x7x12)/Cube 0: Measurement grid: dx=4mm, dy=4mm, dz=2mm

Reference Value = 7.403 V/m; Power Drift = 0.11 dB

Peak SAR (extrapolated) = 1.11 W/kg

SAR(1 g) = 0.445 W/kg; SAR(10 g) = 0.186 W/kg

Smallest distance from peaks to all points 3 dB below = 6.5 mm

Ratio of SAR at M2 to SAR at M1 = 56.5%

Maximum value of SAR (measured) = 0.531 W/kg

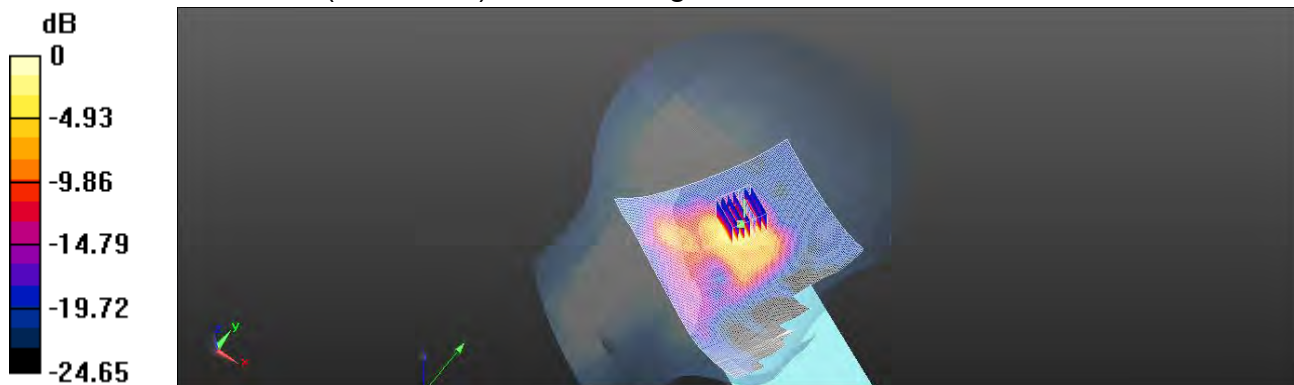

0 dB = 0.531 W/kg = -2.75 dBW/kg

Unless otherwise stated the results shown in this test report refer only to the sample(s) tested and such sample(s) are retained for 90 days only.

除非另有說明，此報告結果僅對測試之樣品負責，同時此樣品僅保留90天。本報告未經本公司書面許可，不可部份複製。

This document is issued by the Company subject to its General Conditions of Service printed overleaf, available on request or accessible at <http://www.sgs.com.tw/Terms-and-Conditions> and for electronic format documents, subject to Terms and Conditions for Electronic Documents at <http://www.sgs.com.tw/Terms-and-Conditions>. Attention is drawn to the limitation of liability, indemnification and jurisdiction issues defined therein. Any holder of this document is advised that information contained hereon reflects the Company's findings at the time of its intervention only and within the limits of Client's instructions, if any. The Company's sole responsibility is to its Client and this document does not exonerate parties to a transaction from exercising all their rights and obligations under the transaction documents. This document cannot be reproduced except in full, without prior written approval of the Company. Any unauthorized alteration, forgery or falsification of the content or appearance of this document is unlawful and offenders may be prosecuted to the fullest extent of the law.

Date: 2020/7/11

Report No. :ES/2020/30005

WLAN 802.11a 5.3G_Head_Le Cheek_CH 52_Chain 0_Ant4

Communication System: Wi-Fi; Frequency: 5260 MHz; Duty cycle= 1:1

Medium parameters used: $f = 5260 \text{ MHz}$; $\sigma = 4.787 \text{ S/m}$; $\epsilon_r = 35.478$; $\rho = 1000 \text{ kg/m}^3$

Phantom section: Left Section

Ambient temperature: 21.5°C; Liquid temperature: 22.1°C

DASY5 Configuration:

- Probe: EX3DV4 - SN3770; ConvF(5.4, 5.4, 5.4) @ 5260 MHz; Calibrated: 2020/5/27
- Sensor-Surface: 2mm (Mechanical Surface Detection)
- Electronics: DAE4 Sn877; Calibrated: 2020/3/17
- Phantom: SAM
- DASY52 52.10.4(1527); SEMCAD X 14.6.14(7483)

Area Scan (121x201x1): Interpolated grid: dx=10 mm, dy=10 mm

Maximum value of SAR (interpolated) = 0.432 W/kg

Zoom Scan (7x7x12)/Cube 0: Measurement grid: dx=4mm, dy=4mm, dz=2mm

Reference Value = 9.382 V/m; Power Drift = -0.17 dB

Peak SAR (extrapolated) = 0.933 W/kg

SAR(1 g) = 0.444 W/kg; SAR(10 g) = 0.218 W/kg

Smallest distance from peaks to all points 3 dB below = 6.4 mm

Ratio of SAR at M2 to SAR at M1 = 55.5%

Maximum value of SAR (measured) = 0.436 W/kg

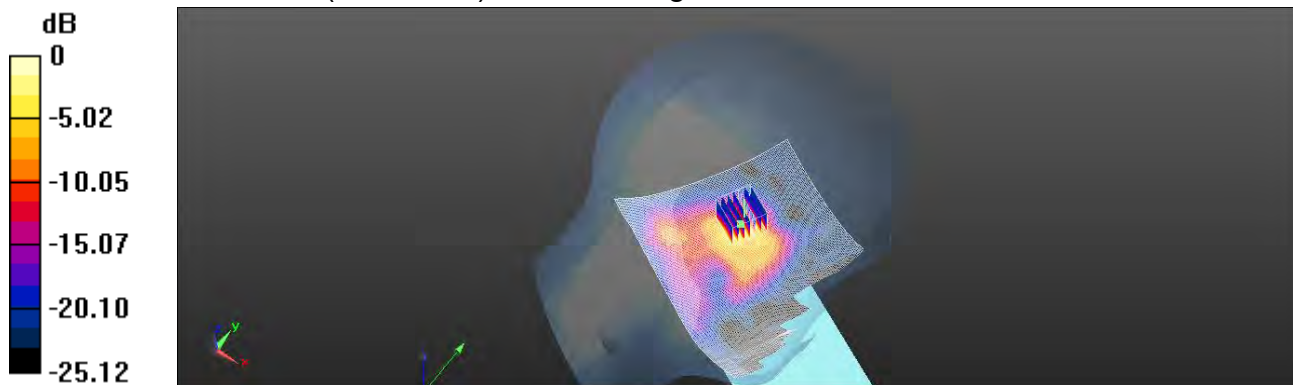

0 dB = 0.436 W/kg = -3.60 dBW/kg

Unless otherwise stated the results shown in this test report refer only to the sample(s) tested and such sample(s) are retained for 90 days only.

除非另有說明，此報告結果僅對測試之樣品負責，同時此樣品僅保留90天。本報告未經本公司書面許可，不可部份複製。

This document is issued by the Company subject to its General Conditions of Service printed overleaf, available on request or accessible at <http://www.sgs.com.tw/Terms-and-Conditions> and for electronic format documents, subject to Terms and Conditions for Electronic Documents at <http://www.sgs.com.tw/Terms-and-Conditions>. Attention is drawn to the limitation of liability, indemnification and jurisdiction issues defined therein. Any holder of this document is advised that information contained hereon reflects the Company's findings at the time of its intervention only and within the limits of Client's instructions, if any. The Company's sole responsibility is to its Client and this document does not exonerate parties to a transaction from exercising all their rights and obligations under the transaction documents. This document cannot be reproduced except in full, without prior written approval of the Company. Any unauthorized alteration, forgery or falsification of the content or appearance of this document is unlawful and offenders may be prosecuted to the fullest extent of the law.

Date: 2020/7/12

Report No. : ES/2020/30005

WLAN 802.11ac(80M) 5.6G_Head_Le Cheek_CH 138_Chain 0_Ant4

Communication System: WLAN 5G; Frequency: 5690 MHz; Duty cycle= 1:1

Medium parameters used: $f = 5690$ MHz; $\sigma = 5.234$ S/m; $\epsilon_r = 34.835$; $\rho = 1000$ kg/m³

Phantom section: Left Section

Ambient temperature: 21.9°C; Liquid temperature: 21.5°C

DASY5 Configuration:

- Probe: EX3DV4 - SN3770; ConvF(4.79, 4.79, 4.79) @ 5690 MHz; Calibrated: 2020/5/27
- Sensor-Surface: 2mm (Mechanical Surface Detection)
- Electronics: DAE4 Sn877; Calibrated: 2020/3/17
- Phantom: SAM
- DASY52 52.10.4(1527); SEMCAD X 14.6.14(7483)

Area Scan (121x201x1): Interpolated grid: dx=10 mm, dy=10 mm

Maximum value of SAR (interpolated) = 0.421 W/kg

Zoom Scan (7x7x12)/Cube 0: Measurement grid: dx=4mm, dy=4mm, dz=2mm

Reference Value = 9.107 V/m; Power Drift = 0.10 dB

Peak SAR (extrapolated) = 0.816 W/kg

SAR(1 g) = 0.465 W/kg; SAR(10 g) = 0.273 W/kg

Smallest distance from peaks to all points 3 dB below = 6.8 mm

Ratio of SAR at M2 to SAR at M1 = 55.8%

Maximum value of SAR (measured) = 0.402 W/kg

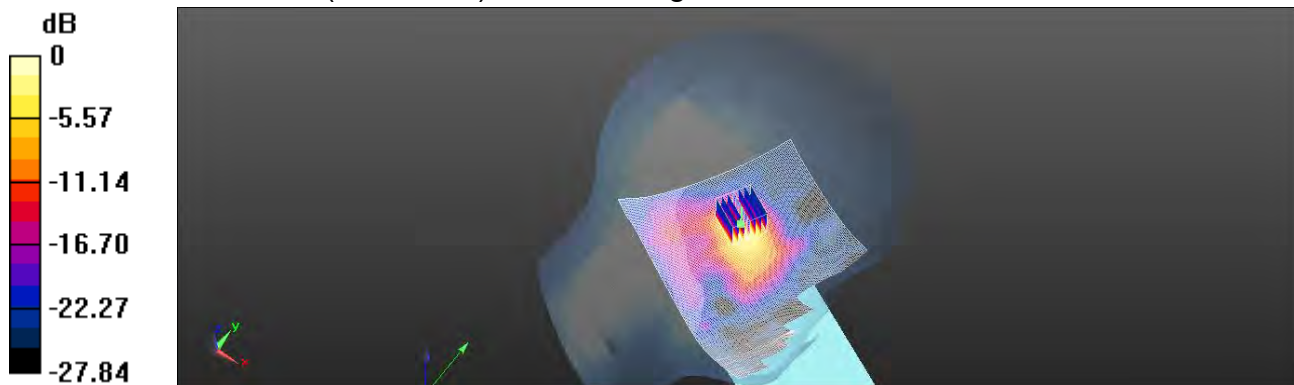

0 dB = 0.402 W/kg = -3.96 dBW/kg

Unless otherwise stated the results shown in this test report refer only to the sample(s) tested and such sample(s) are retained for 90 days only.

除非另有說明，此報告結果僅對測試之樣品負責，同時此樣品僅保留90天。本報告未經本公司書面許可，不可部份複製。

This document is issued by the Company subject to its General Conditions of Service printed overleaf, available on request or accessible at <http://www.sgs.com.tw/Terms-and-Conditions> and for electronic format documents, subject to Terms and Conditions for Electronic Documents at <http://www.sgs.com.tw/Terms-and-Conditions>. Attention is drawn to the limitation of liability, indemnification and jurisdiction issues defined therein. Any holder of this document is advised that information contained hereon reflects the Company's findings at the time of its intervention only and within the limits of Client's instructions, if any. The Company's sole responsibility is to its Client and this document does not exonerate parties to a transaction from exercising all their rights and obligations under the transaction documents. This document cannot be reproduced except in full, without prior written approval of the Company. Any unauthorized alteration, forgery or falsification of the content or appearance of this document is unlawful and offenders may be prosecuted to the fullest extent of the law.

Date: 2020/7/13

Report No. :ES/2020/30005

WLAN 802.11ac(80M) 5.8G _Head_ Le Cheek_ CH 155_ Chain 0_ Ant4

Communication System: Wi-Fi; Frequency: 5775 MHz; Duty cycle= 1:1

Medium parameters used: $f = 5775$ MHz; $\sigma = 5.308$ S/m; $\epsilon_r = 34.656$; $\rho = 1000$ kg/m³

Phantom section: Left Section

Ambient temperature: 21.4°C; Liquid temperature: 21.7°C

DASY5 Configuration:

- Probe: EX3DV4 - SN3770; ConvF(4.9, 4.9, 4.9) @ 5775 MHz; Calibrated: 2020/5/27
- Sensor-Surface: 2mm (Mechanical Surface Detection)
- Electronics: DAE4 Sn877; Calibrated: 2020/3/17
- Phantom: SAM
- DASY52 52.10.4(1527); SEMCAD X 14.6.14(7483)

Area Scan (121x201x1): Interpolated grid: dx=10 mm, dy=10 mm.

Maximum value of SAR (interpolated) = 0.508 W/kg

Zoom Scan (7x7x12)/Cube 0: Measurement grid: dx=4mm, dy=4mm, dz=2mm

Reference Value = 8.460 V/m; Power Drift = -0.06 dB

Peak SAR (extrapolated) = 0.845 W/kg

SAR(1 g) = 0.428 W/kg; SAR(10 g) = 0.229 W/kg

Smallest distance from peaks to all points 3 dB below = 6.6 mm

Ratio of SAR at M2 to SAR at M1 = 56.3%

Maximum value of SAR (measured) = 0.398 W/kg

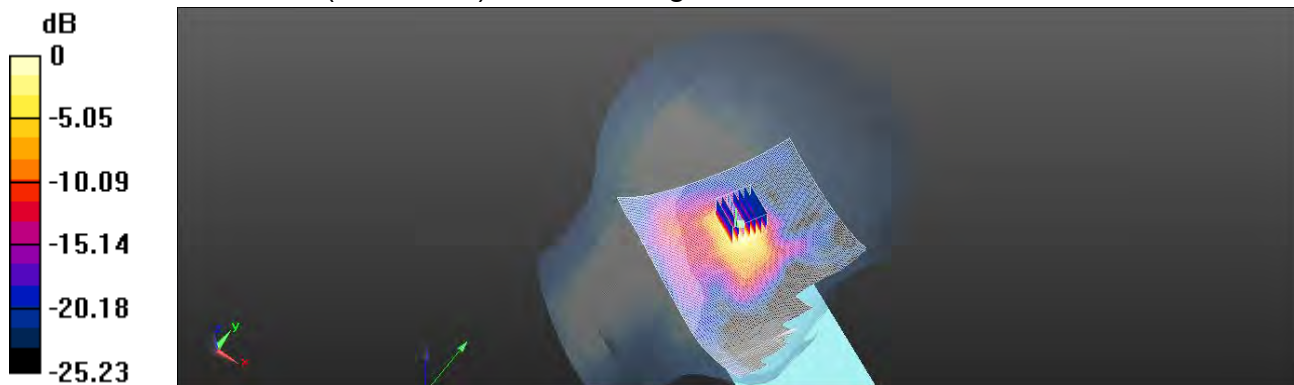

0 dB = 0.398 W/kg = -4.00 dBW/kg

Unless otherwise stated the results shown in this test report refer only to the sample(s) tested and such sample(s) are retained for 90 days only.

除非另有說明，此報告結果僅對測試之樣品負責，同時此樣品僅保留90天。本報告未經本公司書面許可，不可部份複製。

This document is issued by the Company subject to its General Conditions of Service printed overleaf, available on request or accessible at <http://www.sgs.com.tw/Terms-and-Conditions> and for electronic format documents, subject to Terms and Conditions for Electronic Documents at <http://www.sgs.com.tw/Terms-and-Conditions>. Attention is drawn to the limitation of liability, indemnification and jurisdiction issues defined therein. Any holder of this document is advised that information contained hereon reflects the Company's findings at the time of its intervention only and within the limits of Client's instructions, if any. The Company's sole responsibility is to its Client and this document does not exonerate parties to a transaction from exercising all their rights and obligations under the transaction documents. This document cannot be reproduced except in full, without prior written approval of the Company. Any unauthorized alteration, forgery or falsification of the content or appearance of this document is unlawful and offenders may be prosecuted to the fullest extent of the law.

Date: 2020/7/5

Report No. :ES/2020/30005

WLAN 802.11b_Head_Re Cheek_CH 6_Chain 1_Ant6

Communication System: WLAN 2.45G; Frequency: 2437 MHz; Duty cycle= 1:1

Medium parameters used: $f = 2437$ MHz; $\sigma = 1.725$ S/m; $\epsilon_r = 38.898$; $\rho = 1000$ kg/m³

Phantom section: Right Section

Ambient temperature: 22.3°C; Liquid temperature: 22.0°C

DASY5 Configuration:

- Probe: EX3DV4 - SN7509; ConvF(7.51, 7.51, 7.51) @ 2437 MHz; Calibrated: 2020/03/25
- Sensor-Surface: 2mm (Mechanical Surface Detection)
- Electronics: DAE4 Sn558; Calibrated: 2019/10/11
- Phantom: SAM
- DASY52 52.10.4(1527); SEMCAD X 14.6.14(7483)

Area Scan (91x181x1): Interpolated grid: dx=12 mm, dy=12 mm

Maximum value of SAR (interpolated) = 0.237 W/kg

Zoom Scan (7x7x7)/Cube 0: Measurement grid: dx=5mm, dy=5mm, dz=5mm

Reference Value = 2.918 V/m; Power Drift = -0.17 dB

Peak SAR (extrapolated) = 0.274 W/kg

SAR(1 g) = 0.192 W/kg; SAR(10 g) = 0.118 W/kg

Smallest distance from peaks to all points 3 dB below = 7.9 mm

Ratio of SAR at M2 to SAR at M1 = 66.3%

Maximum value of SAR (measured) = 0.226 W/kg

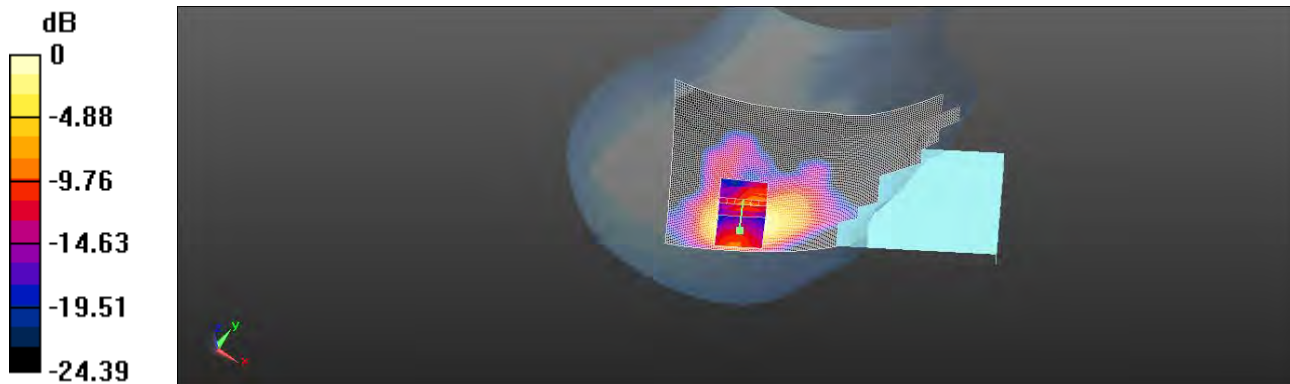

0 dB = 0.226 W/kg = -6.45 dBW/kg

Unless otherwise stated the results shown in this test report refer only to the sample(s) tested and such sample(s) are retained for 90 days only.

除非另有說明，此報告結果僅對測試之樣品負責，同時此樣品僅保留90天。本報告未經本公司書面許可，不可部份複製。

This document is issued by the Company subject to its General Conditions of Service printed overleaf, available on request or accessible at <http://www.sgs.com.tw/Terms-and-Conditions> and for electronic format documents, subject to Terms and Conditions for Electronic Documents at <http://www.sgs.com.tw/Terms-and-Conditions>. Attention is drawn to the limitation of liability, indemnification and jurisdiction issues defined therein. Any holder of this document is advised that information contained hereon reflects the Company's findings at the time of its intervention only and within the limits of Client's instructions, if any. The Company's sole responsibility is to its Client and this document does not exonerate parties to a transaction from exercising all their rights and obligations under the transaction documents. This document cannot be reproduced except in full, without prior written approval of the Company. Any unauthorized alteration, forgery or falsification of the content or appearance of this document is unlawful and offenders may be prosecuted to the fullest extent of the law.

Date: 2020/7/5

Report No. : ES/2020/30005

BLE_1M_Head_Re Cheek_CH 18_Chain0_Ant6

Communication System: Bluetooth; Frequency: 2442 MHz; Duty cycle= 1:1

Medium parameters used: $f = 2442$ MHz; $\sigma = 1.741$ S/m; $\epsilon_r = 38.897$; $\rho = 1000$ kg/m³

Phantom section: Right Section

Ambient temperature: 22.3°C; Liquid temperature: 22.0°C

DASY5 Configuration:

- Probe: EX3DV4 - SN7509; ConvF(7.51, 7.51, 7.51) @ 2442 MHz; Calibrated: 2020/03/25
- Sensor-Surface: 2mm (Mechanical Surface Detection)
- Electronics: DAE4 Sn558; Calibrated: 2019/10/11
- Phantom: SAM
- DASY52 52.10.4(1527); SEMCAD X 14.6.14(7483)

Area Scan (91x181x1): Interpolated grid: dx=12 mm, dy=12 mm

Maximum value of SAR (interpolated) = 0.0653 W/kg

Zoom Scan (7x7x7)/Cube 0: Measurement grid: dx=5mm, dy=5mm, dz=5mm

Reference Value = 2.842 V/m; Power Drift = 0.15 dB

Peak SAR (extrapolated) = 0.0700 W/kg

SAR(1 g) = 0.049 W/kg; SAR(10 g) = 0.029 W/kg

Smallest distance from peaks to all points 3 dB below = 7mm

Ratio of SAR at M2 to SAR at M1 = 66.2%

Maximum value of SAR (measured) = 0.0591 W/kg

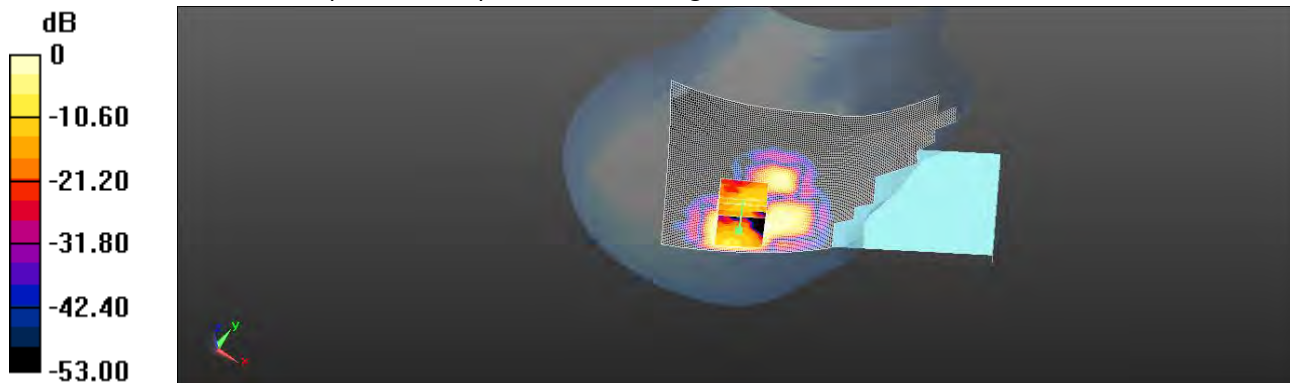

0 dB = 0.0591 W/kg = -12.29 dBW/kg

Unless otherwise stated the results shown in this test report refer only to the sample(s) tested and such sample(s) are retained for 90 days only.

除非另有說明，此報告結果僅對測試之樣品負責，同時此樣品僅保留90天。本報告未經本公司書面許可，不可部份複製。

This document is issued by the Company subject to its General Conditions of Service printed overleaf, available on request or accessible at <http://www.sgs.com.tw/Terms-and-Conditions> and for electronic format documents, subject to Terms and Conditions for Electronic Documents at <http://www.sgs.com.tw/Terms-and-Conditions>. Attention is drawn to the limitation of liability, indemnification and jurisdiction issues defined therein. Any holder of this document is advised that information contained hereon reflects the Company's findings at the time of its intervention only and within the limits of Client's instructions, if any. The Company's sole responsibility is to its Client and this document does not exonerate parties to a transaction from exercising all their rights and obligations under the transaction documents. This document cannot be reproduced except in full, without prior written approval of the Company. Any unauthorized alteration, forgery or falsification of the content or appearance of this document is unlawful and offenders may be prosecuted to the fullest extent of the law.

Date: 2020/7/10

Report No. :ES/2020/30005

WLAN 802.11n(40M) 5.2G_Head_Re Cheek_CH 46_Chain 1_Ant6

Communication System: Wi-Fi; Frequency: 5230 MHz; Duty cycle= 1:1

Medium parameters used: $f = 5230$ MHz; $\sigma = 4.734$ S/m; $\epsilon_r = 35.583$; $\rho = 1000$ kg/m³

Phantom section: Right Section

Ambient temperature: 22.1°C; Liquid temperature: 21.8°C

DASY5 Configuration:

- Probe: EX3DV4 - SN7509; ConvF(5.33, 5.33, 5.33) @ 5230 MHz; Calibrated: 2020/03/25
- Sensor-Surface: 2mm (Mechanical Surface Detection)
- Electronics: DAE4 Sn558; Calibrated: 2019/10/11
- Phantom: SAM
- DASY52 52.10.4(1527); SEMCAD X 14.6.14(7483)

Area Scan (111x201x1): Interpolated grid: dx=10 mm, dy=10 mm

Maximum value of SAR (interpolated) = 0.0525 W/kg

Zoom Scan (7x7x12)/Cube 0: Measurement grid: dx=4mm, dy=4mm, dz=2mm

Reference Value = 3.039 V/m; Power Drift = 0.09 dB

Peak SAR (extrapolated) = 0.149 W/kg

SAR(1 g) = 0.019 W/kg; SAR(10 g) = 0.00606 W/kg

Smallest distance from peaks to all points 3 dB below = 6.9mm

Ratio of SAR at M2 to SAR at M1 = 55.2%

Maximum value of SAR (measured) = 0.0253 W/kg

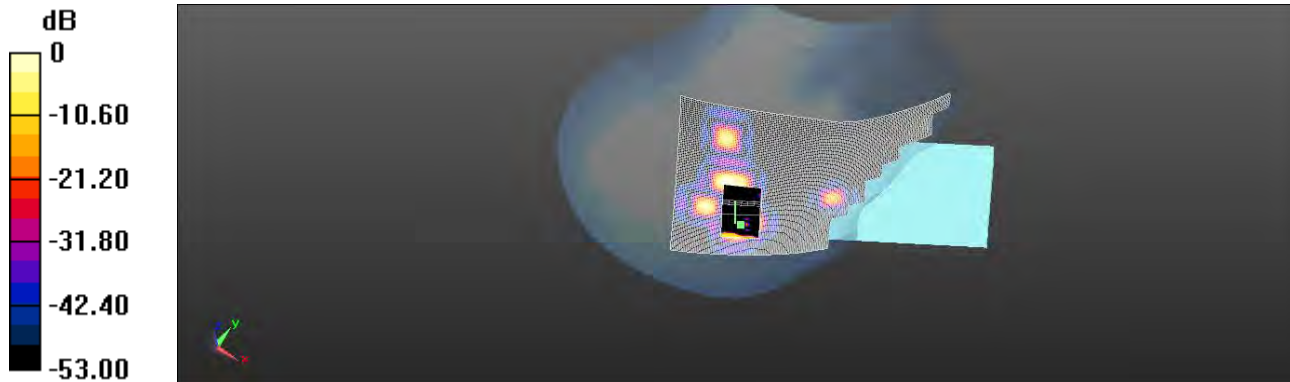

0 dB = 0.0253 W/kg = -15.97 dBW/kg

Unless otherwise stated the results shown in this test report refer only to the sample(s) tested and such sample(s) are retained for 90 days only.

除非另有說明，此報告結果僅對測試之樣品負責，同時此樣品僅保留90天。本報告未經本公司書面許可，不可部份複製。

This document is issued by the Company subject to its General Conditions of Service printed overleaf, available on request or accessible at <http://www.sgs.com.tw/Terms-and-Conditions> and for electronic format documents, subject to Terms and Conditions for Electronic Documents at <http://www.sgs.com.tw/Terms-and-Conditions>. Attention is drawn to the limitation of liability, indemnification and jurisdiction issues defined therein. Any holder of this document is advised that information contained hereon reflects the Company's findings at the time of its intervention only and within the limits of Client's instructions, if any. The Company's sole responsibility is to its Client and this document does not exonerate parties to a transaction from exercising all their rights and obligations under the transaction documents. This document cannot be reproduced except in full, without prior written approval of the Company. Any unauthorized alteration, forgery or falsification of the content or appearance of this document is unlawful and offenders may be prosecuted to the fullest extent of the law.

Date: 2020/7/11

Report No. : ES/2020/30005

WLAN 802.11n(20M) 5.3G_Head_Re Cheek_CH 52_Chain 1_Ant6

Communication System: Wi-Fi; Frequency: 5260 MHz; Duty cycle= 1:1

Medium parameters used: $f = 5260 \text{ MHz}$; $\sigma = 4.787 \text{ S/m}$; $\epsilon_r = 35.478$; $\rho = 1000 \text{ kg/m}^3$

Phantom section: Right Section

Ambient temperature: 21.5°C; Liquid temperature: 22.1°C

DASY5 Configuration:

- Probe: EX3DV4 - SN3770; ConvF(5.4, 5.4, 5.4) @ 5260 MHz; Calibrated: 2020/5/27
- Sensor-Surface: 2mm (Mechanical Surface Detection)
- Electronics: DAE4 Sn877; Calibrated: 2020/3/17
- Phantom: SAM
- DASY52 52.10.4(1527); SEMCAD X 14.6.14(7483)

Area Scan (111x201x1): Interpolated grid: dx=10 mm, dy=10 mm

Maximum value of SAR (interpolated) = 0.0501 W/kg

Zoom Scan (7x7x12)/Cube 0: Measurement grid: dx=4mm, dy=4mm, dz=2mm

Reference Value = 6.794 V/m; Power Drift = -0.12 dB

Peak SAR (extrapolated) = 0.0770 W/kg

SAR(1 g) = 0.030 W/kg; SAR(10 g) = 0.014 W/kg

Smallest distance from peaks to all points 3 dB below = 5.2 mm

Ratio of SAR at M2 to SAR at M1 = 62.9%

Maximum value of SAR (measured) = 0.0403 W/kg

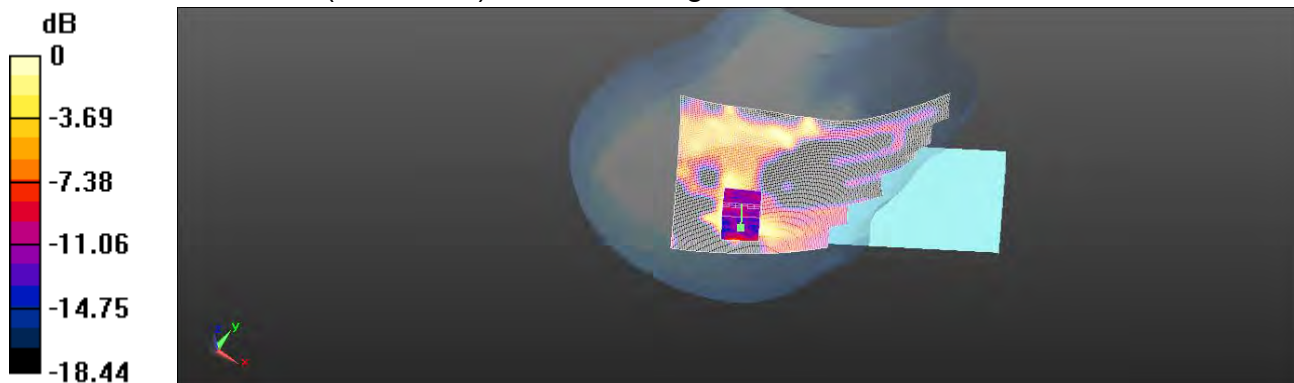

0 dB = 0.0403 W/kg = -13.95 dBW/kg

Unless otherwise stated the results shown in this test report refer only to the sample(s) tested and such sample(s) are retained for 90 days only.

除非另有說明，此報告結果僅對測試之樣品負責，同時此樣品僅保留90天。本報告未經本公司書面許可，不可部份複製。

This document is issued by the Company subject to its General Conditions of Service printed overleaf, available on request or accessible at <http://www.sgs.com.tw/Terms-and-Conditions> and for electronic format documents, subject to Terms and Conditions for Electronic Documents at <http://www.sgs.com.tw/Terms-and-Conditions>. Attention is drawn to the limitation of liability, indemnification and jurisdiction issues defined therein. Any holder of this document is advised that information contained hereon reflects the Company's findings at the time of its intervention only and within the limits of Client's instructions, if any. The Company's sole responsibility is to its Client and this document does not exonerate parties to a transaction from exercising all their rights and obligations under the transaction documents. This document cannot be reproduced except in full, without prior written approval of the Company. Any unauthorized alteration, forgery or falsification of the content or appearance of this document is unlawful and offenders may be prosecuted to the fullest extent of the law.

Date: 2020/7/12

Report No. : ES/2020/30005

WLAN 802.11a 5.6G_Head_Right Cheek_CH 100_Chain 1_Ant6

Communication System: Wi-Fi; Frequency: 5500 MHz; Duty cycle= 1:1

Medium parameters used: $f = 5500 \text{ MHz}$; $\sigma = 5.027 \text{ S/m}$; $\epsilon_r = 35.407$; $\rho = 1000 \text{ kg/m}^3$

Phantom section: Right Section

Ambient temperature: 21.9°C; Liquid temperature: 21.5°C

DASY5 Configuration:

- Probe: EX3DV4 - SN3770; ConvF(4.79, 4.79, 4.79) @ 5500 MHz; Calibrated: 2020/5/27
- Sensor-Surface: 2mm (Mechanical Surface Detection)
- Electronics: DAE4 Sn877; Calibrated: 2020/3/17
- Phantom: SAM
- DASY52 52.10.4(1527); SEMCAD X 14.6.14(7483)

Area Scan (111x201x1): Interpolated grid: dx=10 mm, dy=10 mm

Maximum value of SAR (interpolated) = 0.109 W/kg

Zoom Scan (7x7x12)/Cube 0: Measurement grid: dx=4mm, dy=4mm, dz=2mm

Reference Value = 5.499 V/m; Power Drift = -0.03 dB

Peak SAR (extrapolated) = 0.167 W/kg

SAR(1 g) = 0.067 W/kg; SAR(10 g) = 0.032 W/kg

Smallest distance from peaks to all points 3 dB below = 5.8 mm

Ratio of SAR at M2 to SAR at M1 = 59.5%

Maximum value of SAR (measured) = 0.0892 W/kg

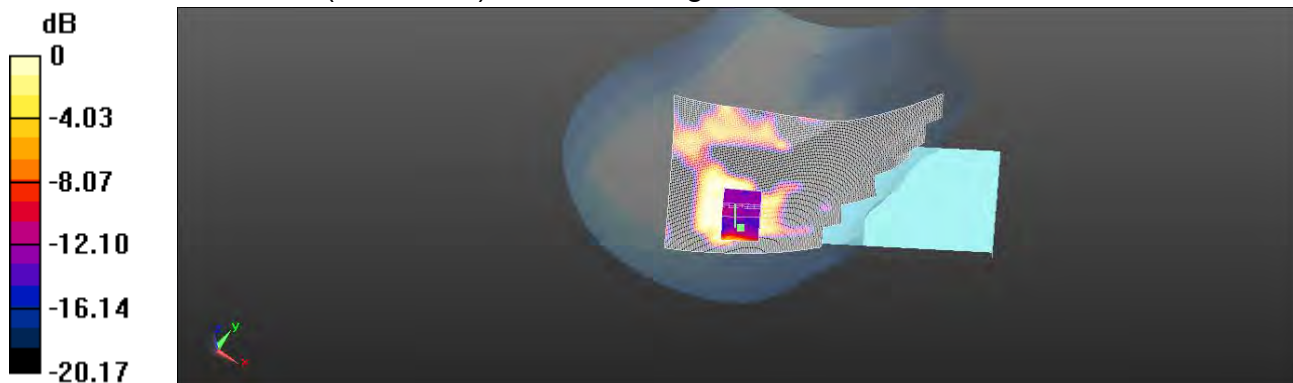

0 dB = 0.0892 W/kg = -10.50 dBW/kg

Unless otherwise stated the results shown in this test report refer only to the sample(s) tested and such sample(s) are retained for 90 days only.

除非另有說明，此報告結果僅對測試之樣品負責，同時此樣品僅保留90天。本報告未經本公司書面許可，不可部份複製。

This document is issued by the Company subject to its General Conditions of Service printed overleaf, available on request or accessible at <http://www.sgs.com.tw/Terms-and-Conditions> and for electronic format documents, subject to Terms and Conditions for Electronic Documents at <http://www.sgs.com.tw/Terms-and-Conditions>. Attention is drawn to the limitation of liability, indemnification and jurisdiction issues defined therein. Any holder of this document is advised that information contained hereon reflects the Company's findings at the time of its intervention only and within the limits of Client's instructions, if any. The Company's sole responsibility is to its Client and this document does not exonerate parties to a transaction from exercising all their rights and obligations under the transaction documents. This document cannot be reproduced except in full, without prior written approval of the Company. Any unauthorized alteration, forgery or falsification of the content or appearance of this document is unlawful and offenders may be prosecuted to the fullest extent of the law.

Date: 2020/7/13

Report No. : ES/2020/30005

WLAN 802.11ac(80M) 5.8G _Head_Re Cheek_CH 155_Chain 1_Ant6

Communication System: Wi-Fi; Frequency: 5775 MHz; Duty cycle= 1:1

Medium parameters used: $f = 5775$ MHz; $\sigma = 5.308$ S/m; $\epsilon_r = 34.656$; $\rho = 1000$ kg/m³

Phantom section: Right Section

Ambient temperature: 21.4°C; Liquid temperature: 21.7°C

DASY5 Configuration:

- Probe: EX3DV4 - SN3770; ConvF(4.9, 4.9, 4.9) @ 5775 MHz; Calibrated: 2020/5/27
- Sensor-Surface: 2mm (Mechanical Surface Detection)
- Electronics: DAE4 Sn877; Calibrated: 2020/3/17
- Phantom: SAM
- DASY52 52.10.4(1527); SEMCAD X 14.6.14(7483)

Area Scan (111x201x1): Interpolated grid: dx=10 mm, dy=10 mm

Maximum value of SAR (interpolated) = 0.236 W/kg

Zoom Scan (7x7x12)/Cube 0: Measurement grid: dx=4mm, dy=4mm, dz=2mm

Reference Value = 6.404 V/m; Power Drift = 0.16 dB

Peak SAR (extrapolated) = 0.496 W/kg

SAR(1 g) = 0.172 W/kg; SAR(10 g) = 0.070 W/kg

Smallest distance from peaks to all points 3 dB below = 5.1 mm

Ratio of SAR at M2 to SAR at M1 = 54.4%

Maximum value of SAR (measured) = 0.235 W/kg

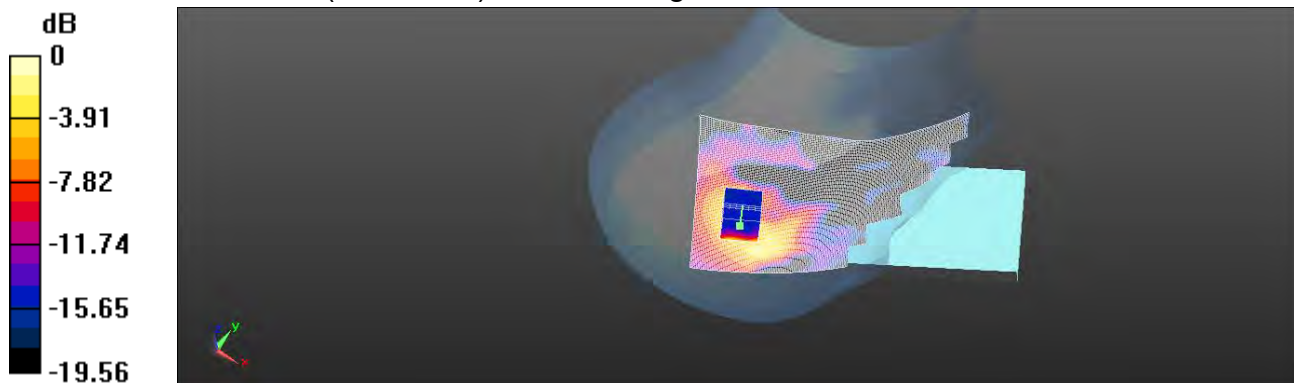

0 dB = 0.235 W/kg = -6.29 dBW/kg

Unless otherwise stated the results shown in this test report refer only to the sample(s) tested and such sample(s) are retained for 90 days only.

除非另有說明，此報告結果僅對測試之樣品負責，同時此樣品僅保留90天。本報告未經本公司書面許可，不可部份複製。

This document is issued by the Company subject to its General Conditions of Service printed overleaf, available on request or accessible at <http://www.sgs.com.tw/Terms-and-Conditions> and for electronic format documents, subject to Terms and Conditions for Electronic Documents at <http://www.sgs.com.tw/Terms-and-Conditions>. Attention is drawn to the limitation of liability, indemnification and jurisdiction issues defined therein. Any holder of this document is advised that information contained hereon reflects the Company's findings at the time of its intervention only and within the limits of Client's instructions, if any. The Company's sole responsibility is to its Client and this document does not exonerate parties to a transaction from exercising all their rights and obligations under the transaction documents. This document cannot be reproduced except in full, without prior written approval of the Company. Any unauthorized alteration, forgery or falsification of the content or appearance of this document is unlawful and offenders may be prosecuted to the fullest extent of the law.

Date: 2020/7/5

Report No. :ES/2020/30005

WLAN 802.11b_Body worn_Back side_CH 11_Chain0_Ant4_15mm

Communication System: WLAN 2.45G; Frequency: 2462 MHz; Duty cycle= 1:1

Medium parameters used: $f = 2462$ MHz; $\sigma = 1.784$ S/m; $\epsilon_r = 38.884$; $\rho = 1000$ kg/m³

Phantom section: Flat Section

Ambient temperature: 22.3°C; Liquid temperature: 22.0°C

DASY5 Configuration:

- Probe: EX3DV4 - SN7509; ConvF(7.51, 7.51, 7.51) @ 2462 MHz; Calibrated: 2020/03/25
- Sensor-Surface: 2mm (Mechanical Surface Detection)
- Electronics: DAE4 Sn558; Calibrated: 2019/10/11
- Phantom: SAM
- DASY52 52.10.4(1527); SEMCAD X 14.6.14(7483)

Area Scan (91x171x1): Interpolated grid: dx=12 mm, dy=12 mm

Maximum value of SAR (interpolated) = 0.0872 W/kg

Zoom Scan (7x7x7)/Cube 0: Measurement grid: dx=5mm, dy=5mm, dz=5mm

Reference Value = 2.866 V/m; Power Drift = 0.06 dB

Peak SAR (extrapolated) = 0.0970 W/kg

SAR(1 g) = 0.073 W/kg; SAR(10 g) = 0.051 W/kg

Smallest distance from peaks to all points 3 dB below = 7.9 mm

Ratio of SAR at M2 to SAR at M1 = 69.7%

Maximum value of SAR (measured) = 0.0834 W/kg

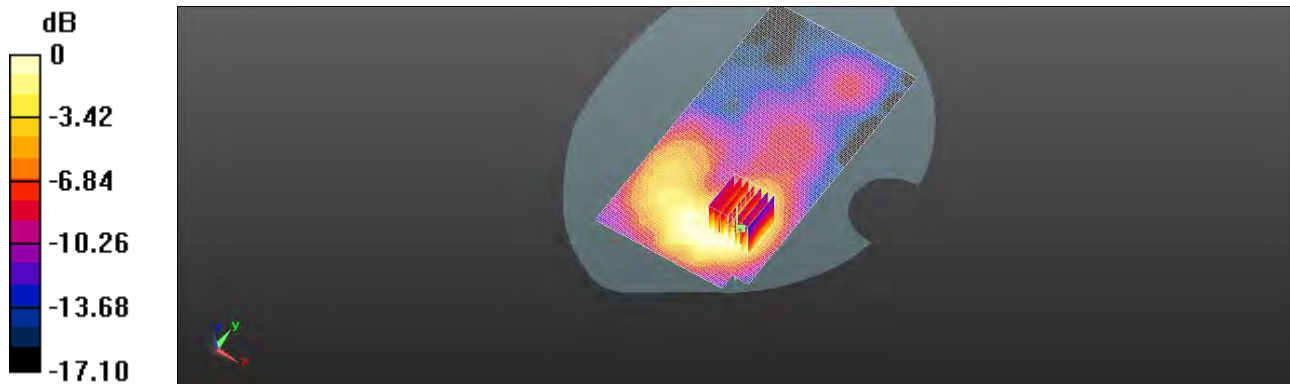

0 dB = 0.0834 W/kg = -10.79 dBW/kg

Unless otherwise stated the results shown in this test report refer only to the sample(s) tested and such sample(s) are retained for 90 days only.

除非另有說明，此報告結果僅對測試之樣品負責，同時此樣品僅保留90天。本報告未經本公司書面許可，不可部份複製。

This document is issued by the Company subject to its General Conditions of Service printed overleaf, available on request or accessible at <http://www.sgs.com.tw/Terms-and-Conditions> and for electronic format documents, subject to Terms and Conditions for Electronic Documents at <http://www.sgs.com.tw/Terms-and-Conditions>. Attention is drawn to the limitation of liability, indemnification and jurisdiction issues defined therein. Any holder of this document is advised that information contained hereon reflects the Company's findings at the time of its intervention only and within the limits of Client's instructions, if any. The Company's sole responsibility is to its Client and this document does not exonerate parties to a transaction from exercising all their rights and obligations under the transaction documents. This document cannot be reproduced except in full, without prior written approval of the Company. Any unauthorized alteration, forgery or falsification of the content or appearance of this document is unlawful and offenders may be prosecuted to the fullest extent of the law.

Date: 2020/7/5

Report No. :ES/2020/30005

BLE_1M_Body worn_Back side_CH 18_Chain0_Ant4_15mm

Communication System: Bluetooth; Frequency: 2442 MHz; Duty cycle= 1:1

Medium parameters used: $f = 2442$ MHz; $\sigma = 1.741$ S/m; $\epsilon_r = 38.897$; $\rho = 1000$ kg/m³

Phantom section: Flat Section

Ambient temperature: 22.3°C; Liquid temperature: 22.0°C

DASY5 Configuration:

- Probe: EX3DV4 - SN7509; ConvF(7.51, 7.51, 7.51) @ 2442 MHz; Calibrated: 2020/03/25
- Sensor-Surface: 2mm (Mechanical Surface Detection)
- Electronics: DAE4 Sn558; Calibrated: 2019/10/11
- Phantom: SAM
- DASY52 52.10.4(1527); SEMCAD X 14.6.14(7483)

Area Scan (91x171x1): Interpolated grid: dx=12 mm, dy=12 mm

Maximum value of SAR (interpolated) = 0.0227 W/kg

Zoom Scan (7x7x7)/Cube 0: Measurement grid: dx=5mm, dy=5mm, dz=5mm

Reference Value = 9.384 V/m; Power Drift = -0.03 dB

Peak SAR (extrapolated) = 0.0180 W/kg

SAR(1 g) = 0.014 W/kg; SAR(10 g) = 0.00994 W/kg

Smallest distance from peaks to all points 3 dB below = 8.9 mm

Ratio of SAR at M2 to SAR at M1 = 70%

Maximum value of SAR (measured) = 0.0165 W/kg

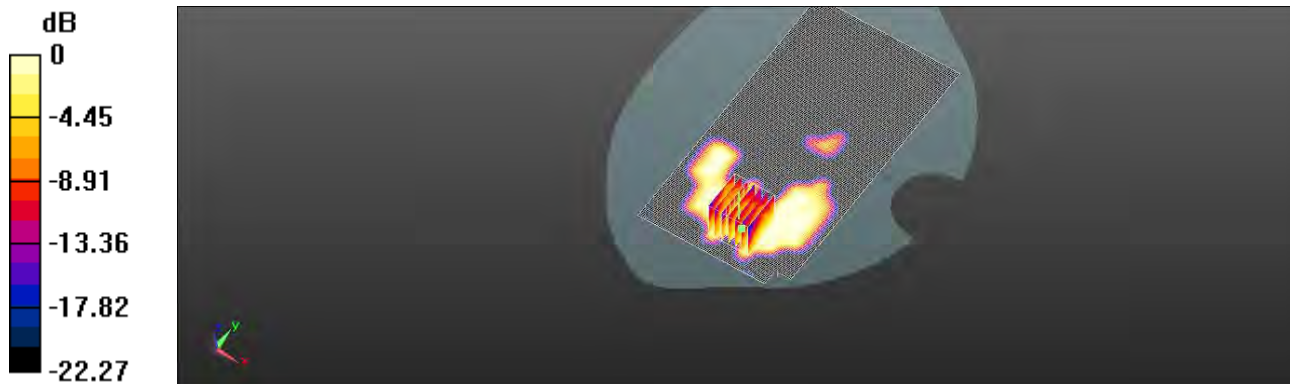

0 dB = 0.0165 W/kg = -17.83 dBW/kg

Unless otherwise stated the results shown in this test report refer only to the sample(s) tested and such sample(s) are retained for 90 days only.

除非另有說明，此報告結果僅對測試之樣品負責，同時此樣品僅保留90天。本報告未經本公司書面許可，不可部份複製。

This document is issued by the Company subject to its General Conditions of Service printed overleaf, available on request or accessible at <http://www.sgs.com.tw/Terms-and-Conditions> and for electronic format documents, subject to Terms and Conditions for Electronic Documents at <http://www.sgs.com.tw/Terms-and-Conditions>. Attention is drawn to the limitation of liability, indemnification and jurisdiction issues defined therein. Any holder of this document is advised that information contained hereon reflects the Company's findings at the time of its intervention only and within the limits of Client's instructions, if any. The Company's sole responsibility is to its Client and this document does not exonerate parties to a transaction from exercising all their rights and obligations under the transaction documents. This document cannot be reproduced except in full, without prior written approval of the Company. Any unauthorized alteration, forgery or falsification of the content or appearance of this document is unlawful and offenders may be prosecuted to the fullest extent of the law.

Date: 2020/7/10

Report No. : ES/2020/30005

WLAN 802.11n(40M) 5.2G_Body worn_Back side_CH 46_Chain0_Ant4_15mm

Communication System: WLAN 5G; Frequency: 5230 MHz; Duty cycle= 1:1

Medium parameters used: $f = 5230$ MHz; $\sigma = 4.734$ S/m; $\epsilon_r = 35.583$; $\rho = 1000$ kg/m³

Phantom section: Flat Section

Ambient temperature: 22.1°C; Liquid temperature: 21.8°C

DASY5 Configuration:

- Probe: EX3DV4 - SN7509; ConvF(5.33, 5.33, 5.33) @ 5230 MHz; Calibrated: 2020/03/25
- Sensor-Surface: 2mm (Mechanical Surface Detection)
- Electronics: DAE4 Sn558; Calibrated: 2019/10/11
- Phantom: SAM
- DASY52 52.10.4(1527); SEMCAD X 14.6.14(7483)

Area Scan (121x211x1): Interpolated grid: dx=10 mm, dy=10 mm

Maximum value of SAR (interpolated) = 0.126 W/kg

Zoom Scan (7x7x12)/Cube 0: Measurement grid: dx=4mm, dy=4mm, dz=2mm

Reference Value = 2.258 V/m; Power Drift = 0.05 dB

Peak SAR (extrapolated) = 0.165 W/kg

SAR(1 g) = 0.079 W/kg; SAR(10 g) = 0.040 W/kg

Smallest distance from peaks to all points 3 dB below = 9.6 mm

Ratio of SAR at M2 to SAR at M1 = 64.2%

Maximum value of SAR (measured) = 0.106 W/kg

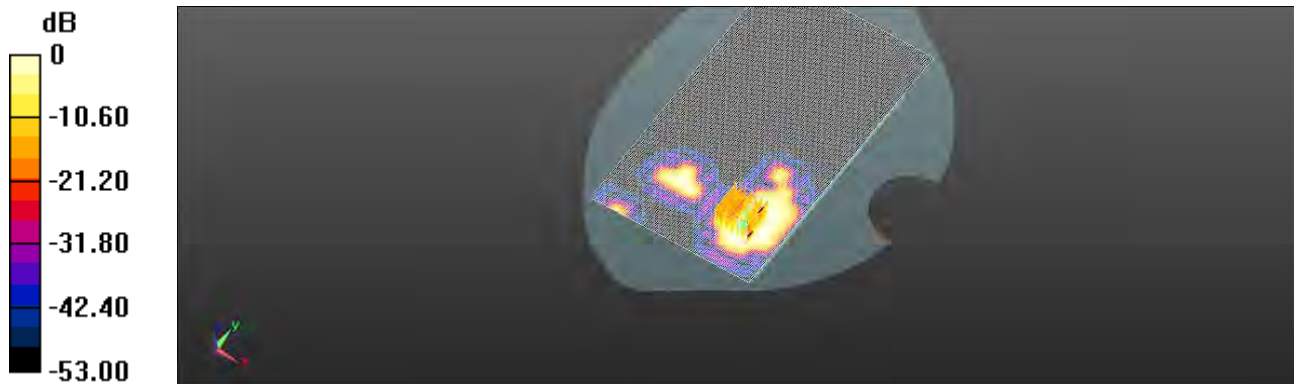

0 dB = 0.106 W/kg = -9.75 dBW/kg

Unless otherwise stated the results shown in this test report refer only to the sample(s) tested and such sample(s) are retained for 90 days only.

除非另有說明，此報告結果僅對測試之樣品負責，同時此樣品僅保留90天。本報告未經本公司書面許可，不可部份複製。

This document is issued by the Company subject to its General Conditions of Service printed overleaf, available on request or accessible at <http://www.sgs.com.tw/Terms-and-Conditions> and for electronic format documents, subject to Terms and Conditions for Electronic Documents at <http://www.sgs.com.tw/Terms-and-Conditions>. Attention is drawn to the limitation of liability, indemnification and jurisdiction issues defined therein. Any holder of this document is advised that information contained hereon reflects the Company's findings at the time of its intervention only and within the limits of Client's instructions, if any. The Company's sole responsibility is to its Client and this document does not exonerate parties to a transaction from exercising all their rights and obligations under the transaction documents. This document cannot be reproduced except in full, without prior written approval of the Company. Any unauthorized alteration, forgery or falsification of the content or appearance of this document is unlawful and offenders may be prosecuted to the fullest extent of the law.

Date: 2020/7/11

Report No. :ES/2020/30005

WLAN 802.11a 5.3G_Body worn_Back side_CH 52_Chain0_Ant4_15mm

Communication System: Wi-Fi; Frequency: 5260 MHz; Duty cycle= 1:1

Medium parameters used: $f = 5260 \text{ MHz}$; $\sigma = 4.787 \text{ S/m}$; $\epsilon_r = 35.478$; $\rho = 1000 \text{ kg/m}^3$

Phantom section: Flat Section

Ambient temperature: 21.5°C; Liquid temperature: 22.1°C

DASY5 Configuration:

- Probe: EX3DV4 - SN7509; ConvF(5.23, 5.23, 5.23) @ 5260 MHz; Calibrated: 2020/03/25
- Sensor-Surface: 2mm (Mechanical Surface Detection)
- Electronics: DAE4 Sn558; Calibrated: 2019/10/11
- Phantom: SAM
- DASY52 52.10.4(1527); SEMCAD X 14.6.14(7483)

Area Scan (121x211x1): Interpolated grid: dx=10 mm, dy=10 mm

Maximum value of SAR (interpolated) = 0.0857 W/kg

Zoom Scan (7x7x12)/Cube 0: Measurement grid: dx=4mm, dy=4mm, dz=2mm

Reference Value = 2.373 V/m; Power Drift = -0.15 dB

Peak SAR (extrapolated) = 0.126 W/kg

SAR(1 g) = 0.075 W/kg; SAR(10 g) = 0.043 W/kg

Smallest distance from peaks to all points 3 dB below = 5.2 mm

Ratio of SAR at M2 to SAR at M1 = 64.3%

Maximum value of SAR (measured) = 0.0869 W/kg

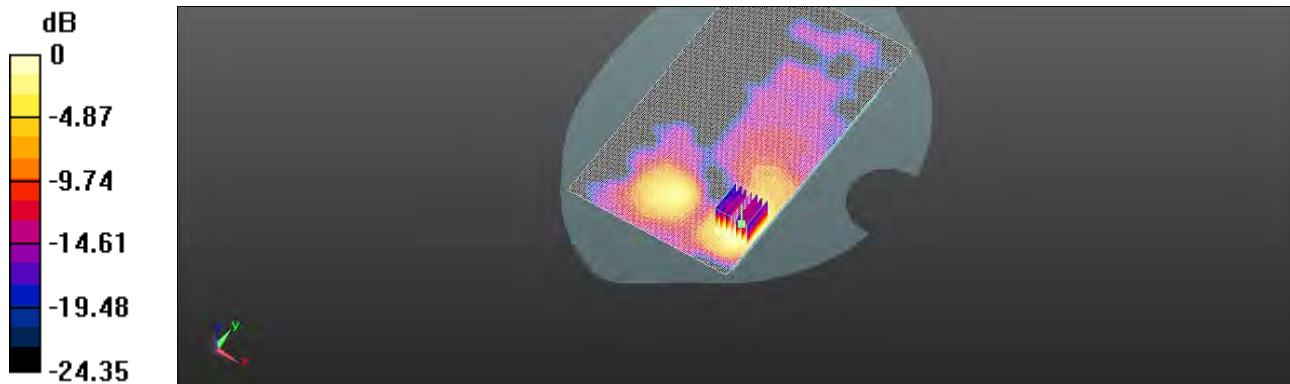

0 dB = 0.0869 W/kg = -10.61 dBW/kg

Unless otherwise stated the results shown in this test report refer only to the sample(s) tested and such sample(s) are retained for 90 days only.

除非另有說明，此報告結果僅對測試之樣品負責，同時此樣品僅保留90天。本報告未經本公司書面許可，不可部份複製。

This document is issued by the Company subject to its General Conditions of Service printed overleaf, available on request or accessible at <http://www.sgs.com.tw/Terms-and-Conditions> and for electronic format documents, subject to Terms and Conditions for Electronic Documents at <http://www.sgs.com.tw/Terms-and-Conditions>. Attention is drawn to the limitation of liability, indemnification and jurisdiction issues defined therein. Any holder of this document is advised that information contained hereon reflects the Company's findings at the time of its intervention only and within the limits of Client's instructions, if any. The Company's sole responsibility is to its Client and this document does not exonerate parties to a transaction from exercising all their rights and obligations under the transaction documents. This document cannot be reproduced except in full, without prior written approval of the Company. Any unauthorized alteration, forgery or falsification of the content or appearance of this document is unlawful and offenders may be prosecuted to the fullest extent of the law.

Date: 2020/7/12

Report No. :ES/2020/30005

**WLAN 802.11ac(80M) 5.6G_Body worn_Back side_CH
138_Chain0_Ant4_15mm**

Communication System: Wi-Fi; Frequency: 5690 MHz; Duty cycle= 1:1

Medium parameters used: $f = 5690$ MHz; $\sigma = 5.234$ S/m; $\epsilon_r = 34.835$; $\rho = 1000$ kg/m³

Phantom section: Flat Section

Ambient temperature: 21.9°C; Liquid temperature: 21.5°C

DASY5 Configuration:

- Probe: EX3DV4 - SN3770; ConvF(4.79, 4.79, 4.79) @ 5610 MHz; Calibrated: 2020/5/27
- Sensor-Surface: 2mm (Mechanical Surface Detection)
- Electronics: DAE4 Sn877; Calibrated: 2020/3/17
- Phantom: SAM
- DASY52 52.10.4(1527); SEMCAD X 14.6.14(7483)

Area Scan (111x191x1): Interpolated grid: dx=10 mm, dy=10 mm

Maximum value of SAR (interpolated) = 0.0775 W/kg

Zoom Scan (7x7x12)/Cube 0: Measurement grid: dx=4mm, dy=4mm, dz=2mm

Reference Value = 3.385 V/m; Power Drift = 0.06 dB

Peak SAR (extrapolated) = 0.121 W/kg

SAR(1 g) = 0.071 W/kg; SAR(10 g) = 0.044 W/kg

Smallest distance from peaks to all points 3 dB below = 5.9 mm

Ratio of SAR at M2 to SAR at M1 = 59.4%

Maximum value of SAR (measured) = 0.0679 W/kg

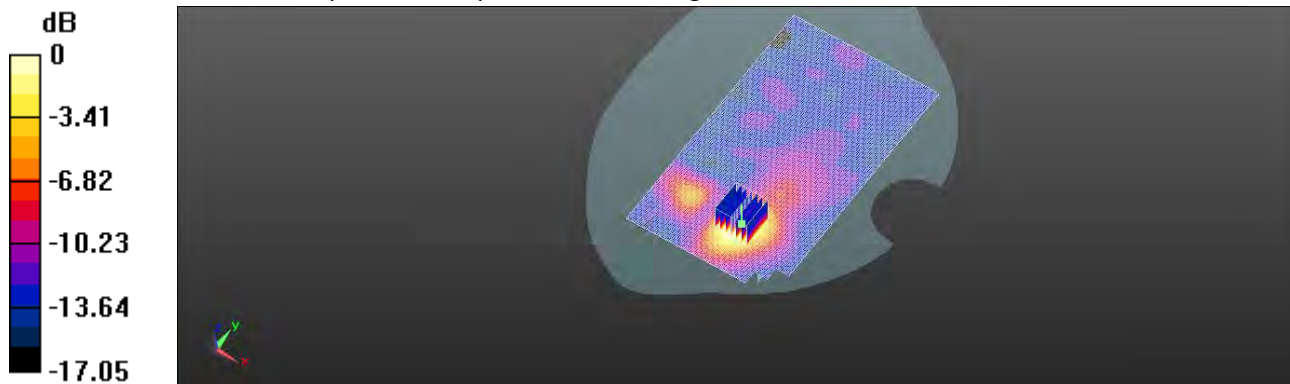

0 dB = 0.0679 W/kg = -11.68 dBW/kg

Unless otherwise stated the results shown in this test report refer only to the sample(s) tested and such sample(s) are retained for 90 days only.

除非另有說明，此報告結果僅對測試之樣品負責，同時此樣品僅保留90天。本報告未經本公司書面許可，不可部份複製。

This document is issued by the Company subject to its General Conditions of Service printed overleaf, available on request or accessible at <http://www.sgs.com.tw/Terms-and-Conditions> and for electronic format documents, subject to Terms and Conditions for Electronic Documents at <http://www.sgs.com.tw/Terms-and-Conditions>. Attention is drawn to the limitation of liability, indemnification and jurisdiction issues defined therein. Any holder of this document is advised that information contained hereon reflects the Company's findings at the time of its intervention only and within the limits of Client's instructions, if any. The Company's sole responsibility is to its Client and this document does not exonerate parties to a transaction from exercising all their rights and obligations under the transaction documents. This document cannot be reproduced except in full, without prior written approval of the Company. Any unauthorized alteration, forgery or falsification of the content or appearance of this document is unlawful and offenders may be prosecuted to the fullest extent of the law.

Date: 2020/7/13

Report No. :ES/2020/30005

**WLAN 802.11ac(80M) 5.8G_Body worn_Back side_CH
155_Chain0_Ant4_15mm**

Communication System: WLAN 5G; Frequency: 5775 MHz; Duty cycle= 1:1

Medium parameters used: $f = 5775$ MHz; $\sigma = 5.308$ S/m; $\epsilon_r = 34.656$; $\rho = 1000$ kg/m³

Phantom section: Flat Section

Ambient temperature: 21.4°C; Liquid temperature: 21.7°C

DASY5 Configuration:

- Probe: EX3DV4 - SN7509; ConvF(4.85, 4.85, 4.85) @ 5775 MHz; Calibrated: 2020/03/25
- Sensor-Surface: 2mm (Mechanical Surface Detection)
- Electronics: DAE4 Sn558; Calibrated: 2019/10/11
- Phantom: SAM
- DASY52 52.10.4(1527); SEMCAD X 14.6.14(7483)

Area Scan (111x191x1): Interpolated grid: dx=10 mm, dy=10 mm

Maximum value of SAR (interpolated) = 0.0779 W/kg

Zoom Scan (7x7x12)/Cube 0: Measurement grid: dx=4mm, dy=4mm, dz=2mm

Reference Value = 7.690 V/m; Power Drift = 0.14 dB

Peak SAR (extrapolated) = 0.125 W/kg

SAR(1 g) = 0.072 W/kg; SAR(10 g) = 0.041 W/kg

Smallest distance from peaks to all points 3 dB below = 5.91 mm

Ratio of SAR at M2 to SAR at M1 = 58.4%

Maximum value of SAR (measured) = 0.0755 W/kg

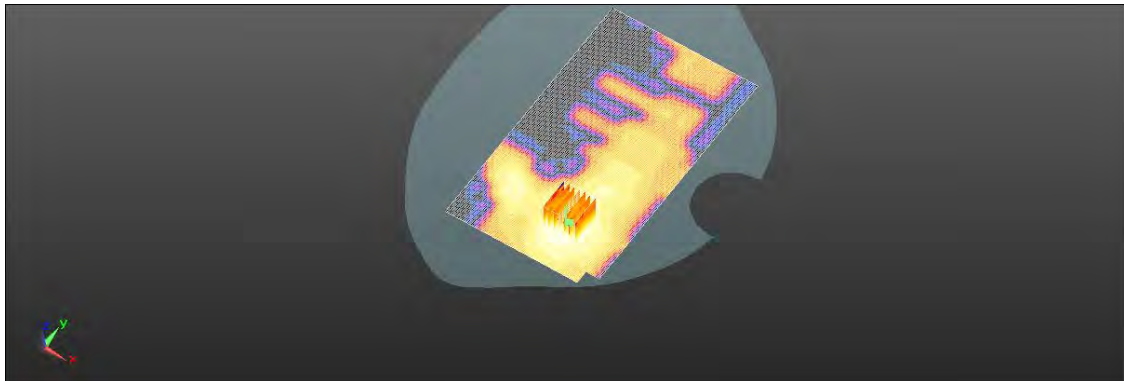
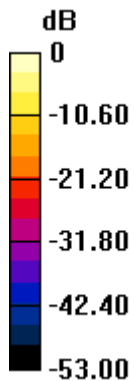

0 dB = 0.0755 W/kg = -11.22 dBW/kg

Unless otherwise stated the results shown in this test report refer only to the sample(s) tested and such sample(s) are retained for 90 days only.

除非另有說明，此報告結果僅對測試之樣品負責，同時此樣品僅保留90天。本報告未經本公司書面許可，不可部份複製。

This document is issued by the Company subject to its General Conditions of Service printed overleaf, available on request or accessible at <http://www.sgs.com.tw/Terms-and-Conditions> and for electronic format documents, subject to Terms and Conditions for Electronic Documents at <http://www.sgs.com.tw/Terms-and-Conditions>. Attention is drawn to the limitation of liability, indemnification and jurisdiction issues defined therein. Any holder of this document is advised that information contained hereon reflects the Company's findings at the time of its intervention only and within the limits of Client's instructions, if any. The Company's sole responsibility is to its Client and this document does not exonerate parties to a transaction from exercising all their rights and obligations under the transaction documents. This document cannot be reproduced except in full, without prior written approval of the Company. Any unauthorized alteration, forgery or falsification of the content or appearance of this document is unlawful and offenders may be prosecuted to the fullest extent of the law.

Date: 2020/7/5

Report No. :ES/2020/30005

WLAN 802.11b_Body worn_Back side_CH 11_Chain1_Ant6_15mm

Communication System: WLAN 2.45G; Frequency: 2462 MHz; Duty cycle= 1:1

Medium parameters used: $f = 2462$ MHz; $\sigma = 1.783$ S/m; $\epsilon_r = 38.884$; $\rho = 1000$ kg/m³

Phantom section: Flat Section

Ambient temperature: 22.3°C; Liquid temperature: 22.0°C

DASY5 Configuration:

- Probe: EX3DV4 - SN7509; ConvF(7.51, 7.51, 7.51) @ 2462 MHz; Calibrated: 2020/03/25
- Sensor-Surface: 2mm (Mechanical Surface Detection)
- Electronics: DAE4 Sn558; Calibrated: 2019/10/11
- Phantom: SAM
- DASY52 52.10.4(1527); SEMCAD X 14.6.14(7483)

Area Scan (91x171x1): Interpolated grid: dx=12 mm, dy=12 mm

Maximum value of SAR (interpolated) = 0.0323 W/kg

Zoom Scan (7x7x7)/Cube 0: Measurement grid: dx=5mm, dy=5mm, dz=5mm

Reference Value = 3.443 V/m; Power Drift = 0.05 dB

Peak SAR (extrapolated) = 0.0380 W/kg

SAR(1 g) = 0.027 W/kg; SAR(10 g) = 0.019 W/kg

Smallest distance from peaks to all points 3 dB below = 6.19 mm

Ratio of SAR at M2 to SAR at M1 = 63.6%

Maximum value of SAR (measured) = 0.0315 W/kg

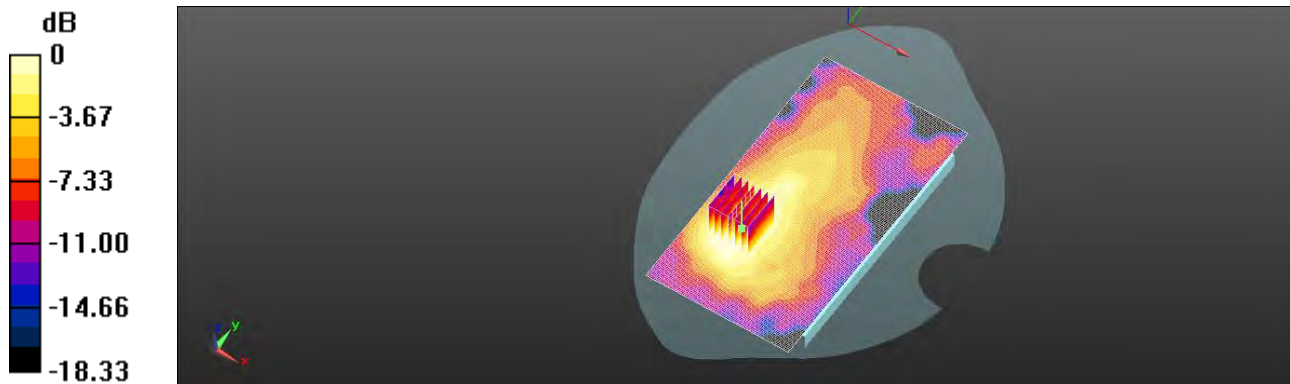

0 dB = 0.0315 W/kg = -15.02 dBW/kg

Unless otherwise stated the results shown in this test report refer only to the sample(s) tested and such sample(s) are retained for 90 days only.

除非另有說明，此報告結果僅對測試之樣品負責，同時此樣品僅保留90天。本報告未經本公司書面許可，不可部份複製。

This document is issued by the Company subject to its General Conditions of Service printed overleaf, available on request or accessible at <http://www.sgs.com.tw/Terms-and-Conditions> and for electronic format documents, subject to Terms and Conditions for Electronic Documents at <http://www.sgs.com.tw/Terms-and-Conditions>. Attention is drawn to the limitation of liability, indemnification and jurisdiction issues defined therein. Any holder of this document is advised that information contained hereon reflects the Company's findings at the time of its intervention only and within the limits of Client's instructions, if any. The Company's sole responsibility is to its Client and this document does not exonerate parties to a transaction from exercising all their rights and obligations under the transaction documents. This document cannot be reproduced except in full, without prior written approval of the Company. Any unauthorized alteration, forgery or falsification of the content or appearance of this document is unlawful and offenders may be prosecuted to the fullest extent of the law.

Date: 2020/7/5

Report No. :ES/2020/30005

BLE_1M_Body worn_Back side_CH 18_Chain1_Ant6_15mm

Communication System: Bluetooth; Frequency: 2442 MHz; Duty cycle= 1:1

Medium parameters used: $f = 2442$ MHz; $\sigma = 1.741$ S/m; $\epsilon_r = 38.897$; $\rho = 1000$ kg/m³

Phantom section: Flat Section

Ambient temperature: 22.3°C; Liquid temperature: 22.0°C

DASY5 Configuration:

- Probe: EX3DV4 - SN7509; ConvF(7.51, 7.51, 7.51) @ 2442 MHz; Calibrated: 2020/03/25
- Sensor-Surface: 2mm (Mechanical Surface Detection)
- Electronics: DAE4 Sn558; Calibrated: 2019/10/11
- Phantom: SAM
- DASY52 52.10.4(1527); SEMCAD X 14.6.14(7483)

Area Scan (91x171x1): Interpolated grid: dx=12 mm, dy=12 mm

Maximum value of SAR (interpolated) = 0.00412 W/kg

Zoom Scan (7x7x7)/Cube 0: Measurement grid: dx=5mm, dy=5mm, dz=5mm

Reference Value = 9.063 V/m; Power Drift = -0.16 dB

Peak SAR (extrapolated) = 0.00415 W/kg

SAR(1 g) = 0.00322 W/kg; SAR(10 g) = 0.00216 W/kg

Smallest distance from peaks to all points 3 dB below = 5.94 mm

Ratio of SAR at M2 to SAR at M1 = 59.2%

Maximum value of SAR (measured) = 0.00338 W/kg

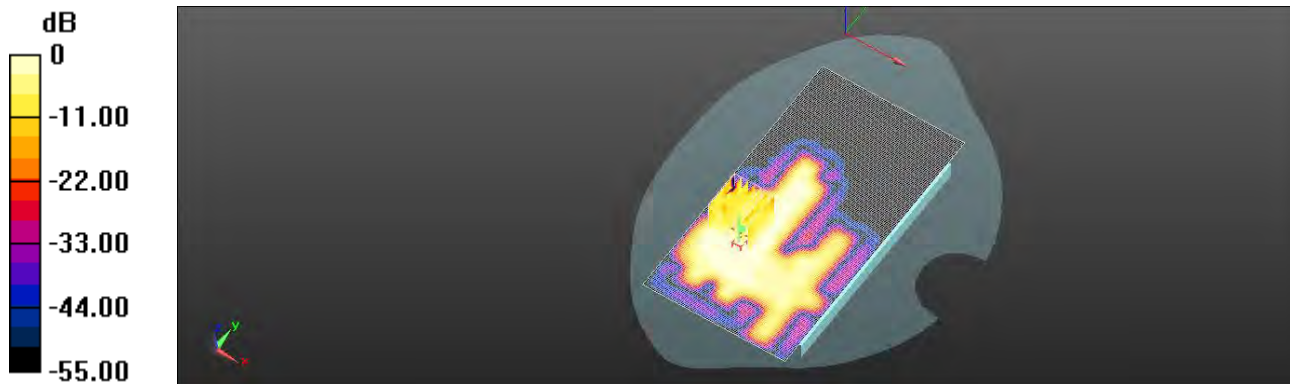

0 dB = 0.00338 W/kg = -24.71 dBW/kg

Unless otherwise stated the results shown in this test report refer only to the sample(s) tested and such sample(s) are retained for 90 days only.

除非另有說明，此報告結果僅對測試之樣品負責，同時此樣品僅保留90天。本報告未經本公司書面許可，不可部份複製。

This document is issued by the Company subject to its General Conditions of Service printed overleaf, available on request or accessible at <http://www.sgs.com.tw/Terms-and-Conditions> and for electronic format documents, subject to Terms and Conditions for Electronic Documents at <http://www.sgs.com.tw/Terms-and-Conditions>. Attention is drawn to the limitation of liability, indemnification and jurisdiction issues defined therein. Any holder of this document is advised that information contained hereon reflects the Company's findings at the time of its intervention only and within the limits of Client's instructions, if any. The Company's sole responsibility is to its Client and this document does not exonerate parties to a transaction from exercising all their rights and obligations under the transaction documents. This document cannot be reproduced except in full, without prior written approval of the Company. Any unauthorized alteration, forgery or falsification of the content or appearance of this document is unlawful and offenders may be prosecuted to the fullest extent of the law.

Date: 2020/7/10

Report No. :ES/2020/30005

WLAN 802.11n(40M) 5.2G_Body worn_Back side_CH 46_Chain1_Ant6_15mm

Communication System: Wi-Fi; Frequency: 5230 MHz; Duty cycle= 1:1

Medium parameters used: $f = 5230 \text{ MHz}$; $\sigma = 4.734 \text{ S/m}$; $\epsilon_r = 35.583$; $\rho = 1000 \text{ kg/m}^3$

Phantom section: Flat Section

Ambient temperature: 22.1°C; Liquid temperature: 21.8°C

DASY5 Configuration:

- Probe: EX3DV4 - SN7509; ConvF(5.33, 5.33, 5.33) @ 5230 MHz; Calibrated: 2020/03/25
- Sensor-Surface: 2mm (Mechanical Surface Detection)
- Electronics: DAE4 Sn558; Calibrated: 2019/10/11
- Phantom: SAM
- DASY52 52.10.4(1527); SEMCAD X 14.6.14(7483)

Area Scan (111x201x1): Interpolated grid: dx=10 mm, dy=10 mm

Maximum value of SAR (interpolated) = 0.183 W/kg

Zoom Scan (7x7x12)/Cube 0: Measurement grid: dx=4mm, dy=4mm, dz=2mm

Reference Value = 6.054 V/m; Power Drift = -0.14 dB

Peak SAR (extrapolated) = 0.284 W/kg

SAR(1 g) = 0.126 W/kg; SAR(10 g) = 0.055 W/kg

Smallest distance from peaks to all points 3 dB below = 6.51 mm

Ratio of SAR at M2 to SAR at M1 = 63.2%

Maximum value of SAR (measured) = 0.190 W/kg

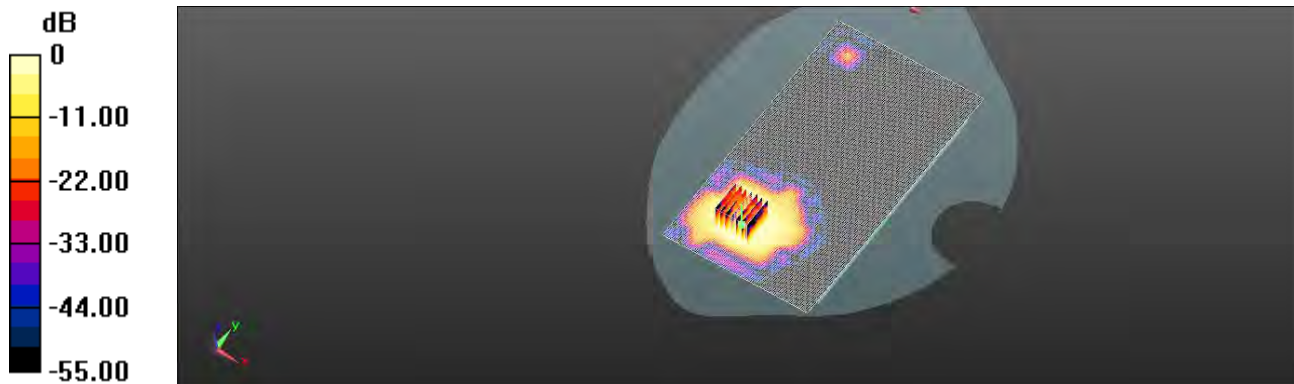

0 dB = 0.190 W/kg = -7.22 dBW/kg

Unless otherwise stated the results shown in this test report refer only to the sample(s) tested and such sample(s) are retained for 90 days only.

除非另有說明，此報告結果僅對測試之樣品負責，同時此樣品僅保留90天。本報告未經本公司書面許可，不可部份複製。

This document is issued by the Company subject to its General Conditions of Service printed overleaf, available on request or accessible at <http://www.sgs.com.tw/Terms-and-Conditions> and for electronic format documents, subject to Terms and Conditions for Electronic Documents at <http://www.sgs.com.tw/Terms-and-Conditions>. Attention is drawn to the limitation of liability, indemnification and jurisdiction issues defined therein. Any holder of this document is advised that information contained hereon reflects the Company's findings at the time of its intervention only and within the limits of Client's instructions, if any. The Company's sole responsibility is to its Client and this document does not exonerate parties to a transaction from exercising all their rights and obligations under the transaction documents. This document cannot be reproduced except in full, without prior written approval of the Company. Any unauthorized alteration, forgery or falsification of the content or appearance of this document is unlawful and offenders may be prosecuted to the fullest extent of the law.

Date: 2020/7/11

Report No. : ES/2020/30005

WLAN 802.11n(20M) 5.3G Body worn Back side CH 60 Chain1 Ant6 15mm

Communication System: WLAN 5G; Frequency: 5300 MHz; Duty cycle= 1:1

Medium parameters used: $f = 5300 \text{ MHz}$; $\sigma = 4.835 \text{ S/m}$; $\epsilon_r = 35.425$; $\rho = 1000 \text{ kg/m}^3$

Phantom section: Flat Section

Ambient temperature: 21.5°C; Liquid temperature: 22.1°C

DASY5 Configuration:

- Probe: EX3DV4 - SN7509; ConvF(5.23, 5.23, 5.23) @ 5300 MHz; Calibrated: 2020/03/25
- Sensor-Surface: 2mm (Mechanical Surface Detection)
- Electronics: DAE4 Sn558; Calibrated: 2019/10/11
- Phantom: SAM
- DASY52 52.10.4(1527); SEMCAD X 14.6.14(7483)

Area Scan (111x201x1): Interpolated grid: dx=10 mm, dy=10 mm

Maximum value of SAR (interpolated) = 0.296 W/kg

Zoom Scan (7x7x12)/Cube 0: Measurement grid: dx=4mm, dy=4mm, dz=2mm

Reference Value = 5.134 V/m; Power Drift = 0.14 dB

Peak SAR (extrapolated) = 0.400 W/kg

SAR(1 g) = 0.217 W/kg; SAR(10 g) = 0.107 W/kg

Smallest distance from peaks to all points 3 dB below = 6.82 mm

Ratio of SAR at M2 to SAR at M1 = 66.2%

Maximum value of SAR (measured) = 0.287 W/kg

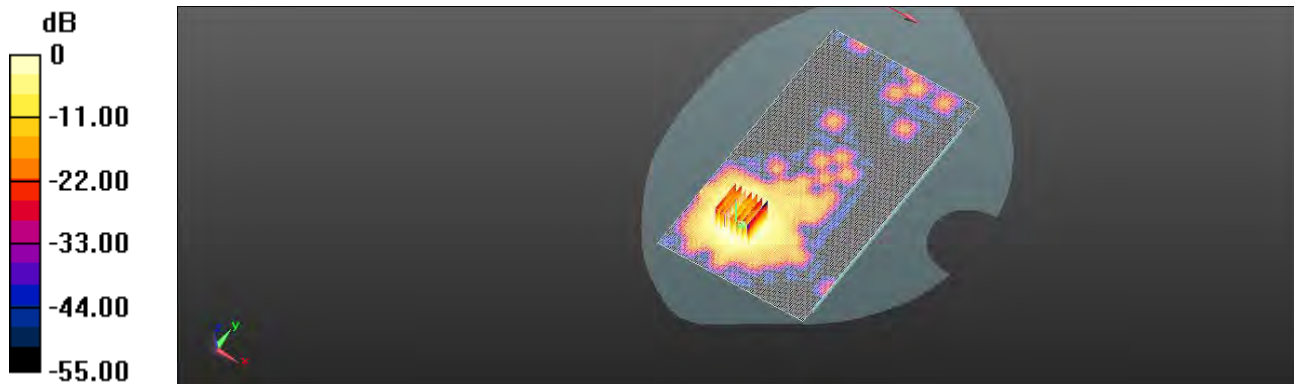

0 dB = 0.287 W/kg = -5.42 dBW/kg

Unless otherwise stated the results shown in this test report refer only to the sample(s) tested and such sample(s) are retained for 90 days only.

除非另有說明，此報告結果僅對測試之樣品負責，同時此樣品僅保留90天。本報告未經本公司書面許可，不可部份複製。

This document is issued by the Company subject to its General Conditions of Service printed overleaf, available on request or accessible at <http://www.sgs.com.tw/Terms-and-Conditions> and for electronic format documents, subject to Terms and Conditions for Electronic Documents at <http://www.sgs.com.tw/Terms-and-Conditions>. Attention is drawn to the limitation of liability, indemnification and jurisdiction issues defined therein. Any holder of this document is advised that information contained hereon reflects the Company's findings at the time of its intervention only and within the limits of Client's instructions, if any. The Company's sole responsibility is to its Client and this document does not exonerate parties to a transaction from exercising all their rights and obligations under the transaction documents. This document cannot be reproduced except in full, without prior written approval of the Company. Any unauthorized alteration, forgery or falsification of the content or appearance of this document is unlawful and offenders may be prosecuted to the fullest extent of the law.

Date: 2020/7/12

Report No. :ES/2020/30005

WLAN 802.11a 5.6G_Body worn_Back side_CH 100_Chain1_Ant6_15mm

Communication System: Wi-Fi; Frequency: 5500 MHz; Duty cycle= 1:1

Medium parameters used: $f = 5500 \text{ MHz}$; $\sigma = 5.027 \text{ S/m}$; $\epsilon_r = 35.407$; $\rho = 1000 \text{ kg/m}^3$

Phantom section: Flat Section

Ambient temperature: 21.9°C; Liquid temperature: 21.5°C

DASY5 Configuration:

- Probe: EX3DV4 - SN7509; ConvF(4.64, 4.64, 4.64) @ 5500 MHz; Calibrated: 2020/03/25
- Sensor-Surface: 2mm (Mechanical Surface Detection)
- Electronics: DAE4 Sn558; Calibrated: 2019/10/11
- Phantom: SAM
- DASY52 52.10.4(1527); SEMCAD X 14.6.14(7483)

Area Scan (111x201x1): Interpolated grid: dx=10 mm, dy=10 mm

Maximum value of SAR (interpolated) = 0.146 W/kg

Zoom Scan (7x7x12)/Cube 0: Measurement grid: dx=4mm, dy=4mm, dz=2mm

Reference Value = 6.148 V/m; Power Drift = -0.07 dB

Peak SAR (extrapolated) = 0.512 W/kg

SAR(1 g) = 0.092 W/kg; SAR(10 g) = 0.033 W/kg

Smallest distance from peaks to all points 3 dB below =5.46 mm

Ratio of SAR at M2 to SAR at M1 = 68.5%

Maximum value of SAR (measured) = 0.169 W/kg

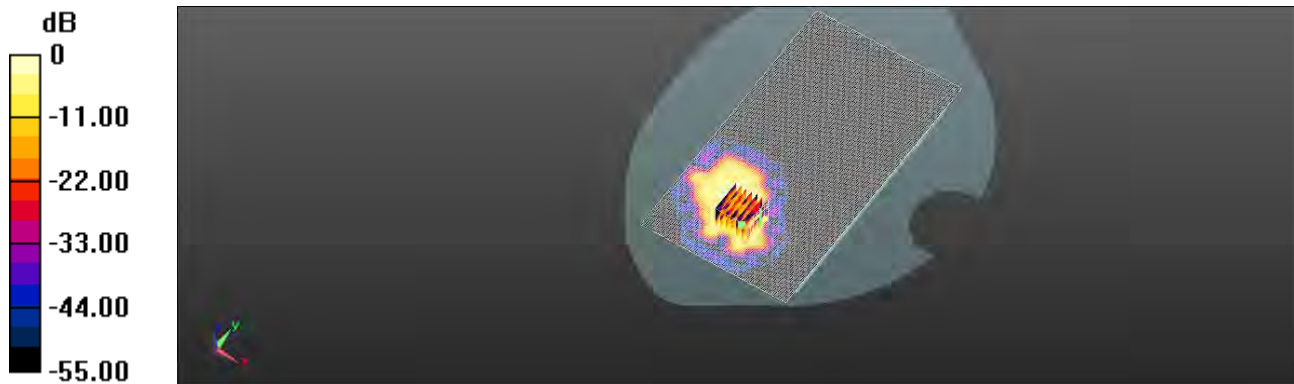

0 dB = 0.169 W/kg = -7.73 dBW/kg

Unless otherwise stated the results shown in this test report refer only to the sample(s) tested and such sample(s) are retained for 90 days only.

除非另有說明，此報告結果僅對測試之樣品負責，同時此樣品僅保留90天。本報告未經本公司書面許可，不可部份複製。

This document is issued by the Company subject to its General Conditions of Service printed overleaf, available on request or accessible at <http://www.sgs.com.tw/Terms-and-Conditions> and for electronic format documents, subject to Terms and Conditions for Electronic Documents at <http://www.sgs.com.tw/Terms-and-Conditions>. Attention is drawn to the limitation of liability, indemnification and jurisdiction issues defined therein. Any holder of this document is advised that information contained hereon reflects the Company's findings at the time of its intervention only and within the limits of Client's instructions, if any. The Company's sole responsibility is to its Client and this document does not exonerate parties to a transaction from exercising all their rights and obligations under the transaction documents. This document cannot be reproduced except in full, without prior written approval of the Company. Any unauthorized alteration, forgery or falsification of the content or appearance of this document is unlawful and offenders may be prosecuted to the fullest extent of the law.

Date: 2020/7/13

Report No. :ES/2020/30005

**WLAN 802.11ac(80M) 5.8G_Body worn_Back side_CH
155_Chain1_Ant6_15mm**

Communication System: Wi-Fi; Frequency: 5775 MHz; Duty cycle= 1:1

Medium parameters used: $f = 5775 \text{ MHz}$; $\sigma = 5.308 \text{ S/m}$; $\epsilon_r = 34.656$; $\rho = 1000 \text{ kg/m}^3$

Phantom section: Flat Section

Ambient temperature: 21.4°C; Liquid temperature: 21.7°C

DASY5 Configuration:

- Probe: EX3DV4 - SN7509; ConvF(4.85, 4.85, 4.85) @ 5775 MHz; Calibrated: 2020/03/25
- Sensor-Surface: 2mm (Mechanical Surface Detection)
- Electronics: DAE4 Sn558; Calibrated: 2019/10/11
- Phantom: SAM
- DASY52 52.10.4(1527); SEMCAD X 14.6.14(7483)

Area Scan (111x201x1): Interpolated grid: $dx=10 \text{ mm}$, $dy=10 \text{ mm}$

Maximum value of SAR (interpolated) = 0.208 W/kg

Zoom Scan (7x7x12)/Cube 0: Measurement grid: $dx=4\text{mm}$, $dy=4\text{mm}$, $dz=2\text{mm}$

Reference Value = 8.760 V/m; Power Drift = -0.10 dB

Peak SAR (extrapolated) = 0.246 W/kg

SAR(1 g) = 0.142 W/kg; SAR(10 g) = 0.067 W/kg

Smallest distance from peaks to all points 3 dB below = 7.4 mm

Ratio of SAR at M2 to SAR at M1 = 70.8%

Maximum value of SAR (measured) = 0.198 W/kg

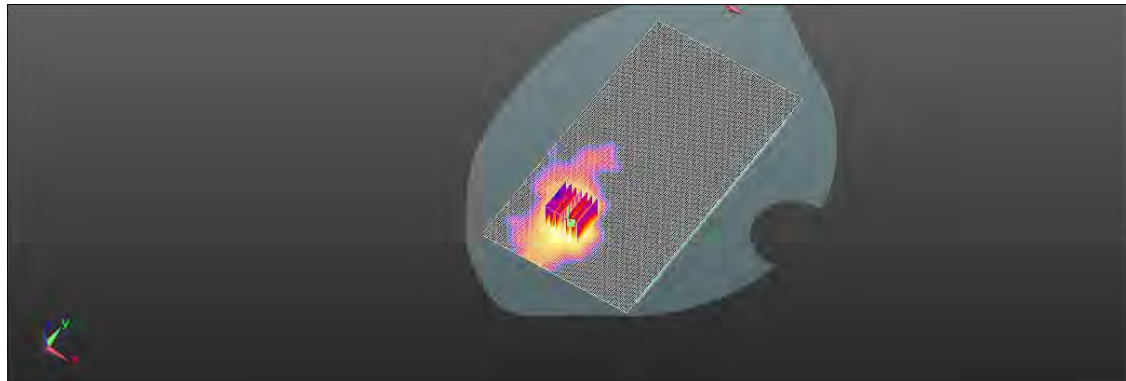
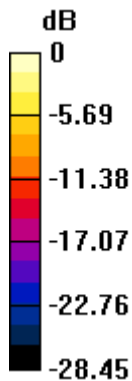

0 dB = 0.198 W/kg = -7.04 dBW/kg

Unless otherwise stated the results shown in this test report refer only to the sample(s) tested and such sample(s) are retained for 90 days only.

除非另有說明，此報告結果僅對測試之樣品負責，同時此樣品僅保留90天。本報告未經本公司書面許可，不可部份複製。

This document is issued by the Company subject to its General Conditions of Service printed overleaf, available on request or accessible at <http://www.sgs.com.tw/Terms-and-Conditions> and for electronic format documents, subject to Terms and Conditions for Electronic Documents at <http://www.sgs.com.tw/Terms-and-Conditions>. Attention is drawn to the limitation of liability, indemnification and jurisdiction issues defined therein. Any holder of this document is advised that information contained hereon reflects the Company's findings at the time of its intervention only and within the limits of Client's instructions, if any. The Company's sole responsibility is to its Client and this document does not exonerate parties to a transaction from exercising all their rights and obligations under the transaction documents. This document cannot be reproduced except in full, without prior written approval of the Company. Any unauthorized alteration, forgery or falsification of the content or appearance of this document is unlawful and offenders may be prosecuted to the fullest extent of the law.

Date: 2020/7/5

Report No. :ES/2020/30005

WLAN 802.11b_Hotspot_Back side_CH 11_Chain0_Ant4_10mm

Communication System: Wi-Fi; Frequency: 2462 MHz; Duty cycle= 1:1

Medium parameters used: $f = 2462 \text{ MHz}$; $\sigma = 1.783 \text{ S/m}$; $\epsilon_r = 38.884$; $\rho = 1000 \text{ kg/m}^3$

Phantom section: Flat Section

Ambient temperature: 22.3°C; Liquid temperature: 22.0°C

DASY5 Configuration:

- Probe: EX3DV4 - SN3770; ConvF(7.4, 7.4, 7.4) @ 2462 MHz; Calibrated: 2020/5/27
- Sensor-Surface: 2mm (Mechanical Surface Detection)
- Electronics: DAE4 Sn877; Calibrated: 2020/3/17
- Phantom: SAM
- DASY52 52.10.4(1527); SEMCAD X 14.6.14(7483)

Area Scan (101x171x1): Interpolated grid: dx=12 mm, dy=12 mm

Maximum value of SAR (interpolated) = 0.156 W/kg

Zoom Scan (7x7x7)/Cube 0: Measurement grid: dx=5mm, dy=5mm, dz=5mm

Reference Value = 3.778 V/m; Power Drift = -0.07 dB

Peak SAR (extrapolated) = 0.240 W/kg

SAR(1 g) = 0.151 W/kg; SAR(10 g) = 0.092 W/kg

Smallest distance from peaks to all points 3 dB below = 6.61 mm

Ratio of SAR at M2 to SAR at M1 = 52.3%

Maximum value of SAR (measured) = 0.181 W/kg

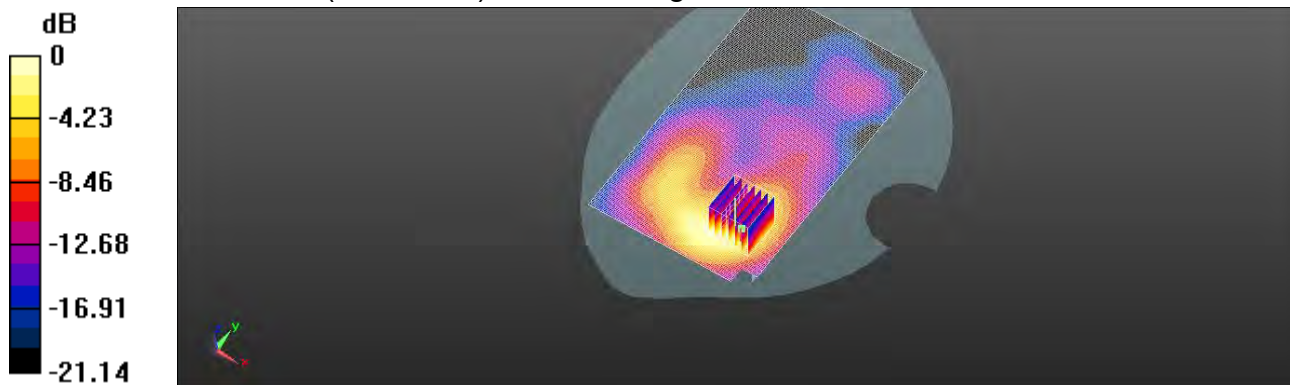

0 dB = 0.181 W/kg = -7.43 dBW/kg

Unless otherwise stated the results shown in this test report refer only to the sample(s) tested and such sample(s) are retained for 90 days only.

除非另有說明，此報告結果僅對測試之樣品負責，同時此樣品僅保留90天。本報告未經本公司書面許可，不可部份複製。

This document is issued by the Company subject to its General Conditions of Service printed overleaf, available on request or accessible at <http://www.sgs.com.tw/Terms-and-Conditions> and for electronic format documents, subject to Terms and Conditions for Electronic Documents at <http://www.sgs.com.tw/Terms-and-Conditions>. Attention is drawn to the limitation of liability, indemnification and jurisdiction issues defined therein. Any holder of this document is advised that information contained hereon reflects the Company's findings at the time of its intervention only and within the limits of Client's instructions, if any. The Company's sole responsibility is to its Client and this document does not exonerate parties to a transaction from exercising all their rights and obligations under the transaction documents. This document cannot be reproduced except in full, without prior written approval of the Company. Any unauthorized alteration, forgery or falsification of the content or appearance of this document is unlawful and offenders may be prosecuted to the fullest extent of the law.

Date: 2020/7/5

Report No. :ES/2020/30005

BLE_1M_Hotspot_Back side_CH 18_Chain0_Ant4_10mm

Communication System: Bluetooth; Frequency: 2442 MHz; Duty cycle= 1:1

Medium parameters used: $f = 2442$ MHz; $\sigma = 1.741$ S/m; $\epsilon_r = 38.897$; $\rho = 1000$ kg/m³

Phantom section: Flat Section

Ambient temperature: 22.3°C; Liquid temperature: 22.0°C

DASY5 Configuration:

- Probe: EX3DV4 - SN7509; ConvF(7.51, 7.51, 7.51) @ 2442 MHz; Calibrated: 2020/03/25
- Sensor-Surface: 2mm (Mechanical Surface Detection)
- Electronics: DAE4 Sn558; Calibrated: 2019/10/11
- Phantom: SAM
- DASY52 52.10.4(1527); SEMCAD X 14.6.14(7483)

Area Scan (91x171x1): Interpolated grid: dx=12 mm, dy=12 mm

Maximum value of SAR (interpolated) = 0.0512 W/kg

Zoom Scan (7x7x7)/Cube 0: Measurement grid: dx=5mm, dy=5mm, dz=5mm

Reference Value = 5.260 V/m; Power Drift = -0.11 dB

Peak SAR (extrapolated) = 0.0490 W/kg

SAR(1 g) = 0.038 W/kg; SAR(10 g) = 0.026 W/kg

Smallest distance from peaks to all points 3 dB below = 7 mm

Ratio of SAR at M2 to SAR at M1 = 71.3%

Maximum value of SAR (measured) = 0.0433 W/kg

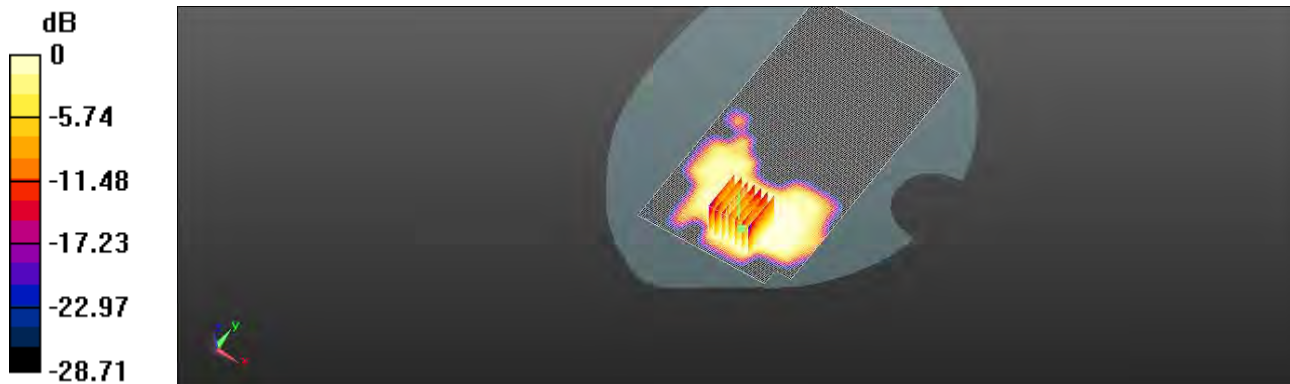

0 dB = 0.0433 W/kg = -13.64 dBW/kg

Unless otherwise stated the results shown in this test report refer only to the sample(s) tested and such sample(s) are retained for 90 days only.

除非另有說明，此報告結果僅對測試之樣品負責，同時此樣品僅保留90天。本報告未經本公司書面許可，不可部份複製。

This document is issued by the Company subject to its General Conditions of Service printed overleaf, available on request or accessible at <http://www.sgs.com.tw/Terms-and-Conditions> and for electronic format documents, subject to Terms and Conditions for Electronic Documents at <http://www.sgs.com.tw/Terms-and-Conditions>. Attention is drawn to the limitation of liability, indemnification and jurisdiction issues defined therein. Any holder of this document is advised that information contained hereon reflects the Company's findings at the time of its intervention only and within the limits of Client's instructions, if any. The Company's sole responsibility is to its Client and this document does not exonerate parties to a transaction from exercising all their rights and obligations under the transaction documents. This document cannot be reproduced except in full, without prior written approval of the Company. Any unauthorized alteration, forgery or falsification of the content or appearance of this document is unlawful and offenders may be prosecuted to the fullest extent of the law.

Date: 2020/7/10

Report No. : ES/2020/30005

WLAN 802.11n(40M) 5.2G_Hotspot_Back side_CH 46_Chain0_Ant4_10mm

Communication System: Wi-Fi; Frequency: 5230 MHz; Duty cycle= 1:1

Medium parameters used: $f = 5230 \text{ MHz}$; $\sigma = 4.734 \text{ S/m}$; $\epsilon_r = 35.583$; $\rho = 1000 \text{ kg/m}^3$

Phantom section: Flat Section

Ambient temperature: 22.1°C; Liquid temperature: 21.8°C

DASY5 Configuration:

- Probe: EX3DV4 - SN3770; ConvF(5.4, 5.4, 5.4) @ 5230 MHz; Calibrated: 2020/5/27
- Sensor-Surface: 2mm (Mechanical Surface Detection)
- Electronics: DAE4 Sn877; Calibrated: 2020/3/17
- Phantom: SAM
- DASY52 52.10.4(1527); SEMCAD X 14.6.14(7483)

Area Scan (121x211x1): Interpolated grid: dx=10 mm, dy=10 mm

Maximum value of SAR (interpolated) = 0.152 W/kg

Zoom Scan (7x7x12)/Cube 0: Measurement grid: dx=4mm, dy=4mm, dz=2mm

Reference Value = 2.065 V/m; Power Drift = 0.12 dB

Peak SAR (extrapolated) = 0.226 W/kg

SAR(1 g) = 0.102 W/kg; SAR(10 g) = 0.049 W/kg

Smallest distance from peaks to all points 3 dB below = 5.5 mm

Ratio of SAR at M2 to SAR at M1 = 60.3%

Maximum value of SAR (measured) = 0.132 W/kg

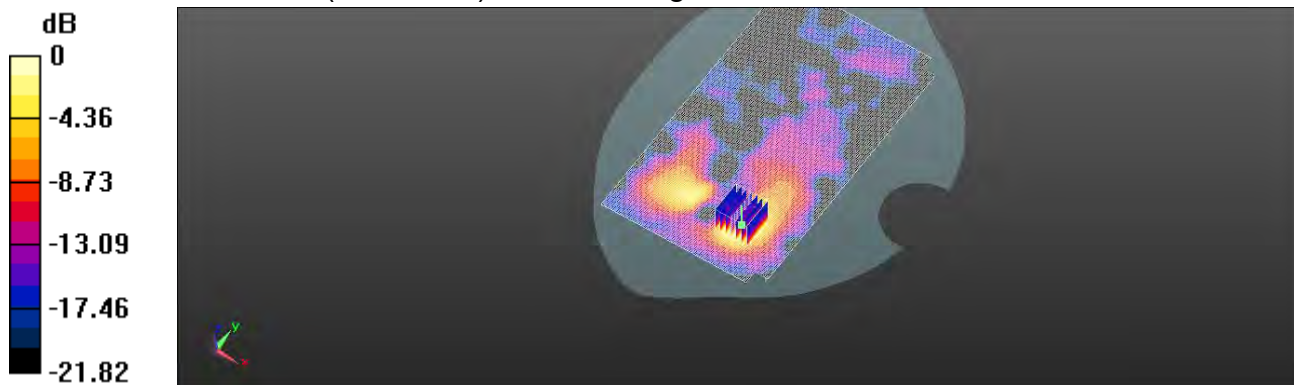

0 dB = 0.132 W/kg = -8.79 dBW/kg

Unless otherwise stated the results shown in this test report refer only to the sample(s) tested and such sample(s) are retained for 90 days only.

除非另有說明，此報告結果僅對測試之樣品負責，同時此樣品僅保留90天。本報告未經本公司書面許可，不可部份複製。

This document is issued by the Company subject to its General Conditions of Service printed overleaf, available on request or accessible at <http://www.sgs.com.tw/Terms-and-Conditions> and for electronic format documents, subject to Terms and Conditions for Electronic Documents at <http://www.sgs.com.tw/Terms-and-Conditions>. Attention is drawn to the limitation of liability, indemnification and jurisdiction issues defined therein. Any holder of this document is advised that information contained hereon reflects the Company's findings at the time of its intervention only and within the limits of Client's instructions, if any. The Company's sole responsibility is to its Client and this document does not exonerate parties to a transaction from exercising all their rights and obligations under the transaction documents. This document cannot be reproduced except in full, without prior written approval of the Company. Any unauthorized alteration, forgery or falsification of the content or appearance of this document is unlawful and offenders may be prosecuted to the fullest extent of the law.

Date: 2020/7/11

Report No. :ES/2020/30005

WLAN 802.11a 5.3G_Hotspot_Back side_CH 52_Chain0_Ant4_10mm

Communication System: Wi-Fi; Frequency: 5260 MHz; Duty cycle= 1:1

Medium parameters used: $f = 5260$ MHz; $\sigma = 4.787$ S/m; $\epsilon_r = 35.478$; $\rho = 1000$ kg/m³

Phantom section: Flat Section

Ambient temperature: 21.5°C; Liquid temperature: 22.1°C

DASY5 Configuration:

- Probe: EX3DV4 - SN3770; ConvF(5.4, 5.4, 5.4) @ 5260 MHz; Calibrated: 2020/5/27
- Sensor-Surface: 2mm (Mechanical Surface Detection)
- Electronics: DAE4 Sn877; Calibrated: 2020/3/17
- Phantom: SAM
- DASY52 52.10.4(1527); SEMCAD X 14.6.14(7483)

Area Scan (121x211x1): Interpolated grid: dx=10 mm, dy=10 mm

Maximum value of SAR (interpolated) = 0.137 W/kg

Zoom Scan (7x7x12)/Cube 0: Measurement grid: dx=4mm, dy=4mm, dz=2mm

Reference Value = 3.290 V/m; Power Drift = -0.15 dB

Peak SAR (extrapolated) = 0.212 W/kg

SAR(1 g) = 0.111 W/kg; SAR(10 g) = 0.060 W/kg

Smallest distance from peaks to all points 3 dB below = 5.2 mm

Ratio of SAR at M2 to SAR at M1 = 59.8%

Maximum value of SAR (measured) = 0.123 W/kg

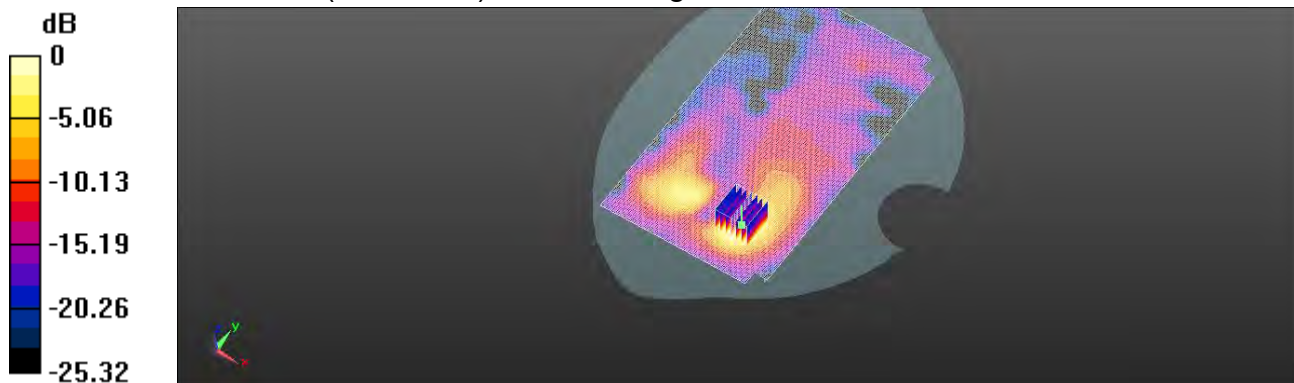

0 dB = 0.123 W/kg = -9.10 dBW/kg

Unless otherwise stated the results shown in this test report refer only to the sample(s) tested and such sample(s) are retained for 90 days only.

除非另有說明，此報告結果僅對測試之樣品負責，同時此樣品僅保留90天。本報告未經本公司書面許可，不可部份複製。

This document is issued by the Company subject to its General Conditions of Service printed overleaf, available on request or accessible at <http://www.sgs.com.tw/Terms-and-Conditions> and for electronic format documents, subject to Terms and Conditions for Electronic Documents at <http://www.sgs.com.tw/Terms-and-Conditions>. Attention is drawn to the limitation of liability, indemnification and jurisdiction issues defined therein. Any holder of this document is advised that information contained hereon reflects the Company's findings at the time of its intervention only and within the limits of Client's instructions, if any. The Company's sole responsibility is to its Client and this document does not exonerate parties to a transaction from exercising all their rights and obligations under the transaction documents. This document cannot be reproduced except in full, without prior written approval of the Company. Any unauthorized alteration, forgery or falsification of the content or appearance of this document is unlawful and offenders may be prosecuted to the fullest extent of the law.

Date: 2020/7/12

Report No. : ES/2020/30005

WLAN 802.11ac(80M) 5.6G_Hotspot_Back side_CH 138_Chain0_Ant4_10mm

Communication System: WLAN 5G; Frequency: 5690 MHz; Duty cycle= 1:1

Medium parameters used: $f = 5690$ MHz; $\sigma = 5.234$ S/m; $\epsilon_r = 34.835$; $\rho = 1000$ kg/m³

Phantom section: Flat Section

Ambient temperature: 21.9°C; Liquid temperature: 21.5°C

DASY5 Configuration:

- Probe: EX3DV4 - SN3770; ConvF(4.79, 4.79, 4.79) @ 5690 MHz; Calibrated: 2020/5/27
- Sensor-Surface: 2mm (Mechanical Surface Detection)
- Electronics: DAE4 Sn877; Calibrated: 2020/3/17
- Phantom: SAM
- DASY52 52.10.4(1527); SEMCAD X 14.6.14(7483)

Area Scan (121x211x1): Interpolated grid: dx=10 mm, dy=10 mm

Maximum value of SAR (interpolated) = 0.0872 W/kg

Zoom Scan (7x7x12)/Cube 0: Measurement grid: dx=4mm, dy=4mm, dz=2mm

Reference Value = 3.416 V/m; Power Drift = -0.02 dB

Peak SAR (extrapolated) = 0.151 W/kg

SAR(1 g) = 0.087 W/kg; SAR(10 g) = 0.053 W/kg

Smallest distance from peaks to all points 3 dB below = 7.14 mm

Ratio of SAR at M2 to SAR at M1 = 56.4%

Maximum value of SAR (measured) = 0.0802 W/kg

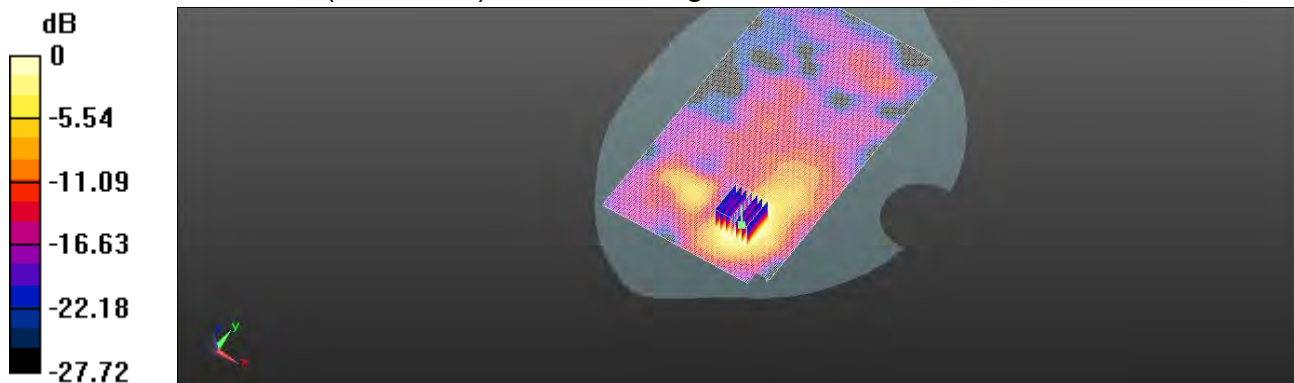

0 dB = 0.0802 W/kg = -10.96 dBW/kg

Unless otherwise stated the results shown in this test report refer only to the sample(s) tested and such sample(s) are retained for 90 days only.

除非另有說明，此報告結果僅對測試之樣品負責，同時此樣品僅保留90天。本報告未經本公司書面許可，不可部份複製。

This document is issued by the Company subject to its General Conditions of Service printed overleaf, available on request or accessible at <http://www.sgs.com.tw/Terms-and-Conditions> and for electronic format documents, subject to Terms and Conditions for Electronic Documents at <http://www.sgs.com.tw/Terms-and-Conditions>. Attention is drawn to the limitation of liability, indemnification and jurisdiction issues defined therein. Any holder of this document is advised that information contained hereon reflects the Company's findings at the time of its intervention only and within the limits of Client's instructions, if any. The Company's sole responsibility is to its Client and this document does not exonerate parties to a transaction from exercising all their rights and obligations under the transaction documents. This document cannot be reproduced except in full, without prior written approval of the Company. Any unauthorized alteration, forgery or falsification of the content or appearance of this document is unlawful and offenders may be prosecuted to the fullest extent of the law.

Date: 2020/7/13

Report No. :ES/2020/30005

WLAN 802.11ac(80M) 5.8G_Hotspot_Back side_CH 155_Chain0_Ant4_10mm

Communication System: Wi-Fi; Frequency: 5775 MHz; Duty cycle= 1:1

Medium parameters used: $f = 5775$ MHz; $\sigma = 5.308$ S/m; $\epsilon_r = 34.656$; $\rho = 1000$ kg/m³

Phantom section: Flat Section

Ambient temperature: 21.4°C; Liquid temperature: 21.7°C

DASY5 Configuration:

- Probe: EX3DV4 - SN3770; ConvF(4.9, 4.9, 4.9) @ 5775 MHz; Calibrated: 2020/5/27
- Sensor-Surface: 2mm (Mechanical Surface Detection)
- Electronics: DAE4 Sn877; Calibrated: 2020/3/17
- Phantom: SAM
- DASY52 52.10.4(1527); SEMCAD X 14.6.14(7483)

Area Scan (111x201x1): Interpolated grid: dx=10 mm, dy=10 mm

Maximum value of SAR (interpolated) = 0.0840 W/kg

Zoom Scan (7x7x12)/Cube 0: Measurement grid: dx=4mm, dy=4mm, dz=2mm

Reference Value = 1.698 V/m; Power Drift = -0.04 dB

Peak SAR (extrapolated) = 0.147 W/kg

SAR(1 g) = 0.077 W/kg; SAR(10 g) = 0.043 W/kg

Smallest distance from peaks to all points 3 dB below = 5.1 mm

Ratio of SAR at M2 to SAR at M1 = 55.1%

Maximum value of SAR (measured) = 0.0779 W/kg

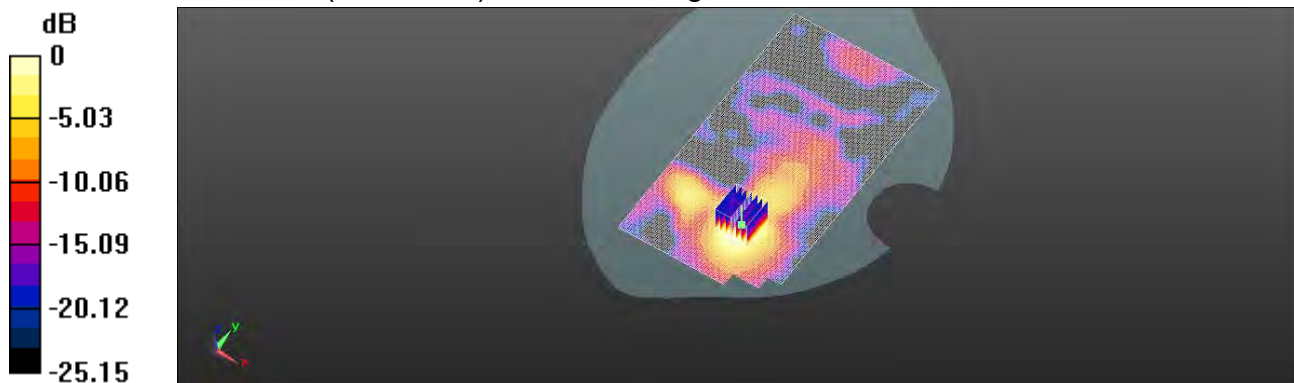

0 dB = 0.0779 W/kg = -11.09 dBW/kg

Unless otherwise stated the results shown in this test report refer only to the sample(s) tested and such sample(s) are retained for 90 days only.

除非另有說明，此報告結果僅對測試之樣品負責，同時此樣品僅保留90天。本報告未經本公司書面許可，不可部份複製。

This document is issued by the Company subject to its General Conditions of Service printed overleaf, available on request or accessible at <http://www.sgs.com.tw/Terms-and-Conditions> and for electronic format documents, subject to Terms and Conditions for Electronic Documents at <http://www.sgs.com.tw/Terms-and-Conditions>. Attention is drawn to the limitation of liability, indemnification and jurisdiction issues defined therein. Any holder of this document is advised that information contained hereon reflects the Company's findings at the time of its intervention only and within the limits of Client's instructions, if any. The Company's sole responsibility is to its Client and this document does not exonerate parties to a transaction from exercising all their rights and obligations under the transaction documents. This document cannot be reproduced except in full, without prior written approval of the Company. Any unauthorized alteration, forgery or falsification of the content or appearance of this document is unlawful and offenders may be prosecuted to the fullest extent of the law.

Date: 2020/7/5

Report No. :ES/2020/30005

WLAN 802.11b_Hotspot_Back side_CH 11_Chain1_Ant6_10mm

Communication System: Wi-Fi; Frequency: 2462 MHz; Duty cycle= 1:1

Medium parameters used: $f = 2462 \text{ MHz}$; $\sigma = 1.783 \text{ S/m}$; $\epsilon_r = 38.884$; $\rho = 1000 \text{ kg/m}^3$

Phantom section: Flat Section

Ambient temperature: 22.3°C; Liquid temperature: 22.0°C

DASY5 Configuration:

- Probe: EX3DV4 - SN3770; ConvF(7.4, 7.4, 7.4) @ 2462 MHz; Calibrated: 2020/5/27
- Sensor-Surface: 2mm (Mechanical Surface Detection)
- Electronics: DAE4 Sn877; Calibrated: 2020/3/17
- Phantom: SAM
- DASY52 52.10.4(1527); SEMCAD X 14.6.14(7483)

Area Scan (91x171x1): Interpolated grid: dx=12 mm, dy=12 mm

Maximum value of SAR (interpolated) = 0.0738 W/kg

Zoom Scan (7x7x7)/Cube 0: Measurement grid: dx=5mm, dy=5mm, dz=5mm

Reference Value = 3.555 V/m; Power Drift = -0.07 dB

Peak SAR (extrapolated) = 0.100 W/kg

SAR(1 g) = 0.060 W/kg; SAR(10 g) = 0.036 W/kg

Smallest distance from peaks to all points 3 dB below = 6.21 mm

Ratio of SAR at M2 to SAR at M1 = 51.3%

Maximum value of SAR (measured) = 0.0743 W/kg

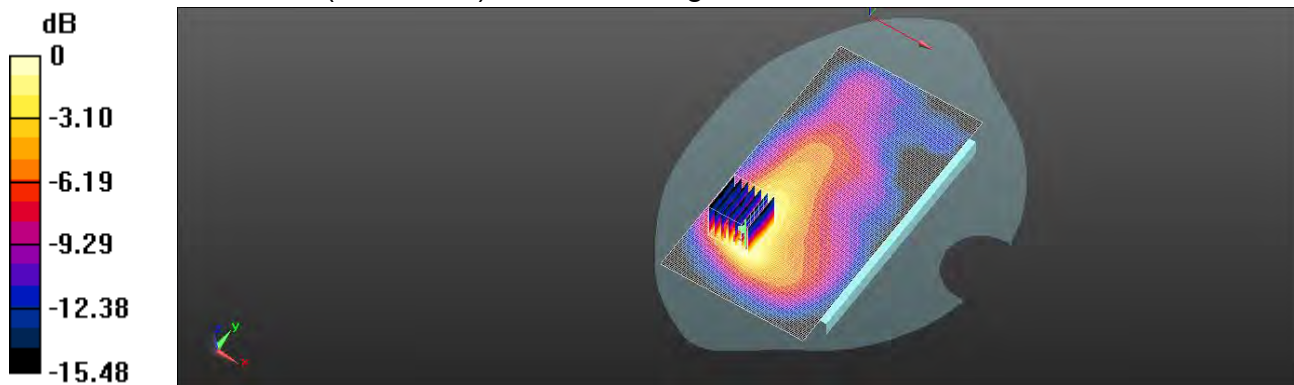

0 dB = 0.0743 W/kg = -11.29 dBW/kg

Unless otherwise stated the results shown in this test report refer only to the sample(s) tested and such sample(s) are retained for 90 days only.

除非另有說明，此報告結果僅對測試之樣品負責，同時此樣品僅保留90天。本報告未經本公司書面許可，不可部份複製。

This document is issued by the Company subject to its General Conditions of Service printed overleaf, available on request or accessible at <http://www.sgs.com.tw/Terms-and-Conditions> and for electronic format documents, subject to Terms and Conditions for Electronic Documents at <http://www.sgs.com.tw/Terms-and-Conditions>. Attention is drawn to the limitation of liability, indemnification and jurisdiction issues defined therein. Any holder of this document is advised that information contained hereon reflects the Company's findings at the time of its intervention only and within the limits of Client's instructions, if any. The Company's sole responsibility is to its Client and this document does not exonerate parties to a transaction from exercising all their rights and obligations under the transaction documents. This document cannot be reproduced except in full, without prior written approval of the Company. Any unauthorized alteration, forgery or falsification of the content or appearance of this document is unlawful and offenders may be prosecuted to the fullest extent of the law.

Date: 2020/7/5

Report No. :ES/2020/30005

BLE_1M_Hotspot_Back side_CH 18_Chain1_Ant6_10mm

Communication System: Bluetooth; Frequency: 2442 MHz; Duty cycle= 1:1

Medium parameters used: $f = 2442$ MHz; $\sigma = 1.741$ S/m; $\epsilon_r = 38.897$; $\rho = 1000$ kg/m³

Phantom section: Flat Section

Ambient temperature: 22.3°C; Liquid temperature: 22.0°C

DASY5 Configuration:

- Probe: EX3DV4 - SN7509; ConvF(7.51, 7.51, 7.51) @ 2442 MHz; Calibrated: 2020/03/25
- Sensor-Surface: 2mm (Mechanical Surface Detection)
- Electronics: DAE4 Sn558; Calibrated: 2019/10/11
- Phantom: SAM
- DASY52 52.10.4(1527); SEMCAD X 14.6.14(7483)

Area Scan (91x171x1): Interpolated grid: dx=12 mm, dy=12 mm

Maximum value of SAR (interpolated) = 0.0202 W/kg

Zoom Scan (7x7x7)/Cube 0: Measurement grid: dx=5mm, dy=5mm, dz=5mm

Reference Value = 6.834 V/m; Power Drift = -0.14 dB

Peak SAR (extrapolated) = 0.0250 W/kg

SAR(1 g) = 0.016 W/kg; SAR(10 g) = 0.010 W/kg

Smallest distance from peaks to all points 3 dB below = 5.65 mm

Ratio of SAR at M2 to SAR at M1 = 53%

Maximum value of SAR (measured) = 0.0195 W/kg

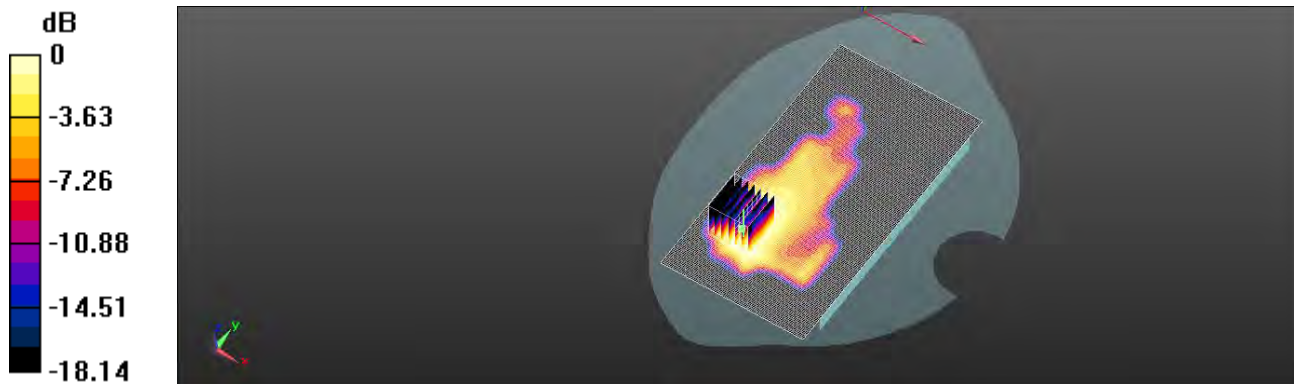

0 dB = 0.0195 W/kg = -17.10 dBW/kg

Unless otherwise stated the results shown in this test report refer only to the sample(s) tested and such sample(s) are retained for 90 days only.

除非另有說明，此報告結果僅對測試之樣品負責，同時此樣品僅保留90天。本報告未經本公司書面許可，不可部份複製。

This document is issued by the Company subject to its General Conditions of Service printed overleaf, available on request or accessible at <http://www.sgs.com.tw/Terms-and-Conditions> and for electronic format documents, subject to Terms and Conditions for Electronic Documents at <http://www.sgs.com.tw/Terms-and-Conditions>. Attention is drawn to the limitation of liability, indemnification and jurisdiction issues defined therein. Any holder of this document is advised that information contained hereon reflects the Company's findings at the time of its intervention only and within the limits of Client's instructions, if any. The Company's sole responsibility is to its Client and this document does not exonerate parties to a transaction from exercising all their rights and obligations under the transaction documents. This document cannot be reproduced except in full, without prior written approval of the Company. Any unauthorized alteration, forgery or falsification of the content or appearance of this document is unlawful and offenders may be prosecuted to the fullest extent of the law.

Date: 2020/7/10

Report No. : ES/2020/30005

WLAN 802.11n(40M) 5.2G_Hotspot_Back side_CH 46_Chain1_Ant6_10mm

Communication System: Wi-Fi; Frequency: 5230 MHz; Duty cycle= 1:1

Medium parameters used: $f = 5230 \text{ MHz}$; $\sigma = 4.734 \text{ S/m}$; $\epsilon_r = 35.583$; $\rho = 1000 \text{ kg/m}^3$

Phantom section: Flat Section

Ambient temperature: 22.1°C; Liquid temperature: 21.8°C

DASY5 Configuration:

- Probe: EX3DV4 - SN3770; ConvF(5.4, 5.4, 5.4) @ 5230 MHz; Calibrated: 2020/5/27
- Sensor-Surface: 2mm (Mechanical Surface Detection)
- Electronics: DAE4 Sn877; Calibrated: 2020/3/17
- Phantom: SAM
- DASY52 52.10.4(1527); SEMCAD X 14.6.14(7483)

Area Scan (111x201x1): Interpolated grid: dx=10 mm, dy=10 mm

Maximum value of SAR (interpolated) = 0.532 W/kg

Zoom Scan (7x7x12)/Cube 0: Measurement grid: dx=4mm, dy=4mm, dz=2mm

Reference Value = 1.016 V/m; Power Drift = 0.15 dB

Peak SAR (extrapolated) = 0.964 W/kg

SAR(1 g) = 0.352 W/kg; SAR(10 g) = 0.132 W/kg

Smallest distance from peaks to all points 3 dB below = 7.2 mm

Ratio of SAR at M2 to SAR at M1 = 58.2%

Maximum value of SAR (measured) = 0.540 W/kg

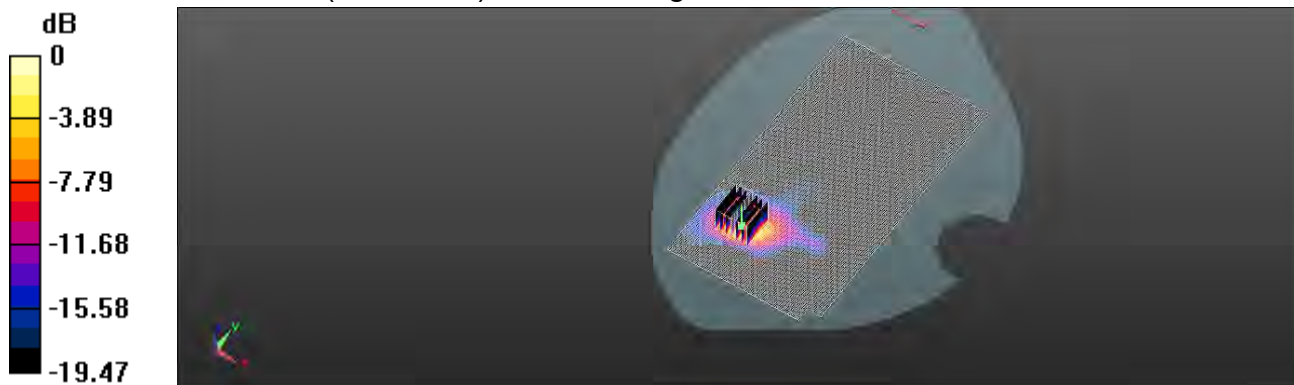

0 dB = 0.540 W/kg = -2.68 dBW/kg

Unless otherwise stated the results shown in this test report refer only to the sample(s) tested and such sample(s) are retained for 90 days only.

除非另有說明，此報告結果僅對測試之樣品負責，同時此樣品僅保留90天。本報告未經本公司書面許可，不可部份複製。

This document is issued by the Company subject to its General Conditions of Service printed overleaf, available on request or accessible at <http://www.sgs.com.tw/Terms-and-Conditions> and for electronic format documents, subject to Terms and Conditions for Electronic Documents at <http://www.sgs.com.tw/Terms-and-Conditions>. Attention is drawn to the limitation of liability, indemnification and jurisdiction issues defined therein. Any holder of this document is advised that information contained hereon reflects the Company's findings at the time of its intervention only and within the limits of Client's instructions, if any. The Company's sole responsibility is to its Client and this document does not exonerate parties to a transaction from exercising all their rights and obligations under the transaction documents. This document cannot be reproduced except in full, without prior written approval of the Company. Any unauthorized alteration, forgery or falsification of the content or appearance of this document is unlawful and offenders may be prosecuted to the fullest extent of the law.

Date: 2020/7/11

Report No. :ES/2020/30005

WLAN 802.11n(20M) 5.3G_Hotspot_Back side_CH 60_Chain1_Ant6_10mm

Communication System: Wi-Fi; Frequency: 5300 MHz; Duty cycle= 1:1

Medium parameters used: $f = 5300 \text{ MHz}$; $\sigma = 4.835 \text{ S/m}$; $\epsilon_r = 35.425$; $\rho = 1000 \text{ kg/m}^3$

Phantom section: Flat Section

Ambient temperature: 21.5°C; Liquid temperature: 22.1°C

DASY5 Configuration:

- Probe: EX3DV4 - SN3770; ConvF(5.4, 5.4, 5.4) @ 5300 MHz; Calibrated: 2020/5/27
- Sensor-Surface: 2mm (Mechanical Surface Detection)
- Electronics: DAE4 Sn877; Calibrated: 2020/3/17
- Phantom: SAM
- DASY52 52.10.4(1527); SEMCAD X 14.6.14(7483)

Zoom Scan (7x7x12)/Cube 0: Measurement grid: dx=4mm, dy=4mm, dz=2mm

Reference Value = 5.029 V/m; Power Drift = 0.13 dB

Peak SAR (extrapolated) = 1.08 W/kg

SAR(1 g) = 0.462 W/kg; SAR(10 g) = 0.199 W/kg

Smallest distance from peaks to all points 3 dB below = 5.2 mm

Ratio of SAR at M2 to SAR at M1 = 57.8%

Maximum value of SAR (measured) = 0.592 W/kg

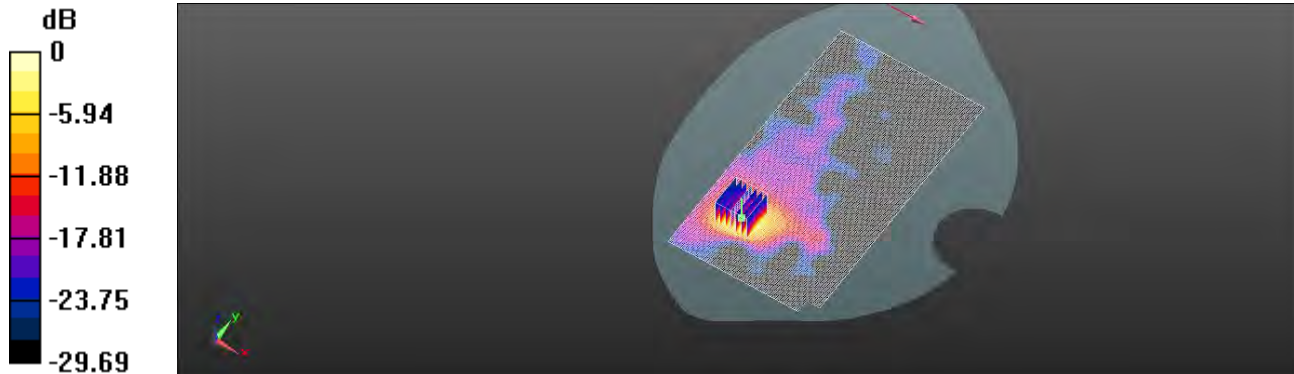

0 dB = 0.592 W/kg = -2.28 dBW/kg

Unless otherwise stated the results shown in this test report refer only to the sample(s) tested and such sample(s) are retained for 90 days only.

除非另有說明，此報告結果僅對測試之樣品負責，同時此樣品僅保留90天。本報告未經本公司書面許可，不可部份複製。

This document is issued by the Company subject to its General Conditions of Service printed overleaf, available on request or accessible at <http://www.sgs.com.tw/Terms-and-Conditions> and for electronic format documents, subject to Terms and Conditions for Electronic Documents at <http://www.sgs.com.tw/Terms-and-Conditions>. Attention is drawn to the limitation of liability, indemnification and jurisdiction issues defined therein. Any holder of this document is advised that information contained hereon reflects the Company's findings at the time of its intervention only and within the limits of Client's instructions, if any. The Company's sole responsibility is to its Client and this document does not exonerate parties to a transaction from exercising all their rights and obligations under the transaction documents. This document cannot be reproduced except in full, without prior written approval of the Company. Any unauthorized alteration, forgery or falsification of the content or appearance of this document is unlawful and offenders may be prosecuted to the fullest extent of the law.

Date: 2020/7/12

Report No. : ES/2020/30005

WLAN 802.11a 5.6G_Hotspot_Back side_CH 100_Chain1_Ant6_10mm

Communication System: Wi-Fi; Frequency: 5500 MHz; Duty cycle= 1:1

Medium parameters used: $f = 5500 \text{ MHz}$; $\sigma = 5.027 \text{ S/m}$; $\epsilon_r = 35.407$; $\rho = 1000 \text{ kg/m}^3$

Phantom section: Flat Section

Ambient temperature: 21.9°C; Liquid temperature: 21.5°C

DASY5 Configuration:

- Probe: EX3DV4 - SN3770; ConvF(4.79, 4.79, 4.79) @ 5500 MHz; Calibrated: 2020/5/27
- Sensor-Surface: 2mm (Mechanical Surface Detection)
- Electronics: DAE4 Sn877; Calibrated: 2020/3/17
- Phantom: SAM
- DASY52 52.10.4(1527); SEMCAD X 14.6.14(7483)

Area Scan (111x201x1): Interpolated grid: dx=10 mm, dy=10 mm

Maximum value of SAR (interpolated) = 0.439 W/kg

Zoom Scan (7x7x12)/Cube 0: Measurement grid: dx=4mm, dy=4mm, dz=2mm

Reference Value = 1.616 V/m; Power Drift = -0.14 dB

Peak SAR (extrapolated) = 0.819 W/kg

SAR(1 g) = 0.308 W/kg; SAR(10 g) = 0.123 W/kg

Smallest distance from peaks to all points 3 dB below = 6.3 mm

Ratio of SAR at M2 to SAR at M1 = 55.1%

Maximum value of SAR (measured) = 0.432 W/kg

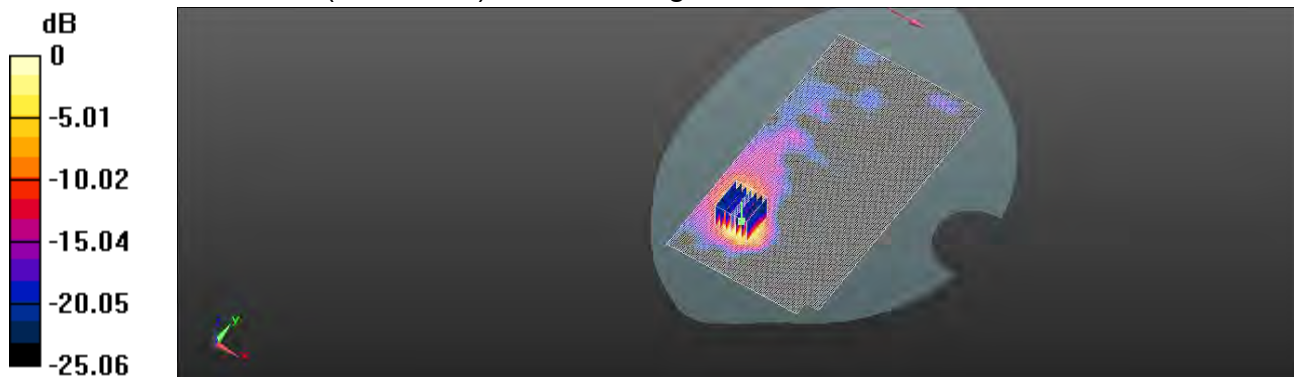

0 dB = 0.432 W/kg = -3.65 dBW/kg

Unless otherwise stated the results shown in this test report refer only to the sample(s) tested and such sample(s) are retained for 90 days only.

除非另有說明，此報告結果僅對測試之樣品負責，同時此樣品僅保留90天。本報告未經本公司書面許可，不可部份複製。

This document is issued by the Company subject to its General Conditions of Service printed overleaf, available on request or accessible at <http://www.sgs.com.tw/Terms-and-Conditions> and for electronic format documents, subject to Terms and Conditions for Electronic Documents at <http://www.sgs.com.tw/Terms-and-Conditions>. Attention is drawn to the limitation of liability, indemnification and jurisdiction issues defined therein. Any holder of this document is advised that information contained hereon reflects the Company's findings at the time of its intervention only and within the limits of Client's instructions, if any. The Company's sole responsibility is to its Client and this document does not exonerate parties to a transaction from exercising all their rights and obligations under the transaction documents. This document cannot be reproduced except in full, without prior written approval of the Company. Any unauthorized alteration, forgery or falsification of the content or appearance of this document is unlawful and offenders may be prosecuted to the fullest extent of the law.

Date: 2020/7/13

Report No. : ES/2020/30005

WLAN 802.11ac(80M) 5.8G_Hotspot_Back side_CH 155_Chain1_Ant6_10mm

Communication System: Wi-Fi; Frequency: 5775 MHz; Duty cycle= 1:1

Medium parameters used: $f = 5775 \text{ MHz}$; $\sigma = 5.308 \text{ S/m}$; $\epsilon_r = 34.656$; $\rho = 1000 \text{ kg/m}^3$

Phantom section: Flat Section

Ambient temperature: 21.4°C; Liquid temperature: 21.7°C

DASY5 Configuration:

- Probe: EX3DV4 - SN3770; ConvF(4.9, 4.9, 4.9) @ 5775 MHz; Calibrated: 2020/5/27
- Sensor-Surface: 2mm (Mechanical Surface Detection)
- Electronics: DAE4 Sn877; Calibrated: 2020/3/17
- Phantom: SAM
- DASY52 52.10.4(1527); SEMCAD X 14.6.14(7483)

Area Scan (111x201x1): Interpolated grid: dx=10 mm, dy=10 mm

Maximum value of SAR (interpolated) = 0.572 W/kg

Zoom Scan (7x7x12)/Cube 0: Measurement grid: dx=4mm, dy=4mm, dz=2mm

Reference Value = 1.156 V/m; Power Drift = 0.11 dB

Peak SAR (extrapolated) = 1.11 W/kg

SAR(1 g) = 0.400 W/kg; SAR(10 g) = 0.153 W/kg

Smallest distance from peaks to all points 3 dB below = 7.3 mm

Ratio of SAR at M2 to SAR at M1 = 55.9%

Maximum value of SAR (measured) = 0.551 W/kg

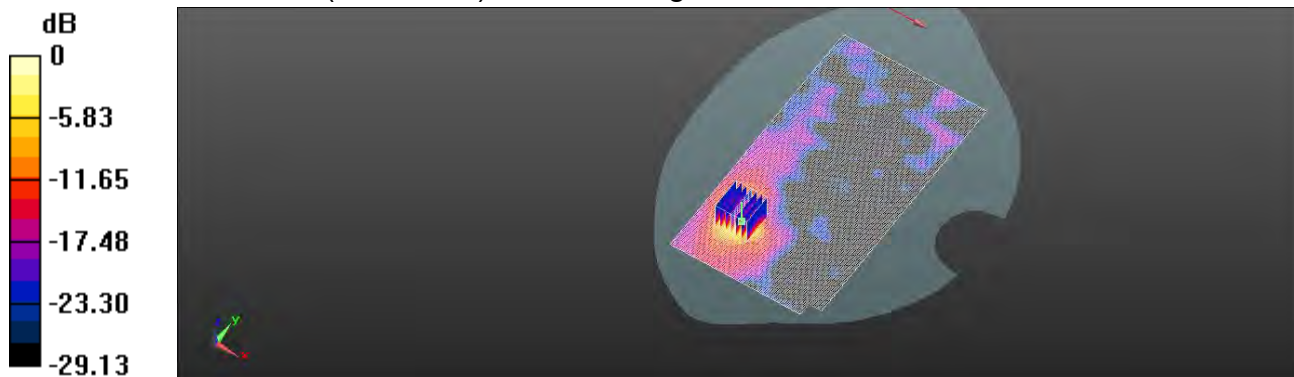

0 dB = 0.551 W/kg = -2.59 dBW/kg

Unless otherwise stated the results shown in this test report refer only to the sample(s) tested and such sample(s) are retained for 90 days only.

除非另有說明，此報告結果僅對測試之樣品負責，同時此樣品僅保留90天。本報告未經本公司書面許可，不可部份複製。

This document is issued by the Company subject to its General Conditions of Service printed overleaf, available on request or accessible at <http://www.sgs.com.tw/Terms-and-Conditions> and for electronic format documents, subject to Terms and Conditions for Electronic Documents at <http://www.sgs.com.tw/Terms-and-Conditions>. Attention is drawn to the limitation of liability, indemnification and jurisdiction issues defined therein. Any holder of this document is advised that information contained hereon reflects the Company's findings at the time of its intervention only and within the limits of Client's instructions, if any. The Company's sole responsibility is to its Client and this document does not exonerate parties to a transaction from exercising all their rights and obligations under the transaction documents. This document cannot be reproduced except in full, without prior written approval of the Company. Any unauthorized alteration, forgery or falsification of the content or appearance of this document is unlawful and offenders may be prosecuted to the fullest extent of the law.

Date: 2020/7/05

Report No. :ES/2020/30005

WLAN 802.11b_Body worn_Back side_CH 1_Chain0_Ant6_15mm

Communication System: Wi-Fi; Frequency: 2412 MHz; Duty cycle= 1:1

Medium parameters used: $f = 2412 \text{ MHz}$; $\sigma = 1.706 \text{ S/m}$; $\epsilon_r = 38.952$; $\rho = 1000 \text{ kg/m}^3$

Phantom section: Flat Section

Ambient temperature: 21.7°C; Liquid temperature: 22.1°C

DASY5 Configuration:

- Probe: EX3DV4 - SN7509; ConvF(7.51, 7.51, 7.51) @ 2412 MHz; Calibrated: 2020/03/25
- Sensor-Surface: 2mm (Mechanical Surface Detection)
- Electronics: DAE4 Sn558; Calibrated: 2019/10/11
- Phantom: SAM
- DASY52 52.10.4(1527); SEMCAD X 14.6.14(7483)

Area Scan (101x171x1): Interpolated grid: $dx=12 \text{ mm}$, $dy=12 \text{ mm}$

Maximum value of SAR (interpolated) = 0.0367 W/kg

Zoom Scan (7x7x7)/Cube 0: Measurement grid: $dx=5\text{mm}$, $dy=5\text{mm}$, $dz=5\text{mm}$

Reference Value = 3.769 V/m; Power Drift = 0.12 dB

Peak SAR (extrapolated) = 0.0430 W/kg

SAR(1 g) = 0.030 W/kg; SAR(10 g) = 0.021 W/kg

Smallest distance from peaks to all points 3 dB below: Larger than measurement grid

Ratio of SAR at M2 to SAR at M1 = 60.5%

Maximum value of SAR (measured) = 0.0349 W/kg

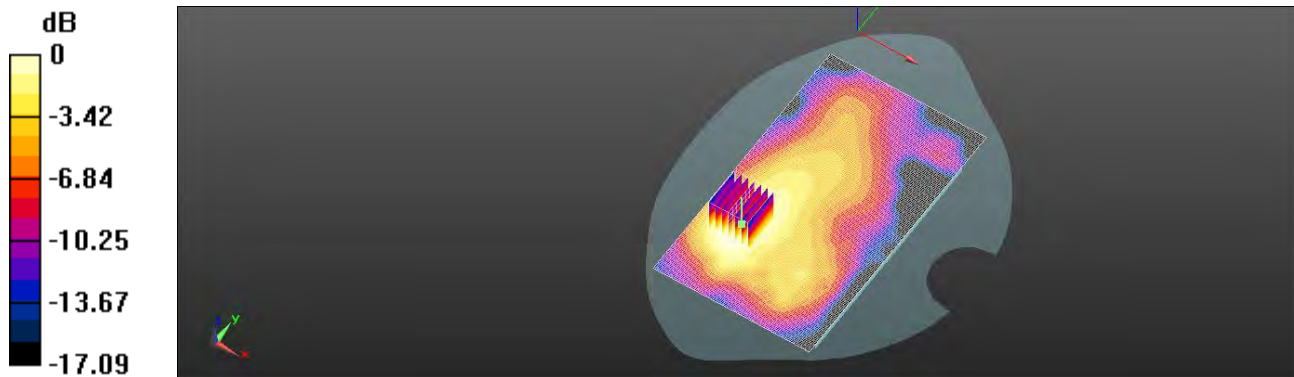

0 dB = 0.0349 W/kg = -14.57 dBW/kg

Unless otherwise stated the results shown in this test report refer only to the sample(s) tested and such sample(s) are retained for 90 days only.

除非另有說明，此報告結果僅對測試之樣品負責，同時此樣品僅保留90天。本報告未經本公司書面許可，不可部份複製。

This document is issued by the Company subject to its General Conditions of Service printed overleaf, available on request or accessible at <http://www.sgs.com.tw/Terms-and-Conditions> and for electronic format documents, subject to Terms and Conditions for Electronic Documents at <http://www.sgs.com.tw/Terms-and-Conditions>. Attention is drawn to the limitation of liability, indemnification and jurisdiction issues defined therein. Any holder of this document is advised that information contained hereon reflects the Company's findings at the time of its intervention only and within the limits of Client's instructions, if any. The Company's sole responsibility is to its Client and this document does not exonerate parties to a transaction from exercising all their rights and obligations under the transaction documents. This document cannot be reproduced except in full, without prior written approval of the Company. Any unauthorized alteration, forgery or falsification of the content or appearance of this document is unlawful and offenders may be prosecuted to the fullest extent of the law.

Date: 2020/7/10

Report No. :ES/2020/30005

WLAN 802.11n(40M) 5.2G_Body worn_Back side_CH 46_Chain0_Ant6_15mm

Communication System: Wi-Fi; Frequency: 5230 MHz; Duty cycle= 1:1

Medium parameters used: $f = 5230 \text{ MHz}$; $\sigma = 4.734 \text{ S/m}$; $\epsilon_r = 35.583$; $\rho = 1000 \text{ kg/m}^3$

Phantom section: Flat Section

Ambient temperature: 21.4°C; Liquid temperature: 21.8°C

DASY5 Configuration:

- Probe: EX3DV4 - SN7509; ConvF(5.33, 5.33, 5.33) @ 5230 MHz; Calibrated: 2020/03/25
- Sensor-Surface: 2mm (Mechanical Surface Detection)
- Electronics: DAE4 Sn558; Calibrated: 2019/10/11
- Phantom: SAM
- DASY52 52.10.4(1527); SEMCAD X 14.6.14(7483)

Area Scan (111x211x1): Interpolated grid: dx=10 mm, dy=10 mm

Maximum value of SAR (interpolated) = 0.248 W/kg

Zoom Scan (7x7x12)/Cube 0: Measurement grid: dx=4mm, dy=4mm, dz=2mm

Reference Value = 1.146 V/m; Power Drift = 0.09 dB

Peak SAR (extrapolated) = 0.348 W/kg

SAR(1 g) = 0.179 W/kg; SAR(10 g) = 0.083 W/kg

Smallest distance from peaks to all points 3 dB below = 9.3 mm

Ratio of SAR at M2 to SAR at M1 = 61.2%

Maximum value of SAR (measured) = 0.254 W/kg

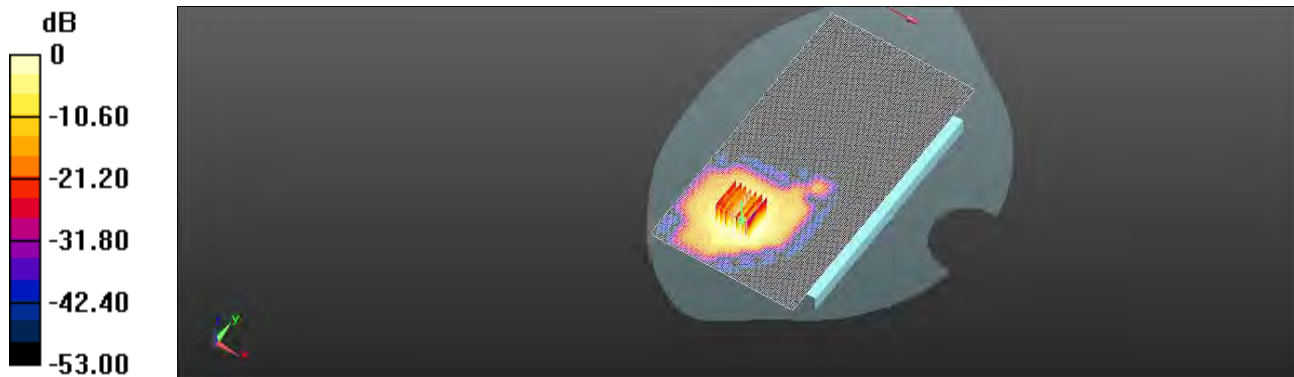

0 dB = 0.254 W/kg = -5.95 dBW/kg

Unless otherwise stated the results shown in this test report refer only to the sample(s) tested and such sample(s) are retained for 90 days only.

除非另有說明，此報告結果僅對測試之樣品負責，同時此樣品僅保留90天。本報告未經本公司書面許可，不可部份複製。

This document is issued by the Company subject to its General Conditions of Service printed overleaf, available on request or accessible at <http://www.sgs.com.tw/Terms-and-Conditions> and for electronic format documents, subject to Terms and Conditions for Electronic Documents at <http://www.sgs.com.tw/Terms-and-Conditions>. Attention is drawn to the limitation of liability, indemnification and jurisdiction issues defined therein. Any holder of this document is advised that information contained hereon reflects the Company's findings at the time of its intervention only and within the limits of Client's instructions, if any. The Company's sole responsibility is to its Client and this document does not exonerate parties to a transaction from exercising all their rights and obligations under the transaction documents. This document cannot be reproduced except in full, without prior written approval of the Company. Any unauthorized alteration, forgery or falsification of the content or appearance of this document is unlawful and offenders may be prosecuted to the fullest extent of the law.

Date: 2020/7/11

Report No. : ES/2020/30005

WLAN 802.11a 5.3G_Body worn_Back side_CH 52_Chain0_Ant6_15mm

Communication System: WLAN 5G; Frequency: 5260 MHz; Duty cycle= 1:1

Medium parameters used: $f = 5260$ MHz; $\sigma = 4.787$ S/m; $\epsilon_r = 35.478$; $\rho = 1000$ kg/m³

Phantom section: Flat Section

Ambient temperature: 22.0°C; Liquid temperature: 21.6°C

DASY5 Configuration:

- Probe: EX3DV4 - SN7509; ConvF(5.23, 5.23, 5.23) @ 5260 MHz; Calibrated: 2020/03/25
- Sensor-Surface: 2mm (Mechanical Surface Detection)
- Electronics: DAE4 Sn558; Calibrated: 2019/10/11
- Phantom: SAM
- DASY52 52.10.4(1527); SEMCAD X 14.6.14(7483)

Area Scan (111x211x1): Interpolated grid: dx=10 mm, dy=10 mm

Maximum value of SAR (interpolated) = 0.460 W/kg

Zoom Scan (7x7x12)/Cube 0: Measurement grid: dx=4mm, dy=4mm, dz=2mm

Reference Value = 1.791 V/m; Power Drift = 0.13 dB

Peak SAR (extrapolated) = 0.637 W/kg

SAR(1 g) = 0.352 W/kg; SAR(10 g) = 0.178 W/kg

Smallest distance from peaks to all points 3 dB below = 10.6 mm

Ratio of SAR at M2 to SAR at M1 = 63.5%

Maximum value of SAR (measured) = 0.460 W/kg

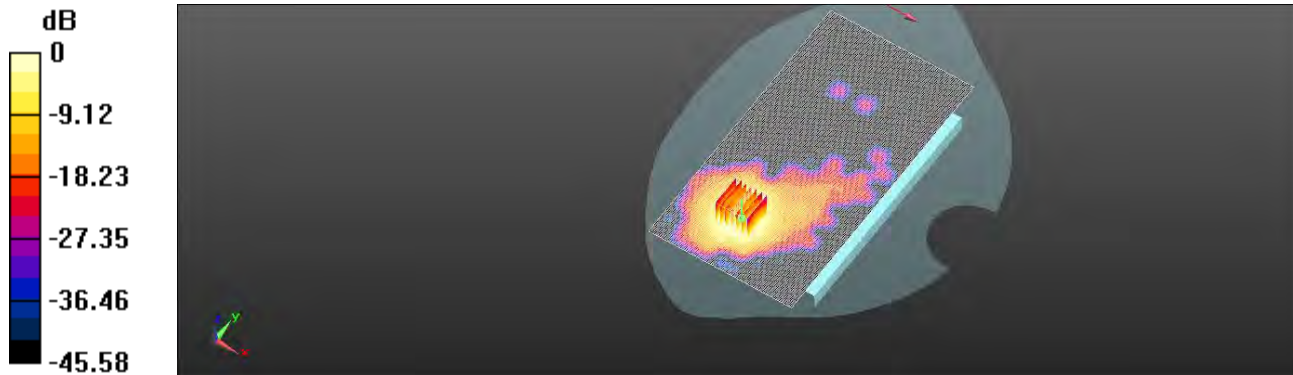

0 dB = 0.460 W/kg = -3.37 dBW/kg

Unless otherwise stated the results shown in this test report refer only to the sample(s) tested and such sample(s) are retained for 90 days only.

除非另有說明，此報告結果僅對測試之樣品負責，同時此樣品僅保留90天。本報告未經本公司書面許可，不可部份複製。

This document is issued by the Company subject to its General Conditions of Service printed overleaf, available on request or accessible at <http://www.sgs.com.tw/Terms-and-Conditions> and for electronic format documents, subject to Terms and Conditions for Electronic Documents at <http://www.sgs.com.tw/Terms-and-Conditions>. Attention is drawn to the limitation of liability, indemnification and jurisdiction issues defined therein. Any holder of this document is advised that information contained hereon reflects the Company's findings at the time of its intervention only and within the limits of Client's instructions, if any. The Company's sole responsibility is to its Client and this document does not exonerate parties to a transaction from exercising all their rights and obligations under the transaction documents. This document cannot be reproduced except in full, without prior written approval of the Company. Any unauthorized alteration, forgery or falsification of the content or appearance of this document is unlawful and offenders may be prosecuted to the fullest extent of the law.

Date: 2020/7/12

Report No. :ES/2020/30005

**WLAN 802.11ac(80M) 5.6G_Body worn_Back side_CH
138_Chain0_Ant6_15mm**

Communication System: WLAN 5G; Frequency: 5690 MHz; Duty cycle= 1:1
Medium parameters used: $f = 5690$ MHz; $\sigma = 5.234$ S/m; $\epsilon_r = 34.835$; $\rho = 1000$ kg/m³
Phantom section: Flat Section
Ambient temperature: 21.6°C; Liquid temperature: 22.1°C

DASY5 Configuration:

- Probe: EX3DV4 - SN7509; ConvF(4.64, 4.64, 4.64) @ 5690 MHz; Calibrated: 2020/03/25
- Sensor-Surface: 2mm (Mechanical Surface Detection)
- Electronics: DAE4 Sn558; Calibrated: 2019/10/11
- Phantom: SAM
- DASY52 52.10.4(1527); SEMCAD X 14.6.14(7483)

Area Scan (111x211x1): Interpolated grid: dx=10 mm, dy=10 mm

Maximum value of SAR (interpolated) = 0.193 W/kg

Zoom Scan (7x7x12)/Cube 0: Measurement grid: dx=4mm, dy=4mm, dz=2mm

Reference Value = 1.319 V/m; Power Drift = 0.19 dB

Peak SAR (extrapolated) = 0.257 W/kg

SAR(1 g) = 0.152 W/kg; SAR(10 g) = 0.078 W/kg

Smallest distance from peaks to all points 3 dB below = 7.7 mm

Ratio of SAR at M2 to SAR at M1 = 70.1%

Maximum value of SAR (measured) = 0.205 W/kg

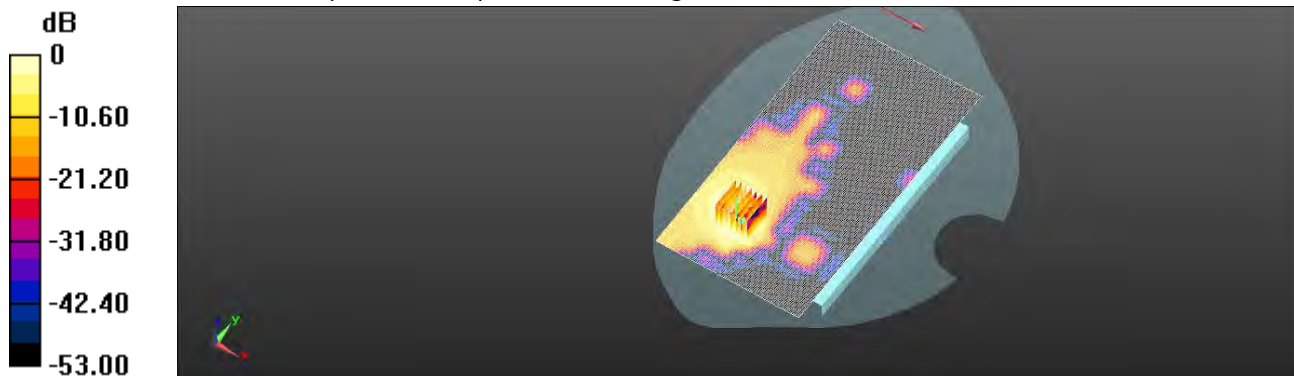

0 dB = 0.205 W/kg = -6.88 dBW/kg

Unless otherwise stated the results shown in this test report refer only to the sample(s) tested and such sample(s) are retained for 90 days only.

除非另有說明，此報告結果僅對測試之樣品負責，同時此樣品僅保留90天。本報告未經本公司書面許可，不可部份複製。

This document is issued by the Company subject to its General Conditions of Service printed overleaf, available on request or accessible at <http://www.sgs.com.tw/Terms-and-Conditions> and for electronic format documents, subject to Terms and Conditions for Electronic Documents at <http://www.sgs.com.tw/Terms-and-Conditions>. Attention is drawn to the limitation of liability, indemnification and jurisdiction issues defined therein. Any holder of this document is advised that information contained hereon reflects the Company's findings at the time of its intervention only and within the limits of Client's instructions, if any. The Company's sole responsibility is to its Client and this document does not exonerate parties to a transaction from exercising all their rights and obligations under the transaction documents. This document cannot be reproduced except in full, without prior written approval of the Company. Any unauthorized alteration, forgery or falsification of the content or appearance of this document is unlawful and offenders may be prosecuted to the fullest extent of the law.

Date: 2020/7/13

Report No. : ES/2020/30005

**WLAN 802.11ac(80M) 5.8G_Body worn_Back side_CH
155_Chain0_Ant6_15mm**

Communication System: WLAN 5G; Frequency: 5775 MHz; Duty cycle= 1:1

Medium parameters used: $f = 5775$ MHz; $\sigma = 5.308$ S/m; $\epsilon_r = 34.656$; $\rho = 1000$ kg/m³

Phantom section: Flat Section

Ambient temperature: 21.5°C; Liquid temperature: 21.9°C

DASY5 Configuration:

- Probe: EX3DV4 - SN7509; ConvF(4.85, 4.85, 4.85) @ 5775 MHz; Calibrated: 2020/03/25
- Sensor-Surface: 2mm (Mechanical Surface Detection)
- Electronics: DAE4 Sn558; Calibrated: 2019/10/11
- Phantom: SAM
- DASY52 52.10.4(1527); SEMCAD X 14.6.14(7483)

Area Scan (111x211x1): Interpolated grid: dx=10 mm, dy=10 mm

Maximum value of SAR (interpolated) = 0.208 W/kg

Zoom Scan (7x7x12)/Cube 0: Measurement grid: dx=4mm, dy=4mm, dz=2mm

Reference Value = 1.011 V/m; Power Drift = 0.09 dB

Peak SAR (extrapolated) = 0.289 W/kg

SAR(1 g) = 0.162 W/kg; SAR(10 g) = 0.079 W/kg

Smallest distance from peaks to all points 3 dB below = 8.7 mm

Ratio of SAR at M2 to SAR at M1 = 68.7%

Maximum value of SAR (measured) = 0.223 W/kg

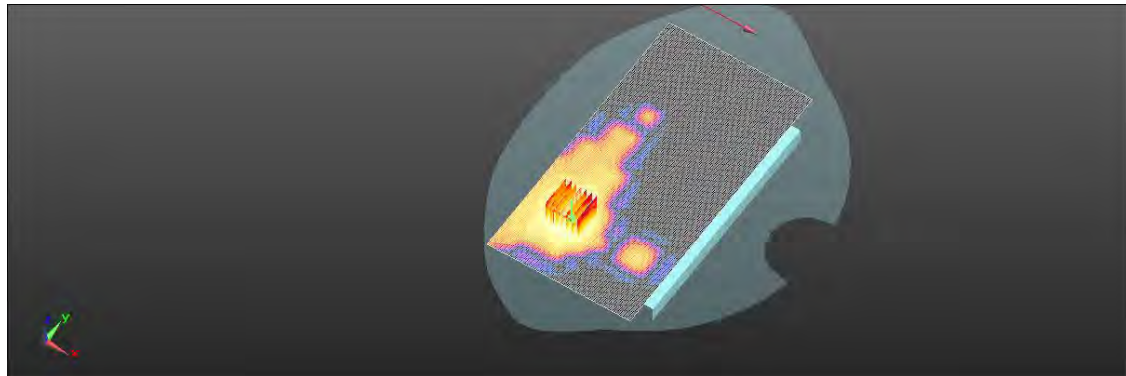
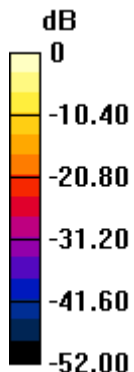

0 dB = 0.223 W/kg = -6.52 dBW/kg

Unless otherwise stated the results shown in this test report refer only to the sample(s) tested and such sample(s) are retained for 90 days only.

除非另有說明，此報告結果僅對測試之樣品負責，同時此樣品僅保留90天。本報告未經本公司書面許可，不可部份複製。

This document is issued by the Company subject to its General Conditions of Service printed overleaf, available on request or accessible at <http://www.sgs.com.tw/Terms-and-Conditions> and for electronic format documents, subject to Terms and Conditions for Electronic Documents at <http://www.sgs.com.tw/Terms-and-Conditions>. Attention is drawn to the limitation of liability, indemnification and jurisdiction issues defined therein. Any holder of this document is advised that information contained hereon reflects the Company's findings at the time of its intervention only and within the limits of Client's instructions, if any. The Company's sole responsibility is to its Client and this document does not exonerate parties to a transaction from exercising all their rights and obligations under the transaction documents. This document cannot be reproduced except in full, without prior written approval of the Company. Any unauthorized alteration, forgery or falsification of the content or appearance of this document is unlawful and offenders may be prosecuted to the fullest extent of the law.

Date: 2020/7/5

Report No. :ES/2020/30005

WLAN 802.11b_Body worn_Back side_CH 11_Chain 1_Ant5_15mm

Communication System: Wi-Fi; Frequency: 2462 MHz; Duty cycle= 1:1

Medium parameters used: $f = 2462 \text{ MHz}$; $\sigma = 1.783 \text{ S/m}$; $\epsilon_r = 38.884$; $\rho = 1000 \text{ kg/m}^3$

Phantom section: Flat Section

Ambient temperature: 21.7°C; Liquid temperature: 22.1°C

DASY5 Configuration:

- Probe: EX3DV4 - SN7509; ConvF(7.51, 7.51, 7.51) @ 2462 MHz; Calibrated: 2020/03/25
- Sensor-Surface: 2mm (Mechanical Surface Detection)
- Electronics: DAE4 Sn558; Calibrated: 2019/10/11
- Phantom: SAM
- DASY52 52.10.4(1527); SEMCAD X 14.6.14(7483)

Area Scan (91x171x1): Interpolated grid: dx=12 mm, dy=12 mm

Maximum value of SAR (interpolated) = 0.0542 W/kg

Zoom Scan (7x7x7)/Cube 0: Measurement grid: dx=5mm, dy=5mm, dz=5mm

Reference Value = 3.856 V/m; Power Drift = 0.14 dB

Peak SAR (extrapolated) = 0.0630 W/kg

SAR(1 g) = 0.045 W/kg; SAR(10 g) = 0.032 W/kg

Smallest distance from peaks to all points 3 dB below: Larger than measurement grid

Ratio of SAR at M2 to SAR at M1 = 64.7%

Maximum value of SAR (measured) = 0.0521 W/kg

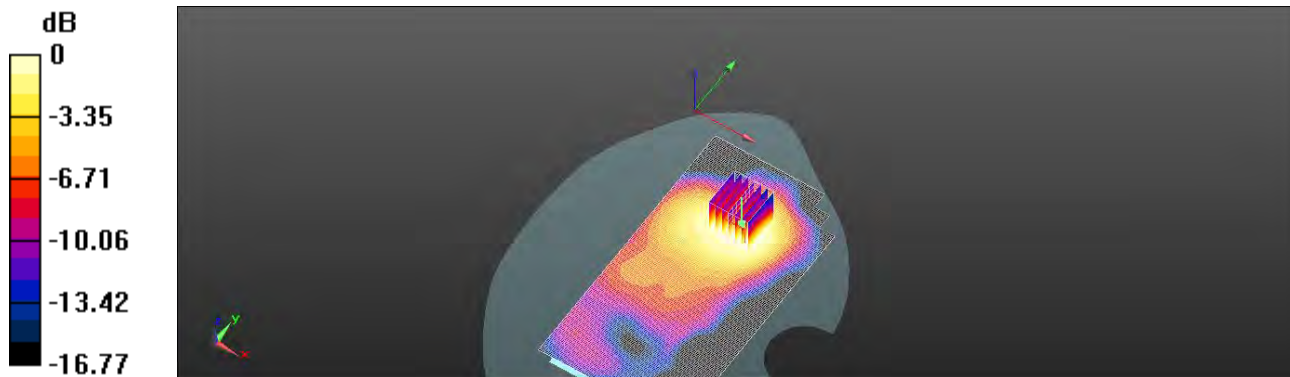

0 dB = 0.0521 W/kg = -12.83 dBW/kg

Unless otherwise stated the results shown in this test report refer only to the sample(s) tested and such sample(s) are retained for 90 days only.

除非另有說明，此報告結果僅對測試之樣品負責，同時此樣品僅保留90天。本報告未經本公司書面許可，不可部份複製。

This document is issued by the Company subject to its General Conditions of Service printed overleaf, available on request or accessible at <http://www.sgs.com.tw/Terms-and-Conditions> and for electronic format documents, subject to Terms and Conditions for Electronic Documents at <http://www.sgs.com.tw/Terms-and-Conditions>. Attention is drawn to the limitation of liability, indemnification and jurisdiction issues defined therein. Any holder of this document is advised that information contained hereon reflects the Company's findings at the time of its intervention only and within the limits of Client's instructions, if any. The Company's sole responsibility is to its Client and this document does not exonerate parties to a transaction from exercising all their rights and obligations under the transaction documents. This document cannot be reproduced except in full, without prior written approval of the Company. Any unauthorized alteration, forgery or falsification of the content or appearance of this document is unlawful and offenders may be prosecuted to the fullest extent of the law.

Date: 2020/7/10

Report No. : ES/2020/30005

WLAN 802.11n(40M) 5.2G_Body worn_Back side_CH 46_Chain1_Ant5_15mm

Communication System: WLAN 5G; Frequency: 5230 MHz; Duty cycle= 1:1

Medium parameters used: $f = 5230 \text{ MHz}$; $\sigma = 4.734 \text{ S/m}$; $\epsilon_r = 35.583$; $\rho = 1000 \text{ kg/m}^3$

Phantom section: Flat Section

Ambient temperature: 21.4°C; Liquid temperature: 21.8°C

DASY5 Configuration:

- Probe: EX3DV4 - SN7509; ConvF(5.33, 5.33, 5.33) @ 5230 MHz; Calibrated: 2020/03/25
- Sensor-Surface: 2mm (Mechanical Surface Detection)
- Electronics: DAE4 Sn558; Calibrated: 2019/10/11
- Phantom: SAM
- DASY52 52.10.4(1527); SEMCAD X 14.6.14(7483)

Area Scan (111x191x1): Interpolated grid: $dx=10 \text{ mm}$, $dy=10 \text{ mm}$

Maximum value of SAR (interpolated) = 0.174 W/kg

Zoom Scan (7x7x12)/Cube 0: Measurement grid: $dx=4\text{mm}$, $dy=4\text{mm}$, $dz=2\text{mm}$

Reference Value = 1.021 V/m; Power Drift = 0.09 dB

Peak SAR (extrapolated) = 0.382 W/kg

SAR(1 g) = 0.075 W/kg; SAR(10 g) = 0.035 W/kg

Smallest distance from peaks to all points 3 dB below = 11.5 mm

Ratio of SAR at M2 to SAR at M1 = 62.4%

Maximum value of SAR (measured) = 0.107 W/kg

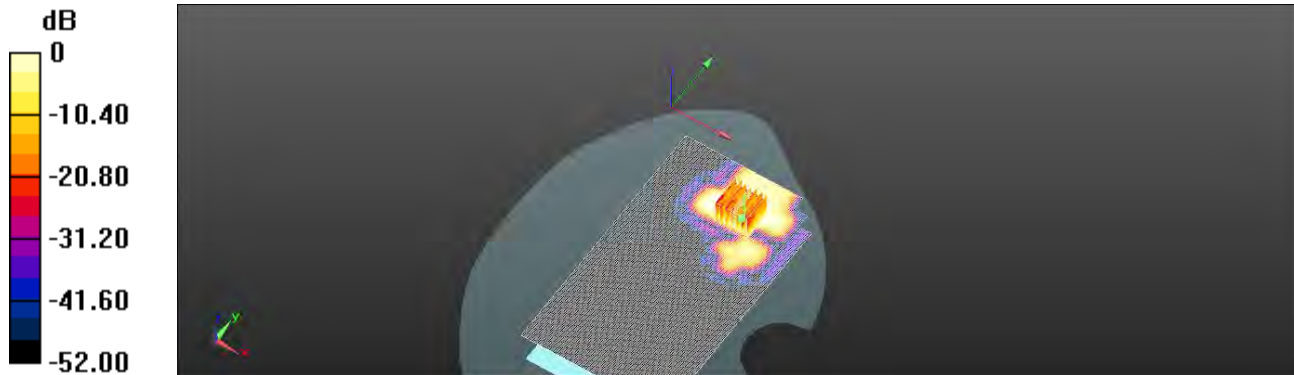

0 dB = 0.107 W/kg = -9.71 dBW/kg

Unless otherwise stated the results shown in this test report refer only to the sample(s) tested and such sample(s) are retained for 90 days only.

除非另有說明，此報告結果僅對測試之樣品負責，同時此樣品僅保留90天。本報告未經本公司書面許可，不可部份複製。

This document is issued by the Company subject to its General Conditions of Service printed overleaf, available on request or accessible at <http://www.sgs.com.tw/Terms-and-Conditions> and for electronic format documents, subject to Terms and Conditions for Electronic Documents at <http://www.sgs.com.tw/Terms-and-Conditions>. Attention is drawn to the limitation of liability, indemnification and jurisdiction issues defined therein. Any holder of this document is advised that information contained hereon reflects the Company's findings at the time of its intervention only and within the limits of Client's instructions, if any. The Company's sole responsibility is to its Client and this document does not exonerate parties to a transaction from exercising all their rights and obligations under the transaction documents. This document cannot be reproduced except in full, without prior written approval of the Company. Any unauthorized alteration, forgery or falsification of the content or appearance of this document is unlawful and offenders may be prosecuted to the fullest extent of the law.

Date: 2020/7/11

Report No. :ES/2020/30005

WLAN 802.11n(20M) 5.3G Body worn Back side CH60 Chain1 Ant5 15mm

Communication System: WLAN 5G; Frequency: 5300 MHz; Duty cycle= 1:1

Medium parameters used: $f = 5300 \text{ MHz}$; $\sigma = 4.835 \text{ S/m}$; $\epsilon_r = 35.425$; $\rho = 1000 \text{ kg/m}^3$

Phantom section: Flat Section

Ambient temperature: 22.0°C; Liquid temperature: 21.6°C

DASY5 Configuration:

- Probe: EX3DV4 - SN7509; ConvF(5.23, 5.23, 5.23) @ 5300 MHz; Calibrated: 2020/03/25
- Sensor-Surface: 2mm (Mechanical Surface Detection)
- Electronics: DAE4 Sn558; Calibrated: 2019/10/11
- Phantom: SAM
- DASY52 52.10.4(1527); SEMCAD X 14.6.14(7483)

Area Scan (111x191x1): Interpolated grid: dx=10 mm, dy=10 mm

Maximum value of SAR (interpolated) = 0.160 W/kg

Zoom Scan (7x7x12)/Cube 0: Measurement grid: dx=4mm, dy=4mm, dz=2mm

Reference Value = 1.171 V/m; Power Drift = 0.19 dB

Peak SAR (extrapolated) = 0.250 W/kg

SAR(1 g) = 0.118 W/kg; SAR(10 g) = 0.060 W/kg

Smallest distance from peaks to all points 3 dB below = 9.5 mm

Ratio of SAR at M2 to SAR at M1 = 63.9%

Maximum value of SAR (measured) = 0.151 W/kg

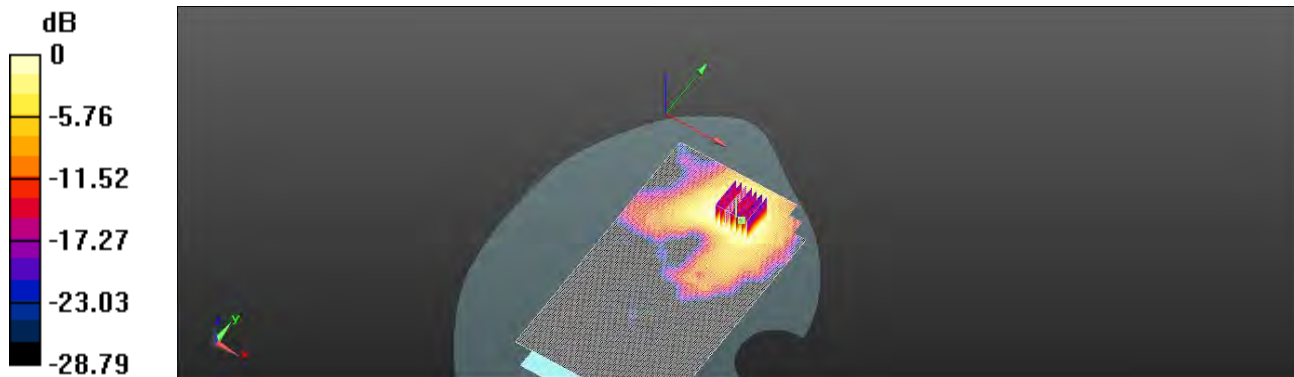

0 dB = 0.151 W/kg = -8.21 dBW/kg

Unless otherwise stated the results shown in this test report refer only to the sample(s) tested and such sample(s) are retained for 90 days only.

除非另有說明，此報告結果僅對測試之樣品負責，同時此樣品僅保留90天。本報告未經本公司書面許可，不可部份複製。

This document is issued by the Company subject to its General Conditions of Service printed overleaf, available on request or accessible at <http://www.sgs.com.tw/Terms-and-Conditions> and for electronic format documents, subject to Terms and Conditions for Electronic Documents at <http://www.sgs.com.tw/Terms-and-Conditions>. Attention is drawn to the limitation of liability, indemnification and jurisdiction issues defined therein. Any holder of this document is advised that information contained hereon reflects the Company's findings at the time of its intervention only and within the limits of Client's instructions, if any. The Company's sole responsibility is to its Client and this document does not exonerate parties to a transaction from exercising all their rights and obligations under the transaction documents. This document cannot be reproduced except in full, without prior written approval of the Company. Any unauthorized alteration, forgery or falsification of the content or appearance of this document is unlawful and offenders may be prosecuted to the fullest extent of the law.

Date: 2020/7/12

Report No. :ES/2020/30005

WLAN 802.11a 5.6G_Body worn_Back side_CH 100_Chain1_Ant5_15mm

Communication System: WLAN 5G; Frequency: 5500 MHz; Duty cycle= 1:1

Medium parameters used: $f = 5500$ MHz; $\sigma = 5.027$ S/m; $\epsilon_r = 35.407$; $\rho = 1000$ kg/m³

Phantom section: Flat Section

Ambient temperature: 21.6°C; Liquid temperature: 22.1°C

DASY5 Configuration:

- Probe: EX3DV4 - SN7509; ConvF(4.64, 4.64, 4.64) @ 5500 MHz; Calibrated: 2020/03/25
- Sensor-Surface: 2mm (Mechanical Surface Detection)
- Electronics: DAE4 Sn558; Calibrated: 2019/10/11
- Phantom: SAM
- DASY52 52.10.4(1527); SEMCAD X 14.6.14(7483)

Area Scan (111x191x1): Interpolated grid: dx=10 mm, dy=10 mm

Maximum value of SAR (interpolated) = 0.308 W/kg

Zoom Scan (7x7x12)/Cube 0: Measurement grid: dx=4mm, dy=4mm, dz=2mm

Reference Value = 1.136 V/m; Power Drift = 0.15 dB

Peak SAR (extrapolated) = 0.385 W/kg

SAR(1 g) = 0.242 W/kg; SAR(10 g) = 0.126 W/kg

Smallest distance from peaks to all points 3 dB below = 8.4 mm

Ratio of SAR at M2 to SAR at M1 = 73.5%

Maximum value of SAR (measured) = 0.318 W/kg

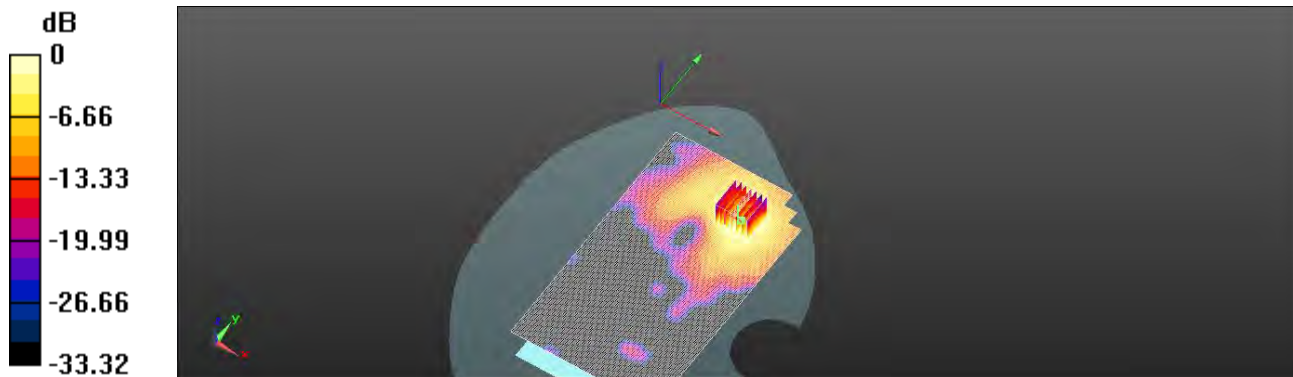

0 dB = 0.318 W/kg = -4.98 dBW/kg

Unless otherwise stated the results shown in this test report refer only to the sample(s) tested and such sample(s) are retained for 90 days only.

除非另有說明，此報告結果僅對測試之樣品負責，同時此樣品僅保留90天。本報告未經本公司書面許可，不可部份複製。

This document is issued by the Company subject to its General Conditions of Service printed overleaf, available on request or accessible at <http://www.sgs.com.tw/Terms-and-Conditions> and for electronic format documents, subject to Terms and Conditions for Electronic Documents at <http://www.sgs.com.tw/Terms-and-Conditions>. Attention is drawn to the limitation of liability, indemnification and jurisdiction issues defined therein. Any holder of this document is advised that information contained hereon reflects the Company's findings at the time of its intervention only and within the limits of Client's instructions, if any. The Company's sole responsibility is to its Client and this document does not exonerate parties to a transaction from exercising all their rights and obligations under the transaction documents. This document cannot be reproduced except in full, without prior written approval of the Company. Any unauthorized alteration, forgery or falsification of the content or appearance of this document is unlawful and offenders may be prosecuted to the fullest extent of the law.

Date: 2020/7/13

Report No. :ES/2020/30005

**WLAN 802.11ac(80M) 5.8G_Body worn_Back side_CH
155_Chain1_Ant5_15mm**

Communication System: Wi-Fi; Frequency: 5775 MHz; Duty cycle= 1:1

Medium parameters used: $f = 5775 \text{ MHz}$; $\sigma = 5.308 \text{ S/m}$; $\epsilon_r = 34.656$; $\rho = 1000 \text{ kg/m}^3$

Phantom section: Flat Section

Ambient temperature: 21.5°C; Liquid temperature: 21.9°C

DASY5 Configuration:

- Probe: EX3DV4 - SN7509; ConvF(4.85, 4.85, 4.85) @ 5775 MHz; Calibrated: 2020/03/25
- Sensor-Surface: 2mm (Mechanical Surface Detection)
- Electronics: DAE4 Sn558; Calibrated: 2019/10/11
- Phantom: SAM
- DASY52 52.10.4(1527); SEMCAD X 14.6.14(7483)

Area Scan (111x191x1): Interpolated grid: $dx=10 \text{ mm}$, $dy=10 \text{ mm}$

Maximum value of SAR (interpolated) = 0.302 W/kg

Zoom Scan (7x7x12)/Cube 0: Measurement grid: $dx=4\text{mm}$, $dy=4\text{mm}$, $dz=2\text{mm}$

Reference Value = 1.031 V/m; Power Drift = 0.05 dB

Peak SAR (extrapolated) = 0.345 W/kg

SAR(1 g) = 0.213 W/kg; SAR(10 g) = 0.104 W/kg

Smallest distance from peaks to all points 3 dB below = 8.3 mm

Ratio of SAR at M2 to SAR at M1 = 73.9%

Maximum value of SAR (measured) = 0.295 W/kg

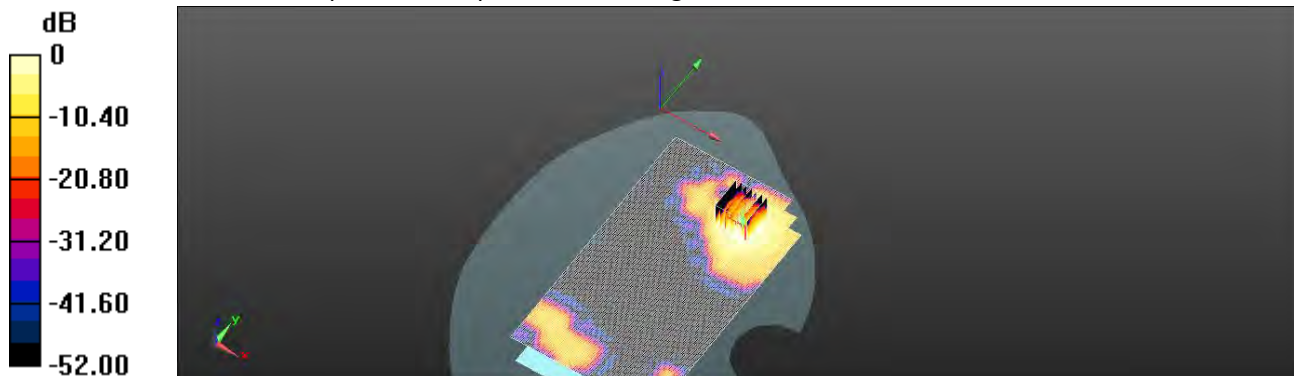

0 dB = 0.295 W/kg = -5.30 dBW/kg

Unless otherwise stated the results shown in this test report refer only to the sample(s) tested and such sample(s) are retained for 90 days only.

除非另有說明，此報告結果僅對測試之樣品負責，同時此樣品僅保留90天。本報告未經本公司書面許可，不可部份複製。

This document is issued by the Company subject to its General Conditions of Service printed overleaf, available on request or accessible at <http://www.sgs.com.tw/Terms-and-Conditions> and for electronic format documents, subject to Terms and Conditions for Electronic Documents at <http://www.sgs.com.tw/Terms-and-Conditions>. Attention is drawn to the limitation of liability, indemnification and jurisdiction issues defined therein. Any holder of this document is advised that information contained hereon reflects the Company's findings at the time of its intervention only and within the limits of Client's instructions, if any. The Company's sole responsibility is to its Client and this document does not exonerate parties to a transaction from exercising all their rights and obligations under the transaction documents. This document cannot be reproduced except in full, without prior written approval of the Company. Any unauthorized alteration, forgery or falsification of the content or appearance of this document is unlawful and offenders may be prosecuted to the fullest extent of the law.

Date: 2020/6/29

Report No. : ES/2020/30005

WLAN 802.11b_Hotspot_Back side_CH1_Chain0_Ant6_10mm

Communication System: Wi-Fi; Frequency: 2412 MHz; Duty cycle= 1:1

Medium parameters used: $f = 2412$ MHz; $\sigma = 1.718$ S/m; $\epsilon_r = 38.867$; $\rho = 1000$ kg/m³

Phantom section: Flat Section

Ambient temperature: 21.7°C; Liquid temperature: 22.1°C

DASY5 Configuration:

- Probe: EX3DV4 - SN7509; ConvF(7.51, 7.51, 7.51) @ 2412 MHz; Calibrated: 2020/03/25
- Sensor-Surface: 2mm (Mechanical Surface Detection)
- Electronics: DAE4 Sn558; Calibrated: 2019/10/11
- Phantom: SAM
- DASY52 52.10.4(1527); SEMCAD X 14.6.14(7483)

Area Scan (101x171x1): Interpolated grid: dx=12 mm, dy=12 mm

Maximum value of SAR (interpolated) = 0.116 W/kg

Zoom Scan (7x7x7)/Cube 0: Measurement grid: dx=5mm, dy=5mm, dz=5mm

Reference Value = 4.618 V/m; Power Drift = 0.18 dB

Peak SAR (extrapolated) = 0.141 W/kg

SAR(1 g) = 0.088 W/kg; SAR(10 g) = 0.055 W/kg

Smallest distance from peaks to all points 3 dB below = 8.7 mm

Ratio of SAR at M2 to SAR at M1 = 52.4%

Maximum value of SAR (measured) = 0.108 W/kg

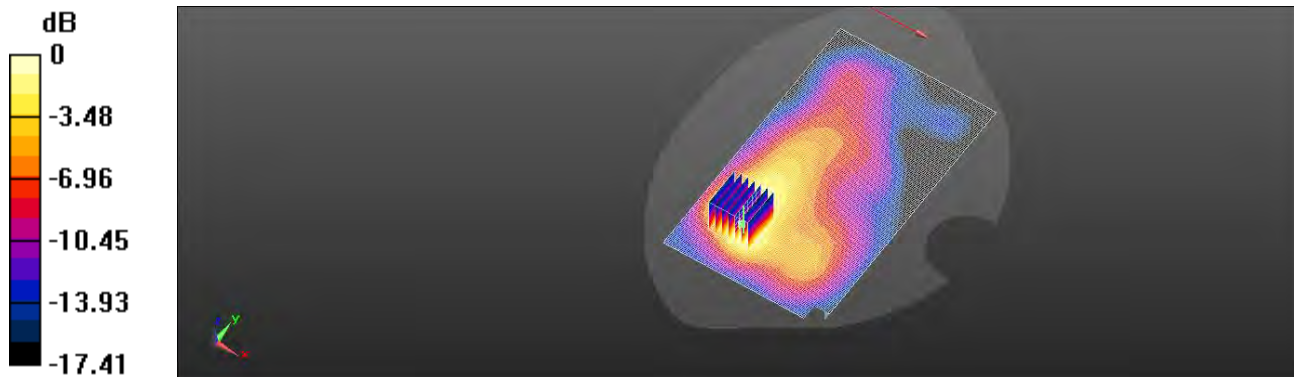

0 dB = 0.108 W/kg = -9.67 dBW/kg

Unless otherwise stated the results shown in this test report refer only to the sample(s) tested and such sample(s) are retained for 90 days only.

除非另有說明，此報告結果僅對測試之樣品負責，同時此樣品僅保留90天。本報告未經本公司書面許可，不可部份複製。

This document is issued by the Company subject to its General Conditions of Service printed overleaf, available on request or accessible at <http://www.sgs.com.tw/Terms-and-Conditions> and for electronic format documents, subject to Terms and Conditions for Electronic Documents at <http://www.sgs.com.tw/Terms-and-Conditions>. Attention is drawn to the limitation of liability, indemnification and jurisdiction issues defined therein. Any holder of this document is advised that information contained hereon reflects the Company's findings at the time of its intervention only and within the limits of Client's instructions, if any. The Company's sole responsibility is to its Client and this document does not exonerate parties to a transaction from exercising all their rights and obligations under the transaction documents. This document cannot be reproduced except in full, without prior written approval of the Company. Any unauthorized alteration, forgery or falsification of the content or appearance of this document is unlawful and offenders may be prosecuted to the fullest extent of the law.

Date: 2020/7/5

Report No. :ES/2020/30005

WLAN 802.11n(40M) 5.2G_Hotspot_Back side_CH 46_Chain0_Ant6_10mm

Communication System: Wi-Fi; Frequency: 5230 MHz; Duty cycle= 1:1

Medium parameters used: $f = 5230 \text{ MHz}$; $\sigma = 4.748 \text{ S/m}$; $\epsilon_r = 35.528$; $\rho = 1000 \text{ kg/m}^3$

Phantom section: Flat Section

Ambient temperature: 21.4°C; Liquid temperature: 21.8°C

DASY5 Configuration:

- Probe: EX3DV4 - SN7509; ConvF(5.33, 5.33, 5.33) @ 5230 MHz; Calibrated: 2020/03/25
- Sensor-Surface: 2mm (Mechanical Surface Detection)
- Electronics: DAE4 Sn558; Calibrated: 2019/10/11
- Phantom: SAM
- DASY52 52.10.4(1527); SEMCAD X 14.6.14(7483)

Area Scan (111x211x1): Interpolated grid: dx=10 mm, dy=10 mm

Maximum value of SAR (interpolated) = 0.603 W/kg

Zoom Scan (7x7x12)/Cube 0: Measurement grid: dx=4mm, dy=4mm, dz=2mm

Reference Value = 1.182 V/m; Power Drift = 0.17 dB

Peak SAR (extrapolated) = 1.09 W/kg

SAR(1 g) = 0.442 W/kg; SAR(10 g) = 0.180 W/kg

Smallest distance from peaks to all points 3 dB below = 7.4 mm

Ratio of SAR at M2 to SAR at M1 = 58.7%

Maximum value of SAR (measured) = 0.607 W/kg

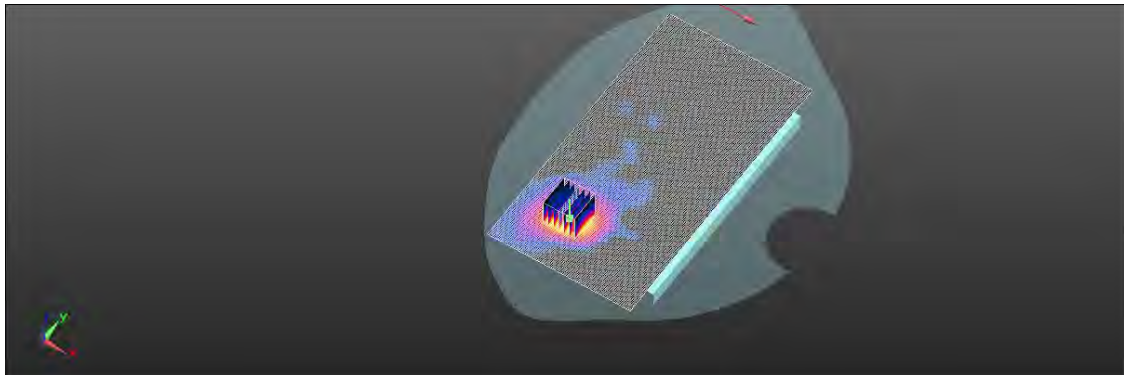
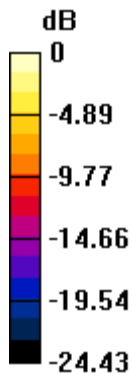

0 dB = 0.607 W/kg = -2.17 dBW/kg

Unless otherwise stated the results shown in this test report refer only to the sample(s) tested and such sample(s) are retained for 90 days only.

除非另有說明，此報告結果僅對測試之樣品負責，同時此樣品僅保留90天。本報告未經本公司書面許可，不可部份複製。

This document is issued by the Company subject to its General Conditions of Service printed overleaf, available on request or accessible at <http://www.sgs.com.tw/Terms-and-Conditions> and for electronic format documents, subject to Terms and Conditions for Electronic Documents at <http://www.sgs.com.tw/Terms-and-Conditions>. Attention is drawn to the limitation of liability, indemnification and jurisdiction issues defined therein. Any holder of this document is advised that information contained hereon reflects the Company's findings at the time of its intervention only and within the limits of Client's instructions, if any. The Company's sole responsibility is to its Client and this document does not exonerate parties to a transaction from exercising all their rights and obligations under the transaction documents. This document cannot be reproduced except in full, without prior written approval of the Company. Any unauthorized alteration, forgery or falsification of the content or appearance of this document is unlawful and offenders may be prosecuted to the fullest extent of the law.

Date: 2020/7/6

Report No. :ES/2020/30005

WLAN 802.11a 5.3G_Hotspot_Back side_CH 52_Chain0_Ant6_10mm

Communication System: Wi-Fi; Frequency: 5260 MHz; Duty cycle= 1:1

Medium parameters used: $f = 5260 \text{ MHz}$; $\sigma = 4.796 \text{ S/m}$; $\epsilon_r = 35.513$; $\rho = 1000 \text{ kg/m}^3$

Phantom section: Flat Section

Ambient temperature: 22.0°C; Liquid temperature: 21.6°C

DASY5 Configuration:

- Probe: EX3DV4 - SN7509; ConvF(5.23, 5.23, 5.23) @ 5260 MHz; Calibrated: 2020/03/25
- Sensor-Surface: 2mm (Mechanical Surface Detection)
- Electronics: DAE4 Sn558; Calibrated: 2019/10/11
- Phantom: SAM
- DASY52 52.10.4(1527); SEMCAD X 14.6.14(7483)

Area Scan (111x211x1): Interpolated grid: dx=10 mm, dy=10 mm

Maximum value of SAR (interpolated) = 0.571 W/kg

Zoom Scan (7x7x12)/Cube 0: Measurement grid: dx=4mm, dy=4mm, dz=2mm

Reference Value = 1.091 V/m; Power Drift = 0.15 dB

Peak SAR (extrapolated) = 1.07 W/kg

SAR(1 g) = 0.457 W/kg; SAR(10 g) = 0.201 W/kg

Smallest distance from peaks to all points 3 dB below = 7.5 mm

Ratio of SAR at M2 to SAR at M1 = 58.7%

Maximum value of SAR (measured) = 0.569 W/kg

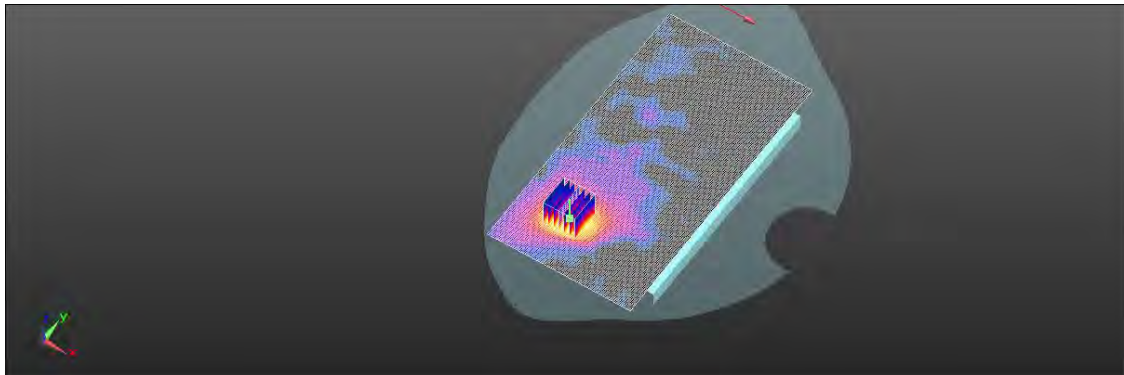
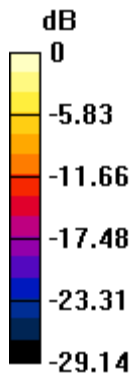

0 dB = 0.569 W/kg = -2.45 dBW/kg

Unless otherwise stated the results shown in this test report refer only to the sample(s) tested and such sample(s) are retained for 90 days only.

除非另有說明，此報告結果僅對測試之樣品負責，同時此樣品僅保留90天。本報告未經本公司書面許可，不可部份複製。

This document is issued by the Company subject to its General Conditions of Service printed overleaf, available on request or accessible at <http://www.sgs.com.tw/Terms-and-Conditions> and for electronic format documents, subject to Terms and Conditions for Electronic Documents at <http://www.sgs.com.tw/Terms-and-Conditions>. Attention is drawn to the limitation of liability, indemnification and jurisdiction issues defined therein. Any holder of this document is advised that information contained hereon reflects the Company's findings at the time of its intervention only and within the limits of Client's instructions, if any. The Company's sole responsibility is to its Client and this document does not exonerate parties to a transaction from exercising all their rights and obligations under the transaction documents. This document cannot be reproduced except in full, without prior written approval of the Company. Any unauthorized alteration, forgery or falsification of the content or appearance of this document is unlawful and offenders may be prosecuted to the fullest extent of the law.

Date: 2020/7/7

Report No. :ES/2020/30005

WLAN 802.11ac(80M) 5.6G_Hotspot_Back side_CH 138_Chain0_Ant6_10mm

Communication System: WLAN 5G; Frequency: 5690 MHz; Duty cycle= 1:1

Medium parameters used: $f = 5690$ MHz; $\sigma = 5.233$ S/m; $\epsilon_r = 34.727$; $\rho = 1000$ kg/m³

Phantom section: Flat Section

Ambient temperature: 21.6°C; Liquid temperature: 22.1°C

DASY5 Configuration:

- Probe: EX3DV4 - SN7509; ConvF(4.64, 4.64, 4.64) @ 5690 MHz; Calibrated: 2020/03/25
- Sensor-Surface: 2mm (Mechanical Surface Detection)
- Electronics: DAE4 Sn558; Calibrated: 2019/10/11
- Phantom: SAM
- DASY52 52.10.4(1527); SEMCAD X 14.6.14(7483)

Area Scan (111x211x1): Interpolated grid: dx=10 mm, dy=10 mm

Maximum value of SAR (interpolated) = 0.459 W/kg

Zoom Scan (7x7x12)/Cube 0: Measurement grid: dx=4mm, dy=4mm, dz=2mm

Reference Value = 1.081 V/m; Power Drift = 0.16 dB

Peak SAR (extrapolated) = 0.901 W/kg

SAR(1 g) = 0.373 W/kg; SAR(10 g) = 0.160 W/kg

Smallest distance from peaks to all points 3 dB below = 7.3 mm

Ratio of SAR at M2 to SAR at M1 = 55.8%

Maximum value of SAR (measured) = 0.465 W/kg

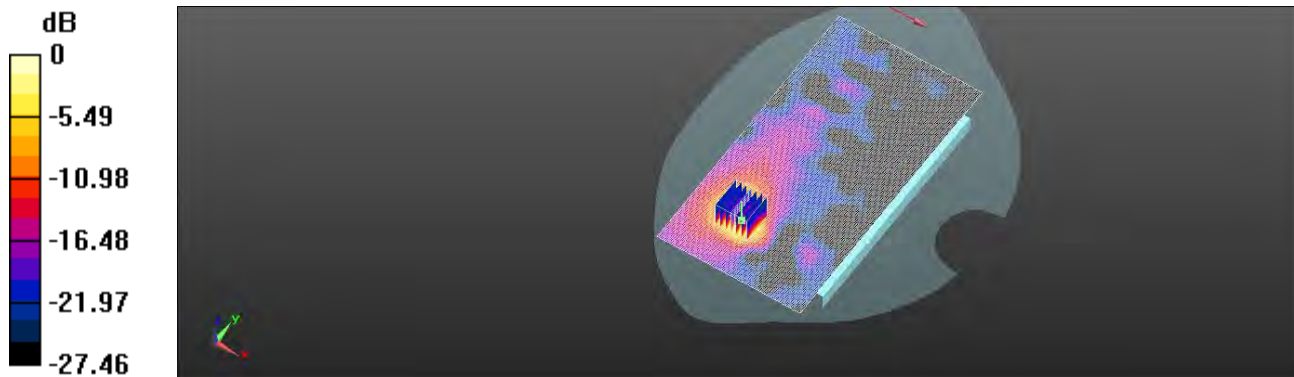

0 dB = 0.465 W/kg = -3.33 dBW/kg

Unless otherwise stated the results shown in this test report refer only to the sample(s) tested and such sample(s) are retained for 90 days only.

除非另有說明，此報告結果僅對測試之樣品負責，同時此樣品僅保留90天。本報告未經本公司書面許可，不可部份複製。

This document is issued by the Company subject to its General Conditions of Service printed overleaf, available on request or accessible at <http://www.sgs.com.tw/Terms-and-Conditions> and for electronic format documents, subject to Terms and Conditions for Electronic Documents at <http://www.sgs.com.tw/Terms-and-Conditions>. Attention is drawn to the limitation of liability, indemnification and jurisdiction issues defined therein. Any holder of this document is advised that information contained hereon reflects the Company's findings at the time of its intervention only and within the limits of Client's instructions, if any. The Company's sole responsibility is to its Client and this document does not exonerate parties to a transaction from exercising all their rights and obligations under the transaction documents. This document cannot be reproduced except in full, without prior written approval of the Company. Any unauthorized alteration, forgery or falsification of the content or appearance of this document is unlawful and offenders may be prosecuted to the fullest extent of the law.