

Plots of System Verification

Annex A. Plots of System Verification

The plots for system verification are shown as follows.

Plots of System Verification

Test Laboratory: Bureau Veritas ADT SAR/HAC Testing Lab

Date: 2022/03/31

S01 System Check_H1900_220331

DUT: Dipole 1900 MHz; Type: D1900V2; SN: 5d036

Communication System: UID 0, CW; Frequency: 1900 MHz; Duty Cycle: 1:1

Medium: H16T20N1_0331 Medium parameters used: $f = 1900$ MHz; $\sigma = 1.464$ S/m; $\epsilon_r = 38.853$; $\rho = 1000$ kg/m³

Ambient Temperature : 23.3 °C ; Liquid Temperature : 23.1 °C

DASY5 Configuration:

- Probe: EX3DV4 - SN7472; ConvF(8.43, 8.43, 8.43) @ 1900 MHz; Calibrated: 2021/06/03
- Sensor-Surface: 1.4mm (Mechanical Surface Detection)
- Electronics: DAE4 Sn1698; Calibrated: 2021/11/09
- Phantom: ELI Phantom_1205; Type: QDOVA002AA;
- Measurement SW: DASY52, Version 52.10 (4); SEMCAD X Version 14.6.14 (7501)

Pin=50mW/Area Scan (61x61x1): Interpolated grid: dx=1.500 mm, dy=1.500 mm

Maximum value of SAR (interpolated) = 3.207 W/kg

Pin=50mW/Zoom Scan (5x5x7)/Cube 0: Measurement grid: dx=8mm, dy=8mm, dz=5mm

Reference Value = 48.02 V/m; Power Drift = 0.02 dB

Peak SAR (extrapolated) = 3.85 W/kg

SAR(1 g) = 2 W/kg; SAR(10 g) = 1.05 W/kg (SAR corrected for target medium)

Maximum value of SAR (measured) = 3.24 W/kg

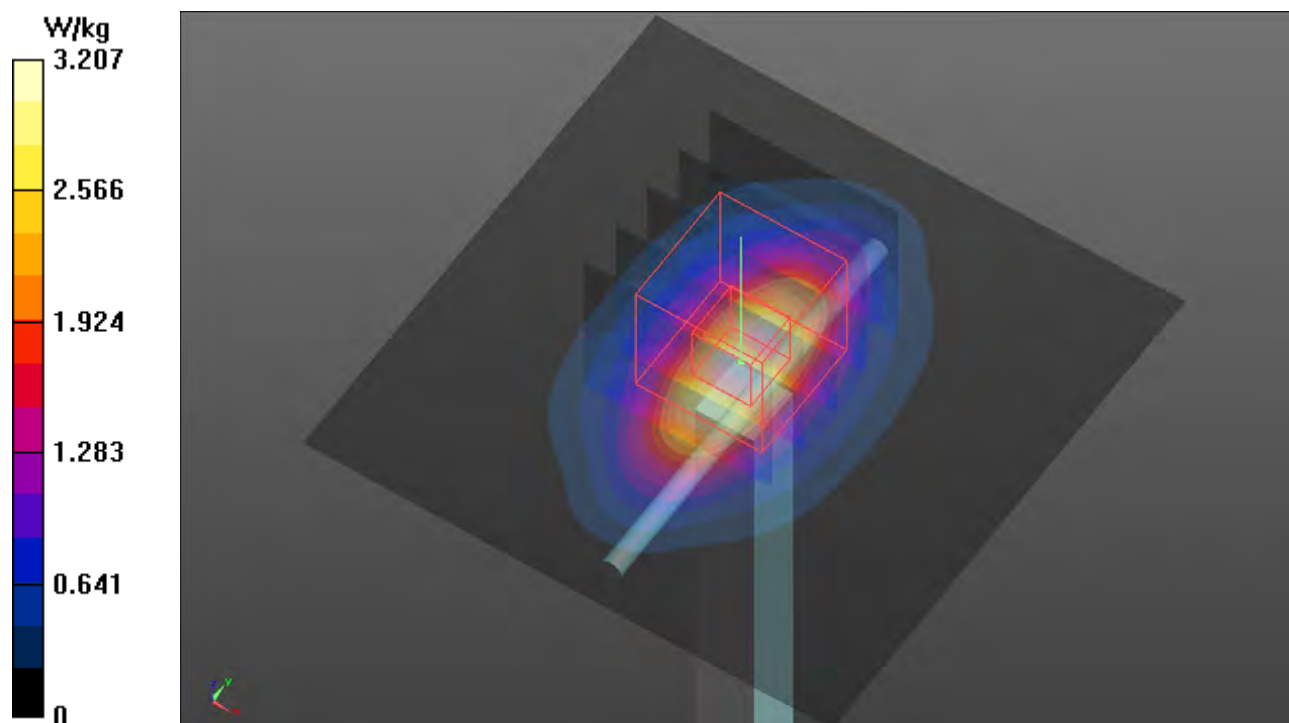

Plots of System Verification

Test Laboratory: Bureau Veritas ADT SAR/HAC Testing Lab

Date: 2022/04/01

S02 System Check_H1750_220401

DUT: Dipole 1750 MHz; Type: D1750V2; SN: 1055

Communication System: UID 0, CW; Frequency: 1750 MHz; Duty Cycle: 1:1

Medium: H16T20N1_0401 Medium parameters used: $f = 1750$ MHz; $\sigma = 1.321$ S/m; $\epsilon_r = 39.14$; $\rho = 1000$ kg/m³

Ambient Temperature : 23.5 °C ; Liquid Temperature : 23.4 °C

DASY5 Configuration:

- Probe: EX3DV4 - SN7472; ConvF(8.77, 8.77, 8.77) @ 1750 MHz; Calibrated: 2021/06/03
- Sensor-Surface: 1.4mm (Mechanical Surface Detection)
- Electronics: DAE4 Sn1698; Calibrated: 2021/11/09
- Phantom: ELI Phantom_1205; Type: QDOVA002AA;
- Measurement SW: DASY52, Version 52.10 (4); SEMCAD X Version 14.6.14 (7501)

Pin=50mW/Area Scan (61x61x1): Interpolated grid: dx=1.500 mm, dy=1.500 mm

Maximum value of SAR (interpolated) = 2.57 W/kg

Pin=50mW/Zoom Scan (5x5x7)/Cube 0: Measurement grid: dx=8mm, dy=8mm, dz=5mm

Reference Value = 41.45 V/m; Power Drift = -0.10 dB

Peak SAR (extrapolated) = 3.13 W/kg

SAR(1 g) = 1.77 W/kg; SAR(10 g) = 0.935 W/kg (SAR corrected for target medium)

Maximum value of SAR (measured) = 2.66 W/kg

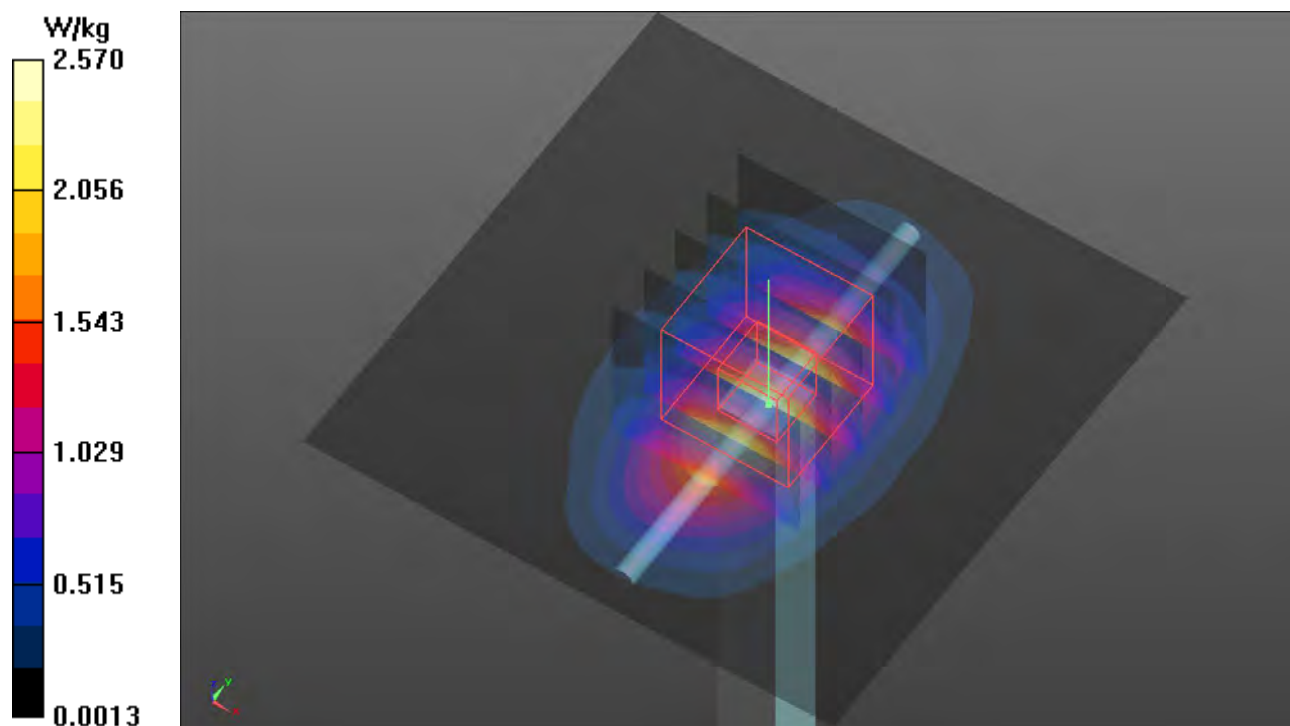

Plots of System Verification

Test Laboratory: Bureau Veritas ADT SAR/HAC Testing Lab

Date: 2022/03/30

S03 System Check_H835_220330

DUT: Dipole 835 MHz; Type: D835V2; SN: 4d121

Communication System: UID 0, CW; Frequency: 835 MHz; Duty Cycle: 1:1

Medium: H07T10N1_0330 Medium parameters used: $f = 835$ MHz; $\sigma = 0.936$ S/m; $\epsilon_r = 40.696$; $\rho = 1000$ kg/m³

Ambient Temperature : 23.3 °C ; Liquid Temperature : 23.2 °C

DASY5 Configuration:

- Probe: EX3DV4 - SN7472; ConvF(10.05, 10.05, 10.05) @ 835 MHz; Calibrated: 2021/06/03
- Sensor-Surface: 1.4mm (Mechanical Surface Detection)
- Electronics: DAE4 Sn1698; Calibrated: 2021/11/09
- Phantom: ELI Phantom_1205; Type: QDOVA002AA;
- Measurement SW: DASY52, Version 52.10 (4); SEMCAD X Version 14.6.14 (7501)

Pin=50mW/Area Scan (61x61x1): Interpolated grid: dx=1.500 mm, dy=1.500 mm

Maximum value of SAR (interpolated) = 0.619 W/kg

Pin=50mW/Zoom Scan (5x5x7)/Cube 0: Measurement grid: dx=8mm, dy=8mm, dz=5mm

Reference Value = 26.75 V/m; Power Drift = -0.01 dB

Peak SAR (extrapolated) = 0.700 W/kg

SAR(1 g) = 0.461 W/kg; SAR(10 g) = 0.312 W/kg (SAR corrected for target medium)

Maximum value of SAR (measured) = 0.623 W/kg

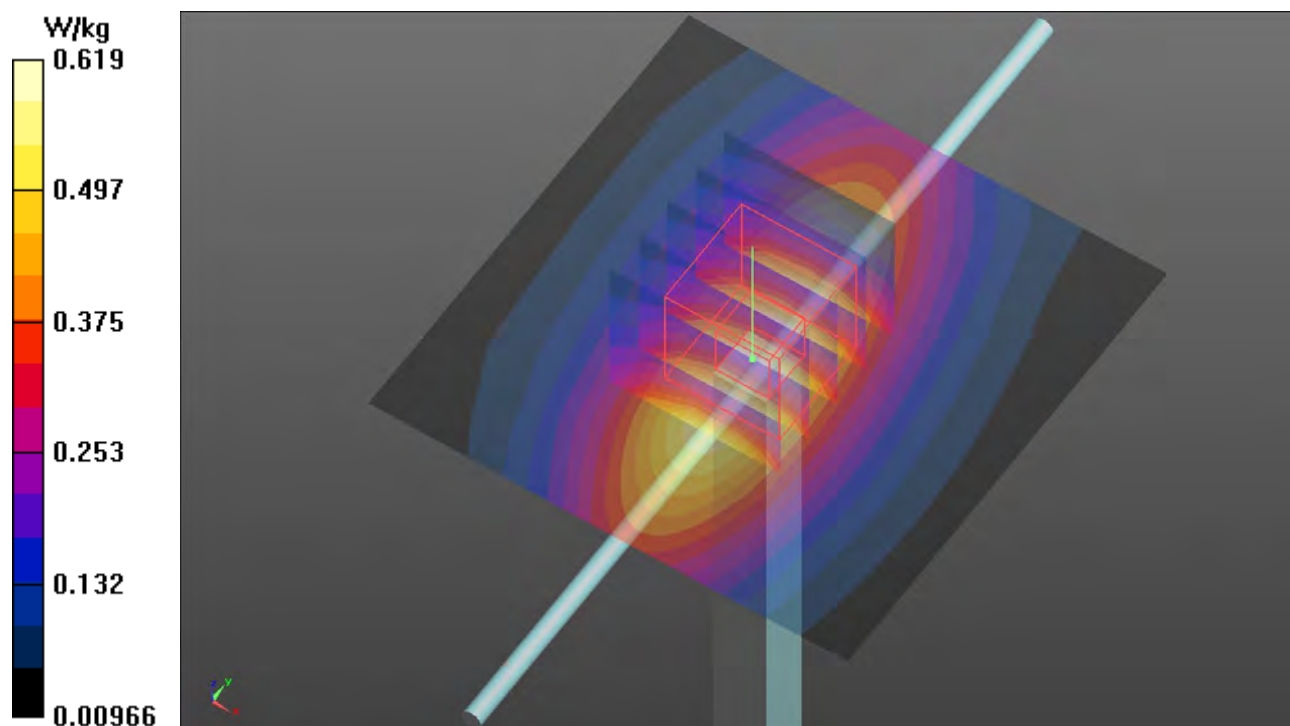

Plots of System Verification

Test Laboratory: Bureau Veritas ADT SAR/HAC Testing Lab

Date: 2022/03/31

S04 System Check_H1900_220331

DUT: Dipole 1900 MHz; Type: D1900V2; SN: 5d036

Communication System: UID 0, CW; Frequency: 1900 MHz; Duty Cycle: 1:1

Medium: H16T20N1_0331 Medium parameters used: $f = 1900$ MHz; $\sigma = 1.464$ S/m; $\epsilon_r = 38.853$; $\rho = 1000$ kg/m³

Ambient Temperature : 23.3 °C ; Liquid Temperature : 23.1 °C

DASY5 Configuration:

- Probe: EX3DV4 - SN7472; ConvF(8.43, 8.43, 8.43) @ 1900 MHz; Calibrated: 2021/06/03
- Sensor-Surface: 1.4mm (Mechanical Surface Detection)
- Electronics: DAE4 Sn1698; Calibrated: 2021/11/09
- Phantom: ELI Phantom_1205; Type: QDOVA002AA;
- Measurement SW: DASY52, Version 52.10 (4); SEMCAD X Version 14.6.14 (7501)

Pin=50mW/Area Scan (61x61x1): Interpolated grid: dx=1.500 mm, dy=1.500 mm

Maximum value of SAR (interpolated) = 3.207 W/kg

Pin=50mW/Zoom Scan (5x5x7)/Cube 0: Measurement grid: dx=8mm, dy=8mm, dz=5mm

Reference Value = 48.02 V/m; Power Drift = 0.02 dB

Peak SAR (extrapolated) = 3.85 W/kg

SAR(1 g) = 2 W/kg; SAR(10 g) = 1.05 W/kg (SAR corrected for target medium)

Maximum value of SAR (measured) = 3.24 W/kg

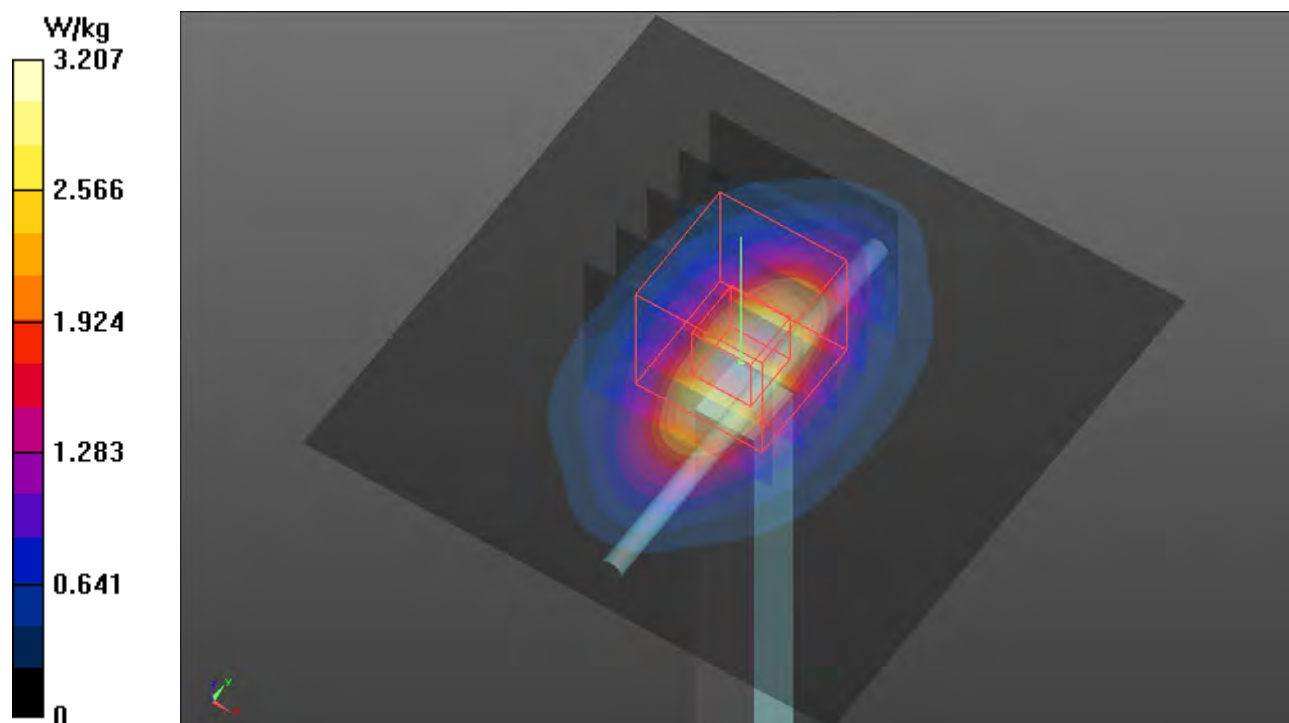

Plots of System Verification

Test Laboratory: Bureau Veritas ADT SAR/HAC Testing Lab

Date: 2022/04/01

S05 System Check_H1750_220401

DUT: Dipole 1750 MHz; Type: D1750V2; SN: 1055

Communication System: UID 0, CW; Frequency: 1750 MHz; Duty Cycle: 1:1

Medium: H16T20N1_0401 Medium parameters used: $f = 1750$ MHz; $\sigma = 1.321$ S/m; $\epsilon_r = 39.14$; $\rho = 1000$ kg/m³

Ambient Temperature : 23.5 °C ; Liquid Temperature : 23.4 °C

DASY5 Configuration:

- Probe: EX3DV4 - SN7472; ConvF(8.77, 8.77, 8.77) @ 1750 MHz; Calibrated: 2021/06/03
- Sensor-Surface: 1.4mm (Mechanical Surface Detection)
- Electronics: DAE4 Sn1698; Calibrated: 2021/11/09
- Phantom: ELI Phantom_1205; Type: QDOVA002AA;
- Measurement SW: DASY52, Version 52.10 (4); SEMCAD X Version 14.6.14 (7501)

Pin=50mW/Area Scan (61x61x1): Interpolated grid: dx=1.500 mm, dy=1.500 mm

Maximum value of SAR (interpolated) = 2.57 W/kg

Pin=50mW/Zoom Scan (5x5x7)/Cube 0: Measurement grid: dx=8mm, dy=8mm, dz=5mm

Reference Value = 41.45 V/m; Power Drift = -0.10 dB

Peak SAR (extrapolated) = 3.13 W/kg

SAR(1 g) = 1.77 W/kg; SAR(10 g) = 0.935 W/kg (SAR corrected for target medium)

Maximum value of SAR (measured) = 2.66 W/kg

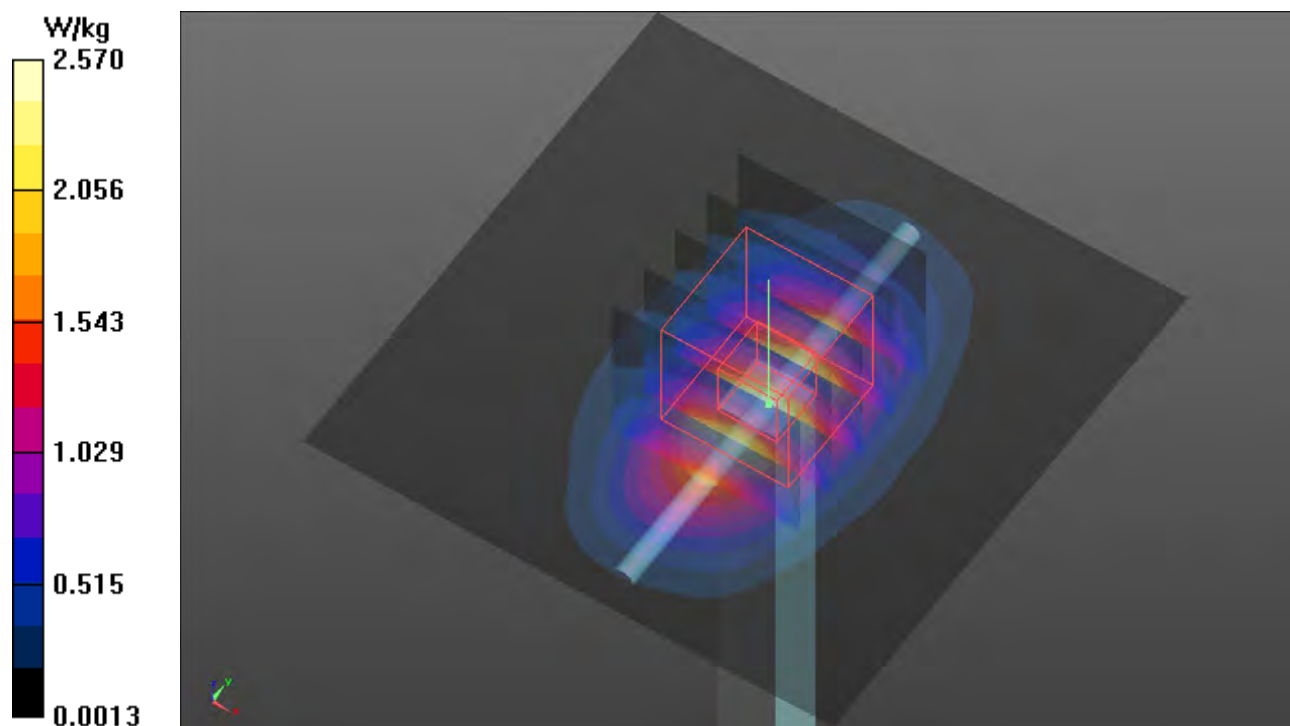

Plots of System Verification

Test Laboratory: Bureau Veritas ADT SAR/HAC Testing Lab

Date: 2022/03/30

S06 System Check_H835_220330

DUT: Dipole 835 MHz; Type: D835V2; SN: 4d121

Communication System: UID 0, CW; Frequency: 835 MHz; Duty Cycle: 1:1

Medium: H07T10N1_0330 Medium parameters used: $f = 835$ MHz; $\sigma = 0.936$ S/m; $\epsilon_r = 40.696$; $\rho = 1000$ kg/m³

Ambient Temperature : 23.3 °C ; Liquid Temperature : 23.2 °C

DASY5 Configuration:

- Probe: EX3DV4 - SN7472; ConvF(10.05, 10.05, 10.05) @ 835 MHz; Calibrated: 2021/06/03
- Sensor-Surface: 1.4mm (Mechanical Surface Detection)
- Electronics: DAE4 Sn1698; Calibrated: 2021/11/09
- Phantom: ELI Phantom_1205; Type: QDOVA002AA;
- Measurement SW: DASY52, Version 52.10 (4); SEMCAD X Version 14.6.14 (7501)

Pin=50mW/Area Scan (61x61x1): Interpolated grid: dx=1.500 mm, dy=1.500 mm

Maximum value of SAR (interpolated) = 0.619 W/kg

Pin=50mW/Zoom Scan (5x5x7)/Cube 0: Measurement grid: dx=8mm, dy=8mm, dz=5mm

Reference Value = 26.75 V/m; Power Drift = -0.01 dB

Peak SAR (extrapolated) = 0.700 W/kg

SAR(1 g) = 0.461 W/kg; SAR(10 g) = 0.312 W/kg (SAR corrected for target medium)

Maximum value of SAR (measured) = 0.623 W/kg

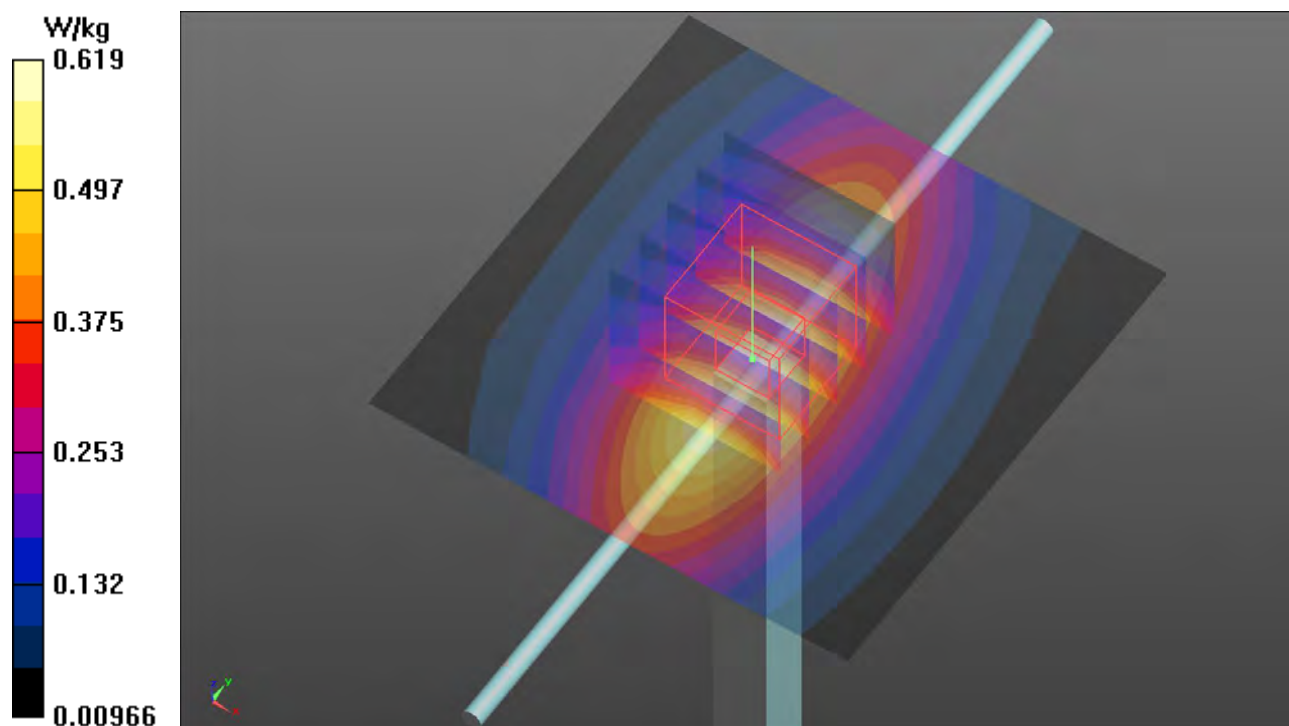

Plots of System Verification

Test Laboratory: Bureau Veritas ADT SAR/HAC Testing Lab

Date: 2022/04/02

S07 System Check_H2600_220402

DUT: Dipole 2600 MHz; Type: D2600V2; SN: 1020

Communication System: UID 0, CW; Frequency: 2600 MHz; Duty Cycle: 1:1

Medium: H19T27N1_0402 Medium parameters used: $f = 2600$ MHz; $\sigma = 2.015$ S/m; $\epsilon_r = 38.715$; $\rho = 1000$ kg/m³

Ambient Temperature : 23.4 °C ; Liquid Temperature : 23.3 °C

DASY5 Configuration:

- Probe: EX3DV4 - SN7472; ConvF(7.58, 7.58, 7.58) @ 2600 MHz; Calibrated: 2021/06/03
- Sensor-Surface: 1.4mm (Mechanical Surface Detection)
- Electronics: DAE4 Sn1698; Calibrated: 2021/11/09
- Phantom: ELI Phantom_1205; Type: QDOVA002AA;
- Measurement SW: DASY52, Version 52.10 (4); SEMCAD X Version 14.6.14 (7501)

Pin=50mW/Area Scan (81x81x1): Interpolated grid: dx=1.200 mm, dy=1.200 mm

Maximum value of SAR (interpolated) = 5.089 W/kg

Pin=50mW/Zoom Scan (7x7x7)/Cube 0: Measurement grid: dx=5mm, dy=5mm, dz=5mm

Reference Value = 51.90 V/m; Power Drift = -0.02 dB

Peak SAR (extrapolated) = 6.40 W/kg

SAR(1 g) = 2.93 W/kg; SAR(10 g) = 1.32 W/kg (SAR corrected for target medium)

Maximum value of SAR (measured) = 5.14 W/kg

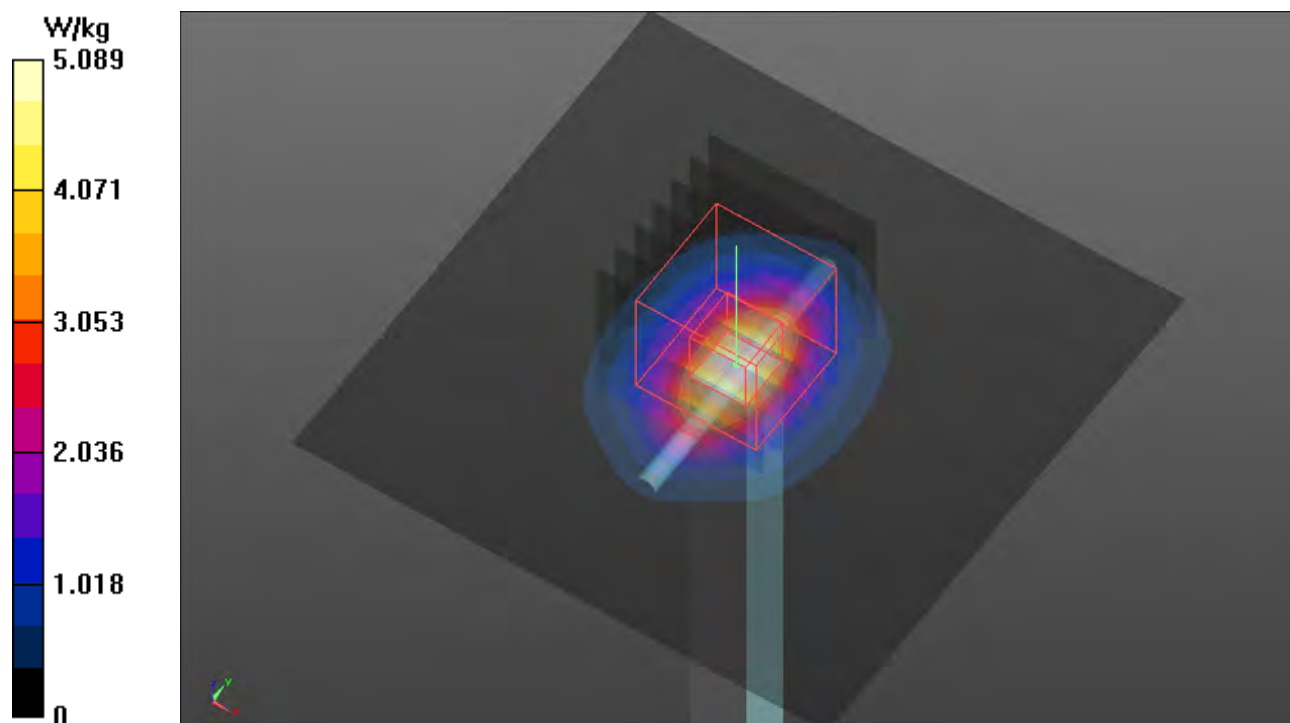

Plots of System Verification

Test Laboratory: Bureau Veritas ADT SAR/HAC Testing Lab

Date: 2022/03/28

S08 System Check_H750_220328

DUT: Dipole 750 MHz; Type: D750V3; SN: 1013

Communication System: UID 0, CW; Frequency: 750 MHz; Duty Cycle: 1:1

Medium: H06T09N1_0328 Medium parameters used: $f = 750$ MHz; $\sigma = 0.895$ S/m; $\epsilon_r = 40.706$; $\rho = 1000$ kg/m³

Ambient Temperature : 23.5 °C ; Liquid Temperature : 23.3 °C

DASY5 Configuration:

- Probe: EX3DV4 - SN7472; ConvF(10.32, 10.32, 10.32) @ 750 MHz; Calibrated: 2021/06/03
- Sensor-Surface: 1.4mm (Mechanical Surface Detection)
- Electronics: DAE4 Sn1698; Calibrated: 2021/11/09
- Phantom: ELI Phantom_1205; Type: QDOVA002AA;
- Measurement SW: DASY52, Version 52.10 (4); SEMCAD X Version 14.6.14 (7501)

Pin=50mW/Area Scan (61x81x1): Interpolated grid: dx=1.500 mm, dy=1.500 mm

Maximum value of SAR (interpolated) = 0.524 W/kg

Pin=50mW/Zoom Scan (5x5x7)/Cube 0: Measurement grid: dx=8mm, dy=8mm, dz=5mm

Reference Value = 25.52 V/m; Power Drift = 0.01 dB

Peak SAR (extrapolated) = 0.595 W/kg

SAR(1 g) = 0.389 W/kg; SAR(10 g) = 0.257 W/kg (SAR corrected for target medium)

Maximum value of SAR (measured) = 0.526 W/kg

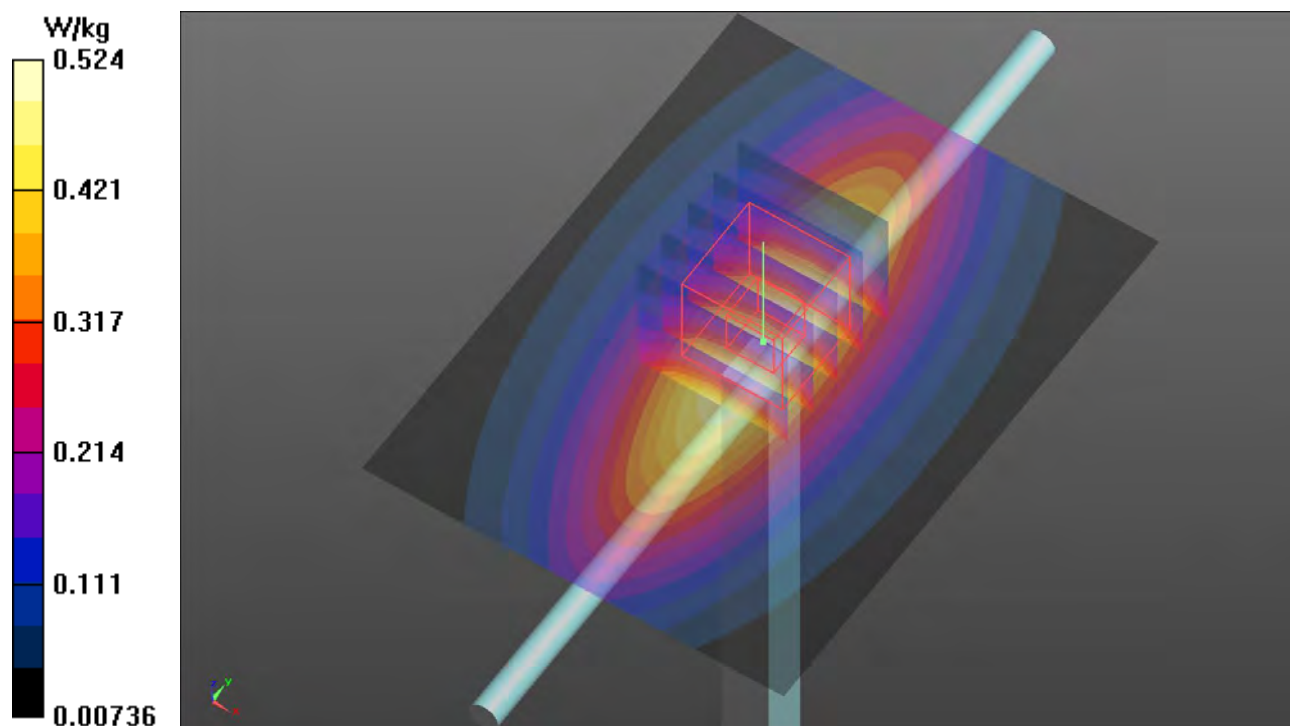

Plots of System Verification

Test Laboratory: Bureau Veritas ADT SAR/HAC Testing Lab

Date: 2022/03/28

S09 System Check_H750_220328

DUT: Dipole 750 MHz; Type: D750V3; SN: 1013

Communication System: UID 0, CW; Frequency: 750 MHz; Duty Cycle: 1:1

Medium: H06T09N1_0328 Medium parameters used: $f = 750$ MHz; $\sigma = 0.895$ S/m; $\epsilon_r = 40.706$; $\rho = 1000$ kg/m³

Ambient Temperature : 23.5 °C ; Liquid Temperature : 23.3 °C

DASY5 Configuration:

- Probe: EX3DV4 - SN7472; ConvF(10.32, 10.32, 10.32) @ 750 MHz; Calibrated: 2021/06/03
- Sensor-Surface: 1.4mm (Mechanical Surface Detection)
- Electronics: DAE4 Sn1698; Calibrated: 2021/11/09
- Phantom: ELI Phantom_1205; Type: QDOVA002AA;
- Measurement SW: DASY52, Version 52.10 (4); SEMCAD X Version 14.6.14 (7501)

Pin=50mW/Area Scan (61x81x1): Interpolated grid: dx=1.500 mm, dy=1.500 mm

Maximum value of SAR (interpolated) = 0.524 W/kg

Pin=50mW/Zoom Scan (5x5x7)/Cube 0: Measurement grid: dx=8mm, dy=8mm, dz=5mm

Reference Value = 25.52 V/m; Power Drift = 0.01 dB

Peak SAR (extrapolated) = 0.595 W/kg

SAR(1 g) = 0.389 W/kg; SAR(10 g) = 0.257 W/kg (SAR corrected for target medium)

Maximum value of SAR (measured) = 0.526 W/kg

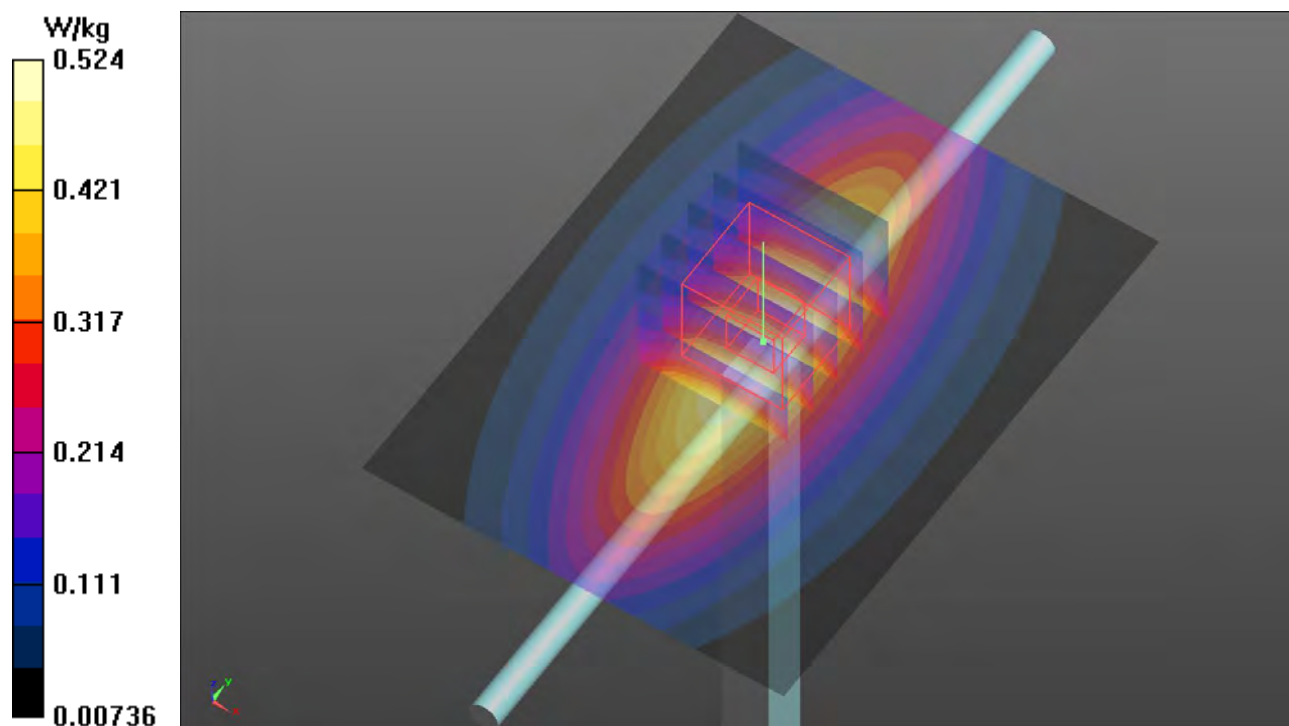

Plots of System Verification

Test Laboratory: Bureau Veritas ADT SAR/HAC Testing Lab

Date: 2022/03/29

S10 System Check_H750_220329

DUT: Dipole 750 MHz; Type: D750V3; SN: 1013

Communication System: UID 0, CW; Frequency: 750 MHz; Duty Cycle: 1:1

Medium: H06T09N1_0329 Medium parameters used: $f = 750$ MHz; $\sigma = 0.895$ S/m; $\epsilon_r = 40.662$; $\rho = 1000$ kg/m³

Ambient Temperature : 23.4 °C ; Liquid Temperature : 23.2 °C

DASY5 Configuration:

- Probe: EX3DV4 - SN7472; ConvF(10.32, 10.32, 10.32) @ 750 MHz; Calibrated: 2021/06/03
- Sensor-Surface: 1.4mm (Mechanical Surface Detection)
- Electronics: DAE4 Sn1698; Calibrated: 2021/11/09
- Phantom: ELI Phantom_1205; Type: QDOVA002AA;
- Measurement SW: DASY52, Version 52.10 (4); SEMCAD X Version 14.6.14 (7501)

Pin=50mW/Area Scan (61x81x1): Interpolated grid: $dx=1.500$ mm, $dy=1.500$ mm

Maximum value of SAR (interpolated) = 0.524 W/kg

Pin=50mW/Zoom Scan (5x5x7)/Cube 0: Measurement grid: $dx=8$ mm, $dy=8$ mm, $dz=5$ mm

Reference Value = 25.52 V/m; Power Drift = 0.01 dB

Peak SAR (extrapolated) = 0.595 W/kg

SAR(1 g) = 0.388 W/kg; SAR(10 g) = 0.254 W/kg (SAR corrected for target medium)

Maximum value of SAR (measured) = 0.526 W/kg

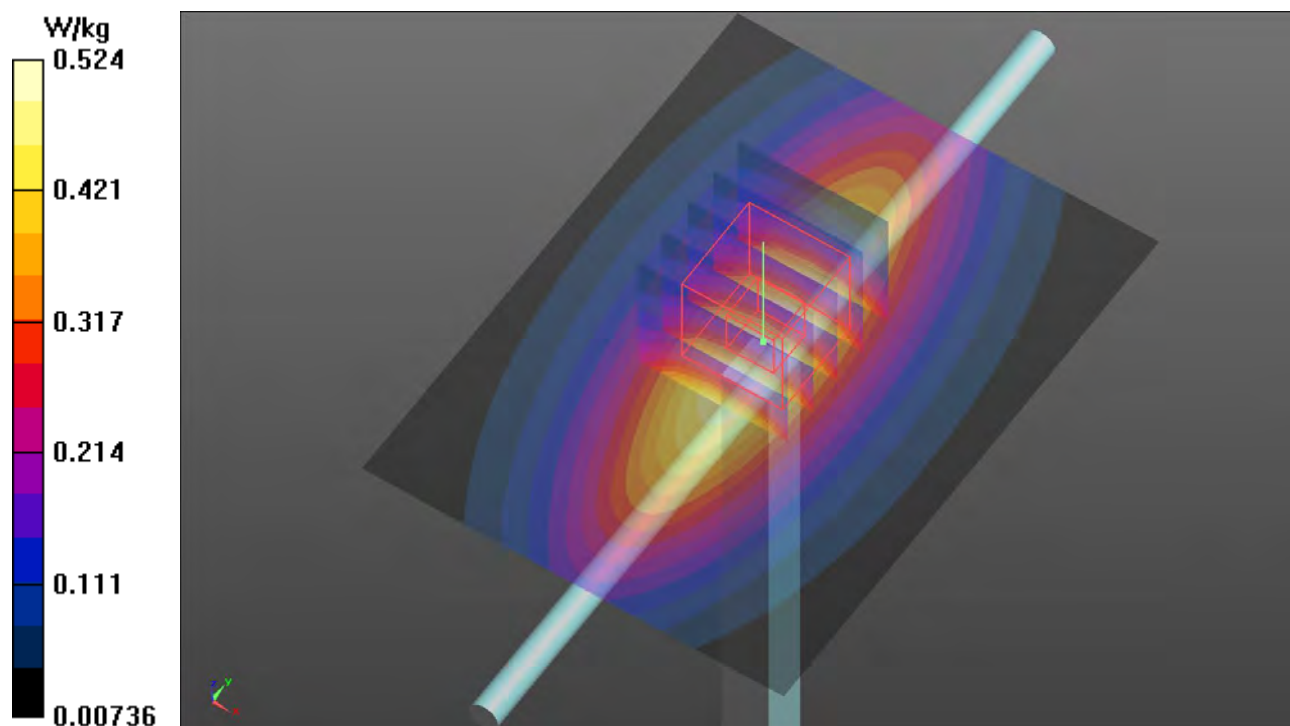

Plots of System Verification

Test Laboratory: Bureau Veritas ADT SAR/HAC Testing Lab

Date: 2022/03/29

S11 System Check_H750_220329

DUT: Dipole 750 MHz; Type: D750V3; SN: 1013

Communication System: UID 0, CW; Frequency: 750 MHz; Duty Cycle: 1:1

Medium: H06T09N1_0329 Medium parameters used: $f = 750$ MHz; $\sigma = 0.895$ S/m; $\epsilon_r = 40.662$; $\rho = 1000$ kg/m³

Ambient Temperature : 23.4 °C ; Liquid Temperature : 23.2 °C

DASY5 Configuration:

- Probe: EX3DV4 - SN7472; ConvF(10.32, 10.32, 10.32) @ 750 MHz; Calibrated: 2021/06/03
- Sensor-Surface: 1.4mm (Mechanical Surface Detection)
- Electronics: DAE4 Sn1698; Calibrated: 2021/11/09
- Phantom: ELI Phantom_1205; Type: QDOVA002AA;
- Measurement SW: DASY52, Version 52.10 (4); SEMCAD X Version 14.6.14 (7501)

Pin=50mW/Area Scan (61x81x1): Interpolated grid: dx=1.500 mm, dy=1.500 mm

Maximum value of SAR (interpolated) = 0.524 W/kg

Pin=50mW/Zoom Scan (5x5x7)/Cube 0: Measurement grid: dx=8mm, dy=8mm, dz=5mm

Reference Value = 25.52 V/m; Power Drift = 0.01 dB

Peak SAR (extrapolated) = 0.595 W/kg

SAR(1 g) = 0.388 W/kg; SAR(10 g) = 0.254 W/kg (SAR corrected for target medium)

Maximum value of SAR (measured) = 0.526 W/kg

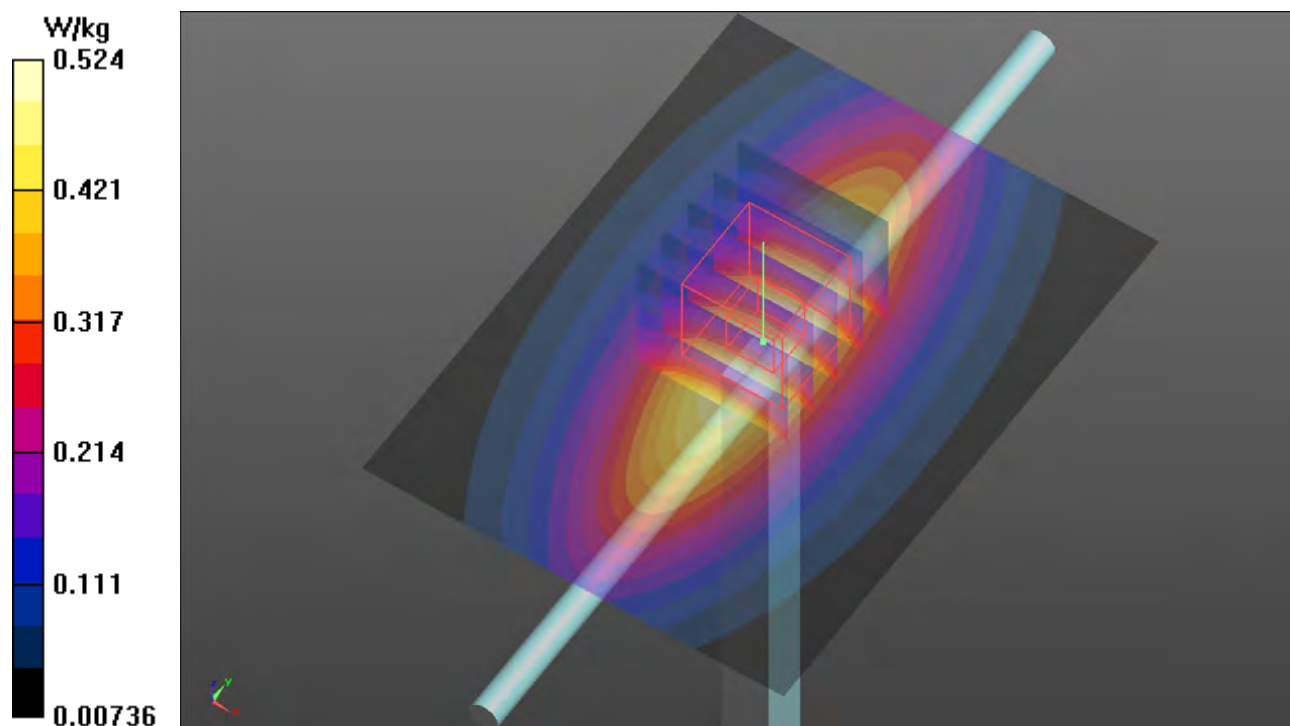

Plots of System Verification

Test Laboratory: Bureau Veritas ADT SAR/HAC Testing Lab

Date: 2022/03/31

S12 System Check_H1900_220331

DUT: Dipole 1900 MHz; Type: D1900V2; SN: 5d036

Communication System: UID 0, CW; Frequency: 1900 MHz; Duty Cycle: 1:1

Medium: H16T20N1_0331 Medium parameters used: $f = 1900$ MHz; $\sigma = 1.464$ S/m; $\epsilon_r = 38.853$; $\rho = 1000$ kg/m³

Ambient Temperature : 23.3 °C ; Liquid Temperature : 23.1 °C

DASY5 Configuration:

- Probe: EX3DV4 - SN7472; ConvF(8.43, 8.43, 8.43) @ 1900 MHz; Calibrated: 2021/06/03
- Sensor-Surface: 1.4mm (Mechanical Surface Detection)
- Electronics: DAE4 Sn1698; Calibrated: 2021/11/09
- Phantom: ELI Phantom_1205; Type: QDOVA002AA;
- Measurement SW: DASY52, Version 52.10 (4); SEMCAD X Version 14.6.14 (7501)

Pin=50mW/Area Scan (61x61x1): Interpolated grid: $dx=1.500$ mm, $dy=1.500$ mm

Maximum value of SAR (interpolated) = 3.207 W/kg

Pin=50mW/Zoom Scan (5x5x7)/Cube 0: Measurement grid: $dx=8$ mm, $dy=8$ mm, $dz=5$ mm

Reference Value = 48.02 V/m; Power Drift = 0.02 dB

Peak SAR (extrapolated) = 3.85 W/kg

SAR(1 g) = 2 W/kg; SAR(10 g) = 1.05 W/kg (SAR corrected for target medium)

Maximum value of SAR (measured) = 3.24 W/kg

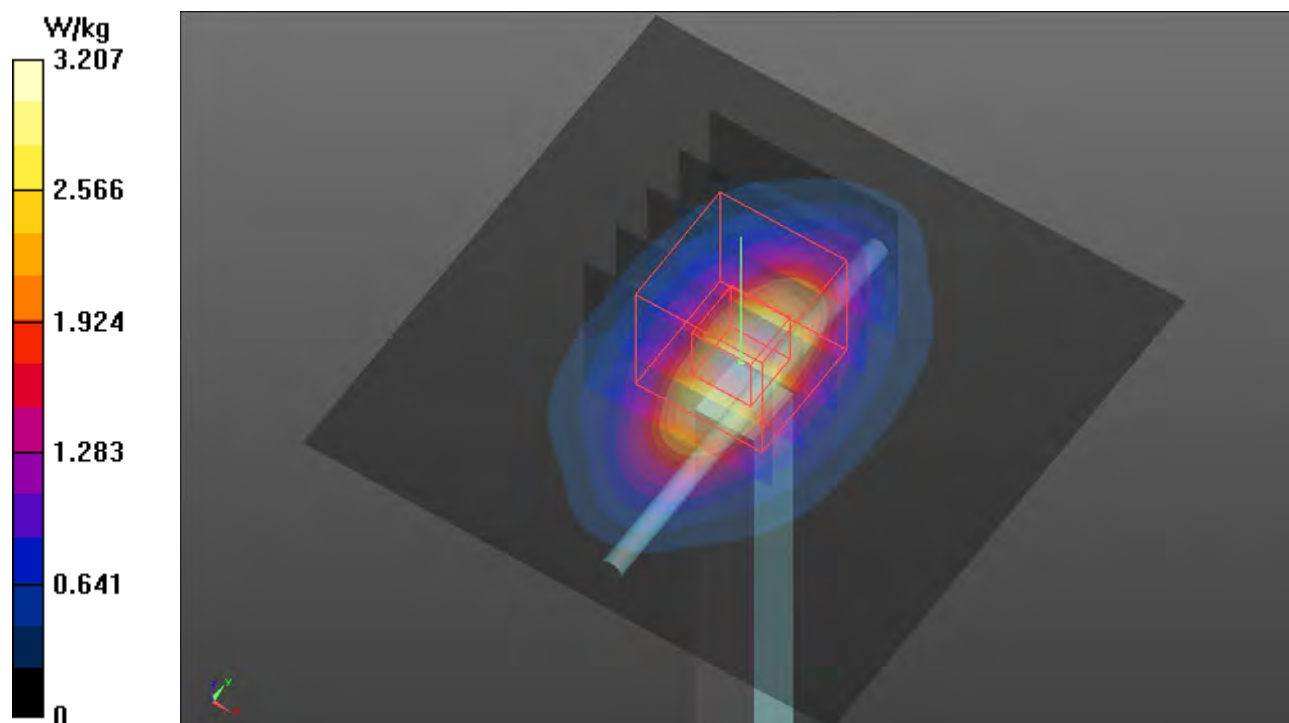

Plots of System Verification

Test Laboratory: Bureau Veritas ADT SAR/HAC Testing Lab

Date: 2022/03/30

S13 System Check_H835_220330

DUT: Dipole 835 MHz; Type: D835V2; SN: 4d121

Communication System: UID 0, CW; Frequency: 835 MHz; Duty Cycle: 1:1

Medium: H07T10N1_0330 Medium parameters used: $f = 835$ MHz; $\sigma = 0.936$ S/m; $\epsilon_r = 40.696$; $\rho = 1000$ kg/m³

Ambient Temperature : 23.3 °C ; Liquid Temperature : 23.2 °C

DASY5 Configuration:

- Probe: EX3DV4 - SN7472; ConvF(10.05, 10.05, 10.05) @ 835 MHz; Calibrated: 2021/06/03
- Sensor-Surface: 1.4mm (Mechanical Surface Detection)
- Electronics: DAE4 Sn1698; Calibrated: 2021/11/09
- Phantom: ELI Phantom_1205; Type: QDOVA002AA;
- Measurement SW: DASY52, Version 52.10 (4); SEMCAD X Version 14.6.14 (7501)

Pin=50mW/Area Scan (61x61x1): Interpolated grid: dx=1.500 mm, dy=1.500 mm

Maximum value of SAR (interpolated) = 0.619 W/kg

Pin=50mW/Zoom Scan (5x5x7)/Cube 0: Measurement grid: dx=8mm, dy=8mm, dz=5mm

Reference Value = 26.75 V/m; Power Drift = -0.01 dB

Peak SAR (extrapolated) = 0.700 W/kg

SAR(1 g) = 0.461 W/kg; SAR(10 g) = 0.312 W/kg (SAR corrected for target medium)

Maximum value of SAR (measured) = 0.623 W/kg

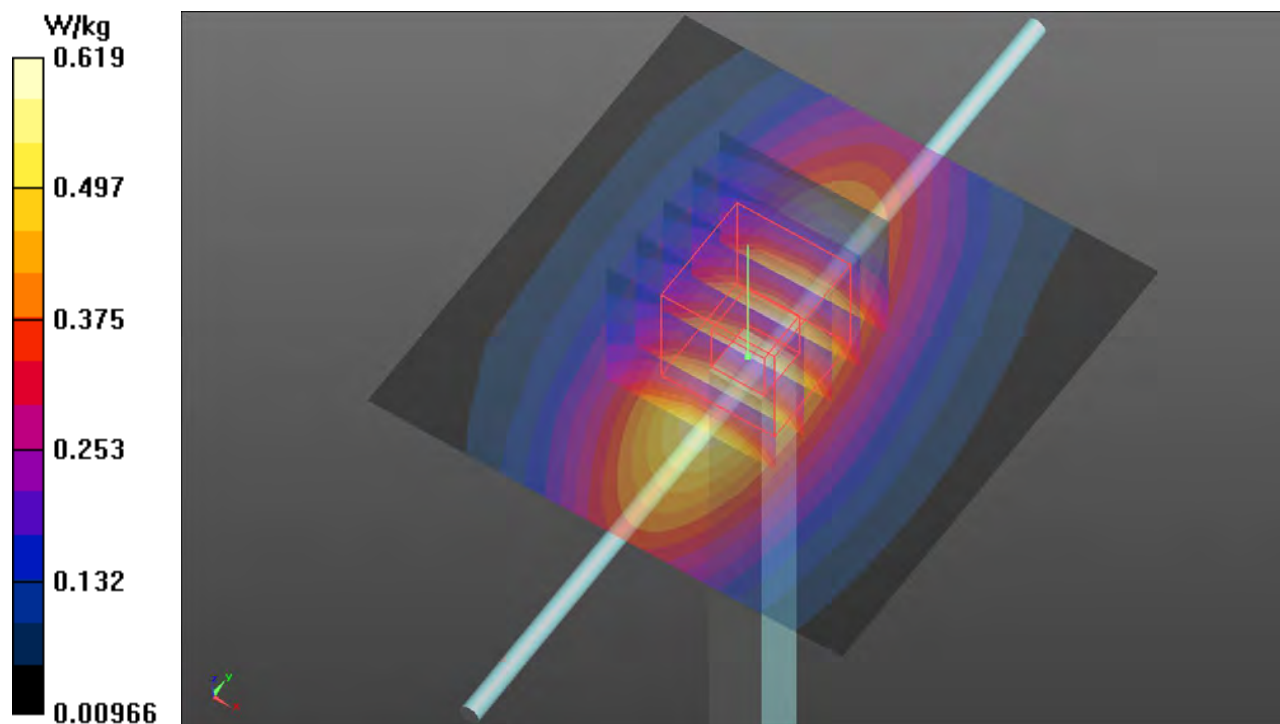

Plots of System Verification

Test Laboratory: Bureau Veritas ADT SAR/HAC Testing Lab

Date: 2022/04/02

S14 System Check_H2300_220402

DUT: Dipole 2300 MHz; Type: D2300V2; SN:1004

Communication System: UID 0, CW; Frequency: 2300 MHz; Duty Cycle: 1:1

Medium: H19T27N1_0402 Medium parameters used: $f = 2300$ MHz; $\sigma = 1.717$ S/m; $\epsilon_r = 39.621$; $\rho = 1000$ kg/m³

Ambient Temperature : 23.4 °C ; Liquid Temperature : 23.3 °C

DASY5 Configuration:

- Probe: EX3DV4 - SN7472; ConvF(8.13, 8.13, 8.13) @ 2300 MHz; Calibrated: 2021/06/03
- Sensor-Surface: 1.4mm (Mechanical Surface Detection)
- Electronics: DAE4 Sn1698; Calibrated: 2021/11/09
- Phantom: ELI Phantom_1205; Type: QDOVA002AA;
- Measurement SW: DASY52, Version 52.10 (4); SEMCAD X Version 14.6.14 (7501)

Pin=50mW/Area Scan (81x81x1): Interpolated grid: dx=1.200 mm, dy=1.200 mm

Maximum value of SAR (interpolated) = 3.963 W/kg

Pin=50mW/Zoom Scan (7x7x7)/Cube 0: Measurement grid: dx=5mm, dy=5mm, dz=5mm

Reference Value = 49.60 V/m; Power Drift = -0.12 dB

Peak SAR (extrapolated) = 4.91 W/kg

SAR(1 g) = 2.39 W/kg; SAR(10 g) = 1.15 W/kg (SAR corrected for target medium)

Maximum value of SAR (measured) = 3.99 W/kg

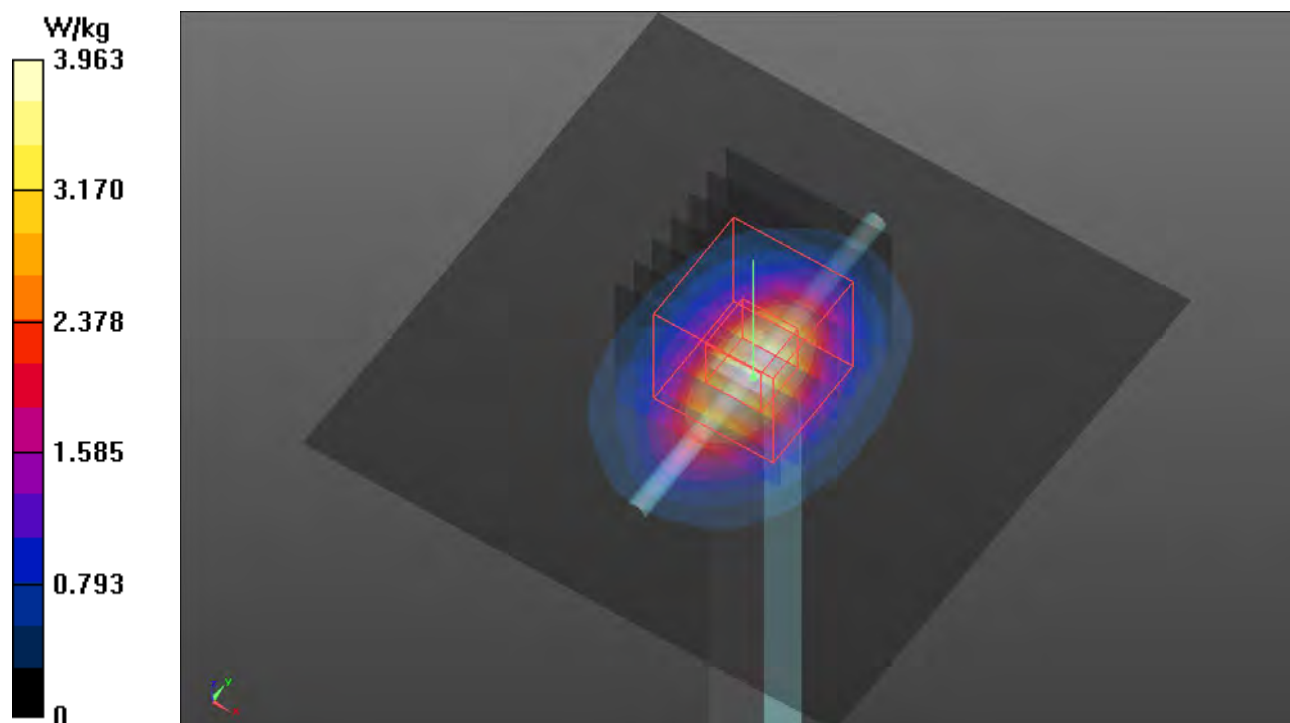

Plots of System Verification

Test Laboratory: Bureau Veritas ADT SAR/HAC Testing Lab

Date: 2022/04/02

S15 System Check_H2600_220402

DUT: Dipole 2600 MHz; Type: D2600V2; SN: 1020

Communication System: UID 0, CW; Frequency: 2600 MHz; Duty Cycle: 1:1

Medium: H19T27N1_0402 Medium parameters used: $f = 2600$ MHz; $\sigma = 2.015$ S/m; $\epsilon_r = 38.715$; $\rho = 1000$ kg/m³

Ambient Temperature : 23.4 °C ; Liquid Temperature : 23.3 °C

DASY5 Configuration:

- Probe: EX3DV4 - SN7472; ConvF(7.58, 7.58, 7.58) @ 2600 MHz; Calibrated: 2021/06/03
- Sensor-Surface: 1.4mm (Mechanical Surface Detection)
- Electronics: DAE4 Sn1698; Calibrated: 2021/11/09
- Phantom: ELI Phantom_1205; Type: QDOVA002AA;
- Measurement SW: DASY52, Version 52.10 (4); SEMCAD X Version 14.6.14 (7501)

Pin=50mW/Area Scan (81x81x1): Interpolated grid: dx=1.200 mm, dy=1.200 mm

Maximum value of SAR (interpolated) = 5.089 W/kg

Pin=50mW/Zoom Scan (7x7x7)/Cube 0: Measurement grid: dx=5mm, dy=5mm, dz=5mm

Reference Value = 51.90 V/m; Power Drift = -0.02 dB

Peak SAR (extrapolated) = 6.40 W/kg

SAR(1 g) = 2.93 W/kg; SAR(10 g) = 1.32 W/kg (SAR corrected for target medium)

Maximum value of SAR (measured) = 5.14 W/kg

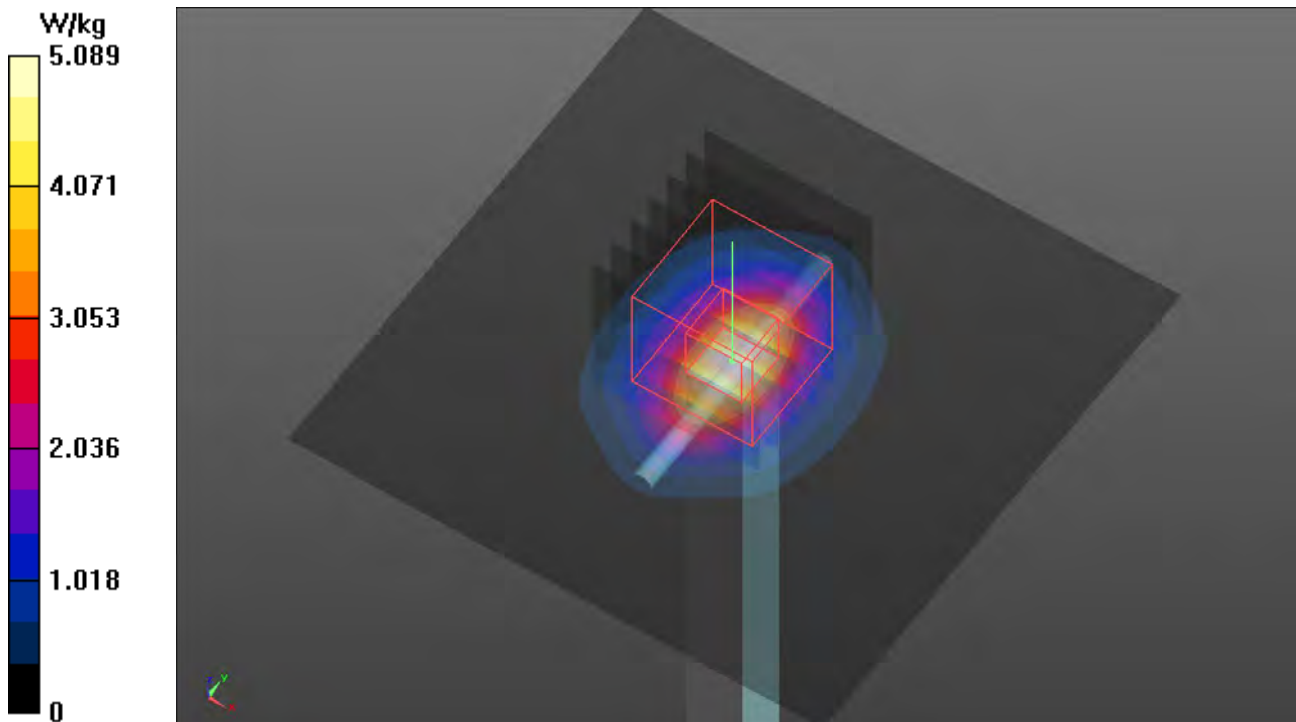

Plots of System Verification

Test Laboratory: Bureau Veritas ADT SAR/HAC Testing Lab

Date: 2022/04/03

S16 System Check_H2300_220403

DUT: Dipole 2300 MHz; Type: D2300V2; SN:1004

Communication System: UID 0, CW; Frequency: 2300 MHz; Duty Cycle: 1:1

Medium: H19T27N1_0403 Medium parameters used: $f = 2300$ MHz; $\sigma = 1.681$ S/m; $\epsilon_r = 38.157$; $\rho = 1000$ kg/m³

Ambient Temperature : 23.3 °C ; Liquid Temperature : 23.1 °C

DASY5 Configuration:

- Probe: EX3DV4 - SN7472; ConvF(8.13, 8.13, 8.13) @ 2300 MHz; Calibrated: 2021/06/03
- Sensor-Surface: 1.4mm (Mechanical Surface Detection)
- Electronics: DAE4 Sn1698; Calibrated: 2021/11/09
- Phantom: ELI Phantom_1205; Type: QDOVA002AA;
- Measurement SW: DASY52, Version 52.10 (4); SEMCAD X Version 14.6.14 (7501)

Pin=50mW/Area Scan (81x81x1): Interpolated grid: dx=1.200 mm, dy=1.200 mm

Maximum value of SAR (interpolated) = 3.88 W/kg

Pin=50mW/Zoom Scan (7x7x7)/Cube 0: Measurement grid: dx=5mm, dy=5mm, dz=5mm

Reference Value = 49.60 V/m; Power Drift = -0.12 dB

Peak SAR (extrapolated) = 4.81 W/kg

SAR(1 g) = 2.34 W/kg; SAR(10 g) = 1.13 W/kg (SAR corrected for target medium)

Maximum value of SAR (measured) = 3.91 W/kg

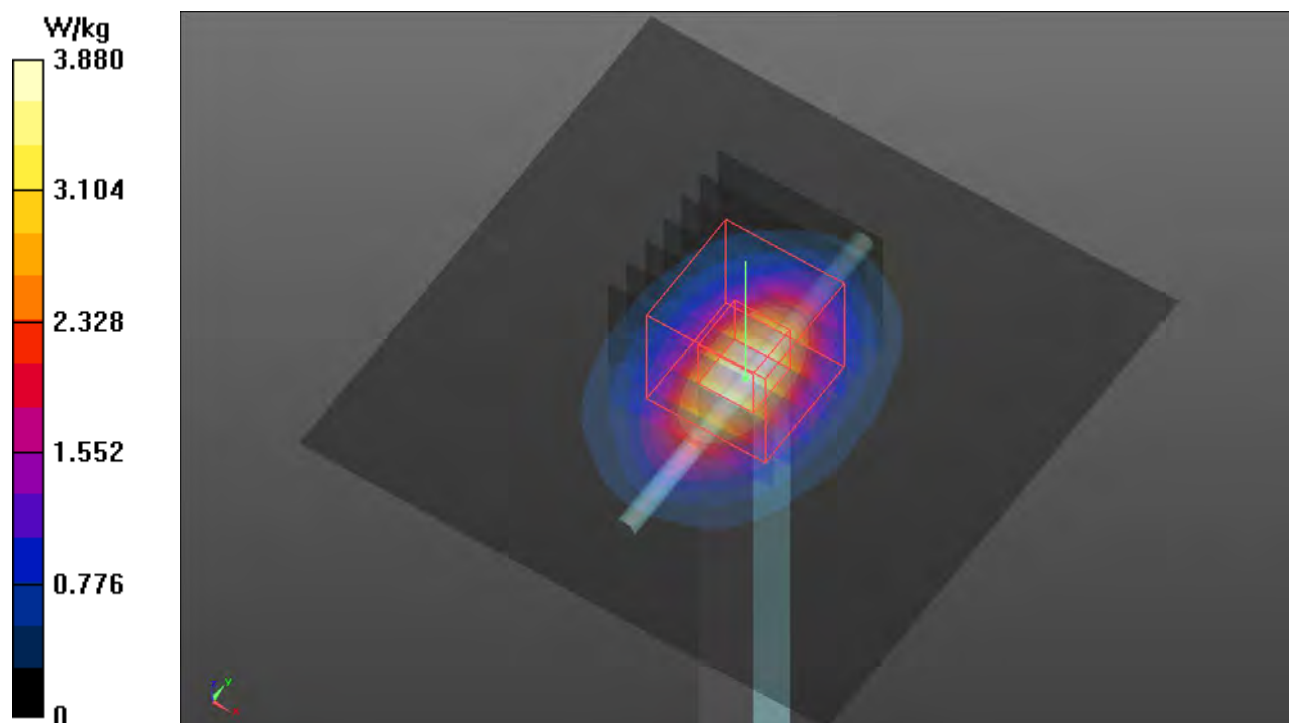

Plots of System Verification

Test Laboratory: Bureau Veritas ADT SAR/HAC Testing Lab

Date: 2022/04/03

S17 System Check_H2600_220403

DUT: Dipole 2600 MHz; Type: D2600V2; SN: 1020

Communication System: UID 0, CW; Frequency: 2600 MHz; Duty Cycle: 1:1

Medium: H19T27N1_0403 Medium parameters used: $f = 2600$ MHz; $\sigma = 1.904$ S/m; $\epsilon_r = 37.668$; $\rho = 1000$ kg/m³

Ambient Temperature : 23.3 °C ; Liquid Temperature : 23.1 °C

DASY5 Configuration:

- Probe: EX3DV4 - SN7472; ConvF(7.58, 7.58, 7.58) @ 2600 MHz; Calibrated: 2021/06/03
- Sensor-Surface: 1.4mm (Mechanical Surface Detection)
- Electronics: DAE4 Sn1698; Calibrated: 2021/11/09
- Phantom: ELI Phantom_1205; Type: QDOVA002AA;
- Measurement SW: DASY52, Version 52.10 (4); SEMCAD X Version 14.6.14 (7501)

Pin=50mW/Area Scan (81x81x1): Interpolated grid: dx=1.200 mm, dy=1.200 mm

Maximum value of SAR (interpolated) = 4.81 W/kg

Pin=50mW/Zoom Scan (7x7x7)/Cube 0: Measurement grid: dx=5mm, dy=5mm, dz=5mm

Reference Value = 51.90 V/m; Power Drift = -0.02 dB

Peak SAR (extrapolated) = 6.05 W/kg

SAR(1 g) = 2.82 W/kg; SAR(10 g) = 1.26 W/kg (SAR corrected for target medium)

Maximum value of SAR (measured) = 4.85 W/kg

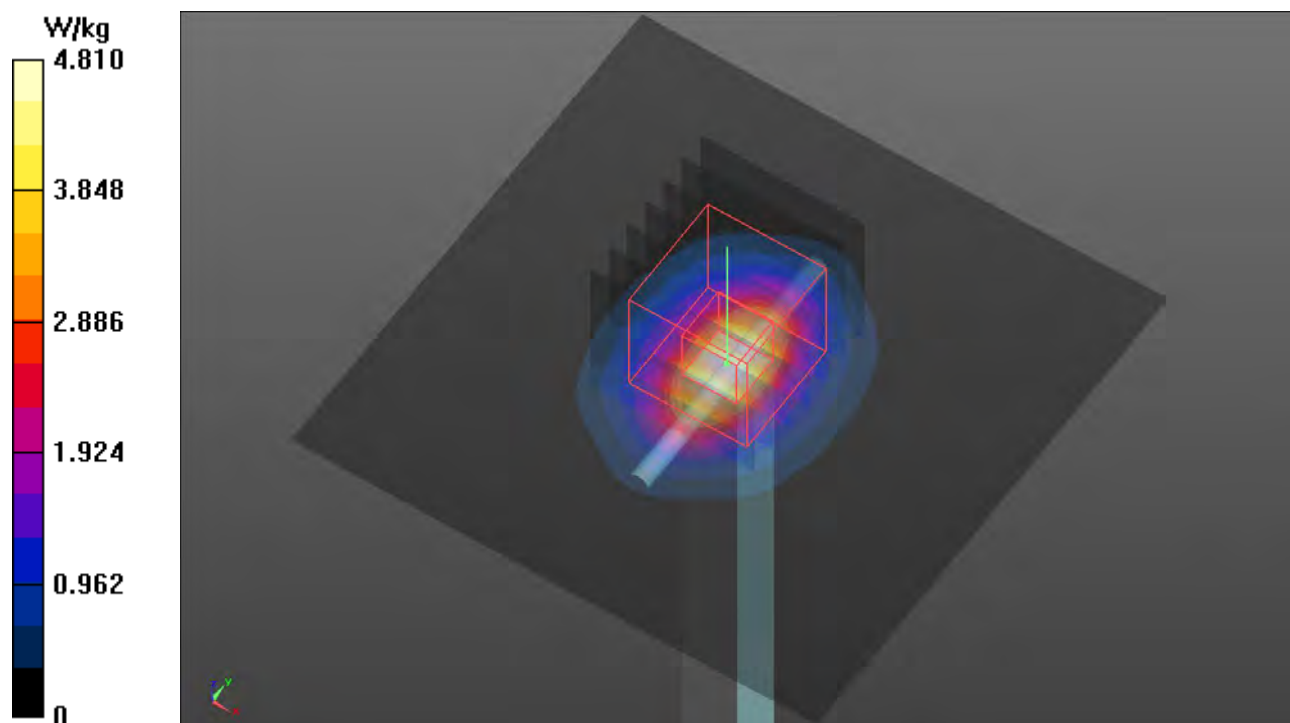

Plots of System Verification

Test Laboratory: Bureau Veritas ADT SAR/HAC Testing Lab

Date: 2022/04/04

S20a System Check_H3500_220404

DUT: Dipole 3500 MHz; Type:D3500V2; SN: 1007

Communication System: UID 0, CW; Frequency: 3500 MHz; Duty Cycle: 1:1

Medium: H34T38N1_0404 Medium parameters used: $f = 3500$ MHz; $\sigma = 2.938$ S/m; $\epsilon_r = 36.985$; $\rho = 1000$ kg/m³

Ambient Temperature : 23.6 °C ; Liquid Temperature : 23.3 °C

DASY5 Configuration:

- Probe: EX3DV4 - SN7472; ConvF(7.17, 7.17, 7.17) @ 3500 MHz; Calibrated: 2021/06/03
- Sensor-Surface: 1.4mm (Mechanical Surface Detection)
- Electronics: DAE4 Sn1698; Calibrated: 2021/11/09
- Phantom: ELI Phantom_1205; Type: QDOVA002AA;
- Measurement SW: DASY52, Version 52.10 (4); SEMCAD X Version 14.6.14 (7501)

Pin=50mW/Area Scan (81x81x1): Interpolated grid: dx=1.200 mm, dy=1.200 mm

Maximum value of SAR (interpolated) = 6.44 W/kg

Pin=50mW/Zoom Scan (7x7x7)/Cube 0: Measurement grid: dx=5mm, dy=5mm, dz=2.5mm

Reference Value = 50.19 V/m; Power Drift = -0.13 dB

Peak SAR (extrapolated) = 8.42 W/kg

SAR(1 g) = 3.38 W/kg; SAR(10 g) = 1.30 W/kg (SAR corrected for target medium)

Maximum value of SAR (measured) = 6.49 W/kg

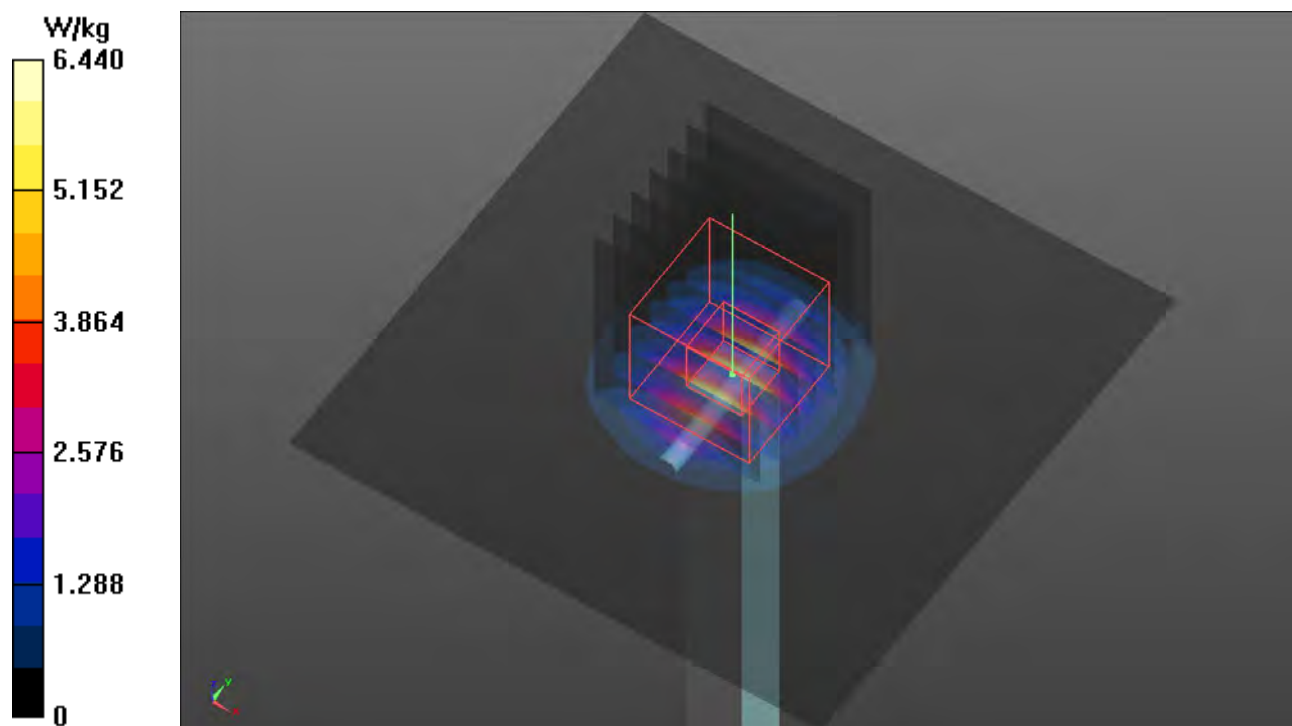

Plots of System Verification

Test Laboratory: Bureau Veritas ADT SAR/HAC Testing Lab

Date: 2022/04/04

S20b System Check_H3700_220404

DUT: Dipole 3700 MHz; Type:D3700V2; SN: 1017

Communication System: UID 0, CW; Frequency: 3700 MHz; Duty Cycle: 1:1

Medium: H34T38N1_0404 Medium parameters used: $f = 3700$ MHz; $\sigma = 3.088$ S/m; $\epsilon_r = 36.804$; $\rho = 1000$ kg/m³

Ambient Temperature : 23.6 °C ; Liquid Temperature : 23.3 °C

DASY5 Configuration:

- Probe: EX3DV4 - SN7472; ConvF(7.12, 7.12, 7.12) @ 3700 MHz; Calibrated: 2021/06/03
- Sensor-Surface: 1.4mm (Mechanical Surface Detection)
- Electronics: DAE4 Sn1698; Calibrated: 2021/11/09
- Phantom: ELI Phantom_1205; Type: QDOVA002AA;
- Measurement SW: DASY52, Version 52.10 (4); SEMCAD X Version 14.6.14 (7501)

Pin=50mW/Area Scan (81x81x1): Interpolated grid: dx=1.200 mm, dy=1.200 mm

Maximum value of SAR (interpolated) = 6.48 W/kg

Pin=50mW/Zoom Scan (7x7x7)/Cube 0: Measurement grid: dx=5mm, dy=5mm, dz=2.5mm

Reference Value = 49.24 V/m; Power Drift = -0.05 dB

Peak SAR (extrapolated) = 8.41 W/kg

SAR(1 g) = 3.32 W/kg; SAR(10 g) = 1.24 W/kg (SAR corrected for target medium)

Maximum value of SAR (measured) = 6.41 W/kg

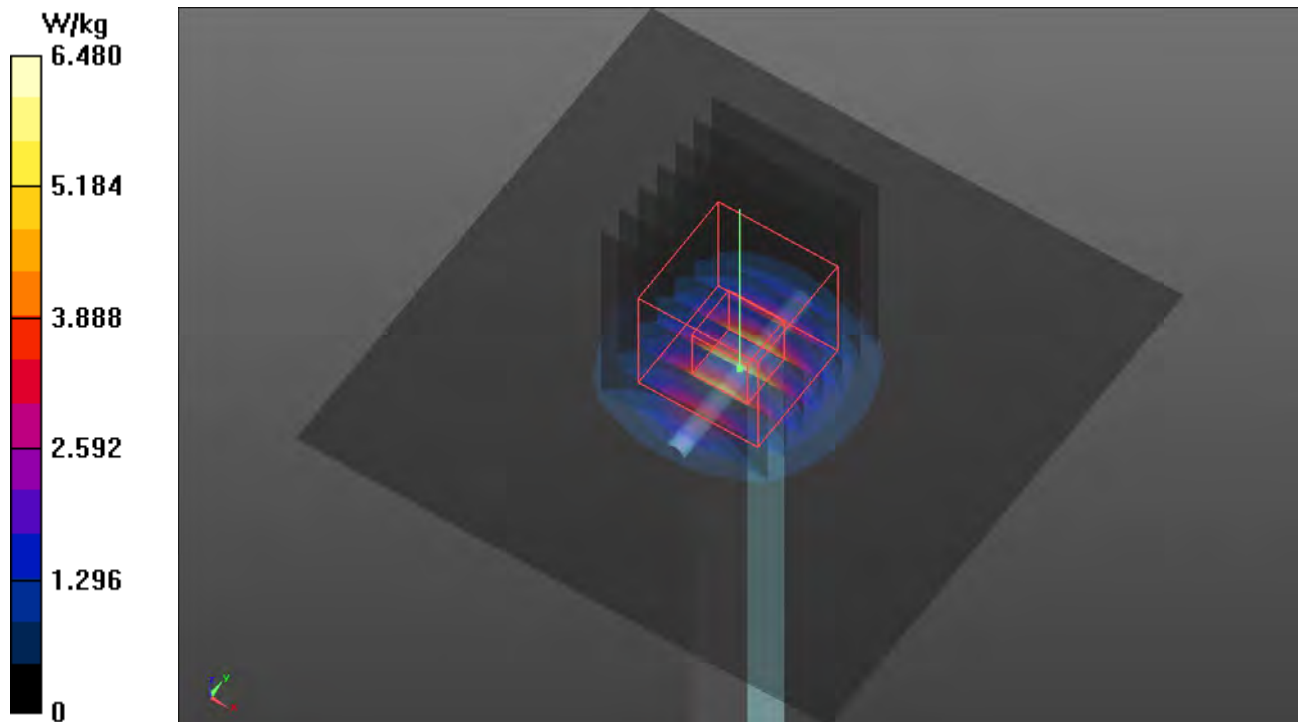

Plots of System Verification

Test Laboratory: Bureau Veritas ADT SAR/HAC Testing Lab

Date: 2022/04/01

S21 System Check_H1750_220401

DUT: Dipole 1750 MHz; Type: D1750V2; SN: 1055

Communication System: UID 0, CW; Frequency: 1750 MHz; Duty Cycle: 1:1

Medium: H16T20N1_0401 Medium parameters used: $f = 1750$ MHz; $\sigma = 1.321$ S/m; $\epsilon_r = 39.14$; $\rho = 1000$ kg/m³

Ambient Temperature : 23.5 °C ; Liquid Temperature : 23.4 °C

DASY5 Configuration:

- Probe: EX3DV4 - SN7472; ConvF(8.77, 8.77, 8.77) @ 1750 MHz; Calibrated: 2021/06/03
- Sensor-Surface: 1.4mm (Mechanical Surface Detection)
- Electronics: DAE4 Sn1698; Calibrated: 2021/11/09
- Phantom: ELI Phantom_1205; Type: QDOVA002AA;
- Measurement SW: DASY52, Version 52.10 (4); SEMCAD X Version 14.6.14 (7501)

Pin=50mW/Area Scan (61x61x1): Interpolated grid: dx=1.500 mm, dy=1.500 mm

Maximum value of SAR (interpolated) = 2.57 W/kg

Pin=50mW/Zoom Scan (5x5x7)/Cube 0: Measurement grid: dx=8mm, dy=8mm, dz=5mm

Reference Value = 41.45 V/m; Power Drift = -0.10 dB

Peak SAR (extrapolated) = 3.13 W/kg

SAR(1 g) = 1.77 W/kg; SAR(10 g) = 0.935 W/kg (SAR corrected for target medium)

Maximum value of SAR (measured) = 2.66 W/kg

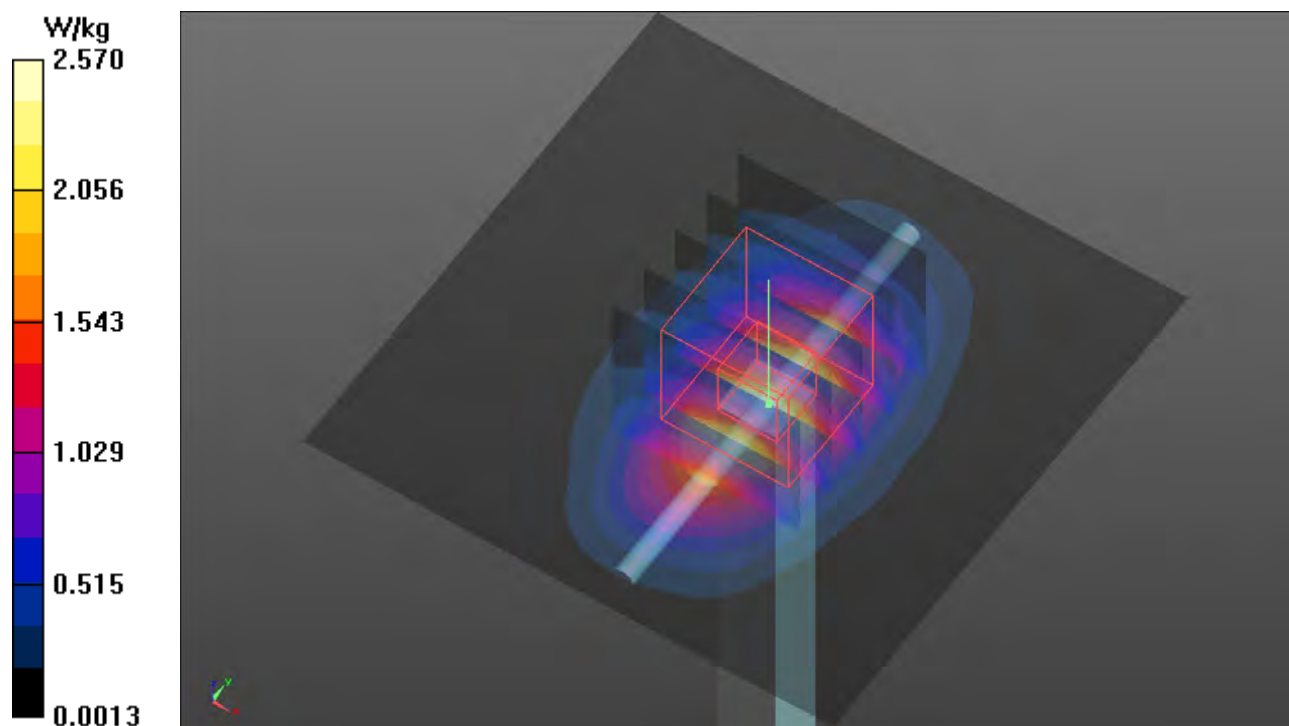

Plots of System Verification

Test Laboratory: Bureau Veritas ADT SAR/HAC Testing Lab

Date: 2022/03/29

S22 System Check_H750_220329

DUT: Dipole 750 MHz; Type: D750V3; SN: 1013

Communication System: UID 0, CW; Frequency: 750 MHz; Duty Cycle: 1:1

Medium: H06T09N0_0329 Medium parameters used: $f = 750$ MHz; $\sigma = 0.914$ S/m; $\epsilon_r = 40.813$; $\rho = 1000$ kg/m³

Ambient Temperature : 23.4 °C ; Liquid Temperature : 23.2 °C

DASY5 Configuration:

- Probe: EX3DV4 - SN7472; ConvF(10.32, 10.32, 10.32) @ 750 MHz; Calibrated: 2021/06/03
- Sensor-Surface: 1.4mm (Mechanical Surface Detection)
- Electronics: DAE4 Sn1698; Calibrated: 2021/11/09
- Phantom: ELI Phantom_1205; Type: QDOVA002AA;
- Measurement SW: DASY52, Version 52.10 (4); SEMCAD X Version 14.6.14 (7501)

Pin=50mW/Area Scan (61x81x1): Interpolated grid: dx=1.500 mm, dy=1.500 mm

Maximum value of SAR (interpolated) = 0.530 W/kg

Pin=50mW/Zoom Scan (5x5x7)/Cube 0: Measurement grid: dx=8mm, dy=8mm, dz=5mm

Reference Value = 25.20 V/m; Power Drift = 0.05 dB

Peak SAR (extrapolated) = 0.600 W/kg

SAR(1 g) = 0.390 W/kg; SAR(10 g) = 0.259 W/kg (SAR corrected for target medium)

Maximum value of SAR (measured) = 0.533 W/kg

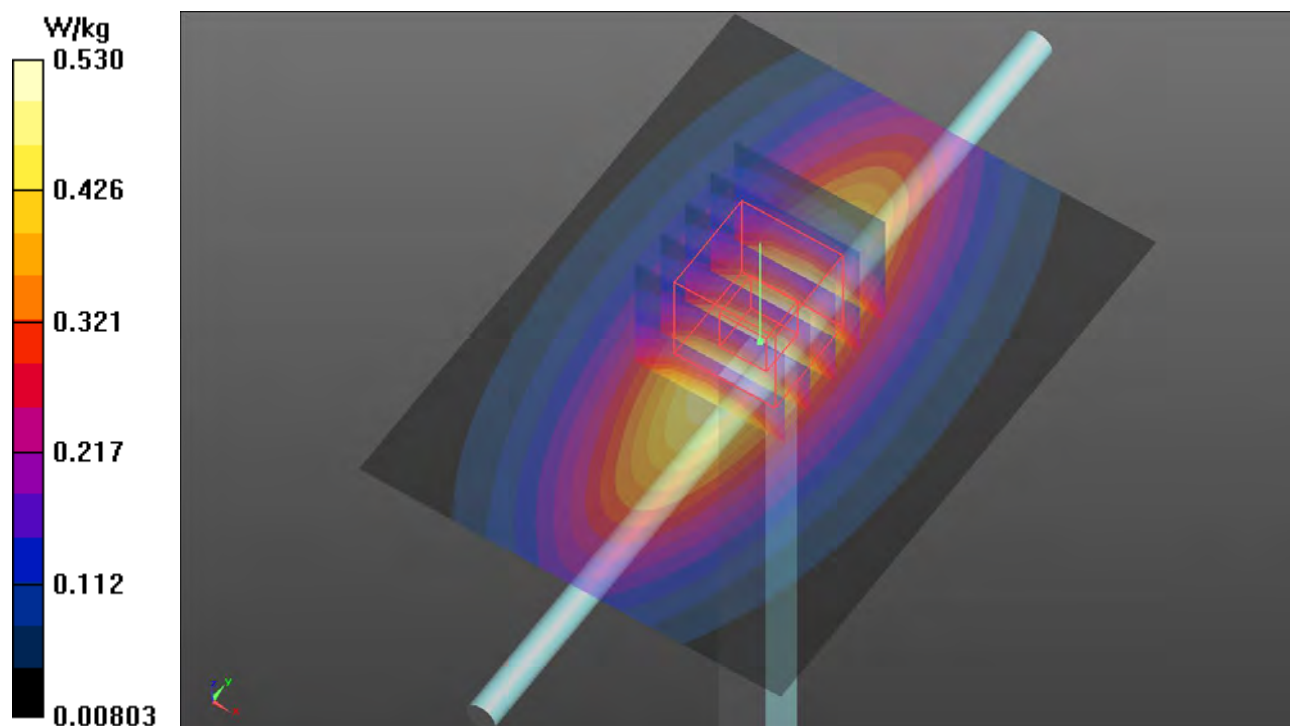

Plots of System Verification

Test Laboratory: Bureau Veritas ADT SAR/HAC Testing Lab

Date: 2022/04/06

S23 System Check_H1900_220406

DUT: Dipole 1900 MHz; Type: D1900V2; SN: 5d036

Communication System: UID 0, CW; Frequency: 1900 MHz; Duty Cycle: 1:1

Medium: H16T20N1_0406 Medium parameters used: $f = 1900$ MHz; $\sigma = 1.463$ S/m; $\epsilon_r = 38.84$; $\rho = 1000$ kg/m³

Ambient Temperature : 23.4 °C ; Liquid Temperature : 23.3 °C

DASY5 Configuration:

- Probe: EX3DV4 - SN7472; ConvF(8.43, 8.43, 8.43) @ 1900 MHz; Calibrated: 2021/06/03
- Sensor-Surface: 1.4mm (Mechanical Surface Detection)
- Electronics: DAE4 Sn1698; Calibrated: 2021/11/09
- Phantom: ELI Phantom_1205; Type: QDOVA002AA;
- Measurement SW: DASY52, Version 52.10 (4); SEMCAD X Version 14.6.14 (7501)

Pin=50mW/Area Scan (61x61x1): Interpolated grid: dx=1.500 mm, dy=1.500 mm

Maximum value of SAR (interpolated) = 3.21 W/kg

Pin=50mW/Zoom Scan (5x5x7)/Cube 0: Measurement grid: dx=8mm, dy=8mm, dz=5mm

Reference Value = 48.02 V/m; Power Drift = 0.02 dB

Peak SAR (extrapolated) = 3.85 W/kg

SAR(1 g) = 2 W/kg; SAR(10 g) = 1.05 W/kg (SAR corrected for target medium)

Maximum value of SAR (measured) = 3.24 W/kg

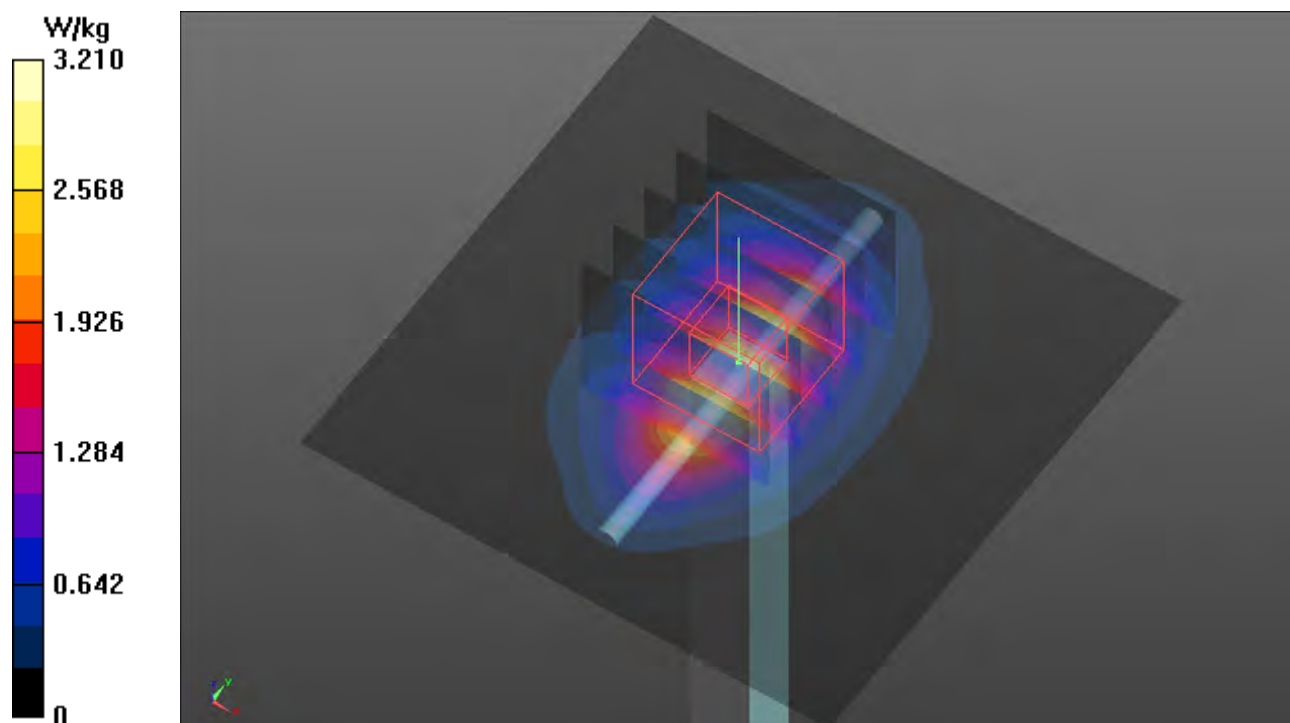

Plots of System Verification

Test Laboratory: Bureau Veritas ADT SAR/HAC Testing Lab

Date: 2022/04/05

S24 System Check_H835_220405

DUT: Dipole 835 MHz; Type: D835V2; SN: 4d121

Communication System: UID 0, CW; Frequency: 835 MHz; Duty Cycle: 1:1

Medium: H06T09N1_0405 Medium parameters used: $f = 835$ MHz; $\sigma = 0.911$ S/m; $\epsilon_r = 42.459$; $\rho = 1000$ kg/m³

Ambient Temperature : 23.3 °C ; Liquid Temperature : 23.2 °C

DASY5 Configuration:

- Probe: EX3DV4 - SN7472; ConvF(10.05, 10.05, 10.05) @ 835 MHz; Calibrated: 2021/06/03
- Sensor-Surface: 1.4mm (Mechanical Surface Detection)
- Electronics: DAE4 Sn1698; Calibrated: 2021/11/09
- Phantom: ELI Phantom_1205; Type: QDOVA002AA;
- Measurement SW: DASY52, Version 52.10 (4); SEMCAD X Version 14.6.14 (7501)

Pin=50mW/Area Scan (61x61x1): Interpolated grid: dx=1.500 mm, dy=1.500 mm

Maximum value of SAR (interpolated) = 0.682 W/kg

Pin=50mW/Zoom Scan (5x5x7)/Cube 0: Measurement grid: dx=8mm, dy=8mm, dz=5mm

Reference Value = 28.57 V/m; Power Drift = 0.01 dB

Peak SAR (extrapolated) = 0.770 W/kg

SAR(1 g) = 0.525 W/kg; SAR(10 g) = 0.353 W/kg (SAR corrected for target medium)

Maximum value of SAR (measured) = 0.687 W/kg

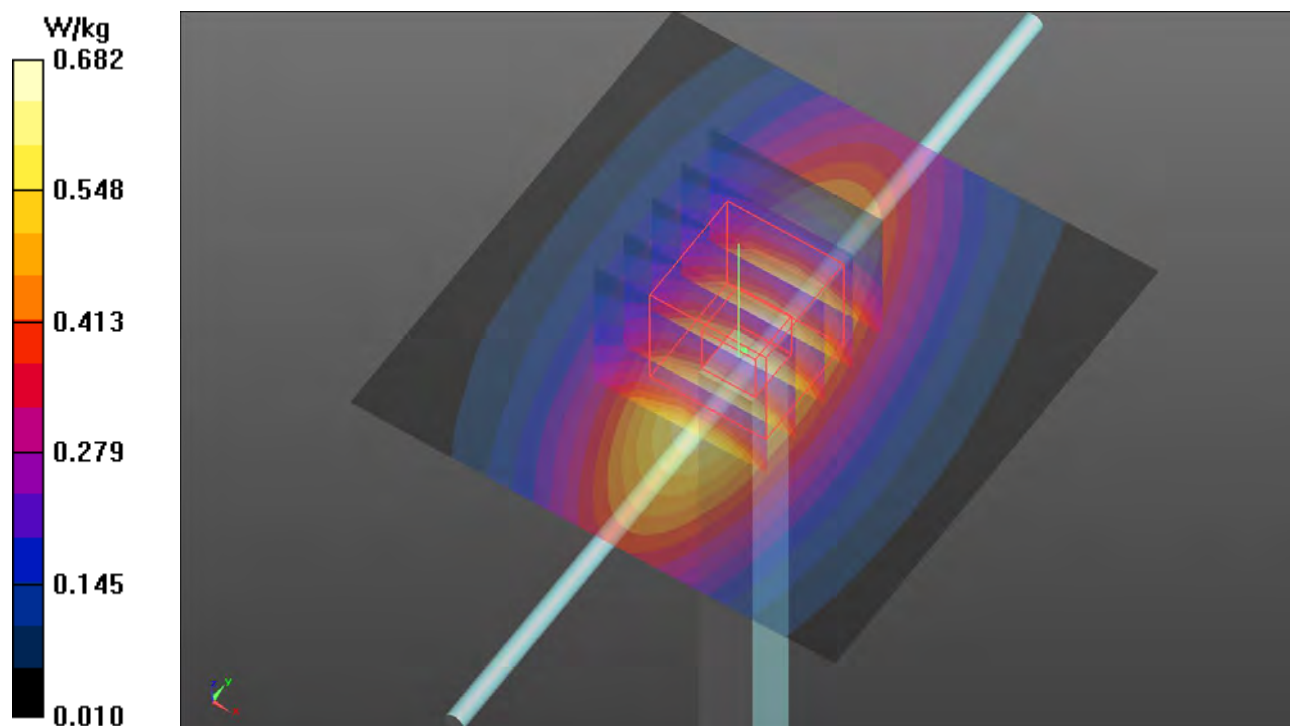

Plots of System Verification

Test Laboratory: Bureau Veritas ADT SAR/HAC Testing Lab

Date: 2022/04/05

S25 System Check_H2600_220405

DUT: Dipole 2600 MHz; Type: D2600V2; SN: 1020

Communication System: UID 0, CW; Frequency: 2600 MHz; Duty Cycle: 1:1

Medium: H19T27N1_0405 Medium parameters used: $f = 2600$ MHz; $\sigma = 1.905$ S/m; $\epsilon_r = 37.687$; $\rho = 1000$ kg/m³

Ambient Temperature : 23.3 °C ; Liquid Temperature : 23.2 °C

DASY5 Configuration:

- Probe: EX3DV4 - SN7472; ConvF(7.58, 7.58, 7.58) @ 2600 MHz; Calibrated: 2021/06/03
- Sensor-Surface: 1.4mm (Mechanical Surface Detection)
- Electronics: DAE4 Sn1698; Calibrated: 2021/11/09
- Phantom: ELI Phantom_1205; Type: QDOVA002AA;
- Measurement SW: DASY52, Version 52.10 (4); SEMCAD X Version 14.6.14 (7501)

Pin=50mW/Area Scan (81x81x1): Interpolated grid: $dx=1.200$ mm, $dy=1.200$ mm

Maximum value of SAR (interpolated) = 4.811 W/kg

Pin=50mW/Zoom Scan (7x7x7)/Cube 0: Measurement grid: $dx=5$ mm, $dy=5$ mm, $dz=5$ mm

Reference Value = 51.90 V/m; Power Drift = -0.02 dB

Peak SAR (extrapolated) = 6.05 W/kg

SAR(1 g) = 2.83 W/kg; SAR(10 g) = 1.26 W/kg (SAR corrected for target medium)

Maximum value of SAR (measured) = 4.85 W/kg

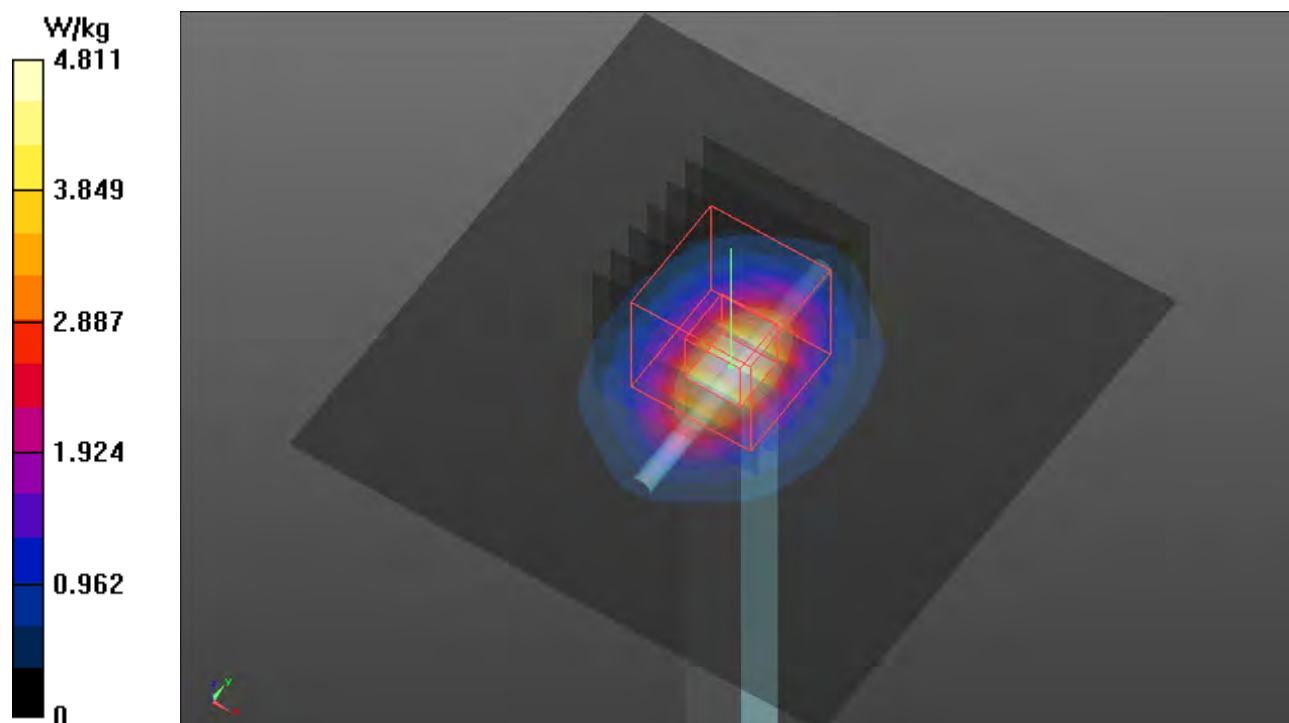

Plots of System Verification

Test Laboratory: Bureau Veritas ADT SAR/HAC Testing Lab

Date: 2022/04/06

S26 System Check_H1900_220406

DUT: Dipole 1900 MHz; Type: D1900V2; SN: 5d036

Communication System: UID 0, CW; Frequency: 1900 MHz; Duty Cycle: 1:1

Medium: H16T20N1_0406 Medium parameters used: $f = 1900$ MHz; $\sigma = 1.463$ S/m; $\epsilon_r = 38.84$; $\rho = 1000$ kg/m³

Ambient Temperature : 23.4 °C ; Liquid Temperature : 23.3 °C

DASY5 Configuration:

- Probe: EX3DV4 - SN7472; ConvF(8.43, 8.43, 8.43) @ 1900 MHz; Calibrated: 2021/06/03
- Sensor-Surface: 1.4mm (Mechanical Surface Detection)
- Electronics: DAE4 Sn1698; Calibrated: 2021/11/09
- Phantom: ELI Phantom_1205; Type: QDOVA002AA;
- Measurement SW: DASY52, Version 52.10 (4); SEMCAD X Version 14.6.14 (7501)

Pin=50mW/Area Scan (61x61x1): Interpolated grid: dx=1.500 mm, dy=1.500 mm

Maximum value of SAR (interpolated) = 3.21 W/kg

Pin=50mW/Zoom Scan (5x5x7)/Cube 0: Measurement grid: dx=8mm, dy=8mm, dz=5mm

Reference Value = 48.02 V/m; Power Drift = 0.02 dB

Peak SAR (extrapolated) = 3.85 W/kg

SAR(1 g) = 2 W/kg; SAR(10 g) = 1.05 W/kg (SAR corrected for target medium)

Maximum value of SAR (measured) = 3.24 W/kg

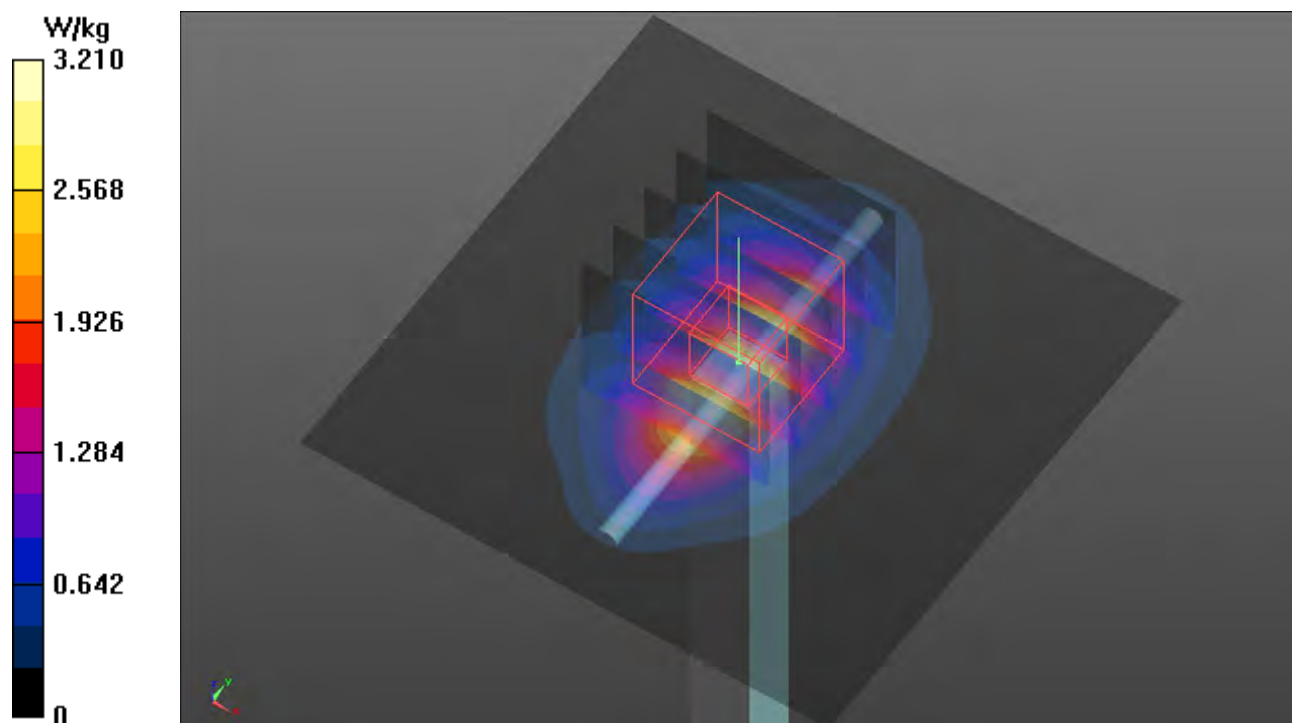

Plots of System Verification

Test Laboratory: Bureau Veritas ADT SAR/HAC Testing Lab

Date: 2022/04/07

S27 System Check_H2300_220407

DUT: Dipole 2300 MHz; Type: D2300V2; SN:1004

Communication System: UID 0, CW; Frequency: 2300 MHz; Duty Cycle: 1:1

Medium: H19T27N1_0407 Medium parameters used: $f = 2300$ MHz; $\sigma = 1.708$ S/m; $\epsilon_r = 39.188$; $\rho = 1000$ kg/m³

Ambient Temperature : 23.5 °C ; Liquid Temperature : 23.3 °C

DASY5 Configuration:

- Probe: EX3DV4 - SN7472; ConvF(8.13, 8.13, 8.13) @ 2300 MHz; Calibrated: 2021/06/03
- Sensor-Surface: 1.4mm (Mechanical Surface Detection)
- Electronics: DAE4 Sn1698; Calibrated: 2021/11/09
- Phantom: ELI Phantom_1205; Type: QDOVA002AA;
- Measurement SW: DASY52, Version 52.10 (4); SEMCAD X Version 14.6.14 (7501)

Pin=50mW/Area Scan (81x81x1): Interpolated grid: dx=1.200 mm, dy=1.200 mm

Maximum value of SAR (interpolated) = 3.94 W/kg

Pin=50mW/Zoom Scan (7x7x7)/Cube 0: Measurement grid: dx=5mm, dy=5mm, dz=5mm

Reference Value = 49.60 V/m; Power Drift = -0.12 dB

Peak SAR (extrapolated) = 4.88 W/kg

SAR(1 g) = 2.38 W/kg; SAR(10 g) = 1.14 W/kg (SAR corrected for target medium)

Maximum value of SAR (measured) = 3.97 W/kg

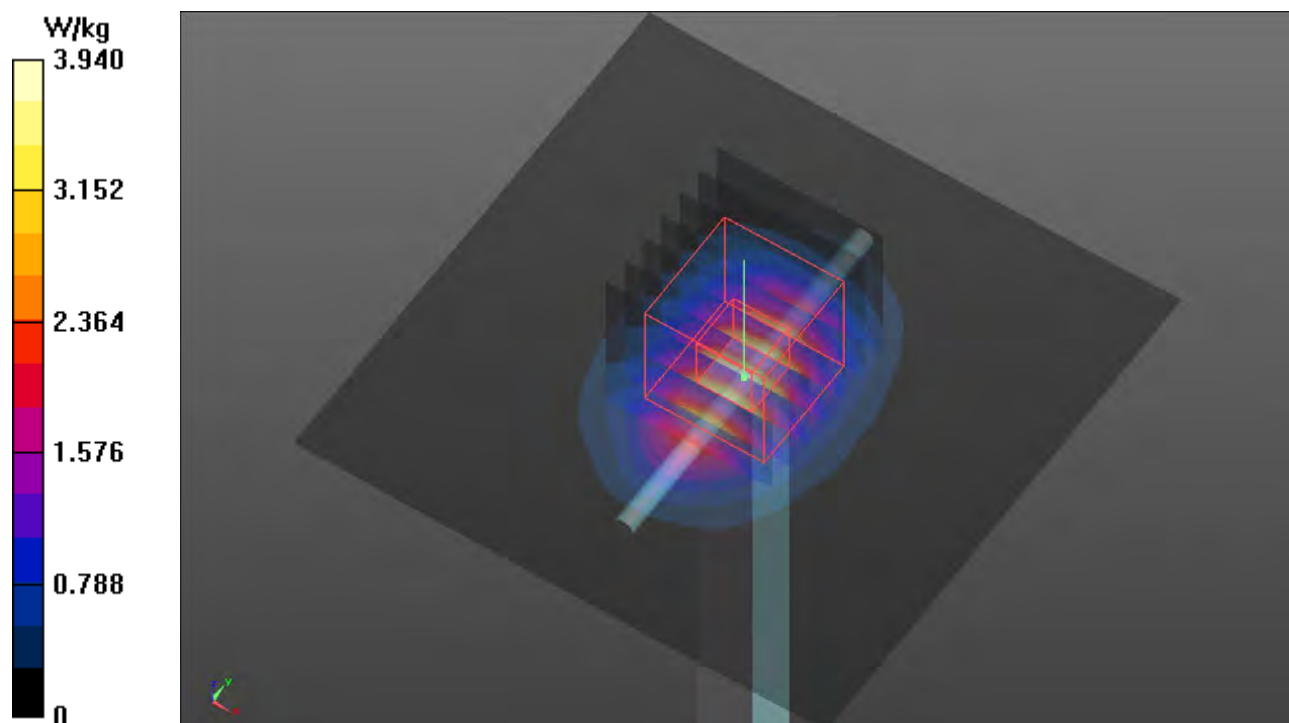

Plots of System Verification

Test Laboratory: Bureau Veritas ADT SAR/HAC Testing Lab

Date: 2022/04/06

S28 System Check_H2600_220406

DUT: Dipole 2600 MHz; Type: D2600V2; SN: 1020

Communication System: UID 0, CW; Frequency: 2600 MHz; Duty Cycle: 1:1

Medium: H19T27N1_0406 Medium parameters used: $f = 2600$ MHz; $\sigma = 2.03$ S/m; $\epsilon_r = 37.41$; $\rho = 1000$ kg/m³

Ambient Temperature : 23.4 °C ; Liquid Temperature : 23.3 °C

DASY5 Configuration:

- Probe: EX3DV4 - SN7472; ConvF(7.58, 7.58, 7.58) @ 2600 MHz; Calibrated: 2021/06/03
- Sensor-Surface: 1.4mm (Mechanical Surface Detection)
- Electronics: DAE4 Sn1698; Calibrated: 2021/11/09
- Phantom: ELI Phantom_1205; Type: QDOVA002AA;
- Measurement SW: DASY52, Version 52.10 (4); SEMCAD X Version 14.6.14 (7501)

Pin=50mW/Area Scan (81x81x1): Interpolated grid: dx=1.200 mm, dy=1.200 mm

Maximum value of SAR (interpolated) = 5.13 W/kg

Pin=50mW/Zoom Scan (7x7x7)/Cube 0: Measurement grid: dx=5mm, dy=5mm, dz=5mm

Reference Value = 51.90 V/m; Power Drift = -0.02 dB

Peak SAR (extrapolated) = 6.45 W/kg

SAR(1 g) = 2.92 W/kg; SAR(10 g) = 1.32 W/kg (SAR corrected for target medium)

Maximum value of SAR (measured) = 5.17 W/kg

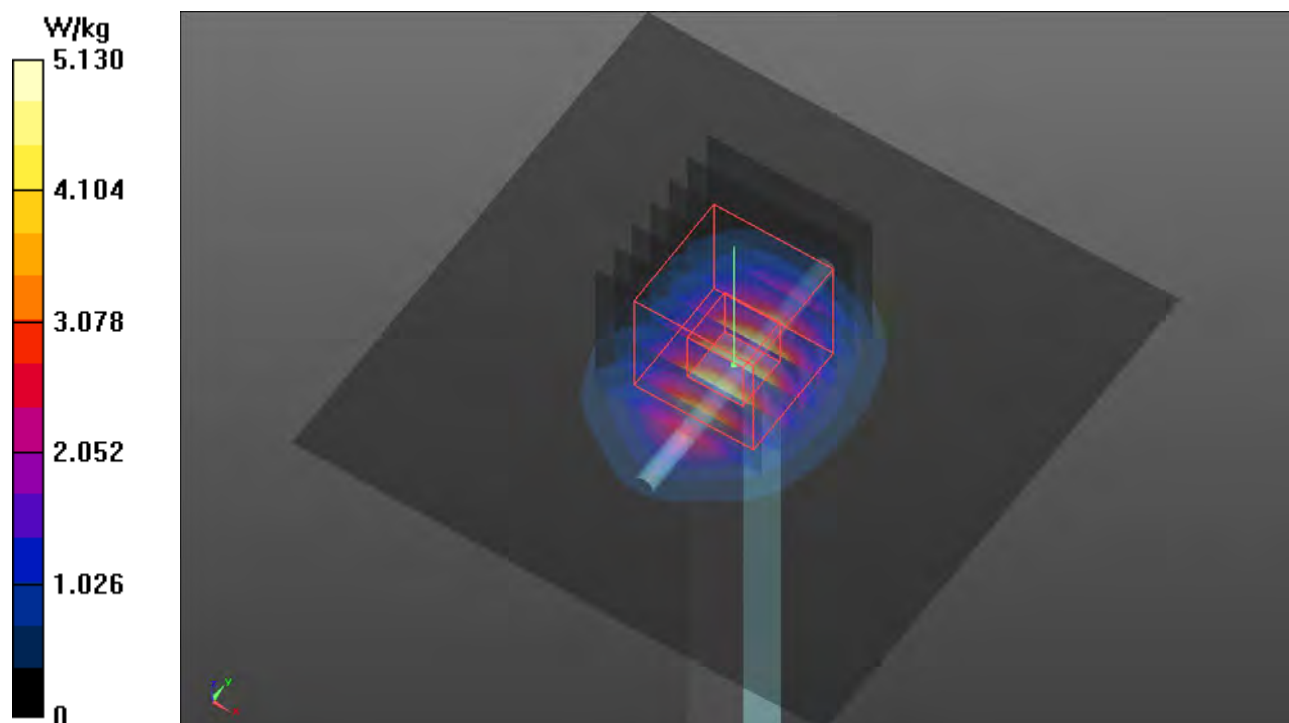

Plots of System Verification

Test Laboratory: Bureau Veritas ADT SAR/HAC Testing Lab

Date: 2022/04/07

S29 System Check_H2300_220407

DUT: Dipole 2300 MHz; Type: D2300V2; SN:1004

Communication System: UID 0, CW; Frequency: 2300 MHz; Duty Cycle: 1:1

Medium: H19T27N1_0407 Medium parameters used: $f = 2300$ MHz; $\sigma = 1.708$ S/m; $\epsilon_r = 39.188$; $\rho = 1000$ kg/m³

Ambient Temperature : 23.5 °C ; Liquid Temperature : 23.3 °C

DASY5 Configuration:

- Probe: EX3DV4 - SN7472; ConvF(8.13, 8.13, 8.13) @ 2300 MHz; Calibrated: 2021/06/03
- Sensor-Surface: 1.4mm (Mechanical Surface Detection)
- Electronics: DAE4 Sn1698; Calibrated: 2021/11/09
- Phantom: ELI Phantom_1205; Type: QDOVA002AA;
- Measurement SW: DASY52, Version 52.10 (4); SEMCAD X Version 14.6.14 (7501)

Pin=50mW/Area Scan (81x81x1): Interpolated grid: dx=1.200 mm, dy=1.200 mm

Maximum value of SAR (interpolated) = 3.94 W/kg

Pin=50mW/Zoom Scan (7x7x7)/Cube 0: Measurement grid: dx=5mm, dy=5mm, dz=5mm

Reference Value = 49.60 V/m; Power Drift = -0.12 dB

Peak SAR (extrapolated) = 4.88 W/kg

SAR(1 g) = 2.38 W/kg; SAR(10 g) = 1.14 W/kg (SAR corrected for target medium)

Maximum value of SAR (measured) = 3.97 W/kg

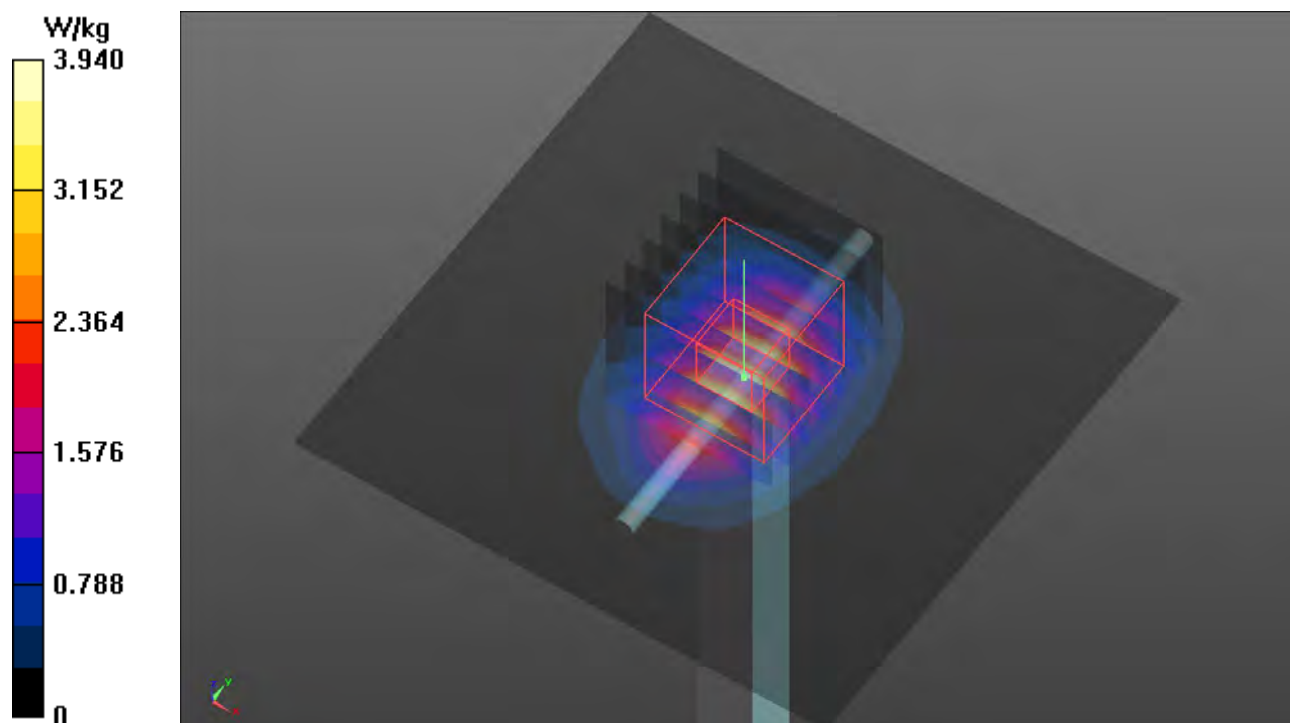

Plots of System Verification

Test Laboratory: Bureau Veritas ADT SAR/HAC Testing Lab

Date: 2022/04/07

S30 System Check_H2600_220407

DUT: Dipole 2600 MHz; Type: D2600V2; SN: 1020

Communication System: UID 0, CW; Frequency: 2600 MHz; Duty Cycle: 1:1

Medium: H19T27N1_0407 Medium parameters used: $f = 2600$ MHz; $\sigma = 2.004$ S/m; $\epsilon_r = 38.246$; $\rho = 1000$ kg/m³

Ambient Temperature : 23.5 °C ; Liquid Temperature : 23.3 °C

DASY5 Configuration:

- Probe: EX3DV4 - SN7472; ConvF(7.58, 7.58, 7.58) @ 2600 MHz; Calibrated: 2021/06/03
- Sensor-Surface: 1.4mm (Mechanical Surface Detection)
- Electronics: DAE4 Sn1698; Calibrated: 2021/11/09
- Phantom: ELI Phantom_1205; Type: QDOVA002AA;
- Measurement SW: DASY52, Version 52.10 (4); SEMCAD X Version 14.6.14 (7501)

Pin=50mW/Area Scan (81x81x1): Interpolated grid: dx=1.200 mm, dy=1.200 mm

Maximum value of SAR (interpolated) = 5.06 W/kg

Pin=50mW/Zoom Scan (7x7x7)/Cube 0: Measurement grid: dx=5mm, dy=5mm, dz=5mm

Reference Value = 51.90 V/m; Power Drift = -0.02 dB

Peak SAR (extrapolated) = 6.36 W/kg

SAR(1 g) = 2.91 W/kg; SAR(10 g) = 1.31 W/kg (SAR corrected for target medium)

Maximum value of SAR (measured) = 5.11 W/kg

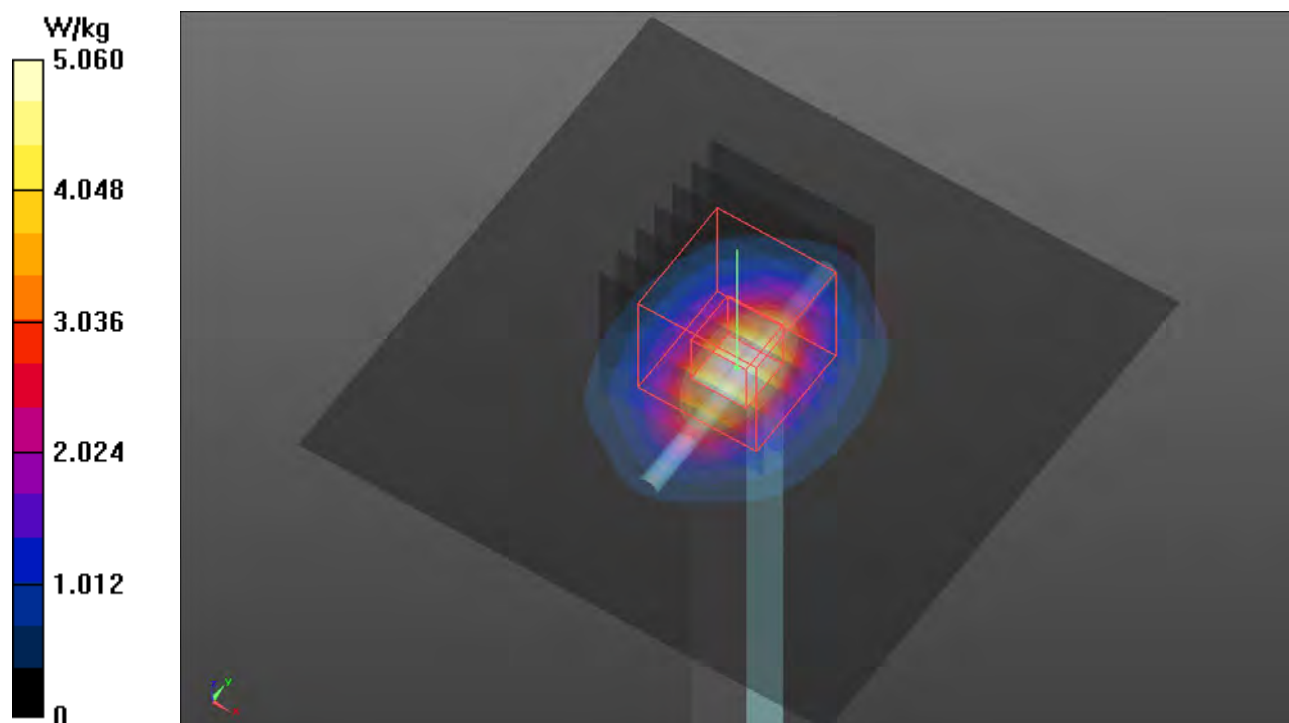

Plots of System Verification

Test Laboratory: Bureau Veritas ADT SAR/HAC Testing Lab

Date: 2022/04/08

S32 System Check_H1750_220408

DUT: Dipole 1750 MHz; Type: D1750V2; SN: 1055

Communication System: UID 0, CW; Frequency: 1750 MHz; Duty Cycle: 1:1

Medium: H16T20N1_0408 Medium parameters used: $f = 1750$ MHz; $\sigma = 1.327$ S/m; $\epsilon_r = 39.343$; $\rho = 1000$ kg/m³

Ambient Temperature : 23.3 °C ; Liquid Temperature : 23.2 °C

DASY5 Configuration:

- Probe: EX3DV4 - SN7472; ConvF(8.77, 8.77, 8.77) @ 1750 MHz; Calibrated: 2021/06/03
- Sensor-Surface: 1.4mm (Mechanical Surface Detection)
- Electronics: DAE4 Sn1698; Calibrated: 2021/11/09
- Phantom: ELI Phantom_1205; Type: QDOVA002AA;
- Measurement SW: DASY52, Version 52.10 (4); SEMCAD X Version 14.6.14 (7501)

Pin=50mW/Area Scan (61x61x1): Interpolated grid: dx=1.500 mm, dy=1.500 mm

Maximum value of SAR (interpolated) = 2.17 W/kg

Pin=50mW/Zoom Scan (5x5x7)/Cube 0: Measurement grid: dx=8mm, dy=8mm, dz=5mm

Reference Value = 37.71 V/m; Power Drift = -0.20 dB

Peak SAR (extrapolated) = 2.67 W/kg

SAR(1 g) = 1.68 W/kg; SAR(10 g) = 0.782 W/kg (SAR corrected for target medium)

Maximum value of SAR (measured) = 2.25 W/kg

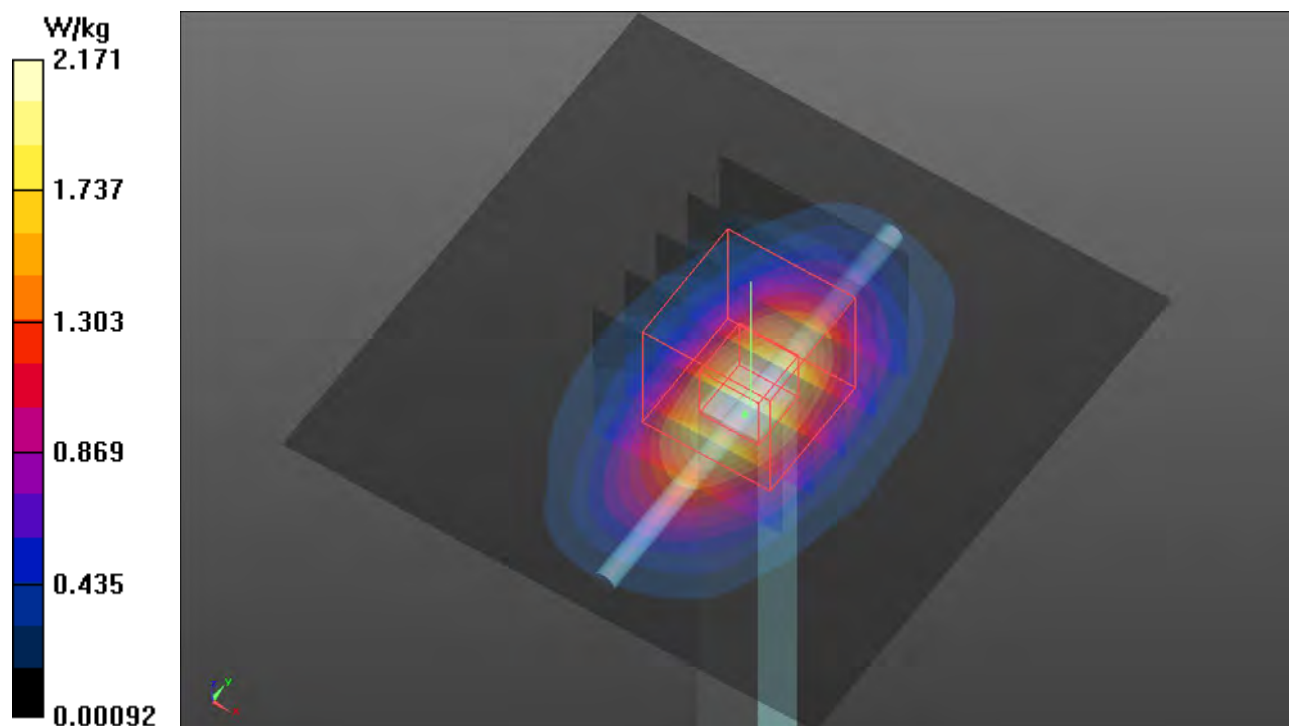

Plots of System Verification

Test Laboratory: Bureau Veritas ADT SAR/HAC Testing Lab

Date: 2021/04/05

S33 System Check_H750_220405

DUT: Dipole 750 MHz; Type: D750V3; SN: 1013

Communication System: UID 0, CW; Frequency: 750 MHz; Duty Cycle: 1:1

Medium: H06T09N1_0405 Medium parameters used: $f = 750$ MHz; $\sigma = 0.889$ S/m; $\epsilon_r = 42.8$; $\rho = 1000$ kg/m³

Ambient Temperature : 23.3 °C ; Liquid Temperature : 23.2 °C

DASY5 Configuration:

- Probe: EX3DV4 - SN7472; ConvF(10.32, 10.32, 10.32) @ 750 MHz; Calibrated: 2021/06/03
- Sensor-Surface: 1.4mm (Mechanical Surface Detection)
- Electronics: DAE4 Sn1698; Calibrated: 2021/11/09
- Phantom: ELI Phantom_1205; Type: QDOVA002AA;
- Measurement SW: DASY52, Version 52.10 (4); SEMCAD X Version 14.6.14 (7501)

Pin=50mW/Area Scan (61x61x1): Interpolated grid: dx=1.500 mm, dy=1.500 mm

Maximum value of SAR (interpolated) = 0.598 W/kg

Pin=50mW/Zoom Scan (5x5x7)/Cube 0: Measurement grid: dx=8mm, dy=8mm, dz=5mm

Reference Value = 26.50 V/m; Power Drift = -0.19 dB

Peak SAR (extrapolated) = 0.633 W/kg

SAR(1 g) = 0.426 W/kg; SAR(10 g) = 0.281 W/kg (SAR corrected for target medium)

Maximum value of SAR (measured) = 0.564 W/kg

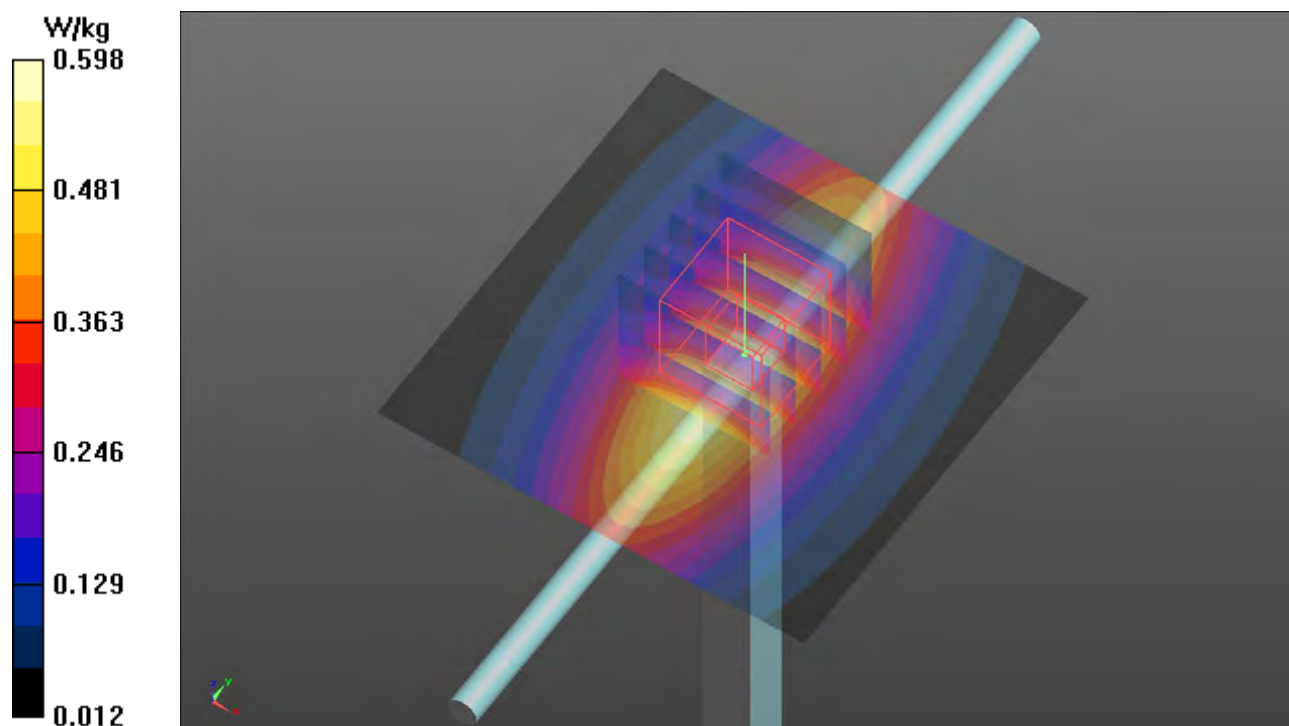

Plots of System Verification

Test Laboratory: Bureau Veritas ADT SAR/HAC Testing Lab

Date: 2022/04/08

S34a System Check_H3700_220408

DUT: Dipole 3700 MHz D3700V2

Communication System: UID 0, CW; Frequency: 3700 MHz; Duty Cycle: 1:1

Medium: H33T42N1_0408 Medium parameters used: $f = 3700$ MHz; $\sigma = 3.048$ S/m; $\epsilon_r = 37.922$; $\rho = 1000$ kg/m³

Ambient Temperature : 23.3 °C ; Liquid Temperature : 23.2 °C

DASY5 Configuration:

- Probe: EX3DV4 - SN7472; ConvF(7.12, 7.12, 7.12) @ 3700 MHz; Calibrated: 2021/06/03
- Sensor-Surface: 1.4mm (Mechanical Surface Detection)
- Electronics: DAE4 Sn1698; Calibrated: 2021/11/09
- Phantom: ELI Phantom_1205; Type: QDOVA002AA;
- Measurement SW: DASY52, Version 52.10 (4); SEMCAD X Version 14.6.14 (7501)

Pin=50mW/Area Scan (81x81x1): Interpolated grid: dx=1.200 mm, dy=1.200 mm

Maximum value of SAR (interpolated) = 6.40 W/kg

Pin=50mW/Zoom Scan (7x7x7)/Cube 0: Measurement grid: dx=5mm, dy=5mm, dz=2.5mm

Reference Value = 49.24 V/m; Power Drift = -0.05 dB

Peak SAR (extrapolated) = 8.30 W/kg

SAR(1 g) = 3.31 W/kg; SAR(10 g) = 1.24 W/kg (SAR corrected for target medium)

Maximum value of SAR (measured) = 6.33 W/kg

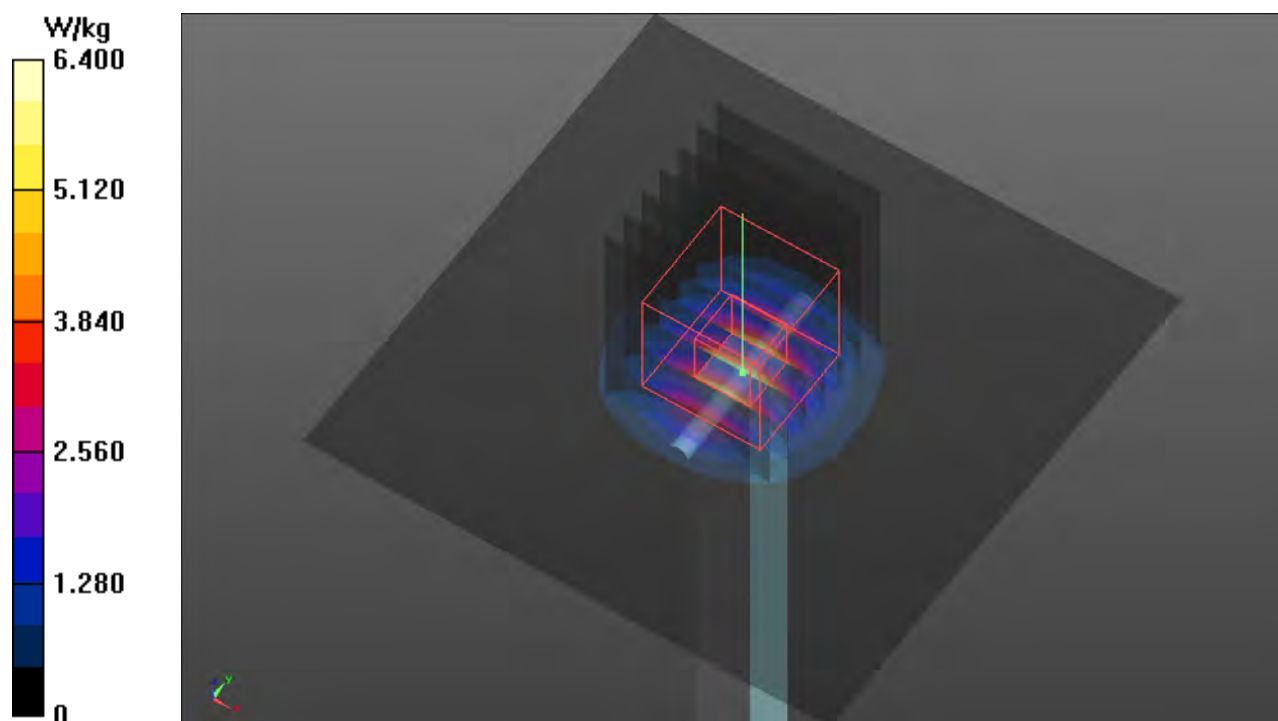

Plots of System Verification

Test Laboratory: Bureau Veritas ADT SAR/HAC Testing Lab

Date: 2022/04/08

S34b System Check_H3900_220408

DUT: Dipole 3900 MHz D3900V2

Communication System: UID 0, CW; Frequency: 3900 MHz; Duty Cycle: 1:1

Medium: H33T42N1_0408 Medium parameters used: $f = 3900$ MHz; $\sigma = 3.254$ S/m; $\epsilon_r = 37.664$; $\rho = 1000$ kg/m³

Ambient Temperature : 23.3 °C ; Liquid Temperature : 23.2 °C

DASY5 Configuration:

- Probe: EX3DV4 - SN7472; ConvF(6.9, 6.9, 6.9) @ 3900 MHz; Calibrated: 2021/06/03
- Sensor-Surface: 1.4mm (Mechanical Surface Detection)
- Electronics: DAE4 Sn1698; Calibrated: 2021/11/09
- Phantom: ELI Phantom_1205; Type: QDOVA002AA;
- Measurement SW: DASY52, Version 52.10 (4); SEMCAD X Version 14.6.14 (7501)

Pin=50mW/Area Scan (81x81x1): Interpolated grid: dx=1.200 mm, dy=1.200 mm

Maximum value of SAR (interpolated) = 6.76 W/kg

Pin=50mW/Zoom Scan (7x7x7)/Cube 0: Measurement grid: dx=5mm, dy=5mm, dz=2.5mm

Reference Value = 49.49 V/m; Power Drift = -0.15 dB

Peak SAR (extrapolated) = 8.86 W/kg

SAR(1 g) = 3.34 W/kg; SAR(10 g) = 1.19 W/kg (SAR corrected for target medium)

Maximum value of SAR (measured) = 6.69 W/kg

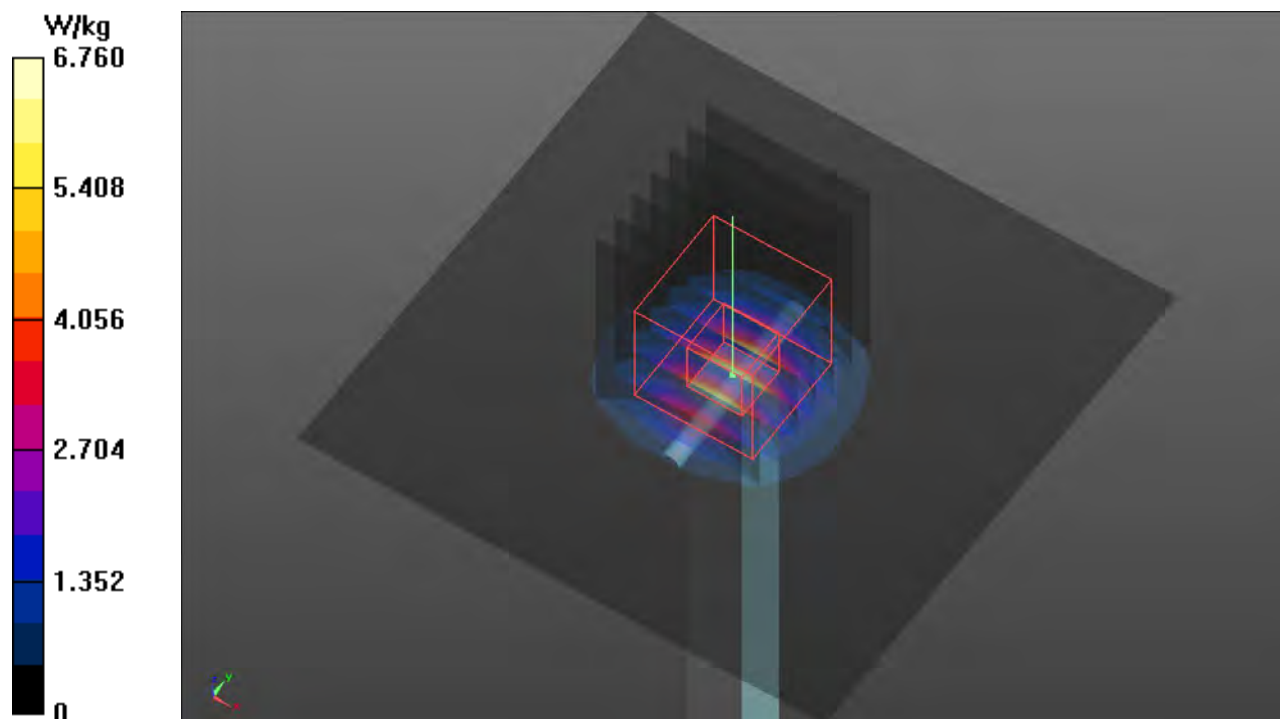

Plots of System Verification

Test Laboratory: Bureau Veritas ADT SAR/HAC Testing Lab

Date: 2022/04/08

S35a System Check_H3500_220408

DUT: Dipole 3500 MHz; Type:D3500V2; SN: 1007

Communication System: UID 0, CW; Frequency: 3500 MHz; Duty Cycle: 1:1

Medium: H33T42N1_0408 Medium parameters used: $f = 3500$ MHz; $\sigma = 2.841$ S/m; $\epsilon_r = 38.289$; $\rho = 1000$ kg/m³

Ambient Temperature : 23.3 °C ; Liquid Temperature : 23.2 °C

DASY5 Configuration:

- Probe: EX3DV4 - SN7472; ConvF(7.17, 7.17, 7.17) @ 3500 MHz; Calibrated: 2021/06/03
- Sensor-Surface: 1.4mm (Mechanical Surface Detection)
- Electronics: DAE4 Sn1698; Calibrated: 2021/11/09
- Phantom: ELI Phantom_1205; Type: QDOVA002AA;
- Measurement SW: DASY52, Version 52.10 (4); SEMCAD X Version 14.6.14 (7483)

Pin=50mW/Area Scan (81x81x1): Interpolated grid: dx=1.200 mm, dy=1.200 mm

Maximum value of SAR (interpolated) = 6.04 W/kg

Pin=50mW/Zoom Scan (7x7x7)/Cube 0: Measurement grid: dx=5mm, dy=5mm, dz=2.5mm

Reference Value = 48.67 V/m; Power Drift = -0.02 dB

Peak SAR (extrapolated) = 7.87 W/kg

SAR(1 g) = 3.28 W/kg; SAR(10 g) = 1.27 W/kg (SAR corrected for target medium)

Maximum value of SAR (measured) = 6.10 W/kg

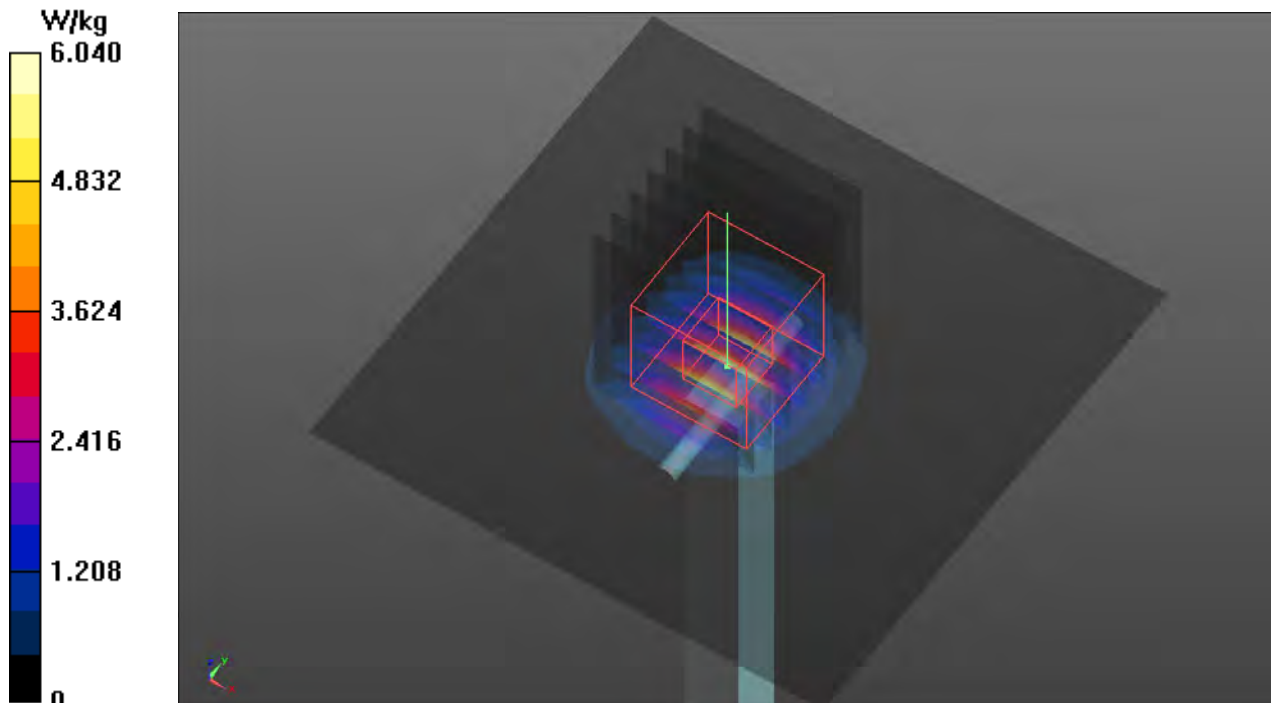

Plots of System Verification

Test Laboratory: Bureau Veritas ADT SAR/HAC Testing Lab

Date: 2022/04/08

S35b System Check_H3700_220408

DUT: Dipole 3700 MHz D3700V2

Communication System: UID 0, CW; Frequency: 3700 MHz; Duty Cycle: 1:1

Medium: H33T42N1_0408 Medium parameters used: $f = 3700$ MHz; $\sigma = 3.048$ S/m; $\epsilon_r = 37.922$; $\rho = 1000$ kg/m³

Ambient Temperature : 23.3 °C ; Liquid Temperature : 23.2 °C

DASY5 Configuration:

- Probe: EX3DV4 - SN7472; ConvF(7.12, 7.12, 7.12) @ 3700 MHz; Calibrated: 2021/06/03
- Sensor-Surface: 1.4mm (Mechanical Surface Detection)
- Electronics: DAE4 Sn1698; Calibrated: 2021/11/09
- Phantom: ELI Phantom_1205; Type: QDOVA002AA;
- Measurement SW: DASY52, Version 52.10 (4); SEMCAD X Version 14.6.14 (7501)

Pin=50mW/Area Scan (81x81x1): Interpolated grid: dx=1.200 mm, dy=1.200 mm

Maximum value of SAR (interpolated) = 6.40 W/kg

Pin=50mW/Zoom Scan (7x7x7)/Cube 0: Measurement grid: dx=5mm, dy=5mm, dz=2.5mm

Reference Value = 49.24 V/m; Power Drift = -0.05 dB

Peak SAR (extrapolated) = 8.30 W/kg

SAR(1 g) = 3.31 W/kg; SAR(10 g) = 1.24 W/kg (SAR corrected for target medium)

Maximum value of SAR (measured) = 6.33 W/kg

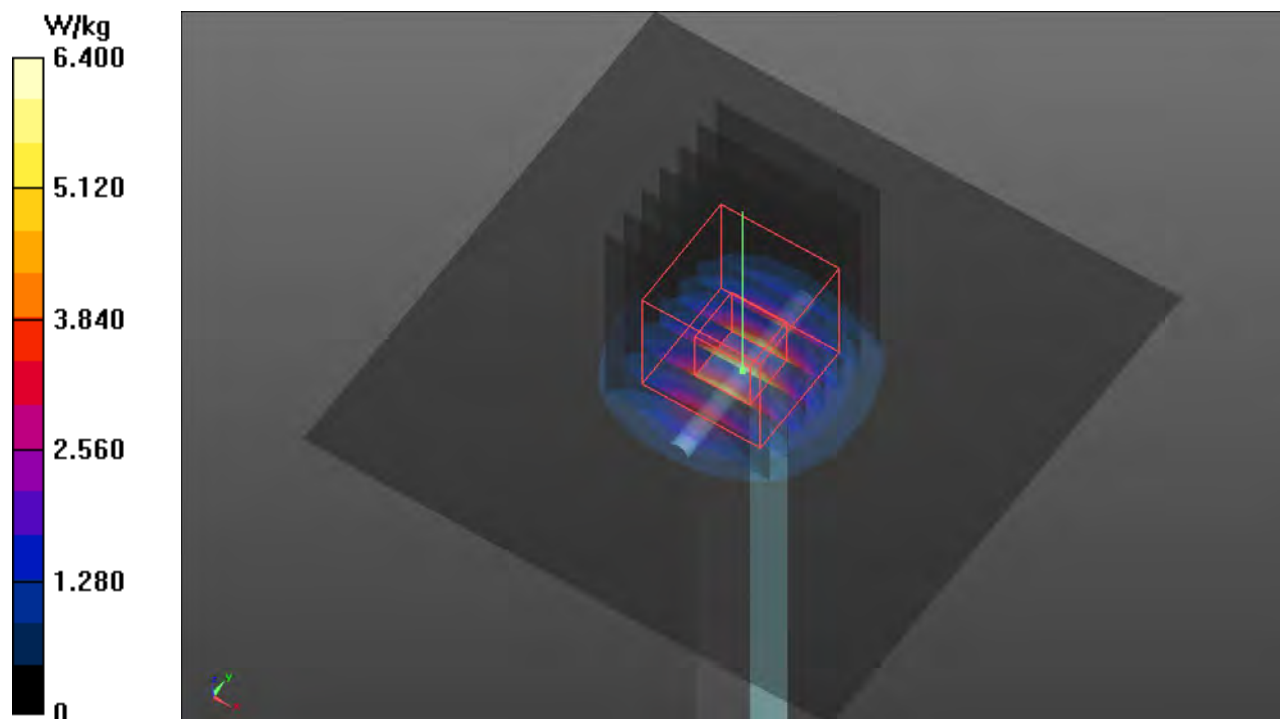

Plots of System Verification

Test Laboratory: Bureau Veritas ADT SAR/HAC Testing Lab

Date: 2022/03/22

S36 System Check_H2450_220322

DUT: Dipole 2450 MHz; Type: D2450V2; SN: 737

Communication System: UID 0, CW; Frequency: 2450 MHz; Duty Cycle: 1:1

Medium: H19T27N1_0322 Medium parameters used (interpolated): $f = 2450$ MHz; $\sigma = 1.877$ S/m; $\epsilon_r = 38.713$; $\rho = 1000$ kg/m³

Ambient Temperature : 23.4 °C ; Liquid Temperature : 23.1 °C

DASY5 Configuration:

- Probe: EX3DV4 - SN7555; ConvF(7.9, 7.9, 7.9) @ 2450 MHz; Calibrated: 2021/09/27
- Sensor-Surface: 1.4mm (Mechanical Surface Detection)
- Electronics: DAE4 Sn1341; Calibrated: 2021/08/20
- Phantom: ELI Phantom_1043; Type: QD OVA 002 Ax
- Measurement SW: DASY52, Version 52.10 (4); SEMCAD X Version 14.6.14 (7501)

Pin=50mW/Area Scan (81x81x1): Interpolated grid: dx=1.200 mm, dy=1.200 mm

Maximum value of SAR (interpolated) = 4.23 W/kg

Pin=50mW/Zoom Scan (7x7x7)/Cube 0: Measurement grid: dx=5mm, dy=5mm, dz=5mm

Reference Value = 48.55 V/m; Power Drift = -0.10 dB

Peak SAR (extrapolated) = 5.31 W/kg

SAR(1 g) = 2.49 W/kg; SAR(10 g) = 1.18 W/kg (SAR corrected for target medium)

Maximum value of SAR (measured) = 4.28 W/kg

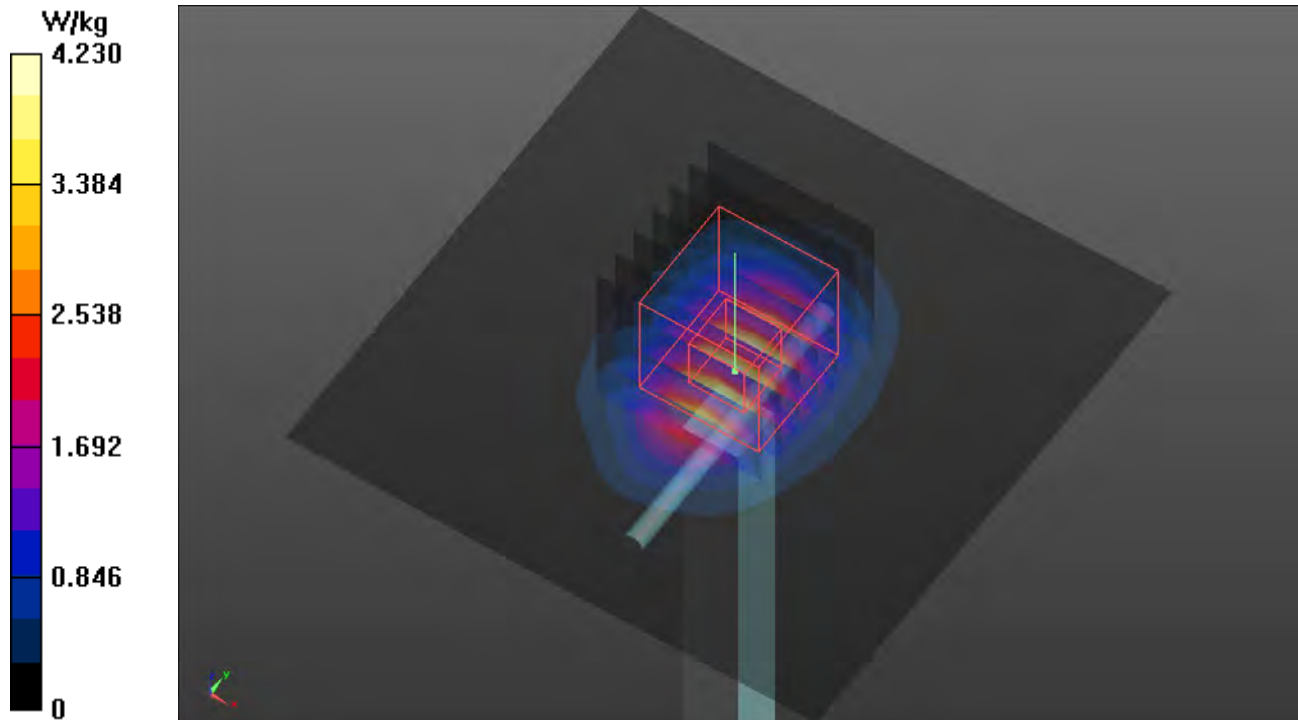

Plots of System Verification

Test Laboratory: Bureau Veritas ADT SAR/HAC Testing Lab

Date: 2022/03/23

S37 System Check_H5250_220323

DUT: Dipole 5 GHz; Type: D5GHzV2; SN: 1019

Communication System: UID 0, CW; Frequency: 5250 MHz; Duty Cycle: 1:1

Medium: H34T60N1_0323 Medium parameters used: $f = 5250$ MHz; $\sigma = 4.702$ S/m; $\epsilon_r = 36.235$; $\rho = 1000$ kg/m³

Ambient Temperature : 23.3 °C ; Liquid Temperature : 23.2 °C

DASY5 Configuration:

- Probe: EX3DV4 - SN7472; ConvF(5.78, 5.78, 5.78) @ 5250 MHz; Calibrated: 2021/06/03
- Sensor-Surface: 1.4mm (Mechanical Surface Detection)
- Electronics: DAE4 Sn1698; Calibrated: 2021/11/09
- Phantom: ELI Phantom_1245; Type: QDOVA002AA;
- Measurement SW: DASY52, Version 52.10 (4); SEMCAD X Version 14.6.14 (7483)

Pin=50mW/Area Scan (91x91x1): Interpolated grid: dx=1.000 mm, dy=1.000 mm

Maximum value of SAR (interpolated) = 8.94 W/kg

Pin=50mW/Zoom Scan (7x7x7)/Cube 0: Measurement grid: dx=4mm, dy=4mm, dz=1.4mm

Reference Value = 48.81 V/m; Power Drift = 0.04 dB

Peak SAR (extrapolated) = 14.7 W/kg

SAR(1 g) = 3.85 W/kg; SAR(10 g) = 1.11 W/kg (SAR corrected for target medium)

Maximum value of SAR (measured) = 9.51 W/kg

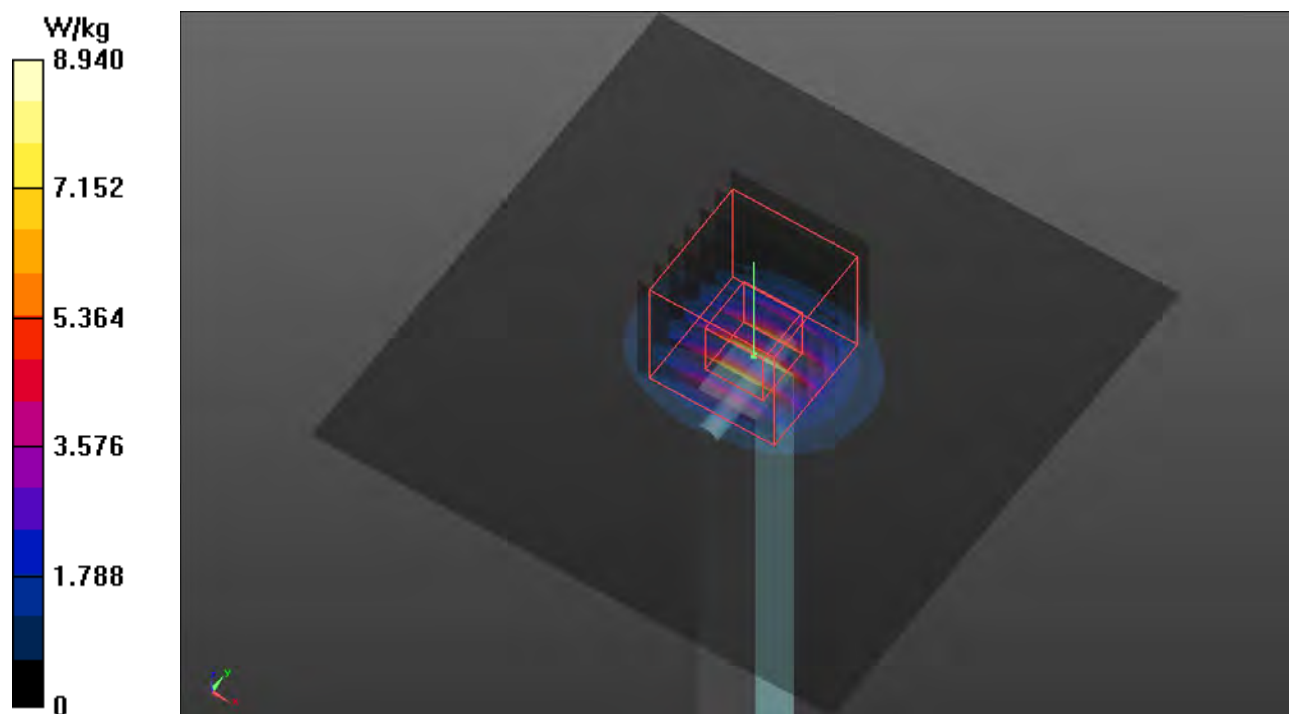

Plots of System Verification

Test Laboratory: Bureau Veritas ADT SAR/HAC Testing Lab

Date: 2022/03/23

S38 System Check_H5600_220323

DUT: Dipole 5 GHz; Type: D5GHzV2; SN: 1019

Communication System: UID 0, CW; Frequency: 5600 MHz; Duty Cycle: 1:1

Medium: H34T60N1_0323 Medium parameters used: $f = 5600$ MHz; $\sigma = 4.996$ S/m; $\epsilon_r = 35.809$; $\rho = 1000$ kg/m³

Ambient Temperature : 23.3 °C ; Liquid Temperature : 23.2 °C

DASY5 Configuration:

- Probe: EX3DV4 - SN7472; ConvF(4.95, 4.95, 4.95) @ 5600 MHz; Calibrated: 2021/06/03
- Sensor-Surface: 1.4mm (Mechanical Surface Detection)
- Electronics: DAE4 Sn1698; Calibrated: 2021/11/09
- Phantom: ELI Phantom_1245; Type: QDOVA002AA;
- Measurement SW: DASY52, Version 52.10 (4); SEMCAD X Version 14.6.14 (7483)

Pin=50mW/Area Scan (91x91x1): Interpolated grid: dx=1.000 mm, dy=1.000 mm

Maximum value of SAR (interpolated) = 10.8 W/kg

Pin=50mW/Zoom Scan (7x7x7)/Cube 0: Measurement grid: dx=4mm, dy=4mm, dz=1.4mm

Reference Value = 52.25 V/m; Power Drift = 0.03 dB

Peak SAR (extrapolated) = 19.0 W/kg

SAR(1 g) = 4.46 W/kg; SAR(10 g) = 1.27 W/kg (SAR corrected for target medium)

Maximum value of SAR (measured) = 11.4 W/kg

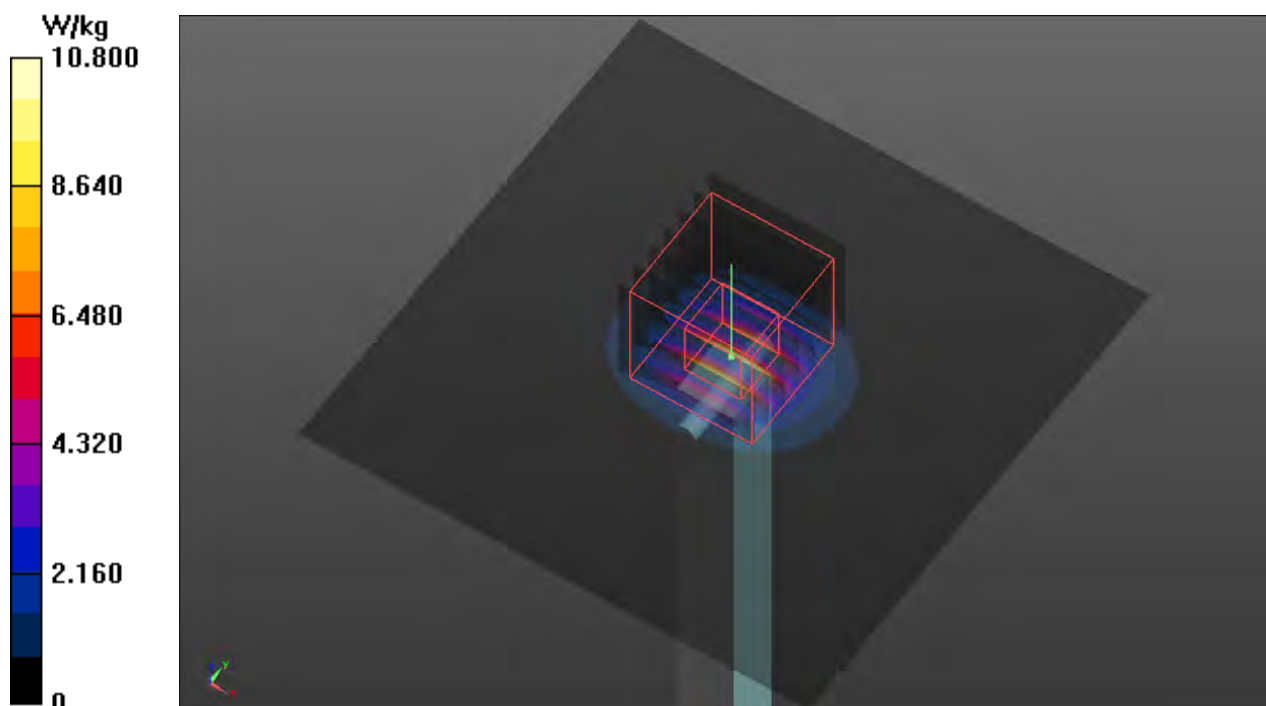

Plots of System Verification

Test Laboratory: Bureau Veritas ADT SAR/HAC Testing Lab

Date: 2022/03/24

S39 System Check_H5750_220324

DUT: Dipole 5 GHz; Type: D5GHzV2; SN: 1019

Communication System: UID 0, CW; Frequency: 5750 MHz; Duty Cycle: 1:1

Medium: H34T60N1_0324 Medium parameters used: $f = 5750$ MHz; $\sigma = 5.266$ S/m; $\epsilon_r = 35.45$; $\rho = 1000$ kg/m³

Ambient Temperature : 23.4 °C ; Liquid Temperature : 23.3 °C

DASY5 Configuration:

- Probe: EX3DV4 - SN7472; ConvF(5.25, 5.25, 5.25) @ 5750 MHz; Calibrated: 2021/06/03
- Sensor-Surface: 1.4mm (Mechanical Surface Detection)
- Electronics: DAE4 Sn1698; Calibrated: 2021/11/09
- Phantom: ELI Phantom_1245; Type: QDOVA002AA;
- Measurement SW: DASY52, Version 52.10 (4); SEMCAD X Version 14.6.14 (7483)

Pin=50mW/Area Scan (91x91x1): Interpolated grid: dx=1.000 mm, dy=1.000 mm

Maximum value of SAR (interpolated) = 9.182 W/kg

Pin=50mW/Zoom Scan (7x7x7)/Cube 0: Measurement grid: dx=4mm, dy=4mm, dz=1.4mm

Reference Value = 47.32 V/m; Power Drift = -0.02 dB

Peak SAR (extrapolated) = 17.3 W/kg

SAR(1 g) = 3.79 W/kg; SAR(10 g) = 1.08 W/kg (SAR corrected for target medium)

Maximum value of SAR (measured) = 10.1 W/kg

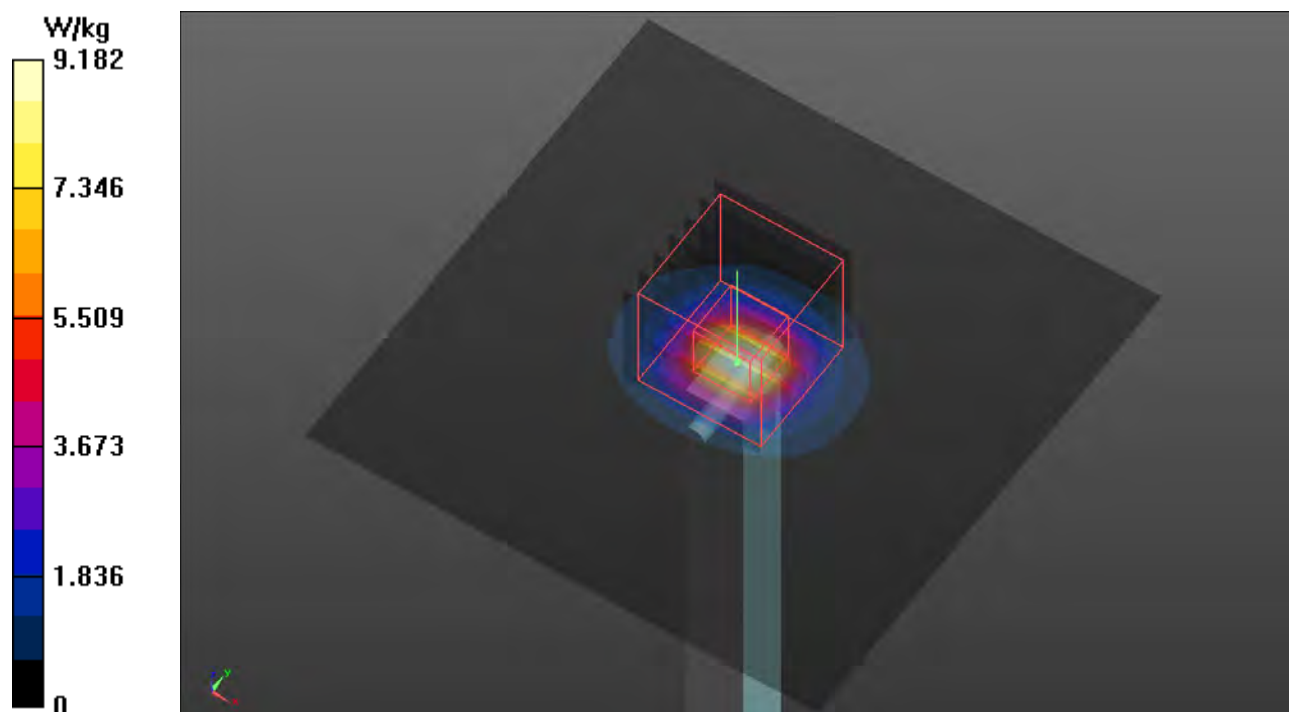

Plots of System Verification

Test Laboratory: Bureau Veritas ADT SAR/HAC Testing Lab

Date: 2022/03/25

S40 System Check_H2450_220325

DUT: Dipole 2450 MHz; Type: D2450V2; SN: 737

Communication System: UID 0, CW; Frequency: 2450 MHz; Duty Cycle: 1:1

Medium: H19T27N1_0325 Medium parameters used: $f = 2450$ MHz; $\sigma = 1.758$ S/m; $\epsilon_r = 38.542$; $\rho = 1000$ kg/m³

Ambient Temperature : 23.5 °C ; Liquid Temperature : 23.2 °C

DASY5 Configuration:

- Probe: EX3DV4 - SN7472; ConvF(7.89, 7.89, 7.89) @ 2450 MHz; Calibrated: 2021/06/03
- Sensor-Surface: 1.4mm (Mechanical Surface Detection)
- Electronics: DAE4 Sn1698; Calibrated: 2021/11/09
- Phantom: ELI Phantom_1245; Type: QDOVA002AA;
- Measurement SW: DASY52, Version 52.10 (4); SEMCAD X Version 14.6.14 (7483)

Pin=50mW/Area Scan (81x81x1): Interpolated grid: dx=1.200 mm, dy=1.200 mm

Maximum value of SAR (interpolated) = 3.99 W/kg

Pin=50mW/Zoom Scan (7x7x7)/Cube 0: Measurement grid: dx=5mm, dy=5mm, dz=5mm

Reference Value = 46.36 V/m; Power Drift = 0.12 dB

Peak SAR (extrapolated) = 5.09 W/kg

SAR(1 g) = 2.47 W/kg; SAR(10 g) = 1.14 W/kg (SAR corrected for target medium)

Maximum value of SAR (measured) = 4.11 W/kg

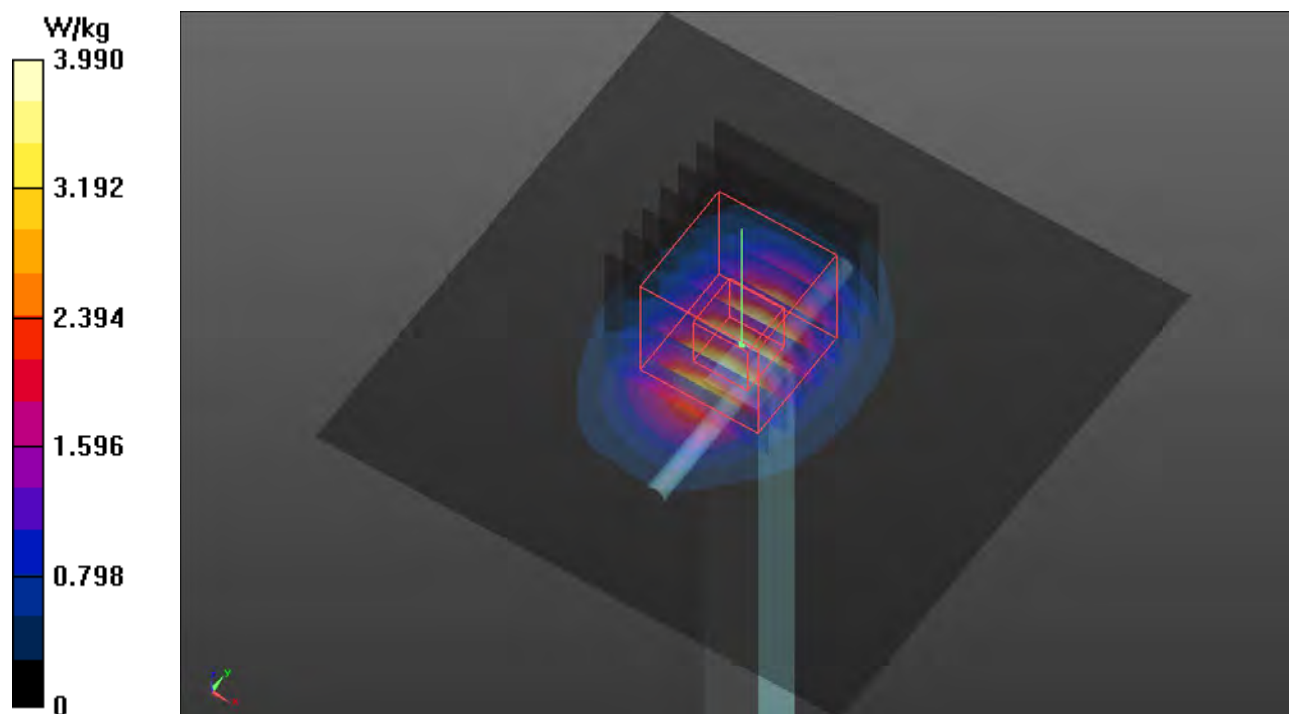

Annex B. Plots of Measurement

The SAR plots for highest measured SAR in each exposure configuration, wireless mode and frequency band combination are shown as follows.

Plots of Measurement

Test Laboratory: Bureau Veritas ADT SAR/HAC Testing Lab

Date: 2022/03/31

P01 WCDMA II_RMC12.2K_Rear Face_0mm_Ch9400_Ant 0_Power Reduction_w

DUT: BFLF-WTW-P22030373

Communication System: UID 10011 - CAB, UMTS-FDD (WCDMA); Frequency: 1880 MHz; Duty Cycle: 1:1.96
Medium: H16T20N1_0331 Medium parameters used: $f = 1880$ MHz; $\sigma = 1.45$ S/m; $\epsilon_r = 38.845$; $\rho = 1000$ kg/m³
Ambient Temperature : 23.3 °C ; Liquid Temperature : 23.1 °C

DASY5 Configuration:

- Probe: EX3DV4 - SN7472; ConvF(8.43, 8.43, 8.43) @ 1880 MHz; Calibrated: 2021/06/03
- Sensor-Surface: 1.4mm (Mechanical Surface Detection)
- Electronics: DAE4 Sn1698; Calibrated: 2021/11/09
- Phantom: ELI Phantom_1205; Type: QDOVA002AA;
- Measurement SW: DASY52, Version 52.10 (4); SEMCAD X Version 14.6.14 (7501)

Area Scan (71x261x1): Interpolated grid: dx=1.500 mm, dy=1.500 mm
Maximum value of SAR (interpolated) = 0.598 W/kg

Zoom Scan (5x5x7)/Cube 0: Measurement grid: dx=8mm, dy=8mm, dz=5mm

Reference Value = 16.42 V/m; Power Drift = 0.03 dB

Peak SAR (extrapolated) = 1.00 W/kg

SAR(1 g) = 0.550 W/kg; SAR(10 g) = 0.313 W/kg (SAR corrected for target medium)

Smallest distance from peaks to all points 3 dB below = 8.1 mm

Ratio of SAR at M2 to SAR at M1 = 46.3%

Maximum value of SAR (measured) = 0.793 W/kg

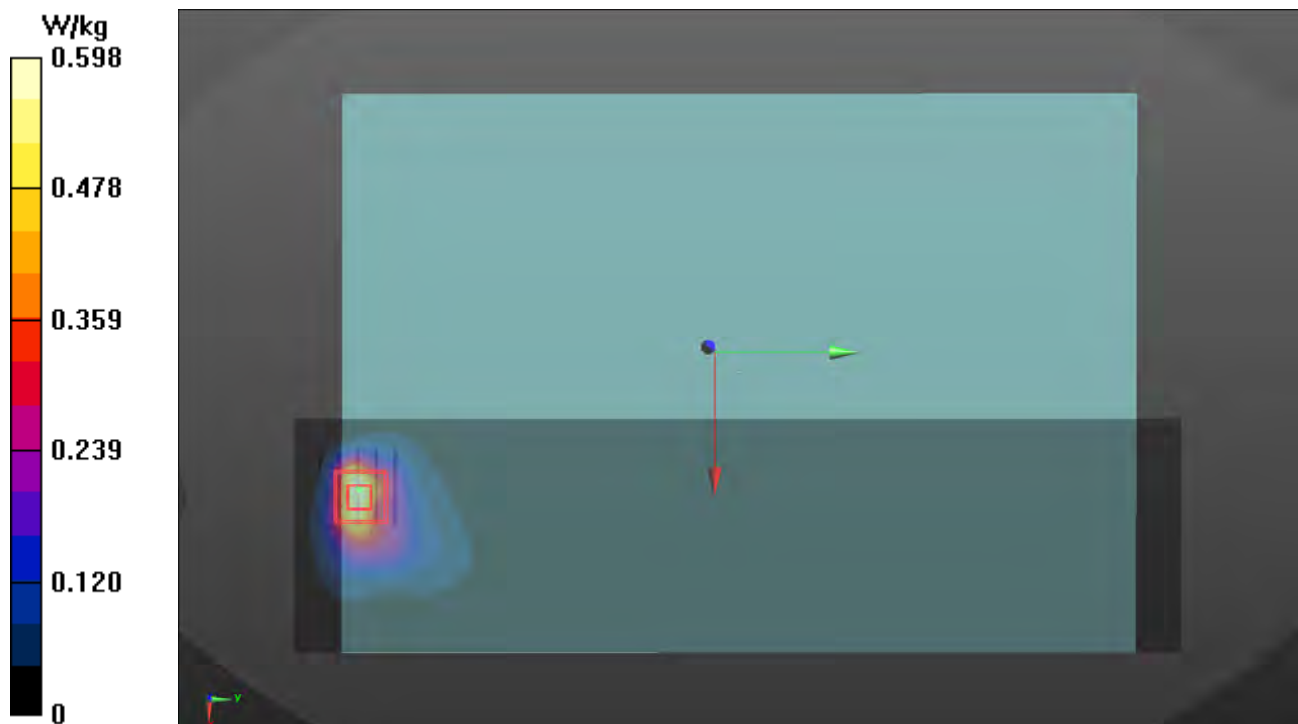

Plots of Measurement

Test Laboratory: Bureau Veritas ADT SAR/HAC Testing Lab

Date: 2022/04/01

P02 WCDMA IV_RMC12.2K_Rear Face_0mm_Ch1312_Ant 0_Power Reduction_w

DUT: BFLF-WTW-P22030373

Communication System: UID 10011 - CAB, UMTS-FDD (WCDMA); Frequency: 1712.4 MHz; Duty Cycle: 1:1.95
 Medium: H16T20N1_0401 Medium parameters used (interpolated): $f = 1712.4$ MHz; $\sigma = 1.287$ S/m; $\epsilon_r = 39.3$; $\rho = 1000$ kg/m³

Ambient Temperature : 23.5 °C ; Liquid Temperature : 23.4 °C

DASY5 Configuration:

- Probe: EX3DV4 - SN7472; ConvF(8.77, 8.77, 8.77) @ 1712.4 MHz; Calibrated: 2021/06/03
- Sensor-Surface: 1.4mm (Mechanical Surface Detection)
- Electronics: DAE4 Sn1698; Calibrated: 2021/11/09
- Phantom: ELI Phantom_1205; Type: QDOVA002AA;
- Measurement SW: DASY52, Version 52.10 (4); SEMCAD X Version 14.6.14 (7501)

Area Scan (71x261x1): Interpolated grid: dx=1.500 mm, dy=1.500 mm
 Maximum value of SAR (interpolated) = 0.805 W/kg

Zoom Scan (5x5x7)/Cube 0: Measurement grid: dx=8mm, dy=8mm, dz=5mm

Reference Value = 25.27 V/m; Power Drift = 0.02 dB

Peak SAR (extrapolated) = 1.35 W/kg

SAR(1 g) = 0.692 W/kg; SAR(10 g) = 0.336 W/kg (SAR corrected for target medium)

Smallest distance from peaks to all points 3 dB below = 8.1 mm

Ratio of SAR at M2 to SAR at M1 = 37.9%

Maximum value of SAR (measured) = 0.987 W/kg

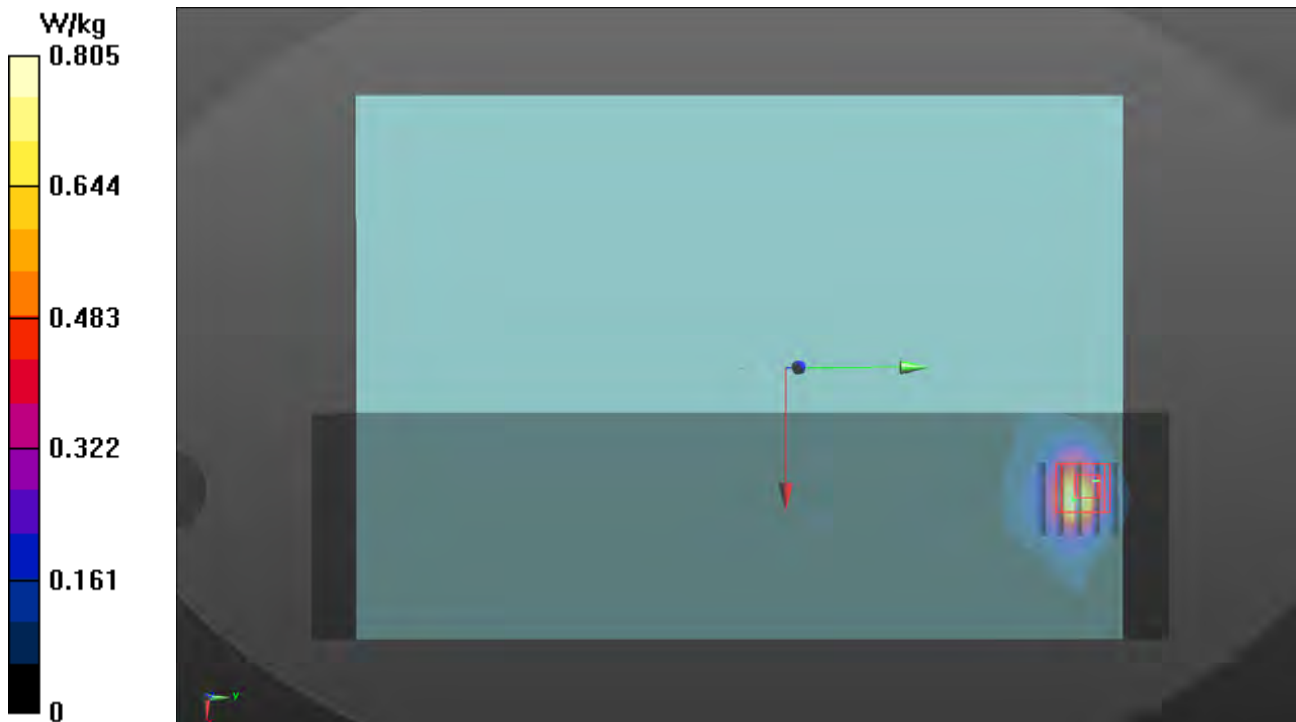

Plots of Measurement

Test Laboratory: Bureau Veritas ADT SAR/HAC Testing Lab

Date: 2022/03/30

P03 WCDMA V_RMC12.2K_Rear Face_0mm_Ch4132_Ant 0_Power Reduction_w

DUT: BFLF-WTW-P22030373

Communication System: UID 10011 - CAB, UMTS-FDD (WCDMA); Frequency: 826.4 MHz; Duty Cycle: 1:1.95
Medium: H07T10N1_0330 Medium parameters used (interpolated): $f = 826.4$ MHz; $\sigma = 0.932$ S/m; $\epsilon_r = 40.744$; $\rho = 1000$ kg/m³

Ambient Temperature : 23.3 °C ; Liquid Temperature : 23.2 °C

DASY5 Configuration:

- Probe: EX3DV4 - SN7472; ConvF(10.05, 10.05, 10.05) @ 826.4 MHz; Calibrated: 2021/06/03
- Sensor-Surface: 1.4mm (Mechanical Surface Detection)
- Electronics: DAE4 Sn1698; Calibrated: 2021/11/09
- Phantom: ELI Phantom_1205; Type: QDOVA002AA;
- Measurement SW: DASY52, Version 52.10 (4); SEMCAD X Version 14.6.14 (7501)

Area Scan (71x261x1): Interpolated grid: dx=1.500 mm, dy=1.500 mm
Maximum value of SAR (interpolated) = 1.25 W/kg

Zoom Scan (5x5x7)/Cube 0: Measurement grid: dx=8mm, dy=8mm, dz=5mm

Reference Value = 34.15 V/m; Power Drift = 0.04 dB

Peak SAR (extrapolated) = 2.46 W/kg

SAR(1 g) = 0.692 W/kg; SAR(10 g) = 0.474 W/kg (SAR corrected for target medium)

Smallest distance from peaks to all points 3 dB below = 9.3 mm

Ratio of SAR at M2 to SAR at M1 = 37.6%

Maximum value of SAR (measured) = 1.48 W/kg

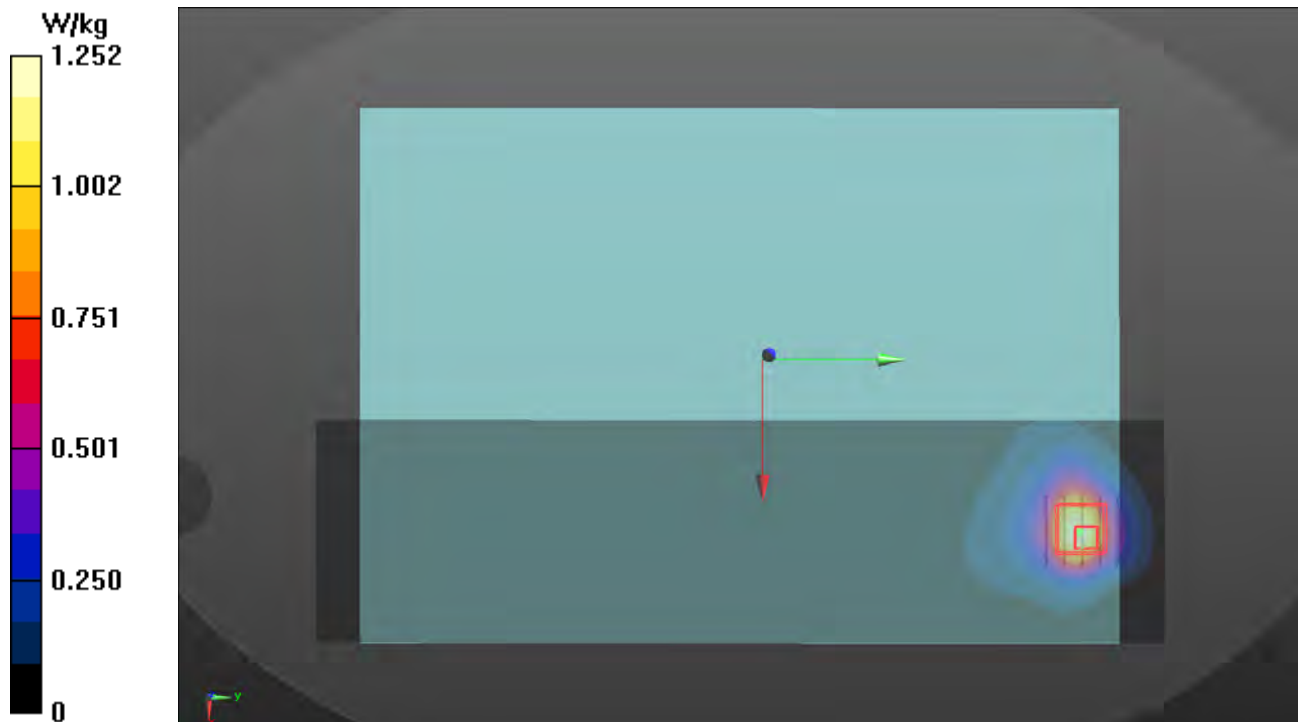

Plots of Measurement

Test Laboratory: Bureau Veritas ADT SAR/HAC Testing Lab

Date: 2022/03/31

P04 LTE 2_QPSK20M_Rear Face_0mm_Ch18700_1RB_OS0_Ant 0_Power Reduction_w

DUT: BFLF-WTW-P22030373

Communication System: UID 10169 - CAE, LTE-FDD (SC-FDMA, 1 RB, 20 MHz, QPSK); Frequency: 1860 MHz; Duty Cycle: 1:3.74

Medium: H16T20N1_0331 Medium parameters used: $f = 1860$ MHz; $\sigma = 1.438$ S/m; $\epsilon_r = 38.889$; $\rho = 1000$ kg/m³

Ambient Temperature : 23.3 °C ; Liquid Temperature : 23.1 °C

DASY5 Configuration:

- Probe: EX3DV4 - SN7472; ConvF(8.43, 8.43, 8.43) @ 1860 MHz; Calibrated: 2021/06/03
- Sensor-Surface: 1.4mm (Mechanical Surface Detection)
- Electronics: DAE4 Sn1698; Calibrated: 2021/11/09
- Phantom: ELI Phantom_1205; Type: QDOVA002AA;
- Measurement SW: DASY52, Version 52.10 (4); SEMCAD X Version 14.6.14 (7501)

Area Scan (71x261x1): Interpolated grid: dx=1.500 mm, dy=1.500 mm

Maximum value of SAR (interpolated) = 0.643 W/kg

Zoom Scan (5x5x7)/Cube 0: Measurement grid: dx=8mm, dy=8mm, dz=5mm

Reference Value = 19.82 V/m; Power Drift = -0.16 dB

Peak SAR (extrapolated) = 1.27 W/kg

SAR(1 g) = 0.643 W/kg; SAR(10 g) = 0.251 W/kg (SAR corrected for target medium)

Smallest distance from peaks to all points 3 dB below = 8.4 mm

Ratio of SAR at M2 to SAR at M1 = 40.6%

Maximum value of SAR (measured) = 0.868 W/kg

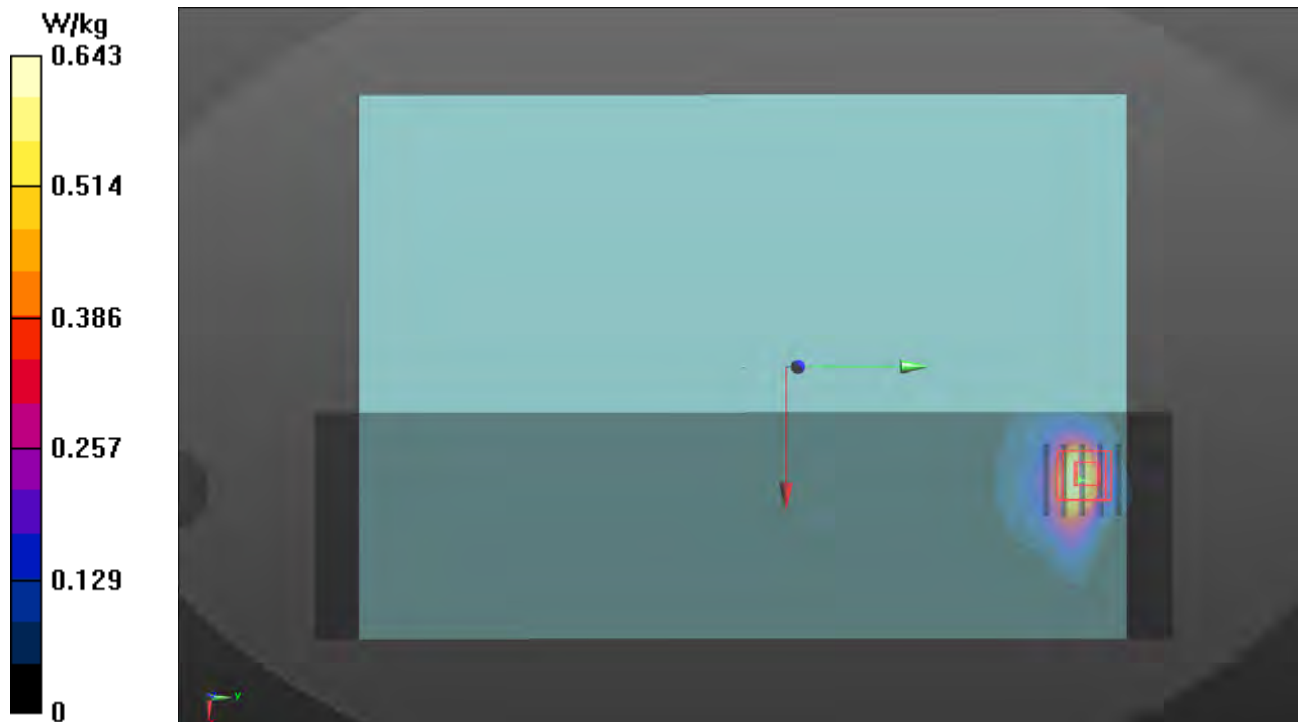

Plots of Measurement

Test Laboratory: Bureau Veritas ADT SAR/HAC Testing Lab

Date: 2022/04/01

P05 LTE 4_QPSK20M_Rear Face_0mm_Ch20050_1RB_OS0_Ant 0_Power Reduction_w

DUT: BFLF-WTW-P22030373

Communication System: UID 10169 - CAE, LTE-FDD (SC-FDMA, 1 RB, 20 MHz, QPSK); Frequency: 1720 MHz; Duty Cycle: 1:3.74

Medium: H16T20N1_0401 Medium parameters used: $f = 1720$ MHz; $\sigma = 1.294$ S/m; $\epsilon_r = 39.274$; $\rho = 1000$ kg/m³

Ambient Temperature : 23.5 °C ; Liquid Temperature : 23.4 °C

DASY5 Configuration:

- Probe: EX3DV4 - SN7472; ConvF(8.77, 8.77, 8.77) @ 1720 MHz; Calibrated: 2021/06/03
- Sensor-Surface: 1.4mm (Mechanical Surface Detection)
- Electronics: DAE4 Sn1698; Calibrated: 2021/11/09
- Phantom: ELI Phantom_1205; Type: QDOVA002AA;
- Measurement SW: DASY52, Version 52.10 (4); SEMCAD X Version 14.6.14 (7501)

Area Scan (71x261x1): Interpolated grid: dx=1.500 mm, dy=1.500 mm

Maximum value of SAR (interpolated) = 1.00 W/kg

Zoom Scan (5x5x7)/Cube 0: Measurement grid: dx=8mm, dy=8mm, dz=5mm

Reference Value = 27.34 V/m; Power Drift = 0.08 dB

Peak SAR (extrapolated) = 1.49 W/kg

SAR(1 g) = 0.686 W/kg; SAR(10 g) = 0.272 W/kg (SAR corrected for target medium)

Smallest distance from peaks to all points 3 dB below = 8.4 mm

Ratio of SAR at M2 to SAR at M1 = 38.3%

Maximum value of SAR (measured) = 1.05 W/kg

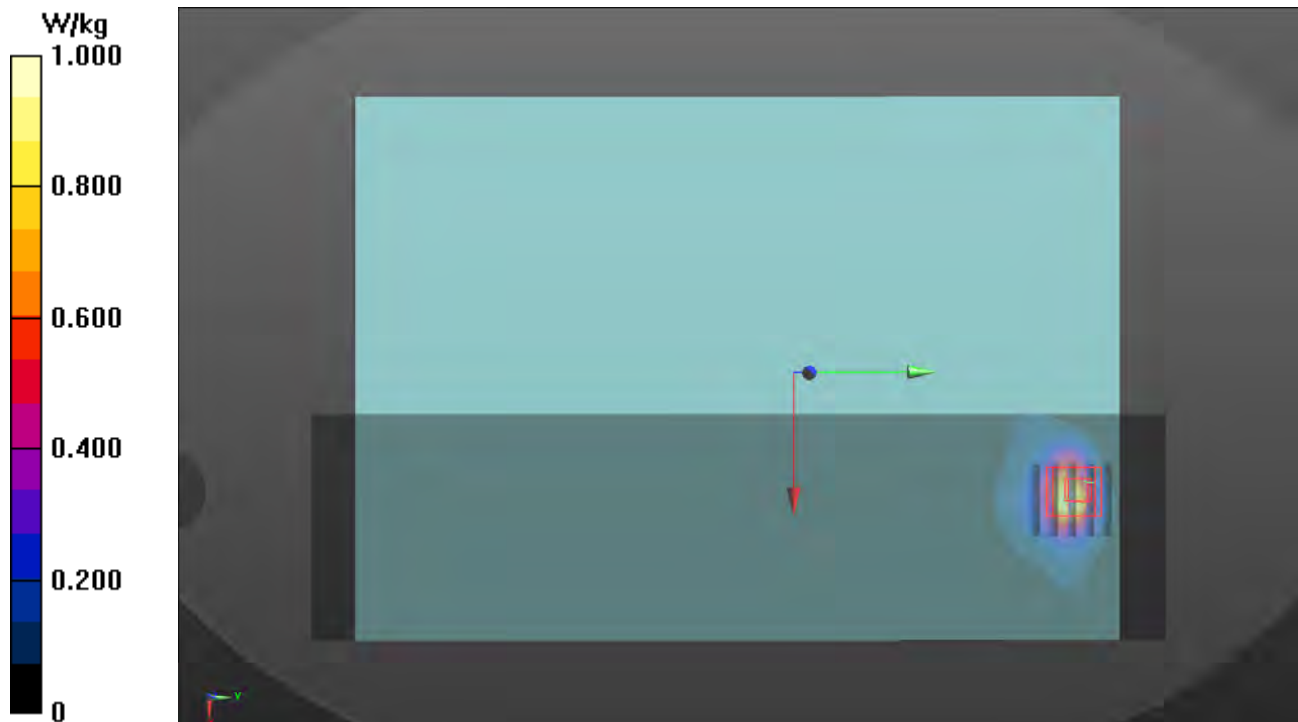

Plots of Measurement

Test Laboratory: Bureau Veritas ADT SAR/HAC Testing Lab

Date: 2022/03/30

P06 LTE 5_QPSK10M_Rear Face_0mm_Ch20525_1RB_OS0_Ant 0_Power Reduction_w

DUT: BFLF-WTW-P22030373

Communication System: UID 10175 - CAG, LTE-FDD (SC-FDMA, 1 RB, 10 MHz, QPSK); Frequency: 836.5 MHz; Duty Cycle: 1:3.74

Medium: H07T10N1_0330 Medium parameters used (interpolated): $f = 836.5$ MHz; $\sigma = 0.936$ S/m; $\epsilon_r = 40.694$; $\rho = 1000$ kg/m³

Ambient Temperature : 23.3 °C ; Liquid Temperature : 23.2 °C

DASY5 Configuration:

- Probe: EX3DV4 - SN7472; ConvF(10.05, 10.05, 10.05) @ 836.5 MHz; Calibrated: 2021/06/03
- Sensor-Surface: 1.4mm (Mechanical Surface Detection)
- Electronics: DAE4 Sn1698; Calibrated: 2021/11/09
- Phantom: ELI Phantom_1205; Type: QDOVA002AA;
- Measurement SW: DASY52, Version 52.10 (4); SEMCAD X Version 14.6.14 (7501)

Area Scan (71x261x1): Interpolated grid: dx=1.500 mm, dy=1.500 mm
Maximum value of SAR (interpolated) = 1.28 W/kg

Zoom Scan (5x5x7)/Cube 0: Measurement grid: dx=8mm, dy=8mm, dz=5mm

Reference Value = 35.35 V/m; Power Drift = -0.02 dB

Peak SAR (extrapolated) = 2.36 W/kg

SAR(1 g) = 0.610 W/kg; SAR(10 g) = 0.316 W/kg (SAR corrected for target medium)

Smallest distance from peaks to all points 3 dB below = 8.1 mm

Ratio of SAR at M2 to SAR at M1 = 30.4%

Maximum value of SAR (measured) = 1.49 W/kg

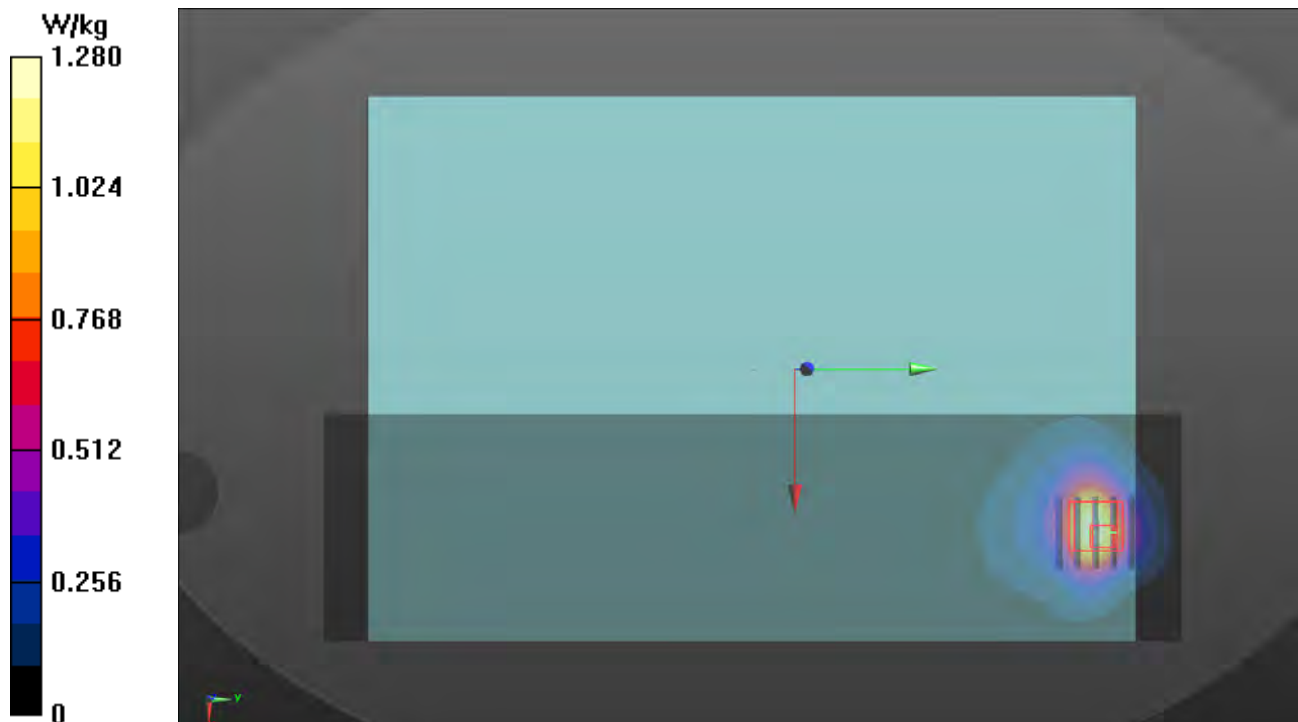

Plots of Measurement

Test Laboratory: Bureau Veritas ADT SAR/HAC Testing Lab

Date: 2022/04/02

P07 LTE 7_QPSK20M_Rear Face_0mm_Ch20850_1RB_OS0_Ant 0_Power Reduction_w

DUT: BFLF-WTW-P22030373

Communication System: UID 10169 - CAE, LTE-FDD (SC-FDMA, 1 RB, 20 MHz, QPSK); Frequency: 2510 MHz; Duty Cycle: 1:3.74

Medium: H19T27N1_0402 Medium parameters used: $f = 2510$ MHz; $\sigma = 1.963$ S/m; $\epsilon_r = 38.846$; $\rho = 1000$ kg/m³

Ambient Temperature : 23.4 °C ; Liquid Temperature : 23.3 °C

DASY5 Configuration:

- Probe: EX3DV4 - SN7472; ConvF(7.58, 7.58, 7.58) @ 2510 MHz; Calibrated: 2021/06/03
- Sensor-Surface: 1.4mm (Mechanical Surface Detection)
- Electronics: DAE4 Sn1698; Calibrated: 2021/11/09
- Phantom: ELI Phantom_1205; Type: QDOVA002AA;
- Measurement SW: DASY52, Version 52.10 (4); SEMCAD X Version 14.6.14 (7501)

Area Scan (91x321x1): Interpolated grid: dx=1.200 mm, dy=1.200 mm

Maximum value of SAR (interpolated) = 0.773 W/kg

Zoom Scan (7x7x7)/Cube 0: Measurement grid: dx=5mm, dy=5mm, dz=5mm

Reference Value = 19.95 V/m; Power Drift = 0.07 dB

Peak SAR (extrapolated) = 2.46 W/kg

SAR(1 g) = 0.575 W/kg; SAR(10 g) = 0.278 W/kg (SAR corrected for target medium)

Smallest distance from peaks to all points 3 dB below = 6 mm

Ratio of SAR at M2 to SAR at M1 = 34.4%

Maximum value of SAR (measured) = 1.64 W/kg

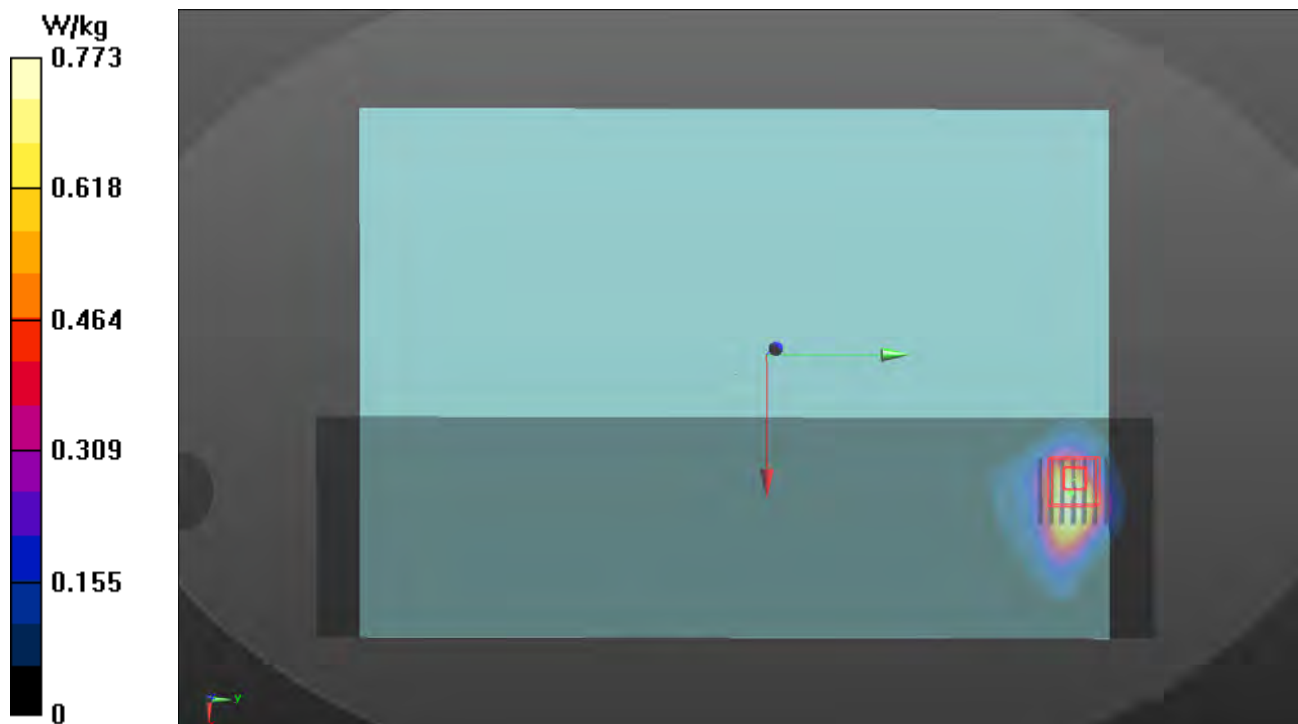

Plots of Measurement

Test Laboratory: Bureau Veritas ADT SAR/HAC Testing Lab

Date: 2022/03/28

P08 LTE 12_QPSK10M_Rear Face_0mm_Ch23095_1RB_OS0_Ant 0_Power Reduction_w

DUT: BFLF-WTW-P22030373

Communication System: UID 10175 - CAG, LTE-FDD (SC-FDMA, 1 RB, 10 MHz, QPSK); Frequency: 707.5 MHz; Duty Cycle: 1:3.74

Medium: H06T09N1_0328 Medium parameters used (interpolated): $f = 707.5$ MHz; $\sigma = 0.882$ S/m; $\epsilon_r = 40.817$; $\rho = 1000$ kg/m³

Ambient Temperature : 23.5 °C ; Liquid Temperature : 23.3 °C

DASY5 Configuration:

- Probe: EX3DV4 - SN7472; ConvF(10.32, 10.32, 10.32) @ 707.5 MHz; Calibrated: 2021/06/03
- Sensor-Surface: 1.4mm (Mechanical Surface Detection)
- Electronics: DAE4 Sn1698; Calibrated: 2021/11/09
- Phantom: ELI Phantom_1205; Type: QDOVA002AA;
- Measurement SW: DASY52, Version 52.10 (4); SEMCAD X Version 14.6.14 (7483)

Area Scan (71x261x1): Interpolated grid: dx=1.500 mm, dy=1.500 mm
Maximum value of SAR (interpolated) = 0.779 W/kg

Zoom Scan (5x5x7)/Cube 0: Measurement grid: dx=8mm, dy=8mm, dz=5mm

Reference Value = 30.89 V/m; Power Drift = 0.11 dB

Peak SAR (extrapolated) = 2.06 W/kg

SAR(1 g) = 0.685 W/kg; SAR(10 g) = 0.310 W/kg (SAR corrected for target medium)

Smallest distance from peaks to all points 3 dB below = 8.8 mm

Ratio of SAR at M2 to SAR at M1 = 32.4%

Maximum value of SAR (measured) = 1.39 W/kg

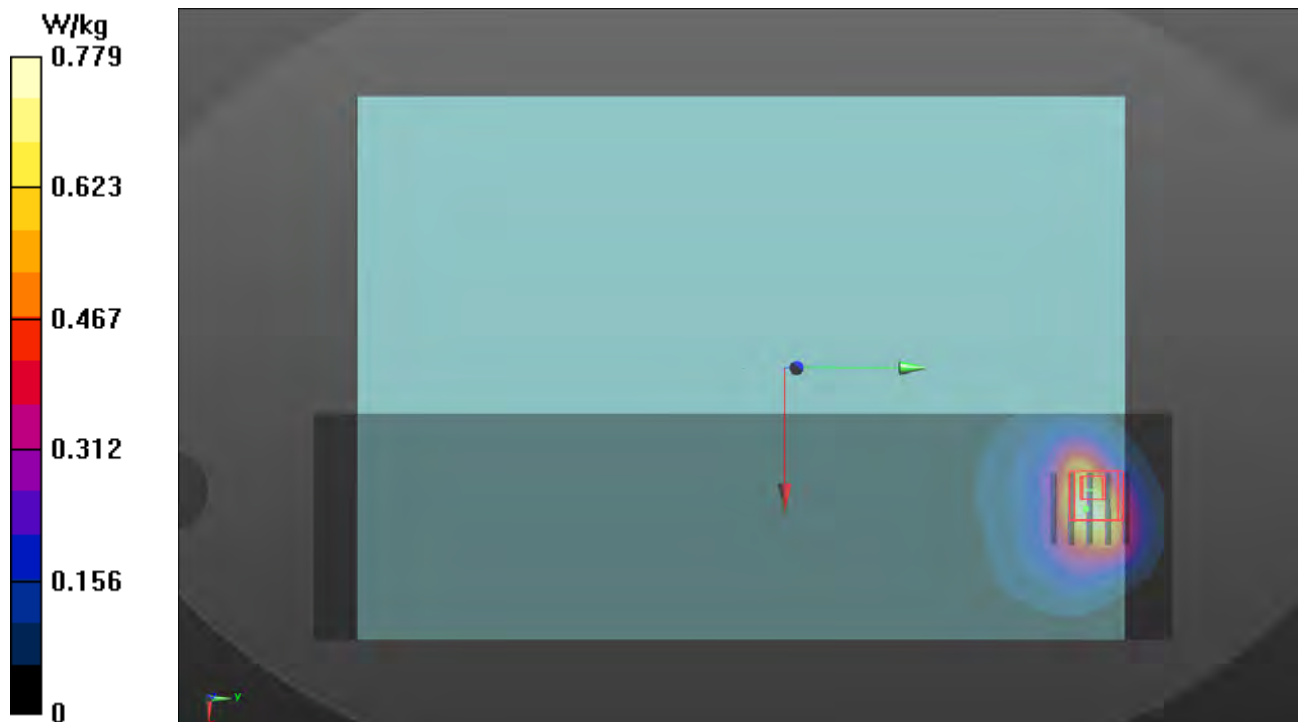

Plots of Measurement

Test Laboratory: Bureau Veritas ADT SAR/HAC Testing Lab

Date: 2022/03/28

P09 LTE 13_QPSK10M_Rear Face_0mm_Ch23230_1RB_OS0_Ant 0_Power Reduction_w

DUT: BFLF-WTW-P22030373

Communication System: UID 10175 - CAG, LTE-FDD (SC-FDMA, 1 RB, 10 MHz, QPSK); Frequency: 782 MHz; Duty Cycle: 1:3.74

Medium: H06T09N1_0328 Medium parameters used: $f = 782$ MHz; $\sigma = 0.905$ S/m; $\epsilon_r = 40.584$; $\rho = 1000$ kg/m³

Ambient Temperature : 23.5 °C ; Liquid Temperature : 23.3 °C

DASY5 Configuration:

- Probe: EX3DV4 - SN7472; ConvF(10.32, 10.32, 10.32) @ 782 MHz; Calibrated: 2021/06/03
- Sensor-Surface: 1.4mm (Mechanical Surface Detection)
- Electronics: DAE4 Sn1698; Calibrated: 2021/11/09
- Phantom: ELI Phantom_1205; Type: QDOVA002AA;
- Measurement SW: DASY52, Version 52.10 (4); SEMCAD X Version 14.6.14 (7501)

Area Scan (71x261x1): Interpolated grid: dx=1.500 mm, dy=1.500 mm

Maximum value of SAR (interpolated) = 0.652 W/kg

Zoom Scan (5x5x7)/Cube 0: Measurement grid: dx=8mm, dy=8mm, dz=5mm

Reference Value = 27.33 V/m; Power Drift = -0.04 dB

Peak SAR (extrapolated) = 1.29 W/kg

SAR(1 g) = 0.400 W/kg; SAR(10 g) = 0.200 W/kg (SAR corrected for target medium)

Smallest distance from peaks to all points 3 dB below = 8.2 mm

Ratio of SAR at M2 to SAR at M1 = 33.1%

Maximum value of SAR (measured) = 0.895 W/kg

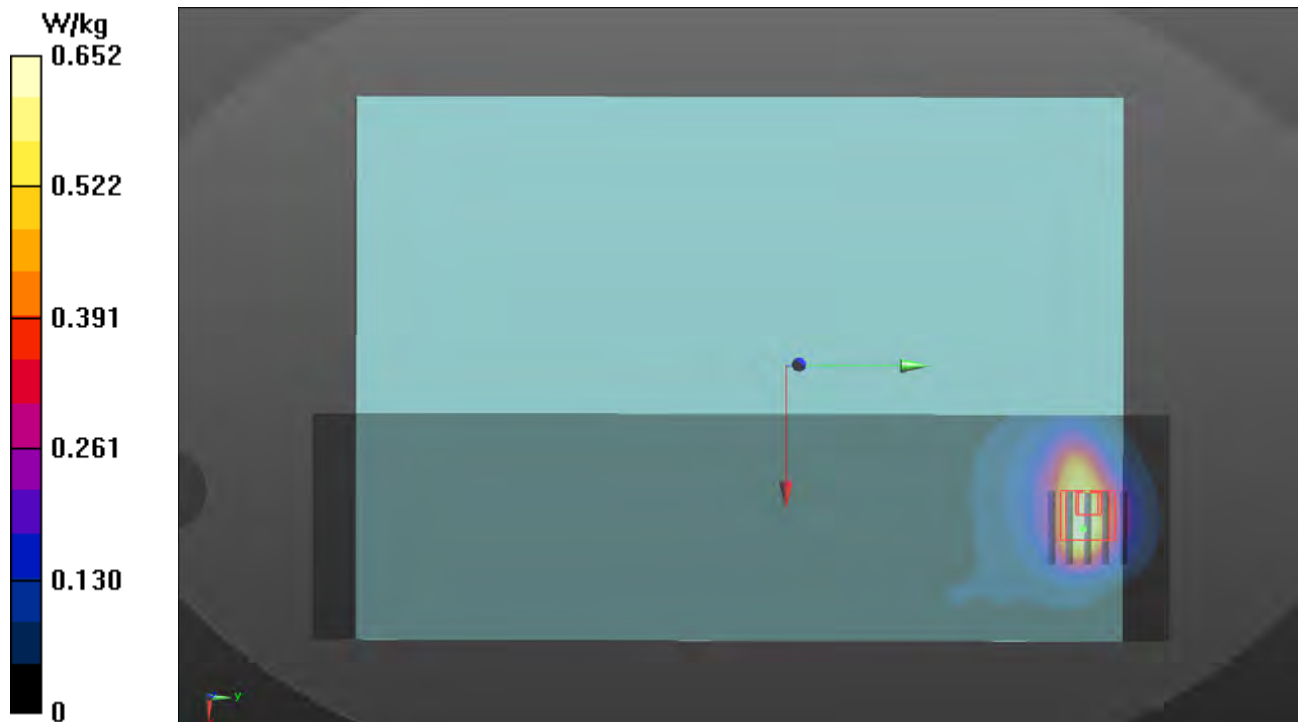

Plots of Measurement

Test Laboratory: Bureau Veritas ADT SAR/HAC Testing Lab

Date: 2022/03/29

P10 LTE 14_QPSK10M_Rear Face_0mm_Ch23330_1RB_OS0_Ant 0_Power Reduction_w

DUT: BFLF-WTW-P22030373

Communication System: UID 10175 - CAG, LTE-FDD (SC-FDMA, 1 RB, 10 MHz, QPSK); Frequency: 793 MHz; Duty Cycle: 1:3.74

Medium: H06T09N1_0329 Medium parameters used: $f = 793$ MHz; $\sigma = 0.907$ S/m; $\epsilon_r = 40.523$; $\rho = 1000$ kg/m³

Ambient Temperature : 23.4 °C ; Liquid Temperature : 23.2 °C

DASY5 Configuration:

- Probe: EX3DV4 - SN7472; ConvF(10.32, 10.32, 10.32) @ 793 MHz; Calibrated: 2021/06/03
- Sensor-Surface: 1.4mm (Mechanical Surface Detection)
- Electronics: DAE4 Sn1698; Calibrated: 2021/11/09
- Phantom: ELI Phantom_1205; Type: QDOVA002AA;
- Measurement SW: DASY52, Version 52.10 (4); SEMCAD X Version 14.6.14 (7501)

Area Scan (71x261x1): Interpolated grid: dx=1.500 mm, dy=1.500 mm

Maximum value of SAR (interpolated) = 0.736 W/kg

Zoom Scan (5x5x7)/Cube 0: Measurement grid: dx=8mm, dy=8mm, dz=5mm

Reference Value = 28.55 V/m; Power Drift = -0.01 dB

Peak SAR (extrapolated) = 1.24 W/kg

SAR(1 g) = 0.400 W/kg; SAR(10 g) = 0.201 W/kg (SAR corrected for target medium)

Smallest distance from peaks to all points 3 dB below = 9.6 mm

Ratio of SAR at M2 to SAR at M1 = 36.4%

Maximum value of SAR (measured) = 0.792 W/kg

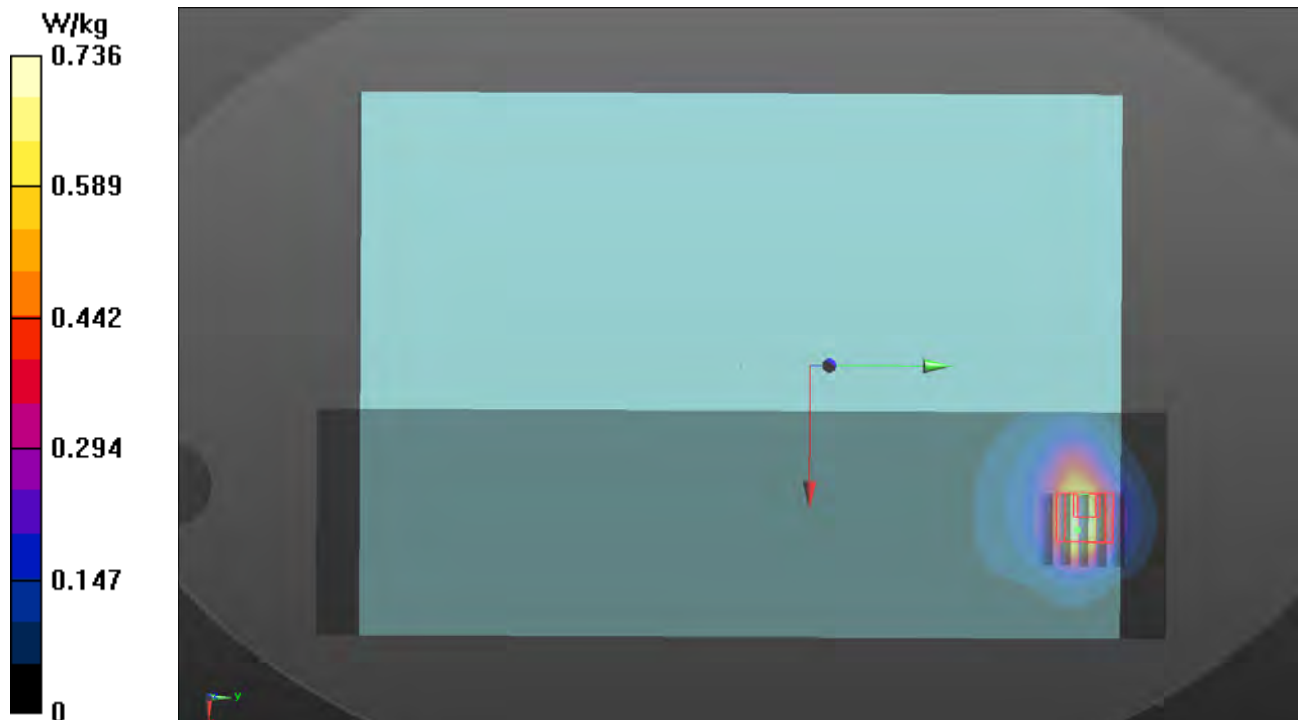

Plots of Measurement

Test Laboratory: Bureau Veritas ADT SAR/HAC Testing Lab

Date: 2022/03/29

P11 LTE 17_QPSK10M_Rear Face_0mm_Ch23800_1RB_OS0_Ant 0_Power Reduction_w

DUT: BFLF-WTW-P22030373

Communication System: UID 10175 - CAG, LTE-FDD (SC-FDMA, 1 RB, 10 MHz, QPSK); Frequency: 711 MHz; Duty Cycle: 1:3.74

Medium: H06T09N1_0329 Medium parameters used: $f = 711$ MHz; $\sigma = 0.882$ S/m; $\epsilon_r = 40.781$; $\rho = 1000$ kg/m³

Ambient Temperature : 23.4 °C ; Liquid Temperature : 23.2 °C

DASY5 Configuration:

- Probe: EX3DV4 - SN7472; ConvF(10.32, 10.32, 10.32) @ 711 MHz; Calibrated: 2021/06/03
- Sensor-Surface: 1.4mm (Mechanical Surface Detection)
- Electronics: DAE4 Sn1698; Calibrated: 2021/11/09
- Phantom: ELI Phantom_1205; Type: QDOVA002AA;
- Measurement SW: DASY52, Version 52.10 (4); SEMCAD X Version 14.6.14 (7501)

Area Scan (71x261x1): Interpolated grid: dx=1.500 mm, dy=1.500 mm

Maximum value of SAR (interpolated) = 0.633 W/kg

Zoom Scan (5x5x7)/Cube 0: Measurement grid: dx=8mm, dy=8mm, dz=5mm

Reference Value = 34.70 V/m; Power Drift = -0.01 dB

Peak SAR (extrapolated) = 1.95 W/kg

SAR(1 g) = 0.611 W/kg; SAR(10 g) = 0.276 W/kg (SAR corrected for target medium)

Smallest distance from peaks to all points 3 dB below = 8.2 mm

Ratio of SAR at M2 to SAR at M1 = 35.3%

Maximum value of SAR (measured) = 1.10 W/kg

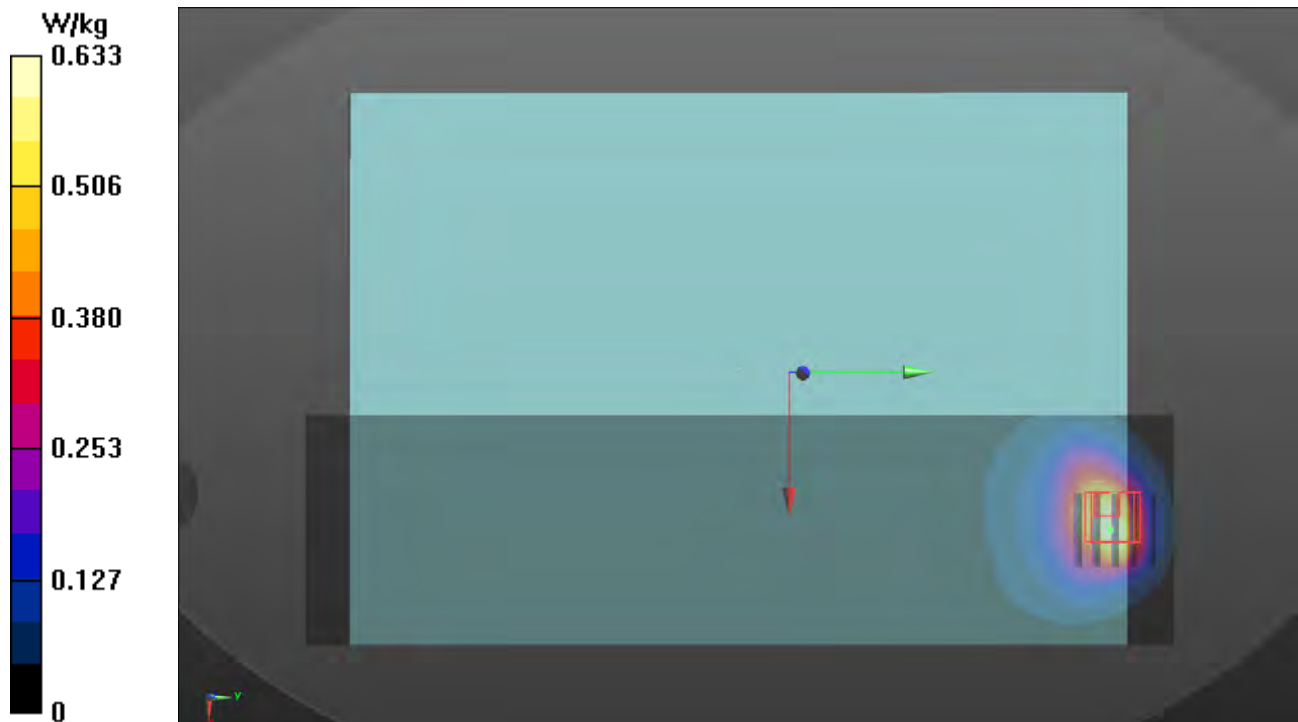

Plots of Measurement

Test Laboratory: Bureau Veritas ADT SAR/HAC Testing Lab

Date: 2022/03/31

P12 LTE 25_QPSK20M_Rear Face_0mm_Ch26590_1RB_OS0_Ant 0_Power Reduction_w

DUT: BFLF-WTW-P22030373

Communication System: UID 10169 - CAE, LTE-FDD (SC-FDMA, 1 RB, 20 MHz, QPSK); Frequency: 1905 MHz; Duty Cycle: 1:3.74

Medium: H16T20N1_0331 Medium parameters used: $f = 1905$ MHz; $\sigma = 1.466$ S/m; $\epsilon_r = 38.856$; $\rho = 1000$ kg/m³

Ambient Temperature : 23.3 °C ; Liquid Temperature : 23.1 °C

DASY5 Configuration:

- Probe: EX3DV4 - SN7472; ConvF(8.43, 8.43, 8.43) @ 1905 MHz; Calibrated: 2021/06/03
- Sensor-Surface: 1.4mm (Mechanical Surface Detection)
- Electronics: DAE4 Sn1698; Calibrated: 2021/11/09
- Phantom: ELI Phantom_1205; Type: QDOVA002AA;
- Measurement SW: DASY52, Version 52.10 (4); SEMCAD X Version 14.6.14 (7501)

Area Scan (71x261x1): Interpolated grid: dx=1.500 mm, dy=1.500 mm

Maximum value of SAR (interpolated) = 0.792 W/kg

Zoom Scan (5x5x7)/Cube 0: Measurement grid: dx=8mm, dy=8mm, dz=5mm

Reference Value = 22.57 V/m; Power Drift = 0.13 dB

Peak SAR (extrapolated) = 1.56 W/kg

SAR(1 g) = 0.578 W/kg; SAR(10 g) = 0.264 W/kg (SAR corrected for target medium)

Smallest distance from peaks to all points 3 dB below = 8.1 mm

Ratio of SAR at M2 to SAR at M1 = 38.1%

Maximum value of SAR (measured) = 1.16 W/kg

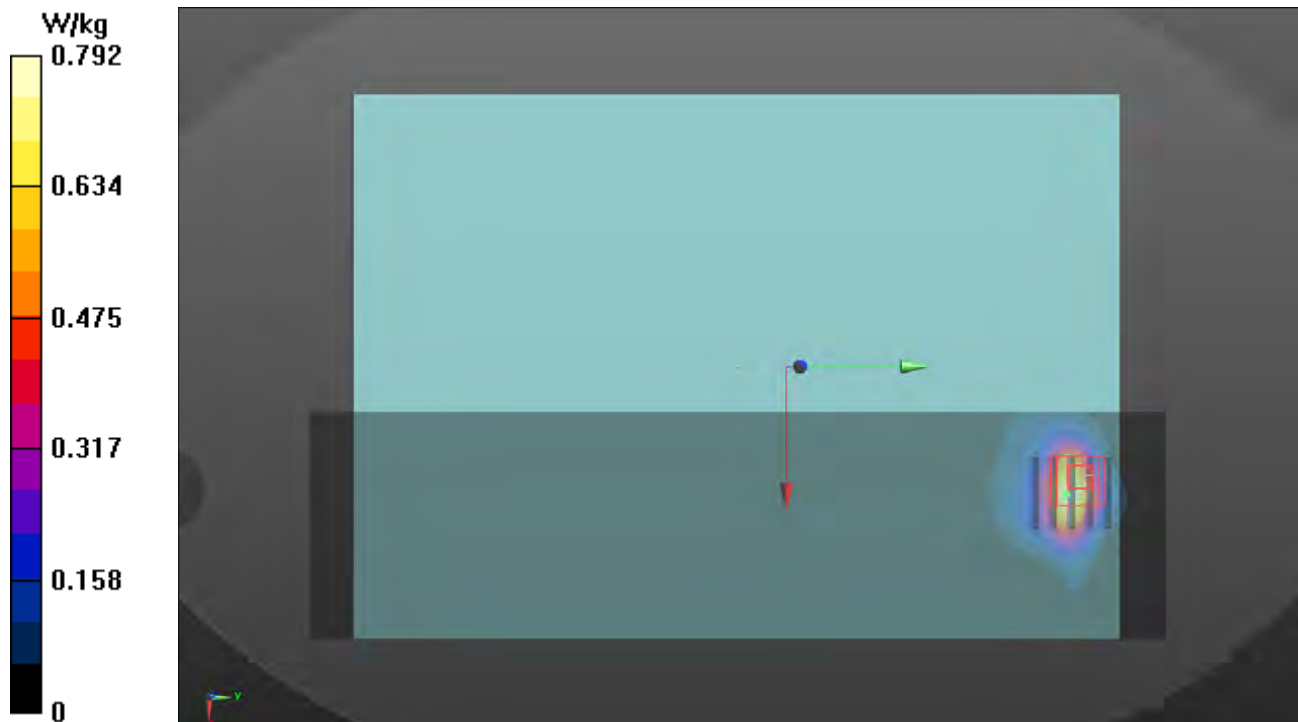

Plots of Measurement

Test Laboratory: Bureau Veritas ADT SAR/HAC Testing Lab

Date: 2022/03/30

P13 LTE 26_QPSK15M_Rear Face_0mm_Ch26965_1RB_OS0_Ant 0_Power Reduction_w

DUT: BFLF-WTW-P22030373

Communication System: UID 10181 - CAE, LTE-FDD (SC-FDMA, 1 RB, 15 MHz, QPSK); Frequency: 841.5 MHz; Duty Cycle: 1:3.74

Medium: H07T10N1_0330 Medium parameters used (interpolated): $f = 841.5$ MHz; $\sigma = 0.937$ S/m; $\epsilon_r = 40.669$; $\rho = 1000$ kg/m³

Ambient Temperature : 23.3 °C ; Liquid Temperature : 23.2 °C

DASY5 Configuration:

- Probe: EX3DV4 - SN7472; ConvF(10.05, 10.05, 10.05) @ 841.5 MHz; Calibrated: 2021/06/03
- Sensor-Surface: 1.4mm (Mechanical Surface Detection)
- Electronics: DAE4 Sn1698; Calibrated: 2021/11/09
- Phantom: ELI Phantom_1205; Type: QDOVA002AA;
- Measurement SW: DASY52, Version 52.10 (4); SEMCAD X Version 14.6.14 (7501)

Area Scan (71x261x1): Interpolated grid: dx=1.500 mm, dy=1.500 mm
Maximum value of SAR (interpolated) = 0.935 W/kg

Zoom Scan (5x5x7)/Cube 0: Measurement grid: dx=8mm, dy=8mm, dz=5mm

Reference Value = 29.31 V/m; Power Drift = -0.09 dB

Peak SAR (extrapolated) = 1.68 W/kg

SAR(1 g) = 0.605 W/kg; SAR(10 g) = 0.318 W/kg (SAR corrected for target medium)

Smallest distance from peaks to all points 3 dB below = 9.6 mm

Ratio of SAR at M2 to SAR at M1 = 32.1%

Maximum value of SAR (measured) = 1.03 W/kg

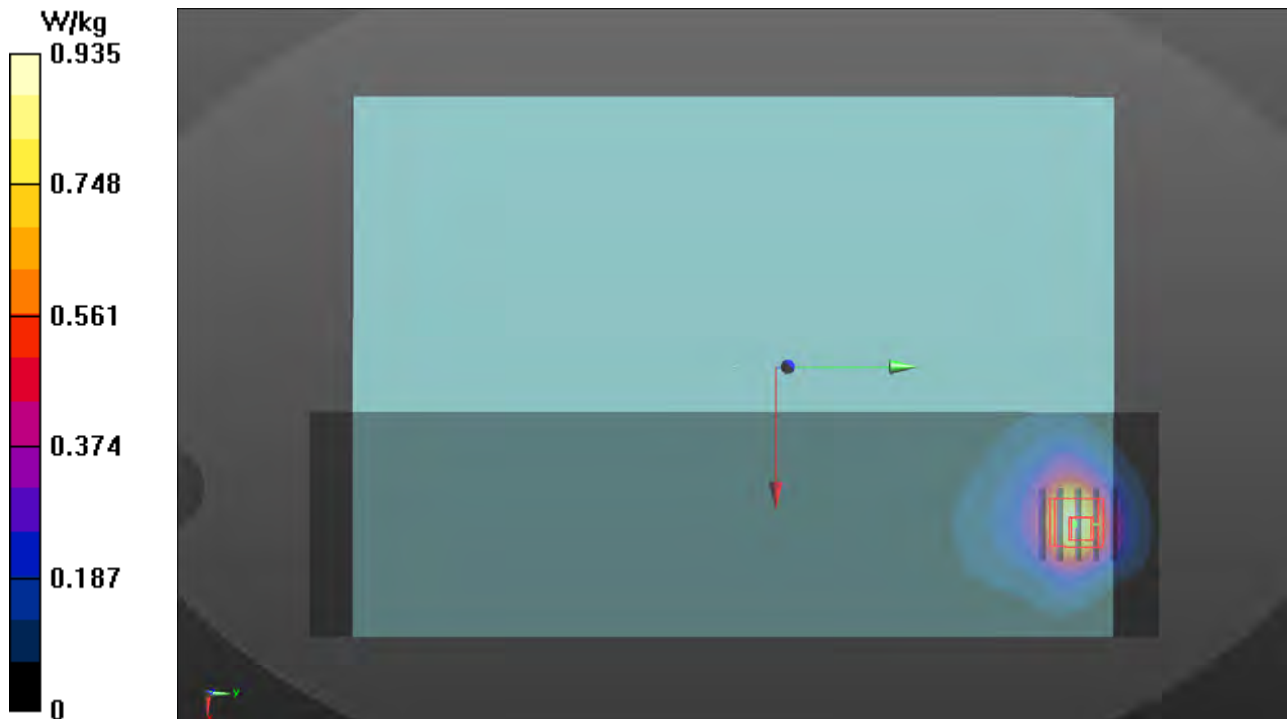

Plots of Measurement

Test Laboratory: Bureau Veritas ADT SAR/HAC Testing Lab

Date: 2022/04/02

P14 LTE 30_QPSK10M_Rear Face_0mm_Ch27710_1RB_OS0_Ant 0_Power Reduction_w

DUT: BFLF-WTW-P22030373

Communication System: UID 10175 - CAG, LTE-FDD (SC-FDMA, 1 RB, 10 MHz, QPSK); Frequency: 2310 MHz; Duty Cycle: 1:3.74

Medium: H19T27N1_0402 Medium parameters used: $f = 2310$ MHz; $\sigma = 1.726$ S/m; $\epsilon_r = 39.593$; $\rho = 1000$ kg/m³

Ambient Temperature : 23.4 °C ; Liquid Temperature : 23.3 °C

DASY5 Configuration:

- Probe: EX3DV4 - SN7472; ConvF(8.13, 8.13, 8.13) @ 2310 MHz; Calibrated: 2021/06/03
- Sensor-Surface: 1.4mm (Mechanical Surface Detection)
- Electronics: DAE4 Sn1698; Calibrated: 2021/11/09
- Phantom: ELI Phantom_1205; Type: QDOVA002AA;
- Measurement SW: DASY52, Version 52.10 (4); SEMCAD X Version 14.6.14 (7501)

Area Scan (91x321x1): Interpolated grid: dx=1.200 mm, dy=1.200 mm

Maximum value of SAR (interpolated) = 0.960 W/kg

Zoom Scan (7x7x7)/Cube 0: Measurement grid: dx=5mm, dy=5mm, dz=5mm

Reference Value = 24.29 V/m; Power Drift = 0.06 dB

Peak SAR (extrapolated) = 2.37 W/kg

SAR(1 g) = 0.643 W/kg; SAR(10 g) = 0.257 W/kg (SAR corrected for target medium)

Smallest distance from peaks to all points 3 dB below = 5.7 mm

Ratio of SAR at M2 to SAR at M1 = 38.5%

Maximum value of SAR (measured) = 1.60 W/kg

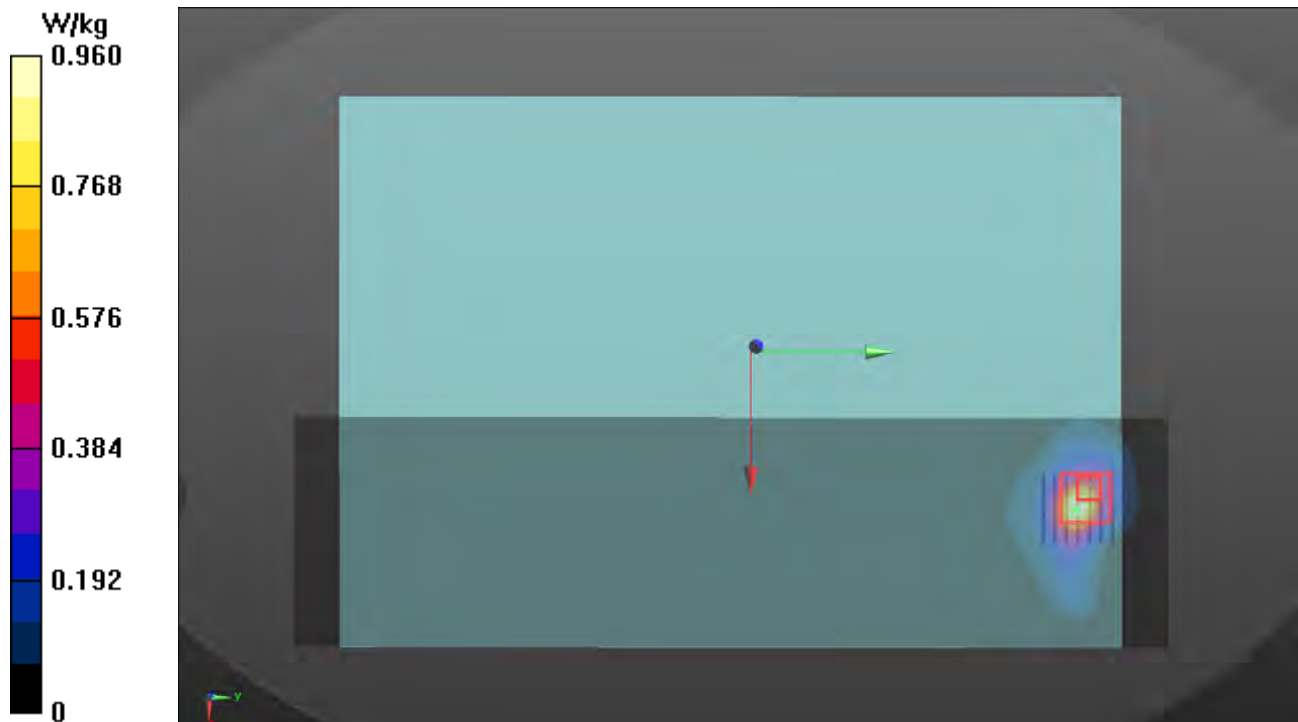

Plots of Measurement

Test Laboratory: Bureau Veritas ADT SAR/HAC Testing Lab

Date: 2022/04/02

P15 LTE 38_QPSK20M_Rear Face_0mm_Ch37850_1RB_OS0_Ant 0_Power Reduction_w

DUT: BFLF-WTW-P22030373

Communication System: UID 10172 - CAG, LTE-TDD (SC-FDMA, 1 RB, 20 MHz, QPSK); Frequency: 2580 MHz; Duty Cycle: 1:8.33

Medium: H19T27N1_0402 Medium parameters used: $f = 2580$ MHz; $\sigma = 1.994$ S/m; $\epsilon_r = 38.779$; $\rho = 1000$ kg/m³

Ambient Temperature : 23.4 °C ; Liquid Temperature : 23.3 °C

DASY5 Configuration:

- Probe: EX3DV4 - SN7472; ConvF(7.58, 7.58, 7.58) @ 2580 MHz; Calibrated: 2021/06/03
- Sensor-Surface: 1.4mm (Mechanical Surface Detection)
- Electronics: DAE4 Sn1698; Calibrated: 2021/11/09
- Phantom: ELI Phantom_1205; Type: QDOVA002AA;
- Measurement SW: DASY52, Version 52.10 (4); SEMCAD X Version 14.6.14 (7501)

Area Scan (91x321x1): Interpolated grid: dx=1.200 mm, dy=1.200 mm

Maximum value of SAR (interpolated) = 0.639 W/kg

Zoom Scan (7x7x7)/Cube 0: Measurement grid: dx=5mm, dy=5mm, dz=5mm

Reference Value = 17.07 V/m; Power Drift = -0.03 dB

Peak SAR (extrapolated) = 1.69 W/kg

SAR(1 g) = 0.502 W/kg; SAR(10 g) = 0.186 W/kg (SAR corrected for target medium)

Smallest distance from peaks to all points 3 dB below = 6.5 mm

Ratio of SAR at M2 to SAR at M1 = 39.5%

Maximum value of SAR (measured) = 1.11 W/kg

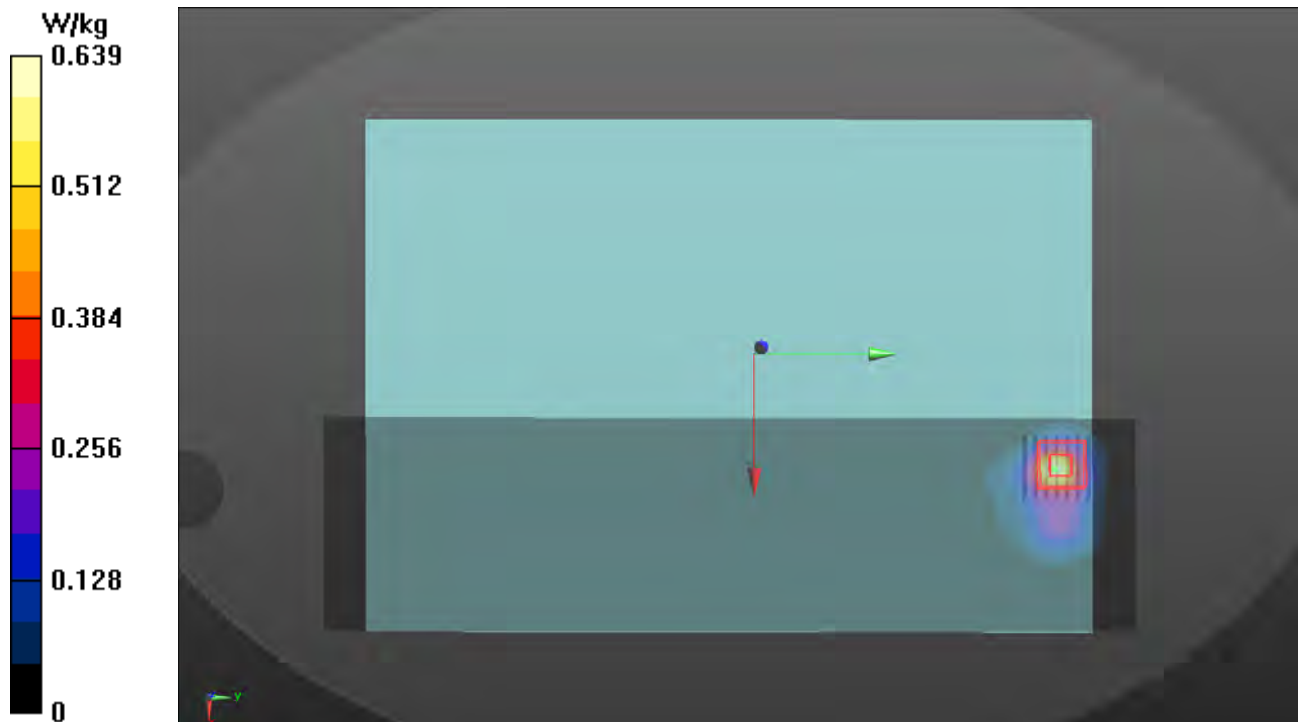

Plots of Measurement

Test Laboratory: Bureau Veritas ADT SAR/HAC Testing Lab

Date: 2022/04/03

P16 LTE 40_QPSK20M_Rear Face_0mm_Ch39150_1RB_OS0_Ant 0_Power Reduction_w

DUT: BFLF-WTW-P22030373

Communication System: UID 10172 - CAG, LTE-TDD (SC-FDMA, 1 RB, 20 MHz, QPSK); Frequency: 2350 MHz; Duty Cycle: 1:8.33

Medium: H19T27N1_0403 Medium parameters used: $f = 2350$ MHz; $\sigma = 1.722$ S/m; $\epsilon_r = 38.068$; $\rho = 1000$ kg/m³

Ambient Temperature : 23.3 °C ; Liquid Temperature : 23.1 °C

DASY5 Configuration:

- Probe: EX3DV4 - SN7472; ConvF(8.13, 8.13, 8.13) @ 2350 MHz; Calibrated: 2021/06/03
- Sensor-Surface: 1.4mm (Mechanical Surface Detection)
- Electronics: DAE4 Sn1698; Calibrated: 2021/11/09
- Phantom: ELI Phantom_1205; Type: QDOVA002AA;
- Measurement SW: DASY52, Version 52.10 (4); SEMCAD X Version 14.6.14 (7501)

Area Scan (91x321x1): Interpolated grid: dx=1.200 mm, dy=1.200 mm

Maximum value of SAR (interpolated) = 0.792 W/kg

Zoom Scan (7x7x7)/Cube 0: Measurement grid: dx=5mm, dy=5mm, dz=5mm

Reference Value = 22.01 V/m; Power Drift = -0.16 dB

Peak SAR (extrapolated) = 1.43 W/kg

SAR(1 g) = 0.495 W/kg; SAR(10 g) = 0.197 W/kg (SAR corrected for target medium)

Smallest distance from peaks to all points 3 dB below = 5.7 mm

Ratio of SAR at M2 to SAR at M1 = 34.3%

Maximum value of SAR (measured) = 0.971 W/kg

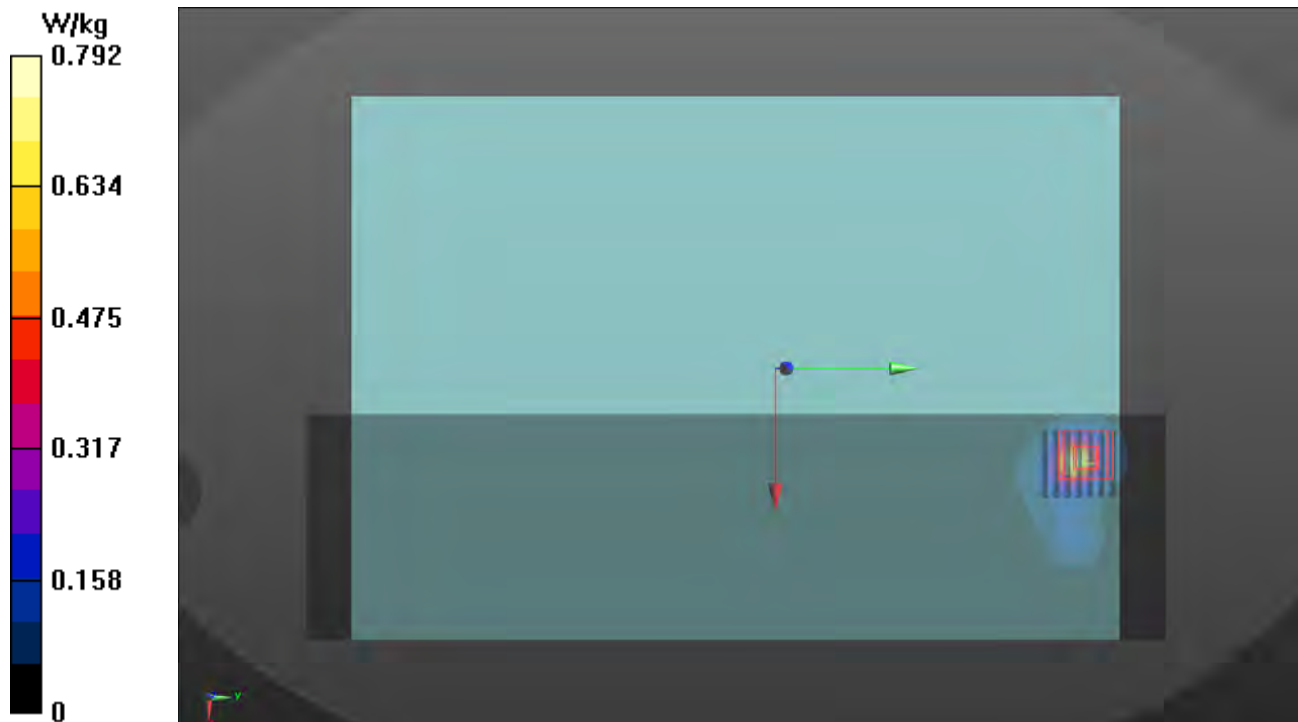

Plots of Measurement

Test Laboratory: Bureau Veritas ADT SAR/HAC Testing Lab

Date: 2022/04/03

P17 LTE 41_QPSK20M_Rear Face_0mm_Ch41055_1RB_OS0_Ant 2_Power Reduction_w

DUT: BFLF-WTW-P22030373

Communication System: UID 10172 - CAG, LTE-TDD (SC-FDMA, 1 RB, 20 MHz, QPSK); Frequency: 2636.5 MHz; Duty Cycle: 1:8.33

Medium: H19T27N1_0403 Medium parameters used (interpolated): $f = 2636.5$ MHz; $\sigma = 1.93$ S/m; $\epsilon_r = 37.629$; $\rho = 1000$ kg/m³

Ambient Temperature : 23.3 °C ; Liquid Temperature : 23.1 °C

DASY5 Configuration:

- Probe: EX3DV4 - SN7472; ConvF(7.58, 7.58, 7.58) @ 2636.5 MHz; Calibrated: 2021/06/03
- Sensor-Surface: 1.4mm (Mechanical Surface Detection)
- Electronics: DAE4 Sn1698; Calibrated: 2021/11/09
- Phantom: ELI Phantom_1205; Type: QDOVA002AA;
- Measurement SW: DASY52, Version 52.10 (4); SEMCAD X Version 14.6.14 (7501)

Area Scan (91x321x1): Interpolated grid: dx=1.200 mm, dy=1.200 mm
Maximum value of SAR (interpolated) = 0.991 W/kg

Zoom Scan (7x7x7)/Cube 0: Measurement grid: dx=5mm, dy=5mm, dz=5mm

Reference Value = 21.97 V/m; Power Drift = 0.09 dB

Peak SAR (extrapolated) = 1.43 W/kg

SAR(1 g) = 0.683 W/kg; SAR(10 g) = 0.256 W/kg (SAR corrected for target medium)

Smallest distance from peaks to all points 3 dB below = 6 mm

Ratio of SAR at M2 to SAR at M1 = 41.9%

Maximum value of SAR (measured) = 1.02 W/kg

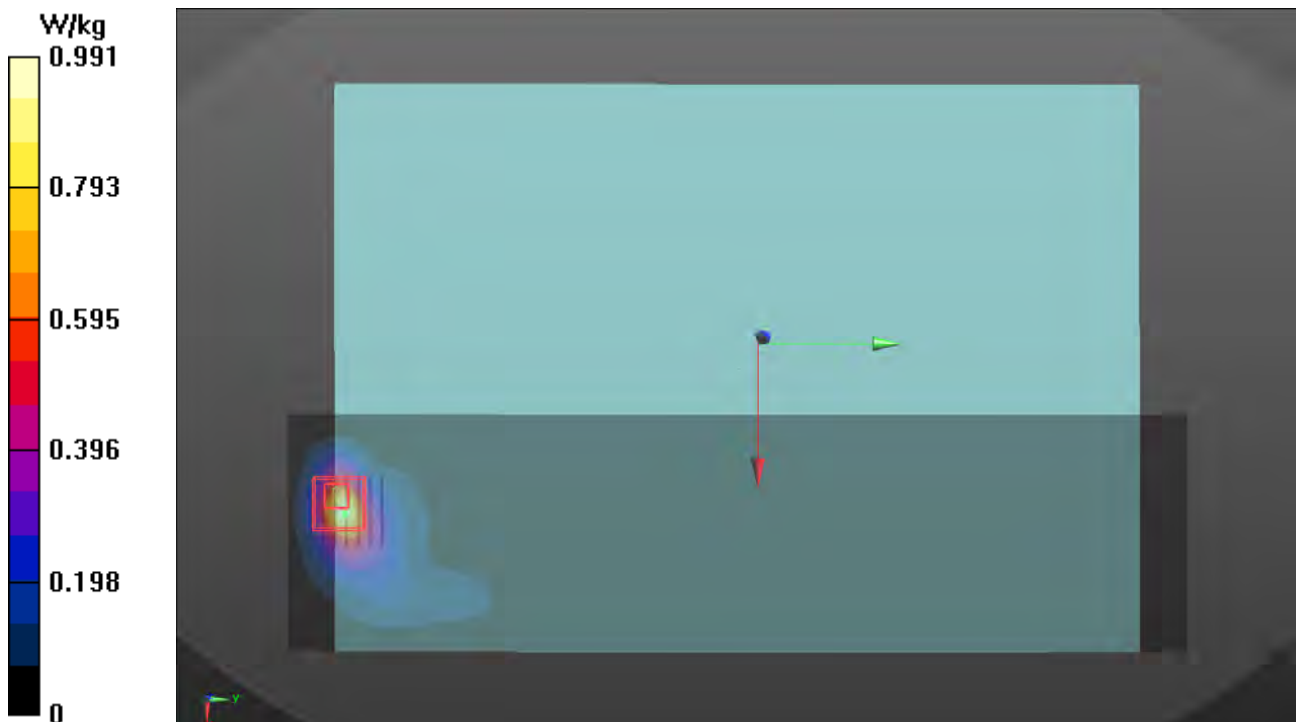

Plots of Measurement

Test Laboratory: Bureau Veritas ADT SAR/HAC Testing Lab

Date: 2022/04/04

P20 LTE 48_QPSK20M_Rear Face_0mm_Ch56640_1RB_OS0_Ant 2_Power Reduction_w

DUT: BFLF-WTW-P22030373

Communication System: UID 10172 - CAG, LTE-TDD (SC-FDMA, 1 RB, 20 MHz, QPSK); Frequency: 3690 MHz; Duty Cycle: 1:8.33

Medium: H34T38N1_0404 Medium parameters used (interpolated): $f = 3690$ MHz; $\sigma = 3.086$ S/m; $\epsilon_r = 36.802$; $\rho = 1000$ kg/m³

Ambient Temperature : 23.6 °C ; Liquid Temperature : 23.3 °C

DASY5 Configuration:

- Probe: EX3DV4 - SN7472; ConvF(7.12, 7.12, 7.12) @ 3690 MHz; Calibrated: 2021/06/03
- Sensor-Surface: 1.4mm (Mechanical Surface Detection)
- Electronics: DAE4 Sn1698; Calibrated: 2021/11/09
- Phantom: ELI Phantom_1205; Type: QDOVA002AA;
- Measurement SW: DASY52, Version 52.10 (4); SEMCAD X Version 14.6.14 (7501)

Area Scan (91x321x1): Interpolated grid: dx=1.200 mm, dy=1.200 mm
Maximum value of SAR (interpolated) = 0.485 W/kg

Zoom Scan (7x7x7)/Cube 0: Measurement grid: dx=5mm, dy=5mm, dz=2.5mm

Reference Value = 10.70 V/m; Power Drift = 0.05 dB

Peak SAR (extrapolated) = 2.06 W/kg

SAR(1 g) = 0.602 W/kg; SAR(10 g) = 0.160 W/kg (SAR corrected for target medium)

Smallest distance from peaks to all points 3 dB below = 5.5 mm

Ratio of SAR at M2 to SAR at M1 = 56.3%

Maximum value of SAR (measured) = 1.46 W/kg

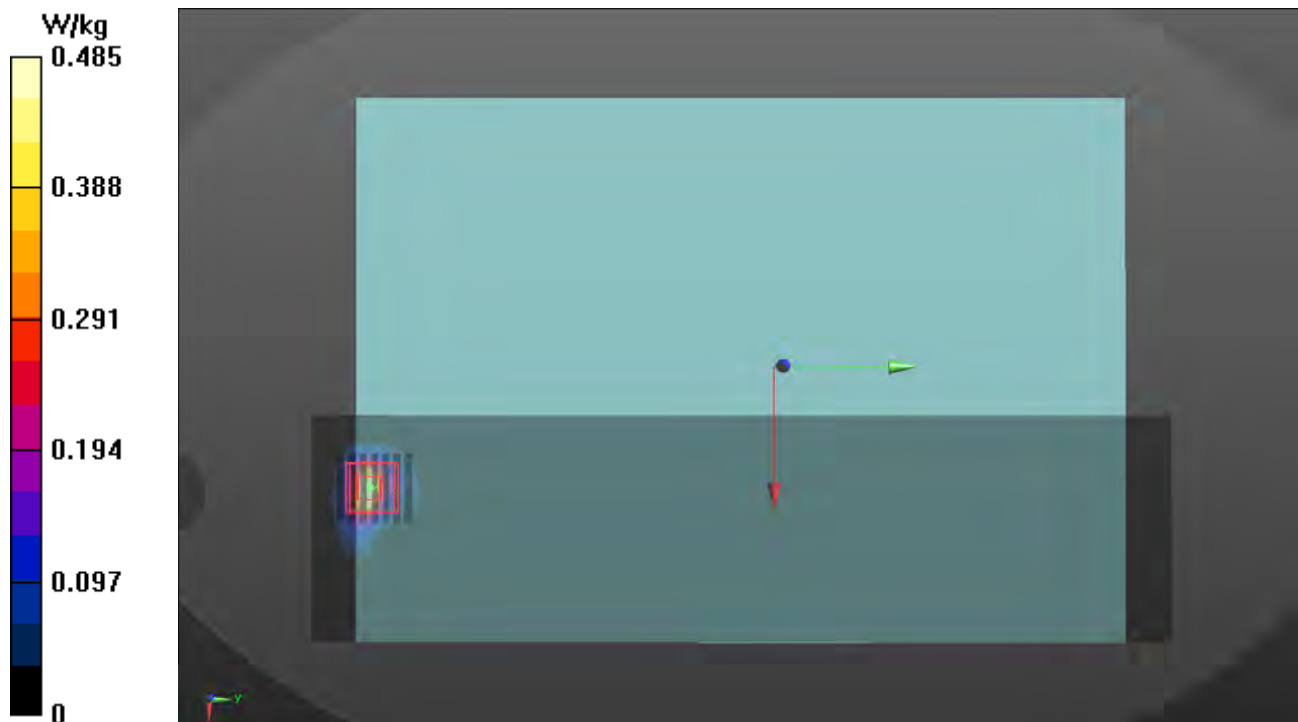

Plots of Measurement

Test Laboratory: Bureau Veritas ADT SAR/HAC Testing Lab

Date: 2022/04/01

P21 LTE 66_QPSK20M_Rear Face_0mm_Ch132322_1RB_OS0_Ant 0_Power Reduction_w

DUT: BFLF-WTW-P22030373

Communication System: UID 10169 - CAE, LTE-FDD (SC-FDMA, 1 RB, 20 MHz, QPSK); Frequency: 1745 MHz; Duty Cycle: 1:3.74

Medium: H16T20N1_0401 Medium parameters used (interpolated): $f = 1745$ MHz; $\sigma = 1.318$ S/m; $\epsilon_r = 39.166$; $\rho = 1000$ kg/m³

Ambient Temperature : 23.5 °C ; Liquid Temperature : 23.4 °C

DASY5 Configuration:

- Probe: EX3DV4 - SN7472; ConvF(8.77, 8.77, 8.77) @ 1745 MHz; Calibrated: 2021/06/03
- Sensor-Surface: 1.4mm (Mechanical Surface Detection)
- Electronics: DAE4 Sn1698; Calibrated: 2021/11/09
- Phantom: ELI Phantom_1205; Type: QDOVA002AA;
- Measurement SW: DASY52, Version 52.10 (4); SEMCAD X Version 14.6.14 (7501)

Area Scan (71x261x1): Interpolated grid: dx=1.500 mm, dy=1.500 mm
Maximum value of SAR (interpolated) = 0.812 W/kg

Zoom Scan (5x5x7)/Cube 0: Measurement grid: dx=8mm, dy=8mm, dz=5mm

Reference Value = 24.19 V/m; Power Drift = -0.13 dB

Peak SAR (extrapolated) = 1.45 W/kg

SAR(1 g) = 0.592 W/kg; SAR(10 g) = 0.270 W/kg (SAR corrected for target medium)

Smallest distance from peaks to all points 3 dB below = 8.4 mm

Ratio of SAR at M2 to SAR at M1 = 38.8%

Maximum value of SAR (measured) = 1.00 W/kg

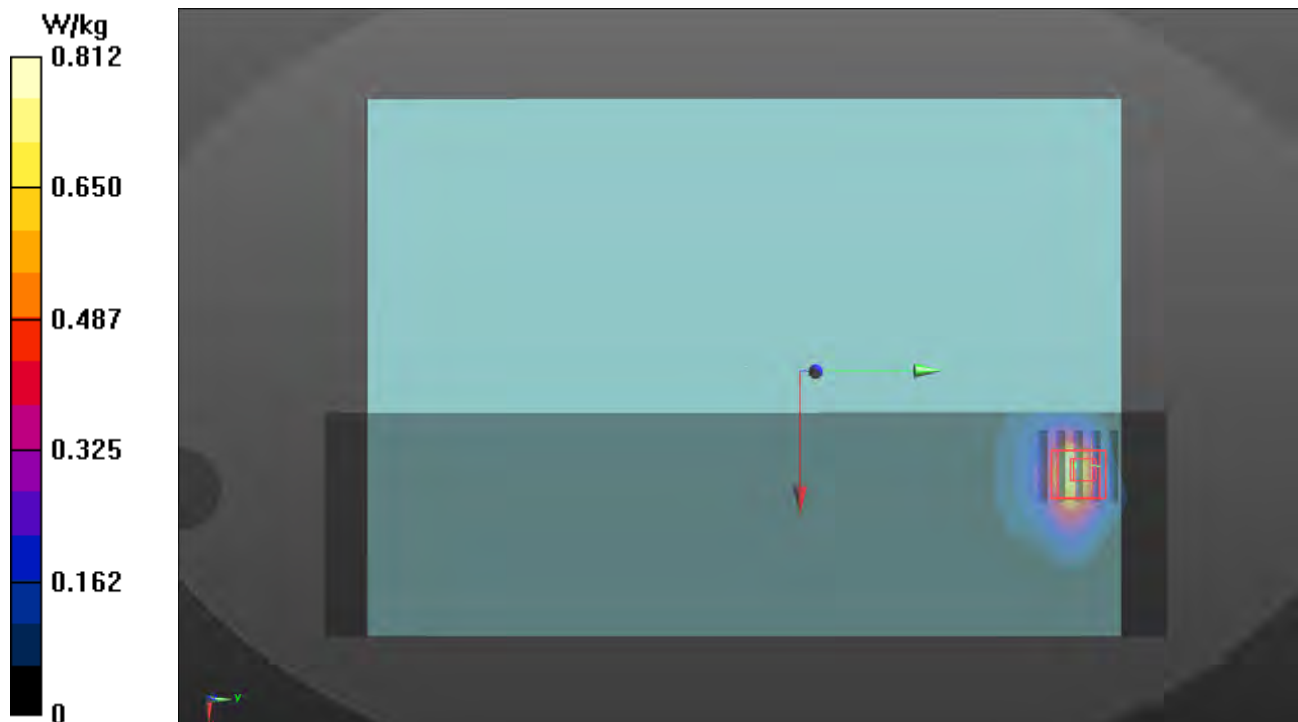

Plots of Measurement

Test Laboratory: Bureau Veritas ADT SAR/HAC Testing Lab

Date: 2022/03/29

P22 LTE 71_QPSK20M_Rear Face_0mm_Ch133297_1RB_OS0_Ant 0_Power Reduction_w

DUT: BFLF-WTW-P22030373

Communication System: UID 10169 - CAE, LTE-FDD (SC-FDMA, 1 RB, 20 MHz, QPSK); Frequency: 680.5 MHz; Duty Cycle: 1:3.74

Medium: H06T09N0_0329 Medium parameters used (interpolated): $f = 680.5$ MHz; $\sigma = 0.891$ S/m; $\epsilon_r = 40.985$; $\rho = 1000$ kg/m³

Ambient Temperature : 23.4 °C ; Liquid Temperature : 23.2 °C

DASY5 Configuration:

- Probe: EX3DV4 - SN7472; ConvF(10.32, 10.32, 10.32) @ 680.5 MHz; Calibrated: 2021/06/03
- Sensor-Surface: 1.4mm (Mechanical Surface Detection)
- Electronics: DAE4 Sn1698; Calibrated: 2021/11/09
- Phantom: ELI Phantom_1205; Type: QDOVA002AA;
- Measurement SW: DASY52, Version 52.10 (4); SEMCAD X Version 14.6.14 (7501)

Area Scan (71x261x1): Interpolated grid: dx=1.500 mm, dy=1.500 mm
Maximum value of SAR (interpolated) = 0.595 W/kg

Zoom Scan (5x5x7)/Cube 0: Measurement grid: dx=8mm, dy=8mm, dz=5mm

Reference Value = 21.60 V/m; Power Drift = 0.01 dB

Peak SAR (extrapolated) = 1.60 W/kg

SAR(1 g) = 0.567 W/kg; SAR(10 g) = 0.236 W/kg (SAR corrected for target medium)

Smallest distance from peaks to all points 3 dB below = 9.1 mm

Ratio of SAR at M2 to SAR at M1 = 32.4%

Maximum value of SAR (measured) = 0.964 W/kg

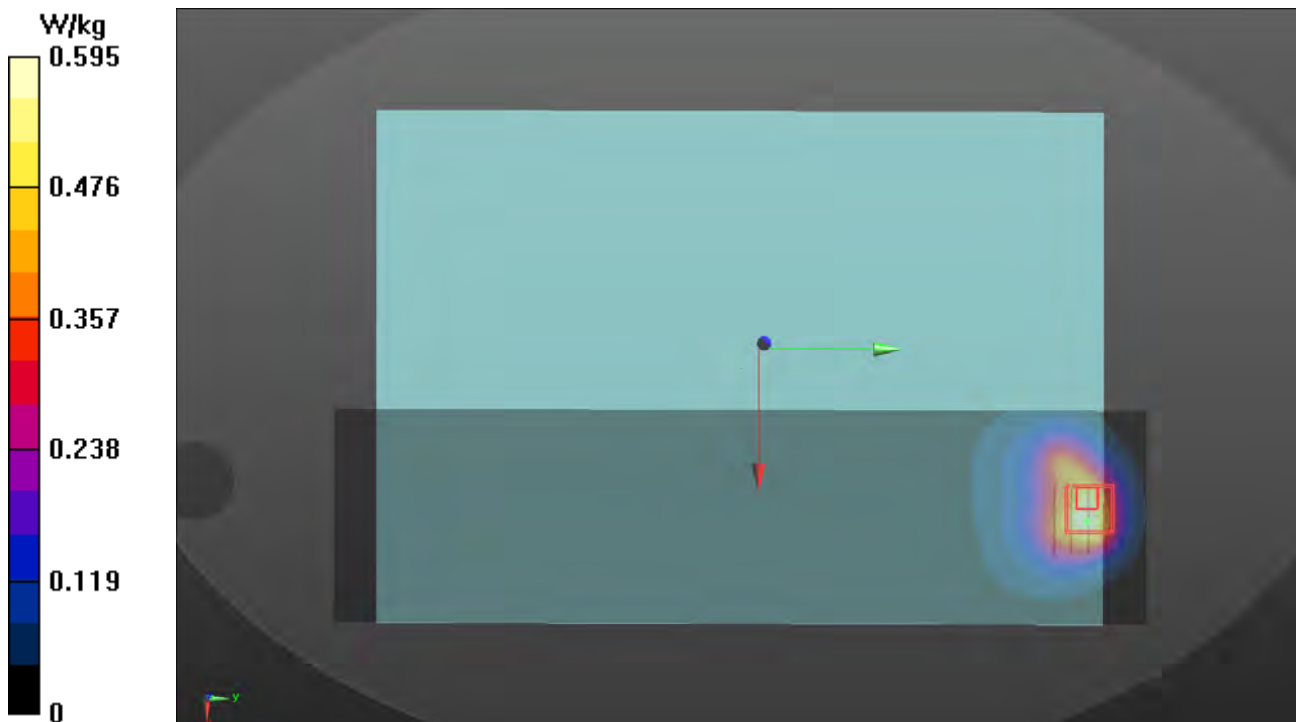

Plots of Measurement

Test Laboratory: Bureau Veritas ADT SAR/HAC Testing Lab

Date: 2022/04/06

P23 5GNR-n2_DFT-S QPSK20M_Rear Face_0mm_Ch376000_1RB_OS1_Ant 0_Power Reduction_w

DUT: BFLF-WTW-P22030373

Communication System: UID 10931 - AAB, 5G NR (DFT-s-OFDM, 1 RB, 20 MHz, QPSK, 15 kHz); Frequency: 1880 MHz; Duty Cycle: 1:3.56

Medium: H16T20N1_0406 Medium parameters used: $f = 1880$ MHz; $\sigma = 1.451$ S/m; $\epsilon_r = 38.846$; $\rho = 1000$ kg/m³

Ambient Temperature : 23.4 °C ; Liquid Temperature : 23.3 °C

DASY5 Configuration:

- Probe: EX3DV4 - SN7472; ConvF(8.43, 8.43, 8.43) @ 1880 MHz; Calibrated: 2021/06/03
- Sensor-Surface: 1.4mm (Mechanical Surface Detection)
- Electronics: DAE4 Sn1698; Calibrated: 2021/11/09
- Phantom: ELI Phantom_1205; Type: QDOVA002AA;
- Measurement SW: DASY52, Version 52.10 (4); SEMCAD X Version 14.6.14 (7501)

Area Scan (71x261x1): Interpolated grid: dx=1.500 mm, dy=1.500 mm

Maximum value of SAR (interpolated) = 1.10 W/kg

Zoom Scan (5x5x7)/Cube 0: Measurement grid: dx=8mm, dy=8mm, dz=5mm

Reference Value = 27.68 V/m; Power Drift = 0.11 dB

Peak SAR (extrapolated) = 1.91 W/kg

SAR(1 g) = 0.652 W/kg; SAR(10 g) = 0.323 W/kg (SAR corrected for target medium)

Smallest distance from peaks to all points 3 dB below = 8.4 mm

Ratio of SAR at M2 to SAR at M1 = 37.8%

Maximum value of SAR (measured) = 1.36 W/kg

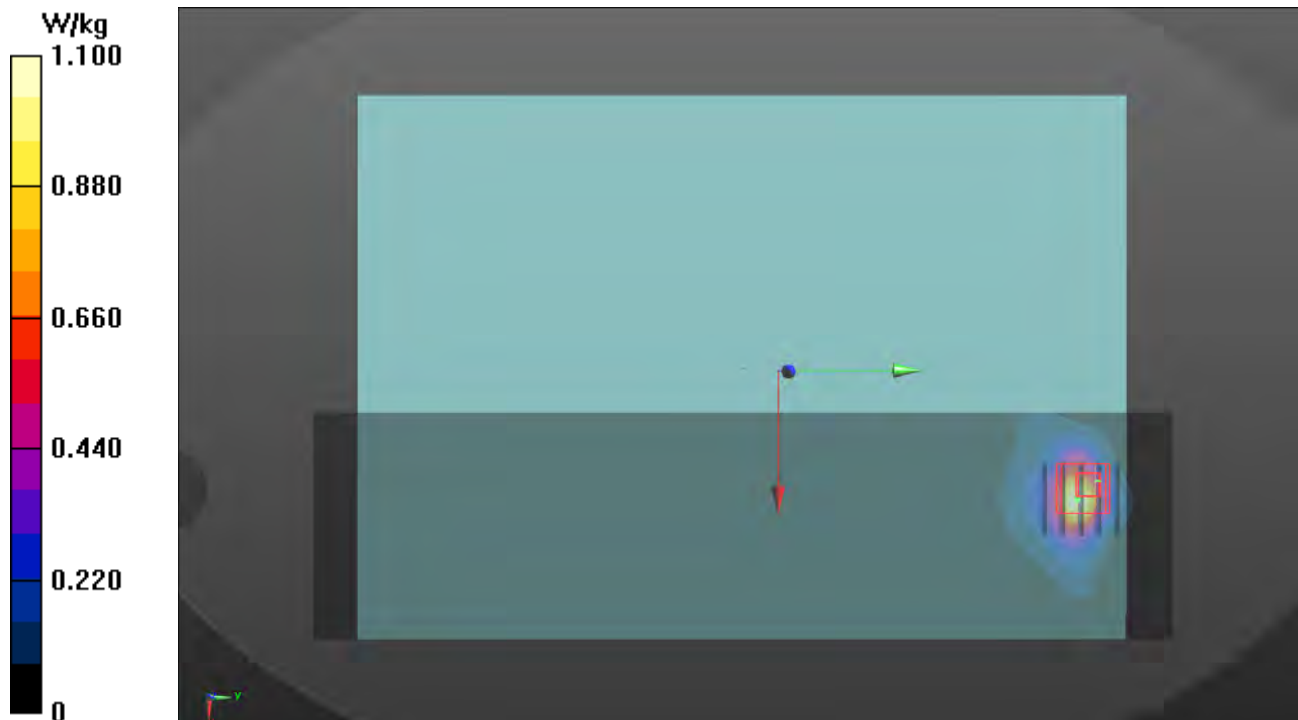

Plots of Measurement

Test Laboratory: Bureau Veritas ADT SAR/HAC Testing Lab

Date: 2022/04/05

P24 5GNR-n5_DFT-S QPSK20M_Rear Face_0mm_Ch167300_1RB_OS1_Ant 0_Power Reduction_w

DUT: BFLF-WTW-P22030373

Communication System: UID 10931 - AAB, 5G NR (DFT-s-OFDM, 1 RB, 20 MHz, QPSK, 15 kHz); Frequency: 836.5 MHz; Duty Cycle: 1:3.56

Medium: H06T09N1_0405 Medium parameters used (interpolated): $f = 836.5$ MHz; $\sigma = 0.936$ S/m; $\epsilon_r = 40.694$; $\rho = 1000$ kg/m³

Ambient Temperature : 23.3 °C ; Liquid Temperature : 23.2 °C

DASY5 Configuration:

- Probe: EX3DV4 - SN7472; ConvF(10.05, 10.05, 10.05) @ 836.5 MHz; Calibrated: 2021/06/03
- Sensor-Surface: 1.4mm (Mechanical Surface Detection)
- Electronics: DAE4 Sn1698; Calibrated: 2021/11/09
- Phantom: ELI Phantom_1205; Type: QDOVA002AA;
- Measurement SW: DASY52, Version 52.10 (4); SEMCAD X Version 14.6.14 (7501)

Area Scan (71x261x1): Interpolated grid: dx=1.500 mm, dy=1.500 mm
Maximum value of SAR (interpolated) = 0.864 W/kg

Zoom Scan (5x5x7)/Cube 0: Measurement grid: dx=8mm, dy=8mm, dz=5mm

Reference Value = 28.12 V/m; Power Drift = 0.01 dB

Peak SAR (extrapolated) = 2.03 W/kg

SAR(1 g) = 0.680 W/kg; SAR(10 g) = 0.386 W/kg (SAR corrected for target medium)

Smallest distance from peaks to all points 3 dB below = 9.4 mm

Ratio of SAR at M2 to SAR at M1 = 32.4%

Maximum value of SAR (measured) = 1.40 W/kg

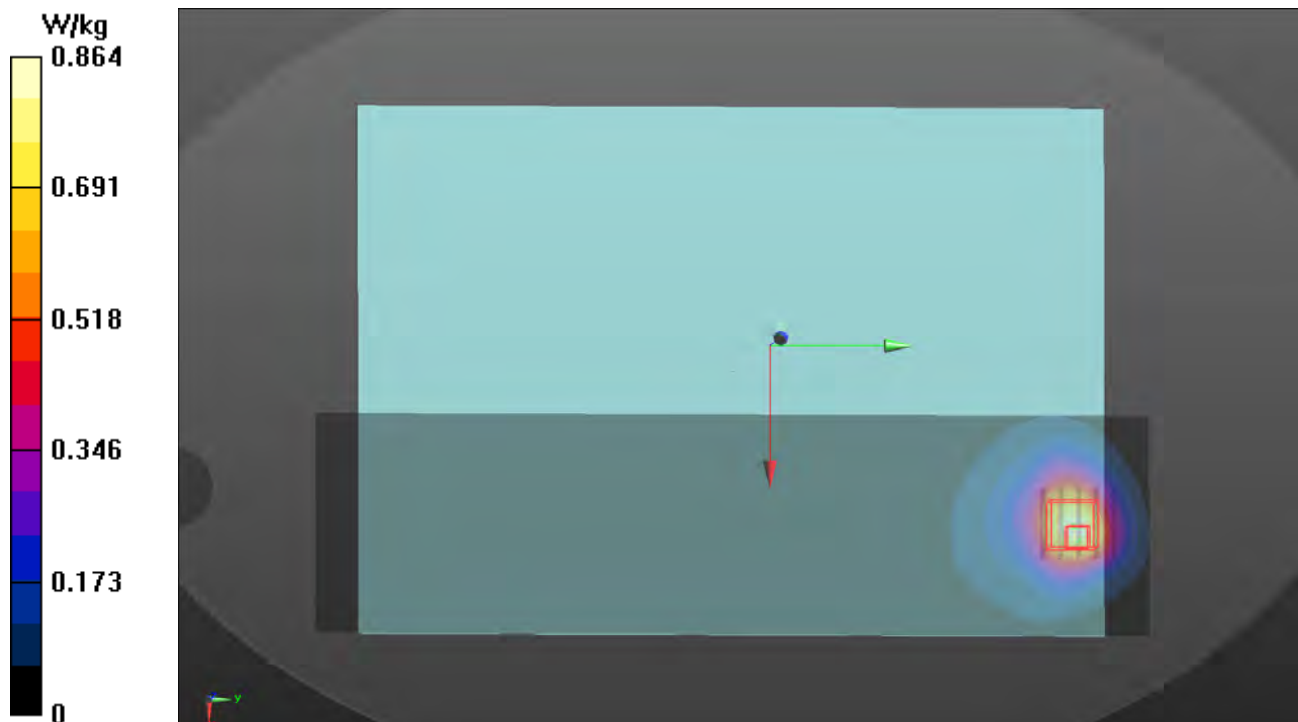

Plots of Measurement

Test Laboratory: Bureau Veritas ADT SAR/HAC Testing Lab

Date: 2022/04/05

P25 GNR-n7_DFT-S QPSK20M_Rear Face_0mm_Ch507000_1RB_OS1_Ant 0_Power Reduction_w

DUT: BFLF-WTW-P22030373

Communication System: UID 10931 - AAB, 5G NR (DFT-s-OFDM, 1 RB, 20 MHz, QPSK, 15 kHz); Frequency: 2535 MHz; Duty Cycle: 1:3.56

Medium: H19T27N1_0405 Medium parameters used (interpolated): $f = 2535$ MHz; $\sigma = 1.858$ S/m; $\epsilon_r = 37.833$; $\rho = 1000$ kg/m³

Ambient Temperature : 23.3 °C ; Liquid Temperature : 23.2 °C

DASY5 Configuration:

- Probe: EX3DV4 - SN7472; ConvF(7.58, 7.58, 7.58) @ 2535 MHz; Calibrated: 2021/06/03
- Sensor-Surface: 1.4mm (Mechanical Surface Detection)
- Electronics: DAE4 Sn1698; Calibrated: 2021/11/09
- Phantom: ELI Phantom_1205; Type: QDOVA002AA;
- Measurement SW: DASY52, Version 52.10 (4); SEMCAD X Version 14.6.14 (7501)

Area Scan (121x401x1): Interpolated grid: dx=1.200 mm, dy=1.200 mm
Maximum value of SAR (interpolated) = 0.772 W/kg

Zoom Scan (7x7x7)/Cube 0: Measurement grid: dx=5mm, dy=5mm, dz=5mm
Reference Value = 20.07 V/m; Power Drift = -0.02 dB

Peak SAR (extrapolated) = 1.39 W/kg

SAR(1 g) = 0.447 W/kg; SAR(10 g) = 0.171 W/kg (SAR corrected for target medium)

Smallest distance from peaks to all points 3 dB below = 6.4 mm

Ratio of SAR at M2 to SAR at M1 = 33.9%

Maximum value of SAR (measured) = 0.940 W/kg

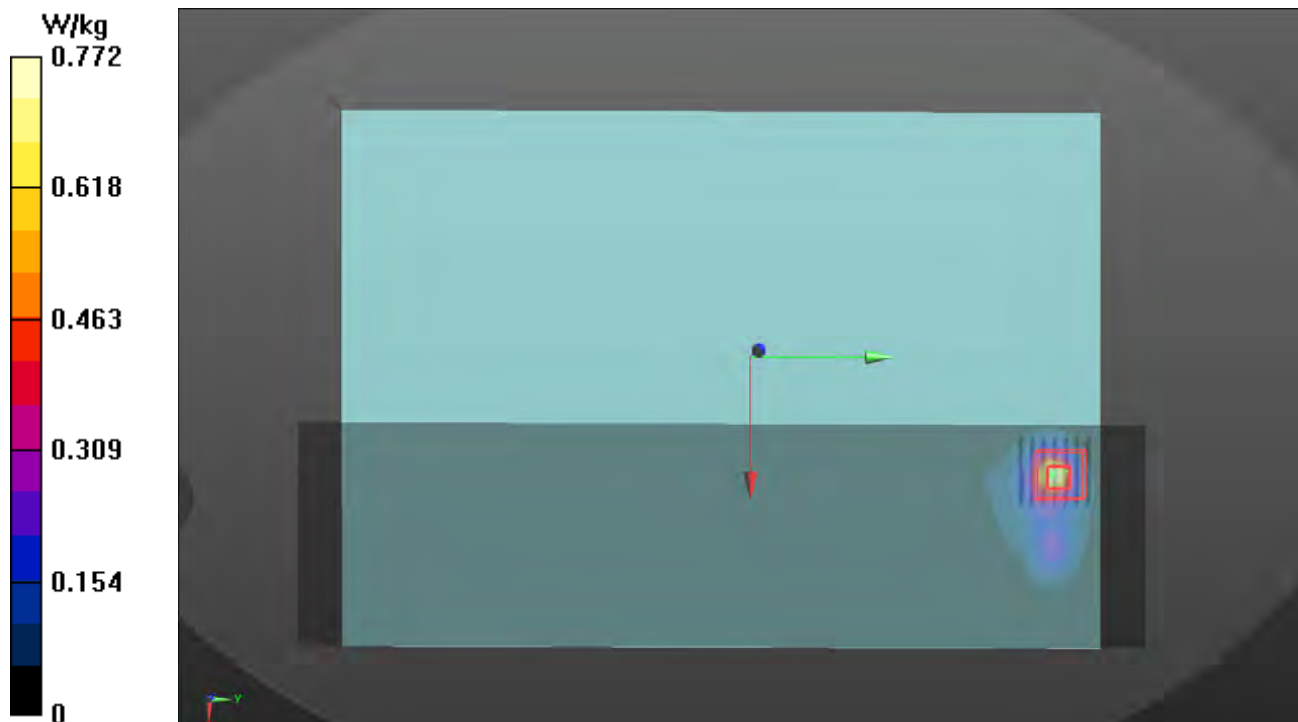

Plots of Measurement

Test Laboratory: Bureau Veritas ADT SAR/HAC Testing Lab

Date: 2022/04/06

P26 5GNR-n25_DFT-S QPSK20M_Rear Face_0mm_Ch381000_1RB_OS1_Ant 0_Power Reduction_w

DUT: BFLF-WTW-P22030373

Communication System: UID 10931 - AAB, 5G NR (DFT-s-OFDM, 1 RB, 20 MHz, QPSK, 15 kHz); Frequency: 1905 MHz; Duty Cycle: 1:3.56

Medium: H16T20N1_0406 Medium parameters used: $f = 1905$ MHz; $\sigma = 1.466$ S/m; $\epsilon_r = 38.839$; $\rho = 1000$ kg/m³

Ambient Temperature : 23.4 °C ; Liquid Temperature : 23.3 °C

DASY5 Configuration:

- Probe: EX3DV4 - SN7472; ConvF(8.43, 8.43, 8.43) @ 1905 MHz; Calibrated: 2021/06/03
- Sensor-Surface: 1.4mm (Mechanical Surface Detection)
- Electronics: DAE4 Sn1698; Calibrated: 2021/11/09
- Phantom: ELI Phantom_1205; Type: QDOVA002AA;
- Measurement SW: DASY52, Version 52.10 (4); SEMCAD X Version 14.6.14 (7501)

Area Scan (71x261x1): Interpolated grid: dx=1.500 mm, dy=1.500 mm

Maximum value of SAR (interpolated) = 0.978 W/kg

Zoom Scan (5x5x7)/Cube 0: Measurement grid: dx=8mm, dy=8mm, dz=5mm

Reference Value = 25.82 V/m; Power Drift = 0.08 dB

Peak SAR (extrapolated) = 1.98 W/kg

SAR(1 g) = 0.659 W/kg; SAR(10 g) = 0.331 W/kg (SAR corrected for target medium)

Smallest distance from peaks to all points 3 dB below = 8.1 mm

Ratio of SAR at M2 to SAR at M1 = 37.6%

Maximum value of SAR (measured) = 1.47 W/kg

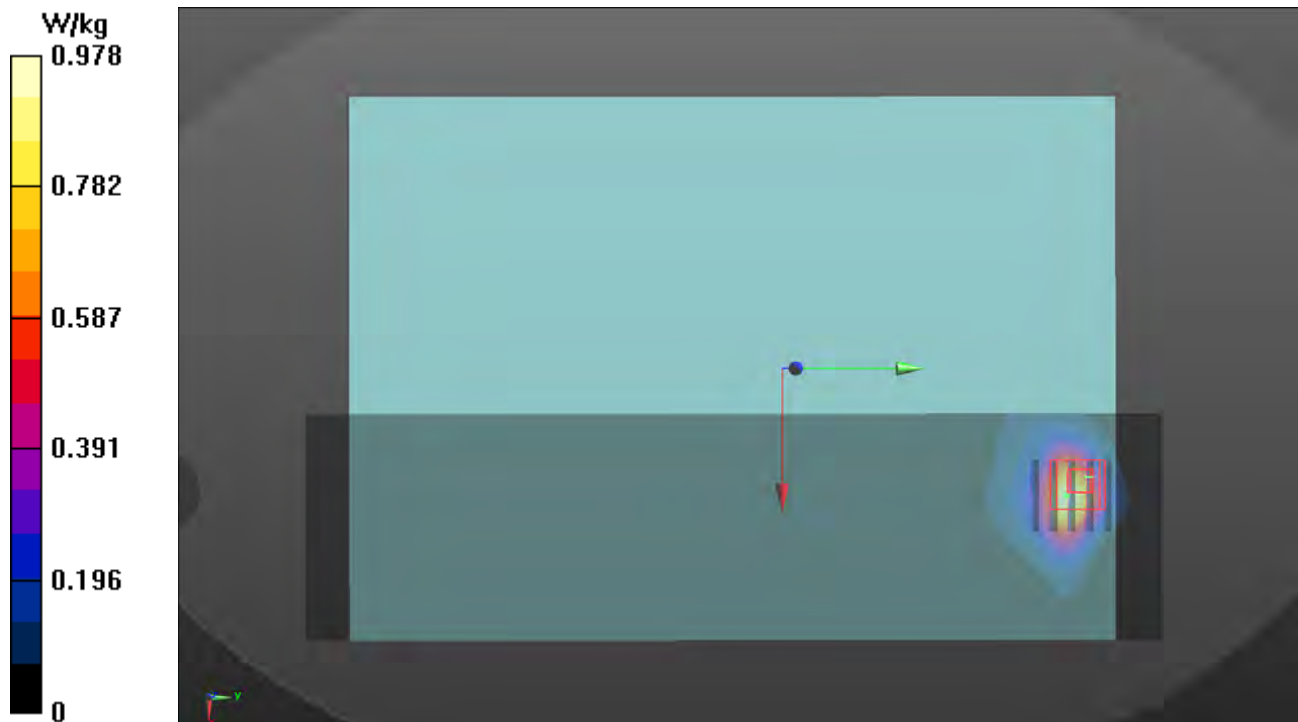

Plots of Measurement

Test Laboratory: Bureau Veritas ADT SAR/HAC Testing Lab

Date: 2022/04/07

P27 5GNR-n30_DFT-S QPSK10M_Rear Face_0mm_Ch462000_1RB_OS1_Ant 0_Power Reduction_w

DUT: BFLF-WTW-P22030373

Communication System: UID 10929 - AAB, 5G NR (DFT-s-OFDM, 1 RB, 10 MHz, QPSK, 15 kHz); Frequency: 2310 MHz; Duty Cycle: 1:3.56

Medium: H19T27N1_0407 Medium parameters used: $f = 2310$ MHz; $\sigma = 1.716$ S/m; $\epsilon_r = 39.105$; $\rho = 1000$ kg/m³

Ambient Temperature : 23.5 °C ; Liquid Temperature : 23.3 °C

DASY5 Configuration:

- Probe: EX3DV4 - SN7472; ConvF(8.13, 8.13, 8.13) @ 2310 MHz; Calibrated: 2021/06/03
- Sensor-Surface: 1.4mm (Mechanical Surface Detection)
- Electronics: DAE4 Sn1698; Calibrated: 2021/11/09
- Phantom: ELI Phantom_1205; Type: QDOVA002AA;
- Measurement SW: DASY52, Version 52.10 (4); SEMCAD X Version 14.6.14 (7501)

Area Scan (91x321x1): Interpolated grid: dx=1.200 mm, dy=1.200 mm

Maximum value of SAR (interpolated) = 0.619 W/kg

Zoom Scan (7x7x7)/Cube 0: Measurement grid: dx=5mm, dy=5mm, dz=5mm

Reference Value = 19.02 V/m; Power Drift = 0.14 dB

Peak SAR (extrapolated) = 2.17 W/kg

SAR(1 g) = 0.655 W/kg; SAR(10 g) = 0.290 W/kg (SAR corrected for target medium)

Smallest distance from peaks to all points 3 dB below = 5.7 mm

Ratio of SAR at M2 to SAR at M1 = 35.1%

Maximum value of SAR (measured) = 1.56 W/kg

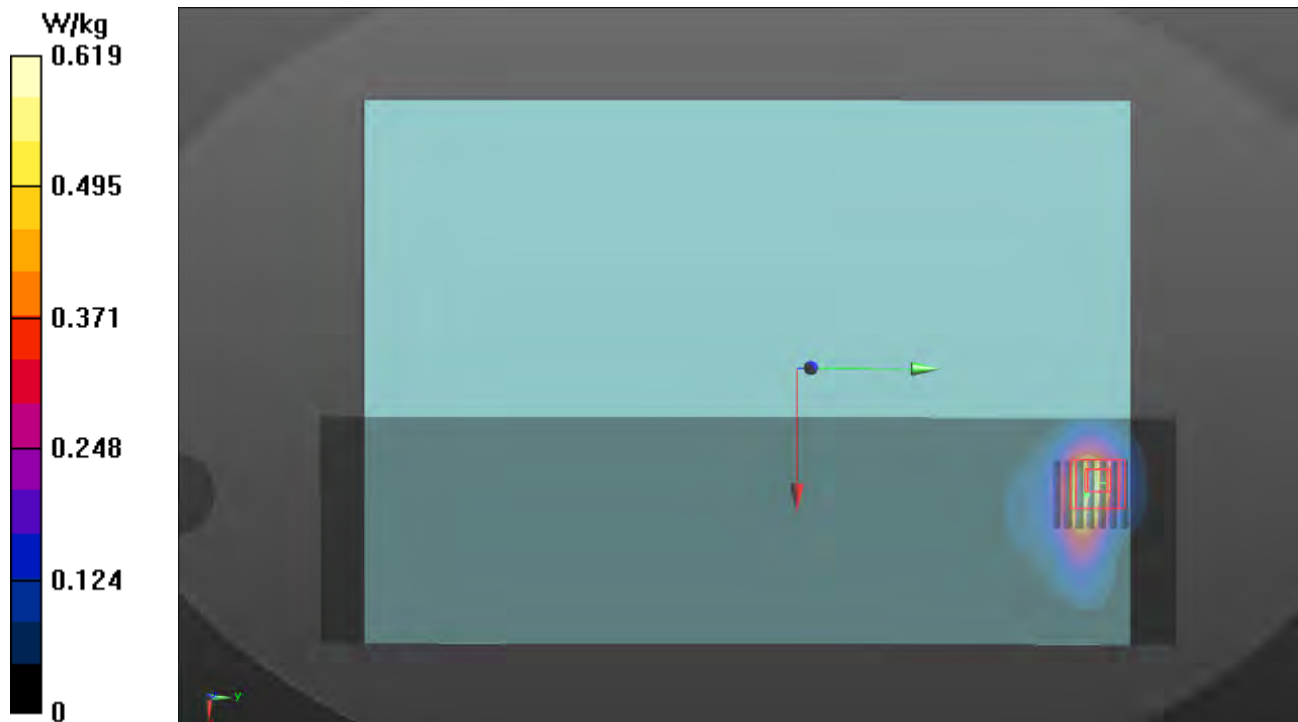

Plots of Measurement

Test Laboratory: Bureau Veritas ADT SAR/HAC Testing Lab

Date: 2022/04/06

P28 5GNR-n38_DFT-S QPSK20M_Rear Face_0mm_Ch516000_1RB_OS1_Ant 0_Power Reduction_w

DUT: BFLF-WTW-P22030373

Communication System: UID 10900 - AAB, 5G NR (DFT-s-OFDM, 1 RB, 20 MHz, QPSK, 30 kHz); Frequency: 2580 MHz; Duty Cycle: 1:3.70

Medium: H19T27N1_0406 Medium parameters used (interpolated): $f = 2580$ MHz; $\sigma = 2.025$ S/m; $\epsilon_r = 37.426$; $\rho = 1000$ kg/m³

Ambient Temperature : 23.4 °C ; Liquid Temperature : 23.3 °C

DASY5 Configuration:

- Probe: EX3DV4 - SN7472; ConvF(7.58, 7.58, 7.58) @ 2580 MHz; Calibrated: 2021/06/03
- Sensor-Surface: 1.4mm (Mechanical Surface Detection)
- Electronics: DAE4 Sn1698; Calibrated: 2021/11/09
- Phantom: ELI Phantom_1205; Type: QDOVA002AA;
- Measurement SW: DASY52, Version 52.10 (4); SEMCAD X Version 14.6.14 (7501)

Area Scan (91x321x1): Interpolated grid: dx=1.200 mm, dy=1.200 mm
Maximum value of SAR (interpolated) = 0.921 W/kg

Zoom Scan (7x7x7)/Cube 0: Measurement grid: dx=5mm, dy=5mm, dz=5mm

Reference Value = 20.32 V/m; Power Drift = 0.06 dB

Peak SAR (extrapolated) = 2.52 W/kg

SAR(1 g) = 0.588 W/kg; SAR(10 g) = 0.235 W/kg (SAR corrected for target medium)

Smallest distance from peaks to all points 3 dB below = 5.2 mm

Ratio of SAR at M2 to SAR at M1 = 30.9%

Maximum value of SAR (measured) = 1.78 W/kg

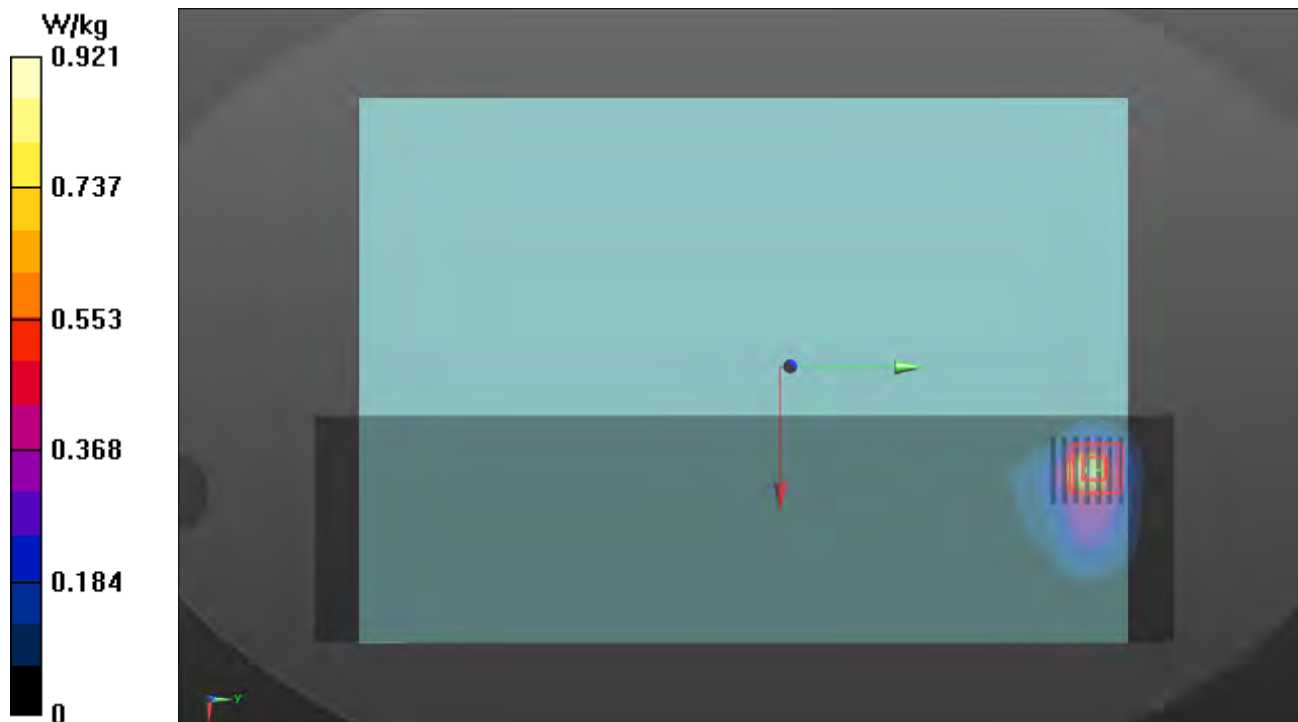

Plots of Measurement

Test Laboratory: Bureau Veritas ADT SAR/HAC Testing Lab

Date: 2022/04/07

P29 5GNR-n40_DFT-S QPSK80M_Rear Face_0mm_Ch470000_1RB_OS1_Ant 0_Power Reduction_w

DUT: BFLF-WTW-P22030373

Communication System: UID 10906 - AAB, 5G NR (DFT-s-OFDM, 1 RB, 80 MHz, QPSK, 30 kHz); Frequency: 2350 MHz; Duty Cycle: 1:3.70

Medium: H19T27N1_0407 Medium parameters used: $f = 2350$ MHz; $\sigma = 1.761$ S/m; $\epsilon_r = 38.932$; $\rho = 1000$ kg/m³

Ambient Temperature : 23.5 °C ; Liquid Temperature : 23.3 °C

DASY5 Configuration:

- Probe: EX3DV4 - SN7472; ConvF(8.13, 8.13, 8.13) @ 2350 MHz; Calibrated: 2021/06/03
- Sensor-Surface: 1.4mm (Mechanical Surface Detection)
- Electronics: DAE4 Sn1698; Calibrated: 2021/11/09
- Phantom: ELI Phantom_1205; Type: QDOVA002AA;
- Measurement SW: DASY52, Version 52.10 (4); SEMCAD X Version 14.6.14 (7501)

Area Scan (91x321x1): Interpolated grid: dx=1.200 mm, dy=1.200 mm

Maximum value of SAR (interpolated) = 0.578 W/kg

Zoom Scan (7x7x7)/Cube 0: Measurement grid: dx=5mm, dy=5mm, dz=5mm

Reference Value = 18.45 V/m; Power Drift = 0.19 dB

Peak SAR (extrapolated) = 1.90 W/kg

SAR(1 g) = 0.645 W/kg; SAR(10 g) = 0.248 W/kg (SAR corrected for target medium)

Smallest distance from peaks to all points 3 dB below = 5.7 mm

Ratio of SAR at M2 to SAR at M1 = 34.1%

Maximum value of SAR (measured) = 1.34 W/kg

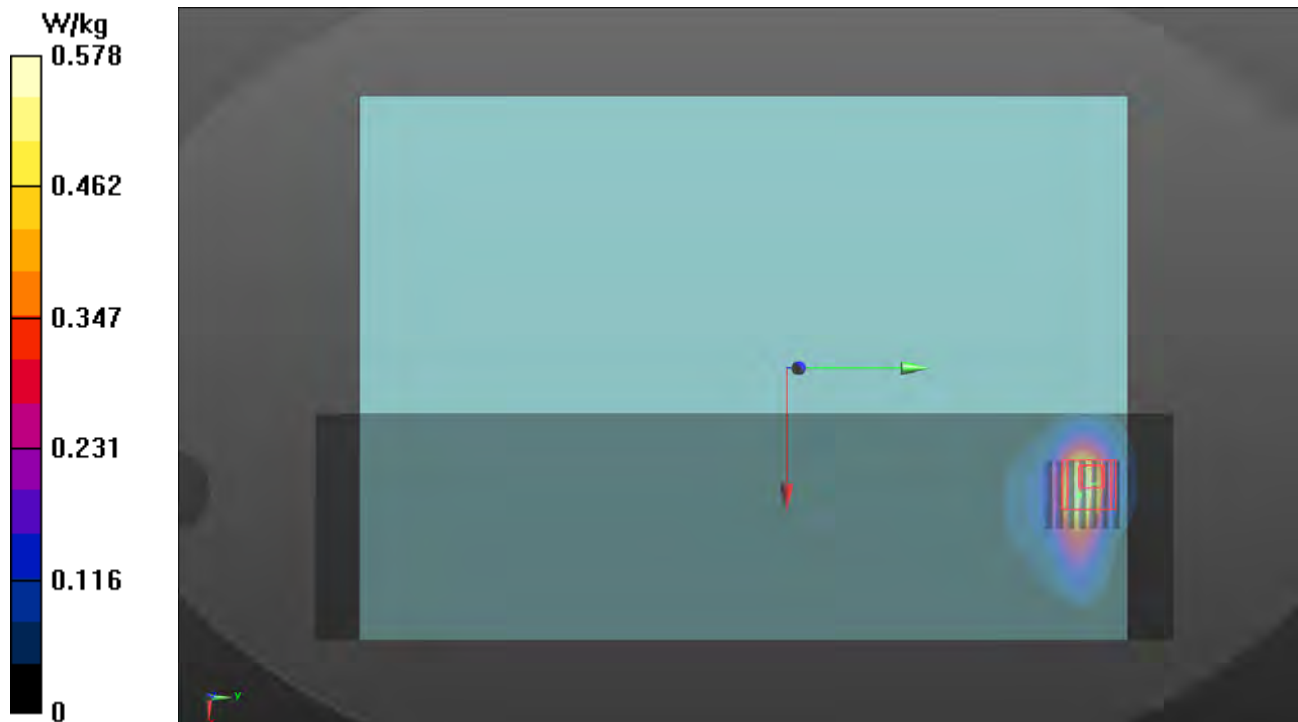

Plots of Measurement

Test Laboratory: Bureau Veritas ADT SAR/HAC Testing Lab

Date: 2022/04/07

P30 5GNR-n41_DFT-S QPSK100M_Rear Face_0mm_Ch509202_1RB_OS1_Ant 2_Power Reduction_w

DUT: BFLF-WTW-P22030373

Communication System: UID 10973 - AAA, 5G NR (DFT-s-OFDM, 1 RB, 100 MHz, QPSK, 30 kHz); Frequency: 2546.01 MHz; Duty Cycle: 1:8.05

Medium: H19T27N1_0407 Medium parameters used (interpolated): $f = 2546.01$ MHz; $\sigma = 1.943$ S/m; $\epsilon_r = 38.33$; $\rho = 1000$ kg/m³

Ambient Temperature : 23.5 °C ; Liquid Temperature : 23.3 °C

DASY5 Configuration:

- Probe: EX3DV4 - SN7472; ConvF(7.58, 7.58, 7.58) @ 2546.01 MHz; Calibrated: 2021/06/03
- Sensor-Surface: 1.4mm (Mechanical Surface Detection)
- Electronics: DAE4 Sn1698; Calibrated: 2021/11/09
- Phantom: ELI Phantom_1205; Type: QDOVA002AA;
- Measurement SW: DASY52, Version 52.10 (4); SEMCAD X Version 14.6.14 (7501)

Area Scan (91x321x1): Interpolated grid: dx=1.200 mm, dy=1.200 mm
Maximum value of SAR (interpolated) = 0.786 W/kg

Zoom Scan (7x7x7)/Cube 0: Measurement grid: dx=5mm, dy=5mm, dz=5mm
Reference Value = 18.29 V/m; Power Drift = -0.05 dB

Peak SAR (extrapolated) = 1.95 W/kg

SAR(1 g) = 0.587 W/kg; SAR(10 g) = 0.273 W/kg (SAR corrected for target medium)

Smallest distance from peaks to all points 3 dB below = 6.3 mm

Ratio of SAR at M2 to SAR at M1 = 42.1%

Maximum value of SAR (measured) = 1.44 W/kg

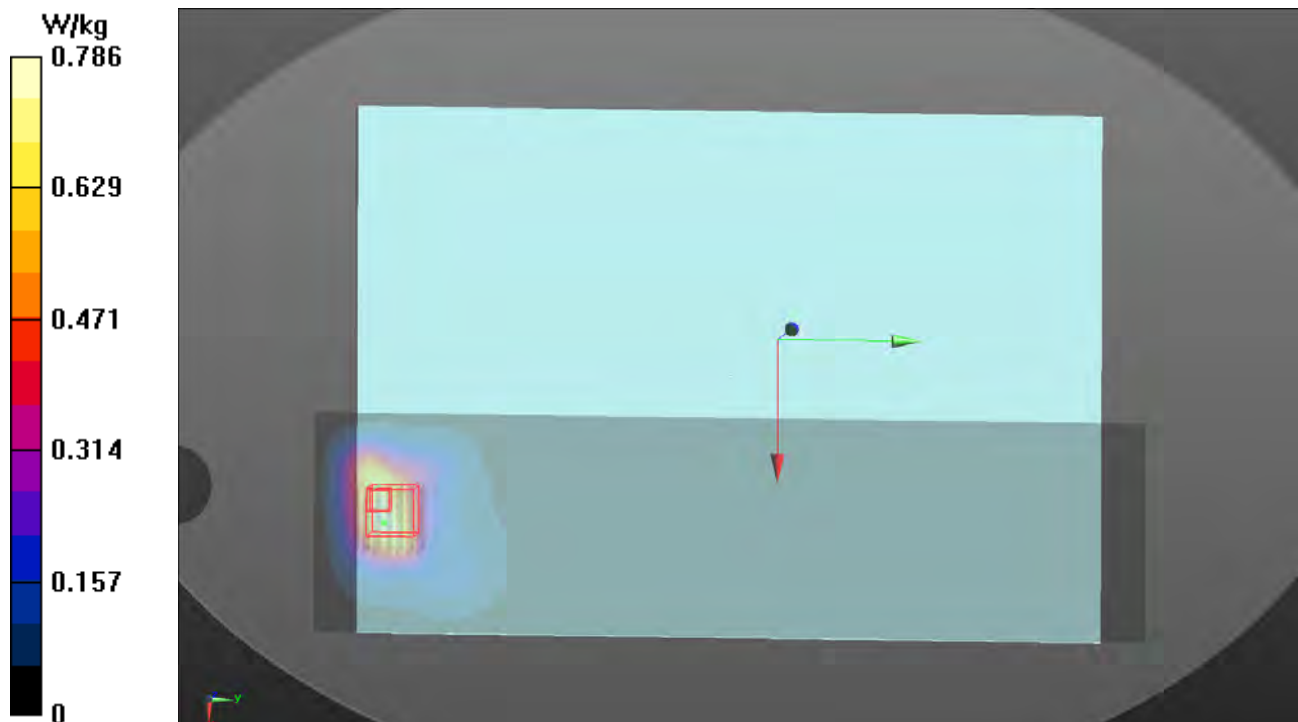

Plots of Measurement

Test Laboratory: Bureau Veritas ADT SAR/HAC Testing Lab

Date: 2022/04/08

P32 5GNR-n66_DFT-S QPSK40M_Rear Face_0mm_Ch349000_1RB_OS1_Ant 0_Power Reduction_w

DUT: BFLF-WTW-P22030373

Communication System: UID 10934 - AAB, 5G NR (DFT-s-OFDM, 1 RB, 40 MHz, QPSK, 15 kHz); Frequency: 1745 MHz; Duty Cycle: 1:3.56

Medium: H16T20N1_0408 Medium parameters used (interpolated): $f = 1745$ MHz; $\sigma = 1.322$ S/m; $\epsilon_r = 39.356$; $\rho = 1000$ kg/m³

Ambient Temperature : 23.3 °C ; Liquid Temperature : 23.2 °C

DASY5 Configuration:

- Probe: EX3DV4 - SN7472; ConvF(8.77, 8.77, 8.77) @ 1745 MHz; Calibrated: 2021/06/03
- Sensor-Surface: 1.4mm (Mechanical Surface Detection)
- Electronics: DAE4 Sn1698; Calibrated: 2021/11/09
- Phantom: ELI Phantom_1205; Type: QDOVA002AA;
- Measurement SW: DASY52, Version 52.10 (4); SEMCAD X Version 14.6.14 (7501)

Area Scan (71x261x1): Interpolated grid: dx=1.500 mm, dy=1.500 mm
Maximum value of SAR (interpolated) = 0.783 W/kg

Zoom Scan (5x5x7)/Cube 0: Measurement grid: dx=8mm, dy=8mm, dz=5mm

Reference Value = 23.33 V/m; Power Drift = -0.09 dB

Peak SAR (extrapolated) = 1.69 W/kg

SAR(1 g) = 0.678 W/kg; SAR(10 g) = 0.307 W/kg (SAR corrected for target medium)

Smallest distance from peaks to all points 3 dB below = 8.5 mm

Ratio of SAR at M2 to SAR at M1 = 38.7%

Maximum value of SAR (measured) = 1.25 W/kg

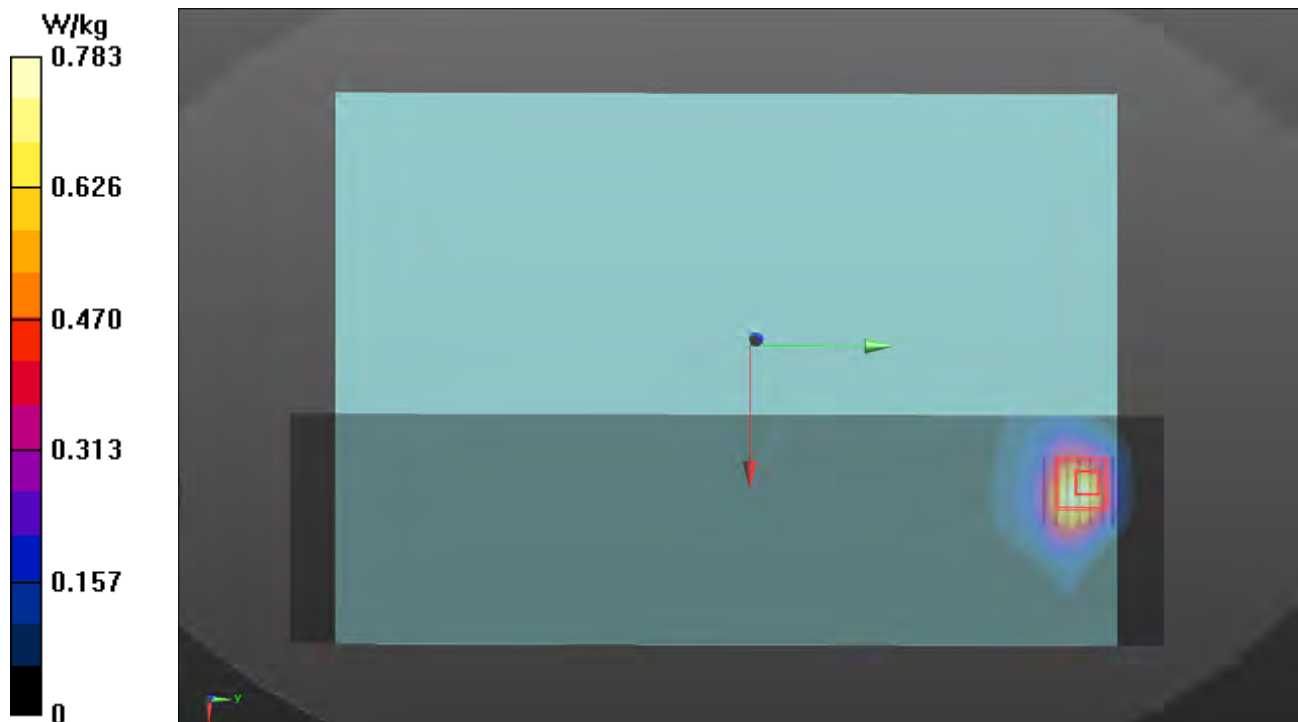

Plots of Measurement

Test Laboratory: Bureau Veritas ADT SAR/HAC Testing Lab

Date: 2022/04/05

P33 5GNR-n71_DFT-S QPSK20M_Rear Face_0mm_Ch136100_1RB_OS1_Ant 0_Power Reduction_w

DUT: BFLF-WTW-P22030373

Communication System: UID 10931 - AAB, 5G NR (DFT-s-OFDM, 1 RB, 20 MHz, QPSK, 15 kHz); Frequency: 680.5 MHz; Duty Cycle: 1:3.56

Medium: H06T09N1_0405 Medium parameters used (interpolated): $f = 680.5$ MHz; $\sigma = 0.87$ S/m; $\epsilon_r = 42.929$; $\rho = 1000$ kg/m³

Ambient Temperature : 23.3 °C ; Liquid Temperature : 23.2 °C

DASY5 Configuration:

- Probe: EX3DV4 - SN7472; ConvF(10.32, 10.32, 10.32) @ 680.5 MHz; Calibrated: 2021/06/03
- Sensor-Surface: 1.4mm (Mechanical Surface Detection)
- Electronics: DAE4 Sn1698; Calibrated: 2021/11/09
- Phantom: ELI Phantom_1205; Type: QDOVA002AA;
- Measurement SW: DASY52, Version 52.10 (4); SEMCAD X Version 14.6.14 (7501)

Area Scan (71x261x1): Interpolated grid: dx=1.500 mm, dy=1.500 mm
Maximum value of SAR (interpolated) = 0.920 W/kg

Zoom Scan (5x5x7)/Cube 0: Measurement grid: dx=8mm, dy=8mm, dz=5mm

Reference Value = 30.95 V/m; Power Drift = 0.04 dB

Peak SAR (extrapolated) = 2.89 W/kg

SAR(1 g) = 0.691 W/kg; SAR(10 g) = 0.187 W/kg (SAR corrected for target medium)

Smallest distance from peaks to all points 3 dB below = 10.8 mm

Ratio of SAR at M2 to SAR at M1 = 47.4%

Maximum value of SAR (measured) = 1.94 W/kg

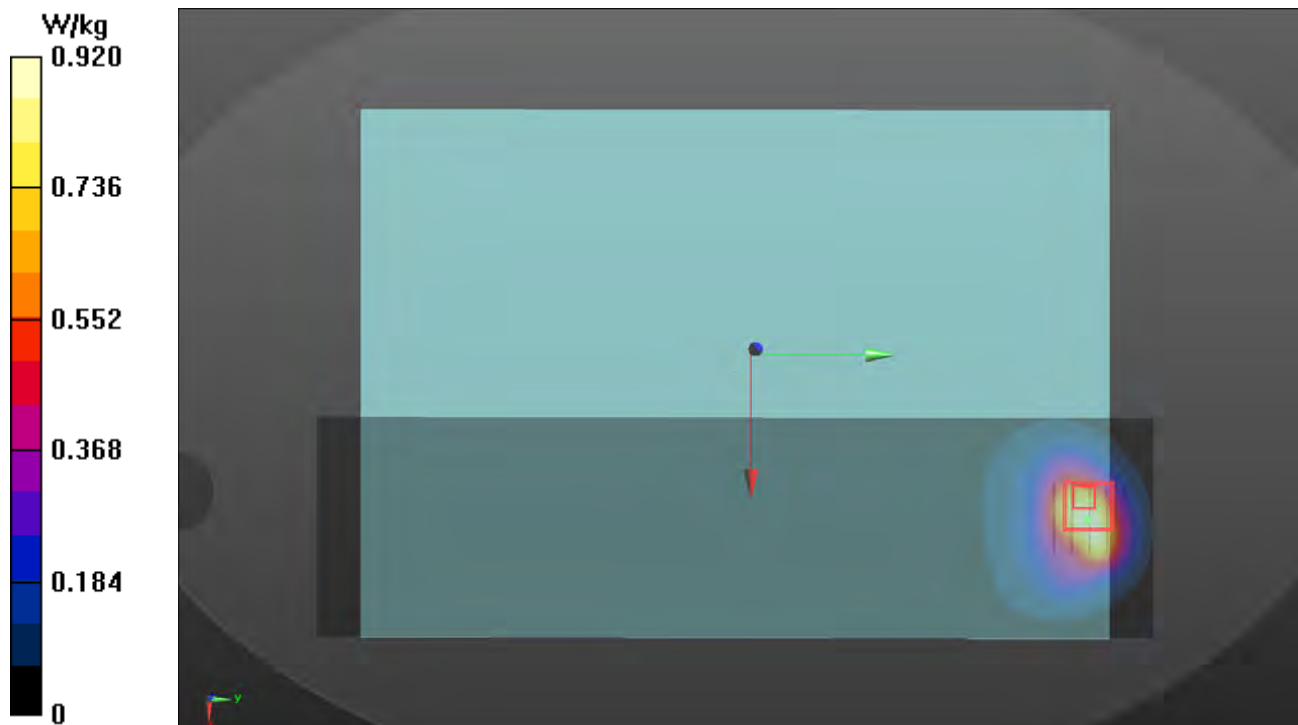

Plots of Measurement

Test Laboratory: Bureau Veritas ADT SAR/HAC Testing Lab

Date: 2022/04/08

P34 5GNR-n77_DFT-S QPSK100M_Rear Face_0mm_Ch662000_1RB_OS1_Ant 2_Power Reduction_w

DUT: BFLF-WTW-P22030373

Communication System: UID 10866 - AAD, 5G NR (DFT-s-OFDM, 1 RB, 100 MHz, QPSK, 30 kHz); Frequency: 3930 MHz; Duty Cycle: 1:3.7

Medium: H33T42N1_0408 Medium parameters used: $f = 3930$ MHz; $\sigma = 3.277$ S/m; $\epsilon_r = 37.575$; $\rho = 1000$ kg/m³

Ambient Temperature : 23.3 °C ; Liquid Temperature : 23.2 °C

DASY5 Configuration:

- Probe: EX3DV4 - SN7472; ConvF(6.9, 6.9, 6.9) @ 3930 MHz; Calibrated: 2021/06/03
- Sensor-Surface: 1.4mm (Mechanical Surface Detection)
- Electronics: DAE4 Sn1698; Calibrated: 2021/11/09
- Phantom: ELI Phantom_1205; Type: QDOVA002AA;
- Measurement SW: DASY52, Version 52.10 (4); SEMCAD X Version 14.6.14 (7501)

Area Scan (91x321x1): Interpolated grid: dx=1.200 mm, dy=1.200 mm

Maximum value of SAR (interpolated) = 0.644 W/kg

Zoom Scan (7x7x7)/Cube 0: Measurement grid: dx=5mm, dy=5mm, dz=2.5mm

Reference Value = 14.06 V/m; Power Drift = 0.05 dB

Peak SAR (extrapolated) = 2.08 W/kg

SAR(1 g) = 0.621 W/kg; SAR(10 g) = 0.168 W/kg (SAR corrected for target medium)

Smallest distance from peaks to all points 3 dB below = 5.1 mm

Ratio of SAR at M2 to SAR at M1 = 59.3%

Maximum value of SAR (measured) = 1.29 W/kg

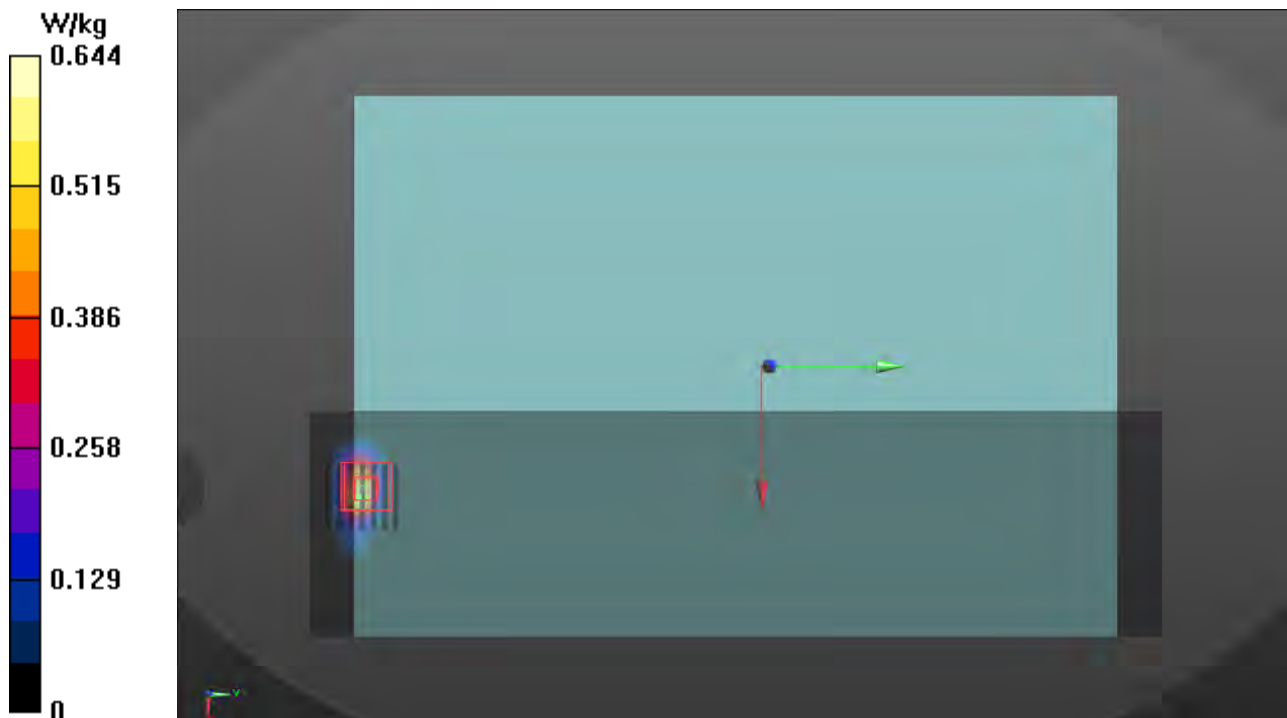

Plots of Measurement

Test Laboratory: Bureau Veritas ADT SAR/HAC Testing Lab

Date: 2022/04/08

P35 5GNR-n78_DFT-S QPSK100M_Rear Face_0mm_Ch650000_1RB_OS1_Ant 2_Power Reduction_w

DUT: BFLF-WTW-P22030373

Communication System: UID 10866 - AAD, 5G NR (DFT-s-OFDM, 1 RB, 100 MHz, QPSK, 30 kHz); Frequency: 3750 MHz; Duty Cycle: 1:3.70

Medium: H33T42N1_0408 Medium parameters used: $f = 3750$ MHz; $\sigma = 3.1$ S/m; $\epsilon_r = 37.874$; $\rho = 1000$ kg/m³

Ambient Temperature : 23.3 °C ; Liquid Temperature : 23.2 °C

DASY5 Configuration:

- Probe: EX3DV4 - SN7472; ConvF(7.12, 7.12, 7.12) @ 3750 MHz; Calibrated: 2021/06/03
- Sensor-Surface: 1.4mm (Mechanical Surface Detection)
- Electronics: DAE4 Sn1698; Calibrated: 2021/11/09
- Phantom: ELI Phantom_1205; Type: QDOVA002AA;
- Measurement SW: DASY52, Version 52.10 (4); SEMCAD X Version 14.6.14 (7501)

Area Scan (91x321x1): Interpolated grid: dx=1.200 mm, dy=1.200 mm

Maximum value of SAR (interpolated) = 0.867 W/kg

Zoom Scan (7x7x7)/Cube 0: Measurement grid: dx=5mm, dy=5mm, dz=2.5mm

Reference Value = 16.87 V/m; Power Drift = 0.10 dB

Peak SAR (extrapolated) = 2.26 W/kg

SAR(1 g) = 0.663 W/kg; SAR(10 g) = 0.178 W/kg (SAR corrected for target medium)

Smallest distance from peaks to all points 3 dB below = 5.1 mm

Ratio of SAR at M2 to SAR at M1 = 56.8%

Maximum value of SAR (measured) = 1.58 W/kg

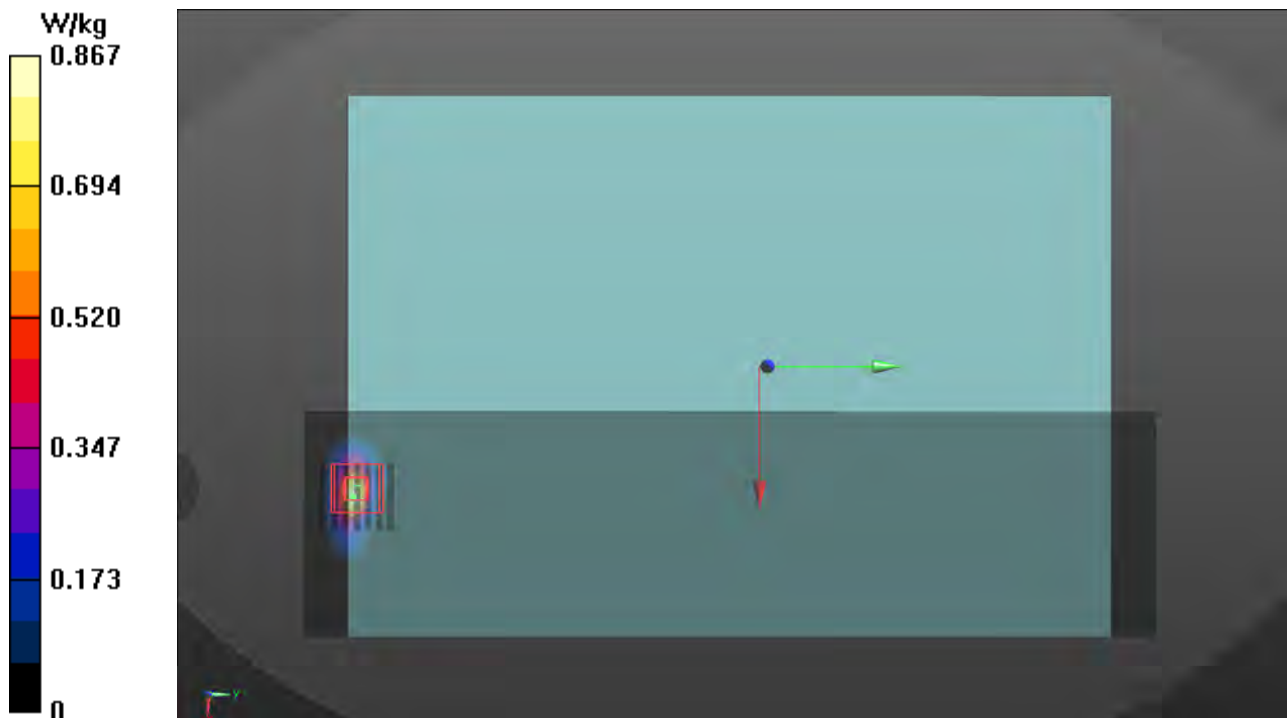

Plots of Measurement

Test Laboratory: Bureau Veritas ADT SAR/HAC Testing Lab

Date: 2022/03/22

P36 WLAN2.4G_802.11b_Top Side_0mm_Ch6_Ant 1

DUT: BFLF-WTW-P22030373

Communication System: UID 10012 - CAB, IEEE 802.11b WiFi 2.4 GHz (DSSS, 1 Mbps); Frequency: 2437 MHz; Duty Cycle: 1:1.01

Medium: H19T27N1_0322 Medium parameters used (interpolated): $f = 2437$ MHz; $\sigma = 1.879$ S/m; $\epsilon_r = 38.326$; $\rho = 1000$ kg/m³

Ambient Temperature : 23.4 °C ; Liquid Temperature : 23.1 °C

DASY5 Configuration:

- Probe: EX3DV4 - SN7555; ConvF(7.9, 7.9, 7.9) @ 2437 MHz; Calibrated: 2021/09/27
- Sensor-Surface: 1.4mm (Mechanical Surface Detection)
- Electronics: DAE4 Sn1341; Calibrated: 2021/08/20
- Phantom: ELI Phantom_1043; Type: QD OVA 002 Ax;
- Measurement SW: DASY52, Version 52.10 (4); SEMCAD X Version 14.6.14 (7483)

Area Scan (71x301x1): Interpolated grid: dx=1.200 mm, dy=1.200 mm
Maximum value of SAR (interpolated) = 1.07 W/kg

Zoom Scan (7x7x7)/Cube 0: Measurement grid: dx=5mm, dy=5mm, dz=5mm

Reference Value = 20.85 V/m; Power Drift = -0.06 dB

Peak SAR (extrapolated) = 1.44 W/kg

SAR(1 g) = 0.485 W/kg; SAR(10 g) = 0.211 W/kg (SAR corrected for target medium)

Smallest distance from peaks to all points 3 dB below = 6.1 mm

Ratio of SAR at M2 to SAR at M1 = 39.9%

Maximum value of SAR (measured) = 0.945 W/kg

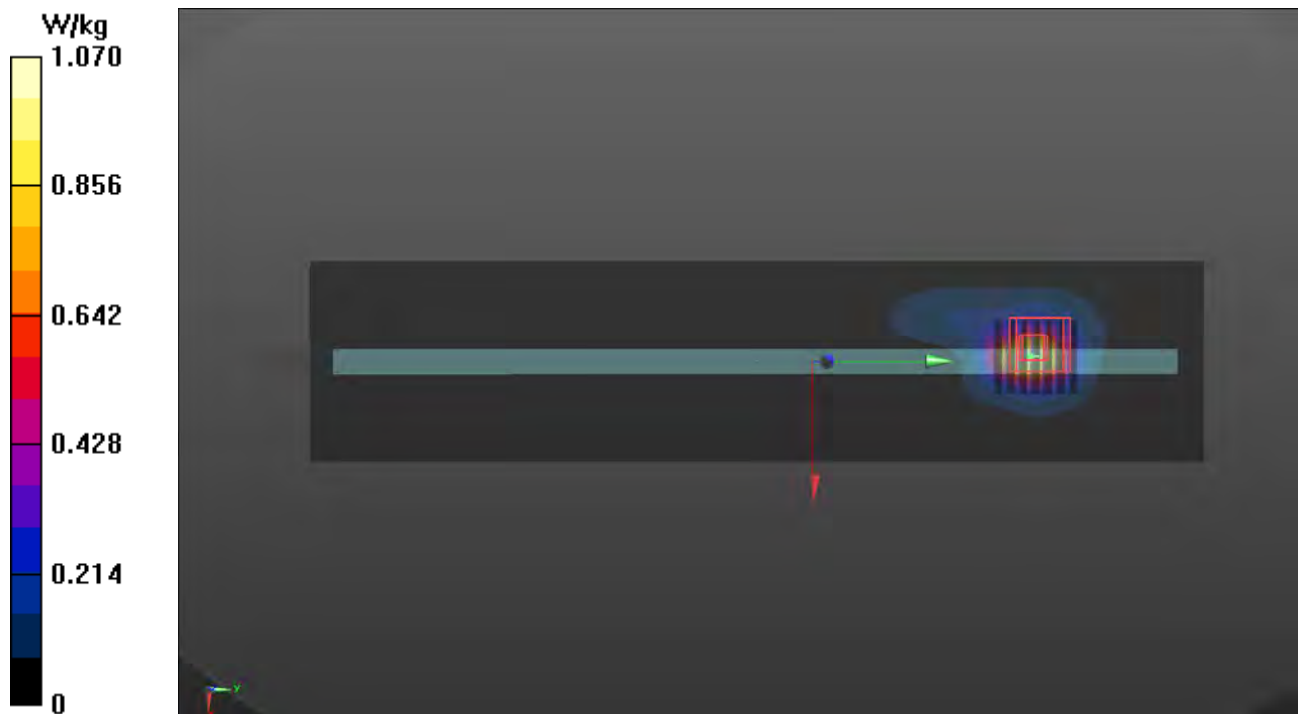

Plots of Measurement

Test Laboratory: Bureau Veritas ADT SAR/HAC Testing Lab

Date: 2022/03/23

P37 WLAN5.3G_802.11ac VHT80_Top Side_0mm_Ch58_Ant 0

DUT: BFLF-WTW-P22030373

Communication System: UID 10544 - AAC, IEEE 802.11ac WiFi (80MHz, MCS0); Frequency: 5290 MHz; Duty Cycle: 1:1.02

Medium: H34T60N1_0323 Medium parameters used: $f = 5290$ MHz; $\sigma = 4.691$ S/m; $\epsilon_r = 35.909$; $\rho = 1000$ kg/m³

Ambient Temperature : 23.3 °C ; Liquid Temperature : 23.2 °C

DASY5 Configuration:

- Probe: EX3DV4 - SN7472; ConvF(5.78, 5.78, 5.78) @ 5290 MHz; Calibrated: 2021/06/03
- Sensor-Surface: 1.4mm (Mechanical Surface Detection)
- Electronics: DAE4 Sn1698; Calibrated: 2021/11/09
- Phantom: ELI Phantom_1245; Type: QDOVA002AA;
- Measurement SW: DASY52, Version 52.10 (4); SEMCAD X Version 14.6.14 (7483)

Area Scan (81x361x1): Interpolated grid: dx=1.000 mm, dy=1.000 mm

Maximum value of SAR (interpolated) = 0.817 W/kg

Zoom Scan (7x7x7)/Cube 0: Measurement grid: dx=4mm, dy=4mm, dz=1.4mm

Reference Value = 12.02 V/m; Power Drift = -0.11 dB

Peak SAR (extrapolated) = 2.96 W/kg

SAR(1 g) = 0.721 W/kg; SAR(10 g) = 0.211 W/kg (SAR corrected for target medium)

Smallest distance from peaks to all points 3 dB below = 4.8 mm

Ratio of SAR at M2 to SAR at M1 = 64.9%

Maximum value of SAR (measured) = 1.68 W/kg

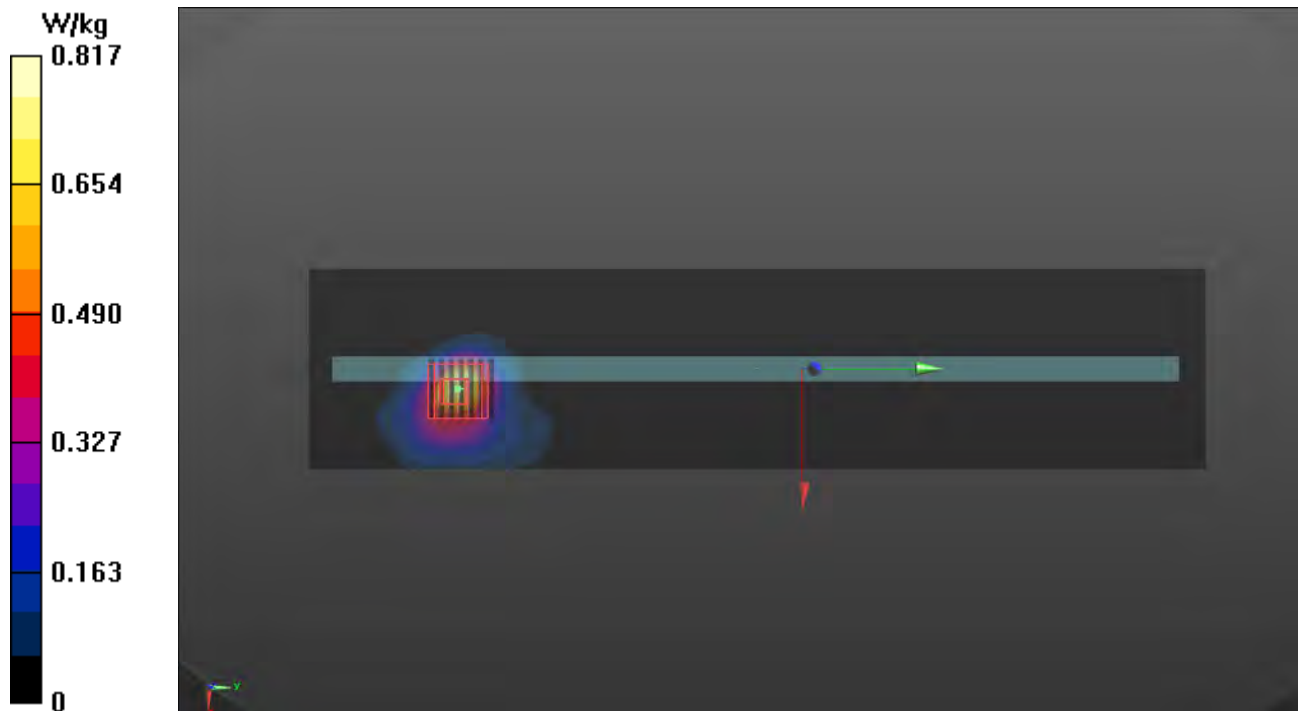

Plots of Measurement

Test Laboratory: Bureau Veritas ADT SAR/HAC Testing Lab

Date: 2022/03/23

P38 WLAN5.6G_802.11ac VHT80_Top Side_0mm_Ch138_Ant 1

DUT: BFLF-WTW-P22030373

Communication System: UID 10544 - AAC, IEEE 802.11ac WiFi (80MHz, MCS0); Frequency: 5690 MHz; Duty Cycle: 1:1.02

Medium: H34T60N1_0323 Medium parameters used: $f = 5690$ MHz; $\sigma = 5.153$ S/m; $\epsilon_r = 35.512$; $\rho = 1000$ kg/m³

Ambient Temperature : 23.3 °C ; Liquid Temperature : 23.2 °C

DASY5 Configuration:

- Probe: EX3DV4 - SN7472; ConvF(5.25, 5.25, 5.25) @ 5690 MHz; Calibrated: 2021/06/03
- Sensor-Surface: 1.4mm (Mechanical Surface Detection)
- Electronics: DAE4 Sn1698; Calibrated: 2021/11/09
- Phantom: ELI Phantom_1245; Type: QDOVA002AA;
- Measurement SW: DASY52, Version 52.10 (4); SEMCAD X Version 14.6.14 (7483)

Area Scan (81x361x1): Interpolated grid: dx=1.000 mm, dy=1.000 mm

Maximum value of SAR (interpolated) = 1.37 W/kg

Zoom Scan (7x7x7)/Cube 0: Measurement grid: dx=4mm, dy=4mm, dz=1.4mm

Reference Value = 16.92 V/m; Power Drift = 0.02 dB

Peak SAR (extrapolated) = 3.64 W/kg

SAR(1 g) = 0.761 W/kg; SAR(10 g) = 0.217 W/kg (SAR corrected for target medium)

Smallest distance from peaks to all points 3 dB below = 5.4 mm

Ratio of SAR at M2 to SAR at M1 = 62.2%

Maximum value of SAR (measured) = 2.06 W/kg

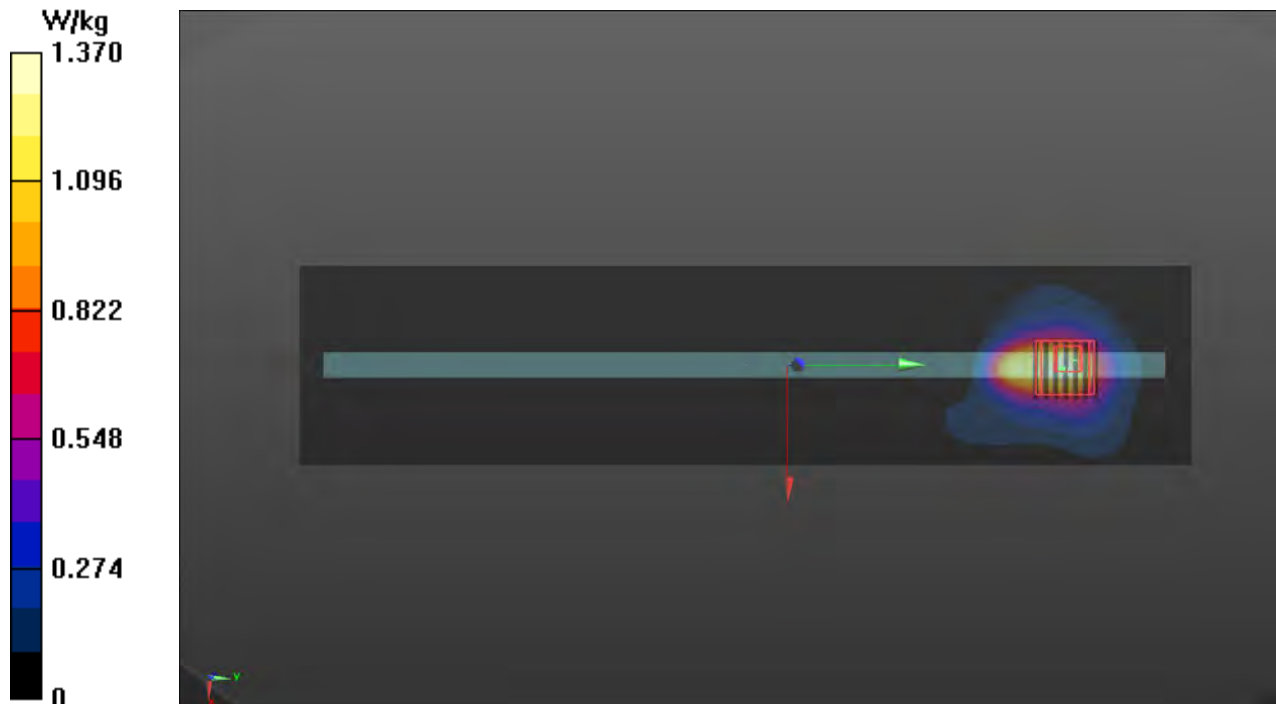

Plots of Measurement

Test Laboratory: Bureau Veritas ADT SAR/HAC Testing Lab

Date: 2022/03/24

P39 WLAN5.8G_802.11ac VHT80_Top Side_0mm_Ch155_Ant 1

DUT: BFLF-WTW-P22030373

Communication System: UID 10544 - AAC, IEEE 802.11ac WiFi (80MHz, MCS0); Frequency: 5775 MHz; Duty Cycle: 1:1.02

Medium: H34T60N1_0324 Medium parameters used: $f = 5775$ MHz; $\sigma = 5.248$ S/m; $\epsilon_r = 35.423$; $\rho = 1000$ kg/m³

Ambient Temperature : 23.4 °C ; Liquid Temperature : 23.3 °C

DASY5 Configuration:

- Probe: EX3DV4 - SN7472; ConvF(5.25, 5.25, 5.25) @ 5775 MHz; Calibrated: 2021/06/03
- Sensor-Surface: 1.4mm (Mechanical Surface Detection)
- Electronics: DAE4 Sn1698; Calibrated: 2021/11/09
- Phantom: ELI Phantom_1245; Type: QDOVA002AA;
- Measurement SW: DASY52, Version 52.10 (4); SEMCAD X Version 14.6.14 (7483)

Area Scan (81x361x1): Interpolated grid: dx=1.000 mm, dy=1.000 mm

Maximum value of SAR (interpolated) = 2.42 W/kg

Zoom Scan (7x7x7)/Cube 0: Measurement grid: dx=4mm, dy=4mm, dz=1.4mm

Reference Value = 20.86 V/m; Power Drift = -0.07 dB

Peak SAR (extrapolated) = 3.62 W/kg

SAR(1 g) = 0.713 W/kg; SAR(10 g) = 0.133 W/kg (SAR corrected for target medium)

Smallest distance from peaks to all points 3 dB below = 4.9 mm

Ratio of SAR at M2 to SAR at M1 = 59.8%

Maximum value of SAR (measured) = 1.92 W/kg

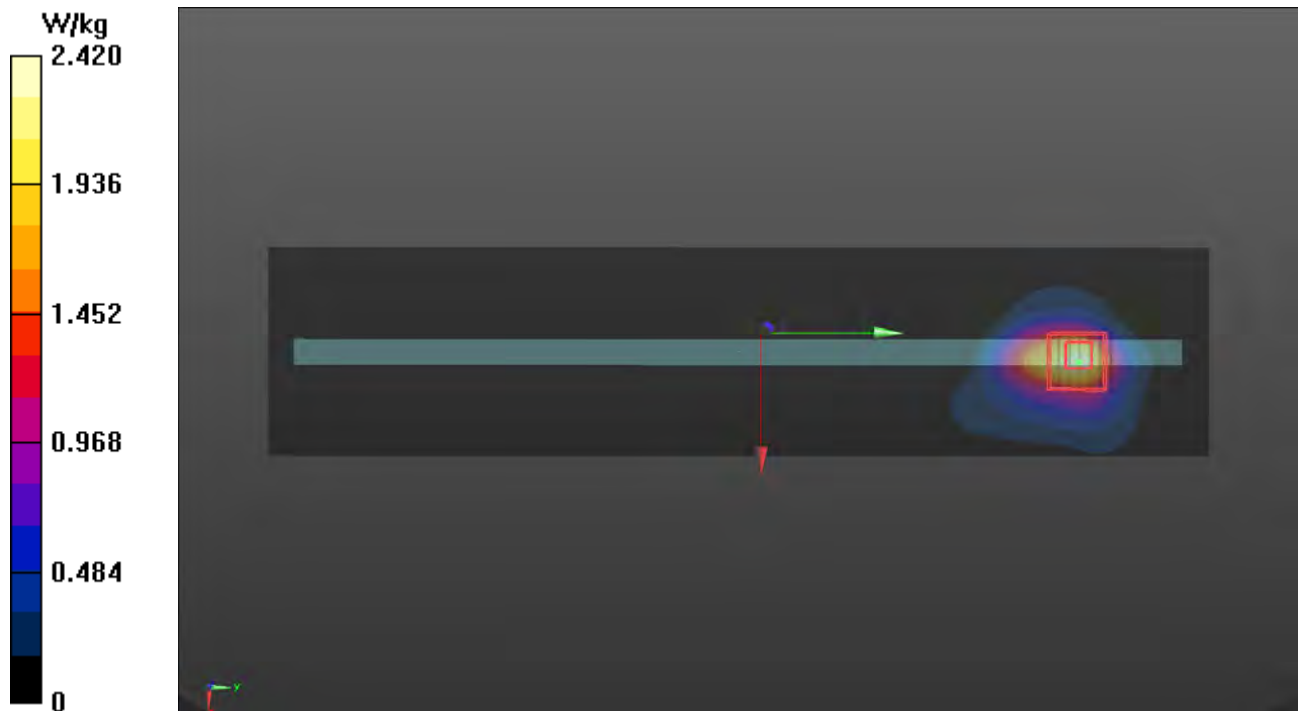

Plots of Measurement

Test Laboratory: Bureau Veritas ADT SAR/HAC Testing Lab

Date: 2022/03/25

P40 BT_BDR_Top Side_0mm_Ch39_Ant 1

DUT: BFLF-WTW-P22030373

Communication System: UID 10032 - CAA, IEEE 802.15.1 Bluetooth (GFSK, DH5); Frequency: 2441 MHz; Duty Cycle: 1:1.3

Medium: H19T27N1_0325 Medium parameters used (interpolated): $f = 2441$ MHz; $\sigma = 1.748$ S/m; $\epsilon_r = 38.565$; $\rho = 1000$ kg/m³

Ambient Temperature : 23.5 °C ; Liquid Temperature : 23.2 °C

DASY5 Configuration:

- Probe: EX3DV4 - SN7472; ConvF(7.89, 7.89, 7.89) @ 2441 MHz; Calibrated: 2021/06/03
- Sensor-Surface: 1.4mm (Mechanical Surface Detection)
- Electronics: DAE4 Sn1698; Calibrated: 2021/11/09
- Phantom: ELI Phantom_1245; Type: QDOVA002AA;
- Measurement SW: DASY52, Version 52.10 (4); SEMCAD X Version 14.6.14 (7483)

Area Scan (71x301x1): Interpolated grid: $dx=1.200$ mm, $dy=1.200$ mm
Maximum value of SAR (interpolated) = 0.0853 W/kg

Zoom Scan (7x7x7)/Cube 0: Measurement grid: $dx=5$ mm, $dy=5$ mm, $dz=5$ mm

Reference Value = 4.940 V/m; Power Drift = -0.01 dB

Peak SAR (extrapolated) = 0.208 W/kg

SAR(1 g) = 0.027 W/kg; SAR(10 g) = 0.00925 W/kg (SAR corrected for target medium)

Smallest distance from peaks to all points 3 dB below: Larger than measurement grid

Ratio of SAR at M2 to SAR at M1 = 30.3%

Maximum value of SAR (measured) = 0.0537 W/kg



Annex C. Tissue & System Verification

The measuring results for tissue simulating liquid and system check are shown as below.

Note:

1. For Section 4.3, the dielectric properties of the tissue simulating liquid have been measured within 24 hours before the SAR testing and within $\pm 10\%$ of the target values. Liquid temperature during the SAR testing has kept within $\pm 2\text{ }^{\circ}\text{C}$.
2. For Section 4.4, The SAR measurement system was validated according to procedures in KDB 865664 D01. The validation status in tabulated summary is as below.
3. For Section 4.5, Comparing to the reference SAR value provided by SPEAG in dipole calibration certificate, the deviation of system check results is within its specification of 10 %. The result indicates the system check can meet the variation criterion and the plots please refer to Annex A of this report.

Tissue Verification										System Validation					Note			
Plot No.	Frequency (MHz)	Liquid Temp. (°C)	Conductivity (σ)	Permittivity (ε _r)	Targeted Conductivity (σ)	Targeted Permittivity (ε _r)	Deviation Conductivity (σ)	Deviation Permittivity (ε _r)	Date	Frequency (MHz)	Targeted 1g SAR (W/kg)	Measured 1g SAR (W/kg)	Normalized 1g SAR (W/kg)	Deviation (%)	Dipole S/N	Probe S/N	DAE S/N	Output Power (dB)
S01	1900	23.1	1.464	38.853	1.4	40	4.57	-2.87	Mar. 31, 2022	1900	40.40	2	39.91	-1.22	5d036	7472	1698	17
S02	1750	23.4	1.321	39.14	1.37	40.1	-3.58	-2.39	Apr. 01, 2022	1750	35.80	1.77	35.32	-1.35	1055	7472	1698	17
S03	835	23.2	0.936	40.696	0.9	41.5	4.00	-1.94	Mar. 30, 2022	835	9.58	0.461	9.20	-3.99	4d121	7472	1698	17
S04	1900	23.1	1.464	38.853	1.4	40	4.57	-2.87	Mar. 31, 2022	1900	40.40	2	39.91	-1.22	5d036	7472	1698	17
S05	1750	23.4	1.321	39.14	1.37	40.1	-3.58	-2.39	Apr. 01, 2022	1750	35.80	1.77	35.32	-1.35	1055	7472	1698	17
S06	835	23.2	0.936	40.696	0.9	41.5	4.00	-1.94	Mar. 30, 2022	835	9.58	0.461	9.20	-3.99	4d121	7472	1698	17
S07	2600	23.3	2.015	38.715	1.96	39	2.81	-0.73	Apr. 02, 2022	2600	57.60	2.93	58.46	1.50	1020	7472	1698	17
S08	750	23.3	0.895	40.706	0.9	42	-0.56	-3.08	Mar. 28, 2022	750	8.56	0.389	7.76	-9.33	1013	7472	1698	17
S09	750	23.3	0.895	40.706	0.9	42	-0.56	-3.08	Mar. 28, 2022	750	8.56	0.389	7.76	-9.33	1013	7472	1698	17
S10	750	23.2	0.895	40.662	0.9	42	-0.56	-3.19	Mar. 29, 2022	750	8.56	0.388	7.74	-9.56	1013	7472	1698	17
S11	750	23.2	0.895	40.662	0.9	42	-0.56	-3.19	Mar. 29, 2022	750	8.56	0.388	7.74	-9.56	1013	7472	1698	17
S12	1900	23.1	1.464	38.853	1.4	40	4.57	-2.87	Mar. 31, 2022	1900	40.40	2	39.91	-1.22	5d036	7472	1698	17
S13	835	23.2	0.936	40.696	0.9	41.5	4.00	-1.94	Mar. 30, 2022	835	9.58	0.461	9.20	-3.99	4d121	7472	1698	17
S14	2300	23.3	1.717	39.621	1.67	39.5	2.81	0.31	Apr. 02, 2022	2300	49.20	2.39	47.69	-3.08	1004	7472	1698	17
S15	2600	23.3	2.015	38.715	1.96	39	2.81	-0.73	Apr. 02, 2022	2600	57.60	2.93	58.46	1.50	1020	7472	1698	17
S16	2300	23.1	1.681	38.157	1.67	39.5	0.66	-3.40	Apr. 03, 2022	2300	49.20	2.34	46.69	-5.10	1004	7472	1698	17
S17	2600	23.1	1.904	37.668	1.96	39	-2.86	-3.42	Apr. 03, 2022	2600	57.60	2.82	56.27	-2.32	1020	7472	1698	17
S20a	3500	23.3	2.938	36.985	2.91	37.9	0.96	-2.41	Apr. 04, 2022	3500	65.60	3.38	67.44	2.80	1007	7472	1698	17
S20b	3700	23.3	3.088	36.804	3.12	37.7	-1.03	-2.38	Apr. 04, 2022	3700	66.70	3.32	66.24	-0.69	1017	7472	1698	17
S21	1750	23.4	1.321	39.14	1.37	40.1	-3.58	-2.39	Apr. 01, 2022	1750	35.80	1.77	35.32	-1.35	1055	7472	1698	17
S22	750	23.2	0.914	40.813	0.9	42	1.56	-2.83	Mar. 29, 2022	750	8.56	0.39	7.78	-9.09	1013	7472	1698	17
S23	1900	23.3	1.463	38.84	1.4	40	4.50	-2.90	Apr. 06, 2022	1900	40.40	2	39.91	-1.22	5d036	7472	1698	17
S24	835	23.2	0.911	42.459	0.9	41.5	1.22	2.31	Apr. 05, 2022	835	9.58	0.525	10.48	9.34	4d121	7472	1698	17
S25	2600	23.2	1.905	37.687	1.96	39	-2.81	-3.37	Apr. 05, 2022	2600	57.60	2.83	56.47	-1.97	1020	7472	1698	17
S26	1900	23.3	1.463	38.84	1.4	40	4.50	-2.90	Apr. 06, 2022	1900	40.40	2	39.91	-1.22	5d036	7472	1698	17
S27	2300	23.3	1.708	39.188	1.67	39.5	2.28	-0.79	Apr. 07, 2022	2300	49.20	2.38	47.49	-3.48	1004	7472	1698	17
S28	2600	23.3	2.03	37.41	1.96	39	3.57	-4.08	Apr. 06, 2022	2600	57.60	2.92	58.26	1.15	1020	7472	1698	17
S29	2300	23.3	1.708	39.188	1.67	39.5	2.28	-0.79	Apr. 07, 2022	2300	49.20	2.38	47.49	-3.48	1004	7472	1698	17
S30	2600	23.3	2.004	38.246	1.96	39	2.24	-1.93	Apr. 07, 2022	2600	57.60	2.91	58.06	0.80	1020	7472	1698	17
S32	1750	23.2	1.327	39.343	1.37	40.1	-3.14	-1.89	Apr. 08, 2022	1750	35.80	1.68	33.52	-6.37	1055	7472	1698	17
S33	750	23.2	0.889	42.8	0.9	42	-1.22	1.90	Apr. 05, 2022	750	8.56	0.426	8.50	-0.70	1013	7472	1698	17
S34a	3700	23.2	3.048	37.922	3.12	37.7	-2.31	0.59	Apr. 08, 2022	3700	66.70	3.31	66.04	-0.98	1017	7472	1698	17
S34b	3900	23.2	3.254	37.664	3.32	37.5	-1.99	0.44	Apr. 08, 2022	3900	70.90	3.34	66.64	-6.01	1020	7472	1698	17
S35a	3500	23.2	2.841	38.289	2.91	37.9	-2.37	1.03	Apr. 08, 2022	3500	65.60	3.28	65.44	-0.24	1007	7472	1698	17
S35b	3700	23.2	3.048	37.922	3.12	37.7	-2.31	0.59	Apr. 08, 2022	3700	66.70	3.31	66.04	-0.98	1017	7472	1698	17
S36	2450	23.1	1.877	38.713	1.8	39.2	4.28	-1.24	Mar. 22, 2022	2450	52.60	2.49	49.68	-5.55	737	7555	1341	17
S37	5250	23.2	4.702	36.235	4.71	35.9	-0.17	0.93	Mar. 23, 2022	5250	80.60	3.85	76.82	-4.69	1019	7472	1698	17
S38	5600	23.2	4.996	35.809	5.07	35.5	-1.46	0.87	Mar. 23, 2022	5600	82.40	4.46	88.99	8.00	1019	7472	1698	17
S39	5750	23.3	5.266	35.45	5.22	35.4	0.88	0.14	Mar. 24, 2022	5750	79.40	3.79	75.62	-4.76	1019	7472	1698	17
S40	2450	23.2	1.758	38.542	1.8	39.2	-2.33	-1.68	Mar. 25, 2022	2450	52.60	2.47	49.28	-6.31	737	7472	1698	17

Annex D. Maximum Target Conducted Power

The maximum conducted average power (Unit: dBm) including tune-up tolerance is shown as below.

WCDMA Max. Tune-up Power (Full)		
Mode	RMC 12.2K	HSDPA DC-HSDPA HSUPA
	Maximum Target Power	Maximum Target Power
WCDMA Band II	24.5	24.5
WCDMA Band IV	24.5	24.5
WCDMA Band V	24.5	24.5

LTE Max. Tune-up Power (Full)				
Mode	QPSK	16QAM	64QAM	256QAM
	Maximum Target Power	Maximum Target Power	Maximum Target Power	Maximum Target Power
LTE 2	24.0	23.0	22.0	19.0
LTE 4	24.0	23.0	22.0	19.0
LTE 5	24.0	23.0	22.0	19.0
LTE 7	24.0	23.0	22.0	19.0
LTE 12	24.0	23.0	22.0	19.0
LTE 13	24.0	23.0	22.0	19.0
LTE 14	24.0	23.0	22.0	19.0
LTE 17	24.0	23.0	22.0	19.0
LTE 25	24.0	23.0	22.0	19.0
LTE 26	24.0	23.0	22.0	19.0
LTE 30	24.0	23.0	22.0	19.0
LTE 38	24.0	23.0	22.0	19.0
LTE 40	24.0	23.0	22.0	19.0
LTE 41(PC2)	27.0	26.0	25.0	22.0
LTE 41(PC3)	24.0	23.0	22.0	19.0
LTE 48	22.0	21.0	20.0	17.0
LTE 66	24.0	23.0	22.0	19.0
LTE 71	24.0	23.0	22.0	19.0

5G NR Max. Tune-up Power (Full)					
DFT-S Mode	PI/2 BPSK	QPSK	16QAM	64QAM	256QAM
	Maximum Target Power	Maximum Target Power	Maximum Target Power	Maximum Target Power	Maximum Target Power
NR 2	24.0	24.0	23.0	21.5	19.5
NR 5	24.0	24.0	23.0	21.5	19.5
NR 7	24.0	24.0	23.0	21.5	19.5
NR 25	24.0	24.0	23.0	21.5	19.5
NR 30	24.0	24.0	23.0	21.5	19.5
NR 38	24.0	24.0	23.0	21.5	19.5
NR 40	24.0	24.0	23.0	21.5	19.5
NR 41(PC2)	27.0	27.0	26.0	24.5	22.5
NR 41(PC3)	24.0	24.0	23.0	21.5	19.5
NR 66	24.0	24.0	23.0	21.5	19.5
NR 71	24.0	24.0	23.0	21.5	19.5
NR 77(PC2)	27.0	27.0	26.0	24.5	22.5
NR 77(PC3)	24.0	24.0	23.0	21.5	19.5
NR 78(PC2)	27.0	27.0	26.0	24.5	22.5
NR 78(PC3)	24.0	24.0	23.0	21.5	19.5

5G NR Max. Tune-up Power (Full)				
CP Mode	QPSK	16QAM	64QAM	256QAM
	Maximum Target Power	Maximum Target Power	Maximum Target Power	Maximum Target Power
NR 2	22.5	22.0	20.5	17.5
NR 5	22.5	22.0	20.5	17.5
NR 7	22.5	22.0	20.5	17.5
NR 25	22.5	22.0	20.5	17.5
NR 30	22.5	22.0	20.5	17.5
NR 38	22.5	22.0	20.5	17.5
NR 40	22.5	22.0	20.5	17.5
NR 41(PC2)	25.5	25.0	23.5	20.5
NR 41(PC3)	22.5	22.0	20.5	17.5
NR 66	22.5	22.0	20.5	17.5
NR 71	22.5	22.0	20.5	17.5
NR 77(PC2)	25.5	25.0	23.5	20.5
NR 77(PC3)	22.5	22.0	20.5	17.5
NR 78(PC2)	25.5	25.0	23.5	20.5
NR 78(PC3)	22.5	22.0	20.5	17.5

WCDMA Max. Tune-up Power (Reduction_Laptop)		
Mode	RMC 12.2K	HSDPA DC-HSDPA HSUPA
	Maximum Target Power	Maximum Target Power
WCDMA Band II	17.5	17.5
WCDMA Band IV	18.5	18.5
WCDMA Band V	22.5	22.5

WCDMA Max. Tune-up Power (Reduction_Tablet)		
Mode	RMC 12.2K	HSDPA DC-HSDPA HSUPA
	Maximum Target Power	Maximum Target Power
WCDMA Band II	13.0	13.0
WCDMA Band IV	12.5	12.5
WCDMA Band V	19.0	19.0

LTE Max. Tune-up Power (Reduction_Laptop)				
Mode	QPSK	16QAM	64QAM	256QAM
	Maximum Target Power	Maximum Target Power	Maximum Target Power	Maximum Target Power
LTE 2	18.0	17.0	16.0	13.0
LTE 4	18.0	17.0	16.0	13.0
LTE 5	21.5	20.5	19.5	16.5
LTE 7	18.0	17.0	16.0	13.0
LTE 12	19.5	18.5	17.5	14.5
LTE 13	20.0	19.0	18.0	15.0
LTE 14	23.0	22.0	21.0	18.0
LTE 17	19.5	18.5	17.5	14.5
LTE 25	18.5	17.5	16.5	13.5
LTE 26	23.0	22.0	21.0	18.0
LTE 30	21.5	20.5	19.5	16.5
LTE 38	20.5	19.5	18.5	15.5
LTE 40	20.5	19.5	18.5	15.5
LTE 41	18.0	17.0	16.0	13.0
LTE 48	17.5	16.5	15.5	12.5
LTE 66	18.5	17.5	16.5	13.5
LTE 71	23.0	22.0	21.0	18.0

LTE Max. Tune-up Power (Reduction_Tablet)				
Mode	QPSK	16QAM	64QAM	256QAM
	Maximum Target Power	Maximum Target Power	Maximum Target Power	Maximum Target Power
LTE 2	13.5	12.5	11.5	8.5
LTE 4	13.5	12.5	11.5	8.5
LTE 5	18.5	17.5	16.5	13.5
LTE 7	13.5	12.5	11.5	8.5
LTE 12	15.5	14.5	13.5	10.5
LTE 13	18.0	17.0	16.0	13.0
LTE 14	18.0	17.0	16.0	13.0
LTE 17	16.5	15.5	14.5	11.5
LTE 25	13.5	12.5	11.5	8.5
LTE 26	18.5	17.5	16.5	13.5
LTE 30	12.5	11.5	10.5	7.5
LTE 38	15.0	14.0	13.0	10.0
LTE 40	16.0	15.0	14.0	11.0
LTE 41	19.0	18.0	17.0	14.0
LTE 48	11.5	10.5	9.5	6.5
LTE 66	13.5	12.5	11.5	8.5
LTE 71	17.0	16.0	15.0	12.0

5G NR Max. Tune-up Power (Reduction Laptop)					
DFT-S Mode	PI/2 BPSK	QPSK	16QAM	64QAM	256QAM
	Maximum Target Power	Maximum Target Power	Maximum Target Power	Maximum Target Power	Maximum Target Power
NR 2	16.5	16.5	15.5	14.0	12.0
NR 5	20.0	20.0	19.0	17.5	15.5
NR 7	16.0	16.0	15.0	13.5	11.5
NR 25	16.5	16.5	15.5	14.0	12.0
NR 30	18.5	22.0	21.0	19.5	17.5
NR 38	19.0	23.0	22.0	20.5	18.5
NR 40	18.0	23.0	22.0	20.5	18.5
NR 41	17.0	21.0	20.0	18.5	16.5
NR 66	17.0	17.0	16.0	14.5	12.5
NR 71	20.0	20.0	19.0	17.5	15.5
NR 77	20.5	25.0	24.0	22.5	20.5
NR 78	21.0	23.0	22.0	20.5	18.5

5G NR Max. Tune-up Power (Reduction Laptop)				
CP Mode	QPSK	16QAM	64QAM	256QAM
	Maximum Target Power	Maximum Target Power	Maximum Target Power	Maximum Target Power
NR 2	15.0	14.5	13.0	10.0
NR 5	18.5	18.0	16.5	13.5
NR 7	14.5	14.0	12.5	9.5
NR 25	15.0	14.5	13.0	10.0
NR 30	17.0	16.5	15.0	12.0
NR 38	17.5	17.0	15.5	12.5
NR 40	16.5	16.0	14.5	11.5
NR 41	15.5	15.0	13.5	10.5
NR 66	15.5	15.0	13.5	10.5
NR 71	18.5	18.0	16.5	13.5
NR 77	19.0	18.5	17.0	14.0
NR 78	19.5	19.0	17.5	14.5

5G NR Max. Tune-up Power (Reduction Table)					
DFT-S Mode	PI/2 BPSK	QPSK	16QAM	64QAM	256QAM
	Maximum Target Power	Maximum Target Power	Maximum Target Power	Maximum Target Power	Maximum Target Power
NR 2	13.0	13.0	12.0	10.5	8.5
NR 5	19.0	19.0	18.0	16.5	14.5
NR 7	11.5	11.5	10.5	9.0	7.0
NR 25	13.0	13.0	12.0	10.5	8.5
NR 30	12.0	12.0	11.0	9.5	7.5
NR 38	13.0	13.0	12.0	10.5	8.5
NR 40	13.5	13.5	12.5	11.0	9.0
NR 41	15.0	15.0	14.0	12.5	10.5
NR 66	14.0	14.0	13.0	11.5	9.5
NR 71	17.0	17.0	16.0	14.5	12.5
NR 77	11.0	11.0	10.0	8.5	6.5
NR 78	11.0	11.0	10.0	8.5	6.5

5G NR Max. Tune-up Power (Reduction Table)				
CP Mode	QPSK	16QAM	64QAM	256QAM
	Maximum Target Power	Maximum Target Power	Maximum Target Power	Maximum Target Power
NR 2	11.5	11.0	9.5	6.5
NR 5	17.5	17.0	15.5	12.5
NR 7	10.0	9.5	8.0	5.0
NR 25	11.5	11.0	9.5	6.5
NR 30	10.5	10.0	8.5	5.5
NR 38	11.5	11.0	9.5	6.5
NR 40	12.0	11.5	10.0	7.0
NR 41	13.5	13.0	11.5	8.5
NR 66	12.5	12.0	10.5	7.5
NR 71	15.5	15.0	13.5	10.5
NR 77	9.5	9.0	7.5	4.5
NR 78	9.5	9.0	7.5	4.5

WLAN Tune-up Power_Laptop							
WLAN 2.4GHz							
Mode	Channel	Frequency	SISO Ant 0 Max Tune up	SISO Ant 1 Max Tune up	MIMO Ant 0 Tune up	MIMO Ant 1 Tune up	MIMO Ant 0+1 Max Tune up
802.11b	1	2412	19.00	19.50			
	6	2437	20.00	20.00			
	11	2462	19.50	19.50			
	12	2467	18.50	18.50			
	13	2472	15.00	15.00			
802.11g	1	2412	17.00	17.00			
	6	2437	20.00	20.00			
	11	2462	17.00	17.00			
	12	2467	15.00	15.00			
	13	2472	1.50	1.50			
802.11n HT20	1	2412	17.00	17.00	14.00	14.00	17.00
	6	2437	20.00	20.00	17.50	17.50	20.50
	11	2462	15.50	15.50	15.00	15.00	18.00
	12	2467	15.00	15.00	12.00	12.00	15.00
	13	2472	1.50	1.50	-1.50	-1.50	1.50
802.11n HT40	3	2422	16.50	16.50	13.50	13.50	16.50
	6	2437	15.50	15.50	14.50	14.50	17.50
	9	2452	16.00	14.50	13.00	13.00	16.00
	10	2457	12.50	12.50	9.50	9.50	12.50
	11	2462	5.00	5.00	2.00	2.00	5.00
802.11ax HE20	1	2412	17.00	17.00	14.00	14.00	17.00
	6	2437	20.00	20.00	17.50	17.50	20.50
	11	2462	15.50	15.50	14.50	14.50	17.50
	12	2467	15.00	15.00	12.00	12.00	15.00
	13	2472	1.50	1.50	-1.50	-1.50	1.50
802.11ax HE40	3	2422	16.50	16.50	13.50	13.50	16.50
	6	2437	15.50	15.50	14.50	14.50	17.50
	9	2452	16.00	15.00	13.00	13.00	16.00
	10	2457	12.50	12.50	9.50	9.50	12.50
	11	2462	5.00	5.00	2.00	2.00	5.00

WLAN Tune-up Power_Laptop

Bluetooth

Mode	Channel	Frequency		Ant 1 Max Tune-up	
BR / EDR	0	2402		8.0	
	39	2441		8.0	
	78	2480		8.0	
LE	0	2402		7.0	
	19	2440		7.0	
	39	2480		7.0	

WLAN Tune-up Power_Laptop							
WLAN 5.2GHz							
Mode	Channel	Frequency	SISO Ant 0 Max Tune up	SISO Ant 1 Max Tune up	MIMO Ant 0 Tune up	MIMO Ant 1 Tune up	MIMO Ant 0+1 Max Tune up
802.11a	36	5180	18.50	18.50			
	40	5200	19.25	19.25			
	44	5220	20.00	20.00			
	48	5240	20.00	20.00			
802.11n HT20	36	5180	18.50	18.50	15.50	15.50	18.50
	40	5200	19.25	19.25	16.25	16.25	19.25
	44	5220	20.00	20.00	17.50	17.50	20.50
	48	5240	20.00	20.00	17.50	17.50	20.50
802.11n HT40	38	5190	18.50	18.50	15.50	15.50	18.50
	46	5230	20.00	20.00	17.25	17.25	20.25
802.11ac VHT80	42	5210	18.25	18.25	15.25	15.25	18.25
802.11ax HE20	36	5180	18.50	18.50	15.50	15.50	18.50
	40	5200	19.25	19.25	16.25	16.25	19.25
	44	5220	20.00	20.00	17.50	17.50	20.50
	48	5240	20.00	20.00	17.50	17.50	20.50
802.11ax HE40	38	5190	18.50	18.50	15.50	15.50	18.50
	46	5230	20.00	20.00	17.25	17.25	20.25
802.11ax HE80	42	5210	15.00	15.00	14.25	14.25	17.25

WLAN Tune-up Power_Laptop							
WLAN 5.3GHz							
Mode	Channel	Frequency	SISO Ant 0 Max Tune up	SISO Ant 1 Max Tune up	MIMO Ant 0 Tune up	MIMO Ant 1 Tune up	MIMO Ant 0+1 Max Tune up
802.11a	52	5260	20.00	20.00			
	56	5280	20.00	20.00			
	60	5300	19.00	19.00			
	64	5320	18.00	18.00			
802.11n HT20	52	5260	20.00	20.00	17.50	17.50	20.50
	56	5280	20.00	20.00	17.50	17.50	20.50
	60	5300	19.00	19.00	16.00	16.00	19.00
	64	5320	18.00	18.00	15.00	15.00	18.00
802.11n HT40	54	5270	19.25	19.75	16.25	16.25	19.25
	62	5310	17.00	17.50	14.00	14.00	17.00
802.11ac VHT80	58	5290	17.25	17.25	14.25	14.25	17.25
802.11ac VHT160	50	5250	14.25	14.00	11.00	11.00	14.00
802.11ax HE20	52	5260	20.00	20.00	17.50	17.50	20.50
	56	5280	20.00	20.00	17.50	17.50	20.50
	60	5300	19.00	19.00	16.00	16.00	19.00
	64	5320	18.00	18.00	15.00	15.00	18.00
802.11ax HE40	54	5270	19.25	19.75	16.25	16.25	19.25
	62	5310	17.00	17.50	14.00	14.00	17.00
802.11ax HE80	58	5290	17.25	17.25	14.25	14.25	17.25
802.11ax HE160	50	5250	14.25	14.00	11.00	11.00	14.00

WLAN Tune-up Power_Laptop							
WLAN 5.6GHz							
Mode	Channel	Frequency	SISO Ant 0 Max Tune up	SISO Ant 1 Max Tune up	MIMO Ant 0 Tune up	MIMO Ant 1 Tune up	MIMO Ant 0+1 Max Tune up
802.11a	100	5500	18.50	18.50			
	116	5580	20.00	20.00			
	120	5600	20.00	20.00			
	124	5620	20.00	20.00			
	132	5660	20.00	20.00			
	140	5700	18.50	18.50			
	144	5720	20.00	20.00			
802.11n HT20	100	5500	18.50	18.50	15.50	15.50	18.50
	116	5580	17.50	17.50	14.50	14.50	17.50
	120	5600	20.00	20.00	17.50	17.50	20.50
	124	5620	20.00	20.00	17.50	17.50	20.50
	132	5660	20.00	20.00	17.50	17.50	20.50
	140	5700	18.50	17.50	14.50	14.50	17.50
	144	5720	20.00	20.00	17.25	17.25	20.25
802.11n HT40	102	5510	17.50	17.50	14.50	14.50	17.50
	110	5550	18.50	18.50	15.50	15.50	18.50
	118	5590	20.00	20.00	17.50	17.50	20.50
	126	5630	20.00	20.00	17.00	17.00	20.00
	134	5670	19.50	19.50	17.00	17.00	20.00
	142	5710	20.00	20.00	17.50	17.50	20.50
802.11ac VHT80	106	5530	18.50	18.50	15.50	15.50	18.50
	122	5610	20.00	20.00	17.50	17.50	20.50
	138	5690	20.00	20.00	17.50	17.50	20.50
802.11ac VHT160	114	5570	13.75	13.75	10.75	10.75	13.75
802.11ax HE20	100	5500	18.50	18.50	15.50	15.50	18.50
	116	5580	17.50	17.50	14.50	14.50	17.50
	120	5600	20.00	20.00	17.50	17.50	20.50
	124	5620	20.00	20.00	17.50	17.50	20.50
	132	5660	20.00	20.00	17.50	17.50	20.50
	140	5700	18.50	17.50	14.50	14.50	17.50
	144	5720	20.00	20.00	17.25	17.25	20.25
802.11ax HE40	102	5510	17.50	17.50	14.50	14.50	17.50
	110	5550	18.50	18.50	15.50	15.50	18.50
	118	5590	20.00	20.00	17.50	17.50	20.50
	126	5630	20.00	20.00	17.00	17.00	20.00
	134	5670	19.00	19.00	17.00	17.00	20.00
	142	5710	20.00	20.00	17.50	17.50	20.50
802.11ax HE80	106	5530	18.50	18.50	15.50	15.50	18.50
	122	5610	19.50	19.50	17.50	17.50	20.50
	138	5690	20.00	20.00	17.50	17.50	20.50

WLAN Tune-up Power_Laptop							
WLAN 5.8GHz							
Mode	Channel	Frequency	SISO Ant 0 Max Tune up	SISO Ant 1 Max Tune up	MIMO Ant 0 Tune up	MIMO Ant 1 Tune up	MIMO Ant 0+1 Max Tune up
802.11a	149	5745	18.50	19.00			
	153	5765	18.50	19.00			
	157	5785	18.50	19.00			
	161	5805	18.50	19.00			
	165	5825	18.50	19.00			
802.11n HT20	149	5745	18.50	19.00	17.25	17.25	20.25
	153	5765	18.50	19.00	17.25	17.25	20.25
	157	5785	18.50	19.00	17.25	17.25	20.25
	161	5805	18.50	19.00	17.25	17.25	20.25
	165	5825	18.50	19.00	17.25	17.25	20.25
802.11n HT40	151	5755	18.50	19.00	17.50	17.50	20.50
	159	5795	18.50	19.00	17.50	17.50	20.50
802.11ac VHT80	155	5775	18.00	18.00	16.00	16.00	19.00
802.11ax HE20	149	5745	18.50	19.00	17.25	17.25	20.25
	153	5765	18.50	19.00	17.25	17.25	20.25
	157	5785	18.50	19.00	17.25	17.25	20.25
	161	5805	18.50	19.00	17.25	17.25	20.25
	165	5825	18.50	19.00	17.25	17.25	20.25
802.11ax HE40	151	5755	18.50	19.00	17.50	17.50	20.50
	159	5795	18.50	19.00	17.50	17.50	20.50
802.11ax HE80	155	5775	18.00	18.00	16.00	16.00	19.00

WLAN Tune-up Power_Tablet							
WLAN 2.4GHz							
Mode	Channel	Frequency	SISO Ant 0 Max Tune up	SISO Ant 1 Max Tune up	MIMO Ant 0 Tune up	MIMO Ant 1 Tune up	MIMO Ant 0+1 Max Tune up
802.11b	1	2412	18.50	19.50			
	6	2437	18.50	20.00			
	11	2462	18.50	19.50			
	12	2467	18.50	18.50			
	13	2472	15.00	15.00			
802.11g	1	2412	17.00	17.00			
	6	2437	18.50	20.00			
	11	2462	17.00	17.00			
	12	2467	15.00	15.00			
	13	2472	1.50	1.50			
802.11n HT20	1	2412	17.00	17.00	14.00	14.00	17.00
	6	2437	18.50	20.00	17.50	17.50	20.50
	11	2462	15.50	15.50	15.00	15.00	18.00
	12	2467	15.00	15.00	12.00	12.00	15.00
	13	2472	1.50	1.50	-1.50	-1.50	1.50
802.11n HT40	3	2422	16.50	16.50	13.50	13.50	16.50
	6	2437	15.50	15.50	14.50	14.50	17.50
	9	2452	16.00	14.50	13.00	13.00	16.00
	10	2457	12.50	12.50	9.50	9.50	12.50
	11	2462	5.00	5.00	2.00	2.00	5.00
802.11ax HE20	1	2412	17.00	17.00	14.00	14.00	17.00
	6	2437	18.50	20.00	17.50	17.50	20.50
	11	2462	15.50	15.50	14.50	14.50	17.50
	12	2467	15.00	15.00	12.00	12.00	15.00
	13	2472	1.50	1.50	-1.50	-1.50	1.50
802.11ax HE40	3	2422	16.50	16.50	13.50	13.50	16.50
	6	2437	15.50	15.50	14.50	14.50	17.50
	9	2452	16.00	15.00	13.00	13.00	16.00
	10	2457	12.50	12.50	9.50	9.50	12.50
	11	2462	5.00	5.00	2.00	2.00	5.00

WLAN Tune-up Power_Tablet

Bluetooth

Mode	Channel	Frequency		Ant 1 Max Tune-up	
BR / EDR	0	2402		8.0	
	39	2441		8.0	
	78	2480		8.0	
LE	0	2402		7.0	
	19	2440		7.0	
	39	2480		7.0	

WLAN Tune-up Power_Tablet							
WLAN 5.2GHz							
Mode	Channel	Frequency	SISO Ant 0 Max Tune up	SISO Ant 1 Max Tune up	MIMO Ant 0 Tune up	MIMO Ant 1 Tune up	MIMO Ant 0+1 Max Tune up
802.11a	36	5180	17.50	18.00			
	40	5200	17.50	18.00			
	44	5220	17.50	18.00			
	48	5240	17.50	18.00			
802.11n HT20	36	5180	17.50	18.00	15.50	15.50	18.50
	40	5200	17.50	18.00	16.25	16.25	19.25
	44	5220	17.50	18.00	17.00	17.00	20.00
	48	5240	17.50	18.00	17.00	17.00	20.00
802.11n HT40	38	5190	17.50	18.00	15.50	15.50	18.50
	46	5230	17.50	18.00	17.25	17.25	20.25
802.11ac VHT80	42	5210	17.50	18.00	15.25	15.25	18.25
802.11ax HE20	36	5180	17.50	18.00	15.50	15.50	18.50
	40	5200	17.50	18.00	16.25	16.25	19.25
	44	5220	17.50	18.00	17.00	17.00	20.00
	48	5240	17.50	18.00	17.00	17.00	20.00
802.11ax HE40	38	5190	17.50	18.00	15.50	15.50	18.50
	46	5230	17.50	18.00	17.25	17.25	20.25
802.11ax HE80	42	5210	15.00	15.00	14.25	14.25	17.25

WLAN Tune-up Power_Tablet							
WLAN 5.3GHz							
Mode	Channel	Frequency	SISO Ant 0 Max Tune up	SISO Ant 1 Max Tune up	MIMO Ant 0 Tune up	MIMO Ant 1 Tune up	MIMO Ant 0+1 Max Tune up
802.11a	52	5260	12.50	15.00			
	56	5280	12.50	15.00			
	60	5300	12.50	15.00			
	64	5320	12.50	15.00			
802.11n HT20	52	5260	12.50	15.00	15.00	15.00	18.00
	56	5280	12.50	15.00	15.00	15.00	18.00
	60	5300	12.50	15.00	15.00	15.00	18.00
	64	5320	12.50	15.00	15.00	15.00	18.00
802.11n HT40	54	5270	12.50	15.00	15.00	15.00	18.00
	62	5310	12.50	15.00	14.00	14.00	17.00
802.11ac VHT80	58	5290	12.50	15.00	14.25	14.25	17.25
802.11ac VHT160	50	5250	12.00	14.00	11.00	11.00	14.00
802.11ax HE20	52	5260	12.50	15.00	15.00	15.00	18.00
	56	5280	12.50	15.00	15.00	15.00	18.00
	60	5300	12.50	15.00	15.00	15.00	18.00
	64	5320	12.50	15.00	15.00	15.00	18.00
802.11ax HE40	54	5270	12.50	15.00	15.00	15.00	18.00
	62	5310	12.50	15.00	14.00	14.00	17.00
802.11ax HE80	58	5290	12.50	15.00	14.25	14.25	17.25
802.11ax HE160	50	5250	12.00	14.00	11.00	11.00	14.00

WLAN Tune-up Power_Tablet							
WLAN 5.6GHz							
Mode	Channel	Frequency	SISO Ant 0 Max Tune up	SISO Ant 1 Max Tune up	MIMO Ant 0 Tune up	MIMO Ant 1 Tune up	MIMO Ant 0+1 Max Tune up
802.11a	100	5500	12.50	15.00			
	116	5580	12.50	15.00			
	120	5600	12.50	15.00			
	124	5620	12.50	15.00			
	132	5660	12.50	15.00			
	140	5700	12.50	15.00			
	144	5720	12.50	15.00			
802.11n HT20	100	5500	12.50	15.00	14.00	14.00	17.00
	116	5580	12.50	15.00	14.00	14.00	17.00
	120	5600	12.50	15.00	14.00	14.00	17.00
	124	5620	12.50	15.00	14.00	14.00	17.00
	132	5660	12.50	15.00	14.00	14.00	17.00
	140	5700	12.50	15.00	13.50	13.50	16.50
	144	5720	12.50	15.00	14.00	14.00	17.00
802.11n HT40	102	5510	12.50	15.00	13.50	13.50	16.50
	110	5550	12.50	15.00	14.00	14.00	17.00
	118	5590	12.50	15.00	14.00	14.00	17.00
	126	5630	12.50	15.00	14.00	14.00	17.00
	134	5670	12.50	15.00	14.00	14.00	17.00
	142	5710	12.50	15.00	14.00	14.00	17.00
802.11ac VHT80	106	5530	12.50	15.00	14.00	14.00	17.00
	122	5610	12.50	15.00	14.00	14.00	17.00
	138	5690	12.50	15.00	14.00	14.00	17.00
802.11ac VHT160	114	5570	12.50	13.75	10.75	10.75	13.75
802.11ax HE20	100	5500	12.50	15.00	14.00	14.00	17.00
	116	5580	12.50	15.00	14.00	14.00	17.00
	120	5600	12.50	15.00	14.00	14.00	17.00
	124	5620	12.50	15.00	14.00	14.00	17.00
	132	5660	12.50	15.00	14.00	14.00	17.00
	140	5700	12.50	15.00	13.50	13.50	16.50
	144	5720	12.50	15.00	14.00	14.00	17.00
802.11ax HE40	102	5510	12.50	15.00	13.50	13.50	16.50
	110	5550	12.50	15.00	14.00	14.00	17.00
	118	5590	12.50	15.00	14.00	14.00	17.00
	126	5630	12.50	15.00	14.00	14.00	17.00
	134	5670	12.50	15.00	14.00	14.00	17.00
	142	5710	12.50	15.00	14.00	14.00	17.00
802.11ax HE80	106	5530	12.50	15.00	14.00	14.00	17.00
	122	5610	12.50	15.00	14.00	14.00	17.00
	138	5690	12.50	15.00	14.00	14.00	17.00

WLAN Tune-up Power_Tablet							
WLAN 5.8GHz							
Mode	Channel	Frequency	SISO Ant 0 Max Tune up	SISO Ant 1 Max Tune up	MIMO Ant 0 Tune up	MIMO Ant 1 Tune up	MIMO Ant 0+1 Max Tune up
802.11a	149	5745	13.50	15.00			
	153	5765	13.50	15.00			
	157	5785	13.50	15.00			
	161	5805	13.50	15.00			
	165	5825	13.50	15.00			
802.11n HT20	149	5745	13.50	15.00	14.50	14.50	17.50
	153	5765	13.50	15.00	14.50	14.50	17.50
	157	5785	13.50	15.00	14.50	14.50	17.50
	161	5805	13.50	15.00	14.50	14.50	17.50
	165	5825	13.50	15.00	14.50	14.50	17.50
802.11n HT40	151	5755	13.50	15.00	14.50	14.50	17.50
	159	5795	13.50	15.00	14.50	14.50	17.50
802.11ac VHT80	155	5775	13.50	15.00	14.50	14.50	17.50
802.11ax HE20	149	5745	13.50	15.00	14.50	14.50	17.50
	153	5765	13.50	15.00	14.50	14.50	17.50
	157	5785	13.50	15.00	14.50	14.50	17.50
	161	5805	13.50	15.00	14.50	14.50	17.50
	165	5825	13.50	15.00	14.50	14.50	17.50
802.11ax HE40	151	5755	13.50	15.00	14.50	14.50	17.50
	159	5795	13.50	15.00	14.50	14.50	17.50
802.11ax HE80	155	5775	13.50	15.00	14.50	14.50	17.50

WCDMA Conducted Power (Full)									
Band	WCDMA II			WCDMA IV			WCDMA V		
TX Channel	9262	9400	9538	1312	1413	1513	4132	4182	4233
Rx Channel	9662	9800	9938	1537	1638	1738	4357	4407	4458
Frequency	1852.4	1880	1907.6	1712.4	1732.6	1752.6	826.4	836.4	846.6
RMC 12.2K	23.83	23.89	23.85	24.11	24.05	24.03	23.66	23.58	23.55
HSDPA Subtest-1	22.76	22.82	22.79	23.11	22.97	22.92	22.68	22.58	22.55
HSDPA Subtest-2	22.75	22.79	22.72	23.08	22.95	22.91	22.66	22.56	22.53
HSDPA Subtest-3	22.32	22.33	22.28	22.65	22.51	22.46	22.18	22.12	22.11
HSDPA Subtest-4	22.26	22.29	22.26	22.62	22.45	22.41	22.15	22.07	22.05
DC-HSDPA Subtest-1	22.54	22.61	22.54	22.84	22.72	22.65	22.58	22.53	22.52
DC-HSDPA Subtest-2	22.53	22.52	22.52	22.86	22.65	22.63	22.55	22.52	22.51
DC-HSDPA Subtest-3	22.03	22.08	22.05	22.41	22.31	22.24	22.08	22.05	22.03
DC-HSDPA Subtest-4	22.01	22.05	22.03	22.40	22.16	22.19	22.05	22.03	22.02
HSUPA Subtest-1	22.51	22.53	22.52	22.51	22.53	22.52	22.54	22.51	22.53
HSUPA Subtest-2	20.75	20.77	20.75	21.06	20.91	20.89	20.61	20.55	20.53
HSUPA Subtest-3	21.77	21.81	21.72	22.07	21.95	21.95	21.65	21.58	21.56
HSUPA Subtest-4	20.55	20.56	20.52	20.75	20.61	20.62	20.55	20.56	20.53
HSUPA Subtest-5	22.50	22.50	22.60	22.60	22.60	22.60	22.50	22.60	22.60

LTE Conducted Power (Full)							
LTE Band 2							
BW	MCS Index	RB Size	RB Offset	Low	Mid	High	3GPP MPR (dB)
		Channel		18700	18900	19100	
		Frequency (MHz)		1860	1880	1900	
20M	QPSK	1	0	23.32	23.13	23.16	0
		1	50	23.27	22.98	22.95	0
		1	99	22.81	22.95	22.92	0
		50	0	22.32	22.31	22.25	1
		50	25	22.10	22.24	22.19	1
		50	50	22.14	22.23	22.17	1
		100	0	22.19	22.23	22.22	1
20M	16QAM	1	0	22.02	22.08	22.03	1
		1	50	21.85	21.94	21.92	1
		1	99	21.86	21.88	21.86	1
		50	0	21.11	21.23	21.16	2
		50	25	21.14	21.21	21.15	2
		50	50	21.08	21.19	21.15	2
		100	0	21.14	21.18	21.18	2
20M	64QAM	1	0	20.68	20.81	20.73	2
		1	50	20.88	20.89	20.88	2
		1	99	20.75	20.77	20.76	2
		50	0	20.07	20.16	20.11	3
		50	25	20.15	20.25	20.25	3
		50	50	20.17	20.29	20.25	3
		100	0	20.04	20.18	20.10	3
20M	256QAM	1	0	18.23	18.26	18.20	5
		1	50	18.16	18.22	18.11	5
		1	99	18.19	18.21	18.13	5
		50	0	18.10	18.11	18.04	5
		50	25	18.14	18.17	18.11	5
		50	50	18.17	18.19	18.10	5
		100	0	18.10	18.13	18.09	5
BW	MCS Index	Channel		18675	18900	19125	3GPP MPR
Frequency (MHz)		1857.5	1880	1902.5			
15M	QPSK	1	0	23.16	23.18	23.12	0
		1	37	22.76	22.89	22.81	0
		1	74	22.75	22.89	22.88	0
		36	0	22.11	22.25	22.24	1
		36	19	22.09	22.16	22.15	1
		36	39	22.07	22.17	22.15	1
		75	0	22.12	22.23	22.19	1
15M	16QAM	1	0	21.94	22.06	22.01	1
		1	37	21.79	21.92	21.89	1
		1	74	21.85	21.87	21.79	1
		36	0	21.07	21.17	21.14	2
		36	19	21.11	21.17	21.09	2
		36	39	20.99	21.17	21.06	2
		75	0	21.11	21.08	21.13	2
15M	64QAM	1	0	20.59	20.80	20.67	2
		1	37	20.85	20.80	20.83	2
		1	74	20.66	20.72	20.76	2
		36	0	19.97	20.11	20.03	3
		36	19	20.11	20.17	20.19	3
		36	39	20.13	20.26	20.25	3
		75	0	19.95	20.12	20.09	3
15M	256QAM	1	0	18.21	18.16	18.14	5
		1	37	18.06	18.17	18.07	5
		1	74	18.09	18.15	18.10	5
		36	0	18.08	18.11	18.03	5
		36	19	18.07	18.10	18.07	5
		36	39	18.12	18.11	18.06	5
		75	0	18.02	18.08	18.00	5

LTE Conducted Power (Full)							
LTE Band 2							
BW	MCS Index	Channel		18650	18900	19150	3GPP MPR
		Frequency (MHz)		1855	1880	1905	
10M	QPSK	1	0	23.09	23.04	23.02	0
		1	24	22.66	22.88	22.74	0
		1	49	22.75	22.78	22.86	0
		25	0	21.99	22.24	22.09	1
		25	12	22.00	22.06	22.14	1
		25	25	22.02	22.02	22.02	1
		50	0	22.06	22.12	22.06	1
10M	16QAM	1	0	21.81	21.94	21.95	1
		1	24	21.67	21.80	21.84	1
		1	49	21.79	21.86	21.70	1
		25	0	21.00	21.06	21.02	2
		25	12	20.98	21.16	20.95	2
		25	25	20.99	21.11	20.97	2
		50	0	20.98	21.08	20.98	2
10M	64QAM	1	0	20.53	20.67	20.55	2
		1	24	20.85	20.80	20.70	2
		1	49	20.59	20.64	20.73	2
		25	0	19.92	20.10	19.89	3
		25	12	20.07	20.08	20.14	3
		25	25	20.07	20.14	20.24	3
		50	0	19.91	20.07	20.08	3
10M	256QAM	1	0	18.13	18.12	18.06	5
		1	24	17.94	18.18	17.93	5
		1	49	18.01	18.07	17.93	5
		25	0	18.10	18.04	17.90	5
		25	12	18.00	18.07	18.00	5
		25	25	18.02	18.18	17.94	5
		50	0	18.05	18.12	18.08	5
BW	MCS Index	Channel		18625	18900	19175	3GPP MPR
Frequency (MHz)		1852.5	1880	1907.5			
5M	QPSK	1	0	23.11	23.07	23.01	0
		1	12	22.74	22.86	22.62	0
		1	24	22.70	22.81	22.72	0
		12	0	21.98	22.12	22.07	1
		12	6	21.98	22.09	22.07	1
		12	13	21.99	22.11	22.02	1
		25	0	22.00	22.13	21.97	1
5M	16QAM	1	0	21.90	22.02	21.99	1
		1	12	21.66	21.83	21.80	1
		1	24	21.82	21.87	21.68	1
		12	0	20.94	21.16	21.06	2
		12	6	20.99	21.04	20.94	2
		12	13	20.90	21.16	21.04	2
		25	0	20.96	21.00	21.13	2
5M	64QAM	1	0	20.49	20.80	20.61	2
		1	12	20.73	20.76	20.79	2
		1	24	20.60	20.67	20.71	2
		12	0	19.94	19.97	19.95	3
		12	6	20.06	20.11	20.07	3
		12	13	20.01	20.15	20.20	3
		25	0	19.89	20.11	20.04	3
5M	256QAM	1	0	18.09	18.13	17.96	5
		1	12	18.09	18.02	17.87	5
		1	24	18.01	18.16	17.87	5
		12	0	18.06	18.09	17.82	5
		12	6	17.97	18.04	17.99	5
		12	13	18.00	18.13	17.87	5
		25	0	18.02	17.98	17.99	5

LTE Conducted Power (Full)							
LTE Band 2							
BW	MCS Index	Channel		18615	18900	19185	3GPP MPR
		Frequency (MHz)		1851.5	1880	1908.5	
3M	QPSK	1	0	23.07	23.15	23.06	0
		1	7	22.75	22.89	22.75	0
		1	14	22.68	22.74	22.79	0
		8	0	22.05	22.24	22.14	1
		8	3	22.04	22.12	22.09	1
		8	7	21.99	22.05	22.09	1
		15	0	22.11	22.12	22.04	1
3M	16QAM	1	0	21.88	22.02	21.86	1
		1	7	21.65	21.82	21.76	1
		1	14	21.85	21.75	21.73	1
		8	0	21.07	21.05	20.99	2
		8	3	21.09	21.06	20.96	2
		8	7	20.94	21.05	21.03	2
		15	0	21.07	21.03	20.98	2
3M	64QAM	1	0	20.58	20.68	20.64	2
		1	7	20.70	20.80	20.79	2
		1	14	20.62	20.68	20.62	2
		8	0	19.93	20.03	19.97	3
		8	3	20.04	20.13	20.12	3
		8	7	20.12	20.22	20.17	3
		15	0	19.92	20.05	19.96	3
3M	256QAM	1	0	18.07	18.09	18.16	5
		1	7	17.95	18.05	17.97	5
		1	14	18.04	18.07	18.09	5
		8	0	17.98	17.95	17.86	5
		8	3	18.03	18.04	17.99	5
		8	7	18.14	18.09	17.89	5
		15	0	18.02	18.07	17.88	5
BW	MCS Index	Channel		18607	18900	19193	3GPP MPR
		Frequency (MHz)		1850.7	1880	1909.3	
1.4M	QPSK	1	0	23.15	23.15	23.03	0
		1	2	22.66	22.92	22.75	0
		1	5	22.71	22.85	22.80	0
		3	0	23.05	22.95	23.01	0
		3	1	22.97	22.93	22.94	0
		3	3	22.91	22.97	22.99	0
		6	0	22.01	22.17	22.09	1
1.4M	16QAM	1	0	21.86	21.97	21.88	1
		1	2	21.76	21.86	21.85	1
		1	5	21.68	21.82	21.75	1
		3	0	21.97	22.16	22.00	1
		3	1	22.05	22.09	22.04	1
		3	3	21.87	22.02	22.04	1
		6	0	21.14	20.98	21.12	2
1.4M	64QAM	1	0	20.51	20.64	20.50	2
		1	2	20.78	20.75	20.72	2
		1	5	20.60	20.76	20.72	2
		3	0	20.97	21.06	21.05	2
		3	1	20.92	21.19	21.03	2
		3	3	21.09	21.22	21.08	2
		6	0	19.91	20.02	19.93	3
1.4M	256QAM	1	0	18.01	18.08	17.97	5
		1	2	18.12	18.09	17.91	5
		1	5	18.15	18.07	17.97	5
		3	0	18.06	17.95	17.80	5
		3	1	17.96	18.04	17.99	5
		3	3	17.93	18.05	18.02	5
		6	0	17.95	18.00	18.01	5

LTE Conducted Power (Full)							
LTE Band 4							
BW	MCS Index	RB Size	RB Offset	Low	Mid	High	3GPP MPR (dB)
		Channel		20050	20175	20300	
		Frequency (MHz)		1720	1732.5	1745	
20M	QPSK	1	0	23.27	23.25	23.22	0
		1	50	23.21	23.18	23.15	0
		1	99	22.85	22.77	22.77	0
		50	0	22.35	22.32	22.26	1
		50	25	22.32	22.28	22.26	1
		50	50	22.29	22.25	22.15	1
		100	0	22.31	22.29	22.19	1
20M	16QAM	1	0	22.57	22.57	22.53	1
		1	50	22.53	22.43	22.35	1
		1	99	22.48	22.39	22.31	1
		50	0	21.17	21.08	20.98	2
		50	25	21.27	21.18	21.11	2
		50	50	21.32	21.22	21.16	2
		100	0	21.26	21.26	21.16	2
20M	64QAM	1	0	21.38	21.28	21.19	2
		1	50	21.42	21.34	21.26	2
		1	99	21.33	21.23	21.15	2
		50	0	20.15	20.08	20.02	3
		50	25	20.27	20.26	20.21	3
		50	50	20.25	20.19	20.15	3
		100	0	20.21	20.19	20.09	3
20M	256QAM	1	0	18.33	18.25	18.15	5
		1	50	18.28	18.27	18.24	5
		1	99	18.26	18.19	18.15	5
		50	0	18.08	18.01	17.96	5
		50	25	18.23	18.21	18.11	5
		50	50	18.26	18.22	18.15	5
		100	0	18.17	18.13	18.10	5
BW	MCS Index	Channel		20025	20175	20325	3GPP MPR
Frequency (MHz)		1717.5	1732.5	1747.5			
15M	QPSK	1	0	23.12	23.06	23.01	0
		1	37	22.88	22.77	22.81	0
		1	74	22.75	22.76	22.74	0
		36	0	22.25	22.28	22.22	1
		36	19	22.23	22.18	22.22	1
		36	39	22.24	22.18	22.05	1
		75	0	22.31	22.27	22.18	1
15M	16QAM	1	0	22.48	22.50	22.46	1
		1	37	22.48	22.33	22.30	1
		1	74	22.41	22.34	22.28	1
		36	0	21.14	20.99	20.89	2
		36	19	21.23	21.13	21.02	2
		36	39	21.23	21.21	21.11	2
		75	0	21.26	21.23	21.12	2
15M	64QAM	1	0	21.35	21.21	21.17	2
		1	37	21.38	21.26	21.18	2
		1	74	21.33	21.18	21.05	2
		36	0	20.14	20.03	19.99	3
		36	19	20.26	20.19	20.15	3
		36	39	20.25	20.14	20.11	3
		75	0	20.11	20.10	20.00	3
15M	256QAM	1	0	18.24	18.19	18.15	5
		1	37	18.24	18.21	18.15	5
		1	74	18.16	18.11	18.05	5
		36	0	18.05	17.95	17.86	5
		36	19	18.22	18.18	18.06	5
		36	39	18.25	18.16	18.05	5
		75	0	18.17	18.12	18.04	5

LTE Conducted Power (Full)							
LTE Band 4							
BW	MCS Index	Channel		20000	20175	20350	3GPP MPR
		Frequency (MHz)		1715	1732.5	1750	
10M	QPSK	1	0	23.11	23.00	22.89	0
		1	24	22.79	22.70	22.74	0
		1	49	22.61	22.66	22.68	0
		25	0	22.16	22.15	22.17	1
		25	12	22.23	22.11	22.13	1
		25	25	22.24	22.17	22.02	1
		50	0	22.21	22.15	22.03	1
10M	16QAM	1	0	22.47	22.45	22.41	1
		1	24	22.46	22.28	22.27	1
		1	49	22.39	22.26	22.23	1
		25	0	21.06	20.90	20.76	2
		25	12	21.16	21.12	20.96	2
		25	25	21.21	21.14	21.00	2
		50	0	21.26	21.09	21.04	2
10M	64QAM	1	0	21.20	21.14	21.07	2
		1	24	21.29	21.19	21.12	2
		1	49	21.27	21.18	20.91	2
		25	0	20.12	19.91	19.99	3
		25	12	20.24	20.15	20.10	3
		25	25	20.25	20.08	20.11	3
		50	0	20.03	19.98	19.92	3
10M	256QAM	1	0	18.25	18.05	18.08	5
		1	24	18.20	18.06	18.05	5
		1	49	18.07	18.02	18.10	5
		25	0	17.86	17.90	17.92	5
		25	12	18.06	18.12	18.10	5
		25	25	18.12	18.11	17.96	5
		50	0	17.97	17.93	17.98	5
BW	MCS Index	Channel		19975	20175	20375	3GPP MPR
		Frequency (MHz)		1712.5	1732.5	1752.5	
5M	QPSK	1	0	23.05	22.95	22.85	0
		1	12	22.79	22.69	22.69	0
		1	24	22.65	22.63	22.63	0
		12	0	22.16	22.24	22.17	1
		12	6	22.10	22.11	22.08	1
		12	13	22.24	22.03	21.88	1
		25	0	22.19	22.19	21.99	1
5M	16QAM	1	0	22.41	22.44	22.31	1
		1	12	22.47	22.23	22.28	1
		1	24	22.41	22.24	22.18	1
		12	0	21.13	20.90	20.86	2
		12	6	21.10	21.03	20.93	2
		12	13	21.09	21.10	21.09	2
		25	0	21.14	21.11	21.11	2
5M	64QAM	1	0	21.29	21.17	21.05	2
		1	12	21.29	21.20	21.11	2
		1	24	21.25	21.14	21.05	2
		12	0	20.13	19.92	19.92	3
		12	6	20.22	20.08	20.15	3
		12	13	20.21	20.03	20.01	3
		25	0	20.10	20.03	19.85	3
5M	256QAM	1	0	18.14	18.07	17.97	5
		1	12	18.24	18.16	17.89	5
		1	24	18.13	18.16	17.89	5
		12	0	17.88	17.98	17.70	5
		12	6	18.02	17.99	17.97	5
		12	13	18.02	18.14	18.04	5
		25	0	18.02	18.05	17.94	5

LTE Conducted Power (Full)							
LTE Band 4							
BW	MCS Index	Channel		19965	20175	20385	3GPP MPR
		Frequency (MHz)		1711.5	1732.5	1753.5	
3M	QPSK	1	0	23.05	23.03	22.93	0
		1	7	22.87	22.63	22.73	0
		1	14	22.60	22.69	22.64	0
		8	0	22.17	22.21	22.11	1
		8	3	22.15	22.10	22.12	1
		8	7	22.24	22.07	21.99	1
		15	0	22.25	22.20	22.07	1
3M	16QAM	1	0	22.38	22.38	22.45	1
		1	7	22.47	22.23	22.16	1
		1	14	22.30	22.34	22.15	1
		8	0	21.08	20.88	20.82	2
		8	3	21.15	20.99	20.92	2
		8	7	21.10	21.15	21.05	2
		15	0	21.17	21.15	21.00	2
3M	64QAM	1	0	21.35	21.15	21.05	2
		1	7	21.32	21.21	21.06	2
		1	14	21.27	21.17	20.95	2
		8	0	19.99	19.97	19.94	3
		8	3	20.14	20.14	20.07	3
		8	7	20.24	20.13	20.08	3
		15	0	20.05	20.07	19.92	3
3M	256QAM	1	0	18.13	18.08	18.04	5
		1	7	18.20	18.19	18.11	5
		1	14	18.19	18.11	18.09	5
		8	0	18.02	17.98	17.77	5
		8	3	18.05	18.07	18.01	5
		8	7	18.18	18.05	18.07	5
		15	0	18.17	18.01	17.99	5
BW	MCS Index	Channel		19957	20175	20393	3GPP MPR
		Frequency (MHz)		1710.7	1732.5	1754.3	
1.4M	QPSK	1	0	23.01	23.04	23.03	0
		1	2	22.81	22.71	22.75	0
		1	5	22.76	22.60	22.69	0
		3	0	23.06	23.00	23.06	0
		3	1	23.07	23.02	23.14	0
		3	3	23.05	23.11	22.82	0
		6	0	22.18	22.24	22.12	1
1.4M	16QAM	1	0	22.51	22.46	22.31	1
		1	2	22.38	22.30	22.30	1
		1	5	22.37	22.33	22.22	1
		3	0	22.03	22.01	21.88	1
		3	1	22.18	22.08	21.89	1
		3	3	22.19	22.08	22.01	1
		6	0	21.08	21.15	20.99	2
1.4M	64QAM	1	0	21.22	21.23	21.09	2
		1	2	21.35	21.12	21.02	2
		1	5	21.20	21.10	20.96	2
		3	0	20.93	21.02	20.92	2
		3	1	21.20	21.15	21.05	2
		3	3	21.04	21.17	21.07	2
		6	0	20.16	20.06	20.02	3
1.4M	256QAM	1	0	18.27	18.11	17.91	5
		1	2	18.03	18.13	18.21	5
		1	5	18.10	18.13	18.08	5
		3	0	17.98	17.91	17.83	5
		3	1	18.13	18.11	17.93	5
		3	3	18.18	18.21	18.09	5
		6	0	18.06	17.96	18.05	5

LTE Conducted Power (Full)							
LTE Band 5							
BW	MCS Index	RB Size	RB Offset	Low	Mid	High	3GPP MPR (dB)
		Channel		20450	20525	20600	
		Frequency (MHz)		829	836.5	844	
10M	QPSK	1	0	23.09	23.22	23.17	0
		1	24	23.05	23.21	23.11	0
		1	49	22.95	23.01	22.93	0
		25	0	22.08	22.21	22.15	1
		25	12	22.06	22.18	22.10	1
		25	25	22.05	22.16	22.05	1
		50	0	22.10	22.19	22.12	1
10M	16QAM	1	0	22.40	22.58	22.48	1
		1	24	22.36	22.49	22.39	1
		1	49	22.44	22.51	22.49	1
		25	0	21.09	21.23	21.15	2
		25	12	21.13	21.21	21.18	2
		25	25	21.15	21.25	21.21	2
		50	0	21.04	21.19	21.09	2
10M	64QAM	1	0	21.42	21.44	21.43	2
		1	24	21.29	21.38	21.32	2
		1	49	21.20	21.33	21.28	2
		25	0	20.06	20.22	20.14	3
		25	12	20.07	20.15	20.10	3
		25	25	20.09	20.19	20.14	3
		50	0	20.11	20.17	20.13	3
10M	256QAM	1	0	18.17	18.33	18.24	5
		1	24	18.21	18.27	18.23	5
		1	49	18.15	18.26	18.21	5
		25	0	18.01	18.16	18.04	5
		25	12	17.98	18.15	18.04	5
		25	25	18.03	18.13	18.12	5
		50	0	18.06	18.18	18.12	5
BW	MCS Index	Channel		20425	20525	20625	3GPP MPR
Frequency (MHz)		826.5	836.5	846.5			
5M	QPSK	1	0	23.09	23.21	23.10	0
		1	12	23.05	23.17	23.02	0
		1	24	22.88	22.95	22.85	0
		12	0	22.00	22.12	22.12	1
		12	6	22.04	22.09	22.01	1
		12	13	22.02	22.14	22.00	1
		25	0	22.07	22.15	22.06	1
5M	16QAM	1	0	22.32	22.49	22.40	1
		1	12	22.32	22.42	22.33	1
		1	24	22.35	22.45	22.45	1
		12	0	21.05	21.16	21.14	2
		12	6	21.08	21.12	21.13	2
		12	13	21.08	21.21	21.20	2
		25	0	20.99	21.09	21.02	2
5M	64QAM	1	0	21.32	21.38	21.43	2
		1	12	21.21	21.35	21.22	2
		1	24	21.12	21.23	21.23	2
		12	0	20.00	20.20	20.08	3
		12	6	20.00	20.08	20.05	3
		12	13	20.07	20.14	20.04	3
		25	0	20.01	20.10	20.09	3
5M	256QAM	1	0	18.07	18.28	18.24	5
		1	12	18.18	18.19	18.14	5
		1	24	18.09	18.18	18.15	5
		12	0	17.99	18.12	18.02	5
		12	6	17.90	18.14	17.94	5
		12	13	18.02	18.06	18.09	5
		25	0	18.03	18.15	18.05	5

LTE Conducted Power (Full)							
LTE Band 5							
BW	MCS Index	Channel		20415	20525	20635	3GPP MPR
		Frequency (MHz)		825.5	836.5	847.5	
3M	QPSK	1	0	23.01	23.14	23.03	0
		1	7	22.98	23.15	22.90	0
		1	14	22.84	22.83	22.72	0
		8	0	21.96	22.03	21.97	1
		8	3	21.97	21.95	21.89	1
		8	7	21.91	22.08	21.87	1
		15	0	21.99	22.09	21.93	1
3M	16QAM	1	0	22.30	22.46	22.30	1
		1	7	22.31	22.34	22.30	1
		1	14	22.26	22.31	22.38	1
		8	0	20.93	21.12	21.08	2
		8	3	21.00	20.97	21.04	2
		8	7	20.95	21.14	21.19	2
		15	0	20.93	20.95	20.87	2
3M	64QAM	1	0	21.18	21.24	21.38	2
		1	7	21.13	21.24	21.11	2
		1	14	21.07	21.18	21.15	2
		8	0	19.91	20.13	19.98	3
		8	3	19.96	19.94	19.94	3
		8	7	19.99	20.04	20.02	3
		15	0	19.90	20.04	20.06	3
3M	256QAM	1	0	18.09	18.14	18.11	5
		1	7	18.00	18.17	18.01	5
		1	14	17.97	18.19	18.07	5
		8	0	17.93	17.98	17.99	5
		8	3	17.92	17.94	17.99	5
		8	7	17.95	17.93	17.97	5
		15	0	17.95	17.99	18.07	5
BW	MCS Index	Channel		20407	20525	20643	3GPP MPR
		Frequency (MHz)		824.7	836.5	848.3	
1.4M	QPSK	1	0	22.88	22.99	23.02	0
		1	2	22.83	23.10	22.92	0
		1	5	22.86	22.84	22.77	0
		3	0	22.80	22.93	22.89	0
		3	1	22.90	22.96	22.96	0
		3	3	22.84	23.03	22.93	0
		6	0	21.98	22.18	22.02	1
1.4M	16QAM	1	0	22.39	22.38	22.30	1
		1	2	22.24	22.41	22.27	1
		1	5	22.36	22.41	22.44	1
		3	0	22.07	21.98	22.02	1
		3	1	22.10	22.12	22.07	1
		3	3	21.98	22.18	22.02	1
		6	0	20.82	21.07	20.91	2
1.4M	64QAM	1	0	21.35	21.27	21.31	2
		1	2	21.18	21.31	21.21	2
		1	5	21.02	21.18	21.09	2
		3	0	20.87	21.19	20.97	2
		3	1	21.01	20.94	21.05	2
		3	3	21.00	21.08	20.96	2
		6	0	19.94	20.08	20.10	3
1.4M	256QAM	1	0	18.03	18.24	18.01	5
		1	2	18.14	18.19	17.96	5
		1	5	17.96	18.14	17.92	5
		3	0	17.79	18.08	17.83	5
		3	1	17.87	18.08	17.83	5
		3	3	17.84	18.07	17.95	5
		6	0	17.82	18.07	18.00	5

LTE Conducted Power (Full)							
LTE Band 7							
BW	MCS Index	RB Size	RB Offset	Low	Mid	High	3GPP MPR (dB)
		Channel		20850	21100	21350	
		Frequency (MHz)		2510	2535	2560	
20M	QPSK	1	0	23.01	23.08	23.19	0
		1	50	22.99	23.06	23.15	0
		1	99	22.98	23.01	23.05	0
		50	0	22.35	22.42	22.48	1
		50	25	22.22	22.27	22.35	1
		50	50	22.18	22.18	22.25	1
		100	0	22.21	22.23	22.31	1
20M	16QAM	1	0	22.51	22.54	22.55	1
		1	50	22.34	22.37	22.39	1
		1	99	21.88	21.92	22.02	1
		50	0	21.42	21.42	21.42	2
		50	25	21.26	21.36	21.46	2
		50	50	21.08	21.16	21.23	2
		100	0	21.12	21.12	21.16	2
20M	64QAM	1	0	21.23	21.29	21.35	2
		1	50	21.38	21.42	21.46	2
		1	99	21.20	21.28	21.32	2
		50	0	20.18	20.26	20.33	3
		50	25	20.26	20.30	20.34	3
		50	50	20.18	20.18	20.22	3
		100	0	20.20	20.20	20.26	3
20M	256QAM	1	0	18.13	18.19	18.26	5
		1	50	18.23	18.30	18.32	5
		1	99	18.17	18.19	18.26	5
		50	0	18.22	18.26	18.29	5
		50	25	18.14	18.23	18.22	5
		50	50	18.17	18.22	18.23	5
		100	0	18.15	18.25	18.26	5
BW	MCS Index	Channel		20825	21100	21375	3GPP MPR
Frequency (MHz)		2507.5	2535	2562.5			
15M	QPSK	1	0	22.96	23.08	23.15	0
		1	37	22.91	23.01	23.13	0
		1	74	22.94	22.95	23.05	0
		36	0	22.27	22.36	22.46	1
		36	19	22.22	22.17	22.35	1
		36	39	22.09	22.13	22.23	1
		75	0	22.21	22.21	22.24	1
15M	16QAM	1	0	22.51	22.49	22.46	1
		1	37	22.27	22.35	22.35	1
		1	74	21.83	21.84	21.93	1
		36	0	21.32	21.35	21.37	2
		36	19	21.16	21.27	21.40	2
		36	39	21.06	21.15	21.23	2
		75	0	21.12	21.08	21.12	2
15M	64QAM	1	0	21.15	21.20	21.29	2
		1	37	21.34	21.39	21.38	2
		1	74	21.12	21.20	21.32	2
		36	0	20.12	20.18	20.28	3
		36	19	20.25	20.28	20.27	3
		36	39	20.15	20.12	20.18	3
		75	0	20.13	20.18	20.25	3
15M	256QAM	1	0	18.06	18.11	18.19	5
		1	37	18.15	18.30	18.24	5
		1	74	18.09	18.14	18.18	5
		36	0	18.15	18.20	18.19	5
		36	19	18.07	18.19	18.22	5
		36	39	18.11	18.17	18.14	5
		75	0	18.14	18.15	18.19	5

LTE Conducted Power (Full)							
LTE Band 7							
BW	MCS Index	Channel		20800	21100	21400	3GPP MPR
		Frequency (MHz)		2505	2535	2565	
10M	QPSK	1	0	22.83	23.05	23.02	0
		1	24	22.81	22.87	23.06	0
		1	49	22.89	22.95	22.92	0
		25	0	22.22	22.34	22.34	1
		25	12	22.09	22.13	22.27	1
		25	25	22.05	22.10	22.13	1
		50	0	22.13	22.13	22.09	1
10M	16QAM	1	0	22.45	22.41	22.35	1
		1	24	22.18	22.26	22.28	1
		1	49	21.68	21.78	21.84	1
		25	0	21.30	21.32	21.31	2
		25	12	21.12	21.24	21.38	2
		25	25	20.97	21.12	21.09	2
		50	0	21.03	21.03	21.04	2
10M	64QAM	1	0	21.13	21.05	21.14	2
		1	24	21.31	21.28	21.34	2
		1	49	20.99	21.13	21.24	2
		25	0	20.00	20.09	20.15	3
		25	12	20.11	20.16	20.15	3
		25	25	20.03	20.08	20.08	3
		50	0	20.01	20.14	20.13	3
10M	256QAM	1	0	18.07	18.09	18.06	5
		1	24	18.07	18.07	18.25	5
		1	49	17.98	18.16	18.14	5
		25	0	18.11	18.09	18.18	5
		25	12	18.05	18.13	18.17	5
		25	25	17.96	18.12	18.11	5
		50	0	17.95	18.09	18.05	5
BW	MCS Index	Channel		20775	21100	21425	3GPP MPR
		Frequency (MHz)		2502.5	2535	2567.5	
5M	QPSK	1	0	22.86	22.93	22.96	0
		1	12	22.84	22.88	23.04	0
		1	24	22.93	22.86	22.82	0
		12	0	22.16	22.32	22.21	1
		12	6	22.11	22.16	22.23	1
		12	13	22.06	22.10	22.04	1
		25	0	22.21	22.19	22.01	1
5M	16QAM	1	0	22.37	22.40	22.40	1
		1	12	22.21	22.25	22.24	1
		1	24	21.68	21.75	21.91	1
		12	0	21.26	21.34	21.34	2
		12	6	21.15	21.23	21.34	2
		12	13	20.96	21.12	21.16	2
		25	0	21.08	20.95	21.11	2
5M	64QAM	1	0	21.00	21.15	21.25	2
		1	12	21.25	21.30	21.25	2
		1	24	20.98	21.05	21.28	2
		12	0	20.12	20.16	20.17	3
		12	6	20.11	20.28	20.22	3
		12	13	20.05	20.09	20.06	3
		25	0	20.08	20.16	20.25	3
5M	256QAM	1	0	18.04	17.97	18.01	5
		1	12	18.12	18.10	18.05	5
		1	24	18.02	18.02	17.99	5
		12	0	18.22	18.07	18.21	5
		12	6	18.01	18.08	18.08	5
		12	13	18.01	18.09	18.01	5
		25	0	18.11	18.10	18.16	5

LTE Conducted Power (Full)							
LTE Band 12							
BW	MCS Index	RB Size	RB Offset	Low	Mid	High	3GPP MPR (dB)
		Channel		23060	23095	23130	
		Frequency (MHz)		704	707.5	711	
10M	QPSK	1	0	22.93	22.85	23.07	0
		1	24	22.89	22.82	22.91	0
		1	49	22.74	22.65	22.81	0
		25	0	22.23	22.18	22.32	1
		25	12	22.19	22.12	22.29	1
		25	25	22.18	22.12	22.23	1
		50	0	22.21	22.17	22.29	1
10M	16QAM	1	0	22.54	22.50	22.61	1
		1	24	22.34	22.28	22.44	1
		1	49	22.43	22.37	22.45	1
		25	0	21.26	21.19	21.33	2
		25	12	21.25	21.22	21.31	2
		25	25	21.23	21.18	21.29	2
		50	0	21.15	21.07	21.18	2
10M	64QAM	1	0	21.49	21.44	21.52	2
		1	24	21.41	21.33	21.48	2
		1	49	21.40	21.31	21.42	2
		25	0	20.30	20.30	20.31	3
		25	12	20.21	20.11	20.25	3
		25	25	20.13	20.07	20.22	3
		50	0	20.28	20.26	20.28	3
10M	256QAM	1	0	18.30	18.29	18.39	5
		1	24	18.32	18.22	18.41	5
		1	49	18.25	18.19	18.29	5
		25	0	18.13	18.09	18.22	5
		25	12	18.31	18.26	18.31	5
		25	25	18.12	18.03	18.19	5
		50	0	18.18	18.18	18.22	5
BW	MCS Index	Channel		23035	23095	23155	3GPP MPR
Frequency (MHz)		701.5	707.5	713.5			
5M	QPSK	1	0	22.91	22.78	23.06	0
		1	12	22.88	22.80	22.86	0
		1	24	22.70	22.65	22.76	0
		12	0	22.23	22.12	22.28	1
		12	6	22.11	22.09	22.26	1
		12	13	22.16	22.02	22.13	1
		25	0	22.21	22.11	22.27	1
5M	16QAM	1	0	22.52	22.46	22.51	1
		1	12	22.26	22.22	22.37	1
		1	24	22.34	22.36	22.43	1
		12	0	21.17	21.13	21.26	2
		12	6	21.19	21.20	21.25	2
		12	13	21.15	21.10	21.25	2
		25	0	21.12	20.98	21.13	2
5M	64QAM	1	0	21.46	21.41	21.42	2
		1	12	21.31	21.23	21.39	2
		1	24	21.36	21.23	21.33	2
		12	0	20.27	20.27	20.27	3
		12	6	20.21	20.09	20.22	3
		12	13	20.10	20.05	20.16	3
		25	0	20.28	20.26	20.22	3
5M	256QAM	1	0	18.28	18.24	18.34	5
		1	12	18.26	18.22	18.37	5
		1	24	18.17	18.16	18.22	5
		12	0	18.04	18.00	18.15	5
		12	6	18.21	18.25	18.27	5
		12	13	18.10	17.96	18.14	5
		25	0	18.16	18.11	18.14	5

LTE Conducted Power (Full)							
LTE Band 12							
BW	MCS Index	Channel		23025	23095	23165	3GPP MPR
		Frequency (MHz)		700.5	707.5	714.5	
3M	QPSK	1	0	22.87	22.67	22.94	0
		1	7	22.88	22.69	22.75	0
		1	14	22.64	22.57	22.68	0
		8	0	22.10	22.04	22.22	1
		8	3	22.04	22.02	22.16	1
		8	7	22.03	22.00	22.12	1
		15	0	22.19	21.97	22.26	1
3M	16QAM	1	0	22.46	22.37	22.47	1
		1	7	22.22	22.17	22.30	1
		1	14	22.24	22.34	22.31	1
		8	0	21.13	21.00	21.14	2
		8	3	21.08	21.09	21.10	2
		8	7	21.02	20.97	21.14	2
		15	0	21.12	20.83	21.05	2
3M	64QAM	1	0	21.40	21.27	21.32	2
		1	7	21.19	21.08	21.31	2
		1	14	21.34	21.09	21.28	2
		8	0	20.20	20.22	20.17	3
		8	3	20.09	19.96	20.07	3
		8	7	20.10	19.93	20.11	3
		15	0	20.27	20.25	20.07	3
3M	256QAM	1	0	18.15	18.15	18.27	5
		1	7	18.22	18.13	18.37	5
		1	14	18.14	18.15	18.14	5
		8	0	17.93	17.93	18.07	5
		8	3	18.14	18.26	18.26	5
		8	7	18.05	17.92	18.00	5
		15	0	18.07	18.04	18.07	5
BW	MCS Index	Channel		23017	23095	23173	3GPP MPR
		Frequency (MHz)		699.7	707.5	715.3	
1.4M	QPSK	1	0	22.81	22.70	22.90	0
		1	2	22.69	22.74	22.75	0
		1	5	22.72	22.59	22.69	0
		3	0	23.05	23.03	23.03	0
		3	1	23.01	22.89	23.05	0
		3	3	22.90	22.95	23.02	0
		6	0	22.13	22.04	22.18	1
1.4M	16QAM	1	0	22.40	22.31	22.52	1
		1	2	22.22	22.16	22.32	1
		1	5	22.35	22.27	22.21	1
		3	0	22.04	22.15	22.18	1
		3	1	22.05	22.15	22.17	1
		3	3	22.03	22.06	22.12	1
		6	0	20.98	20.97	21.01	2
1.4M	64QAM	1	0	21.36	21.27	21.32	2
		1	2	21.29	21.25	21.29	2
		1	5	21.26	21.15	21.28	2
		3	0	21.15	21.15	21.16	2
		3	1	21.01	20.90	21.08	2
		3	3	21.01	20.89	21.20	2
		6	0	20.11	20.19	20.06	3
1.4M	256QAM	1	0	18.20	18.17	18.26	5
		1	2	18.27	18.01	18.17	5
		1	5	18.21	17.98	18.06	5
		3	0	17.94	17.93	18.11	5
		3	1	18.10	18.10	18.02	5
		3	3	18.02	17.94	17.94	5
		6	0	18.07	17.97	17.88	5

LTE Conducted Power (Full)							
LTE Band 13							
BW	MCS Index	RB Size	RB Offset	Mid		3GPP MPR (dB)	
		Channel		23230			
		Frequency (MHz)		782			
10M	QPSK	1	0		23.08		0
		1	24		23.06		0
		1	49		22.91		0
		25	0		22.03		1
		25	12		22.01		1
		25	25		21.95		1
		50	0		22.06		1
10M	16QAM	1	0		22.12		1
		1	24		21.96		1
		1	49		21.81		1
		25	0		21.02		2
		25	12		21.06		2
		25	25		21.05		2
		50	0		21.03		2
10M	64QAM	1	0		21.24		2
		1	24		21.19		2
		1	49		21.11		2
		25	0		19.98		3
		25	12		20.03		3
		25	25		19.97		3
		50	0		20.05		3
10M	256QAM	1	0		18.18		5
		1	24		18.26		5
		1	49		18.03		5
		25	0		17.92		5
		25	12		17.98		5
		25	25		17.95		5
		50	0		18.01		5
BW	MCS Index	Channel		23205	23230	23255	3GPP MPR
Frequency (MHz)		779.5	782	784.5			
5M	QPSK	1	0	23.05	23.07	23.06	0
		1	12	22.86	22.99	22.96	0
		1	24	22.73	22.82	22.79	0
		12	0	21.86	21.94	21.91	1
		12	6	21.83	21.91	21.84	1
		12	13	21.81	21.91	21.86	1
		25	0	21.88	21.98	21.90	1
5M	16QAM	1	0	21.97	22.08	22.00	1
		1	12	21.87	21.91	21.91	1
		1	24	21.53	21.72	21.63	1
		12	0	20.78	20.95	20.85	2
		12	6	20.84	21.03	20.94	2
		12	13	20.94	21.04	21.04	2
		25	0	20.93	21.01	20.97	2
5M	64QAM	1	0	21.10	21.20	21.13	2
		1	12	21.00	21.11	21.10	2
		1	24	20.93	21.03	20.94	2
		12	0	19.81	19.93	19.85	3
		12	6	19.87	19.95	19.92	3
		12	13	19.78	19.94	19.85	3
		25	0	19.89	20.03	19.94	3
5M	256QAM	1	0	18.13	18.12	18.15	5
		1	12	18.16	18.25	18.12	5
		1	24	17.91	17.94	17.90	5
		12	0	17.81	17.84	17.86	5
		12	6	17.90	17.95	17.91	5
		12	13	17.76	17.89	17.86	5
		25	0	17.84	17.99	17.92	5

LTE Conducted Power (Full)							
LTE Band 14							
BW	MCS Index	RB Size	RB Offset	Channel		Mid	3GPP MPR (dB)
		Channel			23330		
		Frequency (MHz)			793		
10M	QPSK	1	0		23.04		0
		1	24		22.98		0
		1	49		22.89		0
		25	0		22.03		1
		25	12		22.01		1
		25	25		22.97		1
		50	0		21.98		1
10M	16QAM	1	0		22.28		1
		1	24		22.42		1
		1	49		22.19		1
		25	0		20.99		2
		25	12		20.96		2
		25	25		21.02		2
		50	0		20.99		2
10M	64QAM	1	0		21.22		2
		1	24		21.18		2
		1	49		21.12		2
		25	0		19.98		3
		25	12		20.03		3
		25	25		19.98		3
		50	0		19.95		3
10M	256QAM	1	0		18.11		5
		1	24		18.08		5
		1	49		17.99		5
		25	0		18.01		5
		25	12		17.94		5
		25	25		17.98		5
		50	0		17.95		5
BW	MCS Index	Channel		23305	23330	23355	3GPP MPR
Frequency (MHz)			790.5	793	795.5		
5M	QPSK	1	0	23.01	23.02	22.99	0
		1	12	22.92	22.95	22.91	0
		1	24	22.78	22.88	22.75	0
		12	0	21.90	21.95	21.85	1
		12	6	21.86	21.95	21.77	1
		12	13	22.93	22.97	22.85	1
		25	0	21.85	21.90	21.78	1
5M	16QAM	1	0	22.16	22.25	22.10	1
		1	12	22.35	22.37	22.32	1
		1	24	22.07	22.14	22.06	1
		12	0	20.91	20.92	20.90	2
		12	6	20.87	20.94	20.84	2
		12	13	20.83	20.92	20.83	2
		25	0	20.88	20.93	20.83	2
5M	64QAM	1	0	21.11	21.13	21.07	2
		1	12	21.08	21.13	20.98	2
		1	24	21.01	21.09	20.91	2
		12	0	19.91	19.93	19.90	3
		12	6	20.02	20.02	19.96	3
		12	13	19.89	19.95	19.84	3
		25	0	19.85	19.89	19.78	3
5M	256QAM	1	0	18.04	18.10	17.99	5
		1	12	17.94	17.99	17.87	5
		1	24	17.83	17.91	17.84	5
		12	0	17.87	17.92	17.78	5
		12	6	17.83	17.88	17.77	5
		12	13	17.88	17.96	17.81	5
		25	0	17.88	17.91	17.79	5

LTE Conducted Power (Full)							
LTE Band 17							
BW	MCS Index	RB Size	RB Offset	Low	Mid	High	3GPP MPR (dB)
		Channel		23780	23790	23800	
		Frequency (MHz)		709	710	711	
10M	QPSK	1	0	22.91	23.01	22.95	0
		1	24	22.82	22.92	22.91	0
		1	49	22.70	22.81	22.80	0
		25	0	22.22	22.38	22.31	1
		25	12	22.19	22.35	22.26	1
		25	25	22.23	22.33	22.26	1
		50	0	22.34	22.36	22.35	1
10M	16QAM	1	0	22.18	22.25	22.24	1
		1	24	22.07	22.26	22.17	1
		1	49	22.07	22.14	22.11	1
		25	0	21.34	21.35	21.35	2
		25	12	21.25	21.36	21.26	2
		25	25	21.20	21.33	21.26	2
		50	0	21.38	21.39	21.38	2
10M	64QAM	1	0	21.39	21.55	21.49	2
		1	24	21.43	21.44	21.44	2
		1	49	21.40	21.46	21.41	2
		25	0	20.18	20.32	20.23	3
		25	12	20.26	20.35	20.30	3
		25	25	20.20	20.33	20.29	3
		50	0	20.22	20.36	20.31	3
10M	256QAM	1	0	18.43	18.52	18.46	5
		1	24	18.45	18.51	18.50	5
		1	49	18.26	18.35	18.33	5
		25	0	18.11	18.29	18.19	5
		25	12	18.26	18.32	18.28	5
		25	25	18.09	18.22	18.17	5
		50	0	18.32	18.35	18.32	5
BW	MCS Index	Channel		23755	23790	23825	3GPP MPR
Frequency (MHz)		706.5	710	713.5			
5M	QPSK	1	0	22.82	22.96	22.85	0
		1	12	22.73	22.87	22.90	0
		1	24	22.65	22.81	22.71	0
		12	0	22.13	22.31	22.30	1
		12	6	22.18	22.32	22.18	1
		12	13	22.15	22.31	22.22	1
		25	0	22.30	22.30	22.26	1
5M	16QAM	1	0	22.14	22.17	22.14	1
		1	12	21.98	22.20	22.10	1
		1	24	22.05	22.14	22.11	1
		12	0	21.34	21.31	21.32	2
		12	6	21.23	21.26	21.19	2
		12	13	21.17	21.31	21.18	2
		25	0	21.34	21.35	21.33	2
5M	64QAM	1	0	21.36	21.54	21.39	2
		1	12	21.35	21.42	21.34	2
		1	24	21.39	21.45	21.32	2
		12	0	20.08	20.32	20.20	3
		12	6	20.19	20.26	20.21	3
		12	13	20.17	20.33	20.21	3
		25	0	20.19	20.36	20.29	3
5M	256QAM	1	0	18.37	18.48	18.42	5
		1	12	18.41	18.44	18.48	5
		1	24	18.21	18.26	18.31	5
		12	0	18.10	18.20	18.10	5
		12	6	18.25	18.28	18.24	5
		12	13	18.04	18.17	18.10	5
		25	0	18.29	18.30	18.24	5

LTE Conducted Power (Full)							
LTE Band 25							
BW	MCS Index	RB Size	RB Offset	Low	Mid	High	3GPP MPR (dB)
		Channel		26140	26365	26590	
		Frequency (MHz)		1860	1882.5	1905	
20M	QPSK	1	0	22.41	22.49	22.52	0
		1	50	22.33	22.41	22.51	0
		1	99	22.32	22.35	22.35	0
		50	0	21.53	21.59	21.61	1
		50	25	21.43	21.48	21.55	1
		50	50	21.35	21.42	21.52	1
		100	0	21.33	21.37	21.45	1
20M	16QAM	1	0	21.65	21.65	21.73	1
		1	50	21.58	21.64	21.68	1
		1	99	21.17	21.20	21.28	1
		50	0	20.40	20.45	20.47	2
		50	25	20.27	20.36	20.44	2
		50	50	20.38	20.40	20.42	2
		100	0	20.27	20.37	20.41	2
20M	64QAM	1	0	20.50	20.59	20.64	2
		1	50	20.57	20.59	20.62	2
		1	99	20.35	20.42	20.43	2
		50	0	19.42	19.47	19.49	3
		50	25	19.29	19.35	19.44	3
		50	50	19.30	19.32	19.41	3
		100	0	19.39	19.40	19.45	3
20M	256QAM	1	0	17.74	17.78	17.88	5
		1	50	17.73	17.77	17.81	5
		1	99	17.68	17.76	17.77	5
		50	0	17.77	17.84	17.87	5
		50	25	17.75	17.78	17.84	5
		50	50	17.73	17.79	17.82	5
		100	0	17.80	17.87	17.89	5
BW	MCS Index	Channel		26115	26365	26615	3GPP MPR
Frequency (MHz)		1857.5	1882.5	1907.5			
15M	QPSK	1	0	22.38	22.47	22.44	0
		1	37	22.25	22.35	22.50	0
		1	74	22.25	22.32	22.34	0
		36	0	21.51	21.55	21.55	1
		36	19	21.38	21.38	21.51	1
		36	39	21.27	21.39	21.52	1
		75	0	21.31	21.30	21.45	1
15M	16QAM	1	0	21.58	21.56	21.71	1
		1	37	21.53	21.64	21.60	1
		1	74	21.10	21.13	21.20	1
		36	0	20.37	20.41	20.47	2
		36	19	20.20	20.32	20.37	2
		36	39	20.31	20.38	20.36	2
		75	0	20.26	20.37	20.31	2
15M	64QAM	1	0	20.44	20.56	20.59	2
		1	37	20.47	20.57	20.61	2
		1	74	20.26	20.40	20.41	2
		36	0	19.41	19.45	19.40	3
		36	19	19.24	19.26	19.36	3
		36	39	19.26	19.24	19.37	3
		75	0	19.39	19.40	19.42	3
15M	256QAM	1	0	17.72	17.70	17.81	5
		1	37	17.67	17.72	17.73	5
		1	74	17.64	17.69	17.70	5
		36	0	17.69	17.80	17.86	5
		36	19	17.74	17.70	17.77	5
		36	39	17.73	17.75	17.82	5
		75	0	17.71	17.87	17.79	5

LTE Conducted Power (Full)							
LTE Band 25							
BW	MCS Index	Channel		26090	26365	26640	3GPP MPR
		Frequency (MHz)		1855	1882.5	1910	
10M	QPSK	1	0	22.31	22.42	22.31	0
		1	24	22.15	22.32	22.40	0
		1	49	22.13	22.13	22.30	0
		25	0	21.43	21.40	21.40	1
		25	12	21.25	21.36	21.34	1
		25	25	21.32	21.23	21.49	1
		50	0	21.19	21.20	21.32	1
10M	16QAM	1	0	21.55	21.54	21.65	1
		1	24	21.49	21.50	21.51	1
		1	49	21.08	21.10	21.26	1
		25	0	20.28	20.36	20.37	2
		25	12	20.12	20.11	20.22	2
		25	25	20.26	20.26	20.37	2
		50	0	20.18	20.23	20.23	2
10M	64QAM	1	0	20.46	20.38	20.49	2
		1	24	20.49	20.56	20.42	2
		1	49	20.17	20.35	20.20	2
		25	0	19.23	19.33	19.33	3
		25	12	19.15	19.12	19.39	3
		25	25	19.19	19.13	19.25	3
		50	0	19.16	19.37	19.31	3
10M	256QAM	1	0	17.59	17.68	17.70	5
		1	24	17.59	17.71	17.64	5
		1	49	17.58	17.62	17.59	5
		25	0	17.59	17.66	17.80	5
		25	12	17.59	17.67	17.60	5
		25	25	17.65	17.61	17.62	5
		50	0	17.65	17.74	17.73	5
BW	MCS Index	Channel		26065	26365	26665	3GPP MPR
		Frequency (MHz)		1852.5	1882.5	1912.5	
5M	QPSK	1	0	22.29	22.40	22.31	0
		1	12	22.19	22.29	22.12	0
		1	24	22.10	22.16	22.16	0
		12	0	21.45	21.53	21.35	1
		12	6	21.38	21.35	21.34	1
		12	13	21.28	21.32	21.22	1
		25	0	21.23	21.22	21.29	1
5M	16QAM	1	0	21.56	21.52	21.67	1
		1	12	21.48	21.42	21.51	1
		1	24	21.07	21.02	21.20	1
		12	0	20.26	20.39	20.41	2
		12	6	20.13	20.35	20.30	2
		12	13	20.22	20.25	20.30	2
		25	0	20.11	20.23	20.26	2
5M	64QAM	1	0	20.34	20.53	20.45	2
		1	12	20.33	20.43	20.42	2
		1	24	20.13	20.33	20.23	2
		12	0	19.25	19.32	19.27	3
		12	6	19.20	19.24	19.37	3
		12	13	19.16	19.14	19.24	3
		25	0	19.31	19.25	19.30	3
5M	256QAM	1	0	17.56	17.58	17.57	5
		1	12	17.59	17.60	17.50	5
		1	24	17.65	17.69	17.54	5
		12	0	17.66	17.62	17.76	5
		12	6	17.71	17.61	17.57	5
		12	13	17.60	17.65	17.54	5
		25	0	17.76	17.86	17.56	5

LTE Conducted Power (Full)							
LTE Band 25							
BW	MCS Index	Channel		26055	26365	26675	3GPP MPR
		Frequency (MHz)		1851.5	1882.5	1913.5	
3M	QPSK	1	0	22.28	22.24	22.51	0
		1	7	22.26	22.28	22.33	0
		1	14	22.07	22.23	22.28	0
		8	0	21.42	21.49	21.47	1
		8	3	21.33	21.41	21.41	1
		8	7	21.28	21.30	21.40	1
		15	0	21.22	21.23	21.31	1
3M	16QAM	1	0	21.50	21.54	21.64	1
		1	7	21.50	21.46	21.46	1
		1	14	21.10	21.07	21.16	1
		8	0	20.33	20.24	20.38	2
		8	3	20.08	20.23	20.32	2
		8	7	20.30	20.26	20.36	2
		15	0	20.18	20.23	20.19	2
3M	64QAM	1	0	20.45	20.48	20.46	2
		1	7	20.54	20.43	20.39	2
		1	14	20.15	20.30	20.34	2
		8	0	19.36	19.31	19.36	3
		8	3	19.22	19.15	19.31	3
		8	7	19.25	19.31	19.27	3
		15	0	19.21	19.27	19.33	3
3M	256QAM	1	0	17.57	17.70	17.71	5
		1	7	17.49	17.65	17.74	5
		1	14	17.55	17.66	17.68	5
		8	0	17.57	17.74	17.77	5
		8	3	17.59	17.72	17.73	5
		8	7	17.53	17.66	17.67	5
		15	0	17.57	17.74	17.74	5
BW	MCS Index	Channel		26047	26365	26683	3GPP MPR
		Frequency (MHz)		1850.7	1882.5	1914.3	
1.4M	QPSK	1	0	22.31	22.40	22.31	0
		1	2	22.16	22.26	22.42	0
		1	5	22.21	22.21	22.26	0
		3	0	22.38	22.37	22.41	0
		3	1	22.30	22.40	22.42	0
		3	3	22.28	22.27	22.46	0
		6	0	21.32	21.19	21.40	1
1.4M	16QAM	1	0	21.55	21.57	21.65	1
		1	2	21.40	21.53	21.68	1
		1	5	21.05	21.08	21.18	1
		3	0	21.24	21.36	21.30	1
		3	1	21.08	21.16	21.25	1
		3	3	21.22	21.36	21.28	1
		6	0	20.11	20.23	20.28	2
1.4M	64QAM	1	0	20.34	20.49	20.51	2
		1	2	20.48	20.44	20.54	2
		1	5	20.24	20.23	20.35	2
		3	0	20.34	20.38	20.41	2
		3	1	20.13	20.25	20.24	2
		3	3	20.13	20.30	20.29	2
		6	0	19.24	19.30	19.37	3
1.4M	256QAM	1	0	17.59	17.72	17.81	5
		1	2	17.69	17.62	17.62	5
		1	5	17.53	17.61	17.62	5
		3	0	17.60	17.76	17.77	5
		3	1	17.69	17.68	17.78	5
		3	3	17.58	17.68	17.74	5
		6	0	17.69	17.87	17.72	5

LTE Conducted Power (Full)							
LTE Band 26							
BW	MCS Index	RB Size	RB Offset	Low	Mid	High	3GPP MPR (dB)
		Channel		26765	26865	26965	
		Frequency (MHz)		821.5	831.5	841.5	
15M	QPSK	1	0	23.09	23.08	23.15	0
		1	37	23.07	23.01	23.08	0
		1	74	22.93	22.84	23.02	0
		36	0	22.19	22.11	22.25	1
		36	19	22.15	22.09	22.23	1
		36	39	22.11	22.06	22.21	1
		75	0	22.18	22.15	22.22	1
15M	16QAM	1	0	22.49	22.48	22.56	1
		1	37	22.55	22.53	22.55	1
		1	74	22.47	22.47	22.53	1
		36	0	21.25	21.17	21.32	2
		36	19	21.17	21.13	21.26	2
		36	39	21.19	21.18	21.25	2
		75	0	21.15	21.10	21.22	2
15M	64QAM	1	0	21.44	21.43	21.45	2
		1	37	21.32	21.31	21.38	2
		1	74	21.32	21.32	21.39	2
		36	0	20.22	20.17	20.29	3
		36	19	20.26	20.21	20.27	3
		36	39	20.23	20.20	20.23	3
		75	0	20.18	20.15	20.22	3
15M	256QAM	1	0	18.47	18.41	18.52	5
		1	37	18.45	18.39	18.51	5
		1	74	18.50	18.44	18.53	5
		36	0	18.41	18.34	18.49	5
		36	19	18.43	18.34	18.48	5
		36	39	18.38	18.37	18.46	5
		75	0	18.40	18.37	18.41	5
BW	MCS Index	Channel		26740	26865	26990	3GPP MPR
Frequency (MHz)		819	831.5	844			
10M	QPSK	1	0	22.99	23.03	23.11	0
		1	24	23.05	22.99	23.08	0
		1	49	22.86	22.74	22.93	0
		25	0	22.19	22.02	22.19	1
		25	12	22.11	22.03	22.15	1
		25	25	22.04	22.02	22.21	1
		50	0	22.17	22.10	22.21	1
10M	16QAM	1	0	22.47	22.39	22.51	1
		1	24	22.51	22.52	22.45	1
		1	49	22.41	22.46	22.43	1
		25	0	21.16	21.10	21.26	2
		25	12	21.12	21.12	21.25	2
		25	25	21.15	21.18	21.24	2
		50	0	21.15	21.01	21.21	2
10M	64QAM	1	0	21.43	21.38	21.37	2
		1	24	21.31	21.31	21.36	2
		1	49	21.27	21.32	21.30	2
		25	0	20.14	20.14	20.19	3
		25	12	20.22	20.13	20.17	3
		25	25	20.22	20.12	20.22	3
		50	0	20.11	20.13	20.20	3
10M	256QAM	1	0	18.41	18.32	18.42	5
		1	24	18.35	18.33	18.51	5
		1	49	18.47	18.40	18.50	5
		25	0	18.35	18.30	18.49	5
		25	12	18.40	18.31	18.42	5
		25	25	18.30	18.36	18.44	5
		50	0	18.35	18.37	18.40	5

LTE Conducted Power (Full)							
LTE Band 26							
BW	MCS Index	Channel		26715	26865	27015	3GPP MPR
		Frequency (MHz)		816.5	831.5	846.5	
5M	QPSK	1	0	22.96	22.97	23.07	0
		1	12	22.97	22.87	22.97	0
		1	24	22.83	22.66	22.81	0
		12	0	22.17	21.97	22.09	1
		12	6	21.96	21.99	22.03	1
		12	13	22.01	22.01	22.06	1
		25	0	22.11	22.04	22.17	1
5M	16QAM	1	0	22.37	22.24	22.46	1
		1	12	22.47	22.40	22.37	1
		1	24	22.28	22.36	22.43	1
		12	0	21.15	21.05	21.11	2
		12	6	21.00	21.02	21.22	2
		12	13	21.07	21.14	21.24	2
		25	0	21.03	20.95	21.20	2
5M	64QAM	1	0	21.37	21.25	21.23	2
		1	12	21.27	21.31	21.30	2
		1	24	21.21	21.29	21.20	2
		12	0	20.14	20.10	20.09	3
		12	6	20.09	20.06	20.03	3
		12	13	20.21	20.05	20.09	3
		25	0	20.03	20.09	20.14	3
5M	256QAM	1	0	18.45	18.17	18.45	5
		1	12	18.31	18.22	18.40	5
		1	24	18.35	18.32	18.44	5
		12	0	18.25	18.25	18.37	5
		12	6	18.31	18.26	18.39	5
		12	13	18.27	18.25	18.34	5
		25	0	18.20	18.35	18.27	5
BW	MCS Index	Channel		26705	26865	27025	3GPP MPR
		Frequency (MHz)		815.5	831.5	847.5	
3M	QPSK	1	0	22.93	22.93	22.99	0
		1	7	23.00	22.85	22.91	0
		1	14	22.83	22.74	22.78	0
		8	0	22.08	21.97	22.01	1
		8	3	22.08	22.01	21.94	1
		8	7	21.97	21.98	21.95	1
		15	0	22.17	21.95	22.16	1
3M	16QAM	1	0	22.32	22.33	22.49	1
		1	7	22.48	22.47	22.44	1
		1	14	22.26	22.41	22.29	1
		8	0	21.03	21.02	21.25	2
		8	3	21.12	21.08	21.13	2
		8	7	21.02	21.18	21.14	2
		15	0	21.04	20.94	21.11	2
3M	64QAM	1	0	21.35	21.27	21.35	2
		1	7	21.23	21.23	21.35	2
		1	14	21.25	21.28	21.26	2
		8	0	20.12	20.05	20.10	3
		8	3	20.12	20.05	20.05	3
		8	7	20.16	19.98	20.07	3
		15	0	20.06	20.00	20.17	3
3M	256QAM	1	0	18.30	18.24	18.38	5
		1	7	18.42	18.18	18.31	5
		1	14	18.44	18.29	18.24	5
		8	0	18.21	18.34	18.17	5
		8	3	18.22	18.34	18.22	5
		8	7	18.30	18.18	18.19	5
		15	0	18.31	18.26	18.30	5

LTE Conducted Power (Full)							
LTE Band 26							
BW	MCS Index	Channel		26697	26865	27033	3GPP MPR
		Frequency (MHz)		814.7	831.5	848.3	
1.4M	QPSK	1	0	22.94	23.02	23.02	0
		1	2	22.95	22.88	23.05	0
		1	5	22.72	22.59	22.89	0
		3	0	23.09	22.96	23.13	0
		3	1	23.05	22.89	23.04	0
		3	3	22.90	22.94	23.12	0
		6	0	22.13	21.97	22.11	1
1.4M	16QAM	1	0	22.43	22.36	22.36	1
		1	2	22.36	22.48	22.31	1
		1	5	22.27	22.44	22.32	1
		3	0	22.11	22.05	22.20	1
		3	1	21.97	22.00	22.25	1
		3	3	22.14	22.03	22.10	1
		6	0	21.05	20.88	21.08	2
1.4M	64QAM	1	0	21.40	21.34	21.28	2
		1	2	21.28	21.23	21.34	2
		1	5	21.15	21.29	21.18	2
		3	0	21.00	21.08	21.17	2
		3	1	21.09	20.98	21.08	2
		3	3	21.18	20.98	21.07	2
		6	0	20.01	20.00	20.06	3
1.4M	256QAM	1	0	18.30	18.35	18.45	5
		1	2	18.20	18.26	18.43	5
		1	5	18.43	18.36	18.38	5
		3	0	18.31	18.15	18.36	5
		3	1	18.40	18.15	18.36	5
		3	3	18.36	18.24	18.38	5
		6	0	18.16	18.21	18.22	5

LTE Conducted Power (Full)							
LTE Band 30							
BW	MCS Index	RB Size	RB Offset	Channel		Mid	3GPP MPR (dB)
		Channel			27710		
		Frequency (MHz)			2310		
10M	QPSK	1	0		22.71		0
		1	24		22.68		0
		1	49		22.66		0
		25	0		21.74		1
		25	12		21.61		1
		25	25		21.58		1
		50	0		21.62		1
10M	16QAM	1	0		21.93		1
		1	24		21.96		1
		1	49		21.90		1
		25	0		20.77		2
		25	12		20.69		2
		25	25		20.63		2
		50	0		20.61		2
10M	64QAM	1	0		20.87		2
		1	24		20.81		2
		1	49		20.79		2
		25	0		19.68		3
		25	12		19.63		3
		25	25		19.52		3
		50	0		19.62		3
10M	256QAM	1	0		17.79		5
		1	24		17.66		5
		1	49		17.67		5
		25	0		17.57		5
		25	12		17.61		5
		25	25		17.56		5
		50	0		17.52		5
BW	MCS Index	Channel		27685	27710	27735	3GPP MPR
Frequency (MHz)			2307.5	2310	2312.5		
5M	QPSK	1	0	22.69	22.70	22.58	0
		1	12	22.63	22.68	22.57	0
		1	24	22.61	22.66	22.55	0
		12	0	21.67	21.75	21.67	1
		12	6	21.57	21.61	21.54	1
		12	13	21.56	21.58	21.46	1
		25	0	21.62	21.63	21.52	1
5M	16QAM	1	0	21.83	21.93	21.76	1
		1	12	21.86	21.96	21.84	1
		1	24	21.89	21.90	21.82	1
		12	0	20.71	20.77	20.61	2
		12	6	20.59	20.69	20.49	2
		12	13	20.57	20.63	20.51	2
		25	0	20.56	20.61	20.52	2
5M	64QAM	1	0	20.78	20.87	20.69	2
		1	12	20.78	20.81	20.68	2
		1	24	20.75	20.79	20.72	2
		12	0	19.66	19.68	19.56	3
		12	6	19.53	19.63	19.44	3
		12	13	19.45	19.52	19.40	3
		25	0	19.59	19.62	19.56	3
5M	256QAM	1	0	17.67	17.72	17.58	5
		1	12	17.56	17.60	17.56	5
		1	24	17.52	17.59	17.47	5
		12	0	17.46	17.53	17.39	5
		12	6	17.55	17.54	17.47	5
		12	13	17.47	17.56	17.41	5
		25	0	17.49	17.51	17.46	5

LTE Conducted Power (Full)							
LTE Band 38							
BW	MCS Index	RB Size	RB Offset	Low	Mid	High	3GPP MPR (dB)
		Channel		37850	38000	38150	
		Frequency (MHz)		2580	2595	2610	
20M	QPSK	1	0	23.38	23.29	23.27	0
		1	50	23.36	23.25	23.22	0
		1	99	23.25	23.16	23.12	0
		50	0	22.39	22.23	22.16	1
		50	25	22.38	22.22	22.15	1
		50	50	22.31	22.20	22.13	1
		100	0	22.33	22.15	22.10	1
20M	16QAM	1	0	22.58	22.40	22.30	1
		1	50	22.61	22.49	22.47	1
		1	99	22.44	22.21	22.15	1
		50	0	21.48	21.38	21.34	2
		50	25	21.46	21.40	21.32	2
		50	50	21.39	21.15	21.11	2
		100	0	21.35	21.12	21.02	2
20M	64QAM	1	0	21.33	21.18	21.09	2
		1	50	21.32	21.23	21.21	2
		1	99	21.21	20.96	20.88	2
		50	0	20.46	20.35	20.30	3
		50	25	20.38	20.22	20.20	3
		50	50	20.35	20.24	20.22	3
		100	0	20.33	20.17	20.17	3
20M	256QAM	1	0	18.31	18.22	18.18	5
		1	50	18.39	18.34	18.30	5
		1	99	18.18	18.12	18.10	5
		50	0	18.42	18.39	18.36	5
		50	25	18.39	18.38	18.37	5
		50	50	18.36	18.35	18.34	5
		100	0	18.32	18.29	18.21	5
BW	MCS Index	Channel		37825	38000	38175	3GPP MPR
Frequency (MHz)		2577.5	2595	2612.5			
15M	QPSK	1	0	23.30	23.20	23.23	0
		1	37	23.32	23.25	23.16	0
		1	74	23.21	23.12	23.04	0
		36	0	22.38	22.17	22.16	1
		36	19	22.30	22.12	22.07	1
		36	39	22.23	22.12	22.09	1
		75	0	22.30	22.10	22.10	1
15M	16QAM	1	0	22.53	22.37	22.22	1
		1	37	22.61	22.39	22.47	1
		1	74	22.43	22.14	22.15	1
		36	0	21.38	21.28	21.25	2
		36	19	21.36	21.35	21.24	2
		36	39	21.32	21.14	21.09	2
		75	0	21.35	21.09	20.96	2
15M	64QAM	1	0	21.33	21.17	21.07	2
		1	37	21.30	21.19	21.19	2
		1	74	21.20	20.90	20.78	2
		36	0	20.40	20.26	20.21	3
		36	19	20.35	20.18	20.17	3
		36	39	20.27	20.18	20.18	3
		75	0	20.29	20.17	20.14	3
15M	256QAM	1	0	18.27	18.14	18.15	5
		1	37	18.35	18.24	18.26	5
		1	74	18.08	18.10	18.09	5
		36	0	18.41	18.37	18.31	5
		36	19	18.32	18.32	18.35	5
		36	39	18.31	18.28	18.31	5
		75	0	18.26	18.25	18.12	5

LTE Conducted Power (Full)							
LTE Band 38							
BW	MCS Index	Channel		37800	38000	38200	3GPP MPR
		Frequency (MHz)		2575	2595	2615	
10M	QPSK	1	0	23.30	23.13	23.23	0
		1	24	23.21	23.21	23.02	0
		1	49	23.20	23.02	22.95	0
		25	0	22.37	22.16	22.09	1
		25	12	22.16	22.04	21.93	1
		25	25	22.20	22.07	22.04	1
		50	0	22.21	22.06	22.00	1
10M	16QAM	1	0	22.44	22.23	22.15	1
		1	24	22.59	22.30	22.47	1
		1	49	22.40	21.99	22.02	1
		25	0	21.26	21.20	21.23	2
		25	12	21.35	21.27	21.22	2
		25	25	21.24	20.99	21.00	2
		50	0	21.25	21.01	20.90	2
10M	64QAM	1	0	21.30	21.17	21.05	2
		1	24	21.21	21.12	21.11	2
		1	49	21.08	20.77	20.69	2
		25	0	20.25	20.19	20.19	3
		25	12	20.32	20.06	20.08	3
		25	25	20.21	20.07	20.15	3
		50	0	20.21	20.08	20.03	3
10M	256QAM	1	0	18.11	18.12	18.06	5
		1	24	18.28	18.18	18.20	5
		1	49	18.06	17.97	17.93	5
		25	0	18.40	18.20	18.25	5
		25	12	18.30	18.22	18.33	5
		25	25	18.22	18.22	18.20	5
		50	0	18.28	18.15	17.97	5
BW	MCS Index	Channel		37775	38000	38225	3GPP MPR
		Frequency (MHz)		2572.5	2595	2617.5	
5M	QPSK	1	0	23.21	23.05	23.10	0
		1	12	23.30	23.20	22.90	0
		1	24	23.13	23.07	22.91	0
		12	0	22.36	22.16	21.96	1
		12	6	22.30	22.10	21.92	1
		12	13	22.17	21.97	22.04	1
		25	0	22.24	22.03	21.99	1
5M	16QAM	1	0	22.47	22.31	22.07	1
		1	12	22.48	22.30	22.34	1
		1	24	22.35	22.12	22.09	1
		12	0	21.36	21.24	21.12	2
		12	6	21.35	21.35	21.13	2
		12	13	21.25	21.11	21.06	2
		25	0	21.32	20.97	20.95	2
5M	64QAM	1	0	21.33	21.09	21.03	2
		1	12	21.18	21.19	21.13	2
		1	24	21.10	20.79	20.71	2
		12	0	20.30	20.24	20.12	3
		12	6	20.20	20.12	20.09	3
		12	13	20.12	20.18	20.09	3
		25	0	20.28	20.07	20.14	3
5M	256QAM	1	0	18.24	18.00	18.01	5
		1	12	18.35	18.19	18.14	5
		1	24	18.03	17.94	17.90	5
		12	0	18.23	18.38	18.19	5
		12	6	18.23	18.23	18.05	5
		12	13	18.20	18.30	18.10	5
		25	0	18.15	18.18	18.01	5

LTE Conducted Power (Full)							
LTE Band 40							
BW	MCS Index	RB Size	RB Offset	Low	Mid	Mid	3GPP MPR (dB)
		Channel		38750	39150	39550	
		Frequency (MHz)		2310	2350	2390	
20M	QPSK	1	0	23.33	23.41	23.28	0
		1	50	23.27	23.38	23.25	0
		1	99	23.12	23.18	23.10	0
		50	0	22.36	22.38	22.28	1
		50	25	22.25	22.35	22.20	1
		50	50	22.32	22.33	22.22	1
		100	0	22.25	22.31	22.15	1
20M	16QAM	1	0	22.27	22.36	22.25	1
		1	50	22.34	22.35	22.27	1
		1	99	22.10	22.13	22.10	1
		50	0	21.29	21.33	21.25	2
		50	25	21.28	21.32	21.20	2
		50	50	21.38	21.38	21.38	2
		100	0	21.22	21.32	21.12	2
20M	64QAM	1	0	21.03	21.07	21.01	2
		1	50	20.93	21.03	20.91	2
		1	99	20.80	20.81	20.75	2
		50	0	20.29	20.38	20.26	3
		50	25	20.29	20.36	20.25	3
		50	50	20.33	20.35	20.26	3
		100	0	20.29	20.32	20.27	3
20M	256QAM	1	0	18.17	18.18	18.07	5
		1	50	18.07	18.16	18.01	5
		1	99	17.95	18.02	17.91	5
		50	0	18.34	18.38	18.24	5
		50	25	18.31	18.36	18.28	5
		50	50	18.19	18.29	18.13	5
		100	0	18.24	18.28	18.17	5
BW	MCS Index	Channel		38725	39150	39575	3GPP MPR
Frequency (MHz)		2307.5	2350	2392.5			
15M	QPSK	1	0	23.23	23.39	23.18	0
		1	37	23.19	23.35	23.22	0
		1	74	23.07	23.14	23.03	0
		36	0	22.35	22.29	22.20	1
		36	19	22.15	22.31	22.16	1
		36	39	22.28	22.30	22.17	1
		75	0	22.15	22.23	22.09	1
15M	16QAM	1	0	22.22	22.30	22.25	1
		1	37	22.24	22.34	22.17	1
		1	74	22.01	22.03	22.04	1
		36	0	21.24	21.32	21.25	2
		36	19	21.18	21.23	21.12	2
		36	39	21.37	21.38	21.37	2
		75	0	21.18	21.22	21.11	2
15M	64QAM	1	0	20.99	21.01	20.99	2
		1	37	20.90	20.98	20.83	2
		1	74	20.78	20.78	20.74	2
		36	0	20.21	20.31	20.20	3
		36	19	20.20	20.30	20.24	3
		36	39	20.31	20.35	20.23	3
		75	0	20.26	20.22	20.18	3
15M	256QAM	1	0	18.16	18.08	17.99	5
		1	37	18.06	18.09	18.00	5
		1	74	17.93	17.94	17.89	5
		36	0	18.34	18.28	18.18	5
		36	19	18.24	18.34	18.27	5
		36	39	18.12	18.23	18.09	5
		75	0	18.17	18.23	18.17	5

LTE Conducted Power (Full)							
LTE Band 40							
BW	MCS Index	Channel		38700	39150	39600	3GPP MPR
		Frequency (MHz)		2305	2350	2395	
10M	QPSK	1	0	23.16	23.39	23.17	0
		1	24	23.07	23.35	23.12	0
		1	49	22.99	23.06	23.02	0
		25	0	22.20	22.27	22.11	1
		25	12	22.15	22.30	22.04	1
		25	25	22.23	22.15	22.06	1
		50	0	22.06	22.15	22.06	1
10M	16QAM	1	0	22.07	22.25	22.11	1
		1	24	22.20	22.21	22.14	1
		1	49	21.86	21.89	21.94	1
		25	0	21.09	21.20	21.17	2
		25	12	21.18	21.19	21.08	2
		25	25	21.31	21.32	21.33	2
		50	0	21.07	21.21	21.10	2
10M	64QAM	1	0	20.84	20.89	20.94	2
		1	24	20.81	20.88	20.70	2
		1	49	20.70	20.69	20.60	2
		25	0	20.13	20.23	20.19	3
		25	12	20.06	20.15	20.20	3
		25	25	20.22	20.34	20.12	3
		50	0	20.14	20.17	20.05	3
10M	256QAM	1	0	18.01	18.09	17.97	5
		1	24	18.01	18.05	17.93	5
		1	49	17.89	17.93	17.79	5
		25	0	18.20	18.28	18.18	5
		25	12	18.16	18.26	18.14	5
		25	25	18.01	18.13	18.01	5
		50	0	18.14	18.08	18.15	5
BW	MCS Index	Channel		38675	39150	39625	3GPP MPR
		Frequency (MHz)		2302.5	2350	2397.5	
5M	QPSK	1	0	23.23	23.25	23.10	0
		1	12	23.17	23.34	22.99	0
		1	24	22.96	23.07	22.95	0
		12	0	22.26	22.28	22.05	1
		12	6	22.11	22.17	21.95	1
		12	13	22.27	22.17	21.93	1
		25	0	22.10	22.08	21.94	1
5M	16QAM	1	0	22.15	22.21	22.20	1
		1	12	22.19	22.32	22.02	1
		1	24	21.97	21.88	21.90	1
		12	0	21.21	21.20	21.15	2
		12	6	21.10	21.14	21.01	2
		12	13	21.33	21.37	21.33	2
		25	0	21.06	21.14	21.02	2
5M	64QAM	1	0	20.91	20.92	20.93	2
		1	12	20.86	20.97	20.68	2
		1	24	20.75	20.72	20.65	2
		12	0	20.11	20.23	20.20	3
		12	6	20.19	20.30	20.22	3
		12	13	20.23	20.32	20.13	3
		25	0	20.26	20.09	20.12	3
5M	256QAM	1	0	18.15	18.01	17.79	5
		1	12	18.00	18.16	17.77	5
		1	24	17.73	17.99	17.71	5
		12	0	18.20	18.36	17.92	5
		12	6	18.08	18.27	18.13	5
		12	13	18.09	18.23	17.99	5
		25	0	18.04	18.11	18.07	5

LTE Conducted Power (Full)										
LTE Band 41_PC2										
BW	MCS Index	RB Size	RB Offset	Low	Low	Mid	Mid	Mid	High	3GPP MPR (dB)
		Channel		39790	39750	40185	40620	41055	41490	
		Frequency (MHz)		2510	2506	2549.5	2593	2636.5	2680	
20M	QPSK	1	0	26.58	26.53	26.63	26.71	26.73	26.65	0
		1	50	26.47	26.44	26.51	26.61	26.66	26.57	0
		1	99	26.37	26.31	26.45	26.52	26.56	26.51	0
		50	0	25.76	25.71	25.86	25.93	25.99	25.90	1
		50	25	25.80	25.71	25.83	25.94	25.97	25.89	1
		50	50	25.77	25.75	25.80	25.86	25.94	25.84	1
		100	0	25.83	25.74	25.86	25.94	25.96	25.88	1
20M	16QAM	1	0	25.58	25.53	25.65	25.88	25.96	25.83	1
		1	50	25.44	25.36	25.47	25.93	25.93	25.86	1
		1	99	25.44	25.41	25.51	25.76	25.78	25.67	1
		50	0	24.73	24.71	24.80	24.82	24.86	24.74	2
		50	25	24.80	24.72	24.87	24.84	24.85	24.80	2
		50	50	24.80	24.72	24.84	24.72	24.77	24.70	2
		100	0	24.73	24.73	24.82	24.69	24.75	24.59	2
20M	64QAM	1	0	24.57	24.55	24.61	24.72	24.73	24.65	2
		1	50	24.46	24.45	24.56	24.89	24.97	24.80	2
		1	99	24.31	24.31	24.41	24.90	24.92	24.84	2
		50	0	23.84	23.80	23.88	23.91	23.93	23.81	3
		50	25	23.81	23.75	23.89	23.81	23.91	23.74	3
		50	50	23.71	23.65	23.74	23.80	23.88	23.77	3
		100	0	23.81	23.78	23.86	23.82	23.83	23.78	3
20M	256QAM	1	0	21.65	21.73	21.75	21.81	21.88	21.76	5
		1	50	21.72	21.72	21.73	21.84	21.84	21.82	5
		1	99	21.74	21.74	21.77	21.83	21.91	21.79	5
		50	0	21.73	21.81	21.81	21.89	21.95	21.82	5
		50	25	21.56	21.63	21.67	21.78	21.88	21.77	5
		50	50	21.62	21.64	21.74	21.85	21.85	21.80	5
		100	0	21.57	21.59	21.61	21.74	21.84	21.65	5
BW	MCS Index	Channel		39765	39725	40173	40620	41068	41515	3GPP MPR
Frequency (MHz)		2507.5	2503.5	2548.3	2593	2637.8	2682.5			
15M	QPSK	1	0	26.57	26.44	26.59	26.68	26.67	26.57	0
		1	37	26.39	26.35	26.49	26.53	26.66	26.50	0
		1	74	26.32	26.21	26.42	26.47	26.50	26.46	0
		36	0	25.71	25.63	25.85	25.85	25.96	25.81	1
		36	19	25.75	25.66	25.77	25.93	25.96	25.82	1
		36	39	25.68	25.74	25.74	25.83	25.92	25.75	1
		75	0	25.81	25.73	25.77	25.89	25.86	25.86	1
15M	16QAM	1	0	25.53	25.45	25.62	25.87	25.92	25.60	1
		1	37	25.36	25.27	25.41	25.91	25.87	25.48	1
		1	74	25.40	25.32	25.44	25.67	25.73	25.44	1
		36	0	24.64	24.71	24.78	24.82	24.83	24.84	2
		36	19	24.71	24.63	24.81	24.74	24.78	24.86	2
		36	39	24.71	24.68	24.80	24.69	24.71	24.84	2
		75	0	24.66	24.71	24.75	24.61	24.66	24.86	2
15M	64QAM	1	0	24.57	24.46	24.57	24.72	24.65	24.60	2
		1	37	24.36	24.35	24.53	24.80	24.91	24.48	2
		1	74	24.27	24.22	24.37	24.88	24.88	24.51	2
		36	0	23.79	23.80	23.84	23.86	23.90	23.84	3
		36	19	23.75	23.69	23.86	23.71	23.81	23.83	3
		36	39	23.68	23.57	23.65	23.71	23.85	23.76	3
		75	0	23.80	23.77	23.83	23.79	23.78	23.86	3
15M	256QAM	1	0	21.55	21.71	21.70	21.77	21.79	21.73	5
		1	37	21.63	21.66	21.63	21.79	21.82	21.79	5
		1	74	21.70	21.71	21.67	21.76	21.90	21.73	5
		36	0	21.71	21.75	21.72	21.87	21.86	21.80	5
		36	19	21.47	21.57	21.58	21.68	21.84	21.72	5
		36	39	21.57	21.54	21.69	21.77	21.83	21.72	5
		75	0	21.52	21.59	21.61	21.66	21.78	21.65	5

LTE Conducted Power (Full)										
LTE Band 41_PC2										
BW	MCS Index	Channel		39740	39700	40160	40620	41080	41540	3GPP MPR
		Frequency (MHz)		2505	2501	2547	2593	2639	2685	
10M	QPSK	1	0	26.54	26.34	26.49	26.67	26.60	26.52	0
		1	24	26.39	26.35	26.41	26.43	26.56	26.46	0
		1	49	26.24	26.11	26.35	26.43	26.45	26.40	0
		25	0	25.62	25.63	25.85	25.77	25.88	25.71	1
		25	12	25.75	25.61	25.68	25.88	25.88	25.75	1
		25	25	25.61	25.66	25.70	25.74	25.91	25.69	1
		50	0	25.77	25.68	25.75	25.82	25.80	25.84	1
10M	16QAM	1	0	25.47	25.34	25.57	25.67	25.61	25.55	1
		1	24	25.37	25.32	25.49	25.46	25.58	25.40	1
		1	49	25.25	25.11	25.34	25.41	25.46	25.43	1
		25	0	24.66	24.57	24.78	24.79	24.87	24.81	2
		25	12	24.71	24.62	24.74	24.92	24.87	24.72	2
		25	25	24.58	24.67	24.71	24.74	24.85	24.71	2
		50	0	24.73	24.72	24.73	24.86	24.76	24.83	2
10M	64QAM	1	0	24.56	24.43	24.57	24.68	24.61	24.57	2
		1	24	24.30	24.33	24.42	24.43	24.60	24.41	2
		1	49	24.30	24.18	24.38	24.42	24.48	24.46	2
		25	0	23.68	23.53	23.83	23.85	23.93	23.73	3
		25	12	23.75	23.60	23.73	23.88	23.93	23.77	3
		25	25	23.63	23.65	23.67	23.82	23.89	23.66	3
		50	0	23.73	23.69	23.73	23.81	23.84	23.79	3
10M	256QAM	1	0	21.57	21.66	21.67	21.76	21.78	21.75	5
		1	24	21.63	21.72	21.67	21.78	21.80	21.81	5
		1	49	21.70	21.68	21.74	21.74	21.87	21.73	5
		25	0	21.66	21.80	21.71	21.86	21.93	21.75	5
		25	12	21.51	21.54	21.61	21.72	21.85	21.76	5
		25	25	21.53	21.64	21.68	21.77	21.77	21.73	5
		50	0	21.51	21.58	21.56	21.66	21.79	21.59	5
BW	MCS Index	Channel		39715	39675	40148	40620	41093	41565	3GPP MPR
		Frequency (MHz)		2502.5	2498.5	2545.8	2593	2640.3	2687.5	
5M	QPSK	1	0	26.57	26.38	26.56	26.61	26.65	26.53	0
		1	12	26.39	26.35	26.46	26.44	26.59	26.50	0
		1	24	26.24	26.20	26.34	26.43	26.40	26.36	0
		12	0	25.66	25.59	25.80	25.82	25.94	25.71	1
		12	6	25.75	25.56	25.76	25.85	25.91	25.78	1
		12	13	25.68	25.70	25.68	25.73	25.87	25.66	1
		25	0	25.74	25.68	25.76	25.85	25.81	25.80	1
5M	16QAM	1	0	25.52	25.40	25.55	25.58	25.61	25.53	1
		1	12	25.31	25.33	25.41	25.50	25.58	25.42	1
		1	24	25.25	25.17	25.40	25.39	25.44	25.46	1
		12	0	24.70	24.55	24.82	24.82	24.93	24.81	2
		12	6	24.75	24.66	24.67	24.85	24.92	24.79	2
		12	13	24.61	24.65	24.66	24.83	24.83	24.74	2
		25	0	24.76	24.67	24.70	24.84	24.85	24.81	2
5M	64QAM	1	0	24.57	24.38	24.52	24.67	24.65	24.50	2
		1	12	24.37	24.32	24.43	24.45	24.60	24.46	2
		1	24	24.26	24.14	24.36	24.47	24.42	24.42	2
		12	0	23.65	23.56	23.83	23.78	23.86	23.75	3
		12	6	23.72	23.56	23.70	23.91	23.86	23.79	3
		12	13	23.68	23.72	23.67	23.78	23.83	23.71	3
		25	0	23.76	23.66	23.73	23.82	23.80	23.80	3
5M	256QAM	1	0	21.59	21.67	21.64	21.70	21.79	21.69	5
		1	12	21.60	21.64	21.54	21.74	21.71	21.66	5
		1	24	21.68	21.66	21.76	21.78	21.78	21.65	5
		12	0	21.62	21.75	21.67	21.74	21.85	21.65	5
		12	6	21.45	21.59	21.56	21.69	21.83	21.72	5
		12	13	21.47	21.54	21.67	21.79	21.73	21.70	5
		25	0	21.53	21.45	21.51	21.62	21.69	21.51	5

LTE Conducted Power (Full)										
LTE Band 41_PC3										
BW	MCS Index	RB Size	RB Offset	Low	Low	Mid	Mid	Mid	High	3GPP MPR (dB)
		Channel		39790	39750	40185	40620	41055	41490	
		Frequency (MHz)		2510	2506	2549.5	2593	2636.5	2680	
20M	QPSK	1	0	23.91	23.95	23.73	23.97	23.99	23.98	0
		1	50	23.78	23.86	23.71	23.92	23.98	23.94	0
		1	99	23.75	23.84	23.68	23.89	23.95	23.95	0
		50	0	22.93	22.94	22.88	22.95	22.99	22.98	1
		50	25	22.87	22.89	22.84	22.91	22.98	22.98	1
		50	50	22.82	22.83	22.81	22.83	22.97	22.93	1
		100	0	22.76	22.76	22.67	22.84	22.96	22.86	1
20M	16QAM	1	0	22.90	22.97	22.90	22.97	22.98	22.95	1
		1	50	22.79	22.91	22.76	22.89	22.97	22.96	1
		1	99	22.83	22.79	22.65	22.88	22.92	22.90	1
		50	0	21.84	21.98	21.83	21.93	21.99	21.94	2
		50	25	21.81	21.83	21.84	21.90	21.98	21.92	2
		50	50	21.78	21.81	21.73	21.88	21.95	21.89	2
		100	0	21.73	21.80	21.67	21.86	21.94	21.90	2
20M	64QAM	1	0	21.86	21.95	21.81	21.88	21.79	21.95	2
		1	50	21.79	21.85	21.76	21.91	21.78	21.95	2
		1	99	21.76	21.82	21.69	21.86	21.65	21.89	2
		50	0	20.85	20.90	20.93	20.95	21.15	20.90	3
		50	25	20.85	20.84	20.81	20.98	21.11	20.94	3
		50	50	20.79	20.73	20.72	20.83	21.09	20.97	3
		100	0	20.76	20.84	20.69	20.77	21.05	20.91	3
20M	256QAM	1	0	18.79	18.86	18.72	18.91	18.97	18.97	5
		1	50	18.72	18.74	18.66	18.83	18.93	18.86	5
		1	99	18.56	18.63	18.55	18.70	18.79	18.70	5
		50	0	18.79	18.79	18.79	18.84	18.96	18.93	5
		50	25	18.74	18.83	18.70	18.83	18.95	18.87	5
		50	50	18.83	18.88	18.75	18.91	18.93	18.91	5
		100	0	18.77	18.80	18.67	18.82	18.91	18.90	5
BW	MCS Index	Channel		39765	39725	40173	40620	41068	41515	3GPP MPR
Frequency (MHz)		2507.5	2503.5	2548.3	2593	2637.8	2682.5			
15M	QPSK	1	0	23.88	23.95	23.64	23.88	23.91	23.97	0
		1	37	23.77	23.76	23.70	23.89	23.92	23.85	0
		1	74	23.69	23.74	23.66	23.83	23.86	23.89	0
		36	0	22.84	22.94	22.80	22.89	22.99	22.95	1
		36	19	22.82	22.86	22.76	22.87	22.98	22.97	1
		36	39	22.76	22.82	22.79	22.76	22.94	22.88	1
		75	0	22.68	22.69	22.60	22.81	22.89	22.77	1
15M	16QAM	1	0	22.90	22.87	22.67	22.93	22.96	22.90	1
		1	37	22.78	22.77	22.63	22.89	22.97	22.91	1
		1	74	22.70	22.75	22.60	22.89	22.95	22.91	1
		36	0	21.89	21.87	21.81	21.87	21.91	21.92	2
		36	19	21.78	21.88	21.79	21.82	21.97	21.93	2
		36	39	21.80	21.77	21.79	21.81	21.87	21.88	2
		75	0	21.72	21.69	21.66	21.79	21.87	21.82	2
15M	64QAM	1	0	21.84	21.86	21.70	21.95	21.89	21.94	2
		1	37	21.75	21.86	21.69	21.85	21.89	21.90	2
		1	74	21.70	21.80	21.63	21.85	21.85	21.85	2
		36	0	20.90	20.85	20.81	20.85	20.93	20.93	3
		36	19	20.78	20.81	20.75	20.84	20.88	20.93	3
		36	39	20.77	20.81	20.77	20.76	20.87	20.83	3
		75	0	20.67	20.71	20.67	20.74	20.92	20.82	3
15M	256QAM	1	0	21.69	21.79	21.64	21.89	21.92	21.88	5
		1	37	21.66	21.67	21.64	21.80	21.91	21.77	5
		1	74	21.49	21.59	21.45	21.67	21.78	21.60	5
		36	0	20.78	20.70	20.70	20.74	20.91	20.86	5
		36	19	20.72	20.79	20.66	20.79	20.88	20.77	5
		36	39	20.76	20.83	20.72	20.84	20.91	20.91	5
		75	0	20.73	20.73	20.59	20.78	20.82	20.81	5

LTE Conducted Power (Full)										
LTE Band 41_PC3										
BW	MCS Index	Channel		39740	39700	40160	40620	41080	41540	3GPP MPR
		Frequency (MHz)		2505	2501	2547	2593	2639	2685	
10M	QPSK	1	0	23.83	23.85	23.57	23.85	23.88	23.95	0
		1	24	23.76	23.77	23.54	23.86	23.90	23.88	0
		1	49	23.67	23.72	23.55	23.75	23.86	23.84	0
		25	0	22.85	22.85	22.76	22.78	22.97	22.86	1
		25	12	22.80	22.78	22.74	22.82	22.94	22.83	1
		25	25	22.73	22.69	22.69	22.75	22.87	22.76	1
		50	0	22.62	22.74	22.63	22.69	22.84	22.76	1
10M	16QAM	1	0	22.82	22.88	22.56	22.80	22.94	22.85	1
		1	24	22.75	22.76	22.55	22.83	22.88	22.89	1
		1	49	22.68	22.72	22.57	22.73	22.87	22.81	1
		25	0	21.83	21.86	21.73	21.78	21.94	21.87	2
		25	12	21.71	21.78	21.68	21.73	21.95	21.81	2
		25	25	21.72	21.67	21.69	21.74	21.82	21.77	2
		50	0	21.70	21.71	21.62	21.75	21.83	21.71	2
10M	64QAM	1	0	21.85	21.87	21.65	21.88	21.85	21.87	2
		1	24	21.68	21.71	21.51	21.87	21.91	21.90	2
		1	49	21.65	21.70	21.61	21.74	21.87	21.84	2
		25	0	20.84	20.86	20.71	20.78	20.89	20.85	3
		25	12	20.78	20.77	20.76	20.74	20.93	20.85	3
		25	25	20.73	20.64	20.73	20.72	20.87	20.84	3
		50	0	20.70	20.73	20.62	20.67	20.84	20.77	3
10M	256QAM	1	0	21.67	21.72	21.63	21.80	21.91	21.83	5
		1	24	21.70	21.64	21.54	21.82	21.86	21.81	5
		1	49	21.44	21.55	21.41	21.63	21.69	21.68	5
		25	0	20.65	20.74	20.65	20.70	20.90	20.77	5
		25	12	20.61	20.78	20.64	20.72	20.87	20.85	5
		25	25	20.73	20.77	20.61	20.82	20.78	20.81	5
		50	0	20.71	20.71	20.61	20.76	20.73	20.87	5
BW	MCS Index	Channel		39715	39675	40148	40620	41093	41565	3GPP MPR
		Frequency (MHz)		2502.5	2498.5	2545.8	2593	2640.3	2687.5	
5M	QPSK	1	0	23.82	23.89	23.69	23.84	23.84	23.86	0
		1	12	23.71	23.75	23.63	23.83	23.90	23.85	0
		1	24	23.63	23.67	23.52	23.83	23.81	23.83	0
		12	0	22.84	22.92	22.73	22.83	22.85	22.92	1
		12	6	22.84	22.89	22.81	22.76	22.83	22.96	1
		12	13	22.70	22.65	22.74	22.72	22.85	22.83	1
		25	0	22.74	22.67	22.58	22.68	22.88	22.77	1
5M	16QAM	1	0	22.81	22.88	22.67	22.88	22.82	22.88	1
		1	12	22.68	22.73	22.61	22.76	22.88	22.92	1
		1	24	22.62	22.75	22.52	22.82	22.88	22.85	1
		12	0	21.84	21.92	21.79	21.84	21.92	21.89	2
		12	6	21.87	21.86	21.81	21.74	21.78	21.96	2
		12	13	21.64	21.67	21.71	21.78	21.82	21.88	2
		25	0	21.71	21.60	21.49	21.71	21.91	21.76	2
5M	64QAM	1	0	21.79	21.89	21.62	21.93	21.91	21.87	2
		1	12	21.72	21.82	21.58	21.77	21.90	21.94	2
		1	24	21.63	21.69	21.53	21.80	21.79	21.86	2
		12	0	20.78	20.85	20.71	20.84	20.86	20.91	3
		12	6	20.85	20.79	20.73	20.79	20.87	20.95	3
		12	13	20.64	20.71	20.66	20.73	20.86	20.87	3
		25	0	20.71	20.63	20.56	20.70	20.82	20.80	3
5M	256QAM	1	0	21.70	21.75	21.63	21.82	21.86	21.84	5
		1	12	21.60	21.61	21.56	21.73	21.91	21.79	5
		1	24	21.41	21.51	21.44	21.59	21.71	21.61	5
		12	0	20.72	20.66	20.65	20.66	20.85	20.82	5
		12	6	20.63	20.75	20.56	20.73	20.85	20.71	5
		12	13	20.75	20.77	20.61	20.79	20.82	20.90	5
		25	0	20.71	20.68	20.63	20.72	20.76	20.83	5

LTE Conducted Power (Full)								
LTE Band 48								
BW	MCS Index	RB Size	RB Offset	Low	Mid	Mid	Mid	3GPP MPR (dB)
		Channel		55340	55780	56210	56640	
		Frequency (MHz)		3560	3603	3647	3690	
20M	QPSK	1	0	21.47	21.29	21.63	21.85	0
		1	50	21.41	21.27	21.58	21.83	0
		1	99	21.39	21.25	21.55	21.81	0
		50	0	20.68	20.61	20.86	20.93	1
		50	25	20.67	20.58	20.83	20.89	1
		50	50	20.65	20.53	20.81	20.88	1
		100	0	20.72	20.56	20.82	20.87	1
20M	16QAM	1	0	20.29	20.31	20.76	20.92	1
		1	50	20.43	20.33	20.79	20.91	1
		1	99	20.47	20.25	20.78	20.89	1
		50	0	19.71	19.54	19.93	19.95	2
		50	25	19.69	19.53	19.83	18.94	2
		50	50	19.75	19.51	19.88	19.91	2
		100	0	19.74	19.59	19.80	19.89	2
20M	64QAM	1	0	19.37	19.29	19.80	19.44	2
		1	50	19.37	19.29	19.74	19.43	2
		1	99	19.47	19.27	19.78	19.41	2
		50	0	18.71	18.55	18.93	18.86	3
		50	25	18.67	18.51	18.82	18.85	3
		50	50	18.70	18.50	18.88	18.84	3
		100	0	18.68	18.58	18.79	18.83	3
20M	256QAM	1	0	16.39	16.39	16.45	16.53	5
		1	50	16.46	16.36	16.53	16.61	5
		1	99	16.40	16.31	16.45	16.51	5
		50	0	16.80	16.71	16.83	16.84	5
		50	25	16.83	16.81	16.83	16.83	5
		50	50	16.70	16.66	16.79	16.82	5
		100	0	16.78	16.75	16.80	16.81	5
BW	MCS Index	Channel		55315	55765	56215	56665	3GPP MPR
		Frequency (MHz)		3557.5	3602.5	3647.5	3692.5	
15M	QPSK	1	0	21.45	21.21	21.60	21.83	0
		1	37	21.33	21.24	21.53	21.78	0
		1	74	21.38	21.24	21.50	21.74	0
		36	0	20.59	20.52	20.77	20.83	1
		36	19	20.58	20.50	20.73	20.81	1
		36	39	20.58	20.46	20.74	20.82	1
		75	0	20.67	20.55	20.72	20.84	1
15M	16QAM	1	0	20.38	20.21	20.54	20.85	1
		1	37	20.37	20.26	20.48	20.74	1
		1	74	20.29	20.24	20.49	20.80	1
		36	0	19.65	19.58	19.83	19.86	2
		36	19	19.66	19.49	19.73	19.89	2
		36	39	19.65	19.51	19.80	19.84	2
		75	0	19.62	19.52	19.79	19.84	2
15M	64QAM	1	0	19.39	19.25	19.54	19.84	2
		1	37	19.33	19.21	19.57	19.80	2
		1	74	19.31	19.18	19.47	19.71	2
		36	0	18.66	18.52	18.80	18.83	3
		36	19	18.62	18.49	18.74	18.83	3
		36	39	18.64	18.53	18.73	18.86	3
		75	0	18.69	18.47	18.75	18.86	3
15M	256QAM	1	0	16.30	16.29	16.45	16.51	5
		1	37	16.42	16.36	16.52	16.60	5
		1	74	16.40	16.23	16.41	16.47	5
		36	0	16.80	16.61	16.81	16.75	5
		36	19	16.77	16.72	16.78	16.76	5
		36	39	16.64	16.60	16.69	16.78	5
		75	0	16.73	16.73	16.73	16.75	5

LTE Conducted Power (Full)								
LTE Band 48								
BW	MCS Index	Channel		55290	55750	56220	56690	3GPP MPR
		Frequency (MHz)		3555	3601	3648	3695	
10M	QPSK	1	0	21.39	21.14	21.60	21.76	0
		1	24	21.30	21.24	21.50	21.69	0
		1	49	21.24	21.16	21.37	21.76	0
		25	0	20.59	20.47	20.79	20.84	1
		25	12	20.50	20.47	20.81	20.80	1
		25	25	20.54	20.47	20.72	20.78	1
		50	0	20.67	20.45	20.67	20.79	1
10M	16QAM	1	0	20.39	20.23	20.55	20.77	1
		1	24	20.28	20.24	20.50	20.68	1
		1	49	20.33	20.09	20.44	20.78	1
		25	0	19.59	19.46	19.82	19.89	2
		25	12	19.56	19.45	19.76	19.85	2
		25	25	19.51	19.49	19.71	19.82	2
		50	0	19.60	19.52	19.72	19.81	2
10M	64QAM	1	0	19.35	19.18	19.56	19.80	2
		1	24	19.27	19.24	19.54	19.76	2
		1	49	19.28	19.06	19.40	19.70	2
		25	0	18.61	18.50	18.77	18.86	3
		25	12	18.50	18.44	18.79	18.79	3
		25	25	18.56	18.44	18.74	18.78	3
		50	0	18.69	18.52	18.76	18.81	3
10M	256QAM	1	0	16.35	16.30	16.32	16.38	5
		1	24	16.27	16.27	16.45	16.55	5
		1	49	16.29	16.22	16.36	16.49	5
		25	0	16.72	16.66	16.76	16.77	5
		25	12	16.72	16.78	16.75	16.80	5
		25	25	16.66	16.58	16.63	16.66	5
		50	0	16.75	16.69	16.68	16.66	5
BW	MCS Index	Channel		55265	55745	56235	56715	3GPP MPR
		Frequency (MHz)		3552.5	3600.5	3649.5	3697.5	
5M	QPSK	1	0	21.38	21.20	21.50	21.80	0
		1	12	21.30	21.13	21.39	21.68	0
		1	24	21.27	21.09	21.51	21.72	0
		12	0	20.56	20.49	20.70	20.77	1
		12	6	20.58	20.48	20.77	20.84	1
		12	13	20.50	20.43	20.69	20.73	1
		25	0	20.70	20.44	20.62	20.80	1
5M	16QAM	1	0	20.42	20.23	20.56	20.84	1
		1	12	20.26	20.17	20.45	20.72	1
		1	24	20.24	20.12	20.43	20.65	1
		12	0	19.56	19.48	19.79	19.81	2
		12	6	19.51	19.44	19.75	19.87	2
		12	13	19.46	19.45	19.67	19.76	2
		25	0	19.66	19.42	19.67	19.82	2
5M	64QAM	1	0	19.41	19.20	19.47	19.77	2
		1	12	19.24	19.15	19.38	19.64	2
		1	24	19.21	19.13	19.47	19.70	2
		12	0	18.61	18.51	18.79	18.77	3
		12	6	18.57	18.47	18.75	18.84	3
		12	13	18.56	18.42	18.71	18.75	3
		25	0	18.69	18.39	18.66	18.84	3
5M	256QAM	1	0	16.24	16.32	16.30	16.41	5
		1	12	16.36	16.18	16.43	16.50	5
		1	24	16.31	16.18	16.31	16.50	5
		12	0	16.65	16.66	16.76	16.71	5
		12	6	16.74	16.76	16.66	16.72	5
		12	13	16.60	16.58	16.67	16.77	5
		25	0	16.66	16.59	16.77	16.65	5

LTE Conducted Power (Full)							
LTE Band 66							
BW	MCS Index	RB Size	RB Offset	Low	Mid	High	3GPP MPR (dB)
		Channel		132072	132322	132572	
		Frequency (MHz)		1720	1745	1770	
20M	QPSK	1	0	23.15	23.26	23.18	0
		1	50	23.11	23.25	23.16	0
		1	99	23.09	23.18	23.15	0
		50	0	22.28	22.35	22.30	1
		50	25	22.12	22.31	22.22	1
		50	50	22.14	22.23	22.22	1
		100	0	22.24	22.31	22.29	1
20M	16QAM	1	0	22.43	22.56	22.49	1
		1	50	22.44	22.54	22.47	1
		1	99	22.37	22.51	22.46	1
		50	0	21.28	21.36	21.36	2
		50	25	21.25	21.33	21.31	2
		50	50	21.08	21.21	21.13	2
		100	0	21.14	21.24	21.16	2
20M	64QAM	1	0	21.31	21.43	21.38	2
		1	50	21.19	21.32	21.26	2
		1	99	21.22	21.41	21.31	2
		50	0	20.14	20.25	20.19	3
		50	25	20.24	20.35	20.33	3
		50	50	20.05	20.21	20.12	3
		100	0	20.10	20.22	20.19	3
20M	256QAM	1	0	18.17	18.33	18.27	5
		1	50	18.36	18.36	18.36	5
		1	99	18.16	18.27	18.19	5
		50	0	18.26	18.33	18.26	5
		50	25	18.21	18.34	18.27	5
		50	50	18.08	18.14	18.09	5
		100	0	18.22	18.23	18.23	5
BW	MCS Index	Channel		132047	132322	132597	3GPP MPR
Frequency (MHz)		1717.5	1745	1772.5			
15M	QPSK	1	0	23.13	23.21	23.18	0
		1	37	23.03	23.24	23.07	0
		1	74	23.07	23.08	23.06	0
		36	0	22.19	22.30	22.20	1
		36	19	22.02	22.30	22.19	1
		36	39	22.10	22.20	22.22	1
		75	0	22.19	22.30	22.29	1
15M	16QAM	1	0	22.34	22.48	22.45	1
		1	37	22.36	22.44	22.43	1
		1	74	22.29	22.50	22.37	1
		36	0	21.20	21.28	21.34	2
		36	19	21.17	21.31	21.23	2
		36	39	21.03	21.11	21.10	2
		75	0	21.04	21.20	21.12	2
15M	64QAM	1	0	21.24	21.34	21.28	2
		1	37	21.16	21.24	21.18	2
		1	74	21.22	21.33	21.23	2
		36	0	20.11	20.15	20.16	3
		36	19	20.24	20.26	20.31	3
		36	39	20.00	20.12	20.03	3
		75	0	20.09	20.15	20.14	3
15M	256QAM	1	0	18.14	18.30	18.05	5
		1	37	18.25	18.35	18.24	5
		1	74	18.00	18.08	18.11	5
		36	0	18.21	18.10	18.13	5
		36	19	18.17	18.18	18.08	5
		36	39	18.00	18.05	17.93	5
		75	0	18.10	18.11	18.14	5

LTE Conducted Power (Full)							
LTE Band 66							
BW	MCS Index	Channel		132022	132322	132622	3GPP MPR
		Frequency (MHz)		1715	1745	1775	
10M	QPSK	1	0	23.10	23.21	23.13	0
		1	24	23.00	23.12	23.02	0
		1	49	22.95	23.07	22.99	0
		25	0	22.07	22.27	22.14	1
		25	12	21.87	22.16	22.18	1
		25	25	22.07	22.18	22.08	1
		50	0	22.13	22.26	22.23	1
10M	16QAM	1	0	22.34	22.47	22.39	1
		1	24	22.23	22.41	22.39	1
		1	49	22.17	22.42	22.25	1
		25	0	21.05	21.25	21.32	2
		25	12	21.07	21.17	21.21	2
		25	25	21.03	21.00	21.07	2
		50	0	20.90	21.10	21.04	2
10M	64QAM	1	0	21.16	21.22	21.22	2
		1	24	21.05	21.14	21.14	2
		1	49	21.18	21.29	21.11	2
		25	0	20.07	20.01	20.10	3
		25	12	20.23	20.15	20.19	3
		25	25	19.91	20.09	19.91	3
		50	0	20.07	20.06	20.00	3
10M	256QAM	1	0	18.08	18.19	18.05	5
		1	24	18.18	18.31	18.20	5
		1	49	17.98	18.26	18.01	5
		25	0	18.06	18.17	18.18	5
		25	12	18.07	18.34	18.11	5
		25	25	17.92	17.94	17.94	5
		50	0	17.99	18.18	18.06	5
BW	MCS Index	Channel		131997	132322	132647	3GPP MPR
		Frequency (MHz)		1712.5	1745	1777.5	
5M	QPSK	1	0	23.01	23.06	22.98	0
		1	12	23.01	23.15	22.99	0
		1	24	23.06	23.08	22.86	0
		12	0	22.05	22.16	22.12	1
		12	6	21.93	22.19	22.10	1
		12	13	22.07	22.12	22.08	1
		25	0	22.12	22.19	22.12	1
5M	16QAM	1	0	22.28	22.34	22.38	1
		1	12	22.34	22.31	22.39	1
		1	24	22.15	22.38	22.23	1
		12	0	21.09	21.17	21.27	2
		12	6	21.16	21.22	21.17	2
		12	13	20.99	21.05	21.04	2
		25	0	20.90	21.11	21.05	2
5M	64QAM	1	0	21.16	21.29	21.24	2
		1	12	21.07	21.09	21.03	2
		1	24	21.17	21.26	21.12	2
		12	0	20.08	20.07	20.01	3
		12	6	20.14	20.13	20.27	3
		12	13	19.92	20.06	19.88	3
		25	0	19.97	20.10	20.06	3
5M	256QAM	1	0	18.06	18.15	18.14	5
		1	12	18.18	18.17	18.27	5
		1	24	18.14	18.15	18.03	5
		12	0	18.11	18.15	18.10	5
		12	6	18.11	18.20	18.08	5
		12	13	17.87	18.02	17.98	5
		25	0	18.07	18.07	18.10	5

LTE Conducted Power (Full)							
LTE Band 66							
BW	MCS Index	Channel		131987	132322	132657	3GPP MPR
		Frequency (MHz)		1711.5	1745	1778.5	
3M	QPSK	1	0	23.03	23.12	23.18	0
		1	7	22.89	23.23	22.96	0
		1	14	22.94	23.02	22.91	0
		8	0	22.16	22.30	22.18	1
		8	3	21.91	22.30	22.08	1
		8	7	22.02	22.13	22.10	1
		15	0	22.07	22.19	22.20	1
3M	16QAM	1	0	22.25	22.48	22.36	1
		1	7	22.28	22.34	22.29	1
		1	14	22.20	22.39	22.23	1
		8	0	21.17	21.28	21.22	2
		8	3	21.03	21.20	21.12	2
		8	7	20.93	21.08	21.00	2
		15	0	20.93	21.05	21.00	2
3M	64QAM	1	0	21.20	21.31	21.19	2
		1	7	21.12	21.19	21.12	2
		1	14	21.07	21.20	21.21	2
		8	0	20.03	20.06	20.07	3
		8	3	20.20	20.18	20.26	3
		8	7	19.87	20.12	19.95	3
		15	0	19.95	20.13	20.01	3
3M	256QAM	1	0	18.10	18.24	18.21	5
		1	7	18.27	18.16	18.29	5
		1	14	18.00	18.12	18.04	5
		8	0	18.08	18.17	18.16	5
		8	3	18.17	18.18	18.17	5
		8	7	17.92	18.01	17.94	5
		15	0	18.02	18.17	18.02	5
BW	MCS Index	Channel		131979	132322	132665	3GPP MPR
		Frequency (MHz)		1710.7	1745	1779.3	
1.4M	QPSK	1	0	23.11	23.14	23.16	0
		1	2	22.88	23.14	22.97	0
		1	5	22.96	22.93	22.98	0
		3	0	23.14	23.21	23.16	0
		3	1	22.87	23.22	23.09	0
		3	3	23.08	23.20	23.08	0
		6	0	22.05	22.24	22.24	1
1.4M	16QAM	1	0	22.26	22.41	22.36	1
		1	2	22.30	22.31	22.40	1
		1	5	22.29	22.41	22.27	1
		3	0	22.10	22.23	22.28	1
		3	1	22.17	22.18	22.17	1
		3	3	21.97	21.96	21.99	1
		6	0	21.03	21.10	21.03	2
1.4M	64QAM	1	0	21.13	21.33	21.18	2
		1	2	21.12	21.23	21.16	2
		1	5	21.20	21.25	21.13	2
		3	0	21.06	21.04	21.10	2
		3	1	21.15	21.15	21.17	2
		3	3	20.88	21.06	21.01	2
		6	0	20.07	20.02	20.13	3
1.4M	256QAM	1	0	18.01	18.29	18.06	5
		1	2	18.16	18.15	18.30	5
		1	5	17.95	18.24	18.06	5
		3	0	18.14	18.19	18.19	5
		3	1	18.11	18.23	18.17	5
		3	3	17.84	17.97	18.05	5
		6	0	18.06	18.20	18.21	5

LTE Conducted Power (Full)							
LTE Band 71							
BW	MCS Index	RB Size	RB Offset	Low	Mid	Mid	3GPP MPR (dB)
		Channel		133222	133297	133372	
		Frequency (MHz)		673	680.5	688	
20M	QPSK	1	0	23.61	23.67	23.65	0
		1	50	23.57	23.62	23.57	0
		1	99	23.52	23.58	23.52	0
		50	0	22.74	22.79	22.71	1
		50	25	22.72	22.77	22.69	1
		50	50	22.60	22.65	22.65	1
		100	0	22.75	22.78	22.70	1
20M	16QAM	1	0	22.91	22.95	22.92	1
		1	50	22.86	22.91	22.89	1
		1	99	22.75	22.79	22.78	1
		50	0	21.82	21.85	21.84	2
		50	25	21.70	21.75	21.70	2
		50	50	21.68	21.71	21.65	2
		100	0	21.76	21.80	21.75	2
20M	64QAM	1	0	21.75	21.81	21.77	2
		1	50	21.71	21.75	21.66	2
		1	99	21.68	21.72	21.63	2
		50	0	20.79	20.84	20.81	3
		50	25	20.67	20.72	20.72	3
		50	50	20.64	20.69	20.61	3
		100	0	20.75	20.79	20.72	3
20M	256QAM	1	0	18.78	18.82	18.76	5
		1	50	18.67	18.72	18.66	5
		1	99	18.57	18.63	18.55	5
		50	0	18.54	18.59	18.50	5
		50	25	18.46	18.51	18.47	5
		50	50	18.39	18.44	18.39	5
		100	0	18.68	18.71	18.65	5
BW	MCS Index	Channel		133197	133297	133397	3GPP MPR
Frequency (MHz)		670.5	680.5	690.5			
15M	QPSK	1	0	23.57	23.65	23.62	0
		1	37	23.48	23.58	23.56	0
		1	74	23.46	23.52	23.49	0
		36	0	22.66	22.72	22.71	1
		36	19	22.71	22.70	22.68	1
		36	39	22.58	22.62	22.63	1
		75	0	22.70	22.70	22.61	1
15M	16QAM	1	0	22.80	22.91	22.87	1
		1	37	22.79	22.90	22.80	1
		1	74	22.63	22.76	22.68	1
		36	0	21.81	21.85	21.79	2
		36	19	21.66	21.66	21.62	2
		36	39	21.66	21.66	21.63	2
		75	0	21.67	21.74	21.65	2
15M	64QAM	1	0	21.70	21.75	21.68	2
		1	37	21.59	21.67	21.60	2
		1	74	21.61	21.69	21.56	2
		36	0	20.76	20.75	20.74	3
		36	19	20.59	20.63	20.64	3
		36	39	20.64	20.60	20.60	3
		75	0	20.69	20.69	20.72	3
15M	256QAM	1	0	18.75	18.78	18.70	5
		1	37	18.58	18.71	18.57	5
		1	74	18.48	18.53	18.50	5
		36	0	18.47	18.50	18.44	5
		36	19	18.45	18.44	18.38	5
		36	39	18.37	18.40	18.36	5
		75	0	18.59	18.63	18.63	5

LTE Conducted Power (Full)							
LTE Band 71							
BW	MCS Index	Channel		133172	133297	133422	3GPP MPR
		Frequency (MHz)		668	680.5	693	
10M	QPSK	1	0	23.41	23.51	23.62	0
		1	24	23.41	23.47	23.34	0
		1	49	23.38	23.43	23.50	0
		25	0	22.52	22.66	22.69	1
		25	12	22.53	22.55	22.59	1
		25	25	22.56	22.57	22.60	1
		50	0	22.65	22.72	22.63	1
10M	16QAM	1	0	22.77	22.84	22.89	1
		1	24	22.81	22.76	22.76	1
		1	49	22.56	22.69	22.67	1
		25	0	21.73	21.67	21.77	2
		25	12	21.63	21.73	21.60	2
		25	25	21.57	21.61	21.45	2
		50	0	21.64	21.69	21.65	2
10M	64QAM	1	0	21.71	21.78	21.67	2
		1	24	21.52	21.74	21.54	2
		1	49	21.58	21.60	21.57	2
		25	0	20.72	20.69	20.65	3
		25	12	20.58	20.69	20.56	3
		25	25	20.53	20.56	20.39	3
		50	0	20.57	20.64	20.51	3
10M	256QAM	1	0	18.75	18.78	18.70	5
		1	24	18.58	18.71	18.57	5
		1	49	18.48	18.53	18.50	5
		25	0	18.47	18.50	18.44	5
		25	12	18.45	18.44	18.38	5
		25	25	18.37	18.40	18.36	5
		50	0	18.59	18.63	18.63	5
BW	MCS Index	Channel		133147	133297	133447	3GPP MPR
		Frequency (MHz)		665.5	680.5	695.5	
5M	QPSK	1	0	23.59	23.45	23.56	0
		1	12	23.35	23.50	23.39	0
		1	24	23.37	23.39	23.34	0
		12	0	22.67	22.75	22.66	1
		12	6	22.59	22.74	22.62	1
		12	13	22.56	22.58	22.58	1
		25	0	22.53	22.70	22.66	1
5M	16QAM	1	0	22.69	22.89	22.82	1
		1	12	22.78	22.73	22.81	1
		1	24	22.68	22.72	22.65	1
		12	0	21.73	21.74	21.62	2
		12	6	21.56	21.58	21.60	2
		12	13	21.64	21.55	21.50	2
		25	0	21.56	21.65	21.55	2
5M	64QAM	1	0	21.56	21.66	21.55	2
		1	12	21.54	21.57	21.51	2
		1	24	21.47	21.63	21.50	2
		12	0	20.77	20.74	20.73	3
		12	6	20.62	20.61	20.58	3
		12	13	20.52	20.59	20.43	3
		25	0	20.60	20.62	20.66	3
5M	256QAM	1	0	18.70	18.82	18.74	5
		1	12	18.63	18.66	18.64	5
		1	24	18.50	18.55	18.50	5
		12	0	18.51	18.53	18.43	5
		12	6	18.46	18.51	18.47	5
		12	13	18.40	18.41	18.39	5
		25	0	18.65	18.64	18.65	5

NR Conducted Power (Full)

NR Band 2_SA

BW	MCS Index	RB Size	RB Offset	Low	Mid	High	3GPP MPR (dB)
		Channel		372000	376000	380000	
		Frequency (MHz)		1860	1880	1900	
20M	DFT-S PI/2 BPSK	1	1	23.93	23.96	23.83	0
20M	DFT-S QPSK	1	1	23.95	23.98	23.86	0
		1	53	23.92	23.95	23.82	0
		1	104	23.91	23.92	23.87	0
		50	0	22.95	22.98	22.89	1
		50	28	23.91	23.96	23.81	0
		50	56	22.89	22.95	22.81	1
		100	0	22.92	22.97	22.86	1
20M	DFT-S 16QAM	1	1	22.87	22.95	22.80	1
20M	DFT-S 64QAM	1	1	21.17	21.18	21.15	2.5
20M	DFT-S 256QAM	1	1	19.39	19.43	19.39	4.5
20M	CP QPSK	1	1	22.48	22.48	22.47	1.5
BW	MCS Index	Channel		371500	376000	380500	3GPP MPR
		Frequency (MHz)		1857.5	1880	1902.5	
15M	DFT-S PI/2 BPSK	1	1	23.86	23.87	23.79	0
15M	DFT-S QPSK	1	1	23.93	23.93	23.82	0
		1	40	23.90	23.88	23.77	0
		1	77	23.85	23.83	23.83	0
		36	0	22.95	22.91	22.89	1
		36	22	23.88	23.91	23.81	0
		36	43	22.88	22.91	22.71	1
		75	0	22.87	22.94	22.86	1
15M	DFT-S 16QAM	1	1	22.80	22.90	22.72	1
15M	DFT-S 64QAM	1	1	21.07	21.14	21.11	2.5
15M	DFT-S 256QAM	1	1	19.29	19.41	19.32	4.5
15M	CP QPSK	1	1	22.43	22.39	22.45	1.5

NR Conducted Power (Full)

NR Band 2_SA

BW	MCS Index	Channel		371000	376000	381000	3GPP MPR
		Frequency (MHz)		1855	1880	1905	
10M	DFT-S PI/2 BPSK	1	1	23.82	23.86	23.74	0
10M	DFT-S QPSK	1	1	23.87	23.84	23.72	0
		1	26	23.75	23.79	23.70	0
		1	50	23.75	23.79	23.70	0
		25	0	22.79	22.84	22.70	1
		25	14	23.78	23.78	23.65	0
		25	27	22.83	22.86	22.74	1
10M	DFT-S 16QAM	1	1	22.66	22.89	22.73	1
10M	DFT-S 64QAM	1	1	21.03	21.02	21.10	2.5
10M	DFT-S 256QAM	1	1	19.21	19.23	19.29	4.5
10M	CP QPSK	1	1	22.38	22.45	22.34	1.5
BW	MCS Index	Channel		370500	376000	381500	3GPP MPR
		Frequency (MHz)		1852.5	1880	1907.5	
5M	DFT-S PI/2 BPSK	1	1	23.83	23.84	23.72	0
5M	DFT-S QPSK	1	1	23.82	23.91	23.66	0
		1	13	23.71	23.84	23.63	0
		1	23	23.66	23.84	23.77	0
		12	0	22.83	22.89	22.71	1
		12	7	23.77	23.77	23.60	0
		12	13	22.80	22.91	22.66	1
5M	DFT-S 16QAM	1	1	22.74	22.71	22.74	1
5M	DFT-S 64QAM	1	1	21.10	21.15	21.00	2.5
5M	DFT-S 256QAM	1	1	19.24	19.36	19.21	4.5
5M	CP QPSK	1	1	22.40	22.37	22.36	1.5

NR Conducted Power (Full)

NR Band 5_SA

BW	MCS Index	RB Size	RB Offset	Low	Mid	High	3GPP MPR (dB)
		Channel		166800	167300	167800	
		Frequency (MHz)		834	836.5	839	
20M	DFT-S PI/2 BPSK	1	1	22.89	23.08	22.98	0
20M	DFT-S QPSK	1	1	22.91	23.11	23.03	0
		1	53	22.98	23.08	23.02	0
		1	104	22.88	23.05	22.98	0
		50	0	22.10	22.18	22.14	1
		50	28	22.95	23.09	23.04	0
		50	56	22.34	22.38	22.35	1
100	0	22.25	22.33	22.29	1		
20M	DFT-S 16QAM	1	1	22.15	22.21	22.16	1
20M	DFT-S 64QAM	1	1	20.05	20.22	20.15	2.5
20M	DFT-S 256QAM	1	1	18.48	18.63	18.55	4.5
20M	CP QPSK	1	1	22.09	22.15	22.14	1.5
BW	MCS Index	Channel		166300	167300	168300	3GPP MPR
		Frequency (MHz)		831.5	836.5	841.5	
15M	DFT-S PI/2 BPSK	1	1	22.81	23.08	22.96	0
15M	DFT-S QPSK	1	1	22.86	23.08	22.95	0
		1	40	22.94	23.05	22.95	0
		1	77	22.81	22.98	22.93	0
		36	0	22.02	22.11	22.04	1
		36	22	22.90	22.99	22.99	0
		36	43	22.30	22.30	22.30	1
75	0	22.17	22.30	22.29	1		
15M	DFT-S 16QAM	1	1	22.09	22.19	22.14	1
15M	DFT-S 64QAM	1	1	20.01	20.21	20.14	2.5
15M	DFT-S 256QAM	1	1	18.47	18.57	18.55	4.5
15M	CP QPSK	1	1	22.07	22.08	22.10	1.5

NR Conducted Power (Full)

NR Band 5_SA

BW	MCS Index	Channel		165800	167300	168800	3GPP MPR
		Frequency (MHz)		829	836.5	844	
10M	DFT-S PI/2 BPSK	1	1	22.81	23.03	22.75	0
10M	DFT-S QPSK	1	1	22.84	23.02	22.95	0
		1	26	22.86	22.95	22.88	0
		1	50	22.67	22.97	22.89	0
		25	0	21.93	22.11	21.98	1
		25	14	22.81	23.01	22.86	0
		25	27	22.25	22.31	22.27	1
10M	DFT-S 16QAM	1	1	22.14	22.03	22.08	1
10M	DFT-S 64QAM	1	1	19.99	20.11	20.09	2.5
10M	DFT-S 256QAM	1	1	18.26	18.42	18.41	4.5
10M	CP QPSK	1	1	22.00	22.02	21.96	1.5
BW	MCS Index	Channel		165300	167300	169300	3GPP MPR
		Frequency (MHz)		826.5	836.5	846.5	
5M	DFT-S PI/2 BPSK	1	1	22.86	22.95	22.72	0
5M	DFT-S QPSK	1	1	22.86	23.02	22.95	0
		1	13	22.85	22.90	22.80	0
		1	23	22.75	22.98	22.84	0
		12	0	21.98	22.13	21.99	1
		12	7	22.74	22.98	22.87	0
		12	13	22.30	22.18	22.14	1
5M	DFT-S 16QAM	1	1	22.12	22.08	22.01	1
5M	DFT-S 64QAM	1	1	19.87	20.08	20.00	2.5
5M	DFT-S 256QAM	1	1	18.26	18.61	18.44	4.5
5M	CP QPSK	1	1	21.96	22.00	21.96	1.5

NR Conducted Power (Full)

NR Band 7_SA

BW	MCS Index	Channel		502000	507000	512000	3GPP MPR
		Frequency (MHz)		2510	2535	2560	
20M	DFT-S PI/2 BPSK	1	1	22.13	22.26	22.15	0
20M	DFT-S QPSK	1	1	22.34	22.47	22.36	0
		1	53	22.21	22.34	22.23	0
		1	104	22.20	22.33	22.22	0
		50	0	21.22	21.35	21.24	1
		50	28	22.21	22.34	22.23	0
		50	56	21.18	21.31	21.20	1
		100	0	21.12	21.25	21.14	1
20M	DFT-S 16QAM	1	1	21.11	21.24	21.13	1
20M	DFT-S 64QAM	1	1	19.82	19.95	19.84	2.5
20M	DFT-S 256QAM	1	1	18.02	18.15	18.04	4.5
20M	CP QPSK	1	1	21.18	21.31	21.20	1.5
BW	MCS Index	Channel		501500	507000	512500	3GPP MPR
		Frequency (MHz)		2507.5	2535	2562.5	
15M	DFT-S PI/2 BPSK	1	1	22.06	22.17	22.08	0
15M	DFT-S QPSK	1	1	22.33	22.45	22.32	0
		1	40	22.14	22.33	22.21	0
		1	77	22.14	22.28	22.18	0
		36	0	21.13	21.25	21.22	1
		36	22	22.11	22.25	22.22	0
		36	43	21.16	21.27	21.16	1
		75	0	21.10	21.24	21.09	1
15M	DFT-S 16QAM	1	1	21.03	21.18	21.04	1
15M	DFT-S 64QAM	1	1	19.80	19.88	19.74	2.5
15M	DFT-S 256QAM	1	1	17.92	18.07	18.03	4.5
15M	CP QPSK	1	1	21.12	21.23	21.12	1.5

NR Conducted Power (Full)

NR Band 7_SA

BW	MCS Index	Channel		501000	507000	513000	3GPP MPR
		Frequency (MHz)		2505	2535	2565	
10M	DFT-S PI/2 BPSK	1	1	22.10	22.24	22.10	0
10M	DFT-S QPSK	1	1	22.29	22.38	22.27	0
		1	26	22.15	22.27	22.13	0
		1	50	22.19	22.25	22.16	0
		25	0	21.21	21.25	21.17	1
		25	14	22.18	22.30	22.22	0
		25	27	21.09	21.26	21.10	1
10M	DFT-S 16QAM	1	1	21.02	21.16	21.03	1
10M	DFT-S 64QAM	1	1	19.77	19.88	19.79	2.5
10M	DFT-S 256QAM	1	1	18.01	18.09	18.04	4.5
10M	CP QPSK	1	1	21.08	21.28	21.15	1.5
BW	MCS Index	Channel		500500	507000	513500	3GPP MPR
		Frequency (MHz)		2502.5	2535	2567.5	
5M	DFT-S PI/2 BPSK	1	1	22.04	22.24	22.15	0
5M	DFT-S QPSK	1	1	22.30	22.46	22.28	0
		1	13	22.16	22.25	22.18	0
		1	23	22.18	22.32	22.12	0
		12	0	21.20	21.26	21.20	1
		12	7	22.21	22.25	22.13	0
		12	13	21.11	21.27	21.15	1
5M	DFT-S 16QAM	1	1	21.11	21.16	21.07	1
5M	DFT-S 64QAM	1	1	19.72	19.86	19.79	2.5
5M	DFT-S 256QAM	1	1	17.99	18.12	18.01	4.5
5M	CP QPSK	1	1	21.18	21.30	21.14	1.5

NR Conducted Power (Full)

NR Band 25_SA

BW	MCS Index	Channel		372000	376500	381000	3GPP MPR
		Frequency (MHz)		1860	1882.5	1905	
20M	DFT-S PI/2 BPSK	1	1	22.16	22.70	22.80	0
20M	DFT-S QPSK	1	1	22.37	22.91	23.01	0
		1	53	22.33	22.87	22.97	0
		1	104	22.08	22.62	22.72	0
		50	0	21.27	21.81	21.91	1
		50	28	22.23	22.77	22.87	0
		50	56	21.15	21.69	21.79	1
		100	0	21.07	21.61	21.71	1
20M	DFT-S 16QAM	1	1	21.16	21.70	21.80	1
20M	DFT-S 64QAM	1	1	19.87	20.41	20.51	2.5
20M	DFT-S 256QAM	1	1	18.07	18.61	18.71	4.5
20M	CP QPSK	1	1	21.23	21.77	21.87	1.5
BW	MCS Index	Channel		371500	376500	381500	3GPP MPR
		Frequency (MHz)		1857.5	1882.5	1907.5	
15M	DFT-S PI/2 BPSK	1	1	22.11	22.62	22.74	0
15M	DFT-S QPSK	1	1	22.33	22.88	22.98	0
		1	40	22.33	22.82	22.88	0
		1	77	22.01	22.60	22.69	0
		36	0	21.20	21.79	21.90	1
		36	22	22.13	22.74	22.77	0
		36	43	21.08	21.62	21.77	1
		75	0	21.07	21.56	21.71	1
15M	DFT-S 16QAM	1	1	21.11	21.67	21.77	1
15M	DFT-S 64QAM	1	1	19.82	20.37	20.42	2.5
15M	DFT-S 256QAM	1	1	18.02	18.52	18.61	4.5
15M	CP QPSK	1	1	21.16	21.67	21.87	1.5

NR Conducted Power (Full)

NR Band 25_SA

BW	MCS Index	Channel		371000	376500	382000	3GPP MPR
		Frequency (MHz)		1855	1882.5	1910	
10M	DFT-S PI/2 BPSK	1	1	22.06	22.62	22.74	0
10M	DFT-S QPSK	1	1	22.34	22.91	22.93	0
		1	26	22.24	22.78	22.91	0
		1	50	22.06	22.57	22.71	0
		25	0	21.27	21.71	21.82	1
		25	14	22.16	22.75	22.78	0
		25	27	21.05	21.59	21.71	1
10M	DFT-S 16QAM	1	1	21.14	21.60	21.78	1
10M	DFT-S 64QAM	1	1	19.78	20.36	20.47	2.5
10M	DFT-S 256QAM	1	1	18.03	18.55	18.64	4.5
10M	CP QPSK	1	1	21.16	21.73	21.79	1.5
BW	MCS Index	Channel		370500	376500	382500	3GPP MPR
		Frequency (MHz)		1852.5	1882.5	1912.5	
5M	DFT-S PI/2 BPSK	1	1	22.11	22.63	22.76	0
5M	DFT-S QPSK	1	1	22.34	22.87	23.00	0
		1	13	22.30	22.84	22.96	0
		1	23	22.05	22.54	22.62	0
		12	0	21.23	21.72	21.89	1
		12	7	22.22	22.72	22.78	0
		12	13	21.13	21.63	21.70	1
5M	DFT-S 16QAM	1	1	21.13	21.69	21.75	1
5M	DFT-S 64QAM	1	1	19.79	20.40	20.46	2.5
5M	DFT-S 256QAM	1	1	18.05	18.53	18.71	4.5
5M	CP QPSK	1	1	21.22	21.70	21.79	1.5

NR Conducted Power (Full)

NR Band 30_SA

BW	MCS Index	RB Size	RB Offset	Mid		3GPP MPR (dB)	
		Channel		462000			
		Frequency (MHz)		2310			
10M	DFT-S PI/2 BPSK	1	1		22.66	0	
10M	DFT-S QPSK	1	1		22.79	0	
		1	26		22.67	0	
		1	50		22.52	0	
		25	0		21.37	1	
		25	14		22.18	0	
		25	27		21.11	1	
		50	0		21.01	1	
10M	DFT-S 16QAM	1	1		21.26	1	
10M	DFT-S 64QAM	1	1		19.97	2.5	
10M	DFT-S 256QAM	1	1		18.17	4.5	
10M	CP QPSK	1	1		21.33	1.5	
BW	MCS Index	Channel		461500	462000	462500	3GPP MPR
		Frequency (MHz)		2307.5	2310	2312.5	
5M	DFT-S PI/2 BPSK	1	1	22.65	22.59	22.60	0
5M	DFT-S QPSK	1	1	22.78	22.77	22.78	0
		1	13	22.64	22.65	22.60	0
		1	23	22.47	22.49	22.46	0
		12	0	21.34	21.32	21.31	1
		12	7	22.11	22.12	22.11	0
		12	13	21.11	21.08	21.08	1
		25	0	20.93	21.00	20.99	1
5M	DFT-S 16QAM	1	1	21.18	21.23	21.26	1
5M	DFT-S 64QAM	1	1	19.93	19.91	19.94	2.5
5M	DFT-S 256QAM	1	1	18.10	18.08	18.13	4.5
5M	CP QPSK	1	1	21.33	21.31	21.30	1.5

NR Conducted Power (Full)

NR Band 66_SA

BW	MCS Index	RB Size	RB Offset	Low	Mid	High	3GPP MPR (dB)
		Channel		346000	349000	352000	
		Frequency (MHz)		1730	1745	1760	
40M	DFT-S PI/2 BPSK	1	1	23.47	23.76	23.68	0
40M	DFT-S QPSK	1	1	23.56	23.86	23.77	0
		1	108	23.53	23.75	23.66	0
		1	214	23.56	23.78	23.75	0
		108	0	22.15	22.36	22.28	1
		108	54	23.71	23.85	23.82	0
		108	108	22.50	22.58	22.55	1
		216	0	22.37	22.52	22.50	1
40M	DFT-S 16QAM	1	1	22.60	22.75	22.75	1
40M	DFT-S 64QAM	1	1	20.86	20.95	20.95	2.5
40M	DFT-S 256QAM	1	1	19.09	19.33	19.30	4.5
40M	CP QPSK	1	1	22.27	22.48	22.39	1.5
BW	MCS Index	Channel		344000	349000	354000	3GPP MPR
		Frequency (MHz)		1720	1745	1770	
20M	DFT-S PI/2 BPSK	1	1	23.40	23.68	23.66	0
20M	DFT-S QPSK	1	1	23.47	23.85	23.74	0
		1	53	23.50	23.69	23.61	0
		1	104	23.46	23.74	23.71	0
		50	0	22.15	22.30	22.24	1
		50	28	23.61	23.75	23.77	0
		50	56	22.40	22.54	22.51	1
		100	0	22.36	22.46	22.45	1
20M	DFT-S 16QAM	1	1	22.57	22.74	22.65	1
20M	DFT-S 64QAM	1	1	20.81	20.95	20.87	2.5
20M	DFT-S 256QAM	1	1	19.07	19.30	19.23	4.5
20M	CP QPSK	1	1	22.23	22.47	22.29	1.5

NR Conducted Power (Full)

NR Band 66_SA

BW	MCS Index	Channel		343500	349000	354500	3GPP MPR
		Frequency (MHz)		1717.5	1745	1772.5	
15M	DFT-S PI/2 BPSK	1	1	23.27	23.65	23.56	0
15M	DFT-S QPSK	1	1	23.41	23.74	23.57	0
		1	40	23.37	23.55	23.63	0
		1	77	23.49	23.59	23.56	0
		36	0	22.06	22.28	22.12	1
		36	22	23.64	23.69	23.68	0
		36	43	22.41	22.46	22.37	1
15M	DFT-S 16QAM	1	1	22.36	22.51	22.72	1
15M	DFT-S 64QAM	1	1	20.71	20.80	20.88	2.5
15M	DFT-S 256QAM	1	1	18.91	19.19	19.16	4.5
15M	CP QPSK	1	1	22.09	22.32	22.30	1.5
BW	MCS Index	Channel		343000	349000	355000	3GPP MPR
		Frequency (MHz)		1715	1745	1775	
10M	DFT-S PI/2 BPSK	1	1	23.31	23.60	23.41	0
10M	DFT-S QPSK	1	1	23.55	23.66	23.55	0
		1	26	23.47	23.66	23.40	0
		1	50	23.43	23.68	23.57	0
		25	0	22.08	22.18	22.06	1
		25	14	23.65	23.74	23.59	0
		25	27	22.37	22.54	22.37	1
10M	DFT-S 16QAM	1	1	22.47	22.57	22.59	1
10M	DFT-S 64QAM	1	1	20.74	20.88	20.91	2.5
10M	DFT-S 256QAM	1	1	19.04	19.13	19.20	4.5
10M	CP QPSK	1	1	22.10	22.36	22.18	1.5

NR Conducted Power (Full)

NR Band 66_SA

BW	MCS Index	Channel		342500	349000	355500	3GPP MPR
		Frequency (MHz)		1712.5	1745	1777.5	
5M	DFT-S PI/2 BPSK	1	1	23.26	23.71	23.52	0
5M	DFT-S QPSK	1	1	23.45	23.77	23.64	0
		1	13	23.47	23.67	23.63	0
		1	23	23.53	23.67	23.59	0
		12	0	22.02	22.25	22.23	1
		12	7	23.53	23.69	23.78	0
		12	13	22.42	22.54	22.46	1
		25	0	22.30	22.50	22.35	1
5M	DFT-S 16QAM	1	1	22.41	22.64	22.66	1
5M	DFT-S 64QAM	1	1	20.76	20.94	20.83	2.5
5M	DFT-S 256QAM	1	1	18.97	19.21	19.11	4.5
5M	CP QPSK	1	1	22.04	22.27	22.30	1.5

NR Conducted Power (Full)

NR Band 71_SA

BW	MCS Index	RB Size	RB Offset	Low	Mid	High	3GPP MPR (dB)
		Channel		134600	136100	137600	
		Frequency (MHz)		673	680.5	688	
20M	DFT-S PI/2 BPSK	1	1	23.29	23.49	23.26	0
20M	DFT-S QPSK	1	1	23.41	23.61	23.38	0
		1	53	23.21	23.41	23.18	0
		1	104	23.08	23.28	23.05	0
		50	0	22.59	22.79	22.56	1
		50	28	23.24	23.44	23.21	0
		50	56	23.16	23.36	23.13	1
100	0	22.33	22.53	22.30	1		
20M	DFT-S 16QAM	1	1	22.44	22.64	22.41	1
20M	DFT-S 64QAM	1	1	20.39	20.59	20.36	2.5
20M	DFT-S 256QAM	1	1	18.29	18.49	18.26	4.5
20M	CP QPSK	1	1	21.39	21.59	21.36	1.5
BW	MCS Index	Channel		134100	136100	138100	3GPP MPR
		Frequency (MHz)		670.5	680.5	690.5	
15M	DFT-S PI/2 BPSK	1	1	23.25	23.43	23.20	0
15M	DFT-S QPSK	1	1	23.33	23.51	23.29	0
		1	40	23.11	23.40	23.09	0
		1	77	23.07	23.25	23.05	0
		36	0	22.52	22.79	22.54	1
		36	22	23.16	23.41	23.19	0
		36	43	23.15	23.34	23.04	1
75	0	22.30	22.51	22.23	1		
15M	DFT-S 16QAM	1	1	22.34	22.56	22.35	1
15M	DFT-S 64QAM	1	1	20.37	20.50	20.32	2.5
15M	DFT-S 256QAM	1	1	18.22	18.46	18.21	4.5
15M	CP QPSK	1	1	21.30	21.49	21.28	1.5

NR Conducted Power (Full)

NR Band 71_SA

BW	MCS Index	Channel		133600	136100	138600	3GPP MPR
		Frequency (MHz)		668	680.5	693	
10M	DFT-S PI/2 BPSK	1	1	23.24	23.46	23.18	0
10M	DFT-S QPSK	1	1	23.40	23.60	23.35	0
		1	26	23.19	23.38	23.11	0
		1	50	23.01	23.18	23.02	0
		25	0	22.52	22.77	22.56	1
		25	14	23.20	23.35	23.14	0
		25	27	23.16	23.36	23.03	1
10M	DFT-S 16QAM	1	1	22.44	22.62	22.35	1
10M	DFT-S 64QAM	1	1	20.30	20.49	20.27	2.5
10M	DFT-S 256QAM	1	1	18.20	18.43	18.20	4.5
10M	CP QPSK	1	1	21.39	21.49	21.36	1.5
BW	MCS Index	Channel		133100	136100	139100	3GPP MPR
		Frequency (MHz)		665.5	680.5	695.5	
5M	DFT-S PI/2 BPSK	1	1	23.28	23.45	23.26	0
5M	DFT-S QPSK	1	1	23.36	23.57	23.36	0
		1	13	23.11	23.40	23.14	0
		1	23	23.00	23.18	22.98	0
		12	0	22.54	22.74	22.50	1
		12	7	23.20	23.41	23.14	0
		12	13	23.16	23.31	23.05	1
5M	DFT-S 16QAM	1	1	22.42	22.64	22.35	1
5M	DFT-S 64QAM	1	1	20.30	20.53	20.27	2.5
5M	DFT-S 256QAM	1	1	18.23	18.43	18.25	4.5
5M	CP QPSK	1	1	21.38	21.53	21.26	1.5

NR Conducted Power (Full)							
NR Band 38_SA							
BW	MCS Index	Channel		516000	519000	522000	3GPP MPR
		Frequency (MHz)		2580	2595	2610	
20M	DFT-S PI/2 BPSK	1	1	23.20	23.21	23.19	0
20M	DFT-S QPSK	1	1	23.32	23.33	23.31	0
		1	26	23.29	23.30	23.27	0
		1	49	23.20	23.21	23.18	0
		25	0	22.37	22.38	22.35	1
		25	13	23.17	23.18	23.15	0
		25	26	22.30	22.31	22.28	1
20M	DFT-S 16QAM	1	1	22.22	22.23	22.20	1
20M	DFT-S 64QAM	1	1	20.17	20.18	20.15	2.5
20M	DFT-S 256QAM	1	1	18.27	18.28	18.25	4.5
20M	CP QPSK	1	1	21.07	21.08	21.05	1.5
BW	MCS Index	Channel		515500	519000	522500	3GPP MPR
		Frequency (MHz)		2577.5	2595	2612.5	
15M	DFT-S PI/2 BPSK	1	1	23.10	23.20	23.18	0
15M	DFT-S QPSK	1	1	23.24	23.32	23.23	0
		1	19	23.22	23.22	23.18	0
		1	36	23.20	23.17	23.16	0
		18	0	22.37	22.29	22.31	1
		18	10	23.08	23.08	23.15	0
		18	20	22.28	22.24	22.18	1
15M	DFT-S 16QAM	1	1	22.16	22.16	22.12	1
15M	DFT-S 64QAM	1	1	20.08	20.17	20.09	2.5
15M	DFT-S 256QAM	1	1	18.20	18.27	18.16	4.5
15M	CP QPSK	1	1	21.00	21.00	20.96	1.5

NR Conducted Power (Full)							
NR Band 38_SA							
BW	MCS Index	Channel		515000	519000	523000	3GPP MPR
		Frequency (MHz)		2575	2595	2615	
10M	DFT-S PI/2 BPSK	1	1	23.11	23.17	23.13	0
10M	DFT-S QPSK	1	1	23.26	23.28	23.27	0
		1	11	23.19	23.28	23.21	0
		1	22	23.14	23.14	23.09	0
		12	0	22.34	22.32	22.33	1
		12	6	23.11	23.12	23.13	0
		12	12	22.21	22.26	22.19	1
		24	0	22.22	22.20	22.22	1
10M	DFT-S 16QAM	1	1	22.19	22.22	22.17	1
10M	DFT-S 64QAM	1	1	20.12	20.09	20.11	2.5
10M	DFT-S 256QAM	1	1	18.23	18.28	18.17	4.5
10M	CP QPSK	1	1	20.99	21.04	21.01	1.5

NR Conducted Power (Full)							
NR Band 40_SA							
BW	MCS Index	Channel		468000	470000	472000	3GPP MPR
		Frequency (MHz)		2340	2350	2360	
80M	DFT-S PI/2 BPSK	1	1	23.40	23.50	23.49	0
80M	DFT-S QPSK	1	1	23.65	23.69	23.59	0
		1	109	23.41	23.51	23.43	0
		1	215	22.42	22.47	22.39	0
		108	0	22.80	22.83	22.83	1
		108	55	23.55	23.57	23.52	0
		108	109	22.49	22.58	22.49	1
80M	DFT-S 16QAM	1	1	22.64	22.68	22.67	1
80M	DFT-S 64QAM	1	1	20.47	20.53	20.45	2.5
80M	DFT-S 256QAM	1	1	18.53	18.63	18.58	4.5
80M	CP QPSK	1	1	22.10	22.13	22.09	1.5
BW	MCS Index	Channel		466000	470000	474000	3GPP MPR
		Frequency (MHz)		2330	2350	2370	
60M	DFT-S PI/2 BPSK	1	1	23.40	23.46	23.49	0
60M	DFT-S QPSK	1	1	23.65	23.66	23.65	0
		1	81	23.48	23.50	23.47	0
		1	160	22.45	22.44	22.47	0
		81	0	22.73	22.82	22.77	1
		81	41	23.47	23.47	23.48	0
		81	81	22.51	22.49	22.49	1
60M	DFT-S 16QAM	1	1	22.66	22.59	22.60	1
60M	DFT-S 64QAM	1	1	20.49	20.47	20.44	2.5
60M	DFT-S 256QAM	1	1	18.57	18.61	18.63	4.5
60M	CP QPSK	1	1	22.07	22.09	22.12	1.5

NR Conducted Power (Full)							
NR Band 40_SA							
BW	MCS Index	Channel		465000	470000	475000	3GPP MPR
		Frequency (MHz)		2325	2350	2375	
50M	DFT-S PI/2 BPSK	1	1	23.40	23.49	23.40	0
50M	DFT-S QPSK	1	1	23.67	23.58	23.65	0
		1	67	23.41	23.43	23.42	0
		1	131	22.37	22.40	22.43	0
		64	0	22.74	22.79	22.79	1
		64	35	23.49	23.48	23.48	0
		64	69	22.49	22.51	22.51	1
50M	DFT-S 16QAM	1	1	22.62	22.64	22.64	1
50M	DFT-S 64QAM	1	1	20.45	20.46	20.47	2.5
50M	DFT-S 256QAM	1	1	18.63	18.55	18.62	4.5
50M	CP QPSK	1	1	22.04	22.12	22.11	1.5
BW	MCS Index	Channel		464000	470000	476000	3GPP MPR
		Frequency (MHz)		2320	2350	2380	
40M	DFT-S PI/2 BPSK	1	1	23.42	23.47	23.50	0
40M	DFT-S QPSK	1	1	23.57	23.61	23.64	0
		1	53	23.46	23.45	23.46	0
		1	104	22.43	22.43	22.37	0
		50	0	22.77	22.83	22.73	1
		50	28	23.56	23.54	23.52	0
		50	56	22.50	22.51	22.52	1
40M	DFT-S 16QAM	1	1	22.63	22.64	22.66	1
40M	DFT-S 64QAM	1	1	20.43	20.52	20.50	2.5
40M	DFT-S 256QAM	1	1	18.59	18.63	18.59	4.5
40M	CP QPSK	1	1	22.09	22.10	22.03	1.5

NR Conducted Power (Full)							
NR Band 40_SA							
BW	MCS Index	Channel		462000	470000	478000	3GPP MPR
		Frequency (MHz)		2310	2350	2390	
20M	DFT-S PI/2 BPSK	1	1	23.42	23.44	23.47	0
20M	DFT-S QPSK	1	1	23.63	23.62	23.63	0
		1	26	23.46	23.41	23.45	0
		1	49	22.40	22.46	22.42	0
		25	0	22.77	22.82	22.77	1
		25	13	23.54	23.55	23.52	0
		25	26	22.57	22.52	22.55	1
50	0	22.49	22.53	22.54	1		
20M	DFT-S 16QAM	1	1	22.64	22.63	22.59	1
20M	DFT-S 64QAM	1	1	20.49	20.45	20.45	2.5
20M	DFT-S 256QAM	1	1	18.60	18.60	18.56	4.5
20M	CP QPSK	1	1	22.13	22.04	22.04	1.5
BW	MCS Index	Channel		461500	470000	478500	3GPP MPR
		Frequency (MHz)		2307.5	2350	2392.5	
15M	DFT-S PI/2 BPSK	1	1	23.50	23.50	23.44	0
15M	DFT-S QPSK	1	1	23.61	23.65	23.66	0
		1	19	23.43	23.44	23.49	0
		1	36	22.44	22.40	22.46	0
		18	0	22.83	22.78	22.83	1
		18	10	23.56	23.55	23.51	0
		18	20	22.54	22.55	22.56	1
36	0	22.47	22.48	22.56	1		
15M	DFT-S 16QAM	1	1	22.63	22.64	22.61	1
15M	DFT-S 64QAM	1	1	20.46	20.43	20.53	2.5
15M	DFT-S 256QAM	1	1	18.56	18.57	18.56	4.5
15M	CP QPSK	1	1	22.07	22.04	22.13	1.5

NR Conducted Power (Full)							
NR Band 40_SA							
BW	MCS Index	Channel		461000	470000	479000	3GPP MPR
		Frequency (MHz)		2305	2350	2395	
10M	DFT-S PI/2 BPSK	1	1	23.50	23.48	23.45	0
10M	DFT-S QPSK	1	1	23.58	23.58	23.67	0
		1	11	23.48	23.51	23.50	0
		1	22	22.38	22.37	22.44	0
		12	0	22.76	22.79	22.83	1
		12	6	23.51	23.50	23.49	0
		12	12	22.57	22.53	22.58	1
		24	0	22.53	22.46	22.50	1
10M	DFT-S 16QAM	1	1	22.68	22.66	22.65	1
10M	DFT-S 64QAM	1	1	20.45	20.51	20.46	2.5
10M	DFT-S 256QAM	1	1	18.63	18.61	18.58	4.5
10M	CP QPSK	1	1	22.09	22.06	22.07	1.5

NR Conducted Power (Full)									
NR Band 41_SA_PC2									
BW	MCS Index	RB Size	RB Offset	Low	Mid-1	Mid-2	Mid-3	High	3GPP MPR (dB)
		Channel		509202	513900	518598	523302	528000	
		Frequency (MHz)		2546.01	2569.5	2592.99	2616.51	2640	
100M	DFT-S PI/2 BPSK	1	1	26.60	26.62	26.65	26.58	26.61	0
100M	DFT-S QPSK	1	1	26.69	26.71	26.74	26.67	26.70	0
		1	137	26.50	26.52	26.55	26.48	26.51	0
		1	271	25.72	25.74	25.77	25.70	25.73	0
		135	0	25.71	25.73	25.76	25.69	25.72	1
		135	69	26.65	26.67	26.70	26.63	26.66	0
		135	138	25.67	25.69	25.72	25.65	25.68	1
100M	DFT-S 16QAM	1	1	25.59	25.61	25.64	25.57	25.60	1
100M	DFT-S 64QAM	1	1	24.29	24.31	24.34	24.27	24.30	2.5
100M	DFT-S 256QAM	1	1	22.29	22.31	22.34	22.27	22.30	4.5
100M	CP QPSK	1	1	25.39	25.41	25.44	25.37	25.40	1.5
BW	MCS Index	Channel		508200	513402	518598	523800	528996	3GPP MPR
		Frequency (MHz)		2541	2567.01	2592.99	2619	2644.98	
90M	DFT-S PI/2 BPSK	1	1	26.58	26.56	26.56	26.58	26.59	0
90M	DFT-S QPSK	1	1	26.62	26.64	26.69	26.63	26.70	0
		1	123	26.49	26.46	26.47	26.50	26.49	0
		1	243	25.69	25.68	25.67	25.69	25.66	0
		120	0	25.69	25.68	25.75	25.63	25.68	1
		120	63	26.60	26.59	26.60	26.58	26.64	0
		120	125	25.59	25.59	25.62	25.64	25.61	1
90M	DFT-S 16QAM	1	1	25.53	25.51	25.64	25.53	25.52	1
90M	DFT-S 64QAM	1	1	24.28	24.30	24.34	24.24	24.30	2.5
90M	DFT-S 256QAM	1	1	22.22	22.30	22.33	22.26	22.30	4.5
90M	CP QPSK	1	1	25.36	25.37	25.35	25.33	25.35	1.5

NR Conducted Power (Full)

NR Band 41_SA_PC2

BW	MCS Index	Channel		507204	509304	518598	500298	529998	3GPP MPR
		Frequency (MHz)		2536.02	2546.52	2592.99	2621.49	2649.99	
80M	DFT-S PI/2 BPSK	1	1	26.59	26.57	26.57	26.59	26.56	0
80M	DFT-S QPSK	1	1	26.69	26.69	26.73	26.65	26.62	0
		1	109	26.43	26.50	26.54	26.50	26.45	0
		1	215	25.64	25.66	25.69	25.72	25.64	0
		108	0	25.63	25.65	25.67	25.67	25.69	1
		108	55	26.61	26.60	26.62	26.57	26.60	0
		108	109	25.60	25.59	25.65	25.61	25.62	1
80M	DFT-S 16QAM	1	1	25.52	25.55	25.60	25.59	25.52	1
80M	DFT-S 64QAM	1	1	24.20	24.24	24.30	24.20	24.29	2.5
80M	DFT-S 256QAM	1	1	22.28	22.23	22.25	22.23	22.26	4.5
80M	CP QPSK	1	1	25.36	25.32	25.41	25.38	25.36	1.5
BW	MCS Index	Channel		506202	512400	518598	524802	531000	3GPP MPR
		Frequency (MHz)		2531.01	2562	2592.99	2624.01	2655	
70M	DFT-S PI/2 BPSK	1	1	26.53	26.55	26.57	26.51	26.62	0
70M	DFT-S QPSK	1	1	26.65	26.69	26.70	26.68	26.69	0
		1	95	26.42	26.52	26.46	26.50	26.42	0
		1	187	25.70	25.70	25.73	25.69	25.66	0
		90	0	25.67	25.65	25.67	25.70	25.64	1
		90	50	26.65	26.60	26.69	26.55	26.59	0
		90	99	25.59	25.66	25.71	25.58	25.66	1
70M	DFT-S 16QAM	1	1	25.52	25.59	25.56	25.53	25.60	1
70M	DFT-S 64QAM	1	1	24.28	24.26	24.26	24.28	24.31	2.5
70M	DFT-S 256QAM	1	1	22.19	22.22	22.24	22.22	22.21	4.5
70M	CP QPSK	1	1	25.36	25.41	25.43	25.29	25.41	1.5

NR Conducted Power (Full)

NR Band 41_SA_PC2

BW	MCS Index	Channel		505200	511896	518598	525294	531996	3GPP MPR
		Frequency (MHz)		2526	2559.48	2592.99	2626.48	2659.98	
60M	DFT-S PI/2 BPSK	1	1	26.53	26.56	26.62	26.51	26.58	0
60M	DFT-S QPSK	1	1	26.60	26.69	26.64	26.63	26.62	0
		1	81	26.50	26.50	26.52	26.49	26.48	0
		1	160	25.63	25.69	25.75	25.69	25.67	0
		81	0	25.71	25.67	25.73	25.67	25.66	1
		81	41	26.63	26.60	26.65	26.64	26.60	0
		81	81	25.64	25.60	25.65	25.66	25.66	1
60M	DFT-S 16QAM	1	1	25.49	25.59	25.64	25.55	25.59	1
60M	DFT-S 64QAM	1	1	24.20	24.26	24.25	24.28	24.22	2.5
60M	DFT-S 256QAM	1	1	22.28	22.22	22.26	22.26	22.31	4.5
60M	CP QPSK	1	1	25.34	25.36	25.37	25.31	25.38	1.5
BW	MCS Index	Channel		504204	511404	518598	525798	532998	3GPP MPR
		Frequency (MHz)		2521.02	2557.02	2592.99	2628.99	2664.99	
50M	DFT-S PI/2 BPSK	1	1	26.57	26.61	26.61	26.58	26.60	0
50M	DFT-S QPSK	1	1	26.66	26.64	26.64	26.68	26.63	0
		1	67	26.49	26.46	26.47	26.49	26.50	0
		1	131	25.65	25.66	25.76	25.69	25.72	0
		64	0	25.68	25.70	25.73	25.71	25.72	1
		64	35	26.56	26.58	26.70	26.60	26.57	0
		64	69	25.60	25.64	25.67	25.65	25.68	1
50M	DFT-S 16QAM	1	1	25.53	25.59	25.59	25.54	25.52	1
50M	DFT-S 64QAM	1	1	24.28	24.31	24.33	24.24	24.30	2.5
50M	DFT-S 256QAM	1	1	22.26	22.27	22.28	22.25	22.29	4.5
50M	CP QPSK	1	1	25.37	25.33	25.35	25.30	25.41	1.5

NR Conducted Power (Full)

NR Band 41_SA_PC2

BW	MCS Index	Channel		503202	510900	518598	526296	534000	3GPP MPR
		Frequency (MHz)		2516.01	2554.5	2592.99	2631.48	2670	
40M	DFT-S PI/2 BPSK	1	1	26.59	26.59	26.58	26.57	26.53	0
40M	DFT-S QPSK	1	1	26.59	26.63	26.68	26.62	26.70	0
		1	53	26.50	26.48	26.51	26.44	26.47	0
		1	104	25.63	25.74	25.68	25.72	25.66	0
		50	0	25.68	25.69	25.67	25.71	25.72	1
		50	28	26.63	26.58	26.69	26.57	26.67	0
		50	56	25.57	25.65	25.62	25.64	25.60	1
100	0	25.65	25.67	25.69	25.65	25.60	1		
40M	DFT-S 16QAM	1	1	25.52	25.52	25.57	25.52	25.53	1
40M	DFT-S 64QAM	1	1	24.25	24.24	24.34	24.25	24.30	2.5
40M	DFT-S 256QAM	1	1	22.29	22.22	22.33	22.23	22.29	4.5
40M	CP QPSK	1	1	25.32	25.39	25.41	25.30	25.35	1.5
BW	MCS Index	Channel		501204	509898	518598	527298	535998	3GPP MPR
		Frequency (MHz)		2506.02	2549.49	2592.99	2636.49	2679.99	
20M	DFT-S PI/2 BPSK	1	1	26.59	26.56	26.65	26.50	26.54	0
20M	DFT-S QPSK	1	1	26.60	26.64	26.66	26.67	26.71	0
		1	26	26.40	26.42	26.51	26.42	26.45	0
		1	49	25.71	25.67	25.75	25.71	25.70	0
		25	0	25.66	25.63	25.67	25.69	25.69	1
		25	13	26.65	26.62	26.63	26.61	26.67	0
		25	26	25.67	25.59	25.70	25.67	25.69	1
50	0	25.57	25.66	25.63	25.56	25.61	1		
20M	DFT-S 16QAM	1	1	25.54	25.52	25.56	25.59	25.57	1
20M	DFT-S 64QAM	1	1	24.22	24.24	24.31	24.26	24.21	2.5
20M	DFT-S 256QAM	1	1	22.27	22.24	22.30	22.20	22.23	4.5
20M	CP QPSK	1	1	25.38	25.41	25.39	25.30	25.34	1.5

NR Conducted Power (Full)

NR Band 41_SA_PC2

BW	MCS Index	Channel		500700	509646	518598	527544	536496	3GPP MPR
		Frequency (MHz)		2503.5	2548.23	2592.99	2637.72	2682.48	
15M	DFT-S PI/2 BPSK	1	1	26.58	26.59	26.64	26.51	26.60	0
15M	DFT-S QPSK	1	1	26.67	26.69	26.68	26.61	26.65	0
		1	19	26.43	26.44	26.53	26.44	26.42	0
		1	36	25.62	25.73	25.70	25.67	25.67	0
		18	0	25.66	25.64	25.73	25.63	25.63	1
		18	10	26.59	26.67	26.64	26.59	26.64	0
		18	20	25.59	25.61	25.65	25.65	25.65	1
		36	0	25.60	25.64	25.61	25.63	25.62	1
15M	DFT-S 16QAM	1	1	25.56	25.61	25.56	25.55	25.54	1
15M	DFT-S 64QAM	1	1	24.19	24.28	24.25	24.24	24.31	2.5
15M	DFT-S 256QAM	1	1	22.29	22.23	22.30	22.23	22.29	4.5
15M	CP QPSK	1	1	25.39	25.35	25.37	25.29	25.41	1.5
BW	MCS Index	Channel		500202	509400	518598	527796	537000	3GPP MPR
		Frequency (MHz)		2501.01	2547	2592.99	2638.98	2685	
10M	DFT-S PI/2 BPSK	1	1	26.50	26.53	26.60	26.55	26.58	0
10M	DFT-S QPSK	1	1	26.65	26.69	26.66	26.69	26.61	0
		1	11	26.40	26.48	26.50	26.45	26.48	0
		1	22	25.65	25.69	25.69	25.68	25.74	0
		12	0	25.69	25.72	25.72	25.68	25.68	1
		12	6	26.63	26.59	26.66	26.59	26.63	0
		12	12	25.62	25.64	25.70	25.58	25.67	1
		24	0	25.56	25.67	25.61	25.63	25.59	1
10M	DFT-S 16QAM	1	1	25.59	25.57	25.60	25.53	25.59	1
10M	DFT-S 64QAM	1	1	24.22	24.24	24.29	24.23	24.22	2.5
10M	DFT-S 256QAM	1	1	22.24	22.26	22.32	22.20	22.28	4.5
10M	CP QPSK	1	1	25.38	25.33	25.35	25.36	25.33	1.5

NR Conducted Power (Full)									
NR Band 41_SA_PC3									
BW	MCS Index	RB Size	RB Offset	Low	Mid-1	Mid-2	Mid-3	High	3GPP MPR (dB)
		Channel		509202	513900	518598	523302	528000	
		Frequency (MHz)		2546.01	2569.5	2592.99	2616.51	2640	
100M	DFT-S PI/2 BPSK	1	1	23.12	23.34	23.67	23.66	23.64	0
100M	DFT-S QPSK	1	1	23.27	23.49	23.82	23.81	23.79	0
		1	137	23.00	23.22	23.55	23.54	23.52	0
		1	271	22.22	22.44	22.77	22.76	22.74	0
		135	0	22.21	22.43	22.76	22.75	22.73	1
		135	69	23.15	23.37	23.70	23.69	23.67	0
		135	138	22.17	22.39	22.72	22.71	22.69	1
100M	DFT-S 16QAM	1	1	22.10	22.32	22.65	22.64	22.62	1
100M	DFT-S 64QAM	1	1	20.01	20.23	20.56	20.55	20.53	2.5
100M	DFT-S 256QAM	1	1	17.91	18.13	18.46	18.45	18.43	4.5
100M	CP QPSK	1	1	22.08	22.30	22.63	22.62	22.60	1.5
BW	MCS Index	Channel		508200	513402	518598	523800	528996	3GPP MPR
		Frequency (MHz)		2541	2567.01	2592.99	2619	2644.98	
90M	DFT-S PI/2 BPSK	1	1	23.07	23.26	23.60	23.08	23.30	0
90M	DFT-S QPSK	1	1	23.20	23.46	23.72	23.22	23.39	0
		1	123	22.94	23.18	23.49	22.90	23.20	0
		1	243	22.14	22.39	22.71	22.22	22.34	0
		120	0	22.16	22.36	22.68	22.20	22.40	1
		120	63	23.10	23.28	23.61	23.09	23.30	0
		120	125	22.12	22.36	22.69	22.08	22.29	1
90M	DFT-S 16QAM	1	1	22.08	22.31	22.60	22.08	22.32	1
90M	DFT-S 64QAM	1	1	19.94	20.15	20.52	20.00	20.16	2.5
90M	DFT-S 256QAM	1	1	17.87	18.06	18.38	17.90	18.09	4.5
90M	CP QPSK	1	1	22.05	22.29	22.53	22.08	22.27	1.5

NR Conducted Power (Full)

NR Band 41_SA_PC3

BW	MCS Index	Channel		507204	509304	518598	500298	529998	3GPP MPR
		Frequency (MHz)		2536.02	2546.52	2592.99	2621.49	2649.99	
80M	DFT-S PI/2 BPSK	1	1	23.08	23.24	23.57	23.11	23.25	0
80M	DFT-S QPSK	1	1	23.24	23.39	23.75	23.19	23.48	0
		1	109	22.92	23.19	23.55	22.97	23.14	0
		1	215	22.16	22.36	22.77	22.20	22.42	0
		108	0	22.20	22.39	22.67	22.19	22.35	1
		108	55	23.13	23.29	23.66	23.15	23.36	0
		108	109	22.16	22.38	22.72	22.08	22.33	1
80M	DFT-S 16QAM	1	1	22.09	22.23	22.65	22.00	22.29	1
80M	DFT-S 64QAM	1	1	19.97	20.23	20.49	19.93	20.21	2.5
80M	DFT-S 256QAM	1	1	17.87	18.10	18.44	17.81	18.12	4.5
80M	CP QPSK	1	1	22.06	22.26	22.63	22.02	22.24	1.5
BW	MCS Index	Channel		506202	512400	518598	524802	531000	3GPP MPR
		Frequency (MHz)		2531.01	2562	2592.99	2624.01	2655	
70M	DFT-S PI/2 BPSK	1	1	23.05	23.29	23.61	23.04	23.31	0
70M	DFT-S QPSK	1	1	23.21	23.43	23.75	23.22	23.42	0
		1	95	22.91	23.19	23.55	22.90	23.19	0
		1	187	22.22	22.43	22.71	22.15	22.36	0
		90	0	22.16	22.41	22.67	22.11	22.34	1
		90	50	23.07	23.32	23.68	23.11	23.35	0
		90	99	22.13	22.39	22.66	22.07	22.38	1
70M	DFT-S 16QAM	1	1	22.06	22.22	22.60	22.01	22.28	1
70M	DFT-S 64QAM	1	1	19.98	20.13	20.47	19.94	20.22	2.5
70M	DFT-S 256QAM	1	1	17.84	18.13	18.36	17.91	18.09	4.5
70M	CP QPSK	1	1	22.02	22.23	22.53	22.02	22.25	1.5

NR Conducted Power (Full)

NR Band 41_SA_PC3

BW	MCS Index	Channel		505200	511896	518598	525294	531996	3GPP MPR
		Frequency (MHz)		2526	2559.48	2592.99	2626.48	2659.98	
60M	DFT-S PI/2 BPSK	1	1	23.05	23.26	23.57	23.07	23.26	0
60M	DFT-S QPSK	1	1	23.23	23.41	23.74	23.20	23.48	0
		1	81	22.99	23.20	23.51	22.96	23.19	0
		1	160	22.16	22.40	22.77	22.15	22.34	0
		81	0	22.16	22.33	22.70	22.15	22.43	1
		81	41	23.11	23.36	23.69	23.08	23.31	0
		81	81	22.13	22.33	22.67	22.13	22.33	1
60M	DFT-S 16QAM	1	1	22.10	22.24	22.56	22.04	22.31	1
60M	DFT-S 64QAM	1	1	19.92	20.22	20.52	20.00	20.21	2.5
60M	DFT-S 256QAM	1	1	17.84	18.10	18.42	17.83	18.12	4.5
60M	CP QPSK	1	1	22.06	22.22	22.54	21.98	22.21	1.5
BW	MCS Index	Channel		504204	511404	518598	525798	532998	3GPP MPR
		Frequency (MHz)		2521.02	2557.02	2592.99	2628.99	2664.99	
50M	DFT-S PI/2 BPSK	1	1	23.05	23.27	23.64	23.05	23.25	0
50M	DFT-S QPSK	1	1	23.22	23.45	23.76	23.21	23.48	0
		1	67	22.92	23.13	23.50	22.90	23.20	0
		1	131	22.17	22.42	22.77	22.18	22.36	0
		64	0	22.11	22.38	22.66	22.11	22.40	1
		64	35	23.09	23.32	23.61	23.14	23.34	0
		64	69	22.17	22.34	22.71	22.13	22.32	1
50M	DFT-S 16QAM	1	1	22.08	22.27	22.58	22.02	22.32	1
50M	DFT-S 64QAM	1	1	19.93	20.14	20.46	19.99	20.17	2.5
50M	DFT-S 256QAM	1	1	17.89	18.04	18.36	17.81	18.11	4.5
50M	CP QPSK	1	1	22.02	22.28	22.62	22.03	22.23	1.5

NR Conducted Power (Full)

NR Band 41_SA_PC3

BW	MCS Index	Channel		503202	510900	518598	526296	534000	3GPP MPR
		Frequency (MHz)		2516.01	2554.5	2592.99	2631.48	2670	
40M	DFT-S PI/2 BPSK	1	1	23.10	23.32	23.62	23.10	23.33	0
40M	DFT-S QPSK	1	1	23.20	23.41	23.75	23.19	23.41	0
		1	53	22.92	23.21	23.48	22.91	23.20	0
		1	104	22.16	22.37	22.68	22.22	22.38	0
		50	0	22.21	22.36	22.69	22.21	22.43	1
		50	28	23.08	23.37	23.66	23.15	23.29	0
		50	56	22.11	22.36	22.72	22.12	22.33	1
40M	DFT-S 16QAM	1	1	22.02	22.27	22.62	22.10	22.22	1
40M	DFT-S 64QAM	1	1	19.97	20.16	20.55	19.93	20.20	2.5
40M	DFT-S 256QAM	1	1	17.90	18.08	18.41	17.91	18.10	4.5
40M	CP QPSK	1	1	22.01	22.25	22.54	22.00	22.26	1.5
BW	MCS Index	Channel		501204	509898	518598	527298	535998	3GPP MPR
		Frequency (MHz)		2506.02	2549.49	2592.99	2636.49	2679.99	
20M	DFT-S PI/2 BPSK	1	1	23.05	23.32	23.60	23.07	23.30	0
20M	DFT-S QPSK	1	1	23.23	23.47	23.72	23.22	23.49	0
		1	26	22.95	23.22	23.51	22.90	23.19	0
		1	49	22.20	22.43	22.68	22.14	22.43	0
		25	0	22.16	22.33	22.70	22.16	22.33	1
		25	13	23.05	23.37	23.63	23.09	23.33	0
		25	26	22.16	22.38	22.64	22.17	22.34	1
20M	DFT-S 16QAM	1	1	22.04	22.30	22.56	22.08	22.28	1
20M	DFT-S 64QAM	1	1	20.01	20.17	20.53	19.93	20.21	2.5
20M	DFT-S 256QAM	1	1	17.82	18.09	18.37	17.85	18.13	4.5
20M	CP QPSK	1	1	22.04	22.27	22.54	22.01	22.28	1.5

NR Conducted Power (Full)									
NR Band 41_SA_PC3									
BW	MCS Index	Channel		500700	509646	518598	527544	536496	3GPP MPR
		Frequency (MHz)		2503.5	2548.23	2592.99	2637.72	2682.48	
15M	DFT-S PI/2 BPSK	1	1	23.12	23.25	23.67	23.02	23.31	0
15M	DFT-S QPSK	1	1	23.17	23.45	23.74	23.24	23.48	0
		1	19	22.94	23.16	23.47	22.96	23.18	0
		1	36	22.21	22.35	22.77	22.19	22.43	0
		18	0	22.21	22.39	22.67	22.21	22.42	1
		18	10	23.13	23.29	23.68	23.05	23.28	0
		18	20	22.13	22.31	22.67	22.11	22.33	1
36	0	22.06	22.34	22.68	22.14	22.32	1		
15M	DFT-S 16QAM	1	1	22.04	22.25	22.56	22.08	22.30	1
15M	DFT-S 64QAM	1	1	19.96	20.19	20.50	19.96	20.21	2.5
15M	DFT-S 256QAM	1	1	17.81	18.09	18.43	17.86	18.12	4.5
15M	CP QPSK	1	1	22.04	22.23	22.53	22.02	22.30	1.5
BW	MCS Index	Channel		500202	509400	518598	527796	537000	3GPP MPR
		Frequency (MHz)		2501.01	2547	2592.99	2638.98	2685	
10M	DFT-S PI/2 BPSK	1	1	23.10	23.30	23.64	23.03	23.32	0
10M	DFT-S QPSK	1	1	23.18	23.41	23.81	23.27	23.39	0
		1	11	22.90	23.22	23.53	22.93	23.13	0
		1	22	22.20	22.38	22.72	22.21	22.35	0
		12	0	22.20	22.33	22.69	22.13	22.40	1
		12	6	23.12	23.34	23.62	23.07	23.36	0
		12	12	22.08	22.39	22.63	22.12	22.39	1
24	0	22.10	22.35	22.67	22.09	22.38	1		
10M	DFT-S 16QAM	1	1	22.04	22.28	22.57	22.08	22.32	1
10M	DFT-S 64QAM	1	1	19.99	20.18	20.48	19.95	20.23	2.5
10M	DFT-S 256QAM	1	1	17.91	18.09	18.44	17.84	18.09	4.5
10M	CP QPSK	1	1	21.99	22.30	22.53	21.99	22.25	1.5

NR Conducted Power (Full)									
NR Band 77_SA_PC2									
BW	MCS Index	RB Size	RB Offset	Low	Mid-1	Mid-2	Mid-3	High	3GPP MPR (dB)
		Channel		650000	653000	656000	659000	662000	
		Frequency (MHz)		3750	3795	3840	3885	3930	
100M	DFT-S PI/2 BPSK	1	1	25.53	26.62	26.09	25.94	25.58	0
100M	DFT-S QPSK	1	1	25.62	26.71	26.18	26.03	25.67	0
		1	137	25.14	26.23	25.70	25.55	25.19	0
		1	271	25.11	26.20	25.67	25.52	25.16	0
		135	0	24.58	25.67	25.14	24.99	24.63	1
		135	69	25.61	26.70	26.17	26.02	25.66	0
		135	138	24.56	25.65	25.12	24.97	24.61	1
100M	DFT-S 16QAM	1	1	24.52	25.61	25.08	24.93	24.57	1
100M	DFT-S 64QAM	1	1	23.22	24.31	23.78	23.63	23.27	2.5
100M	DFT-S 256QAM	1	1	21.22	22.31	21.78	21.63	21.27	4.5
100M	CP QPSK	1	1	24.32	25.41	24.88	24.73	24.37	1.5
BW	MCS Index	Channel		649668	652834	656000	659166	662332	3GPP MPR
		Frequency (MHz)		3745.02	3792.51	3840	3887.49	3934.98	
90M	DFT-S PI/2 BPSK	1	1	25.46	26.62	26.06	25.50	26.60	0
90M	DFT-S QPSK	1	1	25.59	26.70	26.11	25.53	26.61	0
		1	123	25.11	26.18	25.62	25.10	26.15	0
		1	243	25.02	26.14	25.62	25.10	26.19	0
		120	0	24.52	25.57	25.06	24.54	25.65	1
		120	63	25.60	26.61	26.13	25.61	26.61	0
		120	125	24.46	25.55	25.02	24.48	25.61	1
90M	DFT-S 16QAM	1	1	24.51	25.57	25.05	24.47	25.54	1
90M	DFT-S 64QAM	1	1	23.17	24.29	23.69	23.13	24.21	2.5
90M	DFT-S 256QAM	1	1	21.12	22.26	21.75	21.15	22.27	4.5
90M	CP QPSK	1	1	24.24	25.41	24.84	24.28	25.33	1.5

NR Conducted Power (Full)									
NR Band 77_SA_PC2									
BW	MCS Index	Channel		649334	652666	656000	659334	662666	3GPP MPR
		Frequency (MHz)		3740.01	3789.99	3840	3890.01	3939.99	
80M	DFT-S PI/2 BPSK	1	1	25.51	26.58	26.02	25.45	26.55	0
80M	DFT-S QPSK	1	1	25.54	26.69	26.10	25.60	26.63	0
		1	109	25.10	26.17	25.69	25.13	26.16	0
		1	215	25.02	26.10	25.61	25.07	26.16	0
		108	0	24.55	25.65	25.08	24.53	25.61	1
		108	55	25.57	26.64	26.12	25.52	26.67	0
		108	109	24.51	25.61	25.06	24.55	25.65	1
80M	DFT-S 16QAM	1	1	24.43	25.54	25.00	24.46	25.58	1
80M	DFT-S 64QAM	1	1	23.15	24.24	23.76	23.20	24.22	2.5
80M	DFT-S 256QAM	1	1	21.15	22.30	21.76	21.16	22.27	4.5
80M	CP QPSK	1	1	24.24	25.36	24.82	24.27	25.34	1.5
BW	MCS Index	Channel		649000	652500	656000	659500	663000	3GPP MPR
		Frequency (MHz)		3735	3787.5	3840	3892.5	3945	
70M	DFT-S PI/2 BPSK	1	1	25.50	26.57	26.03	25.50	26.60	0
70M	DFT-S QPSK	1	1	25.61	26.68	26.14	25.55	26.61	0
		1	95	25.12	26.19	25.70	25.09	26.16	0
		1	187	25.09	26.20	25.64	25.06	26.17	0
		90	0	24.56	25.66	25.05	24.58	25.61	1
		90	50	25.61	26.65	26.14	25.51	26.65	0
		90	99	24.54	25.57	25.05	24.51	25.62	1
70M	DFT-S 16QAM	1	1	24.52	25.51	25.03	24.46	25.53	1
70M	DFT-S 64QAM	1	1	23.18	24.26	23.77	23.12	24.21	2.5
70M	DFT-S 256QAM	1	1	21.21	22.27	21.68	21.18	22.30	4.5
70M	CP QPSK	1	1	24.29	25.32	24.81	24.26	25.34	1.5

NR Conducted Power (Full)									
NR Band 77_SA_PC2									
BW	MCS Index	Channel		648668	652334	656000	659666	663332	3GPP MPR
		Frequency (MHz)		3730.02	3785.01	3840	3894.99	3949.98	
60M	DFT-S PI/2 BPSK	1	1	25.46	26.58	26.02	25.43	26.62	0
60M	DFT-S QPSK	1	1	25.58	26.66	26.18	25.62	26.70	0
		1	81	25.04	26.17	25.70	25.12	26.20	0
		1	160	25.09	26.20	25.61	25.09	26.12	0
		81	0	24.53	25.58	25.10	24.57	25.57	1
		81	41	25.60	26.69	26.11	25.61	26.69	0
		81	81	24.56	25.55	25.07	24.52	25.57	1
60M	DFT-S 16QAM	1	1	24.52	25.54	25.08	24.50	25.52	1
60M	DFT-S 64QAM	1	1	23.15	24.30	23.75	23.17	24.22	2.5
60M	DFT-S 256QAM	1	1	21.22	22.24	21.70	21.19	22.30	4.5
60M	CP QPSK	1	1	24.30	25.39	24.84	24.27	25.39	1.5
BW	MCS Index	Channel		648334	652166	656000	659834	663666	3GPP MPR
		Frequency (MHz)		3725.01	3782.49	3840	3897.51	3954.99	
50M	DFT-S PI/2 BPSK	1	1	25.53	26.60	26.05	25.48	26.54	0
50M	DFT-S QPSK	1	1	25.58	26.61	26.14	25.59	26.70	0
		1	67	25.10	26.23	25.70	25.06	26.21	0
		1	131	25.08	26.13	25.60	25.05	26.12	0
		64	0	24.54	25.65	25.07	24.55	25.62	1
		64	35	25.53	26.62	26.07	25.57	26.65	0
		64	69	24.56	25.64	25.05	24.48	25.57	1
50M	DFT-S 16QAM	1	1	24.42	25.55	25.01	24.46	25.51	1
50M	DFT-S 64QAM	1	1	23.19	24.31	23.75	23.20	24.31	2.5
50M	DFT-S 256QAM	1	1	21.16	22.27	21.77	21.22	22.26	4.5
50M	CP QPSK	1	1	24.22	25.39	24.87	24.31	25.41	1.5

NR Conducted Power (Full)									
NR Band 77_SA_PC2									
BW	MCS Index	Channel		648000	652000	656000	660000	664000	3GPP MPR
		Frequency (MHz)		3720	3780	3840	3900	3960	
40M	DFT-S PI/2 BPSK	1	1	25.51	26.52	26.04	25.49	26.61	0
40M	DFT-S QPSK	1	1	25.58	26.70	26.16	25.56	26.70	0
		1	53	25.08	26.19	25.63	25.07	26.18	0
		1	104	25.06	26.15	25.65	25.03	26.20	0
		50	0	24.56	25.67	25.11	24.51	25.59	1
		50	28	25.51	26.62	26.16	25.58	26.66	0
		50	56	24.54	25.60	25.02	24.47	25.64	1
100	0	24.50	25.57	25.04	24.57	25.61	1		
40M	DFT-S 16QAM	1	1	24.52	25.61	25.02	24.51	25.59	1
40M	DFT-S 64QAM	1	1	23.12	24.23	23.73	23.17	24.30	2.5
40M	DFT-S 256QAM	1	1	21.20	22.27	21.77	21.18	22.21	4.5
40M	CP QPSK	1	1	24.24	25.39	24.88	24.32	25.37	1.5
BW	MCS Index	Channel		647668	651834	656000	660166	664332	3GPP MPR
		Frequency (MHz)		3715.02	3777.51	3840	3902.49	3964.98	
30M	DFT-S PI/2 BPSK	1	1	25.53	26.58	26.05	25.51	26.56	0
30M	DFT-S QPSK	1	1	25.53	26.67	26.11	25.55	26.65	0
		1	39	25.10	26.21	25.68	25.12	26.17	0
		1	76	25.08	26.18	25.61	25.08	26.14	0
		36	0	24.56	25.61	25.13	24.49	25.62	1
		36	21	25.54	26.68	26.14	25.56	26.60	0
		36	42	24.54	25.61	25.05	24.53	25.60	1
75	0	24.51	25.57	25.09	24.54	25.66	1		
30M	DFT-S 16QAM	1	1	24.49	25.61	25.05	24.52	25.54	1
30M	DFT-S 64QAM	1	1	23.20	24.27	23.71	23.18	24.28	2.5
30M	DFT-S 256QAM	1	1	21.19	22.23	21.77	21.14	22.21	4.5
30M	CP QPSK	1	1	24.23	25.33	24.85	24.27	25.31	1.5

NR Conducted Power (Full)									
NR Band 77_SA_PC2									
BW	MCS Index	Channel		647334	651666	656000	660266	664666	3GPP MPR
		Frequency (MHz)		3710.01	3774.99	3840	3903.99	3969.99	
20M	DFT-S PI/2 BPSK	1	1	25.51	26.59	26.01	25.48	26.52	0
20M	DFT-S QPSK	1	1	25.54	26.62	26.13	25.62	26.68	0
		1	26	25.11	26.20	25.69	25.12	26.20	0
		1	49	25.02	26.16	25.59	25.10	26.13	0
		25	0	24.49	25.62	25.08	24.57	25.57	1
		25	13	25.59	26.68	26.09	25.61	26.66	0
		25	26	24.48	25.55	25.12	24.55	25.63	1
20M	DFT-S 16QAM	1	1	24.49	25.52	24.98	24.50	25.54	1
20M	DFT-S 64QAM	1	1	23.14	24.23	23.75	23.17	24.29	2.5
20M	DFT-S 256QAM	1	1	21.17	22.24	21.78	21.16	22.28	4.5
20M	CP QPSK	1	1	24.22	25.35	24.82	24.25	25.32	1.5
BW	MCS Index	Channel		647168	651584	656000	660416	664832	3GPP MPR
		Frequency (MHz)		3707.52	3773.76	3840	3906.24	3972.48	
15M	DFT-S PI/2 BPSK	1	1	25.45	26.54	26.03	25.51	26.52	0
15M	DFT-S QPSK	1	1	25.54	26.67	26.17	25.55	26.66	0
		1	19	25.09	26.15	25.60	25.14	26.15	0
		1	36	25.05	26.13	25.58	25.04	26.16	0
		18	0	24.53	25.64	25.11	24.52	25.58	1
		18	10	25.53	26.66	26.16	25.61	26.68	0
		18	20	24.53	25.55	25.02	24.46	25.65	1
15M	DFT-S 16QAM	1	1	24.45	25.60	25.05	24.48	25.58	1
15M	DFT-S 64QAM	1	1	23.21	24.30	23.75	23.18	24.29	2.5
15M	DFT-S 256QAM	1	1	21.17	22.23	21.72	21.13	22.27	4.5
15M	CP QPSK	1	1	24.26	25.34	24.86	24.31	25.38	1.5

NR Conducted Power (Full)									
NR Band 77_SA_PC2									
BW	MCS Index	Channel		647000	651500	656000	660500	665000	3GPP MPR
		Frequency (MHz)		3705	3772.5	3840	3907.5	3975	
10M	DFT-S PI/2 BPSK	1	1	25.51	26.55	26.09	25.46	26.61	0
10M	DFT-S QPSK	1	1	25.56	26.69	26.16	25.57	26.62	0
		1	11	25.07	26.16	25.64	25.06	26.20	0
		1	22	25.11	26.14	25.60	25.04	26.19	0
		12	0	24.52	25.59	25.09	24.50	25.64	1
		12	6	25.51	26.69	26.13	25.53	26.69	0
		12	12	24.50	25.62	25.05	24.53	25.63	1
10M	DFT-S 16QAM	1	1	24.49	25.57	25.03	24.45	25.57	1
		1	1	23.13	24.29	23.74	23.14	24.21	2.5
10M	DFT-S 64QAM	1	1	21.14	22.25	21.73	21.21	22.22	4.5
10M	DFT-S 256QAM	1	1	24.22	25.37	24.87	24.30	25.33	1.5
10M	CP QPSK	1	1	24.22	25.37	24.87	24.30	25.33	1.5

NR Conducted Power (Full)									
NR Band 77_SA_PC3									
BW	MCS Index	RB Size	RB Offset	Low	Mid-1	Mid-2	Mid-3	High	3GPP MPR (dB)
		Channel		650000	653000	656000	659000	662000	
		Frequency (MHz)		3750	3795	3840	3885	3930	
100M	DFT-S PI/2 BPSK	1	1	23.89	23.84	23.63	23.33	23.10	0
100M	DFT-S QPSK	1	1	24.00	23.95	23.74	23.44	23.21	0
		1	137	23.54	23.49	23.29	23.00	22.78	0
		1	271	22.66	22.61	22.41	22.12	21.90	0
		135	0	22.60	22.55	22.35	22.06	21.84	1
		135	69	23.67	23.60	23.40	23.11	22.89	0
		135	138	22.47	22.42	22.22	21.93	21.71	1
		270	0	22.44	22.39	22.19	21.90	21.68	1
100M	DFT-S 16QAM	1	1	21.40	21.35	21.15	20.86	20.64	1
100M	DFT-S 64QAM	1	1	20.40	20.35	20.15	19.86	19.64	2.5
100M	DFT-S 256QAM	1	1	18.20	18.15	17.95	17.66	17.44	4.5
100M	CP QPSK	1	1	22.51	22.46	22.26	21.97	21.75	1.5
BW	MCS Index	Channel		649668	652834	656000	659166	662332	3GPP MPR
		Frequency (MHz)		3745.02	3792.51	3840	3887.49	3934.98	
90M	DFT-S PI/2 BPSK	1	1	23.83	23.81	23.56	23.75	23.62	0
90M	DFT-S QPSK	1	1	23.92	23.93	23.69	23.85	23.65	0
		1	123	23.53	23.45	23.26	23.45	23.23	0
		1	243	22.65	22.59	22.40	22.61	22.34	0
		120	0	22.58	22.49	22.27	22.45	22.34	1
		120	63	23.55	23.55	23.32	23.54	23.37	0
		120	125	22.45	22.42	22.19	22.35	22.17	1
		243	0	22.41	22.36	22.17	22.29	22.17	1
90M	DFT-S 16QAM	1	1	21.38	21.33	21.12	21.26	21.12	1
90M	DFT-S 64QAM	1	1	20.35	20.30	20.13	20.30	20.07	2.5
90M	DFT-S 256QAM	1	1	18.14	18.06	17.94	18.12	17.88	4.5
90M	CP QPSK	1	1	22.43	22.38	22.24	22.43	22.18	1.5

NR Conducted Power (Full)									
NR Band 77_SA_PC3									
BW	MCS Index	Channel		649334	652666	656000	659334	662666	3GPP MPR
		Frequency (MHz)		3740.01	3789.99	3840	3890.01	3939.99	
80M	DFT-S PI/2 BPSK	1	1	23.86	23.75	23.61	23.84	23.63	0
80M	DFT-S QPSK	1	1	23.99	23.92	23.69	23.94	23.68	0
		1	109	23.52	23.42	23.26	23.39	23.21	0
		1	215	22.56	22.56	22.35	22.51	22.35	0
		108	0	22.51	22.52	22.27	22.53	22.31	1
		108	55	23.59	23.55	23.36	23.58	23.30	0
		108	109	22.46	22.42	22.17	22.40	22.14	1
80M	DFT-S 16QAM	1	1	21.30	21.31	21.07	21.32	21.12	1
80M	DFT-S 64QAM	1	1	20.34	20.27	20.12	20.34	20.10	2.5
80M	DFT-S 256QAM	1	1	18.16	18.11	17.86	18.07	17.95	4.5
80M	CP QPSK	1	1	22.46	22.37	22.18	22.44	22.26	1.5
BW	MCS Index	Channel		649000	652500	656000	659500	663000	3GPP MPR
		Frequency (MHz)		3735	3787.5	3840	3892.5	3945	
70M	DFT-S PI/2 BPSK	1	1	23.85	23.76	23.63	23.76	23.58	0
70M	DFT-S QPSK	1	1	23.92	23.86	23.64	23.89	23.66	0
		1	95	23.49	23.41	23.24	23.40	23.27	0
		1	187	22.66	22.61	22.31	22.56	22.32	0
		90	0	22.57	22.52	22.31	22.50	22.29	1
		90	50	23.55	23.54	23.39	23.60	23.34	0
		90	99	22.46	22.34	22.20	22.36	22.12	1
70M	DFT-S 16QAM	1	1	21.30	21.30	21.10	21.30	21.06	1
70M	DFT-S 64QAM	1	1	20.39	20.26	20.12	20.29	20.12	2.5
70M	DFT-S 256QAM	1	1	18.18	18.09	17.85	18.08	17.86	4.5
70M	CP QPSK	1	1	22.45	22.37	22.24	22.46	22.21	1.5

NR Conducted Power (Full)									
NR Band 77_SA_PC3									
BW	MCS Index	Channel		648668	652334	656000	659666	663332	3GPP MPR
		Frequency (MHz)		3730.02	3785.01	3840	3894.99	3949.98	
60M	DFT-S PI/2 BPSK	1	1	23.83	23.81	23.63	23.74	23.61	0
60M	DFT-S QPSK	1	1	23.99	23.92	23.66	23.94	23.65	0
		1	81	23.53	23.43	23.27	23.40	23.21	0
		1	160	22.58	22.54	22.34	22.59	22.31	0
		81	0	22.54	22.51	22.33	22.52	22.30	1
		81	41	23.64	23.55	23.33	23.60	23.39	0
		81	81	22.44	22.37	22.14	22.36	22.16	1
60M	DFT-S 16QAM	1	1	21.32	21.35	21.07	21.32	21.12	1
60M	DFT-S 64QAM	1	1	20.36	20.33	20.06	20.29	20.15	2.5
60M	DFT-S 256QAM	1	1	18.14	18.14	17.90	18.10	17.90	4.5
60M	CP QPSK	1	1	22.51	22.44	22.24	22.45	22.20	1.5
BW	MCS Index	Channel		648334	652166	656000	659834	663666	3GPP MPR
		Frequency (MHz)		3725.01	3782.49	3840	3897.51	3954.99	
50M	DFT-S PI/2 BPSK	1	1	23.85	23.74	23.61	23.83	23.59	0
50M	DFT-S QPSK	1	1	23.90	23.94	23.67	23.90	23.67	0
		1	67	23.53	23.44	23.19	23.39	23.21	0
		1	131	22.58	22.54	22.40	22.60	22.39	0
		64	0	22.58	22.54	22.28	22.55	22.26	1
		64	35	23.65	23.57	23.32	23.56	23.39	0
		64	69	22.37	22.37	22.19	22.36	22.20	1
50M	DFT-S 16QAM	1	1	21.36	21.31	21.13	21.34	21.13	1
50M	DFT-S 64QAM	1	1	20.36	20.29	20.14	20.35	20.08	2.5
50M	DFT-S 256QAM	1	1	18.15	18.05	17.91	18.10	17.89	4.5
50M	CP QPSK	1	1	22.43	22.36	22.21	22.40	22.26	1.5

NR Conducted Power (Full)									
NR Band 77_SA_PC3									
BW	MCS Index	Channel		648000	652000	656000	660000	664000	3GPP MPR
		Frequency (MHz)		3720	3780	3840	3900	3960	
40M	DFT-S PI/2 BPSK	1	1	23.89	23.81	23.60	23.74	23.62	0
40M	DFT-S QPSK	1	1	23.94	23.85	23.64	23.95	23.73	0
		1	53	23.51	23.44	23.29	23.47	23.23	0
		1	104	22.66	22.61	22.36	22.60	22.36	0
		50	0	22.55	22.47	22.31	22.54	22.34	1
		50	28	23.55	23.56	23.39	23.52	23.37	0
		50	56	22.41	22.33	22.20	22.32	22.13	1
100	0	22.36	22.30	22.18	22.32	22.10	1		
40M	DFT-S 16QAM	1	1	21.32	21.30	21.10	21.28	21.15	1
40M	DFT-S 64QAM	1	1	20.30	20.31	20.11	20.31	20.08	2.5
40M	DFT-S 256QAM	1	1	18.14	18.08	17.88	18.12	17.90	4.5
40M	CP QPSK	1	1	22.48	22.43	22.22	22.38	22.17	1.5
BW	MCS Index	Channel		647668	651834	656000	660166	664332	3GPP MPR
		Frequency (MHz)		3715.02	3777.51	3840	3902.49	3964.98	
30M	DFT-S PI/2 BPSK	1	1	23.81	23.84	23.63	23.76	23.53	0
30M	DFT-S QPSK	1	1	23.91	23.94	23.65	23.94	23.66	0
		1	39	23.49	23.41	23.24	23.48	23.26	0
		1	76	22.64	22.51	22.36	22.59	22.41	0
		36	0	22.58	22.54	22.35	22.55	22.29	1
		36	21	23.64	23.51	23.34	23.55	23.38	0
		36	42	22.44	22.39	22.21	22.38	22.21	1
75	0	22.39	22.34	22.12	22.33	22.11	1		
30M	DFT-S 16QAM	1	1	21.38	21.26	21.14	21.33	21.14	1
30M	DFT-S 64QAM	1	1	20.34	20.31	20.12	20.32	20.13	2.5
30M	DFT-S 256QAM	1	1	18.13	18.14	17.89	18.13	17.87	4.5
30M	CP QPSK	1	1	22.50	22.42	22.16	22.45	22.17	1.5

NR Conducted Power (Full)									
NR Band 77_SA_PC3									
BW	MCS Index	Channel		647334	651666	656000	660266	664666	3GPP MPR
		Frequency (MHz)		3710.01	3774.99	3840	3903.99	3969.99	
20M	DFT-S PI/2 BPSK	1	1	23.83	23.78	23.62	23.79	23.60	0
20M	DFT-S QPSK	1	1	23.99	23.95	23.66	23.91	23.66	0
		1	26	23.54	23.48	23.29	23.41	23.25	0
		1	49	22.61	22.60	22.37	22.61	22.36	0
		25	0	22.53	22.54	22.28	22.54	22.35	1
		25	13	23.59	23.50	23.30	23.56	23.38	0
		25	26	22.47	22.36	22.15	22.40	22.21	1
		50	0	22.41	22.34	22.15	22.30	22.15	1
20M	DFT-S 16QAM	1	1	21.37	21.33	21.11	21.27	21.15	1
20M	DFT-S 64QAM	1	1	20.35	20.25	20.14	20.27	20.11	2.5
20M	DFT-S 256QAM	1	1	18.16	18.07	17.88	18.11	17.87	4.5
20M	CP QPSK	1	1	22.51	22.39	22.21	22.42	22.19	1.5
BW	MCS Index	Channel		647168	651584	656000	660416	664832	3GPP MPR
		Frequency (MHz)		3707.52	3773.76	3840	3906.24	3972.48	
15M	DFT-S PI/2 BPSK	1	1	23.82	23.78	23.53	23.75	23.61	0
15M	DFT-S QPSK	1	1	23.95	23.95	23.64	23.88	23.69	0
		1	19	23.47	23.40	23.20	23.49	23.21	0
		1	36	22.58	22.59	22.40	22.53	22.35	0
		18	0	22.56	22.53	22.26	22.51	22.32	1
		18	10	23.60	23.58	23.33	23.51	23.36	0
		18	20	22.45	22.38	22.13	22.33	22.17	1
		36	0	22.38	22.32	22.15	22.37	22.19	1
15M	DFT-S 16QAM	1	1	21.30	21.25	21.15	21.27	21.09	1
15M	DFT-S 64QAM	1	1	20.30	20.34	20.05	20.33	20.13	2.5
15M	DFT-S 256QAM	1	1	18.11	18.13	17.85	18.10	17.86	4.5
15M	CP QPSK	1	1	22.50	22.45	22.18	22.43	22.25	1.5

NR Conducted Power (Full)									
NR Band 77_SA_PC3									
BW	MCS Index	Channel		647000	651500	656000	660500	665000	3GPP MPR
		Frequency (MHz)		3705	3772.5	3840	3907.5	3975	
10M	DFT-S PI/2 BPSK	1	1	23.83	23.84	23.56	23.83	23.62	0
10M	DFT-S QPSK	1	1	23.91	23.88	23.69	23.87	23.69	0
		1	11	23.44	23.39	23.29	23.47	23.21	0
		1	22	22.65	22.58	22.40	22.53	22.35	0
		12	0	22.57	22.47	22.27	22.47	22.35	1
		12	6	23.62	23.52	23.32	23.59	23.39	0
		12	12	22.43	22.33	22.17	22.40	22.21	1
10M	DFT-S 16QAM	1	1	21.32	21.27	21.08	21.35	21.12	1
10M	DFT-S 64QAM	1	1	20.30	20.29	20.15	20.30	20.06	2.5
10M	DFT-S 256QAM	1	1	18.10	18.11	17.93	18.06	17.90	4.5
10M	CP QPSK	1	1	22.42	22.46	22.17	22.44	22.26	1.5

NR Conducted Power (Full)							
NR Band 78_SA_PC2							
BW	MCS Index	RB Size	RB Offset	Low	Mid	High	3GPP MPR (dB)
		Channel			650000		
		Frequency (MHz)			3750		
100M	DFT-S PI/2 BPSK	1	1		25.62		0
100M	DFT-S QPSK	1	1		25.71		0
		1	137		25.35		0
		1	271		24.47		0
		135	0		24.41		1
		135	69		25.46		0
		135	138		24.28		1
100M	DFT-S 16QAM	1	1		24.61		1
100M	DFT-S 64QAM	1	1		23.31		2.5
100M	DFT-S 256QAM	1	1		21.31		4.5
100M	CP QPSK	1	1		24.41		1.5
BW	MCS Index	Channel		649668	650000	650332	3GPP MPR
		Frequency (MHz)		3745.02	3750	3754.98	
90M	DFT-S PI/2 BPSK	1	1	25.58	25.59	25.61	0
90M	DFT-S QPSK	1	1	25.64	25.70	25.63	0
		1	123	25.31	25.33	25.34	0
		1	243	24.40	24.38	24.44	0
		120	0	24.38	24.37	24.38	1
		120	63	25.39	25.37	25.42	0
		120	125	24.24	24.21	24.22	1
90M	DFT-S 16QAM	1	1	24.58	24.54	24.56	1
90M	DFT-S 64QAM	1	1	23.21	23.29	23.31	2.5
90M	DFT-S 256QAM	1	1	21.27	21.21	21.28	4.5
90M	CP QPSK	1	1	24.35	24.37	24.32	1.5

NR Conducted Power (Full)							
NR Band 78_SA_PC2							
BW	MCS Index	Channel		649334	650000	650666	3GPP MPR
		Frequency (MHz)		3740.01	3750	3759.99	
80M	DFT-S PI/2 BPSK	1	1	25.59	25.60	25.58	0
80M	DFT-S QPSK	1	1	25.62	25.65	25.69	0
		1	109	25.26	25.31	25.32	0
		1	215	24.41	24.42	24.37	0
		108	0	24.35	24.33	24.41	1
		108	55	25.39	25.36	25.44	0
		108	109	24.21	24.24	24.25	1
80M	DFT-S 16QAM	1	1	24.54	24.58	24.57	1
80M	DFT-S 64QAM	1	1	23.23	23.29	23.28	2.5
80M	DFT-S 256QAM	1	1	21.28	21.31	21.25	4.5
80M	CP QPSK	1	1	24.33	24.31	24.37	1.5
BW	MCS Index	Channel		649000		651000	3GPP MPR
		Frequency (MHz)		3735		3765	
70M	DFT-S PI/2 BPSK	1	1	25.52		25.55	0
70M	DFT-S QPSK	1	1	25.65		25.70	0
		1	95	25.27		25.29	0
		1	187	24.42		24.42	0
		90	0	24.38		24.36	1
		90	50	25.39		25.45	0
		90	99	24.22		24.22	1
70M	DFT-S 16QAM	1	1	24.51		24.59	1
70M	DFT-S 64QAM	1	1	23.26		23.29	2.5
70M	DFT-S 256QAM	1	1	21.28		21.31	4.5
70M	CP QPSK	1	1	24.41		24.39	1.5

NR Conducted Power (Full)							
NR Band 78_SA_PC2							
BW	MCS Index	Channel		648668	650000	651332	3GPP MPR
		Frequency (MHz)		3730.02	3750	3769.98	
60M	DFT-S PI/2 BPSK	1	1	25.58	25.59	25.58	0
60M	DFT-S QPSK	1	1	25.68	25.70	25.67	0
		1	81	25.25	25.33	25.27	0
		1	160	24.45	24.46	24.37	0
		81	0	24.34	24.32	24.41	1
		81	41	25.38	25.39	25.46	0
		81	81	24.20	24.23	24.28	1
60M	DFT-S 16QAM	1	1	24.61	24.54	24.52	1
60M	DFT-S 64QAM	1	1	23.30	23.23	23.30	2.5
60M	DFT-S 256QAM	1	1	21.25	21.25	21.31	4.5
60M	CP QPSK	1	1	24.35	24.38	24.40	1.5
BW	MCS Index	Channel		648334	650000	651666	3GPP MPR
		Frequency (MHz)		3725.01	3750	3774.99	
50M	DFT-S PI/2 BPSK	1	1	25.61	25.53	25.59	0
50M	DFT-S QPSK	1	1	25.62	25.66	25.63	0
		1	67	25.32	25.28	25.26	0
		1	131	24.42	24.44	24.40	0
		64	0	24.39	24.36	24.31	1
		64	35	25.36	25.42	25.45	0
		64	69	24.19	24.25	24.22	1
50M	DFT-S 16QAM	1	1	24.52	24.53	24.53	1
50M	DFT-S 64QAM	1	1	23.21	23.28	23.24	2.5
50M	DFT-S 256QAM	1	1	21.29	21.25	21.21	4.5
50M	CP QPSK	1	1	24.36	24.36	24.41	1.5

NR Conducted Power (Full)							
NR Band 78_SA_PC2							
BW	MCS Index	Channel		648000	650000	652000	3GPP MPR
		Frequency (MHz)		3720	3750	3780	
40M	DFT-S PI/2 BPSK	1	1	25.54	25.54	25.60	0
40M	DFT-S QPSK	1	1	25.62	25.62	25.66	0
		1	53	25.28	25.33	25.26	0
		1	104	24.43	24.42	24.38	0
		50	0	24.38	24.39	24.35	1
		50	28	25.41	25.37	25.40	0
		50	56	24.26	24.18	24.26	1
100	0	24.18	24.23	24.19	1		
40M	DFT-S 16QAM	1	1	24.54	24.51	24.56	1
40M	DFT-S 64QAM	1	1	23.21	23.26	23.24	2.5
40M	DFT-S 256QAM	1	1	21.24	21.25	21.29	4.5
40M	CP QPSK	1	1	24.36	24.33	24.36	1.5
BW	MCS Index	Channel		647668	650000	652332	3GPP MPR
		Frequency (MHz)		3715.02	3750	3784.98	
30M	DFT-S PI/2 BPSK	1	1	25.61	25.61	25.59	0
30M	DFT-S QPSK	1	1	25.63	25.69	25.65	0
		1	39	25.32	25.34	25.26	0
		1	76	24.41	24.38	24.41	0
		36	0	24.37	24.39	24.37	1
		36	21	25.46	25.43	25.45	0
		36	42	24.21	24.20	24.18	1
75	0	24.15	24.22	24.19	1		
30M	DFT-S 16QAM	1	1	24.58	24.61	24.57	1
30M	DFT-S 64QAM	1	1	23.28	23.30	23.22	2.5
30M	DFT-S 256QAM	1	1	21.24	21.22	21.21	4.5
30M	CP QPSK	1	1	24.31	24.36	24.35	1.5

NR Conducted Power (Full)							
NR Band 78_SA_PC2							
BW	MCS Index	Channel		647334	650000	652666	3GPP MPR
		Frequency (MHz)		3710.01	3750	3789.99	
20M	DFT-S PI/2 BPSK	1	1	25.55	25.54	25.61	0
20M	DFT-S QPSK	1	1	25.62	25.70	25.70	0
		1	26	25.33	25.34	25.31	0
		1	49	24.46	24.41	24.44	0
		25	0	24.34	24.35	24.34	1
		25	13	25.41	25.40	25.40	0
		25	26	24.18	24.27	24.25	1
20M	DFT-S 16QAM	1	1	24.53	24.51	24.52	1
20M	DFT-S 64QAM	1	1	23.25	23.24	23.27	2.5
20M	DFT-S 256QAM	1	1	21.23	21.25	21.30	4.5
20M	CP QPSK	1	1	24.34	24.39	24.39	1.5
BW	MCS Index	Channel		647168	650000	652832	3GPP MPR
		Frequency (MHz)		3707.52	3750	3792.48	
15M	DFT-S PI/2 BPSK	1	1	25.52	25.58	25.58	0
15M	DFT-S QPSK	1	1	25.63	25.64	25.70	0
		1	19	25.33	25.29	25.33	0
		1	36	24.38	24.37	24.44	0
		18	0	24.31	24.35	24.40	1
		18	10	25.39	25.45	25.38	0
		18	20	24.18	24.26	24.27	1
15M	DFT-S 16QAM	1	1	24.52	24.52	24.55	1
15M	DFT-S 64QAM	1	1	23.31	23.28	23.31	2.5
15M	DFT-S 256QAM	1	1	21.30	21.31	21.22	4.5
15M	CP QPSK	1	1	24.35	24.37	24.35	1.5

NR Conducted Power (Full)							
NR Band 78_SA_PC2							
BW	MCS Index	Channel		647000	650000	653000	3GPP MPR
		Frequency (MHz)		3705	3750	3795	
10M	DFT-S PI/2 BPSK	1	1	25.61	25.55	25.61	0
10M	DFT-S QPSK	1	1	25.66	25.70	25.66	0
		1	11	25.28	25.34	25.28	0
		1	22	24.40	24.44	24.44	0
		12	0	24.34	24.39	24.39	1
		12	6	25.39	25.36	25.46	0
		12	12	24.28	24.25	24.26	1
10M	DFT-S 16QAM	1	1	24.54	24.53	24.51	1
		1	1	23.26	23.28	23.22	2.5
10M	DFT-S 64QAM	1	1	21.28	21.28	21.28	4.5
10M	DFT-S 256QAM	1	1	21.28	21.28	21.28	4.5
10M	CP QPSK	1	1	24.37	24.34	24.32	1.5

NR Conducted Power (Full)							
NR Band 78_SA_PC3							
BW	MCS Index	RB Size	RB Offset	Low	Mid	High	3GPP MPR (dB)
		Channel			650000		
		Frequency (MHz)			3750		
100M	DFT-S PI/2 BPSK	1	1		23.65		0
100M	DFT-S QPSK	1	1		23.78		0
		1	137		23.34		0
		1	271		22.46		0
		135	0		22.40		1
		135	69		23.47		0
		135	138		22.27		1
		270	0		22.24		1
100M	DFT-S 16QAM	1	1		22.32		1
100M	DFT-S 64QAM	1	1		20.20		2.5
100M	DFT-S 256QAM	1	1		18.10		4.5
100M	CP QPSK	1	1		21.30		1.5
BW	MCS Index	Channel		649668	650000	650332	3GPP MPR
		Frequency (MHz)		3745.02	3750	3754.98	
90M	DFT-S PI/2 BPSK	1	1	23.58	23.56	23.55	0
90M	DFT-S QPSK	1	1	23.67	23.76	23.69	0
		1	123	23.29	23.31	23.31	0
		1	243	22.40	22.41	22.36	0
		120	0	22.39	22.40	22.40	1
		120	63	23.37	23.40	23.38	0
		120	125	22.18	22.26	22.21	1
		243	0	22.20	22.15	22.15	1
90M	DFT-S 16QAM	1	1	22.22	22.30	22.27	1
90M	DFT-S 64QAM	1	1	20.10	20.19	20.20	2.5
90M	DFT-S 256QAM	1	1	18.03	18.08	18.09	4.5
90M	CP QPSK	1	1	21.29	21.25	21.27	1.5

NR Conducted Power (Full)							
NR Band 78_SA_PC3							
BW	MCS Index	Channel		649334	650000	650666	3GPP MPR
		Frequency (MHz)		3740.01	3750	3759.99	
80M	DFT-S PI/2 BPSK	1	1	23.60	23.60	23.56	0
80M	DFT-S QPSK	1	1	23.72	23.69	23.76	0
		1	109	23.34	23.25	23.27	0
		1	215	22.42	22.41	22.44	0
		108	0	22.33	22.33	22.34	1
		108	55	23.39	23.35	23.42	0
		108	109	22.21	22.17	22.20	1
80M	DFT-S 16QAM	1	1	22.31	22.31	22.30	1
80M	DFT-S 64QAM	1	1	20.15	20.15	20.11	2.5
80M	DFT-S 256QAM	1	1	18.09	18.05	18.08	4.5
80M	CP QPSK	1	1	21.29	21.25	21.22	1.5
BW	MCS Index	Channel		649000	650000	651000	3GPP MPR
		Frequency (MHz)		3735	3750	3765	
70M	DFT-S PI/2 BPSK	1	1	23.61	23.63	23.58	0
70M	DFT-S QPSK	1	1	23.66	23.72	23.72	0
		1	95	23.31	23.32	23.28	0
		1	187	22.38	22.39	22.39	0
		90	0	22.35	22.31	22.34	1
		90	50	23.43	23.44	23.35	0
		90	99	22.18	22.19	22.25	1
70M	DFT-S 16QAM	1	1	22.23	22.32	22.29	1
70M	DFT-S 64QAM	1	1	20.13	20.20	20.17	2.5
70M	DFT-S 256QAM	1	1	18.01	18.03	18.03	4.5
70M	CP QPSK	1	1	21.29	21.29	21.25	1.5

NR Conducted Power (Full)							
NR Band 78_SA_PC3							
BW	MCS Index	Channel		648668	650000	651332	3GPP MPR
		Frequency (MHz)		3730.02	3750	3769.98	
60M	DFT-S PI/2 BPSK	1	1	23.61	23.64	23.61	0
60M	DFT-S QPSK	1	1	23.72	23.69	23.74	0
		1	81	23.26	23.33	23.24	0
		1	160	22.38	22.44	22.36	0
		81	0	22.31	22.34	22.40	1
		81	41	23.40	23.35	23.42	0
		81	81	22.27	22.19	22.20	1
60M	DFT-S 16QAM	1	1	22.29	22.22	22.25	1
60M	DFT-S 64QAM	1	1	20.20	20.19	20.14	2.5
60M	DFT-S 256QAM	1	1	18.00	18.08	18.05	4.5
60M	CP QPSK	1	1	21.23	21.20	21.22	1.5
BW	MCS Index	Channel		648334	650000	651666	3GPP MPR
		Frequency (MHz)		3725.01	3750	3774.99	
50M	DFT-S PI/2 BPSK	1	1	23.57	23.63	23.56	0
50M	DFT-S QPSK	1	1	23.69	23.73	23.72	0
		1	67	23.28	23.28	23.28	0
		1	131	22.40	22.37	22.37	0
		64	0	22.32	22.33	22.35	1
		64	35	23.37	23.36	23.41	0
		64	69	22.18	22.26	22.18	1
50M	DFT-S 16QAM	1	1	22.26	22.28	22.29	1
50M	DFT-S 64QAM	1	1	20.17	20.11	20.14	2.5
50M	DFT-S 256QAM	1	1	18.06	18.07	18.04	4.5
50M	CP QPSK	1	1	21.27	21.27	21.23	1.5

NR Conducted Power (Full)							
NR Band 78_SA_PC3							
BW	MCS Index	Channel		648000	650000	652000	3GPP MPR
		Frequency (MHz)		3720	3750	3780	
40M	DFT-S PI/2 BPSK	1	1	23.63	23.61	23.56	0
40M	DFT-S QPSK	1	1	23.69	23.75	23.70	0
		1	53	23.26	23.34	23.26	0
		1	104	22.42	22.40	22.44	0
		50	0	22.30	22.40	22.32	1
		50	28	23.37	23.39	23.38	0
		50	56	22.24	22.22	22.25	1
40M	DFT-S 16QAM	1	1	22.31	22.27	22.25	1
40M	DFT-S 64QAM	1	1	20.18	20.20	20.20	2.5
40M	DFT-S 256QAM	1	1	18.04	18.05	18.06	4.5
40M	CP QPSK	1	1	21.23	21.26	21.21	1.5
BW	MCS Index	Channel		647668	650000	652332	3GPP MPR
		Frequency (MHz)		3715.02	3750	3784.98	
30M	DFT-S PI/2 BPSK	1	1	23.63	23.63	23.58	0
30M	DFT-S QPSK	1	1	23.72	23.71	23.69	0
		1	39	23.28	23.24	23.27	0
		1	76	22.37	22.37	22.44	0
		36	0	22.30	22.38	22.39	1
		36	21	23.39	23.36	23.37	0
		36	42	22.20	22.24	22.17	1
30M	DFT-S 16QAM	1	1	22.26	22.23	22.31	1
30M	DFT-S 64QAM	1	1	20.15	20.11	20.16	2.5
30M	DFT-S 256QAM	1	1	18.06	18.02	18.00	4.5
30M	CP QPSK	1	1	21.20	21.24	21.25	1.5

NR Conducted Power (Full)							
NR Band 78_SA_PC3							
BW	MCS Index	Channel		647334	650000	652666	3GPP MPR
		Frequency (MHz)		3710.01	3750	3789.99	
20M	DFT-S PI/2 BPSK	1	1	23.61	23.58	23.62	0
20M	DFT-S QPSK	1	1	23.72	23.66	23.73	0
		1	26	23.34	23.26	23.24	0
		1	49	22.41	22.39	22.40	0
		25	0	22.39	22.32	22.39	1
		25	13	23.36	23.42	23.35	0
		25	26	22.24	22.17	22.24	1
50	0	22.21	22.20	22.20	1		
20M	DFT-S 16QAM	1	1	22.31	22.22	22.24	1
20M	DFT-S 64QAM	1	1	20.13	20.13	20.19	2.5
20M	DFT-S 256QAM	1	1	18.09	18.05	18.00	4.5
20M	CP QPSK	1	1	21.30	21.28	21.26	1.5
BW	MCS Index	Channel		647168	650000	652832	3GPP MPR
		Frequency (MHz)		3707.52	3750	3792.48	
15M	DFT-S PI/2 BPSK	1	1	23.64	23.62	23.58	0
15M	DFT-S QPSK	1	1	23.69	23.67	23.73	0
		1	19	23.24	23.30	23.27	0
		1	36	22.43	22.36	22.41	0
		18	0	22.35	22.37	22.33	1
		18	10	23.45	23.42	23.36	0
		18	20	22.20	22.17	22.20	1
36	0	22.17	22.16	22.16	1		
15M	DFT-S 16QAM	1	1	22.22	22.26	22.28	1
15M	DFT-S 64QAM	1	1	20.18	20.15	20.11	2.5
15M	DFT-S 256QAM	1	1	18.01	18.04	18.00	4.5
15M	CP QPSK	1	1	21.24	21.21	21.27	1.5

NR Conducted Power (Full)							
NR Band 78_SA_PC3							
BW	MCS Index	Channel		647000	650000	653000	3GPP MPR
		Frequency (MHz)		3705	3750	3795	
10M	DFT-S PI/2 BPSK	1	1	23.64	23.64	23.55	0
10M	DFT-S QPSK	1	1	23.69	23.68	23.66	0
		1	11	23.29	23.33	23.34	0
		1	22	22.44	22.43	22.44	0
		12	0	22.39	22.32	22.31	1
		12	6	23.43	23.36	23.36	0
		12	12	22.19	22.20	22.19	1
10M	DFT-S 16QAM	1	1	22.26	22.26	22.23	1
		1	1	20.17	20.18	20.19	2.5
10M	DFT-S 64QAM	1	1	18.04	18.02	18.10	4.5
10M	DFT-S 256QAM	1	1	21.25	21.20	21.23	1.5
10M	CP QPSK	1	1				

NR Conducted Power (Full)

NR Band 2_NSA

BW	MCS Index	RB Size	RB Offset	Low	Mid	High	3GPP MPR (dB)
		Channel		372000	376000	380000	
		Frequency (MHz)		1860	1880	1900	
20M	DFT-S PI/2 BPSK	1	1	23.81	23.84	23.71	0
20M	DFT-S QPSK	1	1	23.83	23.86	23.74	0
		1	53	23.80	23.83	23.70	0
		1	104	23.79	23.80	23.75	0
		50	0	22.83	22.86	22.77	1
		50	28	23.79	23.84	23.69	0
		50	56	22.77	22.83	22.69	1
		100	0	22.80	22.85	22.74	1
20M	DFT-S 16QAM	1	1	22.75	22.83	22.68	1
20M	DFT-S 64QAM	1	1	21.05	21.06	21.03	2.5
20M	DFT-S 256QAM	1	1	19.27	19.31	19.27	4.5
20M	CP QPSK	1	1	22.36	22.36	22.35	1.5

NR Conducted Power (Full)

NR Band 5_NSA

BW	MCS Index	RB Size	RB Offset	Low	Mid	High	3GPP MPR (dB)
		Channel		166800	167300	167800	
		Frequency (MHz)		834	836.5	839	
20M	DFT-S PI/2 BPSK	1	1	22.77	22.96	22.86	0
20M	DFT-S QPSK	1	1	22.79	22.99	22.91	0
		1	53	22.86	22.96	22.90	0
		1	104	22.76	22.93	22.86	0
		50	0	21.98	22.06	22.02	1
		50	28	22.83	22.97	22.92	0
		50	56	22.22	22.26	22.23	1
100	0	22.13	22.21	22.17	1		
20M	DFT-S 16QAM	1	1	22.03	22.09	22.04	1
20M	DFT-S 64QAM	1	1	19.93	20.10	20.03	2.5
20M	DFT-S 256QAM	1	1	18.36	18.51	18.43	4.5
20M	CP QPSK	1	1	21.41	21.56	21.48	1.5

NR Conducted Power (Full)

NR Band 7_NSA

BW	MCS Index	RB Size	RB Offset	Low	Mid	High	3GPP MPR (dB)
		Channel		502000	507000	512000	
		Frequency (MHz)		2510	2535	2560	
20M	DFT-S PI/2 BPSK	1	1	22.01	22.14	22.03	0
20M	DFT-S QPSK	1	1	22.22	22.35	22.24	0
		1	53	22.09	22.22	22.11	0
		1	104	22.08	22.21	22.10	0
		50	0	21.10	21.23	21.12	1
		50	28	22.09	22.22	22.11	0
		50	56	21.06	21.19	21.08	1
20M	DFT-S 16QAM	1	1	21.01	21.12	21.08	1
20M	DFT-S 64QAM	1	1	19.70	19.83	19.72	2.5
20M	DFT-S 256QAM	1	1	17.90	18.03	17.92	4.5
20M	CP QPSK	1	1	21.06	21.19	21.08	1.5

NR Conducted Power (Full)

NR Band 25_NSA

BW	MCS Index	RB Size	RB Offset	Low	Mid	High	3GPP MPR (dB)
		Channel		372000	376500	381000	
		Frequency (MHz)		1860	1882.5	1905	
20M	DFT-S PI/2 BPSK	1	1	22.04	22.58	22.68	0
20M	DFT-S QPSK	1	1	22.25	22.79	22.89	0
		1	53	22.21	22.75	22.85	0
		1	104	21.96	22.50	22.60	0
		50	0	21.15	21.69	21.79	1
		50	28	22.11	22.65	22.75	0
		50	56	21.03	21.57	21.67	1
		100	0	20.95	21.49	21.59	1
20M	DFT-S 16QAM	1	1	21.04	21.58	21.68	1
20M	DFT-S 64QAM	1	1	19.75	20.29	20.39	2.5
20M	DFT-S 256QAM	1	1	17.95	18.49	18.59	4.5
20M	CP QPSK	1	1	21.11	21.65	21.75	1.5

NR Conducted Power (Full)

NR Band 30_NSA

BW	MCS Index	RB Size	RB Offset		Mid		3GPP MPR (dB)
		Channel			462000		
		Frequency (MHz)			2310		
10M	DFT-S PI/2 BPSK	1	1		22.58		0
10M	DFT-S QPSK	1	1		22.71		0
		1	26		22.59		0
		1	50		22.44		0
		25	0		21.29		1
		25	14		22.1		0
		25	27		21.03		1
		50	0		20.93		1
10M	DFT-S 16QAM	1	1		21.18		1
10M	DFT-S 64QAM	1	1		19.89		2.5
10M	DFT-S 256QAM	1	1		18.09		4.5
10M	CP QPSK	1	1		21.25		1.5

NR Conducted Power (Full)

NR Band 66_NSA

BW	MCS Index	RB Size	RB Offset	Low	Mid	High	3GPP MPR (dB)
		Channel		346000	349000	352000	
		Frequency (MHz)		1730	1745	1760	
40M	DFT-S PI/2 BPSK	1	1	23.39	23.68	23.60	0
40M	DFT-S QPSK	1	1	23.48	23.78	23.69	0
		1	108	23.45	23.67	23.58	0
		1	214	23.48	23.70	23.67	0
		108	0	22.07	22.28	22.20	1
		108	54	23.63	23.77	23.74	0
		108	108	22.42	22.50	22.47	1
		216	0	22.29	22.44	22.42	1
40M	DFT-S 16QAM	1	1	22.52	22.67	22.67	1
40M	DFT-S 64QAM	1	1	20.78	20.87	20.87	2.5
40M	DFT-S 256QAM	1	1	19.01	19.25	19.22	4.5
40M	CP QPSK	1	1	22.19	22.40	22.31	1.5

NR Conducted Power (Full)

NR Band 71_NSA

BW	MCS Index	RB Size	RB Offset	Low	Mid	High	3GPP MPR (dB)
		Channel		134600	136100	137600	
		Frequency (MHz)		673	680.5	688	
20M	DFT-S PI/2 BPSK	1	1	23.21	23.41	23.18	0
20M	DFT-S QPSK	1	1	23.33	23.53	23.30	0
		1	53	23.13	23.33	23.10	0
		1	104	23.00	23.20	22.97	0
		50	0	22.51	22.71	22.48	1
		50	28	23.16	23.36	23.13	0
		50	56	22.46	22.60	22.40	1
		100	0	22.25	22.45	22.22	1
20M	DFT-S 16QAM	1	1	22.36	22.56	22.33	1
20M	DFT-S 64QAM	1	1	21.13	21.20	21.06	2.5
20M	DFT-S 256QAM	1	1	19.02	19.08	19.00	4.5
20M	CP QPSK	1	1	22.03	22.07	21.96	1.5

NR Conducted Power (Full)							
NR Band 38_NSA							
BW	MCS Index	RB Size	RB Offset	Low	Mid	High	3GPP MPR (dB)
		Channel		516000	519000	522000	
		Frequency (MHz)		2580	2595	2610	
20M	DFT-S PI/2 BPSK	1	1	23.12	23.14	23.10	0
20M	DFT-S QPSK	1	1	23.24	23.26	23.22	0
		1	26	23.21	23.23	23.18	0
		1	49	23.12	23.14	23.09	0
		25	0	22.29	22.31	22.26	1
		25	13	23.09	23.11	23.06	0
		25	26	22.22	22.24	22.19	1
		50	0	22.18	22.20	22.15	1
20M	DFT-S 16QAM	1	1	22.14	22.16	22.11	1
20M	DFT-S 64QAM	1	1	20.77	20.81	20.72	2.5
20M	DFT-S 256QAM	1	1	18.65	18.72	18.59	4.5
20M	CP QPSK	1	1	21.67	21.75	21.61	1.5

NR Conducted Power (Full)							
NR Band 40_NSA							
BW	MCS Index	RB Size	RB Offset	Low	Mid	High	3GPP MPR (dB)
		Channel		468000	470000	472000	
		Frequency (MHz)		2340	2350	2360	
80M	DFT-S PI/2 BPSK	1	1	23.32	23.42	23.41	0
80M	DFT-S QPSK	1	1	23.57	23.61	23.51	0
		1	109	23.33	23.43	23.35	0
		1	215	23.28	23.39	23.31	0
		108	0	22.71	22.75	22.73	1
		108	55	23.47	23.49	23.44	0
		108	109	22.40	22.50	22.44	1
80M	DFT-S 16QAM	1	1	22.56	22.60	22.59	1
80M	DFT-S 64QAM	1	1	21.06	21.20	21.13	2.5
80M	DFT-S 256QAM	1	1	19.00	19.14	19.06	4.5
80M	CP QPSK	1	1	21.96	22.05	22.01	1.5

NR Conducted Power (Full)									
NR Band 41_NSA_PC2									
BW	MCS Index	RB Size	RB Offset	Low	Mid-1	Mid-2	Mid-3	High	3GPP MPR (dB)
		Channel		509202	513900	518598	523302	528000	
		Frequency (MHz)		2546.01	2569.5	2592.99	2616.51	2640	
100M	DFT-S PI/2 BPSK	1	1	26.49	26.51	26.54	26.47	26.50	0
100M	DFT-S QPSK	1	1	26.58	26.60	26.63	26.56	26.59	0
		1	137	26.39	26.41	26.54	26.37	26.40	0
		1	271	26.33	26.36	26.46	26.31	26.34	0
		135	0	25.60	25.62	25.65	25.58	25.61	1
		135	69	26.54	26.56	26.59	26.52	26.55	0
		135	138	25.56	25.58	25.61	25.54	25.57	1
		270	0	25.55	25.57	25.60	25.53	25.56	1
100M	DFT-S 16QAM	1	1	25.48	25.50	25.53	25.46	25.49	1
100M	DFT-S 64QAM	1	1	24.18	24.20	24.23	24.16	24.19	2.5
100M	DFT-S 256QAM	1	1	22.18	22.20	22.23	22.16	22.19	4.5
100M	CP QPSK	1	1	25.28	25.30	25.33	25.26	25.29	1.5

NR Conducted Power (Full)									
NR Band 41_NSA_PC3									
BW	MCS Index	RB Size	RB Offset	Low	Mid-1	Mid-2	Mid-3	High	3GPP MPR (dB)
		Channel		509202	513900	518598	523302	528000	
		Frequency (MHz)		2546.01	2569.5	2592.99	2616.51	2640	
100M	DFT-S PI/2 BPSK	1	1	23.03	23.25	23.58	23.57	23.55	0
100M	DFT-S QPSK	1	1	23.18	23.40	23.73	23.72	23.70	0
		1	137	23.13	23.35	23.68	23.67	23.65	0
		1	271	23.09	23.13	23.43	23.43	23.41	0
		135	0	22.12	22.34	22.67	22.66	22.64	1
		135	69	23.06	23.28	23.61	23.60	23.58	0
		135	138	22.08	22.30	22.63	22.62	22.60	1
		270	0	22.07	22.29	22.62	22.61	22.59	1
100M	DFT-S 16QAM	1	1	22.01	22.23	22.56	22.55	22.53	1
100M	DFT-S 64QAM	1	1	20.67	20.92	21.39	21.35	21.32	2.5
100M	DFT-S 256QAM	1	1	18.82	19.02	19.37	19.34	19.29	4.5
100M	CP QPSK	1	1	21.83	21.96	22.29	22.18	22.15	1.5

NR Conducted Power (Full)									
NR Band 77_NSA_PC2									
BW	MCS Index	RB Size	RB Offset	Low	Mid-1	Mid-2	Mid-3	High	3GPP MPR (dB)
		Channel		650000	653000	656000	659000	662000	
		Frequency (MHz)		3750	3795	3840	3885	3930	
100M	DFT-S PI/2 BPSK	1	1	25.45	26.54	26.01	25.86	25.50	0
100M	DFT-S QPSK	1	1	25.54	26.63	26.10	25.95	25.59	0
		1	137	25.06	26.15	25.62	25.47	25.11	0
		1	271	25.03	26.12	25.59	25.44	25.08	0
		135	0	24.50	25.59	25.06	24.91	24.55	1
		135	69	25.53	26.62	26.09	25.94	25.58	0
		135	138	24.48	25.57	25.04	24.89	24.53	1
		270	0	24.49	25.58	25.05	24.90	24.54	1
100M	DFT-S 16QAM	1	1	24.44	25.53	25.00	24.85	24.49	1
100M	DFT-S 64QAM	1	1	23.10	24.18	23.44	23.40	23.18	2.5
100M	DFT-S 256QAM	1	1	21.14	22.23	21.56	21.44	21.19	4.5
100M	CP QPSK	1	1	24.11	25.20	24.48	24.40	24.14	1.5

NR Conducted Power (Full)									
NR Band 77_NSA_PC3									
BW	MCS Index	RB Size	RB Offset	Low	Mid-1	Mid-2	Mid-3	High	3GPP MPR (dB)
		Channel		650000	653000	656000	659000	662000	
		Frequency (MHz)		3750	3795	3840	3885	3930	
100M	DFT-S PI/2 BPSK	1	1	23.81	23.76	23.55	23.25	23.02	0
100M	DFT-S QPSK	1	1	23.90	23.87	23.66	23.36	23.13	0
		1	137	23.68	23.64	23.50	23.17	23.04	0
		1	271	23.46	23.53	23.37	23.04	22.97	0
		135	0	22.52	22.47	22.27	21.98	21.76	1
		135	69	23.59	23.52	23.32	23.03	22.81	0
		135	138	22.39	22.34	22.14	21.85	21.63	1
		270	0	22.36	22.31	22.11	21.82	21.60	1
100M	DFT-S 16QAM	1	1	22.30	22.25	22.06	21.74	21.52	1
100M	DFT-S 64QAM	1	1	21.34	21.30	21.14	20.78	20.60	2.5
100M	DFT-S 256QAM	1	1	19.30	19.23	19.07	18.74	18.53	4.5
100M	CP QPSK	1	1	22.34	22.27	22.18	21.89	21.67	1.5

NR Conducted Power (Full)							
NR Band 78_NSA_PC2							
BW	MCS Index	RB Size	RB Offset	Low	Mid	High	3GPP MPR (dB)
		Channel			650000		
		Frequency (MHz)			3750		
100M	DFT-S PI/2 BPSK	1	1		26.03		0
100M	DFT-S QPSK	1	1		26.12		0
		1	137		25.94		0
		1	271		25.72		0
		135	0		24.88		1
		135	69		26.00		0
		135	138		24.78		1
		270	0		24.74		1
100M	DFT-S 16QAM	1	1		25.02		1
100M	DFT-S 64QAM	1	1		23.66		2.5
100M	DFT-S 256QAM	1	1		21.82		4.5
100M	CP QPSK	1	1		24.86		1.5

NR Conducted Power (Full)							
NR Band 78_NSA_PC3							
BW	MCS Index	RB Size	RB Offset	Low	Mid	High	3GPP MPR (dB)
		Channel			650000		
		Frequency (MHz)			3750		
100M	DFT-S PI/2 BPSK	1	1		23.54		0
100M	DFT-S QPSK	1	1		23.67		0
		1	137		23.35		0
		1	271		23.27		0
		135	0		22.29		1
		135	69		23.36		0
		135	138		22.16		1
		270	0		22.13		1
100M	DFT-S 16QAM	1	1		22.21		1
100M	DFT-S 64QAM	1	1		21.17		2.5
100M	DFT-S 256QAM	1	1		19.04		4.5
100M	CP QPSK	1	1		22.03		1.5

WCDMA Conducted Power (Reduction_Laptop)

Band	WCDMA II			WCDMA IV			WCDMA V		
TX Channel	9262	9400	9538	1312	1413	1513	4132	4182	4233
Rx Channel	9662	9800	9938	1537	1638	1738	4357	4407	4458
Frequency	1852.4	1880	1907.6	1712.4	1732.6	1752.6	826.4	836.4	846.6
RMC 12.2K	16.90	16.98	16.88	17.65	17.63	17.60	21.98	21.90	21.92
HSDPA Subtest-1	15.66	15.72	15.69	16.91	16.77	16.72	20.68	20.58	20.55
HSDPA Subtest-2	15.65	15.69	15.62	16.88	16.75	16.71	20.66	20.56	20.53
HSDPA Subtest-3	15.22	15.23	15.18	16.45	16.31	16.26	20.18	20.12	20.11
HSDPA Subtest-4	15.16	15.19	15.16	16.42	16.25	16.21	20.15	20.07	20.05
DC-HSDPA Subtest-1	15.54	15.51	15.54	16.84	16.72	16.65	20.58	20.53	20.52
DC-HSDPA Subtest-2	15.53	15.52	15.52	16.86	16.65	16.63	20.55	20.52	20.51
DC-HSDPA Subtest-3	15.03	15.08	15.05	16.41	16.31	16.24	20.08	20.05	20.03
DC-HSDPA Subtest-4	15.01	15.05	15.03	16.40	16.16	16.19	20.05	20.03	20.02
HSUPA Subtest-1	15.77	15.78	15.71	16.55	16.62	16.61	20.62	20.52	20.51
HSUPA Subtest-2	13.65	13.67	13.65	15.06	14.91	14.89	18.61	18.55	18.53
HSUPA Subtest-3	14.67	14.71	14.62	16.07	15.95	15.95	19.65	19.58	19.56
HSUPA Subtest-4	13.55	13.56	13.52	14.75	14.61	14.62	18.55	18.56	18.53
HSUPA Subtest-5	16.61	16.71	16.63	17.41	17.22	17.21	21.61	21.51	21.49

WCDMA Conducted Power (Reduction_Tablet)

Band	WCDMA II			WCDMA IV			WCDMA V		
TX Channel	9262	9400	9538	1312	1413	1513	4132	4182	4233
Rx Channel	9662	9800	9938	1537	1638	1738	4357	4407	4458
Frequency	1852.4	1880	1907.6	1712.4	1732.6	1752.6	826.4	836.4	846.6
RMC 12.2K	12.61	12.66	12.54	12.45	12.38	12.40	18.98	18.94	18.92
HSDPA Subtest-1	11.16	11.22	11.19	12.41	12.27	12.22	17.18	17.08	17.05
HSDPA Subtest-2	11.15	11.19	11.12	12.38	12.25	12.21	17.16	17.06	17.03
HSDPA Subtest-3	10.72	10.73	10.68	11.95	11.81	11.76	16.68	16.62	16.61
HSDPA Subtest-4	10.66	10.69	10.66	11.92	11.75	11.71	16.65	16.57	16.55
DC-HSDPA Subtest-1	11.04	11.01	11.04	12.34	12.22	12.15	17.08	17.03	17.02
DC-HSDPA Subtest-2	11.03	11.02	11.02	12.36	12.15	12.13	17.05	17.02	17.01
DC-HSDPA Subtest-3	10.53	10.58	10.55	11.91	11.81	11.74	16.58	16.55	16.53
DC-HSDPA Subtest-4	10.51	10.55	10.53	11.90	11.66	11.69	16.55	16.53	16.52
HSUPA Subtest-1	11.27	11.28	11.21	12.05	12.12	12.11	17.12	17.02	17.01
HSUPA Subtest-2	9.15	9.17	9.15	10.44	10.41	10.39	15.11	15.05	15.03
HSUPA Subtest-3	10.17	10.21	10.12	11.45	11.45	11.45	16.15	16.08	16.06
HSUPA Subtest-4	9.05	9.06	9.02	10.25	10.11	10.12	15.05	15.06	15.03
HSUPA Subtest-5	12.11	12.21	12.13	12.42	12.34	12.31	18.11	18.01	17.99

LTE Conducted Power (Reduction_Laptop)							
LTE Band 2							
BW	MCS Index	RB Size	RB Offset	Low	Mid	High	3GPP MPR (dB)
		Channel		18700	18900	19100	
		Frequency (MHz)		1860	1880	1900	
20M	QPSK	1	0	17.85	17.80	17.81	0
		1	50	17.82	17.79	17.75	0
		1	99	17.81	17.75	17.77	0
		50	0	16.84	16.78	16.80	1
		50	25	16.78	16.72	16.74	1
		50	50	16.72	16.66	16.68	1
		100	0	16.75	16.69	16.71	1
20M	16QAM	1	0	16.72	16.66	16.68	1
		1	50	16.69	16.63	16.65	1
		1	99	16.57	16.51	16.53	1
		50	0	15.80	15.74	15.76	2
		50	25	15.68	15.62	15.64	2
		50	50	15.65	15.59	15.61	2
		100	0	15.81	15.75	15.77	2
20M	64QAM	1	0	15.68	15.62	15.64	2
		1	50	15.57	15.51	15.53	2
		1	99	15.54	15.48	15.50	2
		50	0	14.71	14.65	14.67	3
		50	25	14.67	14.61	14.63	3
		50	50	14.62	14.56	14.58	3
		100	0	14.57	14.51	14.53	3
20M	256QAM	1	0	12.23	12.26	12.20	5
		1	50	12.16	12.22	12.11	5
		1	99	12.19	12.21	12.13	5
		50	0	12.10	12.11	12.04	5
		50	25	12.14	12.17	12.11	5
		50	50	12.17	12.19	12.10	5
		100	0	12.10	12.13	12.09	5
BW	MCS Index	Channel		18675	18900	19125	3GPP MPR
		Frequency (MHz)		1857.5	1880	1902.5	
15M	QPSK	1	0	17.70	17.65	17.68	0
		1	37	17.65	17.68	17.66	0
		1	74	17.80	17.56	17.67	0
		36	0	16.64	16.75	16.72	1
		36	19	16.70	16.66	16.68	1
		36	39	16.55	16.52	16.52	1
		75	0	16.63	16.56	16.54	1
15M	16QAM	1	0	16.57	16.49	16.59	1
		1	37	16.48	16.56	16.58	1
		1	74	16.54	16.46	16.33	1
		36	0	15.67	15.63	15.63	2
		36	19	15.60	15.53	15.61	2
		36	39	15.48	15.58	15.45	2
		75	0	15.67	15.69	15.73	2
15M	64QAM	1	0	15.47	15.42	15.51	2
		1	37	15.43	15.48	15.32	2
		1	74	15.46	15.38	15.25	2
		36	0	14.56	14.62	14.59	3
		36	19	14.49	14.46	14.45	3
		36	39	14.51	14.53	14.43	3
		75	0	14.33	14.37	14.32	3
15M	256QAM	1	0	12.18	12.24	12.14	5
		1	37	12.08	12.15	12.09	5
		1	74	12.09	12.17	12.06	5
		36	0	12.03	12.10	12.01	5
		36	19	12.14	12.08	12.06	5
		36	39	12.07	12.19	12.01	5
		75	0	12.05	12.13	12.09	5

LTE Conducted Power (Reduction_Laptop)							
LTE Band 2							
BW	MCS Index	Channel		18650	18900	19150	3GPP MPR
		Frequency (MHz)		1855	1880	1905	
10M	QPSK	1	0	17.64	17.60	17.62	0
		1	24	17.72	17.64	17.65	0
		1	49	17.66	17.58	17.60	0
		25	0	16.71	16.65	16.62	1
		25	12	16.65	16.53	16.57	1
		25	25	16.55	16.53	16.55	1
		50	0	16.68	16.60	16.49	1
10M	16QAM	1	0	16.64	16.55	16.57	1
		1	24	16.64	16.54	16.59	1
		1	49	16.52	16.36	16.48	1
		25	0	15.68	15.73	15.73	2
		25	12	15.45	15.57	15.40	2
		25	25	15.57	15.42	15.53	2
		50	0	15.69	15.55	15.54	2
10M	64QAM	1	0	15.48	15.44	15.61	2
		1	24	15.47	15.37	15.39	2
		1	49	15.41	15.40	15.38	2
		25	0	14.63	14.50	14.64	3
		25	12	14.62	14.59	14.43	3
		25	25	14.56	14.45	14.51	3
		50	0	14.49	14.31	14.44	3
10M	256QAM	1	0	12.22	12.23	12.19	5
		1	24	12.06	12.17	12.03	5
		1	49	12.16	12.11	12.11	5
		25	0	12.02	12.06	12.04	5
		25	12	12.06	12.17	12.11	5
		25	25	12.07	12.17	12.07	5
		50	0	12.10	12.09	12.03	5
BW	MCS Index	Channel		18625	18900	19175	3GPP MPR
		Frequency (MHz)		1852.5	1880	1907.5	
5M	QPSK	1	0	17.72	17.67	17.71	0
		1	12	17.79	17.66	17.62	0
		1	24	17.73	17.66	17.60	0
		12	0	16.68	16.64	16.65	1
		12	6	16.65	16.51	16.58	1
		12	13	16.63	16.64	16.51	1
		25	0	16.60	16.62	16.56	1
5M	16QAM	1	0	16.56	16.49	16.60	1
		1	12	16.60	16.48	16.54	1
		1	24	16.41	16.28	16.43	1
		12	0	15.62	15.70	15.60	2
		12	6	15.54	15.44	15.47	2
		12	13	15.48	15.43	15.47	2
		25	0	15.67	15.59	15.66	2
5M	64QAM	1	0	15.49	15.53	15.61	2
		1	12	15.48	15.30	15.30	2
		1	24	15.48	15.38	15.29	2
		12	0	14.57	14.65	14.59	3
		12	6	14.58	14.56	14.43	3
		12	13	14.38	14.42	14.38	3
		25	0	14.47	14.32	14.34	3
5M	256QAM	1	0	12.22	12.25	12.11	5
		1	12	12.06	12.22	12.04	5
		1	24	12.11	12.14	12.12	5
		12	0	12.02	12.01	11.94	5
		12	6	12.13	12.12	12.11	5
		12	13	12.13	12.13	12.04	5
		25	0	12.04	12.10	12.03	5

LTE Conducted Power (Reduction_Laptop)							
LTE Band 2							
BW	MCS Index	Channel		18615	18900	19185	3GPP MPR
		Frequency (MHz)		1851.5	1880	1908.5	
3M	QPSK	1	0	17.75	17.70	17.73	0
		1	7	17.77	17.57	17.75	0
		1	14	17.60	17.57	17.65	0
		8	0	16.82	16.67	16.67	1
		8	3	16.72	16.64	16.57	1
		8	7	16.56	16.60	16.62	1
		15	0	16.60	16.54	16.64	1
3M	16QAM	1	0	16.55	16.47	16.56	1
		1	7	16.59	16.46	16.58	1
		1	14	16.40	16.32	16.35	1
		8	0	15.79	15.57	15.58	2
		8	3	15.58	15.41	15.42	2
		8	7	15.59	15.49	15.53	2
		15	0	15.76	15.62	15.62	2
3M	64QAM	1	0	15.58	15.46	15.55	2
		1	7	15.46	15.32	15.51	2
		1	14	15.41	15.29	15.47	2
		8	0	14.67	14.51	14.50	3
		8	3	14.51	14.42	14.43	3
		8	7	14.42	14.53	14.43	3
		15	0	14.53	14.48	14.48	3
3M	256QAM	1	0	12.17	12.17	12.15	5
		1	7	12.07	12.14	12.10	5
		1	14	12.12	12.18	12.05	5
		8	0	12.03	12.03	12.03	5
		8	3	12.13	12.08	12.09	5
		8	7	12.13	12.16	12.04	5
		15	0	12.10	12.12	12.07	5
BW	MCS Index	Channel		18607	18900	19193	3GPP MPR
		Frequency (MHz)		1850.7	1880	1909.3	
1.4M	QPSK	1	0	17.76	17.61	17.56	0
		1	2	17.78	17.72	17.71	0
		1	5	17.68	17.64	17.72	0
		3	0	16.70	16.55	16.69	0
		3	1	16.75	16.57	16.65	0
		3	3	16.48	16.51	16.49	0
		6	0	16.72	16.46	16.55	1
1.4M	16QAM	1	0	16.59	16.54	16.59	1
		1	2	16.61	16.55	16.47	1
		1	5	16.41	16.39	16.40	1
		3	0	15.75	15.70	15.64	1
		3	1	15.56	15.42	15.48	1
		3	3	15.57	15.49	15.57	1
		6	0	15.61	15.55	15.64	2
1.4M	64QAM	1	0	15.61	15.53	15.55	2
		1	2	15.50	15.36	15.47	2
		1	5	15.44	15.33	15.36	2
		3	0	14.54	14.56	14.59	2
		3	1	14.46	14.42	14.47	2
		3	3	14.49	14.42	14.50	2
		6	0	14.40	14.26	14.47	3
1.4M	256QAM	1	0	12.16	12.20	12.17	5
		1	2	12.13	12.20	12.04	5
		1	5	12.12	12.17	12.11	5
		3	0	12.10	12.08	11.96	5
		3	1	12.10	12.09	12.11	5
		3	3	12.16	12.16	12.06	5
		6	0	12.08	12.09	12.06	5

LTE Conducted Power (Reduction_Laptop)							
LTE Band 4							
BW	MCS Index	RB Size	RB Offset	Low	Mid	High	3GPP MPR (dB)
		Channel		20050	20175	20300	
		Frequency (MHz)		1720	1732.5	1745	
20M	QPSK	1	0	17.81	17.74	17.75	0
		1	50	17.73	17.66	17.67	0
		1	99	17.69	17.62	17.63	0
		50	0	16.57	16.50	16.51	1
		50	25	16.55	16.48	16.49	1
		50	50	16.51	16.44	16.45	1
		100	0	16.59	16.52	16.53	1
20M	16QAM	1	0	16.56	16.49	16.50	1
		1	50	16.48	16.41	16.42	1
		1	99	16.45	16.38	16.39	1
		50	0	15.65	15.58	15.59	2
		50	25	15.62	15.55	15.56	2
		50	50	15.63	15.56	15.57	2
		100	0	15.46	15.39	15.40	2
20M	64QAM	1	0	15.68	15.61	15.62	2
		1	50	15.47	15.40	15.41	2
		1	99	15.45	15.38	15.39	2
		50	0	14.63	14.56	14.57	3
		50	25	14.58	14.51	14.52	3
		50	50	14.44	14.37	14.38	3
		100	0	14.48	14.41	14.42	3
20M	256QAM	1	0	12.18	12.24	12.19	5
		1	50	12.08	12.17	12.04	5
		1	99	12.16	12.12	12.10	5
		50	0	12.08	12.02	11.97	5
		50	25	12.10	12.17	12.03	5
		50	50	12.14	12.11	12.08	5
		100	0	12.04	12.06	12.09	5
BW	MCS Index	Channel		20025	20175	20325	3GPP MPR
		Frequency (MHz)		1717.5	1732.5	1747.5	
15M	QPSK	1	0	17.79	17.66	17.70	0
		1	37	17.73	17.56	17.58	0
		1	74	17.64	17.54	17.63	0
		36	0	16.52	16.46	16.50	1
		36	19	16.46	16.38	16.40	1
		36	39	16.47	16.43	16.41	1
		75	0	16.52	16.48	16.48	1
15M	16QAM	1	0	16.52	16.42	16.42	1
		1	37	16.44	16.37	16.39	1
		1	74	16.37	16.35	16.29	1
		36	0	15.59	15.58	15.57	2
		36	19	15.57	15.53	15.48	2
		36	39	15.59	15.55	15.51	2
		75	0	15.45	15.39	15.32	2
15M	64QAM	1	0	15.61	15.54	15.52	2
		1	37	15.37	15.40	15.39	2
		1	74	15.38	15.28	15.36	2
		36	0	14.55	14.51	14.51	3
		36	19	14.48	14.49	14.51	3
		36	39	14.42	14.37	14.34	3
		75	0	14.41	14.37	14.35	3
15M	256QAM	1	0	12.23	12.24	12.14	5
		1	37	12.14	12.15	12.05	5
		1	74	12.17	12.16	12.10	5
		36	0	12.05	12.11	12.01	5
		36	19	12.04	12.08	12.04	5
		36	39	12.13	12.19	12.05	5
		75	0	12.00	12.03	12.08	5

LTE Conducted Power (Reduction_Laptop)							
LTE Band 4							
BW	MCS Index	Channel		20000	20175	20350	3GPP MPR
		Frequency (MHz)		1715	1732.5	1750	
10M	QPSK	1	0	17.73	17.70	17.72	0
		1	24	17.65	17.66	17.58	0
		1	49	17.67	17.62	17.54	0
		25	0	16.53	16.50	16.41	1
		25	12	16.49	16.41	16.42	1
		25	25	16.47	16.39	16.40	1
		50	0	16.52	16.45	16.52	1
10M	16QAM	1	0	16.50	16.47	16.42	1
		1	24	16.47	16.32	16.32	1
		1	49	16.44	16.37	16.31	1
		25	0	15.58	15.50	15.57	2
		25	12	15.61	15.55	15.52	2
		25	25	15.58	15.51	15.51	2
		50	0	15.37	15.39	15.34	2
10M	64QAM	1	0	15.68	15.57	15.58	2
		1	24	15.39	15.32	15.40	2
		1	49	15.45	15.35	15.38	2
		25	0	14.53	14.47	14.53	3
		25	12	14.56	14.49	14.42	3
		25	25	14.35	14.28	14.33	3
		50	0	14.38	14.41	14.36	3
10M	256QAM	1	0	12.14	12.19	12.19	5
		1	24	12.14	12.20	12.10	5
		1	49	12.15	12.12	12.13	5
		25	0	12.00	12.04	12.04	5
		25	12	12.14	12.14	12.09	5
		25	25	12.10	12.09	12.02	5
		50	0	12.00	12.09	11.99	5
BW	MCS Index	Channel		19975	20175	20375	3GPP MPR
		Frequency (MHz)		1712.5	1732.5	1752.5	
5M	QPSK	1	0	17.74	17.73	17.65	0
		1	12	17.71	17.65	17.58	0
		1	24	17.64	17.61	17.57	0
		12	0	16.53	16.42	16.45	1
		12	6	16.46	16.42	16.49	1
		12	13	16.48	16.40	16.44	1
		25	0	16.53	16.51	16.45	1
5M	16QAM	1	0	16.50	16.49	16.42	1
		1	12	16.41	16.36	16.37	1
		1	24	16.42	16.38	16.35	1
		12	0	15.58	15.55	15.50	2
		12	6	15.62	15.45	15.46	2
		12	13	15.58	15.48	15.54	2
		25	0	15.42	15.31	15.33	2
5M	64QAM	1	0	15.61	15.56	15.62	2
		1	12	15.47	15.32	15.36	2
		1	24	15.35	15.35	15.30	2
		12	0	14.57	14.51	14.47	3
		12	6	14.58	14.42	14.51	3
		12	13	14.42	14.34	14.37	3
		25	0	14.42	14.38	14.39	3
5M	256QAM	1	0	12.23	12.26	12.12	5
		1	12	12.09	12.16	12.04	5
		1	24	12.12	12.20	12.11	5
		12	0	12.00	12.11	11.97	5
		12	6	12.09	12.13	12.11	5
		12	13	12.07	12.16	12.00	5
		25	0	12.07	12.11	12.08	5

LTE Conducted Power (Reduction_Laptop)							
LTE Band 4							
BW	MCS Index	Channel		19965	20175	20385	3GPP MPR
		Frequency (MHz)		1711.5	1732.5	1753.5	
3M	QPSK	1	0	17.78	17.67	17.74	0
		1	7	17.65	17.59	17.63	0
		1	14	17.60	17.59	17.55	0
		8	0	16.56	16.40	16.46	1
		8	3	16.46	16.43	16.46	1
		8	7	16.46	16.42	16.41	1
		15	0	16.49	16.50	16.50	1
3M	16QAM	1	0	16.52	16.45	16.40	1
		1	7	16.43	16.41	16.42	1
		1	14	16.38	16.37	16.33	1
		8	0	15.65	15.53	15.52	2
		8	3	15.56	15.49	15.52	2
		8	7	15.54	15.53	15.52	2
		15	0	15.44	15.38	15.30	2
3M	64QAM	1	0	15.63	15.54	15.55	2
		1	7	15.45	15.37	15.32	2
		1	14	15.38	15.29	15.33	2
		8	0	14.62	14.47	14.50	3
		8	3	14.54	14.41	14.52	3
		8	7	14.44	14.28	14.36	3
		15	0	14.40	14.34	14.37	3
3M	256QAM	1	0	12.15	12.24	12.11	5
		1	7	12.06	12.22	12.09	5
		1	14	12.14	12.18	12.10	5
		8	0	12.01	12.08	11.95	5
		8	3	12.09	12.15	12.02	5
		8	7	12.07	12.10	12.10	5
		15	0	12.06	12.04	12.05	5
BW	MCS Index	Channel		19957	20175	20393	3GPP MPR
		Frequency (MHz)		1710.7	1732.5	1754.3	
1.4M	QPSK	1	0	17.76	17.59	17.65	0
		1	2	17.58	17.61	17.55	0
		1	5	17.50	17.53	17.53	0
		3	0	17.45	17.32	17.39	0
		3	1	17.47	17.37	17.37	0
		3	3	17.39	17.35	17.34	0
		6	0	16.45	16.36	16.31	1
1.4M	16QAM	1	0	16.44	16.34	16.46	1
		1	2	16.25	16.21	16.35	1
		1	5	16.33	16.26	16.22	1
		3	0	16.48	16.46	16.45	1
		3	1	16.48	16.50	16.42	1
		3	3	16.55	16.44	16.47	1
		6	0	15.44	15.19	15.26	2
1.4M	64QAM	1	0	15.53	15.61	15.42	2
		1	2	15.40	15.19	15.35	2
		1	5	15.28	15.27	15.18	2
		3	0	15.58	15.41	15.49	2
		3	1	15.47	15.40	15.39	2
		3	3	15.42	15.26	15.14	2
		6	0	14.40	14.30	14.35	3
1.4M	256QAM	1	0	12.16	12.24	12.19	5
		1	2	12.07	12.21	12.04	5
		1	5	12.17	12.15	12.11	5
		3	0	12.05	12.03	11.95	5
		3	1	12.05	12.13	12.04	5
		3	3	12.07	12.19	12.10	5
		6	0	12.09	12.06	11.99	5

LTE Conducted Power (Reduction_Laptop)							
LTE Band 5							
BW	MCS Index	RB Size	RB Offset	Low	Mid	High	3GPP MPR (dB)
		Channel		20450	20525	20600	
		Frequency (MHz)		829	836.5	844	
10M	QPSK	1	0	21.30	21.31	21.12	0
		1	24	20.98	21.07	21.03	0
		1	49	20.96	21.05	21.01	0
		25	0	20.38	20.47	20.43	1
		25	12	20.25	20.34	20.30	1
		25	25	20.23	20.32	20.28	1
		50	0	20.22	20.31	20.27	1
10M	16QAM	1	0	20.11	20.20	20.16	1
		1	24	20.05	20.14	20.10	1
		1	49	19.99	20.08	20.04	1
		25	0	19.33	19.42	19.38	2
		25	12	19.28	19.37	19.33	2
		25	25	19.22	19.31	19.27	2
		50	0	19.21	19.30	19.26	2
10M	64QAM	1	0	19.29	19.38	19.34	2
		1	24	19.04	19.13	19.09	2
		1	49	19.01	19.10	19.06	2
		25	0	18.44	18.47	18.46	3
		25	12	18.32	18.40	18.36	3
		25	25	18.30	18.39	18.34	3
		50	0	18.21	18.29	18.22	3
10M	256QAM	1	0	16.17	16.33	16.24	5
		1	24	16.21	16.27	16.23	5
		1	49	16.15	16.26	16.21	5
		25	0	16.01	16.16	16.04	5
		25	12	15.98	16.15	16.04	5
		25	25	16.03	16.13	16.12	5
		50	0	16.06	16.18	16.12	5
BW	MCS Index	Channel		20425	20525	20625	3GPP MPR
		Frequency (MHz)		826.5	836.5	846.5	
5M	QPSK	1	0	21.04	21.11	21.09	0
		1	12	20.98	21.07	20.99	0
		1	24	20.93	20.99	20.98	0
		12	0	20.32	20.44	20.34	1
		12	6	20.19	20.33	20.23	1
		12	13	20.15	20.31	20.19	1
		25	0	20.22	20.25	20.27	1
5M	16QAM	1	0	20.07	20.14	20.06	1
		1	12	19.97	20.08	20.00	1
		1	24	19.89	19.98	20.00	1
		12	0	19.26	19.40	19.30	2
		12	6	19.21	19.37	19.24	2
		12	13	19.15	19.27	19.25	2
		25	0	19.15	19.26	19.18	2
5M	64QAM	1	0	19.27	19.36	19.34	2
		1	12	18.96	19.10	19.03	2
		1	24	18.99	19.05	19.05	2
		12	0	18.45	18.46	18.40	3
		12	6	18.41	18.44	18.39	3
		12	13	18.38	18.39	18.35	3
		25	0	18.26	18.33	18.27	3
5M	256QAM	1	0	16.10	16.25	16.21	5
		1	12	16.14	16.21	16.23	5
		1	24	16.05	16.19	16.11	5
		12	0	15.93	16.06	15.95	5
		12	6	15.95	16.09	16.04	5
		12	13	15.96	16.13	16.09	5
		25	0	16.05	16.10	16.05	5

LTE Conducted Power (Reduction_Laptop)							
LTE Band 5							
BW	MCS Index	Channel		20415	20525	20635	3GPP MPR
		Frequency (MHz)		825.5	836.5	847.5	
3M	QPSK	1	0	20.99	21.09	21.00	0
		1	7	20.89	21.01	20.97	0
		1	14	20.95	20.99	21.00	0
		8	0	20.35	20.36	20.33	1
		8	3	20.15	20.30	20.20	1
		8	7	20.14	20.25	20.27	1
		15	0	20.13	20.31	20.27	1
3M	16QAM	1	0	20.09	20.20	20.14	1
		1	7	19.95	20.13	20.03	1
		1	14	19.91	20.03	20.03	1
		8	0	19.23	19.41	19.30	2
		8	3	19.18	19.36	19.26	2
		8	7	19.22	19.23	19.22	2
		15	0	19.17	19.28	19.17	2
3M	64QAM	1	0	19.21	19.28	19.27	2
		1	7	19.03	19.12	19.05	2
		1	14	19.01	19.10	18.99	2
		8	0	18.46	18.49	18.44	3
		8	3	18.43	18.44	18.34	3
		8	7	18.41	18.43	18.30	3
		15	0	18.34	18.36	18.29	3
3M	256QAM	1	0	16.13	16.31	16.24	5
		1	7	16.16	16.23	16.14	5
		1	14	16.09	16.20	16.13	5
		8	0	15.99	16.14	15.97	5
		8	3	15.91	16.12	16.04	5
		8	7	15.93	16.08	16.05	5
		15	0	16.03	16.17	16.11	5
BW	MCS Index	Channel		20407	20525	20643	3GPP MPR
		Frequency (MHz)		824.7	836.5	848.3	
1.4M	QPSK	1	0	20.92	20.98	20.91	0
		1	2	20.93	20.92	20.89	0
		1	5	20.92	20.94	20.80	0
		3	0	20.83	20.96	21.03	0
		3	1	20.85	20.94	20.97	0
		3	3	20.93	20.88	20.86	0
		6	0	19.99	20.17	20.08	1
1.4M	16QAM	1	0	20.05	20.15	20.15	1
		1	2	19.98	20.06	19.93	1
		1	5	19.86	19.94	19.94	1
		3	0	20.17	20.32	20.32	1
		3	1	20.11	20.20	20.27	1
		3	3	20.08	20.18	20.10	1
		6	0	19.12	19.25	19.13	2
1.4M	64QAM	1	0	19.08	19.25	19.17	2
		1	2	18.93	19.04	18.97	2
		1	5	18.86	18.85	18.93	2
		3	0	19.42	19.45	19.46	2
		3	1	19.36	19.43	19.44	2
		3	3	19.41	19.45	19.44	2
		6	0	18.16	18.31	18.29	3
1.4M	256QAM	1	0	16.15	16.26	16.18	5
		1	2	16.15	16.22	16.21	5
		1	5	16.12	16.23	16.11	5
		3	0	15.92	16.14	16.01	5
		3	1	15.89	16.15	15.96	5
		3	3	15.94	16.08	16.09	5
		6	0	16.00	16.10	16.06	5

LTE Conducted Power (Reduction_Laptop)							
LTE Band 7							
BW	MCS Index	RB Size	RB Offset	Low	Mid	High	3GPP MPR (dB)
		Channel		20850	21100	21350	
		Frequency (MHz)		2510	2535	2560	
20M	QPSK	1	0	17.82	17.66	17.86	0
		1	50	17.17	17.27	17.42	0
		1	99	17.08	17.18	17.33	0
		50	0	16.19	16.29	16.44	1
		50	25	16.17	16.27	16.42	1
		50	50	16.06	16.16	16.31	1
		100	0	16.14	16.24	16.39	1
20M	16QAM	1	0	16.11	16.21	16.36	1
		1	50	15.76	15.86	16.01	1
		1	99	15.41	15.51	15.66	1
		50	0	15.11	15.21	15.36	2
		50	25	15.00	15.10	15.25	2
		50	50	14.90	15.00	15.15	2
		100	0	15.03	15.13	15.28	2
20M	64QAM	1	0	14.92	15.02	15.17	2
		1	50	14.54	14.64	14.79	2
		1	99	14.23	14.33	14.48	2
		50	0	14.13	14.23	14.38	3
		50	25	14.10	14.20	14.35	3
		50	50	14.02	14.12	14.27	3
		100	0	14.13	14.23	14.38	3
20M	256QAM	1	0	12.13	12.19	12.26	5
		1	50	12.23	12.30	12.32	5
		1	99	12.17	12.19	12.26	5
		50	0	12.22	12.26	12.29	5
		50	25	12.14	12.23	12.22	5
		50	50	12.17	12.22	12.23	5
		100	0	12.15	12.25	12.26	5
BW	MCS Index	Channel		20825	21100	21375	3GPP MPR
		Frequency (MHz)		2507.5	2535	2562.5	
15M	QPSK	1	0	17.20	17.30	17.39	0
		1	37	17.08	17.23	17.39	0
		1	74	16.98	17.17	17.25	0
		36	0	16.19	16.23	16.42	1
		36	19	16.13	16.18	16.40	1
		36	39	15.98	16.12	16.22	1
		75	0	16.05	16.23	16.35	1
15M	16QAM	1	0	16.05	16.21	16.31	1
		1	37	15.68	15.86	15.94	1
		1	74	15.32	15.44	15.64	1
		36	0	15.08	15.15	15.28	2
		36	19	14.95	15.10	15.25	2
		36	39	14.80	15.00	15.05	2
		75	0	14.98	15.10	15.19	2
15M	64QAM	1	0	14.86	14.97	15.09	2
		1	37	14.47	14.59	14.79	2
		1	74	14.20	14.30	14.40	2
		36	0	14.10	14.14	14.34	3
		36	19	14.07	14.20	14.29	3
		36	39	13.94	14.04	14.23	3
		75	0	14.11	14.13	14.34	3
15M	256QAM	1	0	12.10	12.16	12.16	5
		1	37	12.20	12.28	12.26	5
		1	74	12.10	12.10	12.18	5
		36	0	12.17	12.22	12.22	5
		36	19	12.14	12.19	12.13	5
		36	39	12.17	12.16	12.17	5
		75	0	12.15	12.20	12.24	5

LTE Conducted Power (Reduction_Laptop)							
LTE Band 7							
BW	MCS Index	Channel		20800	21100	21400	3GPP MPR
		Frequency (MHz)		2505	2535	2565	
10M	QPSK	1	0	17.14	17.21	17.41	0
		1	24	17.10	17.17	17.39	0
		1	49	17.05	17.12	17.26	0
		25	0	16.15	16.26	16.44	1
		25	12	16.08	16.26	16.38	1
		25	25	16.01	16.15	16.22	1
		50	0	16.14	16.22	16.39	1
10M	16QAM	1	0	16.07	16.13	16.31	1
		1	24	15.72	15.82	15.97	1
		1	49	15.36	15.43	15.58	1
		25	0	15.03	15.21	15.31	2
		25	12	14.98	15.05	15.18	2
		25	25	14.89	14.99	15.10	2
		50	0	15.00	15.08	15.28	2
10M	64QAM	1	0	14.91	14.95	15.07	2
		1	24	14.50	14.61	14.72	2
		1	49	14.16	14.24	14.45	2
		25	0	14.08	14.13	14.38	3
		25	12	14.00	14.18	14.26	3
		25	25	14.01	14.07	14.17	3
		50	0	14.13	14.21	14.33	3
10M	256QAM	1	0	12.09	12.16	12.26	5
		1	24	12.16	12.23	12.32	5
		1	49	12.17	12.12	12.19	5
		25	0	12.17	12.17	12.27	5
		25	12	12.10	12.22	12.20	5
		25	25	12.13	12.16	12.19	5
		50	0	12.11	12.19	12.24	5
BW	MCS Index	Channel		20775	21100	21425	3GPP MPR
		Frequency (MHz)		2502.5	2535	2567.5	
5M	QPSK	1	0	17.17	17.27	17.38	0
		1	12	17.07	17.23	17.42	0
		1	24	17.00	17.14	17.31	0
		12	0	16.16	16.23	16.38	1
		12	6	16.10	16.25	16.32	1
		12	13	16.05	16.07	16.25	1
		25	0	16.04	16.19	16.32	1
5M	16QAM	1	0	16.02	16.11	16.36	1
		1	12	15.68	15.85	16.00	1
		1	24	15.32	15.48	15.66	1
		12	0	15.09	15.21	15.27	2
		12	6	15.00	15.06	15.21	2
		12	13	14.82	14.97	15.11	2
		25	0	14.96	15.12	15.26	2
5M	64QAM	1	0	14.91	14.99	15.08	2
		1	12	14.53	14.63	14.69	2
		1	24	14.14	14.31	14.43	2
		12	0	14.03	14.19	14.34	3
		12	6	14.05	14.20	14.29	3
		12	13	13.96	14.03	14.25	3
		25	0	14.03	14.22	14.32	3
5M	256QAM	1	0	12.07	12.09	12.17	5
		1	12	12.13	12.29	12.30	5
		1	24	12.10	12.10	12.21	5
		12	0	12.20	12.23	12.28	5
		12	6	12.04	12.19	12.12	5
		12	13	12.17	12.21	12.17	5
		25	0	12.07	12.22	12.23	5

LTE Conducted Power (Reduction_Laptop)							
LTE Band 12							
BW	MCS Index	RB Size	RB Offset	Low	Mid	High	3GPP MPR (dB)
		Channel		23060	23095	23130	
		Frequency (MHz)		704	707.5	711	
10M	QPSK	1	0	19.29	19.33	19.35	0
		1	24	19.10	18.99	19.15	0
		1	49	19.02	18.91	19.07	0
		25	0	18.01	17.90	18.06	1
		25	12	17.97	17.86	18.02	1
		25	25	17.96	17.85	18.01	1
		50	0	17.93	17.82	17.98	1
10M	16QAM	1	0	17.67	17.56	17.72	1
		1	24	17.66	17.55	17.71	1
		1	49	17.57	17.46	17.62	1
		25	0	17.07	16.96	17.12	2
		25	12	16.51	16.40	16.56	2
		25	25	16.46	16.35	16.51	2
		50	0	16.43	16.32	16.48	2
10M	64QAM	1	0	16.34	16.23	16.39	2
		1	24	16.28	16.17	16.33	2
		1	49	16.21	16.10	16.26	2
		25	0	15.66	15.55	15.71	3
		25	12	15.60	15.49	15.65	3
		25	25	15.48	15.37	15.53	3
		50	0	15.60	15.49	15.65	3
10M	256QAM	1	0	13.30	13.29	13.39	5
		1	24	13.32	13.22	13.41	5
		1	49	13.25	13.19	13.29	5
		25	0	13.13	13.09	13.22	5
		25	12	13.31	13.26	13.31	5
		25	25	13.12	13.03	13.19	5
		50	0	13.18	13.18	13.22	5
BW	MCS Index	Channel		23035	23095	23155	3GPP MPR
		Frequency (MHz)		701.5	707.5	713.5	
5M	QPSK	1	0	19.18	19.15	19.27	0
		1	12	19.31	19.23	19.31	0
		1	24	19.29	19.19	19.29	0
		12	0	18.01	17.86	18.06	1
		12	6	17.90	17.81	18.01	1
		12	13	17.91	17.75	17.99	1
		25	0	17.88	17.75	17.94	1
5M	16QAM	1	0	17.67	17.49	17.70	1
		1	12	17.56	17.46	17.61	1
		1	24	17.49	17.39	17.56	1
		12	0	17.07	16.95	17.09	2
		12	6	16.48	16.34	16.56	2
		12	13	16.42	16.27	16.47	2
		25	0	16.34	16.28	16.46	2
5M	64QAM	1	0	16.33	16.21	16.39	2
		1	12	16.18	16.08	16.27	2
		1	24	16.18	16.00	16.17	2
		12	0	15.57	15.48	15.65	3
		12	6	15.56	15.45	15.60	3
		12	13	15.47	15.32	15.45	3
		25	0	15.57	15.45	15.63	3
5M	256QAM	1	0	13.27	13.23	13.32	5
		1	12	13.28	13.14	13.37	5
		1	24	13.15	13.11	13.28	5
		12	0	13.10	12.99	13.12	5
		12	6	13.24	13.17	13.27	5
		12	13	13.12	12.97	13.09	5
		25	0	13.12	13.12	13.17	5

LTE Conducted Power (Reduction_Laptop)							
LTE Band 12							
BW	MCS Index	Channel		23025	23095	23165	3GPP MPR
		Frequency (MHz)		700.5	707.5	714.5	
3M	QPSK	1	0	19.21	19.09	19.28	0
		1	7	19.09	18.92	19.06	0
		1	14	18.92	18.90	19.01	0
		8	0	18.00	17.80	17.99	1
		8	3	17.94	17.77	17.94	1
		8	7	17.93	17.79	17.99	1
		15	0	17.86	17.77	17.88	1
3M	16QAM	1	0	17.66	17.47	17.66	1
		1	7	17.58	17.54	17.71	1
		1	14	17.51	17.39	17.59	1
		8	0	17.04	16.90	17.06	2
		8	3	16.42	16.33	16.49	2
		8	7	16.42	16.35	16.50	2
		15	0	16.33	16.27	16.42	2
3M	64QAM	1	0	16.32	16.21	16.31	2
		1	7	16.25	16.17	16.25	2
		1	14	16.12	16.10	16.16	2
		8	0	15.65	15.51	15.63	3
		8	3	15.52	15.48	15.65	3
		8	7	15.46	15.31	15.50	3
		15	0	15.56	15.39	15.55	3
3M	256QAM	1	0	13.24	13.23	13.30	5
		1	7	13.29	13.16	13.38	5
		1	14	13.20	13.12	13.27	5
		8	0	13.12	13.02	13.15	5
		8	3	13.30	13.21	13.31	5
		8	7	13.06	12.94	13.10	5
		15	0	13.17	13.15	13.21	5
BW	MCS Index	Channel		23017	23095	23173	3GPP MPR
		Frequency (MHz)		699.7	707.5	715.3	
1.4M	QPSK	1	0	19.04	19.03	19.14	0
		1	2	18.89	18.81	19.06	0
		1	5	18.87	18.73	19.00	0
		3	0	19.07	18.98	19.24	0
		3	1	19.06	18.84	19.02	0
		3	3	18.92	18.80	19.04	0
		6	0	17.76	17.67	17.78	1
1.4M	16QAM	1	0	17.59	17.43	17.50	1
		1	2	17.50	17.54	17.59	1
		1	5	17.49	17.31	17.42	1
		3	0	17.98	17.84	18.04	1
		3	1	17.47	17.33	17.49	1
		3	3	17.30	17.18	17.36	1
		6	0	16.27	16.15	16.41	2
1.4M	64QAM	1	0	16.18	16.10	16.32	2
		1	2	16.21	16.00	16.16	2
		1	5	16.08	16.09	16.20	2
		3	0	16.48	16.45	16.50	2
		3	1	16.45	16.28	16.53	2
		3	3	16.26	16.19	16.47	2
		6	0	15.58	15.30	15.46	3
1.4M	256QAM	1	0	13.26	13.19	13.30	5
		1	2	13.31	13.15	13.32	5
		1	5	13.23	13.09	13.23	5
		3	0	13.03	13.05	13.18	5
		3	1	13.30	13.21	13.27	5
		3	3	13.02	12.98	13.10	5
		6	0	13.16	13.12	13.19	5

LTE Conducted Power (Reduction_Laptop)							
LTE Band 13							
BW	MCS Index	RB Size	RB Offset		Mid		3GPP MPR (dB)
		Channel			23230		
		Frequency (MHz)			782		
10M	QPSK	1	0		19.98		0
		1	24		19.92		0
		1	49		19.83		0
		25	0		18.80		1
		25	12		18.75		1
		25	25		18.67		1
		50	0		18.79		1
10M	16QAM	1	0		18.68		1
		1	24		18.59		1
		1	49		18.43		1
		25	0		17.95		2
		25	12		17.90		2
		25	25		17.81		2
		50	0		17.76		2
10M	64QAM	1	0		17.68		2
		1	24		17.36		2
		1	49		17.15		2
		25	0		16.39		3
		25	12		16.33		3
		25	25		16.22		3
		50	0		16.15		3
10M	256QAM	1	0		14.18		5
		1	24		14.26		5
		1	49		14.03		5
		25	0		13.92		5
		25	12		13.98		5
		25	25		13.95		5
		50	0		14.01		5
BW	MCS Index	Channel		23205	23230	23255	3GPP MPR
		Frequency (MHz)		779.5	782	784.5	
5M	QPSK	1	0	19.86	19.89	19.78	0
		1	12	19.78	19.81	19.70	0
		1	24	19.69	19.72	19.61	0
		12	0	18.67	18.70	18.59	1
		12	6	18.59	18.62	18.51	1
		12	13	18.48	18.51	18.40	1
		25	0	18.66	18.69	18.58	1
5M	16QAM	1	0	18.52	18.55	18.44	1
		1	12	18.46	18.49	18.38	1
		1	24	18.29	18.32	18.21	1
		12	0	17.83	17.86	17.75	2
		12	6	17.76	17.79	17.68	2
		12	13	17.60	17.63	17.52	2
		25	0	17.61	17.64	17.53	2
5M	64QAM	1	0	17.50	17.53	17.42	2
		1	12	17.20	17.23	17.12	2
		1	24	16.98	17.01	16.90	2
		12	0	16.17	16.20	16.09	3
		12	6	16.19	16.22	16.11	3
		12	13	16.10	16.13	16.02	3
		25	0	15.95	15.98	15.87	3
5M	256QAM	1	0	14.10	14.11	14.11	5
		1	12	14.25	14.17	14.20	5
		1	24	13.95	14.02	13.96	5
		12	0	13.91	13.87	13.83	5
		12	6	13.88	13.94	13.94	5
		12	13	13.93	13.92	13.86	5
		25	0	13.93	14.00	13.91	5

LTE Conducted Power (Reduction_Laptop)							
LTE Band 14							
BW	MCS Index	RB Size	RB Offset	Mid		3GPP MPR (dB)	
		Channel		23330			
		Frequency (MHz)		793			
10M	QPSK	1	0		22.67		0
		1	24		22.64		0
		1	49		22.60		0
		25	0		21.70		1
		25	12		21.66		1
		25	25		21.65		1
		50	0		21.63		1
10M	16QAM	1	0		21.60		1
		1	24		21.58		1
		1	49		21.57		1
		25	0		20.70		2
		25	12		20.68		2
		25	25		20.67		2
		50	0		20.66		2
10M	64QAM	1	0		20.60		2
		1	24		20.58		2
		1	49		20.55		2
		25	0		19.70		3
		25	12		19.68		3
		25	25		19.66		3
		50	0		19.64		3
10M	256QAM	1	0		17.11		5
		1	24		17.08		5
		1	49		16.99		5
		25	0		17.01		5
		25	12		16.94		5
		25	25		16.98		5
		50	0		16.95		5
BW	MCS Index	Channel		23305	23330	23355	3GPP MPR
		Frequency (MHz)		790.5	793	795.5	
5M	QPSK	1	0	22.60	22.62	22.54	0
		1	12	22.59	22.61	22.53	0
		1	24	22.58	22.60	22.52	0
		12	0	21.64	21.66	21.58	1
		12	6	21.62	21.64	21.56	1
		12	13	21.61	21.63	21.55	1
		25	0	21.59	21.61	21.53	1
5M	16QAM	1	0	21.64	21.66	21.58	1
		1	12	21.62	21.64	21.56	1
		1	24	21.60	21.62	21.54	1
		12	0	20.63	20.65	20.57	2
		12	6	20.62	20.64	20.56	2
		12	13	20.60	20.62	20.54	2
		25	0	20.58	20.60	20.52	2
5M	64QAM	1	0	20.62	20.64	20.56	2
		1	12	20.61	20.63	20.55	2
		1	24	20.59	20.61	20.53	2
		12	0	19.62	19.64	19.56	3
		12	6	19.60	19.62	19.54	3
		12	13	19.59	19.61	19.53	3
		25	0	19.57	19.59	19.51	3
5M	256QAM	1	0	17.05	17.01	17.07	5
		1	12	17.01	17.05	17.07	5
		1	24	16.89	16.90	16.93	5
		12	0	16.92	16.95	17.00	5
		12	6	16.93	16.91	16.89	5
		12	13	16.88	16.90	16.97	5
		25	0	16.89	16.94	16.93	5

LTE Conducted Power (Reduction_Laptop)							
LTE Band 17							
BW	MCS Index	RB Size	RB Offset	Low	Mid	High	3GPP MPR (dB)
		Channel		23780	23790	23800	
		Frequency (MHz)		709	710	711	
10M	QPSK	1	0	19.32	19.42	19.16	0
		1	24	19.20	19.22	19.15	0
		1	49	19.18	19.20	19.13	0
		25	0	18.26	18.28	18.21	1
		25	12	18.24	18.26	18.19	1
		25	25	18.23	18.25	18.18	1
		50	0	18.21	18.23	18.16	1
10M	16QAM	1	0	18.24	18.26	18.19	1
		1	24	18.18	18.20	18.13	1
		1	49	18.16	18.18	18.11	1
		25	0	17.24	17.26	17.19	2
		25	12	17.22	17.24	17.17	2
		25	25	17.20	17.22	17.15	2
		50	0	17.18	17.20	17.13	2
10M	64QAM	1	0	17.22	17.24	17.17	2
		1	24	17.17	17.19	17.12	2
		1	49	17.14	17.16	17.09	2
		25	0	16.22	16.24	16.17	3
		25	12	16.20	16.22	16.15	3
		25	25	16.18	16.20	16.13	3
		50	0	16.16	16.18	16.11	3
10M	256QAM	1	0	14.43	14.44	14.46	5
		1	24	14.45	14.38	14.50	5
		1	49	14.26	14.35	14.33	5
		25	0	14.11	14.29	14.19	5
		25	12	14.26	14.32	14.28	5
		25	25	14.09	14.22	14.17	5
		50	0	14.32	14.35	14.32	5
BW	MCS Index	Channel		23755	23790	23825	3GPP MPR
		Frequency (MHz)		706.5	710	713.5	
5M	QPSK	1	0	19.20	19.20	19.21	0
		1	12	19.11	19.13	19.15	0
		1	24	19.11	19.12	19.11	0
		12	0	18.26	18.26	18.11	1
		12	6	18.15	18.18	18.17	1
		12	13	18.21	18.16	18.12	1
		25	0	18.18	18.21	18.07	1
5M	16QAM	1	0	18.20	18.23	18.15	1
		1	12	18.18	18.19	18.13	1
		1	24	18.13	18.13	18.04	1
		12	0	17.20	17.18	17.14	2
		12	6	17.19	17.24	17.08	2
		12	13	17.20	17.16	17.09	2
		25	0	17.09	17.19	17.03	2
5M	64QAM	1	0	17.13	17.21	17.14	2
		1	12	17.14	17.18	17.03	2
		1	24	17.04	17.09	16.99	2
		12	0	16.20	16.15	16.16	3
		12	6	16.20	16.16	16.13	3
		12	13	16.08	16.16	16.09	3
		25	0	16.06	16.12	16.04	3
5M	256QAM	1	0	14.43	14.40	14.41	5
		1	12	14.35	14.35	14.43	5
		1	24	14.22	14.30	14.29	5
		12	0	14.01	14.26	14.14	5
		12	6	14.22	14.23	14.18	5
		12	13	13.99	14.13	14.07	5
		25	0	14.32	14.29	14.23	5

LTE Conducted Power (Reduction_Laptop)							
LTE Band 25							
BW	MCS Index	RB Size	RB Offset	Low	Mid	High	3GPP MPR (dB)
		Channel		26140	26365	26590	
		Frequency (MHz)		1860	1882.5	1905	
20M	QPSK	1	0	18.00	18.02	18.07	0
		1	50	17.98	18.00	18.05	0
		1	99	17.97	17.99	18.04	0
		50	0	17.02	17.04	17.09	1
		50	25	16.94	16.96	17.01	1
		50	50	16.92	16.94	16.99	1
		100	0	16.89	16.91	16.96	1
20M	16QAM	1	0	16.99	17.01	17.06	1
		1	50	16.97	16.99	17.04	1
		1	99	16.96	16.98	17.03	1
		50	0	16.04	16.06	16.11	2
		50	25	16.02	16.04	16.09	2
		50	50	15.99	16.01	16.06	2
		100	0	15.97	15.99	16.04	2
20M	64QAM	1	0	16.04	16.06	16.11	2
		1	50	16.02	16.04	16.09	2
		1	99	16.01	16.03	16.08	2
		50	0	15.02	15.04	15.09	3
		50	25	15.00	15.02	15.07	3
		50	50	14.99	15.01	15.06	3
		100	0	14.97	14.99	15.04	3
20M	256QAM	1	0	13.24	13.28	13.38	5
		1	50	13.23	13.27	13.31	5
		1	99	13.18	13.26	13.27	5
		50	0	13.27	13.34	13.37	5
		50	25	13.25	13.28	13.34	5
		50	50	13.23	13.29	13.32	5
		100	0	13.30	13.37	13.39	5
BW	MCS Index	Channel		26115	26365	26615	3GPP MPR
		Frequency (MHz)		1857.5	1882.5	1907.5	
15M	QPSK	1	0	17.95	17.99	17.98	0
		1	37	17.94	17.97	18.02	0
		1	74	17.88	17.91	18.02	0
		36	0	16.96	16.98	17.04	1
		36	19	16.85	16.96	17.00	1
		36	39	16.89	16.93	16.90	1
		75	0	16.83	16.87	16.87	1
15M	16QAM	1	0	16.97	16.97	17.01	1
		1	37	16.93	16.98	17.03	1
		1	74	16.87	16.98	17.01	1
		36	0	15.99	15.97	16.01	2
		36	19	16.01	16.03	16.06	2
		36	39	15.95	16.01	16.06	2
		75	0	15.92	15.99	15.99	2
15M	64QAM	1	0	16.03	16.00	16.05	2
		1	37	16.01	16.02	16.02	2
		1	74	16.01	16.02	16.06	2
		36	0	14.93	15.03	15.01	3
		36	19	14.96	14.97	15.00	3
		36	39	14.97	14.95	15.06	3
		75	0	14.93	14.95	15.01	3
15M	256QAM	1	0	13.16	13.18	13.28	5
		1	37	13.16	13.17	13.21	5
		1	74	13.14	13.25	13.24	5
		36	0	13.20	13.32	13.34	5
		36	19	13.19	13.20	13.32	5
		36	39	13.15	13.20	13.25	5
		75	0	13.20	13.28	13.30	5

LTE Conducted Power (Reduction_Laptop)							
LTE Band 25							
BW	MCS Index	Channel		26090	26365	26640	3GPP MPR
		Frequency (MHz)		1855	1882.5	1910	
10M	QPSK	1	0	18.00	18.02	17.98	0
		1	24	17.89	17.97	18.02	0
		1	49	17.93	17.99	18.02	0
		25	0	16.94	16.99	17.04	1
		25	12	16.90	16.86	16.93	1
		25	25	16.91	16.89	16.95	1
		50	0	16.85	16.86	16.88	1
10M	16QAM	1	0	16.97	16.97	17.02	1
		1	24	16.93	16.90	17.02	1
		1	49	16.88	16.89	17.00	1
		25	0	16.04	15.98	16.01	2
		25	12	15.97	15.96	16.05	2
		25	25	15.97	15.95	16.00	2
		50	0	15.89	15.89	16.04	2
10M	64QAM	1	0	16.01	15.98	16.06	2
		1	24	15.95	16.02	15.99	2
		1	49	15.97	16.02	16.05	2
		25	0	14.93	14.99	15.09	3
		25	12	14.97	14.99	15.03	3
		25	25	14.93	14.95	14.96	3
		50	0	14.91	14.90	14.97	3
10M	256QAM	1	0	13.18	13.19	13.36	5
		1	24	13.17	13.26	13.23	5
		1	49	13.12	13.16	13.27	5
		25	0	13.20	13.26	13.28	5
		25	12	13.18	13.21	13.31	5
		25	25	13.17	13.21	13.30	5
		50	0	13.28	13.30	13.34	5
BW	MCS Index	Channel		26065	26365	26665	3GPP MPR
		Frequency (MHz)		1852.5	1882.5	1912.5	
5M	QPSK	1	0	17.91	17.94	18.03	0
		1	12	17.92	17.90	17.96	0
		1	24	17.92	17.94	17.97	0
		12	0	16.97	16.99	17.02	1
		12	6	16.88	16.89	16.99	1
		12	13	16.84	16.92	16.89	1
		25	0	16.87	16.90	16.93	1
5M	16QAM	1	0	16.92	16.99	17.00	1
		1	12	16.91	16.97	16.95	1
		1	24	16.86	16.88	17.01	1
		12	0	16.03	15.96	16.07	2
		12	6	15.96	15.99	15.99	2
		12	13	15.99	15.99	16.00	2
		25	0	15.89	15.94	15.98	2
5M	64QAM	1	0	16.00	16.04	16.04	2
		1	12	16.02	16.00	16.02	2
		1	24	15.98	15.93	16.08	2
		12	0	14.96	14.96	15.09	3
		12	6	14.96	15.02	15.06	3
		12	13	14.99	14.97	15.02	3
		25	0	14.91	14.99	14.95	3
5M	256QAM	1	0	13.16	13.21	13.32	5
		1	12	13.16	13.22	13.29	5
		1	24	13.11	13.17	13.26	5
		12	0	13.27	13.25	13.35	5
		12	6	13.17	13.25	13.28	5
		12	13	13.19	13.21	13.25	5
		25	0	13.29	13.36	13.29	5

LTE Conducted Power (Reduction_Laptop)							
LTE Band 25							
BW	MCS Index	Channel		26055	26365	26675	3GPP MPR
		Frequency (MHz)		1851.5	1882.5	1913.5	
3M	QPSK	1	0	17.92	17.97	18.00	0
		1	7	17.94	17.93	18.00	0
		1	14	17.89	17.92	17.95	0
		8	0	17.02	17.01	17.03	1
		8	3	16.88	16.92	17.00	1
		8	7	16.87	16.88	16.99	1
		15	0	16.84	16.81	16.91	1
3M	16QAM	1	0	16.94	16.94	17.03	1
		1	7	16.96	16.91	17.04	1
		1	14	16.92	16.88	17.01	1
		8	0	15.96	16.00	16.05	2
		8	3	15.96	15.99	16.00	2
		8	7	15.95	15.96	16.05	2
		15	0	15.88	15.96	15.94	2
3M	64QAM	1	0	16.03	15.98	16.10	2
		1	7	15.98	15.96	16.02	2
		1	14	15.95	15.95	16.01	2
		8	0	14.96	14.95	15.08	3
		8	3	14.91	14.96	15.06	3
		8	7	14.93	15.00	15.05	3
		15	0	14.92	14.98	14.99	3
3M	256QAM	1	0	13.18	13.28	13.33	5
		1	7	13.13	13.20	13.25	5
		1	14	13.14	13.17	13.22	5
		8	0	13.20	13.31	13.30	5
		8	3	13.17	13.20	13.31	5
		8	7	13.14	13.25	13.23	5
		15	0	13.25	13.29	13.39	5
BW	MCS Index	Channel		26047	26365	26683	3GPP MPR
		Frequency (MHz)		1850.7	1882.5	1914.3	
1.4M	QPSK	1	0	17.97	17.95	18.02	0
		1	2	17.96	17.91	18.00	0
		1	5	17.89	17.99	17.93	0
		3	0	16.96	17.00	16.99	0
		3	1	16.93	16.89	16.92	0
		3	3	16.89	16.94	16.92	0
		6	0	16.80	16.91	16.96	1
1.4M	16QAM	1	0	16.95	17.01	17.00	1
		1	2	16.96	16.95	17.02	1
		1	5	16.88	16.96	17.02	1
		3	0	15.96	16.00	16.09	1
		3	1	15.97	16.04	16.00	1
		3	3	15.95	16.01	15.99	1
		6	0	15.91	15.94	15.99	2
1.4M	64QAM	1	0	15.95	15.96	16.01	2
		1	2	16.00	16.02	16.03	2
		1	5	15.96	15.95	16.05	2
		3	0	15.01	14.97	15.01	2
		3	1	14.95	14.99	14.99	2
		3	3	14.95	14.94	14.98	2
		6	0	14.93	14.95	15.02	3
1.4M	256QAM	1	0	13.20	13.18	13.32	5
		1	2	13.19	13.26	13.24	5
		1	5	13.12	13.24	13.25	5
		3	0	13.26	13.31	13.27	5
		3	1	13.20	13.26	13.25	5
		3	3	13.15	13.27	13.25	5
		6	0	13.20	13.32	13.37	5

LTE Conducted Power (Reduction_Laptop)							
LTE Band 26							
BW	MCS Index	RB Size	RB Offset	Low	Mid	High	3GPP MPR (dB)
		Channel		26765	26865	26965	
		Frequency (MHz)		821.5	831.5	841.5	
15M	QPSK	1	0	22.83	22.82	22.87	0
		1	37	22.82	22.81	22.86	0
		1	74	22.80	22.79	22.84	0
		36	0	21.79	21.78	21.83	1
		36	19	21.77	21.76	21.81	1
		36	39	21.75	21.74	21.79	1
		75	0	21.74	21.73	21.78	1
15M	16QAM	1	0	21.84	21.83	21.88	1
		1	37	21.82	21.81	21.86	1
		1	74	21.81	21.80	21.85	1
		36	0	20.84	20.83	20.88	2
		36	19	20.82	20.81	20.86	2
		36	39	20.81	20.80	20.85	2
		75	0	20.80	20.79	20.84	2
15M	64QAM	1	0	20.84	20.83	20.88	2
		1	37	20.82	20.81	20.86	2
		1	74	20.81	20.80	20.85	2
		36	0	19.80	19.79	19.84	3
		36	19	19.78	19.77	19.82	3
		36	39	19.77	19.76	19.81	3
		75	0	19.76	19.75	19.80	3
15M	256QAM	1	0	17.47	17.41	17.52	5
		1	37	17.45	17.39	17.51	5
		1	74	17.50	17.44	17.53	5
		36	0	17.41	17.34	17.49	5
		36	19	17.43	17.34	17.48	5
		36	39	17.38	17.37	17.46	5
		75	0	17.40	17.37	17.41	5
BW	MCS Index	Channel		26740	26865	26990	3GPP MPR
		Frequency (MHz)		819	831.5	844	
10M	QPSK	1	0	22.79	22.74	22.80	0
		1	24	22.81	22.76	22.83	0
		1	49	22.70	22.76	22.76	0
		25	0	21.76	21.76	21.82	1
		25	12	21.76	21.69	21.81	1
		25	25	21.69	21.65	21.72	1
		50	0	21.68	21.66	21.72	1
10M	16QAM	1	0	21.84	21.80	21.88	1
		1	24	21.75	21.81	21.81	1
		1	49	21.76	21.76	21.84	1
		25	0	20.80	20.79	20.83	2
		25	12	20.77	20.73	20.83	2
		25	25	20.76	20.73	20.80	2
		50	0	20.70	20.73	20.76	2
10M	64QAM	1	0	20.83	20.82	20.85	2
		1	24	20.73	20.78	20.79	2
		1	49	20.71	20.74	20.76	2
		25	0	19.74	19.74	19.74	3
		25	12	19.73	19.77	19.82	3
		25	25	19.68	19.75	19.76	3
		50	0	19.76	19.65	19.79	3
10M	256QAM	1	0	17.43	17.41	17.48	5
		1	24	17.41	17.31	17.50	5
		1	49	17.47	17.44	17.49	5
		25	0	17.37	17.33	17.44	5
		25	12	17.37	17.25	17.48	5
		25	25	17.37	17.35	17.44	5
		50	0	17.38	17.34	17.37	5

LTE Conducted Power (Reduction_Laptop)							
LTE Band 26							
BW	MCS Index	Channel		26715	26865	27015	3GPP MPR
		Frequency (MHz)		816.5	831.5	846.5	
5M	QPSK	1	0	22.74	22.72	22.79	0
		1	12	22.79	22.79	22.81	0
		1	24	22.80	22.70	22.76	0
		12	0	21.75	21.73	21.80	1
		12	6	21.72	21.71	21.79	1
		12	13	21.70	21.73	21.77	1
		25	0	21.65	21.66	21.78	1
5M	16QAM	1	0	21.74	21.77	21.80	1
		1	12	21.73	21.81	21.82	1
		1	24	21.74	21.80	21.85	1
		12	0	20.79	20.81	20.85	2
		12	6	20.80	20.76	20.83	2
		12	13	20.76	20.79	20.79	2
		25	0	20.73	20.70	20.82	2
5M	64QAM	1	0	20.84	20.82	20.83	2
		1	12	20.75	20.71	20.80	2
		1	24	20.77	20.72	20.76	2
		12	0	19.78	19.76	19.76	3
		12	6	19.72	19.69	19.74	3
		12	13	19.76	19.75	19.72	3
		25	0	19.75	19.68	19.72	3
5M	256QAM	1	0	17.44	17.32	17.46	5
		1	12	17.45	17.32	17.43	5
		1	24	17.41	17.42	17.51	5
		12	0	17.36	17.25	17.43	5
		12	6	17.39	17.25	17.47	5
		12	13	17.38	17.35	17.38	5
		25	0	17.40	17.36	17.37	5
BW	MCS Index	Channel		26705	26865	27025	3GPP MPR
		Frequency (MHz)		815.5	831.5	847.5	
3M	QPSK	1	0	22.83	22.78	22.85	0
		1	7	22.72	22.78	22.86	0
		1	14	22.71	22.76	22.80	0
		8	0	21.72	21.68	21.78	1
		8	3	21.70	21.68	21.78	1
		8	7	21.71	21.73	21.75	1
		15	0	21.66	21.69	21.74	1
3M	16QAM	1	0	21.84	21.74	21.81	1
		1	7	21.73	21.80	21.84	1
		1	14	21.75	21.75	21.81	1
		8	0	20.74	20.77	20.79	2
		8	3	20.77	20.71	20.80	2
		8	7	20.79	20.79	20.76	2
		15	0	20.71	20.73	20.75	2
3M	64QAM	1	0	20.81	20.81	20.86	2
		1	7	20.81	20.74	20.85	2
		1	14	20.71	20.79	20.80	2
		8	0	19.75	19.71	19.83	3
		8	3	19.76	19.73	19.72	3
		8	7	19.67	19.68	19.81	3
		15	0	19.74	19.71	19.71	3
3M	256QAM	1	0	17.42	17.35	17.46	5
		1	7	17.36	17.32	17.51	5
		1	14	17.40	17.42	17.45	5
		8	0	17.31	17.25	17.46	5
		8	3	17.36	17.32	17.44	5
		8	7	17.30	17.35	17.41	5
		15	0	17.34	17.27	17.37	5

LTE Conducted Power (Reduction_Laptop)							
LTE Band 26							
BW	MCS Index	Channel		26697	26865	27033	3GPP MPR
		Frequency (MHz)		814.7	831.5	848.3	
1.4M	QPSK	1	0	22.76	22.76	22.80	0
		1	2	22.76	22.71	22.86	0
		1	5	22.70	22.79	22.78	0
		3	0	21.75	21.78	21.74	0
		3	1	21.73	21.69	21.71	0
		3	3	21.74	21.65	21.69	0
		6	0	21.70	21.70	21.68	1
1.4M	16QAM	1	0	21.79	21.80	21.78	1
		1	2	21.78	21.74	21.86	1
		1	5	21.80	21.70	21.82	1
		3	0	20.82	20.77	20.79	1
		3	1	20.72	20.75	20.79	1
		3	3	20.80	20.71	20.76	1
		6	0	20.80	20.79	20.79	2
1.4M	64QAM	1	0	20.75	20.80	20.78	2
		1	2	20.74	20.75	20.83	2
		1	5	20.73	20.78	20.79	2
		3	0	19.73	19.70	19.78	2
		3	1	19.76	19.67	19.74	2
		3	3	19.72	19.75	19.81	2
		6	0	19.75	19.69	19.77	3
1.4M	256QAM	1	0	17.38	17.40	17.49	5
		1	2	17.43	17.36	17.49	5
		1	5	17.46	17.44	17.49	5
		3	0	17.33	17.28	17.42	5
		3	1	17.34	17.31	17.41	5
		3	3	17.28	17.29	17.41	5
		6	0	17.34	17.31	17.34	5

LTE Conducted Power (Reduction_Laptop)							
LTE Band 30							
BW	MCS Index	RB Size	RB Offset	Mid		3GPP MPR (dB)	
		Channel		27710			
		Frequency (MHz)		2310			
10M	QPSK	1	0		20.96		0
		1	24		20.94		0
		1	49		20.92		0
		25	0		19.98		1
		25	12		19.97		1
		25	25		19.95		1
		50	0		19.94		1
10M	16QAM	1	0		19.96		1
		1	24		19.94		1
		1	49		19.93		1
		25	0		18.95		2
		25	12		18.93		2
		25	25		18.92		2
		50	0		18.90		2
10M	64QAM	1	0		18.96		2
		1	24		18.93		2
		1	49		18.92		2
		25	0		17.96		3
		25	12		17.94		3
		25	25		17.92		3
		50	0		17.90		3
10M	256QAM	1	0		15.79		5
		1	24		15.66		5
		1	49		15.67		5
		25	0		15.57		5
		25	12		15.61		5
		25	25		15.56		5
		50	0		15.52		5
BW	MCS Index	Channel		27685	27710	27735	3GPP MPR
		Frequency (MHz)		2307.5	2310	2312.5	
5M	QPSK	1	0	20.81	20.91	20.78	0
		1	12	20.78	20.88	20.75	0
		1	24	20.74	20.84	20.71	0
		12	0	19.78	19.88	19.75	1
		12	6	19.78	19.88	19.75	1
		12	13	19.80	19.90	19.77	1
		25	0	19.76	19.86	19.73	1
5M	16QAM	1	0	19.86	19.96	19.83	1
		1	12	19.83	19.93	19.80	1
		1	24	19.83	19.93	19.80	1
		12	0	18.80	18.90	18.77	2
		12	6	18.80	18.90	18.77	2
		12	13	18.81	18.91	18.78	2
		25	0	18.72	18.82	18.69	2
5M	64QAM	1	0	18.81	18.91	18.78	2
		1	12	18.74	18.84	18.71	2
		1	24	18.74	18.84	18.71	2
		12	0	17.84	17.94	17.81	3
		12	6	17.74	17.84	17.71	3
		12	13	17.78	17.88	17.75	3
		25	0	17.75	17.85	17.72	3
5M	256QAM	1	0	15.77	15.76	15.79	5
		1	12	15.66	15.56	15.60	5
		1	24	15.59	15.67	15.66	5
		12	0	15.53	15.53	15.51	5
		12	6	15.52	15.60	15.57	5
		12	13	15.49	15.51	15.53	5
		25	0	15.48	15.49	15.49	5

LTE Conducted Power (Reduction_Laptop)							
LTE Band 38							
BW	MCS Index	RB Size	RB Offset	Low	Mid	High	3GPP MPR (dB)
		Channel		37850	38000	38150	
		Frequency (MHz)		2580	2595	2610	
20M	QPSK	1	0	20.20	20.05	20.18	0
		1	50	20.05	19.99	20.03	0
		1	99	20.04	19.98	20.02	0
		50	0	19.03	18.97	19.01	1
		50	25	19.00	18.94	18.98	1
		50	50	18.99	18.93	18.97	1
		100	0	18.98	18.92	18.96	1
20M	16QAM	1	0	18.06	18.00	18.04	1
		1	50	18.04	17.98	18.02	1
		1	99	18.03	17.97	18.01	1
		50	0	17.09	17.03	17.07	2
		50	25	17.06	17.00	17.04	2
		50	50	17.04	16.98	17.02	2
		100	0	17.01	16.95	16.99	2
20M	64QAM	1	0	17.06	17.00	17.04	2
		1	50	17.04	16.98	17.02	2
		1	99	17.01	16.95	16.99	2
		50	0	16.09	16.03	16.07	3
		50	25	16.07	16.01	16.05	3
		50	50	16.05	15.99	16.03	3
		100	0	16.03	15.97	16.01	3
20M	256QAM	1	0	15.31	15.22	15.18	5
		1	50	15.39	15.34	15.30	5
		1	99	15.18	15.12	15.10	5
		50	0	15.42	15.39	15.36	5
		50	25	15.39	15.38	15.37	5
		50	50	15.36	15.35	15.34	5
		100	0	15.32	15.29	15.21	5
BW	MCS Index	Channel		37825	38000	38175	3GPP MPR
		Frequency (MHz)		2577.5	2595	2612.5	
15M	QPSK	1	0	19.98	19.93	20.04	0
		1	37	19.95	19.97	19.96	0
		1	74	19.96	19.91	20.01	0
		36	0	18.96	18.92	18.95	1
		36	19	18.98	18.94	18.89	1
		36	39	18.95	18.91	18.87	1
		75	0	18.95	18.88	18.86	1
15M	16QAM	1	0	17.97	17.94	18.01	1
		1	37	18.00	17.98	17.92	1
		1	74	17.94	17.91	18.00	1
		36	0	17.07	17.02	17.04	2
		36	19	16.99	16.97	17.02	2
		36	39	16.97	16.88	16.96	2
		75	0	16.99	16.93	16.92	2
15M	64QAM	1	0	16.97	16.91	16.95	2
		1	37	17.03	16.95	16.94	2
		1	74	16.92	16.87	16.89	2
		36	0	16.04	15.99	16.03	3
		36	19	16.06	15.91	15.96	3
		36	39	16.03	15.90	15.96	3
		75	0	16.02	15.87	16.00	3
15M	256QAM	1	0	15.25	15.20	15.16	5
		1	37	15.34	15.24	15.24	5
		1	74	15.10	15.09	15.08	5
		36	0	15.34	15.33	15.29	5
		36	19	15.31	15.36	15.33	5
		36	39	15.36	15.27	15.28	5
		75	0	15.23	15.21	15.12	5

LTE Conducted Power (Reduction_Laptop)									
LTE Band 38									
BW	MCS Index	Channel		37800	38000	38200	3GPP MPR		
		Frequency (MHz)		2575	2595	2615			
10M	QPSK	1	0	20.01	19.91	20.04	0		
		1	24	20.01	19.92	20.00	0		
		1	49	19.99	19.89	19.99	0		
		25	0	19.01	18.96	18.93	1		
		25	12	18.90	18.91	18.96	1		
		25	25	18.93	18.87	18.93	1		
10M	16QAM	50	0	18.88	18.85	18.96	1		
		1	0	18.04	17.96	18.04	1		
		1	24	18.04	17.93	17.98	1		
		1	49	18.03	17.89	17.98	1		
		25	0	17.02	16.96	16.97	2		
		25	12	16.96	17.00	16.94	2		
10M	64QAM	25	25	16.96	16.91	17.00	2		
		50	0	16.93	16.95	16.95	2		
		1	0	17.04	16.90	17.02	2		
		1	24	16.96	16.93	17.02	2		
		1	49	17.01	16.86	16.96	2		
		25	0	16.02	16.03	16.01	3		
10M	256QAM	25	12	15.98	15.91	15.98	3		
		25	25	15.98	15.96	16.02	3		
		50	0	15.94	15.91	15.91	3		
		1	0	15.25	15.19	15.10	5		
		1	24	15.32	15.32	15.20	5		
		1	49	15.18	15.05	15.05	5		
10M	256QAM	25	0	15.40	15.34	15.32	5		
		25	12	15.33	15.34	15.28	5		
		25	25	15.31	15.32	15.26	5		
		50	0	15.22	15.19	15.20	5		
		BW	MCS Index	Channel		37775	38000	38225	3GPP MPR
				Frequency (MHz)		2572.5	2595	2617.5	
5M	QPSK	1	0	20.01	19.91	20.02	0		
		1	12	20.03	19.94	19.97	0		
		1	24	19.94	19.88	19.95	0		
		12	0	19.03	18.93	19.00	1		
		12	6	18.93	18.90	18.89	1		
		12	13	18.92	18.83	18.96	1		
5M	16QAM	25	0	18.88	18.89	18.91	1		
		1	0	18.06	17.98	18.03	1		
		1	12	18.01	17.92	18.02	1		
		1	24	18.03	17.96	17.94	1		
		12	0	17.06	16.99	17.03	2		
		12	6	17.02	16.91	17.03	2		
5M	64QAM	12	13	16.96	16.89	16.99	2		
		25	0	16.92	16.91	16.96	2		
		1	0	16.97	16.99	17.02	2		
		1	12	17.03	16.91	16.94	2		
		1	24	16.96	16.89	16.98	2		
		12	0	16.07	15.94	16.00	3		
5M	256QAM	12	6	16.06	15.95	16.00	3		
		12	13	16.04	15.92	16.02	3		
		25	0	15.93	15.96	15.91	3		
		1	0	15.30	15.16	15.18	5		
		1	12	15.36	15.24	15.30	5		
		1	24	15.10	15.04	15.10	5		
5M	256QAM	12	0	15.36	15.36	15.28	5		
		12	6	15.35	15.33	15.32	5		
		12	13	15.33	15.30	15.24	5		
		25	0	15.22	15.24	15.17	5		

LTE Conducted Power (Reduction_Laptop)							
LTE Band 40							
BW	MCS Index	RB Size	RB Offset	Low	Mid	Mid	3GPP MPR (dB)
		Channel		38750	39150	39550	
		Frequency (MHz)		2310	2350	2390	
20M	QPSK	1	0	20.13	20.39	20.07	0
		1	50	20.04	20.17	19.99	0
		1	99	20.02	20.15	19.97	0
		50	0	19.19	19.32	19.14	1
		50	25	19.17	19.30	19.12	1
		50	50	19.15	19.28	19.10	1
		100	0	19.08	19.21	19.03	1
20M	16QAM	1	0	19.05	19.18	19.00	1
		1	50	19.03	19.16	18.98	1
		1	99	19.00	19.13	18.95	1
		50	0	18.17	18.30	18.12	2
		50	25	18.15	18.28	18.10	2
		50	50	18.14	18.27	18.09	2
		100	0	18.12	18.25	18.07	2
20M	64QAM	1	0	18.05	18.18	18.00	2
		1	50	18.03	18.16	17.98	2
		1	99	18.00	18.13	17.95	2
		50	0	17.18	17.31	17.13	3
		50	25	17.15	17.28	17.10	3
		50	50	17.13	17.26	17.08	3
		100	0	17.12	17.25	17.07	3
20M	256QAM	1	0	15.17	15.18	15.07	5
		1	50	15.07	15.16	15.01	5
		1	99	14.95	15.02	14.91	5
		50	0	15.34	15.38	15.24	5
		50	25	15.31	15.36	15.28	5
		50	50	15.19	15.29	15.13	5
		100	0	15.24	15.28	15.17	5
BW	MCS Index	Channel		38725	39150	39575	3GPP MPR
		Frequency (MHz)		2307.5	2350	2392.5	
15M	QPSK	1	0	19.98	20.09	19.91	0
		1	37	19.98	20.08	19.91	0
		1	74	20.00	20.07	19.87	0
		36	0	19.18	19.31	19.06	1
		36	19	19.10	19.29	19.06	1
		36	39	19.12	19.22	19.09	1
		75	0	18.98	19.16	18.96	1
15M	16QAM	1	0	18.96	19.10	18.97	1
		1	37	19.01	19.08	18.93	1
		1	74	18.92	19.07	18.85	1
		36	0	18.12	18.20	18.11	2
		36	19	18.14	18.26	18.08	2
		36	39	18.04	18.17	18.07	2
		75	0	18.07	18.22	18.06	2
15M	64QAM	1	0	18.04	18.14	17.99	2
		1	37	18.00	18.11	17.93	2
		1	74	17.94	18.13	17.94	2
		36	0	17.14	17.21	17.09	3
		36	19	17.10	17.25	17.03	3
		36	39	17.03	17.21	17.00	3
		75	0	17.02	17.18	17.03	3
15M	256QAM	1	0	15.08	15.12	14.98	5
		1	37	15.05	15.12	15.00	5
		1	74	14.95	14.92	14.84	5
		36	0	15.32	15.31	15.20	5
		36	19	15.27	15.29	15.18	5
		36	39	15.17	15.24	15.11	5
		75	0	15.18	15.20	15.09	5

LTE Conducted Power (Reduction_Laptop)							
LTE Band 40							
BW	MCS Index	Channel		38700	39150	39600	3GPP MPR
		Frequency (MHz)		2305	2350	2395	
10M	QPSK	1	0	19.96	20.10	19.98	0
		1	24	19.94	20.15	19.92	0
		1	49	19.94	20.14	19.92	0
		25	0	19.14	19.22	19.08	1
		25	12	19.07	19.22	19.09	1
		25	25	19.10	19.22	19.08	1
		50	0	18.98	19.13	18.95	1
10M	16QAM	1	0	18.95	19.09	19.00	1
		1	24	19.02	19.12	18.98	1
		1	49	18.95	19.11	18.92	1
		25	0	18.12	18.28	18.08	2
		25	12	18.13	18.28	18.04	2
		25	25	18.10	18.22	18.06	2
		50	0	18.06	18.19	18.06	2
10M	64QAM	1	0	17.97	18.17	17.91	2
		1	24	18.01	18.16	17.98	2
		1	49	18.00	18.13	17.88	2
		25	0	17.17	17.28	17.12	3
		25	12	17.06	17.19	17.05	3
		25	25	17.06	17.17	17.01	3
		50	0	17.05	17.22	17.07	3
10M	256QAM	1	0	15.15	15.15	14.97	5
		1	24	15.05	15.14	14.98	5
		1	49	14.92	14.92	14.82	5
		25	0	15.26	15.28	15.19	5
		25	12	15.23	15.26	15.20	5
		25	25	15.19	15.26	15.07	5
		50	0	15.23	15.21	15.15	5
BW	MCS Index	Channel		38675	39150	39625	3GPP MPR
		Frequency (MHz)		2302.5	2350	2397.5	
5M	QPSK	1	0	20.06	20.18	19.92	0
		1	12	19.99	20.08	19.97	0
		1	24	19.93	20.10	19.95	0
		12	0	19.14	19.24	19.12	1
		12	6	19.16	19.21	19.04	1
		12	13	19.07	19.21	19.09	1
		25	0	19.01	19.18	19.02	1
5M	16QAM	1	0	19.04	19.10	18.90	1
		1	12	18.93	19.09	18.96	1
		1	24	18.95	19.12	18.85	1
		12	0	18.14	18.30	18.12	2
		12	6	18.12	18.25	18.10	2
		12	13	18.13	18.21	18.09	2
		25	0	18.10	18.15	17.97	2
5M	64QAM	1	0	18.02	18.18	17.95	2
		1	12	17.98	18.13	17.95	2
		1	24	17.96	18.04	17.85	2
		12	0	17.08	17.24	17.03	3
		12	6	17.14	17.23	17.02	3
		12	13	17.06	17.20	16.99	3
		25	0	17.12	17.16	17.01	3
5M	256QAM	1	0	15.10	15.14	14.99	5
		1	12	15.01	15.12	14.99	5
		1	24	14.88	14.92	14.82	5
		12	0	15.25	15.36	15.22	5
		12	6	15.24	15.33	15.23	5
		12	13	15.18	15.21	15.12	5
		25	0	15.17	15.18	15.07	5

LTE Conducted Power (Reduction_Laptop)										
LTE Band 41										
BW	MCS Index	RB Size	RB Offset	Low	Low	Mid	Mid	Mid	High	3GPP MPR (dB)
		Channel		39790	39750	40185	40620	41055	41490	
		Frequency (MHz)		2510	2506	2549.5	2593	2636.5	2680	
20M	QPSK	1	0	17.55	17.45	17.24	17.34	17.60	17.48	0
		1	50	17.50	17.40	17.19	17.29	17.55	17.43	0
		1	99	17.46	17.36	17.15	17.25	17.51	17.39	0
		50	0	16.58	16.48	16.27	16.37	16.63	16.51	1
		50	25	16.55	16.45	16.24	16.34	16.60	16.48	1
		50	50	16.53	16.43	16.22	16.32	16.58	16.46	1
		100	0	16.46	16.36	16.15	16.25	16.51	16.39	1
20M	16QAM	1	0	16.55	16.45	16.24	16.34	16.60	16.48	1
		1	50	16.20	16.10	15.89	15.99	16.25	16.13	1
		1	99	15.85	15.75	15.54	15.64	15.90	15.78	1
		50	0	15.55	15.45	15.24	15.34	15.60	15.48	2
		50	25	15.44	15.34	15.13	15.23	15.49	15.37	2
		50	50	15.34	15.24	15.03	15.13	15.39	15.27	2
		100	0	15.47	15.37	15.16	15.26	15.52	15.40	2
20M	64QAM	1	0	15.36	15.26	15.05	15.15	15.41	15.29	2
		1	50	14.98	14.88	14.67	14.77	15.03	14.91	2
		1	99	14.67	14.57	14.36	14.46	14.72	14.60	2
		50	0	14.57	14.47	14.26	14.36	14.62	14.50	3
		50	25	14.54	14.44	14.23	14.33	14.59	14.47	3
		50	50	14.46	14.36	14.15	14.25	14.51	14.39	3
		100	0	14.57	14.47	14.26	14.36	14.62	14.50	3
20M	256QAM	1	0	12.65	12.73	12.75	12.81	12.88	12.76	5
		1	50	12.72	12.72	12.73	12.84	12.84	12.82	5
		1	99	12.74	12.74	12.77	12.83	12.91	12.79	5
		50	0	12.73	12.81	12.81	12.89	12.95	12.82	5
		50	25	12.56	12.63	12.67	12.78	12.88	12.77	5
		50	50	12.62	12.64	12.74	12.85	12.85	12.80	5
		100	0	12.57	12.59	12.61	12.74	12.84	12.65	5
BW	MCS Index	Channel		39765	39725	40173	40620	41068	41515	3GPP MPR
		Frequency (MHz)		2507.5	2503.5	2548.3	2593	2637.8	2682.5	
15M	QPSK	1	0	17.28	17.57	17.39	17.29	17.53	17.47	0
		1	37	17.28	17.50	17.43	17.28	17.49	17.38	0
		1	74	17.20	17.47	17.31	17.25	17.49	17.29	0
		36	0	16.33	16.63	16.48	16.32	16.56	16.42	1
		36	19	16.24	16.57	16.41	16.26	16.57	16.44	1
		36	39	16.25	16.56	16.44	16.25	16.58	16.45	1
		75	0	16.18	16.45	16.39	16.25	16.49	16.30	1
15M	16QAM	1	0	16.28	16.53	16.39	16.24	16.53	16.48	1
		1	37	15.89	16.22	16.10	15.93	16.21	16.04	1
		1	74	15.62	15.90	15.77	15.62	15.86	15.68	1
		36	0	15.24	15.57	15.47	15.24	15.50	15.40	2
		36	19	15.19	15.45	15.29	15.21	15.46	15.29	2
		36	39	15.09	15.31	15.19	15.04	15.33	15.20	2
		75	0	15.21	15.49	15.32	15.24	15.43	15.31	2
15M	64QAM	1	0	15.11	15.41	15.23	15.13	15.35	15.23	2
		1	37	14.73	14.94	14.84	14.70	14.94	14.84	2
		1	74	14.38	14.71	14.51	14.39	14.66	14.57	2
		36	0	14.36	14.56	14.40	14.36	14.61	14.50	3
		36	19	14.29	14.57	14.37	14.26	14.59	14.46	3
		36	39	14.24	14.44	14.29	14.18	14.41	14.34	3
		75	0	14.34	14.55	14.45	14.31	14.53	14.45	3
15M	256QAM	1	0	12.71	12.76	12.86	12.68	12.79	12.88	5
		1	37	12.72	12.81	12.78	12.65	12.80	12.76	5
		1	74	12.69	12.73	12.87	12.67	12.73	12.84	5
		36	0	12.80	12.84	12.88	12.72	12.82	12.85	5
		36	19	12.64	12.78	12.84	12.60	12.73	12.86	5
		36	39	12.69	12.77	12.79	12.70	12.79	12.80	5
		75	0	12.52	12.71	12.74	12.59	12.71	12.82	5

LTE Conducted Power (Reduction_Laptop)										
LTE Band 41										
BW	MCS Index	Channel		39740	39700	40160	40620	41080	41540	3GPP MPR
		Frequency (MHz)		2505	2501	2547	2593	2639	2685	
10M	QPSK	1	0	17.27	17.55	17.46	17.30	17.53	17.44	0
		1	24	17.27	17.54	17.42	17.29	17.54	17.39	0
		1	49	17.19	17.42	17.33	17.20	17.49	17.31	0
		25	0	16.28	16.62	16.48	16.32	16.63	16.45	1
		25	12	16.26	16.56	16.45	16.29	16.52	16.46	1
		25	25	16.24	16.57	16.40	16.25	16.53	16.40	1
		50	0	16.24	16.48	16.38	16.16	16.41	16.32	1
10M	16QAM	1	0	16.32	16.52	16.42	16.33	16.60	16.46	1
		1	24	15.93	16.25	16.06	15.92	16.23	16.03	1
		1	49	15.56	15.88	15.74	15.56	15.89	15.68	1
		25	0	15.24	15.60	15.43	15.27	15.53	15.45	2
		25	12	15.15	15.48	15.33	15.19	15.46	15.33	2
		25	25	15.10	15.34	15.27	15.13	15.36	15.20	2
		50	0	15.18	15.52	15.32	15.20	15.43	15.36	2
10M	64QAM	1	0	15.12	15.41	15.27	15.09	15.33	15.26	2
		1	24	14.70	15.01	14.86	14.68	14.97	14.91	2
		1	49	14.45	14.63	14.58	14.39	14.69	14.51	2
		25	0	14.31	14.53	14.41	14.31	14.58	14.46	3
		25	12	14.30	14.56	14.39	14.29	14.55	14.42	3
		25	25	14.17	14.49	14.33	14.18	14.50	14.36	3
		50	0	14.29	14.58	14.41	14.35	14.54	14.40	3
10M	256QAM	1	0	12.68	12.71	12.86	12.74	12.72	12.88	5
		1	24	12.71	12.77	12.75	12.66	12.81	12.81	5
		1	49	12.75	12.82	12.87	12.71	12.74	12.88	5
		25	0	12.79	12.82	12.90	12.71	12.83	12.90	5
		25	12	12.59	12.71	12.86	12.66	12.77	12.81	5
		25	25	12.64	12.83	12.85	12.64	12.83	12.78	5
		50	0	12.57	12.64	12.80	12.58	12.73	12.75	5
BW	MCS Index	Channel		39715	39675	40148	40620	41093	41565	3GPP MPR
		Frequency (MHz)		2502.5	2498.5	2545.8	2593	2640.3	2687.5	
5M	QPSK	1	0	17.34	17.52	17.45	17.24	17.58	17.47	0
		1	12	17.22	17.45	17.39	17.27	17.50	17.35	0
		1	24	17.15	17.41	17.39	17.20	17.51	17.32	0
		12	0	16.27	16.57	16.51	16.35	16.54	16.50	1
		12	6	16.27	16.54	16.43	16.28	16.54	16.47	1
		12	13	16.30	16.51	16.40	16.28	16.49	16.40	1
		25	0	16.15	16.46	16.30	16.22	16.48	16.29	1
5M	16QAM	1	0	16.27	16.58	16.45	16.31	16.58	16.46	1
		1	12	15.91	16.22	16.04	15.91	16.17	16.12	1
		1	24	15.57	15.90	15.75	15.55	15.86	15.68	1
		12	0	15.26	15.55	15.47	15.27	15.54	15.41	2
		12	6	15.22	15.46	15.29	15.17	15.49	15.31	2
		12	13	15.07	15.31	15.19	15.10	15.38	15.24	2
		25	0	15.24	15.52	15.36	15.18	15.43	15.31	2
5M	64QAM	1	0	15.15	15.33	15.21	15.11	15.37	15.28	2
		1	12	14.74	14.97	14.87	14.73	15.03	14.85	2
		1	24	14.42	14.66	14.56	14.43	14.62	14.56	2
		12	0	14.31	14.62	14.47	14.30	14.58	14.46	3
		12	6	14.30	14.50	14.39	14.29	14.58	14.41	3
		12	13	14.25	14.50	14.35	14.16	14.50	14.37	3
		25	0	14.31	14.62	14.50	14.34	14.53	14.43	3
5M	256QAM	1	0	12.68	12.80	12.85	12.67	12.71	12.85	5
		1	12	12.63	12.76	12.74	12.67	12.79	12.75	5
		1	24	12.67	12.81	12.82	12.67	12.78	12.88	5
		12	0	12.72	12.79	12.86	12.71	12.80	12.89	5
		12	6	12.64	12.74	12.87	12.67	12.69	12.83	5
		12	13	12.70	12.85	12.81	12.73	12.75	12.79	5
		25	0	12.53	12.67	12.80	12.51	12.69	12.79	5

LTE Conducted Power (Reduction_Laptop)								
LTE Band 48								
BW	MCS Index	RB Size	RB Offset	Low	Mid	Mid	Mid	3GPP MPR (dB)
		Channel		55340	55780	56210	56640	
		Frequency (MHz)		3560	3603	3647	3690	
20M	QPSK	1	0	16.81	16.73	16.99	17.19	0
		1	50	16.77	16.69	16.95	17.15	0
		1	99	16.70	16.62	16.88	17.08	0
		50	0	15.93	15.85	16.11	16.31	1
		50	25	15.84	15.76	16.02	16.22	1
		50	50	15.81	15.73	15.99	16.19	1
		100	0	15.90	15.82	16.08	16.28	1
20M	16QAM	1	0	15.72	15.64	15.90	16.10	1
		1	50	15.71	15.63	15.89	16.09	1
		1	99	15.69	15.61	15.87	16.07	1
		50	0	14.75	14.67	14.93	15.13	2
		50	25	13.74	13.66	13.92	14.12	2
		50	50	14.71	14.63	14.89	15.09	2
		100	0	14.69	14.61	14.87	15.07	2
20M	64QAM	1	0	14.24	14.16	14.42	14.62	2
		1	50	14.23	14.15	14.41	14.61	2
		1	99	14.21	14.13	14.39	14.59	2
		50	0	13.66	13.58	13.84	14.04	3
		50	25	13.65	13.57	13.83	14.03	3
		50	50	13.64	13.56	13.82	14.02	3
		100	0	13.63	13.55	13.81	14.01	3
20M	256QAM	1	0	11.89	11.89	11.95	12.03	5
		1	50	11.96	11.86	12.03	12.11	5
		1	99	11.90	11.81	11.95	12.01	5
		50	0	12.30	12.21	12.33	12.34	5
		50	25	12.33	12.31	12.33	12.33	5
		50	50	12.20	12.16	12.29	12.32	5
		100	0	12.28	12.25	12.30	12.31	5
BW	MCS Index	Channel		55315	55765	56215	56665	3GPP MPR
		Frequency (MHz)		3557.5	3602.5	3647.5	3692.5	
15M	QPSK	1	0	16.63	16.98	17.17	16.71	0
		1	37	16.60	16.95	17.05	16.65	0
		1	74	16.53	16.80	17.00	16.55	0
		36	0	15.78	16.06	16.31	15.83	1
		36	19	15.73	16.02	16.12	15.70	1
		36	39	15.64	15.90	16.12	15.73	1
		75	0	15.73	16.00	16.22	15.81	1
15M	16QAM	1	0	15.55	15.85	16.07	15.60	1
		1	37	15.59	15.80	16.07	15.60	1
		1	74	15.58	15.79	16.01	15.57	1
		36	0	14.57	14.84	15.07	14.62	2
		36	19	13.61	13.84	14.08	13.66	2
		36	39	14.57	14.82	15.00	14.62	2
		75	0	14.60	14.77	15.02	14.58	2
15M	64QAM	1	0	14.06	14.35	14.55	14.14	2
		1	37	14.14	14.38	14.58	14.12	2
		1	74	14.05	14.34	14.49	14.10	2
		36	0	13.54	13.80	14.02	13.55	3
		36	19	13.47	13.80	13.99	13.56	3
		36	39	13.53	13.74	13.95	13.48	3
		75	0	13.47	13.79	13.93	13.51	3
15M	256QAM	1	0	11.79	11.84	11.88	11.84	5
		1	37	11.91	11.79	11.87	11.86	5
		1	74	11.87	11.71	11.83	11.73	5
		36	0	12.27	12.18	12.20	12.21	5
		36	19	12.28	12.31	12.28	12.21	5
		36	39	12.20	12.14	12.15	12.07	5
		75	0	12.22	12.18	12.28	12.18	5

LTE Conducted Power (Reduction_Laptop)								
LTE Band 48								
BW	MCS Index	Channel		55290	55750	56220	56690	3GPP MPR
		Frequency (MHz)		3555	3601	3648	3695	
10M	QPSK	1	0	16.69	16.99	17.16	16.63	0
		1	24	16.68	16.85	17.10	16.67	0
		1	49	16.57	16.81	17.00	16.52	0
		25	0	15.82	16.11	16.22	15.84	1
		25	12	15.70	15.99	16.15	15.70	1
		25	25	15.73	15.94	16.12	15.73	1
		50	0	15.74	16.03	16.26	15.77	1
10M	16QAM	1	0	15.61	15.84	16.08	15.54	1
		1	24	15.62	15.86	16.02	15.53	1
		1	49	15.53	15.78	16.03	15.56	1
		25	0	14.60	14.91	15.10	14.67	2
		25	12	13.65	13.91	14.12	13.63	2
		25	25	14.61	14.79	15.05	14.56	2
		50	0	14.53	14.78	15.01	14.55	2
10M	64QAM	1	0	14.11	14.38	14.52	14.15	2
		1	24	14.13	14.36	14.52	14.11	2
		1	49	14.12	14.33	14.56	14.03	2
		25	0	13.56	13.77	13.99	13.57	3
		25	12	13.53	13.75	13.94	13.54	3
		25	25	13.51	13.80	13.94	13.56	3
		50	0	13.53	13.71	13.92	13.53	3
10M	256QAM	1	0	11.82	11.86	11.79	11.84	5
		1	24	11.87	11.77	11.94	11.82	5
		1	49	11.87	11.79	11.88	11.76	5
		25	0	12.21	12.13	12.21	12.17	5
		25	12	12.25	12.27	12.26	12.29	5
		25	25	12.15	12.09	12.16	12.16	5
		50	0	12.19	12.18	12.19	12.21	5
BW	MCS Index	Channel		55265	55745	56235	56715	3GPP MPR
		Frequency (MHz)		3552.5	3600.5	3649.5	3697.5	
5M	QPSK	1	0	16.70	16.93	17.09	16.71	0
		1	12	16.65	16.94	17.11	16.60	0
		1	24	16.62	16.88	17.02	16.57	0
		12	0	15.82	16.05	16.21	15.76	1
		12	6	15.76	15.93	16.14	15.74	1
		12	13	15.67	15.93	16.13	15.69	1
		25	0	15.82	16.01	16.24	15.78	1
5M	16QAM	1	0	15.56	15.83	16.03	15.60	1
		1	12	15.58	15.86	16.08	15.57	1
		1	24	15.55	15.83	15.99	15.56	1
		12	0	14.62	14.87	15.09	14.57	2
		12	6	13.63	13.86	14.07	13.59	2
		12	13	14.62	14.88	15.00	14.57	2
		25	0	14.56	14.83	14.98	14.56	2
5M	64QAM	1	0	14.13	14.37	14.52	14.12	2
		1	12	14.10	14.33	14.60	14.13	2
		1	24	14.11	14.31	14.49	14.06	2
		12	0	13.50	13.80	13.94	13.54	3
		12	6	13.48	13.82	14.02	13.47	3
		12	13	13.51	13.78	14.02	13.51	3
		25	0	13.49	13.73	14.01	13.50	3
5M	256QAM	1	0	11.86	11.81	11.81	11.86	5
		1	12	11.89	11.78	11.96	11.86	5
		1	24	11.88	11.71	11.82	11.78	5
		12	0	12.26	12.20	12.28	12.20	5
		12	6	12.32	12.28	12.32	12.27	5
		12	13	12.11	12.15	12.20	12.14	5
		25	0	12.25	12.23	12.18	12.22	5

LTE Conducted Power (Reduction_Laptop)							
LTE Band 66							
BW	MCS Index	RB Size	RB Offset	Low	Mid	High	3GPP MPR (dB)
		Channel		132072	132322	132572	
		Frequency (MHz)		1720	1745	1770	
20M	QPSK	1	0	18.21	18.24	18.20	0
		1	50	18.02	18.15	18.13	0
		1	99	17.99	18.12	18.10	0
		50	0	16.98	17.11	17.09	1
		50	25	16.96	17.09	17.07	1
		50	50	16.93	17.06	17.04	1
		100	0	16.91	17.04	17.02	1
20M	16QAM	1	0	17.03	17.16	17.14	1
		1	50	17.01	17.14	17.12	1
		1	99	17.00	17.13	17.11	1
		50	0	16.00	16.13	16.11	2
		50	25	15.97	16.10	16.08	2
		50	50	15.96	16.09	16.07	2
		100	0	15.90	16.03	16.01	2
20M	64QAM	1	0	16.03	16.16	16.14	2
		1	50	16.00	16.13	16.11	2
		1	99	15.97	16.10	16.08	2
		50	0	14.99	15.12	15.10	3
		50	25	14.98	15.11	15.09	3
		50	50	14.96	15.09	15.07	3
		100	0	14.89	15.02	15.00	3
20M	256QAM	1	0	13.17	13.33	13.27	5
		1	50	13.36	13.36	13.36	5
		1	99	13.16	13.27	13.19	5
		50	0	13.26	13.33	13.26	5
		50	25	13.21	13.34	13.27	5
		50	50	13.08	13.14	13.09	5
		100	0	13.22	13.23	13.23	5
BW	MCS Index	Channel		132047	132322	132597	3GPP MPR
		Frequency (MHz)		1717.5	1745	1772.5	
15M	QPSK	1	0	18.03	18.16	18.09	0
		1	37	17.97	18.09	18.12	0
		1	74	17.97	18.02	18.08	0
		36	0	16.90	17.09	17.06	1
		36	19	16.91	17.06	16.99	1
		36	39	16.83	17.03	17.01	1
		75	0	16.83	16.97	17.02	1
15M	16QAM	1	0	17.02	17.12	17.06	1
		1	37	16.99	17.13	17.05	1
		1	74	16.95	17.04	17.07	1
		36	0	15.96	16.03	16.04	2
		36	19	15.87	16.06	15.98	2
		36	39	15.93	16.01	15.99	2
		75	0	15.85	15.95	15.94	2
15M	64QAM	1	0	16.03	16.13	16.11	2
		1	37	15.94	16.07	16.01	2
		1	74	15.87	16.10	15.98	2
		36	0	14.99	15.02	15.03	3
		36	19	14.89	15.10	15.03	3
		36	39	14.96	14.99	15.07	3
		75	0	14.81	14.92	14.98	3
15M	256QAM	1	0	13.15	13.24	13.20	5
		1	37	13.30	13.34	13.36	5
		1	74	13.09	13.20	13.14	5
		36	0	13.20	13.26	13.18	5
		36	19	13.15	13.29	13.23	5
		36	39	13.00	13.12	13.01	5
		75	0	13.22	13.18	13.17	5

LTE Conducted Power (Reduction_Laptop)							
LTE Band 66							
BW	MCS Index	Channel		132022	132322	132622	3GPP MPR
		Frequency (MHz)		1715	1745	1775	
10M	QPSK	1	0	18.02	18.15	18.15	0
		1	24	17.95	18.08	18.12	0
		1	49	17.94	18.08	18.10	0
		25	0	16.98	17.11	17.08	1
		25	12	16.90	17.06	17.04	1
		25	25	16.84	16.98	16.95	1
		50	0	16.89	17.03	17.00	1
10M	16QAM	1	0	17.02	17.16	17.08	1
		1	24	16.91	17.09	17.12	1
		1	49	16.92	17.10	17.08	1
		25	0	15.95	16.06	16.10	2
		25	12	15.95	16.04	16.03	2
		25	25	15.95	16.00	16.02	2
		50	0	15.83	15.94	15.96	2
10M	64QAM	1	0	15.95	16.11	16.09	2
		1	24	15.98	16.10	16.09	2
		1	49	15.92	16.00	16.06	2
		25	0	14.99	15.02	15.06	3
		25	12	14.90	15.11	14.99	3
		25	25	14.94	15.08	15.00	3
		50	0	14.83	14.94	14.98	3
10M	256QAM	1	0	13.13	13.27	13.23	5
		1	24	13.29	13.32	13.36	5
		1	49	13.16	13.18	13.12	5
		25	0	13.22	13.24	13.26	5
		25	12	13.20	13.26	13.24	5
		25	25	12.99	13.10	13.04	5
		50	0	13.13	13.19	13.15	5
BW	MCS Index	Channel		131997	132322	132647	3GPP MPR
		Frequency (MHz)		1712.5	1745	1777.5	
5M	QPSK	1	0	17.99	18.14	18.05	0
		1	12	17.92	18.05	18.04	0
		1	24	17.99	18.06	18.04	0
		12	0	16.96	17.02	17.02	1
		12	6	16.90	17.06	17.03	1
		12	13	16.88	16.99	16.95	1
		25	0	16.88	16.94	16.97	1
5M	16QAM	1	0	16.99	17.16	17.05	1
		1	12	16.96	17.08	17.02	1
		1	24	16.98	17.07	17.07	1
		12	0	15.96	16.09	16.05	2
		12	6	15.92	16.01	16.03	2
		12	13	15.93	16.06	16.03	2
		25	0	15.85	16.00	15.93	2
5M	64QAM	1	0	16.03	16.10	16.11	2
		1	12	15.90	16.09	16.05	2
		1	24	15.94	16.08	16.06	2
		12	0	14.90	15.07	15.07	3
		12	6	14.90	15.05	15.05	3
		12	13	14.94	15.01	14.99	3
		25	0	14.89	14.98	14.91	3
5M	256QAM	1	0	13.10	13.27	13.26	5
		1	12	13.35	13.33	13.31	5
		1	24	13.10	13.21	13.11	5
		12	0	13.23	13.27	13.24	5
		12	6	13.11	13.25	13.19	5
		12	13	13.07	13.10	13.03	5
		25	0	13.18	13.16	13.22	5

LTE Conducted Power (Reduction_Laptop)							
LTE Band 66							
BW	MCS Index	Channel		131987	132322	132657	3GPP MPR
		Frequency (MHz)		1711.5	1745	1778.5	
3M	QPSK	1	0	18.04	18.13	18.08	0
		1	7	18.00	18.13	18.03	0
		1	14	17.92	18.04	18.05	0
		8	0	16.92	17.03	17.05	1
		8	3	16.96	17.05	17.02	1
		8	7	16.90	17.06	16.99	1
		15	0	16.86	16.98	16.99	1
3M	16QAM	1	0	17.00	17.09	17.09	1
		1	7	16.94	17.08	17.03	1
		1	14	16.94	17.03	17.05	1
		8	0	15.93	16.09	16.06	2
		8	3	15.96	16.07	16.06	2
		8	7	15.94	16.04	16.01	2
		15	0	15.87	16.03	15.96	2
3M	64QAM	1	0	15.96	16.14	16.12	2
		1	7	15.92	16.06	16.01	2
		1	14	15.91	16.02	16.05	2
		8	0	14.98	15.08	15.04	3
		8	3	14.94	15.05	15.09	3
		8	7	14.86	15.00	15.02	3
		15	0	14.83	14.97	14.95	3
3M	256QAM	1	0	13.09	13.28	13.25	5
		1	7	13.36	13.28	13.31	5
		1	14	13.09	13.26	13.12	5
		8	0	13.19	13.27	13.18	5
		8	3	13.13	13.30	13.24	5
		8	7	13.05	13.05	13.09	5
		15	0	13.12	13.21	13.18	5
BW	MCS Index	Channel		131979	132322	132665	3GPP MPR
		Frequency (MHz)		1710.7	1745	1779.3	
1.4M	QPSK	1	0	18.04	18.13	18.08	0
		1	2	17.94	18.10	18.09	0
		1	5	17.95	18.10	18.02	0
		3	0	16.94	17.01	17.04	0
		3	1	16.88	17.08	16.99	0
		3	3	16.92	16.97	17.03	0
		6	0	16.91	16.99	17.00	1
1.4M	16QAM	1	0	16.96	17.10	17.13	1
		1	2	16.91	17.12	17.05	1
		1	5	16.97	17.04	17.01	1
		3	0	15.99	16.05	16.09	1
		3	1	15.96	16.01	16.07	1
		3	3	15.89	16.04	16.02	1
		6	0	15.85	16.02	15.98	2
1.4M	64QAM	1	0	15.95	16.10	16.11	2
		1	2	15.90	16.08	16.05	2
		1	5	15.89	16.04	16.02	2
		3	0	14.98	15.06	15.05	2
		3	1	14.97	15.05	15.03	2
		3	3	14.96	15.06	14.99	2
		6	0	14.79	14.93	15.00	3
1.4M	256QAM	1	0	13.07	13.30	13.19	5
		1	2	13.32	13.31	13.27	5
		1	5	13.11	13.26	13.12	5
		3	0	13.22	13.26	13.26	5
		3	1	13.18	13.34	13.18	5
		3	3	13.08	13.10	13.05	5
		6	0	13.16	13.18	13.19	5

LTE Conducted Power (Reduction_Laptop)							
LTE Band 71							
BW	MCS Index	RB Size	RB Offset	Low	Mid	Mid	3GPP MPR (dB)
		Channel		133222	133297	133372	
		Frequency (MHz)		673	680.5	688	
20M	QPSK	1	0	22.78	22.83	22.74	0
		1	50	22.76	22.81	22.72	0
		1	99	22.75	22.80	22.71	0
		50	0	21.88	21.93	21.84	1
		50	25	21.87	21.92	21.83	1
		50	50	21.85	21.90	21.81	1
		100	0	21.77	21.82	21.73	1
20M	16QAM	1	0	21.77	21.82	21.73	1
		1	50	21.75	21.80	21.71	1
		1	99	20.94	20.99	20.90	1
		50	0	20.87	20.92	20.83	2
		50	25	20.85	20.90	20.81	2
		50	50	20.82	20.87	20.78	2
		100	0	20.77	20.82	20.73	2
20M	64QAM	1	0	20.77	20.82	20.73	2
		1	50	20.76	20.81	20.72	2
		1	99	20.75	20.80	20.71	2
		50	0	19.88	19.93	19.84	3
		50	25	19.85	19.90	19.81	3
		50	50	19.83	19.88	19.79	3
		100	0	19.78	19.83	19.74	3
20M	256QAM	1	0	17.77	17.82	17.76	5
		1	50	17.68	17.72	17.66	5
		1	99	17.57	17.63	17.55	5
		50	0	17.54	17.59	17.50	5
		50	25	17.47	17.51	17.47	5
		50	50	17.40	17.44	17.39	5
		100	0	17.68	17.71	17.65	5
BW	MCS Index	Channel		133197	133297	133397	3GPP MPR
		Frequency (MHz)		670.5	680.5	690.5	
15M	QPSK	1	0	22.68	22.74	22.81	0
		1	37	22.75	22.63	22.79	0
		1	74	22.72	22.61	22.71	0
		36	0	21.87	21.79	21.90	1
		36	19	21.85	21.79	21.86	1
		36	39	21.77	21.73	21.90	1
		75	0	21.75	21.71	21.73	1
15M	16QAM	1	0	21.73	21.70	21.81	1
		1	37	21.70	21.71	21.75	1
		1	74	20.92	20.81	20.95	1
		36	0	20.77	20.76	20.91	2
		36	19	20.76	20.79	20.81	2
		36	39	20.73	20.69	20.80	2
		75	0	20.70	20.71	20.82	2
15M	64QAM	1	0	20.73	20.69	20.81	2
		1	37	20.69	20.68	20.81	2
		1	74	20.71	20.71	20.73	2
		36	0	19.87	19.77	19.89	3
		36	19	19.78	19.74	19.81	3
		36	39	19.78	19.73	19.80	3
		75	0	19.74	19.73	19.82	3
15M	256QAM	1	0	17.76	17.74	17.75	5
		1	37	17.68	17.71	17.65	5
		1	74	17.53	17.53	17.45	5
		36	0	17.49	17.53	17.50	5
		36	19	17.43	17.44	17.46	5
		36	39	17.35	17.43	17.32	5
		75	0	17.64	17.67	17.62	5

LTE Conducted Power (Reduction_Laptop)							
LTE Band 71							
BW	MCS Index	Channel		133172	133297	133422	3GPP MPR
		Frequency (MHz)		668	680.5	693	
10M	QPSK	1	0	22.70	22.74	22.77	0
		1	24	22.72	22.63	22.76	0
		1	49	22.66	22.64	22.70	0
		25	0	21.80	21.77	21.83	1
		25	12	21.87	21.79	21.88	1
		25	25	21.81	21.78	21.80	1
		50	0	21.71	21.67	21.76	1
10M	16QAM	1	0	21.68	21.69	21.76	1
		1	24	21.66	21.65	21.73	1
		1	49	20.93	20.87	20.90	1
		25	0	20.82	20.82	20.86	2
		25	12	20.84	20.73	20.83	2
		25	25	20.78	20.68	20.85	2
		50	0	20.76	20.66	20.80	2
10M	64QAM	1	0	20.68	20.67	20.78	2
		1	24	20.73	20.62	20.71	2
		1	49	20.75	20.71	20.76	2
		25	0	19.80	19.79	19.87	3
		25	12	19.80	19.74	19.85	3
		25	25	19.78	19.78	19.82	3
		50	0	19.74	19.73	19.78	3
10M	256QAM	1	0	17.69	17.80	17.67	5
		1	24	17.66	17.63	17.62	5
		1	49	17.55	17.54	17.48	5
		25	0	17.48	17.59	17.43	5
		25	12	17.39	17.45	17.45	5
		25	25	17.36	17.37	17.39	5
		50	0	17.58	17.68	17.62	5
BW	MCS Index	Channel		133147	133297	133447	3GPP MPR
		Frequency (MHz)		665.5	680.5	695.5	
5M	QPSK	1	0	22.78	22.66	22.81	0
		1	12	22.73	22.65	22.74	0
		1	24	22.69	22.70	22.76	0
		12	0	21.79	21.77	21.88	1
		12	6	21.79	21.78	21.89	1
		12	13	21.80	21.76	21.88	1
		25	0	21.72	21.73	21.78	1
5M	16QAM	1	0	21.69	21.68	21.77	1
		1	12	21.72	21.68	21.74	1
		1	24	20.93	20.83	20.90	1
		12	0	20.87	20.79	20.87	2
		12	6	20.83	20.79	20.87	2
		12	13	20.74	20.74	20.86	2
		25	0	20.67	20.71	20.75	2
5M	64QAM	1	0	20.76	20.71	20.78	2
		1	12	20.66	20.69	20.78	2
		1	24	20.70	20.64	20.73	2
		12	0	19.84	19.79	19.91	3
		12	6	19.75	19.80	19.81	3
		12	13	19.83	19.74	19.83	3
		25	0	19.69	19.74	19.73	3
5M	256QAM	1	0	17.77	17.74	17.76	5
		1	12	17.67	17.66	17.61	5
		1	24	17.48	17.59	17.49	5
		12	0	17.48	17.49	17.46	5
		12	6	17.46	17.43	17.42	5
		12	13	17.36	17.42	17.39	5
		25	0	17.68	17.68	17.63	5

LTE Conducted Power (Reduction_Tablet)							
LTE Band 2							
BW	MCS Index	RB Size	RB Offset	Low	Mid	High	3GPP MPR (dB)
		Channel		18700	18900	19100	
		Frequency (MHz)		1860	1880	1900	
20M	QPSK	1	0	13.34	13.13	13.11	0
		1	50	13.27	13.07	13.10	0
		1	99	13.15	13.08	12.98	0
		50	0	12.27	12.20	12.10	1
		50	25	12.21	12.14	12.04	1
		50	50	12.18	12.11	12.01	1
		100	0	12.20	12.13	12.03	1
20M	16QAM	1	0	12.19	12.12	12.02	1
		1	50	12.16	12.09	11.99	1
		1	99	12.04	11.97	11.87	1
		50	0	11.27	11.20	11.10	2
		50	25	11.15	11.08	10.98	2
		50	50	11.12	11.05	10.95	2
		100	0	11.28	11.21	11.11	2
20M	64QAM	1	0	11.15	11.08	10.98	2
		1	50	11.04	10.97	10.87	2
		1	99	11.01	10.94	10.84	2
		50	0	10.18	10.11	10.01	3
		50	25	10.14	10.07	9.97	3
		50	50	10.09	10.02	9.92	3
		100	0	10.04	9.97	9.87	3
20M	256QAM	1	0	8.23	8.26	8.20	5
		1	50	8.16	8.22	8.11	5
		1	99	8.19	8.21	8.13	5
		50	0	8.10	8.11	8.04	5
		50	25	8.14	8.17	8.11	5
		50	50	8.17	8.19	8.10	5
		100	0	8.10	8.13	8.09	5
BW	MCS Index	Channel		18675	18900	19125	3GPP MPR
		Frequency (MHz)		1857.5	1880	1902.5	
15M	QPSK	1	0	13.27	13.20	13.13	0
		1	37	13.25	13.20	13.08	0
		1	74	13.09	13.07	12.89	0
		36	0	12.23	12.18	12.10	1
		36	19	12.14	12.12	11.97	1
		36	39	12.14	12.06	11.97	1
		75	0	12.14	12.09	11.96	1
15M	16QAM	1	0	12.09	12.10	12.01	1
		1	37	12.16	12.00	11.99	1
		1	74	11.94	11.94	11.82	1
		36	0	11.20	11.12	11.08	2
		36	19	11.11	11.01	10.94	2
		36	39	11.08	11.05	10.89	2
		75	0	11.27	11.21	11.05	2
15M	64QAM	1	0	11.15	11.02	10.96	2
		1	37	11.03	10.89	10.87	2
		1	74	11.01	10.93	10.78	2
		36	0	10.16	10.10	9.97	3
		36	19	10.12	10.04	9.95	3
		36	39	10.05	9.96	9.84	3
		75	0	10.03	9.95	9.79	3
15M	256QAM	1	0	8.20	8.20	8.11	5
		1	37	8.08	8.16	8.04	5
		1	74	8.18	8.16	8.12	5
		36	0	8.04	8.01	8.03	5
		36	19	8.05	8.17	8.06	5
		36	39	8.17	8.18	8.07	5
		75	0	8.08	8.06	8.05	5

LTE Conducted Power (Reduction_Tablet)							
LTE Band 2							
BW	MCS Index	Channel		18650	18900	19150	3GPP MPR
		Frequency (MHz)		1855	1880	1905	
10M	QPSK	1	0	13.27	13.16	13.13	0
		1	24	13.20	13.18	13.02	0
		1	49	13.15	13.05	12.96	0
		25	0	12.21	12.11	12.06	1
		25	12	12.20	12.05	11.99	1
		25	25	12.12	12.11	11.99	1
		50	0	12.18	12.08	11.97	1
10M	16QAM	1	0	12.13	12.05	11.93	1
		1	24	12.12	12.07	11.93	1
		1	49	12.04	11.96	11.86	1
		25	0	11.27	11.18	11.01	2
		25	12	11.08	11.00	10.93	2
		25	25	11.12	11.05	10.85	2
		50	0	11.23	11.13	11.08	2
10M	64QAM	1	0	11.12	11.07	10.92	2
		1	24	10.99	10.94	10.81	2
		1	49	10.97	10.93	10.80	2
		25	0	10.13	10.10	9.93	3
		25	12	10.06	9.97	9.90	3
		25	25	9.99	9.95	9.88	3
		50	0	9.97	9.87	9.85	3
10M	256QAM	1	0	8.18	8.19	8.10	5
		1	24	8.13	8.18	8.04	5
		1	49	8.14	8.20	8.06	5
		25	0	8.04	8.02	8.03	5
		25	12	8.14	8.11	8.09	5
		25	25	8.07	8.17	8.00	5
		50	0	8.07	8.03	8.06	5
BW	MCS Index	Channel		18625	18900	19175	3GPP MPR
		Frequency (MHz)		1852.5	1880	1907.5	
5M	QPSK	1	0	13.22	13.24	13.13	0
		1	12	13.26	13.14	13.08	0
		1	24	13.09	13.05	12.91	0
		12	0	12.23	12.17	12.08	1
		12	6	12.16	12.05	12.02	1
		12	13	12.14	12.05	11.94	1
		25	0	12.17	12.07	12.01	1
5M	16QAM	1	0	12.13	12.11	11.92	1
		1	12	12.08	12.03	11.98	1
		1	24	11.96	11.92	11.85	1
		12	0	11.24	11.10	11.00	2
		12	6	11.06	10.99	10.91	2
		12	13	11.09	10.98	10.91	2
		25	0	11.24	11.14	11.11	2
5M	64QAM	1	0	11.12	11.01	10.95	2
		1	12	11.02	10.87	10.85	2
		1	24	10.96	10.84	10.80	2
		12	0	10.14	10.09	9.96	3
		12	6	10.09	10.04	9.88	3
		12	13	10.02	9.98	9.92	3
		25	0	10.02	9.91	9.80	3
5M	256QAM	1	0	8.23	8.25	8.11	5
		1	12	8.12	8.14	8.02	5
		1	24	8.11	8.18	8.06	5
		12	0	8.04	8.06	7.94	5
		12	6	8.07	8.16	8.06	5
		12	13	8.16	8.10	8.02	5
		25	0	8.00	8.05	8.03	5

LTE Conducted Power (Reduction_Tablet)							
LTE Band 2							
BW	MCS Index	Channel		18615	18900	19185	3GPP MPR
		Frequency (MHz)		1851.5	1880	1908.5	
3M	QPSK	1	0	13.24	13.24	13.13	0
		1	7	13.17	13.18	13.09	0
		1	14	13.06	13.06	12.88	0
		8	0	12.19	12.11	12.01	1
		8	3	12.16	12.11	12.04	1
		8	7	12.16	12.11	12.01	1
		15	0	12.17	12.10	11.99	1
3M	16QAM	1	0	12.17	12.07	12.01	1
		1	7	12.14	12.03	11.92	1
		1	14	11.95	11.90	11.85	1
		8	0	11.27	11.10	11.00	2
		8	3	11.08	11.00	10.95	2
		8	7	11.06	10.97	10.88	2
		15	0	11.18	11.18	11.10	2
3M	64QAM	1	0	11.15	11.05	10.93	2
		1	7	11.04	10.95	10.85	2
		1	14	10.96	10.85	10.84	2
		8	0	10.12	10.04	9.92	3
		8	3	10.09	9.99	9.90	3
		8	7	10.03	9.96	9.91	3
		15	0	9.97	9.88	9.81	3
3M	256QAM	1	0	8.14	8.26	8.13	5
		1	7	8.09	8.22	8.07	5
		1	14	8.11	8.15	8.13	5
		8	0	8.06	8.11	7.99	5
		8	3	8.08	8.11	8.07	5
		8	7	8.08	8.09	8.02	5
		15	0	8.07	8.13	8.03	5
BW	MCS Index	Channel		18607	18900	19193	3GPP MPR
		Frequency (MHz)		1850.7	1880	1909.3	
1.4M	QPSK	1	0	13.24	13.03	13.09	0
		1	2	13.13	13.12	12.92	0
		1	5	13.02	12.94	12.87	0
		3	0	13.17	13.14	12.93	0
		3	1	13.12	13.00	12.93	0
		3	3	13.03	12.94	12.85	0
		6	0	12.00	11.89	11.84	1
1.4M	16QAM	1	0	12.13	11.95	11.97	1
		1	2	12.06	11.99	11.76	1
		1	5	11.87	11.89	11.73	1
		3	0	12.12	12.18	12.00	1
		3	1	12.00	12.00	11.79	1
		3	3	11.99	11.97	11.95	1
		6	0	11.12	11.13	10.97	2
1.4M	64QAM	1	0	10.98	10.96	10.85	2
		1	2	10.94	10.93	10.79	2
		1	5	10.95	10.78	10.74	2
		3	0	11.02	11.05	10.94	2
		3	1	10.96	10.87	10.89	2
		3	3	10.90	10.91	10.76	2
		6	0	9.83	9.89	9.68	3
1.4M	256QAM	1	0	8.20	8.21	8.15	5
		1	2	8.15	8.21	8.11	5
		1	5	8.15	8.12	8.07	5
		3	0	8.06	8.06	7.95	5
		3	1	8.07	8.08	8.10	5
		3	3	8.15	8.14	8.03	5
		6	0	8.01	8.06	8.08	5

LTE Conducted Power (Reduction_Tablet)							
LTE Band 4							
BW	MCS Index	RB Size	RB Offset	Low	Mid	High	3GPP MPR (dB)
		Channel		20050	20175	20300	
		Frequency (MHz)		1720	1732.5	1745	
20M	QPSK	1	0	13.39	13.36	13.15	0
		1	50	13.18	13.10	12.96	0
		1	99	13.10	13.02	12.88	0
		50	0	12.49	12.41	12.37	1
		50	25	12.24	12.16	12.02	1
		50	50	12.15	12.07	11.93	1
		100	0	12.09	12.01	11.87	1
20M	16QAM	1	0	11.98	11.90	11.76	1
		1	50	11.90	11.82	11.68	1
		1	99	11.87	11.79	11.65	1
		50	0	11.07	10.99	10.85	2
		50	25	11.04	10.96	10.82	2
		50	50	11.05	10.97	10.83	2
		100	0	10.88	10.80	10.66	2
20M	64QAM	1	0	11.10	11.02	10.88	2
		1	50	10.89	10.81	10.67	2
		1	99	10.87	10.79	10.65	2
		50	0	10.05	9.97	9.83	3
		50	25	10.00	9.92	9.78	3
		50	50	9.86	9.78	9.64	3
		100	0	9.90	9.82	9.68	3
20M	256QAM	1	0	8.16	8.20	8.15	5
		1	50	8.13	8.16	8.07	5
		1	99	8.14	8.15	8.12	5
		50	0	8.00	8.10	8.02	5
		50	25	8.05	8.12	8.04	5
		50	50	8.11	8.12	8.00	5
		100	0	8.04	8.13	8.03	5
BW	MCS Index	Channel		20025	20175	20325	3GPP MPR
		Frequency (MHz)		1717.5	1732.5	1747.5	
15M	QPSK	1	0	13.21	13.06	12.94	0
		1	37	13.12	13.04	12.93	0
		1	74	13.07	12.96	12.78	0
		36	0	12.39	12.36	12.24	1
		36	19	12.16	12.09	11.97	1
		36	39	12.15	12.04	11.87	1
		75	0	12.08	11.99	11.83	1
15M	16QAM	1	0	11.92	11.89	11.70	1
		1	37	11.83	11.79	11.62	1
		1	74	11.84	11.69	11.61	1
		36	0	11.02	10.92	10.83	2
		36	19	10.96	10.87	10.80	2
		36	39	11.04	10.97	10.75	2
		75	0	10.80	10.74	10.62	2
15M	64QAM	1	0	11.04	10.93	10.82	2
		1	37	10.84	10.75	10.63	2
		1	74	10.78	10.76	10.60	2
		36	0	10.00	9.96	9.79	3
		36	19	9.95	9.91	9.72	3
		36	39	9.76	9.70	9.58	3
		75	0	9.85	9.77	9.60	3
15M	256QAM	1	0	8.23	8.20	8.16	5
		1	37	8.12	8.14	8.09	5
		1	74	8.18	8.16	8.04	5
		36	0	8.07	8.07	8.04	5
		36	19	8.10	8.10	8.01	5
		36	39	8.12	8.18	8.00	5
		75	0	8.02	8.05	8.05	5

LTE Conducted Power (Reduction_Tablet)							
LTE Band 4							
BW	MCS Index	Channel		20000	20175	20350	3GPP MPR
		Frequency (MHz)		1715	1732.5	1750	
10M	QPSK	1	0	13.16	13.05	12.97	0
		1	24	13.14	13.10	12.87	0
		1	49	13.03	12.96	12.84	0
		25	0	12.40	12.32	12.19	1
		25	12	12.15	12.11	12.01	1
		25	25	12.12	11.98	11.87	1
		50	0	12.07	11.91	11.85	1
10M	16QAM	1	0	11.91	11.88	11.72	1
		1	24	11.83	11.74	11.62	1
		1	49	11.81	11.77	11.56	1
		25	0	11.03	10.97	10.78	2
		25	12	10.95	10.91	10.82	2
		25	25	11.05	10.94	10.80	2
		50	0	10.85	10.73	10.58	2
10M	64QAM	1	0	11.00	10.98	10.80	2
		1	24	10.85	10.72	10.66	2
		1	49	10.77	10.69	10.62	2
		25	0	10.00	9.90	9.73	3
		25	12	9.90	9.86	9.74	3
		25	25	9.82	9.78	9.59	3
		50	0	9.89	9.82	9.58	3
10M	256QAM	1	0	8.20	8.18	8.12	5
		1	24	8.14	8.17	8.11	5
		1	49	8.18	8.20	8.11	5
		25	0	8.06	8.08	8.01	5
		25	12	8.10	8.07	8.05	5
		25	25	8.08	8.18	8.02	5
		50	0	8.06	8.04	7.99	5
BW	MCS Index	Channel		19975	20175	20375	3GPP MPR
		Frequency (MHz)		1712.5	1732.5	1752.5	
5M	QPSK	1	0	13.16	13.11	12.92	0
		1	12	13.09	13.01	12.96	0
		1	24	13.10	12.95	12.79	0
		12	0	12.45	12.32	12.23	1
		12	6	12.21	12.16	12.00	1
		12	13	12.11	11.99	11.86	1
		25	0	12.07	11.96	11.87	1
5M	16QAM	1	0	11.92	11.85	11.70	1
		1	12	11.84	11.80	11.61	1
		1	24	11.77	11.72	11.57	1
		12	0	11.01	10.96	10.84	2
		12	6	11.00	10.90	10.72	2
		12	13	10.98	10.97	10.82	2
		25	0	10.86	10.79	10.62	2
5M	64QAM	1	0	11.05	10.92	10.84	2
		1	12	10.82	10.74	10.67	2
		1	24	10.79	10.69	10.61	2
		12	0	9.96	9.90	9.83	3
		12	6	9.94	9.91	9.68	3
		12	13	9.77	9.76	9.64	3
		25	0	9.85	9.73	9.63	3
5M	256QAM	1	0	8.19	8.18	8.19	5
		1	12	8.16	8.15	8.05	5
		1	24	8.13	8.11	8.07	5
		12	0	8.08	8.10	8.01	5
		12	6	8.10	8.08	8.03	5
		12	13	8.09	8.16	8.02	5
		25	0	8.06	8.05	8.04	5

LTE Conducted Power (Reduction_Tablet)							
LTE Band 4							
BW	MCS Index	Channel		19965	20175	20385	3GPP MPR
		Frequency (MHz)		1711.5	1732.5	1753.5	
3M	QPSK	1	0	13.20	13.14	12.91	0
		1	7	13.09	13.10	12.92	0
		1	14	13.09	13.02	12.85	0
		8	0	12.46	12.45	12.33	1
		8	3	12.22	12.13	11.93	1
		8	7	12.11	12.00	11.88	1
		15	0	12.05	11.99	11.80	1
3M	16QAM	1	0	11.92	11.85	11.71	1
		1	7	11.89	11.77	11.59	1
		1	14	11.85	11.77	11.65	1
		8	0	11.02	10.89	10.85	2
		8	3	11.04	10.92	10.77	2
		8	7	10.99	10.94	10.76	2
		15	0	10.86	10.80	10.63	2
3M	64QAM	1	0	11.06	10.98	10.85	2
		1	7	10.84	10.74	10.61	2
		1	14	10.78	10.77	10.61	2
		8	0	9.97	9.89	9.80	3
		8	3	9.96	9.91	9.77	3
		8	7	9.76	9.78	9.56	3
		15	0	9.87	9.73	9.65	3
3M	256QAM	1	0	8.17	8.17	8.17	5
		1	7	8.14	8.13	8.09	5
		1	14	8.14	8.18	8.10	5
		8	0	8.09	8.06	7.99	5
		8	3	8.14	8.16	8.08	5
		8	7	8.10	8.17	8.01	5
		15	0	8.01	8.06	8.08	5
BW	MCS Index	Channel		19957	20175	20393	3GPP MPR
		Frequency (MHz)		1710.7	1732.5	1754.3	
1.4M	QPSK	1	0	13.06	13.04	12.93	0
		1	2	13.11	13.02	12.89	0
		1	5	13.13	13.04	12.87	0
		3	0	13.05	12.99	12.78	0
		3	1	12.97	12.88	12.76	0
		3	3	13.05	13.00	12.71	0
		6	0	12.00	11.82	11.73	1
1.4M	16QAM	1	0	11.96	11.81	11.71	1
		1	2	11.79	11.67	11.54	1
		1	5	11.76	11.55	11.54	1
		3	0	12.03	11.78	11.63	1
		3	1	11.81	11.87	11.71	1
		3	3	11.95	11.81	11.64	1
		6	0	10.67	10.62	10.58	2
1.4M	64QAM	1	0	10.94	10.81	10.79	2
		1	2	10.77	10.68	10.60	2
		1	5	10.76	10.56	10.60	2
		3	0	11.02	10.81	10.71	2
		3	1	10.86	10.92	10.62	2
		3	3	10.77	10.71	10.52	2
		6	0	9.86	9.73	9.62	3
1.4M	256QAM	1	0	8.13	8.16	8.20	5
		1	2	8.08	8.20	8.04	5
		1	5	8.19	8.15	8.10	5
		3	0	8.01	8.05	7.97	5
		3	1	8.14	8.15	8.05	5
		3	3	8.13	8.19	8.09	5
		6	0	8.04	8.09	8.02	5

LTE Conducted Power (Reduction_Tablet)							
LTE Band 5							
BW	MCS Index	RB Size	RB Offset	Low	Mid	High	3GPP MPR (dB)
		Channel		20450	20525	20600	
		Frequency (MHz)		829	836.5	844	
10M	QPSK	1	0	18.32	18.45	18.16	0
		1	24	18.24	18.33	18.12	0
		1	49	18.23	18.32	18.11	0
		25	0	17.22	17.31	17.10	1
		25	12	17.19	17.28	17.07	1
		25	25	17.15	17.24	17.03	1
		50	0	17.24	17.33	17.12	1
10M	16QAM	1	0	17.33	17.42	17.21	1
		1	24	17.27	17.36	17.15	1
		1	49	17.21	17.30	17.09	1
		25	0	16.35	16.44	16.23	2
		25	12	16.30	16.39	16.18	2
		25	25	16.24	16.33	16.12	2
		50	0	16.23	16.32	16.11	2
10M	64QAM	1	0	16.31	16.40	16.19	2
		1	24	16.26	16.35	16.14	2
		1	49	16.23	16.32	16.11	2
		25	0	15.27	15.36	15.15	3
		25	12	15.33	15.42	15.21	3
		25	25	15.30	15.39	15.18	3
		50	0	15.35	15.44	15.23	3
10M	256QAM	1	0	13.17	13.33	13.24	5
		1	24	13.21	13.27	13.23	5
		1	49	13.15	13.26	13.21	5
		25	0	13.01	13.16	13.04	5
		25	12	12.98	13.15	13.04	5
		25	25	13.03	13.13	13.12	5
		50	0	13.06	13.18	13.12	5
BW	MCS Index	Channel		20425	20525	20625	3GPP MPR
		Frequency (MHz)		826.5	836.5	846.5	
5M	QPSK	1	0	18.25	18.27	18.04	0
		1	12	18.21	18.24	18.02	0
		1	24	18.22	18.23	18.07	0
		12	0	17.17	17.24	17.07	1
		12	6	17.17	17.19	17.01	1
		12	13	17.11	17.23	16.94	1
		25	0	17.14	17.30	17.05	1
5M	16QAM	1	0	17.33	17.32	17.20	1
		1	12	17.25	17.35	17.06	1
		1	24	17.13	17.28	17.05	1
		12	0	16.35	16.43	16.19	2
		12	6	16.20	16.38	16.16	2
		12	13	16.22	16.26	16.11	2
		25	0	16.15	16.30	16.05	2
5M	64QAM	1	0	16.28	16.36	16.18	2
		1	12	16.19	16.26	16.11	2
		1	24	16.18	16.27	16.04	2
		12	0	15.26	15.36	15.05	3
		12	6	15.33	15.39	15.16	3
		12	13	15.28	15.33	15.10	3
		25	0	15.31	15.43	15.18	3
5M	256QAM	1	0	13.17	13.23	13.23	5
		1	12	13.13	13.23	13.20	5
		1	24	13.06	13.24	13.19	5
		12	0	12.98	13.09	12.97	5
		12	6	12.92	13.15	12.98	5
		12	13	13.01	13.08	13.05	5
		25	0	12.96	13.09	13.04	5

LTE Conducted Power (Reduction_Tablet)							
LTE Band 5							
BW	MCS Index	Channel		20415	20525	20635	3GPP MPR
		Frequency (MHz)		825.5	836.5	847.5	
3M	QPSK	1	0	18.17	18.25	18.06	0
		1	7	18.23	18.29	18.12	0
		1	14	18.21	18.27	18.11	0
		8	0	17.14	17.21	17.01	1
		8	3	17.10	17.24	16.97	1
		8	7	17.13	17.17	17.02	1
		15	0	17.14	17.27	17.05	1
3M	16QAM	1	0	17.25	17.38	17.17	1
		1	7	17.18	17.35	17.12	1
		1	14	17.12	17.22	17.05	1
		8	0	16.30	16.38	16.23	2
		8	3	16.21	16.32	16.13	2
		8	7	16.23	16.25	16.11	2
		15	0	16.18	16.22	16.03	2
3M	64QAM	1	0	16.24	16.30	16.17	2
		1	7	16.17	16.32	16.05	2
		1	14	16.23	16.24	16.03	2
		8	0	15.23	15.32	15.14	3
		8	3	15.24	15.41	15.20	3
		8	7	15.26	15.29	15.18	3
		15	0	15.35	15.37	15.13	3
3M	256QAM	1	0	13.07	13.27	13.17	5
		1	7	13.14	13.17	13.23	5
		1	14	13.10	13.19	13.21	5
		8	0	13.00	13.15	12.95	5
		8	3	12.89	13.08	13.01	5
		8	7	13.01	13.07	13.09	5
		15	0	13.06	13.18	13.06	5
BW	MCS Index	Channel		20407	20525	20643	3GPP MPR
		Frequency (MHz)		824.7	836.5	848.3	
1.4M	QPSK	1	0	18.17	18.33	17.97	0
		1	2	18.03	18.17	17.88	0
		1	5	18.12	18.23	17.98	0
		3	0	18.19	18.16	17.93	0
		3	1	18.08	18.15	17.90	0
		3	3	18.13	18.10	17.84	0
		6	0	17.09	17.21	16.97	1
1.4M	16QAM	1	0	17.24	17.33	17.08	1
		1	2	17.15	17.20	17.03	1
		1	5	17.00	17.07	16.94	1
		3	0	17.27	17.31	17.15	1
		3	1	17.14	17.26	16.95	1
		3	3	17.10	17.27	16.90	1
		6	0	16.11	16.10	15.91	2
1.4M	64QAM	1	0	16.17	16.21	16.09	2
		1	2	16.23	16.16	15.94	2
		1	5	16.17	16.17	16.00	2
		3	0	16.12	16.18	15.95	2
		3	1	16.15	16.28	16.10	2
		3	3	16.25	16.18	16.08	2
		6	0	15.17	15.39	15.08	3
1.4M	256QAM	1	0	13.12	13.24	13.23	5
		1	2	13.16	13.22	13.22	5
		1	5	13.07	13.26	13.17	5
		3	0	12.98	13.09	13.00	5
		3	1	12.89	13.07	12.95	5
		3	3	12.95	13.07	13.11	5
		6	0	13.06	13.17	13.10	5

LTE Conducted Power (Reduction_Tablet)							
LTE Band 7							
BW	MCS Index	RB Size	RB Offset	Low	Mid	High	3GPP MPR (dB)
		Channel		20850	21100	21350	
		Frequency (MHz)		2510	2535	2560	
20M	QPSK	1	0	12.73	12.76	12.77	0
		1	50	12.63	12.66	12.67	0
		1	99	12.57	12.60	12.61	0
		50	0	11.87	11.90	11.91	1
		50	25	11.81	11.84	11.85	1
		50	50	11.79	11.82	11.83	1
		100	0	11.82	11.85	11.86	1
20M	16QAM	1	0	11.62	11.65	11.66	1
		1	50	11.27	11.30	11.31	1
		1	99	10.92	10.95	10.96	1
		50	0	10.62	10.65	10.66	2
		50	25	10.51	10.54	10.55	2
		50	50	10.41	10.44	10.45	2
		100	0	10.54	10.57	10.58	2
20M	64QAM	1	0	10.43	10.46	10.47	2
		1	50	10.05	10.08	10.09	2
		1	99	9.74	9.77	9.78	2
		50	0	9.64	9.67	9.68	3
		50	25	9.61	9.64	9.65	3
		50	50	9.53	9.56	9.57	3
		100	0	9.64	9.67	9.68	3
20M	256QAM	1	0	8.15	8.20	8.18	5
		1	50	8.09	8.16	8.03	5
		1	99	8.14	8.20	8.13	5
		50	0	8.05	8.06	8.04	5
		50	25	8.06	8.10	8.06	5
		50	50	8.10	8.17	8.04	5
		100	0	8.07	8.10	8.09	5
BW	MCS Index	Channel		20825	21100	21375	3GPP MPR
		Frequency (MHz)		2507.5	2535	2562.5	
15M	QPSK	1	0	12.64	12.76	12.75	0
		1	37	12.57	12.59	12.66	0
		1	74	12.51	12.58	12.54	0
		36	0	11.78	11.88	11.86	1
		36	19	11.75	11.80	11.83	1
		36	39	11.71	11.77	11.78	1
		75	0	11.77	11.77	11.79	1
15M	16QAM	1	0	11.57	11.55	11.65	1
		1	37	11.17	11.20	11.25	1
		1	74	10.92	10.89	10.94	1
		36	0	10.57	10.57	10.61	2
		36	19	10.51	10.54	10.52	2
		36	39	10.35	10.40	10.37	2
		75	0	10.47	10.55	10.55	2
15M	64QAM	1	0	10.34	10.46	10.38	2
		1	37	10.05	10.06	10.04	2
		1	74	9.73	9.74	9.68	2
		36	0	9.55	9.63	9.64	3
		36	19	9.57	9.54	9.62	3
		36	39	9.52	9.47	9.56	3
		75	0	9.60	9.63	9.62	3
15M	256QAM	1	0	8.18	8.22	8.15	5
		1	37	8.09	8.16	8.03	5
		1	74	8.12	8.13	8.03	5
		36	0	8.06	8.04	7.96	5
		36	19	8.11	8.13	8.08	5
		36	39	8.12	8.12	8.02	5
		75	0	8.01	8.03	8.08	5

LTE Conducted Power (Reduction_Tablet)							
LTE Band 7							
BW	MCS Index	Channel		20800	21100	21400	3GPP MPR
		Frequency (MHz)		2505	2535	2565	
10M	QPSK	1	0	12.72	12.74	12.71	0
		1	24	12.63	12.64	12.66	0
		1	49	12.51	12.51	12.54	0
		25	0	11.77	11.89	11.89	1
		25	12	11.79	11.84	11.84	1
		25	25	11.77	11.80	11.77	1
		50	0	11.77	11.81	11.77	1
10M	16QAM	1	0	11.54	11.58	11.58	1
		1	24	11.22	11.21	11.26	1
		1	49	10.83	10.93	10.87	1
		25	0	10.58	10.56	10.62	2
		25	12	10.51	10.47	10.52	2
		25	25	10.32	10.40	10.38	2
		50	0	10.54	10.47	10.54	2
10M	64QAM	1	0	10.35	10.36	10.42	2
		1	24	9.99	10.08	10.03	2
		1	49	9.71	9.74	9.72	2
		25	0	9.55	9.62	9.68	3
		25	12	9.60	9.64	9.63	3
		25	25	9.44	9.48	9.53	3
		50	0	9.63	9.60	9.63	3
10M	256QAM	1	0	8.22	8.17	8.16	5
		1	24	8.09	8.19	8.07	5
		1	49	8.18	8.18	8.12	5
		25	0	8.10	8.07	7.96	5
		25	12	8.09	8.08	8.01	5
		25	25	8.14	8.12	8.08	5
		50	0	8.08	8.05	8.00	5
BW	MCS Index	Channel		20775	21100	21425	3GPP MPR
		Frequency (MHz)		2502.5	2535	2567.5	
5M	QPSK	1	0	12.64	12.68	12.75	0
		1	12	12.56	12.64	12.59	0
		1	24	12.50	12.58	12.51	0
		12	0	11.78	11.83	11.81	1
		12	6	11.75	11.82	11.80	1
		12	13	11.70	11.78	11.77	1
		25	0	11.80	11.85	11.76	1
5M	16QAM	1	0	11.61	11.59	11.65	1
		1	12	11.23	11.24	11.23	1
		1	24	10.92	10.93	10.88	1
		12	0	10.62	10.58	10.63	2
		12	6	10.46	10.44	10.51	2
		12	13	10.36	10.41	10.41	2
		25	0	10.47	10.57	10.48	2
5M	64QAM	1	0	10.35	10.45	10.45	2
		1	12	9.97	10.04	10.03	2
		1	24	9.69	9.76	9.68	2
		12	0	9.56	9.62	9.68	3
		12	6	9.56	9.61	9.61	3
		12	13	9.46	9.53	9.54	3
		25	0	9.59	9.62	9.63	3
5M	256QAM	1	0	8.19	8.24	8.20	5
		1	12	8.11	8.22	8.02	5
		1	24	8.09	8.16	8.10	5
		12	0	8.05	8.08	8.01	5
		12	6	8.11	8.09	8.09	5
		12	13	8.11	8.09	8.05	5
		25	0	8.00	8.09	8.04	5

LTE Conducted Power (Reduction_Tablet)							
LTE Band 12							
BW	MCS Index	RB Size	RB Offset	Low	Mid	High	3GPP MPR (dB)
		Channel		23060	23095	23130	
		Frequency (MHz)		704	707.5	711	
10M	QPSK	1	0	15.16	15.12	15.22	0
		1	24	14.61	14.73	14.76	0
		1	49	14.57	14.69	14.72	0
		25	0	13.58	13.70	13.73	1
		25	12	13.49	13.61	13.64	1
		25	25	13.46	13.58	13.61	1
		50	0	13.45	13.57	13.60	1
10M	16QAM	1	0	13.77	13.89	13.92	1
		1	24	13.76	13.88	13.91	1
		1	49	13.77	13.89	13.92	1
		25	0	12.77	12.89	12.92	2
		25	12	12.71	12.83	12.86	2
		25	25	12.66	12.78	12.81	2
		50	0	12.63	12.75	12.78	2
10M	64QAM	1	0	12.54	12.66	12.69	2
		1	24	12.48	12.60	12.63	2
		1	49	12.41	12.53	12.56	2
		25	0	11.76	11.88	11.91	3
		25	12	11.80	11.92	11.95	3
		25	25	11.68	11.80	11.83	3
		50	0	11.80	11.92	11.95	3
10M	256QAM	1	0	10.30	10.29	10.39	5
		1	24	10.32	10.22	10.41	5
		1	49	10.25	10.19	10.29	5
		25	0	10.13	10.09	10.22	5
		25	12	10.31	10.26	10.31	5
		25	25	10.12	10.03	10.19	5
		50	0	10.18	10.18	10.22	5
BW	MCS Index	Channel		23035	23095	23155	3GPP MPR
		Frequency (MHz)		701.5	707.5	713.5	
5M	QPSK	1	0	14.69	14.80	14.87	0
		1	12	14.55	14.63	14.74	0
		1	24	14.56	14.62	14.69	0
		12	0	13.54	13.65	13.72	1
		12	6	13.46	13.61	13.60	1
		12	13	13.37	13.52	13.60	1
		25	0	13.42	13.47	13.50	1
5M	16QAM	1	0	13.70	13.87	13.89	1
		1	12	13.73	13.81	13.81	1
		1	24	13.74	13.79	13.85	1
		12	0	12.74	12.82	12.89	2
		12	6	12.63	12.81	12.76	2
		12	13	12.61	12.75	12.73	2
		25	0	12.62	12.68	12.72	2
5M	64QAM	1	0	12.45	12.63	12.64	2
		1	12	12.38	12.59	12.63	2
		1	24	12.39	12.51	12.54	2
		12	0	11.68	11.86	11.87	3
		12	6	11.70	11.84	11.91	3
		12	13	11.62	11.77	11.83	3
		25	0	11.74	11.89	11.91	3
5M	256QAM	1	0	10.25	10.27	10.30	5
		1	12	10.31	10.18	10.41	5
		1	24	10.21	10.19	10.25	5
		12	0	10.09	10.08	10.19	5
		12	6	10.26	10.18	10.25	5
		12	13	10.09	9.95	10.12	5
		25	0	10.10	10.16	10.13	5

LTE Conducted Power (Reduction_Tablet)							
LTE Band 12							
BW	MCS Index	Channel		23025	23095	23165	3GPP MPR
		Frequency (MHz)		700.5	707.5	714.5	
3M	QPSK	1	0	14.69	14.87	14.87	0
		1	7	14.61	14.71	14.67	0
		1	14	14.54	14.67	14.71	0
		8	0	13.52	13.68	13.71	1
		8	3	13.47	13.59	13.61	1
		8	7	13.46	13.55	13.57	1
		15	0	13.42	13.48	13.52	1
3M	16QAM	1	0	13.71	13.88	13.87	1
		1	7	13.72	13.79	13.82	1
		1	14	13.77	13.89	13.84	1
		8	0	12.76	12.86	12.88	2
		8	3	12.68	12.75	12.80	2
		8	7	12.57	12.77	12.77	2
		15	0	12.63	12.73	12.72	2
3M	64QAM	1	0	12.50	12.65	12.59	2
		1	7	12.43	12.53	12.56	2
		1	14	12.36	12.52	12.56	2
		8	0	11.70	11.88	11.90	3
		8	3	11.80	11.83	11.86	3
		8	7	11.66	11.72	11.79	3
		15	0	11.80	11.86	11.87	3
3M	256QAM	1	0	10.25	10.21	10.35	5
		1	7	10.32	10.13	10.37	5
		1	14	10.15	10.18	10.19	5
		8	0	10.06	10.00	10.14	5
		8	3	10.29	10.17	10.28	5
		8	7	10.04	10.02	10.12	5
		15	0	10.08	10.16	10.13	5
BW	MCS Index	Channel		23017	23095	23173	3GPP MPR
		Frequency (MHz)		699.7	707.5	715.3	
1.4M	QPSK	1	0	14.63	14.71	14.69	0
		1	2	14.55	14.58	14.70	0
		1	5	14.41	14.52	14.59	0
		3	0	14.38	14.61	14.68	0
		3	1	14.31	14.49	14.46	0
		3	3	14.29	14.43	14.43	0
		6	0	13.31	13.46	13.41	1
1.4M	16QAM	1	0	13.58	13.84	13.79	1
		1	2	13.62	13.72	13.78	1
		1	5	13.58	13.83	13.79	1
		3	0	13.69	13.77	13.86	1
		3	1	13.52	13.77	13.72	1
		3	3	13.52	13.68	13.72	1
		6	0	12.54	12.67	12.74	2
1.4M	64QAM	1	0	12.38	12.50	12.55	2
		1	2	12.28	12.49	12.45	2
		1	5	12.25	12.40	12.52	2
		3	0	12.66	12.80	12.74	2
		3	1	12.68	12.69	12.84	2
		3	3	12.57	12.65	12.69	2
		6	0	11.73	11.80	11.75	3
1.4M	256QAM	1	0	10.23	10.22	10.34	5
		1	2	10.30	10.21	10.40	5
		1	5	10.21	10.16	10.21	5
		3	0	10.03	10.01	10.22	5
		3	1	10.24	10.23	10.31	5
		3	3	10.07	9.98	10.17	5
		6	0	10.12	10.13	10.22	5

LTE Conducted Power (Reduction_Tablet)							
LTE Band 13							
BW	MCS Index	RB Size	RB Offset	Mid		3GPP MPR (dB)	
		Channel		23230			
		Frequency (MHz)		782			
10M	QPSK	1	0		17.28		0
		1	24		17.17		0
		1	49		17.10		0
		25	0		16.32		1
		25	12		16.21		1
		25	25		16.12		1
		50	0		16.11		1
10M	16QAM	1	0		16.88		1
		1	24		16.79		1
		1	49		16.63		1
		25	0		15.95		2
		25	12		15.90		2
		25	25		15.81		2
		50	0		15.96		2
10M	64QAM	1	0		15.88		2
		1	24		15.56		2
		1	49		15.35		2
		25	0		14.59		3
		25	12		14.53		3
		25	25		14.42		3
		50	0		14.35		3
10M	256QAM	1	0		12.68		5
		1	24		12.76		5
		1	49		12.53		5
		25	0		12.42		5
		25	12		12.48		5
		25	25		12.45		5
		50	0		12.51		5
BW	MCS Index	Channel		23205	23230	23255	3GPP MPR
		Frequency (MHz)		779.5	782	784.5	
5M	QPSK	1	0	17.26	17.27	17.22	0
		1	12	17.07	17.13	17.10	0
		1	24	17.05	17.00	17.05	0
		12	0	16.22	16.22	16.28	1
		12	6	16.20	16.14	16.21	1
		12	13	16.12	16.10	16.05	1
		25	0	16.01	16.04	16.03	1
5M	16QAM	1	0	16.80	16.88	16.88	1
		1	12	16.79	16.75	16.72	1
		1	24	16.59	16.57	16.53	1
		12	0	15.86	15.95	15.87	2
		12	6	15.81	15.80	15.86	2
		12	13	15.78	15.73	15.72	2
		25	0	15.96	15.92	15.88	2
5M	64QAM	1	0	15.83	15.82	15.83	2
		1	12	15.50	15.52	15.48	2
		1	24	15.29	15.33	15.35	2
		12	0	14.53	14.52	14.51	3
		12	6	14.52	14.47	14.51	3
		12	13	14.42	14.41	14.42	3
		25	0	14.32	14.27	14.32	3
5M	256QAM	1	0	12.68	12.65	12.58	5
		1	12	12.76	12.70	12.74	5
		1	24	12.46	12.45	12.46	5
		12	0	12.34	12.39	12.41	5
		12	6	12.44	12.42	12.39	5
		12	13	12.44	12.36	12.44	5
		25	0	12.41	12.46	12.45	5

LTE Conducted Power (Reduction_Tablet)							
LTE Band 14							
BW	MCS Index	RB Size	RB Offset	Mid		3GPP MPR (dB)	
		Channel		23330			
		Frequency (MHz)		793			
10M	QPSK	1	0		17.20		0
		1	24		17.13		0
		1	49		17.04		0
		25	0		16.15		1
		25	12		16.13		1
		25	25		16.10		1
		50	0		16.12		1
10M	16QAM	1	0		16.10		1
		1	24		16.08		1
		1	49		16.07		1
		25	0		15.20		2
		25	12		15.18		2
		25	25		15.17		2
		50	0		15.16		2
10M	64QAM	1	0		15.10		2
		1	24		15.08		2
		1	49		15.05		2
		25	0		14.20		3
		25	12		14.18		3
		25	25		14.16		3
		50	0		14.14		3
10M	256QAM	1	0		12.59		5
		1	24		12.67		5
		1	49		12.50		5
		25	0		12.38		5
		25	12		12.40		5
		25	25		12.42		5
		50	0		12.47		5
BW	MCS Index	Channel		23305	23330	23355	3GPP MPR
		Frequency (MHz)		790.5	793	795.5	
5M	QPSK	1	0	17.12	17.13	17.18	0
		1	12	17.08	17.10	17.07	0
		1	24	17.02	17.03	16.95	0
		12	0	16.11	16.15	16.12	1
		12	6	16.04	16.11	16.04	1
		12	13	16.06	16.04	16.09	1
		25	0	16.06	16.10	16.07	1
5M	16QAM	1	0	16.09	16.00	16.03	1
		1	12	16.06	16.06	16.02	1
		1	24	16.00	15.97	16.03	1
		12	0	15.19	15.20	15.18	2
		12	6	15.18	15.13	15.11	2
		12	13	15.12	15.11	15.07	2
		25	0	15.10	15.11	15.11	2
5M	64QAM	1	0	15.04	15.07	15.02	2
		1	12	14.99	15.07	14.98	2
		1	24	15.01	15.01	14.97	2
		12	0	14.13	14.17	14.15	3
		12	6	14.14	14.14	14.16	3
		12	13	14.15	14.15	14.15	3
		25	0	14.08	14.05	14.13	3
5M	256QAM	1	0	12.66	12.62	12.67	5
		1	12	12.72	12.74	12.67	5
		1	24	12.46	12.50	12.43	5
		12	0	12.35	12.42	12.32	5
		12	6	12.40	12.47	12.45	5
		12	13	12.42	12.42	12.39	5
		25	0	12.46	12.49	12.44	5

LTE Conducted Power (Reduction_Tablet)							
LTE Band 17							
BW	MCS Index	RB Size	RB Offset	Low	Mid	High	3GPP MPR (dB)
		Channel		23780	23790	23800	
		Frequency (MHz)		709	710	711	
10M	QPSK	1	0	16.37	16.40	16.34	0
		1	24	16.32	16.35	16.29	0
		1	49	16.29	16.32	16.26	0
		25	0	15.20	15.23	15.17	1
		25	12	15.19	15.22	15.16	1
		25	25	15.15	15.18	15.12	1
		50	0	15.19	15.22	15.16	1
10M	16QAM	1	0	15.33	15.36	15.30	1
		1	24	15.27	15.30	15.24	1
		1	49	15.25	15.28	15.22	1
		25	0	14.33	14.36	14.30	2
		25	12	14.31	14.34	14.28	2
		25	25	14.29	14.32	14.26	2
		50	0	14.27	14.30	14.24	2
10M	64QAM	1	0	14.31	14.34	14.28	2
		1	24	14.26	14.29	14.23	2
		1	49	14.23	14.26	14.20	2
		25	0	13.31	13.34	13.28	3
		25	12	13.29	13.32	13.26	3
		25	25	13.27	13.30	13.24	3
		50	0	13.25	13.28	13.22	3
10M	256QAM	1	0	10.93	11.02	10.96	5
		1	24	10.95	11.01	11.00	5
		1	49	10.76	10.85	10.83	5
		25	0	10.61	10.79	10.69	5
		25	12	10.76	10.82	10.78	5
		25	25	10.59	10.72	10.67	5
		50	0	10.82	10.85	10.82	5
BW	MCS Index	Channel		23755	23790	23825	3GPP MPR
		Frequency (MHz)		706.5	710	713.5	
5M	QPSK	1	0	16.29	16.32	16.30	0
		1	12	16.26	16.31	16.23	0
		1	24	16.28	16.22	16.26	0
		12	0	15.16	15.22	15.12	1
		12	6	15.18	15.19	15.15	1
		12	13	15.06	15.16	15.12	1
		25	0	15.09	15.21	15.16	1
5M	16QAM	1	0	15.23	15.33	15.26	1
		1	12	15.27	15.29	15.20	1
		1	24	15.16	15.23	15.13	1
		12	0	14.33	14.35	14.28	2
		12	6	14.23	14.26	14.28	2
		12	13	14.21	14.23	14.21	2
		25	0	14.22	14.30	14.24	2
5M	64QAM	1	0	14.27	14.26	14.24	2
		1	12	14.25	14.28	14.18	2
		1	24	14.17	14.16	14.19	2
		12	0	13.26	13.32	13.28	3
		12	6	13.28	13.23	13.19	3
		12	13	13.27	13.22	13.20	3
		25	0	13.22	13.24	13.20	3
5M	256QAM	1	0	10.85	10.95	10.93	5
		1	12	10.86	10.95	11.00	5
		1	24	10.74	10.82	10.76	5
		12	0	10.58	10.78	10.66	5
		12	6	10.71	10.72	10.73	5
		12	13	10.54	10.70	10.57	5
		25	0	10.79	10.80	10.81	5

LTE Conducted Power (Reduction_Tablet)							
LTE Band 25							
BW	MCS Index	RB Size	RB Offset	Low	Mid	High	3GPP MPR (dB)
		Channel		26140	26365	26590	
		Frequency (MHz)		1860	1882.5	1905	
20M	QPSK	1	0	13.13	13.15	13.21	0
		1	50	13.05	13.07	13.13	0
		1	99	12.91	12.93	12.99	0
		50	0	11.99	12.01	12.07	1
		50	25	11.95	11.97	12.03	1
		50	50	11.85	11.87	11.93	1
		100	0	11.96	11.98	12.04	1
20M	16QAM	1	0	12.08	12.10	12.16	1
		1	50	12.06	12.08	12.14	1
		1	99	12.05	12.07	12.13	1
		50	0	11.13	11.15	11.21	2
		50	25	11.11	11.13	11.19	2
		50	50	11.08	11.10	11.16	2
		100	0	11.06	11.08	11.14	2
20M	64QAM	1	0	11.13	11.15	11.21	2
		1	50	11.11	11.13	11.19	2
		1	99	11.10	11.12	11.18	2
		50	0	10.11	10.13	10.19	3
		50	25	10.09	10.11	10.17	3
		50	50	10.08	10.10	10.16	3
		100	0	10.06	10.08	10.14	3
20M	256QAM	1	0	8.19	8.16	8.20	5
		1	50	8.15	8.19	8.01	5
		1	99	8.14	8.20	8.03	5
		50	0	8.04	8.01	7.99	5
		50	25	8.06	8.12	8.09	5
		50	50	8.09	8.12	8.02	5
		100	0	8.06	8.04	8.09	5
BW	MCS Index	Channel		26115	26365	26615	3GPP MPR
		Frequency (MHz)		1857.5	1882.5	1907.5	
15M	QPSK	1	0	13.06	13.07	13.19	0
		1	37	12.97	13.06	13.13	0
		1	74	12.82	12.85	12.97	0
		36	0	11.99	11.93	12.01	1
		36	19	11.87	11.91	12.00	1
		36	39	11.78	11.79	11.88	1
		75	0	11.93	11.93	12.01	1
15M	16QAM	1	0	12.05	12.06	12.15	1
		1	37	11.97	12.03	12.06	1
		1	74	12.01	12.06	12.05	1
		36	0	11.08	11.08	11.14	2
		36	19	11.10	11.08	11.13	2
		36	39	11.06	11.09	11.10	2
		75	0	10.98	11.02	11.11	2
15M	64QAM	1	0	11.09	11.13	11.11	2
		1	37	11.05	11.04	11.10	2
		1	74	11.04	11.08	11.13	2
		36	0	10.01	10.12	10.13	3
		36	19	10.07	10.04	10.14	3
		36	39	9.98	10.07	10.13	3
		75	0	10.03	10.04	10.09	3
15M	256QAM	1	0	8.13	8.19	8.12	5
		1	37	8.10	8.16	8.10	5
		1	74	8.10	8.16	8.12	5
		36	0	8.02	8.07	7.97	5
		36	19	8.07	8.11	8.04	5
		36	39	8.10	8.10	8.09	5
		75	0	8.00	8.13	8.05	5

LTE Conducted Power (Reduction_Tablet)							
LTE Band 25							
BW	MCS Index	Channel		26090	26365	26640	3GPP MPR
		Frequency (MHz)		1855	1882.5	1910	
10M	QPSK	1	0	13.04	13.11	13.15	0
		1	24	12.99	13.01	13.13	0
		1	49	12.88	12.85	12.90	0
		25	0	11.90	11.92	11.99	1
		25	12	11.85	11.93	12.00	1
		25	25	11.78	11.78	11.86	1
		50	0	11.96	11.98	11.94	1
10M	16QAM	1	0	12.06	12.09	12.13	1
		1	24	11.96	12.08	12.12	1
		1	49	11.96	11.99	12.11	1
		25	0	11.11	11.13	11.20	2
		25	12	11.02	11.03	11.09	2
		25	25	11.08	11.09	11.12	2
		50	0	11.00	11.00	11.13	2
10M	64QAM	1	0	11.13	11.13	11.19	2
		1	24	11.03	11.05	11.10	2
		1	49	11.05	11.06	11.08	2
		25	0	10.05	10.09	10.11	3
		25	12	10.04	10.03	10.07	3
		25	25	10.02	10.03	10.14	3
		50	0	9.98	9.99	10.11	3
10M	256QAM	1	0	8.19	8.23	8.11	5
		1	24	8.10	8.22	8.03	5
		1	49	8.14	8.17	8.04	5
		25	0	8.02	8.02	7.96	5
		25	12	8.05	8.07	8.05	5
		25	25	8.10	8.16	8.07	5
		50	0	8.05	8.10	8.04	5
BW	MCS Index	Channel		26065	26365	26665	3GPP MPR
		Frequency (MHz)		1852.5	1882.5	1912.5	
5M	QPSK	1	0	13.13	13.05	13.19	0
		1	12	13.05	13.03	13.10	0
		1	24	12.81	12.88	12.92	0
		12	0	11.94	11.98	12.02	1
		12	6	11.94	11.96	12.03	1
		12	13	11.75	11.85	11.88	1
		25	0	11.93	11.92	12.01	1
5M	16QAM	1	0	12.07	12.03	12.14	1
		1	12	11.97	12.08	12.07	1
		1	24	11.97	12.01	12.08	1
		12	0	11.13	11.05	11.15	2
		12	6	11.08	11.12	11.18	2
		12	13	11.00	11.02	11.12	2
		25	0	10.97	11.07	11.09	2
5M	64QAM	1	0	11.11	11.07	11.12	2
		1	12	11.08	11.12	11.17	2
		1	24	11.04	11.11	11.17	2
		12	0	10.07	10.10	10.13	3
		12	6	10.02	10.03	10.11	3
		12	13	10.06	10.04	10.11	3
		25	0	9.96	10.03	10.10	3
5M	256QAM	1	0	8.14	8.21	8.14	5
		1	12	8.14	8.20	8.08	5
		1	24	8.16	8.19	8.08	5
		12	0	8.02	8.08	8.03	5
		12	6	8.04	8.12	8.09	5
		12	13	8.15	8.19	8.10	5
		25	0	8.10	8.03	8.02	5

LTE Conducted Power (Reduction_Tablet)							
LTE Band 25							
BW	MCS Index	Channel		26055	26365	26675	3GPP MPR
		Frequency (MHz)		1851.5	1882.5	1913.5	
3M	QPSK	1	0	13.07	13.14	13.13	0
		1	7	12.95	12.97	13.13	0
		1	14	12.86	12.85	12.89	0
		8	0	11.97	11.94	11.97	1
		8	3	11.85	11.94	11.94	1
		8	7	11.82	11.83	11.92	1
		15	0	11.89	11.93	11.98	1
3M	16QAM	1	0	12.08	12.10	12.08	1
		1	7	12.06	11.98	12.12	1
		1	14	12.05	12.07	12.06	1
		8	0	11.11	11.14	11.13	2
		8	3	11.03	11.08	11.12	2
		8	7	11.04	11.04	11.14	2
		15	0	10.97	11.00	11.12	2
3M	64QAM	1	0	11.08	11.08	11.19	2
		1	7	11.06	11.08	11.15	2
		1	14	11.03	11.12	11.10	2
		8	0	10.04	10.08	10.09	3
		8	3	10.08	10.04	10.15	3
		8	7	9.99	10.07	10.11	3
		15	0	10.06	9.98	10.06	3
3M	256QAM	1	0	8.14	8.17	8.18	5
		1	7	8.10	8.14	8.09	5
		1	14	8.12	8.20	8.09	5
		8	0	8.00	8.09	8.00	5
		8	3	8.05	8.11	8.10	5
		8	7	8.10	8.16	8.09	5
		15	0	8.02	8.13	8.02	5
BW	MCS Index	Channel		26047	26365	26683	3GPP MPR
		Frequency (MHz)		1850.7	1882.5	1914.3	
1.4M	QPSK	1	0	12.93	13.08	13.12	0
		1	2	12.91	12.95	13.06	0
		1	5	12.82	12.88	12.81	0
		3	0	12.85	12.85	12.95	0
		3	1	12.75	12.83	12.80	0
		3	3	12.68	12.72	12.87	0
		6	0	11.83	11.91	11.90	1
1.4M	16QAM	1	0	12.02	11.93	12.00	1
		1	2	11.97	11.98	12.04	1
		1	5	11.97	11.91	11.94	1
		3	0	11.91	11.97	12.10	1
		3	1	11.98	11.99	12.02	1
		3	3	11.95	12.08	12.07	1
		6	0	10.91	11.04	11.07	2
1.4M	64QAM	1	0	11.06	11.01	11.09	2
		1	2	10.96	11.10	10.99	2
		1	5	11.00	10.95	11.13	2
		3	0	11.00	10.97	11.11	2
		3	1	10.96	10.98	11.02	2
		3	3	11.03	11.03	10.95	2
		6	0	9.93	9.99	9.98	3
1.4M	256QAM	1	0	8.15	8.22	8.13	5
		1	2	8.16	8.20	8.01	5
		1	5	8.11	8.20	8.06	5
		3	0	8.06	8.02	8.00	5
		3	1	8.13	8.13	8.09	5
		3	3	8.14	8.19	8.02	5
		6	0	8.04	8.12	8.04	5

LTE Conducted Power (Reduction_Tablet)							
LTE Band 26							
BW	MCS Index	RB Size	RB Offset	Low	Mid	High	3GPP MPR (dB)
		Channel		26765	26865	26965	
		Frequency (MHz)		821.5	831.5	841.5	
15M	QPSK	1	0	18.05	18.32	18.35	0
		1	37	17.97	18.24	18.27	0
		1	74	17.94	18.21	18.24	0
		36	0	16.96	17.23	17.26	1
		36	19	16.87	17.14	17.17	1
		36	39	16.85	17.12	17.15	1
		75	0	16.95	17.22	17.25	1
15M	16QAM	1	0	16.98	17.25	17.28	1
		1	37	16.96	17.23	17.26	1
		1	74	16.95	17.22	17.25	1
		36	0	15.98	16.25	16.28	2
		36	19	15.96	16.23	16.26	2
		36	39	15.95	16.22	16.25	2
		75	0	15.94	16.21	16.24	2
15M	64QAM	1	0	15.98	16.25	16.28	2
		1	37	15.96	16.23	16.26	2
		1	74	15.95	16.22	16.25	2
		36	0	14.94	15.21	15.24	3
		36	19	14.92	15.19	15.22	3
		36	39	14.91	15.18	15.21	3
		75	0	14.90	15.17	15.20	3
15M	256QAM	1	0	13.10	13.27	13.23	5
		1	37	13.14	13.20	13.15	5
		1	74	13.09	13.26	13.15	5
		36	0	12.92	13.13	12.98	5
		36	19	12.91	13.14	12.94	5
		36	39	13.01	13.07	13.11	5
		75	0	13.06	13.10	13.02	5
BW	MCS Index	Channel		26740	26865	26990	3GPP MPR
		Frequency (MHz)		819	831.5	844	
10M	QPSK	1	0	18.00	18.24	18.32	0
		1	24	17.89	18.17	18.18	0
		1	49	17.89	18.21	18.22	0
		25	0	16.87	17.23	17.24	1
		25	12	16.80	17.14	17.10	1
		25	25	16.76	17.12	17.11	1
		50	0	16.94	17.14	17.20	1
10M	16QAM	1	0	16.95	17.19	17.25	1
		1	24	16.90	17.17	17.26	1
		1	49	16.91	17.12	17.23	1
		25	0	15.96	16.22	16.24	2
		25	12	15.96	16.15	16.19	2
		25	25	15.87	16.16	16.16	2
		50	0	15.90	16.20	16.21	2
10M	64QAM	1	0	15.97	16.23	16.21	2
		1	24	15.95	16.23	16.21	2
		1	49	15.91	16.21	16.20	2
		25	0	14.85	15.15	15.20	3
		25	12	14.92	15.13	15.18	3
		25	25	14.90	15.15	15.14	3
		50	0	14.86	15.15	15.20	3
10M	256QAM	1	0	13.11	13.23	13.22	5
		1	24	13.12	13.23	13.15	5
		1	49	13.14	13.19	13.13	5
		25	0	12.92	13.10	12.98	5
		25	12	12.92	13.12	12.94	5
		25	25	12.94	13.05	13.02	5
		50	0	12.99	13.10	13.10	5

LTE Conducted Power (Reduction_Tablet)							
LTE Band 26							
BW	MCS Index	Channel		26715	26865	27015	3GPP MPR
		Frequency (MHz)		816.5	831.5	846.5	
5M	QPSK	1	0	18.05	18.25	18.30	0
		1	12	17.91	18.23	18.25	0
		1	24	17.85	18.15	18.18	0
		12	0	16.89	17.19	17.16	1
		12	6	16.79	17.09	17.09	1
		12	13	16.84	17.06	17.07	1
		25	0	16.93	17.15	17.17	1
5M	16QAM	1	0	16.90	17.16	17.19	1
		1	12	16.90	17.18	17.21	1
		1	24	16.90	17.12	17.23	1
		12	0	15.92	16.15	16.27	2
		12	6	15.90	16.20	16.26	2
		12	13	15.91	16.19	16.23	2
		25	0	15.85	16.17	16.24	2
5M	64QAM	1	0	15.89	16.23	16.22	2
		1	12	15.89	16.15	16.22	2
		1	24	15.95	16.17	16.19	2
		12	0	14.90	15.11	15.22	3
		12	6	14.88	15.10	15.18	3
		12	13	14.84	15.10	15.16	3
		25	0	14.85	15.11	15.12	3
5M	256QAM	1	0	13.11	13.32	13.19	5
		1	12	13.18	13.17	13.15	5
		1	24	13.11	13.19	13.13	5
		12	0	13.00	13.16	12.95	5
		12	6	12.92	13.09	12.98	5
		12	13	12.96	13.03	13.07	5
		25	0	13.00	13.16	13.08	5
BW	MCS Index	Channel		26705	26865	27025	3GPP MPR
		Frequency (MHz)		815.5	831.5	847.5	
3M	QPSK	1	0	18.04	18.31	18.26	0
		1	7	17.92	18.23	18.23	0
		1	14	17.84	18.13	18.20	0
		8	0	16.86	17.16	17.20	1
		8	3	16.86	17.14	17.11	1
		8	7	16.83	17.12	17.09	1
		15	0	16.91	17.21	17.21	1
3M	16QAM	1	0	16.90	17.23	17.21	1
		1	7	16.96	17.21	17.25	1
		1	14	16.95	17.19	17.24	1
		8	0	15.89	16.21	16.20	2
		8	3	15.91	16.16	16.18	2
		8	7	15.91	16.20	16.16	2
		15	0	15.93	16.15	16.14	2
3M	64QAM	1	0	15.88	16.15	16.26	2
		1	7	15.90	16.23	16.18	2
		1	14	15.88	16.16	16.21	2
		8	0	14.93	15.19	15.24	3
		8	3	14.92	15.11	15.13	3
		8	7	14.82	15.08	15.18	3
		15	0	14.88	15.07	15.15	3
3M	256QAM	1	0	13.14	13.23	13.21	5
		1	7	13.18	13.19	13.19	5
		1	14	13.12	13.17	13.12	5
		8	0	12.91	13.15	13.02	5
		8	3	12.93	13.10	13.01	5
		8	7	12.97	13.08	13.02	5
		15	0	13.06	13.18	13.02	5

LTE Conducted Power (Reduction_Tablet)							
LTE Band 26							
BW	MCS Index	Channel		26697	26865	27033	3GPP MPR
		Frequency (MHz)		814.7	831.5	848.3	
1.4M	QPSK	1	0	18.01	18.23	18.26	0
		1	2	17.89	18.19	18.23	0
		1	5	17.87	18.18	18.19	0
		3	0	16.87	17.21	17.23	0
		3	1	16.77	17.06	17.10	0
		3	3	16.79	17.11	17.06	0
		6	0	16.95	17.21	17.18	1
1.4M	16QAM	1	0	16.93	17.25	17.26	1
		1	2	16.92	17.18	17.26	1
		1	5	16.85	17.22	17.17	1
		3	0	15.91	16.18	16.26	1
		3	1	15.88	16.14	16.24	1
		3	3	15.93	16.19	16.25	1
		6	0	15.94	16.21	16.19	2
1.4M	64QAM	1	0	15.96	16.15	16.27	2
		1	2	15.87	16.21	16.17	2
		1	5	15.89	16.19	16.16	2
		3	0	14.94	15.20	15.14	2
		3	1	14.86	15.17	15.17	2
		3	3	14.87	15.15	15.11	2
		6	0	14.81	15.15	15.11	3
1.4M	256QAM	1	0	13.08	13.27	13.19	5
		1	2	13.16	13.26	13.17	5
		1	5	13.08	13.16	13.11	5
		3	0	12.95	13.11	12.98	5
		3	1	12.92	13.12	12.96	5
		3	3	12.97	13.06	13.02	5
		6	0	12.97	13.08	13.06	5

LTE Conducted Power (Reduction_Tablet)							
LTE Band 30							
BW	MCS Index	RB Size	RB Offset		Mid		3GPP MPR (dB)
		Channel			27710		
		Frequency (MHz)			2310		
10M	QPSK	1	0		12.44		0
		1	24		12.13		0
		1	49		12.05		0
		25	0		11.48		1
		25	12		11.45		1
		25	25		11.38		1
		50	0		11.44		1
10M	16QAM	1	0		11.46		1
		1	24		11.44		1
		1	49		11.43		1
		25	0		10.45		2
		25	12		10.43		2
		25	25		10.42		2
		50	0		10.40		2
10M	64QAM	1	0		10.46		2
		1	24		10.43		2
		1	49		10.42		2
		25	0		9.46		3
		25	12		9.44		3
		25	25		9.42		3
		50	0		9.40		3
10M	256QAM	1	0		6.79		5
		1	24		6.66		5
		1	49		6.67		5
		25	0		6.57		5
		25	12		6.61		5
		25	25		6.56		5
		50	0		6.52		5
BW	MCS Index	Channel		27685	27710	27735	3GPP MPR
		Frequency (MHz)		2307.5	2310	2312.5	
5M	QPSK	1	0	12.43	12.42	12.43	0
		1	12	12.04	12.04	12.13	0
		1	24	11.95	11.98	11.98	0
		12	0	11.42	11.44	11.42	1
		12	6	11.35	11.36	11.37	1
		12	13	11.34	11.30	11.33	1
		25	0	11.43	11.41	11.34	1
5M	16QAM	1	0	11.40	11.38	11.44	1
		1	12	11.39	11.37	11.40	1
		1	24	11.33	11.40	11.35	1
		12	0	10.38	10.43	10.44	2
		12	6	10.34	10.42	10.37	2
		12	13	10.37	10.32	10.39	2
		25	0	10.39	10.37	10.34	2
5M	64QAM	1	0	10.41	10.44	10.43	2
		1	12	10.37	10.33	10.33	2
		1	24	10.39	10.41	10.32	2
		12	0	9.46	9.44	9.37	3
		12	6	9.37	9.41	9.34	3
		12	13	9.33	9.37	9.40	3
		25	0	9.31	9.38	9.30	3
5M	256QAM	1	0	6.76	6.69	6.78	5
		1	12	6.61	6.59	6.61	5
		1	24	6.58	6.67	6.57	5
		12	0	6.53	6.52	6.56	5
		12	6	6.53	6.60	6.60	5
		12	13	6.48	6.52	6.54	5
		25	0	6.45	6.52	6.52	5

LTE Conducted Power (Reduction_Tablet)							
LTE Band 38							
BW	MCS Index	RB Size	RB Offset	Low	Mid	High	3GPP MPR (dB)
		Channel		37850	38000	38150	
		Frequency (MHz)		2580	2595	2610	
20M	QPSK	1	0	14.93	14.91	14.79	0
		1	50	14.90	14.88	14.76	0
		1	99	14.82	14.80	14.68	0
		50	0	13.90	13.88	13.76	1
		50	25	13.87	13.85	13.73	1
		50	50	13.61	13.59	13.47	1
		100	0	13.80	13.78	13.66	1
20M	16QAM	1	0	12.86	12.84	12.72	1
		1	50	12.84	12.82	12.70	1
		1	99	12.83	12.81	12.69	1
		50	0	11.89	11.87	11.75	2
		50	25	11.86	11.84	11.72	2
		50	50	11.84	11.82	11.70	2
		100	0	11.81	11.79	11.67	2
20M	64QAM	1	0	11.86	11.84	11.72	2
		1	50	11.84	11.82	11.70	2
		1	99	11.81	11.79	11.67	2
		50	0	10.89	10.87	10.75	3
		50	25	10.87	10.85	10.73	3
		50	50	10.85	10.83	10.71	3
		100	0	10.83	10.81	10.69	3
20M	256QAM	1	0	9.31	9.22	9.18	5
		1	50	9.39	9.34	9.30	5
		1	99	9.18	9.12	9.10	5
		50	0	9.42	9.39	9.36	5
		50	25	9.39	9.38	9.37	5
		50	50	9.36	9.35	9.34	5
		100	0	9.32	9.29	9.21	5
BW	MCS Index	Channel		37825	38000	38175	3GPP MPR
		Frequency (MHz)		2577.5	2595	2612.5	
15M	QPSK	1	0	14.91	14.82	14.74	0
		1	37	14.80	14.80	14.72	0
		1	74	14.76	14.73	14.58	0
		36	0	13.86	13.85	13.68	1
		36	19	13.80	13.76	13.72	1
		36	39	13.55	13.58	13.46	1
		75	0	13.72	13.75	13.62	1
15M	16QAM	1	0	12.80	12.82	12.65	1
		1	37	12.79	12.80	12.64	1
		1	74	12.75	12.80	12.69	1
		36	0	11.88	11.84	11.75	2
		36	19	11.85	11.76	11.66	2
		36	39	11.78	11.73	11.63	2
		75	0	11.74	11.70	11.58	2
15M	64QAM	1	0	11.78	11.74	11.71	2
		1	37	11.77	11.74	11.69	2
		1	74	11.78	11.77	11.57	2
		36	0	10.80	10.77	10.66	3
		36	19	10.79	10.81	10.68	3
		36	39	10.82	10.82	10.63	3
		75	0	10.81	10.74	10.59	3
15M	256QAM	1	0	9.26	9.20	9.13	5
		1	37	9.32	9.25	9.24	5
		1	74	9.12	9.02	9.02	5
		36	0	9.35	9.29	9.33	5
		36	19	9.31	9.28	9.34	5
		36	39	9.26	9.34	9.28	5
		75	0	9.26	9.19	9.19	5

LTE Conducted Power (Reduction_Tablet)							
LTE Band 38							
BW	MCS Index	Channel		37800	38000	38200	3GPP MPR
		Frequency (MHz)		2575	2595	2615	
10M	QPSK	1	0	14.88	14.83	14.76	0
		1	24	14.86	14.78	14.67	0
		1	49	14.78	14.74	14.65	0
		25	0	13.87	13.79	13.67	1
		25	12	13.77	13.77	13.71	1
		25	25	13.57	13.59	13.40	1
		50	0	13.79	13.73	13.65	1
10M	16QAM	1	0	12.77	12.77	12.71	1
		1	24	12.74	12.81	12.68	1
		1	49	12.76	12.74	12.68	1
		25	0	11.89	11.87	11.73	2
		25	12	11.78	11.81	11.66	2
		25	25	11.76	11.79	11.68	2
		50	0	11.81	11.77	11.59	2
10M	64QAM	1	0	11.86	11.84	11.67	2
		1	24	11.76	11.72	11.60	2
		1	49	11.75	11.79	11.66	2
		25	0	10.85	10.79	10.67	3
		25	12	10.77	10.85	10.67	3
		25	25	10.82	10.81	10.63	3
		50	0	10.78	10.73	10.68	3
10M	256QAM	1	0	9.27	9.22	9.14	5
		1	24	9.33	9.24	9.30	5
		1	49	9.13	9.11	9.05	5
		25	0	9.32	9.36	9.36	5
		25	12	9.36	9.28	9.27	5
		25	25	9.34	9.26	9.29	5
		50	0	9.30	9.20	9.18	5
BW	MCS Index	Channel		37775	38000	38225	3GPP MPR
		Frequency (MHz)		2572.5	2595	2617.5	
5M	QPSK	1	0	14.87	14.85	14.79	0
		1	12	14.85	14.85	14.72	0
		1	24	14.73	14.77	14.66	0
		12	0	13.80	13.88	13.69	1
		12	6	13.81	13.75	13.65	1
		12	13	13.51	13.50	13.46	1
		25	0	13.76	13.71	13.66	1
5M	16QAM	1	0	12.82	12.75	12.67	1
		1	12	12.79	12.82	12.61	1
		1	24	12.83	12.80	12.64	1
		12	0	11.88	11.80	11.73	2
		12	6	11.80	11.80	11.64	2
		12	13	11.77	11.75	11.62	2
		25	0	11.78	11.79	11.58	2
5M	64QAM	1	0	11.81	11.82	11.62	2
		1	12	11.80	11.72	11.65	2
		1	24	11.78	11.79	11.67	2
		12	0	10.80	10.87	10.75	3
		12	6	10.83	10.84	10.71	3
		12	13	10.83	10.76	10.70	3
		25	0	10.81	10.77	10.65	3
5M	256QAM	1	0	9.25	9.21	9.12	5
		1	12	9.36	9.29	9.24	5
		1	24	9.08	9.04	9.03	5
		12	0	9.34	9.34	9.27	5
		12	6	9.38	9.37	9.31	5
		12	13	9.33	9.34	9.33	5
		25	0	9.23	9.23	9.11	5

LTE Conducted Power (Reduction_Tablet)							
LTE Band 40							
BW	MCS Index	RB Size	RB Offset	Low	Mid	Mid	3GPP MPR (dB)
		Channel		38750	39150	39550	
		Frequency (MHz)		2310	2350	2390	
20M	QPSK	1	0	15.91	15.95	15.65	0
		1	50	15.89	15.93	15.63	0
		1	99	15.62	15.66	15.36	0
		50	0	14.77	14.81	14.51	1
		50	25	14.73	14.77	14.47	1
		50	50	14.71	14.75	14.45	1
		100	0	14.76	14.80	14.50	1
20M	16QAM	1	0	14.84	14.88	14.58	1
		1	50	14.82	14.86	14.56	1
		1	99	14.79	14.83	14.53	1
		50	0	13.96	14.00	13.70	2
		50	25	13.94	13.98	13.68	2
		50	50	13.93	13.97	13.67	2
		100	0	13.91	13.95	13.65	2
20M	64QAM	1	0	13.84	13.88	13.58	2
		1	50	13.82	13.86	13.56	2
		1	99	13.79	13.83	13.53	2
		50	0	12.95	12.99	12.69	3
		50	25	12.94	12.98	12.68	3
		50	50	12.92	12.96	12.66	3
		100	0	12.91	12.95	12.65	3
20M	256QAM	1	0	10.67	10.68	10.57	5
		1	50	10.57	10.66	10.51	5
		1	99	10.45	10.52	10.41	5
		50	0	10.84	10.88	10.74	5
		50	25	10.81	10.86	10.78	5
		50	50	10.69	10.79	10.63	5
		100	0	10.74	10.78	10.67	5
BW	MCS Index	Channel		38725	39150	39575	3GPP MPR
		Frequency (MHz)		2307.5	2350	2392.5	
15M	QPSK	1	0	15.86	15.91	15.56	0
		1	37	15.83	15.89	15.62	0
		1	74	15.52	15.62	15.26	0
		36	0	14.76	14.80	14.51	1
		36	19	14.73	14.72	14.47	1
		36	39	14.70	14.69	14.44	1
		75	0	14.75	14.74	14.45	1
15M	16QAM	1	0	14.81	14.84	14.52	1
		1	37	14.82	14.80	14.49	1
		1	74	14.71	14.76	14.53	1
		36	0	13.89	13.91	13.61	2
		36	19	13.94	13.93	13.65	2
		36	39	13.85	13.97	13.61	2
		75	0	13.82	13.91	13.62	2
15M	64QAM	1	0	13.76	13.87	13.53	2
		1	37	13.75	13.79	13.51	2
		1	74	13.72	13.80	13.43	2
		36	0	12.85	12.94	12.60	3
		36	19	12.91	12.94	12.68	3
		36	39	12.86	12.94	12.66	3
		75	0	12.86	12.93	12.62	3
15M	256QAM	1	0	10.65	10.61	10.50	5
		1	37	10.52	10.63	10.49	5
		1	74	10.37	10.49	10.40	5
		36	0	10.83	10.87	10.71	5
		36	19	10.79	10.85	10.75	5
		36	39	10.65	10.77	10.59	5
		75	0	10.67	10.77	10.64	5

LTE Conducted Power (Reduction_Tablet)							
LTE Band 40							
BW	MCS Index	Channel		38700	39150	39600	3GPP MPR
		Frequency (MHz)		2305	2350	2395	
10M	QPSK	1	0	15.83	15.86	15.65	0
		1	24	15.89	15.84	15.58	0
		1	49	15.57	15.61	15.30	0
		25	0	14.72	14.79	14.50	1
		25	12	14.72	14.71	14.37	1
		25	25	14.61	14.75	14.41	1
		50	0	14.75	14.74	14.45	1
10M	16QAM	1	0	14.74	14.82	14.52	1
		1	24	14.76	14.86	14.53	1
		1	49	14.79	14.76	14.46	1
		25	0	13.90	13.92	13.60	2
		25	12	13.94	13.88	13.68	2
		25	25	13.89	13.93	13.61	2
		50	0	13.90	13.86	13.56	2
10M	64QAM	1	0	13.84	13.84	13.50	2
		1	24	13.80	13.85	13.53	2
		1	49	13.75	13.73	13.44	2
		25	0	12.92	12.91	12.59	3
		25	12	12.86	12.94	12.58	3
		25	25	12.91	12.93	12.61	3
		50	0	12.87	12.92	12.64	3
10M	256QAM	1	0	10.67	10.67	10.48	5
		1	24	10.49	10.59	10.41	5
		1	49	10.45	10.48	10.39	5
		25	0	10.84	10.84	10.74	5
		25	12	10.73	10.80	10.75	5
		25	25	10.67	10.70	10.60	5
		50	0	10.70	10.70	10.63	5
BW	MCS Index	Channel		38675	39150	39625	3GPP MPR
		Frequency (MHz)		2302.5	2350	2397.5	
5M	QPSK	1	0	15.89	15.94	15.65	0
		1	12	15.86	15.86	15.62	0
		1	24	15.58	15.56	15.33	0
		12	0	14.70	14.80	14.47	1
		12	6	14.64	14.70	14.43	1
		12	13	14.61	14.72	14.39	1
		25	0	14.68	14.71	14.43	1
5M	16QAM	1	0	14.74	14.83	14.58	1
		1	12	14.80	14.77	14.51	1
		1	24	14.72	14.77	14.46	1
		12	0	13.96	13.96	13.65	2
		12	6	13.89	13.91	13.62	2
		12	13	13.93	13.91	13.63	2
		25	0	13.82	13.94	13.56	2
5M	64QAM	1	0	13.83	13.81	13.54	2
		1	12	13.81	13.84	13.49	2
		1	24	13.77	13.82	13.51	2
		12	0	12.92	12.97	12.65	3
		12	6	12.93	12.95	12.66	3
		12	13	12.83	12.92	12.63	3
		25	0	12.91	12.85	12.55	3
5M	256QAM	1	0	10.63	10.64	10.57	5
		1	12	10.48	10.60	10.42	5
		1	24	10.37	10.50	10.35	5
		12	0	10.84	10.83	10.66	5
		12	6	10.81	10.83	10.68	5
		12	13	10.66	10.79	10.62	5
		25	0	10.64	10.76	10.60	5

LTE Conducted Power (Reduction_Tablet)										
LTE Band 41										
BW	MCS Index	RB Size	RB Offset	Low	Low	Mid	Mid	Mid	High	3GPP MPR (dB)
		Channel		39790	39750	40185	40620	41055	41490	
		Frequency (MHz)		2510	2506	2549.5	2593	2636.5	2680	
20M	QPSK	1	0	18.48	18.51	18.18	18.45	18.71	18.51	0
		1	50	18.38	18.40	18.08	18.35	18.61	18.41	0
		1	99	18.30	18.32	18.00	18.27	18.53	18.33	0
		50	0	17.39	17.41	17.09	17.36	17.62	17.42	1
		50	25	17.36	17.38	17.06	17.33	17.59	17.39	1
		50	50	17.32	17.34	17.02	17.29	17.55	17.35	1
		100	0	17.30	17.32	17.00	17.27	17.53	17.33	1
20M	16QAM	1	0	16.37	16.39	16.07	16.34	16.60	16.40	1
		1	50	16.02	16.04	16.02	16.09	16.25	16.05	1
		1	99	16.27	16.29	16.07	16.24	16.20	16.10	1
		50	0	15.37	15.39	15.17	15.34	15.60	15.40	2
		50	25	15.26	15.28	15.06	15.23	15.49	15.29	2
		50	50	15.16	15.18	15.06	15.13	15.39	15.19	2
		100	0	15.29	15.31	15.09	15.26	15.52	15.32	2
20M	64QAM	1	0	15.18	15.20	15.08	15.15	15.41	15.21	2
		1	50	15.10	15.12	15.10	15.07	15.03	15.03	2
		1	99	15.09	15.11	15.09	15.06	15.02	15.02	2
		50	0	14.39	14.41	14.19	14.36	14.62	14.42	3
		50	25	14.36	14.38	14.16	14.33	14.59	14.39	3
		50	50	14.28	14.30	14.08	14.25	14.51	14.31	3
		100	0	14.39	14.41	14.19	14.36	14.62	14.42	3
20M	256QAM	1	0	13.65	13.73	13.75	13.81	13.88	13.76	5
		1	50	13.72	13.72	13.73	13.84	13.84	13.82	5
		1	99	13.74	13.74	13.77	13.83	13.91	13.79	5
		50	0	13.73	13.81	13.81	13.89	13.95	13.82	5
		50	25	13.56	13.63	13.67	13.78	13.88	13.77	5
		50	50	13.62	13.64	13.74	13.85	13.85	13.80	5
		100	0	13.57	13.59	13.61	13.74	13.84	13.65	5
BW	MCS Index	Channel		39765	39725	40173	40620	41068	41515	3GPP MPR
		Frequency (MHz)		2507.5	2503.5	2548.3	2593	2637.8	2682.5	
15M	QPSK	1	0	18.36	18.62	18.41	18.40	18.68	18.42	0
		1	37	18.35	18.51	18.41	18.35	18.55	18.36	0
		1	74	18.22	18.48	18.27	18.18	18.46	18.29	0
		36	0	17.31	17.52	17.38	17.35	17.53	17.41	1
		36	19	17.23	17.59	17.30	17.27	17.51	17.30	1
		36	39	17.21	17.48	17.32	17.20	17.55	17.33	1
		75	0	17.26	17.52	17.23	17.25	17.43	17.28	1
15M	16QAM	1	0	16.32	16.53	16.36	16.31	16.51	16.40	1
		1	37	16.01	16.15	16.05	16.06	16.21	16.02	1
		1	74	16.16	16.11	16.03	16.21	16.14	16.06	1
		36	0	15.33	15.52	15.33	15.26	15.59	15.40	2
		36	19	15.17	15.47	15.27	15.18	15.41	15.19	2
		36	39	15.13	15.31	15.12	15.12	15.34	15.18	2
		75	0	15.19	15.45	15.28	15.18	15.51	15.23	2
15M	64QAM	1	0	15.09	15.34	15.12	15.15	15.38	15.11	2
		1	37	15.15	15.11	15.06	15.16	15.08	15.07	2
		1	74	15.06	15.05	15.06	15.10	15.07	15.05	2
		36	0	14.34	14.58	14.39	14.35	14.60	14.40	3
		36	19	14.29	14.49	14.31	14.27	14.55	14.29	3
		36	39	14.25	14.51	14.31	14.24	14.51	14.30	3
		75	0	14.32	14.54	14.34	14.33	14.59	14.38	3
15M	256QAM	1	0	13.77	13.81	13.69	13.74	13.88	13.68	5
		1	37	13.79	13.78	13.76	13.83	13.76	13.74	5
		1	74	13.79	13.88	13.73	13.76	13.83	13.70	5
		36	0	13.79	13.94	13.77	13.84	13.86	13.76	5
		36	19	13.77	13.88	13.70	13.74	13.78	13.68	5
		36	39	13.78	13.78	13.73	13.84	13.75	13.74	5
		75	0	13.67	13.75	13.60	13.68	13.79	13.58	5

LTE Conducted Power (Reduction_Tablet)										
LTE Band 41										
BW	MCS Index	Channel		39740	39700	40160	40620	41080	41540	3GPP MPR
		Frequency (MHz)		2505	2501	2547	2593	2639	2685	
10M	QPSK	1	0	18.37	18.61	18.42	18.39	18.70	18.42	0
		1	24	18.35	18.57	18.38	18.25	18.60	18.35	0
		1	49	18.26	18.51	18.28	18.18	18.50	18.24	0
		25	0	17.30	17.56	17.42	17.33	17.52	17.35	1
		25	12	17.24	17.57	17.34	17.28	17.57	17.36	1
		25	25	17.20	17.45	17.29	17.27	17.49	17.27	1
		50	0	17.22	17.43	17.28	17.17	17.43	17.32	1
10M	16QAM	1	0	16.26	16.59	16.36	16.33	16.59	16.32	1
		1	24	16.02	16.18	16.05	16.07	16.24	16.01	1
		1	49	16.21	16.13	16.02	16.19	16.13	16.01	1
		25	0	15.31	15.50	15.38	15.28	15.52	15.39	2
		25	12	15.22	15.49	15.26	15.18	15.39	15.29	2
		25	25	15.08	15.29	15.09	15.09	15.30	15.18	2
		50	0	15.24	15.47	15.29	15.25	15.51	15.26	2
10M	64QAM	1	0	15.09	15.31	15.18	15.11	15.39	15.14	2
		1	24	15.10	15.08	15.12	15.13	15.10	15.04	2
		1	49	15.13	15.05	15.08	15.09	15.07	15.10	2
		25	0	14.29	14.62	14.36	14.36	14.61	14.34	3
		25	12	14.23	14.53	14.32	14.32	14.55	14.35	3
		25	25	14.15	14.42	14.29	14.20	14.48	14.22	3
		50	0	14.33	14.61	14.38	14.27	14.59	14.32	3
10M	256QAM	1	0	13.74	13.87	13.76	13.77	13.88	13.72	5
		1	24	13.79	13.77	13.75	13.82	13.81	13.73	5
		1	49	13.75	13.84	13.70	13.80	13.83	13.72	5
		25	0	13.81	13.88	13.74	13.82	13.91	13.78	5
		25	12	13.75	13.79	13.73	13.69	13.82	13.71	5
		25	25	13.85	13.78	13.75	13.83	13.82	13.75	5
		50	0	13.64	13.82	13.61	13.68	13.81	13.62	5
BW	MCS Index	Channel		39715	39675	40148	40620	41093	41565	3GPP MPR
		Frequency (MHz)		2502.5	2498.5	2545.8	2593	2640.3	2687.5	
5M	QPSK	1	0	18.38	18.70	18.41	18.44	18.62	18.46	0
		1	12	18.25	18.61	18.33	18.26	18.56	18.31	0
		1	24	18.27	18.49	18.23	18.24	18.44	18.32	0
		12	0	17.28	17.52	17.42	17.28	17.55	17.33	1
		12	6	17.28	17.58	17.36	17.32	17.55	17.31	1
		12	13	17.23	17.48	17.27	17.23	17.52	17.29	1
		25	0	17.24	17.53	17.23	17.23	17.51	17.23	1
5M	16QAM	1	0	16.28	16.58	16.40	16.25	16.60	16.39	1
		1	12	16.05	16.25	16.09	16.05	16.18	16.07	1
		1	24	16.20	16.17	16.01	16.18	16.19	16.09	1
		12	0	15.27	15.58	15.38	15.25	15.53	15.40	2
		12	6	15.22	15.47	15.20	15.20	15.44	15.29	2
		12	13	15.11	15.34	15.15	15.12	15.32	15.12	2
		25	0	15.26	15.46	15.26	15.21	15.45	15.31	2
5M	64QAM	1	0	15.08	15.39	15.18	15.14	15.38	15.20	2
		1	12	15.03	15.03	15.04	15.07	15.02	15.03	2
		1	24	15.06	15.09	15.25	15.06	15.03	15.03	2
		12	0	14.36	14.60	14.32	14.36	14.59	14.42	3
		12	6	14.31	14.57	14.34	14.23	14.49	14.30	3
		12	13	14.22	14.51	14.21	14.24	14.48	14.30	3
		25	0	14.26	14.62	14.36	14.33	14.57	14.42	3
5M	256QAM	1	0	13.77	13.87	13.76	13.74	13.86	13.71	5
		1	12	13.84	13.84	13.73	13.79	13.74	13.72	5
		1	24	13.82	13.81	13.78	13.79	13.83	13.70	5
		12	0	13.89	13.95	13.77	13.87	13.88	13.74	5
		12	6	13.71	13.85	13.71	13.75	13.81	13.73	5
		12	13	13.78	13.77	13.71	13.83	13.84	13.74	5
		25	0	13.64	13.83	13.60	13.65	13.77	13.65	5

LTE Conducted Power (Reduction_Tablet)								
LTE Band 48								
BW	MCS Index	RB Size	RB Offset	Low	Mid	Mid	Mid	3GPP MPR (dB)
		Channel		55340	55780	56210	56640	
		Frequency (MHz)		3560	3603	3647	3690	
20M	QPSK	1	0	11.08	11.02	11.14	11.40	0
		1	50	11.06	10.98	11.12	11.38	0
		1	99	10.99	10.91	11.07	11.37	0
		50	0	10.22	10.14	10.40	10.45	1
		50	25	10.13	10.05	10.31	9.41	1
		50	50	10.10	10.02	10.28	9.38	1
		100	0	10.19	10.11	10.37	10.47	1
20M	16QAM	1	0	10.01	9.93	10.19	10.39	1
		1	50	10.00	9.92	10.18	10.38	1
		1	99	9.98	9.90	10.16	10.36	1
		50	0	9.04	8.96	9.22	9.42	2
		50	25	8.03	7.95	8.21	8.41	2
		50	50	9.00	8.92	9.18	9.38	2
		100	0	8.98	8.90	9.16	9.36	2
20M	64QAM	1	0	8.53	8.45	8.71	8.91	2
		1	50	8.52	8.44	8.70	8.90	2
		1	99	8.50	8.42	8.68	8.88	2
		50	0	7.95	7.87	8.13	8.33	3
		50	25	7.94	7.86	8.12	8.32	3
		50	50	7.93	7.85	8.11	8.31	3
		100	0	7.92	7.84	8.10	8.30	3
20M	256QAM	1	0	6.22	6.21	6.28	6.21	5
		1	50	6.10	6.23	6.15	6.21	5
		1	99	6.10	6.07	6.09	6.10	5
		50	0	6.45	6.42	6.34	6.43	5
		50	25	6.35	6.44	6.28	6.47	5
		50	50	6.37	6.35	6.35	6.35	5
		100	0	6.28	6.41	6.23	6.37	5
BW	MCS Index	Channel		55315	55765	56215	56665	3GPP MPR
		Frequency (MHz)		3557.5	3602.5	3647.5	3692.5	
15M	QPSK	1	0	11.33	10.99	11.21	11.26	0
		1	37	11.31	10.94	11.21	11.21	0
		1	74	11.32	10.88	11.07	11.20	0
		36	0	10.38	10.07	10.32	10.35	1
		36	19	9.41	9.97	10.21	9.40	1
		36	39	9.34	9.95	10.23	9.33	1
		75	0	10.42	10.01	10.28	10.37	1
15M	16QAM	1	0	10.31	9.87	10.15	10.30	1
		1	37	10.31	9.92	10.10	10.33	1
		1	74	10.26	9.81	10.07	10.26	1
		36	0	9.33	8.88	9.18	9.33	2
		36	19	8.37	7.86	8.13	8.31	2
		36	39	9.33	8.86	9.08	9.35	2
		75	0	9.27	8.88	9.16	9.27	2
15M	64QAM	1	0	8.81	8.44	8.71	8.91	2
		1	37	8.81	8.40	8.70	8.81	2
		1	74	8.80	8.36	8.61	8.80	2
		36	0	8.28	7.85	8.10	8.27	3
		36	19	8.27	7.79	8.08	8.24	3
		36	39	8.24	7.76	8.04	8.31	3
		75	0	8.27	7.83	8.06	8.28	3
15M	256QAM	1	0	6.23	6.27	6.24	6.20	5
		1	37	6.12	6.25	6.12	6.16	5
		1	74	6.07	6.09	6.00	6.02	5
		36	0	6.44	6.38	6.30	6.31	5
		36	19	6.36	6.47	6.26	6.30	5
		36	39	6.34	6.43	6.32	6.29	5
		75	0	6.27	6.33	6.19	6.26	5

LTE Conducted Power (Reduction_Tablet)								
LTE Band 48								
BW	MCS Index	Channel		55290	55750	56220	56690	3GPP MPR
		Frequency (MHz)		3555	3601	3648	3695	
10M	QPSK	1	0	11.27	10.98	11.21	11.27	0
		1	24	11.30	10.86	11.05	11.24	0
		1	49	11.17	10.77	11.02	11.24	0
		25	0	10.38	10.13	10.34	10.42	1
		25	12	9.41	10.05	10.22	9.35	1
		25	25	9.28	9.93	10.20	9.29	1
		50	0	10.39	10.08	10.27	10.38	1
10M	16QAM	1	0	10.38	9.83	10.17	10.33	1
		1	24	10.36	9.91	10.18	10.34	1
		1	49	10.29	9.82	10.09	10.27	1
		25	0	9.39	8.92	9.19	9.35	2
		25	12	8.38	7.89	8.21	8.31	2
		25	25	9.30	8.88	9.15	9.35	2
		50	0	9.26	8.88	9.11	9.31	2
10M	64QAM	1	0	8.83	8.38	8.61	8.88	2
		1	24	8.80	8.39	8.64	8.89	2
		1	49	8.80	8.35	8.63	8.87	2
		25	0	8.23	7.83	8.12	8.27	3
		25	12	8.32	7.80	8.02	8.23	3
		25	25	8.24	7.83	8.02	8.31	3
		50	0	8.23	7.80	8.04	8.27	3
10M	256QAM	1	0	6.27	6.31	6.28	6.26	5
		1	24	6.13	6.23	6.21	6.20	5
		1	49	6.10	6.11	6.09	6.03	5
		25	0	6.45	6.41	6.30	6.39	5
		25	12	6.36	6.44	6.24	6.26	5
		25	25	6.36	6.37	6.36	6.34	5
		50	0	6.29	6.41	6.28	6.28	5
BW	MCS Index	Channel		55265	55745	56235	56715	3GPP MPR
		Frequency (MHz)		3552.5	3600.5	3649.5	3697.5	
5M	QPSK	1	0	11.29	10.95	11.17	11.34	0
		1	12	11.26	10.84	11.06	11.28	0
		1	24	11.19	10.70	10.98	11.20	0
		12	0	10.45	10.06	10.37	10.45	1
		12	6	9.32	9.96	10.25	9.35	1
		12	13	9.28	9.99	10.20	9.28	1
		25	0	10.37	10.08	10.33	10.41	1
5M	16QAM	1	0	10.33	9.93	10.18	10.30	1
		1	12	10.35	9.85	10.09	10.37	1
		1	24	10.27	9.84	10.06	10.32	1
		12	0	9.42	8.95	9.22	9.35	2
		12	6	8.40	7.91	8.14	8.35	2
		12	13	9.37	8.89	9.16	9.29	2
		25	0	9.28	8.84	9.09	9.34	2
5M	64QAM	1	0	8.85	8.45	8.70	8.86	2
		1	12	8.82	8.35	8.64	8.87	2
		1	24	8.78	8.32	8.62	8.86	2
		12	0	8.24	7.84	8.05	8.31	3
		12	6	8.25	7.79	8.02	8.23	3
		12	13	8.22	7.79	8.06	8.26	3
		25	0	8.29	7.79	8.04	8.25	3
5M	256QAM	1	0	6.28	6.21	6.30	6.29	5
		1	12	6.09	6.21	6.21	6.16	5
		1	24	6.03	6.10	6.08	6.08	5
		12	0	6.43	6.43	6.35	6.32	5
		12	6	6.41	6.47	6.32	6.32	5
		12	13	6.43	6.35	6.28	6.34	5
		25	0	6.27	6.37	6.27	6.24	5

LTE Conducted Power (Reduction_Tablet)							
LTE Band 66							
BW	MCS Index	RB Size	RB Offset	Low	Mid	High	3GPP MPR (dB)
		Channel		132072	132322	132572	
		Frequency (MHz)		1720	1745	1770	
20M	QPSK	1	0	13.36	13.41	13.11	0
		1	50	13.00	13.18	13.10	0
		1	99	12.98	13.16	13.08	0
		50	0	12.00	12.18	12.10	1
		50	25	11.92	12.10	12.02	1
		50	50	11.90	12.08	12.00	1
		100	0	11.97	12.15	12.07	1
20M	16QAM	1	0	11.98	12.16	12.08	1
		1	50	11.96	12.14	12.06	1
		1	99	11.95	12.13	12.05	1
		50	0	10.95	11.13	11.05	2
		50	25	10.92	11.10	11.02	2
		50	50	10.91	11.09	11.01	2
		100	0	10.85	11.03	10.95	2
20M	64QAM	1	0	10.98	11.16	11.08	2
		1	50	10.95	11.13	11.05	2
		1	99	10.92	11.10	11.02	2
		50	0	9.94	10.12	10.04	3
		50	25	9.93	10.11	10.03	3
		50	50	9.91	10.09	10.01	3
		100	0	9.84	10.02	9.94	3
20M	256QAM	1	0	8.14	8.20	8.19	5
		1	50	8.15	8.16	8.11	5
		1	99	8.13	8.15	8.09	5
		50	0	8.09	8.09	8.01	5
		50	25	8.07	8.09	8.11	5
		50	50	8.17	8.12	8.10	5
		100	0	8.00	8.12	8.09	5
BW	MCS Index	Channel		132047	132322	132597	3GPP MPR
		Frequency (MHz)		1717.5	1745	1772.5	
15M	QPSK	1	0	13.03	13.22	13.10	0
		1	37	13.00	13.09	13.10	0
		1	74	12.90	13.06	12.99	0
		36	0	11.92	12.09	12.08	1
		36	19	11.82	12.03	11.95	1
		36	39	11.84	12.06	11.96	1
		75	0	11.91	12.05	12.07	1
15M	16QAM	1	0	11.94	12.14	11.98	1
		1	37	11.89	12.04	12.05	1
		1	74	11.95	12.03	12.00	1
		36	0	10.88	11.12	11.04	2
		36	19	10.90	11.04	10.93	2
		36	39	10.88	11.09	10.92	2
		75	0	10.82	11.01	10.85	2
15M	64QAM	1	0	10.97	11.07	11.06	2
		1	37	10.88	11.12	10.96	2
		1	74	10.88	11.03	10.96	2
		36	0	9.86	10.12	9.98	3
		36	19	9.86	10.02	9.97	3
		36	39	9.84	10.05	9.93	3
		75	0	9.82	9.95	9.93	3
15M	256QAM	1	0	8.13	8.26	8.18	5
		1	37	8.14	8.17	8.09	5
		1	74	8.15	8.17	8.07	5
		36	0	8.02	8.01	7.94	5
		36	19	8.11	8.17	8.06	5
		36	39	8.10	8.15	8.02	5
		75	0	8.09	8.10	8.02	5

LTE Conducted Power (Reduction_Tablet)							
LTE Band 66							
BW	MCS Index	Channel		132022	132322	132622	3GPP MPR
		Frequency (MHz)		1715	1745	1775	
10M	QPSK	1	0	13.02	13.17	13.14	0
		1	24	12.91	13.12	13.09	0
		1	49	12.97	13.10	13.04	0
		25	0	11.99	12.08	12.02	1
		25	12	11.85	12.09	12.00	1
		25	25	11.90	11.99	11.93	1
		50	0	11.97	12.08	12.07	1
10M	16QAM	1	0	11.93	12.14	12.06	1
		1	24	11.88	12.04	12.04	1
		1	49	11.91	12.10	12.05	1
		25	0	10.93	11.09	11.02	2
		25	12	10.85	11.07	10.98	2
		25	25	10.90	11.01	10.99	2
		50	0	10.78	10.98	10.94	2
10M	64QAM	1	0	10.89	11.11	11.06	2
		1	24	10.87	11.05	10.95	2
		1	49	10.88	11.08	10.92	2
		25	0	9.91	10.04	9.94	3
		25	12	9.85	10.03	9.97	3
		25	25	9.91	10.05	9.94	3
		50	0	9.79	10.00	9.90	3
10M	256QAM	1	0	8.15	8.18	8.10	5
		1	24	8.10	8.15	8.03	5
		1	49	8.19	8.16	8.03	5
		25	0	8.02	8.03	8.01	5
		25	12	8.11	8.08	8.06	5
		25	25	8.16	8.17	8.09	5
		50	0	8.10	8.06	8.05	5
BW	MCS Index	Channel		131997	132322	132647	3GPP MPR
		Frequency (MHz)		1712.5	1745	1777.5	
5M	QPSK	1	0	13.03	13.21	13.10	0
		1	12	13.00	13.16	13.04	0
		1	24	12.98	13.07	13.04	0
		12	0	11.97	12.12	12.01	1
		12	6	11.89	12.09	11.94	1
		12	13	11.89	11.98	11.97	1
		25	0	11.96	12.05	11.98	1
5M	16QAM	1	0	11.89	12.13	12.02	1
		1	12	11.95	12.07	12.04	1
		1	24	11.94	12.08	11.99	1
		12	0	10.86	11.10	10.97	2
		12	6	10.83	11.10	11.00	2
		12	13	10.81	11.03	10.91	2
		25	0	10.76	10.93	10.95	2
5M	64QAM	1	0	10.88	11.08	11.07	2
		1	12	10.92	11.05	10.97	2
		1	24	10.84	11.03	11.01	2
		12	0	9.84	10.02	9.96	3
		12	6	9.86	10.08	10.00	3
		12	13	9.87	10.01	9.93	3
		25	0	9.75	10.02	9.91	3
5M	256QAM	1	0	8.21	8.26	8.19	5
		1	12	8.15	8.13	8.11	5
		1	24	8.17	8.18	8.09	5
		12	0	8.05	8.03	7.94	5
		12	6	8.10	8.09	8.04	5
		12	13	8.14	8.16	8.01	5
		25	0	8.10	8.05	8.06	5

LTE Conducted Power (Reduction_Tablet)							
LTE Band 66							
BW	MCS Index	Channel		131987	132322	132657	3GPP MPR
		Frequency (MHz)		1711.5	1745	1778.5	
3M	QPSK	1	0	13.03	13.17	13.13	0
		1	7	12.94	13.17	13.10	0
		1	14	12.93	13.15	13.08	0
		8	0	11.94	12.13	12.03	1
		8	3	11.86	12.01	11.99	1
		8	7	11.81	12.08	11.97	1
		15	0	11.95	12.14	11.97	1
3M	16QAM	1	0	11.89	12.16	12.06	1
		1	7	11.91	12.14	11.98	1
		1	14	11.86	12.05	12.04	1
		8	0	10.92	11.11	10.96	2
		8	3	10.84	11.08	10.97	2
		8	7	10.86	11.03	11.01	2
		15	0	10.84	10.95	10.85	2
3M	64QAM	1	0	10.98	11.09	11.07	2
		1	7	10.87	11.10	10.98	2
		1	14	10.82	11.02	10.99	2
		8	0	9.88	10.10	9.95	3
		8	3	9.88	10.02	10.02	3
		8	7	9.90	9.99	9.98	3
		15	0	9.81	9.96	9.84	3
3M	256QAM	1	0	8.17	8.22	8.19	5
		1	7	8.11	8.21	8.07	5
		1	14	8.17	8.15	8.12	5
		8	0	8.06	8.05	7.97	5
		8	3	8.07	8.15	8.03	5
		8	7	8.13	8.09	8.10	5
		15	0	8.10	8.03	8.03	5
BW	MCS Index	Channel		131979	132322	132665	3GPP MPR
		Frequency (MHz)		1710.7	1745	1779.3	
1.4M	QPSK	1	0	12.88	13.05	13.02	0
		1	2	12.99	12.97	13.08	0
		1	5	12.87	13.03	12.93	0
		3	0	12.88	13.05	12.97	0
		3	1	12.71	12.91	12.92	0
		3	3	12.74	12.90	12.78	0
		6	0	11.96	12.11	11.86	1
1.4M	16QAM	1	0	11.80	11.98	11.89	1
		1	2	11.87	12.11	11.90	1
		1	5	11.79	11.96	11.96	1
		3	0	11.85	12.05	12.03	1
		3	1	11.69	11.90	11.90	1
		3	3	11.89	11.90	11.78	1
		6	0	10.70	10.86	10.82	2
1.4M	64QAM	1	0	10.80	11.10	10.95	2
		1	2	10.76	10.98	10.88	2
		1	5	10.76	10.96	10.98	2
		3	0	10.73	10.91	10.92	2
		3	1	10.81	11.01	10.88	2
		3	3	10.78	10.90	10.94	2
		6	0	9.79	9.90	9.79	3
1.4M	256QAM	1	0	8.23	8.25	8.19	5
		1	2	8.09	8.21	8.04	5
		1	5	8.18	8.17	8.05	5
		3	0	8.09	8.11	7.96	5
		3	1	8.06	8.09	8.07	5
		3	3	8.14	8.16	8.08	5
		6	0	8.06	8.11	7.99	5

LTE Conducted Power (Reduction_Tablet)							
LTE Band 71							
BW	MCS Index	RB Size	RB Offset	Low	Mid	Mid	3GPP MPR (dB)
		Channel		133222	133297	133372	
		Frequency (MHz)		673	680.5	688	
20M	QPSK	1	0	16.23	16.36	16.19	0
		1	50	16.19	16.32	16.15	0
		1	99	16.11	16.24	16.07	0
		50	0	15.34	15.47	15.30	1
		50	25	15.27	15.40	15.23	1
		50	50	15.24	15.37	15.20	1
		100	0	15.23	15.36	15.19	1
20M	16QAM	1	0	15.19	15.32	15.15	1
		1	50	15.17	15.30	15.13	1
		1	99	14.36	14.49	14.32	1
		50	0	14.29	14.42	14.25	2
		50	25	14.27	14.40	14.23	2
		50	50	14.24	14.37	14.20	2
		100	0	14.19	14.32	14.15	2
20M	64QAM	1	0	14.19	14.32	14.15	2
		1	50	14.18	14.31	14.14	2
		1	99	14.17	14.30	14.13	2
		50	0	13.30	13.43	13.26	3
		50	25	13.27	13.40	13.23	3
		50	50	13.25	13.38	13.21	3
		100	0	13.20	13.33	13.16	3
20M	256QAM	1	0	11.78	11.82	11.76	5
		1	50	11.68	11.72	11.66	5
		1	99	11.58	11.63	11.55	5
		50	0	11.54	11.59	11.50	5
		50	25	11.46	11.51	11.47	5
		50	50	11.39	11.44	11.39	5
		100	0	11.68	11.71	11.65	5
BW	MCS Index	Channel		133197	133297	133397	3GPP MPR
		Frequency (MHz)		670.5	680.5	690.5	
15M	QPSK	1	0	16.14	16.13	16.35	0
		1	37	16.12	16.14	16.30	0
		1	74	16.06	16.04	16.16	0
		36	0	15.26	15.29	15.44	1
		36	19	15.19	15.17	15.39	1
		36	39	15.22	15.10	15.33	1
		75	0	15.21	15.14	15.31	1
15M	16QAM	1	0	15.18	15.14	15.22	1
		1	37	15.10	15.05	15.23	1
		1	74	14.34	14.25	14.43	1
		36	0	14.29	14.19	14.39	2
		36	19	14.25	14.17	14.31	2
		36	39	14.14	14.20	14.27	2
		75	0	14.09	14.11	14.27	2
15M	64QAM	1	0	14.17	14.10	14.32	2
		1	37	14.17	14.07	14.24	2
		1	74	14.17	14.05	14.24	2
		36	0	13.26	13.25	13.43	3
		36	19	13.18	13.23	13.32	3
		36	39	13.20	13.13	13.36	3
		75	0	13.18	13.14	13.25	3
15M	256QAM	1	0	11.78	11.80	11.72	5
		1	37	11.58	11.71	11.63	5
		1	74	11.54	11.54	11.45	5
		36	0	11.46	11.57	11.42	5
		36	19	11.38	11.42	11.38	5
		36	39	11.31	11.39	11.34	5
		75	0	11.63	11.66	11.64	5

LTE Conducted Power (Reduction_Tablet)							
LTE Band 71							
BW	MCS Index	Channel		133172	133297	133422	3GPP MPR
		Frequency (MHz)		668	680.5	693	
10M	QPSK	1	0	16.16	16.09	16.31	0
		1	24	16.13	16.05	16.26	0
		1	49	16.01	15.99	16.24	0
		25	0	15.32	15.28	15.38	1
		25	12	15.27	15.18	15.33	1
		25	25	15.17	15.14	15.37	1
		50	0	15.14	15.12	15.33	1
10M	16QAM	1	0	15.13	15.05	15.28	1
		1	24	15.13	15.08	15.29	1
		1	49	14.32	14.25	14.43	1
		25	0	14.28	14.19	14.38	2
		25	12	14.18	14.23	14.33	2
		25	25	14.21	14.20	14.31	2
		50	0	14.10	14.13	14.22	2
10M	64QAM	1	0	14.17	14.13	14.28	2
		1	24	14.08	14.10	14.26	2
		1	49	14.13	14.08	14.29	2
		25	0	13.27	13.23	13.42	3
		25	12	13.26	13.19	13.37	3
		25	25	13.22	13.16	13.32	3
		50	0	13.10	13.14	13.33	3
10M	256QAM	1	0	11.71	11.77	11.67	5
		1	24	11.66	11.65	11.61	5
		1	49	11.50	11.53	11.48	5
		25	0	11.44	11.53	11.41	5
		25	12	11.44	11.45	11.40	5
		25	25	11.37	11.36	11.29	5
		50	0	11.61	11.71	11.63	5
BW	MCS Index	Channel		133147	133297	133447	3GPP MPR
		Frequency (MHz)		665.5	680.5	695.5	
5M	QPSK	1	0	16.15	16.13	16.31	0
		1	12	16.11	16.13	16.32	0
		1	24	16.10	15.98	16.22	0
		12	0	15.32	15.23	15.44	1
		12	6	15.18	15.16	15.39	1
		12	13	15.15	15.11	15.36	1
		25	0	15.22	15.19	15.33	1
5M	16QAM	1	0	15.19	15.13	15.31	1
		1	12	15.07	15.05	15.20	1
		1	24	14.34	14.27	14.45	1
		12	0	14.19	14.22	14.33	2
		12	6	14.19	14.18	14.34	2
		12	13	14.19	14.12	14.28	2
		25	0	14.15	14.11	14.22	2
5M	64QAM	1	0	14.10	14.13	14.23	2
		1	12	14.16	14.10	14.31	2
		1	24	14.13	14.06	14.23	2
		12	0	13.30	13.16	13.41	3
		12	6	13.25	13.21	13.30	3
		12	13	13.18	13.16	13.30	3
		25	0	13.18	13.10	13.27	3
5M	256QAM	1	0	11.71	11.76	11.75	5
		1	12	11.61	11.63	11.57	5
		1	24	11.55	11.53	11.51	5
		12	0	11.49	11.54	11.46	5
		12	6	11.46	11.46	11.40	5
		12	13	11.38	11.39	11.29	5
		25	0	11.60	11.68	11.59	5

NR Conducted Power (Reduction_Laptop)							
NR Band 2_SA							
BW	MCS Index	RB Size	RB Offset	Low	Mid	High	3GPP MPR (dB)
		Channel		372000	376000	380000	
		Frequency (MHz)		1860	1880	1900	
20M	DFT-S PI/2 BPSK	1	1	16.33	16.41	16.35	0
20M	DFT-S QPSK	1	1	16.44	16.48	16.43	0
		1	53	15.90	15.93	15.87	0
		1	104	15.86	15.89	15.83	0
		50	0	15.39	15.42	15.36	1
		50	28	15.86	15.89	15.83	0
		50	56	15.39	15.42	15.36	1
100	0	15.44	15.47	15.41	1		
20M	DFT-S 16QAM	1	1	15.33	15.37	15.34	1
20M	DFT-S 64QAM	1	1	13.83	13.87	13.84	2.5
20M	DFT-S 256QAM	1	1	11.84	11.88	11.85	4.5
20M	CP QPSK	1	1	14.87	14.91	14.88	1.5
BW	MCS Index	Channel		371500	376000	380500	3GPP MPR
		Frequency (MHz)		1857.5	1880	1902.5	
15M	DFT-S PI/2 BPSK	1	1	16.31	16.33	16.35	0
15M	DFT-S QPSK	1	1	16.40	16.40	16.34	0
		1	40	15.86	15.86	15.85	0
		1	77	15.84	15.88	15.73	0
		36	0	15.32	15.36	15.34	1
		36	22	15.77	15.87	15.79	0
		36	43	15.31	15.40	15.28	1
75	0	15.35	15.45	15.41	1		
15M	DFT-S 16QAM	1	1	15.29	15.31	15.26	1
15M	DFT-S 64QAM	1	1	13.76	13.84	13.80	2.5
15M	DFT-S 256QAM	1	1	11.80	11.80	11.76	4.5
15M	CP QPSK	1	1	14.84	14.91	14.78	1.5

NR Conducted Power (Reduction_Laptop)

NR Band 2_SA							
BW	MCS Index	Channel		371000	376000	381000	3GPP MPR
		Frequency (MHz)		1855	1880	1905	
10M	DFT-S PI/2 BPSK	1	1	16.28	16.36	16.30	0
10M	DFT-S QPSK	1	1	16.34	16.40	16.36	0
		1	26	15.90	15.88	15.83	0
		1	50	15.84	15.87	15.75	0
		25	0	15.34	15.40	15.27	1
		25	14	15.77	15.83	15.82	0
		25	27	15.39	15.41	15.26	1
50	0	15.42	15.44	15.34	1		
10M	DFT-S 16QAM	1	1	15.25	15.29	15.25	1
10M	DFT-S 64QAM	1	1	13.82	13.77	13.74	2.5
10M	DFT-S 256QAM	1	1	11.79	11.85	11.81	4.5
10M	CP QPSK	1	1	14.80	14.89	14.86	1.5
BW	MCS Index	Channel		370500	376000	381500	3GPP MPR
		Frequency (MHz)		1852.5	1880	1907.5	
5M	DFT-S PI/2 BPSK	1	1	16.25	16.40	16.27	0
5M	DFT-S QPSK	1	1	16.37	16.44	16.40	0
		1	13	15.86	15.83	15.86	0
		1	23	15.79	15.86	15.76	0
		12	0	15.32	15.37	15.28	1
		12	7	15.82	15.81	15.80	0
		12	13	15.38	15.38	15.29	1
25	0	15.40	15.45	15.33	1		
5M	DFT-S 16QAM	1	1	15.24	15.37	15.29	1
5M	DFT-S 64QAM	1	1	13.82	13.83	13.84	2.5
5M	DFT-S 256QAM	1	1	11.78	11.87	11.81	4.5
5M	CP QPSK	1	1	14.78	14.86	14.81	1.5

NR Conducted Power (Reduction_Laptop)							
NR Band 5_SA							
BW	MCS Index	RB Size	RB Offset	Low	Mid	High	3GPP MPR (dB)
		Channel		166800	167300	167800	
		Frequency (MHz)		834	836.5	839	
20M	DFT-S PI/2 BPSK	1	1	19.10	19.31	19.09	0
20M	DFT-S QPSK	1	1	19.14	19.36	19.15	0
		1	53	19.12	19.33	19.11	0
		1	104	19.11	19.32	19.10	0
		50	0	18.21	18.42	18.20	1
		50	28	19.13	19.34	19.12	0
		50	56	18.32	18.53	18.31	1
100	0	18.35	18.56	18.34	1		
20M	DFT-S 16QAM	1	1	18.14	18.36	18.14	1
20M	DFT-S 64QAM	1	1	16.64	16.86	16.64	2.5
20M	DFT-S 256QAM	1	1	14.64	14.86	14.64	4.5
20M	CP QPSK	1	1	17.64	17.86	17.64	1.5
BW	MCS Index	Channel		166300	167300	168300	3GPP MPR
		Frequency (MHz)		831.5	836.5	841.5	
15M	DFT-S PI/2 BPSK	1	1	19.07	19.24	19.07	0
15M	DFT-S QPSK	1	1	19.07	19.31	19.13	0
		1	40	19.12	19.28	19.02	0
		1	77	19.04	19.26	19.10	0
		36	0	18.17	18.35	18.19	1
		36	22	19.03	19.27	19.03	0
		36	43	18.30	18.52	18.24	1
75	0	18.33	18.46	18.28	1		
15M	DFT-S 16QAM	1	1	18.06	18.32	18.07	1
15M	DFT-S 64QAM	1	1	16.62	16.80	16.54	2.5
15M	DFT-S 256QAM	1	1	14.60	14.81	14.61	4.5
15M	CP QPSK	1	1	17.59	17.76	17.57	1.5

NR Conducted Power (Reduction_Laptop)

NR Band 5_SA							
BW	MCS Index	Channel		165800	167300	168800	3GPP MPR
		Frequency (MHz)		829	836.5	844	
10M	DFT-S PI/2 BPSK	1	1	19.02	19.22	19.08	0
10M	DFT-S QPSK	1	1	19.10	19.34	19.08	0
		1	26	19.06	19.29	19.07	0
		1	50	19.08	19.22	19.05	0
		25	0	18.21	18.39	18.16	1
		25	14	19.07	19.30	19.10	0
		25	27	18.31	18.45	18.31	1
50	0	18.26	18.52	18.30	1		
10M	DFT-S 16QAM	1	1	18.13	18.28	18.05	1
10M	DFT-S 64QAM	1	1	16.56	16.84	16.59	2.5
10M	DFT-S 256QAM	1	1	14.61	14.78	14.59	4.5
10M	CP QPSK	1	1	17.58	17.77	17.59	1.5
BW	MCS Index	Channel		165300	167300	169300	3GPP MPR
		Frequency (MHz)		826.5	836.5	846.5	
5M	DFT-S PI/2 BPSK	1	1	19.03	19.30	19.08	0
5M	DFT-S QPSK	1	1	19.05	19.27	19.13	0
		1	13	19.04	19.27	19.04	0
		1	23	19.06	19.27	19.05	0
		12	0	18.20	18.40	18.13	1
		12	7	19.09	19.32	19.07	0
		12	13	18.23	18.52	18.26	1
25	0	18.28	18.54	18.29	1		
5M	DFT-S 16QAM	1	1	18.09	18.35	18.12	1
5M	DFT-S 64QAM	1	1	16.57	16.82	16.59	2.5
5M	DFT-S 256QAM	1	1	14.62	14.76	14.54	4.5
5M	CP QPSK	1	1	17.61	17.85	17.62	1.5

NR Conducted Power (Reduction_Laptop)

BW	MCS Index	Channel		502000	507000	512000	3GPP MPR
		Frequency (MHz)		2510	2535	2560	
20M	DFT-S PI/2 BPSK	1	1	15.17	15.28	15.14	0
20M	DFT-S QPSK	1	1	15.22	15.32	15.17	0
		1	53	15.17	15.26	15.15	0
		1	104	15.15	15.24	15.13	0
		50	0	14.22	14.29	14.18	1
		50	28	15.15	15.31	15.10	0
		50	56	14.22	14.30	14.19	1
100	0	14.25	14.31	14.20	1		
20M	DFT-S 16QAM	1	1	14.25	14.32	14.19	1
20M	DFT-S 64QAM	1	1	12.71	12.80	12.66	2.5
20M	DFT-S 256QAM	1	1	10.77	10.84	10.66	4.5
20M	CP QPSK	1	1	13.72	13.82	13.67	1.5
BW	MCS Index	Channel		501500	507000	512500	3GPP MPR
		Frequency (MHz)		2507.5	2535	2562.5	
15M	DFT-S PI/2 BPSK	1	1	15.07	15.19	15.06	0
15M	DFT-S QPSK	1	1	15.17	15.29	15.14	0
		1	40	15.08	15.16	15.13	0
		1	77	15.14	15.15	15.12	0
		36	0	14.21	14.23	14.12	1
		36	22	15.21	15.29	15.16	0
		36	43	14.21	14.20	14.12	1
75	0	14.24	14.28	14.19	1		
15M	DFT-S 16QAM	1	1	14.19	14.27	14.17	1
15M	DFT-S 64QAM	1	1	12.62	12.79	12.57	2.5
15M	DFT-S 256QAM	1	1	10.74	10.80	10.57	4.5
15M	CP QPSK	1	1	13.69	13.74	13.61	1.5

NR Conducted Power (Reduction_Laptop)

BW	MCS Index	Channel		501000	507000	513000	3GPP MPR
		Frequency (MHz)		2505	2535	2565	
10M	DFT-S PI/2 BPSK	1	1	15.10	15.22	15.09	0
10M	DFT-S QPSK	1	1	15.19	15.31	15.08	0
		1	26	15.11	15.26	15.14	0
		1	50	15.05	15.23	15.04	0
		25	0	14.18	14.25	14.08	1
		25	14	15.20	15.23	15.16	0
		25	27	14.21	14.30	14.19	1
10M	DFT-S 16QAM	1	1	14.24	14.22	14.11	1
10M	DFT-S 64QAM	1	1	12.64	12.80	12.66	2.5
10M	DFT-S 256QAM	1	1	10.67	10.76	10.62	4.5
10M	CP QPSK	1	1	13.72	13.76	13.65	1.5
BW	MCS Index	Channel		500500	507000	513500	3GPP MPR
		Frequency (MHz)		2502.5	2535	2567.5	
5M	DFT-S PI/2 BPSK	1	1	15.13	15.20	15.07	0
5M	DFT-S QPSK	1	1	15.19	15.22	15.09	0
		1	13	15.14	15.17	15.11	0
		1	23	15.07	15.17	15.09	0
		12	0	14.18	14.19	14.15	1
		12	7	15.17	15.29	15.17	0
		12	13	14.20	14.25	14.15	1
5M	DFT-S 16QAM	1	1	14.25	14.29	14.09	1
5M	DFT-S 64QAM	1	1	12.69	12.72	12.62	2.5
5M	DFT-S 256QAM	1	1	10.67	10.82	10.59	4.5
5M	CP QPSK	1	1	13.69	13.82	13.65	1.5

NR Conducted Power (Reduction_Laptop)							
NR Band 25_SA							
BW	MCS Index	Channel		372000	376500	381000	3GPP MPR
		Frequency (MHz)		1860	1882.5	1905	
20M	DFT-S PI/2 BPSK	1	1	16.42	16.41	16.48	0
20M	DFT-S QPSK	1	1	16.45	16.43	16.49	0
		1	53	15.67	15.65	15.71	0
		1	104	15.58	15.56	15.62	0
		50	0	14.66	14.64	14.70	1
		50	28	15.71	15.69	15.75	0
		50	56	14.55	14.53	14.59	1
100	0	14.60	14.58	14.64	1		
20M	DFT-S 16QAM	1	1	15.48	15.33	15.49	1
20M	DFT-S 64QAM	1	1	13.94	13.91	13.98	2.5
20M	DFT-S 256QAM	1	1	12.00	11.95	11.98	4.5
20M	CP QPSK	1	1	14.95	14.93	14.99	1.5
BW	MCS Index	Channel		371500	376500	381500	3GPP MPR
		Frequency (MHz)		1857.5	1882.5	1907.5	
15M	DFT-S PI/2 BPSK	1	1	16.36	16.37	16.39	0
15M	DFT-S QPSK	1	1	16.45	16.34	16.41	0
		1	40	15.60	15.61	15.62	0
		1	77	15.50	15.55	15.52	0
		36	0	14.66	14.60	14.67	1
		36	22	15.62	15.69	15.74	0
		36	43	14.55	14.43	14.55	1
75	0	14.53	14.54	14.60	1		
15M	DFT-S 16QAM	1	1	15.41	15.28	15.47	1
15M	DFT-S 64QAM	1	1	13.87	13.90	13.90	2.5
15M	DFT-S 256QAM	1	1	11.91	11.94	11.91	4.5
15M	CP QPSK	1	1	14.85	14.93	14.89	1.5

NR Conducted Power (Reduction_Laptop)

NR Band 25_SA							
BW	MCS Index	Channel		371000	376500	382000	3GPP MPR
		Frequency (MHz)		1855	1882.5	1910	
10M	DFT-S PI/2 BPSK	1	1	16.34	16.41	16.38	0
10M	DFT-S QPSK	1	1	16.42	16.43	16.39	0
		1	26	15.66	15.60	15.65	0
		1	50	15.56	15.51	15.58	0
		25	0	14.58	14.64	14.62	1
		25	14	15.63	15.69	15.73	0
		25	27	14.48	14.52	14.57	1
10M	DFT-S 16QAM	1	1	15.40	15.28	15.39	1
10M	DFT-S 64QAM	1	1	13.84	13.84	13.91	2.5
10M	DFT-S 256QAM	1	1	11.93	11.95	11.98	4.5
10M	CP QPSK	1	1	14.92	14.90	14.97	1.5
BW	MCS Index	Channel		370500	376500	382500	3GPP MPR
		Frequency (MHz)		1852.5	1882.5	1912.5	
5M	DFT-S PI/2 BPSK	1	1	16.38	16.32	16.44	0
5M	DFT-S QPSK	1	1	16.45	16.40	16.44	0
		1	13	15.58	15.59	15.67	0
		1	23	15.54	15.49	15.60	0
		12	0	14.58	14.59	14.67	1
		12	7	15.63	15.65	15.72	0
		12	13	14.49	14.52	14.55	1
5M	DFT-S 16QAM	1	1	15.47	15.24	15.48	1
5M	DFT-S 64QAM	1	1	13.91	13.84	13.97	2.5
5M	DFT-S 256QAM	1	1	11.98	11.91	11.97	4.5
5M	CP QPSK	1	1	14.87	14.90	14.92	1.5

NR Conducted Power (Reduction_Laptop)

NR Band 30_SA							
BW	MCS Index	RB Size	RB Offset		Mid		3GPP MPR (dB)
		Channel			462000		
		Frequency (MHz)			2310		
10M	DFT-S PI/2 BPSK	1	1		17.78		0
10M	DFT-S QPSK	1	1		18.24		0
		1	26		17.81		0
		1	50		17.79		0
		25	0		17.12		1
		25	14		17.81		0
		25	27		17.06		1
		50	0		17.11		1
10M	DFT-S 16QAM	1	1		16.72		1
10M	DFT-S 64QAM	1	1		15.30		2.5
10M	DFT-S 256QAM	1	1		13.34		4.5
10M	CP QPSK	1	1		16.32		1.5
BW	MCS Index	Channel		461500	462000	462500	3GPP MPR
		Frequency (MHz)		2307.5	2310	2312.5	
5M	DFT-S PI/2 BPSK	1	1	17.70	17.68	17.77	0
5M	DFT-S QPSK	1	1	17.78	17.79	17.76	0
		1	13	17.75	17.80	17.74	0
		1	23	17.70	17.75	17.77	0
		12	0	17.11	17.06	17.07	1
		12	7	17.71	17.75	17.76	0
		12	13	16.97	17.02	17.01	1
		25	0	17.05	17.07	17.05	1
5M	DFT-S 16QAM	1	1	16.72	16.68	16.63	1
5M	DFT-S 64QAM	1	1	15.28	15.28	15.21	2.5
5M	DFT-S 256QAM	1	1	13.31	13.28	13.28	4.5
5M	CP QPSK	1	1	16.22	16.25	16.30	1.5

NR Conducted Power (Reduction_Laptop)							
NR Band 66_SA							
BW	MCS Index	RB Size	RB Offset	Low	Mid	High	3GPP MPR (dB)
		Channel		346000	349000	352000	
		Frequency (MHz)		1730	1745	1760	
40M	DFT-S PI/2 BPSK	1	1	16.68	16.91	16.71	0
40M	DFT-S QPSK	1	1	16.75	16.99	16.78	0
		1	108	16.54	16.57	16.55	0
		1	214	16.93	16.93	16.89	0
		108	0	15.89	15.99	15.95	1
		108	54	16.26	16.34	16.24	0
		108	108	15.09	15.15	15.09	1
		216	0	15.15	15.17	15.11	1
40M	DFT-S 16QAM	1	1	15.78	15.89	15.80	1
40M	DFT-S 64QAM	1	1	14.24	14.47	14.27	2.5
40M	DFT-S 256QAM	1	1	12.30	12.51	12.27	4.5
40M	CP QPSK	1	1	15.25	15.49	15.28	1.5
BW	MCS Index	Channel		344000	349000	354000	3GPP MPR
		Frequency (MHz)		1720	1745	1770	
20M	DFT-S PI/2 BPSK	1	1	16.67	16.86	16.70	0
20M	DFT-S QPSK	1	1	16.65	16.89	16.72	0
		1	53	16.47	16.49	16.52	0
		1	104	16.92	16.89	16.86	0
		50	0	15.81	15.99	15.94	1
		50	28	16.24	16.28	16.16	0
		50	56	15.07	15.14	15.08	1
		100	0	15.11	15.10	15.08	1
20M	DFT-S 16QAM	1	1	15.74	15.82	15.75	1
20M	DFT-S 64QAM	1	1	14.23	14.40	14.20	2.5
20M	DFT-S 256QAM	1	1	12.20	12.43	12.22	4.5
20M	CP QPSK	1	1	15.18	15.40	15.25	1.5

NR Conducted Power (Reduction_Laptop)

NR Band 66_SA							
BW	MCS Index	Channel		343500	349000	354500	3GPP MPR
		Frequency (MHz)		1717.5	1745	1772.5	
15M	DFT-S PI/2 BPSK	1	1	16.59	16.87	16.61	0
15M	DFT-S QPSK	1	1	16.72	16.92	16.74	0
		1	40	16.53	16.48	16.49	0
		1	77	16.90	16.93	16.84	0
		36	0	15.79	15.95	15.95	1
		36	22	16.16	16.29	16.22	0
		36	43	15.04	15.14	15.07	1
15M	DFT-S 16QAM	1	1	15.68	15.83	15.76	1
15M	DFT-S 64QAM	1	1	14.22	14.46	14.17	2.5
15M	DFT-S 256QAM	1	1	12.27	12.51	12.19	4.5
15M	CP QPSK	1	1	15.15	15.48	15.27	1.5
BW	MCS Index	Channel		343000	349000	355000	3GPP MPR
		Frequency (MHz)		1715	1745	1775	
10M	DFT-S PI/2 BPSK	1	1	16.67	16.90	16.65	0
10M	DFT-S QPSK	1	1	16.71	16.89	16.78	0
		1	26	16.47	16.49	16.45	0
		1	50	16.85	16.89	16.84	0
		25	0	15.86	15.97	15.89	1
		25	14	16.20	16.26	16.18	0
		25	27	15.00	15.14	15.03	1
10M	DFT-S 16QAM	1	1	15.69	15.88	15.74	1
10M	DFT-S 64QAM	1	1	14.14	14.44	14.19	2.5
10M	DFT-S 256QAM	1	1	12.26	12.41	12.26	4.5
10M	CP QPSK	1	1	15.22	15.39	15.21	1.5

NR Conducted Power (Reduction_Laptop)							
NR Band 66_SA							
BW	MCS Index	Channel		342500	349000	355500	3GPP MPR
		Frequency (MHz)		1712.5	1745	1777.5	
5M	DFT-S PI/2 BPSK	1	1	16.63	16.90	16.68	0
5M	DFT-S QPSK	1	1	16.71	16.93	16.68	0
		1	13	16.48	16.56	16.46	0
		1	23	16.84	16.92	16.84	0
		12	0	15.81	15.99	15.90	1
		12	7	16.24	16.25	16.23	0
		12	13	15.05	15.12	14.99	1
5M	DFT-S 16QAM	1	1	15.77	15.80	15.75	1
5M	DFT-S 64QAM	1	1	14.20	14.47	14.20	2.5
5M	DFT-S 256QAM	1	1	12.28	12.49	12.25	4.5
5M	CP QPSK	1	1	15.17	15.49	15.27	1.5

NR Conducted Power (Reduction_Laptop)

NR Band 71_SA							
BW	MCS Index	RB Size	RB Offset	Low	Mid	High	3GPP MPR (dB)
		Channel		134600	136100	137600	
		Frequency (MHz)		673	680.5	688	
20M	DFT-S PI/2 BPSK	1	1	19.81	19.91	19.83	0
20M	DFT-S QPSK	1	1	19.89	19.99	19.91	0
		1	53	19.10	19.13	19.11	0
		1	104	19.06	19.06	19.02	0
		50	0	18.05	18.15	18.11	1
		50	28	19.13	19.21	19.11	0
		50	56	18.25	18.31	18.25	1
100	0	18.16	18.18	18.12	1		
20M	DFT-S 16QAM	1	1	18.92	19.02	18.93	1
20M	DFT-S 64QAM	1	1	17.38	17.47	17.40	2.5
20M	DFT-S 256QAM	1	1	15.44	15.51	15.40	4.5
20M	CP QPSK	1	1	18.39	18.49	18.41	1.5
BW	MCS Index	Channel		134100	136100	138100	3GPP MPR
		Frequency (MHz)		670.5	680.5	690.5	
15M	DFT-S PI/2 BPSK	1	1	19.74	19.88	19.82	0
15M	DFT-S QPSK	1	1	19.79	19.96	19.89	0
		1	40	19.08	19.07	19.10	0
		1	77	19.05	19.04	19.01	0
		36	0	18.04	18.09	18.05	1
		36	22	19.04	19.19	19.04	0
		36	43	18.24	18.23	18.16	1
75	0	18.13	18.18	18.09	1		
15M	DFT-S 16QAM	1	1	18.85	19.01	18.93	1
15M	DFT-S 64QAM	1	1	17.29	17.37	17.31	2.5
15M	DFT-S 256QAM	1	1	15.37	15.51	15.37	4.5
15M	CP QPSK	1	1	18.35	18.46	18.39	1.5

NR Conducted Power (Reduction_Laptop)

NR Band 71_SA							
BW	MCS Index	Channel		133600	136100	138600	3GPP MPR
		Frequency (MHz)		668	680.5	693	
10M	DFT-S PI/2 BPSK	1	1	19.72	19.87	19.82	0
10M	DFT-S QPSK	1	1	19.84	19.93	19.89	0
		1	26	19.04	19.06	19.09	0
		1	50	19.05	18.99	18.99	0
		25	0	18.02	18.11	18.11	1
		25	14	19.08	19.12	19.11	0
		25	27	18.16	18.23	18.17	1
10M	DFT-S 16QAM	1	1	18.84	18.97	18.85	1
10M	DFT-S 64QAM	1	1	17.28	17.46	17.32	2.5
10M	DFT-S 256QAM	1	1	15.34	15.44	15.33	4.5
10M	CP QPSK	1	1	18.34	18.46	18.40	1.5
BW	MCS Index	Channel		133100	136100	139100	3GPP MPR
		Frequency (MHz)		665.5	680.5	695.5	
5M	DFT-S PI/2 BPSK	1	1	19.74	19.83	19.74	0
5M	DFT-S QPSK	1	1	19.82	19.96	19.85	0
		1	13	19.05	19.11	19.05	0
		1	23	18.97	18.97	18.95	0
		12	0	18.05	18.12	18.08	1
		12	7	19.11	19.12	19.09	0
		12	13	18.19	18.31	18.24	1
5M	DFT-S 16QAM	1	1	18.88	18.96	18.85	1
5M	DFT-S 64QAM	1	1	17.34	17.41	17.32	2.5
5M	DFT-S 256QAM	1	1	15.35	15.44	15.33	4.5
5M	CP QPSK	1	1	18.34	18.42	18.32	1.5

NR Conducted Power (Laptop)							
NR Band 38_SA							
BW	MCS Index	Channel		516000	519000	522000	3GPP MPR
		Frequency (MHz)		2580	2595	2610	
20M	DFT-S PI/2 BPSK	1	1	18.39	18.62	18.47	0
20M	DFT-S QPSK	1	1	18.74	18.79	18.71	0
		1	26	18.45	18.64	18.49	0
		1	49	18.36	18.55	18.40	0
		25	0	18.34	18.53	18.38	1
		25	13	18.42	18.61	18.46	0
		25	26	18.38	18.57	18.42	1
50	0	18.37	18.56	18.41	1		
20M	DFT-S 16QAM	1	1	17.47	17.68	17.53	1
20M	DFT-S 64QAM	1	1	15.95	16.14	16.00	2.5
20M	DFT-S 256QAM	1	1	13.97	14.18	13.98	4.5
20M	CP QPSK	1	1	16.95	17.14	17.01	1.5
BW	MCS Index	Channel		515500	519000	522500	3GPP MPR
		Frequency (MHz)		2577.5	2595	2612.5	
15M	DFT-S PI/2 BPSK	1	1	18.30	18.59	18.41	0
15M	DFT-S QPSK	1	1	18.41	18.57	18.49	0
		1	19	18.45	18.60	18.46	0
		1	36	18.34	18.50	18.34	0
		18	0	18.34	18.61	18.45	1
		18	10	18.33	18.58	18.36	0
		18	20	18.33	18.57	18.32	1
36	0	18.35	18.51	18.37	1		
15M	DFT-S 16QAM	1	1	17.42	17.60	17.49	1
15M	DFT-S 64QAM	1	1	15.87	16.13	15.94	2.5
15M	DFT-S 256QAM	1	1	13.91	14.18	13.94	4.5
15M	CP QPSK	1	1	16.92	17.07	16.95	1.5

NR Conducted Power (Laptop)							
NR Band 38_SA							
BW	MCS Index	Channel		515000	519000	523000	3GPP MPR
		Frequency (MHz)		2575	2595	2615	
10M	DFT-S PI/2 BPSK	1	1	18.34	18.53	18.47	0
10M	DFT-S QPSK	1	1	18.38	18.63	18.49	0
		1	11	18.45	18.62	18.49	0
		1	22	18.28	18.53	18.35	0
		12	0	18.39	18.57	18.48	1
		12	6	18.33	18.52	18.37	0
		12	12	18.30	18.49	18.38	1
		24	0	18.29	18.53	18.41	1
10M	DFT-S 16QAM	1	1	17.47	17.66	17.49	1
10M	DFT-S 64QAM	1	1	15.87	16.10	15.97	2.5
10M	DFT-S 256QAM	1	1	13.94	14.12	13.90	4.5
10M	CP QPSK	1	1	16.89	17.11	17.01	1.5

NR Conducted Power (Laptop)							
NR Band 40_SA							
BW	MCS Index	Channel		468000	470000	472000	3GPP MPR
		Frequency (MHz)		2340	2350	2360	
80M	DFT-S PI/2 BPSK	1	1	17.63	17.75	17.69	0
80M	DFT-S QPSK	1	1	17.74	17.77	17.71	0
		1	109	17.73	17.75	17.66	0
		1	215	17.67	17.67	17.63	0
		108	0	17.65	17.58	17.64	1
		108	55	17.62	17.66	17.59	0
		108	109	17.08	17.14	17.10	1
80M	DFT-S 16QAM	1	1	17.04	17.09	17.00	1
80M	DFT-S 64QAM	1	1	16.66	16.86	16.72	1
80M	DFT-S 256QAM	1	1	15.16	15.39	15.22	2.5
80M	CP QPSK	1	1	13.16	13.36	13.22	4.5
80M	CP QPSK	1	1	16.17	16.37	16.22	1.5
BW	MCS Index	Channel		466000	470000	474000	3GPP MPR
		Frequency (MHz)		2330	2350	2370	
60M	DFT-S PI/2 BPSK	1	1	17.26	17.48	17.37	0
60M	DFT-S QPSK	1	1	17.34	17.54	17.38	0
		1	81	17.71	17.65	17.56	0
		1	160	17.67	17.64	17.61	0
		81	0	17.56	17.50	17.49	1
		81	41	17.52	17.59	17.50	0
		81	81	17.04	17.04	17.03	1
60M	DFT-S 16QAM	162	0	17.01	17.04	16.91	1
60M	DFT-S 64QAM	1	1	16.66	16.84	16.71	1
60M	DFT-S 256QAM	1	1	15.12	15.34	15.19	2.5
60M	CP QPSK	1	1	13.09	13.32	13.20	4.5
60M	CP QPSK	1	1	16.11	16.36	16.16	1.5

NR Conducted Power (Laptop)							
NR Band 40_SA							
BW	MCS Index	Channel		465000	470000	475000	3GPP MPR
		Frequency (MHz)		2325	2350	2375	
50M	DFT-S PI/2 BPSK	1	1	17.63	17.74	17.61	0
50M	DFT-S QPSK	1	1	17.37	17.56	17.33	0
		1	67	17.68	17.69	17.57	0
		1	131	17.64	17.63	17.63	0
		64	0	17.46	17.55	17.47	1
		64	35	17.54	17.60	17.55	0
		64	69	17.00	17.10	17.09	1
50M	DFT-S 16QAM	1	1	16.62	16.85	16.64	1
50M	DFT-S 64QAM	1	1	15.08	15.35	15.22	2.5
50M	DFT-S 256QAM	1	1	13.07	13.30	13.21	4.5
50M	CP QPSK	1	1	16.17	16.27	16.13	1.5
BW	MCS Index	Channel		464000	470000	476000	3GPP MPR
		Frequency (MHz)		2320	2350	2380	
40M	DFT-S PI/2 BPSK	1	1	17.59	17.71	17.69	0
40M	DFT-S QPSK	1	1	17.33	17.56	17.37	0
		1	53	17.63	17.73	17.62	0
		1	104	17.65	17.65	17.54	0
		50	0	17.75	17.70	17.65	1
		50	28	17.56	17.58	17.50	0
		50	56	17.05	17.06	17.06	1
40M	DFT-S 16QAM	1	1	16.66	16.79	16.69	1
40M	DFT-S 64QAM	1	1	15.10	15.30	15.16	2.5
40M	DFT-S 256QAM	1	1	13.07	13.34	13.13	4.5
40M	CP QPSK	1	1	16.16	16.33	16.17	1.5

NR Conducted Power (Laptop)							
NR Band 40_SA							
BW	MCS Index	Channel		462000	470000	478000	3GPP MPR
		Frequency (MHz)		2310	2350	2390	
20M	DFT-S PI/2 BPSK	1	1	17.63	17.73	17.62	0
20M	DFT-S QPSK	1	1	17.32	17.56	17.41	0
		1	26	17.63	17.74	17.61	0
		1	49	17.66	17.58	17.55	0
		25	0	17.36	17.47	17.40	1
		25	13	17.61	17.63	17.49	0
		25	26	16.99	17.12	17.04	1
		50	0	16.95	17.07	17.00	1
20M	DFT-S 16QAM	1	1	16.58	16.84	16.69	1
20M	DFT-S 64QAM	1	1	15.11	15.32	15.22	2.5
20M	DFT-S 256QAM	1	1	13.07	13.26	13.16	4.5
20M	CP QPSK	1	1	16.07	16.37	16.12	1.5
BW	MCS Index	Channel		461500	470000	478500	3GPP MPR
		Frequency (MHz)		2307.5	2350	2392.5	
15M	DFT-S PI/2 BPSK	1	1	17.61	17.75	17.65	0
15M	DFT-S QPSK	1	1	17.58	17.53	17.64	0
		1	19	17.64	17.65	17.59	0
		1	36	17.67	17.67	17.58	0
		18	0	17.74	17.68	17.66	1
		18	10	17.54	17.56	17.50	0
		18	20	17.04	17.05	17.09	1
		36	0	16.98	17.05	16.96	1
15M	DFT-S 16QAM	1	1	16.56	16.83	16.66	1
15M	DFT-S 64QAM	1	1	15.14	15.37	15.12	2.5
15M	DFT-S 256QAM	1	1	13.15	13.34	13.18	4.5
15M	CP QPSK	1	1	16.07	16.33	16.21	1.5

NR Conducted Power (Laptop)							
NR Band 40_SA							
BW	MCS Index	Channel		461000	470000	479000	3GPP MPR
		Frequency (MHz)		2305	2350	2395	
10M	DFT-S PI/2 BPSK	1	1	17.62	17.74	17.69	0
10M	DFT-S QPSK	1	1	17.62	17.53	17.72	0
		1	11	17.65	17.74	17.59	0
		1	22	17.66	17.65	17.61	0
		12	0	17.68	17.68	17.67	1
		12	6	17.54	17.63	17.57	0
		12	12	17.05	17.06	17.10	1
		24	0	17.04	17.02	16.98	1
10M	DFT-S 16QAM	1	1	16.57	16.81	16.67	1
10M	DFT-S 64QAM	1	1	15.06	15.30	15.19	2.5
10M	DFT-S 256QAM	1	1	13.14	13.31	13.15	4.5
10M	CP QPSK	1	1	16.12	16.28	16.17	1.5

NR Conducted Power (Laptop)									
NR Band 41_SA									
BW	MCS Index	RB Size	RB Offset	Low	Mid-1	Mid-2	Mid-3	High	3GPP MPR (dB)
		Channel		509202	513900	518598	523302	528000	
		Frequency (MHz)		2546.01	2569.5	2592.99	2616.51	2640	
100M	DFT-S PI/2 BPSK	1	1	16.54	16.65	16.92	16.53	16.62	0
100M	DFT-S QPSK	1	1	16.71	16.68	16.99	16.65	16.73	0
		1	137	16.43	16.32	16.74	16.32	16.18	0
		1	271	16.39	16.28	16.70	16.28	16.14	0
		135	0	15.18	15.07	15.49	15.07	14.93	1
		135	69	16.20	16.09	16.51	16.09	15.95	0
		135	138	15.69	15.58	15.99	15.58	15.44	1
100M	DFT-S 16QAM	1	1	15.58	15.47	15.89	15.47	15.33	1
100M	DFT-S 64QAM	1	1	14.08	13.97	14.39	13.97	13.83	2.5
100M	DFT-S 256QAM	1	1	12.08	11.97	12.39	11.97	11.83	4.5
100M	CP QPSK	1	1	14.88	14.77	15.19	14.77	14.63	1.5
BW	MCS Index	Channel		508200	513402	518598	523800	528996	3GPP MPR
		Frequency (MHz)		2541	2567.01	2592.99	2619	2644.98	
90M	DFT-S PI/2 BPSK	1	1	16.42	16.36	16.89	16.30	16.43	0
90M	DFT-S QPSK	1	1	16.62	16.48	16.95	16.37	16.40	0
		1	123	16.68	16.68	16.76	16.76	16.80	0
		1	243	16.44	16.45	16.69	16.62	16.52	0
		120	0	15.32	15.33	15.39	15.48	15.40	1
		120	63	14.06	13.89	14.02	13.99	13.99	0
		120	125	15.54	15.46	15.72	15.58	15.59	1
90M	DFT-S 16QAM	1	1	15.61	15.53	15.97	15.42	15.33	1
90M	DFT-S 64QAM	1	1	14.04	14.02	14.49	13.90	13.89	2.5
90M	DFT-S 256QAM	1	1	12.11	11.96	12.40	11.96	11.90	4.5
90M	CP QPSK	1	1	15.06	15.04	15.47	14.97	14.92	1.5

NR Conducted Power (Laptop)									
NR Band 41_SA									
BW	MCS Index	Channel		507204	509304	518598	500298	529998	3GPP MPR
		Frequency (MHz)		2536.02	2546.52	2592.99	2621.49	2649.99	
80M	DFT-S PI/2 BPSK	1	1	16.42	16.41	16.84	16.28	16.44	0
80M	DFT-S QPSK	1	1	16.59	16.56	16.91	16.39	16.36	0
		1	109	16.61	16.73	16.80	16.74	16.81	0
		1	215	16.45	16.45	16.61	16.65	16.51	0
		108	0	15.36	15.28	15.42	15.45	15.36	1
		108	55	13.99	13.81	14.02	13.91	13.99	0
		108	109	15.57	15.50	15.67	15.60	15.57	1
80M	DFT-S 16QAM	1	1	15.55	15.53	15.97	15.38	15.34	1
80M	DFT-S 64QAM	1	1	14.10	14.07	14.46	13.89	13.92	2.5
80M	DFT-S 256QAM	1	1	12.03	11.95	12.48	11.88	11.92	4.5
80M	CP QPSK	1	1	15.10	14.97	15.48	14.96	14.94	1.5
BW	MCS Index	Channel		506202	512400	518598	524802	531000	3GPP MPR
		Frequency (MHz)		2531.01	2562	2592.99	2624.01	2655	
70M	DFT-S PI/2 BPSK	1	1	16.50	16.40	16.88	16.32	16.35	0
70M	DFT-S QPSK	1	1	16.61	16.54	16.94	16.43	16.41	0
		1	95	16.62	16.70	16.76	16.77	16.82	0
		1	187	16.38	16.46	16.65	16.59	16.58	0
		90	0	15.31	15.34	15.39	15.40	15.46	1
		90	50	13.99	13.87	13.99	13.90	13.93	0
		90	99	15.56	15.51	15.63	15.58	15.63	1
70M	DFT-S 16QAM	1	1	15.55	15.48	15.99	15.39	15.39	1
70M	DFT-S 64QAM	1	1	14.08	13.99	14.45	13.91	13.87	2.5
70M	DFT-S 256QAM	1	1	12.10	12.02	12.44	11.93	11.93	4.5
70M	CP QPSK	1	1	15.06	14.97	15.50	14.94	14.91	1.5

NR Conducted Power (Laptop)									
NR Band 41_SA									
BW	MCS Index	Channel		505200	511896	518598	525294	531996	3GPP MPR
		Frequency (MHz)		2526	2559.48	2592.99	2626.48	2659.98	
60M	DFT-S PI/2 BPSK	1	1	16.44	16.41	16.87	16.26	16.41	0
60M	DFT-S QPSK	1	1	16.55	16.55	16.92	16.37	16.35	0
		1	81	16.59	16.67	16.78	16.81	16.83	0
		1	160	16.39	16.43	16.66	16.61	16.57	0
		81	0	15.31	15.29	15.40	15.38	15.38	1
		81	41	14.00	13.87	14.00	13.96	13.92	0
		81	81	15.63	15.52	15.70	15.58	15.60	1
60M	DFT-S 16QAM	1	1	15.53	15.53	15.95	15.45	15.33	1
60M	DFT-S 64QAM	1	1	14.01	14.05	14.48	13.96	13.93	2.5
60M	DFT-S 256QAM	1	1	12.06	12.02	12.47	11.94	11.90	4.5
60M	CP QPSK	1	1	15.03	15.03	15.48	14.96	14.90	1.5
BW	MCS Index	Channel		504204	511404	518598	525798	532998	3GPP MPR
		Frequency (MHz)		2521.02	2557.02	2592.99	2628.99	2664.99	
50M	DFT-S PI/2 BPSK	1	1	16.44	16.41	16.88	16.31	16.44	0
50M	DFT-S QPSK	1	1	16.58	16.51	16.94	16.39	16.35	0
		1	67	16.66	16.65	16.82	16.73	16.76	0
		1	131	16.45	16.53	16.64	16.66	16.54	0
		64	0	15.35	15.31	15.4	15.44	15.37	1
		64	35	14.03	13.8	13.99	13.93	13.9	0
		64	69	15.62	15.53	15.65	15.66	15.54	1
50M	DFT-S 16QAM	1	1	15.54	15.54	15.95	15.37	15.4	1
50M	DFT-S 64QAM	1	1	14.02	13.97	14.47	13.9	13.91	2.5
50M	DFT-S 256QAM	1	1	12.08	12.01	12.44	11.96	11.88	4.5
50M	CP QPSK	1	1	15.09	15	15.48	14.88	14.92	1.5

NR Conducted Power (Laptop)									
NR Band 41_SA									
BW	MCS Index	Channel		503202	510900	518598	526296	534000	3GPP MPR
		Frequency (MHz)		2516.01	2554.5	2592.99	2631.48	2670	
40M	DFT-S PI/2 BPSK	1	1	16.43	16.43	16.82	16.33	16.44	0
40M	DFT-S QPSK	1	1	16.58	16.48	16.93	16.39	16.41	0
		1	53	16.64	16.63	16.79	16.81	16.77	0
		1	104	16.45	16.45	16.66	16.66	16.51	0
		50	0	15.35	15.33	15.42	15.47	15.45	1
		50	28	14.01	13.86	13.98	13.89	13.97	0
		50	56	15.58	15.51	15.72	15.64	15.63	1
40M	DFT-S 16QAM	1	1	15.54	15.45	15.96	15.46	15.40	1
40M	DFT-S 64QAM	1	1	14.04	14.05	14.47	13.86	13.95	2.5
40M	DFT-S 256QAM	1	1	12.09	12.02	12.49	11.88	11.89	4.5
40M	CP QPSK	1	1	15.04	15.03	15.48	14.91	14.85	1.5
BW	MCS Index	Channel		501204	509898	518598	527298	535998	3GPP MPR
		Frequency (MHz)		2506.02	2549.49	2592.99	2636.49	2679.99	
20M	DFT-S PI/2 BPSK	1	1	16.49	16.61	16.89	16.49	16.64	0
20M	DFT-S QPSK	1	1	16.64	16.61	16.97	16.61	16.64	0
		1	26	16.41	16.25	16.71	16.36	16.32	0
		1	49	16.32	16.21	16.65	16.35	16.18	0
		25	0	15.14	15.05	15.43	15.09	15.05	1
		25	13	16.11	16.02	16.45	16.10	16.09	0
		25	26	15.59	15.51	15.89	15.59	15.58	1
20M	DFT-S 16QAM	1	1	15.48	15.42	15.89	15.54	15.37	1
20M	DFT-S 64QAM	1	1	14.08	13.96	14.38	14.05	13.89	2.5
20M	DFT-S 256QAM	1	1	12.01	11.97	12.32	11.99	11.91	4.5
20M	CP QPSK	1	1	14.78	14.71	15.16	14.82	14.77	1.5

NR Conducted Power (Laptop)									
NR Band 41_SA									
BW	MCS Index	Channel		500700	509646	518598	527544	536496	3GPP MPR
		Frequency (MHz)		2503.5	2548.23	2592.99	2637.72	2682.48	
15M	DFT-S PI/2 BPSK	1	1	16.52	16.62	16.91	16.45	16.56	0
15M	DFT-S QPSK	1	1	16.65	16.65	16.93	16.67	16.60	0
		1	19	16.39	16.27	16.64	16.34	16.28	0
		1	36	16.31	16.24	16.62	16.30	16.18	0
		18	0	15.16	15.02	15.46	15.17	15.02	1
		18	10	16.19	16.04	16.47	16.15	16.00	0
		18	20	15.66	15.57	15.89	15.64	15.58	1
36	0	15.65	15.57	15.96	15.61	15.54	1		
15M	DFT-S 16QAM	1	1	15.58	15.47	15.81	15.50	15.43	1
15M	DFT-S 64QAM	1	1	14.00	13.90	14.32	14.05	13.91	2.5
15M	DFT-S 256QAM	1	1	12.00	11.96	12.31	12.03	11.91	4.5
15M	CP QPSK	1	1	14.84	14.75	15.16	14.82	14.77	1.5
BW	MCS Index	Channel		500202	509400	518598	527796	537000	3GPP MPR
		Frequency (MHz)		2501.01	2547	2592.99	2638.98	2685	
10M	DFT-S PI/2 BPSK	1	1	16.54	16.56	16.89	16.45	16.57	0
10M	DFT-S QPSK	1	1	16.67	16.65	16.95	16.70	16.58	0
		1	11	16.37	16.25	16.74	16.37	16.22	0
		1	22	16.33	16.24	16.60	16.38	16.19	0
		12	0	15.17	15.07	15.48	15.10	15.01	1
		12	6	16.13	16.08	16.44	16.16	16.01	0
		12	12	15.68	15.52	15.91	15.59	15.52	1
24	0	15.59	15.50	15.93	15.65	15.54	1		
10M	DFT-S 16QAM	1	1	15.53	15.43	15.79	15.48	15.39	1
10M	DFT-S 64QAM	1	1	13.99	13.93	14.37	14.08	13.90	2.5
10M	DFT-S 256QAM	1	1	12.01	11.94	12.33	12.03	11.88	4.5
10M	CP QPSK	1	1	14.87	14.77	15.11	14.86	14.71	1.5

NR Conducted Power (Laptop)									
NR Band 77_SA									
BW	MCS Index	RB Size	RB Offset	Low	Mid-1	Mid-2	Mid-3	High	3GPP MPR (dB)
		Channel		650000	653000	656000	659000	662000	
		Frequency (MHz)		3750	3795	3840	3885	3930	
100M	DFT-S PI/2 BPSK	1	1	20.39	20.34	20.13	19.83	19.60	0
100M	DFT-S QPSK	1	1	20.47	20.49	20.36	20.41	19.93	0
		1	137	20.04	19.99	19.79	19.50	19.28	0
		1	271	19.16	19.11	18.91	18.62	18.40	0
		135	0	19.10	19.05	18.85	18.56	18.34	1
		135	69	20.10	20.17	19.90	19.61	19.39	0
		135	138	18.97	18.92	18.72	18.43	18.21	1
100M	DFT-S 16QAM	1	1	17.90	17.85	17.65	17.36	17.14	1
100M	DFT-S 64QAM	1	1	16.90	16.85	16.65	16.36	16.14	2.5
100M	DFT-S 256QAM	1	1	14.70	14.65	14.45	14.16	13.94	4.5
100M	CP QPSK	1	1	19.01	18.96	18.76	18.47	18.25	1.5
BW	MCS Index	Channel		649668	652834	656000	659166	662332	3GPP MPR
		Frequency (MHz)		3745.02	3792.51	3840	3887.49	3934.98	
90M	DFT-S PI/2 BPSK	1	1	20.33	20.31	20.32	20.26	20.13	0
90M	DFT-S QPSK	1	1	20.42	20.43	20.40	20.43	20.36	0
		1	123	20.03	19.95	19.99	19.98	19.71	0
		1	243	19.15	19.09	19.12	19.04	18.91	0
		120	0	19.08	18.99	19.02	18.96	18.76	1
		120	63	20.05	20.05	20.09	20.09	19.80	0
		120	125	18.95	18.92	18.96	18.86	18.65	1
90M	DFT-S 16QAM	1	1	17.88	17.83	17.89	17.85	17.65	1
90M	DFT-S 64QAM	1	1	16.85	16.80	16.85	16.82	16.65	2.5
90M	DFT-S 256QAM	1	1	14.64	14.56	14.69	14.60	14.36	4.5
90M	CP QPSK	1	1	18.93	18.88	18.99	18.93	18.69	1.5

NR Conducted Power (Laptop)									
NR Band 77_SA									
BW	MCS Index	Channel		649334	652666	656000	659334	662666	3GPP MPR
		Frequency (MHz)		3740.01	3789.99	3840	3890.01	3939.99	
80M	DFT-S PI/2 BPSK	1	1	20.37	20.26	20.08	20.25	20.12	0
80M	DFT-S QPSK	1	1	20.48	20.47	20.36	20.35	20.15	0
		1	109	20.03	19.99	19.71	19.95	19.73	0
		1	215	19.08	19.02	18.91	19.11	18.84	0
		108	0	19.10	18.99	18.76	18.95	18.84	1
		108	55	20.15	20.07	19.85	20.04	19.87	0
		108	109	18.92	18.88	18.71	18.85	18.67	1
80M	DFT-S 16QAM	1	1	17.87	17.80	17.65	17.76	17.62	1
80M	DFT-S 64QAM	1	1	16.87	16.77	16.57	16.80	16.57	2.5
80M	DFT-S 256QAM	1	1	14.64	14.59	14.35	14.62	14.38	4.5
80M	CP QPSK	1	1	18.92	18.88	18.69	18.93	18.68	1.5
BW	MCS Index	Channel		649000	652500	656000	659500	663000	3GPP MPR
		Frequency (MHz)		3735	3787.5	3840	3892.5	3945	
70M	DFT-S PI/2 BPSK	1	1	20.33	20.39	20.27	20.04	20.12	0
70M	DFT-S QPSK	1	1	20.42	20.45	20.38	20.34	20.15	0
		1	95	20.03	19.96	19.97	19.74	19.73	0
		1	187	19.15	19.09	19.07	18.88	18.84	0
		90	0	19.08	19.08	18.97	18.80	18.84	1
		90	50	20.05	20.14	20.00	19.80	19.87	0
		90	99	18.95	18.94	18.87	18.67	18.67	1
70M	DFT-S 16QAM	1	1	17.88	17.81	17.78	17.62	17.62	1
70M	DFT-S 64QAM	1	1	16.85	16.88	16.77	16.55	16.57	2.5
70M	DFT-S 256QAM	1	1	14.64	14.61	14.63	14.35	14.38	4.5
70M	CP QPSK	1	1	18.93	18.92	18.92	18.69	18.68	1.5

NR Conducted Power (Laptop)									
NR Band 77_SA									
BW	MCS Index	Channel		648668	652334	656000	659666	663332	3GPP MPR
		Frequency (MHz)		3730.02	3785.01	3840	3894.99	3949.98	
60M	DFT-S PI/2 BPSK	1	1	20.35	20.26	20.04	20.25	20.12	0
60M	DFT-S QPSK	1	1	20.46	20.38	20.31	20.35	20.15	0
		1	81	19.97	19.93	19.79	19.95	19.73	0
		1	160	19.07	19.10	18.86	19.11	18.84	0
		81	0	19.10	19.01	18.77	18.95	18.84	1
		81	41	20.14	20.09	19.84	20.04	19.87	0
		81	81	18.88	18.91	18.63	18.85	18.67	1
60M	DFT-S 16QAM	1	1	17.84	17.77	17.61	17.76	17.62	1
60M	DFT-S 64QAM	1	1	16.84	16.83	16.55	16.80	16.57	2.5
60M	DFT-S 256QAM	1	1	14.62	14.63	14.40	14.62	14.38	4.5
60M	CP QPSK	1	1	18.96	18.95	18.68	18.93	18.68	1.5
BW	MCS Index	Channel		648334	652166	656000	659834	663666	3GPP MPR
		Frequency (MHz)		3725.01	3782.49	3840	3897.51	3954.99	
50M	DFT-S PI/2 BPSK	1	1	20.33	20.31	20.37	20.28	20.08	0
50M	DFT-S QPSK	1	1	20.42	20.43	20.44	20.45	20.36	0
		1	67	20.03	19.95	20.03	19.95	19.70	0
		1	131	19.15	19.09	19.08	19.06	18.90	0
		64	0	19.08	18.99	19.07	18.97	18.77	1
		64	35	20.05	20.05	20.12	20.04	19.81	0
		64	69	18.95	18.92	18.92	18.83	18.68	1
50M	DFT-S 16QAM	1	1	17.88	17.83	17.87	17.76	17.61	1
50M	DFT-S 64QAM	1	1	16.85	16.80	16.83	16.84	16.64	2.5
50M	DFT-S 256QAM	1	1	14.64	14.56	14.65	14.65	14.38	4.5
50M	CP QPSK	1	1	18.93	18.88	19.00	18.96	18.72	1.5

NR Conducted Power (Laptop)									
NR Band 77_SA									
BW	MCS Index	Channel		648000	652000	656000	660000	664000	3GPP MPR
		Frequency (MHz)		3720	3780	3840	3900	3960	
40M	DFT-S PI/2 BPSK	1	1	20.33	20.34	20.33	20.12	20.12	0
40M	DFT-S QPSK	1	1	20.42	20.41	20.46	20.33	20.15	0
		1	53	20.03	20.01	19.91	19.71	19.73	0
		1	104	19.15	19.14	19.02	18.81	18.84	0
		50	0	19.08	19.04	18.99	18.83	18.84	1
		50	28	20.05	20.07	20.04	19.82	19.87	0
		50	56	18.95	18.96	18.84	18.71	18.67	1
100	0	18.91	18.84	18.85	18.68	18.67	1		
40M	DFT-S 16QAM	1	1	17.88	17.88	17.84	17.61	17.62	1
40M	DFT-S 64QAM	1	1	16.85	16.84	16.85	16.63	16.57	2.5
40M	DFT-S 256QAM	1	1	14.64	14.69	14.56	14.42	14.38	4.5
40M	CP QPSK	1	1	18.93	18.91	18.88	18.76	18.68	1.5
BW	MCS Index	Channel		647668	651834	656000	660166	664332	3GPP MPR
		Frequency (MHz)		3715.02	3777.51	3840	3902.49	3964.98	
30M	DFT-S PI/2 BPSK	1	1	20.37	20.28	20.04	20.25	20.12	0
30M	DFT-S QPSK	1	1	20.42	20.45	20.28	20.35	20.15	0
		1	39	19.96	19.92	19.76	19.95	19.73	0
		1	76	19.08	19.09	18.82	19.11	18.84	0
		36	0	19.05	19.00	18.83	18.95	18.84	1
		36	21	20.15	20.10	19.83	20.04	19.87	0
		36	42	18.91	18.84	18.64	18.85	18.67	1
75	0	18.89	18.87	18.63	18.79	18.67	1		
30M	DFT-S 16QAM	1	1	17.88	17.78	17.62	17.76	17.62	1
30M	DFT-S 64QAM	1	1	16.81	16.77	16.59	16.80	16.57	2.5
30M	DFT-S 256QAM	1	1	14.69	14.55	14.37	14.62	14.38	4.5
30M	CP QPSK	1	1	18.96	18.96	18.66	18.93	18.68	1.5

NR Conducted Power (Laptop)									
NR Band 77_SA									
BW	MCS Index	Channel		647334	651666	656000	660266	664666	3GPP MPR
		Frequency (MHz)		3710.01	3774.99	3840	3903.99	3969.99	
20M	DFT-S PI/2 BPSK	1	1	20.33	20.31	20.30	20.30	20.11	0
20M	DFT-S QPSK	1	1	20.42	20.43	20.46	20.37	20.28	0
		1	26	20.03	19.95	20.01	19.92	19.77	0
		1	49	19.15	19.09	19.10	19.03	18.85	0
		25	0	19.08	18.99	19.10	18.98	18.83	1
		25	13	20.05	20.05	20.16	20.06	19.90	0
		25	26	18.95	18.92	18.89	18.83	18.72	1
		50	0	18.91	18.86	18.93	18.87	18.61	1
20M	DFT-S 16QAM	1	1	17.88	17.83	17.83	17.81	17.64	1
20M	DFT-S 64QAM	1	1	16.85	16.80	16.88	16.76	16.58	2.5
20M	DFT-S 256QAM	1	1	14.64	14.56	14.65	14.64	14.41	4.5
20M	CP QPSK	1	1	18.93	18.88	19.01	18.94	18.66	1.5
BW	MCS Index	Channel		647168	651584	656000	660416	664832	3GPP MPR
		Frequency (MHz)		3707.52	3773.76	3840	3906.24	3972.48	
15M	DFT-S PI/2 BPSK	1	1	20.33	20.32	20.25	20.07	20.12	0
15M	DFT-S QPSK	1	1	20.42	20.42	20.44	20.32	20.15	0
		1	19	20.03	20.00	19.99	19.79	19.73	0
		1	36	19.15	19.12	19.05	18.88	18.84	0
		18	0	19.08	19.10	18.97	18.79	18.84	1
		18	10	20.05	20.15	20.05	19.85	19.87	0
		18	20	18.95	18.89	18.89	18.66	18.67	1
		36	0	18.91	18.87	18.86	18.66	18.67	1
15M	DFT-S 16QAM	1	1	17.88	17.85	17.77	17.61	17.62	1
15M	DFT-S 64QAM	1	1	16.85	16.82	16.75	16.56	16.57	2.5
15M	DFT-S 256QAM	1	1	14.64	14.65	14.60	14.40	14.38	4.5
15M	CP QPSK	1	1	18.93	18.93	18.96	18.68	18.68	1.5

NR Conducted Power (Laptop)									
NR Band 77_SA									
BW	MCS Index	Channel		647000	651500	656000	660500	665000	3GPP MPR
		Frequency (MHz)		3705	3772.5	3840	3907.5	3975	
10M	DFT-S PI/2 BPSK	1	1	20.33	20.27	20.13	20.25	20.12	0
10M	DFT-S QPSK	1	1	20.42	20.43	20.34	20.35	20.15	0
		1	11	20.00	19.91	19.78	19.95	19.73	0
		1	22	19.06	19.03	18.81	19.11	18.84	0
		12	0	19.06	18.97	18.77	18.95	18.84	1
		12	6	20.08	20.07	19.85	20.04	19.87	0
		12	12	18.89	18.91	18.71	18.85	18.67	1
10M	DFT-S 16QAM	1	1	17.80	17.83	17.59	17.76	17.62	1
		1	1	16.88	16.77	16.55	16.80	16.57	2.5
10M	DFT-S 64QAM	1	1	14.69	14.65	14.37	14.62	14.38	4.5
10M	DFT-S 256QAM	1	1	18.96	18.95	18.68	18.93	18.68	1.5
10M	CP QPSK	1	1	18.96	18.95	18.68	18.93	18.68	1.5

NR Conducted Power (Laptop)							
NR Band 78_SA							
BW	MCS Index	RB Size	RB Offset	Low	Mid	High	3GPP MPR (dB)
		Channel			650000		
		Frequency (MHz)			3750		
100M	DFT-S PI/2 BPSK	1	1		20.88		0
100M	DFT-S QPSK	1	1		20.98		0
		1	137		20.58		0
		1	271		20.61		0
		135	0		19.51		1
		135	69		20.78		0
		135	138		19.68		1
100M	DFT-S 16QAM	1	1		19.89		1
100M	DFT-S 64QAM	1	1		18.42		2.5
100M	DFT-S 256QAM	1	1		16.39		4.5
100M	CP QPSK	1	1		19.40		1.5
BW	MCS Index	Channel		649668	650000	650332	3GPP MPR
		Frequency (MHz)		3745.02	3750	3754.98	
90M	DFT-S PI/2 BPSK	1	1	20.74	20.84	20.81	0
90M	DFT-S QPSK	1	1	20.79	20.89	20.84	0
		1	123	20.40	20.48	20.45	0
		1	243	20.53	20.58	20.57	0
		120	0	19.43	19.43	19.34	1
		120	63	20.63	20.68	20.62	0
		120	125	19.61	19.62	19.54	1
90M	DFT-S 16QAM	1	1	19.78	19.88	19.82	1
90M	DFT-S 64QAM	1	1	18.27	18.38	18.32	2.5
90M	DFT-S 256QAM	1	1	16.30	16.38	16.32	4.5
90M	CP QPSK	1	1	19.28	19.38	19.32	1.5

NR Conducted Power (Laptop)							
NR Band 78_SA							
BW	MCS Index	Channel		649334	650000	650666	3GPP MPR
		Frequency (MHz)		3740.01	3750	3759.99	
80M	DFT-S PI/2 BPSK	1	1	20.72	20.76	20.78	0
80M	DFT-S QPSK	1	1	20.74	20.80	20.77	0
		1	109	20.32	20.43	20.35	0
		1	215	20.52	20.55	20.57	0
		108	0	19.36	19.40	19.29	1
		108	55	20.60	20.59	20.62	0
		108	109	19.51	19.58	19.45	1
80M	DFT-S 16QAM	1	1	19.76	19.78	19.78	1
80M	DFT-S 64QAM	1	1	18.17	18.36	18.27	2.5
80M	DFT-S 256QAM	1	1	16.22	16.37	16.23	4.5
80M	CP QPSK	1	1	19.22	19.33	19.24	1.5
BW	MCS Index	Channel		649000	650000	651000	3GPP MPR
		Frequency (MHz)		3735	3750	3765	
70M	DFT-S PI/2 BPSK	1	1	20.71	20.54	20.73	0
70M	DFT-S QPSK	1	1	20.78	20.61	20.75	0
		1	95	20.40	20.27	20.39	0
		1	187	20.52	19.41	20.52	0
		90	0	19.33	18.35	19.33	1
		90	50	20.57	20.43	20.53	0
		90	99	19.51	18.28	19.51	1
70M	DFT-S 16QAM	1	1	19.77	19.52	19.76	1
70M	DFT-S 64QAM	1	1	18.26	18.24	18.24	2.5
70M	DFT-S 256QAM	1	1	16.23	16.30	16.32	4.5
70M	CP QPSK	1	1	19.25	19.37	19.24	1.5

NR Conducted Power (Laptop)							
NR Band 78_SA							
BW	MCS Index	Channel		648668	650000	651332	3GPP MPR
		Frequency (MHz)		3730.02	3750	3769.98	
60M	DFT-S PI/2 BPSK	1	1	20.73	20.74	20.77	0
60M	DFT-S QPSK	1	1	20.74	20.89	20.81	0
		1	81	20.33	20.38	20.37	0
		1	160	20.51	20.56	20.54	0
		81	0	19.33	19.40	19.27	1
		81	41	20.56	20.60	20.54	0
		81	81	19.55	19.56	19.51	1
60M	DFT-S 16QAM	1	1	19.73	19.80	19.75	1
60M	DFT-S 64QAM	1	1	18.24	18.33	18.25	2.5
60M	DFT-S 256QAM	1	1	16.30	16.31	16.30	4.5
60M	CP QPSK	1	1	19.23	19.34	19.32	1.5
BW	MCS Index	Channel		648334	650000	651666	3GPP MPR
		Frequency (MHz)		3725.01	3750	3774.99	
50M	DFT-S PI/2 BPSK	1	1	20.74	20.79	20.80	0
50M	DFT-S QPSK	1	1	20.79	20.86	20.79	0
		1	67	20.34	20.41	20.37	0
		1	131	20.44	20.52	20.50	0
		64	0	19.39	19.39	19.29	1
		64	35	20.54	20.64	20.55	0
		64	69	19.59	19.62	19.48	1
50M	DFT-S 16QAM	1	1	19.74	19.88	19.80	1
50M	DFT-S 64QAM	1	1	18.27	18.33	18.26	2.5
50M	DFT-S 256QAM	1	1	16.20	16.36	16.32	4.5
50M	CP QPSK	1	1	19.18	19.33	19.23	1.5

NR Conducted Power (Laptop)							
NR Band 78_SA							
BW	MCS Index	Channel		648000	650000	652000	3GPP MPR
		Frequency (MHz)		3720	3750	3780	
40M	DFT-S PI/2 BPSK	1	1	20.67	20.82	20.77	0
40M	DFT-S QPSK	1	1	20.79	20.84	20.80	0
		1	53	20.40	20.41	20.38	0
		1	104	20.46	20.52	20.48	0
		50	0	19.38	19.36	19.31	1
		50	28	20.54	20.65	20.57	0
		50	56	19.59	19.54	19.47	1
40M	DFT-S 16QAM	1	1	19.69	19.80	19.73	1
40M	DFT-S 64QAM	1	1	18.19	18.32	18.25	2.5
40M	DFT-S 256QAM	1	1	16.30	16.31	16.27	4.5
40M	CP QPSK	1	1	19.19	19.32	19.27	1.5
BW	MCS Index	Channel		647668	650000	652332	3GPP MPR
		Frequency (MHz)		3715.02	3750	3784.98	
30M	DFT-S PI/2 BPSK	1	1	20.66	20.80	20.80	0
30M	DFT-S QPSK	1	1	20.72	20.84	20.83	0
		1	39	20.39	20.38	20.38	0
		1	76	20.45	20.50	20.48	0
		36	0	19.40	19.43	19.29	1
		36	21	20.58	20.61	20.52	0
		36	42	19.61	19.55	19.51	1
30M	DFT-S 16QAM	1	1	19.74	19.82	19.76	1
30M	DFT-S 64QAM	1	1	18.17	18.29	18.27	2.5
30M	DFT-S 256QAM	1	1	16.21	16.31	16.25	4.5
30M	CP QPSK	1	1	19.24	19.32	19.28	1.5

NR Conducted Power (Laptop)							
NR Band 78_SA							
BW	MCS Index	Channel		647334	650000	652666	3GPP MPR
		Frequency (MHz)		3710.01	3750	3789.99	
20M	DFT-S PI/2 BPSK	1	1	20.68	20.83	20.80	0
20M	DFT-S QPSK	1	1	20.73	20.79	20.84	0
		1	26	20.40	20.47	20.36	0
		1	49	20.51	20.53	20.47	0
		25	0	19.34	19.41	19.32	1
		25	13	20.63	20.64	20.59	0
		25	26	19.61	19.61	19.52	1
20M	DFT-S 16QAM	1	1	19.68	19.85	19.72	1
20M	DFT-S 64QAM	1	1	18.19	18.32	18.24	2.5
20M	DFT-S 256QAM	1	1	16.25	16.34	16.25	4.5
20M	CP QPSK	1	1	19.23	19.30	19.27	1.5
BW	MCS Index	Channel		647168	650000	652832	3GPP MPR
		Frequency (MHz)		3707.52	3750	3792.48	
15M	DFT-S PI/2 BPSK	1	1	20.72	20.74	20.72	0
15M	DFT-S QPSK	1	1	20.76	20.87	20.81	0
		1	19	20.34	20.48	20.37	0
		1	36	20.44	20.57	20.48	0
		18	0	19.42	19.39	19.27	1
		18	10	20.57	20.65	20.61	0
		18	20	19.61	19.62	19.48	1
15M	DFT-S 16QAM	1	1	19.68	19.82	19.82	1
15M	DFT-S 64QAM	1	1	18.18	18.28	18.22	2.5
15M	DFT-S 256QAM	1	1	16.29	16.34	16.29	4.5
15M	CP QPSK	1	1	19.18	19.37	19.30	1.5

NR Conducted Power (Laptop)							
NR Band 78_SA							
BW	MCS Index	Channel		647000	650000	653000	3GPP MPR
		Frequency (MHz)		3705	3750	3795	
10M	DFT-S PI/2 BPSK	1	1	20.64	20.77	20.76	0
10M	DFT-S QPSK	1	1	20.76	20.86	20.74	0
		1	11	20.38	20.45	20.44	0
		1	22	20.51	20.48	20.57	0
		12	0	19.35	19.41	19.32	1
		12	6	20.57	20.65	20.56	0
		12	12	19.55	19.54	19.54	1
		24	0	19.57	19.60	19.57	1
10M	DFT-S 16QAM	1	1	19.77	19.82	19.78	1
10M	DFT-S 64QAM	1	1	18.18	18.37	18.30	2.5
10M	DFT-S 256QAM	1	1	16.26	16.35	16.31	4.5
10M	CP QPSK	1	1	19.24	19.34	19.27	1.5

NR Conducted Power (Reduction_Tablet)

NR Band 2_SA							
BW	MCS Index	RB Size	RB Offset	Low	Mid	High	3GPP MPR (dB)
		Channel		372000	376000	380000	
		Frequency (MHz)		1860	1880	1900	
20M	DFT-S PI/2 BPSK	1	1	12.39	12.73	12.51	0
20M	DFT-S QPSK	1	1	12.89	12.95	12.87	0
		1	53	12.28	12.62	12.40	0
		1	104	12.22	12.56	12.34	0
		50	0	11.23	11.57	11.35	1
		50	28	12.39	12.73	12.51	0
		50	56	11.44	11.78	11.56	1
		100	0	11.33	11.67	11.45	1
20M	DFT-S 16QAM	1	1	11.39	11.73	11.51	1
20M	DFT-S 64QAM	1	1	9.89	10.23	10.01	2.5
20M	DFT-S 256QAM	1	1	7.89	8.23	8.01	4.5
20M	CP QPSK	1	1	10.69	11.03	10.81	1.5
BW	MCS Index	Channel		371500	376000	380500	3GPP MPR
		Frequency (MHz)		1857.5	1880	1902.5	
15M	DFT-S PI/2 BPSK	1	1	12.39	12.72	12.44	0
15M	DFT-S QPSK	1	1	12.46	12.74	12.54	0
		1	40	12.22	12.57	12.34	0
		1	77	12.19	12.52	12.27	0
		36	0	11.22	11.49	11.25	1
		36	22	12.32	12.66	12.49	0
		36	43	11.42	11.69	11.55	1
		75	0	11.32	11.66	11.43	1
15M	DFT-S 16QAM	1	1	11.35	11.69	11.47	1
15M	DFT-S 64QAM	1	1	9.88	10.14	9.99	2.5
15M	DFT-S 256QAM	1	1	7.86	8.23	7.96	4.5
15M	CP QPSK	1	1	10.64	11.02	10.76	1.5

NR Conducted Power (Reduction_Tablet)

NR Band 2_SA

BW	MCS Index	Channel		371000	376000	381000	3GPP MPR
		Frequency (MHz)		1855	1880	1905	
10M	DFT-S PI/2 BPSK	1	1	12.33	12.67	12.42	0
10M	DFT-S QPSK	1	1	12.48	12.81	12.57	0
		1	26	12.20	12.59	12.31	0
		1	50	12.17	12.47	12.28	0
		25	0	11.13	11.49	11.30	1
		25	14	12.37	12.67	12.47	0
		25	27	11.38	11.76	11.55	1
10M	DFT-S 16QAM	1	1	11.37	11.67	11.47	1
10M	DFT-S 64QAM	1	1	9.88	10.13	9.92	2.5
10M	DFT-S 256QAM	1	1	7.88	8.22	8.01	4.5
10M	CP QPSK	1	1	10.63	10.98	10.78	1.5
BW	MCS Index	Channel		370500	376000	381500	3GPP MPR
		Frequency (MHz)		1852.5	1880	1907.5	
5M	DFT-S PI/2 BPSK	1	1	12.33	12.71	12.42	0
5M	DFT-S QPSK	1	1	12.49	12.80	12.56	0
		1	13	12.23	12.60	12.32	0
		1	23	12.18	12.51	12.24	0
		12	0	11.23	11.47	11.30	1
		12	7	12.37	12.68	12.44	0
		12	13	11.41	11.72	11.49	1
5M	DFT-S 16QAM	1	1	11.34	11.69	11.48	1
5M	DFT-S 64QAM	1	1	9.80	10.17	9.98	2.5
5M	DFT-S 256QAM	1	1	7.84	8.22	7.98	4.5
5M	CP QPSK	1	1	10.67	10.95	10.77	1.5

NR Conducted Power (Reduction_Tablet)

NR Band 5_SA							
BW	MCS Index	RB Size	RB Offset	Low	Mid	High	3GPP MPR (dB)
		Channel		166800	167300	167800	
		Frequency (MHz)		834	836.5	839	
20M	DFT-S PI/2 BPSK	1	1	18.57	18.87	18.77	0
20M	DFT-S QPSK	1	1	18.67	18.97	18.87	0
		1	53	18.16	18.46	18.36	0
		1	104	18.03	18.33	18.23	0
		50	0	17.02	17.32	17.22	1
		50	28	18.07	18.37	18.27	0
		50	56	16.87	17.17	17.07	1
100	0	16.91	17.21	17.11	1		
20M	DFT-S 16QAM	1	1	17.57	17.87	17.77	1
20M	DFT-S 64QAM	1	1	16.07	16.37	16.27	2.5
20M	DFT-S 256QAM	1	1	14.07	14.37	14.27	4.5
20M	CP QPSK	1	1	16.87	17.17	17.07	1.5
BW	MCS Index	Channel		166300	167300	168300	3GPP MPR
		Frequency (MHz)		831.5	836.5	841.5	
15M	DFT-S PI/2 BPSK	1	1	18.53	18.79	18.68	0
15M	DFT-S QPSK	1	1	18.62	18.93	18.81	0
		1	40	18.16	18.43	18.34	0
		1	77	17.95	18.32	18.16	0
		36	0	16.98	17.28	17.15	1
		36	22	18.03	18.33	18.17	0
		36	43	16.78	17.07	16.98	1
75	0	16.86	17.12	17.06	1		
15M	DFT-S 16QAM	1	1	17.48	17.82	17.69	1
15M	DFT-S 64QAM	1	1	15.98	16.30	16.24	2.5
15M	DFT-S 256QAM	1	1	14.06	14.32	14.24	4.5
15M	CP QPSK	1	1	16.82	17.14	16.98	1.5

NR Conducted Power (Reduction_Tablet)

NR Band 5_SA

BW	MCS Index	Channel		165800	167300	168800	3GPP MPR
		Frequency (MHz)		829	836.5	844	
10M	DFT-S PI/2 BPSK	1	1	18.47	18.83	18.71	0
10M	DFT-S QPSK	1	1	18.60	18.91	18.83	0
		1	26	18.11	18.45	18.28	0
		1	50	17.98	18.24	18.17	0
		25	0	16.95	17.29	17.12	1
		25	14	17.97	18.30	18.24	0
		25	27	16.78	17.07	16.98	1
50	0	16.88	17.13	17.01	1		
10M	DFT-S 16QAM	1	1	17.48	17.82	17.69	1
10M	DFT-S 64QAM	1	1	15.98	16.29	16.21	2.5
10M	DFT-S 256QAM	1	1	14.02	14.36	14.22	4.5
10M	CP QPSK	1	1	16.83	17.09	17.03	1.5
BW	MCS Index	Channel		165300	167300	169300	3GPP MPR
		Frequency (MHz)		826.5	836.5	846.5	
5M	DFT-S PI/2 BPSK	1	1	18.51	18.77	18.73	0
5M	DFT-S QPSK	1	1	18.58	18.90	18.87	0
		1	13	18.13	18.43	18.32	0
		1	23	18.01	18.29	18.15	0
		12	0	17.02	17.22	17.17	1
		12	7	18.06	18.35	18.24	0
		12	13	16.80	17.13	17.00	1
25	0	16.85	17.18	17.01	1		
5M	DFT-S 16QAM	1	1	17.48	17.83	17.72	1
5M	DFT-S 64QAM	1	1	16.06	16.30	16.24	2.5
5M	DFT-S 256QAM	1	1	14.00	14.32	14.20	4.5
5M	CP QPSK	1	1	16.85	17.08	17.04	1.5

NR Conducted Power (Reduction_Tablet)

NR Band 7_SA

BW	MCS Index	Channel		502000	507000	512000	3GPP MPR
		Frequency (MHz)		2510	2535	2560	
20M	DFT-S PI/2 BPSK	1	1	10.65	10.67	10.58	0
20M	DFT-S QPSK	1	1	10.75	10.77	10.68	0
		1	53	10.64	10.66	10.57	0
		1	104	10.60	10.62	10.53	0
		50	0	10.39	10.41	10.32	1
		50	28	10.69	10.71	10.62	0
		50	56	10.45	10.47	10.38	1
100	0	10.43	10.45	10.36	1		
20M	DFT-S 16QAM	1	1	9.65	9.67	9.58	1
20M	DFT-S 64QAM	1	1	8.15	8.17	8.08	2.5
20M	DFT-S 256QAM	1	1	6.15	6.17	6.08	4.5
20M	CP QPSK	1	1	8.95	8.97	8.88	1.5
BW	MCS Index	Channel		501500	507000	512500	3GPP MPR
		Frequency (MHz)		2507.5	2535	2562.5	
15M	DFT-S PI/2 BPSK	1	1	10.58	10.63	10.50	0
15M	DFT-S QPSK	1	1	10.75	10.76	10.63	0
		1	40	10.54	10.57	10.53	0
		1	77	10.58	10.55	10.50	0
		36	0	10.31	10.34	10.28	1
		36	22	10.64	10.61	10.54	0
		36	43	10.35	10.44	10.37	1
75	0	10.37	10.38	10.35	1		
15M	DFT-S 16QAM	1	1	9.56	9.67	9.49	1
15M	DFT-S 64QAM	1	1	8.12	8.07	8.07	2.5
15M	DFT-S 256QAM	1	1	6.11	6.10	5.98	4.5
15M	CP QPSK	1	1	8.94	8.90	8.80	1.5

NR Conducted Power (Reduction_Tablet)

NR Band 7_SA							
BW	MCS Index	Channel		501000	507000	513000	3GPP MPR
		Frequency (MHz)		2505	2535	2565	
10M	DFT-S PI/2 BPSK	1	1	10.61	10.63	10.54	0
10M	DFT-S QPSK	1	1	10.68	10.70	10.59	0
		1	26	10.63	10.63	10.47	0
		1	50	10.57	10.60	10.45	0
		25	0	10.31	10.40	10.26	1
		25	14	10.66	10.67	10.57	0
		25	27	10.40	10.44	10.38	1
10M	DFT-S 16QAM	1	1	9.62	9.58	9.51	1
10M	DFT-S 64QAM	1	1	8.15	8.13	8.08	2.5
10M	DFT-S 256QAM	1	1	6.15	6.13	6.06	4.5
10M	CP QPSK	1	1	8.94	8.88	8.82	1.5
BW	MCS Index	Channel		500500	507000	513500	3GPP MPR
		Frequency (MHz)		2502.5	2535	2567.5	
5M	DFT-S PI/2 BPSK	1	1	10.55	10.65	10.55	0
5M	DFT-S QPSK	1	1	10.73	10.74	10.65	0
		1	13	10.63	10.62	10.56	0
		1	23	10.58	10.60	10.48	0
		12	0	10.39	10.35	10.32	1
		12	7	10.60	10.63	10.61	0
		12	13	10.45	10.46	10.28	1
5M	DFT-S 16QAM	1	1	9.55	9.63	9.55	1
5M	DFT-S 64QAM	1	1	8.12	8.09	8.02	2.5
5M	DFT-S 256QAM	1	1	6.13	6.12	5.99	4.5
5M	CP QPSK	1	1	8.87	8.94	8.81	1.5

NR Conducted Power (Reduction_Tablet)

NR Band 25_SA							
BW	MCS Index	Channel		372000	376500	381000	3GPP MPR
		Frequency (MHz)		1860	1882.5	1905	
20M	DFT-S PI/2 BPSK	1	1	12.74	12.76	12.83	0
20M	DFT-S QPSK	1	1	12.74	12.89	12.98	0
		1	53	12.69	12.81	12.88	0
		1	104	12.71	12.73	12.80	0
		50	0	11.82	11.84	11.91	1
		50	28	12.81	12.83	12.90	0
		50	56	11.77	11.79	11.86	1
		100	0	11.81	11.83	11.90	1
20M	DFT-S 16QAM	1	1	11.74	11.76	11.83	1
20M	DFT-S 64QAM	1	1	10.24	10.26	10.33	2.5
20M	DFT-S 256QAM	1	1	8.24	8.26	8.33	4.5
20M	CP QPSK	1	1	11.04	11.06	11.13	1.5
BW	MCS Index	Channel		371500	376500	381500	3GPP MPR
		Frequency (MHz)		1857.5	1882.5	1907.5	
15M	DFT-S PI/2 BPSK	1	1	12.65	12.69	12.78	0
15M	DFT-S QPSK	1	1	12.74	12.83	12.88	0
		1	40	12.76	12.73	12.88	0
		1	77	12.62	12.72	12.71	0
		36	0	11.78	11.79	11.89	1
		36	22	12.80	12.78	12.90	0
		36	43	11.69	11.79	11.76	1
		75	0	11.79	11.78	11.89	1
15M	DFT-S 16QAM	1	1	11.73	11.74	11.81	1
15M	DFT-S 64QAM	1	1	10.21	10.17	10.25	2.5
15M	DFT-S 256QAM	1	1	8.19	8.16	8.28	4.5
15M	CP QPSK	1	1	11.03	10.96	11.09	1.5

NR Conducted Power (Reduction_Tablet)

NR Band 25_SA

BW	MCS Index	Channel		371000	376500	382000	3GPP MPR
		Frequency (MHz)		1855	1882.5	1910	
10M	DFT-S PI/2 BPSK	1	1	12.74	12.69	12.78	0
10M	DFT-S QPSK	1	1	12.79	12.80	12.85	0
		1	26	12.72	12.71	12.85	0
		1	50	12.64	12.70	12.79	0
		25	0	11.74	11.84	11.88	1
		25	14	12.80	12.79	12.88	0
		25	27	11.70	11.77	11.84	1
10M	DFT-S 16QAM	1	1	11.72	11.76	11.75	1
10M	DFT-S 64QAM	1	1	10.21	10.24	10.27	2.5
10M	DFT-S 256QAM	1	1	8.20	8.25	8.25	4.5
10M	CP QPSK	1	1	10.94	10.98	11.10	1.5
BW	MCS Index	Channel		370500	376500	382500	3GPP MPR
		Frequency (MHz)		1852.5	1882.5	1912.5	
5M	DFT-S PI/2 BPSK	1	1	12.72	12.66	12.75	0
5M	DFT-S QPSK	1	1	12.74	12.79	12.84	0
		1	13	12.78	12.78	12.82	0
		1	23	12.65	12.73	12.76	0
		12	0	11.80	11.84	11.85	1
		12	7	12.81	12.81	12.80	0
		12	13	11.68	11.72	11.85	1
5M	DFT-S 16QAM	1	1	11.74	11.72	11.80	1
5M	DFT-S 64QAM	1	1	10.24	10.21	10.25	2.5
5M	DFT-S 256QAM	1	1	8.17	8.19	8.31	4.5
5M	CP QPSK	1	1	11.01	11.01	11.08	1.5

NR Conducted Power (Reduction_Tablet)

NR Band 30_SA							
BW	MCS Index	RB Size	RB Offset		Mid		3GPP MPR (dB)
		Channel			462000		
		Frequency (MHz)			2310		
10M	DFT-S PI/2 BPSK	1	1		11.91		0
10M	DFT-S QPSK	1	1		11.95		0
		1	26		11.79		0
		1	50		11.71		0
		25	0		10.71		1
		25	14		11.75		0
		25	27		10.7		1
		50	0		10.65		1
10M	DFT-S 16QAM	1	1		10.97		1
10M	DFT-S 64QAM	1	1		9.47		2.5
10M	DFT-S 256QAM	1	1		7.47		4.5
10M	CP QPSK	1	1		10.27		1.5
BW	MCS Index	Channel		461500	462000	462500	3GPP MPR
		Frequency (MHz)		2307.5	2310	2312.5	
5M	DFT-S PI/2 BPSK	1	1	11.92	11.87	11.91	0
5M	DFT-S QPSK	1	1	11.87	11.88	11.82	0
		1	13	11.79	11.77	11.77	0
		1	23	11.65	11.71	11.64	0
		12	0	10.69	10.61	10.70	1
		12	7	11.75	11.66	11.72	0
		12	13	10.68	10.67	10.62	1
		25	0	10.58	10.58	10.63	1
5M	DFT-S 16QAM	1	1	10.97	10.91	10.88	1
5M	DFT-S 64QAM	1	1	9.42	9.46	9.44	2.5
5M	DFT-S 256QAM	1	1	7.41	7.40	7.38	4.5
5M	CP QPSK	1	1	10.18	10.17	10.25	1.5

NR Conducted Power (Reduction_Tablet)

NR Band 66_SA							
BW	MCS Index	RB Size	RB Offset	Low	Mid	High	3GPP MPR (dB)
		Channel		346000	349000	352000	
		Frequency (MHz)		1730	1745	1760	
40M	DFT-S PI/2 BPSK	1	1	13.18	13.41	13.21	0
40M	DFT-S QPSK	1	1	13.57	13.62	13.61	0
		1	108	13.04	13.07	13.05	0
		1	214	13.41	13.43	13.39	0
		108	0	12.39	12.49	12.45	1
		108	54	12.76	12.84	12.74	0
		108	108	11.59	11.65	11.59	1
		216	0	11.65	11.67	11.61	1
40M	DFT-S 16QAM	1	1	12.28	12.39	12.30	1
40M	DFT-S 64QAM	1	1	10.74	10.97	10.77	2.5
40M	DFT-S 256QAM	1	1	8.80	9.01	8.77	4.5
40M	CP QPSK	1	1	11.75	11.99	11.78	1.5
BW	MCS Index	Channel		344000	349000	354000	3GPP MPR
		Frequency (MHz)		1720	1745	1770	
20M	DFT-S PI/2 BPSK	1	1	13.17	13.36	13.20	0
20M	DFT-S QPSK	1	1	13.15	13.39	13.22	0
		1	53	12.97	12.99	13.02	0
		1	104	13.42	13.39	13.36	0
		50	0	12.31	12.49	12.44	1
		50	28	12.74	12.78	12.66	0
		50	56	11.57	11.64	11.58	1
		100	0	11.61	11.60	11.58	1
20M	DFT-S 16QAM	1	1	12.24	12.32	12.25	1
20M	DFT-S 64QAM	1	1	10.73	10.90	10.70	2.5
20M	DFT-S 256QAM	1	1	8.70	8.93	8.72	4.5
20M	CP QPSK	1	1	11.68	11.90	11.75	1.5

NR Conducted Power (Reduction_Tablet)

NR Band 66_SA

BW	MCS Index	Channel		344000	349000	354000	3GPP MPR
		Frequency (MHz)		1720	1745	1770	
20M	DFT-S PI/2 BPSK	1	1	13.17	13.36	13.20	0
20M	DFT-S QPSK	1	1	13.15	13.39	13.22	0
		1	53	12.97	12.99	13.02	0
		1	104	13.42	13.39	13.36	0
		50	0	12.31	12.49	12.44	1
		50	28	12.74	12.78	12.66	0
		50	56	11.57	11.64	11.58	1
		100	0	11.61	11.60	11.58	1
20M	DFT-S 16QAM	1	1	12.24	12.32	12.25	1
20M	DFT-S 64QAM	1	1	10.73	10.90	10.70	2.5
20M	DFT-S 256QAM	1	1	8.70	8.93	8.72	4.5
20M	CP QPSK	1	1	11.68	11.90	11.75	1.5

NR Conducted Power (Reduction_Tablet)

NR Band 66_SA

BW	MCS Index	Channel		343500	349000	354500	3GPP MPR
		Frequency (MHz)		1717.5	1745	1772.5	
15M	DFT-S PI/2 BPSK	1	1	13.09	13.37	13.11	0
15M	DFT-S QPSK	1	1	13.22	13.42	13.24	0
		1	40	13.03	12.98	12.99	0
		1	77	13.40	13.43	13.34	0
		36	0	12.29	12.45	12.45	1
		36	22	12.66	12.79	12.72	0
		36	43	11.54	11.64	11.57	1
		75	0	11.62	11.60	11.54	1
15M	DFT-S 16QAM	1	1	12.18	12.33	12.26	1
15M	DFT-S 64QAM	1	1	10.72	10.96	10.67	2.5
15M	DFT-S 256QAM	1	1	8.77	9.01	8.69	4.5
15M	CP QPSK	1	1	11.65	11.98	11.77	1.5
BW	MCS Index	Channel		343000	349000	355000	3GPP MPR
		Frequency (MHz)		1715	1745	1775	
10M	DFT-S PI/2 BPSK	1	1	13.17	13.40	13.15	0
10M	DFT-S QPSK	1	1	13.21	13.39	13.28	0
		1	26	12.97	12.99	12.95	0
		1	50	13.35	13.39	13.34	0
		25	0	12.36	12.47	12.39	1
		25	14	12.70	12.76	12.68	0
		25	27	11.50	11.64	11.53	1
		50	0	11.65	11.63	11.59	1
10M	DFT-S 16QAM	1	1	12.19	12.38	12.24	1
10M	DFT-S 64QAM	1	1	10.64	10.94	10.69	2.5
10M	DFT-S 256QAM	1	1	8.76	8.91	8.76	4.5
10M	CP QPSK	1	1	11.72	11.89	11.71	1.5

NR Conducted Power (Reduction_Tablet)

NR Band 66_SA							
BW	MCS Index	Channel		342500	349000	355500	3GPP MPR
		Frequence (MHz)		1712.5	1745	1777.5	
5M	DFT-S PI/2 BPSK	1	1	13.13	13.40	13.18	0
5M	DFT-S QPSK	1	1	13.21	13.43	13.18	0
		1	13	12.98	13.06	12.96	0
		1	23	13.34	13.42	13.34	0
		12	0	12.31	12.49	12.40	1
		12	7	12.74	12.75	12.73	0
		12	13	11.55	11.62	11.49	1
5M	DFT-S 16QAM	1	1	12.27	12.30	12.25	1
5M	DFT-S 64QAM	1	1	10.70	10.97	10.70	2.5
5M	DFT-S 256QAM	1	1	8.78	8.99	8.75	4.5
5M	CP QPSK	1	1	11.67	11.99	11.77	1.5

NR Conducted Power (Reduction_Tablet)

NR Band 71_SA							
BW	MCS Index	RB Size	RB Offset	Low	Mid	High	3GPP MPR (dB)
		Channel		134600	136100	137600	
		Frequency (MHz)		673	680.5	688	
20M	DFT-S PI/2 BPSK	1	1	16.31	16.41	16.33	0
20M	DFT-S QPSK	1	1	16.79	16.80	16.66	0
		1	53	15.60	15.63	15.61	0
		1	104	15.56	15.56	15.52	0
		50	0	14.55	14.65	14.61	1
		50	28	15.63	15.71	15.61	0
		50	56	14.75	14.81	14.75	1
		100	0	14.66	14.68	14.62	1
20M	DFT-S 16QAM	1	1	15.42	15.52	15.43	1
20M	DFT-S 64QAM	1	1	13.88	13.97	13.90	2.5
20M	DFT-S 256QAM	1	1	11.94	12.01	11.90	4.5
20M	CP QPSK	1	1	14.89	14.99	14.91	1.5
BW	MCS Index	Channel		134100	136100	138100	3GPP MPR
		Frequency (MHz)		670.5	680.5	690.5	
15M	DFT-S PI/2 BPSK	1	1	16.24	16.38	16.32	0
15M	DFT-S QPSK	1	1	16.29	16.46	16.39	0
		1	40	15.58	15.57	15.60	0
		1	77	15.55	15.54	15.51	0
		36	0	14.54	14.59	14.55	1
		36	22	15.54	15.69	15.54	0
		36	43	14.74	14.73	14.66	1
		75	0	14.63	14.68	14.59	1
15M	DFT-S 16QAM	1	1	15.35	15.51	15.43	1
15M	DFT-S 64QAM	1	1	13.79	13.87	13.81	2.5
15M	DFT-S 256QAM	1	1	11.87	12.01	11.87	4.5
15M	CP QPSK	1	1	14.85	14.96	14.89	1.5

NR Conducted Power (Reduction_Tablet)

NR Band 71_SA

BW	MCS Index	Channel		133600	136100	138600	3GPP MPR
		Frequency (MHz)		668	680.5	693	
10M	DFT-S PI/2 BPSK	1	1	16.22	16.37	16.32	0
10M	DFT-S QPSK	1	1	16.34	16.43	16.39	0
		1	26	15.54	15.56	15.59	0
		1	50	15.55	15.49	15.49	0
		25	0	14.52	14.61	14.61	1
		25	14	15.58	15.62	15.61	0
		25	27	14.66	14.73	14.67	1
10M	DFT-S 16QAM	1	1	15.34	15.47	15.35	1
10M	DFT-S 64QAM	1	1	13.78	13.96	13.82	2.5
10M	DFT-S 256QAM	1	1	11.84	11.94	11.83	4.5
10M	CP QPSK	1	1	14.84	14.96	14.90	1.5
BW	MCS Index	Channel		133100	136100	139100	3GPP MPR
		Frequency (MHz)		665.5	680.5	695.5	
5M	DFT-S PI/2 BPSK	1	1	16.24	16.33	16.24	0
5M	DFT-S QPSK	1	1	16.32	16.46	16.35	0
		1	13	15.55	15.61	15.55	0
		1	23	15.47	15.47	15.45	0
		12	0	14.55	14.62	14.58	1
		12	7	15.61	15.62	15.59	0
		12	13	14.69	14.81	14.74	1
5M	DFT-S 16QAM	1	1	15.38	15.46	15.35	1
5M	DFT-S 64QAM	1	1	13.84	13.91	13.82	2.5
5M	DFT-S 256QAM	1	1	11.85	11.94	11.83	4.5
5M	CP QPSK	1	1	14.84	14.92	14.82	1.5

NR Conducted Power (Reduction_Tablet)							
NR Band 38_SA							
BW	MCS Index	Channel		516000	519000	522000	3GPP MPR
		Frequency (MHz)		2580	2595	2610	
20M	DFT-S PI/2 BPSK	1	1	12.24	12.32	12.31	0
20M	DFT-S QPSK	1	1	12.44	12.72	12.34	0
		1	26	11.56	11.63	11.61	0
		1	49	11.44	11.51	11.49	0
		25	0	10.55	10.62	10.60	1
		25	13	11.66	11.83	11.71	0
		25	26	11.40	11.47	11.45	1
50	0	11.38	11.45	11.43	1		
20M	DFT-S 16QAM	1	1	11.23	11.31	11.30	1
20M	DFT-S 64QAM	1	1	9.73	9.81	9.80	2.5
20M	DFT-S 256QAM	1	1	7.73	7.81	7.80	4.5
20M	CP QPSK	1	1	10.53	10.61	10.60	1.5
BW	MCS Index	Channel		515500	519000	522500	3GPP MPR
		Frequency (MHz)		2577.5	2595	2612.5	
15M	DFT-S PI/2 BPSK	1	1	12.22	12.30	12.28	0
15M	DFT-S QPSK	1	1	12.28	12.32	12.37	0
		1	19	11.47	11.60	11.61	0
		1	36	11.34	11.43	11.47	0
		18	0	10.53	10.60	10.51	1
		18	10	11.42	11.51	11.45	0
		18	20	11.33	11.46	11.35	1
36	0	11.35	11.41	11.36	1		
15M	DFT-S 16QAM	1	1	11.18	11.21	11.22	1
15M	DFT-S 64QAM	1	1	9.71	9.77	9.80	2.5
15M	DFT-S 256QAM	1	1	7.69	7.79	7.76	4.5
15M	CP QPSK	1	1	10.49	10.52	10.51	1.5

NR Conducted Power (Reduction_Tablet)							
NR Band 38_SA							
BW	MCS Index	Channel		515000	519000	523000	3GPP MPR
		Frequency (MHz)		2575	2595	2615	
10M	DFT-S PI/2 BPSK	1	1	12.18	12.25	12.27	0
10M	DFT-S QPSK	1	1	12.30	12.31	12.33	0
		1	11	11.51	11.55	11.60	0
		1	22	11.38	11.44	11.42	0
		12	0	10.52	10.58	10.57	1
		12	6	11.44	11.49	11.50	0
		12	12	11.34	11.40	11.35	1
10M	DFT-S 16QAM	1	1	11.18	11.23	11.28	1
10M	DFT-S 64QAM	1	1	9.63	9.79	9.70	2.5
10M	DFT-S 256QAM	1	1	7.72	7.80	7.73	4.5
10M	CP QPSK	1	1	10.50	10.55	10.59	1.5

NR Conducted Power (Reduction_Tablet)							
NR Band 40_SA							
BW	MCS Index	Channel		468000	470000	472000	3GPP MPR
		Frequency (MHz)		2340	2350	2360	
80M	DFT-S PI/2 BPSK	1	1	13.14	13.28	13.15	0
80M	DFT-S QPSK	1	1	13.37	13.46	13.39	0
		1	109	13.20	13.34	13.19	0
		1	215	12.48	12.62	12.47	0
		108	0	12.46	12.60	12.45	1
		108	55	13.17	13.31	13.16	0
		108	109	12.18	12.32	12.17	1
80M	DFT-S 16QAM	1	1	12.13	12.27	12.14	1
80M	DFT-S 64QAM	1	1	10.63	10.77	10.64	2.5
80M	DFT-S 256QAM	1	1	8.63	8.77	8.64	4.5
80M	CP QPSK	1	1	11.43	11.57	11.44	1.5
BW	MCS Index	Channel		466000	470000	474000	3GPP MPR
		Frequency (MHz)		2330	2350	2370	
60M	DFT-S PI/2 BPSK	1	1	13.05	13.21	13.05	0
60M	DFT-S QPSK	1	1	13.23	13.30	13.20	0
		1	81	13.13	13.24	13.17	0
		1	160	12.38	12.56	12.46	0
		81	0	12.42	12.60	12.41	1
		81	41	13.14	13.23	13.11	0
		81	81	12.15	12.29	12.11	1
60M	DFT-S 16QAM	1	1	12.09	12.21	12.06	1
60M	DFT-S 64QAM	1	1	10.56	10.76	10.61	2.5
60M	DFT-S 256QAM	1	1	8.61	8.73	8.62	4.5
60M	CP QPSK	1	1	11.39	11.53	11.36	1.5

NR Conducted Power (Reduction_Tablet)							
NR Band 40_SA							
BW	MCS Index	Channel		465000	470000	475000	3GPP MPR
		Frequency (MHz)		2325	2350	2375	
50M	DFT-S PI/2 BPSK	1	1	13.11	13.19	13.15	0
50M	DFT-S QPSK	1	1	13.14	13.33	13.18	0
		1	67	13.15	13.26	13.16	0
		1	131	12.41	12.58	12.47	0
		64	0	12.46	12.59	12.37	1
		64	35	13.07	13.31	13.07	0
		64	69	12.13	12.30	12.12	1
50M	DFT-S 16QAM	1	1	12.11	12.17	12.13	1
50M	DFT-S 64QAM	1	1	10.53	10.68	10.58	2.5
50M	DFT-S 256QAM	1	1	8.59	8.68	8.59	4.5
50M	CP QPSK	1	1	11.42	11.48	11.37	1.5
BW	MCS Index	Channel		464000	470000	476000	3GPP MPR
		Frequency (MHz)		2320	2350	2380	
40M	DFT-S PI/2 BPSK	1	1	13.13	13.22	13.08	0
40M	DFT-S QPSK	1	1	13.15	13.33	13.23	0
		1	53	13.14	13.34	13.09	0
		1	104	12.40	12.57	12.42	0
		50	0	12.40	12.52	12.42	1
		50	28	13.10	13.30	13.07	0
		50	56	12.16	12.26	12.14	1
40M	DFT-S 16QAM	1	1	12.07	12.27	12.07	1
40M	DFT-S 64QAM	1	1	10.62	10.76	10.61	2.5
40M	DFT-S 256QAM	1	1	8.53	8.70	8.56	4.5
40M	CP QPSK	1	1	11.36	11.53	11.39	1.5

NR Conducted Power (Reduction_Tablet)							
NR Band 40_SA							
BW	MCS Index	Channel		462000	470000	478000	3GPP MPR
		Frequency (MHz)		2310	2350	2390	
20M	DFT-S PI/2 BPSK	1	1	13.08	13.22	13.05	0
20M	DFT-S QPSK	1	1	13.20	13.31	13.21	0
		1	26	13.10	13.29	13.18	0
		1	49	12.39	12.52	12.47	0
		25	0	12.43	12.53	12.36	1
		25	13	13.15	13.22	13.09	0
		25	26	12.09	12.23	12.14	1
		50	0	12.24	12.39	12.22	1
20M	DFT-S 16QAM	1	1	12.04	12.25	12.07	1
20M	DFT-S 64QAM	1	1	10.59	10.70	10.60	2.5
20M	DFT-S 256QAM	1	1	8.54	8.68	8.60	4.5
20M	CP QPSK	1	1	11.43	11.48	11.40	1.5
BW	MCS Index	Channel		461500	470000	478500	3GPP MPR
		Frequency (MHz)		2307.5	2350	2392.5	
15M	DFT-S PI/2 BPSK	1	1	13.06	13.25	13.11	0
15M	DFT-S QPSK	1	1	13.13	13.35	13.14	0
		1	19	13.15	13.34	13.15	0
		1	36	12.43	12.58	12.40	0
		18	0	12.45	12.55	12.38	1
		18	10	13.12	13.29	13.10	0
		18	20	12.12	12.23	12.07	1
		36	0	12.25	12.39	12.19	1
15M	DFT-S 16QAM	1	1	12.04	12.24	12.11	1
15M	DFT-S 64QAM	1	1	10.55	10.77	10.64	2.5
15M	DFT-S 256QAM	1	1	8.55	8.76	8.56	4.5
15M	CP QPSK	1	1	11.43	11.57	11.42	1.5

NR Conducted Power (Reduction_Tablet)							
NR Band 40_SA							
BW	MCS Index	Channel		461000	470000	479000	3GPP MPR
		Frequency (MHz)		2305	2350	2395	
10M	DFT-S PI/2 BPSK	1	1	13.08	13.25	13.08	0
10M	DFT-S QPSK	1	1	13.15	13.36	13.24	0
		1	11	13.15	13.25	13.14	0
		1	22	12.46	12.57	12.38	0
		12	0	12.39	12.53	12.40	1
		12	6	13.12	13.31	13.06	0
		12	12	12.15	12.31	12.14	1
		24	0	12.17	12.37	12.17	1
10M	DFT-S 16QAM	1	1	12.05	12.25	12.11	1
10M	DFT-S 64QAM	1	1	10.55	10.73	10.63	2.5
10M	DFT-S 256QAM	1	1	8.58	8.77	8.56	4.5
10M	CP QPSK	1	1	11.37	11.48	11.34	1.5

NR Conducted Power (Reduction_Tablet)									
NR Band 41_SA									
BW	MCS Index	RB Size	RB Offset	Low	Mid-1	Mid-2	Mid-3	High	3GPP MPR (dB)
		Channel		509202	513900	518598	523302	528000	
		Frequency (MHz)		2546.01	2569.5	2592.99	2616.51	2640	
100M	DFT-S PI/2 BPSK	1	1	14.61	14.57	14.86	14.51	14.49	0
100M	DFT-S QPSK	1	1	14.91	14.81	14.95	14.83	14.79	0
		1	137	14.44	14.40	14.69	14.34	14.37	0
		1	271	14.39	14.35	14.64	14.29	14.32	0
		135	0	13.74	13.70	13.99	13.64	13.67	1
		135	69	14.69	14.65	14.94	14.59	14.62	0
		135	138	13.69	13.65	13.94	13.59	13.62	1
100M	DFT-S 16QAM	1	1	13.60	13.56	13.85	13.50	13.48	1
100M	DFT-S 64QAM	1	1	12.10	12.06	12.35	12.00	11.98	2.5
100M	DFT-S 256QAM	1	1	10.10	10.06	10.35	10.00	9.98	4.5
100M	CP QPSK	1	1	12.90	12.86	13.15	12.80	12.78	1.5
BW	MCS Index	Channel		508200	513402	518598	523800	528996	3GPP MPR
		Frequency (MHz)		2541	2567.01	2592.99	2619	2644.98	
90M	DFT-S PI/2 BPSK	1	1	14.55	14.56	14.84	14.61	14.49	0
90M	DFT-S QPSK	1	1	14.63	14.58	14.92	14.68	14.64	0
		1	123	14.36	14.35	14.63	14.41	14.30	0
		1	243	14.35	14.32	14.64	14.37	14.34	0
		120	0	13.74	13.65	13.94	13.67	13.70	1
		120	63	14.59	14.56	14.88	14.63	14.65	0
		120	125	13.67	13.58	13.87	13.68	13.60	1
90M	DFT-S 16QAM	1	1	13.53	13.55	13.77	13.57	13.53	1
90M	DFT-S 64QAM	1	1	12.02	11.99	12.31	12.04	12.05	2.5
90M	DFT-S 256QAM	1	1	10.05	9.98	10.27	10.02	10.01	4.5
90M	CP QPSK	1	1	12.88	12.78	13.05	12.83	12.79	1.5

NR Conducted Power (Reduction_Tablet)

NR Band 41_SA

BW	MCS Index	Channel		507204	509304	518598	500298	529998	3GPP MPR
		Frequency (MHz)		2536.02	2546.52	2592.99	2621.49	2649.99	
80M	DFT-S PI/2 BPSK	1	1	14.57	14.49	14.84	14.54	14.47	0
80M	DFT-S QPSK	1	1	14.61	14.65	14.85	14.70	14.63	0
		1	109	14.39	14.39	14.62	14.41	14.40	0
		1	215	14.35	14.25	14.64	14.30	14.29	0
		108	0	13.64	13.68	13.93	13.71	13.65	1
		108	55	14.63	14.61	14.92	14.59	14.57	0
		108	109	13.61	13.64	13.91	13.65	13.63	1
80M	DFT-S 16QAM	1	1	13.57	13.50	13.82	13.59	13.52	1
80M	DFT-S 64QAM	1	1	12.05	11.96	12.28	12.04	11.99	2.5
80M	DFT-S 256QAM	1	1	10.02	10.06	10.34	10.04	10.04	4.5
80M	CP QPSK	1	1	12.81	12.76	13.13	12.80	12.76	1.5
BW	MCS Index	Channel		506202	512400	518598	524802	531000	3GPP MPR
		Frequency (MHz)		2531.01	2562	2592.99	2624.01	2655	
70M	DFT-S PI/2 BPSK	1	1	14.52	14.47	14.84	14.56	14.52	0
70M	DFT-S QPSK	1	1	14.67	14.63	14.93	14.63	14.66	0
		1	95	14.38	14.38	14.67	14.39	14.33	0
		1	187	14.37	14.35	14.61	14.29	14.26	0
		90	0	13.70	13.61	13.96	13.66	13.63	1
		90	50	14.64	14.65	14.90	14.66	14.64	0
		90	99	13.69	13.59	13.92	13.65	13.64	1
70M	DFT-S 16QAM	1	1	13.60	13.51	13.82	13.58	13.53	1
70M	DFT-S 64QAM	1	1	12.05	12.00	12.30	12.10	11.98	2.5
70M	DFT-S 256QAM	1	1	10.07	10.04	10.30	10.04	10.04	4.5
70M	CP QPSK	1	1	12.82	12.77	13.11	12.82	12.77	1.5

NR Conducted Power (Reduction_Tablet)

NR Band 41_SA									
BW	MCS Index	Channel		505200	511896	518598	525294	531996	3GPP MPR
		Frequency (MHz)		2526	2559.48	2592.99	2626.48	2659.98	
60M	DFT-S PI/2 BPSK	1	1	14.54	14.57	14.78	14.59	14.48	0
60M	DFT-S QPSK	1	1	14.61	14.63	14.86	14.65	14.61	0
		1	81	14.42	14.34	14.62	14.37	14.38	0
		1	160	14.35	14.32	14.56	14.33	14.32	0
		81	0	13.73	13.62	13.96	13.68	13.61	1
		81	41	14.69	14.63	14.86	14.64	14.55	0
		81	81	13.68	13.60	13.87	13.66	13.61	1
60M	DFT-S 16QAM	1	1	13.51	13.46	13.75	13.60	13.49	1
60M	DFT-S 64QAM	1	1	12.02	12.02	12.30	12.01	12.04	2.5
60M	DFT-S 256QAM	1	1	10.09	10.04	10.34	10.03	9.98	4.5
60M	CP QPSK	1	1	12.85	12.80	13.13	12.84	12.84	1.5
BW	MCS Index	Channel		504204	511404	518598	525798	532998	3GPP MPR
		Frequency (MHz)		2521.02	2557.02	2592.99	2628.99	2664.99	
50M	DFT-S PI/2 BPSK	1	1	14.61	14.56	14.85	14.52	14.48	0
50M	DFT-S QPSK	1	1	14.66	14.62	14.89	14.61	14.60	0
		1	67	14.37	14.34	14.67	14.43	14.30	0
		1	131	14.33	14.30	14.60	14.33	14.27	0
		64	0	13.64	13.68	13.91	13.65	13.64	1
		64	35	14.61	14.63	14.86	14.64	14.62	0
		64	69	13.64	13.62	13.88	13.59	13.56	1
50M	DFT-S 16QAM	1	1	13.55	13.56	13.76	13.56	13.49	1
50M	DFT-S 64QAM	1	1	12.06	12.00	12.25	12.02	12.02	2.5
50M	DFT-S 256QAM	1	1	10.10	9.97	10.26	10.07	9.99	4.5
50M	CP QPSK	1	1	12.84	12.77	13.15	12.82	12.85	1.5

NR Conducted Power (Reduction_Tablet)

NR Band 41_SA

BW	MCS Index	Channel		503202	510900	518598	526296	534000	3GPP MPR
		Frequency (MHz)		2516.01	2554.5	2592.99	2631.48	2670	
40M	DFT-S PI/2 BPSK	1	1	14.60	14.52	14.86	14.61	14.53	0
40M	DFT-S QPSK	1	1	14.65	14.56	14.86	14.67	14.59	0
		1	53	14.36	14.30	14.62	14.39	14.30	0
		1	104	14.38	14.28	14.60	14.39	14.29	0
		50	0	13.73	13.61	13.91	13.69	13.64	1
		50	28	14.66	14.57	14.90	14.64	14.63	0
		50	56	13.62	13.58	13.93	13.62	13.65	1
100	0	13.63	13.58	13.90	13.62	13.54	1		
40M	DFT-S 16QAM	1	1	13.57	13.48	13.83	13.50	13.55	1
40M	DFT-S 64QAM	1	1	12.06	12.02	12.27	12.06	11.98	2.5
40M	DFT-S 256QAM	1	1	10.07	9.96	10.27	10.05	10.01	4.5
40M	CP QPSK	1	1	12.81	12.76	13.08	12.87	12.77	1.5
BW	MCS Index	Channel		501204	509898	518598	527298	535998	3GPP MPR
		Frequency (MHz)		2506.02	2549.49	2592.99	2636.49	2679.99	
20M	DFT-S PI/2 BPSK	1	1	14.53	14.49	14.55	14.52	14.83	0
20M	DFT-S QPSK	1	1	14.84	14.75	14.83	14.74	14.85	0
		1	26	14.36	14.30	14.39	14.37	14.65	0
		1	49	14.32	14.26	14.35	14.26	14.60	0
		25	0	13.64	13.61	13.73	13.65	13.98	1
		25	13	14.65	14.59	14.69	14.60	14.86	0
		25	26	13.59	13.55	13.69	13.62	13.88	1
50	0	13.63	13.56	13.66	13.55	13.87	1		
20M	DFT-S 16QAM	1	1	13.53	13.47	13.55	13.54	13.85	1
20M	DFT-S 64QAM	1	1	12.08	11.97	12.06	12.01	12.25	2.5
20M	DFT-S 256QAM	1	1	10.04	10.03	10.09	9.98	10.27	4.5
20M	CP QPSK	1	1	12.81	12.77	12.82	12.76	13.05	1.5

NR Conducted Power (Reduction_Tablet)									
NR Band 41_SA									
BW	MCS Index	Channel		500700	509646	518598	527544	536496	3GPP MPR
		Frequency (MHz)		2503.5	2548.23	2592.99	2637.72	2682.48	
15M	DFT-S PI/2 BPSK	1	1	14.61	14.54	14.57	14.56	14.82	0
15M	DFT-S QPSK	1	1	14.85	14.76	14.90	14.75	14.87	0
		1	19	14.41	14.32	14.37	14.31	14.66	0
		1	36	14.32	14.34	14.30	14.34	14.55	0
		18	0	13.64	13.64	13.65	13.67	13.89	1
		18	10	14.59	14.65	14.67	14.61	14.87	0
		18	20	13.67	13.58	13.62	13.62	13.85	1
36	0	13.63	13.63	13.63	13.57	13.87	1		
15M	DFT-S 16QAM	1	1	13.59	13.56	13.60	13.48	13.85	1
15M	DFT-S 64QAM	1	1	12.09	12.04	12.06	11.99	12.31	2.5
15M	DFT-S 256QAM	1	1	10.08	10.01	10.02	9.99	10.31	4.5
15M	CP QPSK	1	1	12.83	12.76	12.82	12.76	13.10	1.5
BW	MCS Index	Channel		500202	509400	518598	527796	537000	3GPP MPR
		Frequency (MHz)		2501.01	2547	2592.99	2638.98	2685	
10M	DFT-S PI/2 BPSK	1	1	14.57	14.47	14.60	14.49	14.76	0
10M	DFT-S QPSK	1	1	14.87	14.77	14.86	14.80	14.90	0
		1	11	14.40	14.38	14.35	14.34	14.68	0
		1	22	14.30	14.35	14.30	14.28	14.57	0
		12	0	13.64	13.65	13.70	13.63	13.95	1
		12	6	14.64	14.64	14.66	14.61	14.84	0
		12	12	13.68	13.55	13.65	13.65	13.90	1
24	0	13.62	13.54	13.62	13.54	13.93	1		
10M	DFT-S 16QAM	1	1	13.51	13.47	13.50	13.55	13.85	1
10M	DFT-S 64QAM	1	1	12.09	11.99	12.06	12.03	12.29	2.5
10M	DFT-S 256QAM	1	1	10.02	10.02	10.01	10.06	10.34	4.5
10M	CP QPSK	1	1	12.89	12.85	12.90	12.83	13.08	1.5

NR Conducted Power (Reduction_Tablet)									
NR Band 77_SA									
BW	MCS Index	RB Size	RB Offset	Low	Mid-1	Mid-2	Mid-3	High	3GPP MPR (dB)
		Channel		650000	653000	656000	659000	662000	
		Frequency (MHz)		3750	3795	3840	3885	3930	
100M	DFT-S PI/2 BPSK	1	1	10.09	10.09	10.11	10.04	10.04	0
100M	DFT-S QPSK	1	1	10.33	10.68	10.63	10.55	10.42	0
		1	137	10.01	10.33	10.06	10.43	10.22	0
		1	271	10.29	10.29	10.01	10.33	10.39	0
		135	0	9.30	9.34	9.34	9.37	9.46	1
		135	69	10.33	10.41	10.06	10.40	10.40	0
		135	138	9.35	9.30	9.28	9.37	9.46	1
		270	0	9.36	9.28	9.37	9.44	9.42	1
100M	DFT-S 16QAM	1	1	8.91	9.58	9.53	9.45	9.12	1
100M	DFT-S 64QAM	1	1	7.71	8.38	8.33	8.25	7.92	2.5
100M	DFT-S 256QAM	1	1	5.91	6.44	6.41	6.45	6.12	4.5
100M	CP QPSK	1	1	8.81	9.48	9.43	9.35	9.02	1.5
BW	MCS Index	Channel		649668	652834	656000	659166	662332	3GPP MPR
		Frequency (MHz)		3745.02	3792.51	3840	3887.49	3934.98	
90M	DFT-S PI/2 BPSK	1	1	10.03	10.06	10.02	10.06	10.04	0
90M	DFT-S QPSK	1	1	10.61	10.62	10.13	10.65	10.17	0
		1	123	10.04	10.29	10.41	10.25	10.32	0
		1	243	9.94	10.28	10.32	10.23	10.31	0
		120	0	9.34	9.28	9.46	9.29	9.41	1
		120	63	10.00	10.26	10.40	10.24	10.30	0
		120	125	9.18	9.23	9.46	9.29	9.39	1
		243	0	9.35	9.27	9.41	9.23	9.33	1
90M	DFT-S 16QAM	1	1	9.52	9.48	9.06	9.49	9.10	1
90M	DFT-S 64QAM	1	1	8.23	8.28	7.82	8.37	7.90	2.5
90M	DFT-S 256QAM	1	1	6.40	6.42	6.06	6.41	6.03	4.5
90M	CP QPSK	1	1	9.40	9.48	8.99	9.43	8.92	1.5

NR Conducted Power (Reduction_Tablet)									
NR Band 77_SA									
BW	MCS Index	Channel		649334	652666	656000	659334	662666	3GPP MPR
		Frequency (MHz)		3740.01	3789.99	3840	3890.01	3939.99	
80M	DFT-S PI/2 BPSK	1	1	10.05	9.99	9.94	10.09	9.97	0
80M	DFT-S QPSK	1	1	10.59	10.61	10.14	10.64	10.12	0
		1	109	9.96	10.26	10.36	10.23	10.33	0
		1	215	9.93	10.27	10.33	10.25	10.39	0
		108	0	9.24	9.32	9.38	9.32	9.39	1
		108	55	10.03	10.34	10.36	10.34	10.35	0
		108	109	9.21	9.23	9.37	9.25	9.37	1
80M	DFT-S 16QAM	1	1	9.53	9.50	9.09	9.56	9.08	1
80M	DFT-S 64QAM	1	1	8.32	8.33	7.84	8.38	7.91	2.5
80M	DFT-S 256QAM	1	1	6.32	6.38	6.02	6.36	6.12	4.5
80M	CP QPSK	1	1	9.38	9.44	8.96	9.38	8.93	1.5
BW	MCS Index	Channel		649000	652500	656000	659500	663000	3GPP MPR
		Frequency (MHz)		3735	3787.5	3840	3892.5	3945	
70M	DFT-S PI/2 BPSK	1	1	10.03	10.04	9.95	10.04	9.95	0
70M	DFT-S QPSK	1	1	10.57	10.60	10.16	10.62	10.17	0
		1	95	10.06	10.31	10.38	10.23	10.37	0
		1	187	9.91	10.24	10.39	10.25	10.35	0
		90	0	9.28	9.28	9.41	9.29	9.45	1
		90	50	10.00	10.29	10.39	10.34	10.37	0
		90	99	9.24	9.26	9.44	9.25	9.44	1
70M	DFT-S 16QAM	1	1	9.45	9.49	9.08	9.49	9.06	1
70M	DFT-S 64QAM	1	1	8.33	8.28	7.91	8.37	7.90	2.5
70M	DFT-S 256QAM	1	1	6.35	6.42	6.04	6.43	6.09	4.5
70M	CP QPSK	1	1	9.41	9.48	8.98	9.48	8.95	1.5

NR Conducted Power (Reduction_Tablet)									
NR Band 77_SA									
BW	MCS Index	Channel		648668	652334	656000	659666	663332	3GPP MPR
		Frequency (MHz)		3730.02	3785.01	3840	3894.99	3949.98	
60M	DFT-S PI/2 BPSK	1	1	10.07	10.08	9.99	10.04	10.04	0
60M	DFT-S QPSK	1	1	10.55	10.66	10.17	10.60	10.13	0
		1	81	10.01	10.32	10.40	10.23	10.39	0
		1	160	10.00	10.24	10.37	10.23	10.30	0
		81	0	9.34	9.33	9.40	9.25	9.46	1
		81	41	10.02	10.27	10.32	10.31	10.38	0
		81	81	9.20	9.22	9.46	9.25	9.45	1
		162	0	9.31	9.18	9.39	9.21	9.32	1
60M	DFT-S 16QAM	1	1	9.50	9.54	9.04	9.52	9.10	1
60M	DFT-S 64QAM	1	1	8.31	8.33	7.90	8.38	7.86	2.5
60M	DFT-S 256QAM	1	1	6.40	6.37	6.10	6.41	6.03	4.5
60M	CP QPSK	1	1	9.43	9.42	8.92	9.38	9.00	1.5
BW	MCS Index	Channel		648334	652166	656000	659834	663666	3GPP MPR
		Frequency (MHz)		3725.01	3782.49	3840	3897.51	3954.99	
50M	DFT-S PI/2 BPSK	1	1	10.03	10.06	10.03	9.99	9.95	0
50M	DFT-S QPSK	1	1	10.63	10.63	10.13	10.66	10.21	0
		1	67	10.05	10.31	10.39	10.27	10.38	0
		1	131	9.91	10.27	10.35	10.28	10.39	0
		64	0	9.26	9.26	9.44	9.32	9.40	1
		64	35	9.96	10.28	10.35	10.32	10.34	0
		64	69	9.21	9.30	9.40	9.22	9.46	1
		128	0	9.30	9.27	9.36	9.19	9.36	1
50M	DFT-S 16QAM	1	1	9.51	9.49	9.06	9.52	9.09	1
50M	DFT-S 64QAM	1	1	8.32	8.28	7.91	8.29	7.84	2.5
50M	DFT-S 256QAM	1	1	6.35	6.38	6.10	6.40	6.02	4.5
50M	CP QPSK	1	1	9.39	9.39	8.99	9.44	8.95	1.5

NR Conducted Power (Reduction_Tablet)									
NR Band 77_SA									
BW	MCS Index	Channel		648000	652000	656000	660000	664000	3GPP MPR
		Frequency (MHz)		3720	3780	3840	3900	3960	
40M	DFT-S PI/2 BPSK	1	1	10.05	10.02	10.04	10.01	10.04	0
40M	DFT-S QPSK	1	1	10.63	10.59	10.17	10.64	10.20	0
		1	53	9.99	10.25	10.39	10.26	10.32	0
		1	104	9.91	10.26	10.35	10.23	10.30	0
		50	0	9.25	9.30	9.41	9.30	9.46	1
		50	28	10.05	10.24	10.34	10.26	10.38	0
		50	56	9.19	9.29	9.45	9.27	9.46	1
100	0	9.33	9.28	9.36	9.24	9.33	1		
40M	DFT-S 16QAM	1	1	9.53	9.49	9.12	9.55	9.11	1
40M	DFT-S 64QAM	1	1	8.31	8.37	7.89	8.37	7.86	2.5
40M	DFT-S 256QAM	1	1	6.33	6.37	6.05	6.39	6.05	4.5
40M	CP QPSK	1	1	9.42	9.40	8.98	9.47	9.01	1.5
BW	MCS Index	Channel		647668	651834	656000	660166	664332	3GPP MPR
		Frequency (MHz)		3715.02	3777.51	3840	3902.49	3964.98	
30M	DFT-S PI/2 BPSK	1	1	10.08	10.00	9.94	10.06	10.01	0
30M	DFT-S QPSK	1	1	10.58	10.58	10.22	10.62	10.15	0
		1	39	10.01	10.27	10.38	10.29	10.32	0
		1	76	9.91	10.25	10.29	10.26	10.32	0
		36	0	9.30	9.30	9.43	9.31	9.45	1
		36	21	9.97	10.30	10.37	10.32	10.36	0
		36	42	9.26	9.26	9.41	9.28	9.45	1
75	0	9.28	9.23	9.36	9.27	9.42	1		
30M	DFT-S 16QAM	1	1	9.47	9.52	9.03	9.55	9.03	1
30M	DFT-S 64QAM	1	1	8.30	8.32	7.84	8.33	7.88	2.5
30M	DFT-S 256QAM	1	1	6.35	6.36	6.08	6.37	6.04	4.5
30M	CP QPSK	1	1	9.36	9.47	9.02	9.39	8.95	1.5

NR Conducted Power (Reduction_Tablet)									
NR Band 77_SA									
BW	MCS Index	Channel		647334	651666	656000	660266	664666	3GPP MPR
		Frequency (MHz)		3710.01	3774.99	3840	3903.99	3969.99	
20M	DFT-S PI/2 BPSK	1	1	10.10	10.05	9.99	10.06	9.96	0
20M	DFT-S QPSK	1	1	10.61	10.67	10.17	10.64	10.15	0
		1	26	10.05	10.25	10.33	10.28	10.36	0
		1	49	9.99	10.28	10.34	10.20	10.32	0
		25	0	9.25	9.24	9.37	9.31	9.46	1
		25	13	10.02	10.32	10.39	10.29	10.35	0
		25	26	9.18	9.27	9.37	9.28	9.37	1
50	0	9.37	9.19	9.34	9.28	9.37	1		
20M	DFT-S 16QAM	1	1	9.53	9.49	9.12	9.56	9.08	1
20M	DFT-S 64QAM	1	1	8.26	8.31	7.90	8.31	7.89	2.5
20M	DFT-S 256QAM	1	1	6.35	6.35	6.09	6.34	6.06	4.5
20M	CP QPSK	1	1	9.34	9.48	9.00	9.39	8.95	1.5
BW	MCS Index	Channel		647168	651584	656000	660416	664832	3GPP MPR
		Frequency (MHz)		3707.52	3773.76	3840	3906.24	3972.48	
15M	DFT-S PI/2 BPSK	1	1	10.11	10.02	10.01	10.03	10.01	0
15M	DFT-S QPSK	1	1	10.60	10.62	10.17	10.67	10.21	0
		1	19	10.02	10.33	10.40	10.30	10.33	0
		1	36	9.98	10.21	10.39	10.19	10.29	0
		18	0	9.30	9.33	9.40	9.28	9.37	1
		18	10	10.05	10.34	10.36	10.29	10.40	0
		18	20	9.23	9.22	9.39	9.26	9.44	1
36	0	9.29	9.19	9.34	9.18	9.37	1		
15M	DFT-S 16QAM	1	1	9.48	9.51	9.02	9.57	9.04	1
15M	DFT-S 64QAM	1	1	8.24	8.34	7.91	8.38	7.84	2.5
15M	DFT-S 256QAM	1	1	6.39	6.39	6.09	6.37	6.02	4.5
15M	CP QPSK	1	1	9.42	9.48	8.97	9.41	8.94	1.5

NR Conducted Power (Reduction_Tablet)									
NR Band 77_SA									
BW	MCS Index	Channel		647000	651500	656000	660500	665000	3GPP MPR
		Frequency (MHz)		3705	3772.5	3840	3907.5	3975	
10M	DFT-S PI/2 BPSK	1	1	10.01	10.06	9.97	10.00	10.01	0
10M	DFT-S QPSK	1	1	10.63	10.62	10.13	10.62	10.14	0
		1	11	9.98	10.33	10.35	10.32	10.40	0
		1	22	9.96	10.23	10.39	10.26	10.33	0
		12	0	9.32	9.32	9.40	9.32	9.36	1
		12	6	10.06	10.28	10.34	10.29	10.40	0
		12	12	9.20	9.22	9.36	9.25	9.41	1
10M	DFT-S 16QAM	1	1	9.44	9.58	9.06	9.50	9.04	1
10M	DFT-S 64QAM	1	1	8.23	8.31	7.84	8.38	7.86	2.5
10M	DFT-S 256QAM	1	1	6.37	6.44	6.03	6.38	6.08	4.5
10M	CP QPSK	1	1	9.43	9.47	8.98	9.42	8.96	1.5

NR Conducted Power (Reduction_Tablet)							
NR Band 78_SA							
BW	MCS Index	RB Size	RB Offset	Low	Mid	High	3GPP MPR (dB)
		Channel			650000		
		Frequency (MHz)			3750		
100M	DFT-S PI/2 BPSK	1	1		10.62		0
100M	DFT-S QPSK	1	1		10.88		0
		1	137		10.35		0
		1	271		9.47		0
		135	0		9.41		1
		135	69		10.46		0
		135	138		9.28		1
		270	0		9.25		1
100M	DFT-S 16QAM	1	1		9.61		1
100M	DFT-S 64QAM	1	1		8.31		2.5
100M	DFT-S 256QAM	1	1		6.31		4.5
100M	CP QPSK	1	1		9.41		1.5
BW	MCS Index	Channel		649668	650000	650332	3GPP MPR
		Frequency (MHz)		3745.02	3750	3754.98	
90M	DFT-S PI/2 BPSK	1	1	10.58	10.59	10.61	0
90M	DFT-S QPSK	1	1	10.64	10.70	10.63	0
		1	123	10.31	10.33	10.34	0
		1	243	9.40	9.38	9.44	0
		120	0	9.38	9.37	9.38	1
		120	63	10.39	10.37	10.42	0
		120	125	9.24	9.21	9.22	1
		243	0	9.18	9.16	9.15	1
90M	DFT-S 16QAM	1	1	9.58	9.54	9.56	1
90M	DFT-S 64QAM	1	1	8.21	8.29	8.31	2.5
90M	DFT-S 256QAM	1	1	6.27	6.21	6.28	4.5
90M	CP QPSK	1	1	9.35	9.37	9.32	1.5

NR Conducted Power (Reduction_Tablet)							
NR Band 78_SA							
BW	MCS Index	Channel		649334	650000	650666	3GPP MPR
		Frequency (MHz)		3740.01	3750	3759.99	
80M	DFT-S PI/2 BPSK	1	1	10.59	10.60	10.58	0
80M	DFT-S QPSK	1	1	10.62	10.65	10.69	0
		1	109	10.26	10.31	10.32	0
		1	215	9.41	9.42	9.37	0
		108	0	9.35	9.33	9.41	1
		108	55	10.39	10.36	10.44	0
		108	109	9.21	9.24	9.25	1
80M	DFT-S 16QAM	1	1	9.54	9.58	9.57	1
80M	DFT-S 64QAM	1	1	8.23	8.29	8.28	2.5
80M	DFT-S 256QAM	1	1	6.28	6.31	6.25	4.5
80M	CP QPSK	1	1	9.33	9.31	9.37	1.5
BW	MCS Index	Channel		649000	650000	651000	3GPP MPR
		Frequency (MHz)		3735	3750	3765	
70M	DFT-S PI/2 BPSK	1	1	10.52	10.54	10.55	0
70M	DFT-S QPSK	1	1	10.65	10.61	10.70	0
		1	95	10.27	10.27	10.29	0
		1	187	9.42	9.41	9.42	0
		90	0	9.38	9.35	9.36	1
		90	50	10.39	10.43	10.45	0
		90	99	9.22	9.28	9.22	1
70M	DFT-S 16QAM	1	1	9.51	9.52	9.59	1
70M	DFT-S 64QAM	1	1	8.26	8.24	8.29	2.5
70M	DFT-S 256QAM	1	1	6.28	6.30	6.31	4.5
70M	CP QPSK	1	1	9.41	9.37	9.39	1.5

NR Conducted Power (Reduction_Tablet)							
NR Band 78_SA							
BW	MCS Index	Channel		648668	650000	651332	3GPP MPR
		Frequency (MHz)		3730.02	3750	3769.98	
60M	DFT-S PI/2 BPSK	1	1	10.58	10.59	10.58	0
60M	DFT-S QPSK	1	1	10.68	10.70	10.67	0
		1	81	10.25	10.33	10.27	0
		1	160	9.45	9.46	9.37	0
		81	0	9.34	9.32	9.41	1
		81	41	10.38	10.39	10.46	0
		81	81	9.20	9.23	9.28	1
60M	DFT-S 16QAM	1	1	9.61	9.54	9.52	1
60M	DFT-S 64QAM	1	1	8.30	8.23	8.30	2.5
60M	DFT-S 256QAM	1	1	6.25	6.25	6.31	4.5
60M	CP QPSK	1	1	9.35	9.38	9.40	1.5
BW	MCS Index	Channel		648334	650000	651666	3GPP MPR
		Frequency (MHz)		3725.01	3750	3774.99	
50M	DFT-S PI/2 BPSK	1	1	10.61	10.53	10.59	0
50M	DFT-S QPSK	1	1	10.62	10.66	10.63	0
		1	67	10.32	10.28	10.26	0
		1	131	9.42	9.44	9.40	0
		64	0	9.39	9.36	9.31	1
		64	35	10.36	10.42	10.45	0
		64	69	9.19	9.25	9.22	1
50M	DFT-S 16QAM	1	1	9.52	9.53	9.53	1
50M	DFT-S 64QAM	1	1	8.21	8.28	8.24	2.5
50M	DFT-S 256QAM	1	1	6.29	6.25	6.21	4.5
50M	CP QPSK	1	1	9.36	9.36	9.41	1.5

NR Conducted Power (Reduction_Tablet)							
NR Band 78_SA							
BW	MCS Index	Channel		648000	650000	652000	3GPP MPR
		Frequency (MHz)		3720	3750	3780	
40M	DFT-S PI/2 BPSK	1	1	10.54	10.54	10.60	0
40M	DFT-S QPSK	1	1	10.62	10.62	10.66	0
		1	53	10.28	10.33	10.26	0
		1	104	9.43	9.42	9.38	0
		50	0	9.38	9.39	9.35	1
		50	28	10.41	10.37	10.40	0
		50	56	9.26	9.18	9.26	1
100	0	9.18	9.23	9.19	1		
40M	DFT-S 16QAM	1	1	9.54	9.51	9.56	1
40M	DFT-S 64QAM	1	1	8.21	8.26	8.24	2.5
40M	DFT-S 256QAM	1	1	6.24	6.25	6.29	4.5
40M	CP QPSK	1	1	9.36	9.33	9.36	1.5
BW	MCS Index	Channel		647668	650000	652332	3GPP MPR
		Frequency (MHz)		3715.02	3750	3784.98	
30M	DFT-S PI/2 BPSK	1	1	10.61	10.61	10.59	0
30M	DFT-S QPSK	1	1	10.63	10.69	10.65	0
		1	39	10.32	10.34	10.26	0
		1	76	9.41	9.38	9.41	0
		36	0	9.37	9.39	9.37	1
		36	21	10.46	10.43	10.45	0
		36	42	9.21	9.20	9.18	1
75	0	9.15	9.22	9.19	1		
30M	DFT-S 16QAM	1	1	9.58	9.61	9.57	1
30M	DFT-S 64QAM	1	1	8.28	8.30	8.22	2.5
30M	DFT-S 256QAM	1	1	6.24	6.22	6.21	4.5
30M	CP QPSK	1	1	9.31	9.36	9.35	1.5

NR Conducted Power (Reduction_Tablet)							
NR Band 78_SA							
BW	MCS Index	Channel		647334	650000	652666	3GPP MPR
		Frequency (MHz)		3710.01	3750	3789.99	
20M	DFT-S PI/2 BPSK	1	1	10.55	10.54	10.61	0
20M	DFT-S QPSK	1	1	10.62	10.70	10.70	0
		1	26	10.33	10.34	10.31	0
		1	49	9.46	9.41	9.44	0
		25	0	9.34	9.35	9.34	1
		25	13	10.41	10.40	10.40	0
		25	26	9.18	9.27	9.25	1
50	0	9.15	9.16	9.22	1		
20M	DFT-S 16QAM	1	1	9.53	9.51	9.52	1
20M	DFT-S 64QAM	1	1	8.25	8.24	8.27	2.5
20M	DFT-S 256QAM	1	1	6.23	6.25	6.30	4.5
20M	CP QPSK	1	1	9.34	9.39	9.39	1.5
BW	MCS Index	Channel		647168	650000	652832	3GPP MPR
		Frequency (MHz)		3707.52	3750	3792.48	
15M	DFT-S PI/2 BPSK	1	1	10.52	10.58	10.58	0
15M	DFT-S QPSK	1	1	10.63	10.64	10.70	0
		1	19	10.33	10.29	10.33	0
		1	36	9.38	9.37	9.44	0
		18	0	9.31	9.35	9.40	1
		18	10	10.39	10.45	10.38	0
		18	20	9.18	9.26	9.27	1
36	0	9.21	9.19	9.17	1		
15M	DFT-S 16QAM	1	1	9.52	9.52	9.55	1
15M	DFT-S 64QAM	1	1	8.31	8.28	8.31	2.5
15M	DFT-S 256QAM	1	1	6.30	6.31	6.22	4.5
15M	CP QPSK	1	1	9.35	9.37	9.35	1.5

NR Conducted Power (Reduction_Tablet)							
NR Band 78_SA							
BW	MCS Index	Channel		647000	650000	653000	3GPP MPR
		Frequency (MHz)		3705	3750	3795	
10M	DFT-S PI/2 BPSK	1	1	10.61	10.55	10.61	0
10M	DFT-S QPSK	1	1	10.66	10.70	10.66	0
		1	11	10.28	10.34	10.28	0
		1	22	9.40	9.44	9.44	0
		12	0	9.34	9.39	9.39	1
		12	6	10.39	10.36	10.46	0
		12	12	9.28	9.25	9.26	1
10M	DFT-S 16QAM	1	1	9.54	9.53	9.51	1
10M	DFT-S 64QAM	1	1	8.26	8.28	8.22	2.5
10M	DFT-S 256QAM	1	1	6.28	6.28	6.28	4.5
10M	CP QPSK	1	1	9.37	9.34	9.32	1.5

Downlink Carrier Aggregation Exclusion Table

Intra Band					Inter Band								
Contiguous	3CC Non-Contiguous	3CC Non-Contiguous	4CC Non-Contiguous	5CC Non-Contiguous	2 Bands / 2CC	2 Bands / 3CC	2 Bands / 4CC	2 Bands / 5CC	3 Bands / 3CC	3 Bands / 4CC	3 Bands / 5CC	4 Bands / 4CC	4 Bands / 5CC
						CA 2A-2A-4A				CA 2A-2A-4A-5A CA 2A-2A-4A-12A CA 2A-2A-4A-71A CA 2A-2A-46C CA 2A-2A-66A-71A	CA 13A-48A-48C-66A		
					CA 4A-71A	CA 2A-2A-71A			CA 2A-4A-71A				
					CA 66A-71A								
	CA 4A-4A					CA 2A-4A-4A CA 4A-4A-5A CA 4A-4A-12A CA 4A-5B CA 5A-46C CA 12A-66C CA 13A-46C				CA 2A-4A-4A-5A CA 2A-4A-12A CA 2A-4A-5B CA 2A-5A-46C CA 2A-12A-66C CA 2A-13A-46C CA 2A-13A-66C CA 2A-46A-48C CA 2A-46C-48A			
					CA 2A-71A	CA 46A-48C CA 48C-48A CA 66A-66A-71A CA 66C-71A CA 19A-43C CA 4A-4A-30A			CA 2A-66A-71A	CA 2A-66A-66A-71A CA 2A-66C-71A CA 3A-19A-43C CA 4A-4A-12A-30A CA 5A-46C-66A CA 13A-46C-66A CA 13A-48A-66B CA 13A-48A-66C CA 46A-48C-66A CA 46C-48A-66A			
CA 42C													
						CA 4A-7A CA 4A-13A CA 4A-28A CA 5A-46A CA 13A-46A CA 29A-30A CA 5A-7A CA 19A-42A CA 4A-29A			CA 2A-4A-7A CA 2A-4A-13A CA 2A-4A-28A CA 2A-5A-46A CA 2A-13A-46A CA 2A-29A-30A CA 2A-46A-48A CA 3A-5A-7A CA 3A-19A-42A CA 4A-7A-28A CA 4A-29A-30A CA 5A-46A-66A CA 13A-46A-66A				
									CA 2A-2A-46D CA 2A-46A-46D CA 2A-46C-46C CA 2A-46E CA 2A-48A-48D CA 2A-48C-48C CA 2A-48E CA 4A-46A-46D CA 4A-48E CA 5A-46E CA 5A-48A-48D CA 5A-48C-48C CA 5A-48E CA 5B-46D CA 13A-46E CA 13A-48C-48C CA 13A-48E CA 46A-46D-66A CA 46C-46C-66A CA 46C-48D CA 46C-66A-66A-66A CA 46D-48C CA 46D-66A-66A CA 46E-48A CA 46E-66A CA 48A-48C-66B CA 48A-48C-66C CA 48A-48D-66A CA 48C-48C-66A CA 48C-66A-66A-66A CA 48E-66A				
CA 48E					CA 4A-46A								
									CA 48C-66A-66A	CA 2A-2A-4A-4A CA 2A-46A-46A-66A			
						CA 2A-46A-46A CA 46A-46A-66A CA 2C-66A	CA 2A-46A-46A-66A			CA 2C-66A-66A CA 4A-4A-5B CA 4A-46A-46C CA 4A-46D CA 4A-48D CA 5A-5A-66A-66A			
CA 2C													
	CA 5A-5A					CA 5A-5A-66A	CA 5A-5A-66A-66A						

Downlink Carrier Aggregation Exclusion Table

Intra Band					Inter Band								
Contiguous	3CC Non-Contiguous	3CC Non-Contiguous	4CC Non-Contiguous	5CC Non-Contiguous	2 Bands / 2CC	2 Bands / 3CC	2 Bands / 4CC	2 Bands / 5CC	3 Bands / 3CC	3 Bands / 4CC	3 Bands / 5CC	4 Bands / 4CC	4 Bands / 5CC
							CA 5A-5A-66B						
							CA 5A-5A-66C						
							CA 5B-46C						
							CA 30A-66A-66A-66A						
CA 39C							CA 39A-41D						
CA 41C							CA 39C-41C						
							CA 41C-42C						
							CA 46A-66A-66A	CA 46A-66A-66A-66A					
							CA 48A-66A-66A	CA 48A-66A-66A-66A					
								CA 48A-48A-66B					
								CA 48A-48A-66C					
								CA 48A-66A-66A-66A					
								CA 2A-2A-46A					
								CA 4A-4A-13A					
								CA 4A-4A-71A					
								CA 4A-46A-46A					
								CA 4A-46C					
								CA 4A-48C					
								CA 5A-7A-7A					
								CA 5B-46A					
								CA 7A-7A-20A					
								CA 8A-39C					
								CA 26A-41C					
								CA 39A-41C					
								CA 39C-41A					
								CA 41A-42C					
								CA 41A-46C					
								CA 41C-42A					
								CA 42A-42C					
								CA 2A-7A					
								CA 2A-28A					
								CA 3A-18A					
								CA 3A-26A					
								CA 4A-48A					
								CA 8A-32A					
								CA 8A-39A					
								CA 25A-26A					
								CA 29A-66A					
								CA 34A-39A					
								CA 39A-41A					
								CA 41A-42A					
								CA 41A-46A					
								CA 26A-41A					
								CA 48A-48D	CA 48A-48A-48D				
								CA 48C-48C	CA 48A-48C-48C				
CA 41D								CA 41A-41D					
								CA 41C-41C					
								CA 42C-42C					
								CA 48A-48A-48C					
								CA 41A-41C					
								CA 48A-48A-48A					
								CA 66A-66C					
								CA 25A-25A					
								CA 41A-41A					
								CA 42A-42A					
CA 38C													

Note : The only blue marked of downlink carrier aggregation power required to be measured, the others can be excluded.

Uplink Carrier Aggregation Scenarios Conducted Power (Full)

Confugure	Combination	PCC							SCC							Measurement Power					
		Band	BW (MHz)	Modulation	RB Size	RB Offset	UL Channel	UL Frequency (MHz)	Band	BW (MHz)	Modulation	RB Size	RB Offset	UL Channel	UL Frequency (MHz)	Maximum Tune-up Power	Single Carrier Tx Power without UL-CA Active (dBm)	MPR Level (dB)	Tx Power with UL-CA Active (dBm)		
																			PCC	SCC	Total
Intra Band Contiguous	CA_5B	5	10	QPSK	1	0	20450	829	5	10	QPSK	1	49	20549	838.9	24.0	23.09	0-8.5	11.83	11.78	14.82
					1	49						24.0	22.95			0	19.82	19.77	22.81		
		5	10	QPSK	1	0	20476	831.6	5	10	QPSK	1	49	20575	841.5	24.0	23.17	0-8.5	11.92	11.85	14.90
					1	49						24.0	23.02			0	19.91	19.88	22.91		
		5	10	QPSK	1	0	20501	834.1	5	10	QPSK	1	49	20600	844	24.0	23.15	0-8.5	11.97	11.91	14.95
					1	49						24.0	22.91			0	19.89	19.81	22.86		
	CA_7C	7	20	QPSK	1	0	20850	2510	7	20	QPSK	1	99	21048	2529.8	24.0	23.01	0-8.5	11.85	11.76	14.82
					1	99						24.0	22.98			0	19.89	19.81	22.86		
		7	20	QPSK	1	0	21001	2525.1	7	20	QPSK	1	99	21199	2544.9	24.0	23.05	0-8.5	11.96	11.91	14.95
					1	99						24.0	22.97			0	19.85	19.77	22.82		
		7	20	QPSK	1	0	21152	2540.2	7	20	QPSK	1	99	21350	2560	24.0	23.16	0-8.5	12.03	12.01	15.03
					1	99						24.0	23.04			0	19.96	19.92	22.95		
	CA_38C	38	20	QPSK	1	0	37850	2580	38	20	QPSK	1	99	38048	2602.5	24.0	23.38	0-8.5	11.99	11.95	14.98
					1	99						24.0	23.25			0	20.11	20.06	23.10		
		38	20	QPSK	1	0	37901	2585.1	38	20	QPSK	1	99	38099	2604.9	24.0	23.26	0-8.5	12.06	12.02	15.05
					1	99						24.0	23.15			0	20.05	19.97	23.02		
		38	20	QPSK	1	0	37952	2590.2	38	20	QPSK	1	99	38150	2610	24.0	23.24	0-8.5	12.12	12.07	15.11
					1	99						24.0	23.05			0	20.01	19.92	22.98		
CA_41C	41	20	QPSK	1	0	39750	2506	41	20	QPSK	1	99	39948	2525.8	24.0	23.95	0-8.5	12.77	12.71	15.75	
				1	99						24.0	23.84			0	20.77	20.71	23.75			
	41	20	QPSK	1	0	40185	2549.5	41	20	QPSK	1	99	40383	2569.3	24.0	23.73	0-8.5	12.63	12.58	15.62	
				1	99						24.0	23.68			0	20.65	20.63	23.65			
	41	20	QPSK	1	0	40620	2593	41	20	QPSK	1	99	40818	2612.8	24.0	23.97	0-8.5	12.85	12.84	15.86	
				1	99						24.0	23.89			0	20.82	20.79	23.82			
	41	20	QPSK	1	0	41055	2636.5	41	20	QPSK	1	99	41253	2656.3	24.0	23.99	0-8.5	12.89	12.86	15.89	
				1	99						24.0	23.95			0	20.83	20.73	23.79			
	41	20	QPSK	1	0	41292	2660.2	41	20	QPSK	1	99	41490	2680	24.0	23.96	0-8.5	12.84	12.77	15.82	
				1	99						24.0	23.91			0	20.84	20.71	23.79			
CA_48C	48	20	QPSK	1	0	55340	3560	48	20	QPSK	1	99	55538	3579.8	22.0	21.47	0-8.5	10.22	10.17	13.21	
				1	99						22.0	21.39			0	18.42	18.31	21.38			
	48	20	QPSK	1	0	55830	3609	48	20	QPSK	1	99	55632	3589.2	22.0	21.25	0-8.5	10.31	10.25	13.29	
				1	99						22.0	21.24			0	18.21	18.15	21.19			
	48	20	QPSK	1	0	56150	3641	48	20	QPSK	1	99	55952	3621.2	22.0	21.58	0-8.5	10.42	10.35	13.40	
				1	99						22.0	21.51			0	18.47	18.33	21.41			
	48	20	QPSK	1	0	56640	3550	48	20	QPSK	1	99	56442	3670.2	22.0	21.85	0-8.5	10.69	10.58	13.65	
				1	99						22.0	21.81			0	18.77	18.69	21.74			
CA_66B	66	10	QPSK	1	0	132022	1715	66	10	QPSK	1	49	132121	1724.9	24.0	23.13	0-8.5	12.23	12.17	15.21	
				1	49						24.0	23.07			0	20.05	19.99	23.03			
	66	10	QPSK	1	0	132373	1750.1	66	10	QPSK	1	49	132472	1760	24.0	23.21	0-8.5	12.36	12.33	15.36	
				1	49						24.0	23.11			0	20.01	19.95	22.99			
	66	10	QPSK	1	0	132523	1765.1	66	10	QPSK	1	49	132622	1775	24.0	23.15	0-8.5	12.17	12.14	15.17	
				1	49						24.0	23.14			0	20.03	19.91	22.98			

Uplink Carrier Aggregation Scenarios Conducted Power (Full)

Confugure	Combination	PCC							SCC							Measurement Power					
		Band	BW (MHz)	Modulation	RB Size	RB Offset	UL Channel	UL Frequency (MHz)	Band	BW (MHz)	Modulation	RB Size	RB Offset	UL Channel	UL Frequency (MHz)	Maximum Tune-up Power	Single Carrier Tx Power without UL-CA Active (dBm)	MPR Level (dB)	Tx Power with UL-CA Active (dBm)		
																			PCC	SCC	Total
CA_66C	66	20	QPSK	1	0	132072	1720	66	20	QPSK	1	99	132270	1739.8	24.0	23.15	0-8.5	12.22	12.18	15.21	
				1	99						24.0	23.09			0	20.01	19.92	22.98			
	66	20	QPSK	1	0	132323	1745.1	66	20	QPSK	1	99	132521	1764.9	24.0	23.25	0-8.5	12.41	12.36	15.40	
				1	99						24.0	23.16			0	20.05	19.92	23.00			
	66	20	QPSK	1	0	132374	1750.2	66	20	QPSK	1	99	132572	1770	24.0	23.14	0-8.5	12.35	12.31	15.34	
				1	99						24.0	23.09			0	19.98	19.96	22.98			
CA_2A-5A	2	20	QPSK	1	0	18700	1860	5	10	QPSK	1	49	20525	836.5	24.0	23.32	0-8.5	12.51	12.47	15.50	
				1	99						24.0	22.81			0	19.77	19.72	22.76			
	2	20	QPSK	1	0	18900	1880	5	10	QPSK	1	49	20525	836.5	24.0	23.13	0-8.5	12.43	12.35	15.40	
				1	99						24.0	22.95			0	19.82	19.79	22.82			
	2	20	QPSK	1	0	19100	1900	5	10	QPSK	1	49	20525	836.5	24.0	23.16	0-8.5	12.36	12.31	15.35	
				1	99						24.0	22.92			0	19.79	19.71	22.76			
	CA_2A-12A	2	20	QPSK	1	0	18700	1860	12	10	QPSK	1	49	23095	707.5	24.0	23.32	0-8.5	12.47	12.44	15.47
					1	99						24.0	22.81			0	19.79	19.68	22.75		
		2	20	QPSK	1	0	18900	1880	12	10	QPSK	1	49	23095	707.5	24.0	23.13	0-8.5	12.38	12.32	15.36
					1	99						24.0	22.95			0	19.82	19.76	22.80		
		2	20	QPSK	1	0	19100	1900	12	10	QPSK	1	49	23095	707.5	24.0	23.16	0-8.5	12.28	12.22	15.26
					1	99						24.0	22.92			0	19.89	19.82	22.87		
	CA_2A-13A	2	20	QPSK	1	0	18700	1860	13	10	QPSK	1	49	23230	782	24.0	23.32	0-8.5	12.42	12.34	15.39
					1	99						24.0	22.81			0	19.73	19.69	22.72		
		2	20	QPSK	1	0	18900	1880	13	10	QPSK	1	49	23230	782	24.0	23.13	0-8.5	12.36	12.26	15.32
					1	99						24.0	22.95			0	19.81	19.74	22.79		
		2	20	QPSK	1	0	19100	1900	13	10	QPSK	1	49	23230	782	24.0	23.16	0-8.5	12.27	12.22	15.26
					1	99						24.0	22.92			0	19.82	19.77	22.81		
	CA_2A-14A	2	20	QPSK	1	0	18700	1860	14	10	QPSK	1	49	23330	793	24.0	23.32	0-8.5	12.39	12.35	15.38
					1	99						24.0	22.81			0	19.76	19.72	22.75		
		2	20	QPSK	1	0	18900	1880	14	10	QPSK	1	49	23330	793	24.0	23.13	0-8.5	12.35	12.34	15.36
					1	99						24.0	22.95			0	19.91	19.85	22.89		
		2	20	QPSK	1	0	19100	1900	14	10	QPSK	1	49	23330	793	24.0	23.16	0-8.5	12.24	12.21	15.24
					1	99						24.0	22.92			0	19.89	19.83	22.87		
CA_2A-48A	2	20	QPSK	1	0	18700	1860	48	20	QPSK	1	99	56210	3647	24.0	23.32	0-8.5	12.46	12.42	15.45	
				1	99						24.0	22.81			0	19.77	19.75	22.77			
	2	20	QPSK	1	0	18900	1880	48	20	QPSK	1	99	56210	3647	24.0	23.13	0-8.5	12.41	12.35	15.39	
				1	99						24.0	22.95			0	19.83	19.79	22.82			
	2	20	QPSK	1	0	18900	1880	48	20	QPSK	1	99	56210	3647	24.0	23.16	0-8.5	12.42	12.37	15.41	
				1	99						24.0	22.92			0	19.84	19.71	22.79			
CA_4A-5A	4	20	QPSK	1	0	20050	1720	5	10	QPSK	1	49	20525	836.5	24.0	23.27	0-8.5	12.25	12.17	15.22	
				1	99						24.0	22.85			0	19.79	19.65	22.73			
	4	20	QPSK	1	0	20175	1732.5	5	10	QPSK	1	49	20525	836.5	24.0	23.25	0-8.5	12.17	12.11	15.15	
				1	99						24.0	22.77			0	19.68	19.59	22.65			
	4	20	QPSK	1	0	20300	1745	5	10	QPSK	1	49	20525	836.5	24.0	23.22	0-8.5	12.13	12.05	15.10	
				1	99						24.0	22.77			0	19.61	19.55	22.59			

Uplink Carrier Aggregation Scenarios Conducted Power (Full)

Configure	Combination	PCC							SCC							Measurement Power					
		Band	BW (MHz)	Modulation	RB Size	RB Offset	UL Channel	UL Frequency (MHz)	Band	BW (MHz)	Modulation	RB Size	RB Offset	UL Channel	UL Frequency (MHz)	Maximum Tune-up Power	Single Carrier Tx Power without UL-CA Active (dBm)	MPR Level (dB)	Tx Power with UL-CA Active (dBm)		
																			PCC	SCC	Total
Inter Band	CA_4A-12A	4	20	QPSK	1	0	20050	1720	12	10	QPSK	1	49	23095	707.5	24.0	23.27	0-8.5	12.19	12.16	15.19
					1	99						24.0	22.85			0	19.63	19.51	22.58		
		4	20	QPSK	1	0	20175	1732.5	12	10	QPSK	1	49	23095	707.5	24.0	23.25	0-8.5	12.22	12.09	15.17
					1	99						24.0	22.77			0	19.71	19.63	22.68		
		4	20	QPSK	1	0	20300	1745	12	10	QPSK	1	49	23095	707.5	24.0	23.22	0-8.5	12.27	12.11	15.20
					1	99						24.0	22.77			0	19.72	19.65	22.70		
	CA_4A-13A	4	20	QPSK	1	0	20050	1720	13	10	QPSK	1	49	23230	782	24.0	23.27	0-8.5	12.32	12.23	15.29
					1	99						24.0	22.85			0	19.79	19.75	22.78		
		4	20	QPSK	1	0	20175	1732.5	13	10	QPSK	1	49	23230	782	24.0	23.25	0-8.5	12.27	12.17	15.23
					1	99						24.0	22.77			0	19.71	19.66	22.70		
		4	20	QPSK	1	0	20300	1745	13	10	QPSK	1	49	23230	782	24.0	23.22	0-8.5	12.21	12.14	15.19
					1	99						24.0	22.77			0	19.63	19.57	22.61		
	CA_5A-7A	5	10	QPSK	1	0	20450	829	7	20	QPSK	1	99	21100	2535	24.0	23.09	0-8.5	12.09	12.05	15.08
					1	49						24.0	22.95			0	19.95	19.91	22.94		
		5	10	QPSK	1	0	20525	836.5	7	20	QPSK	1	99	21100	2535	24.0	23.22	0-8.5	12.15	12.07	15.12
					1	49						24.0	23.01			0	19.99	19.87	22.94		
		5	10	QPSK	1	0	20600	844	7	20	QPSK	1	99	21100	2535	24.0	23.17	0-8.5	12.13	12.06	15.11
					1	49						24.0	22.93			0	19.85	19.81	22.84		
	CA_5A-30A	5	10	QPSK	1	0	20450	829	30	10	QPSK	1	49	27710	2310	24.0	23.09	0-8.5	12.16	12.05	15.12
					1	49						24.0	22.95			0	19.82	19.75	22.80		
		5	10	QPSK	1	0	20525	836.5	30	10	QPSK	1	49	27710	2310	24.0	23.22	0-8.5	12.25	12.11	15.19
					1	49						24.0	23.01			0	19.93	19.86	22.91		
		5	10	QPSK	1	0	20600	844	30	10	QPSK	1	49	27710	2310	24.0	23.17	0-8.5	12.22	12.13	15.19
					1	49						24.0	22.93			0	19.85	19.74	22.81		
CA_5A-48A	5	10	QPSK	1	0	20450	829	48	20	QPSK	1	99	56210	3647	24.0	23.09	0-8.5	12.14	12.06	15.11	
				1	49						24.0	22.95			0	19.86	19.79	22.84			
	5	10	QPSK	1	0	20525	836.5	48	20	QPSK	1	99	56210	3647	24.0	23.22	0-8.5	12.18	12.09	15.15	
				1	49						24.0	23.01			0	19.92	19.82	22.88			
	5	10	QPSK	1	0	20600	844	48	20	QPSK	1	99	56210	3647	24.0	23.17	0-8.5	12.09	12.01	15.06	
				1	49						24.0	22.93			0	19.73	19.65	22.70			
CA_5A-66A	5	10	QPSK	1	0	20450	829	66	20	QPSK	1	99	132322	1745	24.0	23.09	0-8.5	12.09	12.06	15.09	
				1	49						24.0	22.95			0	19.84	19.71	22.79			
	5	10	QPSK	1	0	20525	836.5	66	20	QPSK	1	99	132322	1745	24.0	23.22	0-8.5	12.14	12.08	15.12	
				1	49						24.0	23.01			0	19.92	19.83	22.89			
	5	10	QPSK	1	0	20600	844	66	20	QPSK	1	99	132322	1745	24.0	23.17	0-8.5	12.12	12.02	15.08	
				1	49						24.0	22.93			0	19.79	19.72	22.77			
CA_12A-30A	12	10	QPSK	1	0	23060	704	30	10	QPSK	1	49	27710	2310	24.0	22.93	0-8.5	11.91	11.88	14.91	
				1	49						24.0	22.74			0	19.63	19.55	22.60			
	12	10	QPSK	1	0	23095	707.5	30	10	QPSK	1	49	27710	2310	24.0	22.85	0-8.5	11.73	11.63	14.69	
				1	49						24.0	22.65			0	19.58	19.47	22.54			
	12	10	QPSK	1	0	23130	711	30	10	QPSK	1	49	27710	2310	24.0	23.07	0-8.5	12.05	12.01	15.04	
				1	49						24.0	22.81			0	19.72	19.66	22.70			

Uplink Carrier Aggregation Scenarios Conducted Power (Full)

Configure	Combination	PCC							SCC							Measurement Power					
		Band	BW (MHz)	Modulation	RB Size	RB Offset	UL Channel	UL Frequency (MHz)	Band	BW (MHz)	Modulation	RB Size	RB Offset	UL Channel	UL Frequency (MHz)	Maximum Tune-up Power	Single Carrier Tx Power without UL-CA Active (dBm)	MPR Level (dB)	Tx Power with UL-CA Active (dBm)		
																			PCC	SCC	Total
	CA_12A-66A	12	10	QPSK	1	0	23060	704	66	20	QPSK	1	99	132322	1745	24.0	22.93	0-8.5	11.96	11.94	14.96
					1	49						1	0			24.0	22.74	0	19.69	19.62	22.67
		12	10	QPSK	1	0	23095	707.5	66	20	QPSK	1	99	132322	1745	24.0	22.85	0-8.5	11.91	11.87	14.90
					1	49						1	0			24.0	22.65	0	19.61	19.58	22.61
		12	10	QPSK	1	0	23130	711	66	20	QPSK	1	99	132322	1745	24.0	23.07	0-8.5	12.03	11.96	15.01
					1	49						1	0			24.0	22.81	0	19.64	19.55	22.61
	CA_13A-48A	13	10	QPSK	1	0	23230	782	48	20	QPSK	1	99	56210	3647	24.0	23.08	0-8.5	12.13	12.06	15.11
					1	49						1	0			24.0	22.91	0	19.87	19.73	22.81
	CA_13A-66A	13	10	QPSK	1	0	23230	782	66	20	QPSK	1	99	132322	1745	24.0	23.08	0-8.5	12.17	12.11	15.15
					1	49						1	0			24.0	22.91	0	19.85	19.79	22.83
	CA_14A-30A	14	10	QPSK	1	0	23330	793	30	10	QPSK	1	49	27710	2310	24.0	23.04	0-8.5	12.15	12.06	15.12
					1	99						1	0			24.0	22.89	0	19.76	19.74	22.76
	CA_14A-66A	14	10	QPSK	1	0	23330	793	66	20	QPSK	1	99	132322	1745	24.0	23.04	0-8.5	12.01	11.98	15.01
					1	99						1	0			24.0	22.89	0	19.81	19.72	22.78
	CA_48A-66A	48	20	QPSK	1	0	55340	3560	66	20	QPSK	1	99	132322	1745	22.0	21.47	0-8.5	10.42	10.38	13.41
					1	99						1	0			22.0	21.39	0	18.32	18.27	21.31
		48	20	QPSK	1	0	55780	3603	66	20	QPSK	1	99	132322	1745	22.0	21.29	0-8.5	10.35	10.33	13.35
					1	99						1	0			22.0	21.25	0	18.21	18.14	21.19
		48	20	QPSK	1	0	56210	3647	66	20	QPSK	1	99	132322	1745	22.0	21.63	0-8.5	10.52	10.47	13.51
					1	99						1	0			22.0	21.55	0	18.41	18.33	21.38
		48	20	QPSK	1	0	56640	3690	66	20	QPSK	1	99	132322	1745	22.0	21.85	0-8.5	10.71	10.65	13.69
					1	99						1	0			22.0	21.81	0	18.69	18.65	21.68

Uplink Carrier Aggregation Scenarios Conducted Power (Reduction) - Laptop

Configure	Combination	PCC							SCC							Measurement Power					
		Band	BW (MHz)	Modulation	RB Size	RB Offset	UL Channel	UL Frequency (MHz)	Band	BW (MHz)	Modulation	RB Size	RB Offset	UL Channel	UL Frequency (MHz)	Maximum Tune-up Power	Single Carrier Tx Power without UL-CA Active (dBm)	MPR Level (dB)	Tx Power with UL-CA Active (dBm)		
																			PCC	SCC	Total
Intra Band Contiguous	CA_5B	5	10	QPSK	1	0	20450	829	5	10	QPSK	1	49	20549	838.9	23	22.04	0-8.5	18.98	18.91	21.96
					1	49						23	21.96			0	18.89	18.85	21.88		
		5	10	QPSK	1	0	20476	831.6	5	10	QPSK	1	49	20575	841.5	23	22.11	0-8.5	18.97	18.92	21.96
					1	49						23	22.04			0	19.02	18.98	22.01		
		5	10	QPSK	1	0	20501	834.1	5	10	QPSK	1	49	20600	844	23	22.05	0-8.5	18.96	18.84	21.91
					1	49						23	21.98			0	18.91	18.86	21.90		
	CA_7C	7	20	QPSK	1	0	20850	2510	7	20	QPSK	1	99	21048	2529.8	19.5	19.21	0-8.5	16.13	16.05	19.10
					1	99						19.5	19.08			0	16.02	15.98	19.01		
		7	20	QPSK	1	0	21001	2525.1	7	20	QPSK	1	99	21199	2544.9	19.5	19.27	0-8.5	16.17	16.03	19.11
					1	99						19.5	19.17			0	16.04	15.98	19.02		
		7	20	QPSK	1	0	21152	2540.2	7	20	QPSK	1	99	21350	2560	19.5	19.44	0-8.5	16.32	16.25	19.30
					1	99						19.5	19.31			0	16.21	16.17	19.20		
	CA_38C	38	20	QPSK	1	0	37850	2580	38	20	QPSK	1	99	38048	2602.5	21.5	21.07	0-8.5	17.97	17.92	20.96
					1	99						21.5	21.04			0	17.85	17.79	20.83		
		38	20	QPSK	1	0	37901	2585.1	38	20	QPSK	1	99	38099	2604.9	21.5	20.98	0-8.5	17.94	17.84	20.90
					1	99						21.5	20.95			0	17.91	17.83	20.88		
		38	20	QPSK	1	0	37952	2590.2	38	20	QPSK	1	99	38150	2610	21.5	21.03	0-8.5	17.93	17.85	20.90
					1	99						21.5	21.01			0	17.85	17.76	20.82		
	CA_41C	41	20	QPSK	1	0	39750	2506	41	20	QPSK	1	99	39948	2525.8	18	17.45	0-8.5	14.41	14.35	17.39
					1	99						18	17.36			0	14.29	14.22	17.27		
		41	20	QPSK	1	0	40185	2549.5	41	20	QPSK	1	99	40383	2569.3	18	17.24	0-8.5	14.21	14.17	17.20
					1	99						18	17.15			0	14.08	14.02	17.06		
		41	20	QPSK	1	0	40620	2593	41	20	QPSK	1	99	40818	2612.8	18	17.34	0-8.5	14.22	14.13	17.19
					1	99						18	17.25			0	14.16	14.05	17.12		
	41	20	QPSK	1	0	41055	2636.5	41	20	QPSK	1	99	41253	2656.3	18	17.6	0-8.5	14.55	14.47	17.52	
				1	99						18	17.51			0	14.47	14.36	17.43			
	41	20	QPSK	1	0	41292	2660.2	41	20	QPSK	1	99	41490	2680	18	17.45	0-8.5	14.32	14.28	17.31	
				1	99						18	17.35			0	14.27	14.22	17.26			
	CA_48C	48	20	QPSK	1	0	55340	3560	48	20	QPSK	1	99	55538	3579.8	17.5	16.81	0-8.5	13.75	13.68	16.73
					1	99						17.5	16.7			0	13.61	13.55	16.59		
		48	20	QPSK	1	0	55830	3609	48	20	QPSK	1	99	55632	3589.2	17.5	16.71	0-8.5	13.59	13.51	16.56
					1	99						17.5	16.58			0	13.42	13.38	16.41		
		48	20	QPSK	1	0	56150	3641	48	20	QPSK	1	99	55952	3621.2	17.5	16.95	0-8.5	13.86	13.81	16.85
					1	99						17.5	16.87			0	13.82	13.77	16.81		
	48	20	QPSK	1	0	56640	3550	48	20	QPSK	1	99	56442	3670.2	17.5	17.19	0-8.5	14.11	14.06	17.10	
				1	99						17.5	17.08			0	14.02	13.96	17.00			
	CA_66B	66	10	QPSK	1	0	132022	1715	66	10	QPSK	1	49	132121	1724.9	21.5	21.02	0-8.5	17.96	17.91	20.95
					1	49						21.5	20.95			0	17.91	17.85	20.89		
		66	10	QPSK	1	0	132373	1750.1	66	10	QPSK	1	49	132472	1760	21.5	21.11	0-8.5	18.02	17.92	20.98
					1	49						21.5	21.08			0	17.91	17.85	20.89		
		66	10	QPSK	1	0	132523	1765.1	66	10	QPSK	1	49	132622	1775	21.5	21.14	0-8.5	17.99	17.93	20.97
					1	49						21.5	21.06			0	17.96	17.84	20.91		

Uplink Carrier Aggregation Scenarios Conducted Power (Reduction) - Laptop

Configure	Combination	PCC							SCC							Measurement Power					
		Band	BW (MHz)	Modulation	RB Size	RB Offset	UL Channel	UL Frequency (MHz)	Band	BW (MHz)	Modulation	RB Size	RB Offset	UL Channel	UL Frequency (MHz)	Maximum Tune-up Power	Single Carrier Tx Power without UL-CA Active (dBm)	MPR Level (dB)	Tx Power with UL-CA Active (dBm)		
																			PCC	SCC	Total
CA_66C	66	20	QPSK	1	0	132072	1720	66	20	QPSK	1	99	132270	1739.8	21.5	21.04	0-8.5	17.95	17.89	20.93	
				1	99						21.5	20.99			0	17.85	17.79	20.83			
	66	20	QPSK	1	0	132323	1745.1	66	20	QPSK	1	99	132521	1764.9	21.5	21.14	0-8.5	17.97	17.82	20.91	
				1	99						21.5	21.09			0	17.89	17.84	20.88			
	66	20	QPSK	1	0	132374	1750.2	66	20	QPSK	1	99	132572	1770	21.5	21.13	0-8.5	17.98	17.86	20.93	
				1	99						21.5	21.07			0	17.92	17.82	20.88			
CA_2A-5A	2	20	QPSK	1	0	18700	1860	5	10	QPSK	1	49	20525	836.5	18	17.85	0-8.5	14.73	14.68	17.72	
				1	99						18	17.81			0	14.65	14.61	17.64			
	2	20	QPSK	1	0	18900	1880	5	10	QPSK	1	49	20525	836.5	18	17.8	0-8.5	14.77	14.62	17.71	
				1	99						18	17.75			0	14.69	14.58	17.65			
	2	20	QPSK	1	0	19100	1900	5	10	QPSK	1	49	20525	836.5	18	17.81	0-8.5	14.68	14.59	17.65	
				1	99						18	17.77			0	14.62	14.51	17.58			
	CA_2A-12A	2	20	QPSK	1	0	18700	1860	12	10	QPSK	1	49	23095	707.5	18	17.85	0-8.5	14.79	14.72	17.77
					1	99						18	17.81			0	14.75	14.68	17.73		
		2	20	QPSK	1	0	18900	1880	12	10	QPSK	1	49	23095	707.5	18	17.8	0-8.5	14.69	14.65	17.68
					1	99						18	17.75			0	14.62	14.58	17.61		
		2	20	QPSK	1	0	19100	1900	12	10	QPSK	1	49	23095	707.5	18	17.81	0-8.5	14.67	14.61	17.65
					1	99						18	17.77			0	14.72	14.66	17.70		
	CA_2A-13A	2	20	QPSK	1	0	18700	1860	13	10	QPSK	1	49	23230	782	18	17.85	0-8.5	14.79	14.71	17.76
					1	99						18	17.81			0	14.65	14.58	17.63		
		2	20	QPSK	1	0	18900	1880	13	10	QPSK	1	49	23230	782	18	17.8	0-8.5	14.67	14.59	17.64
					1	99						18	17.75			0	14.63	14.51	17.58		
		2	20	QPSK	1	0	19100	1900	13	10	QPSK	1	49	23230	782	18	17.81	0-8.5	14.72	14.62	17.68
					1	99						18	17.77			0	14.64	14.55	17.61		
	CA_2A-14A	2	20	QPSK	1	0	18700	1860	14	10	QPSK	1	49	23330	793	18	17.85	0-8.5	14.73	14.63	17.69
					1	99						18	17.81			0	14.64	14.54	17.60		
		2	20	QPSK	1	0	18900	1880	14	10	QPSK	1	49	23330	793	18	17.8	0-8.5	14.72	14.67	17.71
					1	99						18	17.75			0	14.66	14.59	17.64		
		2	20	QPSK	1	0	19100	1900	14	10	QPSK	1	49	23330	793	18	17.81	0-8.5	14.76	14.67	17.73
					1	99						18	17.77			0	14.72	14.62	17.68		
CA_2A-48A	2	20	QPSK	1	0	18700	1860	48	20	QPSK	1	99	56210	3647	18	17.85	0-8.5	14.73	14.65	17.70	
				1	99						18	17.81			0	14.69	14.62	17.67			
	2	20	QPSK	1	0	18900	1880	48	20	QPSK	1	99	56210	3647	18	17.8	0-8.5	14.65	14.51	17.59	
				1	99						18	17.75			0	14.62	14.47	17.56			
	2	20	QPSK	1	0	19100	1900	48	20	QPSK	1	99	56210	3647	18	17.81	0-8.5	14.71	14.58	17.66	
				1	99						18	17.77			0	14.63	14.51	17.58			
CA_4A-5A	4	20	QPSK	1	0	20050	1720	5	10	QPSK	1	49	20525	836.5	18.0	17.81	0-8.5	14.75	14.69	17.73	
				1	99						18.0	17.69			0	14.56	14.52	17.55			
	4	20	QPSK	1	0	20175	1732.5	5	10	QPSK	1	49	20525	836.5	18.0	17.74	0-8.5	14.68	14.61	17.66	
				1	99						18.0	17.62			0	14.51	14.47	17.50			
	4	20	QPSK	1	0	20300	1745	5	10	QPSK	1	49	20525	836.5	18.0	17.75	0-8.5	14.69	14.63	17.67	
				1	99						18.0	17.63			0	14.52	14.47	17.51			

Uplink Carrier Aggregation Scenarios Conducted Power (Reduction) - Laptop

Configure	Combination	PCC							SCC							Measurement Power					
		Band	BW (MHz)	Modulation	RB Size	RB Offset	UL Channel	UL Frequency (MHz)	Band	BW (MHz)	Modulation	RB Size	RB Offset	UL Channel	UL Frequency (MHz)	Maximum Tune-up Power	Single Carrier Tx Power without UL-CA Active (dBm)	MPR Level (dB)	Tx Power with UL-CA Active (dBm)		
																			PCC	SCC	Total
Inter Band	CA_4A-12A	4	20	QPSK	1	0	20050	1720	12	10	QPSK	1	49	23095	707.5	18.0	17.81	0-8.5	14.63	14.59	17.62
					1	99						18.0	17.69			0	14.51	14.44	17.49		
		4	20	QPSK	1	0	20175	1732.5	12	10	QPSK	1	49	23095	707.5	18.0	17.74	0-8.5	14.55	14.41	17.49
					1	99						18.0	17.62			0	14.47	14.42	17.46		
		4	20	QPSK	1	0	20300	1745	12	10	QPSK	1	49	23095	707.5	18.0	17.75	0-8.5	14.62	14.59	17.62
					1	99						18.0	17.63			0	14.53	14.45	17.50		
	CA_4A-13A	4	20	QPSK	1	0	20050	1720	13	10	QPSK	1	49	23230	782	18.0	17.81	0-8.5	14.74	14.68	17.72
					1	99						18.0	17.69			0	14.61	14.54	17.59		
		4	20	QPSK	1	0	20175	1732.5	13	10	QPSK	1	49	23230	782	18.0	17.74	0-8.5	14.65	14.53	17.60
					1	99						18.0	17.62			0	14.53	14.47	17.51		
		4	20	QPSK	1	0	20300	1745	13	10	QPSK	1	49	23230	782	18.0	17.75	0-8.5	14.59	14.51	17.56
					1	99						18.0	17.63			0	14.47	14.38	17.44		
	CA_5A-7A	5	10	QPSK	1	0	20450	829	7	20	QPSK	1	99	21100	2535	23	22.04	0-8.5	18.92	18.88	21.91
					1	49						23	21.96			0	18.88	18.82	21.86		
		5	10	QPSK	1	0	20525	836.5	7	20	QPSK	1	99	21100	2535	23	22.13	0-8.5	18.93	18.81	21.88
					1	49						23	22.05			0	18.89	18.74	21.83		
		5	10	QPSK	1	0	20600	844	7	20	QPSK	1	99	21100	2535	23	22.09	0-8.5	18.85	18.79	21.83
					1	49						23	22.01			0	18.81	18.75	21.79		
	CA_5A-30A	5	10	QPSK	1	0	20450	829	30	10	QPSK	1	49	27710	2310	23	22.04	0-8.5	18.96	18.91	21.95
					1	49						23	21.96			0	18.84	18.82	21.8		
		5	10	QPSK	1	0	20525	836.5	30	10	QPSK	1	49	27710	2310	23	22.13	0-8.5	18.91	18.85	21.89
					1	49						23	22.05			0	18.82	18.77	21.81		
		5	10	QPSK	1	0	20600	844	30	10	QPSK	1	49	27710	2310	23	22.09	0-8.5	18.89	18.83	21.87
					1	49						23	22.01			0	18.78	18.72	21.76		
	CA_5A-48A	5	10	QPSK	1	0	20450	829	48	20	QPSK	1	99	56210	3647	23	22.04	0-8.5	18.96	18.86	21.92
					1	49						23	21.96			0	18.82	18.74	21.79		
		5	10	QPSK	1	0	20525	836.5	48	20	QPSK	1	99	56210	3647	23	22.13	0-8.5	18.99	18.92	21.97
					1	49						23	22.05			0	18.91	18.85	21.89		
		5	10	QPSK	1	0	20600	844	48	20	QPSK	1	99	56210	3647	23	22.09	0-8.5	18.92	18.87	21.91
					1	49						23	22.01			0	18.93	18.83	21.89		
	CA_5A-66A	5	10	QPSK	1	0	20450	829	66	20	QPSK	1	99	132322	1745	23	22.04	0-8.5	19.01	18.96	22.00
					1	49						23	21.96			0	18.85	18.73	21.80		
		5	10	QPSK	1	0	20525	836.5	66	20	QPSK	1	99	132322	1745	23	22.13	0-8.5	19.05	18.92	22.00
					1	49						23	22.05			0	18.96	18.89	21.94		
		5	10	QPSK	1	0	20600	844	66	20	QPSK	1	99	132322	1745	23	22.09	0-8.5	18.99	18.91	21.96
					1	49						23	22.01			0	18.97	18.86	21.93		
	CA_12A-30A	12	10	QPSK	1	0	23060	704	30	10	QPSK	1	49	27710	2310	23.0	22.06	0-8.5	18.97	18.87	21.93
					1	49						23.0	21.82			0	18.77	18.73	21.76		
		12	10	QPSK	1	0	23095	707.5	30	10	QPSK	1	49	27710	2310	23.0	21.95	0-8.5	18.89	18.77	21.84
					1	49						23.0	21.71			0	18.63	18.58	21.62		
		12	10	QPSK	1	0	23130	711	30	10	QPSK	1	49	27710	2310	23.0	22.11	0-8.5	19.03	18.89	21.97
					1	49						23.0	21.87			0	18.79	18.62	21.72		

Uplink Carrier Aggregation Scenarios Conducted Power (Reduction) - Laptop

Confugure	Combination	PCC							SCC							Measurement Power					
		Band	BW (MHz)	Modulation	RB Size	RB Offset	UL Channel	UL Frequency (MHz)	Band	BW (MHz)	Modulation	RB Size	RB Offset	UL Channel	UL Frequency (MHz)	Maximum Tune-up Power	Single Carrier Tx Power without UL-CA Active (dBm)	MPR Level (dB)	Tx Power with UL-CA Active (dBm)		
																			PCC	SCC	Total
	CA_12A-66A	12	10	QPSK	1	0	23060	704	66	20	QPSK	1	99	132322	1745	23.0	22.06	0-8.5	19.02	18.91	21.98
					1	49						1	0			23.0	21.82	0	18.77	18.63	21.71
		12	10	QPSK	1	0	23095	707.5	66	20	QPSK	1	99	132322	1745	23.0	21.95	0-8.5	18.84	18.72	21.79
					1	49						1	0			23.0	21.71	0	18.65	18.58	21.63
		12	10	QPSK	1	0	23130	711	66	20	QPSK	1	99	132322	1745	23.0	22.11	0-8.5	18.96	18.89	21.94
					1	49						1	0			23.0	21.87	0	18.72	18.65	21.70
	CA_13A-48A	13	10	QPSK	1	0	23230	782	48	20	QPSK	1	99	56210	3647	23	22	0-8.5	18.95	18.91	21.94
					1	49						1	0			23	21.83	0	18.81	18.78	21.81
	CA_13A-66A	13	10	QPSK	1	0	23230	782	66	20	QPSK	1	99	132322	1745	23	22	0-8.5	18.92	18.85	21.90
					1	49						1	0			23	21.83	0	18.77	18.72	21.76
	CA_14A-30A	14	10	QPSK	1	0	23330	793	30	10	QPSK	1	49	27710	2310	23	22.67	0-8.5	19.52	19.47	22.51
					1	49						1	0			23	22.6	0	19.47	19.38	22.44
	CA_14A-66A	14	10	QPSK	1	0	23330	793	66	20	QPSK	1	99	132322	1745	23	22.67	0-8.5	19.55	19.47	22.52
					1	49						1	0			23	22.6	0	19.49	19.41	22.46
	CA_48A-66A	48	20	QPSK	1	0	55340	3560	66	20	QPSK	1	99	132322	1745	17.5	16.81	0-8.5	13.77	13.72	16.76
					1	99						1	0			17.5	16.7	0	13.62	13.58	16.61
		48	20	QPSK	1	0	55780	3603	66	20	QPSK	1	99	132322	1745	17.5	16.73	0-8.5	13.68	13.55	16.63
					1	99						1	0			17.5	16.62	0	13.55	13.47	16.52
		48	20	QPSK	1	0	56210	3647	66	20	QPSK	1	99	132322	1745	17.5	16.99	0-8.5	13.89	13.79	16.85
					1	99						1	0			17.5	16.88	0	13.81	13.72	16.78
		48	20	QPSK	1	0	56640	3690	66	20	QPSK	1	99	132322	1745	17.5	17.19	0-8.5	14.03	13.96	17.01
					1	99						1	0			17.5	17.08	0	14.01	13.95	16.99

Uplink Carrier Aggregation Scenarios Conducted Power (Reduction) - Tablet

Configure	Combination	PCC							SCC							Measurement Power					
		Band	BW (MHz)	Modulation	RB Size	RB Offset	UL Channel	UL Frequency (MHz)	Band	BW (MHz)	Modulation	RB Size	RB Offset	UL Channel	UL Frequency (MHz)	Maximum Tune-up Power	Single Carrier Tx Power without UL-CA Active (dBm)	MPR Level (dB)	Tx Power with UL-CA Active (dBm)		
																			PCC	SCC	Total
Intra Band Contiguous	CA_5B	5	10	QPSK	1	0	20450	829	5	10	QPSK	1	49	20549	838.9	19.5	19.26	0-8.5	16.13	16.05	19.10
					1	49						19.5	19.23			0	16.05	16.01	19.04		
		5	10	QPSK	1	0	20476	831.6	5	10	QPSK	1	49	20575	841.5	19.5	19.35	0-8.5	16.22	16.17	19.21
					1	49						19.5	19.32			0	16.17	16.12	19.16		
		5	10	QPSK	1	0	20501	834.1	5	10	QPSK	1	49	20600	844	19.5	19.14	0-8.5	16.09	16.03	19.07
					1	49						19.5	19.11			0	16.01	15.96	19.00		
	CA_7C	7	20	QPSK	1	0	20850	2510	7	20	QPSK	1	99	21048	2529.8	13.5	12.73	0-8.5	9.65	9.53	12.60
					1	99						13.5	12.57			0	9.51	9.47	12.50		
		7	20	QPSK	1	0	21001	2525.1	7	20	QPSK	1	99	21199	2544.9	13.5	12.76	0-8.5	9.55	9.45	12.51
					1	99						13.5	12.6			0	9.43	9.38	12.42		
		7	20	QPSK	1	0	21152	2540.2	7	20	QPSK	1	99	21350	2560	13.5	12.77	0-8.5	9.69	9.62	12.67
					1	99						13.5	12.61			0	9.57	9.47	12.53		
	CA_38C	38	20	QPSK	1	0	37850	2580	38	20	QPSK	1	99	38048	2602.5	15.0	14.93	0-8.5	11.86	11.73	14.81
					1	99						15.0	14.82			0	11.73	11.68	14.72		
		38	20	QPSK	1	0	37901	2585.1	38	20	QPSK	1	99	38099	2604.9	15.0	14.88	0-8.5	11.82	11.77	14.81
					1	99						15.0	14.79			0	11.74	11.65	14.71		
		38	20	QPSK	1	0	37952	2590.2	38	20	QPSK	1	99	38150	2610	15.0	14.78	0-8.5	11.64	11.54	14.60
					1	99						15.0	14.65			0	11.53	11.47	14.51		
	CA_41C	41	20	QPSK	1	0	39750	2506	41	20	QPSK	1	99	39948	2525.8	19.0	18.51	0-8.5	15.47	15.43	18.46
					1	99						19.0	18.32			0	15.28	15.21	18.26		
		41	20	QPSK	1	0	40185	2549.5	41	20	QPSK	1	99	40383	2569.3	19.0	18.18	0-8.5	15.05	15.01	18.04
					1	99						19.0	18			0	14.94	14.91	17.94		
		41	20	QPSK	1	0	40620	2593	41	20	QPSK	1	99	40818	2612.8	19.0	18.45	0-8.5	15.32	15.27	18.31
					1	99						19.0	18.27			0	15.22	15.17	18.21		
		41	20	QPSK	1	0	41055	2636.5	41	20	QPSK	1	99	41253	2656.3	19.0	18.71	0-8.5	15.67	15.53	18.61
					1	99						19.0	18.53			0	15.46	15.42	18.45		
		41	20	QPSK	1	0	41292	2660.2	41	20	QPSK	1	99	41490	2680	19.0	18.49	0-8.5	15.42	15.38	18.41
					1	99						19.0	18.31			0	15.27	15.22	18.26		
	CA_48C	48	20	QPSK	1	0	55340	3560	48	20	QPSK	1	99	55538	3579.8	14.0	13.75	0-8.5	10.69	10.65	13.68
					1	99						14.0	13.49			0	10.42	10.38	13.41		
		48	20	QPSK	1	0	55830	3609	48	20	QPSK	1	99	55632	3589.2	14.0	13.65	0-8.5	10.57	10.41	13.50
					1	99						14.0	13.41			0	10.35	10.24	13.31		
		48	20	QPSK	1	0	56150	3641	48	20	QPSK	1	99	55952	3621.2	14.0	13.88	0-8.5	10.73	10.68	13.72
					1	99						14.0	13.67			0	10.61	10.55	13.59		
		48	20	QPSK	1	0	56640	3550	48	20	QPSK	1	99	56442	3670.2	14.0	13.98	0-8.5	10.84	10.77	13.82
					1	99						14.0	13.87			0	10.79	10.71	13.76		
	CA_66B	66	10	QPSK	1	0	132022	1715	66	10	QPSK	1	49	132121	1724.9	16.5	16.01	0-8.5	13.01	12.95	15.99
					1	49						16.5	15.95			0	12.85	12.73	15.80		
		66	10	QPSK	1	0	132373	1750.1	66	10	QPSK	1	49	132472	1760	16.5	16.19	0-8.5	13.11	13.01	16.07
					1	49						16.5	16.12			0	13.05	12.94	16.01		
		66	10	QPSK	1	0	132523	1765.1	66	10	QPSK	1	49	132622	1775	16.5	16.14	0-8.5	13.01	12.96	16.00
					1	49						16.5	16.02			0	12.96	12.85	15.92		

Uplink Carrier Aggregation Scenarios Conducted Power (Reduction) - Tablet

Configure	Combination	PCC							SCC							Measurement Power					
		Band	BW (MHz)	Modulation	RB Size	RB Offset	UL Channel	UL Frequency (MHz)	Band	BW (MHz)	Modulation	RB Size	RB Offset	UL Channel	UL Frequency (MHz)	Maximum Tune-up Power	Single Carrier Tx Power without UL-CA Active (dBm)	MPR Level (dB)	Tx Power with UL-CA Active (dBm)		
																			PCC	SCC	Total
CA_66C	66	20	QPSK	1	0	132072	1720	66	20	QPSK	1	99	132270	1739.8	16.5	16.05	0-8.5	13.02	12.91	15.98	
				1	99						16.5	15.98			0	12.94	12.86	15.91			
	66	20	QPSK	1	0	132323	1745.1	66	20	QPSK	1	99	132521	1764.9	16.5	16.21	0-8.5	13.14	13.02	16.09	
				1	99						16.5	16.15			0	13.06	12.97	16.03			
	66	20	QPSK	1	0	132374	1750.2	66	20	QPSK	1	99	132572	1770	16.5	16.13	0-8.5	13.02	12.93	15.99	
				1	99						16.5	16.02			0	12.92	12.83	15.89			
CA_2A-5A	2	20	QPSK	1	0	18700	1860	5	10	QPSK	1	49	20525	836.5	16	15.32	0-8.5	12.25	12.2	15.24	
				1	99						16	15.15			0	12.03	11.96	15.01			
	2	20	QPSK	1	0	18900	1880	5	10	QPSK	1	49	20525	836.5	16	15.25	0-8.5	12.21	12.17	15.20	
				1	99						16	15.08			0	12.01	11.94	14.99			
	2	20	QPSK	1	0	19100	1900	5	10	QPSK	1	49	20525	836.5	16	15.15	0-8.5	12.03	11.99	15.02	
				1	99						16	14.98			0	11.95	11.85	14.91			
	CA_2A-12A	2	20	QPSK	1	0	18700	1860	12	10	QPSK	1	49	23095	707.5	16	15.32	0-8.5	12.24	12.19	15.23
					1	99						16	15.15			0	12.04	12.01	15.04		
		2	20	QPSK	1	0	18900	1880	12	10	QPSK	1	49	23095	707.5	16	15.25	0-8.5	12.21	12.16	15.20
					1	99						16	15.08			0	12.03	11.94	15.00		
		2	20	QPSK	1	0	19100	1900	12	10	QPSK	1	49	23095	707.5	16	15.15	0-8.5	12.06	11.98	15.03
					1	99						16	14.98			0	11.91	11.82	14.88		
CA_2A-13A	2	20	QPSK	1	0	18700	1860	13	10	QPSK	1	49	23230	782	16	15.32	0-8.5	12.22	12.13	15.19	
				1	99						16	15.15			0	12.06	12.02	15.05			
	2	20	QPSK	1	0	18900	1880	13	10	QPSK	1	49	23230	782	16	15.25	0-8.5	12.05	11.98	15.03	
				1	99						16	15.08			0	11.97	11.92	14.96			
	2	20	QPSK	1	0	19100	1900	13	10	QPSK	1	49	23230	782	16	15.15	0-8.5	12.03	11.91	14.98	
				1	99						16	14.98			0	11.89	11.83	14.87			
CA_2A-14A	2	20	QPSK	1	0	18700	1860	14	10	QPSK	1	49	23330	793	16	15.32	0-8.5	12.23	12.17	15.21	
				1	99						16	15.15			0	12.05	12.01	15.04			
	2	20	QPSK	1	0	18900	1880	14	10	QPSK	1	49	23330	793	16	15.25	0-8.5	12.17	12.05	15.12	
				1	99						16	15.08			0	12.03	11.96	15.01			
	2	20	QPSK	1	0	19100	1900	14	10	QPSK	1	49	23330	793	16	15.15	0-8.5	11.98	11.91	14.96	
				1	99						16	14.98			0	11.86	11.82	14.85			
CA_2A-48A	2	20	QPSK	1	0	18700	1860	48	20	QPSK	1	99	56210	3647	16	15.32	0-8.5	12.27	12.22	15.26	
				1	99						16	15.15			0	12.05	12.03	15.05			
	2	20	QPSK	1	0	18900	1880	48	20	QPSK	1	99	56210	3647	16	15.25	0-8.5	12.13	12.04	15.10	
				1	99						16	15.08			0	11.94	11.89	14.93			
	2	20	QPSK	1	0	19100	1900	48	20	QPSK	1	99	56210	3647	16	15.15	0-8.5	11.98	11.91	14.96	
				1	99						16	14.98			0	11.86	11.81	14.85			
CA_4A-5A	4	20	QPSK	1	0	20050	1720	5	10	QPSK	1	49	20525	836.5	17	16.23	0-8.5	13.03	12.98	16.02	
				1	99						17	16.1			0	12.95	12.86	15.92			
	4	20	QPSK	1	0	20175	1732.5	5	10	QPSK	1	49	20525	836.5	17	16.15	0-8.5	13.05	12.98	16.03	
				1	99						17	16.02			0	12.91	12.85	15.89			
	4	20	QPSK	1	0	20300	1745	5	10	QPSK	1	49	20525	836.5	17	16.01	0-8.5	12.85	12.81	15.84	
				1	99						17	15.88			0	12.83	12.77	15.81			

Uplink Carrier Aggregation Scenarios Conducted Power (Reduction) - Tablet

Configure	Combination	PCC							SCC							Measurement Power					
		Band	BW (MHz)	Modulation	RB Size	RB Offset	UL Channel	UL Frequency (MHz)	Band	BW (MHz)	Modulation	RB Size	RB Offset	UL Channel	UL Frequency (MHz)	Maximum Tune-up Power	Single Carrier Tx Power without UL-CA Active (dBm)	MPR Level (dB)	Tx Power with UL-CA Active (dBm)		
																			PCC	SCC	Total
Inter Band	CA_4A-12A	4	20	QPSK	1	0	20050	1720	12	10	QPSK	1	49	23095	707.5	17	16.23	0-8.5	13.03	12.96	16.01
					1	99						17	16.1			0	12.97	12.91	15.95		
		4	20	QPSK	1	0	20175	1732.5	12	10	QPSK	1	49	23095	707.5	17	16.15	0-8.5	13.05	12.94	16.01
					1	99						17	16.02			0	12.94	12.89	15.93		
		4	20	QPSK	1	0	20300	1745	12	10	QPSK	1	49	23095	707.5	17	16.01	0-8.5	12.96	12.92	15.95
					1	99						17	15.88			0	12.81	12.73	15.78		
	CA_4A-13A	4	20	QPSK	1	0	20050	1720	13	10	QPSK	1	49	23230	782	17	16.23	0-8.5	13.09	12.98	16.05
					1	99						17	16.1			0	12.95	12.88	15.93		
		4	20	QPSK	1	0	20175	1732.5	13	10	QPSK	1	49	23230	782	17	16.15	0-8.5	12.99	12.84	15.93
					1	99						17	16.02			0	12.92	12.85	15.90		
		4	20	QPSK	1	0	20300	1745	13	10	QPSK	1	49	23230	782	17	16.01	0-8.5	12.89	12.83	15.87
					1	99						17	15.88			0	12.73	12.66	15.71		
	CA_5A-7A	5	10	QPSK	1	0	20450	829	7	20	QPSK	1	99	21100	2535	19.5	19.26	0-8.5	16.14	16.03	19.10
					1	49						19.5	19.23			0	16.12	15.98	19.06		
		5	10	QPSK	1	0	20525	836.5	7	20	QPSK	1	99	21100	2535	19.5	19.35	0-8.5	16.23	16.12	19.19
					1	49						19.5	19.32			0	16.11	16.02	19.08		
		5	10	QPSK	1	0	20600	844	7	20	QPSK	1	99	21100	2535	19.5	19.14	0-8.5	16.05	15.98	19.03
					1	49						19.5	19.11			0	16.01	15.92	18.98		
	CA_5A-30A	5	10	QPSK	1	0	20450	829	30	10	QPSK	1	49	27710	2310	19.5	19.26	0-8.5	16.17	16.12	19.16
					1	49						19.5	19.23			0	16.13	16.08	19.12		
		5	10	QPSK	1	0	20525	836.5	30	10	QPSK	1	49	27710	2310	19.5	19.35	0-8.5	16.25	16.21	19.24
					1	49						19.5	19.32			0	16.21	16.14	19.19		
		5	10	QPSK	1	0	20600	844	30	10	QPSK	1	49	27710	2310	19.5	19.14	0-8.5	16.08	16.02	19.06
					1	49						19.5	19.11			0	16.05	15.98	19.03		
	CA_5A-48A	5	10	QPSK	1	0	20450	829	48	20	QPSK	1	99	56210	3647	19.5	19.26	0-8.5	16.21	16.17	19.20
					1	49						19.5	19.23			0	16.19	16.02	19.12		
		5	10	QPSK	1	0	20525	836.5	48	20	QPSK	1	99	56210	3647	19.5	19.35	0-8.5	16.25	16.16	19.22
					1	49						19.5	19.32			0	16.21	16.09	19.16		
		5	10	QPSK	1	0	20600	844	48	20	QPSK	1	99	56210	3647	19.5	19.14	0-8.5	16.07	16.02	19.06
					1	49						19.5	19.11			0	16.02	15.97	19.01		
CA_5A-66A	5	10	QPSK	1	0	20450	829	66	20	QPSK	1	99	132322	1745	19.5	19.26	0-8.5	16.06	16.01	19.05	
				1	49						19.5	19.23			0	16.01	15.97	19.00			
	5	10	QPSK	1	0	20525	836.5	66	20	QPSK	1	99	132322	1745	19.5	19.35	0-8.5	16.27	16.14	19.22	
				1	49						19.5	19.32			0	16.21	16.09	19.16			
	5	10	QPSK	1	0	20600	844	66	20	QPSK	1	99	132322	1745	19.5	19.14	0-8.5	16.09	15.96	19.04	
				1	49						19.5	19.11			0	16.02	15.87	18.96			
CA_12A-30A	12	10	QPSK	1	0	23060	704	30	10	QPSK	1	49	27710	2310	17.5	17.25	0-8.5	14.16	14.13	17.16	
				1	49						17.5	17.07			0	14.05	14.01	17.04			
	12	10	QPSK	1	0	23095	707.5	30	10	QPSK	1	49	27710	2310	17.5	17.37	0-8.5	14.28	14.09	17.20	
				1	49						17.5	17.19			0	14.16	13.98	17.08			
	12	10	QPSK	1	0	23130	711	30	10	QPSK	1	49	27710	2310	17.5	17.4	0-8.5	14.32	14.12	17.23	
				1	49						17.5	17.22			0	14.17	14.03	17.11			

Uplink Carrier Aggregation Scenarios Conducted Power (Reduction) - Tablet

Confugure	Combination	PCC							SCC							Measurement Power					
		Band	BW (MHz)	Modulation	RB Size	RB Offset	UL Channel	UL Frequency (MHz)	Band	BW (MHz)	Modulation	RB Size	RB Offset	UL Channel	UL Frequency (MHz)	Maximum Tune-up Power	Single Carrier Tx Power without UL-CA Active (dBm)	MPR Level (dB)	Tx Power with UL-CA Active (dBm)		
																			PCC	SCC	Total
	CA_12A-66A	12	10	QPSK	1	0	23060	704	66	20	QPSK	1	99	132322	1745	17.5	17.25	0-8.5	14.21	14.05	17.14
					1	49						1	0			17.5	17.07	0	14.05	13.92	17.00
		12	10	QPSK	1	0	23095	707.5	66	20	QPSK	1	99	132322	1745	17.5	17.37	0-8.5	14.23	14.06	17.16
					1	49						1	0			17.5	17.19	0	14.09	13.98	17.05
		12	10	QPSK	1	0	23130	711	66	20	QPSK	1	99	132322	1745	17.5	17.4	0-8.5	14.28	14.11	17.21
					1	49						1	0			17.5	17.22	0	14.13	13.99	17.07
	CA_13A-48A	13	10	QPSK	1	0	23230	782	48	20	QPSK	1	99	56210	3647	18	17.28	0-8.5	14.06	14.02	17.05
					1	49						1	0			18	17.1	0	13.96	13.85	16.92
	CA_13A-66A	13	10	QPSK	1	0	23230	782	66	20	QPSK	1	99	132322	1745	18	17.28	0-8.5	14.15	14.06	17.12
					1	49						1	0			18	17.1	0	14.02	13.98	17.01
	CA_14A-30A	14	10	QPSK	1	0	23330	793	30	10	QPSK	1	49	27710	2310	18.0	17.2	0-8.5	14.08	14.02	17.06
					1	49						1	0			18.0	17.04	0	13.96	13.91	16.95
	CA_14A-66A	14	10	QPSK	1	0	23330	793	66	20	QPSK	1	99	132322	1745	18.0	17.2	0-8.5	13.99	13.83	16.92
					1	49						1	0			18.0	17.04	0	13.92	13.81	16.88
	CA_48A-66A	48	20	QPSK	1	0	55340	3560	66	20	QPSK	1	99	132322	1745	14.0	13.75	0-8.5	10.71	10.65	13.69
					1	99						1	0			14.0	13.49	0	10.43	10.34	13.40
		48	20	QPSK	1	0	55780	3603	66	20	QPSK	1	99	132322	1745	14.0	13.65	0-8.5	10.52	10.47	13.51
					1	99						1	0			14.0	13.41	0	10.38	10.25	13.33
		48	20	QPSK	1	0	56210	3647	66	20	QPSK	1	99	132322	1745	14.0	13.88	0-8.5	10.74	10.61	13.69
					1	99						1	0			14.0	13.67	0	10.63	10.58	13.62
		48	20	QPSK	1	0	56640	3690	66	20	QPSK	1	99	132322	1745	14.0	13.98	0-8.5	10.89	10.82	13.87
					1	99						1	0			14.0	13.87	0	10.79	10.69	13.75

Downlink Carrier Aggregation Scenarios Conducted Power (Full)

Configure	Combination	PCC								SCC1				SCC2				SCC3				SCC4				Measurement Power							
		LTE Band	BW [Mhz]	UL Channel	UL Freq. [MHz]	UL RB	UL Offset	DL Channel	DL Freq. [MHz]	LTE Band	BW [Mhz]	DL Channel	DL Freq. [MHz]	LTE Band	BW [Mhz]	DL Channel	DL Freq. [MHz]	LTE Band	BW [Mhz]	DL Channel	DL Freq. [MHz]	LTE Band	BW [Mhz]	DL Channel	DL Freq. [MHz]	LTE Band	BW [Mhz]	DL Channel	DL Freq. [MHz]	Maximum Tune-up Power	Single Carrier Tx Power without DL-CA Active (dBm)	Tx Power with DL-CA Active (dBm)	
																														PCC	Total		
Intra Band Contiguous	CA_38C	38	20	38150	2610	1	0	38150	2610	38	20	37952	2590.2															24.0	23.27	23.21	23.21		
	CA_41E	41	20	39750	2506	1	0	39750	2506	41	20	39950	2526	41	20	40150	2546	41	20	40350	2566							24.0	23.95	23.89	23.89		
	CA_41F	41	20	39750	2506	1	0	39750	2506	41	20	39948	2525.8	41	20	40146	2545.6	41	20	40344	2565.4	41	20	40542	2585.2	24.0	23.95	23.85	23.85				
	CA_48F	48	20	55340	3560	1	0	55340	3560	48	20	55538	3579.8	48	20	55736	3599.6	48	20	55934	3619.4	48	20	56132	3639.2	22.0	21.47	21.42	21.42				
Intra Band Non-Contiguous	CA_25A-25A	25	20	26140	1860	1	0	8140	1940	25	20	8590	1985														24.0	22.41	22.35	22.35			
	CA_41A-41A	41	20	39750	2506	1	0	39750	2506	41	20	41490	2680														24.0	23.95	23.81	23.81			
	CA_41A-41C	41	20	39750	2506	1	0	39750	2506	41	20	41292	2660.2	41	20	41490	2680										24.0	23.95	23.92	23.92			
	CA_48A-48A-48A	48	20	55340	3560	1	0	55340	3560	48	20	55780	3603	48	20	56640	3690										22.0	21.47	21.44	21.44			
	CA_66A-66C	66	20	132072	17200	1	0	66536	2120	66	20	67038	2170.2	66	20	67236	2190										24.0	23.15	23.02	23.02			
	CA_41A-41D	41	20	39750	2506	1	0	39750	2506	41	20	41094	2640.4	41	20	41292	2660.2	41	20	41490	2680						24.0	23.95	23.93	23.93			
	CA_41C-41C	41	20	39750	2506	1	0	39750	2506	41	20	39948	2525.8	41	20	41292	2660.2	41	20	41490	2680						24.0	23.95	23.81	23.81			
	CA_48A-48A-48C	48	20	55340	3560	1	0	55340	3560	48	20	55780	3603	48	20	56442	3670.2	48	20	56640	3690						22.0	21.47	21.45	21.45			
	CA_48A-48A-48D	48	20	55340	3560	1	0	55340	3560	48	20	55780	3603	48	20	56244	3650.4	48	20	56442	3670.2	48	20	56640	3690	22.0	21.47	21.35	21.35				
	CA_48A-48C-48C	48	20	55340	3560	1	0	55340	3560	48	20	55780	3603	48	20	55968	3622.8	48	20	56442	3670.2	48	20	56640	3690	22.0	21.47	21.39	21.39				
	CA_2A-7A	2	20	19100	1900	1	0	1100	1980	7	20	3100	2655														24.0	23.16	23.05	23.05			
	CA_4A-48A	4	20	20050	1720	1	0	2050	2120	48	20	56210	3647														24.0	23.27	23.11	23.11			
CA_25A-26A	25	20	26140	1860	1	0	8140	1940	26	15	8865	876.5														24.0	22.41	22.31	22.31				
CA_41A-46A	41	20	39750	2506	1	0	39750	2506	46	20	46890	5160														24.0	23.95	23.92	23.92				
CA_26A-41A	26	15	26765	821.5	1	0	8765	866.5	41	20	40620	2593														24.0	23.09	23.02	23.02				
CA_2A-2A-46A	2	20	19100	1900	1	0	1100	1980	2	20	900	1960	46	20	46890	5160										24.0	23.16	23.01	23.01				
CA_4A-4A-13A	4	20	20050	17200	1	0	2050	2120	4	20	2300	2145	13	10	5230	751										24.0	23.27	23.13	23.13				
CA_4A-46A-46A	4	20	20050	17200	1	0	2050	2120	46	20	46890	5160	46	20	54340	5905										24.0	23.27	23.17	23.17				
CA_4A-46C	4	20	20050	17200	1	0	2050	2120	46	20	46890	5160	46	20	47088	5179.8										24.0	23.27	23.14	23.14				
CA_4A-48C	4	20	20050	17200	1	0	2050	2120	48	20	56210	3647	48	20	56012	3627.2										24.0	23.27	23.05	23.05				
CA_5A-7A-7A	5	10	20450	829	1	0	2450	874	7	20	3100	2655	7	20	3350	2680										24.0	23.09	23.06	23.06				
CA_5B-46A	5	10	20450	829	1	0	2450	874	5	10	2549	883.9	46	20	46890	5160										24.0	23.09	22.97	22.97				
CA_26A-41C	26	15	26765	821.5	1	0	8765	866.5	41	20	41292	2660.2	41	20	41490	2680										24.0	23.09	22.99	22.99				
CA_41A-46C	41	20	39750	2506	1	0	39750	2506	46	20	46890	5160	46	20	47088	5179.8										24.0	23.95	23.84	23.84				
CA_2A-2A-4A-4A	2	20	19100	1900	1	0	1100	1980	2	20	900	1960	4	20	2050	2120	4	20	2300	2145						24.0	23.16	23.07	23.07				
CA_2A-46A-46A-66A	2	20	19100	1900	1	0	1100	1980	46	20	46890	5160	46	20	54340	5905	66	20	67036	2170						24.0	23.16	23.02	23.02				
CA_2C-66A-66A	2	20	19100	1900	1	0	1100	1980	2	20	898	1959.8	66	20	66536	2120	66	20	67236	2190						24.0	23.16	23.11	23.11				
CA_4A-4A-5B	4	20	20050	1720	1	0	2050	2120	4	20	2300	2145	5	10	2476	876.6	5	10	2575	886.5						24.0	23.27	23.05	23.05				
CA_4A-46A-46C	4	20	20050	1720	1	0	2050	2120	46	20	46890	5160	46	20	50892	5540.2	46	20	50892	5560						24.0	23.27	23.12	23.12				
CA_4A-46D	4	20	20050	1720	1	0	2050	2120	46	20	53942	5865.2	46	20	54140	5885	46	20	54338	5904.8						24.0	23.27	23.17	23.17				
CA_4A-48D	4	20	20050	1720	1	0	2050	2120	48	20	56442	3650.4	48	20	56442	3670.2	48	20	56640	3690						24.0	23.27	23.21	23.21				
CA_5A-5A-66A-66A	5	10	20450	829	1	0	2450	874	5	10	2600	889	66	20	66536	2120	66	20	67236	2190						24.0	23.09	23.06	23.06				
CA_5A-5A-66B	5	10	20450	829	1	0	2450	874	5	10	2600	889	66	10	67086	2175	66	10	66987	2165.1						24.0	23.09	23.05	23.05				
CA_5A-5A-66C	5	10	20450	829	1	0	2450	874	5	10	2600	889	66	20	67036	2170	66	20	66838	2150.2						24.0	23.09	23.01	23.01				
CA_5B-46C	5	10	20450	829	1	0	2450	874	5	10	2549	883.9	46	20	50692	5540.2	46	20	50892	5560						24.0	23.09	23.05	23.05				
CA_30A-66A-66A-66A	30	10	27710	2310	1	0	8920	2355	66	20	67036	2170	66	20	66786	2145	66	20	66536	2120						24.0	22.71	22.66	22.66				
CA_48A-48A-66A-66A	48	20	55340	3560	1	0	55340	3560	48	20	56640	3690	66	20	66786	2145	66	20	66536	2120						22.0	21.47	21.41	21.41				
CA_48A-48A-66B	48	20	55340	3560	1	0	55340	3560	48	20	56640	3690	66	10	67086	2175	66	10	66987	2165.1						22.0	21.47	21.34	21.34				
CA_48A-48A-66C	48	20	55340	3560	1	0	55340	3560	48	20	56640	3690	66	20	67036	2170	66	20	66838	2150.2						22.0	21.47	21.39	21.39				
CA_48A-66A-66A-66A	48	20	55340	3560	1	0	55340	3560	66	20	66786	2170	66	20	66786	2145	66	20	66536	2120						22.0	21.47	21.42	21.42				
CA_2A-2A-46D	2	20	1																														

Downlink Carrier Aggregation Scenarios Conducted Power (Full)

Configure	Combination	PCC								SCC1				SCC2				SCC3				SCC4				Measurement Power				
		LTE Band	BW [Mhz]	UL Channel	UL Freq. [MHz]	UL RB	UL Offset	DL Channel	DL Freq. [MHz]	LTE Band	BW [Mhz]	DL Channel	DL Freq. [MHz]	LTE Band	BW [Mhz]	DL Channel	DL Freq. [MHz]	LTE Band	BW [Mhz]	DL Channel	DL Freq. [MHz]	LTE Band	BW [Mhz]	DL Channel	DL Freq. [MHz]	Maximum Tune-up Power	Single Carrier Tx Power without DL-CA Active (dBm)	Tx Power with DL-CA Active (dBm)		
																											PCC	Total		
Inter Band	CA_4BA-4BC-66B	48	20	55340	3560	1	0	55340	3560	48	20	56210	3647	48	20	56408	3666.8	66	10	67086	2175	66	10	66987	2165.1	22.0	21.47	21.41	21.41	
	CA_4BA-4BC-66C	48	20	55340	3560	1	0	55340	3560	48	20	56210	3647	48	20	56408	3666.8	66	20	67036	2170	66	20	66838	2150.2	22.0	21.47	21.33	21.33	
	CA_4BA-4BD-66A	48	20	55340	3560	1	0	55340	3560	48	20	56244	3650.4	48	20	56442	3670.2	48	20	56640	3690	66	20	67036	2170	22.0	21.47	21.37	21.37	
	CA_4BC-4BC-66A	48	20	55340	3560	1	0	55340	3560	48	20	55538	3579.8	48	20	56210	3647	48	20	56408	3666.8	66	20	67036	2170	22.0	21.47	21.35	21.35	
	CA_4BC-66A-66A-66A	48	20	55340	3560	1	0	55340	3560	48	20	55538	3579.8	66	20	67036	2170	66	20	66786	2145	66	20	66536	2120	22.0	21.47	21.39	21.39	
	CA_4BE-66A	48	20	55340	3560	1	0	55340	3560	48	20	55538	3579.8	48	20	55736	3599.6	48	20	55934	3619.4	66	20	67036	2170	22.0	21.47	21.44	21.44	
	CA_2A-4A-7A	2	20	19100	1900	1	0	1100	1980	4	20	2175	2132.5	7	20	3100	2655										24.0	23.16	23.06	23.06
	CA_2A-4A-13A	2	20	19100	1900	1	0	1100	1980	4	20	2175	2132.5	13	10	5230	751										24.0	23.16	23.02	23.02
	CA_2A-5A-46A	2	20	19100	1900	1	0	1100	1980	5	10	2450	874	46	20	50665	5537.5										24.0	23.16	22.98	22.98
	CA_2A-13A-46A	2	20	19100	1900	1	0	1100	1980	13	10	5230	751	46	20	50665	5537.5										24.0	23.16	23.04	23.04
	CA_2A-29A-30A	2	20	19100	1900	1	0	1100	1980	29	10	9715	722.5	30	10	9820	2355										24.0	23.16	23.11	23.11
	CA_2A-46A-48A	2	20	19100	1900	1	0	1100	1980	46	20	50665	5537.5	48	20	56210	3647										24.0	23.16	23.14	23.14
	CA_4A-7A-28A	4	20	20050	1720	1	0	2050	2120	7	20	3100	2655	28	20	9435	780.5										24.0	23.27	23.21	23.21
	CA_4A-29A-30A	4	20	20050	1720	1	0	2050	2120	29	10	9715	722.5	30	10	9820	2355										24.0	23.27	23.16	23.16
	CA_5A-46A-66A	5	10	20450	829	1	0	2450	874	46	20	50665	5537.5	66	20	67036	2170										24.0	23.09	23.02	23.02
	CA_13A-46A-66A	13	10	23230	782	1	0	5230	751	46	20	50665	5537.5	66	20	67036	2170										24.0	23.08	23.01	23.01
	CA_2A-2A-4A-5A	2	20	19100	1900	1	0	1100	1980	2	20	900	1960	4	20	2175	2132.5	5	10	2450	874						24.0	23.16	23.08	23.08
	CA_2A-2A-4A-12A	2	20	19100	1900	1	0	1100	1980	2	20	900	1960	4	20	2175	2132.5	12	10	5094	737.4						24.0	23.16	23.04	23.04
	CA_2A-2A-46C	2	20	19100	1900	1	0	1100	1980	2	20	900	1960	46	20	54142	5885.2	46	20	54340	5905						24.0	23.16	23.11	23.11
	CA_2A-4A-4A-5A	2	20	19100	1900	1	0	1100	1980	4	20	2050	2120	4	20	2300	2145	5	10	2450	874						24.0	23.16	23.04	23.04
	CA_2A-4A-4A-12A	2	20	19100	1900	1	0	1100	1980	4	20	2050	2120	4	20	2300	2145	12	10	5094	737.4						24.0	23.16	22.94	22.94
	CA_2A-4A-5B	2	20	19100	1900	1	0	1100	1980	4	20	2175	2132.5	5	10	2450	874	5	10	2549	883.9						24.0	23.16	22.99	22.99
	CA_2A-5A-46C	2	20	19100	1900	1	0	1100	1980	5	10	2549	883.9	46	20	54142	5885.2	46	20	54340	5905						24.0	23.16	23.06	23.06
	CA_2A-12A-66C	2	20	19100	1900	1	0	1100	1980	12	10	5094	737.4	66	20	67036	2170	66	20	66838	2150.2						24.0	23.16	22.97	22.97
	CA_2A-13A-46C	2	20	19100	1900	1	0	1100	1980	13	10	5230	751	46	20	54142	5885.2	46	20	54340	5905						24.0	23.16	23.05	23.05
	CA_2A-13A-66C	2	20	19100	1900	1	0	1100	1980	13	10	5230	751	66	20	67036	2170	66	20	66838	2150.2						24.0	23.16	23.03	23.03
	CA_2A-46A-48C	2	20	19100	1900	1	0	1100	1980	46	20	46890	5160	48	20	56442	3670.2	48	20	56640	3690						24.0	23.16	23.04	23.04
	CA_2A-46C-48A	2	20	19100	1900	1	0	1100	1980	46	20	50665	5537.5	46	20	50863	5557.3	48	20	56210	3647						24.0	23.16	22.98	22.98
	CA_4A-4A-12A-30A	4	20	20050	1720	1	0	2050	2120	4	20	2300	2145	12	10	5094	737.4	30	10	9820	2355						24.0	23.27	23.21	23.21
	CA_5A-46C-66A	5	10	20450	829	1	0	2450	874	46	20	50665	5537.5	46	20	50863	5557.3	66	20	67036	2170						24.0	23.09	23.06	23.06
	CA_13A-46C-66A	13	10	23230	782	1	0	5230	751	46	20	50665	5537.5	46	20	50863	5557.3	66	20	67036	2170						24.0	23.08	23.02	23.02
	CA_13A-48A-66B	13	10	23230	782	1	0	5230	751	48	20	56210	3647	66	10	67086	2175	66	10	66987	2165.1						24.0	23.08	23.01	23.01
	CA_13A-48A-66C	13	10	23230	782	1	0	5230	751	48	20	56210	3647	66	20	67036	2170	66	20	66838	2150.2						24.0	23.08	22.97	22.97
	CA_2A-2A-5A-66A-66A	2	20	19100	1900	1	0	1100	1980	2	20	900	1960	5	10	2450	874	66	20	67036	2170	66	20	66786	2145	24.0	23.16	23.14	23.14	
	CA_2A-2A-5A-66B	2	20	19100	1900	1	0	1100	1980	2	20	900	1960	5	10	2450	874	66	10	67086	2175	66	10	66987	2165.1	24.0	23.16	22.89	22.89	
	CA_2A-2A-5A-66C	2	20	19100	1900	1	0	1100	1980	2	20	900	1960	5	10	2450	874	66	20	67036	2170	66	20	66838	2150.2	24.0	23.16	22.94	22.94	
	CA_2A-2A-12A-66A-66A	2	20	19100	1900	1	0	1100	1980	2	20	900	1960	12	10	5094	737.4	66	20	67036	2170	66	20	66786	2145	24.0	23.16	23.06	23.06	
	CA_2A-2A-13A-66A-66A	2	20	19100	1900	1	0	1100	1980	2	20	900	1960	13	10	5230	751	66	20	67036	2170	66	20	66786	2145	24.0	23.16	23.01	23.01	
	CA_2A-2A-13A-66B	2	20	19100	1900	1	0	1100	1980	2	20	900	1960	13	10	5230	751	66	10	67086	2175	66	10	66987	2165.1	24.0	23.16	22.99	22.99	
	CA_2A-2A-14A-66A-66A	2	20	19100	1900	1	0	1100	1980	2	20	900	1960	14	10	5330	763	66	20	67036	2170	66	20	66786	2145	24.0	23.16	23.07	23.07	
	CA_2A-5A-46D	2	20	19100	1900	1	0	1100	1980	5	10	2450	874	46	20	53942	5865.2	46	20	54140	5885	46	20	54338	5904.8	24.0	23.16	23.11	23.11	
	CA_2A-5A-48A-48C	2	20	19100	1900	1	0	1100	1980	5	10	2450	874	48	20	56210	3647	48	20	56442	3670.2	48	20	56640	3690	24.0	23.16	23.01	23.01	
	CA_2A-5A-48D	2	20	19100	1900	1	0	1100	1980	5	10	2450	874	48	20	56244	3650.4	48	20	56442	3670.2	48	20	56640	3690	24.0	23.16	22.96	22.96	
	CA_2A-5B-66A-66A	2	20	19100	1900	1	0	1100	1980	5	10	2450	874	5	10	2549	883.9	66	20	67036	2170	66	20	66786	2145	24.0	23.16	22.94	22.94	
	CA_2A-5B-66B	2	20	19100	1900	1	0	1100	1980	5	10	2450	874	5	10	2549	883.9	66	10	67086	2175	66	10	66987	2165.1	24.0	23.16	23.05	23.05	
	CA_2A-5B-66C	2	20	19100	1900	1	0	1100	1980	5	10	2450	874	5	10	2549	883.9	66	20	67036	2170	66	20	66838	2150.2	24.0	23.16	22.97	22.97	
	CA_2A-13A-48A-48C	2	20	19100	1900	1	0	1100	1980	13	10	5230	751	48	20	56210	3647	48	20	56442	3670.2	48	20	56640	3690	24.0	23.16	22.98	22.98	
	CA_2A-14A-66A-66A-66A	2	20	19100	1900	1	0	1100	1980	14	10	5330	763	66	20	67036	2170	66	20	66786	2145	66	20	66536	2120	24.0	23.16	23.03	23.03	
	CA_2A-46A-46C-66A	2																												

Downlink Carrier Aggregation Scenarios Conducted Power (Full)

Configure	Combination	PCC									SCC1				SCC2				SCC3				SCC4				Measurement Power			
		LTE Band	BW [Mhz]	UL Channel	UL Freq. [MHz]	UL RB	UL Offset	DL Channel	DL Freq. [MHz]	LTE Band	BW [Mhz]	DL Channel	DL Freq. [MHz]	LTE Band	BW [Mhz]	DL Channel	DL Freq. [MHz]	LTE Band	BW [Mhz]	DL Channel	DL Freq. [MHz]	LTE Band	BW [Mhz]	DL Channel	DL Freq. [MHz]	Maximum Tune-up Power	Single Carrier Tx Power without DL-CA Active (dBm)	Tx Power with DL-CA Active (dBm)		
																											PCC	Total		
	CA_2A-13A-48D	2	20	19100	1900	1	0	1100	1980	13	10	5230	751	48	20	56244	3650.4	48	20	56442	3670.2	48	20	56640	3690	24.0	23.16	23.11	23.11	
	CA_5A-48A-48C-66A	5	10	20450	829	1	0	2450	874	48	20	56210	3647	48	20	56442	3670.2	48	20	56640	3690	66	20	67036	2170	24.0	23.09	23.02	23.02	
	CA_13A-48A-48C-66A	13	10	23230	782	1	0	5230	751	48	20	56210	3647	48	20	56442	3670.2	48	20	56640	3690	66	20	67036	2170	24.0	23.08	23.01	23.01	
	CA_2A-4A-5A-30A	2	20	19100	1900	1	0	1100	1980	4	20	2175	2132.5	5	10	2450	874	30	10	9820	2355					24.0	23.16	23.14	23.14	
	CA_2A-4A-12A-30A	2	20	19100	1900	1	0	1100	1980	4	20	2175	2132.5	12	10	5094	737.4	30	10	9820	2355					24.0	23.16	23.08	23.08	
	CA_2A-5A-30A-66A	2	20	19100	1900	1	0	1100	1980	5	10	2450	874	30	10	9820	2355	66	20	67036	2170					24.0	23.16	23.01	23.01	
	CA_2A-5A-48A-48A-66A	2	20	19100	1900	1	0	1100	1980	5	10	2450	874	48	20	55780	3603	48	20	56640	3690	66	20	67036	2170	24.0	23.16	23.03	23.03	
	CA_2A-5B-30A-66A	2	20	19100	1900	1	0	1100	1980	5	10	2450	874	5	10	2549	883.9	30	10	9820	2355	66	20	67036	2170	24.0	23.16	22.96	22.96	
	CA_2A-12A-30A-66A-66A	2	20	19100	1900	1	0	1100	1980	12	10	5094	737.4	30	10	9820	2355	66	20	67036	2170	66	20	66786	2145	24.0	23.16	22.99	22.99	
	CA_2A-13A-48A-48A-66A	2	20	19100	1900	1	0	1100	1980	13	10	5230	751	48	20	56210	3647	48	20	56012	3627.2	66	20	67036	2170	24.0	23.16	23.01	23.01	
	CA_2A-13A-48C-66A	2	20	19100	1900	1	0	1100	1980	13	10	5230	751	48	20	56442	3670.2	48	20	56640	3690	66	20	67036	2170	24.0	23.16	22.98	22.98	
	CA_2A-14A-30A-66A-66A	2	20	19100	1900	1	0	1100	1980	14	10	5330	763	30	10	9820	2355	66	20	67036	2170	66	20	66786	2145	24.0	23.16	23.11	23.11	
	CA_2A-5A-48C-66A	2	20	19100	1900	1	0	1100	1980	5	10	2450	874	48	20	56442	3670.2	48	20	56640	3690	66	20	67036	2170	24.0	23.16	23.08	23.08	

Downlink Carrier Aggregation Scenarios Conducted Power (Reduction) - Laptop

Configure	Combination	PCC								SCC1				SCC2				SCC3				SCC4				Measurement Power				
		LTE Band	BW [Mhz]	UL Channel	UL Freq. [MHz]	UL RB	UL Offset	DL Channel	DL Freq. [MHz]	LTE Band	BW [Mhz]	DL Channel	DL Freq. [MHz]	LTE Band	BW [Mhz]	DL Channel	DL Freq. [MHz]	LTE Band	BW [Mhz]	DL Channel	DL Freq. [MHz]	LTE Band	BW [Mhz]	DL Channel	DL Freq. [MHz]	Maximum Tune-up Power	Single Carrier Tx Power without DL-CA Active (dBm)	Tx Power with DL-CA Active (dBm)		
																												PCC	Total	
Intra Band Contiguous	CA_38C	38	20	38000	2595	1	0	38000	2595	38	20	37952	2590.2														21.5	21.01	20.96	20.96
	CA_41E	41	20	40620	2593	1	0	40620	2593	41	20	40818	2612.8	41	20	41016	2632.6	41	20	41214	2652.4						18.0	17.34	17.32	17.32
	CA_41F	41	20	40620	2593	1	0	40620	2593	41	20	40818	2612.8	41	20	41016	2632.6	41	20	41214	2652.4	41	20	41412	2672.2	18.0	17.34	17.28	17.28	
	CA_48F	48	20	56210	3647	1	0	56210	3647	48	20	56012	3627.2	48	20	55814	3607.4	48	20	55616	3587.6	48	20	55418	3567.8	17.5	16.99	16.95	16.95	
Intra Band Non-Contiguous	CA_25A-25A	25	20	26365	1882.5	1	0	8365	1962.5	25	20	8590	1985														18.5	18.02	17.96	17.96
	CA_41A-41A	41	20	40620	2593	1	0	40620	2593	41	20	41490	2680														18.0	17.34	17.22	17.22
	CA_41A-41C	41	20	40620	2593	1	0	40620	2593	41	20	41292	2660.2	41	20	41490	2680										18.0	17.34	17.17	17.17
	CA_48A-48A-48A	48	20	56210	3647	1	0	56210	3647	48	20	55780	3603	48	20	56640	3690										17.5	16.99	16.91	16.91
	CA_66A-66C	66	20	132322	1745	1	0	66786	2145	66	20	67038	2170.2	66	20	67236	2190										21.5	21.17	21.11	21.11
	CA_41A-41D	41	20	40620	2593	1	0	40620	2593	41	20	41094	2640.4	41	20	41292	2660.2	41	20	41490	2680						18.0	17.34	17.32	17.32
	CA_41C-41C	41	20	40620	2593	1	0	40620	2593	41	20	40818	2612.8	41	20	41292	2660.2	41	20	41490	2680						18.0	17.34	17.25	17.25
	CA_48A-48A-48C	48	20	56210	3647	1	0	56210	3647	48	20	55780	3603	48	20	56442	3670.2	48	20	56640	3690						17.5	16.99	16.91	16.91
	CA_48A-48A-48D	48	20	56210	3647	1	0	56210	3647	48	20	55780	3603	48	20	56244	3650.4	48	20	56442	3670.2	48	20	56640	3690	17.5	16.99	16.92	16.92	
	CA_48A-48C-48C	48	20	56210	3647	1	0	56210	3647	48	20	55780	3603	48	20	55968	3622.8	48	20	56442	3670.2	48	20	56640	3690	17.5	16.99	16.93	16.93	
Intra Band Non-Contiguous	CA_2A-7A	2	20	18900	1880	1	0	900	1960	7	20	3100	2655														18.0	17.80	17.77	17.77
	CA_4A-48A	4	20	20175	1732.5	1	0	2175	2132.5	48	20	56210	3647														18.0	17.74	17.65	17.65
	CA_25A-26A	25	20	26365	1882.5	1	0	8365	1962.5	26	15	8865	876.5														18.5	18.02	17.98	17.98
	CA_41A-46A	41	20	40620	2593	1	0	40620	2593	46	20	46890	5160														18.0	17.34	17.23	17.23
	CA_26A-41A	26	15	26865	831.5	1	0	8865	876.5	41	20	40620	2593														23.0	22.82	22.71	22.71
	CA_2A-2A-46A	2	20	18900	1880	1	0	900	1960	2	20	700	1940	46	20	46890	5160										18.0	17.80	17.63	17.63
	CA_4A-4A-13A	4	20	20300	1745	1	0	2300	2145	4	20	2050	2145	13	10	5230	751										18.0	17.75	17.64	17.64
	CA_4A-46A-46A	4	20	20175	1732.5	1	0	2175	2132.5	46	20	46890	5160	46	20	54340	5905										18.0	17.74	17.71	17.71
	CA_4A-46C	4	20	20175	1732.5	1	0	2175	2132.5	46	20	46890	5160	46	20	47088	5179.8										18.0	17.74	17.65	17.65
	CA_4A-48C	4	20	20175	1732.5	1	0	2175	2132.5	48	20	56210	3647	48	20	56012	3627.2										18.0	17.74	17.72	17.72
	CA_5A-7A-7A	5	10	20525	836.5	1	0	2525	881.5	7	20	3100	2655	7	20	3350	2680										23.0	22.13	22.11	22.11
	CA_5B-46A	5	10	20525	836.5	1	0	2525	881.5	5	10	2549	883.9	46	20	46890	5160										23.0	22.13	22.03	22.03
	CA_26A-41C	26	15	26865	831.5	1	0	8865	876.5	41	20	41292	2660.2	41	20	41490	2680										23.0	22.82	22.67	22.67
	CA_41A-46C	41	20	40620	2593	1	0	40620	2593	46	20	46890	5160	46	20	47088	5179.8										18.0	17.34	17.31	17.31
	CA_2A-2A-4A-4A	2	20	18900	1880	1	0	900	1960	2	20	700	1940	4	20	2050	2120	4	20	2300	2145						18.0	17.80	17.77	17.77
	CA_2A-46A-46A-66A	2	20	18900	1880	1	0	900	1960	46	20	46890	5160	46	20	54340	5905	66	20	67036	2170						18.0	17.80	17.69	17.69
	CA_2C-66A-66A	2	20	18900	1880	1	0	900	1960	2	20	1100	1980	66	20	66536	2120	66	20	67236	2190						18.0	17.80	17.65	17.65
	CA_4A-4A-5B	4	20	20300	1745	1	0	2300	2145	4	20	2050	2145	5	10	2476	876.6	5	10	2575	886.5						18.0	17.75	17.71	17.71
	CA_4A-46A-46C	4	20	20175	1732.5	1	0	2175	2132.5	46	20	46890	5160	46	20	50692	5540.2	46	20	50892	5560						18.0	17.74	17.68	17.68
	CA_4A-46D	4	20	20175	1732.5	1	0	2175	2132.5	46	20	53942	5865.2	46	20	54140	5885	46	20	54338	5904.8						18.0	17.74	17.64	17.64
	CA_4A-48D	4	20	20175	1732.5	1	0	2175	2132.5	48	20	56244	3650.4	48	20	56442	3670.2	48	20	56640	3690						18.0	17.74	17.58	17.58
	CA_5A-5A-66A-66A	5	10	20525	836.5	1	0	2525	881.5	5	10	2600	889	66	20	66536	2120	66	20	67236	2190						23.0	22.13	22.11	22.11
	CA_5A-5A-66B	5	10	20525	836.5	1	0	2525	881.5	5	10	2600	889	66	10	67086	2175	66	10	66987	2165.1						23.0	22.13	22.05	22.05
	CA_5A-5A-66C	5	10	20525	836.5	1	0	2525	881.5	5	10	2600	889	66	20	67036	2170	66	20	66838	2150.2						23.0	22.13	22.01	22.01
	CA_5B-46C	5	10	20525	836.5	1	0	2525	881.5	5	10	2549	883.9	46	20	50692	5540.2	46	20	50892	5560						23.0	22.13	22.09	22.09
	CA_30A-66A-66A-66A	30	10	27710	2310	1	0	8920	2355	66	20	67036	2170	66	20	66786	2145	66	20	66536	2120						21.5	20.96	20.91	20.91
	CA_48A-48A-66A-66A	48	20	56210	3647	1	0	56210	3647	48	20	56640	3690	66	20	66786	2145	66	20	66536	2120						17.5	16.99	16.97	16.97
	CA_48A-48A-66B	48	20	56210	3647	1	0	56210	3647	48	20	56640	3690	66	10	67086	2175	66	10	66987	2165.1						17.5	16.99	16.82	16.82
	CA_48A-48A-66C	48	20	56210	3647	1	0	56210	3647	48	20	56640	3690	66	20	67036	2170	66	20	66838	2150.2						17.5	16.99	16.89	16.89
	CA_48A-66A-66A-66A	48	20	56210	3647	1	0	56210	3647	66	20	67036	2170	66	20	66786	2145	66	20	66536	2120						17.5	16.99	16.84	16.84
	CA_2A-2A-48D																													

Downlink Carrier Aggregation Scenarios Conducted Power (Reduction) - Laptop

Configure	Combination	PCC									SCC1				SCC2				SCC3				SCC4				Measurement Power			
		LTE Band	BW [MHz]	UL Channel	UL Freq. [MHz]	UL RB	UL Offset	DL Channel	DL Freq. [MHz]	LTE Band	BW [MHz]	DL Channel	DL Freq. [MHz]	LTE Band	BW [MHz]	DL Channel	DL Freq. [MHz]	LTE Band	BW [MHz]	DL Channel	DL Freq. [MHz]	LTE Band	BW [MHz]	DL Channel	DL Freq. [MHz]	Maximum Tune-up Power	Single Carrier Tx Power without DL-CA Active (dBm)	Tx Power with DL-CA Active (dBm)		
																											PCC	Total		
Inter Band	CA_48A-48C-66B	48	20	56210	3647	1	0	56210	3647	48	20	56442	3670.2	48	20	56640	3690	66	10	67086	2175	66	10	66987	2165.1	17.5	16.99	16.97	16.97	
	CA_48A-48C-66C	48	20	56210	3647	1	0	56210	3647	48	20	56442	3670.2	48	20	56640	3690	66	20	67036	2170	66	20	66838	2150.2	17.5	16.99	16.91	16.91	
	CA_48A-48D-66A	48	20	56210	3647	1	0	56210	3647	48	20	56244	3650.4	48	20	56442	3670.2	48	20	56640	3690	66	20	67036	2170	17.5	16.99	16.89	16.89	
	CA_48C-48C-66A	48	20	56210	3647	1	0	56210	3647	48	20	56408	3666.8	48	20	55340	3560	48	20	55538	3579.8	66	20	67036	2170	17.5	16.99	16.85	16.85	
	CA_48C-66A-66A-66A	48	20	56210	3647	1	0	56210	3647	48	20	56408	3666.8	66	20	67036	2170	66	20	66786	2145	66	20	66536	2120	17.5	16.99	16.91	16.91	
	CA_48E-66A	48	20	55340	3560	1	0	55340	3560	48	20	55538	3579.8	48	20	55736	3599.6	48	20	55934	3619.4	66	20	67036	2170	17.5	16.81	16.77	16.77	
	CA_2A-4A-7A	2	20	18900	1880	1	0	900	1960	4	20	2175	2132.5	7	20	3100	2655									18.0	17.80	17.77	17.77	
	CA_2A-4A-13A	2	20	18900	1880	1	0	900	1960	4	20	2175	2132.5	13	10	5230	751									18.0	17.80	17.71	17.71	
	CA_2A-5A-46A	2	20	18900	1880	1	0	900	1960	5	10	2450	874	46	20	50665	5537.5									18.0	17.80	17.62	17.62	
	CA_2A-13A-46A	2	20	18900	1880	1	0	900	1960	13	10	5230	751	46	20	50665	5537.5									18.0	17.80	17.63	17.63	
	CA_2A-29A-30A	2	20	18900	1880	1	0	900	1960	29	10	9715	722.5	30	10	9820	2355									18.0	17.80	17.69	17.69	
	CA_2A-46A-48A	2	20	18900	1880	1	0	900	1960	46	20	50665	5537.5	48	20	56210	3647									18.0	17.80	17.77	17.77	
	CA_4A-7A-28A	4	20	20175	1732.5	1	0	2175	2132.5	7	20	3100	2655	28	20	9435	780.5									18.0	17.74	17.65	17.65	
	CA_4A-29A-30A	4	20	20175	1732.5	1	0	2175	2132.5	29	10	9715	722.5	30	10	9820	2355									18.0	17.74	17.61	17.61	
	CA_5A-46A-66A	5	10	20525	836.5	1	0	2525	881.5	46	20	50665	5537.5	66	20	67036	2170									23.0	22.13	22.05	22.05	
	CA_13A-46A-66A	13	10	23230	782	1	0	5230	751	46	20	50665	5537.5	66	20	67036	2170									23.0	22.00	21.91	21.91	
	CA_2A-2A-4A-5A	2	20	18900	1880	1	0	900	1960	2	20	700	1940	4	20	2175	2132.5	5	10	2450	874					18.0	17.80	17.63	17.63	
	CA_2A-2A-4A-12A	2	20	18900	1880	1	0	900	1960	2	20	700	1940	4	20	2175	2132.5	12	10	5094	737.4					18.0	17.80	17.62	17.62	
	CA_2A-2A-46C	2	20	18900	1880	1	0	900	1960	2	20	700	1940	46	20	54142	5885.2	46	20	54340	5905					18.0	17.80	17.77	17.77	
	CA_2A-4A-4A-5A	2	20	18900	1880	1	0	900	1960	4	20	2050	2120	4	20	2300	2145	5	10	2450	874					18.0	17.80	17.58	17.58	
	CA_2A-4A-4A-12A	2	20	18900	1880	1	0	900	1960	4	20	2050	2120	4	20	2300	2145	12	10	5094	737.4					18.0	17.80	17.61	17.61	
	CA_2A-4A-5B	2	20	18900	1880	1	0	900	1960	4	20	2175	2132.5	5	10	2450	874	5	10	2549	883.9					18.0	17.80	17.66	17.66	
	CA_2A-5A-46C	2	20	18900	1880	1	0	900	1960	5	10	2549	883.9	46	20	54142	5885.2	46	20	54340	5905					18.0	17.80	17.72	17.72	
	CA_2A-12A-66C	2	20	18900	1880	1	0	900	1960	12	10	5094	737.4	66	20	67036	2170	66	20	66838	2150.2					18.0	17.80	17.69	17.69	
	CA_2A-13A-46C	2	20	18900	1880	1	0	900	1960	13	10	5230	751	46	20	54142	5885.2	46	20	54340	5905					18.0	17.80	17.69	17.69	
	CA_2A-13A-66C	2	20	18900	1880	1	0	900	1960	13	10	5230	751	66	20	67036	2170	66	20	66838	2150.2					18.0	17.80	17.63	17.63	
	CA_2A-46A-48C	2	20	18900	1880	1	0	900	1960	46	20	46890	5160	48	20	56442	3670.2	48	20	56640	3690					18.0	17.80	17.79	17.79	
	CA_2A-46C-48A	2	20	18900	1880	1	0	900	1960	46	20	50665	5537.5	46	20	50863	5557.3	48	20	56210	3647					18.0	17.80	17.71	17.71	
	CA_4A-4A-12A-30A	4	20	20300	1745	1	0	2300	2145	4	20	2050	2120	12	10	5094	737.4	30	10	9820	2355					18.0	17.75	17.64	17.64	
	CA_5A-46C-66A	5	10	20525	836.5	1	0	2525	881.5	46	20	50665	5537.5	46	20	50863	5557.3	66	20	67036	2170					23	22.13	22.05	22.05	
	CA_13A-46C-66A	13	10	23230	782	1	0	5230	751	46	20	50665	5537.5	46	20	50863	5557.3	66	20	67036	2170					23	22.00	21.96	21.96	
	CA_13A-48A-66B	13	10	23230	782	1	0	5230	751	48	20	56210	3647	66	10	67086	2175	66	10	66987	2165.1					23	22.00	21.95	21.95	
	CA_13A-48A-66C	13	10	23230	782	1	0	5230	751	48	20	56210	3647	66	20	67036	2170	66	20	66838	2150.2					23	22.00	21.89	21.89	
	CA_2A-2A-5A-66A-66A	2	20	18900	1880	1	0	900	1960	2	20	700	1940	5	10	2450	874	66	20	67036	2170	66	20	66786	2145	18	17.80	17.63	17.63	
	CA_2A-2A-5A-66B	2	20	18900	1880	1	0	900	1960	2	20	700	1940	5	10	2450	874	66	10	67086	2175	66	10	66987	2165.1	18	17.80	17.61	17.61	
	CA_2A-2A-5A-66C	2	20	18900	1880	1	0	900	1960	2	20	700	1940	5	10	2450	874	66	20	67036	2170	66	20	66838	2150.2	18	17.80	17.55	17.55	
	CA_2A-2A-12A-66A-66A	2	20	18900	1880	1	0	900	1960	2	20	700	1940	12	10	5094	737.4	66	20	67036	2170	66	20	66786	2145	18	17.80	17.57	17.57	
	CA_2A-2A-13A-66A-66A	2	20	18900	1880	1	0	900	1960	2	20	700	1940	13	10	5230	751	66	20	67036	2170	66	20	66786	2145	18	17.80	17.59	17.59	
	CA_2A-2A-13A-66B	2	20	18900	1880	1	0	900	1960	2	20	700	1940	13	10	5230	751	66	10	67086	2175	66	10	66987	2165.1	18	17.80	17.69	17.69	
	CA_2A-2A-14A-66A-66A	2	20	18900	1880	1	0	900	1960	2	20	700	1940	14	10	5330	763	66	20	67036	2170	66	20	66786	2145	18	17.80	17.73	17.73	
	CA_2A-5A-46D	2	20	18900	1880	1	0	900	1960	5	10	2450	874	46	20	53942	5865.2	46	20	54140	5885	46	20	54338	5904.8	18	17.80	17.75	17.75	
	CA_2A-5A-48A-48C	2	20	18900	1880	1	0	900	1960	5	10	2450	874	48	20	56210	3647	48	20	56442	3670.2	48	20	56640	3690	18	17.80	17.74	17.74	
	CA_2A-5A-48D	2	20	18900	1880	1	0	900	1960	5	10	2450	874	48	20	56244	3650.4	48	20	56442	3670.2	48	20	56640	3690	18	17.80	17.77	17.77	
	CA_2A-5B-66A-66A	2	20	18900	1880	1	0	900	1960	5	10	2450	874	5	10	2549	883.9	66	20	67036	2170	66	20	66786	2145	18	17.80	17.64	17.64	
	CA_2A-5B-66B	2	20	18900	1880	1	0	900	1960	5	10	2450	874	5	10	2549	883.9	66	10	67086	2175	66	10	66987	2165.1	18	17.80	17.57	17.57	
	CA_2A-5B-66C	2	20	18900	1880	1	0	900	1960	5	10	2450	874	5	10	2549	883.9	66	20	67036	2170	66	20	66838	2150.2	18	17.80	17.55	17.55	
	CA_2A-13A-48A-48C	2	20	18900	1880	1	0	900	1960	13	10	5230	751	48	20	56210	3647	48	20	56442	3670.2	48	20	56640	3690	18	17.80	17.52	17.52	
	CA_2A-14A-66A-66A-66A	2	20	18900	1880	1	0	900	1960	14	10	5330	763	66	20	67036	2170	66	20	66786	2145	66	20	66536	2120	18	17.80	17.59	17.59	
	CA_2A-46A-46C-66A	2	20	18900	1880	1	0	900	1960	46	20	46890	5160	46	20	50692	5540.2	46												

Downlink Carrier Aggregation Scenarios Conducted Power (Reduction) - Laptop

Configure	Combination	PCC								SCC1				SCC2				SCC3				SCC4				Measurement Power			
		LTE Band	BW [Mhz]	UL Channel	UL Freq. [MHz]	UL RB	UL Offset	DL Channel	DL Freq. [MHz]	LTE Band	BW [Mhz]	DL Channel	DL Freq. [MHz]	LTE Band	BW [Mhz]	DL Channel	DL Freq. [MHz]	LTE Band	BW [Mhz]	DL Channel	DL Freq. [MHz]	LTE Band	BW [Mhz]	DL Channel	DL Freq. [MHz]	Maximum Tune-up Power	Single Carrier Tx Power without DL-CA Active (dBm)	Tx Power with DL-CA Active (dBm)	
																												PCC	Total
	CA_2A-13A-48D	2	20	18900	1880	1	0	900	1960	13	10	5230	751	48	20	56244	3650.4	48	20	56442	3670.2	48	20	56640	3690	18	17.80	17.73	17.73
	CA_5A-48A-48C-66A	5	10	20525	836.5	1	0	2525	881.5	48	20	56210	3647	48	20	56442	3670.2	48	20	56640	3690	66	20	67036	2170	23	22.13	22.05	22.05
	CA_13A-48A-48C-66A	13	10	23230	782	1	0	5230	751	48	20	56210	3647	48	20	56442	3670.2	48	20	56640	3690	66	20	67036	2170	23	22.00	21.96	21.96
	CA_2A-4A-5A-30A	2	20	18900	1880	1	0	900	1960	4	20	2175	2132.5	5	10	2450	874	30	10	9820	2355					18	17.80	17.73	17.73
	CA_2A-4A-12A-30A	2	20	18900	1880	1	0	900	1960	4	20	2175	2132.5	12	10	5094	737.4	30	10	9820	2355					18	17.80	17.71	17.71
	CA_2A-5A-30A-66A	2	20	18900	1880	1	0	900	1960	5	10	2450	874	30	10	9820	2355	66	20	67036	2170					18	17.80	17.65	17.65
	CA_2A-5A-48A-48A-66A	2	20	18900	1880	1	0	900	1960	5	10	2450	874	48	20	55780	3603	48	20	56640	3690	66	20	67036	2170	18	17.80	17.61	17.61
	CA_2A-5B-30A-66A	2	20	18900	1880	1	0	900	1960	5	10	2450	874	5	10	2549	883.9	30	10	9820	2355	66	20	67036	2170	18	17.80	17.69	17.69
	CA_2A-12A-30A-66A-66A	2	20	18900	1880	1	0	900	1960	12	10	5094	737.4	30	10	9820	2355	66	20	67036	2170	66	20	66786	2145	18	17.80	17.72	17.72
	CA_2A-13A-48A-48A-66A	2	20	18900	1880	1	0	900	1960	13	10	5230	751	48	20	56210	3647	48	20	56012	3627.2	66	20	67036	2170	18	17.80	17.63	17.63
	CA_2A-13A-48C-66A	2	20	18900	1880	1	0	900	1960	13	10	5230	751	48	20	56442	3670.2	48	20	56640	3690	66	20	67036	2170	18	17.80	17.64	17.64
	CA_2A-14A-30A-66A-66A	2	20	18900	1880	1	0	900	1960	14	10	5330	763	30	10	9820	2355	66	20	67036	2170	66	20	66786	2145	18	17.80	17.75	17.75
	CA_2A-5A-48C-66A	2	20	18900	1880	1	0	900	1960	5	10	2450	874	48	20	56442	3670.2	48	20	56640	3690	66	20	67036	2170	18	17.80	17.74	17.74

Downlink Carrier Aggregation Scenarios Conducted Power (Reduction) - Tablet

Configure	Combination	PCC								SCC1				SCC2				SCC3				SCC4				Measurement Power							
		LTE Band	BW [Mhz]	UL Channel	UL Freq. [MHz]	UL RB	UL Offset	DL Channel	DL Freq. [MHz]	LTE Band	BW [Mhz]	DL Channel	DL Freq. [MHz]	LTE Band	BW [Mhz]	DL Channel	DL Freq. [MHz]	LTE Band	BW [Mhz]	DL Channel	DL Freq. [MHz]	LTE Band	BW [Mhz]	DL Channel	DL Freq. [MHz]	LTE Band	BW [Mhz]	DL Channel	DL Freq. [MHz]	Maximum Tune-up Power	Single Carrier Tx Power without DL-CA Active (dBm)	Tx Power with DL-CA Active (dBm)	
																																PCC	Total
Inter Band	CA_48A-48C-66B	48	20	56210	3647	1	0	56210	3647	48	20	56442	3670.2	48	20	56640	3690	66	10	67086	2175	66	10	66987	2165.1	14.0	13.88	13.82	13.82				
	CA_48A-48C-66C	48	20	56210	3647	1	0	56210	3647	48	20	56442	3670.2	48	20	56640	3690	66	20	67036	2170	66	20	66838	2150.2	14.0	13.88	13.77	13.77				
	CA_48A-48D-66A	48	20	56210	3647	1	0	56210	3647	48	20	56244	3650.4	48	20	56442	3670.2	48	20	56640	3690	66	20	67036	2170	14.0	13.88	13.73	13.73				
	CA_48C-48C-66A	48	20	56210	3647	1	0	56210	3647	48	20	56408	3666.8	48	20	55340	3560	48	20	55538	3579.8	66	20	67036	2170	14.0	13.88	13.79	13.79				
	CA_48C-66A-66A-66A	48	20	56210	3647	1	0	56210	3647	48	20	56408	3666.8	66	20	67036	2170	66	20	66786	2145	66	20	66536	2120	14.0	13.88	13.81	13.81				
	CA_48E-66A	48	20	55340	3560	1	0	55340	3560	48	20	55538	3579.8	48	20	55736	3599.6	48	20	55934	3619.4	66	20	67036	2170	14.0	13.75	13.71	13.71				
	CA_2A-4A-7A	2	20	18900	1880	1	0	900	1960	4	20	2175	2132.5	7	20	3100	2655										16.0	15.25	15.22	15.22			
	CA_2A-4A-13A	2	20	18900	1880	1	0	900	1960	4	20	2175	2132.5	13	10	5230	751										16.0	15.25	15.13	15.13			
	CA_2A-5A-46A	2	20	18900	1880	1	0	900	1960	5	10	2450	874	46	20	50665	5537.5										16.0	15.25	15.08	15.08			
	CA_2A-13A-46A	2	20	18900	1880	1	0	900	1960	13	10	5230	751	46	20	50665	5537.5										16.0	15.25	15.17	15.17			
	CA_2A-29A-30A	2	20	18900	1880	1	0	900	1960	29	10	9715	722.5	30	10	9820	2355										16.0	15.25	15.21	15.21			
	CA_2A-46A-48A	2	20	18900	1880	1	0	900	1960	46	20	50665	5537.5	48	20	56210	3647										16.0	15.25	15.09	15.09			
	CA_4A-7A-28A	4	20	20175	1732.5	1	0	2175	2132.5	7	20	3100	2655	28	20	9435	780.5										17.0	16.15	16.02	16.02			
	CA_4A-29A-30A	4	20	20175	1732.5	1	0	2175	2132.5	29	10	9715	722.5	30	10	9820	2355										17.0	16.15	16.11	16.11			
	CA_5A-46A-66A	5	10	20525	836.5	1	0	2525	881.5	46	20	50665	5537.5	66	20	67036	2170										19.5	19.35	19.23	19.23			
	CA_13A-46A-66A	13	10	23230	782	1	0	5230	751	46	20	50665	5537.5	66	20	67036	2170										18.0	17.28	17.21	17.21			
	CA_2A-2A-4A-5A	2	20	18900	1880	1	0	900	1960	2	20	700	1940	4	20	2175	2132.5	5	10	2450	874						16.0	15.25	15.13	15.13			
	CA_2A-2A-4A-12A	2	20	18900	1880	1	0	900	1960	2	20	700	1940	4	20	2175	2132.5	12	10	5094	737.4						16.0	15.25	15.07	15.07			
	CA_2A-2A-46C	2	20	18900	1880	1	0	900	1960	2	20	700	1940	46	20	54142	5885.2	46	20	54340	5905						16.0	15.25	15.11	15.11			
	CA_2A-4A-4A-5A	2	20	18900	1880	1	0	900	1960	4	20	2050	2120	4	20	2300	2145	5	10	2450	874						16.0	15.25	15.02	15.02			
	CA_2A-4A-4A-12A	2	20	18900	1880	1	0	900	1960	4	20	2050	2120	4	20	2300	2145	12	10	5094	737.4						16.0	15.25	15.01	15.01			
	CA_2A-4A-5B	2	20	18900	1880	1	0	900	1960	4	20	2175	2132.5	5	10	2450	874	5	10	2549	883.9						16.0	15.25	15.13	15.13			
	CA_2A-5A-46C	2	20	18900	1880	1	0	900	1960	5	10	2549	883.9	46	20	54142	5885.2	46	20	54340	5905						16.0	15.25	15.17	15.17			
	CA_2A-12A-66C	2	20	18900	1880	1	0	900	1960	12	10	5094	737.4	66	20	67036	2170	66	20	66838	2150.2						16.0	15.25	15.05	15.05			
	CA_2A-13A-46C	2	20	18900	1880	1	0	900	1960	13	10	5230	751	46	20	54142	5885.2	46	20	54340	5905						16.0	15.25	15.08	15.08			
	CA_2A-13A-66C	2	20	18900	1880	1	0	900	1960	13	10	5230	751	66	20	67036	2170	66	20	66838	2150.2						16.0	15.25	15.02	15.02			
	CA_2A-46A-48C	2	20	18900	1880	1	0	900	1960	46	20	46890	5160	48	20	56442	3670.2	48	20	56640	3690						16.0	15.25	15.17	15.17			
	CA_2A-46C-48A	2	20	18900	1880	1	0	900	1960	46	20	50665	5537.5	46	20	50863	5557.3	48	20	56210	3647						16.0	15.25	15.03	15.03			
	CA_4A-4A-12A-30A	4	20	20300	1745	1	0	2300	2145	4	20	2050	2120	12	10	5094	737.4	30	10	9820	2355						17.0	16.01	15.98	15.98			
	CA_5A-46C-66A	5	10	20525	836.5	1	0	2525	881.5	46	20	50665	5537.5	46	20	50863	5557.3	66	20	67036	2170						19.5	19.35	19.22	19.22			
	CA_13A-46C-66A	13	10	23230	782	1	0	5230	751	46	20	50665	5537.5	46	20	50863	5557.3	66	20	67036	2170						18.0	17.28	17.22	17.22			
	CA_13A-48A-66B	13	10	23230	782	1	0	5230	751	48	20	56210	3647	66	10	67086	2175	66	10	66987	2165.1						18.0	17.28	17.21	17.21			
	CA_13A-48A-66C	13	10	23230	782	1	0	5230	751	48	20	56210	3647	66	20	67036	2170	66	20	66838	2150.2						18.0	17.28	17.17	17.17			
	CA_2A-2A-5A-66A-66A	2	20	18900	1880	1	0	900	1960	2	20	700	1940	5	10	2450	874	66	20	67036	2170	66	20	66786	2145	16.0	15.25	15.21	15.21				
	CA_2A-2A-5A-66B	2	20	18900	1880	1	0	900	1960	2	20	700	1940	5	10	2450	874	66	10	67086	2175	66	10	66987	2165.1	16.0	15.25	15.13	15.13				
	CA_2A-2A-5A-66C	2	20	18900	1880	1	0	900	1960	2	20	700	1940	5	10	2450	874	66	20	67036	2170	66	20	66838	2150.2	16.0	15.25	15.08	15.08				
	CA_2A-2A-12A-66A-66A	2	20	18900	1880	1	0	900	1960	2	20	700	1940	12	10	5094	737.4	66	20	67036	2170	66	20	66786	2145	16.0	15.25	15.22	15.22				
	CA_2A-2A-13A-66A-66A	2	20	18900	1880	1	0	900	1960	2	20	700	1940	13	10	5230	751	66	20	67036	2170	66	20	66786	2145	16.0	15.25	15.17	15.17				
	CA_2A-2A-13A-66B	2	20	18900	1880	1	0	900	1960	2	20	700	1940	13	10	5230	751	66	10	67086	2175	66	10	66987	2165.1	16.0	15.25	15.03	15.03				
	CA_2A-2A-14A-66A-66A	2	20	18900	1880	1	0	900	1960	2	20	700	1940	14	10	5330	763	66	20	67036	2170	66	20	66786	2145	16.0	15.25	15.07	15.07				
	CA_2A-5A-46D	2	20	18900	1880	1	0	900	1960	5	10	2450	874	46	20	53942	5885.2	46	20	54140	5885	46	20	54338	5904.8	16.0	15.25	15.19	15.19				
	CA_2A-5A-48A-48C	2	20	18900	1880	1	0	900	1960	5	10	2450	874	48	20	56442	3670.2	48	20	56442	3670.2	48	20	56640	3690	16.0	15.25	15.06	15.06				
	CA_2A-5A-48D	2	20	18900	1880	1	0	900	1960	5	10	2450	874	48	20	56244	3650.4	48	20	56442	3670.2	48	20	56640	3690	16.0	15.25	15.11	15.11				
	CA_2A-5B-66A-66A	2	20	18900	1880	1	0	900	1960	5	10	2450	874	5	10	2549	883.9	66	20	67036	2170	66	20	66786	2145	16.0	15.25	15.22	15.22				
	CA_2A-5B-66B	2	20	18900	1880	1	0	900	1960	5	10	2450	874	5	10	2549	883.9	66	10	67086	2175	66	10	66987	2165.1	16.0	15.25	15.17	15.17				
	CA_2A-5B-66C	2	20	18900	1880	1	0	900	1960	5	10	2450	874	5	10	2549	883.9	66	20	67036	2170	66	20	66838	2150.2	16.0	15.25	15.08	15.08				
	CA_2A-13A-48A-48C	2	20	18900	1880	1	0	900	1960	13	10	5230	751	48	20	56210	3647	48	20	56442	3670.2	48	20	56640	3690	16.0	15.25	15.02	15.02				
	CA_2A-14A-66A-66A-66A	2	20	18900	1880	1	0	900	1960	14	10	5330	763	66	20	67036	2170	66	20	66786	2145	66	20	66536	2120	16.0							

Downlink Carrier Aggregation Scenarios Conducted Power (Reduction) - Tablet

Configure	Combination	PCC								SCC1				SCC2				SCC3				SCC4				Measurement Power			
		LTE Band	BW [Mhz]	UL Channel	UL Freq. [MHz]	UL RB	UL Offset	DL Channel	DL Freq. [MHz]	LTE Band	BW [Mhz]	DL Channel	DL Freq. [MHz]	LTE Band	BW [Mhz]	DL Channel	DL Freq. [MHz]	LTE Band	BW [Mhz]	DL Channel	DL Freq. [MHz]	LTE Band	BW [Mhz]	DL Channel	DL Freq. [MHz]	Maximum Tune-up Power	Single Carrier Tx Power without DL-CA Active (dBm)	Tx Power with DL-CA Active (dBm)	
																												PCC	Total
	CA_5A-48A-48C-66A	5	10	20525	836.5	1	0	2525	881.5	48	20	56210	3647	48	20	56442	3670.2	48	20	56640	3690	66	20	67036	2170	19.5	19.35	19.21	19.21
	CA_13A-48A-48C-66A	13	10	23230	782	1	0	5230	751	48	20	56210	3647	48	20	56442	3670.2	48	20	56640	3690	66	20	67036	2170	18	17.28	17.22	17.22
	CA_2A-4A-5A-30A	2	20	18900	1880	1	0	900	1960	4	20	2175	2132.5	5	10	2450	874	30	10	9820	2355					16	15.25	15.03	15.03
	CA_2A-4A-12A-30A	2	20	18900	1880	1	0	900	1960	4	20	2175	2132.5	12	10	5094	737.4	30	10	9820	2355					16	15.25	15.04	15.04
	CA_2A-5A-30A-66A	2	20	18900	1880	1	0	900	1960	5	10	2450	874	30	10	9820	2355	66	20	67036	2170					16	15.25	15.21	15.21
	CA_2A-5A-48A-48A-66A	2	20	18900	1880	1	0	900	1960	5	10	2450	874	48	20	55780	3603	48	20	56640	3690	66	20	67036	2170	16	15.25	15.17	15.17
	CA_2A-5B-30A-66A	2	20	18900	1880	1	0	900	1960	5	10	2450	874	5	10	2549	883.9	30	10	9820	2355	66	20	67036	2170	16	15.25	15.21	15.21
	CA_2A-12A-30A-66A-66A	2	20	18900	1880	1	0	900	1960	12	10	5094	737.4	30	10	9820	2355	66	20	67036	2170	66	20	66786	2145	16	15.25	15.16	15.16
	CA_2A-13A-48A-48A-66A	2	20	18900	1880	1	0	900	1960	13	10	5230	751	48	20	56210	3647	48	20	56012	3627.2	66	20	67036	2170	16	15.25	15.11	15.11
	CA_2A-13A-48C-66A	2	20	18900	1880	1	0	900	1960	13	10	5230	751	48	20	56442	3670.2	48	20	56640	3690	66	20	67036	2170	16	15.25	15.21	15.21
	CA_2A-14A-30A-66A-66A	2	20	18900	1880	1	0	900	1960	14	10	5330	763	30	10	9820	2355	66	20	67036	2170	66	20	66786	2145	16	15.25	15.11	15.11
	CA_2A-5A-48C-66A	2	20	18900	1880	1	0	900	1960	5	10	2450	874	48	20	56442	3670.2	48	20	56640	3690	66	20	67036	2170	16	15.25	15.06	15.06

WLAN Conducted Power (Laptop)			
WLAN2.4GHz Ant 0			
Mode	Channel	Frequency	SISO Ant 0 Avg. Power
802.11b	1	2412	18.98
	6	2437	19.98
	11	2462	19.4
	12	2467	18.4
	13	2472	14.98
802.11g	1	2412	16.81
	6	2437	19.82
	11	2462	16.72
	12	2467	14.66
	13	2472	1.18
802.11n HT20	1	2412	16.85
	6	2437	19.85
	11	2462	15.25
	12	2467	14.69
	13	2472	1.27
802.11n HT40	3	2422	16.28
	6	2437	15.25
	9	2452	15.77
	10	2457	12.22
	11	2462	4.76
802.11ax HE20	1	2412	16.8
	6	2437	19.72
	11	2462	15.3
	12	2467	14.75
	13	2472	1.32
802.11ax HE40	3	2422	16.33
	6	2437	15.22
	9	2452	15.72
	10	2457	12.26
	11	2462	4.84

WLAN Conducted Power (Laptop)			
WLAN2.4GHz Ant 1			
Mode	Channel	Frequency	SISO Ant 1 Avg. Power
802.11b	1	2412	19.43
	6	2437	19.91
	11	2462	19.41
	12	2467	18.42
	13	2472	14.95
802.11g	1	2412	16.67
	6	2437	19.72
	11	2462	16.8
	12	2467	14.68
	13	2472	1.18
802.11n HT20	1	2412	16.77
	6	2437	19.69
	11	2462	15.19
	12	2467	14.69
	13	2472	1.32
802.11n HT40	3	2422	16.22
	6	2437	15.21
	9	2452	14.29
	10	2457	12.24
	11	2462	4.82
802.11ax HE20	1	2412	16.78
	6	2437	19.67
	11	2462	15.28
	12	2467	14.68
	13	2472	1.35
802.11ax HE40	3	2422	16.32
	6	2437	15.21
	9	2452	14.7
	10	2457	12.35
	11	2462	4.73

WLAN Conducted Power (Laptop)					
WLAN2.4GHz Ant 0+1					
Mode	Channel	Frequency	MIMO Ant 0 Avg. Power	MIMO Ant 1 Avg. Power	MIMO Ant 0+1 Avg. Power
802.11n HT20	1	2412	13.98	13.91	16.96
	6	2437	17.44	17.48	20.47
	11	2462	14.93	14.93	17.94
	12	2467	11.85	11.95	14.91
	13	2472	-1.78	-1.36	1.45
802.11n HT40	3	2422	13.25	13.3	16.29
	6	2437	14.17	14.15	17.17
	9	2452	12.8	12.68	15.75
	10	2457	9.27	9.29	12.29
	11	2462	1.76	1.78	4.78
802.11ax HE20	1	2412	13.84	13.69	16.78
	6	2437	17.17	17.22	20.21
	11	2462	14.22	14.28	17.26
	12	2467	11.8	11.66	14.74
	13	2472	-1.69	-1.82	1.26
802.11ax HE40	3	2422	13.24	13.31	16.29
	6	2437	14.32	14.35	17.35
	9	2452	12.73	12.82	15.79
	10	2457	9.28	9.24	12.27
	11	2462	1.75	1.77	4.77

WLAN Conducted Power (Laptop)			
Bluetooth Ant 1			
Mode	Channel	Frequency	SISO Ant 1 Avg. Power
BR / EDR	0	2402	7.79
	39	2441	7.99
	78	2480	7.96
LE	0	2402	6.71
	19	2440	6.71
	39	2480	6.67

WLAN Conducted Power (Laptop)			
WLAN 5.3GHz Ant 0			
Mode	Channel	Frequency	SISO Ant 0 Avg. Power
802.11a	52	5260	19.91
	56	5280	19.97
	60	5300	18.42
	64	5320	17.88
802.11n HT20	52	5260	19.65
	56	5280	19.7
	60	5300	18.8
	64	5320	17.76
802.11n HT40	54	5270	19.02
	62	5310	16.79
802.11ac VHT80	58	5290	17.05
802.11ac VHT160	50	5250	14.01
802.11ax HE20	52	5260	19.84
	56	5280	19.7
	60	5300	18.66
	64	5320	17.81
802.11ax HE40	54	5270	18.93
	62	5310	16.73
802.11ax HE80	58	5290	16.91
802.11ax HE160	50	5250	13.99

WLAN Conducted Power (Laptop)			
WLAN 5.3GHz Ant 1			
Mode	Channel	Frequency	SISO Ant 1 Avg. Power
802.11a	52	5260	19.88
	56	5280	19.93
	60	5300	18.82
	64	5320	17.99
802.11n HT20	52	5260	19.73
	56	5280	19.69
	60	5300	18.82
	64	5320	17.79
802.11n HT40	54	5270	19.48
	62	5310	17.3
802.11ac VHT80	58	5290	17
802.11ac VHT160	50	5250	13.83
802.11ax HE20	52	5260	19.65
	56	5280	19.76
	60	5300	18.76
	64	5320	17.67
802.11ax HE40	54	5270	19.44
	62	5310	17.15
802.11ax HE80	58	5290	17.01
802.11ax HE160	50	5250	13.84

WLAN Conducted Power (Laptop)					
WLAN 5.3GHz Ant 0+1					
Mode	Channel	Frequency	MIMO Ant 0 Avg. Power	MIMO Ant 1 Avg. Power	MIMO Ant 0+1 Avg. Power
802.11n HT20	52	5260	17.47	17.4	20.45
	56	5280	17.49	17.41	20.46
	60	5300	15.87	15.93	18.91
	64	5320	14.9	14.88	17.9
802.11n HT40	54	5270	16.05	16.07	19.07
	62	5310	13.82	13.76	16.8
802.11ac VHT80	58	5290	13.9	13.99	16.96
802.11ac VHT160	50	5250	10.76	10.85	13.82
802.11ax HE20	52	5260	17.34	17.26	20.31
	56	5280	17.33	17.32	20.34
	60	5300	15.84	15.78	18.82
	64	5320	14.83	14.78	17.82
802.11ax HE40	54	5270	16.01	16.08	19.06
	62	5310	13.77	13.67	16.73
802.11ax HE80	58	5290	14.09	14.02	17.07
802.11ax HE160	50	5250	10.75	10.81	13.79

WLAN Conducted Power (Laptop)			
WLAN 5.6GHz Ant 0			
Mode	Channel	Frequency	SISO Ant 0 Avg. Power
802.11a	100	5500	18.29
	116	5580	18.84
	120	5600	18.83
	124	5620	18.75
	132	5660	18.85
	140	5700	18.22
	144	5720	18.92
802.11n HT20	100	5500	18.15
	116	5580	17.27
	120	5600	18.84
	124	5620	18.76
	132	5660	18.75
	140	5700	18.3
	144	5720	18.89
802.11n HT40	102	5510	17.17
	110	5550	18.28
	118	5590	18.91
	126	5630	18.87
	134	5670	18.86
	142	5710	18.77
802.11ac VHT80	106	5530	18.43
	122	5610	18.84
	138	5690	18.96
802.11ac VHT160	114	5570	13.47
802.11ax HE20	100	5500	18.29
	116	5580	17.43
	120	5600	18.79
	124	5620	18.79
	132	5660	18.78
	140	5700	18.34
	144	5720	18.74
802.11ax HE40	102	5510	17.15
	110	5550	18.2
	118	5590	18.77
	126	5630	18.78
	134	5670	18.85
	142	5710	18.87
802.11ax HE80	106	5530	18.23
	122	5610	18.42
	138	5690	18.87
802.11ax HE160	114	5570	13.66

WLAN Conducted Power (Laptop)			
WLAN 5.6GHz Ant 1			
Mode	Channel	Frequency	SISO Ant 1 Avg. Power
802.11a	100	5500	18.18
	116	5580	19.69
	120	5600	19.71
	124	5620	19.72
	132	5660	19.71
	140	5700	17.26
	144	5720	19.65
802.11n HT20	100	5500	18.33
	116	5580	17.17
	120	5600	19.71
	124	5620	19.76
	132	5660	19.65
	140	5700	17.15
	144	5720	19.77
802.11n HT40	102	5510	17.29
	110	5550	18.26
	118	5590	19.85
	126	5630	19.66
	134	5670	19.22
	142	5710	19.82
802.11ac VHT80	106	5530	18.48
	122	5610	19.84
	138	5690	19.91
802.11ac VHT160	114	5570	13.6
802.11ax HE20	100	5500	18.29
	116	5580	17.34
	120	5600	19.77
	124	5620	19.75
	132	5660	19.74
	140	5700	17.41
	144	5720	19.67
802.11ax HE40	102	5510	17.26
	110	5550	18.33
	118	5590	19.77
	126	5630	19.76
	134	5670	18.75
	142	5710	19.78
802.11ax HE80	106	5530	18.32
	122	5610	19.32
	138	5690	19.83
802.11ax HE160	114	5570	13.44

WLAN Conducted Power (Laptop)					
WLAN 5.6GHz Ant 0+1					
Mode	Channel	Frequency	MIMO Ant 0 Avg. Power	MIMO Ant 1 Avg. Power	MIMO Ant 0+1 Avg. Power
802.11n HT20	100	5500	15.34	15.22	18.29
	116	5580	14.2	14.24	17.23
	120	5600	17.17	17.25	20.22
	124	5620	17.17	17.2	20.2
	132	5660	17.19	17.27	20.24
	140	5700	14.25	14.26	17.27
	144	5720	17.05	16.91	19.99
802.11n HT40	102	5510	14.2	14.15	17.19
	110	5550	15.17	15.32	18.26
	118	5590	17.27	17.19	20.24
	126	5630	16.84	16.77	19.82
	134	5670	16.74	16.83	19.8
	142	5710	17.22	17.26	20.25
802.11ac VHT80	106	5530	15.41	15.42	18.43
	122	5610	17.44	17.41	20.44
	138	5690	17.43	17.45	20.45
802.11ac VHT160	114	5570	10.43	10.4	13.43
802.11ax HE20	100	5500	15.27	15.32	18.31
	116	5580	14.3	14.26	17.29
	120	5600	17.17	17.23	20.21
	124	5620	17.25	17.2	20.24
	132	5660	17.24	17.23	20.25
	140	5700	14.33	14.23	17.29
	144	5720	16.91	16.95	19.94
802.11ax HE40	102	5510	14.19	14.15	17.18
	110	5550	15.23	15.22	18.24
	118	5590	17.25	17.16	20.22
	126	5630	16.74	16.66	19.71
	134	5670	16.82	16.69	19.77
	142	5710	17.24	17.32	20.29
802.11ax HE80	106	5530	15.23	15.23	18.24
	122	5610	17.26	17.33	20.31
	138	5690	17.27	17.28	20.29
802.11ax HE160	114	5570	10.71	10.73	13.73

WLAN Conducted Power (Laptop)			
WLAN 5.8GHz Ant 0			
Mode	Channel	Frequency	SISO Ant 0 Avg. Power
802.11a	149	5745	18.33
	153	5765	18.31
	157	5785	18.29
	161	5805	18.29
	165	5825	18.3
802.11n HT20	149	5745	18.42
	153	5765	18.35
	157	5785	18.25
	161	5805	18.33
	165	5825	18.4
802.11n HT40	151	5755	18.44
	159	5795	18.38
802.11ac VHT80	155	5775	17.83
802.11ax HE20	149	5745	18.34
	153	5765	18.38
	157	5785	18.34
	161	5805	18.4
	165	5825	18.28
802.11ax HE40	151	5755	18.34
	159	5795	18.38
802.11ax HE80	155	5775	17.91

WLAN Conducted Power (Laptop)			
WLAN 5.8GHz Ant 1			
Mode	Channel	Frequency	SISO Ant 1 Avg. Power
802.11a	149	5745	18.67
	153	5765	18.77
	157	5785	18.74
	161	5805	18.73
	165	5825	18.81
802.11n HT20	149	5745	18.79
	153	5765	18.76
	157	5785	18.7
	161	5805	18.69
	165	5825	18.77
802.11n HT40	151	5755	18.85
	159	5795	18.62
802.11ac VHT80	155	5775	17.83
802.11ax HE20	149	5745	18.82
	153	5765	18.84
	157	5785	18.82
	161	5805	18.74
	165	5825	18.75
802.11ax HE40	151	5755	18.82
	159	5795	18.76
802.11ax HE80	155	5775	17.74

WLAN Conducted Power (Laptop)					
WLAN 5.8GHz Ant 0+1					
Mode	Channel	Frequency	MIMO Ant 0 Avg. Power	MIMO Ant 1 Avg. Power	MIMO Ant 0+1 Avg. Power
802.11n HT20	149	5745	17.06	17.08	20.08
	153	5765	16.92	16.97	19.96
	157	5785	17.01	17.02	20.03
	161	5805	17.1	16.98	20.05
	165	5825	16.9	17.09	20.01
802.11n HT40	151	5755	17.45	17.44	20.46
	159	5795	17.44	17.37	20.42
802.11ac VHT80	155	5775	15.82	15.82	18.83
802.11ax HE20	149	5745	17.09	17.05	20.08
	153	5765	17.03	17.07	20.06
	157	5785	17.01	16.91	19.97
	161	5805	16.97	16.95	19.97
	165	5825	17	17.1	20.06
802.11ax HE40	151	5755	17.25	17.24	20.26
	159	5795	17.17	17.19	20.19
802.11ax HE80	155	5775	15.84	15.7	18.78

WLAN Conducted Power (Tablet)			
WLAN2.4GHz Ant 0			
Mode	Channel	Frequency	SISO Ant 0 Avg. Power
802.11b	1	2412	18.45
	6	2437	18.49
	11	2462	18.43
	12	2467	18.4
	13	2472	14.98
802.11g	1	2412	16.81
	6	2437	18.41
	11	2462	16.72
	12	2467	14.66
	13	2472	1.18
802.11n HT20	1	2412	16.85
	6	2437	18.39
	11	2462	15.25
	12	2467	14.69
	13	2472	1.27
802.11n HT40	3	2422	16.28
	6	2437	15.25
	9	2452	15.77
	10	2457	12.22
	11	2462	4.76
802.11ax HE20	1	2412	16.8
	6	2437	18.37
	11	2462	15.3
	12	2467	14.75
	13	2472	1.32
802.11ax HE40	3	2422	16.33
	6	2437	15.22
	9	2452	15.72
	10	2457	12.26
	11	2462	4.84

WLAN Conducted Power (Tablet)			
WLAN2.4GHz Ant 1			
Mode	Channel	Frequency	SISO Ant 1 Avg. Power
802.11b	1	2412	19.43
	6	2437	19.91
	11	2462	19.41
	12	2467	18.42
	13	2472	14.95
802.11g	1	2412	16.67
	6	2437	19.72
	11	2462	16.8
	12	2467	14.68
	13	2472	1.18
802.11n HT20	1	2412	16.77
	6	2437	19.69
	11	2462	15.19
	12	2467	14.69
	13	2472	1.32
802.11n HT40	3	2422	16.22
	6	2437	15.21
	9	2452	14.29
	10	2457	12.24
	11	2462	4.82
802.11ax HE20	1	2412	16.78
	6	2437	19.67
	11	2462	15.28
	12	2467	14.68
	13	2472	1.35
802.11ax HE40	3	2422	16.32
	6	2437	15.21
	9	2452	14.7
	10	2457	12.35
	11	2462	4.73

WLAN Conducted Power (Tablet)					
WLAN2.4GHz Ant 0+1					
Mode	Channel	Frequency	MIMO Ant 0 Avg. Power	MIMO Ant 1 Avg. Power	MIMO Ant 0+1 Avg. Power
802.11n HT20	1	2412	13.98	13.91	16.96
	6	2437	17.44	17.48	20.47
	11	2462	14.93	14.93	17.94
	12	2467	11.85	11.95	14.91
	13	2472	-1.78	-1.36	1.45
802.11n HT40	3	2422	13.25	13.3	16.29
	6	2437	14.17	14.15	17.17
	9	2452	12.8	12.68	15.75
	10	2457	9.27	9.29	12.29
	11	2462	1.76	1.78	4.78
802.11ax HE20	1	2412	13.84	13.69	16.78
	6	2437	17.17	17.22	20.21
	11	2462	14.22	14.28	17.26
	12	2467	11.8	11.66	14.74
	13	2472	-1.69	-1.82	1.26
802.11ax HE40	3	2422	13.24	13.31	16.29
	6	2437	14.32	14.35	17.35
	9	2452	12.73	12.82	15.79
	10	2457	9.28	9.24	12.27
	11	2462	1.75	1.77	4.77

WLAN Conducted Power (Tablet)			
Bluetooth Ant 1			
Mode	Channel	Frequency	SISO Ant 1 Avg. Power
BR / EDR	0	2402	7.79
	39	2441	7.99
	78	2480	7.96
LE	0	2402	6.71
	19	2440	6.71
	39	2480	6.67

WLAN Conducted Power (Tablet)			
WLAN 5.3GHz Ant 0			
Mode	Channel	Frequency	SISO Ant 0 Avg. Power
802.11a	52	5260	12.33
	56	5280	12.35
	60	5300	12.24
	64	5320	12.4
802.11n HT20	52	5260	12.38
	56	5280	12.37
	60	5300	12.35
	64	5320	12.4
802.11n HT40	54	5270	12.39
	62	5310	12.24
802.11ac VHT80	58	5290	12.41
802.11ac VHT160	50	5250	11.84
802.11ax HE20	52	5260	12.32
	56	5280	12.31
	60	5300	12.3
	64	5320	12.27
802.11ax HE40	54	5270	12.26
	62	5310	12.34
802.11ax HE80	58	5290	12.27
802.11ax HE160	50	5250	11.82

WLAN Conducted Power (Tablet)			
WLAN 5.3GHz Ant 1			
Mode	Channel	Frequency	SISO Ant 1 Avg. Power
802.11a	52	5260	14.77
	56	5280	14.65
	60	5300	14.7
	64	5320	14.73
802.11n HT20	52	5260	14.75
	56	5280	14.62
	60	5300	14.78
	64	5320	14.79
802.11n HT40	54	5270	14.76
	62	5310	14.68
802.11ac VHT80	58	5290	14.95
802.11ac VHT160	50	5250	13.88
802.11ax HE20	52	5260	14.73
	56	5280	14.64
	60	5300	14.81
	64	5320	14.8
802.11ax HE40	54	5270	14.62
	62	5310	14.62
802.11ax HE80	58	5290	14.67
802.11ax HE160	50	5250	13.81

WLAN Conducted Power (Tablet)					
WLAN 5.3GHz Ant 0+1					
Mode	Channel	Frequency	MIMO Ant 0 Avg. Power	MIMO Ant 1 Avg. Power	MIMO Ant 0+1 Avg. Power
802.11n HT20	52	5260	14.82	14.89	17.87
	56	5280	14.89	14.8	17.86
	60	5300	14.88	14.76	17.83
	64	5320	14.91	14.81	17.87
802.11n HT40	54	5270	14.93	14.98	17.97
	62	5310	13.89	13.91	16.91
802.11ac VHT80	58	5290	14.14	14.06	17.11
802.11ac VHT160	50	5250	10.96	10.88	13.93
802.11ax HE20	52	5260	14.91	14.76	17.85
	56	5280	14.88	14.72	17.81
	60	5300	14.89	14.85	17.88
	64	5320	14.82	14.87	17.86
802.11ax HE40	54	5270	14.86	14.86	17.87
	62	5310	13.89	13.8	16.86
802.11ax HE80	58	5290	14.18	14.13	17.17
802.11ax HE160	50	5250	10.84	10.83	13.85

WLAN Conducted Power (Tablet)			
WLAN 5.6GHz Ant 0			
Mode	Channel	Frequency	SISO Ant 0 Avg. Power
802.11a	100	5500	12.23
	116	5580	12.19
	120	5600	12.33
	124	5620	12.28
	132	5660	12.23
	140	5700	12.24
	144	5720	12.35
802.11n HT20	100	5500	12.22
	116	5580	12.19
	120	5600	12.28
	124	5620	12.34
	132	5660	12.28
	140	5700	12.35
	144	5720	12.2
802.11n HT40	102	5510	12.34
	110	5550	12.33
	118	5590	12.22
	126	5630	12.18
	134	5670	12.27
	142	5710	12.28
802.11ac VHT80	106	5530	12.4
	122	5610	12.38
	138	5690	12.49
802.11ac VHT160	114	5570	12.45
802.11ax HE20	100	5500	12.32
	116	5580	12.3
	120	5600	12.22
	124	5620	12.33
	132	5660	12.24
	140	5700	12.31
	144	5720	12.34
802.11ax HE40	102	5510	12.34
	110	5550	12.32
	118	5590	12.26
	126	5630	12.35
	134	5670	12.34
	142	5710	12.28
802.11ax HE80	106	5530	12.15
	122	5610	12.15
	138	5690	12.17
802.11ax HE160	114	5570	12.28

WLAN Conducted Power (Tablet)			
WLAN 5.6GHz Ant 1			
Mode	Channel	Frequency	SISO Ant 1 Avg. Power
802.11a	100	5500	14.76
	116	5580	14.81
	120	5600	14.73
	124	5620	14.74
	132	5660	14.77
	140	5700	14.81
	144	5720	14.82
802.11n HT20	100	5500	14.83
	116	5580	14.74
	120	5600	14.72
	124	5620	14.77
	132	5660	14.79
	140	5700	14.84
	144	5720	14.82
802.11n HT40	102	5510	14.81
	110	5550	14.74
	118	5590	14.82
	126	5630	14.74
	134	5670	14.87
	142	5710	14.83
802.11ac VHT80	106	5530	14.63
	122	5610	14.62
	138	5690	14.88
802.11ac VHT160	114	5570	13.41
802.11ax HE20	100	5500	14.76
	116	5580	14.78
	120	5600	14.73
	124	5620	14.74
	132	5660	14.84
	140	5700	14.73
	144	5720	14.72
802.11ax HE40	102	5510	14.74
	110	5550	14.75
	118	5590	14.79
	126	5630	14.81
	134	5670	14.87
	142	5710	14.79
802.11ax HE80	106	5530	14.76
	122	5610	14.81
	138	5690	14.71
802.11ax HE160	114	5570	13.14

WLAN Conducted Power (Tablet)					
WLAN 5.6GHz Ant 0+1					
Mode	Channel	Frequency	MIMO Ant 0 Avg. Power	MIMO Ant 1 Avg. Power	MIMO Ant 0+1 Avg. Power
802.11n HT20	100	5500	13.8	13.68	16.75
	116	5580	13.73	13.79	16.77
	120	5600	13.78	13.65	16.73
	124	5620	13.75	13.72	16.75
	132	5660	13.76	13.72	16.75
	140	5700	13.26	13.16	16.22
	144	5720	13.78	13.79	16.8
802.11n HT40	102	5510	13.28	13.26	16.28
	110	5550	13.81	13.76	16.8
	118	5590	13.79	13.84	16.83
	126	5630	13.71	13.76	16.75
	134	5670	13.68	13.8	16.75
	142	5710	13.77	13.73	16.76
802.11ac VHT80	106	5530	13.91	13.95	16.94
	122	5610	13.88	13.85	16.88
	138	5690	13.91	13.99	16.96
802.11ac VHT160	114	5570	10.4	10.5	13.46
802.11ax HE20	100	5500	13.66	13.7	16.69
	116	5580	13.76	13.77	16.78
	120	5600	13.8	13.71	16.77
	124	5620	13.67	13.65	16.67
	132	5660	13.69	13.75	16.73
	140	5700	13.15	13.25	16.21
	144	5720	13.81	13.77	16.8
802.11ax HE40	102	5510	13.31	13.17	16.25
	110	5550	13.7	13.69	16.71
	118	5590	13.82	13.72	16.78
	126	5630	13.7	13.8	16.76
	134	5670	13.84	13.77	16.82
	142	5710	13.8	13.73	16.78
802.11ax HE80	106	5530	13.7	13.77	16.75
	122	5610	13.71	13.74	16.74
	138	5690	13.74	13.81	16.79
802.11ax HE160	114	5570	10.66	10.51	13.6

WLAN Conducted Power (Tablet)			
WLAN 5.8GHz Ant 0			
Mode	Channel	Frequency	SISO Ant 0 Avg. Power
802.11a	149	5745	13.3
	153	5765	13.33
	157	5785	13.2
	161	5805	13.22
	165	5825	13.34
802.11n HT20	149	5745	13.22
	153	5765	13.25
	157	5785	13.23
	161	5805	13.2
	165	5825	13.2
802.11n HT40	151	5755	13.26
	159	5795	13.19
802.11ac VHT80	155	5775	13.49
802.11ax HE20	149	5745	13.29
	153	5765	13.31
	157	5785	13.27
	161	5805	13.33
	165	5825	13.25
802.11ax HE40	151	5755	13.15
	159	5795	13.25
802.11ax HE80	155	5775	13.23

WLAN Conducted Power (Tablet)			
WLAN 5.8GHz Ant 1			
Mode	Channel	Frequency	SISO Ant 1 Avg. Power
802.11a	149	5745	14.55
	153	5765	14.43
	157	5785	14.36
	161	5805	14.38
	165	5825	14.4
802.11n HT20	149	5745	14.39
	153	5765	14.46
	157	5785	14.52
	161	5805	14.43
	165	5825	14.35
802.11n HT40	151	5755	14.53
	159	5795	14.36
802.11ac VHT80	155	5775	14.68
802.11ax HE20	149	5745	14.37
	153	5765	14.35
	157	5785	14.43
	161	5805	14.53
	165	5825	14.51
802.11ax HE40	151	5755	14.47
	159	5795	14.38
802.11ax HE80	155	5775	14.5

WLAN Conducted Power (Tablet)					
WLAN 5.8GHz Ant 0+1					
Mode	Channel	Frequency	MIMO Ant 0 Avg. Power	MIMO Ant 1 Avg. Power	MIMO Ant 0+1 Avg. Power
802.11n HT20	149	5745	14.24	14.36	17.31
	153	5765	14.31	14.21	17.27
	157	5785	14.23	14.31	17.28
	161	5805	14.22	14.29	17.27
	165	5825	14.23	14.21	17.23
802.11n HT40	151	5755	14.29	14.39	17.35
	159	5795	14.23	14.27	17.26
802.11ac VHT80	155	5775	14.46	14.42	17.45
802.11ax HE20	149	5745	14.35	14.35	17.36
	153	5765	14.25	14.38	17.33
	157	5785	14.35	14.39	17.38
	161	5805	14.29	14.34	17.33
	165	5825	14.27	14.39	17.34
802.11ax HE40	151	5755	14.24	14.27	17.27
	159	5795	14.32	14.22	17.28
802.11ax HE80	155	5775	14.31	14.26	17.3

Annex F. SAR Test Result

SAR Results for Body Exposure Condition.

Note:

1. SAR testing for WLAN was performed on the maximum power mode.
2. SAR testing for LTE / NR was performed on the maximum power mode.
3. The “< 0.001” means there is no SAR value or the SAR is too low to be measured.

Body SAR Test Result

System & Position										DUT & Accessory			SAR						
Plot No.	Band	Frequency For System Check (MHz)	Mode	Test Position	Separation Distance (mm)	Channel	RB#	RB offset	Ant Status	Power Reduction	Duty Cycle	Crest Factor	Max. Tune-up Power (dBm)	Measured Conducted Power (dBm)	Scaling Factor	Power Drift (dB)	Measured SAR-1g (W/kg)	Scaled SAR-1g (W/kg)	
	WCDMA II	1900	RMC12.2K	Bottom for Laptop	0	9400			Ant 0	w/	-	1.00	17.50	16.98	1.13	0.02	0.516	0.58	
	WCDMA II	1900	RMC12.2K	Rear Face	20	9400			Ant 0	w/o	-	1.00	24.50	23.89	1.15	0.15	0.501	0.58	
	WCDMA II	1900	RMC12.2K	Left Side	0	9400			Ant 0	w/o	-	1.00	24.50	23.89	1.15	0.13	0.008	0.01	
	WCDMA II	1900	RMC12.2K	Right Side	15	9400			Ant 0	w/o	-	1.00	24.50	23.89	1.15	0.08	0.241	0.28	
	WCDMA II	1900	RMC12.2K	Top Side	0	9400			Ant 0	w/o	-	1.00	24.50	23.89	1.15	0.03	0.03	0.03	
	WCDMA II	1900	RMC12.2K	Bottom Side	0	9400			Ant 0	w/o	-	1.00	24.50	23.89	1.15	0.11	0.014	0.02	
1	WCDMA II	1900	RMC12.2K	Rear Face	0	9400			Ant 0	w/	-	1.00	13.00	12.66	1.08	0.03	0.55	0.59	
	WCDMA II	1900	RMC12.2K	Right Side	0	9400			Ant 0	w/	-	1.00	13.00	12.66	1.08	-0.07	0.241	0.26	
	WCDMA II	1900	RMC12.2K	Rear Face	0	9262			Ant 0	w/	-	1.00	13.00	12.61	1.09	-0.02	0.521	0.57	
	WCDMA II	1900	RMC12.2K	Rear Face	0	9538			Ant 0	w/	-	1.00	13.00	12.54	1.11	-0.15	0.519	0.58	
	WCDMA II	1900	RMC12.2K	Lid Closed for Laptop	0	9400			Ant 0	w/	-	1.00	17.50	16.98	1.13	0.01	0.243	0.27	
	-	-	-	-	-	-			-	-	-	-	-	-	-	-	-	-	
	WCDMA IV	1750	RMC12.2K	Bottom for Laptop	0	1312			Ant 0	w/	-	1.00	18.50	17.65	1.22	0.06	0.554	0.68	
	WCDMA IV	1750	RMC12.2K	Rear Face	20	1312			Ant 0	w/o	-	1.00	24.50	24.11	1.09	0.02	0.635	0.69	
	WCDMA IV	1750	RMC12.2K	Left Side	0	1312			Ant 0	w/o	-	1.00	24.50	24.11	1.09	0.05	0.008	0.01	
	WCDMA IV	1750	RMC12.2K	Right Side	15	1312			Ant 0	w/o	-	1.00	24.50	24.11	1.09	0.08	0.222	0.24	
	WCDMA IV	1750	RMC12.2K	Top Side	0	1312			Ant 0	w/o	-	1.00	24.50	24.11	1.09	-0.08	0.024	0.03	
	WCDMA IV	1750	RMC12.2K	Bottom Side	0	1312			Ant 0	w/o	-	1.00	24.50	24.11	1.09	-0.06	0.013	0.01	
2	WCDMA IV	1750	RMC12.2K	Rear Face	0	1312			Ant 0	w/	-	1.00	12.50	12.45	1.01	0.02	0.692	0.70	
	WCDMA IV	1750	RMC12.2K	Right Side	0	1312			Ant 0	w/	-	1.00	12.50	12.45	1.01	0.04	0.222	0.22	
	WCDMA IV	1750	RMC12.2K	Rear Face	0	1413			Ant 0	w/	-	1.00	12.50	12.38	1.03	0.13	0.621	0.64	
	WCDMA IV	1750	RMC12.2K	Rear Face	0	1513			Ant 0	w/	-	1.00	12.50	12.40	1.02	-0.05	0.613	0.63	
	WCDMA IV	1750	RMC12.2K	Lid Closed for Laptop	0	1312			Ant 0	w/	-	1.00	18.50	17.65	1.22	0.03	0.277	0.34	
	-	-	-	-	-	-			-	-	-	-	-	-	-	-	-	-	
	WCDMA V	835	RMC12.2K	Bottom for Laptop	0	4132			Ant 0	w/	-	1.00	22.50	21.98	1.13	-0.03	0.599	0.68	
	WCDMA V	835	RMC12.2K	Rear Face	20	4132			Ant 0	w/o	-	1.00	24.50	23.66	1.21	-0.19	0.543	0.66	
	WCDMA V	835	RMC12.2K	Left Side	0	4132			Ant 0	w/o	-	1.00	24.50	23.66	1.21	0	<0.001	0.00	
	WCDMA V	835	RMC12.2K	Right Side	15	4132			Ant 0	w/o	-	1.00	24.50	23.66	1.21	0.17	0.317	0.38	
	WCDMA V	835	RMC12.2K	Top Side	0	4132			Ant 0	w/o	-	1.00	24.50	23.66	1.21	0.05	0.064	0.08	
	WCDMA V	835	RMC12.2K	Bottom Side	0	4132			Ant 0	w/o	-	1.00	24.50	23.66	1.21	0.14	0.022	0.03	
3	WCDMA V	835	RMC12.2K	Rear Face	0	4132			Ant 0	w/	-	1.00	19.00	18.98	1.00	0.04	0.692	0.69	
	WCDMA V	835	RMC12.2K	Right Side	0	4132			Ant 0	w/	-	1.00	19.00	18.98	1.00	-0.06	0.317	0.32	
	WCDMA V	835	RMC12.2K	Rear Face	0	4182			Ant 0	w/	-	1.00	19.00	18.94	1.01	0.02	0.526	0.53	
	WCDMA V	835	RMC12.2K	Rear Face	0	4233			Ant 0	w/	-	1.00	19.00	18.92	1.02	0.04	0.513	0.52	
	WCDMA V	835	RMC12.2K	Lid Closed for Laptop	0	4132			Ant 0	w/	-	1.00	22.50	21.98	1.13	0.08	0.298	0.34	

Body SAR Test Result																			
System & Position									DUT & Accessory			SAR							
Plot No.	Band	Frequency For System Check (MHz)	Mode	Test Position	Separation Distance (mm)	Channel	RB#	RB offset	Ant Status	Power Reduction	Duty Cycle	Crest Factor	Max. Tune-up Power (dBm)	Measured Conducted Power (dBm)	Scaling Factor	Power Drift (dB)	Measured SAR-1g (W/kg)	Scaled SAR-1g (W/kg)	
	LTE 2	1900	QPSK20M	Bottom for Laptop	0	18700	1	0	Ant 0	w/	-	1.00	18.00	17.85	1.04	0.06	0.61	0.63	
	LTE 2	1900	QPSK20M	Bottom for Laptop	0	18700	50	0	Ant 0	w/	-	1.00	17.00	16.84	1.04	0.02	0.503	0.52	
	LTE 2	1900	QPSK20M	Rear Face	20	18700	1	0	Ant 0	w/o	-	1.00	24.00	23.32	1.17	0.01	0.535	0.63	
	LTE 2	1900	QPSK20M	Left Side	0	18700	1	0	Ant 0	w/o	-	1.00	24.00	23.32	1.17	-0.09	0.203	0.24	
	LTE 2	1900	QPSK20M	Right Side	15	18700	1	0	Ant 0	w/o	-	1.00	24.00	23.32	1.17	0	0.025	0.03	
	LTE 2	1900	QPSK20M	Top Side	0	18700	1	0	Ant 0	w/o	-	1.00	24.00	23.32	1.17	0.02	0.017	0.02	
	LTE 2	1900	QPSK20M	Bottom Side	0	18700	1	0	Ant 0	w/o	-	1.00	24.00	23.32	1.17	0.11	0.523	0.61	
	LTE 2	1900	QPSK20M	Rear Face	20	18700	50	0	Ant 0	w/o	-	1.00	23.00	22.32	1.17	0.13	0.009	0.01	
	LTE 2	1900	QPSK20M	Left Side	0	18700	50	0	Ant 0	w/o	-	1.00	23.00	22.32	1.17	0.03	0.168	0.20	
	LTE 2	1900	QPSK20M	Right Side	15	18700	50	0	Ant 0	w/o	-	1.00	23.00	22.32	1.17	-0.18	0.019	0.02	
	LTE 2	1900	QPSK20M	Top Side	0	18700	50	0	Ant 0	w/o	-	1.00	23.00	22.32	1.17	0.08	0.013	0.02	
	LTE 2	1900	QPSK20M	Bottom Side	0	18700	50	0	Ant 0	w/o	-	1.00	23.00	22.32	1.17	0.09	0.507	0.59	
4	LTE 2	1900	QPSK20M	Rear Face	0	18700	1	0	Ant 0	w/	-	1.00	13.50	13.34	1.04	-0.16	0.643	0.67	
	LTE 2	1900	QPSK20M	Right Side	0	18700	1	0	Ant 0	w/	-	1.00	13.50	13.34	1.04	-0.13	0.203	0.21	
	LTE 2	1900	QPSK20M	Rear Face	0	18700	50	0	Ant 0	w/	-	1.00	12.50	12.27	1.05	0.15	0.493	0.52	
	LTE 2	1900	QPSK20M	Right Side	0	18700	50	0	Ant 0	w/	-	1.00	12.50	12.27	1.05	-0.14	0.168	0.18	
	LTE 2	1900	QPSK20M	Rear Face	0	18900	1	0	Ant 0	w/	-	1.00	13.50	13.13	1.09	0.08	0.606	0.66	
	LTE 2	1900	QPSK20M	Rear Face	0	19100	1	0	Ant 0	w/	-	1.00	13.50	13.11	1.09	-0.15	0.592	0.65	
	LTE 2	1900	QPSK20M	Lid Closed for Laptop	0	18700	1	0	Ant 0	w/	-	1.00	18.00	17.85	1.04	0.01	0.312	0.32	
	LTE 4	1750	QPSK20M	Bottom for Laptop	0	20050	1	0	Ant 0	w/	-	1.00	18.00	17.81	1.04	0.06	0.654	0.68	
	LTE 4	1750	QPSK20M	Bottom for Laptop	0	20050	50	0	Ant 0	w/	-	1.00	17.00	16.57	1.10	-0.06	0.132	0.15	
	LTE 4	1750	QPSK20M	Rear Face	20	20050	1	0	Ant 0	w/o	-	1.00	24.00	23.27	1.18	0.07	0.503	0.59	
	LTE 4	1750	QPSK20M	Left Side	0	20050	1	0	Ant 0	w/o	-	1.00	24.00	23.27	1.18	-0.14	0.011	0.01	
	LTE 4	1750	QPSK20M	Right Side	15	20050	1	0	Ant 0	w/o	-	1.00	24.00	23.27	1.18	-0.04	0.187	0.22	
	LTE 4	1750	QPSK20M	Top Side	0	20050	1	0	Ant 0	w/o	-	1.00	24.00	23.27	1.18	0.17	0.019	0.02	
	LTE 4	1750	QPSK20M	Bottom Side	0	20050	1	0	Ant 0	w/o	-	1.00	24.00	23.27	1.18	0.12	0.011	0.01	
	LTE 4	1750	QPSK20M	Rear Face	20	20050	50	0	Ant 0	w/o	-	1.00	23.00	22.35	1.16	0.15	0.497	0.58	
	LTE 4	1750	QPSK20M	Left Side	0	20050	50	0	Ant 0	w/o	-	1.00	23.00	22.35	1.16	0.07	0.00845	0.01	
	LTE 4	1750	QPSK20M	Right Side	15	20050	50	0	Ant 0	w/o	-	1.00	23.00	22.35	1.16	-0.14	0.15	0.17	
	LTE 4	1750	QPSK20M	Top Side	0	20050	50	0	Ant 0	w/o	-	1.00	23.00	22.35	1.16	-0.04	0.012	0.01	
	LTE 4	1750	QPSK20M	Bottom Side	0	20050	50	0	Ant 0	w/o	-	1.00	23.00	22.35	1.16	0.17	0.00932	0.01	
5	LTE 4	1750	QPSK20M	Rear Face	0	20050	1	0	Ant 0	w/	-	1.00	13.50	13.39	1.03	0.08	0.686	0.71	
	LTE 4	1750	QPSK20M	Right Side	0	20050	1	0	Ant 0	w/	-	1.00	13.50	13.39	1.03	0.17	0.187	0.19	
	LTE 4	1750	QPSK20M	Rear Face	0	20050	50	0	Ant 0	w/	-	1.00	12.50	12.49	1.00	0.12	0.497	0.50	
	LTE 4	1750	QPSK20M	Right Side	0	20050	50	0	Ant 0	w/	-	1.00	12.50	12.49	1.00	0.15	0.15	0.15	
	LTE 4	1750	QPSK20M	Rear Face	0	20175	1	0	Ant 0	w/	-	1.00	13.50	13.36	1.03	0.04	0.571	0.59	
	LTE 4	1750	QPSK20M	Rear Face	0	20300	1	0	Ant 0	w/	-	1.00	13.50	13.15	1.08	0.06	0.553	0.60	
	LTE 4	1750	QPSK20M	Lid Closed for Laptop	0	20050	1	0	Ant 0	w/	-	1.00	18.00	17.81	1.04	0.13	0.327	0.34	
	LTE 5	835	QPSK10M	Bottom for Laptop	0	20525	1	0	Ant 0	w/	-	1.00	21.50	21.31	1.04	0.01	0.55	0.57	
	LTE 5	835	QPSK10M	Bottom for Laptop	0	20525	25	0	Ant 0	w/	-	1.00	20.50	20.47	1.01	-0.05	0.51	0.52	
	LTE 5	835	QPSK10M	Rear Face	20	20525	1	0	Ant 0	w/o	-	1.00	24.00	23.22	1.20	0.18	0.463	0.56	
	LTE 5	835	QPSK10M	Left Side	0	20525	1	0	Ant 0	w/o	-	1.00	24.00	23.22	1.20	0	<0.001	0.00	
	LTE 5	835	QPSK10M	Right Side	15	20525	1	0	Ant 0	w/o	-	1.00	24.00	23.22	1.20	-0.03	0.283	0.34	
	LTE 5	835	QPSK10M	Top Side	0	20525	1	0	Ant 0	w/o	-	1.00	24.00	23.22	1.20	0.18	0.036	0.04	
	LTE 5	835	QPSK10M	Bottom Side	0	20525	1	0	Ant 0	w/o	-	1.00	24.00	23.22	1.20	0	<0.001	0.00	
	LTE 5	835	QPSK10M	Rear Face	20	20525	25	0	Ant 0	w/o	-	1.00	23.00	22.21	1.20	-0.11	0.496	0.60	
	LTE 5	835	QPSK10M	Left Side	0	20525	25	0	Ant 0	w/o	-	1.00	23.00	22.21	1.20	0	<0.001	0.00	
	LTE 5	835	QPSK10M	Right Side	15	20525	25	0	Ant 0	w/o	-	1.00	23.00	22.21	1.20	-0.07	0.224	0.27	
	LTE 5	835	QPSK10M	Top Side	0	20525	25	0	Ant 0	w/o	-	1.00	23.00	22.21	1.20	-0.05	0.032	0.04	
	LTE 5	835	QPSK10M	Bottom Side	0	20525	25	0	Ant 0	w/o	-	1.00	23.00	22.21	1.20	0	<0.001	0.00	
6	LTE 5	835	QPSK10M	Rear Face	0	20525	1	0	Ant 0	w/	-	1.00	18.50	18.45	1.01	-0.02	0.61	0.62	
	LTE 5	835	QPSK10M	Right Side	0	20525	1	0	Ant 0	w/	-	1.00	18.50	18.45	1.01	0.19	0.283	0.29	
	LTE 5	835	QPSK10M	Rear Face	0	20525	25	0	Ant 0	w/	-	1.00	17.50	17.31	1.04	0.19	0.496	0.52	
	LTE 5	835	QPSK10M	Right Side	0	20525	25	0	Ant 0	w/	-	1.00	17.50	17.31	1.04	0.04	0.224	0.23	
	LTE 5	835	QPSK10M	Rear Face	0	20450	1	0	Ant 0	w/	-	1.00	18.50	18.32	1.04	-0.16	0.57	0.59	
	LTE 5	835	QPSK10M	Rear Face	0	20600	1	0	Ant 0	w/	-	1.00	18.50	18.16	1.08	-0.06	0.568	0.61	
	LTE 5	835	QPSK10M	Rear Face	0	PCC : 20476 SCC : 20575	PCC : 1 SCC : 1	PCC : 0 SCC : 49	Ant 0	w/	-	1.00	19.50	19.21	1.07	0.06	0.503	0.54	
	LTE 5	835	QPSK10M	Lid Closed for Laptop	0	20525	1	0	Ant 0	w/	-	1.00	21.50	21.31	1.04	0.03	0.275	0.29	

Body SAR Test Result

System & Position										DUT & Accessory			SAR					
Plot No.	Band	Frequency For System Check (MHz)	Mode	Test Position	Separation Distance (mm)	Channel	RB#	RB offset	Ant Status	Power Reduction	Duty Cycle	Crest Factor	Max. Tune-up Power (dBm)	Measured Conducted Power (dBm)	Scaling Factor	Power Drift (dB)	Measured SAR-1g (W/kg)	Scaled SAR-1g (W/kg)
	LTE 7	2600	QPSK20M	Bottom for Laptop	0	21350	1	0	Ant 0	w/	-	1.00	18.00	17.86	1.03	0.04	0.512	0.53
	LTE 7	2600	QPSK20M	Bottom for Laptop	0	21350	50	0	Ant 0	w/	-	1.00	17.00	16.44	1.14	0.03	0.146	0.17
	LTE 7	2600	QPSK20M	Rear Face	20	21350	1	0	Ant 0	w/o	-	1.00	24.00	23.19	1.21	-0.12	0.48	0.58
	LTE 7	2600	QPSK20M	Left Side	0	21350	1	0	Ant 0	w/o	-	1.00	24.00	23.19	1.21	-0.01	0.00453	0.01
	LTE 7	2600	QPSK20M	Right Side	15	21350	1	0	Ant 0	w/o	-	1.00	24.00	23.19	1.21	0.17	0.181	0.22
	LTE 7	2600	QPSK20M	Top Side	0	21350	1	0	Ant 0	w/o	-	1.00	24.00	23.19	1.21	-0.16	0.024	0.03
	LTE 7	2600	QPSK20M	Bottom Side	0	21350	1	0	Ant 0	w/o	-	1.00	24.00	23.19	1.21	-0.1	0.011	0.01
	LTE 7	2600	QPSK20M	Rear Face	20	21350	50	0	Ant 0	w/o	-	1.00	23.00	22.48	1.13	0.14	0.48	0.54
	LTE 7	2600	QPSK20M	Left Side	0	21350	50	0	Ant 0	w/o	-	1.00	23.00	22.48	1.13	-0.13	0.00358	0.00
	LTE 7	2600	QPSK20M	Right Side	15	21350	50	0	Ant 0	w/o	-	1.00	23.00	22.48	1.13	-0.04	0.157	0.18
	LTE 7	2600	QPSK20M	Top Side	0	21350	50	0	Ant 0	w/o	-	1.00	23.00	22.48	1.13	-0.01	0.017	0.02
	LTE 7	2600	QPSK20M	Bottom Side	0	21350	50	0	Ant 0	w/o	-	1.00	23.00	22.48	1.13	0.18	0.00848	0.01
	LTE 7	2600	QPSK20M	Rear Face	0	21350	1	0	Ant 0	w/	-	1.00	13.50	12.77	1.18	0.04	0.48	0.57
	LTE 7	2600	QPSK20M	Right Side	0	21350	1	0	Ant 0	w/	-	1.00	13.50	12.77	1.18	0.12	0.181	0.21
	LTE 7	2600	QPSK20M	Rear Face	0	21350	50	0	Ant 0	w/	-	1.00	12.50	11.91	1.15	0.01	0.572	0.66
	LTE 7	2600	QPSK20M	Right Side	0	21350	50	0	Ant 0	w/	-	1.00	12.50	11.91	1.15	0.04	0.157	0.18
7	LTE 7	2600	QPSK20M	Rear Face	0	20850	1	0	Ant 0	w/	-	1.00	13.50	12.73	1.19	0.07	0.575	0.68
	LTE 7	2600	QPSK20M	Rear Face	0	21100	1	0	Ant 0	w/	-	1.00	13.50	12.76	1.19	0.05	0.502	0.60
	LTE 7	2600	QPSK20M	Rear Face	0	PCC : 21152 SCC : 21350	PCC : 1 SCC : 1	PCC : 0 SCC : 99	Ant 0	w/	-	1.00	13.50	12.67	1.21	0.14	0.561	0.68
	LTE 7	2600	QPSK20M	Lid Closed for Laptop	0	21350	1	0	Ant 0	w/	-	1.00	18.00	17.86	1.03	0.04	0.494	0.51
	-	-	-	-	-	-	-	-	-	-	-	-	-	-	-	-	-	-
	LTE 12	750	QPSK10M	Bottom for Laptop	0	23130	1	0	Ant 0	w/	-	1.00	19.50	19.35	1.04	0.01	0.491	0.51
	LTE 12	750	QPSK10M	Bottom for Laptop	0	23130	25	0	Ant 0	w/	-	1.00	18.50	18.06	1.11	0.03	0.388	0.43
	LTE 12	750	QPSK10M	Rear Face	20	23130	1	0	Ant 0	w/o	-	1.00	24.00	23.07	1.24	-0.07	0.554	0.69
	LTE 12	750	QPSK10M	Left Side	0	23130	1	0	Ant 0	w/o	-	1.00	24.00	23.07	1.24	0	<0.001	0.00
	LTE 12	750	QPSK10M	Right Side	15	23130	1	0	Ant 0	w/o	-	1.00	24.00	23.07	1.24	0.01	0.437	0.54
	LTE 12	750	QPSK10M	Top Side	0	23130	1	0	Ant 0	w/o	-	1.00	24.00	23.07	1.24	0.02	0.015	0.02
	LTE 12	750	QPSK10M	Bottom Side	0	23130	1	0	Ant 0	w/o	-	1.00	24.00	23.07	1.24	0	<0.001	0.00
	LTE 12	750	QPSK10M	Rear Face	20	23130	25	0	Ant 0	w/o	-	1.00	23.00	22.32	1.17	-0.14	0.531	0.62
	LTE 12	750	QPSK10M	Left Side	0	23130	25	0	Ant 0	w/o	-	1.00	23.00	22.32	1.17	0	<0.001	0.00
	LTE 12	750	QPSK10M	Right Side	15	23130	25	0	Ant 0	w/o	-	1.00	23.00	22.32	1.17	-0.13	0.37	0.43
	LTE 12	750	QPSK10M	Top Side	0	23130	25	0	Ant 0	w/o	-	1.00	23.00	22.32	1.17	-0.12	0.011	0.01
	LTE 12	750	QPSK10M	Bottom Side	0	23130	25	0	Ant 0	w/o	-	1.00	23.00	22.32	1.17	0	<0.001	0.00
	LTE 12	750	QPSK10M	Rear Face	0	23130	1	0	Ant 0	w/	-	1.00	15.50	15.22	1.07	0.02	0.654	0.70
	LTE 12	750	QPSK10M	Right Side	0	23130	1	0	Ant 0	w/	-	1.00	15.50	15.22	1.07	0.15	0.437	0.47
	LTE 12	750	QPSK10M	Rear Face	0	23130	25	0	Ant 0	w/	-	1.00	14.50	13.73	1.19	-0.16	0.531	0.63
	LTE 12	750	QPSK10M	Right Side	0	23130	25	0	Ant 0	w/	-	1.00	14.50	13.73	1.19	-0.02	0.37	0.44
	LTE 12	750	QPSK10M	Rear Face	0	23060	1	0	Ant 0	w/	-	1.00	15.50	15.16	1.08	0.14	0.658	0.71
8	LTE 12	750	QPSK10M	Rear Face	0	23095	1	0	Ant 0	w/	-	1.00	15.50	15.12	1.09	0.11	0.685	0.75
	LTE 12	750	QPSK10M	Lid Closed for Laptop	0	23130	1	0	Ant 0	w/	-	1.00	19.50	19.35	1.04	0.04	0.451	0.47
	-	-	-	-	-	-	-	-	-	-	-	-	-	-	-	-	-	-
	LTE 13	750	QPSK10M	Bottom for Laptop	0	23230	1	0	Ant 0	w/	-	1.00	20.00	19.98	1.00	-0.01	0.385	0.39
	LTE 13	750	QPSK10M	Bottom for Laptop	0	23230	25	0	Ant 0	w/	-	1.00	19.00	18.80	1.05	0.03	0.15	0.16
	LTE 13	750	QPSK10M	Rear Face	20	23230	1	0	Ant 0	w/o	-	1.00	24.00	23.08	1.24	0.02	0.358	0.44
	LTE 13	750	QPSK10M	Left Side	0	23230	1	0	Ant 0	w/o	-	1.00	24.00	23.08	1.24	0	<0.001	0.00
	LTE 13	750	QPSK10M	Right Side	15	23230	1	0	Ant 0	w/o	-	1.00	24.00	23.08	1.24	-0.02	0.224	0.28
	LTE 13	750	QPSK10M	Top Side	0	23230	1	0	Ant 0	w/o	-	1.00	24.00	23.08	1.24	0.07	0.019	0.02
	LTE 13	750	QPSK10M	Bottom Side	0	23230	1	0	Ant 0	w/o	-	1.00	24.00	23.08	1.24	0	<0.001	0.00
	LTE 13	750	QPSK10M	Rear Face	20	23230	25	0	Ant 0	w/o	-	1.00	23.00	22.03	1.25	-0.1	0.296	0.37
	LTE 13	750	QPSK10M	Left Side	0	23230	25	0	Ant 0	w/o	-	1.00	23.00	22.03	1.25	0	<0.001	0.00
	LTE 13	750	QPSK10M	Right Side	15	23230	25	0	Ant 0	w/o	-	1.00	23.00	22.03	1.25	0.05	0.181	0.23
	LTE 13	750	QPSK10M	Top Side	0	23230	25	0	Ant 0	w/o	-	1.00	23.00	22.03	1.25	-0.16	0.014	0.02
	LTE 13	750	QPSK10M	Bottom Side	0	23230	25	0	Ant 0	w/o	-	1.00	23.00	22.03	1.25	0	<0.001	0.00
9	LTE 13	750	QPSK10M	Rear Face	0	23230	1	0	Ant 0	w/	-	1.00	18.00	17.28	1.18	-0.04	0.4	0.47
	LTE 13	750	QPSK10M	Right Side	0	23230	1	0	Ant 0	w/	-	1.00	18.00	17.28	1.18	0.08	0.224	0.26
	LTE 13	750	QPSK10M	Rear Face	0	23230	25	0	Ant 0	w/	-	1.00	17.00	16.32	1.17	0.03	0.296	0.35
	LTE 13	750	QPSK10M	Right Side	0	23230	25	0	Ant 0	w/	-	1.00	17.00	16.32	1.17	-0.03	0.181	0.21
	LTE 13	750	QPSK10M	Lid Closed for Laptop	0	23230	1	0	Ant 0	w/	-	1.00	20.00	19.98	1.00	0.02	0.301	0.30

Body SAR Test Result																		
System & Position								DUT & Accessory				SAR						
Plot No.	Band	Frequency For System Check (MHz)	Mode	Test Position	Separation Distance (mm)	Channel	RB#	RB offset	Ant Status	Power Reduction	Duty Cycle	Crest Factor	Max. Tune-up Power (dBm)	Measured Conducted Power (dBm)	Scaling Factor	Power Drift (dB)	Measured SAR-1g (W/kg)	Scaled SAR-1g (W/kg)
	LTE 14	750	QPSK10M	Bottom for Laptop	0	23330	1	0	Ant 0	w/	-	1.00	23.00	22.67	1.08	0.01	0.375	0.41
	LTE 14	750	QPSK10M	Bottom for Laptop	0	23330	25	0	Ant 0	w/	-	1.00	22.00	21.70	1.07	0.03	0.291	0.31
	LTE 14	750	QPSK10M	Rear Face	20	23330	1	0	Ant 0	w/o	-	1.00	24.00	23.04	1.25	0.19	0.375	0.47
	LTE 14	750	QPSK10M	Left Side	0	23330	1	0	Ant 0	w/o	-	1.00	24.00	23.04	1.25	0	<0.001	0.00
	LTE 14	750	QPSK10M	Right Side	15	23330	1	0	Ant 0	w/o	-	1.00	24.00	23.04	1.25	-0.06	0.225	0.28
	LTE 14	750	QPSK10M	Top Side	0	23330	1	0	Ant 0	w/o	-	1.00	24.00	23.04	1.25	0.05	0.02	0.03
	LTE 14	750	QPSK10M	Bottom Side	0	23330	1	0	Ant 0	w/o	-	1.00	24.00	23.04	1.25	0	<0.001	0.00
	LTE 14	750	QPSK10M	Rear Face	20	23330	25	0	Ant 0	w/o	-	1.00	23.00	22.03	1.25	0.1	0.303	0.38
	LTE 14	750	QPSK10M	Left Side	0	23330	25	0	Ant 0	w/o	-	1.00	23.00	22.03	1.25	0	<0.001	0.00
	LTE 14	750	QPSK10M	Right Side	15	23330	25	0	Ant 0	w/o	-	1.00	23.00	22.03	1.25	0.14	0.169	0.21
	LTE 14	750	QPSK10M	Top Side	0	23330	25	0	Ant 0	w/o	-	1.00	23.00	22.03	1.25	0.02	0.015	0.02
	LTE 14	750	QPSK10M	Bottom Side	0	23330	25	0	Ant 0	w/o	-	1.00	23.00	22.03	1.25	0	<0.001	0.00
10	LTE 14	750	QPSK10M	Rear Face	0	23330	1	0	Ant 0	w/	-	1.00	18.00	17.20	1.20	-0.01	0.4	0.48
	LTE 14	750	QPSK10M	Right Side	0	23330	1	0	Ant 0	w/	-	1.00	18.00	17.20	1.20	0.13	0.225	0.27
	LTE 14	750	QPSK10M	Rear Face	0	23330	25	0	Ant 0	w/	-	1.00	17.00	16.15	1.22	-0.12	0.303	0.37
	LTE 14	750	QPSK10M	Right Side	0	23330	25	0	Ant 0	w/	-	1.00	17.00	16.15	1.22	-0.09	0.169	0.21
	LTE 14	750	QPSK10M	Lid Closed for Laptop	0	23330	1	0	Ant 0	w/	-	1.00	23.00	22.67	1.08	0.06	0.276	0.30
	LTE 17	750	QPSK10M	Bottom for Laptop	0	23790	1	0	Ant 0	w/	-	1.00	19.50	19.42	1.02	0.01	0.503	0.51
	LTE 17	750	QPSK10M	Bottom for Laptop	0	23790	25	0	Ant 0	w/	-	1.00	18.50	18.28	1.05	0.03	0.216	0.23
	LTE 17	750	QPSK10M	Rear Face	20	23790	1	0	Ant 0	w/o	-	1.00	24.00	23.01	1.26	0.02	0.503	0.63
	LTE 17	750	QPSK10M	Left Side	0	23790	1	0	Ant 0	w/o	-	1.00	24.00	23.01	1.26	0	<0.001	0.00
	LTE 17	750	QPSK10M	Right Side	15	23790	1	0	Ant 0	w/o	-	1.00	24.00	23.01	1.26	-0.01	0.383	0.48
	LTE 17	750	QPSK10M	Top Side	0	23790	1	0	Ant 0	w/o	-	1.00	24.00	23.01	1.26	-0.1	0.012	0.02
	LTE 17	750	QPSK10M	Bottom Side	0	23790	1	0	Ant 0	w/o	-	1.00	24.00	23.01	1.26	0	<0.001	0.00
	LTE 17	750	QPSK10M	Rear Face	20	23790	25	0	Ant 0	w/o	-	1.00	23.00	22.38	1.15	-0.14	0.464	0.53
	LTE 17	750	QPSK10M	Left Side	0	23790	25	0	Ant 0	w/o	-	1.00	23.00	22.38	1.15	0	<0.001	0.00
	LTE 17	750	QPSK10M	Right Side	15	23790	25	0	Ant 0	w/o	-	1.00	23.00	22.38	1.15	-0.11	0.299	0.34
	LTE 17	750	QPSK10M	Top Side	0	23790	25	0	Ant 0	w/o	-	1.00	23.00	22.38	1.15	-0.15	0.00912	0.01
	LTE 17	750	QPSK10M	Bottom Side	0	23790	25	0	Ant 0	w/o	-	1.00	23.00	22.38	1.15	0	<0.001	0.00
	LTE 17	750	QPSK10M	Rear Face	0	23790	1	0	Ant 0	w/	-	1.00	16.50	16.40	1.02	0.08	0.604	0.62
	LTE 17	750	QPSK10M	Right Side	0	23790	1	0	Ant 0	w/	-	1.00	16.50	16.40	1.02	-0.07	0.383	0.39
	LTE 17	750	QPSK10M	Rear Face	0	23790	25	0	Ant 0	w/	-	1.00	15.50	15.23	1.06	0.09	0.464	0.49
	LTE 17	750	QPSK10M	Right Side	0	23790	25	0	Ant 0	w/	-	1.00	15.50	15.23	1.06	-0.08	0.299	0.32
	LTE 17	750	QPSK10M	Rear Face	0	23780	1	0	Ant 0	w/	-	1.00	16.50	16.37	1.03	-0.08	0.604	0.62
11	LTE 17	750	QPSK10M	Rear Face	0	23800	1	0	Ant 0	w/	-	1.00	16.50	16.34	1.04	-0.01	0.611	0.64
	LTE 17	750	QPSK10M	Lid Closed for Laptop	0	23790	1	0	Ant 0	w/	-	1.00	19.50	19.42	1.02	-0.03	0.437	0.45
	LTE 25	1900	QPSK20M	Bottom for Laptop	0	26590	1	0	Ant 0	w/	-	1.00	18.50	18.07	1.10	0.06	0.512	0.56
	LTE 25	1900	QPSK20M	Bottom for Laptop	0	26590	50	0	Ant 0	w/	-	1.00	17.50	17.09	1.10	0.03	0.503	0.55
	LTE 25	1900	QPSK20M	Rear Face	20	26590	1	0	Ant 0	w/o	-	1.00	24.00	22.52	1.41	0.06	0.409	0.58
	LTE 25	1900	QPSK20M	Left Side	0	26590	1	0	Ant 0	w/o	-	1.00	24.00	22.52	1.41	0.03	0.00653	0.01
	LTE 25	1900	QPSK20M	Right Side	15	26590	1	0	Ant 0	w/o	-	1.00	24.00	22.52	1.41	-0.07	0.277	0.39
	LTE 25	1900	QPSK20M	Top Side	0	26590	1	0	Ant 0	w/o	-	1.00	24.00	22.52	1.41	-0.1	0.028	0.04
	LTE 25	1900	QPSK20M	Bottom Side	0	26590	1	0	Ant 0	w/o	-	1.00	24.00	22.52	1.41	-0.07	0.021	0.03
	LTE 25	1900	QPSK20M	Rear Face	20	26590	50	0	Ant 0	w/o	-	1.00	23.00	21.61	1.38	0.05	0.414	0.57
	LTE 25	1900	QPSK20M	Left Side	0	26590	50	0	Ant 0	w/o	-	1.00	23.00	21.61	1.38	0.07	0.00478	0.01
	LTE 25	1900	QPSK20M	Right Side	15	26590	50	0	Ant 0	w/o	-	1.00	23.00	21.61	1.38	0.18	0.225	0.31
	LTE 25	1900	QPSK20M	Top Side	0	26590	50	0	Ant 0	w/o	-	1.00	23.00	21.61	1.38	-0.14	0.024	0.03
	LTE 25	1900	QPSK20M	Bottom Side	0	26590	50	0	Ant 0	w/o	-	1.00	23.00	21.61	1.38	-0.11	0.012	0.02
12	LTE 25	1900	QPSK20M	Rear Face	0	26590	1	0	Ant 0	w/	-	1.00	13.50	13.21	1.07	0.13	0.578	0.62
	LTE 25	1900	QPSK20M	Right Side	0	26590	1	0	Ant 0	w/	-	1.00	13.50	13.21	1.07	-0.05	0.277	0.30
	LTE 25	1900	QPSK20M	Rear Face	0	26590	50	0	Ant 0	w/	-	1.00	12.50	12.07	1.10	-0.07	0.454	0.50
	LTE 25	1900	QPSK20M	Right Side	0	26590	50	0	Ant 0	w/	-	1.00	12.50	12.07	1.10	-0.02	0.225	0.25
	LTE 25	1900	QPSK20M	Rear Face	0	26140	1	0	Ant 0	w/	-	1.00	13.50	13.13	1.09	0.09	0.539	0.59
	LTE 25	1900	QPSK20M	Rear Face	0	26365	1	0	Ant 0	w/	-	1.00	13.50	13.15	1.08	-0.12	0.554	0.60
	LTE 25	1900	QPSK20M	Lid Closed for Laptop	0	26590	1	0	Ant 0	w/	-	1.00	18.50	18.07	1.10	0.15	0.522	0.57

Body SAR Test Result

System & Position								DUT & Accessory				SAR						
Plot No.	Band	Frequency For System Check (MHz)	Mode	Test Position	Separation Distance (mm)	Channel	RB#	RB offset	Ant Status	Power Reduction	Duty Cycle	Crest Factor	Max. Tune-up Power (dBm)	Measured Conducted Power (dBm)	Scaling Factor	Power Drift (dB)	Measured SAR-1g (W/kg)	Scaled SAR-1g (W/kg)
	LTE 26	835	QPSK15M	Bottom for Laptop	0	26965	1	0	Ant 0	w/	-	1.00	23.00	22.87	1.03	-0.02	0.553	0.57
	LTE 26	835	QPSK15M	Bottom for Laptop	0	26965	36	0	Ant 0	w/	-	1.00	22.00	21.83	1.04	-0.1	0.447	0.46
	LTE 26	835	QPSK15M	Rear Face	20	26965	1	0	Ant 0	w/o	-	1.00	24.00	23.15	1.22	0.15	0.485	0.59
	LTE 26	835	QPSK15M	Left Side	0	26965	1	0	Ant 0	w/o	-	1.00	24.00	23.15	1.22	0	<0.001	0.00
	LTE 26	835	QPSK15M	Right Side	15	26965	1	0	Ant 0	w/o	-	1.00	24.00	23.15	1.22	-0.08	0.36	0.44
	LTE 26	835	QPSK15M	Top Side	0	26965	1	0	Ant 0	w/o	-	1.00	24.00	23.15	1.22	0.19	0.03	0.04
	LTE 26	835	QPSK15M	Bottom Side	0	26965	1	0	Ant 0	w/o	-	1.00	24.00	23.15	1.22	0	<0.001	0.00
	LTE 26	835	QPSK15M	Rear Face	20	26965	36	0	Ant 0	w/o	-	1.00	23.00	22.25	1.19	-0.02	0.478	0.57
	LTE 26	835	QPSK15M	Left Side	0	26965	36	0	Ant 0	w/o	-	1.00	23.00	22.25	1.19	0	<0.001	0.00
	LTE 26	835	QPSK15M	Right Side	15	26965	36	0	Ant 0	w/o	-	1.00	23.00	22.25	1.19	0.07	0.262	0.31
	LTE 26	835	QPSK15M	Top Side	0	26965	36	0	Ant 0	w/o	-	1.00	23.00	22.25	1.19	0.09	0.029	0.03
	LTE 26	835	QPSK15M	Bottom Side	0	26965	36	0	Ant 0	w/o	-	1.00	23.00	22.25	1.19	0	<0.001	0.00
13	LTE 26	835	QPSK15M	Rear Face	0	26965	1	0	Ant 0	w/	-	1.00	18.50	18.35	1.04	-0.09	0.605	0.63
	LTE 26	835	QPSK15M	Right Side	0	26965	1	0	Ant 0	w/	-	1.00	18.50	18.35	1.04	0.16	0.36	0.37
	LTE 26	835	QPSK15M	Rear Face	0	26965	36	0	Ant 0	w/	-	1.00	17.50	17.26	1.06	0.07	0.478	0.51
	LTE 26	835	QPSK15M	Right Side	0	26965	36	0	Ant 0	w/	-	1.00	17.50	17.26	1.06	-0.19	0.262	0.28
	LTE 26	835	QPSK15M	Rear Face	0	26765	1	0	Ant 0	w/	-	1.00	18.50	18.05	1.11	0.14	0.541	0.60
	LTE 26	835	QPSK15M	Rear Face	0	26865	1	0	Ant 0	w/	-	1.00	18.50	18.32	1.04	-0.11	0.575	0.60
	LTE 26	835	QPSK15M	Lid Closed for Laptop	0	26965	1	0	Ant 0	w/	-	1.00	23.00	22.87	1.03	0.06	0.513	0.53
	LTE 30	2300	QPSK10M	Bottom for Laptop	0	27710	1	0	Ant 0	w/	-	1.00	21.50	20.96	1.13	0.02	0.495	0.56
	LTE 30	2300	QPSK10M	Bottom for Laptop	0	27710	25	0	Ant 0	w/	-	1.00	20.50	19.98	1.13	-0.06	0.343	0.39
	LTE 30	2300	QPSK10M	Rear Face	20	27710	1	0	Ant 0	w/o	-	1.00	24.00	22.71	1.35	0.18	0.432	0.58
	LTE 30	2300	QPSK10M	Left Side	0	27710	1	0	Ant 0	w/o	-	1.00	24.00	22.71	1.35	-0.03	0.00967	0.01
	LTE 30	2300	QPSK10M	Right Side	15	27710	1	0	Ant 0	w/o	-	1.00	24.00	22.71	1.35	0.17	0.168	0.23
	LTE 30	2300	QPSK10M	Top Side	0	27710	1	0	Ant 0	w/o	-	1.00	24.00	22.71	1.35	-0.12	0.014	0.02
	LTE 30	2300	QPSK10M	Bottom Side	0	27710	1	0	Ant 0	w/o	-	1.00	24.00	22.71	1.35	-0.01	0.013	0.02
	LTE 30	2300	QPSK10M	Rear Face	20	27710	25	0	Ant 0	w/o	-	1.00	23.00	21.74	1.34	0.1	0.415	0.56
	LTE 30	2300	QPSK10M	Left Side	0	27710	25	0	Ant 0	w/o	-	1.00	23.00	21.74	1.34	-0.16	0.00801	0.01
	LTE 30	2300	QPSK10M	Right Side	15	27710	25	0	Ant 0	w/o	-	1.00	23.00	21.74	1.34	0.02	0.134	0.18
	LTE 30	2300	QPSK10M	Top Side	0	27710	25	0	Ant 0	w/o	-	1.00	23.00	21.74	1.34	0.1	0.011	0.01
	LTE 30	2300	QPSK10M	Bottom Side	0	27710	25	0	Ant 0	w/o	-	1.00	23.00	21.74	1.34	0.09	0.011	0.01
14	LTE 30	2300	QPSK10M	Rear Face	0	27710	1	0	Ant 0	w/	-	1.00	12.50	12.44	1.01	0.06	0.643	0.65
	LTE 30	2300	QPSK10M	Right Side	0	27710	1	0	Ant 0	w/	-	1.00	12.50	12.44	1.01	-0.15	0.134	0.14
	LTE 30	2300	QPSK10M	Rear Face	0	27710	25	0	Ant 0	w/	-	1.00	11.50	11.48	1.00	0.19	0.515	0.52
	LTE 30	2300	QPSK10M	Right Side	0	27710	25	0	Ant 0	w/	-	1.00	11.50	11.48	1.00	0.02	0.168	0.17
	LTE 30	2300	QPSK10M	Lid Closed for Laptop	0	27710	1	0	Ant 0	w/	-	1.00	21.50	20.96	1.13	0.01	0.376	0.42
	LTE 38	2600	QPSK20M	Bottom for Laptop	0	37850	1	0	Ant 0	w/	-	1.00	20.50	20.20	1.07	-0.17	0.431	0.46
	LTE 38	2600	QPSK20M	Bottom for Laptop	0	37850	50	0	Ant 0	w/	-	1.00	19.50	19.03	1.11	0.09	0.327	0.36
	LTE 38	2600	QPSK20M	Rear Face	20	37850	1	0	Ant 0	w/o	-	1.00	24.00	23.38	1.15	0.11	0.384	0.44
	LTE 38	2600	QPSK20M	Left Side	0	37850	1	0	Ant 0	w/o	-	1.00	24.00	23.38	1.15	0	<0.001	0.00
	LTE 38	2600	QPSK20M	Right Side	15	37850	1	0	Ant 0	w/o	-	1.00	24.00	23.38	1.15	0.19	0.18	0.21
	LTE 38	2600	QPSK20M	Top Side	0	37850	1	0	Ant 0	w/o	-	1.00	24.00	23.38	1.15	0.12	0.02	0.02
	LTE 38	2600	QPSK20M	Bottom Side	0	37850	1	0	Ant 0	w/o	-	1.00	24.00	23.38	1.15	0.15	0.011	0.01
	LTE 38	2600	QPSK20M	Rear Face	20	37850	50	0	Ant 0	w/o	-	1.00	23.00	22.39	1.15	-0.05	0.399	0.46
	LTE 38	2600	QPSK20M	Left Side	0	37850	50	0	Ant 0	w/o	-	1.00	23.00	22.39	1.15	0	<0.001	0.00
	LTE 38	2600	QPSK20M	Right Side	15	37850	50	0	Ant 0	w/o	-	1.00	23.00	22.39	1.15	0.01	0.145	0.17
	LTE 38	2600	QPSK20M	Top Side	0	37850	50	0	Ant 0	w/o	-	1.00	23.00	22.39	1.15	0.06	0.02	0.02
	LTE 38	2600	QPSK20M	Bottom Side	0	37850	50	0	Ant 0	w/o	-	1.00	23.00	22.39	1.15	0.19	0.01	0.01
15	LTE 38	2600	QPSK20M	Rear Face	0	37850	1	0	Ant 0	w/	-	1.00	15.00	14.93	1.02	-0.03	0.502	0.51
	LTE 38	2600	QPSK20M	Right Side	0	37850	1	0	Ant 0	w/	-	1.00	15.00	14.93	1.02	-0.16	0.18	0.18
	LTE 38	2600	QPSK20M	Rear Face	0	37850	50	0	Ant 0	w/	-	1.00	14.00	13.90	1.02	-0.01	0.399	0.41
	LTE 38	2600	QPSK20M	Right Side	0	37850	50	0	Ant 0	w/	-	1.00	14.00	13.90	1.02	-0.15	0.145	0.15
	LTE 38	2600	QPSK20M	Rear Face	0	38000	1	0	Ant 0	w/	-	1.00	15.00	14.91	1.02	0.1	0.471	0.48
	LTE 38	2600	QPSK20M	Rear Face	0	38150	1	0	Ant 0	w/	-	1.00	15.00	14.79	1.05	-0.1	0.447	0.47
	LTE 38	2600	QPSK20M	Rear Face	0	PCC : 37850 SCC : 38048	PCC : 1 SCC : 1	PCC : 0 SCC : 99	Ant 0	w/	-	1.00	15.00	14.81	1.04	0.13	0.18	0.19
	LTE 38	2600	QPSK20M	Lid Closed for Laptop	0	38150	1	0	Ant 0	w/	-	1.00	20.50	20.20	1.07	0.09	0.413	0.44

Body SAR Test Result

System & Position										DUT & Accessory			SAR					
Plot No.	Band	Frequency For System Check (MHz)	Mode	Test Position	Separation Distance (mm)	Channel	RB#	RB offset	Ant Status	Power Reduction	Duty Cycle	Crest Factor	Max. Tune-up Power (dBm)	Measured Conducted Power (dBm)	Scaling Factor	Power Drift (dB)	Measured SAR-1g (W/kg)	Scaled SAR-1g (W/kg)
	LTE 40	2300	QPSK20M	Bottom for Laptop	0	39150	1	0	Ant 0	w/	-	1.00	20.50	20.39	1.03	-0.14	0.436	0.45
	LTE 40	2300	QPSK20M	Bottom for Laptop	0	39150	50	0	Ant 0	w/	-	1.00	19.50	19.32	1.04	-0.1	0.417	0.43
	LTE 40	2300	QPSK20M	Rear Face	20	39150	1	0	Ant 0	w/o	-	1.00	24.00	23.41	1.15	-0.19	0.413	0.47
	LTE 40	2300	QPSK20M	Left Side	0	39150	1	0	Ant 0	w/o	-	1.00	24.00	23.41	1.15	-0.11	0.00866	0.01
	LTE 40	2300	QPSK20M	Right Side	15	39150	1	0	Ant 0	w/o	-	1.00	24.00	23.41	1.15	-0.03	0.147	0.17
	LTE 40	2300	QPSK20M	Top Side	0	39150	1	0	Ant 0	w/o	-	1.00	24.00	23.41	1.15	0.07	0.01	0.01
	LTE 40	2300	QPSK20M	Bottom Side	0	39150	1	0	Ant 0	w/o	-	1.00	24.00	23.41	1.15	0.02	0.013	0.01
	LTE 40	2300	QPSK20M	Rear Face	20	39150	50	0	Ant 0	w/o	-	1.00	23.00	22.38	1.15	0.16	0.39	0.45
	LTE 40	2300	QPSK20M	Left Side	0	39150	50	0	Ant 0	w/o	-	1.00	23.00	22.38	1.15	0	<0.001	0.00
	LTE 40	2300	QPSK20M	Right Side	15	39150	50	0	Ant 0	w/o	-	1.00	23.00	22.38	1.15	0.04	0.124	0.14
	LTE 40	2300	QPSK20M	Top Side	0	39150	50	0	Ant 0	w/o	-	1.00	23.00	22.38	1.15	0.04	0.00821	0.01
	LTE 40	2300	QPSK20M	Bottom Side	0	39150	50	0	Ant 0	w/o	-	1.00	23.00	22.38	1.15	0.12	0.00935	0.01
16	LTE 40	2300	QPSK20M	Rear Face	0	39150	1	0	Ant 0	w/	-	1.00	16.00	15.95	1.01	-0.16	0.495	0.50
	LTE 40	2300	QPSK20M	Right Side	0	39150	1	0	Ant 0	w/	-	1.00	16.00	15.95	1.01	0.02	0.147	0.15
	LTE 40	2300	QPSK20M	Rear Face	0	39150	50	0	Ant 0	w/	-	1.00	15.00	14.81	1.04	0.15	0.39	0.41
	LTE 40	2300	QPSK20M	Right Side	0	39150	50	0	Ant 0	w/	-	1.00	15.00	14.81	1.04	-0.01	0.124	0.13
	LTE 40	2300	QPSK20M	Rear Face	0	38750	1	0	Ant 0	w/	-	1.00	16.00	15.91	1.02	-0.18	0.463	0.47
	LTE 40	2300	QPSK20M	Rear Face	0	39550	1	0	Ant 0	w/	-	1.00	16.00	15.65	1.08	0.16	0.46	0.50
	LTE 40	2300	QPSK20M	Lid Closed for Laptop	0	38750	1	0	Ant 0	w/	-	1.00	20.50	20.39	1.03	0.14	0.421	0.43
	LTE 41	2600	QPSK20M	Bottom for Laptop	0	41055	1	0	Ant 2	w/	-	1.00	18.00	17.60	1.10	0.03	0.438	0.48
	LTE 41	2600	QPSK20M	Bottom for Laptop	0	41055	50	0	Ant 2	w/	-	1.00	17.00	16.63	1.09	0.06	0.419	0.46
	LTE 41	2600	QPSK20M	Rear Face	20	41055	1	0	Ant 2	w/o	-	1.00	24.00	23.99	1.00	-0.01	0.567	0.57
	LTE 41	2600	QPSK20M	Left Side	15	41055	1	0	Ant 2	w/o	-	1.00	24.00	23.99	1.00	0.11	0.33	0.33
	LTE 41	2600	QPSK20M	Right Side	0	41055	1	0	Ant 2	w/o	-	1.00	24.00	23.99	1.00	0	<0.001	0.00
	LTE 41	2600	QPSK20M	Top Side	0	41055	1	0	Ant 2	w/o	-	1.00	24.00	23.99	1.00	0.12	0.09	0.09
	LTE 41	2600	QPSK20M	Bottom Side	0	41055	1	0	Ant 2	w/o	-	1.00	24.00	23.99	1.00	-0.11	0.013	0.01
	LTE 41	2600	QPSK20M	Rear Face	20	41055	50	0	Ant 2	w/o	-	1.00	23.00	22.99	1.00	0.07	0.522	0.52
	LTE 41	2600	QPSK20M	Left Side	15	41055	50	0	Ant 2	w/o	-	1.00	23.00	22.99	1.00	0.05	0.269	0.27
	LTE 41	2600	QPSK20M	Right Side	0	41055	50	0	Ant 2	w/o	-	1.00	23.00	22.99	1.00	0	<0.001	0.00
	LTE 41	2600	QPSK20M	Top Side	0	41055	50	0	Ant 2	w/o	-	1.00	23.00	22.99	1.00	-0.03	0.074	0.07
	LTE 41	2600	QPSK20M	Bottom Side	0	41055	50	0	Ant 2	w/o	-	1.00	23.00	22.99	1.00	-0.05	0.01	0.01
17	LTE 41	2600	QPSK20M	Rear Face	0	41055	1	0	Ant 2	w/	-	1.00	19.00	18.71	1.07	0.09	0.683	0.73
	LTE 41	2600	QPSK20M	Left Side	0	41055	1	0	Ant 2	w/	-	1.00	19.00	18.71	1.07	0	<0.001	0.00
	LTE 41	2600	QPSK20M	Rear Face	0	41055	50	0	Ant 2	w/	-	1.00	18.00	17.62	1.09	0.1	0.522	0.57
	LTE 41	2600	QPSK20M	Left Side	0	41055	50	0	Ant 2	w/	-	1.00	18.00	17.62	1.09	-0.19	0.269	0.29
	LTE 41	2600	QPSK20M	Rear Face	0	39790	1	0	Ant 2	w/	-	1.00	19.00	18.48	1.13	-0.13	0.637	0.72
	LTE 41	2600	QPSK20M	Rear Face	0	40185	1	0	Ant 2	w/	-	1.00	19.00	18.18	1.21	-0.17	0.579	0.70
	LTE 41	2600	QPSK20M	Rear Face	0	40620	1	0	Ant 2	w/	-	1.00	19.00	18.45	1.14	0.19	0.624	0.71
	LTE 41	2600	QPSK20M	Rear Face	0	41490	1	0	Ant 2	w/	-	1.00	19.00	18.51	1.12	-0.16	0.614	0.69
	LTE 41	2600	QPSK20M	Rear Face	0	41055	1	0	Ant 2	w/o	-	1.00	27.00	26.73	1.06	-0.12	0.654	0.69
	LTE 41	2600	QPSK20M	Rear Face	0	PCC : 41055 SCC : 41253	PCC : 1 SCC : 1	PCC : 0 SCC : 99	Ant 2	w/	-	1.00	19.00	18.61	1.09	0.01	0.526	0.57
	LTE 41	2600	QPSK20M	Lid Closed for Laptop	0	41055	1	0	Ant 2	w/	-	1.00	18.00	17.60	1.10	0.01	0.426	0.47
	LTE 48	3500*	QPSK20M	Bottom for Laptop	0	56640	1	0	Ant 2	w/	-	1.00	17.50	17.19	1.07	-0.06	0.242	0.26
	LTE 48	3500*	QPSK20M	Bottom for Laptop	0	56640	50	0	Ant 2	w/	-	1.00	16.50	16.31	1.04	0.03	0.214	0.22
	LTE 48	3500*	QPSK20M	Rear Face	20	56640	1	0	Ant 2	w/o	-	1.00	22.00	21.85	1.04	-0.08	0.518	0.54
	LTE 48	3500*	QPSK20M	Left Side	15	56640	1	0	Ant 2	w/o	-	1.00	22.00	21.85	1.04	-0.01	0.095	0.10
	LTE 48	3500*	QPSK20M	Right Side	0	56640	1	0	Ant 2	w/o	-	1.00	22.00	21.85	1.04	0	<0.001	0.00
	LTE 48	3500*	QPSK20M	Top Side	0	56640	1	0	Ant 2	w/o	-	1.00	22.00	21.85	1.04	-0.08	0.00549	0.01
	LTE 48	3500*	QPSK20M	Bottom Side	0	56640	1	0	Ant 2	w/o	-	1.00	22.00	21.85	1.04	0.13	0.00354	0.00
	LTE 48	3500*	QPSK20M	Rear Face	20	56640	50	0	Ant 2	w/o	-	1.00	21.00	20.93	1.02	0.11	0.442	0.45
	LTE 48	3500*	QPSK20M	Left Side	15	56640	50	0	Ant 2	w/o	-	1.00	21.00	20.93	1.02	0.17	0.077	0.08
	LTE 48	3500*	QPSK20M	Right Side	0	56640	50	0	Ant 2	w/o	-	1.00	21.00	20.93	1.02	0	<0.001	0.00
	LTE 48	3500*	QPSK20M	Top Side	0	56640	50	0	Ant 2	w/o	-	1.00	21.00	20.93	1.02	-0.13	0.00344	0.00
	LTE 48	3500*	QPSK20M	Bottom Side	0	56640	50	0	Ant 2	w/o	-	1.00	21.00	20.93	1.02	0.06	0.00326	0.00
20	LTE 48	3500*	QPSK20M	Rear Face	0	56640	1	0	Ant 2	w/	-	1.00	11.50	11.40	1.02	0.05	0.602	0.61
	LTE 48	3500*	QPSK20M	Left Side	0	56640	1	0	Ant 2	w/	-	1.00	11.50	11.40	1.02	0	0.086	0.09
	LTE 48	3500*	QPSK20M	Rear Face	0	56640	50	0	Ant 2	w/	-	1.00	10.50	10.45	1.01	-0.09	0.442	0.45
	LTE 48	3500*	QPSK20M	Left Side	0	56640	50	0	Ant 2	w/	-	1.00	10.50	10.45	1.01	-0.14	0.077	0.08
	LTE 48	3500*	QPSK20M	Rear Face	0	55340	1	0	Ant 2	w/	-	1.00	11.50	11.08	1.10	0.11	0.524	0.58
	LTE 48	3500*	QPSK20M	Rear Face	0	55780	1	0	Ant 2	w/	-	1.00	11.50	11.02	1.12	0.05	0.518	0.58
	LTE 48	3500*	QPSK20M	Rear Face	0	56210	1	0	Ant 2	w/	-	1.00	11.50	11.14	1.09	0.14	0.541	0.59
	LTE 48	3500*	QPSK20M	Rear Face	0	PCC : 56640 SCC : 56442	PCC : 1 SCC : 1	PCC : 0 SCC : 99	Ant 2	w/	-	1.00	14.00	13.82	1.04	0.02	0.442	0.46
	LTE 48	3500*	QPSK20M	Lid Closed for Laptop	0	56640	1	0	Ant 2	w/	-	1.00	17.50	17.19	1.07	-0.06	0.223	0.24

Body SAR Test Result

System & Position										DUT & Accessory			SAR					
Plot No.	Band	Frequency For System Check (MHz)	Mode	Test Position	Separation Distance (mm)	Channel	RB#	RB offset	Ant Status	Power Reduction	Duty Cycle	Crest Factor	Max. Tune-up Power (dBm)	Measured Conducted Power (dBm)	Scaling Factor	Power Drift (dB)	Measured SAR-1g (W/kg)	Scaled SAR-1g (W/kg)
	LTE 66	1750	QPSK20M	Bottom for Laptop	0	132322	1	0	Ant 0	w/	-	1.00	18.50	18.24	1.06	0.06	0.472	0.50
	LTE 66	1750	QPSK20M	Bottom for Laptop	0	132322	50	0	Ant 0	w/	-	1.00	17.50	17.11	1.09	0.05	0.432	0.47
	LTE 66	1750	QPSK20M	Rear Face	20	132322	1	0	Ant 0	w/o	-	1.00	24.00	23.26	1.19	-0.13	0.488	0.58
	LTE 66	1750	QPSK20M	Left Side	0	132322	1	0	Ant 0	w/o	-	1.00	24.00	23.26	1.19	0.01	0.00766	0.01
	LTE 66	1750	QPSK20M	Right Side	15	132322	1	0	Ant 0	w/o	-	1.00	24.00	23.26	1.19	0.09	0.175	0.21
	LTE 66	1750	QPSK20M	Top Side	0	132322	1	0	Ant 0	w/o	-	1.00	24.00	23.26	1.19	0.19	0.013	0.02
	LTE 66	1750	QPSK20M	Bottom Side	0	132322	1	0	Ant 0	w/o	-	1.00	24.00	23.26	1.19	-0.05	0.014	0.02
	LTE 66	1750	QPSK20M	Rear Face	20	132322	50	0	Ant 0	w/o	-	1.00	23.00	22.35	1.16	0.11	0.483	0.56
	LTE 66	1750	QPSK20M	Left Side	0	132322	50	0	Ant 0	w/o	-	1.00	23.00	22.35	1.16	-0.14	0.00633	0.01
	LTE 66	1750	QPSK20M	Right Side	15	132322	50	0	Ant 0	w/o	-	1.00	23.00	22.35	1.16	-0.13	0.14	0.16
	LTE 66	1750	QPSK20M	Top Side	0	132322	50	0	Ant 0	w/o	-	1.00	23.00	22.35	1.16	-0.19	0.011	0.01
	LTE 66	1750	QPSK20M	Bottom Side	0	132322	50	0	Ant 0	w/o	-	1.00	23.00	22.35	1.16	-0.14	0.01	0.01
21	LTE 66	1750	QPSK20M	Rear Face	0	132322	1	0	Ant 0	w/	-	1.00	13.50	13.41	1.02	-0.13	0.592	0.60
	LTE 66	1750	QPSK20M	Right Side	0	132322	1	0	Ant 0	w/	-	1.00	13.50	13.41	1.02	-0.14	0.175	0.18
	LTE 66	1750	QPSK20M	Rear Face	0	132322	50	0	Ant 0	w/	-	1.00	12.50	12.18	1.08	-0.09	0.483	0.52
	LTE 66	1750	QPSK20M	Right Side	0	132322	50	0	Ant 0	w/	-	1.00	12.50	12.18	1.08	-0.19	0.14	0.15
	LTE 66	1750	QPSK20M	Rear Face	0	132072	1	0	Ant 0	w/	-	1.00	13.50	13.36	1.03	-0.03	0.565	0.58
	LTE 66	1750	QPSK20M	Rear Face	0	132572	1	0	Ant 0	w/	-	1.00	13.50	13.11	1.09	-0.06	0.538	0.59
	LTE 66	1750	QPSK20M	Rear Face	0	PCC : 132323 SCC : 132521	PCC : 1 SCC : 1	PCC : 0 SCC : 99	Ant 0	w/	-	1.00	16.50	16.09	1.10	-0.02	0.483	0.53
	LTE 66	1750	QPSK20M	Lid Closed for Laptop	0	132322	1	0	Ant 0	w/	-	1.00	18.50	18.24	1.06	0.02	0.436	0.46
	-	-	-	-	-	-	-	-	-	-	-	-	-	-	-	-	-	-
	LTE 71	750	QPSK20M	Bottom for Laptop	0	133297	1	0	Ant 0	w/	-	1.00	23.00	22.83	1.04	-0.02	0.628	0.65
	LTE 71	750	QPSK20M	Bottom for Laptop	0	133297	50	0	Ant 0	w/	-	1.00	22.00	21.93	1.02	0.03	0.596	0.61
	LTE 71	750	QPSK20M	Rear Face	20	133297	1	0	Ant 0	w/o	-	1.00	24.00	23.67	1.08	-0.13	0.549	0.59
	LTE 71	750	QPSK20M	Left Side	0	133297	1	0	Ant 0	w/o	-	1.00	24.00	23.67	1.08	0	<0.001	0.00
	LTE 71	750	QPSK20M	Right Side	15	133297	1	0	Ant 0	w/o	-	1.00	24.00	23.67	1.08	0.18	0.281	0.30
	LTE 71	750	QPSK20M	Top Side	0	133297	1	0	Ant 0	w/o	-	1.00	24.00	23.67	1.08	0	<0.001	0.00
	LTE 71	750	QPSK20M	Bottom Side	0	133297	1	0	Ant 0	w/o	-	1.00	24.00	23.67	1.08	0	<0.001	0.00
	LTE 71	750	QPSK20M	Rear Face	20	133297	50	0	Ant 0	w/o	-	1.00	23.00	22.79	1.05	-0.11	0.495	0.52
	LTE 71	750	QPSK20M	Left Side	0	133297	50	0	Ant 0	w/o	-	1.00	23.00	22.79	1.05	0	<0.001	0.00
	LTE 71	750	QPSK20M	Right Side	15	133297	50	0	Ant 0	w/o	-	1.00	23.00	22.79	1.05	-0.06	0.256	0.27
	LTE 71	750	QPSK20M	Top Side	0	133297	50	0	Ant 0	w/o	-	1.00	23.00	22.79	1.05	0	<0.001	0.00
	LTE 71	750	QPSK20M	Bottom Side	0	133297	50	0	Ant 0	w/o	-	1.00	23.00	22.79	1.05	0	<0.001	0.00
22	LTE 71	750	QPSK20M	Rear Face	0	133297	1	0	Ant 0	w/	-	1.00	17.00	16.36	1.16	0.01	0.567	0.66
	LTE 71	750	QPSK20M	Right Side	0	133297	1	0	Ant 0	w/	-	1.00	17.00	16.36	1.16	0.14	0.281	0.33
	LTE 71	750	QPSK20M	Rear Face	0	133297	50	0	Ant 0	w/	-	1.00	16.00	15.47	1.13	0.08	0.495	0.56
	LTE 71	750	QPSK20M	Right Side	0	133297	50	0	Ant 0	w/	-	1.00	16.00	15.47	1.13	-0.05	0.256	0.29
	LTE 71	750	QPSK20M	Rear Face	0	133222	1	0	Ant 0	w/	-	1.00	17.00	16.23	1.19	-0.08	0.519	0.62
	LTE 71	750	QPSK20M	Rear Face	0	133372	1	0	Ant 0	w/	-	1.00	17.00	16.19	1.21	-0.13	0.527	0.64
	LTE 71	750	QPSK20M	Lid Closed for Laptop	0	133297	1	0	Ant 0	w/	-	1.00	23.00	22.83	1.04	0.06	0.587	0.61
	-	-	-	-	-	-	-	-	-	-	-	-	-	-	-	-	-	-
	5G NR-n2	1900	DFT-S QPSK20M	Bottom for Laptop	0	376000	1	1	Ant 0	w/	-	1.00	16.50	16.48	1.00	0.08	0.619	0.62
	5G NR-n2	1900	DFT-S QPSK20M	Bottom for Laptop	0	376000	50	28	Ant 0	w/	-	1.00	16.50	15.89	1.15	-0.04	0.527	0.61
	5G NR-n2	1900	DFT-S QPSK20M	Rear Face	20	376000	1	1	Ant 0	w/o	-	1.00	24.00	23.98	1.00	0	0.571	0.57
	5G NR-n2	1900	DFT-S QPSK20M	Left Side	0	376000	1	1	Ant 0	w/o	-	1.00	24.00	23.98	1.00	-0.13	0.00942	0.01
	5G NR-n2	1900	DFT-S QPSK20M	Right Side	15	376000	1	1	Ant 0	w/o	-	1.00	24.00	23.98	1.00	0.06	0.228	0.23
	5G NR-n2	1900	DFT-S QPSK20M	Top Side	0	376000	1	1	Ant 0	w/o	-	1.00	24.00	23.98	1.00	-0.14	0.02	0.02
	5G NR-n2	1900	DFT-S QPSK20M	Bottom Side	0	376000	1	1	Ant 0	w/o	-	1.00	24.00	23.98	1.00	0.08	0.027	0.03
	5G NR-n2	1900	DFT-S QPSK20M	Rear Face	20	376000	50	28	Ant 0	w/o	-	1.00	24.00	23.96	1.01	0.18	0.636	0.64
	5G NR-n2	1900	DFT-S QPSK20M	Left Side	0	376000	50	28	Ant 0	w/o	-	1.00	24.00	23.96	1.01	0.11	0.008	0.01
	5G NR-n2	1900	DFT-S QPSK20M	Right Side	15	376000	50	28	Ant 0	w/o	-	1.00	24.00	23.96	1.01	-0.07	0.236	0.24
	5G NR-n2	1900	DFT-S QPSK20M	Top Side	0	376000	50	28	Ant 0	w/o	-	1.00	24.00	23.96	1.01	0.1	0.023	0.02
	5G NR-n2	1900	DFT-S QPSK20M	Bottom Side	0	376000	50	28	Ant 0	w/o	-	1.00	24.00	23.96	1.01	0.07	0.027	0.03
23	5G NR-n2	1900	DFT-S QPSK20M	Rear Face	0	376000	1	1	Ant 0	w/	-	1.00	13.00	12.95	1.01	0.11	0.652	0.66
	5G NR-n2	1900	DFT-S QPSK20M	Right Side	0	376000	1	1	Ant 0	w/	-	1.00	13.00	12.95	1.01	0.07	0.228	0.23
	5G NR-n2	1900	DFT-S QPSK20M	Rear Face	0	376000	50	28	Ant 0	w/	-	1.00	13.00	12.73	1.06	0.13	0.57	0.60
	5G NR-n2	1900	DFT-S QPSK20M	Right Side	0	376000	50	28	Ant 0	w/	-	1.00	13.00	12.73	1.06	-0.09	0.236	0.25
	5G NR-n2	1900	DFT-S QPSK20M	Rear Face	0	372000	1	1	Ant 0	w/	-	1.00	13.00	12.89	1.03	-0.04	0.457	0.47
	5G NR-n2	1900	DFT-S QPSK20M	Rear Face	0	380000	1	1	Ant 0	w/	-	1.00	13.00	12.87	1.03	0.11	0.441	0.45
	5G NR-n2	1900	DFT-S QPSK20M	Lid Closed for Laptop	0	376000	1	1	Ant 0	w/	-	1.00	16.50	16.48	1.00	-0.04	0.563	0.56

Body SAR Test Result

System & Position										DUT & Accessory			SAR					
Plot No.	Band	Frequency For System Check (MHz)	Mode	Test Position	Separation Distance (mm)	Channel	RB#	RB offset	Ant Status	Power Reduction	Duty Cycle	Crest Factor	Max. Tune-up Power (dBm)	Measured Conducted Power (dBm)	Scaling Factor	Power Drift (dB)	Measured SAR-1g (W/kg)	Scaled SAR-1g (W/kg)
	5GNR-n5	835	DFT-S QPSK20M	Bottom for Laptop	0	167300	1	1	Ant 0	w/	-	1.00	20.00	19.36	1.16	-0.05	0.261	0.30
	5GNR-n5	835	DFT-S QPSK20M	Bottom for Laptop	0	167300	50	28	Ant 0	w/	-	1.00	20.00	19.34	1.16	0.09	0.243	0.28
	5GNR-n5	835	DFT-S QPSK20M	Rear Face	20	167300	1	1	Ant 0	w/o	-	1.00	24.00	23.11	1.23	0.05	0.525	0.65
	5GNR-n5	835	DFT-S QPSK20M	Left Side	0	167300	1	1	Ant 0	w/o	-	1.00	24.00	23.11	1.23	0	<0.001	0.00
	5GNR-n5	835	DFT-S QPSK20M	Right Side	15	167300	1	1	Ant 0	w/o	-	1.00	24.00	23.11	1.23	-0.04	0.342	0.42
	5GNR-n5	835	DFT-S QPSK20M	Top Side	0	167300	1	1	Ant 0	w/o	-	1.00	24.00	23.11	1.23	0.06	0.02	0.02
	5GNR-n5	835	DFT-S QPSK20M	Bottom Side	0	167300	1	1	Ant 0	w/o	-	1.00	24.00	23.11	1.23	0	<0.001	0.00
	5GNR-n5	835	DFT-S QPSK20M	Rear Face	20	167300	50	28	Ant 0	w/o	-	1.00	24.00	23.09	1.23	0.04	0.523	0.64
	5GNR-n5	835	DFT-S QPSK20M	Left Side	0	167300	50	28	Ant 0	w/o	-	1.00	24.00	23.09	1.23	0	<0.001	0.00
	5GNR-n5	835	DFT-S QPSK20M	Right Side	15	167300	50	28	Ant 0	w/o	-	1.00	24.00	23.09	1.23	-0.09	0.379	0.47
	5GNR-n5	835	DFT-S QPSK20M	Top Side	0	167300	50	28	Ant 0	w/o	-	1.00	24.00	23.09	1.23	-0.17	0.025	0.03
	5GNR-n5	835	DFT-S QPSK20M	Bottom Side	0	167300	50	28	Ant 0	w/o	-	1.00	24.00	23.09	1.23	0	<0.001	0.00
24	5GNR-n5	835	DFT-S QPSK20M	Rear Face	0	167300	1	1	Ant 0	w/	-	1.00	19.00	18.97	1.01	0.01	0.68	0.69
	5GNR-n5	835	DFT-S QPSK20M	Right Side	0	167300	1	1	Ant 0	w/	-	1.00	19.00	18.97	1.01	0.17	0.342	0.35
	5GNR-n5	835	DFT-S QPSK20M	Rear Face	0	167300	50	28	Ant 0	w/	-	1.00	19.00	18.37	1.16	0.14	0.587	0.68
	5GNR-n5	835	DFT-S QPSK20M	Right Side	0	167300	50	28	Ant 0	w/	-	1.00	19.00	18.37	1.16	0.07	0.379	0.44
	5GNR-n5	835	DFT-S QPSK20M	Rear Face	0	166800	1	1	Ant 0	w/	-	1.00	19.00	18.67	1.08	0.1	0.405	0.44
	5GNR-n5	835	DFT-S QPSK20M	Rear Face	0	167800	1	1	Ant 0	w/	-	1.00	19.00	18.87	1.03	-0.15	0.413	0.43
	5GNR-n5	835	DFT-S QPSK20M	Lid Closed for Laptop	0	167300	1	1	Ant 0	w/	-	1.00	20.00	19.36	1.16	-0.06	0.254	0.29
	5GNR-n7	2600	DFT-S QPSK20M	Bottom for Laptop	0	507000	1	1	Ant 0	w/	-	1.00	16.00	15.32	1.17	0.01	0.389	0.46
	5GNR-n7	2600	DFT-S QPSK20M	Bottom for Laptop	0	507000	50	28	Ant 0	w/	-	1.00	16.00	15.31	1.17	-0.05	0.346	0.40
	5GNR-n7	2600	DFT-S QPSK20M	Rear Face	20	507000	1	1	Ant 0	w/o	-	1.00	24.00	22.47	1.42	-0.12	0.367	0.52
	5GNR-n7	2600	DFT-S QPSK20M	Left Side	0	507000	1	1	Ant 0	w/o	-	1.00	24.00	22.47	1.42	0.14	0.00929	0.01
	5GNR-n7	2600	DFT-S QPSK20M	Right Side	15	507000	1	1	Ant 0	w/o	-	1.00	24.00	22.47	1.42	-0.03	0.094	0.13
	5GNR-n7	2600	DFT-S QPSK20M	Top Side	0	507000	1	1	Ant 0	w/o	-	1.00	24.00	22.47	1.42	0.13	0.016	0.02
	5GNR-n7	2600	DFT-S QPSK20M	Bottom Side	0	507000	1	1	Ant 0	w/o	-	1.00	24.00	22.47	1.42	-0.19	0.00451	0.01
	5GNR-n7	2600	DFT-S QPSK20M	Rear Face	20	507000	50	28	Ant 0	w/o	-	1.00	24.00	22.34	1.47	0.16	0.361	0.53
	5GNR-n7	2600	DFT-S QPSK20M	Left Side	0	507000	50	28	Ant 0	w/o	-	1.00	24.00	22.34	1.47	-0.09	0.00964	0.01
	5GNR-n7	2600	DFT-S QPSK20M	Right Side	15	507000	50	28	Ant 0	w/o	-	1.00	24.00	22.34	1.47	-0.13	0.098	0.14
	5GNR-n7	2600	DFT-S QPSK20M	Top Side	0	507000	50	28	Ant 0	w/o	-	1.00	24.00	22.34	1.47	0.12	0.014	0.02
	5GNR-n7	2600	DFT-S QPSK20M	Bottom Side	0	507000	50	28	Ant 0	w/o	-	1.00	24.00	22.34	1.47	0.03	0.00451	0.01
25	5GNR-n7	2600	DFT-S QPSK20M	Rear Face	0	507000	1	1	Ant 0	w/	-	1.00	11.50	10.77	1.18	-0.02	0.447	0.53
	5GNR-n7	2600	DFT-S QPSK20M	Right Side	0	507000	1	1	Ant 0	w/	-	1.00	11.50	10.77	1.18	0.05	0.094	0.11
	5GNR-n7	2600	DFT-S QPSK20M	Rear Face	0	507000	50	28	Ant 0	w/	-	1.00	11.50	10.71	1.20	0.13	0.361	0.43
	5GNR-n7	2600	DFT-S QPSK20M	Right Side	0	507000	50	28	Ant 0	w/	-	1.00	11.50	10.71	1.20	0.11	0.098	0.12
	5GNR-n7	2600	DFT-S QPSK20M	Rear Face	0	502000	1	1	Ant 0	w/	-	1.00	11.50	10.75	1.19	0.02	0.367	0.44
	5GNR-n7	2600	DFT-S QPSK20M	Rear Face	0	512000	1	1	Ant 0	w/	-	1.00	11.50	10.68	1.21	0.02	0.425	0.51
	5GNR-n7	2600	DFT-S QPSK20M	Lid Closed for Laptop	0	507000	1	1	Ant 0	w/	-	1.00	16.00	15.32	1.17	0.15	0.372	0.44
	5GNR-n25	1900	DFT-S QPSK20M	Bottom for Laptop	0	381000	1	1	Ant 0	w/	-	1.00	16.50	16.49	1.00	0.04	0.58	0.58
	5GNR-n25	1900	DFT-S QPSK20M	Bottom for Laptop	0	381000	50	28	Ant 0	w/	-	1.00	16.50	15.75	1.19	-0.1	0.49	0.58
	5GNR-n25	1900	DFT-S QPSK20M	Rear Face	20	381000	1	1	Ant 0	w/o	-	1.00	24.00	23.01	1.26	-0.16	0.48	0.60
	5GNR-n25	1900	DFT-S QPSK20M	Left Side	0	381000	1	1	Ant 0	w/o	-	1.00	24.00	23.01	1.26	-0.02	0.00735	0.01
	5GNR-n25	1900	DFT-S QPSK20M	Right Side	15	381000	1	1	Ant 0	w/o	-	1.00	24.00	23.01	1.26	-0.01	0.233	0.29
	5GNR-n25	1900	DFT-S QPSK20M	Top Side	0	381000	1	1	Ant 0	w/o	-	1.00	24.00	23.01	1.26	-0.08	0.026	0.03
	5GNR-n25	1900	DFT-S QPSK20M	Bottom Side	0	381000	1	1	Ant 0	w/o	-	1.00	24.00	23.01	1.26	-0.1	0.031	0.04
	5GNR-n25	1900	DFT-S QPSK20M	Rear Face	20	381000	50	28	Ant 0	w/o	-	1.00	24.00	22.87	1.30	0.18	0.46	0.60
	5GNR-n25	1900	DFT-S QPSK20M	Left Side	0	381000	50	28	Ant 0	w/o	-	1.00	24.00	22.87	1.30	0.15	0.0063	0.01
	5GNR-n25	1900	DFT-S QPSK20M	Right Side	15	381000	50	28	Ant 0	w/o	-	1.00	24.00	22.87	1.30	0.18	0.228	0.30
	5GNR-n25	1900	DFT-S QPSK20M	Top Side	0	381000	50	28	Ant 0	w/o	-	1.00	24.00	22.87	1.30	0.06	0.024	0.03
	5GNR-n25	1900	DFT-S QPSK20M	Bottom Side	0	381000	50	28	Ant 0	w/o	-	1.00	24.00	22.87	1.30	0.04	0.022	0.03
26	5GNR-n25	1900	DFT-S QPSK20M	Rear Face	0	381000	1	1	Ant 0	w/	-	1.00	13.00	12.98	1.00	0.08	0.659	0.66
	5GNR-n25	1900	DFT-S QPSK20M	Right Side	0	381000	1	1	Ant 0	w/	-	1.00	13.00	12.98	1.00	-0.09	0.233	0.23
	5GNR-n25	1900	DFT-S QPSK20M	Rear Face	0	381000	50	28	Ant 0	w/	-	1.00	13.00	12.90	1.02	0.1	0.56	0.57
	5GNR-n25	1900	DFT-S QPSK20M	Right Side	0	381000	50	28	Ant 0	w/	-	1.00	13.00	12.90	1.02	-0.04	0.228	0.23
	5GNR-n25	1900	DFT-S QPSK20M	Rear Face	0	372000	1	1	Ant 0	w/	-	1.00	13.00	12.74	1.06	0.13	0.613	0.65
	5GNR-n25	1900	DFT-S QPSK20M	Rear Face	0	376500	1	1	Ant 0	w/	-	1.00	13.00	12.89	1.03	-0.18	0.619	0.64
	5GNR-n25	1900	DFT-S QPSK20M	Lid Closed for Laptop	0	381000	1	1	Ant 0	w/	-	1.00	16.50	16.49	1.00	-0.04	0.564	0.56

Body SAR Test Result

System & Position										DUT & Accessory				SAR				
Plot No.	Band	Frequency For System Check (MHz)	Mode	Test Position	Separation Distance (mm)	Channel	RB#	RB offset	Ant Status	Power Reduction	Duty Cycle	Crest Factor	Max. Tune-up Power (dBm)	Measured Conducted Power (dBm)	Scaling Factor	Power Drift (dB)	Measured SAR-1g (W/kg)	Scaled SAR-1g (W/kg)
	5G NR-n30	2300	DFT-S QPSK10M	Bottom for Laptop	0	462000	1	1	Ant 0	w/	-	1.00	18.50	18.24	1.06	-0.06	0.675	0.72
	5G NR-n30	2300	DFT-S QPSK10M	Bottom for Laptop	0	462000	25	14	Ant 0	w/	-	1.00	18.50	17.81	1.17	-0.09	0.521	0.61
	5G NR-n30	2300	DFT-S QPSK10M	Rear Face	20	462000	1	1	Ant 0	w/o	-	1.00	24.00	22.79	1.32	0.01	0.423	0.56
	5G NR-n30	2300	DFT-S QPSK10M	Left Side	0	462000	1	1	Ant 0	w/o	-	1.00	24.00	22.79	1.32	0.05	0.013	0.02
	5G NR-n30	2300	DFT-S QPSK10M	Right Side	15	462000	1	1	Ant 0	w/o	-	1.00	24.00	22.79	1.32	0.14	0.137	0.18
	5G NR-n30	2300	DFT-S QPSK10M	Top Side	0	462000	1	1	Ant 0	w/o	-	1.00	24.00	22.79	1.32	-0.11	0.00622	0.01
	5G NR-n30	2300	DFT-S QPSK10M	Bottom Side	0	462000	1	1	Ant 0	w/o	-	1.00	24.00	22.79	1.32	0	<-0.001	0.00
	5G NR-n30	2300	DFT-S QPSK10M	Rear Face	20	462000	25	14	Ant 0	w/o	-	1.00	24.00	22.18	1.52	-0.11	0.406	0.62
	5G NR-n30	2300	DFT-S QPSK10M	Left Side	0	462000	25	14	Ant 0	w/o	-	1.00	24.00	22.18	1.52	0.18	0.014	0.02
	5G NR-n30	2300	DFT-S QPSK10M	Right Side	15	462000	25	14	Ant 0	w/o	-	1.00	24.00	22.18	1.52	0.05	0.15	0.23
	5G NR-n30	2300	DFT-S QPSK10M	Top Side	0	462000	25	14	Ant 0	w/o	-	1.00	24.00	22.18	1.52	0.03	0.00632	0.01
	5G NR-n30	2300	DFT-S QPSK10M	Bottom Side	0	462000	25	14	Ant 0	w/o	-	1.00	24.00	22.18	1.52	-0.19	0.00867	0.01
27	5G NR-n30	2300	DFT-S QPSK10M	Rear Face	0	462000	1	1	Ant 0	w/	-	1.00	12.00	11.95	1.01	0.14	0.655	0.66
	5G NR-n30	2300	DFT-S QPSK10M	Right Side	0	462000	1	1	Ant 0	w/	-	1.00	12.00	11.95	1.01	-0.16	0.137	0.14
	5G NR-n30	2300	DFT-S QPSK10M	Rear Face	0	462000	25	14	Ant 0	w/	-	1.00	12.00	11.75	1.06	-0.05	0.544	0.58
	5G NR-n30	2300	DFT-S QPSK10M	Right Side	0	462000	25	14	Ant 0	w/	-	1.00	12.00	11.75	1.06	0.01	0.15	0.16
	5G NR-n30	2300	DFT-S QPSK10M	Lid Closed for Laptop	0	462000	1	1	Ant 0	w/	-	1.00	18.50	18.24	1.06	0.03	0.593	0.63
	-	-	-	-	-	-	-	-	-	-	-	-	-	-	-	-	-	-
	5G NR-n38	2600	DFT-S QPSK20M	Bottom for Laptop	0	519000	1	1	Ant 0	w/	-	1.00	19.00	18.79	1.05	-0.02	0.571	0.60
	5G NR-n38	2600	DFT-S QPSK20M	Bottom for Laptop	0	519000	25	13	Ant 0	w/	-	1.00	19.00	18.61	1.09	0.05	0.531	0.58
	5G NR-n38	2600	DFT-S QPSK20M	Rear Face	20	519000	1	1	Ant 0	w/o	-	1.00	24.00	23.33	1.17	-0.02	0.578	0.68
	5G NR-n38	2600	DFT-S QPSK20M	Left Side	0	519000	1	1	Ant 0	w/o	-	1.00	24.00	23.33	1.17	0.09	0.011	0.01
	5G NR-n38	2600	DFT-S QPSK20M	Right Side	15	519000	1	1	Ant 0	w/o	-	1.00	24.00	23.33	1.17	0.01	0.109	0.13
	5G NR-n38	2600	DFT-S QPSK20M	Top Side	0	519000	1	1	Ant 0	w/o	-	1.00	24.00	23.33	1.17	0.15	0.03	0.04
	5G NR-n38	2600	DFT-S QPSK20M	Bottom Side	0	519000	1	1	Ant 0	w/o	-	1.00	24.00	23.33	1.17	-0.02	0.011	0.01
	5G NR-n38	2600	DFT-S QPSK20M	Rear Face	20	519000	25	13	Ant 0	w/o	-	1.00	24.00	23.18	1.21	-0.15	0.513	0.62
	5G NR-n38	2600	DFT-S QPSK20M	Left Side	0	519000	25	13	Ant 0	w/o	-	1.00	24.00	23.18	1.21	0.19	0.01	0.01
	5G NR-n38	2600	DFT-S QPSK20M	Right Side	15	519000	25	13	Ant 0	w/o	-	1.00	24.00	23.18	1.21	0.1	0.108	0.13
	5G NR-n38	2600	DFT-S QPSK20M	Top Side	0	519000	25	13	Ant 0	w/o	-	1.00	24.00	23.18	1.21	0.06	0.031	0.04
	5G NR-n38	2600	DFT-S QPSK20M	Bottom Side	0	519000	25	13	Ant 0	w/o	-	1.00	24.00	23.18	1.21	-0.13	0.011	0.01
	5G NR-n38	2600	DFT-S QPSK20M	Right Side	0	519000	1	1	Ant 0	w/	-	1.00	13.00	12.72	1.07	0.17	0.109	0.12
	5G NR-n38	2600	DFT-S QPSK20M	Rear Face	0	519000	1	1	Ant 0	w/	-	1.00	13.00	12.72	1.07	0.04	0.578	0.62
	5G NR-n38	2600	DFT-S QPSK20M	Rear Face	0	519000	25	13	Ant 0	w/	-	1.00	13.00	11.83	1.31	0.1	0.513	0.67
	5G NR-n38	2600	DFT-S QPSK20M	Right Side	0	519000	25	13	Ant 0	w/	-	1.00	13.00	11.83	1.31	0.06	0.108	0.14
28	5G NR-n38	2600	DFT-S QPSK20M	Rear Face	0	516000	1	1	Ant 0	w/	-	1.00	13.00	12.44	1.14	0.06	0.588	0.67
	5G NR-n38	2600	DFT-S QPSK20M	Rear Face	0	522000	1	1	Ant 0	w/	-	1.00	13.00	12.34	1.16	0.01	0.565	0.66
	5G NR-n38	2600	DFT-S QPSK20M	Lid Closed for Laptop	0	519000	1	1	Ant 0	w/	-	1.00	19.00	18.79	1.05	-0.02	0.547	0.57
	-	-	-	-	-	-	-	-	-	-	-	-	-	-	-	-	-	-
	5G NR-n40	2300	DFT-S QPSK80M	Bottom for Laptop	0	470000	1	1	Ant 0	w/	-	1.00	18.00	17.77	1.05	-0.05	0.607	0.64
	5G NR-n40	2300	DFT-S QPSK80M	Bottom for Laptop	0	470000	108	55	Ant 0	w/	-	1.00	18.00	17.66	1.08	0.14	0.588	0.64
	5G NR-n40	2300	DFT-S QPSK80M	Rear Face	20	470000	1	1	Ant 0	w/o	-	1.00	24.00	23.69	1.07	-0.16	0.593	0.63
	5G NR-n40	2300	DFT-S QPSK80M	Left Side	0	470000	1	1	Ant 0	w/o	-	1.00	24.00	23.69	1.07	-0.17	0.013	0.01
	5G NR-n40	2300	DFT-S QPSK80M	Right Side	15	470000	1	1	Ant 0	w/o	-	1.00	24.00	23.69	1.07	0.09	0.164	0.18
	5G NR-n40	2300	DFT-S QPSK80M	Top Side	0	470000	1	1	Ant 0	w/o	-	1.00	24.00	23.69	1.07	-0.16	0.00701	0.01
	5G NR-n40	2300	DFT-S QPSK80M	Bottom Side	0	470000	1	1	Ant 0	w/o	-	1.00	24.00	23.69	1.07	0.14	0.00913	0.01
	5G NR-n40	2300	DFT-S QPSK80M	Rear Face	0	470000	108	55	Ant 0	w/o	-	1.00	24.00	23.57	1.10	0	0.587	0.65
	5G NR-n40	2300	DFT-S QPSK80M	Left Side	0	470000	108	55	Ant 0	w/o	-	1.00	24.00	23.57	1.10	-0.13	0.016	0.02
	5G NR-n40	2300	DFT-S QPSK80M	Right Side	0	470000	108	55	Ant 0	w/o	-	1.00	24.00	23.57	1.10	-0.18	0.181	0.20
	5G NR-n40	2300	DFT-S QPSK80M	Top Side	0	470000	108	55	Ant 0	w/o	-	1.00	24.00	23.57	1.10	0.13	0.013	0.01
	5G NR-n40	2300	DFT-S QPSK80M	Bottom Side	0	470000	108	55	Ant 0	w/o	-	1.00	24.00	23.57	1.10	0.01	0.00821	0.01
29	5G NR-n40	2300	DFT-S QPSK80M	Rear Face	0	470000	1	1	Ant 0	w/	-	1.00	13.50	13.46	1.01	0.19	0.645	0.65
	5G NR-n40	2300	DFT-S QPSK80M	Right Side	0	470000	1	1	Ant 0	w/	-	1.00	13.50	13.46	1.01	0.1	0.164	0.17
	5G NR-n40	2300	DFT-S QPSK80M	Rear Face	0	470000	108	55	Ant 0	w/	-	1.00	13.50	13.31	1.04	-0.07	0.593	0.62
	5G NR-n40	2300	DFT-S QPSK80M	Right Side	0	470000	108	55	Ant 0	w/	-	1.00	13.50	13.31	1.04	-0.17	0.475	0.49
	5G NR-n40	2300	DFT-S QPSK80M	Rear Face	0	468000	1	1	Ant 0	w/	-	1.00	13.50	13.37	1.03	-0.02	0.61	0.63
	5G NR-n40	2300	DFT-S QPSK80M	Rear Face	0	472000	1	1	Ant 0	w/	-	1.00	13.50	13.39	1.03	-0.18	0.614	0.63
	5G NR-n40	2300	DFT-S QPSK80M	Lid Closed for Laptop	0	470000	1	1	Ant 0	w/	-	1.00	18.00	17.77	1.05	-0.17	0.585	0.61

Body SAR Test Result

System & Position										DUT & Accessory			SAR					
Plot No.	Band	Frequency For System Check (MHz)	Mode	Test Position	Separation Distance (mm)	Channel	RB#	RB offset	Ant Status	Power Reduction	Duty Cycle	Crest Factor	Max. Tune-up Power (dBm)	Measured Conducted Power (dBm)	Scaling Factor	Power Drift (dB)	Measured SAR-1g (W/kg)	Scaled SAR-1g (W/kg)
	5G NR-n41	2600	DFT-S QPSK100M	Bottom for Laptop	0	518598	1	1	Ant 2	w/	-	1.00	17.00	16.99	1.00	-0.05	0.559	0.56
	5G NR-n41	2600	DFT-S QPSK100M	Bottom for Laptop	0	518598	135	69	Ant 2	w/	-	1.00	17.00	16.51	1.12	-0.07	0.502	0.56
	5G NR-n41	2600	DFT-S QPSK100M	Rear Face	20	518598	1	1	Ant 2	w/o	-	1.00	27.00	26.74	1.06	-0.04	0.112	0.12
	5G NR-n41	2600	DFT-S QPSK100M	Left Side	15	518598	1	1	Ant 2	w/o	-	1.00	27.00	26.74	1.06	0.13	0.092	0.10
	5G NR-n41	2600	DFT-S QPSK100M	Right Side	0	518598	1	1	Ant 2	w/o	-	1.00	27.00	26.74	1.06	-0.04	0.058	0.06
	5G NR-n41	2600	DFT-S QPSK100M	Top Side	0	518598	1	1	Ant 2	w/o	-	1.00	27.00	26.74	1.06	-0.16	0.108	0.11
	5G NR-n41	2600	DFT-S QPSK100M	Bottom Side	0	518598	1	1	Ant 2	w/o	-	1.00	27.00	26.74	1.06	-0.15	0.038	0.04
	5G NR-n41	2600	DFT-S QPSK100M	Rear Face	20	518598	135	69	Ant 2	w/o	-	1.00	27.00	26.70	1.07	-0.13	0.104	0.11
	5G NR-n41	2600	DFT-S QPSK100M	Left Side	15	518598	135	69	Ant 2	w/o	-	1.00	27.00	26.70	1.07	-0.04	0.074	0.08
	5G NR-n41	2600	DFT-S QPSK100M	Right Side	0	518598	135	69	Ant 2	w/o	-	1.00	27.00	26.70	1.07	0.06	0.074	0.08
	5G NR-n41	2600	DFT-S QPSK100M	Top Side	0	518598	135	69	Ant 2	w/o	-	1.00	27.00	26.70	1.07	-0.07	0.103	0.11
	5G NR-n41	2600	DFT-S QPSK100M	Bottom Side	0	518598	135	69	Ant 2	w/o	-	1.00	27.00	26.70	1.07	-0.08	0.038	0.04
	5G NR-n41	2600	DFT-S QPSK100M	Rear Face	0	518598	1	1	Ant 2	w/	-	1.00	15.00	14.95	1.01	-0.02	0.571	0.58
	5G NR-n41	2600	DFT-S QPSK100M	Left Side	0	518598	1	1	Ant 2	w/	-	1.00	15.00	14.95	1.01	-0.19	0.284	0.29
	5G NR-n41	2600	DFT-S QPSK100M	Rear Face	0	518598	135	69	Ant 2	w/	-	1.00	15.00	14.94	1.01	-0.08	0.532	0.54
	5G NR-n41	2600	DFT-S QPSK100M	Left Side	0	518598	135	69	Ant 2	w/	-	1.00	15.00	14.94	1.01	0.07	0.262	0.26
30	5G NR-n41	2600	DFT-S QPSK100M	Rear Face	0	509202	1	1	Ant 2	w/	-	1.00	15.00	14.91	1.02	-0.05	0.587	0.60
	5G NR-n41	2600	DFT-S QPSK100M	Rear Face	0	513900	1	1	Ant 2	w/	-	1.00	15.00	14.81	1.04	-0.13	0.532	0.55
	5G NR-n41	2600	DFT-S QPSK100M	Rear Face	0	523302	1	1	Ant 2	w/	-	1.00	15.00	14.83	1.04	-0.04	0.57	0.59
	5G NR-n41	2600	DFT-S QPSK100M	Rear Face	0	528000	1	1	Ant 2	w/	-	1.00	15.00	14.79	1.05	0.06	0.553	0.58
	5G NR-n41	2600	DFT-S QPSK100M	Lid Closed for Laptop	0	518598	1	1	Ant 2	w/	-	1.00	17.00	16.99	1.00	-0.07	0.539	0.54
	5G NR-n66	1750	DFT-S QPSK40M	Bottom for Laptop	0	349000	1	1	Ant 0	w/	-	1.00	17.00	16.99	1.00	0.02	0.625	0.63
	5G NR-n66	1750	DFT-S QPSK40M	Bottom for Laptop	0	349000	108	54	Ant 0	w/	-	1.00	17.00	16.34	1.16	0.04	0.528	0.61
	5G NR-n66	1750	DFT-S QPSK40M	Rear Face	20	349000	1	1	Ant 0	w/o	-	1.00	24.00	23.86	1.03	-0.03	0.641	0.66
	5G NR-n66	1750	DFT-S QPSK40M	Left Side	0	349000	1	1	Ant 0	w/o	-	1.00	24.00	23.86	1.03	-0.09	0.01	0.01
	5G NR-n66	1750	DFT-S QPSK40M	Right Side	15	349000	1	1	Ant 0	w/o	-	1.00	24.00	23.86	1.03	-0.02	0.208	0.21
	5G NR-n66	1750	DFT-S QPSK40M	Top Side	0	349000	1	1	Ant 0	w/o	-	1.00	24.00	23.86	1.03	0.01	0.016	0.02
	5G NR-n66	1750	DFT-S QPSK40M	Bottom Side	0	349000	1	1	Ant 0	w/o	-	1.00	24.00	23.86	1.03	0.03	0.023	0.02
	5G NR-n66	1750	DFT-S QPSK40M	Rear Face	20	349000	108	54	Ant 0	w/o	-	1.00	24.00	23.85	1.04	-0.07	0.644	0.67
	5G NR-n66	1750	DFT-S QPSK40M	Left Side	0	349000	108	54	Ant 0	w/o	-	1.00	24.00	23.85	1.04	-0.04	0.01	0.01
	5G NR-n66	1750	DFT-S QPSK40M	Right Side	15	349000	108	54	Ant 0	w/o	-	1.00	24.00	23.85	1.04	0.03	0.208	0.22
	5G NR-n66	1750	DFT-S QPSK40M	Top Side	0	349000	108	54	Ant 0	w/o	-	1.00	24.00	23.85	1.04	0.04	0.016	0.02
	5G NR-n66	1750	DFT-S QPSK40M	Bottom Side	0	349000	108	54	Ant 0	w/o	-	1.00	24.00	23.85	1.04	0.13	0.021	0.02
32	5G NR-n66	1750	DFT-S QPSK40M	Rear Face	0	349000	1	1	Ant 0	w/	-	1.00	14.00	13.62	1.09	-0.09	0.678	0.74
	5G NR-n66	1750	DFT-S QPSK40M	Right Side	0	349000	1	1	Ant 0	w/	-	1.00	14.00	13.62	1.09	0.16	0.208	0.23
	5G NR-n66	1750	DFT-S QPSK40M	Rear Face	0	349000	108	54	Ant 0	w/	-	1.00	14.00	12.84	1.31	0.02	0.533	0.70
	5G NR-n66	1750	DFT-S QPSK40M	Right Side	0	349000	108	54	Ant 0	w/	-	1.00	14.00	12.84	1.31	-0.18	0.208	0.27
	5G NR-n66	1750	DFT-S QPSK40M	Rear Face	0	346000	1	1	Ant 0	w/	-	1.00	14.00	13.57	1.10	0.05	0.624	0.69
	5G NR-n66	1750	DFT-S QPSK40M	Rear Face	0	352000	1	1	Ant 0	w/	-	1.00	14.00	13.61	1.09	-0.18	0.629	0.69
	5G NR-n66	1750	DFT-S QPSK40M	Lid Closed for Laptop	0	349000	1	1	Ant 0	w/	-	1.00	17.00	16.99	1.00	0.05	0.556	0.56
	5G NR-n71	750	DFT-S QPSK20M	Bottom for Laptop	0	136100	1	1	Ant 0	w/	-	1.00	20.00	19.99	1.00	-0.02	0.586	0.59
	5G NR-n71	750	DFT-S QPSK20M	Bottom for Laptop	0	136100	50	28	Ant 0	w/	-	1.00	20.00	19.21	1.20	0.12	0.494	0.59
	5G NR-n71	750	DFT-S QPSK20M	Rear Face	20	136100	1	1	Ant 0	w/o	-	1.00	24.00	23.61	1.09	-0.19	0.62	0.68
	5G NR-n71	750	DFT-S QPSK20M	Left Side	0	136100	1	1	Ant 0	w/o	-	1.00	24.00	23.61	1.09	0	<0.001	0.00
	5G NR-n71	750	DFT-S QPSK20M	Right Side	15	136100	1	1	Ant 0	w/o	-	1.00	24.00	23.61	1.09	0.17	0.368	0.40
	5G NR-n71	750	DFT-S QPSK20M	Top Side	0	136100	1	1	Ant 0	w/o	-	1.00	24.00	23.61	1.09	0	<0.001	0.00
	5G NR-n71	750	DFT-S QPSK20M	Bottom Side	0	136100	1	1	Ant 0	w/o	-	1.00	24.00	23.61	1.09	0	<0.001	0.00
	5G NR-n71	750	DFT-S QPSK20M	Rear Face	20	136100	50	28	Ant 0	w/o	-	1.00	24.00	23.44	1.14	0.12	0.622	0.71
	5G NR-n71	750	DFT-S QPSK20M	Left Side	0	136100	50	28	Ant 0	w/o	-	1.00	24.00	23.44	1.14	0	<0.001	0.00
	5G NR-n71	750	DFT-S QPSK20M	Right Side	15	136100	50	28	Ant 0	w/o	-	1.00	24.00	23.44	1.14	0.11	0.447	0.51
	5G NR-n71	750	DFT-S QPSK20M	Top Side	0	136100	50	28	Ant 0	w/o	-	1.00	24.00	23.44	1.14	0	<0.001	0.00
	5G NR-n71	750	DFT-S QPSK20M	Bottom Side	0	136100	50	28	Ant 0	w/o	-	1.00	24.00	23.44	1.14	0	<0.001	0.00
33	5G NR-n71	750	DFT-S QPSK20M	Rear Face	0	136100	1	1	Ant 0	w/	-	1.00	17.00	16.80	1.05	0.04	0.691	0.73
	5G NR-n71	750	DFT-S QPSK20M	Right Side	0	136100	1	1	Ant 0	w/	-	1.00	17.00	16.80	1.05	0.12	0.368	0.39
	5G NR-n71	750	DFT-S QPSK20M	Rear Face	0	136100	50	28	Ant 0	w/	-	1.00	17.00	15.71	1.35	-0.05	0.508	0.69
	5G NR-n71	750	DFT-S QPSK20M	Right Side	0	136100	50	28	Ant 0	w/	-	1.00	17.00	15.71	1.35	0.02	0.519	0.70
	5G NR-n71	750	DFT-S QPSK20M	Rear Face	0	134600	1	1	Ant 0	w/	-	1.00	17.00	16.79	1.05	-0.05	0.682	0.72
	5G NR-n71	750	DFT-S QPSK20M	Rear Face	0	137600	1	1	Ant 0	w/	-	1.00	17.00	16.66	1.08	0.07	0.447	0.48
	5G NR-n71	750	DFT-S QPSK20M	Lid Closed for Laptop	0	136100	1	1	Ant 0	w/	-	1.00	20.00	19.99	1.00	-0.07	0.543	0.54

Body SAR Test Result																		
System & Position						DUT & Accessory				SAR								
Plot No.	Band	Frequency For System Check (MHz)	Mode	Test Position	Separation Distance (mm)	Channel	RB#	RB offset	Ant Status	Power Reduction	Duty Cycle	Crest Factor	Max. Tune-up Power (dBm)	Measured Conducted Power (dBm)	Scaling Factor	Power Drift (dB)	Measured SAR-1g (W/kg)	Scaled SAR-1g (W/kg)
	5G NR-n77	3700*	DFT-S QPSK100M	Bottom for Laptop	0	653000	1	1	Ant 2	w/	-	1.00	20.50	20.49	1.00	-0.04	0.605	0.61
	5G NR-n77	3700*	DFT-S QPSK100M	Bottom for Laptop	0	653000	135	69	Ant 2	w/	-	1.00	20.50	20.17	1.08	-0.03	0.533	0.58
	5G NR-n77	3700*	DFT-S QPSK100M	Rear Face	20	653000	1	1	Ant 2	w/o	-	1.00	27.00	26.71	1.07	-0.08	0.277	0.30
	5G NR-n77	3700*	DFT-S QPSK100M	Left Side	15	653000	1	1	Ant 2	w/o	-	1.00	27.00	26.71	1.07	0.07	0.157	0.17
	5G NR-n77	3700*	DFT-S QPSK100M	Right Side	0	653000	1	1	Ant 2	w/o	-	1.00	27.00	26.71	1.07	-0.19	0.031	0.03
	5G NR-n77	3700*	DFT-S QPSK100M	Top Side	0	653000	1	1	Ant 2	w/o	-	1.00	27.00	26.71	1.07	0.09	0.096	0.10
	5G NR-n77	3700*	DFT-S QPSK100M	Bottom Side	0	653000	1	1	Ant 2	w/o	-	1.00	27.00	26.71	1.07	0	<-0.001	0.00
	5G NR-n77	3700*	DFT-S QPSK100M	Rear Face	20	653000	135	69	Ant 2	w/o	-	1.00	27.00	26.70	1.07	-0.15	0.143	0.15
	5G NR-n77	3700*	DFT-S QPSK100M	Left Side	15	653000	135	69	Ant 2	w/o	-	1.00	27.00	26.70	1.07	0.15	0.173	0.19
	5G NR-n77	3700*	DFT-S QPSK100M	Right Side	0	653000	135	69	Ant 2	w/o	-	1.00	27.00	26.70	1.07	-0.14	0.042	0.04
	5G NR-n77	3700*	DFT-S QPSK100M	Top Side	0	653000	135	69	Ant 2	w/o	-	1.00	27.00	26.70	1.07	-0.03	0.087	0.09
	5G NR-n77	3700*	DFT-S QPSK100M	Bottom Side	0	653000	135	69	Ant 2	w/o	-	1.00	27.00	26.70	1.07	0.06	0.034	0.04
	5G NR-n77	3700*	DFT-S QPSK100M	Rear Face	0	653000	1	1	Ant 2	w/	-	1.00	11.00	10.68	1.08	-0.03	0.474	0.51
	5G NR-n77	3700*	DFT-S QPSK100M	Left Side	0	653000	1	1	Ant 2	w/	-	1.00	11.00	10.68	1.08	-0.1	0.156	0.17
	5G NR-n77	3700*	DFT-S QPSK100M	Rear Face	0	653000	135	69	Ant 2	w/	-	1.00	11.00	10.41	1.15	-0.14	0.419	0.48
	5G NR-n77	3700*	DFT-S QPSK100M	Left Side	0	653000	135	69	Ant 2	w/	-	1.00	11.00	10.41	1.15	-0.14	0.141	0.16
	5G NR-n77	3700*	DFT-S QPSK100M	Rear Face	0	650000	1	1	Ant 2	w/	-	1.00	11.00	10.33	1.17	-0.14	0.468	0.55
	5G NR-n77	3700*	DFT-S QPSK100M	Rear Face	0	656000	1	1	Ant 2	w/	-	1.00	11.00	10.63	1.09	-0.03	0.516	0.56
	5G NR-n77	3700*	DFT-S QPSK100M	Rear Face	0	659000	1	1	Ant 2	w/	-	1.00	11.00	10.55	1.11	0.06	0.449	0.50
34	5G NR-n77	3700*	DFT-S QPSK100M	Rear Face	0	662000	1	1	Ant 2	w/	-	1.00	11.00	10.42	1.14	0.05	0.621	0.71
	5G NR-n77	3700*	DFT-S QPSK100M	Lid Closed for Laptop	0	653000	1	1	Ant 2	w/	-	1.00	20.50	20.49	1.00	-0.03	0.539	0.54
	5G NR-n78	3500*	DFT-S QPSK100M	Bottom for Laptop	0	650000	1	1	Ant 2	w/	-	1.00	21.00	20.98	1.00	0.07	0.631	0.63
	5G NR-n78	3500*	DFT-S QPSK100M	Bottom for Laptop	0	650000	135	69	Ant 2	w/	-	1.00	21.00	20.78	1.05	0.04	0.562	0.59
	5G NR-n78	3500*	DFT-S QPSK100M	Rear Face	20	650000	1	1	Ant 2	w/o	-	1.00	27.00	25.71	1.35	0.01	0.148	0.20
	5G NR-n78	3500*	DFT-S QPSK100M	Left Side	15	650000	1	1	Ant 2	w/o	-	1.00	27.00	25.71	1.35	0.05	0.193	0.26
	5G NR-n78	3500*	DFT-S QPSK100M	Right Side	0	650000	1	1	Ant 2	w/o	-	1.00	27.00	25.71	1.35	0	<-0.001	0.00
	5G NR-n78	3500*	DFT-S QPSK100M	Top Side	0	650000	1	1	Ant 2	w/o	-	1.00	27.00	25.71	1.35	0.05	0.168	0.23
	5G NR-n78	3500*	DFT-S QPSK100M	Bottom Side	0	650000	1	1	Ant 2	w/o	-	1.00	27.00	25.71	1.35	0	<-0.001	0.00
	5G NR-n78	3500*	DFT-S QPSK100M	Rear Face	0	650000	135	69	Ant 2	w/o	-	1.00	27.00	25.46	1.43	-0.14	0.134	0.19
	5G NR-n78	3500*	DFT-S QPSK100M	Left Side	0	650000	135	69	Ant 2	w/o	-	1.00	27.00	25.46	1.43	-0.19	0.178	0.25
	5G NR-n78	3500*	DFT-S QPSK100M	Right Side	0	650000	135	69	Ant 2	w/o	-	1.00	27.00	25.46	1.43	0.16	0.059	0.08
	5G NR-n78	3500*	DFT-S QPSK100M	Top Side	0	650000	135	69	Ant 2	w/o	-	1.00	27.00	25.46	1.43	-0.16	0.271	0.39
	5G NR-n78	3500*	DFT-S QPSK100M	Bottom Side	0	650000	135	69	Ant 2	w/o	-	1.00	27.00	25.46	1.43	0	<-0.001	0.00
35	5G NR-n78	3500*	DFT-S QPSK100M	Rear Face	0	650000	1	1	Ant 2	w/	-	1.00	11.00	10.88	1.03	0.1	0.663	0.68
	5G NR-n78	3500*	DFT-S QPSK100M	Left Side	0	650000	1	1	Ant 2	w/	-	1.00	11.00	10.88	1.03	0.05	0.163	0.17
	5G NR-n78	3500*	DFT-S QPSK100M	Rear Face	0	650000	135	69	Ant 2	w/	-	1.00	11.00	10.46	1.13	0.18	0.526	0.59
	5G NR-n78	3500*	DFT-S QPSK100M	Left Side	0	650000	135	69	Ant 2	w/	-	1.00	11.00	10.46	1.13	-0.14	0.121	0.14
	5G NR-n78	3500*	DFT-S QPSK100M	Lid Closed for Laptop	0	650000	1	1	Ant 2	w/	-	1.00	21.00	20.98	1.00	-0.19	0.619	0.62

Body SAR Test Result																		
System & Position								DUT & Accessory		SAR								
Plot No.	Band	Frequency For System Check (MHz)	Mode	Test Position	Separation Distance (mm)	Channel	RB#	RB offset	Ant Status	Power Reduction	Duty Cycle	Crest Factor	Max. Tune-up Power (dBm)	Measured Conducted Power (dBm)	Scaling Factor	Power Drift (dB)	Measured SAR-1g (W/kg)	Scaled SAR-1g (W/kg)
	WLAN2.4G	2450	802.11b	Bottom for Laptop	0	6			Ant 0		98.20	1.02	20.00	19.98	1.00	0	<0.001	0.00
	WLAN2.4G	2450	802.11b	Bottom for Laptop	0	6			Ant 1		99.10	1.01	20.00	19.91	1.02	0	<0.001	0.00
	WLAN2.4G	2450	802.11n HT20	Bottom for Laptop	0	6			Ant 0+1		99.20	1.01	20.50	20.47	1.01	0	<0.001	0.00
	WLAN2.4G	2450	802.11b	Rear Face	0	6			Ant 0		98.20	1.02	18.50	18.49	1.00	0.09	0.083	0.08
	WLAN2.4G	2450	802.11b	Left Side	0	6			Ant 0		98.20	1.02	18.50	18.49	1.00	-0.15	0.04	0.04
	WLAN2.4G	2450	802.11b	Right Side	0	6			Ant 0		98.20	1.02	18.50	18.49	1.00	0	<0.001	0.00
	WLAN2.4G	2450	802.11b	Top Side	0	6			Ant 0		98.20	1.02	18.50	18.49	1.00	0.01	0.385	0.39
	WLAN2.4G	2450	802.11b	Bottom Side	0	6			Ant 0		98.20	1.02	18.50	18.49	1.00	0	<0.001	0.00
	WLAN2.4G	2450	802.11b	Rear Face	0	6			Ant 1		99.10	1.01	20.00	19.91	1.02	-0.15	0.09	0.09
	WLAN2.4G	2450	802.11b	Left Side	0	6			Ant 1		99.10	1.01	20.00	19.91	1.02	0	<0.001	0.00
	WLAN2.4G	2450	802.11b	Right Side	0	6			Ant 1		99.10	1.01	20.00	19.91	1.02	-0.13	0.051	0.05
36	WLAN2.4G	2450	802.11b	Top Side	0	6			Ant 1		99.10	1.01	20.00	19.91	1.02	-0.06	0.485	0.50
	WLAN2.4G	2450	802.11b	Bottom Side	0	6			Ant 1		99.10	1.01	20.00	19.91	1.02	0	<0.001	0.00
	WLAN2.4G	2450	802.11n HT20	Rear Face	0	6			Ant 0+1		99.20	1.01	20.50	20.47	1.01	-0.1	0.072	0.07
	WLAN2.4G	2450	802.11n HT20	Left Side	0	6			Ant 0+1		99.20	1.01	20.50	20.47	1.01	-0.04	0.076	0.08
	WLAN2.4G	2450	802.11n HT20	Right Side	0	6			Ant 0+1		99.20	1.01	20.50	20.47	1.01	0.11	0.065	0.07
	WLAN2.4G	2450	802.11n HT20	Top Side	0	6			Ant 0+1		99.20	1.01	20.50	20.47	1.01	0.03	0.378	0.39
	WLAN2.4G	2450	802.11n HT20	Bottom Side	0	6			Ant 0+1		99.20	1.01	20.50	20.47	1.01	0	<0.001	0.00
	WLAN2.4G	2450	802.11b	Top Side	0	1			Ant 1		99.10	1.01	19.50	19.43	1.02	0.05	0.21	0.22
	WLAN2.4G	2450	802.11b	Top Side	0	11			Ant 1		99.10	1.01	19.50	19.41	1.02	-0.07	0.306	0.32
	WLAN2.4G	2450	802.11b	Top Side	0	12			Ant 1		99.10	1.01	18.50	18.42	1.02	-0.03	0.222	0.23
	WLAN2.4G	2450	802.11b	Top Side	0	13			Ant 1		99.10	1.01	15.00	14.95	1.01	-0.18	0.097	0.10
	WLAN2.4G	2450	802.11b	Lid Closed for Laptop	0	6			Ant 1		99.10	1.01	20.00	19.91	1.02	-0.05	0.138	0.14
	WLAN5.3G	5250	802.11a	Bottom for Laptop	0	56			Ant 0		94.90	1.05	20.00	19.97	1.01	0	<0.001	0.00
	WLAN5.3G	5250	802.11a	Bottom for Laptop	0	56			Ant 1		95.90	1.04	20.00	19.93	1.02	0	<0.001	0.00
	WLAN5.3G	5250	802.11n HT20	Bottom for Laptop	0	56			Ant 0+1		99.40	1.01	20.50	20.46	1.01	0	<0.001	0.00
	WLAN5.3G	5250	802.11ac VHT80	Rear Face	0	58			Ant 0		97.90	1.02	12.50	12.41	1.02	-0.18	0.095	0.10
	WLAN5.3G	5250	802.11ac VHT80	Left Side	0	58			Ant 0		97.90	1.02	12.50	12.41	1.02	0.08	0.123	0.13
	WLAN5.3G	5250	802.11ac VHT80	Right Side	0	58			Ant 0		97.90	1.02	12.50	12.41	1.02	0	<0.001	0.00
37	WLAN5.3G	5250	802.11ac VHT80	Top Side	0	58			Ant 0		97.90	1.02	12.50	12.41	1.02	-0.11	0.721	0.75
	WLAN5.3G	5250	802.11ac VHT80	Bottom Side	0	58			Ant 0		97.90	1.02	12.50	12.41	1.02	0	<0.001	0.00
	WLAN5.3G	5250	802.11ac VHT80	Rear Face	0	58			Ant 1		97.60	1.02	15.00	14.95	1.01	-0.01	0.105	0.11
	WLAN5.3G	5250	802.11ac VHT80	Left Side	0	58			Ant 1		97.60	1.02	15.00	14.95	1.01	0	<0.001	0.00
	WLAN5.3G	5250	802.11ac VHT80	Right Side	0	58			Ant 1		97.60	1.02	15.00	14.95	1.01	0.18	0.073	0.08
	WLAN5.3G	5250	802.11ac VHT80	Top Side	0	58			Ant 1		97.60	1.02	15.00	14.95	1.01	0.17	0.702	0.72
	WLAN5.3G	5250	802.11ac VHT80	Bottom Side	0	58			Ant 1		97.60	1.02	15.00	14.95	1.01	0	<0.001	0.00
	WLAN5.3G	5250	802.11n HT40	Rear Face	0	54			Ant 0+1		99.30	1.01	18.00	17.97	1.01	0.02	0.092	0.09
	WLAN5.3G	5250	802.11n HT40	Left Side	0	54			Ant 0+1		99.30	1.01	18.00	17.97	1.01	-0.08	0.093	0.09
	WLAN5.3G	5250	802.11n HT40	Right Side	0	54			Ant 0+1		99.30	1.01	18.00	17.97	1.01	0.09	0.096	0.10
	WLAN5.3G	5250	802.11n HT40	Top Side	0	54			Ant 0+1		99.30	1.01	18.00	17.97	1.01	-0.04	0.701	0.72
	WLAN5.3G	5250	802.11n HT40	Bottom Side	0	54			Ant 0+1		99.30	1.01	18.00	17.97	1.01	0	<0.001	0.00
	WLAN5.3G	5250	802.11a	Lid Closed for Laptop	0	56			Ant 0		94.90	1.05	20.00	19.97	1.01	0.14	0.48	0.51

Body SAR Test Result

System & Position										DUT & Accessory		SAR						
Plot No.	Band	Frequency For System Check (MHz)	Mode	Test Position	Separation Distance (mm)	Channel	RB#	RB offset	Ant Status	Power Reduction	Duty Cycle	Crest Factor	Max. Tune-up Power (dBm)	Measured Conducted Power (dBm)	Scaling Factor	Power Drift (dB)	Measured SAR-1g (W/kg)	Scaled SAR-1g (W/kg)
	WLAN5.6G	5600	802.11ac VHT80	Bottom for Laptop	0	138			Ant 0		96.90	1.03	20.00	18.96	1.27	0	<0.001	0.00
	WLAN5.6G	5600	802.11ac VHT80	Bottom for Laptop	0	138			Ant 1		97.60	1.02	20.00	19.91	1.02	0	<0.001	0.00
	WLAN5.6G	5600	802.11ac VHT80	Bottom for Laptop	0	138			Ant 0+1		98.60	1.01	20.50	20.45	1.01	0	<0.001	0.00
	WLAN5.6G	5600	802.11ac VHT80	Rear Face	0	138			Ant 0		96.90	1.03	12.50	12.49	1.00	0.16	0.081	0.08
	WLAN5.6G	5600	802.11ac VHT80	Left Side	0	138			Ant 0		96.90	1.03	12.50	12.49	1.00	-0.18	0.055	0.06
	WLAN5.6G	5600	802.11ac VHT80	Right Side	0	138			Ant 0		96.90	1.03	12.50	12.49	1.00	0	<0.001	0.00
	WLAN5.6G	5600	802.11ac VHT80	Top Side	0	138			Ant 0		96.90	1.03	12.50	12.49	1.00	-0.02	0.612	0.63
	WLAN5.6G	5600	802.11ac VHT80	Bottom Side	0	138			Ant 0		96.90	1.03	12.50	12.49	1.00	0	<0.001	0.00
	WLAN5.6G	5600	802.11ac VHT80	Rear Face	0	138			Ant 1		97.60	1.02	15.00	14.88	1.03	-0.11	0.119	0.13
	WLAN5.6G	5600	802.11ac VHT80	Left Side	0	138			Ant 1		97.60	1.02	15.00	14.88	1.03	0	<0.001	0.00
	WLAN5.6G	5600	802.11ac VHT80	Right Side	0	138			Ant 1		97.60	1.02	15.00	14.88	1.03	0.11	0.08	0.08
38	WLAN5.6G	5600	802.11ac VHT80	Top Side	0	138			Ant 1		97.60	1.02	15.00	14.88	1.03	0.02	0.761	0.80
	WLAN5.6G	5600	802.11ac VHT80	Bottom Side	0	138			Ant 1		97.60	1.02	15.00	14.88	1.03	0	<0.001	0.00
	WLAN5.6G	5600	802.11ac VHT80	Rear Face	0	138			Ant 0+1		98.60	1.01	17.00	16.96	1.01	-0.04	0.096	0.10
	WLAN5.6G	5600	802.11ac VHT80	Left Side	0	138			Ant 0+1		98.60	1.01	17.00	16.96	1.01	-0.11	0.075	0.08
	WLAN5.6G	5600	802.11ac VHT80	Right Side	0	138			Ant 0+1		98.60	1.01	17.00	16.96	1.01	-0.13	0.078	0.08
	WLAN5.6G	5600	802.11ac VHT80	Top Side	0	138			Ant 0+1		98.60	1.01	17.00	16.96	1.01	0.18	0.566	0.58
	WLAN5.6G	5600	802.11ac VHT80	Bottom Side	0	138			Ant 0+1		98.60	1.01	17.00	16.96	1.01	0	<0.001	0.00
	WLAN5.6G	5600	802.11ac VHT80	Top Side	0	106			Ant 1		97.60	1.02	15.00	14.63	1.09	0.09	0.693	0.77
	WLAN5.6G	5600	802.11ac VHT80	Lid Closed for Laptop	0	138			Ant 0		96.90	1.03	0.00	0.00	1	0.09	0.427	0.44
	-	-	-	-	-	-			-		-	-	-	-	-	-	-	-
	WLAN5.8G	5750	802.11n HT40	Bottom for Laptop	0	151			Ant 0		97.90	1.02	18.50	18.44	1.01	0	<0.001	0.00
	WLAN5.8G	5750	802.11n HT40	Bottom for Laptop	0	151			Ant 1		96.40	1.04	19.00	18.85	1.04	0	<0.001	0.00
	WLAN5.8G	5750	802.11n HT40	Bottom for Laptop	0	151			Ant 0+1		99.30	1.01	20.50	20.46	1.01	0	<0.001	0.00
	WLAN5.8G	5750	802.11ac VHT80	Rear Face	0	155			Ant 0		96.90	1.03	13.50	13.49	1.00	0.12	0.095	0.10
	WLAN5.8G	5750	802.11ac VHT80	Left Side	0	155			Ant 0		96.90	1.03	13.50	13.49	1.00	-0.16	0.08	0.08
	WLAN5.8G	5750	802.11ac VHT80	Right Side	0	155			Ant 0		96.90	1.03	13.50	13.49	1.00	0	<0.001	0.00
	WLAN5.8G	5750	802.11ac VHT80	Top Side	0	155			Ant 0		96.90	1.03	13.50	13.49	1.00	0.01	0.747	0.77
	WLAN5.8G	5750	802.11ac VHT80	Bottom Side	0	155			Ant 0		96.90	1.03	13.50	13.49	1.00	0	<0.001	0.00
	WLAN5.8G	5750	802.11ac VHT80	Rear Face	0	155			Ant 1		97.60	1.02	15.00	14.68	1.08	0.1	0.116	0.13
	WLAN5.8G	5750	802.11ac VHT80	Left Side	0	155			Ant 1		97.60	1.02	15.00	14.68	1.08	0	<0.001	0.00
	WLAN5.8G	5750	802.11ac VHT80	Right Side	0	155			Ant 1		97.60	1.02	15.00	14.68	1.08	0.08	0.083	0.09
39	WLAN5.8G	5750	802.11ac VHT80	Top Side	0	155			Ant 1		97.60	1.02	15.00	14.68	1.08	-0.07	0.713	0.79
	WLAN5.8G	5750	802.11ac VHT80	Bottom Side	0	155			Ant 1		97.60	1.02	15.00	14.68	1.08	0	<0.001	0.00
	WLAN5.8G	5750	802.11ac VHT80	Rear Face	0	155			Ant 0+1		98.60	1.01	17.50	17.45	1.01	0.03	0.097	0.10
	WLAN5.8G	5750	802.11ac VHT80	Left Side	0	155			Ant 0+1		98.60	1.01	17.50	17.45	1.01	-0.18	0.052	0.05
	WLAN5.8G	5750	802.11ac VHT80	Right Side	0	155			Ant 0+1		98.60	1.01	17.50	17.45	1.01	0.18	0.07	0.07
	WLAN5.8G	5750	802.11ac VHT80	Top Side	0	155			Ant 0+1		98.60	1.01	17.50	17.45	1.01	-0.09	0.749	0.76
	WLAN5.8G	5750	802.11ac VHT80	Bottom Side	0	155			Ant 0+1		98.60	1.01	17.50	17.45	1.01	0	<0.001	0.00
	WLAN5.8G	5750	802.11n HT40	Lid Closed for Laptop	0	151			Ant 0		97.90	1.02	18.50	18.44	1.01	-0.08	0.403	0.42
	-	-	-	-	-	-			-		-	-	-	-	-	-	-	-
	BT	2450	BDR	Bottom for Laptop	0	39			Ant 1		76.80	1.30	8.00	7.99	1.00	0	<0.001	0.00
	BT	2450	BDR	Rear Face	0	39			Ant 1		76.80	1.30	8.00	7.99	1.00	0	<0.001	0.00
	BT	2450	BDR	Left Side	0	39			Ant 1		76.80	1.30	8.00	7.99	1.00	0	<0.001	0.00
	BT	2450	BDR	Right Side	0	39			Ant 1		76.80	1.30	8.00	7.99	1.00	0	<0.001	0.00
40	BT	2450	BDR	Top Side	0	39			Ant 1		76.80	1.30	8.00	7.99	1.00	-0.01	0.027	0.04
	BT	2450	BDR	Bottom Side	0	39			Ant 1		76.80	1.30	8.00	7.99	1.00	0	<0.001	0.00
	BT	2450	BDR	Top Side	0	0			Ant 1		76.80	1.30	8.00	7.79	1.05	0	<0.001	0.00
	BT	2450	BDR	Top Side	0	78			Ant 1		76.80	1.30	8.00	7.96	1.01	0	<0.001	0.00
	BT	2450	BDR	Lid Closed for Laptop	0	39			Ant 1		76.80	1.30	8.00	7.99	1.00	0	<0.001	0.00

Annex G. SAR Measurement Variability

Since all the measured SAR_{1g} are less than 0.8 W/kg, the repeated measurement is not required.

Annex H. Analysis of Simultaneous Transmission SAR.

The analysis of simultaneous transmission SAR are shown as below.

<Possibilities of Simultaneous Transmission>

The simultaneous transmission possibilities for this device are listed as below.

Simultaneous TX Combination	Capable Transmit Configurations	Body Exposure Condition
A	WWAN + WLAN 2.4G_Ant 0 + BT_Ant 1	Yes
B	WWAN + WLAN 5G_Ant 0 + BT_Ant 1	Yes
C	WWAN + WLAN 5G_Ant 0+1 + BT_Ant 1	Yes
D	WLAN 2.4G_Ant 0+BT_Ant 1	Yes
E	WLAN 5G_Ant 0+BT_Ant 1	Yes
F	WLAN 5G_Ant 0+1+BT_Ant 1	Yes

Notes

1. The WLAN 2.4G and WLAN 5G cannot transmit simultaneously.
2. The WLAN and Bluetooth cannot transmit simultaneously.
3. Simultaneous TX Combination D can be covered by A
4. Simultaneous TX Combination E can be covered by B
5. Simultaneous TX Combination F can be covered by C

Simultaneous Transmission SAR Evaluation (Body)									
Band	Position	1	2	5	8	9	A (1+2+9)	B (1+5+9)	C (1+8+9)
		Max WWAN	WLAN 2.4GHz Ant 0	WLAN 5GHz Ant 0	WLAN 5GHz Ant 0+1	BT Ant 1	Summing result 1g SAR W/kg	Summing result 1g SAR W/kg	Summing result 1g SAR W/kg
		1g SAR W/kg	1g SAR W/kg	1g SAR W/kg	1g SAR W/kg	1g SAR W/kg			
WCDMA II	Bottom for Laptop	0.58	0.00	0.00	0.10	0.00	0.58	0.58	0.68
	Back of Panel	0.00	0.15	0.93	0.56	0.00	0.15	0.93	0.56
	Top of Panel	0.00	0.06	0.13	0.09	0.00	0.06	0.13	0.09
	Lid Closed for Laptop	0.27	0.00	0.56	0.00	0.00	0.27	0.83	0.27
	Rear Face	0.59	0.08	0.10	0.10	0.00	0.67	0.69	0.69
	Left Side	0.01	0.04	0.13	0.09	0.00	0.05	0.14	0.10
	Right Side	0.28	0.00	0.00	0.10	0.00	0.28	0.28	0.38
	Top Side	0.03	0.39	0.77	0.76	0.04	0.46	0.84	0.83
WCDMA IV	Bottom for Laptop	0.68	0.00	0.00	0.10	0.00	0.68	0.68	0.78
	Back of Panel	0.00	0.15	0.93	0.56	0.00	0.15	0.93	0.56
	Top of Panel	0.00	0.06	0.13	0.09	0.00	0.06	0.13	0.09
	Lid Closed for Laptop	0.34	0.00	0.56	0.00	0.00	0.34	0.90	0.34
	Rear Face	0.70	0.08	0.10	0.10	0.00	0.78	0.80	0.80
	Left Side	0.01	0.04	0.13	0.09	0.00	0.05	0.14	0.10
	Right Side	0.24	0.00	0.00	0.10	0.00	0.24	0.24	0.34
	Top Side	0.03	0.39	0.77	0.76	0.04	0.46	0.84	0.83
WCDMA V	Bottom for Laptop	0.68	0.00	0.00	0.10	0.00	0.68	0.68	0.78
	Back of Panel	0.00	0.15	0.93	0.56	0.00	0.15	0.93	0.56
	Top of Panel	0.00	0.06	0.13	0.09	0.00	0.06	0.13	0.09
	Lid Closed for Laptop	0.34	0.00	0.56	0.00	0.00	0.34	0.90	0.34
	Rear Face	0.69	0.08	0.10	0.10	0.00	0.77	0.79	0.79
	Left Side	0.00	0.04	0.13	0.09	0.00	0.04	0.13	0.09
	Right Side	0.38	0.00	0.00	0.10	0.00	0.38	0.38	0.48
	Top Side	0.08	0.39	0.77	0.76	0.04	0.51	0.89	0.88
LTE 2	Bottom for Laptop	0.63	0.00	0.00	0.10	0.00	0.63	0.63	0.73
	Back of Panel	0.00	0.15	0.93	0.56	0.00	0.15	0.93	0.56
	Top of Panel	0.00	0.06	0.13	0.09	0.00	0.06	0.13	0.09
	Lid Closed for Laptop	0.32	0.00	0.56	0.00	0.00	0.32	0.88	0.32
	Rear Face	0.67	0.08	0.10	0.10	0.00	0.75	0.77	0.77
	Left Side	0.24	0.04	0.13	0.09	0.00	0.28	0.37	0.33
	Right Side	0.21	0.00	0.00	0.10	0.00	0.21	0.21	0.31
	Top Side	0.02	0.39	0.77	0.76	0.04	0.45	0.83	0.82
LTE 4	Bottom for Laptop	0.68	0.00	0.00	0.10	0.00	0.68	0.68	0.78
	Back of Panel	0.00	0.15	0.93	0.56	0.00	0.15	0.93	0.56
	Top of Panel	0.00	0.06	0.13	0.09	0.00	0.06	0.13	0.09
	Lid Closed for Laptop	0.34	0.00	0.56	0.00	0.00	0.34	0.90	0.34
	Rear Face	0.71	0.08	0.10	0.10	0.00	0.79	0.81	0.81
	Left Side	0.01	0.04	0.13	0.09	0.00	0.05	0.14	0.10
	Right Side	0.22	0.00	0.00	0.10	0.00	0.22	0.22	0.32
	Top Side	0.02	0.39	0.77	0.76	0.04	0.45	0.83	0.82
LTE 5	Bottom for Laptop	0.57	0.00	0.00	0.10	0.00	0.57	0.57	0.67
	Back of Panel	0.00	0.15	0.93	0.56	0.00	0.15	0.93	0.56
	Top of Panel	0.00	0.06	0.13	0.09	0.00	0.06	0.13	0.09
	Lid Closed for Laptop	0.29	0.00	0.56	0.00	0.00	0.29	0.85	0.29
	Rear Face	0.62	0.08	0.10	0.10	0.00	0.70	0.72	0.72
	Left Side	0.00	0.04	0.13	0.09	0.00	0.04	0.13	0.09
	Right Side	0.34	0.00	0.00	0.10	0.00	0.34	0.34	0.44
	Top Side	0.04	0.39	0.77	0.76	0.04	0.47	0.85	0.84
LTE 7	Bottom for Laptop	0.53	0.00	0.00	0.10	0.00	0.53	0.53	0.63
	Back of Panel	0.00	0.15	0.93	0.56	0.00	0.15	0.93	0.56
	Top of Panel	0.00	0.06	0.13	0.09	0.00	0.06	0.13	0.09
	Lid Closed for Laptop	0.51	0.00	0.56	0.00	0.00	0.51	1.07	0.51
	Rear Face	0.68	0.08	0.10	0.10	0.00	0.76	0.78	0.78
	Left Side	0.01	0.04	0.13	0.09	0.00	0.05	0.14	0.10
	Right Side	0.22	0.00	0.00	0.10	0.00	0.22	0.22	0.32
	Top Side	0.03	0.39	0.77	0.76	0.04	0.46	0.84	0.83
	Bottom Side	0.01	0.00	0.00	0.00	0.00	0.01	0.01	0.01

Simultaneous Transmission SAR Evaluation (Body)									
Band	Position	1	2	5	8	9	A (1+2+9)	B (1+5+9)	C (1+8+9)
		Max WWAN	WLAN 2.4GHz Ant 0	WLAN 5GHz Ant 0	WLAN 5GHz Ant 0+1	BT Ant 1	Summimg result 1g SAR W/kg	Summimg result 1g SAR W/kg	Summimg result 1g SAR W/kg
		1g SAR W/kg	1g SAR W/kg	1g SAR W/kg	1g SAR W/kg	1g SAR W/kg			
LTE 12	Bottom for Laptop	0.51	0.00	0.00	0.10	0.00	0.51	0.51	0.61
	Back of Panel	0.00	0.15	0.93	0.56	0.00	0.15	0.93	0.56
	Top of Panel	0.00	0.06	0.13	0.09	0.00	0.06	0.13	0.09
	Lid Closed for Laptop	0.47	0.00	0.56	0.00	0.00	0.47	1.03	0.47
	Rear Face	0.75	0.08	0.10	0.10	0.00	0.83	0.85	0.85
	Left Side	0.00	0.04	0.13	0.09	0.00	0.04	0.13	0.09
	Right Side	0.54	0.00	0.00	0.10	0.00	0.54	0.54	0.64
	Top Side	0.02	0.39	0.77	0.76	0.04	0.45	0.83	0.82
LTE 13	Bottom Side	0.00	0.00	0.00	0.00	0.00	0.00	0.00	0.00
	Bottom for Laptop	0.39	0.00	0.00	0.10	0.00	0.39	0.39	0.49
	Back of Panel	0.00	0.15	0.93	0.56	0.00	0.15	0.93	0.56
	Top of Panel	0.00	0.06	0.13	0.09	0.00	0.06	0.13	0.09
	Lid Closed for Laptop	0.30	0.00	0.56	0.00	0.00	0.30	0.86	0.30
	Rear Face	0.47	0.08	0.10	0.10	0.00	0.55	0.57	0.57
	Left Side	0.00	0.04	0.13	0.09	0.00	0.04	0.13	0.09
	Right Side	0.28	0.00	0.00	0.10	0.00	0.28	0.28	0.38
LTE 14	Top Side	0.02	0.39	0.77	0.76	0.04	0.45	0.83	0.82
	Bottom Side	0.00	0.00	0.00	0.00	0.00	0.00	0.00	0.00
	Bottom for Laptop	0.41	0.00	0.00	0.10	0.00	0.41	0.41	0.51
	Back of Panel	0.00	0.15	0.93	0.56	0.00	0.15	0.93	0.56
	Top of Panel	0.00	0.06	0.13	0.09	0.00	0.06	0.13	0.09
	Lid Closed for Laptop	0.30	0.00	0.56	0.00	0.00	0.30	0.86	0.30
	Rear Face	0.48	0.08	0.10	0.10	0.00	0.56	0.58	0.58
	Left Side	0.00	0.04	0.13	0.09	0.00	0.04	0.13	0.09
LTE 17	Right Side	0.28	0.00	0.00	0.10	0.00	0.28	0.28	0.38
	Top Side	0.03	0.39	0.77	0.76	0.04	0.46	0.84	0.83
	Bottom Side	0.00	0.00	0.00	0.00	0.00	0.00	0.00	0.00
	Bottom for Laptop	0.51	0.00	0.00	0.10	0.00	0.51	0.51	0.61
	Back of Panel	0.00	0.15	0.93	0.56	0.00	0.15	0.93	0.56
	Top of Panel	0.00	0.06	0.13	0.09	0.00	0.06	0.13	0.09
	Lid Closed for Laptop	0.45	0.00	0.56	0.00	0.00	0.45	1.01	0.45
	Rear Face	0.64	0.08	0.10	0.10	0.00	0.72	0.74	0.74
LTE 25	Left Side	0.00	0.04	0.13	0.09	0.00	0.04	0.13	0.09
	Right Side	0.48	0.00	0.00	0.10	0.00	0.48	0.48	0.58
	Top Side	0.02	0.39	0.77	0.76	0.04	0.45	0.83	0.82
	Bottom Side	0.00	0.00	0.00	0.00	0.00	0.00	0.00	0.00
	Bottom for Laptop	0.56	0.00	0.00	0.10	0.00	0.56	0.56	0.66
	Back of Panel	0.00	0.15	0.93	0.56	0.00	0.15	0.93	0.56
	Top of Panel	0.00	0.06	0.13	0.09	0.00	0.06	0.13	0.09
	Lid Closed for Laptop	0.57	0.00	0.56	0.00	0.00	0.57	1.13	0.57
LTE 26	Rear Face	0.62	0.08	0.10	0.10	0.00	0.70	0.72	0.72
	Left Side	0.01	0.04	0.13	0.09	0.00	0.05	0.14	0.10
	Right Side	0.39	0.00	0.00	0.10	0.00	0.39	0.39	0.49
	Top Side	0.04	0.39	0.77	0.76	0.04	0.47	0.85	0.84
	Bottom Side	0.03	0.00	0.00	0.00	0.00	0.03	0.03	0.03
	Bottom for Laptop	0.57	0.00	0.00	0.10	0.00	0.57	0.57	0.67
	Back of Panel	0.00	0.15	0.93	0.56	0.00	0.15	0.93	0.56
	Top of Panel	0.00	0.06	0.13	0.09	0.00	0.06	0.13	0.09
LTE 30	Lid Closed for Laptop	0.53	0.00	0.56	0.00	0.00	0.53	1.09	0.53
	Rear Face	0.63	0.08	0.10	0.10	0.00	0.71	0.73	0.73
	Left Side	0.00	0.04	0.13	0.09	0.00	0.04	0.13	0.09
	Right Side	0.44	0.00	0.00	0.10	0.00	0.44	0.44	0.54
	Top Side	0.04	0.39	0.77	0.76	0.04	0.47	0.85	0.84
	Bottom Side	0.00	0.00	0.00	0.00	0.00	0.00	0.00	0.00
	Bottom for Laptop	0.56	0.00	0.00	0.10	0.00	0.56	0.56	0.66
	Back of Panel	0.00	0.15	0.93	0.56	0.00	0.15	0.93	0.56
LTE 38	Top of Panel	0.00	0.06	0.13	0.09	0.00	0.06	0.13	0.09
	Lid Closed for Laptop	0.42	0.00	0.56	0.00	0.00	0.42	0.98	0.42
	Rear Face	0.65	0.08	0.10	0.10	0.00	0.73	0.75	0.75
	Left Side	0.01	0.04	0.13	0.09	0.00	0.05	0.14	0.10
	Right Side	0.23	0.00	0.00	0.10	0.00	0.23	0.23	0.33
	Top Side	0.02	0.39	0.77	0.76	0.04	0.45	0.83	0.82
	Bottom Side	0.02	0.00	0.00	0.00	0.00	0.02	0.02	0.02
	Bottom for Laptop	0.46	0.00	0.00	0.10	0.00	0.46	0.46	0.56
LTE 38	Back of Panel	0.00	0.15	0.93	0.56	0.00	0.15	0.93	0.56
	Top of Panel	0.00	0.06	0.13	0.09	0.00	0.06	0.13	0.09
	Lid Closed for Laptop	0.44	0.00	0.56	0.00	0.00	0.44	1.00	0.44
	Rear Face	0.51	0.08	0.10	0.10	0.00	0.59	0.61	0.61
	Left Side	0.00	0.04	0.13	0.09	0.00	0.04	0.13	0.09
	Right Side	0.21	0.00	0.00	0.10	0.00	0.21	0.21	0.31
	Top Side	0.02	0.39	0.77	0.76	0.04	0.45	0.83	0.82
	Bottom Side	0.01	0.00	0.00	0.00	0.00	0.01	0.01	0.01

Simultaneous Transmission SAR Evaluation (Body)									
Band	Position	1	2	5	8	9	A (1+2+9)	B (1+5+9)	C (1+8+9)
		Max WWAN	WLAN 2.4GHz Ant 0	WLAN 5GHz Ant 0	WLAN 5GHz Ant 0+1	BT Ant 1	Summimng result 1g SAR W/kg	Summimng result 1g SAR W/kg	Summimng result 1g SAR W/kg
		1g SAR W/kg	1g SAR W/kg	1g SAR W/kg	1g SAR W/kg	1g SAR W/kg			
LTE 40	Bottom for Laptop	0.45	0.00	0.00	0.10	0.00	0.45	0.45	0.55
	Back of Panel	0.00	0.15	0.93	0.56	0.00	0.15	0.93	0.56
	Top of Panel	0.00	0.06	0.13	0.09	0.00	0.06	0.13	0.09
	Lid Closed for Laptop	0.43	0.00	0.56	0.00	0.00	0.43	0.99	0.43
	Rear Face	0.50	0.08	0.10	0.10	0.00	0.58	0.60	0.60
	Left Side	0.01	0.04	0.13	0.09	0.00	0.05	0.14	0.10
	Right Side	0.17	0.00	0.00	0.10	0.00	0.17	0.17	0.27
	Top Side	0.01	0.39	0.77	0.76	0.04	0.44	0.82	0.81
LTE 41	Bottom for Laptop	0.48	0.00	0.00	0.10	0.00	0.48	0.48	0.58
	Back of Panel	0.00	0.15	0.93	0.56	0.00	0.15	0.93	0.56
	Top of Panel	0.00	0.06	0.13	0.09	0.00	0.06	0.13	0.09
	Lid Closed for Laptop	0.47	0.00	0.56	0.00	0.00	0.47	1.03	0.47
	Rear Face	0.73	0.08	0.10	0.10	0.00	0.81	0.83	0.83
	Left Side	0.33	0.04	0.13	0.09	0.00	0.37	0.46	0.42
	Right Side	0.00	0.00	0.00	0.10	0.00	0.00	0.00	0.10
	Top Side	0.09	0.39	0.77	0.76	0.04	0.52	0.90	0.89
LTE 48	Bottom for Laptop	0.26	0.00	0.00	0.10	0.00	0.26	0.26	0.36
	Back of Panel	0.00	0.15	0.93	0.56	0.00	0.15	0.93	0.56
	Top of Panel	0.00	0.06	0.13	0.09	0.00	0.06	0.13	0.09
	Lid Closed for Laptop	0.24	0.00	0.56	0.00	0.00	0.24	0.80	0.24
	Rear Face	0.61	0.08	0.10	0.10	0.00	0.69	0.71	0.71
	Left Side	0.10	0.04	0.13	0.09	0.00	0.14	0.23	0.19
	Right Side	0.00	0.00	0.00	0.10	0.00	0.00	0.00	0.10
	Top Side	0.01	0.39	0.77	0.76	0.04	0.44	0.82	0.81
LTE 66	Bottom for Laptop	0.50	0.00	0.00	0.10	0.00	0.50	0.50	0.60
	Back of Panel	0.00	0.15	0.93	0.56	0.00	0.15	0.93	0.56
	Top of Panel	0.00	0.06	0.13	0.09	0.00	0.06	0.13	0.09
	Lid Closed for Laptop	0.46	0.00	0.56	0.00	0.00	0.46	1.02	0.46
	Rear Face	0.60	0.08	0.10	0.10	0.00	0.68	0.70	0.70
	Left Side	0.01	0.04	0.13	0.09	0.00	0.05	0.14	0.10
	Right Side	0.21	0.00	0.00	0.10	0.00	0.21	0.21	0.31
	Top Side	0.02	0.39	0.77	0.76	0.04	0.45	0.83	0.82
LTE 71	Bottom for Laptop	0.65	0.00	0.00	0.10	0.00	0.65	0.65	0.75
	Back of Panel	0.00	0.15	0.93	0.56	0.00	0.15	0.93	0.56
	Top of Panel	0.00	0.06	0.13	0.09	0.00	0.06	0.13	0.09
	Lid Closed for Laptop	0.61	0.00	0.56	0.00	0.00	0.61	1.17	0.61
	Rear Face	0.66	0.08	0.10	0.10	0.00	0.74	0.76	0.76
	Left Side	0.00	0.04	0.13	0.09	0.00	0.04	0.13	0.09
	Right Side	0.33	0.00	0.00	0.10	0.00	0.33	0.33	0.43
	Top Side	0.00	0.39	0.77	0.76	0.04	0.43	0.81	0.80
	Bottom Side	0.00	0.00	0.00	0.00	0.00	0.00	0.00	0.00

Simultaneous Transmission SAR Evaluation (Body)									
Band	Position	1	2	5	8	9	A (1+2+9)	B (1+5+9)	C (1+8+9)
		Max WWAN	WLAN 2.4GHz Ant 0	WLAN 5GHz Ant 0	WLAN 5GHz Ant 0+1	BT Ant 1	Summimng result 1g SAR W/kg	Summimng result 1g SAR W/kg	Summimng result 1g SAR W/kg
		1g SAR W/kg	1g SAR W/kg	1g SAR W/kg	1g SAR W/kg	1g SAR W/kg			
5G NR-n2	Bottom for Laptop	0.62	0.00	0.00	0.10	0.00	0.62	0.62	0.72
	Back of Panel	0.00	0.15	0.93	0.56	0.00	0.15	0.93	0.56
	Top of Panel	0.00	0.06	0.13	0.09	0.00	0.06	0.13	0.09
	Lid Closed for Laptop	0.56	0.00	0.56	0.00	0.00	0.56	1.12	0.56
	Rear Face	0.66	0.08	0.10	0.10	0.00	0.74	0.76	0.76
	Left Side	0.01	0.04	0.13	0.09	0.00	0.05	0.14	0.10
	Right Side	0.25	0.00	0.00	0.10	0.00	0.25	0.25	0.35
	Top Side	0.02	0.39	0.77	0.76	0.04	0.45	0.83	0.82
5G NR-n5	Bottom for Laptop	0.30	0.00	0.00	0.10	0.00	0.30	0.30	0.40
	Back of Panel	0.00	0.15	0.93	0.56	0.00	0.15	0.93	0.56
	Top of Panel	0.00	0.06	0.13	0.09	0.00	0.06	0.13	0.09
	Lid Closed for Laptop	0.29	0.00	0.56	0.00	0.00	0.29	0.85	0.29
	Rear Face	0.69	0.08	0.10	0.10	0.00	0.77	0.79	0.79
	Left Side	0.00	0.04	0.13	0.09	0.00	0.04	0.13	0.09
	Right Side	0.47	0.00	0.00	0.10	0.00	0.47	0.47	0.57
	Top Side	0.03	0.39	0.77	0.76	0.04	0.46	0.84	0.83
5G NR-n7	Bottom for Laptop	0.46	0.00	0.00	0.10	0.00	0.46	0.46	0.56
	Back of Panel	0.00	0.15	0.93	0.56	0.00	0.15	0.93	0.56
	Top of Panel	0.00	0.06	0.13	0.09	0.00	0.06	0.13	0.09
	Lid Closed for Laptop	0.44	0.00	0.56	0.00	0.00	0.44	1.00	0.44
	Rear Face	0.53	0.08	0.10	0.10	0.00	0.61	0.63	0.63
	Left Side	0.01	0.04	0.13	0.09	0.00	0.05	0.14	0.10
	Right Side	0.14	0.00	0.00	0.10	0.00	0.14	0.14	0.24
	Top Side	0.02	0.39	0.77	0.76	0.04	0.45	0.83	0.82
5G NR-n25	Bottom for Laptop	0.58	0.00	0.00	0.10	0.00	0.58	0.58	0.68
	Back of Panel	0.00	0.15	0.93	0.56	0.00	0.15	0.93	0.56
	Top of Panel	0.00	0.06	0.13	0.09	0.00	0.06	0.13	0.09
	Lid Closed for Laptop	0.56	0.00	0.56	0.00	0.00	0.56	1.12	0.56
	Rear Face	0.66	0.08	0.10	0.10	0.00	0.74	0.76	0.76
	Left Side	0.01	0.04	0.13	0.09	0.00	0.05	0.14	0.10
	Right Side	0.30	0.00	0.00	0.10	0.00	0.30	0.30	0.40
	Top Side	0.03	0.39	0.77	0.76	0.04	0.46	0.84	0.83
5G NR-n30	Bottom for Laptop	0.72	0.00	0.00	0.10	0.00	0.72	0.72	0.82
	Back of Panel	0.00	0.15	0.93	0.56	0.00	0.15	0.93	0.56
	Top of Panel	0.00	0.06	0.13	0.09	0.00	0.06	0.13	0.09
	Lid Closed for Laptop	0.63	0.00	0.56	0.00	0.00	0.63	1.19	0.63
	Rear Face	0.66	0.08	0.10	0.10	0.00	0.74	0.76	0.76
	Left Side	0.02	0.04	0.13	0.09	0.00	0.06	0.15	0.11
	Right Side	0.23	0.00	0.00	0.10	0.00	0.23	0.23	0.33
	Top Side	0.01	0.39	0.77	0.76	0.04	0.44	0.82	0.81
5G NR-n38	Bottom for Laptop	0.60	0.00	0.00	0.10	0.00	0.60	0.60	0.70
	Back of Panel	0.00	0.15	0.93	0.56	0.00	0.15	0.93	0.56
	Top of Panel	0.00	0.06	0.13	0.09	0.00	0.06	0.13	0.09
	Lid Closed for Laptop	0.57	0.00	0.56	0.00	0.00	0.57	1.13	0.57
	Rear Face	0.68	0.08	0.10	0.10	0.00	0.76	0.78	0.78
	Left Side	0.01	0.04	0.13	0.09	0.00	0.05	0.14	0.10
	Right Side	0.14	0.00	0.00	0.10	0.00	0.14	0.14	0.24
	Top Side	0.04	0.39	0.77	0.76	0.04	0.47	0.85	0.84
5G NR-n40	Bottom for Laptop	0.64	0.00	0.00	0.10	0.00	0.64	0.64	0.74
	Back of Panel	0.00	0.15	0.93	0.56	0.00	0.15	0.93	0.56
	Top of Panel	0.00	0.06	0.13	0.09	0.00	0.06	0.13	0.09
	Lid Closed for Laptop	0.61	0.00	0.56	0.00	0.00	0.61	1.17	0.61
	Rear Face	0.65	0.08	0.10	0.10	0.00	0.73	0.75	0.75
	Left Side	0.02	0.04	0.13	0.09	0.00	0.06	0.15	0.11
	Right Side	0.49	0.00	0.00	0.10	0.00	0.49	0.49	0.59
	Top Side	0.01	0.39	0.77	0.76	0.04	0.44	0.82	0.81
	Bottom Side	0.01	0.00	0.00	0.00	0.00	0.01	0.01	0.01

Simultaneous Transmission SAR Evaluation (Body)									
Band	Position	1	2	5	8	9	A (1+2+9)	B (1+5+9)	C (1+8+9)
		Max WWAN	WLAN 2.4GHz Ant 0	WLAN 5GHz Ant 0	WLAN 5GHz Ant 0+1	BT Ant 1	Summimng result 1g SAR W/kg	Summimng result 1g SAR W/kg	Summimng result 1g SAR W/kg
		1g SAR W/kg	1g SAR W/kg	1g SAR W/kg	1g SAR W/kg	1g SAR W/kg			
5G NR-n41	Bottom for Laptop	0.56	0.00	0.00	0.10	0.00	0.56	0.56	0.66
	Back of Panel	0.00	0.15	0.93	0.56	0.00	0.15	0.93	0.56
	Top of Panel	0.00	0.06	0.13	0.09	0.00	0.06	0.13	0.09
	Lid Closed for Laptop	0.54	0.00	0.56	0.00	0.00	0.54	1.10	0.54
	Rear Face	0.60	0.08	0.10	0.10	0.00	0.68	0.70	0.70
	Left Side	0.29	0.04	0.13	0.09	0.00	0.33	0.42	0.38
	Right Side	0.08	0.00	0.00	0.10	0.00	0.08	0.08	0.18
	Top Side	0.11	0.39	0.77	0.76	0.04	0.54	0.92	0.91
5G NR-n66	Bottom for Laptop	0.63	0.00	0.00	0.10	0.00	0.63	0.63	0.73
	Back of Panel	0.00	0.15	0.93	0.56	0.00	0.15	0.93	0.56
	Top of Panel	0.00	0.06	0.13	0.09	0.00	0.06	0.13	0.09
	Lid Closed for Laptop	0.56	0.00	0.56	0.00	0.00	0.56	1.12	0.56
	Rear Face	0.74	0.08	0.10	0.10	0.00	0.82	0.84	0.84
	Left Side	0.01	0.04	0.13	0.09	0.00	0.05	0.14	0.10
	Right Side	0.27	0.00	0.00	0.10	0.00	0.27	0.27	0.37
	Top Side	0.02	0.39	0.77	0.76	0.04	0.45	0.83	0.82
5G NR-n71	Bottom for Laptop	0.59	0.00	0.00	0.10	0.00	0.59	0.59	0.69
	Back of Panel	0.00	0.15	0.93	0.56	0.00	0.15	0.93	0.56
	Top of Panel	0.00	0.06	0.13	0.09	0.00	0.06	0.13	0.09
	Lid Closed for Laptop	0.54	0.00	0.56	0.00	0.00	0.54	1.10	0.54
	Rear Face	0.73	0.08	0.10	0.10	0.00	0.81	0.83	0.83
	Left Side	0.00	0.04	0.13	0.09	0.00	0.04	0.13	0.09
	Right Side	0.70	0.00	0.00	0.10	0.00	0.70	0.70	0.80
	Top Side	0.00	0.39	0.77	0.76	0.04	0.43	0.81	0.80
5G NR-n77	Bottom for Laptop	0.61	0.00	0.00	0.10	0.00	0.61	0.61	0.71
	Back of Panel	0.00	0.15	0.93	0.56	0.00	0.15	0.93	0.56
	Top of Panel	0.00	0.06	0.13	0.09	0.00	0.06	0.13	0.09
	Lid Closed for Laptop	0.54	0.00	0.56	0.00	0.00	0.54	1.10	0.54
	Rear Face	0.71	0.08	0.10	0.10	0.00	0.79	0.81	0.81
	Left Side	0.19	0.04	0.13	0.09	0.00	0.23	0.32	0.28
	Right Side	0.28	0.00	0.00	0.10	0.00	0.28	0.28	0.38
	Top Side	0.10	0.39	0.77	0.76	0.04	0.53	0.91	0.90
5G NR-n78	Bottom for Laptop	0.63	0.00	0.00	0.10	0.00	0.63	0.63	0.73
	Back of Panel	0.00	0.15	0.93	0.56	0.00	0.15	0.93	0.56
	Top of Panel	0.00	0.06	0.13	0.09	0.00	0.06	0.13	0.09
	Lid Closed for Laptop	0.62	0.00	0.56	0.00	0.00	0.62	1.18	0.62
	Rear Face	0.68	0.08	0.10	0.10	0.00	0.76	0.78	0.78
	Left Side	0.26	0.04	0.13	0.09	0.00	0.30	0.39	0.35
	Right Side	0.28	0.00	0.00	0.10	0.00	0.28	0.28	0.38
	Top Side	0.39	0.39	0.77	0.76	0.04	0.82	1.20	1.19
Bottom Side	0.02	0.00	0.00	0.00	0.00	0.02	0.02	0.02	

Annex H. Analysis of Simultaneous Transmission SAR.

The analysis of simultaneous transmission SAR are shown as below.

<Possibilities of Simultaneous Transmission>

The simultaneous transmission possibilities for this device are listed as below.

Simultaneous TX Combination	Capable Transmit Configurations	Body / Hotspot / Extremity / Limb / Product Specific Exposure Condition
A	WWAN+NR + WLAN 2.4G_Ant 0 + BT_Ant 1	Yes
B	WWAN+NR + WLAN 5G_Ant 0 + BT_Ant 1	Yes
C	WWAN +NR+ WLAN 5G_Ant 0+1 + BT_Ant 1	Yes
D	WLAN 2.4G_Ant 0+BT_Ant 1	Yes
E	WLAN 5G_Ant 0+BT_Ant 1	Yes
F	WLAN 5G_Ant 0+1+BT_Ant 1	Yes

Notes

1. The WLAN 2.4G and WLAN 5G cannot transmit simultaneously.
2. The WLAN and Bluetooth cannot transmit simultaneously.
3. Simultaneous TX Combination D can be covered by A
4. Simultaneous TX Combination E can be covered by B
5. Simultaneous TX Combination F can be covered by C

Simultaneous Transmission SAR Evaluation (Body)											
Band	Band	Position	1	2	3	4	5	6	A (1+2+3+6)	B (1+2+4+6)	C (1+2+5+6)
			Max WWAN	Max NR	WLAN 2.4GHz Ant 0	WLAN 5GHz Ant 0	WLAN 5GHz Ant 0+1	BT Ant 1	Summimg result 1g SAR W/kg	Summimg result 1g SAR W/kg	Summimg result 1g SAR W/kg
			1g SAR W/kg	1g SAR W/kg	1g SAR W/kg	1g SAR W/kg	1g SAR W/kg	1g SAR W/kg			
LTE 5	5G NR-n2	Bottom for Laptop	0.57	0.62	0.00	0.00	0.00	0.00	1.19	1.19	1.19
		Lid Closed for Laptop	0.29	0.56	0.00	0.56	0.00	0.00	0.85	1.41	0.85
		Rear Face	0.62	0.66	0.08	0.10	0.10	0.00	1.36	1.38	1.38
		Left Side	0.00	0.01	0.00	0.00	0.00	0.00	0.01	0.01	0.01
		Right Side	0.34	0.25	0.00	0.00	0.00	0.00	0.59	0.59	0.59
		Top Side	0.04	0.02	0.00	0.00	0.00	0.00	0.06	0.06	0.06
		Bottom Side	0.00	0.03	0.00	0.00	0.00	0.00	0.03	0.03	0.03
		Rear Face	0.62	0.66	0.08	0.10	0.10	0.00	1.36	1.38	1.38
LTE 12	5G NR-n2	Left Side	0.00	0.01	0.00	0.00	0.00	0.00	0.01	0.01	0.01
		Bottom for Laptop	0.51	0.62	0.00	0.00	0.00	0.00	1.13	1.13	1.13
		Lid Closed for Laptop	0.47	0.56	0.00	0.56	0.00	0.00	1.03	1.59	1.03
		Rear Face	0.75	0.66	0.08	0.10	0.10	0.00	1.49	1.51	1.51
		Left Side	0.00	0.01	0.00	0.00	0.00	0.00	0.01	0.01	0.01
		Right Side	0.54	0.25	0.00	0.00	0.00	0.00	0.79	0.79	0.79
		Top Side	0.02	0.02	0.00	0.00	0.00	0.00	0.04	0.04	0.04
		Bottom Side	0.00	0.03	0.00	0.00	0.00	0.00	0.03	0.03	0.03
LTE 13	5G NR-n2	Rear Face	0.75	0.66	0.08	0.10	0.10	0.00	1.49	1.51	1.51
		Left Side	0.00	0.01	0.00	0.00	0.00	0.00	0.01	0.01	0.01
		Bottom for Laptop	0.39	0.62	0.00	0.00	0.00	0.00	1.01	1.01	1.01
		Lid Closed for Laptop	0.30	0.56	0.00	0.56	0.00	0.00	0.86	1.42	0.86
		Rear Face	0.47	0.66	0.08	0.10	0.10	0.00	1.21	1.23	1.23
		Left Side	0.00	0.01	0.00	0.00	0.00	0.00	0.01	0.01	0.01
		Right Side	0.28	0.25	0.00	0.00	0.00	0.00	0.53	0.53	0.53
		Top Side	0.02	0.02	0.00	0.00	0.00	0.00	0.04	0.04	0.04
LTE 2	5G NR-n5	Bottom Side	0.00	0.03	0.00	0.00	0.00	0.00	0.03	0.03	0.03
		Rear Face	0.47	0.66	0.08	0.10	0.10	0.00	1.21	1.23	1.23
		Left Side	0.00	0.01	0.00	0.00	0.00	0.00	0.01	0.01	0.01
		Bottom for Laptop	0.63	0.30	0.00	0.00	0.00	0.00	0.93	0.93	0.93
		Lid Closed for Laptop	0.32	0.29	0.00	0.56	0.00	0.00	0.61	1.17	0.61
		Rear Face	0.67	0.69	0.08	0.10	0.10	0.00	1.44	1.46	1.46
		Left Side	0.24	0.00	0.00	0.00	0.00	0.00	0.24	0.24	0.24
		Right Side	0.21	0.47	0.00	0.00	0.00	0.00	0.68	0.68	0.68
LTE 30	5G NR-n5	Top Side	0.02	0.03	0.00	0.00	0.00	0.00	0.05	0.05	0.05
		Bottom Side	0.61	0.00	0.00	0.00	0.00	0.00	0.61	0.61	0.61
		Rear Face	0.67	0.69	0.08	0.10	0.10	0.00	1.44	1.46	1.46
		Left Side	0.24	0.00	0.00	0.00	0.00	0.00	0.24	0.24	0.24
		Bottom for Laptop	0.56	0.30	0.00	0.00	0.00	0.00	0.86	0.86	0.86
		Lid Closed for Laptop	0.42	0.29	0.00	0.56	0.00	0.00	0.71	1.27	0.71
		Rear Face	0.65	0.69	0.08	0.10	0.10	0.00	1.42	1.44	1.44
		Left Side	0.01	0.00	0.00	0.00	0.00	0.00	0.01	0.01	0.01
LTE 48	5G NR-n5	Right Side	0.23	0.47	0.00	0.00	0.00	0.00	0.70	0.70	0.70
		Top Side	0.02	0.03	0.00	0.00	0.00	0.00	0.05	0.05	0.05
		Bottom Side	0.02	0.00	0.00	0.00	0.00	0.00	0.02	0.02	0.02
		Rear Face	0.65	0.69	0.08	0.10	0.10	0.00	1.42	1.44	1.44
		Left Side	0.01	0.00	0.00	0.00	0.00	0.00	0.01	0.01	0.01
		Bottom for Laptop	0.26	0.30	0.00	0.00	0.00	0.00	0.56	0.56	0.56
		Lid Closed for Laptop	0.24	0.29	0.00	0.56	0.00	0.00	0.53	1.09	0.53
		Rear Face	0.61	0.69	0.08	0.10	0.10	0.00	1.38	1.40	1.40
LTE 66	5G NR-n5	Left Side	0.10	0.00	0.00	0.00	0.00	0.00	0.10	0.10	0.10
		Right Side	0.00	0.47	0.00	0.00	0.00	0.00	0.47	0.47	0.47
		Top Side	0.01	0.03	0.00	0.00	0.00	0.00	0.04	0.04	0.04
		Bottom Side	0.00	0.00	0.00	0.00	0.00	0.00	0.00	0.00	0.00
		Rear Face	0.61	0.69	0.08	0.10	0.10	0.00	1.38	1.40	1.40
		Left Side	0.10	0.00	0.00	0.00	0.00	0.00	0.10	0.10	0.10
		Bottom for Laptop	0.50	0.30	0.00	0.00	0.00	0.00	0.80	0.80	0.80
		Lid Closed for Laptop	0.46	0.29	0.00	0.56	0.00	0.00	0.75	1.31	0.75
LTE 1	5G NR-n28	Rear Face	0.60	0.69	0.08	0.10	0.10	0.00	1.37	1.39	1.39
		Left Side	0.01	0.00	0.00	0.00	0.00	0.00	0.01	0.01	0.01
		Right Side	0.21	0.47	0.00	0.00	0.00	0.00	0.68	0.68	0.68
		Top Side	0.02	0.03	0.00	0.00	0.00	0.00	0.05	0.05	0.05
		Bottom Side	0.02	0.00	0.00	0.00	0.00	0.00	0.02	0.02	0.02
		Rear Face	0.60	0.69	0.08	0.10	0.10	0.00	1.37	1.39	1.39
		Left Side	0.01	0.00	0.00	0.00	0.00	0.00	0.01	0.01	0.01
		Bottom for Laptop	0.00	0.00	0.00	0.00	0.00	0.00	0.00	0.00	0.00
LTE 1	5G NR-n28	Lid Closed for Laptop	0.00	0.00	0.00	0.56	0.00	0.00	0.00	0.56	0.00
		Rear Face	0.00	0.00	0.08	0.10	0.10	0.00	0.08	0.10	0.10
		Left Side	0.00	0.00	0.00	0.00	0.00	0.00	0.00	0.00	0.00
		Right Side	0.00	0.00	0.00	0.00	0.00	0.00	0.00	0.00	0.00
		Top Side	0.00	0.00	0.00	0.00	0.00	0.00	0.00	0.00	0.00
		Bottom Side	0.00	0.00	0.00	0.00	0.00	0.00	0.00	0.00	0.00
		Rear Face	0.00	0.00	0.08	0.10	0.10	0.00	0.08	0.10	0.10
		Left Side	0.00	0.00	0.00	0.00	0.00	0.00	0.00	0.00	0.00

Simultaneous Transmission SAR Evaluation (Body)												
Band	Band	Position	1	2	3	4	5	6	A (1+2+3+6)	B (1+2+4+6)	C (1+2+5+6)	
			Max WWAN	Max NR	WLAN 2.4GHz Ant 0	WLAN 5GHz Ant 0	WLAN 5GHz Ant 0+1	BT Ant 1	Summimg result 1g SAR W/kg	Summimg result 1g SAR W/kg	Summimg result 1g SAR W/kg	
			1g SAR W/kg	1g SAR W/kg	1g SAR W/kg	1g SAR W/kg	1g SAR W/kg	1g SAR W/kg				
LTE 3	5G NR-n28	Bottom for Laptop	0.00	0.00	0.00	0.00	0.00	0.00	0.00	0.00	0.00	
		Lid Closed for Laptop	0.00	0.00	0.00	0.56	0.00	0.00	0.00	0.00	0.56	0.00
		Rear Face	0.00	0.00	0.08	0.10	0.10	0.00	0.00	0.08	0.10	0.10
		Left Side	0.00	0.00	0.00	0.00	0.00	0.00	0.00	0.00	0.00	0.00
		Right Side	0.00	0.00	0.00	0.00	0.00	0.00	0.00	0.00	0.00	0.00
		Top Side	0.00	0.00	0.00	0.00	0.00	0.00	0.00	0.00	0.00	0.00
		Bottom Side	0.00	0.00	0.00	0.00	0.00	0.00	0.00	0.00	0.00	0.00
		Rear Face	0.00	0.00	0.08	0.10	0.10	0.00	0.00	0.08	0.10	0.10
Left Side	0.00	0.00	0.00	0.00	0.00	0.00	0.00	0.00	0.00	0.00		
LTE 7	5G NR-n28	Bottom for Laptop	0.53	0.00	0.00	0.00	0.00	0.00	0.53	0.53	0.53	
		Lid Closed for Laptop	0.51	0.00	0.00	0.56	0.00	0.00	0.51	1.07	0.51	
		Rear Face	0.68	0.00	0.08	0.10	0.10	0.00	0.76	0.78	0.78	
		Left Side	0.01	0.00	0.00	0.00	0.00	0.00	0.01	0.01	0.01	
		Right Side	0.22	0.00	0.00	0.00	0.00	0.00	0.22	0.22	0.22	
		Top Side	0.03	0.00	0.00	0.00	0.00	0.00	0.03	0.03	0.03	
		Bottom Side	0.01	0.00	0.00	0.00	0.00	0.00	0.01	0.01	0.01	
		Rear Face	0.68	0.00	0.08	0.10	0.10	0.00	0.76	0.78	0.78	
Left Side	0.01	0.00	0.00	0.00	0.00	0.00	0.01	0.01	0.01			
LTE 3	5G NR-n41	Bottom for Laptop	0.00	0.56	0.00	0.00	0.00	0.00	0.56	0.56	0.56	
		Lid Closed for Laptop	0.00	0.54	0.00	0.56	0.00	0.00	0.54	1.10	0.54	
		Rear Face	0.00	0.60	0.08	0.10	0.10	0.00	0.68	0.70	0.70	
		Left Side	0.00	0.00	0.00	0.00	0.00	0.00	0.00	0.00	0.00	
		Right Side	0.00	0.00	0.00	0.00	0.00	0.00	0.00	0.00	0.00	
		Top Side	0.00	0.00	0.00	0.00	0.00	0.00	0.00	0.00	0.00	
		Bottom Side	0.00	0.00	0.00	0.00	0.00	0.00	0.00	0.00	0.00	
		Rear Face	0.00	0.60	0.08	0.10	0.10	0.00	0.68	0.70	0.70	
Left Side	0.00	0.00	0.00	0.00	0.00	0.00	0.00	0.00	0.00			
LTE 39	5G NR-n41	Bottom for Laptop	0.00	0.56	0.00	0.00	0.00	0.00	0.56	0.56	0.56	
		Lid Closed for Laptop	0.00	0.54	0.00	0.56	0.00	0.00	0.54	1.10	0.54	
		Rear Face	0.00	0.60	0.08	0.10	0.10	0.00	0.68	0.70	0.70	
		Left Side	0.00	0.00	0.00	0.00	0.00	0.00	0.00	0.00	0.00	
		Right Side	0.00	0.00	0.00	0.00	0.00	0.00	0.00	0.00	0.00	
		Top Side	0.00	0.00	0.00	0.00	0.00	0.00	0.00	0.00	0.00	
		Bottom Side	0.00	0.00	0.00	0.00	0.00	0.00	0.00	0.00	0.00	
		Rear Face	0.00	0.60	0.08	0.10	0.10	0.00	0.68	0.70	0.70	
Left Side	0.00	0.00	0.00	0.00	0.00	0.00	0.00	0.00	0.00			
LTE 40	5G NR-n41	Bottom for Laptop	0.45	0.56	0.00	0.00	0.00	0.00	1.01	1.01	1.01	
		Lid Closed for Laptop	0.43	0.54	0.00	0.56	0.00	0.00	0.97	1.53	0.97	
		Rear Face	0.50	0.60	0.08	0.10	0.10	0.00	1.18	1.20	1.20	
		Left Side	0.01	0.00	0.00	0.00	0.00	0.00	0.01	0.01	0.01	
		Right Side	0.17	0.00	0.00	0.00	0.00	0.00	0.17	0.17	0.17	
		Top Side	0.01	0.00	0.00	0.00	0.00	0.00	0.01	0.01	0.01	
		Bottom Side	0.01	0.00	0.00	0.00	0.00	0.00	0.01	0.01	0.01	
		Rear Face	0.50	0.60	0.08	0.10	0.10	0.00	1.18	1.20	1.20	
Left Side	0.01	0.00	0.00	0.00	0.00	0.00	0.01	0.01	0.01			
LTE 41	5G NR-n41	Bottom for Laptop	0.48	0.56	0.00	0.00	0.00	0.00	1.04	1.04	1.04	
		Lid Closed for Laptop	0.47	0.54	0.00	0.56	0.00	0.00	1.01	1.57	1.01	
		Rear Face	0.73	0.60	0.08	0.10	0.10	0.00	1.41	1.43	1.43	
		Left Side	0.33	0.00	0.00	0.00	0.00	0.00	0.33	0.33	0.33	
		Right Side	0.00	0.00	0.00	0.00	0.00	0.00	0.00	0.00	0.00	
		Top Side	0.09	0.00	0.00	0.00	0.00	0.00	0.09	0.09	0.09	
		Bottom Side	0.01	0.00	0.00	0.00	0.00	0.00	0.01	0.01	0.01	
		Rear Face	0.73	0.60	0.08	0.10	0.10	0.00	1.41	1.43	1.43	
Left Side	0.33	0.00	0.00	0.00	0.00	0.00	0.33	0.33	0.33			
LTE 5	5G NR-n66	Bottom for Laptop	0.57	0.63	0.00	0.00	0.00	0.00	1.20	1.20	1.20	
		Lid Closed for Laptop	0.29	0.56	0.00	0.56	0.00	0.00	0.85	1.41	0.85	
		Rear Face	0.62	0.74	0.08	0.10	0.10	0.00	1.44	1.46	1.46	
		Left Side	0.00	0.01	0.00	0.00	0.00	0.00	0.01	0.01	0.01	
		Right Side	0.34	0.27	0.00	0.00	0.00	0.00	0.61	0.61	0.61	
		Top Side	0.04	0.02	0.00	0.00	0.00	0.00	0.06	0.06	0.06	
		Bottom Side	0.00	0.02	0.00	0.00	0.00	0.00	0.02	0.02	0.02	
		Rear Face	0.62	0.74	0.08	0.10	0.10	0.00	1.44	1.46	1.46	
Left Side	0.00	0.01	0.00	0.00	0.00	0.00	0.01	0.01	0.01			
LTE 12	5G NR-n66	Bottom for Laptop	0.51	0.63	0.00	0.00	0.00	0.00	1.14	1.14	1.14	
		Lid Closed for Laptop	0.47	0.56	0.00	0.56	0.00	0.00	1.03	1.59	1.03	
		Rear Face	0.75	0.74	0.08	0.10	0.10	0.00	1.57	1.59	1.59	
		Left Side	0.00	0.01	0.00	0.00	0.00	0.00	0.01	0.01	0.01	
		Right Side	0.54	0.27	0.00	0.00	0.00	0.00	0.81	0.81	0.81	
		Top Side	0.02	0.02	0.00	0.00	0.00	0.00	0.04	0.04	0.04	
		Bottom Side	0.00	0.02	0.00	0.00	0.00	0.00	0.02	0.02	0.02	
		Rear Face	0.75	0.74	0.08	0.10	0.10	0.00	1.57	1.59	1.59	
Left Side	0.00	0.01	0.00	0.00	0.00	0.00	0.01	0.01	0.01			

Simultaneous Transmission SAR Evaluation (Body)											
Band	Band	Position	1	2	3	4	5	6	A (1+2+3+6)	B (1+2+4+6)	C (1+2+5+6)
			Max WWAN	Max NR	WLAN 2.4GHz Ant 0	WLAN 5GHz Ant 0	WLAN 5GHz Ant 0+1	BT Ant 1	Summimg result 1g SAR W/kg	Summimg result 1g SAR W/kg	Summimg result 1g SAR W/kg
			1g SAR W/kg	1g SAR W/kg	1g SAR W/kg	1g SAR W/kg	1g SAR W/kg	1g SAR W/kg			
LTE 13	5G NR-n66	Bottom for Laptop	0.39	0.63	0.00	0.00	0.00	0.00	1.02	1.02	1.02
		Lid Closed for Laptop	0.30	0.56	0.00	0.56	0.00	0.00	0.86	1.42	0.86
		Rear Face	0.47	0.74	0.08	0.10	0.10	0.00	1.29	1.31	1.31
		Left Side	0.00	0.01	0.00	0.00	0.00	0.00	0.01	0.01	0.01
		Right Side	0.28	0.27	0.00	0.00	0.00	0.00	0.55	0.55	0.55
		Top Side	0.02	0.02	0.00	0.00	0.00	0.00	0.04	0.04	0.04
		Bottom Side	0.00	0.02	0.00	0.00	0.00	0.00	0.02	0.02	0.02
		Rear Face	0.47	0.74	0.08	0.10	0.10	0.00	1.29	1.31	1.31
LTE 48	5G NR-n66	Left Side	0.00	0.01	0.00	0.00	0.00	0.00	0.01	0.01	0.01
		Bottom for Laptop	0.26	0.63	0.00	0.00	0.00	0.00	0.89	0.89	0.89
		Lid Closed for Laptop	0.24	0.56	0.00	0.56	0.00	0.00	0.80	1.36	0.80
		Rear Face	0.61	0.74	0.08	0.10	0.10	0.00	1.43	1.45	1.45
		Left Side	0.10	0.01	0.00	0.00	0.00	0.00	0.11	0.11	0.11
		Right Side	0.00	0.27	0.00	0.00	0.00	0.00	0.27	0.27	0.27
		Top Side	0.01	0.02	0.00	0.00	0.00	0.00	0.03	0.03	0.03
		Bottom Side	0.00	0.02	0.00	0.00	0.00	0.00	0.02	0.02	0.02
LTE 2	5G NR-n71	Rear Face	0.61	0.74	0.08	0.10	0.10	0.00	1.43	1.45	1.45
		Left Side	0.10	0.01	0.00	0.00	0.00	0.00	0.11	0.11	0.11
		Bottom for Laptop	0.63	0.59	0.00	0.00	0.00	0.00	1.22	1.22	1.22
		Lid Closed for Laptop	0.32	0.54	0.00	0.56	0.00	0.00	0.86	1.42	0.86
		Rear Face	0.67	0.73	0.08	0.10	0.10	0.00	1.48	1.50	1.50
		Left Side	0.24	0.00	0.00	0.00	0.00	0.00	0.24	0.24	0.24
		Right Side	0.21	0.70	0.00	0.00	0.00	0.00	0.91	0.91	0.91
		Top Side	0.02	0.00	0.00	0.00	0.00	0.00	0.02	0.02	0.02
LTE 66	5G NR-n71	Bottom Side	0.61	0.00	0.00	0.00	0.00	0.00	0.61	0.61	0.61
		Rear Face	0.67	0.73	0.08	0.10	0.10	0.00	1.48	1.50	1.50
		Left Side	0.24	0.00	0.00	0.00	0.00	0.00	0.24	0.24	0.24
		Bottom for Laptop	0.50	0.59	0.00	0.00	0.00	0.00	1.09	1.09	1.09
		Lid Closed for Laptop	0.46	0.54	0.00	0.56	0.00	0.00	1.00	1.56	1.00
		Rear Face	0.60	0.73	0.08	0.10	0.10	0.00	1.41	1.43	1.43
		Left Side	0.01	0.00	0.00	0.00	0.00	0.00	0.01	0.01	0.01
		Right Side	0.21	0.70	0.00	0.00	0.00	0.00	0.91	0.91	0.91
LTE 41	5G NR-n77	Top Side	0.02	0.00	0.00	0.00	0.00	0.00	0.02	0.02	0.02
		Bottom Side	0.02	0.00	0.00	0.00	0.00	0.00	0.02	0.02	0.02
		Rear Face	0.60	0.73	0.08	0.10	0.10	0.00	1.41	1.43	1.43
		Left Side	0.01	0.00	0.00	0.00	0.00	0.00	0.01	0.01	0.01
		Bottom for Laptop	0.48	0.61	0.00	0.00	0.00	0.00	1.09	1.09	1.09
		Lid Closed for Laptop	0.47	0.54	0.00	0.56	0.00	0.00	1.01	1.57	1.01
		Rear Face	0.73	0.71	0.08	0.10	0.10	0.00	1.52	1.54	1.54
		Left Side	0.33	0.00	0.00	0.00	0.00	0.00	0.33	0.33	0.33
LTE 2	5G NR-n78	Right Side	0.00	0.00	0.00	0.00	0.00	0.00	0.00	0.00	0.00
		Top Side	0.09	0.00	0.00	0.00	0.00	0.00	0.09	0.09	0.09
		Bottom Side	0.01	0.00	0.00	0.00	0.00	0.00	0.01	0.01	0.01
		Rear Face	0.73	0.71	0.08	0.10	0.10	0.00	1.52	1.54	1.54
		Left Side	0.33	0.00	0.00	0.00	0.00	0.00	0.33	0.33	0.33
		Bottom for Laptop	0.63	0.63	0.00	0.00	0.00	0.00	1.26	1.26	1.26
		Lid Closed for Laptop	0.32	0.62	0.00	0.56	0.00	0.00	0.94	1.50	0.94
		Rear Face	0.67	0.68	0.08	0.10	0.10	0.00	1.43	1.45	1.45
LTE 5	5G NR-n78	Left Side	0.24	0.00	0.00	0.00	0.00	0.00	0.24	0.24	0.24
		Right Side	0.21	0.00	0.00	0.00	0.00	0.00	0.21	0.21	0.21
		Top Side	0.02	0.00	0.00	0.00	0.00	0.00	0.02	0.02	0.02
		Bottom Side	0.61	0.00	0.00	0.00	0.00	0.00	0.61	0.61	0.61
		Rear Face	0.67	0.68	0.08	0.10	0.10	0.00	1.43	1.45	1.45
		Left Side	0.24	0.00	0.00	0.00	0.00	0.00	0.24	0.24	0.24
		Bottom for Laptop	0.57	0.63	0.00	0.00	0.00	0.00	1.20	1.20	1.20
		Lid Closed for Laptop	0.29	0.62	0.00	0.56	0.00	0.00	0.91	1.47	0.91
LTE 7	5G NR-n78	Rear Face	0.62	0.68	0.08	0.10	0.10	0.00	1.38	1.40	1.40
		Left Side	0.00	0.00	0.00	0.00	0.00	0.00	0.00	0.00	0.00
		Right Side	0.34	0.00	0.00	0.00	0.00	0.00	0.34	0.34	0.34
		Top Side	0.04	0.00	0.00	0.00	0.00	0.00	0.04	0.04	0.04
		Bottom Side	0.00	0.00	0.00	0.00	0.00	0.00	0.00	0.00	0.00
		Rear Face	0.62	0.68	0.08	0.10	0.10	0.00	1.38	1.40	1.40
		Left Side	0.00	0.00	0.00	0.00	0.00	0.00	0.00	0.00	0.00
		Bottom for Laptop	0.53	0.63	0.00	0.00	0.00	0.00	1.16	1.16	1.16
LTE 7	5G NR-n78	Lid Closed for Laptop	0.00	0.62	0.00	0.56	0.00	0.00	0.62	1.18	0.62
		Rear Face	0.58	0.68	0.08	0.10	0.10	0.00	1.34	1.36	1.36
		Left Side	0.01	0.00	0.00	0.00	0.00	0.00	0.01	0.01	0.01
		Right Side	0.22	0.00	0.00	0.00	0.00	0.00	0.22	0.22	0.22
		Top Side	0.03	0.00	0.00	0.00	0.00	0.00	0.03	0.03	0.03
		Bottom Side	0.01	0.00	0.00	0.00	0.00	0.00	0.01	0.01	0.01
		Rear Face	0.58	0.68	0.08	0.10	0.10	0.00	1.34	1.36	1.36
		Left Side	0.01	0.00	0.00	0.00	0.00	0.00	0.01	0.01	0.01

Annex I. SAR to Peak Location Separation Ratio Analysis.

Since sum of simultaneous transmission SAR is less than the SAR limit for Body : SAR_{1g} 1.6 W/kg. There is no requirement for SAR to Peak Location Separation Ratio Analysis.

Annex J. Calibration of Test Equipment List

Calibration of Test Equipment List are shown as below.

Equipment for SAR Test					
Equipment	Manufacturer	Model	SN	Cal. Date	Cal. Interval
System Validation Dipole	SPEAG	D750V3	1013	Aug. 31, 2021	1 Year
System Validation Dipole	SPEAG	D835V2	4d121	Aug. 31, 2021	1 Year
System Validation Dipole	SPEAG	D1750V2	1055	Sep. 02, 2021	1 Year
System Validation Dipole	SPEAG	D1900V2	5d036	Jan. 22, 2021	1 Year
System Validation Dipole	SPEAG	D2300V2	1004	Jan. 22, 2021	1 Year
System Validation Dipole	SPEAG	D2450V2	737	Aug. 26, 2021	1 Year
System Validation Dipole	SPEAG	D2600V2	1020	Aug. 17, 2021	1 Year
System Validation Dipole	SPEAG	D3500V2	1007	Jan. 19, 2021	1 Year
System Validation Dipole	SPEAG	D3700V2	1017	Aug. 19, 2021	1 Year
System Validation Dipole	SPEAG	D3900V2	1020	Mar. 21, 2021	1 Year
System Validation Dipole	SPEAG	D5GHzV2	1019	Mar. 19, 2021	1 Year
Dosimetric E-Field Probe	SPEAG	EX3DV4	7472	Jun. 03, 2021	1 Year
Dosimetric E-Field Probe	SPEAG	EX3DV4	7555	Sep. 27, 2021	1 Year
Data Acquisition Electronics	SPEAG	DAE4	1698	Nov. 09, 2021	1 Year
Data Acquisition Electronics	SPEAG	DAE4	1341	Aug. 20, 2021	1 Year
Universal Radio Communication Tester	Anritsu	MT8821C	6201381727	Aug. 24, 2021	1 Year
Universal Radio Communication Tester	Anritsu	MT8000A	6262012865	Nov. 30, 2021	1 Year
Spectrum Analyzer	R&S	FPH	103560	Jan. 28, 2022	1 Year
Universal Wireless Test Set	Anritsu	MT8870A/MU887000A	6201699387	Sep. 22, 2021	1 Year
Thermometer	YFE	YF-160A	120702365	Aug. 06, 2021	1 Year
Dielectric Assessment Kit	SPEAG	DAKS-3.5	1151	Jul. 14, 2021	1 Year
Powersource1	SPEAG	SE_UMS_160 BA	4010	Jul. 13, 2021	1 Year

Annex K. Considerations Related to Bluetooth for Setup and Testing

This device has installed Bluetooth engineering testing software which can provide continuous transmitting RF signal. During Bluetooth SAR testing, this device was operated to transmit continuously at the maximum transmission duty with specified transmission mode, operating frequency, lowest data rate, and maximum output power.

The Bluetooth call box has been used during SAR measurement and the EUT was set to DH5 mode at the maximum output power. Its duty factor was calculated as below and the measured SAR for Bluetooth would be scaled to the 100% transmission duty factor to determine compliance.

<Time-domain plot for Bluetooth transmission signal>

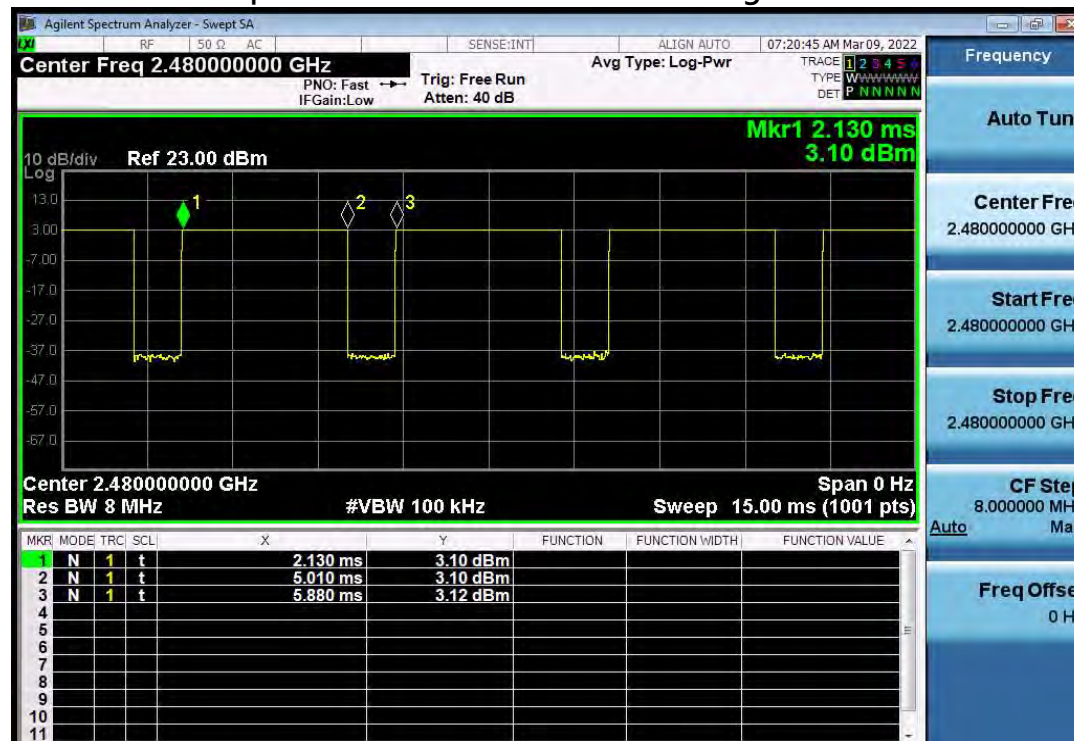

The duty factor of Bluetooth signal has been calculated as following.

$$\text{Duty Factor} = \text{Pulse Width} / \text{Total Period} = (5.01 - 2.13) / (5.88 - 2.13) = 76.80\%$$

Annex L. Verifying the Mechanism Operation of Gravity-sensor

The power verified by LCD angle changed are shown as below.

Note. Only WLAN 5.3/5.6/5.8G had supported G-sensor and the selection of G-sensor experimental verification is based on the test result of worst SAR value(WLAN5.8G_802.11ac VHT80_Ch.155_Ant 1).

1.Hall Effect and Gravity-Sensor

Orientation 1																																											
Laptop mode	<A> From the lid in closed mode (0 degrees), open the screen in 10 degree steps until laptop mode is obtained																																										
Degree	0	10	20	30	40	50	60	70	80	90	100	110	120	130	140	150	160	170	180	190	200	210	220	230	240	250	260	270	280	290	300	310	320	330	340	350	360						
Power	17.88	17.87	17.85	17.87	17.86																																						
Range of trigger angle	 Lower the screen by 5 degrees increments to verify that the "closed mode" is triggered.																																										
240	0	5	10	15	20	25	30	35	40	45	50	55	60	65	70	75	80	85	...	270	275	280	285	290	295	300	305	310	315	320	325	330	335	340	345	350	355						
Power										17.83	17.85	17.86																															
	<C> Open the screen in 1 degree steps until laptop mode is reobtained and continue opening the screen in 1 degree steps at least 5 degrees.																																										
Degree	0	1	2	3	4	5	6	7	8	9	10	11	12	13	14	15	16	17	18	19	20	21	22	23	24	25	26	27	28	29	30	31	32	33	34	35	36						
Power																																						17.83	17.81	17.84	17.82	17.83	17.81
	<D> Then continue opening the screen in 10 degree steps until tablet mode is obtained.																																										
Degree	0	10	20	30	40	50	60	70	80	90	100	110	120	130	140	150	160	170	180	190	200	210	220	230	240	250	260	270	280	290	300	310	320	330	340	350	360						
Power				17.83	17.81	17.82	17.84																		17.81	17.8	17.82	14.84	14.83	14.81	14.82	14.85	14.82	14.84	14.81	14.83	14.82	14.84	14.79	14.79			
Orientation 2																																											
<A> From Tablet mode 0 degrees, open the screen in 10 degree step until laptop mode is obtained.																																											
Tablet mode																																											
Degree	360	350	340	330	320	310	300	290	280	270	260	250	240	230	220	210	200	190	180	170	160	150	140	130	120	110	100	90	80	70	60	50	40	30	20	10	0						
Power	14.79	14.81	14.83	14.82	14.84	14.81	14.85	14.83	14.81	14.82	14.84	14.79	17.88																														
Range of trigger angle	 Move back by 5 degree, until Tablet mode is reobtained.																																										
240	360	355	350	345	340	335	330	325	320	315	310	305	300																														
Power																																											
	<C> Open the screen in 1 degree steps until laptop mode is reobtained and continue opening the screen in 1 degree steps at least 5 degrees.																																										
Degree	360	359	358	357	356	355	354	353	352	351	350	349	348																														
Power																																											
	<D> Then continue opening the screen in 10 degree steps until Close mode is obtained.																																										
Degree	360	350	340	330	320	310	300	290	280	270	260	250	236	230	220	210	200	190	180	170	160	150	140	130	120	110	100	90	80	70	60	50	40	30	20	10	0						
Power													17.86	17.85	17.86	17.87	17.85	17.83	17.81	17.84	17.82	17.85	17.88	17.84	17.81	17.86	17.82	17.84	17.81	17.87	17.88	17.84	17.82	17.86									