

SAR Test Report

Product Name : Notebook P.C.
Model No. : F9S, F9E, F9D

Applicant : ASUSTeK COMPUTER INC.
Address : 4FL., No. 150, Li-Te Rd., Peitou,
Taipei, Taiwan, R.O.C.

Date of Receipt : 2007/04/02
Issued Date : 2007/06/26
Report No. : 074L043-HPUSP09V01

The test results relate only to the samples tested.

The test report shall not be reproduced except in full without the written approval of QuieTek Corporation.

Test Report Certification

Issued Date: 2007/06/26

Report No.:074L043-HPUSP09V01



Product Name : Notebook P.C.
Applicant : ASUSTeK COMPUTER INC.
Address : 4FL., No. 150, Li-Te Rd., Peitou, Taipei, Taiwan, R.O.C.
Manufacturer : ASUSTeK COMPUTER INC.
Model No. : F9S, F9E, F9D
FCC ID : MSQF94965AGN
Trade Name : ASUS
Applicable Standard : FCC Oet65 Supplement C June 2001
IEEE Std. 1528-2003 47CFR § 2.1093
Test Result : Max. SAR Measurement (1g)
2.4GHz Band (2412MHz~2462MHz): 1.445 W/kg
5.2GHz Band (5150MHz~5250MHz): 0.983 W/kg
5.8GHz Band (5725MHz~5850MHz): 1.477 W/kg
Application Type : Certification

The test results relate only to the samples tested.

The test report shall not be reproduced except in full without the written approval of Quietek Corporation.

Documented By : 
(Engineering Adm. Assistant/
Eva Huang)

Tested By : 
(Senior Engineer / Shine Hsu)

Approved By : 
(President / Gene Chang)

TABLE OF CONTENTS

Description	Page
1. General Information	5
1.1 EUT Description	5
1.2 Test Environment	5
2. SAR Measurement System	6
2.1 ALSAS-10U System Description	6
2.1.1 Applications	6
2.1.2 Area Scans.....	6
2.1.3 Zoom Scan (Cube Scan Averaging).....	7
2.1.4 ALSAS-10U Interpolation and Extrapolation Uncertainty.....	7
2.2 Isotropic E-Field Probe	7
2.2.1 Isotropic E-Field Probe Specification.....	9
2.3 Boundary Detection Unit and Probe Mounting Device	9
2.4 Daq-Paq (Analog to Digital Electronics).....	10
2.5 Axis Articulated Robot	10
2.6 ALSAS Universal Workstation.....	11
2.7 Universal Device Positioner.....	11
2.8 Phantom Types.....	11
2.8.1 APREL SAM Phantoms	12
2.8.2 APREL Laboratories Universal Phantom	12
3. Tissue Simulating Liquid	13
3.1 The composition of the tissue simulating liquid	13
3.2 Tissue Calibration Result	13
3.3 Tissue Dielectric Parameters for Head and Body Phantoms	16
4. SAR Measurement Procedure	17
4.1 SAR System Validation.....	17
4.1.1 Validation Dipoles.....	17
4.1.2 Validation Result	17
4.2 SAR Measurement Procedure	19
4.3.1 SAR Measurement Procedure.....	19
5. SAR Exposure Limits	20
6. Test Equipment List	21
7. Measurement Uncertainty	22
8. Procedure Used to Establish Test Signal	23
8.1. Conducted Power-2.4GHz Band.....	23

8.2. Conducted power-5.2GHz Band 24

8.3. Conducted power-5.8GHz Band 25

9. Test Results 26

9.1 SAR Test Results Summary-2.4GHz Band..... 26

9.2 SAR Test Results Summary-5.2GHz Band..... 27

9.3 SAR Test Results Summary-5.8GHz Band..... 28

Appendix A. SAR System Validation Data..... 29

Appendix B. SAR measurement Data..... 29

Appendix C. Test Setup Photographs & EUT Photographs..... 29

Appendix D. Probe Calibration Data 29

Appendix E. Dipole Calibration Data 29

1. General Information

1.1 EUT Description

Product Name	Notebook P.C.
Trade Name	ASUS
Model No.	F9S, F9E, F9D
FCC ID	MSQF94965AGN
TX Frequency	2412MHz~2462MHz 5150MHz~5250MHz 5725MHz~5850MHz
Number of Channel	2.4GHz Band: 11 5GHz Band: 9 5GHz Band (802.11n): 3
Type of Modulation	DSSS/OFDM
Antenna Type	Fixed
Device Category	Portable
RF Exposure Environment	Uncontrolled
Transfer Rate	802.11b: 11Mbps 802.11g: 54Mbps 802.11a: 54Mbps 802.11n: 144Mbps / 300Mbps

1.2 Test Environment

Ambient conditions in the laboratory:

Items	Required	Actual
Temperature (°C)	18-25	22.4
Humidity (%RH)	30-70	56

2. SAR Measurement System

2.1 ALSAS-10U System Description

ALSAS-10-U is fully compliant with the technical and scientific requirements of IEEE 1528, IEC 62209, CENELEC, ARIB, ACA, and the Federal Communications Commission. The system comprises of a six axes articulated robot which utilizes a dedicated controller.

ALSAS-10U uses the latest methodologies and FDTD modeling to provide a platform which is repeatable with minimum uncertainty.

2.1.1 Applications

Predefined measurement procedures compliant with the guidelines of CENELEC, IEEE, IEC, FCC, etc are utilized during the assessment for the device. Automatic detection for all SAR

maxima are embedded within the core architecture for the system, ensuring that peak locations used for centering the zoom scan are within a 1mm resolution and a 0.05mm repeatable position. System operation range currently available up-to 6 GHz in simulated tissue.

2.1.2 Area Scans

Area scans are defined prior to the measurement process being executed with a user defined variable spacing between each measurement point (integral) allowing low uncertainty measurements to be conducted. Scans defined for FCC applications utilize a 10mm² step integral, with 1mm interpolation used to locate the peak SAR area used for zoom scan assessments.

Where the system identifies multiple SAR peaks (which are within 25% of peak value) the system will provide the user with the option of assessing each peak location individually for zoom scan averaging.



2.1.3 Zoom Scan (Cube Scan Averaging)

The averaging zoom scan volume utilized in the ALSAS-10U software is in the shape of a cube and the side dimension of a 1 g or 10 g mass is dependent on the density of the liquid representing the simulated tissue. A density of 1000 kg/m³ is used to represent the head and body tissue density and not the phantom liquid density, in order to be consistent with the definition of the liquid dielectric properties, i.e. the side length of the 1 g cube is 10mm, with the side length of the 10 g cube 21,5mm.

When the cube intersects with the surface of the phantom, it is oriented so that 3 vertices touch the surface of the shell or the center of a face is tangent to the surface. The face of the cube closest to the surface is modified in order to conform to the tangent surface.

The zoom scan integer steps can be user defined so as to reduce uncertainty, but normal practice for typical test applications (including FCC) utilize a physical step of 5x5x8 (8mmx8mmx5mm) providing a volume of 32mm in the X & Y axis, and 35mm in the Z axis.

2.1.4 ALSAS-10U Interpolation and Extrapolation Uncertainty

The overall uncertainty for the methodology and algorithms the used during the SAR calculation was evaluated using the data from IEEE 1528 based on the example f3 algorithm:

$$f_3(x, y, z) = A \frac{a^2}{\frac{a^2}{4} + x'^2 + y'^2} \cdot \left(e^{-\frac{2z}{a}} + \frac{a^2}{2(a + 2z)^2} \right)$$

2.2 Isotropic E-Field Probe

The isotropic E-Field probe has been fully calibrated and assessed for isotropicity, and boundary effect within a controlled environment. Depending on the frequency for which the probe is calibrated the method utilized for calibration will change. A number of methods is used for calibrating probes, and these are outlined in the table below:

Calibration Frequency	Air Calibration	Tissue Calibration
2450MHz	Waveguide	Temperature
5200MHz	Waveguide	Temperature
5800MHz	Waveguide	Temperature

The E-Field probe utilizes a triangular sensor arrangement as detailed in the diagram below:

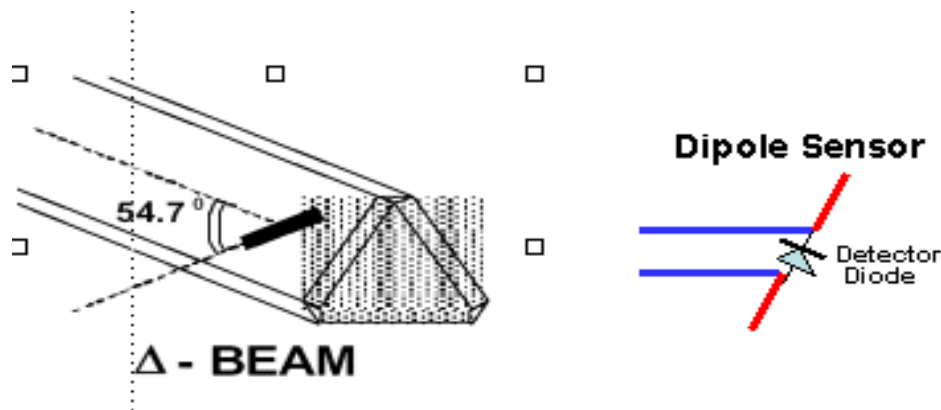

SAR is assessed with a calibrated probe which moves at a default height of 5mm from the center of the diode, which is mounted to the sensor, to the phantom surface (in the Z Axis). The 5mm offset height has been selected so as to minimize any resultant boundary effect due to the probe being in close proximity to the phantom surface.

The following algorithm is an example of the function used by the system for linearization of the output from the probe when measuring complex modulation schemes.

$$V_i = U_i + U_i^2 \cdot \frac{cf}{dcp_i}$$

2.2.1 Isotropic E-Field Probe Specification

Calibration in Air	Frequency Dependent Below 2GHz Calibration in air performed in a TEM Cell Above 2GHz Calibration in air performed in waveguide
Sensitivity	0.70 $\mu\text{V}/(\text{V}/\text{m})^2$ to 0.85 $\mu\text{V}/(\text{V}/\text{m})^2$
Dynamic Range	0.0005 W/kg to 100W/kg
Isotropic Response	Better than 0.2dB
Diode Compression point (DCP)	Calibration for Specific Frequency
Probe Tip Radius	< 5mm
Sensor Offset	1.56 (+/- 0.02mm)
Probe Length	290mm
Video Bandwidth	@ 500 Hz: 1dB @1.02 KHz: 3dB
Boundary Effect	Less than 2% for distance greater than 2.4mm
Spatial Resolution	Diameter less than 5mm Compliant with Standards

2.3 Boundary Detection Unit and Probe Mounting Device

ALSAS-10U incorporates a boundary detection unit with a sensitivity of 0.05mm for detecting all types of surfaces. The robust design allows for detection during probe tilt (probe normalize) exercises, and utilizes a second stage emergency stop. The signal electronics are fed directly into the robot controller for high accuracy surface detection in lateral and axial detection modes (X, Y, & Z).

The probe is mounted directly onto the Boundary Detection unit for accurate tooling and displacement calculations controlled by the robot kinematics. The probe is connect to an isolated probe interconnect where the output stage of the probe is fed directly into the amplifier stage of the Daq-Paq

2.4 Daq-Paq (Analog to Digital Electronics)

ALSAS-10U incorporates a fully calibrated Daq-Paq (analog to digital conversion system) which has a 4 channel input stage, sent via a 2 stage auto-set amplifier module. The input signal is amplified accordingly so as to offer a dynamic range from 5µV to 800mV. Integration of the fields measured is carried out at board level utilizing a Co-Processor which then sends the measured fields down into the main computational module in digitized form via an RS232 communications port. Probe linearity and duty cycle compensation is carried out within the main Daq-Paq module.

ADC	12 Bit
Amplifier Range	20mV to 200mV and 150mV to 800mV
Field Integration	Local Co-Processor utilizing proprietary integration algorithms
Number of Input Channels	4 in total 3 dedicated and 1 spare
Communication	Packet data via RS232

2.5 Axis Articulated Robot



ALSAS-10U utilizes a six axis articulated robot, which is controlled using a Pentium based real-time movement controller. The movement kinematics engine utilizes proprietary (Thermo CRS) interpolation and extrapolation algorithms, which allow full freedom of movement for each of the six joints within the working envelope. Utilization of joint 6 allows for full probe rotation with a tolerance better than 0.05mm around the central axis.

Robot/Controller Manufacturer	Thermo CRS
Number of Axis	Six independently controlled axis
Positioning Repeatability	0.05mm
Controller Type	Single phase Pentium based C500C
Robot Reach	710mm
Communication	RS232 and LAN compatible

2.6 ALSAS Universal Workstation

ALSAS Universal workstation allows for repeatability and fast adaptability. It allows users to do calibration, testing and measurements using different types of phantoms with one set up, which significantly speeds up the measurement process.

2.7 Universal Device Positioner

The universal device positioner allow complete freedom of movement of the EUT. Developed to hold a EUT in a free-space scenario any additional loading attributable to the material used in the construction of the positioner has been eliminated. Repeatability has been enhanced through the linear scales which form the design used to indicate positioning for any given test scenario in all major axes. A 15° tilt indicator is included for the of aid cheek to tilt movements for head SAR analysis. Overall uncertainty for measurements have been reduced due to the design of the Universal device positioner, which allows positioning of a device in as near to a free-space scenario as possible, and by providing the means for complete repeatability.



2.8 Phantom Types

The ALSAS-10U allows the integration of multiple phantom types. SAM Phantoms fully compliant with IEEE 1528, Universal Phantom, and Universal Flat.

2.8.1 APREL SAM Phantoms

The SAM phantoms developed using the IEEE SAM CAD file. They are fully compliant with the requirements for both IEEE 1528 and FCC Supplement C. Both the left and right SAM phantoms are interchangeable, transparent and include the IEEE 1528 grid with visible NF and MB lines.

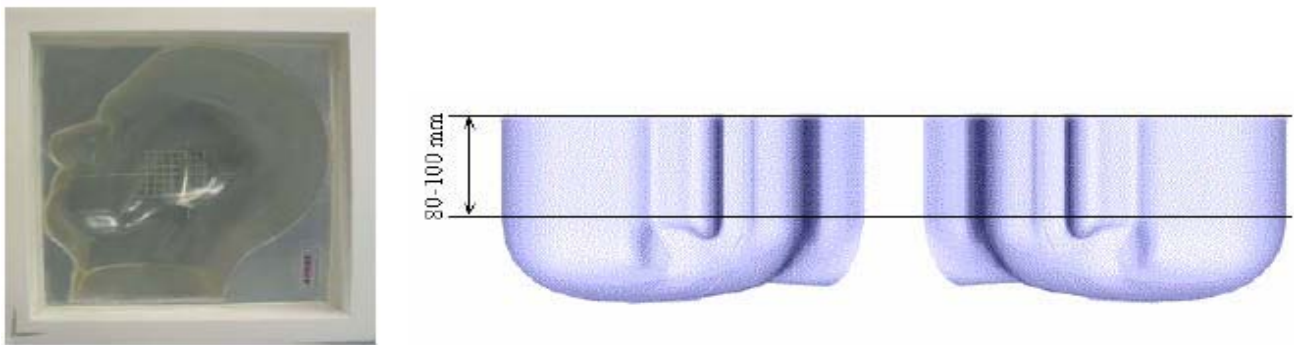

2.8.2 APREL Laboratories Universal Phantom

The Universal Phantom is used on the ALSAS-10U as a system validation phantom. The Universal Phantom has been fully validated both experimentally from 800MHz to 6GHz and numerically using XFDTD numerical software. The shell thickness is 2mm overall, with a 4mm spacer located at the NF/MB intersection providing an overall thickness of 6mm in line with the requirements of IEEE-1528.



The design allows for fast and accurate measurements, of handsets, by allowing the conservative SAR to be evaluated at on frequency for both left and right head experiments in one measurement.

3. Tissue Simulating Liquid

3.1 The composition of the tissue simulating liquid

INGREDIENT (% Weight)	2450MHz Head	2450MHz Body	5200MHz Head	5200MHz Body	5800MHz Head	5800MHz Body
Water	46.7	73.2	67.63	76	68.29	75.68
Salt	0.00	0.04	0.00	0.00	0.00	0.43
Sugar	0.00	0.00	0.00	0.00	0.00	0.00
HEC	0.00	0.00	0.00	0.00	0.00	0.00
Preventol	0.00	0.00	0.00	0.00	0.00	0.00
DGBE	53.3	26.7	3.38	4.44	2.44	4.42
Triton X-100	0.00	0.00	28.99	19.56	29.27	19.47

3.2 Tissue Calibration Result

The dielectric parameters of the liquids were verified prior to the SAR evaluation using APREL Dielectric Probe Kit and Anritsu MS4623B Vector Network Analyzer

Head Tissue Simulant Measurement				
Frequency [MHz]	Description	Dielectric Parameters		Tissue Temp. [°C]
		ϵ_r	σ [s/m]	
2450MHz	Reference result ± 5% window	39.2 37.24 to 41.16	1.8 1.71 to 1.89	N/A
	11-Apr-07	38.09	1.855	21.5

Body Tissue Simulant Measurement				
Frequency [MHz]	Description	Dielectric Parameters		Tissue Temp. [°C]
		ϵ_r	σ [s/m]	
2450MHz	Reference result ± 5% window	52.7 50.065 to 55.335	1.95 1.8525 to 2.0475	N/A
	11-Apr-07	51.32	2.002	21.5
2412 MHz	Low channel	51.66	1.978	21.5
2437 MHz	Mid channel	51.43	1.997	21.5
2462 MHz	High channel	51.22	2.016	21.5

Head Tissue Simulant Measurement				
Frequency [MHz]	Description	Dielectric Parameters		Tissue Temp. [°C]
		ϵ_r	σ [s/m]	
5200MHz	Reference result ± 5% window	35.9 34.105 to 37.695	4.7 4.465 to 4.935	N/A
	11-Apr-07	36.98	4.834	21.5

Body Tissue Simulant Measurement				
Frequency [MHz]	Description	Dielectric Parameters		Tissue Temp. [°C]
		ϵ_r	σ [s/m]	
5200MHz	Reference result ± 5% window	48.9 46.455 to 51.345	5.35 5.0825 to 5.6175	N/A
	11-Apr-07	50.62	5.254	21.5
5180 MHz	Low channel	50.65	5.183	21.5
5220 MHz	Mid channel	50.52	5.33	21.5
5240 MHz	High channel	50.41	5.421	21.5

Head Tissue Simulant Measurement				
Frequency [MHz]	Description	Dielectric Parameters		Tissue Temp. [°C]
		ϵ_r	σ [s/m]	
5800MHz	Reference result ± 5% window	35.3 33.535 to 37.065	5.27 5.0065 to 5.5335	N/A
	11-Apr-07	36.37	5.425	21.5

Body Tissue Simulant Measurement				
Frequency [MHz]	Description	Dielectric Parameters		Tissue Temp. [°C]
		ϵ_r	σ [s/m]	
5800MHz	Reference result ± 5% window	48.2 45.79 to 50.61	6 5.7 to 6.3	N/A
	11-Apr-07	49.41	6.234	21.5
5745 MHz	Low channel	49.78	6.147	21.5
5785 MHz	Mid channel	49.52	6.208	21.5
5825 MHz	High channel	49.2	6.278	21.5

3.3 Tissue Dielectric Parameters for Head and Body Phantoms

The head tissue dielectric parameters recommended by the IEEE SCC-34/SC-2 in P1528 have been incorporated in the following table. These head parameters are derived from planar layer models simulating the highest expected SAR for the dielectric properties and tissue thickness variations in a human head. Other head and body tissue parameters that have not been specified in P1528 are derived from the tissue dielectric parameters computed from the 4-Cole-Cole equations described in Reference [12] and extrapolated according to the head parameters specified in P1528.

Target Frequency (MHz)	Head		Body	
	ϵ_r	σ (S/m)	ϵ_r	σ (S/m)
150	52.3	0.76	61.9	0.80
300	45.3	0.87	58.2	0.92
450	43.5	0.87	56.7	0.94
835	41.5	0.90	55.2	0.97
900	41.5	0.97	55.0	1.05
915	41.5	0.98	55.0	1.06
1450	40.5	1.20	54.0	1.30
1610	40.3	1.29	53.8	1.40
1800 – 2000	40.0	1.40	53.3	1.52
2450	39.2	1.80	52.7	1.95
3000	38.5	2.40	52.0	2.73
5800	35.3	5.27	48.2	6.00

(ϵ_r = relative permittivity, σ = conductivity and $\rho = 1000 \text{ kg/m}^3$)

4. SAR Measurement Procedure

4.1 SAR System Validation

4.1.1 Validation Dipoles

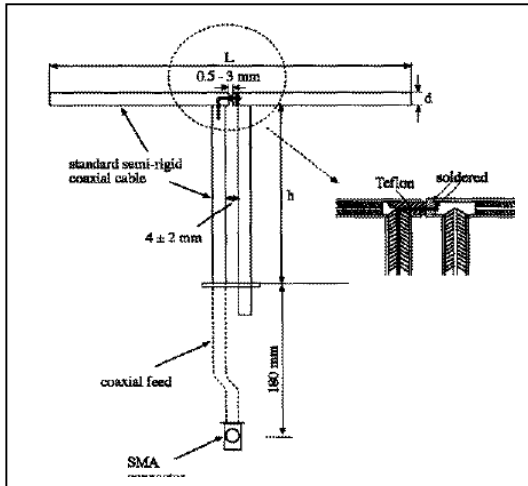

The dipoles used is based on the IEEE-1528 standard, and is complied with mechanical and electrical specifications in line with the requirements of both IEEE and FCC Supplement C. the table below provides details for the mechanical and electrical specifications for the dipoles.

Frequency	L (mm)	h (mm)	d (mm)
2450MHz	53.5	30.4	3.6
5200MHz	23.1	14.2	3.6
5800MHz	21.2	13.1	3.6

4.1.2 Validation Result

System Performance Check at 2450MHz				
Validation Kit: ASL-D-2450-S-2				
Frequency [MHz]	Description	SAR [w/kg] 1g	SAR [w/kg] 10g	Tissue Temp. [°C]
2450 MHz	Reference result ± 5% window	52.4 49.78 to 55.02	24 22.8 to 25.2	N/A
	11-Apr-07	53.553	24.672	21.5
Note: All SAR values are normalized to 1W forward power.				

System Performance Check at 5200MHz			
Validation Kit: ASL-D-5200-S-2			
Frequency [MHz]	Description	SAR [w/kg] 1g	Tissue Temp. [°C]
5200 MHz	Reference result ± 5% window	58.8 55.86 to 61.74	N/A
	11-Apr-07	59.54	21.5
Note: All SAR values are normalized to 1W forward power.			

System Performance Check at 5800MHz			
Validation Kit: ASL-D-5800-S-2			
Frequency [MHz]	Description	SAR [w/kg] 1g	Tissue Temp. [°C]
5200 MHz	Reference result ± 5% window	57.9 55.005 to 60.795	N/A
	11-Apr-07	56.544	21.5
Note: All SAR values are normalized to 1W forward power.			

4.2 SAR Measurement Procedure

The ALSAS-10U calculates SAR using the following equation,

$$SAR = \frac{\sigma |E|^2}{\rho}$$

σ : represents the simulated tissue conductivity

ρ : represents the tissue density

The EUT is set to transmit at the required power in line with product specification, at each frequency relating to the LOW, MID, and HIGH channel settings.

Pre-scans are made on the device to establish the location for the transmitting antenna, using a large area scan in either air or tissue simulation fluid.

The EUT is placed against the Universal Phantom where the maximum area scan dimensions are larger than the physical size of the resonating antenna. When the scan size is not large enough to cover the peak SAR distribution, it is modified by either extending the area scan size in both the X and Y directions, or the device is shifted within the predefined area.

The area scan is then run to establish the peak SAR location (interpolated resolution set at 1mm²) which is then used to orient the center of the zoom scan. The zoom scan is then executed and the 1g and 10g averages are derived from the zoom scan volume (interpolated resolution set at 1mm³).

4.3.1 SAR Measurement Procedure

1. The device was put into operation by using a call tester. Communication between the device and the call tester was established by air link.
2. The device output power was set to maximum power level for all tests; a fully charged battery was use for every test sequence.
3. In all operating band in measurements were performed on lowest,middle and highest channels

5. SAR Exposure Limits

SAR assessments have been made in line with the requirements of IEEE-1528, FCC Supplement C, and comply with ANSI/IEEE C95.1-1992 “Uncontrolled Environments” limits. These limits apply to a location which is deemed as “Uncontrolled Environment” which can be described as a situation where the general public may be exposed to an RF source with no prior knowledge or control over their exposure.

Limits for General Population/Uncontrolled Exposure (W/kg)

Type Exposure	Uncontrolled Environment Limit
Spatial Peak SAR (1g cube tissue for brain or body)	1.60 W/kg
Spatial Average SAR (whole body)	0.08 W/kg
Spatial Peak SAR (10g for hands, feet, ankles and wrist)	4.00 W/kg

6. Test Equipment List

Instrument	Manufacturer	Model No.	Serial No.	Last Calibration	Next Calibration
Data Acquisition Package	Apriel	ALS-DAQ-PAQ-2	QTK-337	Nov. 2006	only once
Apriel Laboratories Probe	Apriel	ALS-E020	264	Mar. 2006	Mar. 2008
Apriel Reference Dipole 2450Mhz	Apriel	ALS-D-2450-S-2	QTK-319	Jun. 2006	Jun. 2008
Apriel Reference Dipole 5200Mhz	Apriel	ALS-D-5200-S-2	QTK-320	Jun. 2006	Jun. 2008
Apriel Reference Dipole 5800Mhz	Apriel	ALS-D-5800-S-2	QTK-321	Jun. 2006	Jun. 2008
Boundary Detection Sensor System	Apriel	ALS-PMDPS-2	QTK-336	N/A	N/A
Dielectric Probe Kit	Apriel	ALS-PR-DIEL	QTK-296	N/A	N/A
Universal Work Station	Apriel	ALS-UWS	QTK-326	N/A	N/A
Device Holder 2.0	Apriel	ALS-H-E-SET-2	QTK-294	N/A	N/A
Left Ear SAM Phantom	Apriel	ALS-P-SAM-L	QTK-292	N/A	N/A
Right Ear SAM Phantom	Apriel	ALS-P-SAM-R	QTK-288	N/A	N/A
Universal Phantom	Apriel	ALS-P-UP-1	QTK-246	N/A	N/A
Apriel Dipole Spacer	Apriel	ALS-DS-U	QTK-295	N/A	N/A
SAR Software	Apriel	ALSAS-10	Ver. 2.1.0	N/A	N/A
CRS C500C Controller	Thermo	ALS-C500	RCF0404433	N/A	N/A
CRF F3 Robot	Thermo	ALS-F3	RAF0412222	N/A	N/A
Power Amplifier	Mini-Circuit	ZHL-42	D051404-20	N/A	N/A
Directional Coupler	Agilent	778D-012	50550	N/A	N/A
Universal Radio Communication Tester	Rohde & Schwarz	CMU 200	104846	Mar. 2007	Mar. 2008
Radio Communication Analyzer	Anritsu	MT8820A	6200323183	Apr. 2007	Apr. 2008
Vector Network	Anritsu	MS4623B	992801	Apr. 2007	Apr. 2008
Signal Generator	Anritsu	MG3692A	042319	Jun. 2006	Jun. 2007
Power Meter	Anritsu	ML2487A	6K00001447	Apr. 2007	Apr. 2008
Wide Bandwidth Sensor	Anritsu	MA2491	030677	Apr. 2007	Apr. 2008

7. Measurement Uncertainty

Exposure Assessment Measurement Uncertainty

Source of Uncertainty	Tolerance Value	Probability Distribution	Divisor	c_1 (1-g)	c_1 (10-g)	Standard Uncertainty (1-g) %	Standard Uncertainty (10-g) %
Measurement System							
Probe Calibration	3.5	normal	1	1	1	3.5	3.5
Axial Isotropy	3.7	rectangular	$\sqrt{3}$	$(1-cp)^{1/2}$	$(1-cp)^{1/2}$	1.5	1.5
Hemispherical Isotropy	10.9	rectangular	$\sqrt{3}$	\sqrt{cp}	\sqrt{cp}	4.4	4.4
Boundary Effect	1.0	rectangular	$\sqrt{3}$	1	1	0.6	0.6
Linearity	4.7	rectangular	$\sqrt{3}$	1	1	2.7	2.7
Detection Limit	1.0	rectangular	$\sqrt{3}$	1	1	0.6	0.6
Readout Electronics	1.0	normal	1	1	1	1.0	1.0
Response Time	0.8	rectangular	$\sqrt{3}$	1	1	0.5	0.5
Integration Time	1.7	rectangular	$\sqrt{3}$	1	1	1.0	1.0
RF Ambient Condition	3.0	rectangular	$\sqrt{3}$	1	1	1.7	1.7
Probe Positioner Mech.	0.4	rectangular	$\sqrt{3}$	1	1	0.2	0.2
Restriction							
Probe Positioning with respect to Phantom Shell	2.9	rectangular	$\sqrt{3}$	1	1	1.7	1.7
Extrapolation and Integration	3.7	rectangular	$\sqrt{3}$	1	1	2.1	2.1
Test Sample Positioning	4.0	normal	1	1	1	4.0	4.0
Device Holder Uncertainty	2.0	normal	1	1	1	2.0	2.0
Drift of Output Power	4.7	rectangular	$\sqrt{3}$	1	1	2.7	2.7
Phantom and Setup							
Phantom Uncertainty(shape & thickness tolerance)	3.4	rectangular	$\sqrt{3}$	1	1	2.0	2.0
Liquid Conductivity(target)	5.0	rectangular	$\sqrt{3}$	0.7	0.5	2.0	1.4
Liquid Conductivity(meas.)	0.1	normal	1	0.7	0.5	0.1	0.0
Liquid Permittivity(target)	2.0	rectangular	$\sqrt{3}$	0.6	0.5	0.7	0.6
Liquid Permittivity(meas.)	2.6	normal	1	0.6	0.5	1.6	1.3
Combined Uncertainty		RSS				9.6	9.5
Combined Uncertainty (coverage factor=2)		Normal (k=2)				19.3	18.9

8. Procedure Used to Establish Test Signal

The following produces had been used to prepare the EUT for the SAR test. The client provided batch files to control the frequency and output power of the module.

8.1. Conducted Power-2.4GHz Band

802.11b (1Mbps)

Channel	Frequency (MHz)	Antenna A (dBm)	Antenna B (dBm)
1	2412	15.25	16.28
6	2437	15.81	16.74
11	2462	15.99	17.16

802.11g (6Mbps)

Channel	Frequency (MHz)	Antenna A (dBm)	Antenna B (dBm)
1	2412	19.86	20.81
6	2437	20.45	21.15
11	2462	20.72	21.30

802.11n HT0 (20Mhz)

Channel	Frequency (MHz)	Antenna A (dBm)	Antenna B (dBm)
1	2412	19.99	20.49
6	2437	20.43	21.59
11	2462	20.47	21.73

802.11n HT8 (20Mhz)

Channel	Frequency (MHz)	Antenna A (dBm)	Antenna B (dBm)	Total (dBm)
1	2412	22.11	22.85	25.51
6	2437	21.14	22.60	24.94
11	2462	21.51	22.65	25.13

8.2. Conducted power-5.2GHz Band

802.11a (6Mbps)

Channel	Frequency (MHz)	Antenna A (dBm)	Antenna B (dBm)
36	5180	16.14	16.03
44	5220	16.11	16.03
48	5240	16.33	16.02

802.11n HT0 (20MHz)

Channel	Frequency (MHz)	Antenna A (dBm)	Antenna B (dBm)
36	5180	16.02	16.16
44	5220	16.40	16.08
48	5240	16.48	16.12

802.11n HT0 (40MHz)

Channel	Frequency (MHz)	Antenna A (dBm)	Antenna B (dBm)
38	5190	15.07	15.01

802.11n HT8(20MHz)

Channel	Frequency (MHz)	Antenna A (dBm)	Antenna B (dBm)	Total (dBm)
36	5180	13.04	11.65	15.41
44	5220	13.04	11.40	15.31
48	5240	13.31	12.62	15.99

802.11n HT8(40MHz)

Channel	Frequency (MHz)	Antenna A (dBm)	Antenna B (dBm)	Total (dBm)
38	5190	13.44	12.03	15.80

8.3. Conducted power-5.8GHz Band

802.11a (6Mbps)

Channel	Frequency (MHz)	Antenna A (dBm)	Antenna B (dBm)
149	5745	20.26	20.25
157	5785	20.45	20.41
165	5825	18.52	20.35

802.11n HT0 (20MHz)

Channel	Frequency (MHz)	Antenna A (dBm)	Antenna B (dBm)
149	5745	20.36	19.94
157	5785	20.28	20.64
165	5825	20.41	19.47

802.11n HT0 (40MHz)

Channel	Frequency (MHz)	Antenna A (dBm)	Antenna B (dBm)
151	5755	18.44	18.44
159	5795	18.15	18.22

802.11n HT8 (20MHz)

Channel	Frequency (MHz)	Antenna A (dBm)	Antenna B (dBm)	Total (dBm)
149	5745	20.08	19.34	22.74
157	5785	20.75	19.30	23.10
165	5825	21.62	20.21	23.98

802.11n HT8 (40MHz)

Channel	Frequency (MHz)	Antenna A (dBm)	Antenna B (dBm)	Total (dBm)
151	5755	18.59	18.35	21.48
159	5795	18.62	18.72	21.68

9. Test Results

9.1 SAR Test Results Summary-2.4GHz Band

SAR MEASUREMENT					
Ambient Temperature (°C) : 22.4 ±2			Relative Humidity (%): 56		
Liquid Temperature (°C) : 21.5 ±2			Depth of Liquid (cm):>15		
Test Mode: 802.11b (1Mbps)- Antenna A (ACON)					
Test Position Body	Antenna Position	Frequency		SAR 1g (W/kg)	Limit (W/kg)
		Channel	MHz		
Back	Fixed	1	2412	1.282	1.6
Back	Fixed	6	2437	1.363	1.6
Back	Fixed	11	2462	1.445	1.6
Test Mode: 802.11b (1Mbps)- Antenna B (ACON)					
Back	Fixed	6	2437	1.251	1.6
Test Mode: 802.11g (6Mbps)					
Back	Fixed	1	2412	1.297	1.6
Back	Fixed	6	2437	1.276	1.6
Back	Fixed	11	2462	1.275	1.6
Test Mode: 802.11n HT0 (20MHz)					
Back	Fixed	1	2412	0.887	1.6
Back	Fixed	6	2437	0.986	1.6
Back	Fixed	11	2462	1.031	1.6
Test Mode: 802.11n HT8 (20MHz)					
Back	Fixed	1	2412	1.305	1.6
Back	Fixed	6	2437	1.086	1.6
Back	Fixed	11	2462	1.041	1.6
Note: The SAR test in EUT back is the worst condition.					

9.2 SAR Test Results Summary-5.2GHz Band

SAR MEASUREMENT					
Ambient Temperature (°C) : 22.4 ±2			Relative Humidity (%) : 56		
Liquid Temperature (°C) : 21.5 ±2			Depth of Liquid (cm) : >15		
Test Mode: 802.11a (6Mbps)- Antenna A (Tyco)					
Test Position Body	Antenna Position	Frequency		SAR 1g (W/kg)	Limit (W/kg)
		Channel	MHz		
Back	Fixed	36	5180	0.657	1.6
Back	Fixed	44	5220	0.983	1.6
Back	Fixed	48	5240	0.743	1.6
Test Mode: 802.11a (6Mbps)- Antenna B (Tyco)					
Back	Fixed	44	5220	0.739	1.6
Test Mode: 802.11n HT0 (20Mbps)					
Back	Fixed	36	5180	0.731	1.6
Back	Fixed	44	5220	0.871	1.6
Back	Fixed	48	5240	0.885	1.6
Test Mode: 802.11n HT0 (40MHz)					
Back	Fixed	38	5190	0.6	1.6
Test Mode: 802.11n HT8 (20MHz)					
Back	Fixed	36	5180	0.445	1.6
Back	Fixed	44	5220	0.913	1.6
Back	Fixed	48	5240	0.938	1.6
Test Mode: 802.11n HT8 (40MHz)					
Back	Fixed	38	5190	0.457	1.6
Note: The SAR test in EUT back is the worst condition.					

9.3 SAR Test Results Summary-5.8GHz Band

SAR MEASUREMENT					
Ambient Temperature (°C) : 22.4 ±2			Relative Humidity (%) : 56		
Liquid Temperature (°C) : 21.5 ±2			Depth of Liquid (cm) : >15		
Test Mode: 802.11a (6Mbps)- Antenna A (Tyco)					
Test Position Body	Antenna Position	Frequency		SAR 1g (W/kg)	Limit (W/kg)
		Channel	MHz		
Back	Fixed	149	5745	1.477	1.6
Back	Fixed	157	5785	1.257	1.6
Back	Fixed	165	5825	1.371	1.6
Test Mode: 802.11a (6Mbps)- Antenna B (Tyco)					
Back	Fixed	157	5785	0.89	1.6
Test Mode: 802.11n HT0 (20MHz)					
Back	Fixed	149	5745	1.462	1.6
Back	Fixed	157	5785	1.22	1.6
Back	Fixed	165	5825	1.303	1.6
Test Mode: 802.11n HT0 (40MHz)					
Back	Fixed	151	5755	1.02	1.6
Back	Fixed	159	5795	1.031	1.6
Test Mode: 802.11n HT8 (20MHz)					
Back	Fixed	149	5745	1.448	1.6
Back	Fixed	157	5785	1.452	1.6
Back	Fixed	165	5825	1.204	1.6
Test Mode: 802.11n HT8 (40MHz)					
Back	Fixed	151	5755	1.236	1.6
Back	Fixed	159	5795	1.256	1.6
Note: The SAR test in EUT back is the worst condition.					

Appendix A. SAR System Validation Data

Appendix B. SAR measurement Data

Appendix C. Test Setup Photographs & EUT Photographs

Appendix D. Probe Calibration Data

Appendix E. Dipole Calibration Data

SAR System Validation Data

ALSAS-10U VER 2.3.2 APREL Laboratories
SAR Test Report

Report Date : 11-Apr-2007
Measurement Date : 11-Apr-2007

Product Data

Device Name : Dipole-2450
Type : Dipole
Frequency : 2450.00 MHz
Max. Transmit Pwr : 0.25 W
Drift Time : 0 min(s)
Length : 51.5 mm
Width : 3.6 mm
Depth : 30.4 mm
Power Drift-Start : 6.453 W/kg
Power Drift-Finish: 6.348 W/kg
Power Drift (%) : -1.635

Phantom Data

Type : Uni-Phantom
Size (mm) : 280 x 280 x 200
Location : Center

Tissue Data

Type : HEAD
Serial No. : 325-H
Frequency : 2450.00 MHz
Last Calib. Date : 11-Apr-2007
Temperature : 21.50 °C
Ambient Temp. : 22.40 °C
Humidity : 56.00 RH%
Epsilon : 38.09 F/m
Sigma : 1.855 S/m
Density : 1000.00 kg/cu. m

Probe Data

Name : Probe 264
Model : E020
Type : E-Field Triangle
Serial No. : 264
Last Calib. Date : 21-Mar-2006
Frequency : 2450.00 MHz
Duty Cycle Factor: 1
Conversion Factor: 5
Probe Sensitivity: 1.20 1.20 1.20 $\mu\text{V}/(\text{V}/\text{m})^2$
Compression Point: 95.00 mV
Offset : 1.56 mm

Measurement Data

Crest Factor : 1
Tissue Temp. : 21.50 °C
Ambient Temp. : 22.40 °C
Area Scan : 5x5x1 : Measurement x=12mm, y=12mm, z=4mm
Zoom Scan : 7x7x7 : Measurement x=5mm, y=5mm, z=5mm
Frequency : 2450 MHz

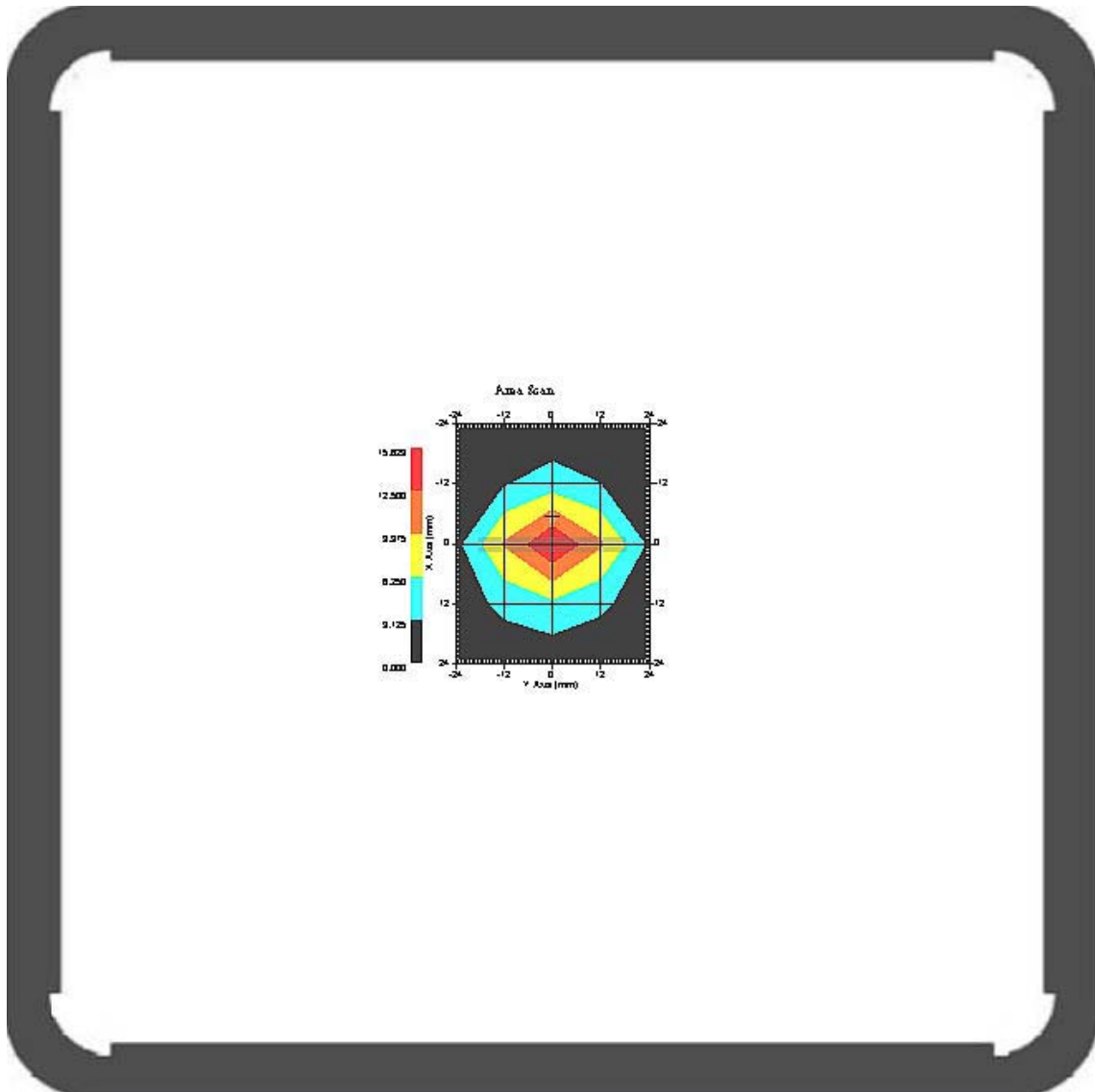

1 gram SAR value : 13.388 W/kg
10 gram SAR value : 6.168 W/kg
Area Scan Peak SAR : 15.623 W/kg
Zoom Scan Peak SAR : 24.621 W/kg

SAR-Z Axis
at Hotspot x:0.03 y:-0.01

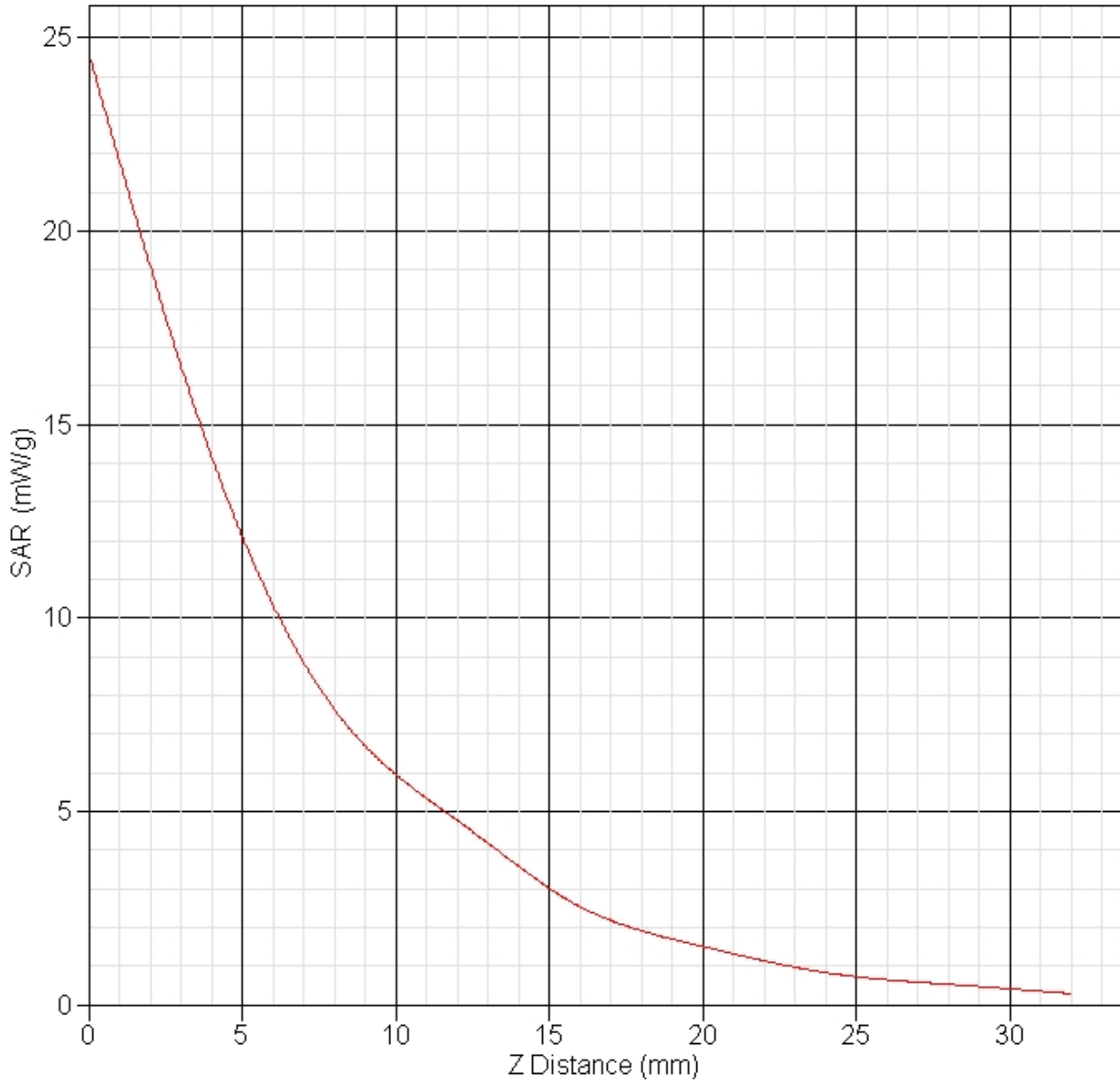

Area Scan

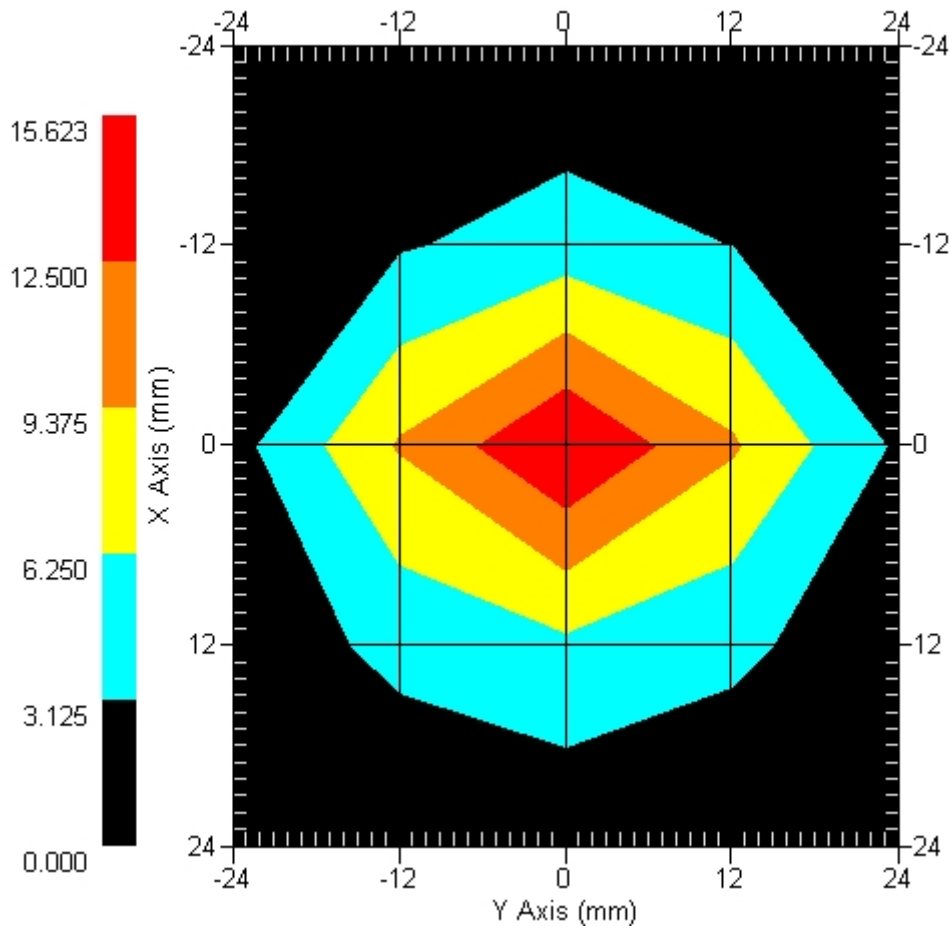

ALSAS-10U VER 2.3.2 APREL Laboratories SAR Test Report

Report Date : 11-Apr-2007
Measurement Date : 11-Apr-2007

Product Data

Device Name : Dipole-5200
Type : Dipole
Frequency : 5200.00 MHz
Max. Transmit Pwr : 0.25 W
Drift Time : 0 min(s)
Length : 23 mm
Width : 3.6 mm
Depth : 89.8 mm
Power Drift-Start : 11.466 W/kg
Power Drift-Finish: 11.149 W/kg
Power Drift (%) : -2.762

Phantom Data

Type : Uni-Phantom
Size (mm) : 280 x 280 x 200
Location : Center

Tissue Data

Type : HEAD
Serial No. : 326-H
Frequency : 5200.00 MHz
Last Calib. Date : 11-Apr-2007
Temperature : 21.50 °C
Ambient Temp. : 22.40 °C
Humidity : 56.00 RH%
Epsilon : 36.98 F/m
Sigma : 4.834 S/m
Density : 1000.00 kg/cu. m

Probe Data

Name : Probe 264
Model : E020
Type : E-Field Triangle
Serial No. : 264
Last Calib. Date : 21-Mar-2006
Frequency : 5200.00 MHz
Duty Cycle Factor: 1
Conversion Factor: 3.9
Probe Sensitivity: 0.61 0.61 0.61 $\mu\text{V}/(\text{V}/\text{m})^2$
Compression Point: 95.00 mV
Offset : 1.56 mm

Measurement Data

Crest Factor : 1
Tissue Temp. : 21.50 °C
Ambient Temp. : 22.40 °C
Area Scan : 5x5x1 : Measurement x=12mm, y=12mm, z=4mm
Zoom Scan : 7x7x7 : Measurement x=5mm, y=5mm, z=5mm
Frequency : 5200 MHz

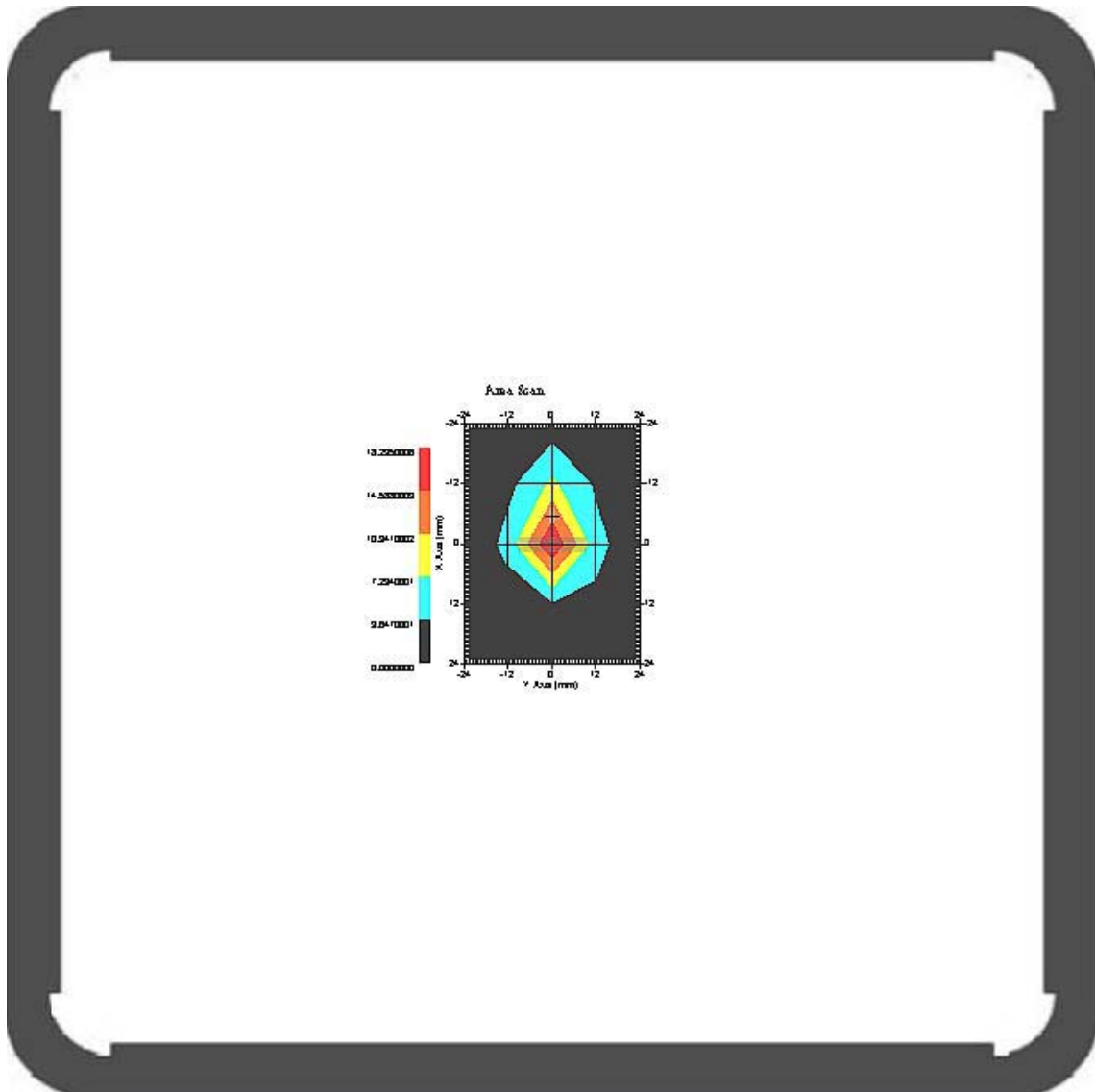

1 gram SAR value : 14.885 W/kg
10 gram SAR value : 5.037 W/kg
Area Scan Peak SAR : 18.235 W/kg
Zoom Scan Peak SAR : 45.736 W/kg

SAR-Z Axis
at Hotspot x:0.06 y:-0.01

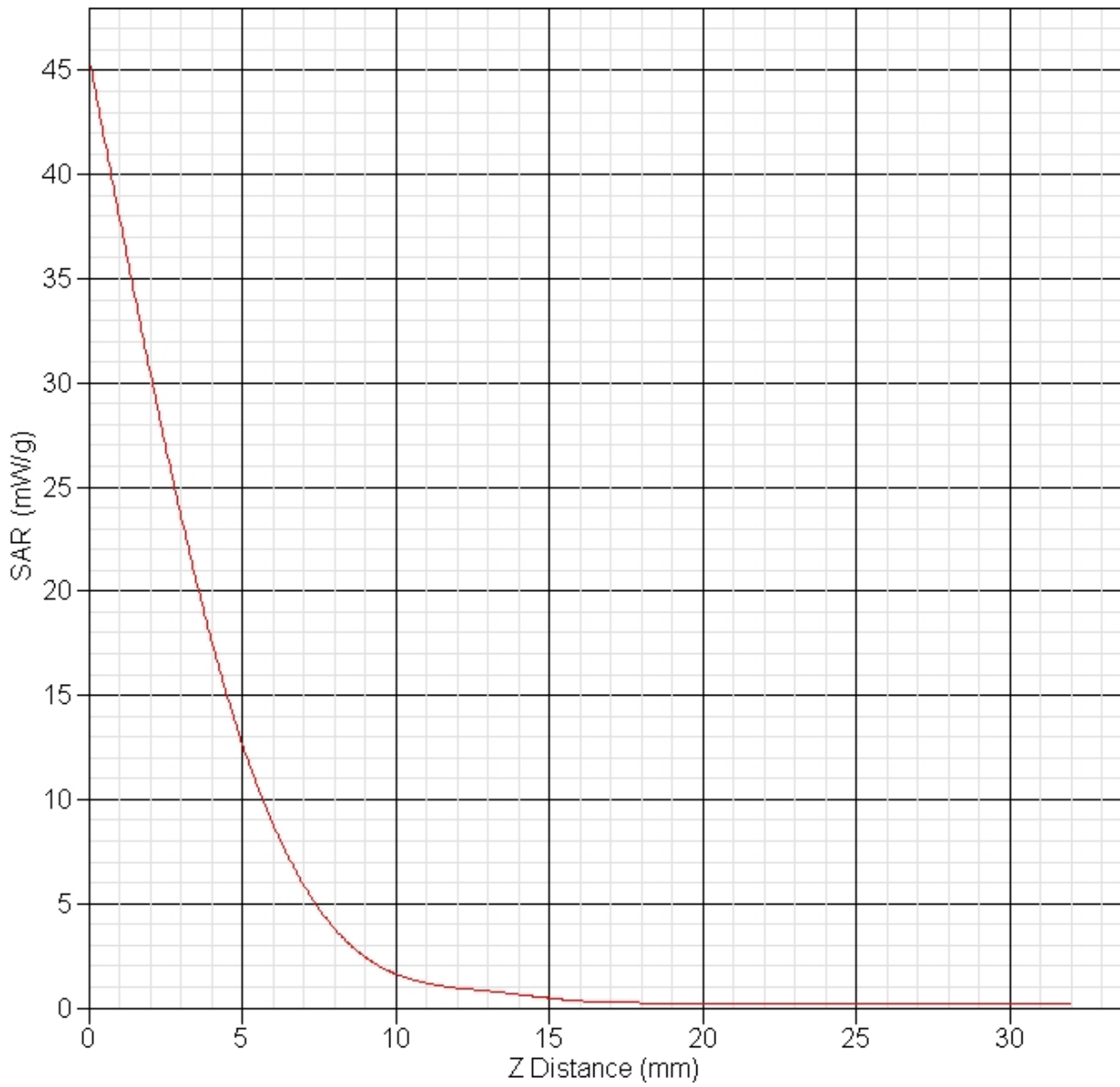

Area Scan

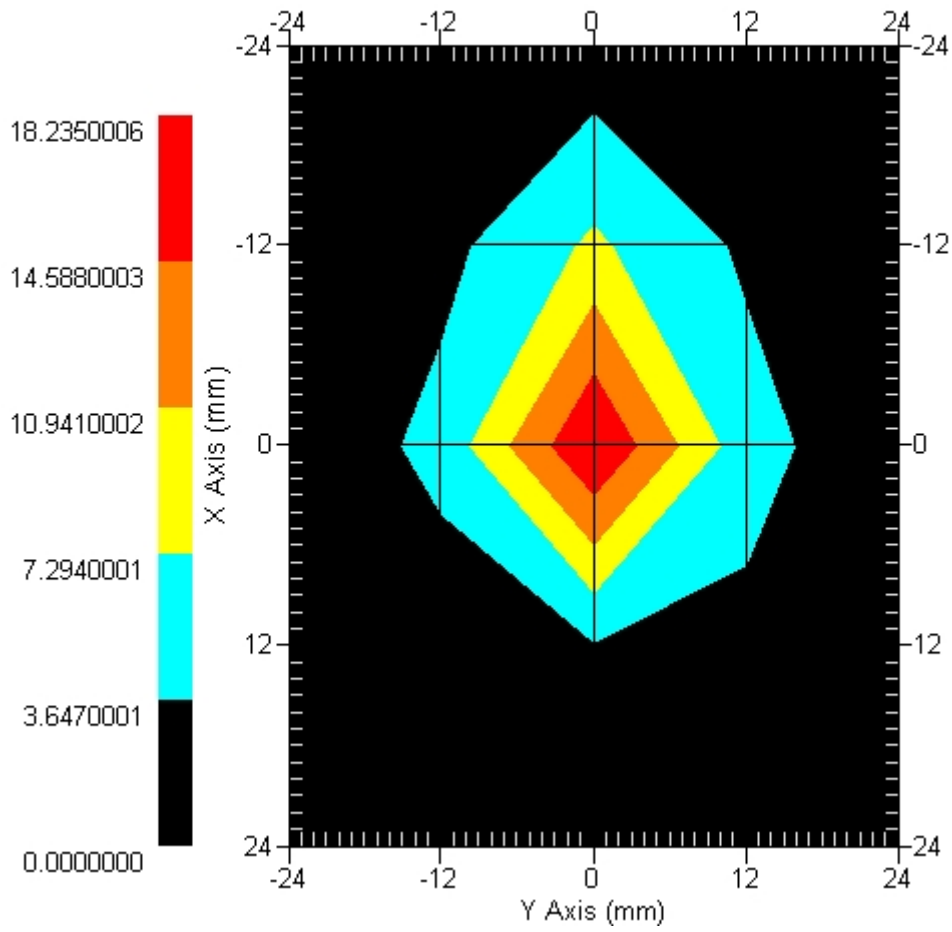

ALSAS-10U VER 2.3.2 APREL Laboratories SAR Test Report

Report Date : 11-Apr-2007
Measurement Date : 11-Apr-2007

Product Data

Device Name : Dipole-5800
Type : Dipole
Frequency : 5800.00 MHz
Max. Transmit Pwr : 0.25 W
Drift Time : 0 min(s)
Length : 21.4 mm
Width : 3.6 mm
Depth : 89.8 mm
Power Drift-Start : 11.270 W/kg
Power Drift-Finish: 11.754 W/kg
Power Drift (%) : 4.300

Phantom Data

Name : APREL-Uni
Type : Uni-Phantom
Size (mm) : 280 x 280 x 200
Location : Center

Tissue Data

Type : HEAD
Serial No. : 327-H
Frequency : 5800.00 MHz
Last Calib. Date : 11-Apr-2007
Temperature : 21.50 °C
Ambient Temp. : 22.40 °C
Humidity : 56.00 RH%
Epsilon : 36.37 F/m
Sigma : 5.425 S/m
Density : 1000.00 kg/cu. m

Probe Data

Name : Probe 264
Model : E020
Type : E-Field Triangle
Serial No. : 264
Last Calib. Date : 21-Mar-2006
Frequency : 5800.00 MHz
Duty Cycle Factor: 1
Conversion Factor: 3.3
Probe Sensitivity: 0.61 0.61 0.61 $\mu\text{V}/(\text{V}/\text{m})^2$
Compression Point: 95.00 mV
Offset : 1.56 mm

Measurement Data

Crest Factor : 1
Tissue Temp. : 21.50 °C
Ambient Temp. : 22.40 °C
Area Scan : 5x5x1 : Measurement x=12mm, y=12mm, z=4mm
Zoom Scan : 7x7x7 : Measurement x=5mm, y=5mm, z=5mm
Frequency : 5800 MHz

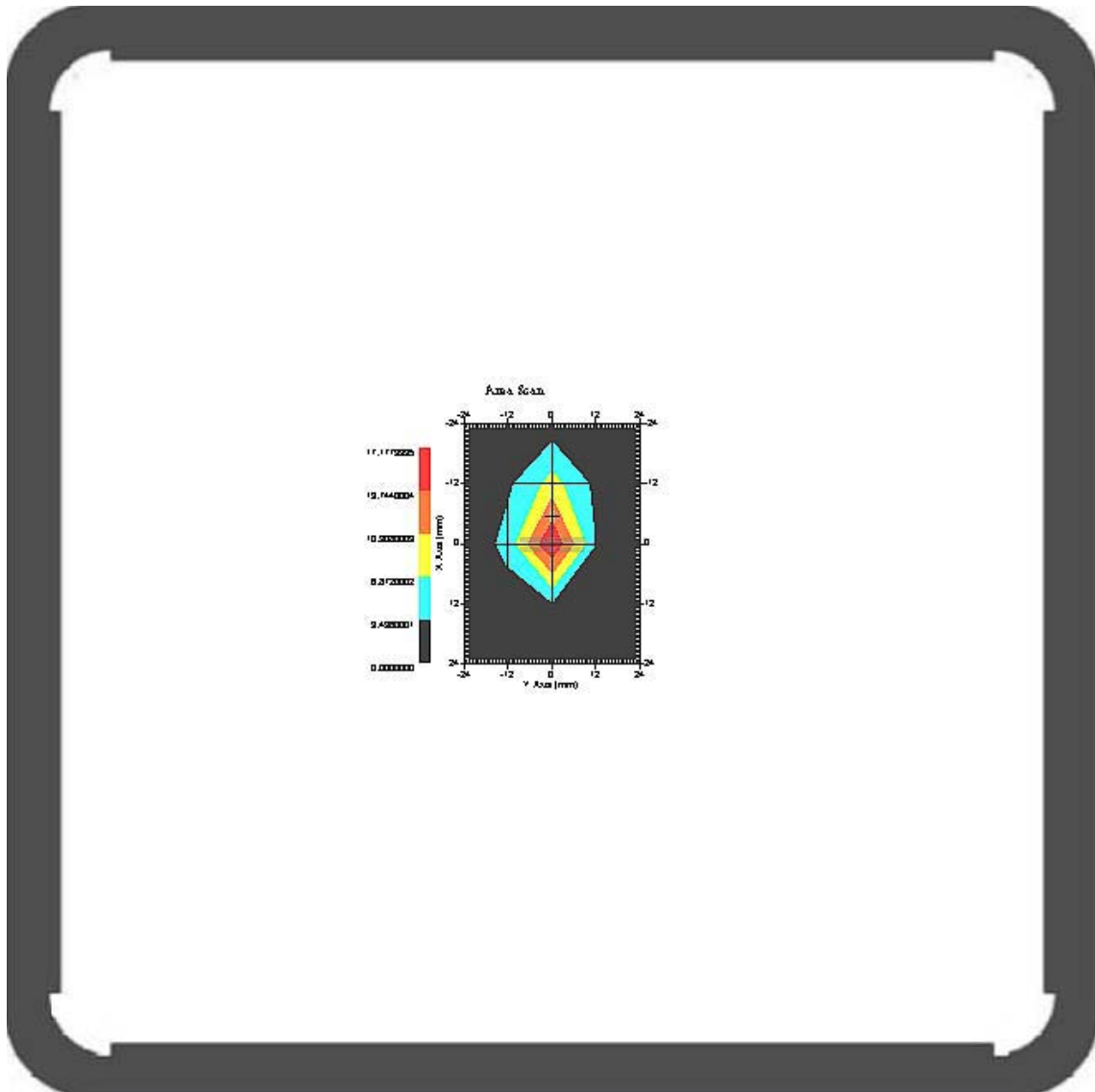

1 gram SAR value : 14.136 W/kg
10 gram SAR value : 4.858 W/kg
Area Scan Peak SAR : 17.178 W/kg
Zoom Scan Peak SAR : 44.735 W/kg

SAR-Z Axis
at Hotspot x:0.08 y:-0.01

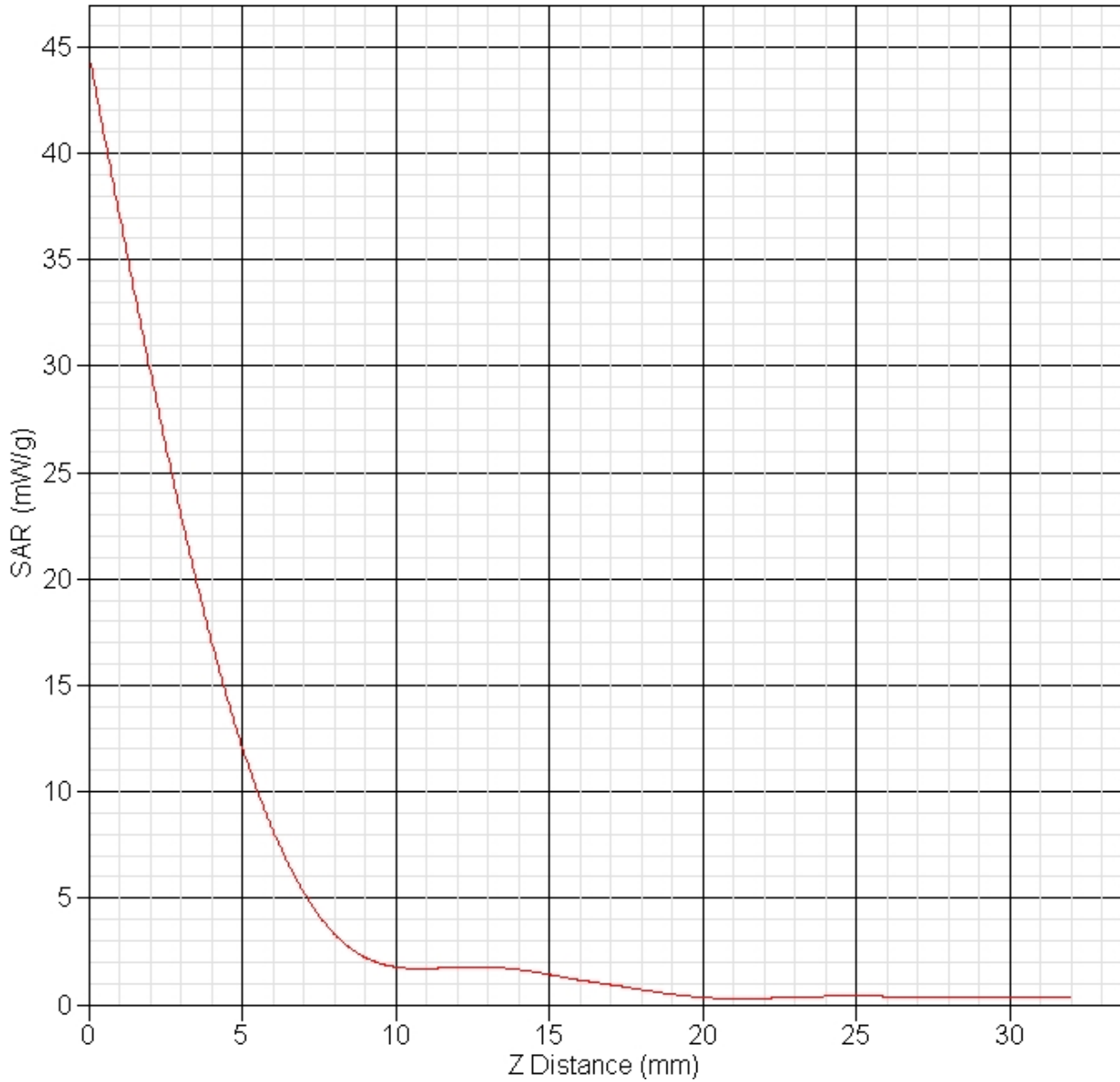

Area Scan

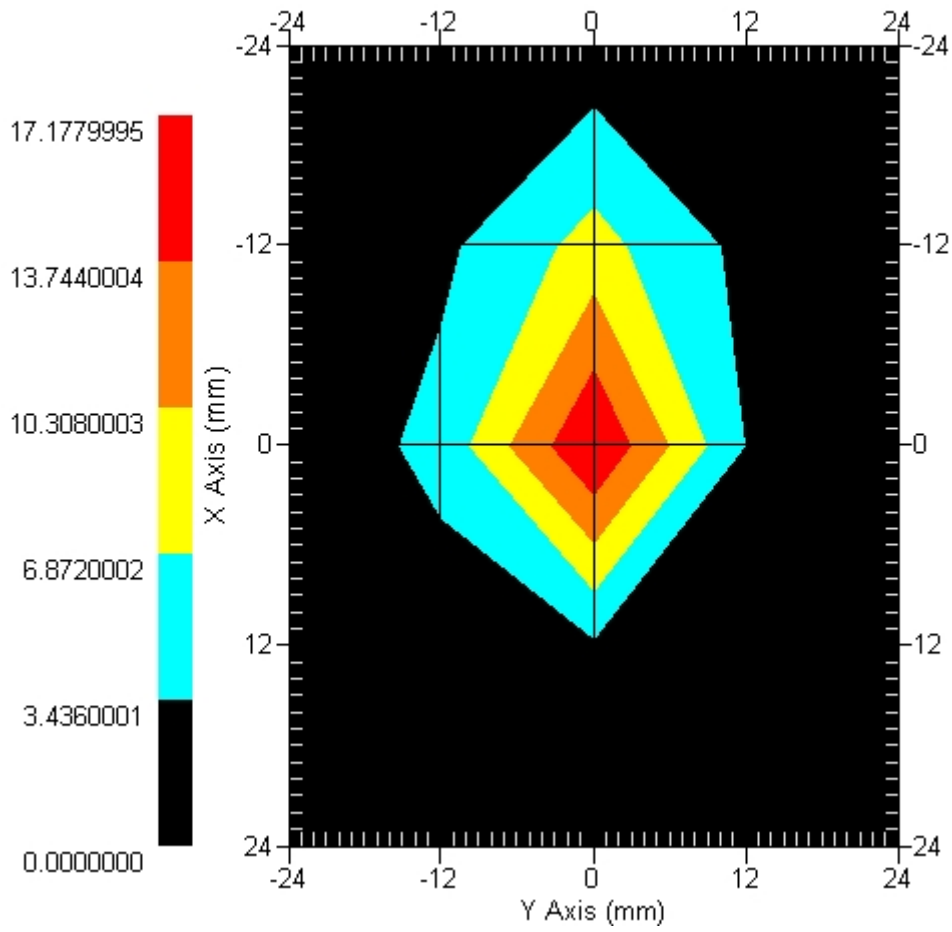

SAR Measurement Data

ALSAS-10U VER 2.3.2 APREL Laboratories

SAR Test Report -2.4GHz Band: 802.11b (1Mbps)-Antenna A (ACON)

Report Date : 11-Apr-2007
Measurement Date : 11-Apr-2007

Product Data

Device Name : ASUS
Type : Other
Model : F9S, F9E, F9D
Frequency : 2450.00 MHz
Drift Time : 0 min(s)
Length : 305 mm
Width : 245 mm
Depth : 9.4 mm
Antenna Type : Internal

Phantom Data

Type : Uni-Phantom
Size (mm) : 280 x 280 x 200
Location : Center

Tissue Data

Type : BODY
Serial No. : 325-B
Frequency : 2450.00 MHz
Last Calib. Date : 11-Apr-2007
Temperature : 21.50 °C
Ambient Temp. : 22.40 °C
Humidity : 56.00 RH%
Epsilon : 51.32 F/m
Sigma : 2.002 S/m
Density : 1000.00 kg/cu. m

Probe Data

Name : Probe 264
Model : E020
Type : E-Field Triangle
Serial No. : 264
Last Calib. Date : 21-Mar-2006
Frequency : 2450.00 MHz
Duty Cycle Factor: 1
Conversion Factor: 5.2
Probe Sensitivity: 1.20 1.20 1.20 $\mu\text{V}/(\text{V}/\text{m})^2$
Compression Point: 95.00 mV
Offset : 1.56 mm

Measurement Data

Crest Factor : 1
Tissue Temp. : 21.50 °C
Ambient Temp. : 22.40 °C
Area Scan : 5x6x1 : Measurement x=12mm, y=12mm, z=4mm
Zoom Scan : 7x7x7 : Measurement x=5mm, y=5mm, z=5mm
Power Drift-Start : 1.035 W/kg
Power Drift-Finish: 1.001 W/kg
Power Drift (%) : -3.326

DUT Position : Touch ETU Back
Channel : 1

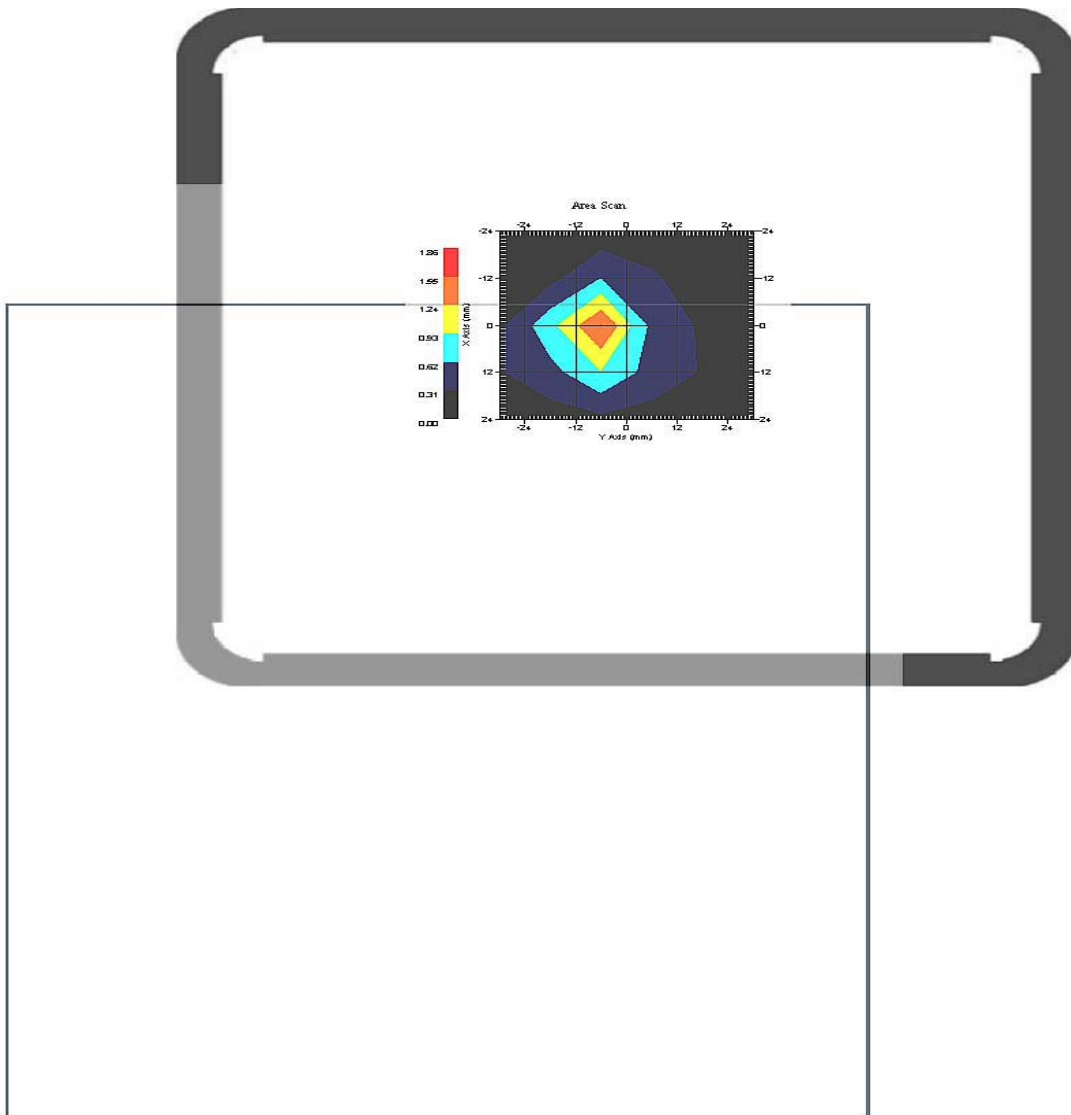

1 gram SAR value : 1.282 W/kg
10 gram SAR value : 0.551 W/kg
Area Scan Peak SAR : 1.552 W/kg
Zoom Scan Peak SAR : 2.372 W/kg

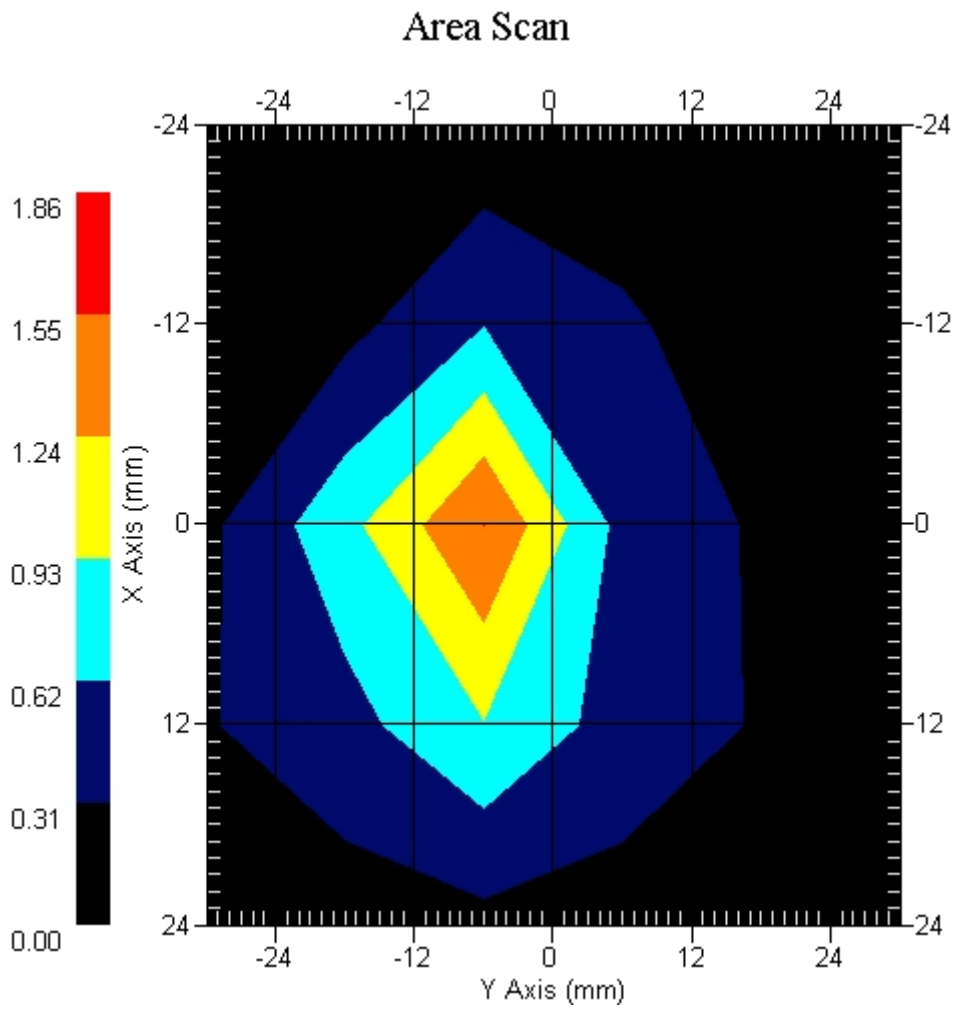

Measurement Data

Crest Factor : 1
Tissue Temp. : 21.50 °C
Ambient Temp. : 22.40 °C
Area Scan : 5x6x1 : Measurement x=12mm, y=12mm, z=4mm
Zoom Scan : 7x7x7 : Measurement x=5mm, y=5mm, z=5mm
Power Drift-Start : 1.032 W/kg
Power Drift-Finish: 1.045 W/kg
Power Drift (%) : 1.273

DUT Position : Touch EUT Back
Channel : 6

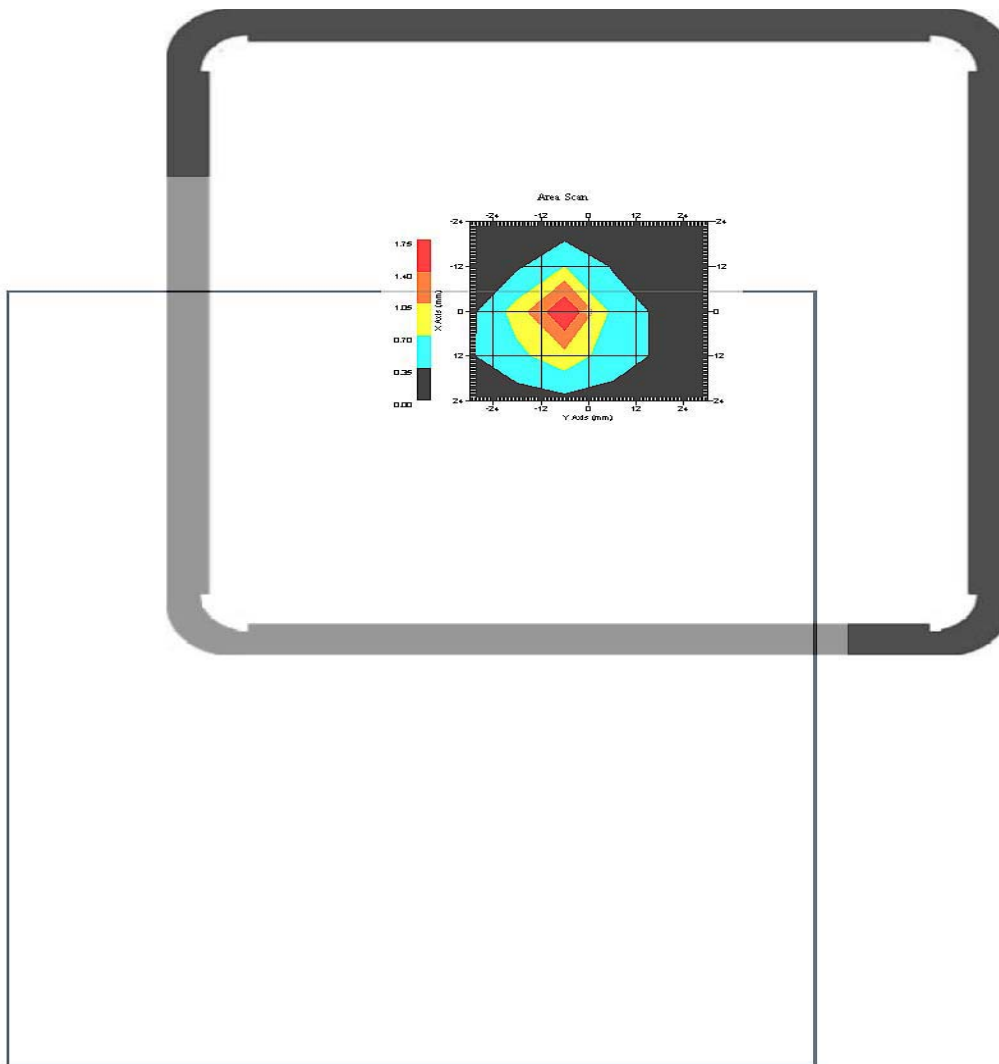

1 gram SAR value : 1.363 W/kg
10 gram SAR value : 0.625 W/kg
Area Scan Peak SAR : 1.750 W/kg
Zoom Scan Peak SAR : 2.682 W/kg

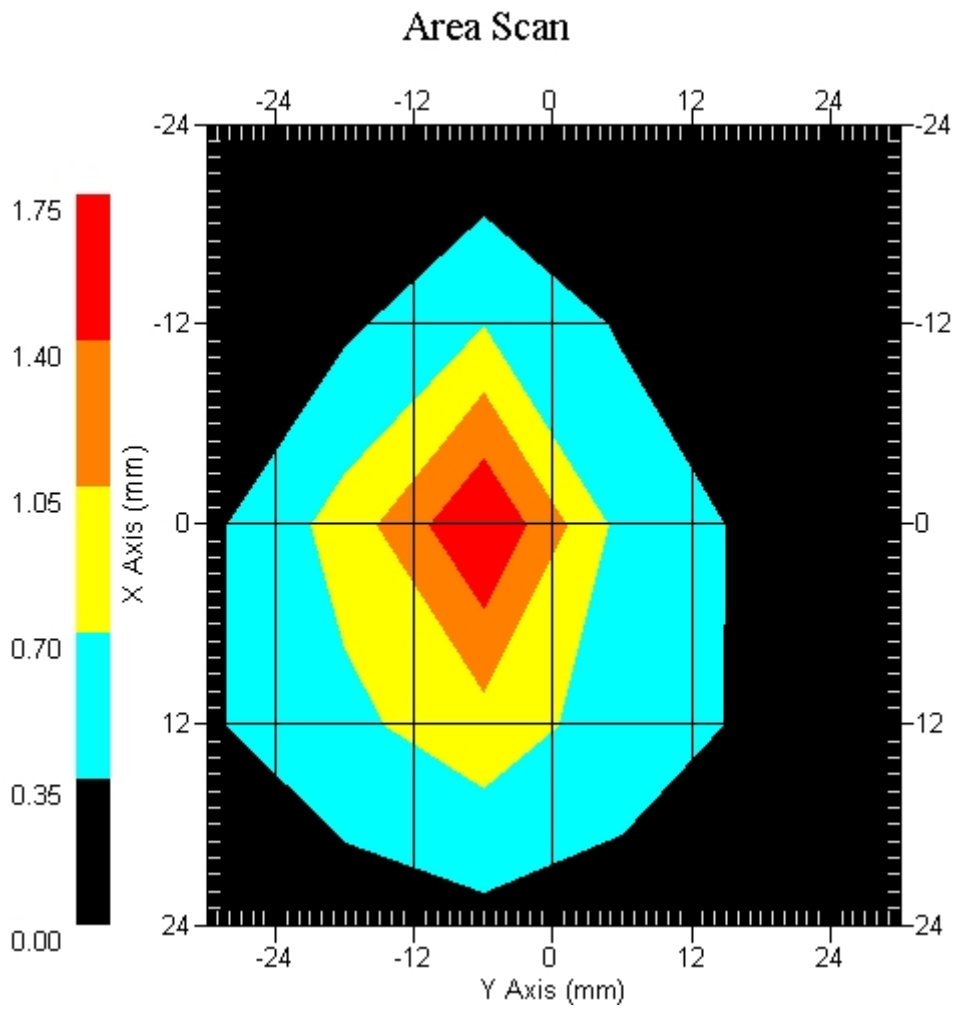

Measurement Data

Crest Factor : 1
Tissue Temp. : 21.50 °C
Ambient Temp. : 22.40 °C
Area Scan : 5x6x1 : Measurement x=12mm, y=12mm, z=4mm
Zoom Scan : 7x7x7 : Measurement x=5mm, y=5mm, z=5mm
Power Drift-Start : 1.092 W/kg
Power Drift-Finish: 1.081 W/kg
Power Drift (%) : -0.936

DUT Position : Touch EUT Back
Channel : 11

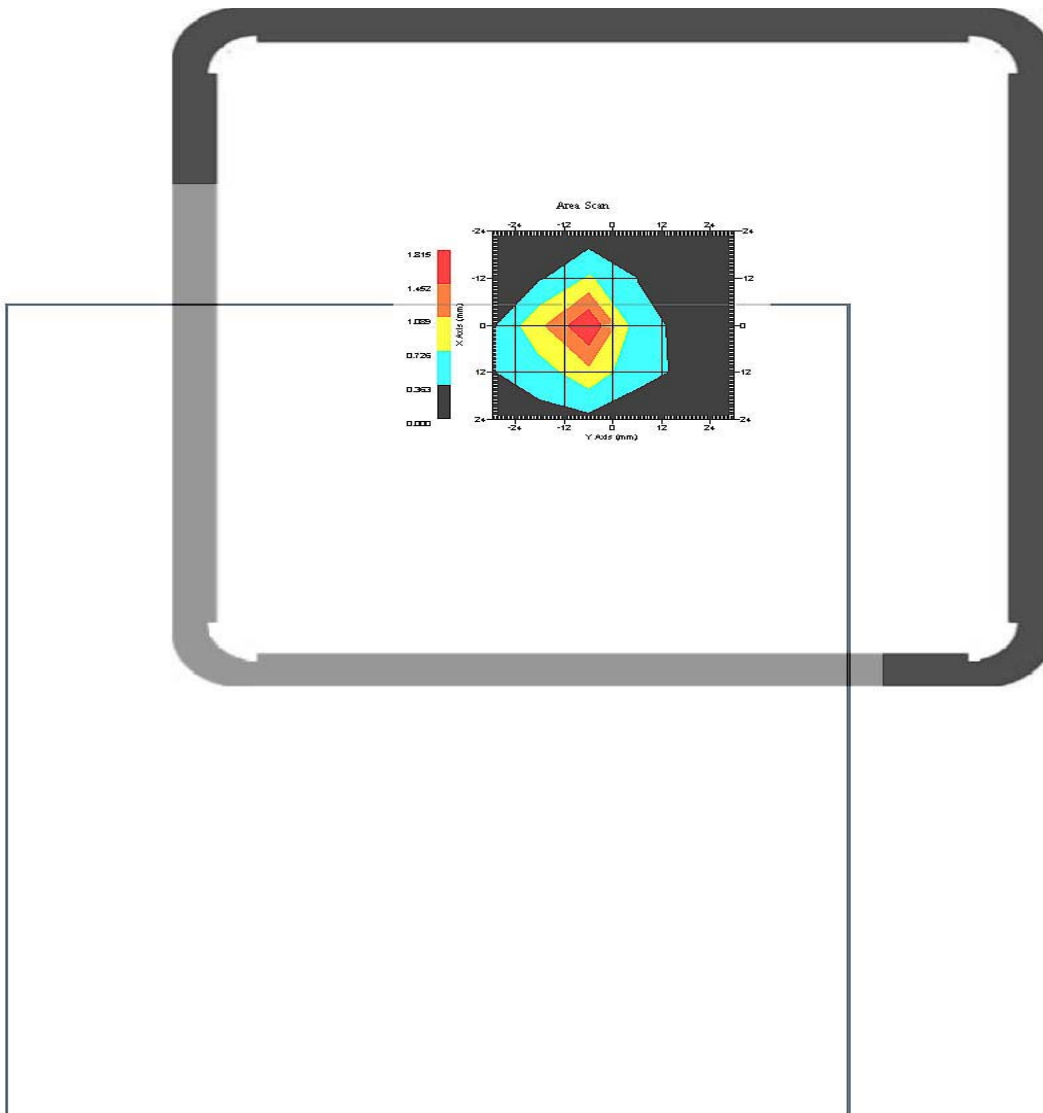

1 gram SAR value : 1.445 W/kg
10 gram SAR value : 0.670 W/kg
Area Scan Peak SAR : 1.815 W/kg
Zoom Scan Peak SAR : 3.533 W/kg

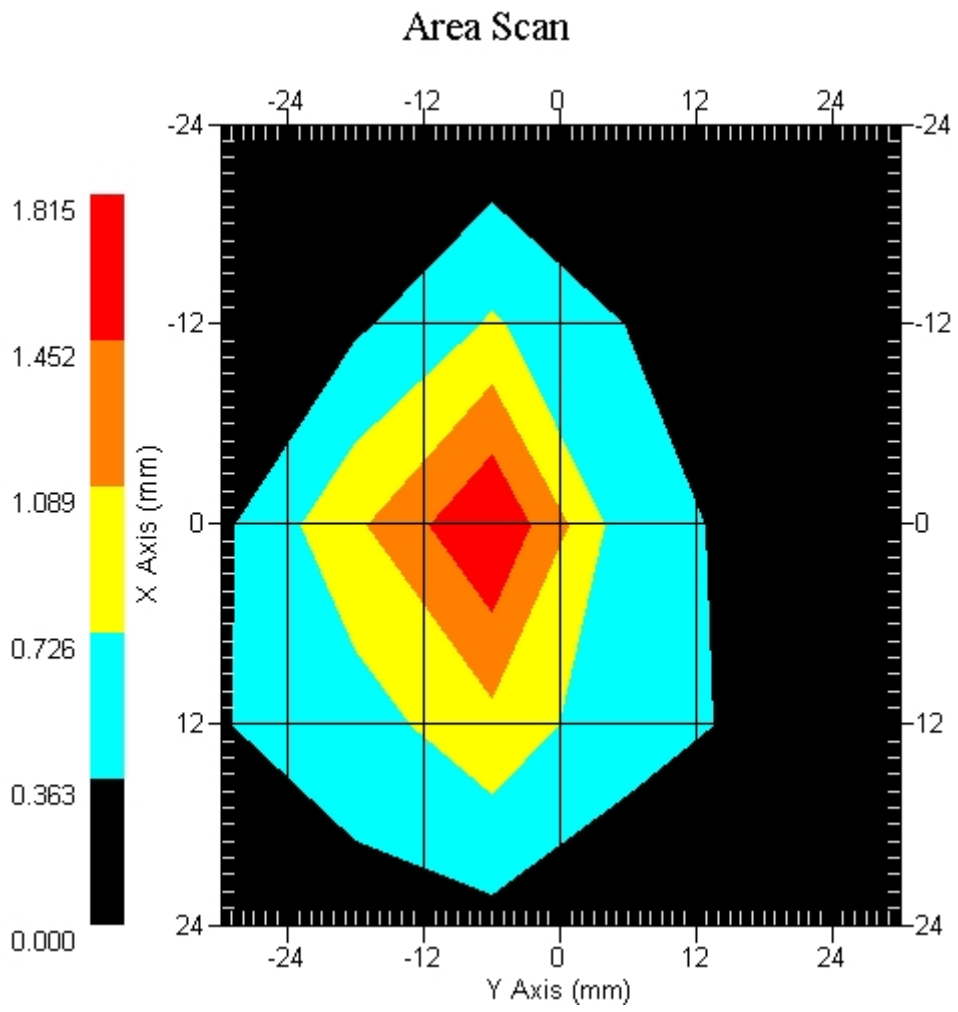

ALSAS-10U VER 2.3.2 APREL Laboratories
SAR Test Report -2.4GHz Band: 802.11b (1Mbps)-Antenna B (ACON)

Report Date : 11-Apr-2007
Measurement Date : 11-Apr-2007

Product Data

Device Name : ASUS
Type : Other
Model : F9S, F9E, F9D
Frequency : 2450.00 MHz
Drift Time : 0 min(s)
Length : 305 mm
Width : 245 mm
Depth : 9.4 mm
Antenna Type : Internal

Phantom Data

Type : Uni-Phantom
Size (mm) : 280 x 280 x 200
Location : Center

Tissue Data

Type : BODY
Serial No. : 325-B
Frequency : 2450.00 MHz
Last Calib. Date : 11-Apr-2007
Temperature : 21.50 °C
Ambient Temp. : 22.40 °C
Humidity : 56.00 RH%
Epsilon : 51.32 F/m
Sigma : 2.002 S/m
Density : 1000.00 kg/cu. m

Probe Data

Name : Probe 264
Model : E020
Type : E-Field Triangle
Serial No. : 264
Last Calib. Date : 21-Mar-2006
Frequency : 2450.00 MHz
Duty Cycle Factor: 1
Conversion Factor: 5.2
Probe Sensitivity: 1.20 1.20 1.20 $\mu\text{V}/(\text{V}/\text{m})^2$
Compression Point: 95.00 mV
Offset : 1.56 mm

Measurement Data

Crest Factor : 1
Tissue Temp. : 21.50 °C
Ambient Temp. : 22.40 °C
Area Scan : 5x6x1 : Measurement x=12mm, y=12mm, z=4mm
Zoom Scan : 7x7x7 : Measurement x=5mm, y=5mm, z=5mm
Power Drift-Start : 1.012 W/kg
Power Drift-Finish: 1.027 W/kg
Power Drift (%) : 1.483

DUT Position : Touch EUT Back
Channel : 6

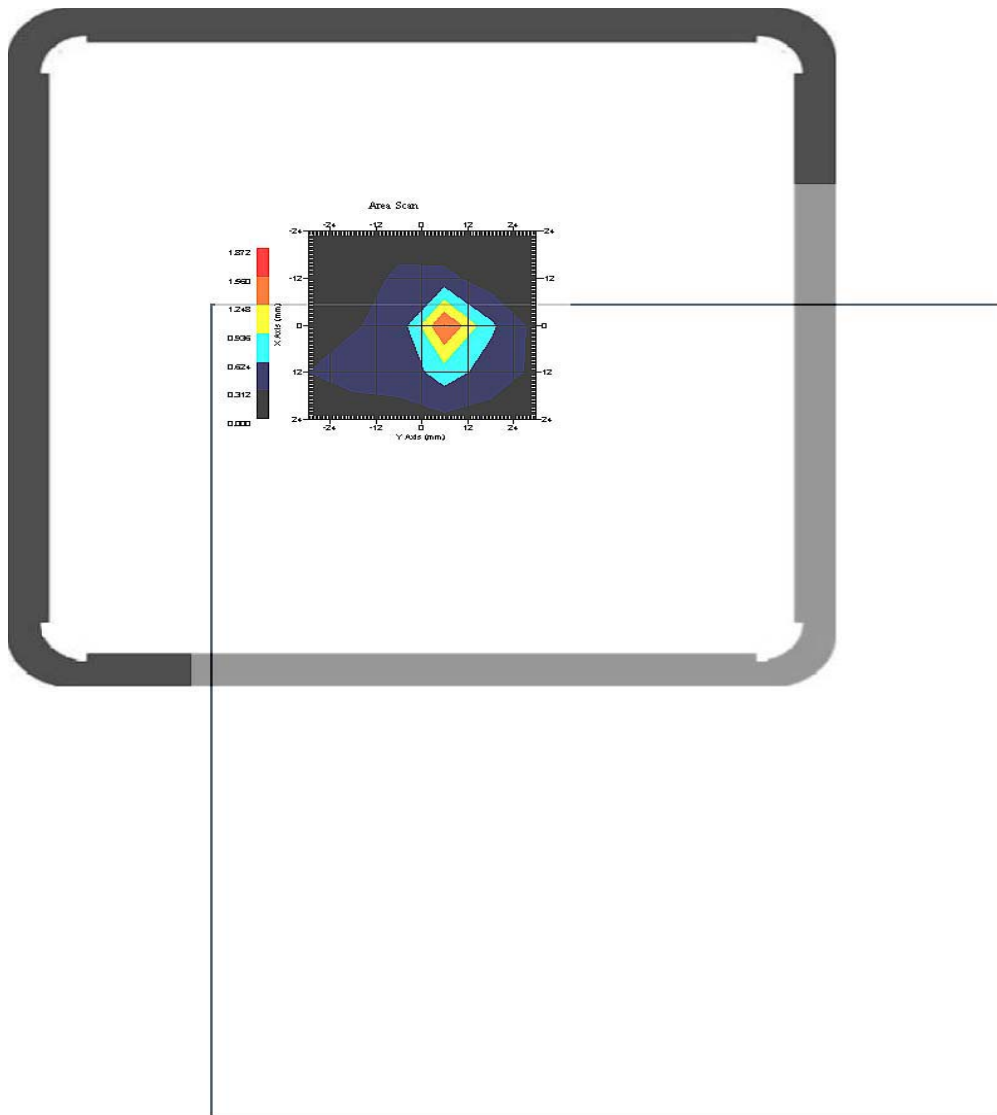

1 gram SAR value : 1.251 W/kg
10 gram SAR value : 0.547 W/kg
Area Scan Peak SAR : 1.562 W/kg
Zoom Scan Peak SAR : 3.212 W/kg

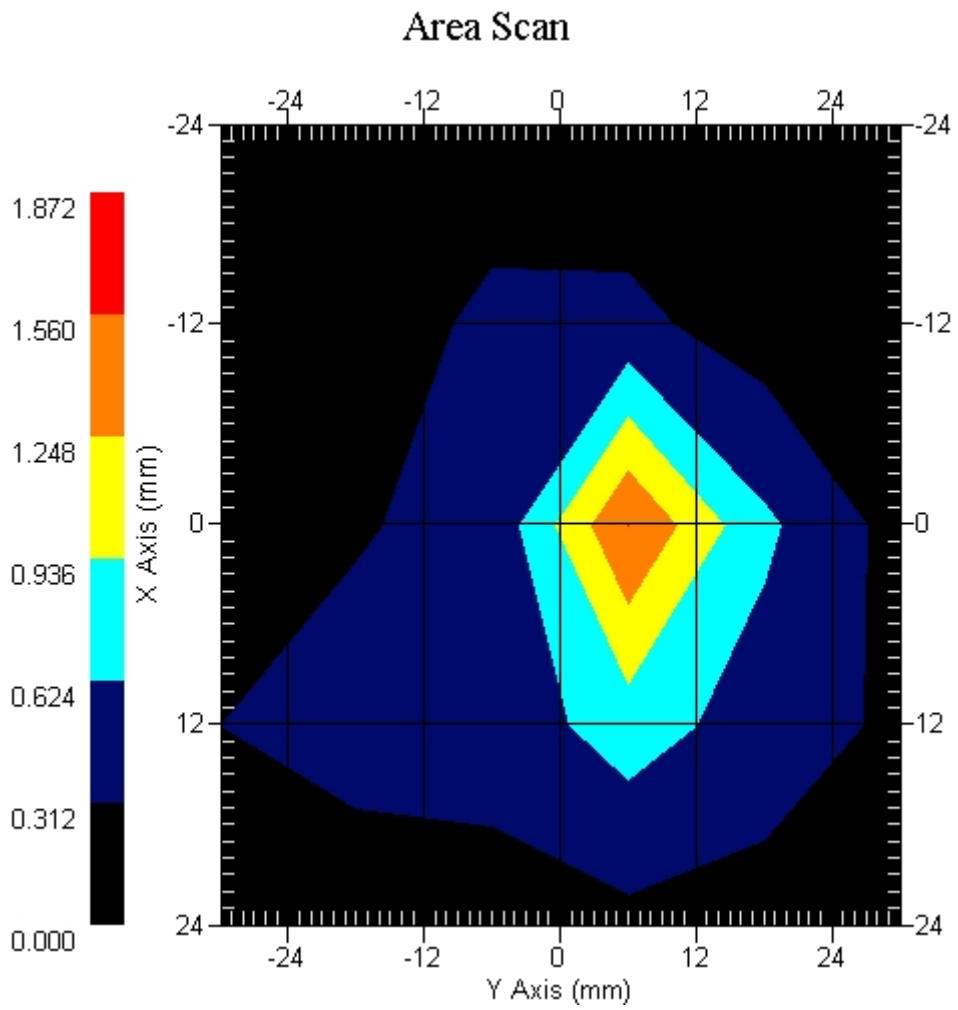

ALSAS-10U VER 2.3.2 APREL Laboratories
SAR Test Report -2.4GHz Band: 802.11g (6Mbps)

Report Date : 11-Apr-2007
Measurement Date : 11-Apr-2007

Product Data

Device Name : ASUS
Type : Other
Model : F9S, F9E, F9D
Frequency : 2450.00 MHz
Drift Time : 0 min(s)
Length : 305 mm
Width : 245 mm
Depth : 9.4 mm
Antenna Type : Internal

Phantom Data

Type : Uni-Phantom
Size (mm) : 280 x 280 x 200
Location : Center

Tissue Data

Type : BODY
Serial No. : 325-B
Frequency : 2450.00 MHz
Last Calib. Date : 11-Apr-2007
Temperature : 21.50 °C
Ambient Temp. : 22.40 °C
Humidity : 56.00 RH%
Epsilon : 51.32 F/m
Sigma : 2.002 S/m
Density : 1000.00 kg/cu. m

Probe Data

Name : Probe 264
Model : E020
Type : E-Field Triangle
Serial No. : 264
Last Calib. Date : 21-Mar-2006
Frequency : 2450.00 MHz
Duty Cycle Factor: 1
Conversion Factor: 5.2
Probe Sensitivity: 1.20 1.20 1.20 $\mu\text{V}/(\text{V}/\text{m})^2$
Compression Point: 95.00 mV
Offset : 1.56 mm

Measurement Data

Crest Factor : 1
Tissue Temp. : 21.50 °C
Ambient Temp. : 22.40 °C
Area Scan : 5x6x1 : Measurement x=12mm, y=12mm, z=4mm
Zoom Scan : 7x7x7 : Measurement x=5mm, y=5mm, z=5mm
Power Drift-Start : 1.006 W/kg
Power Drift-Finish: 0.990 W/kg
Power Drift (%) : -1.584

DUT Position : Touch EUT Back
Channel : 1

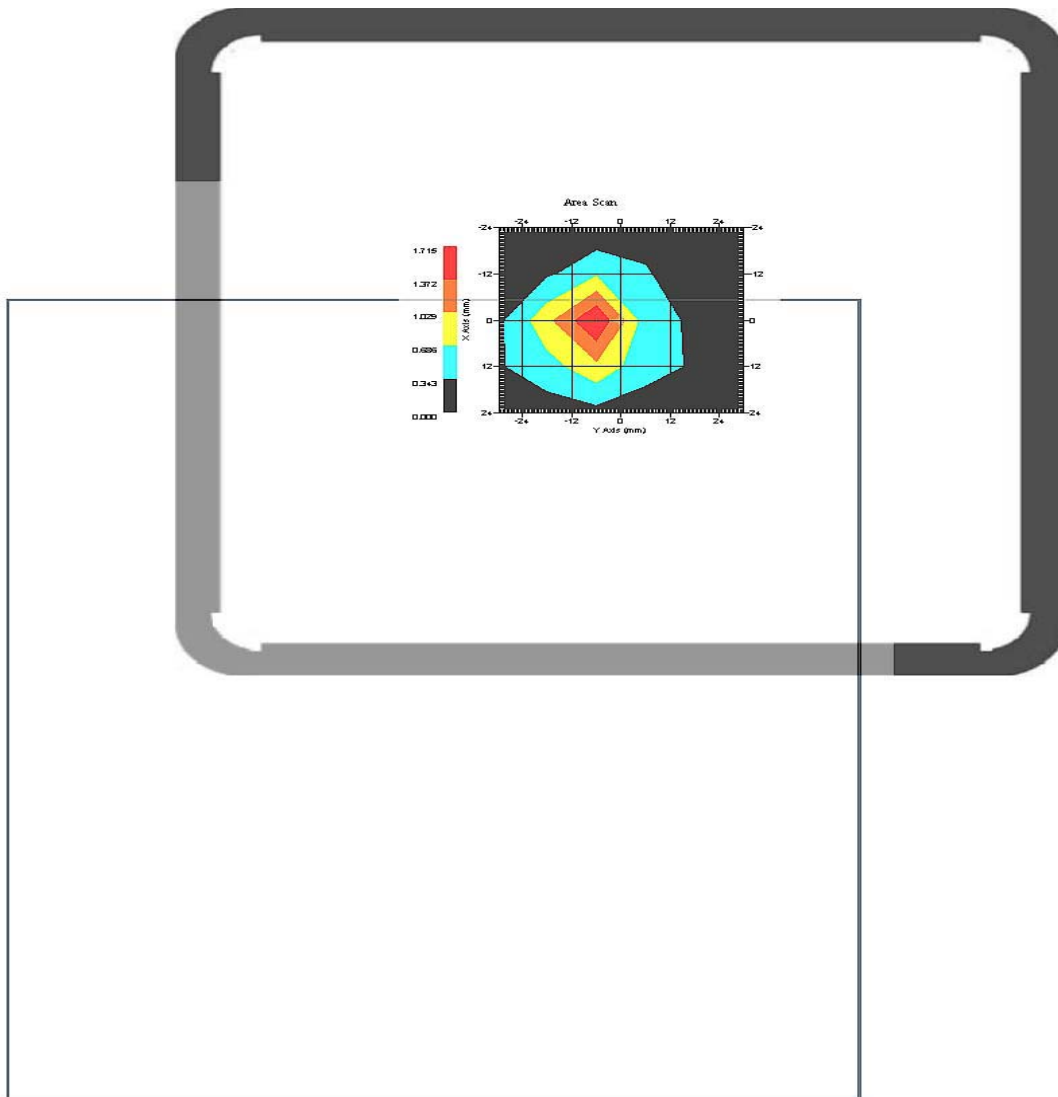

1 gram SAR value : 1.297 W/kg
10 gram SAR value : 0.597 W/kg
Area Scan Peak SAR : 1.715 W/kg
Zoom Scan Peak SAR : 2.472 W/kg

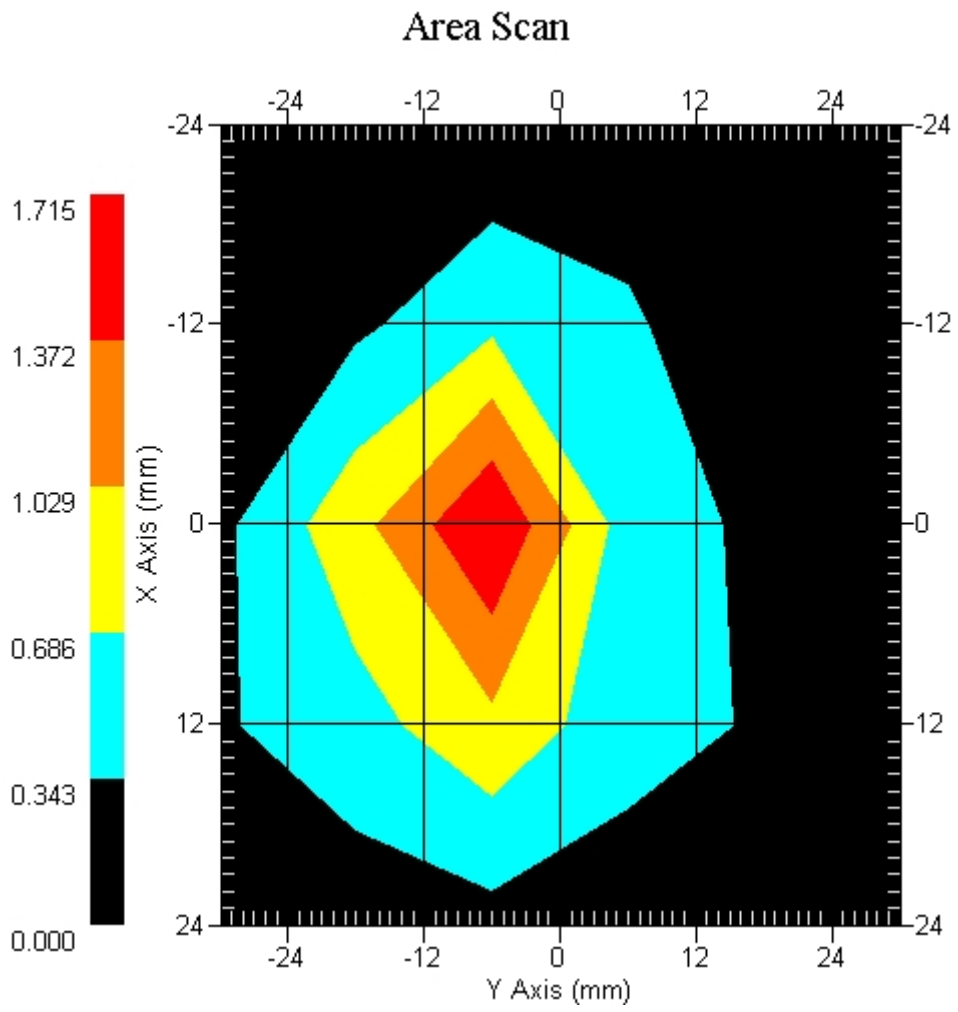

Measurement Data

Crest Factor : 1
 Tissue Temp. : 21.50 °C
 Ambient Temp. : 22.40 °C
 Area Scan : 5x6x1 : Measurement x=12mm, y=12mm, z=4mm
 Zoom Scan : 7x7x7 : Measurement x=5mm, y=5mm, z=5mm
 Power Drift-Start : 0.810 W/kg
 Power Drift-Finish: 0.838 W/kg
 Power Drift (%) : 3.482

DUT Position : Touch EUT Back
 Channel : 6

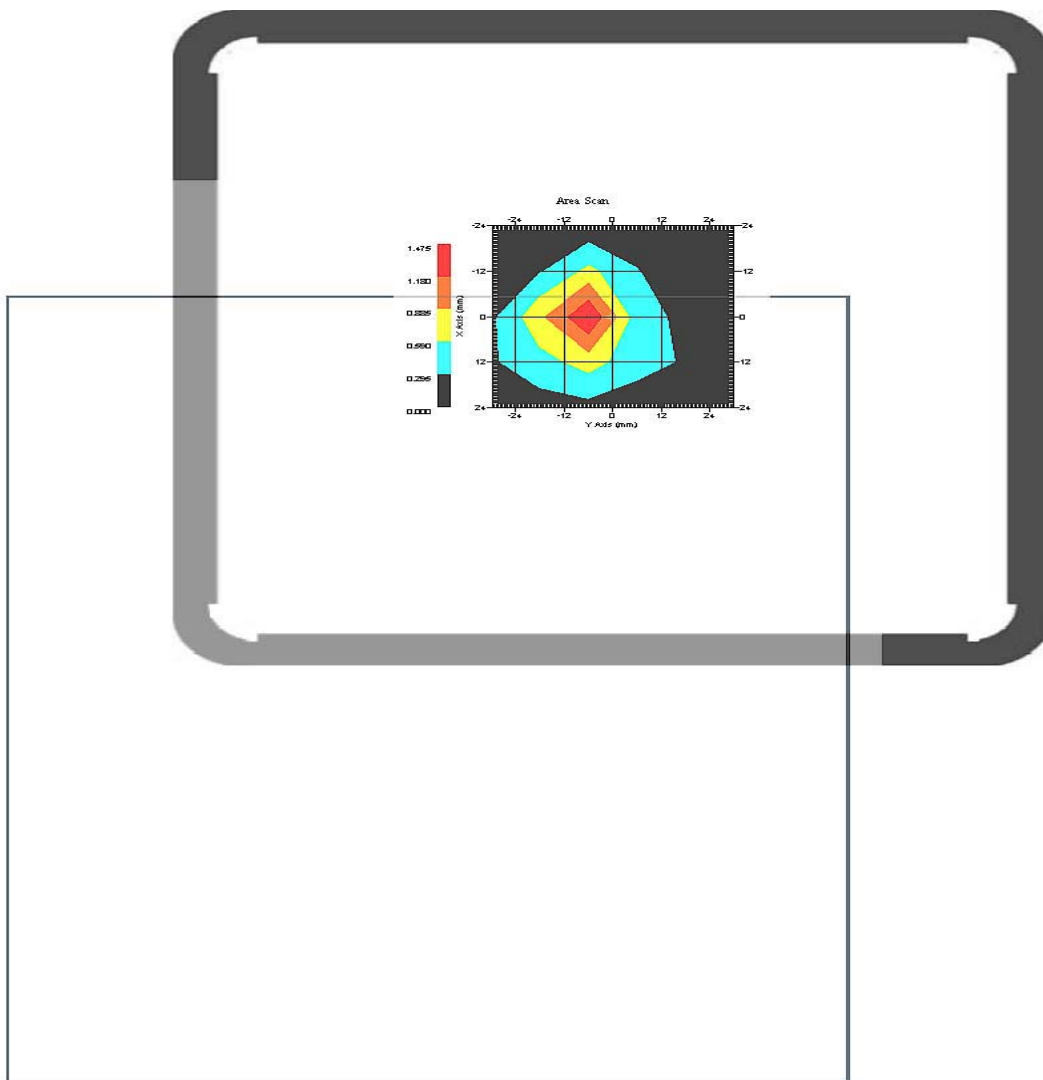

1 gram SAR value : 1.276 W/kg
 10 gram SAR value : 0.574 W/kg
 Area Scan Peak SAR : 1.475 W/kg
 Zoom Scan Peak SAR : 2.472 W/kg

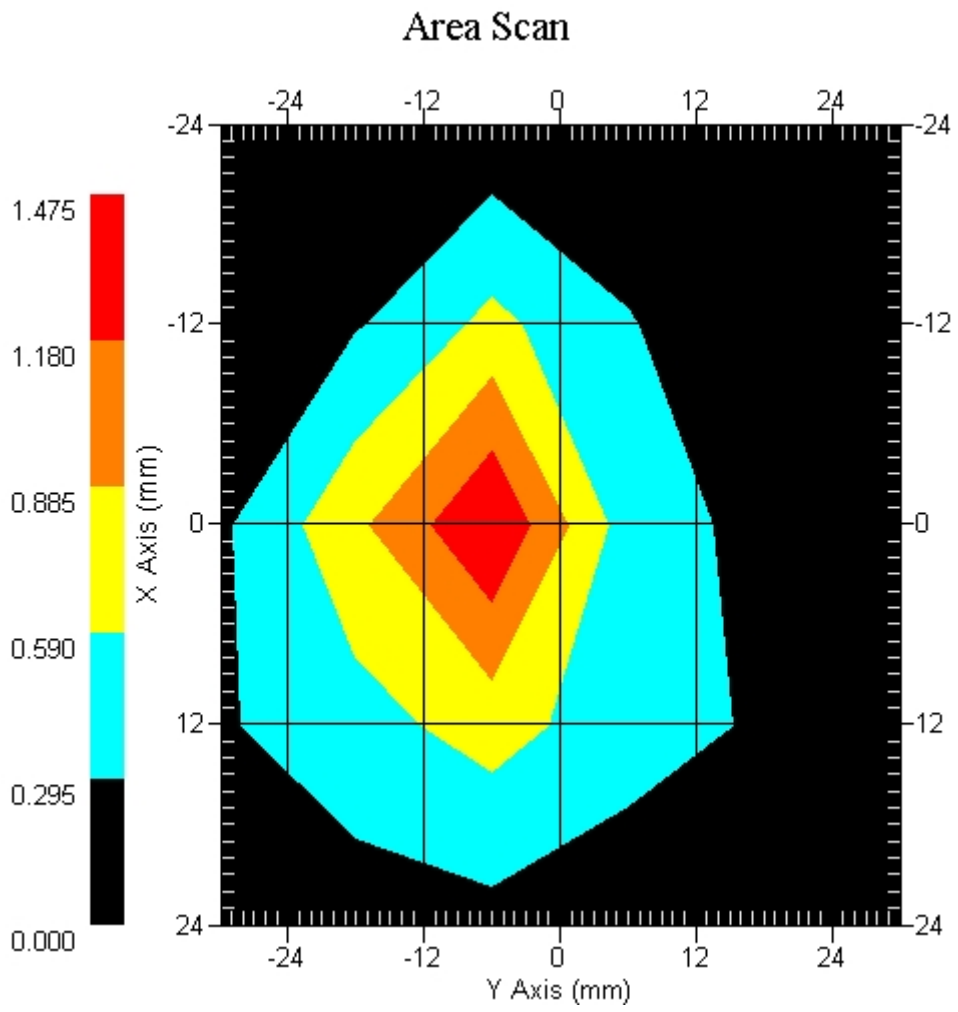

Measurement Data

Crest Factor : 1
 Tissue Temp. : 21.50 °C
 Ambient Temp. : 22.40 °C
 Area Scan : 5x6x1 : Measurement x=12mm, y=12mm, z=4mm
 Zoom Scan : 7x7x7 : Measurement x=5mm, y=5mm, z=5mm
 Power Drift-Start : 0.846 W/kg
 Power Drift-Finish: 0.857 W/kg
 Power Drift (%) : 1.316

DUT Position : Touch EUT Back
 Channel : 11

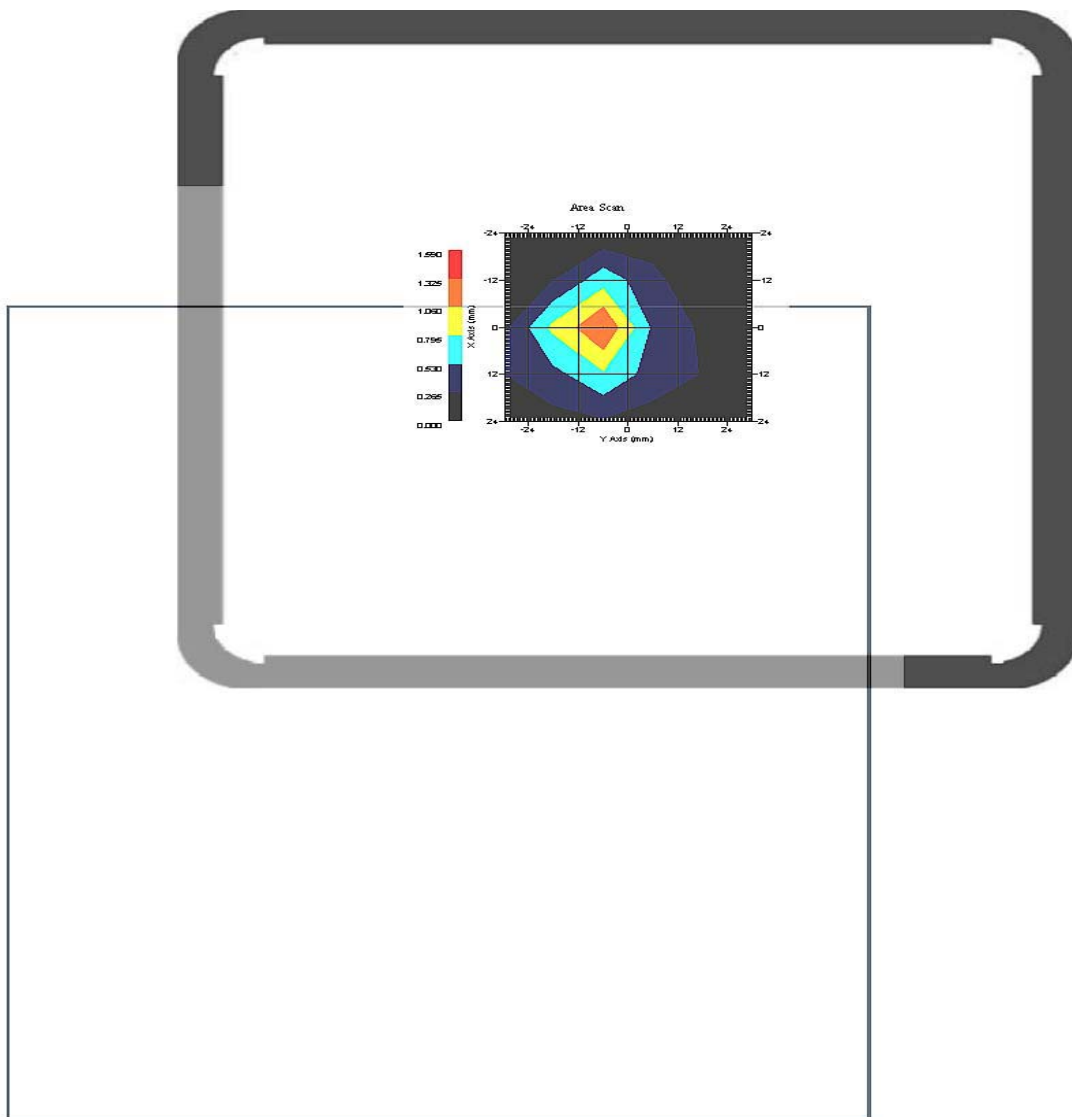

1 gram SAR value : 1.275 W/kg
 10 gram SAR value : 0.558 W/kg
 Area Scan Peak SAR : 1.327 W/kg
 Zoom Scan Peak SAR : 2.622 W/kg

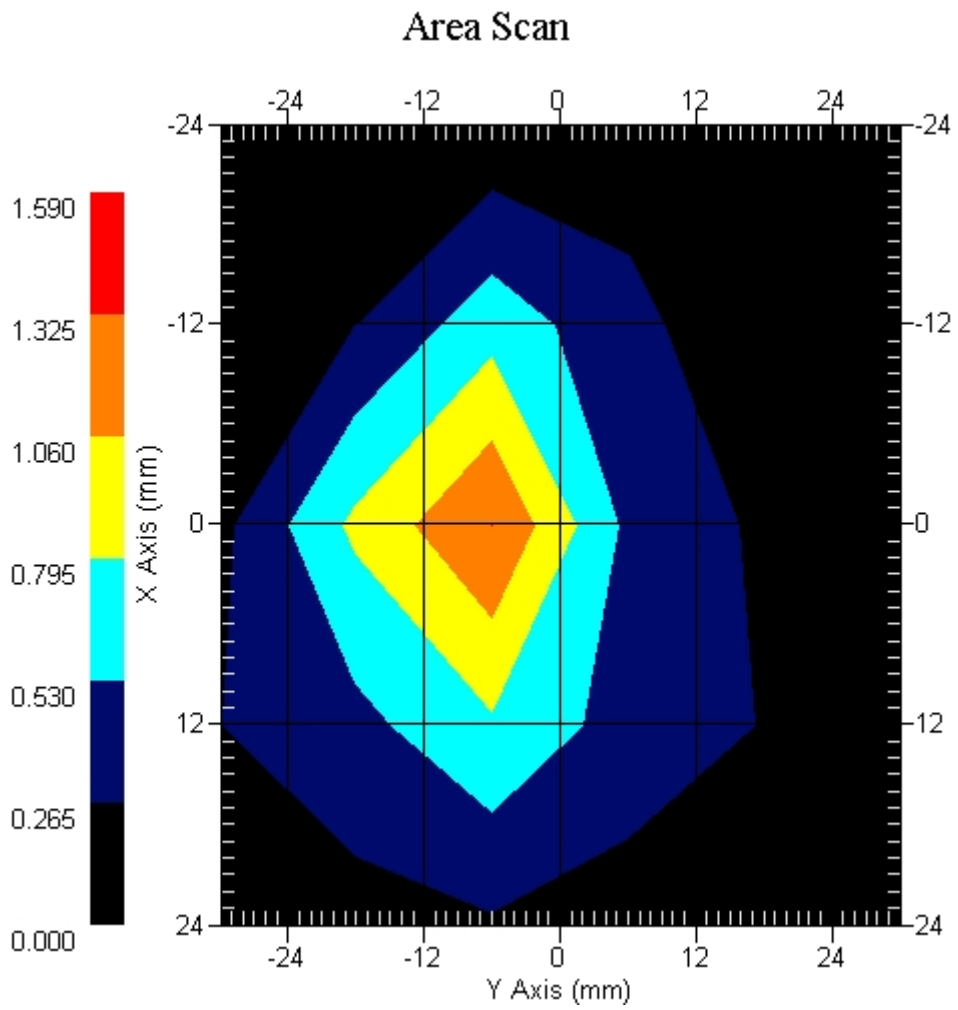

ALSAS-10U VER 2.3.2 APREL Laboratories

SAR Test Report -2.4GHz Band: 802.11n HT0 (20MHz)

Report Date : 11-Apr-2007
Measurement Date : 11-Apr-2007

Product Data

Device Name : ASUS
Type : Other
Model : F9S, F9E, F9D
Frequency : 2450.00 MHz
Drift Time : 0 min(s)
Length : 305 mm
Width : 245 mm
Depth : 9.4 mm
Antenna Type : Internal

Phantom Data

Type : Uni-Phantom
Size (mm) : 280 x 280 x 200
Location : Center

Tissue Data

Type : BODY
Serial No. : 325-B
Frequency : 2450.00 MHz
Last Calib. Date : 11-Apr-2007
Temperature : 21.50 °C
Ambient Temp. : 22.40 °C
Humidity : 56.00 RH%
Epsilon : 51.32 F/m
Sigma : 2.002 S/m
Density : 1000.00 kg/cu. m

Probe Data

Name : Probe 264
Model : E020
Type : E-Field Triangle
Serial No. : 264
Last Calib. Date : 21-Mar-2006
Frequency : 2450.00 MHz
Duty Cycle Factor: 1
Conversion Factor: 5.2
Probe Sensitivity: 1.20 1.20 1.20 $\mu\text{V}/(\text{V}/\text{m})^2$
Compression Point: 95.00 mV
Offset : 1.56 mm

Measurement Data

Crest Factor : 1
 Tissue Temp. : 21.50 °C
 Ambient Temp. : 22.40 °C
 Area Scan : 5x6x1 : Measurement x=12mm, y=12mm, z=4mm
 Zoom Scan : 7x7x7 : Measurement x=5mm, y=5mm, z=5mm
 Power Drift-Start : 0.646 W/kg
 Power Drift-Finish: 0.628 W/kg
 Power Drift (%) : -2.766

DUT Position : Touch EUT Back
 Channel : 1

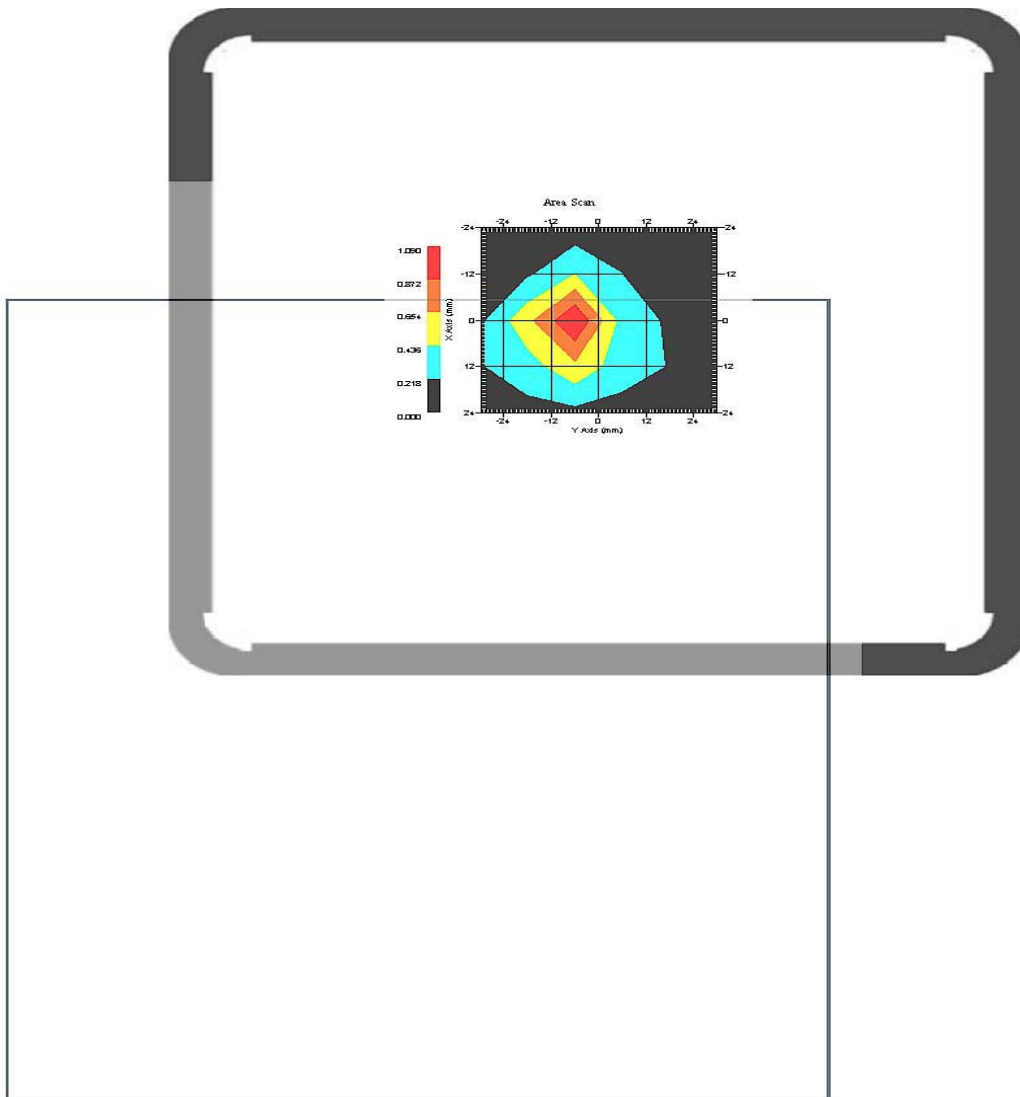

1 gram SAR value : 0.887 W/kg
 10 gram SAR value : 0.402 W/kg
 Area Scan Peak SAR : 1.089 W/kg
 Zoom Scan Peak SAR : 2.031 W/kg

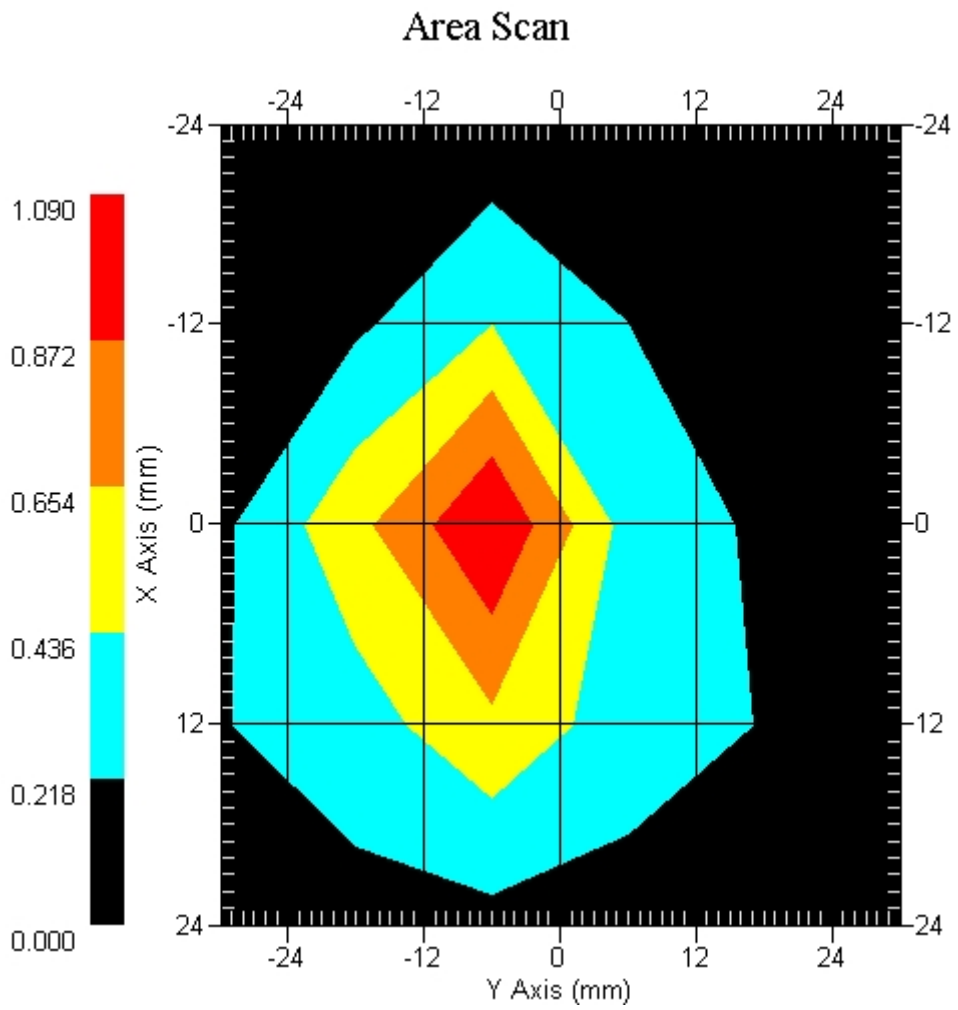

Measurement Data

Crest Factor : 1
Tissue Temp. : 21.50 °C
Ambient Temp. : 22.40 °C
Area Scan : 5x6x1 : Measurement x=12mm, y=12mm, z=4mm
Zoom Scan : 7x7x7 : Measurement x=5mm, y=5mm, z=5mm
Power Drift-Start : 0.678 W/kg
Power Drift-Finish: 0.689 W/kg
Power Drift (%) : 1.616

DUT Position : Touch EUT Back
Channel : 6

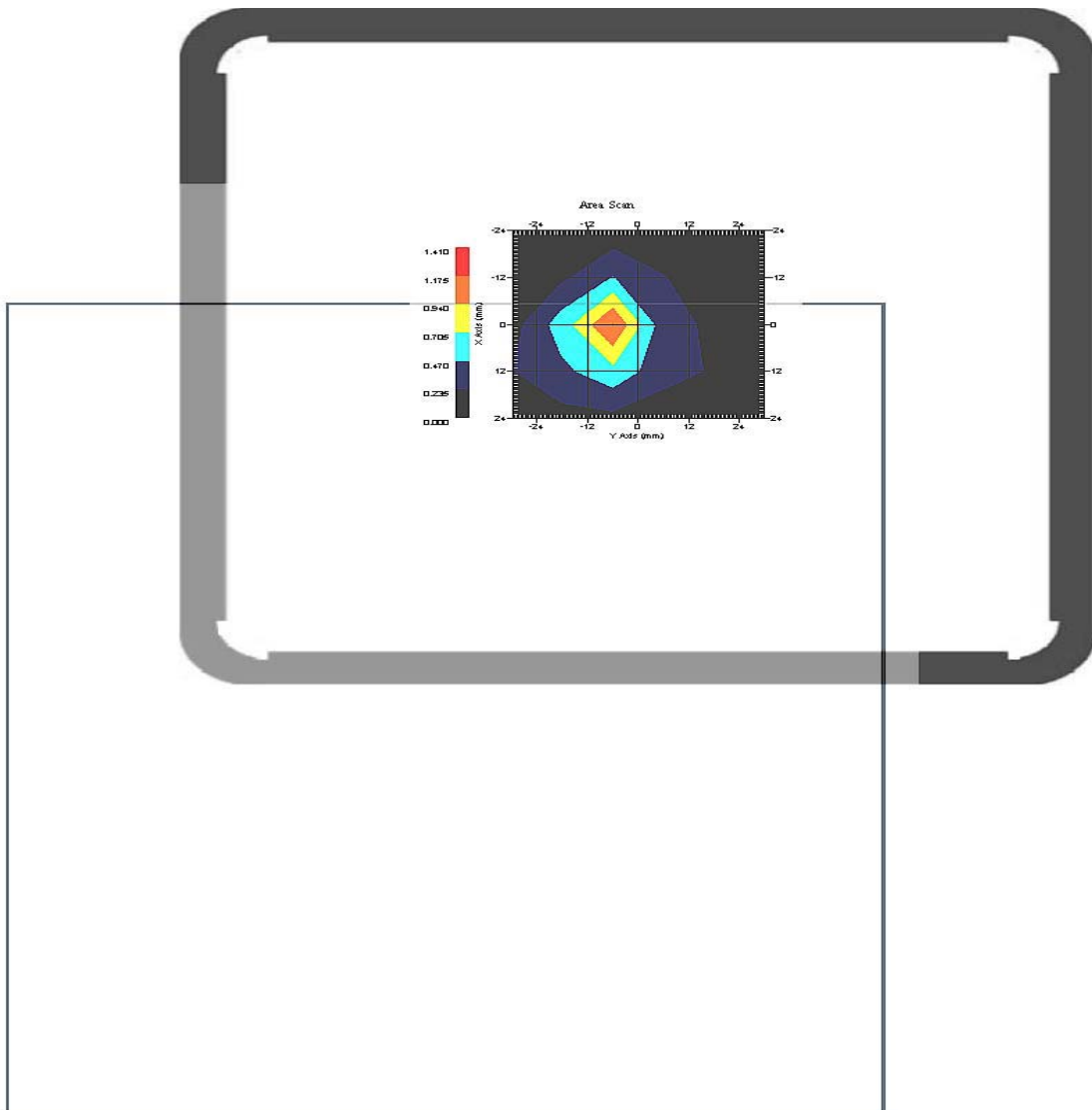

1 gram SAR value : 0.986 W/kg
10 gram SAR value : 0.448 W/kg
Area Scan Peak SAR : 1.177 W/kg
Zoom Scan Peak SAR : 2.181 W/kg

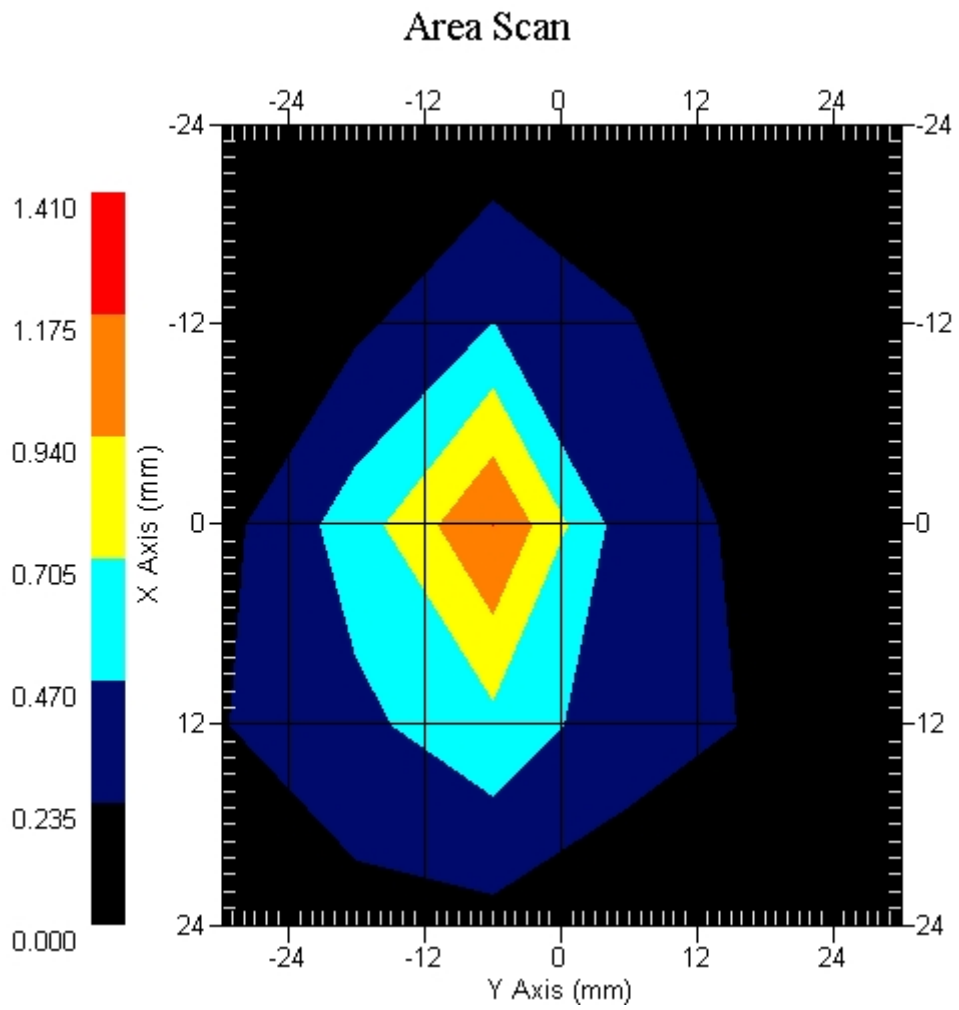

Measurement Data

Crest Factor : 1
Tissue Temp. : 21.50 °C
Ambient Temp. : 22.40 °C
Area Scan : 5x6x1 : Measurement x=12mm, y=12mm, z=4mm
Zoom Scan : 7x7x7 : Measurement x=5mm, y=5mm, z=5mm
Power Drift-Start : 0.732 W/kg
Power Drift-Finish: 0.720 W/kg
Power Drift (%) : -1.630

DUT Position : Touch EUT Back
Channel : 11

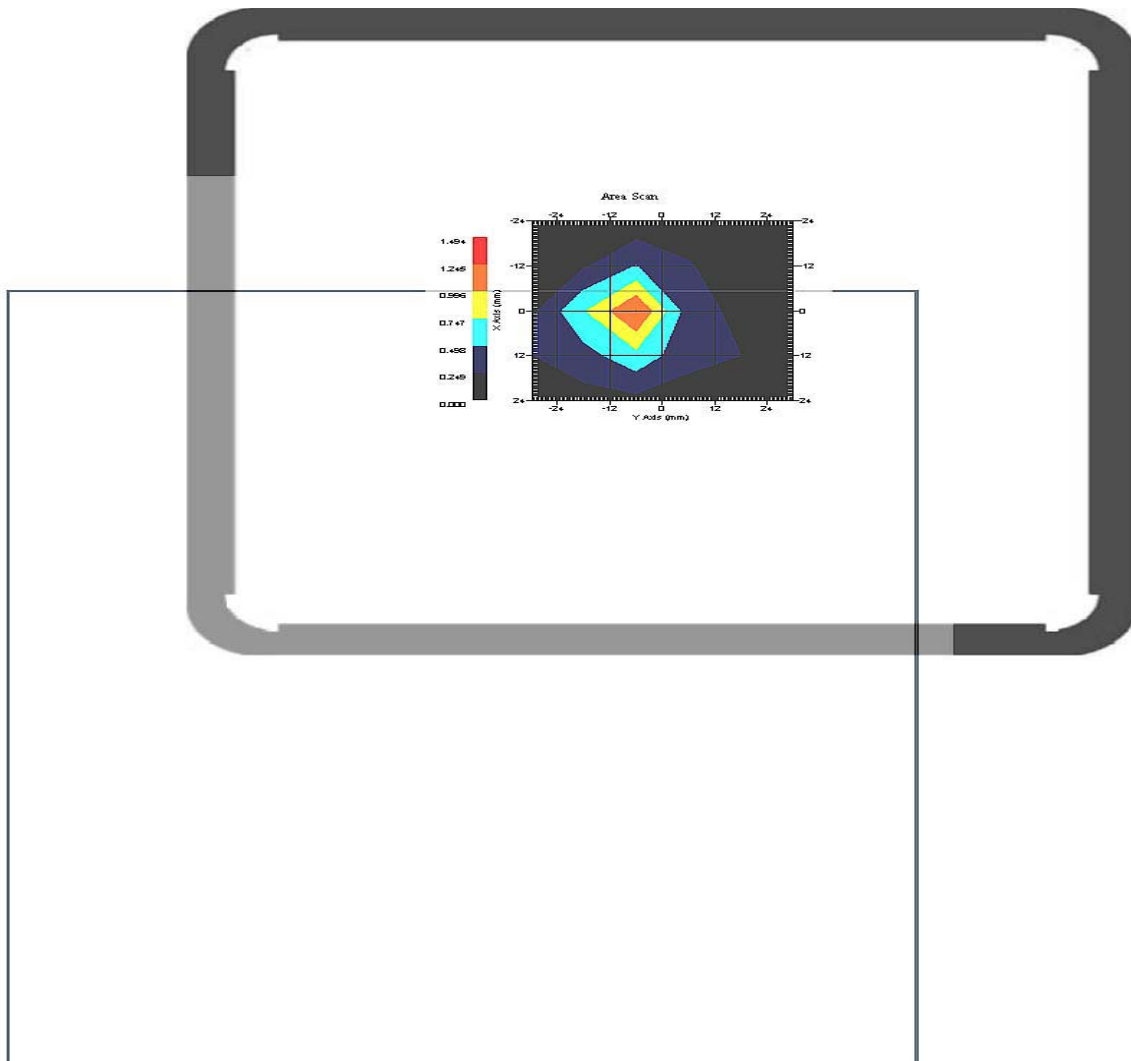

1 gram SAR value : 1.031 W/kg
10 gram SAR value : 0.455 W/kg
Area Scan Peak SAR : 1.247 W/kg
Zoom Scan Peak SAR : 2.452 W/kg

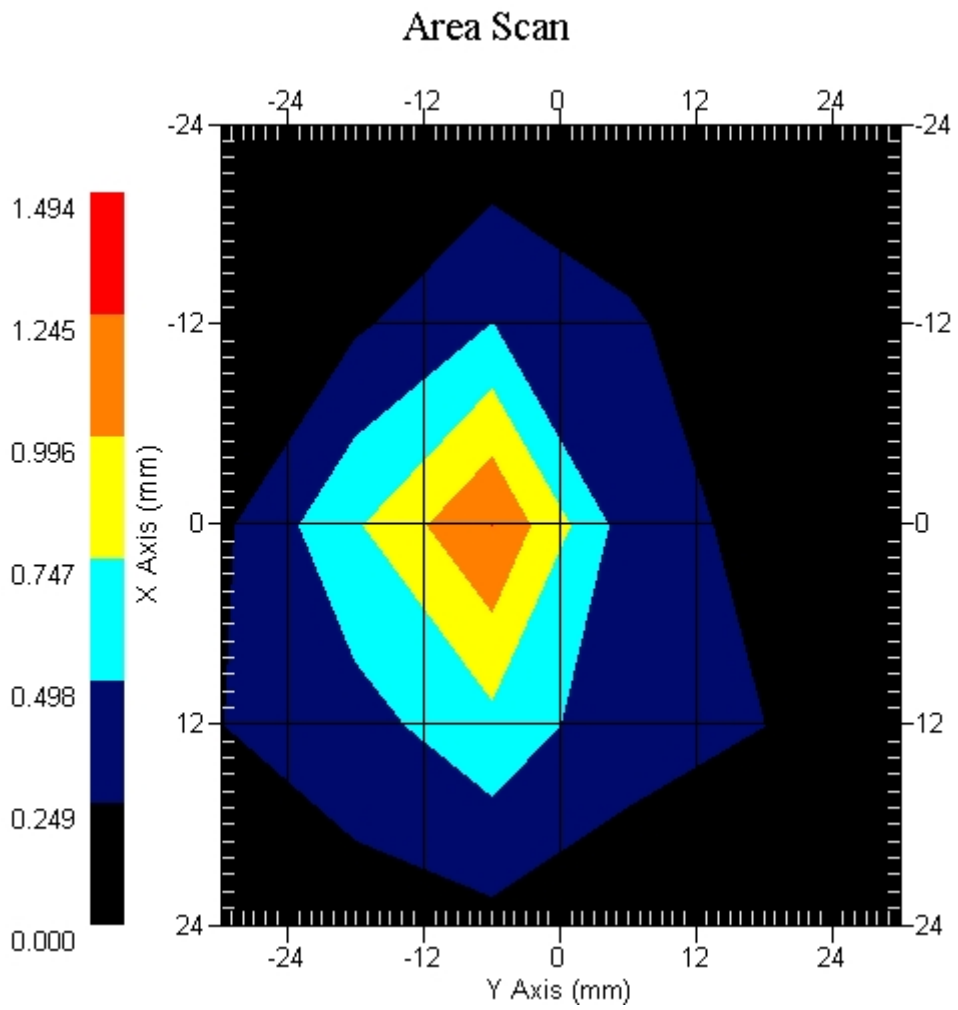

ALSAS-10U VER 2.3.2 APREL Laboratories

SAR Test Report-2.4GHz Band: 802.11n HT8 (20MHz)

Report Date : 11-Apr-2007
Measurement Date : 11-Apr-2007

Product Data

Device Name : ASUS
Type : Other
Model : F9S, F9E, F9D
Frequency : 2450.00 MHz
Drift Time : 0 min(s)
Length : 305 mm
Width : 245 mm
Depth : 9.4 mm
Antenna Type : Internal

Phantom Data

Type : Uni-Phantom
Size (mm) : 280 x 280 x 200
Location : Center

Tissue Data

Type : BODY
Serial No. : 325-B
Frequency : 2450.00 MHz
Last Calib. Date : 11-Apr-2007
Temperature : 21.50 °C
Ambient Temp. : 22.40 °C
Humidity : 56.00 RH%
Epsilon : 51.32 F/m
Sigma : 2.002 S/m
Density : 1000.00 kg/cu. m

Probe Data

Name : Probe 264
Model : E020
Type : E-Field Triangle
Serial No. : 264
Last Calib. Date : 21-Mar-2006
Frequency : 2450.00 MHz
Duty Cycle Factor: 1
Conversion Factor: 5.2
Probe Sensitivity: 1.20 1.20 1.20 $\mu\text{V}/(\text{V}/\text{m})^2$
Compression Point: 95.00 mV
Offset : 1.56 mm

Measurement Data

Crest Factor : 1
Tissue Temp. : 21.50 °C
Ambient Temp. : 22.40 °C
Area Scan : 5x6x1 : Measurement x=12mm, y=12mm, z=4mm
Zoom Scan : 7x7x7 : Measurement x=5mm, y=5mm, z=5mm
Power Drift-Start : 0.869 W/kg
Power Drift-Finish: 0.875 W/kg
Power Drift (%) : 0.705

DUT Position : Touch EUT Back
Channel : 1

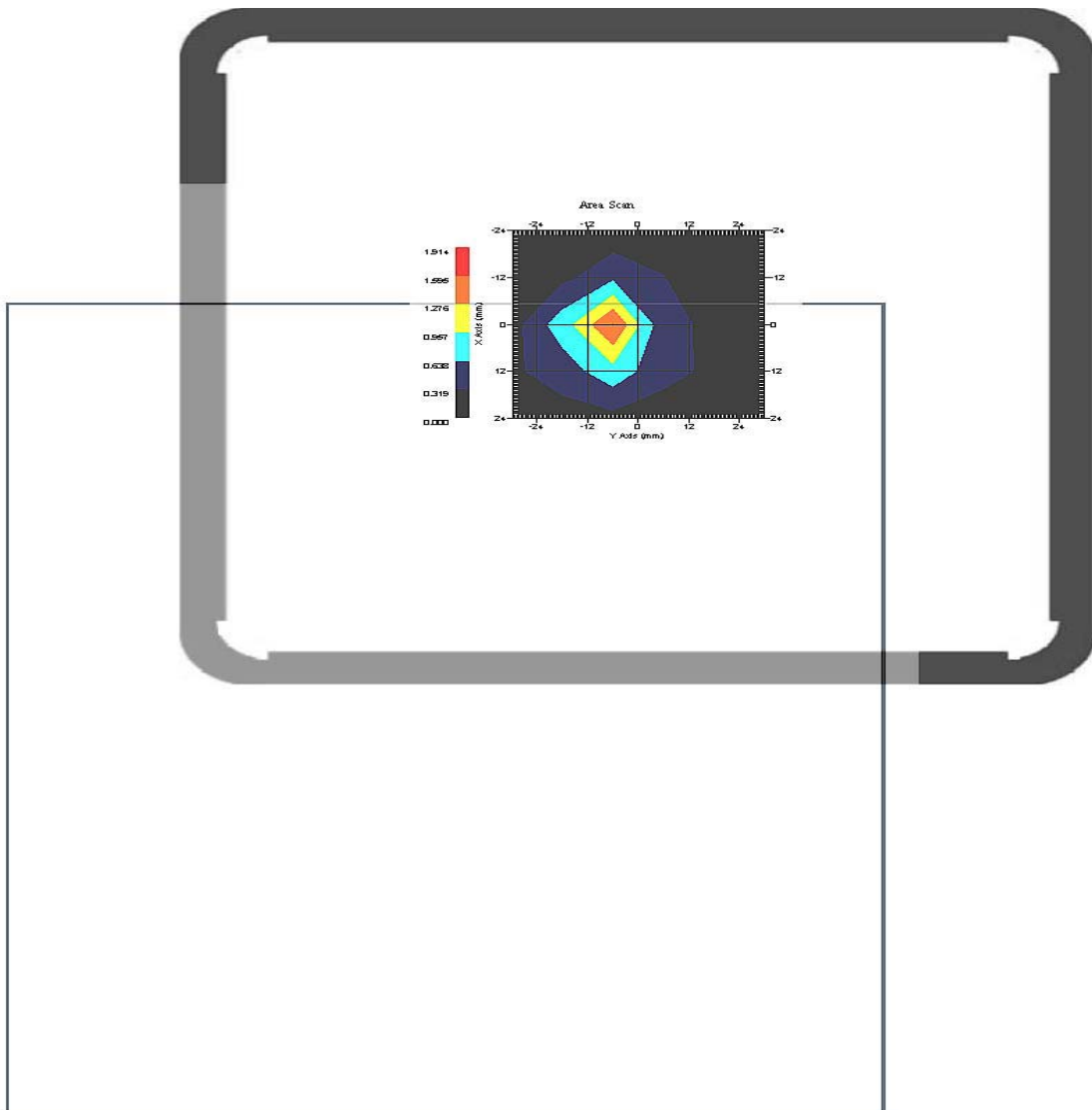

1 gram SAR value : 1.305 W/kg
10 gram SAR value : 0.565 W/kg
Area Scan Peak SAR : 1.597 W/kg
Zoom Scan Peak SAR : 2.832 W/kg

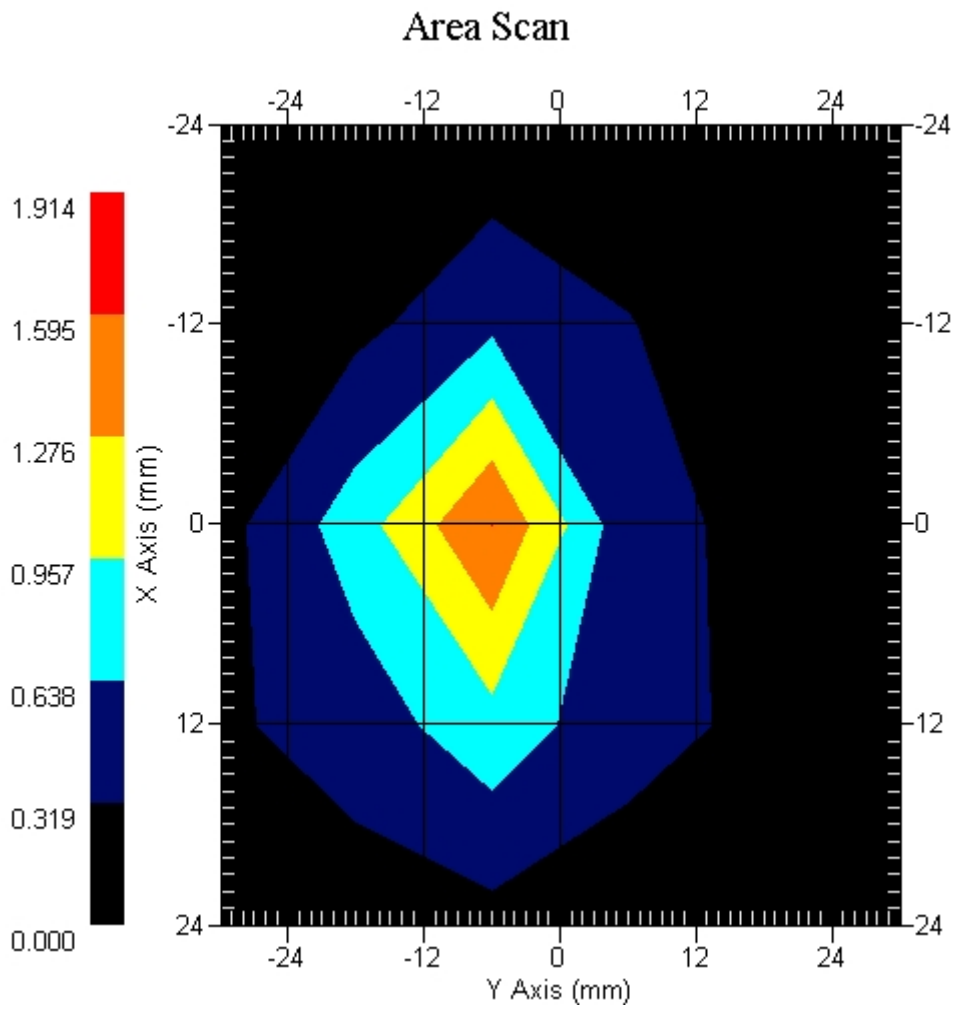

Measurement Data

Crest Factor : 1
 Tissue Temp. : 21.50 °C
 Ambient Temp. : 22.40 °C
 Area Scan : 5x6x1 : Measurement x=12mm, y=12mm, z=4mm
 Zoom Scan : 7x7x7 : Measurement x=5mm, y=5mm, z=5mm
 Power Drift-Start : 0.815 W/kg
 Power Drift-Finish: 0.820 W/kg
 Power Drift (%) : 0.612

DUT Position : Touch EUT Back
 Channel : 6

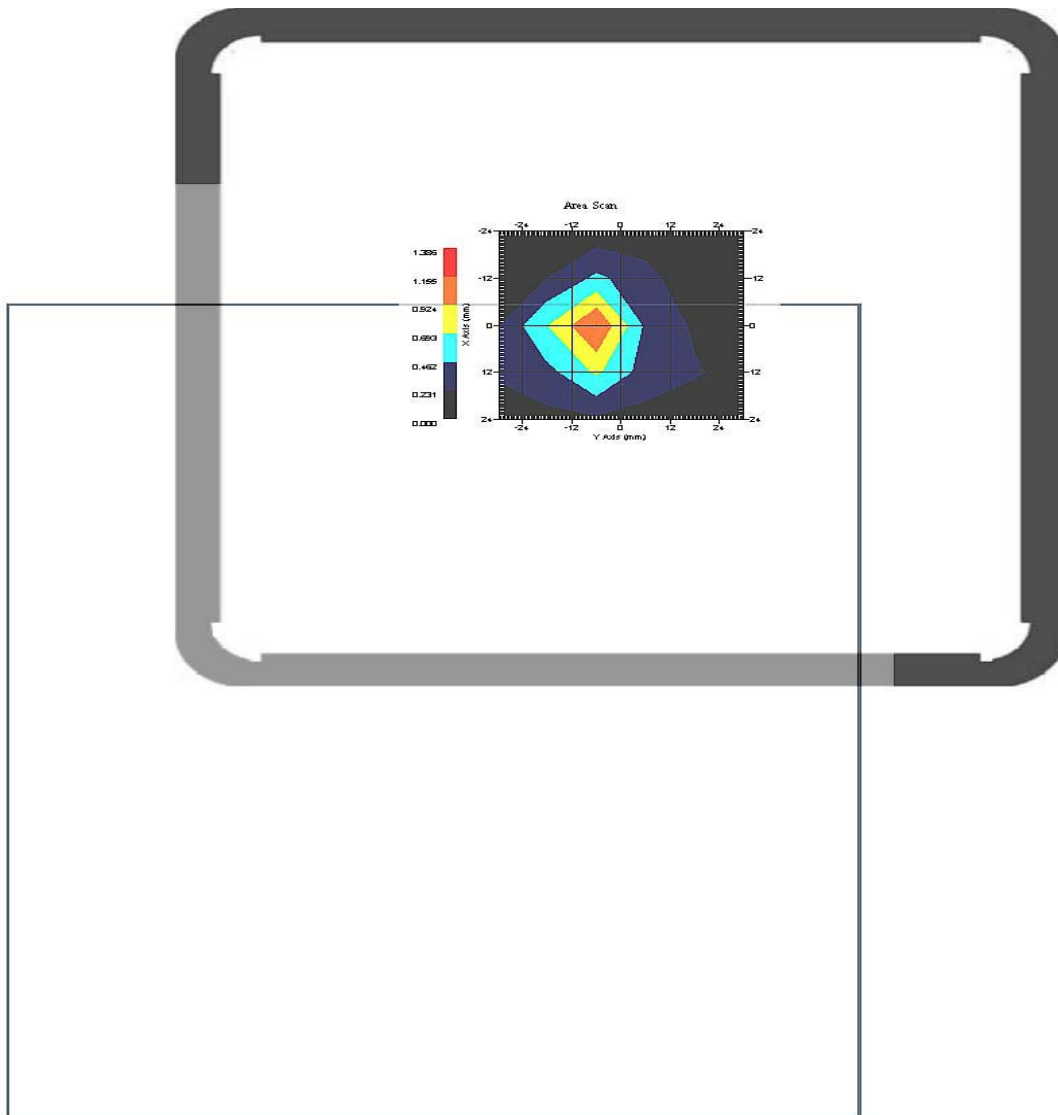

1 gram SAR value : 1.086 W/kg
 10 gram SAR value : 0.484 W/kg
 Area Scan Peak SAR : 1.157 W/kg
 Zoom Scan Peak SAR : 2.412 W/kg

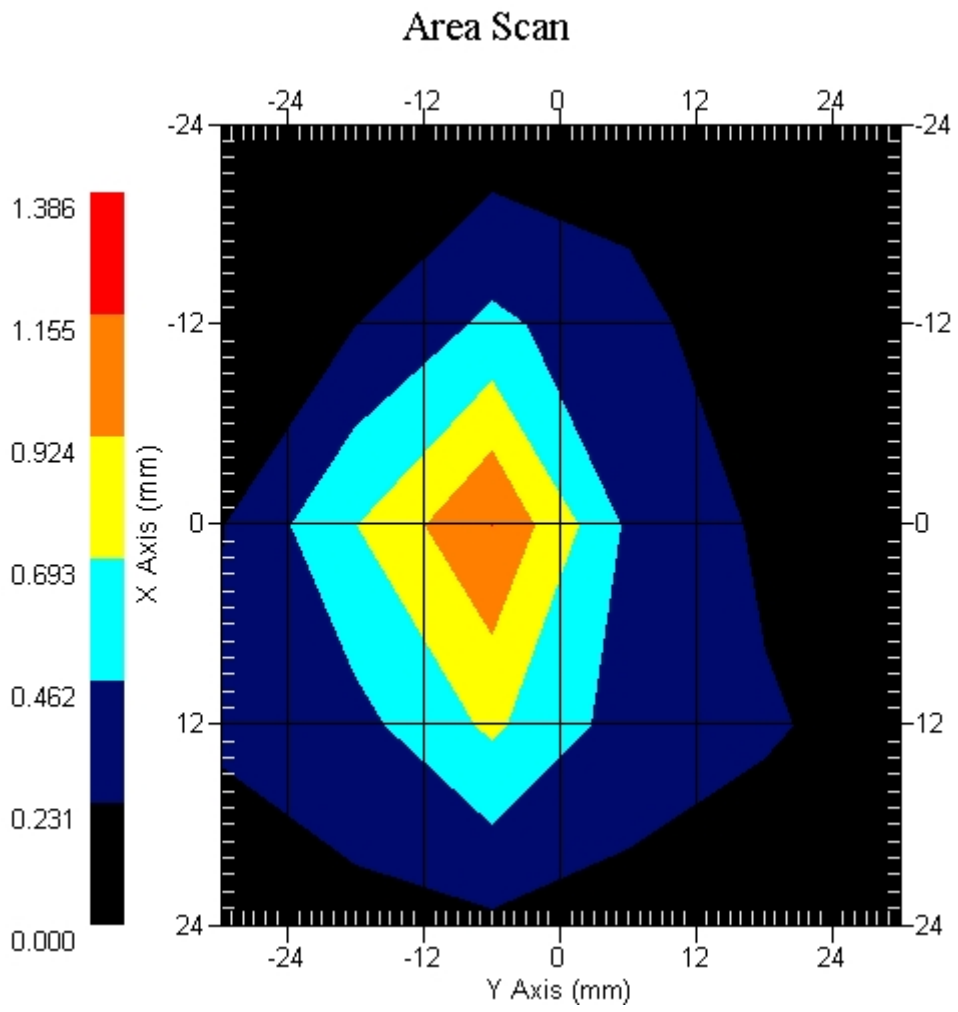

Measurement Data

Crest Factor : 1
Tissue Temp. : 21.50 °C
Ambient Temp. : 22.40 °C
Area Scan : 5x6x1 : Measurement x=12mm, y=12mm, z=4mm
Zoom Scan : 7x7x7 : Measurement x=5mm, y=5mm, z=5mm
Power Drift-Start : 0.725 W/kg
Power Drift-Finish: 0.720 W/kg
Power Drift (%) : -0.692

DUT Position : Touch EUT Back
Channel : 11

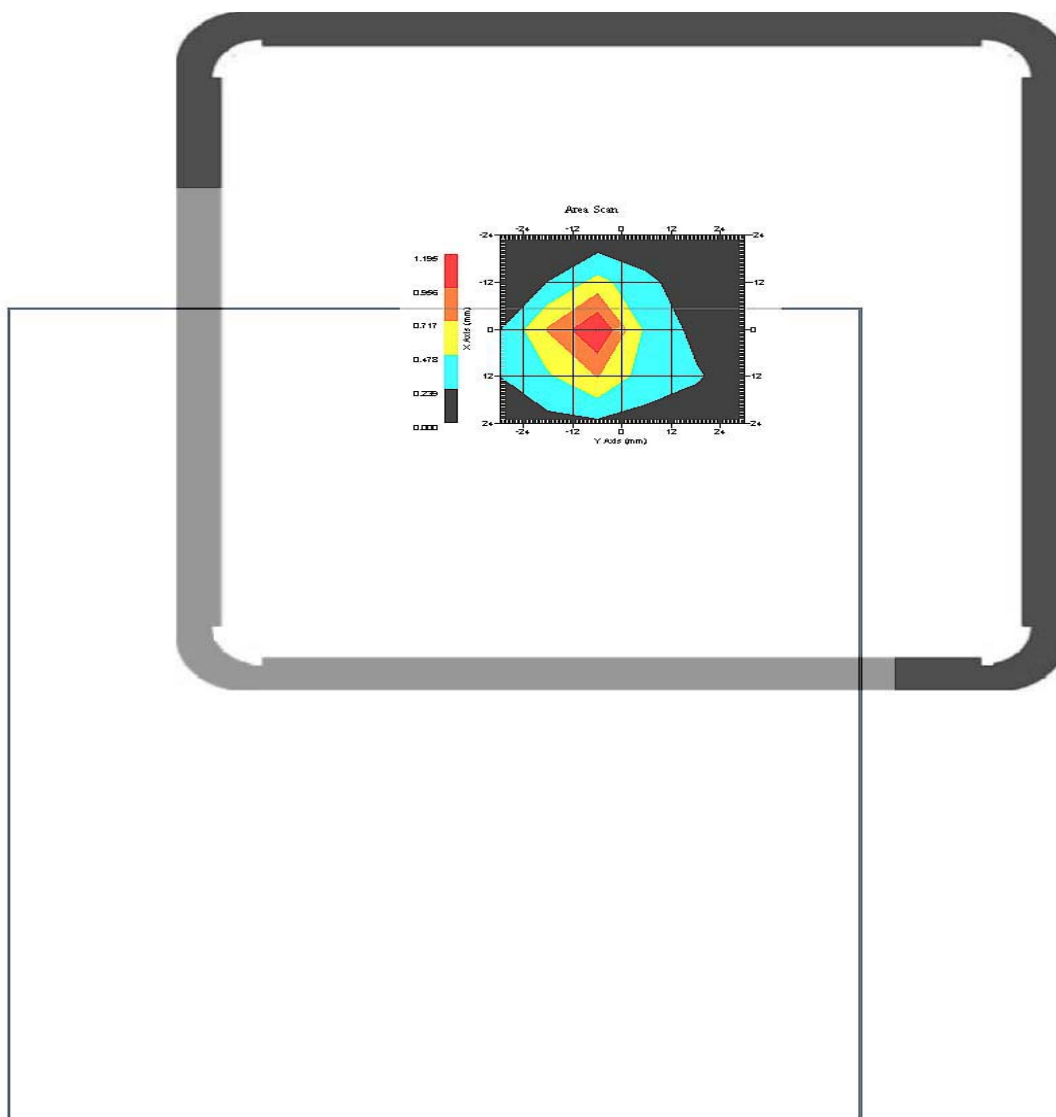

1 gram SAR value : 1.041 W/kg
10 gram SAR value : 0.485 W/kg
Area Scan Peak SAR : 1.195 W/kg
Zoom Scan Peak SAR : 2.171 W/kg

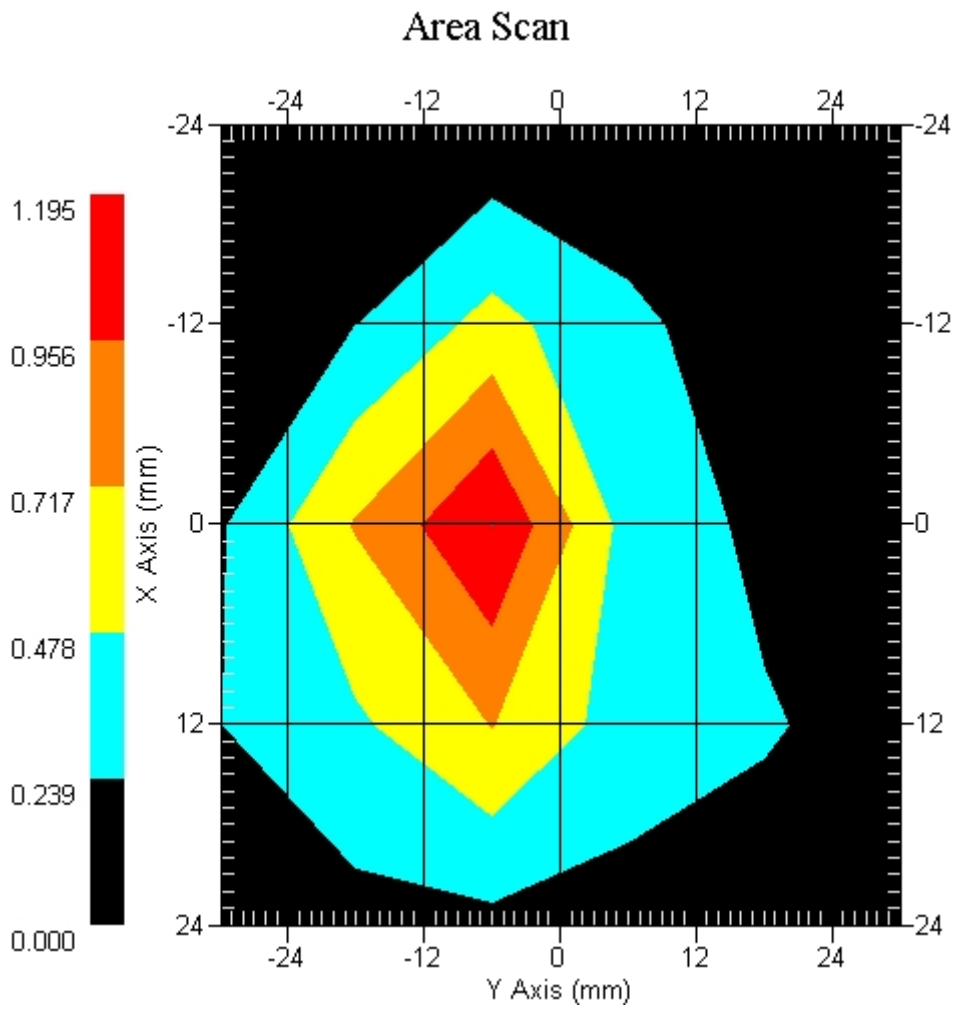

2.4GHz Band Z-Axis plot

802.11b (1Mbps)-Antenna A (ACON) channel: 11

SAR-Z Axis

at Hotspot x:0.09 y:-6.01

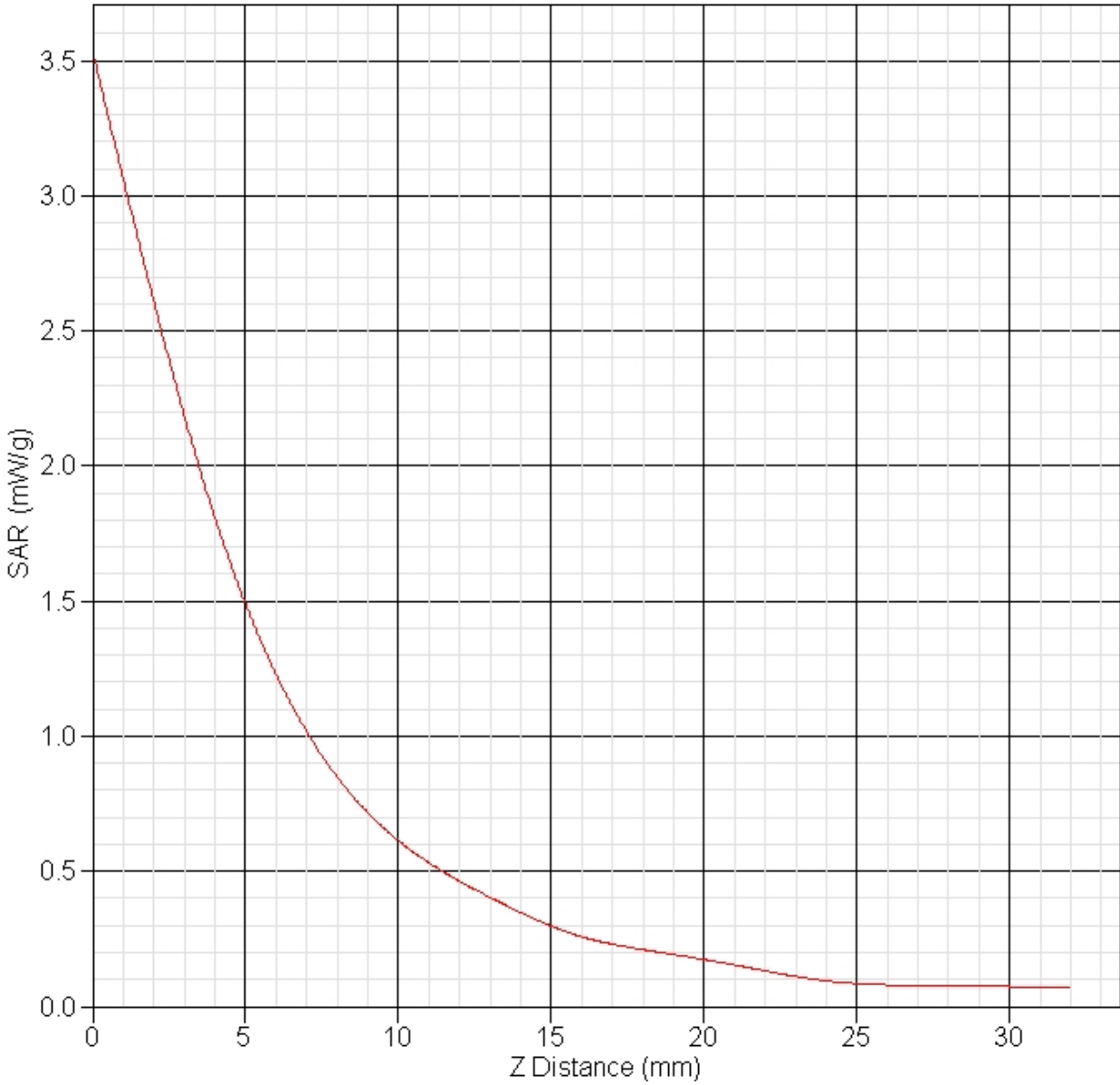

SAR Measurement Data

ALSAS-10U VER 2.3.2 APREL Laboratories

SAR Test Report -5.2GHz Band: 802.11a (6Mbps)-Antenna A (Tyco)

Report Date : 11-Apr-2007
 Measurement Date : 11-Apr-2007

Product Data

Device Name : ASUS
 Type : Other
 Model : F9S, F9E, F9D
 Frequency : 5200.00 MHz
 Drift Time : 0 min(s)
 Length : 305 mm
 Width : 245 mm
 Depth : 9.4 mm
 Antenna Type : Internal

Phantom Data

Type : Uni-Phantom
 Size (mm) : 280 x 280 x 200
 Location : Center

Tissue Data

Type : BODY
 Serial No. : 326-B
 Frequency : 5200.00 MHz
 Last Calib. Date : 11-Apr-2007
 Temperature : 21.50 °C
 Ambient Temp. : 22.40 °C
 Humidity : 56.00 RH%
 Epsilon : 50.62 F/m
 Sigma : 5.254 S/m
 Density : 1000.00 kg/cu. m

Probe Data

Name : Probe 264
 Model : E020
 Type : E-Field Triangle
 Serial No. : 264
 Last Calib. Date : 21-Mar-2006
 Frequency : 5200.00 MHz
 Duty Cycle Factor: 1
 Conversion Factor: 4.5
 Probe Sensitivity: 0.61 0.61 0.61 $\mu\text{V}/(\text{V}/\text{m})^2$
 Compression Point: 95.00 mV
 Offset : 1.56 mm

Measurement Data

Crest Factor : 1
 Tissue Temp. : 21.50 °C
 Ambient Temp. : 22.40 °C
 Area Scan : 5x6x1 : Measurement x=12mm, y=12mm, z=4mm
 Zoom Scan : 7x7x7 : Measurement x=5mm, y=5mm, z=5mm
 Power Drift-Start : 0.602 W/kg
 Power Drift-Finish: 0.591 W/kg
 Power Drift (%) : -1.836

DUT Position : Touch EUT Back
 Channel : 36

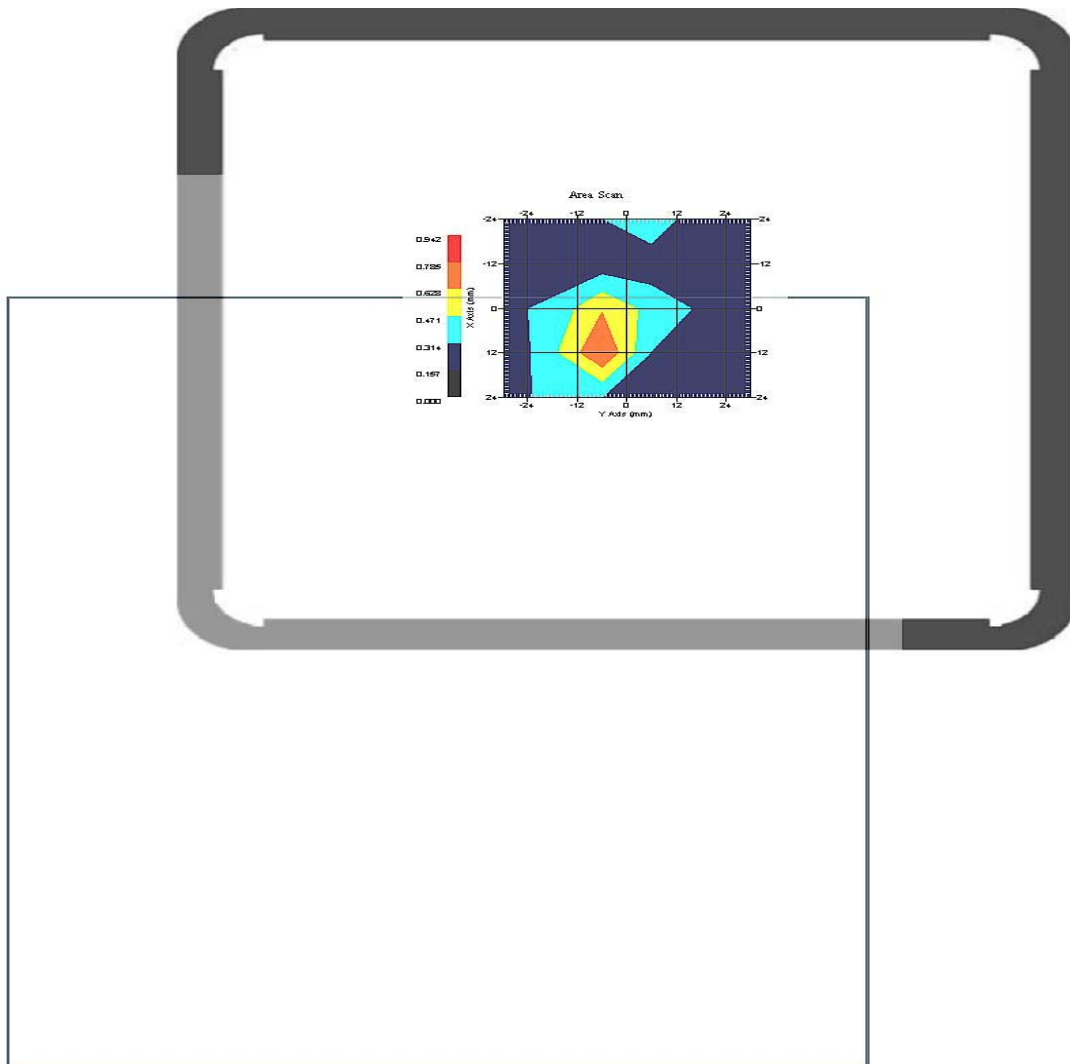

1 gram SAR value : 0.657 W/kg
 10 gram SAR value : 0.388 W/kg
 Area Scan Peak SAR : 0.787 W/kg
 Zoom Scan Peak SAR : 1.151 W/kg

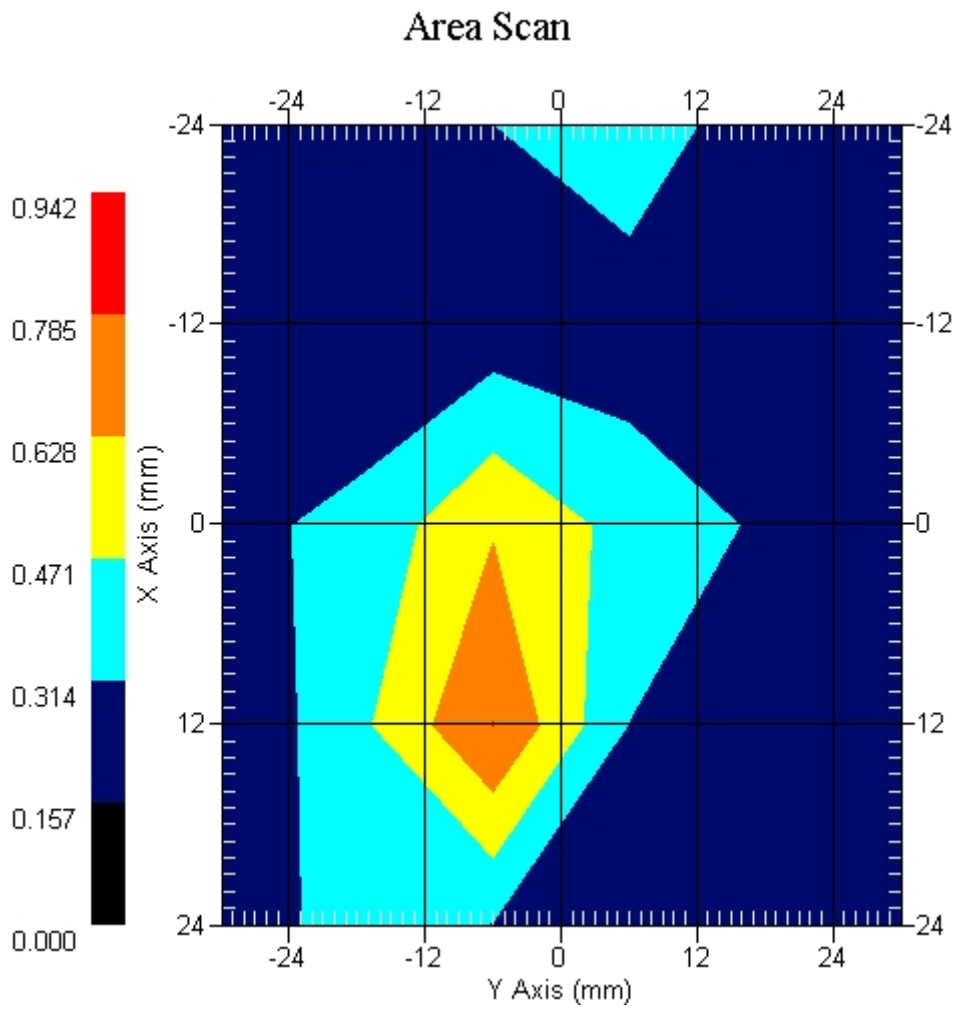

Measurement Data

Crest Factor : 1
 Tissue Temp. : 21.50 °C
 Ambient Temp. : 22.40 °C
 Area Scan : 5x6x1 : Measurement x=12mm, y=12mm, z=4mm
 Zoom Scan : 7x7x7 : Measurement x=5mm, y=5mm, z=5mm
 Power Drift-Start : 0.613 W/kg
 Power Drift-Finish: 0.612 W/kg
 Power Drift (%) : -0.100

DUT Position : Touch EUT Back
 Channel : 44

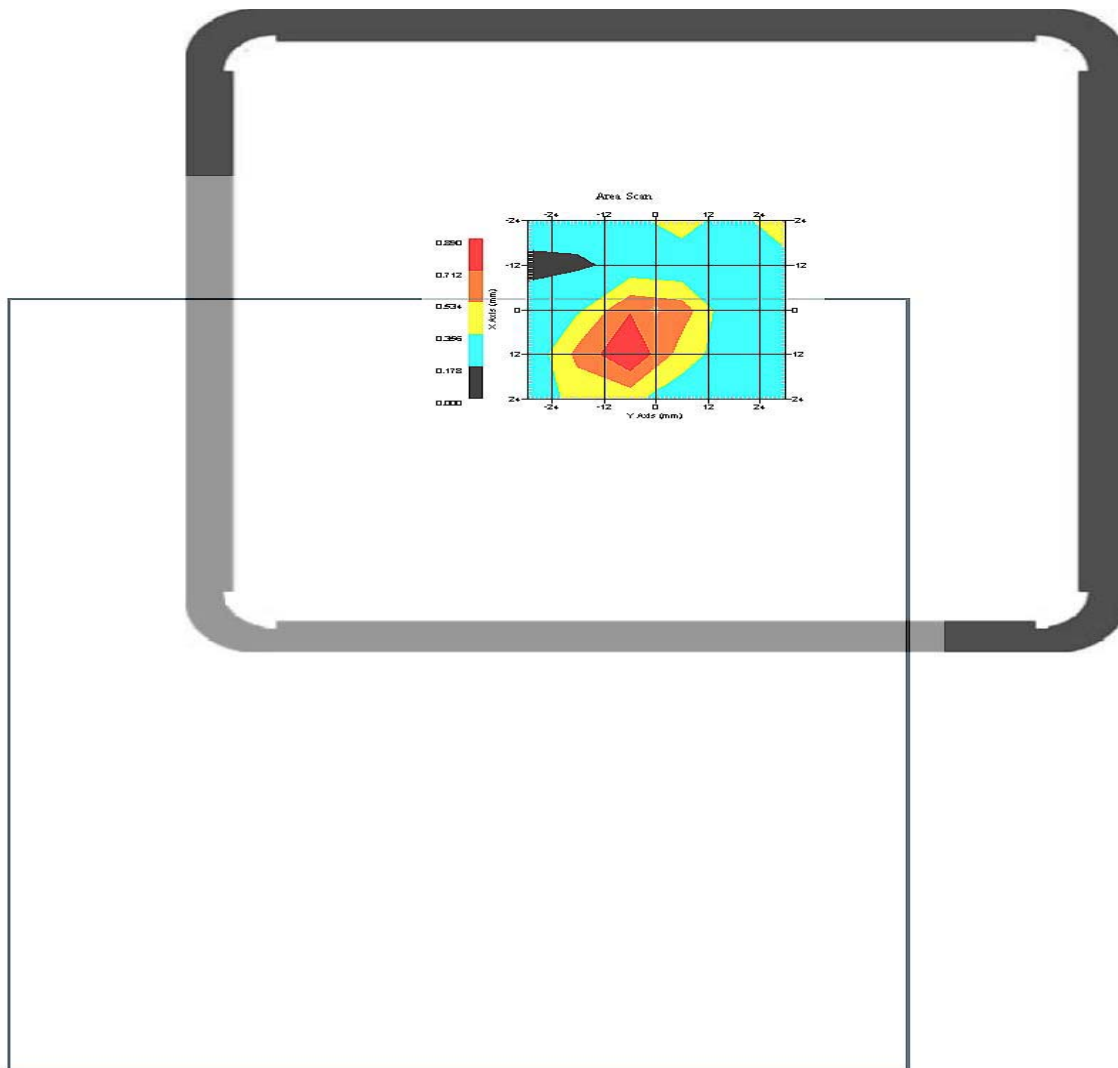

1 gram SAR value : 0.983 W/kg
 10 gram SAR value : 0.515 W/kg
 Area Scan Peak SAR : 0.889 W/kg
 Zoom Scan Peak SAR : 2.252 W/kg

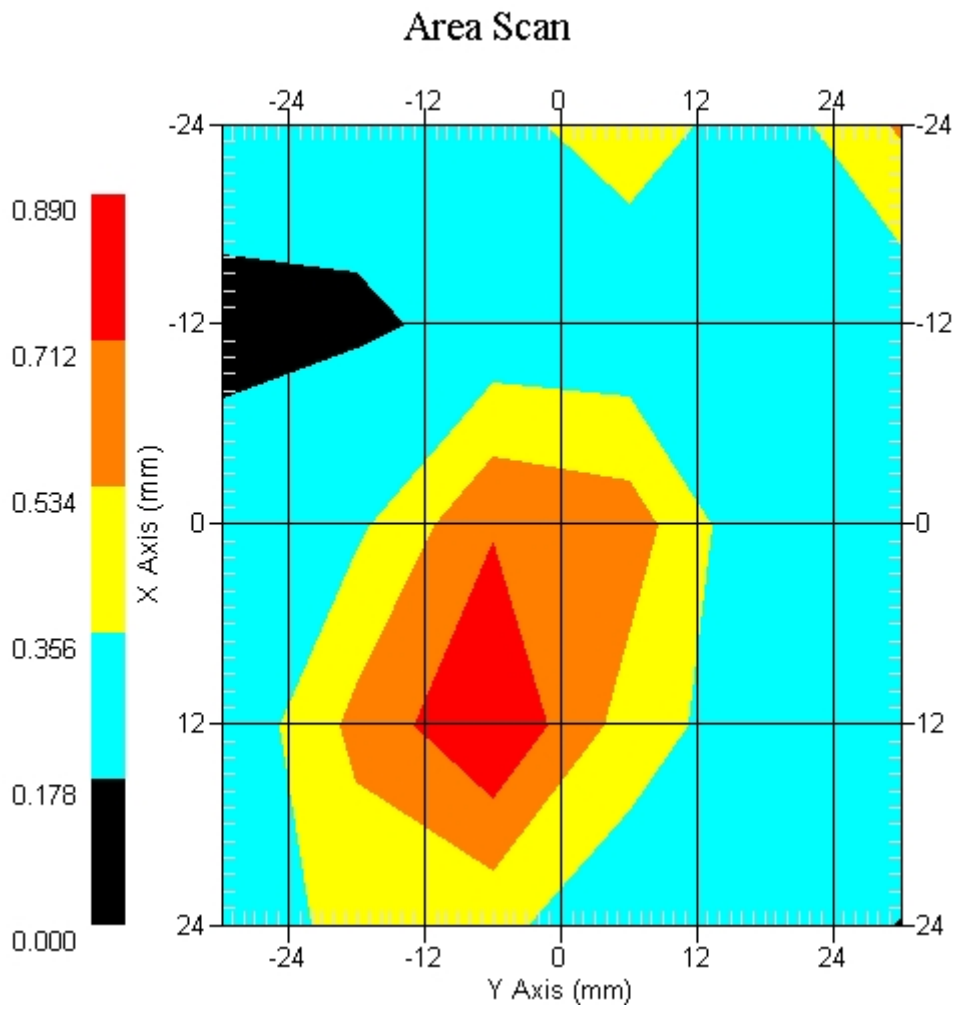

Measurement Data

Crest Factor : 1
 Tissue Temp. : 21.50 °C
 Ambient Temp. : 22.40 °C
 Area Scan : 5x6x1 : Measurement x=12mm, y=12mm, z=4mm
 Zoom Scan : 7x7x7 : Measurement x=5mm, y=5mm, z=5mm
 Power Drift-Start : 0.526 W/kg
 Power Drift-Finish: 0.531 W/kg
 Power Drift (%) : 0.956

DUT Position : Touch EUT Back
 Channel : 48

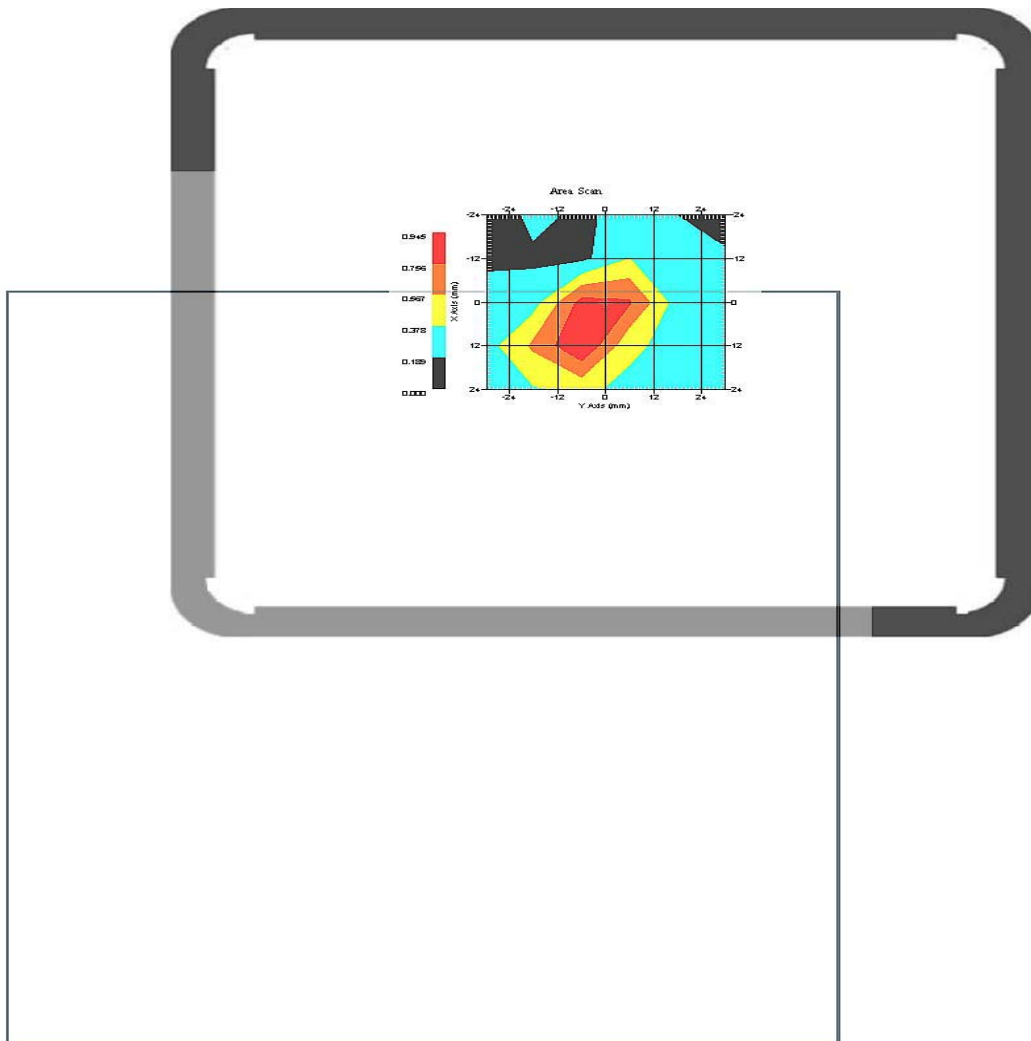

1 gram SAR value : 0.743 W/kg
 10 gram SAR value : 0.418 W/kg
 Area Scan Peak SAR : 0.943 W/kg
 Zoom Scan Peak SAR : 1.831 W/kg

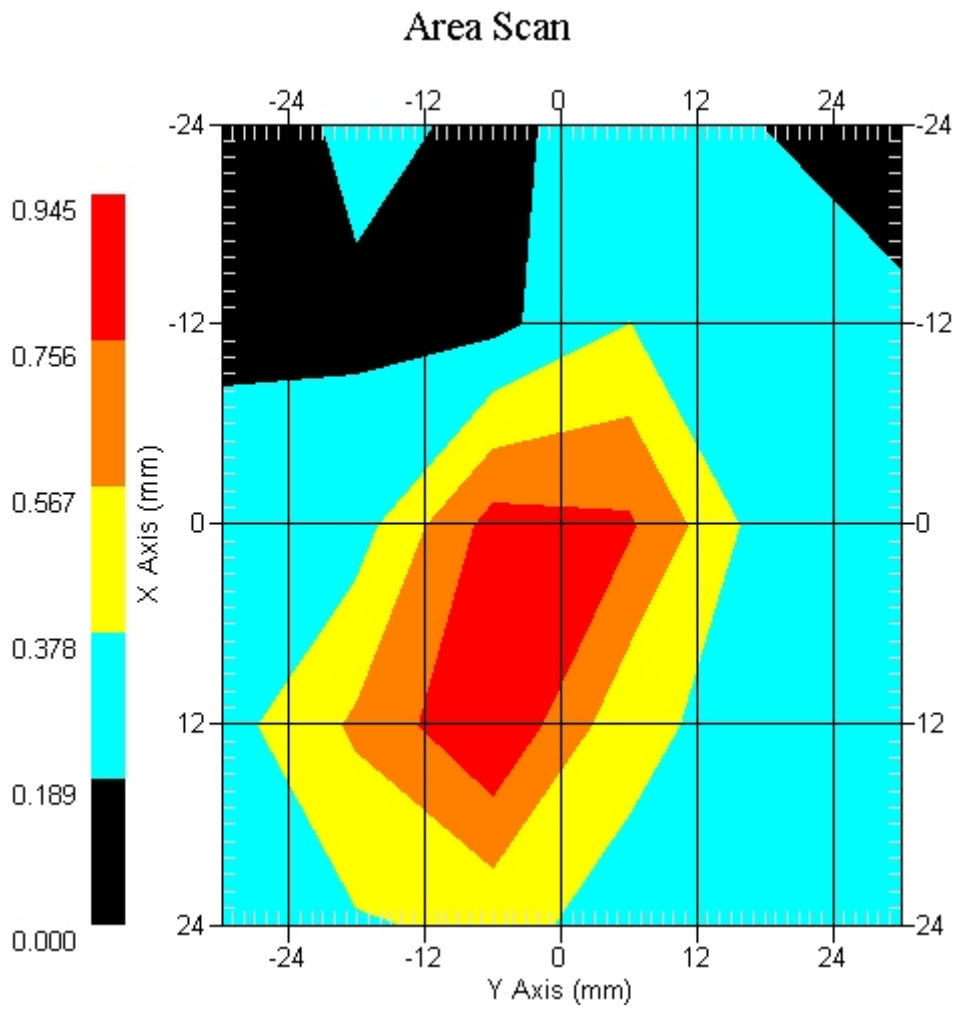

ALSAS-10U VER 2.3.2 APREL Laboratories

SAR Test Report -5.2GHz Band: 802.11a (6Mbps)-Antenna B (Tyco)

Report Date : 11-Apr-2007
Measurement Date : 11-Apr-2007

Product Data

Device Name : ASUS
Type : Other
Model : F9S, F9E, F9D
Frequency : 5200.00 MHz
Drift Time : 0 min(s)
Length : 305 mm
Width : 245 mm
Depth : 9.4 mm
Antenna Type : Internal

Phantom Data

Type : Uni-Phantom
Size (mm) : 280 x 280 x 200
Location : Center

Tissue Data

Type : BODY
Serial No. : 326-B
Frequency : 5200.00 MHz
Last Calib. Date : 11-Apr-2007
Temperature : 21.50 °C
Ambient Temp. : 22.40 °C
Humidity : 56.00 RH%
Epsilon : 50.62 F/m
Sigma : 5.254 S/m
Density : 1000.00 kg/cu. m

Probe Data

Name : Probe 264
Model : E020
Type : E-Field Triangle
Serial No. : 264
Last Calib. Date : 21-Mar-2006
Frequency : 5200.00 MHz
Duty Cycle Factor: 1
Conversion Factor: 4.5
Probe Sensitivity: 0.61 0.61 0.61 $\mu\text{V}/(\text{V}/\text{m})^2$
Compression Point: 95.00 mV
Offset : 1.56 mm

Measurement Data

Crest Factor : 1
Tissue Temp. : 21.50 °C
Ambient Temp. : 22.40 °C
Area Scan : 5x6x1 : Measurement x=12mm, y=12mm, z=4mm
Zoom Scan : 7x7x7 : Measurement x=5mm, y=5mm, z=5mm
Power Drift-Start : 0.524 W/kg
Power Drift-Finish: 0.543 W/kg
Power Drift (%) : 3.731

DUT Position : Touch EUT Back
Channel : 44

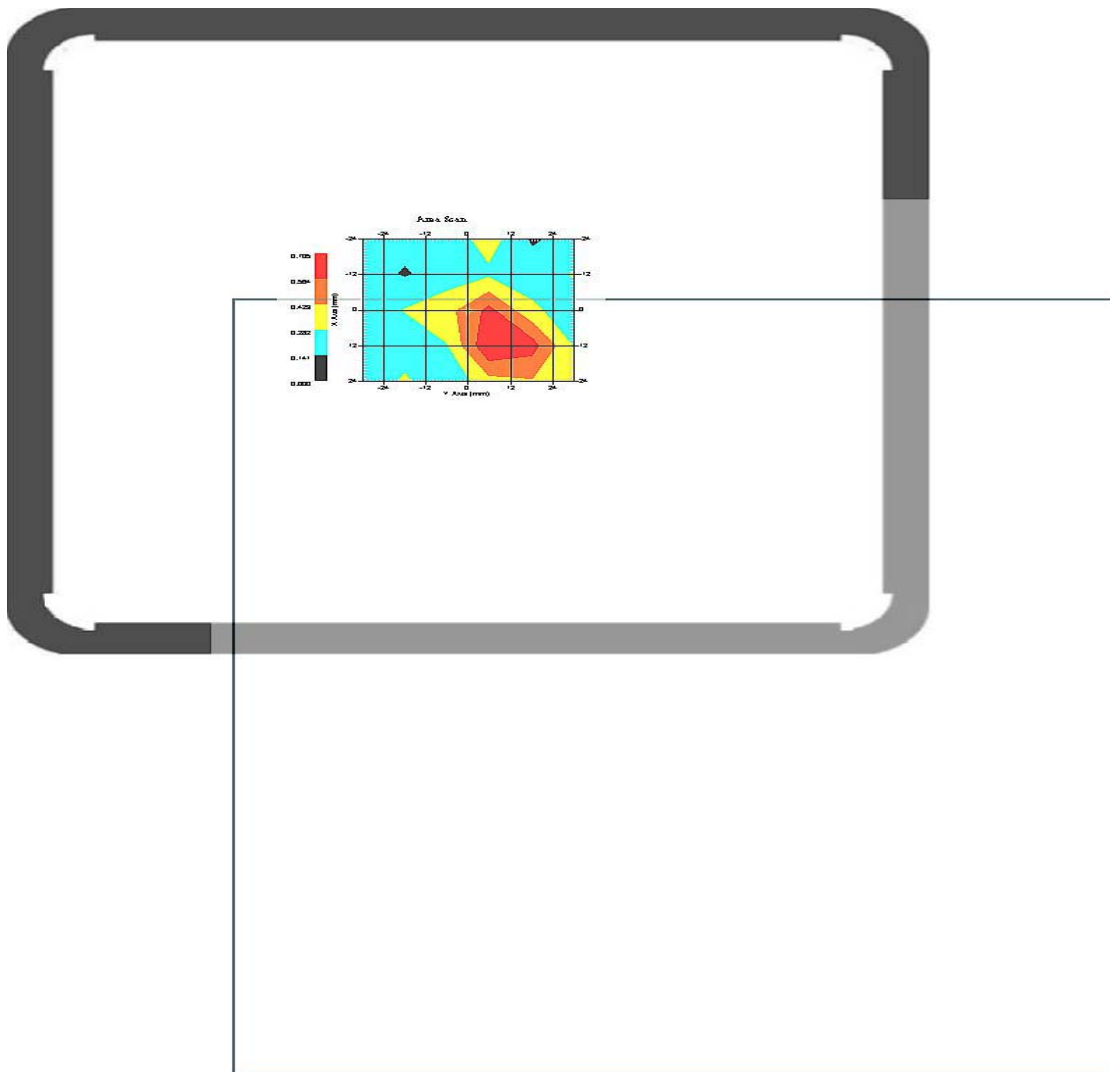

1 gram SAR value : 0.739 W/kg
10 gram SAR value : 0.461 W/kg
Area Scan Peak SAR : 0.703 W/kg
Zoom Scan Peak SAR : 1.611 W/kg

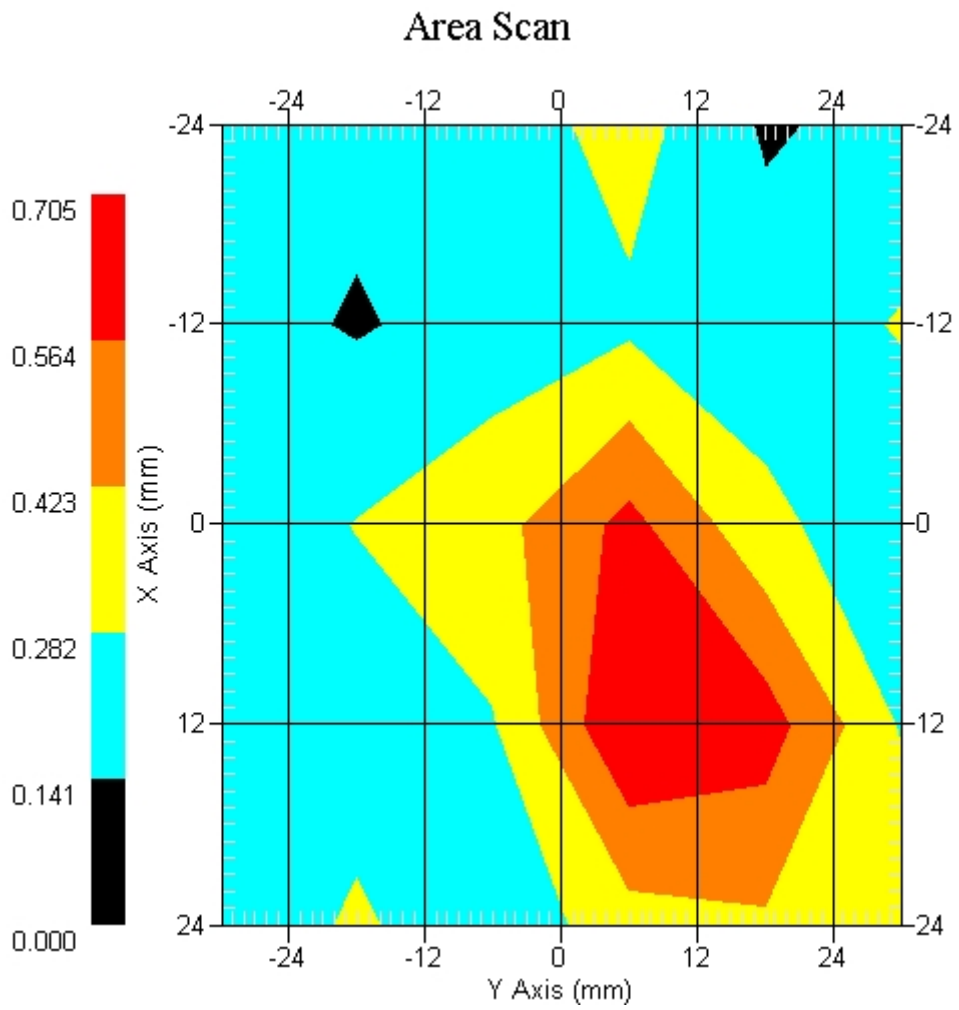

ALSAS-10U VER 2.3.2 APREL Laboratories

SAR Test Report -5.2GHz Band: 802.11n HT0 (20MHz)

Report Date : 11-Apr-2007
Measurement Date : 11-Apr-2007

Product Data

Device Name : ASUS
Type : Other
Model : F9S, F9E, F9D
Frequency : 5200.00 MHz
Drift Time : 0 min(s)
Length : 305 mm
Width : 245 mm
Depth : 9.4 mm
Antenna Type : Internal

Phantom Data

Type : Uni-Phantom
Size (mm) : 280 x 280 x 200
Location : Center

Tissue Data

Type : BODY
Serial No. : 326-B
Frequency : 5200.00 MHz
Last Calib. Date : 11-Apr-2007
Temperature : 21.50 °C
Ambient Temp. : 22.40 °C
Humidity : 56.00 RH%
Epsilon : 50.62 F/m
Sigma : 5.254 S/m
Density : 1000.00 kg/cu. m

Probe Data

Name : Probe 264
Model : E020
Type : E-Field Triangle
Serial No. : 264
Last Calib. Date : 21-Mar-2006
Frequency : 5200.00 MHz
Duty Cycle Factor: 1
Conversion Factor: 4.5
Probe Sensitivity: 0.61 0.61 0.61 $\mu\text{V}/(\text{V}/\text{m})^2$
Compression Point: 95.00 mV
Offset : 1.56 mm

Measurement Data

Crest Factor : 1
 Tissue Temp. : 21.50 °C
 Ambient Temp. : 22.40 °C
 Area Scan : 5x6x1 : Measurement x=12mm, y=12mm, z=4mm
 Zoom Scan : 7x7x7 : Measurement x=5mm, y=5mm, z=5mm
 Power Drift-Start : 0.499 W/kg
 Power Drift-Finish: 0.501 W/kg
 Power Drift (%) : 0.405

DUT Position : Touch EUT Back
 Channel : 36

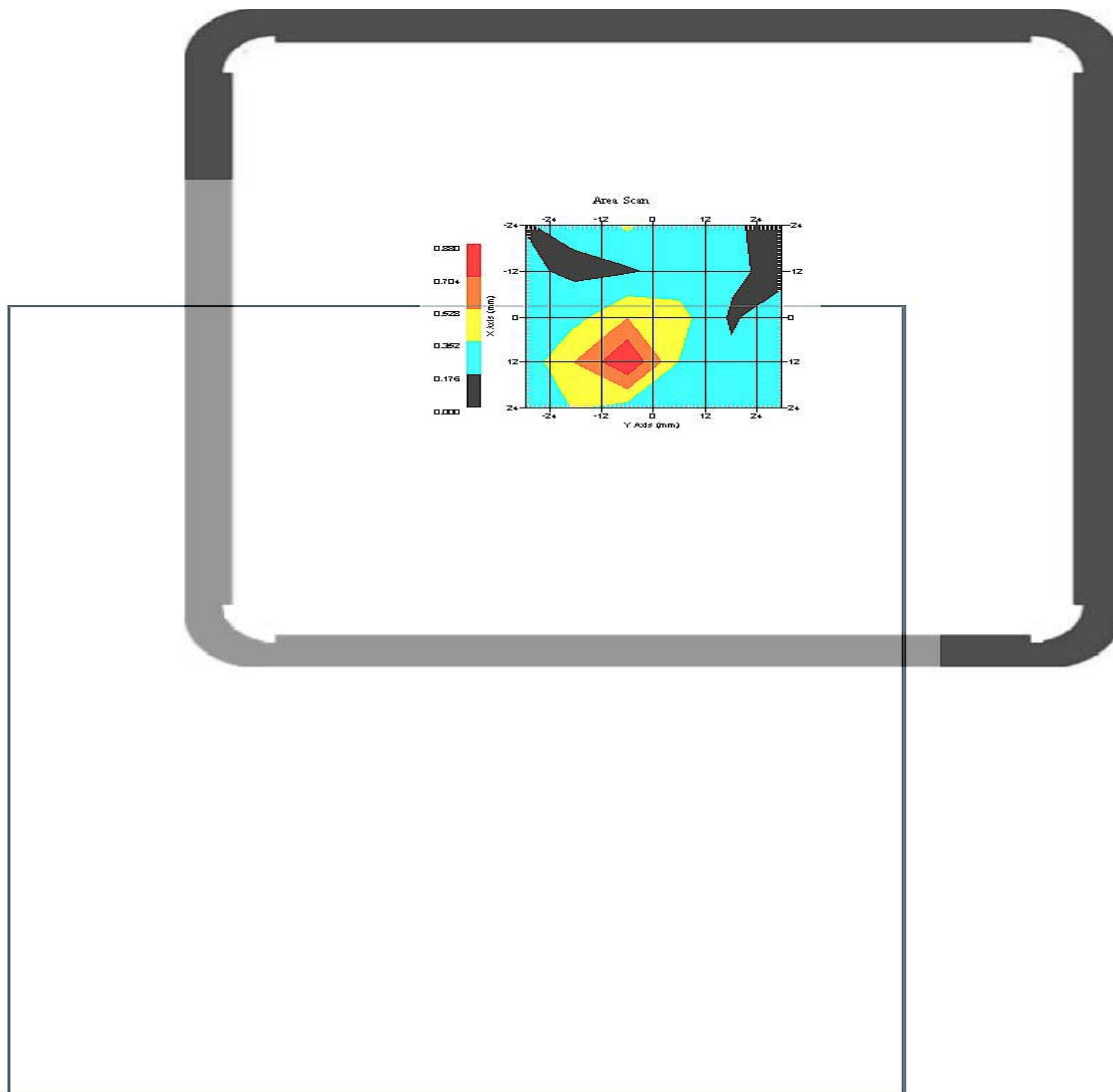

1 gram SAR value : 0.731 W/kg
 10 gram SAR value : 0.403 W/kg
 Area Scan Peak SAR : 0.879 W/kg
 Zoom Scan Peak SAR : 1.431 W/kg

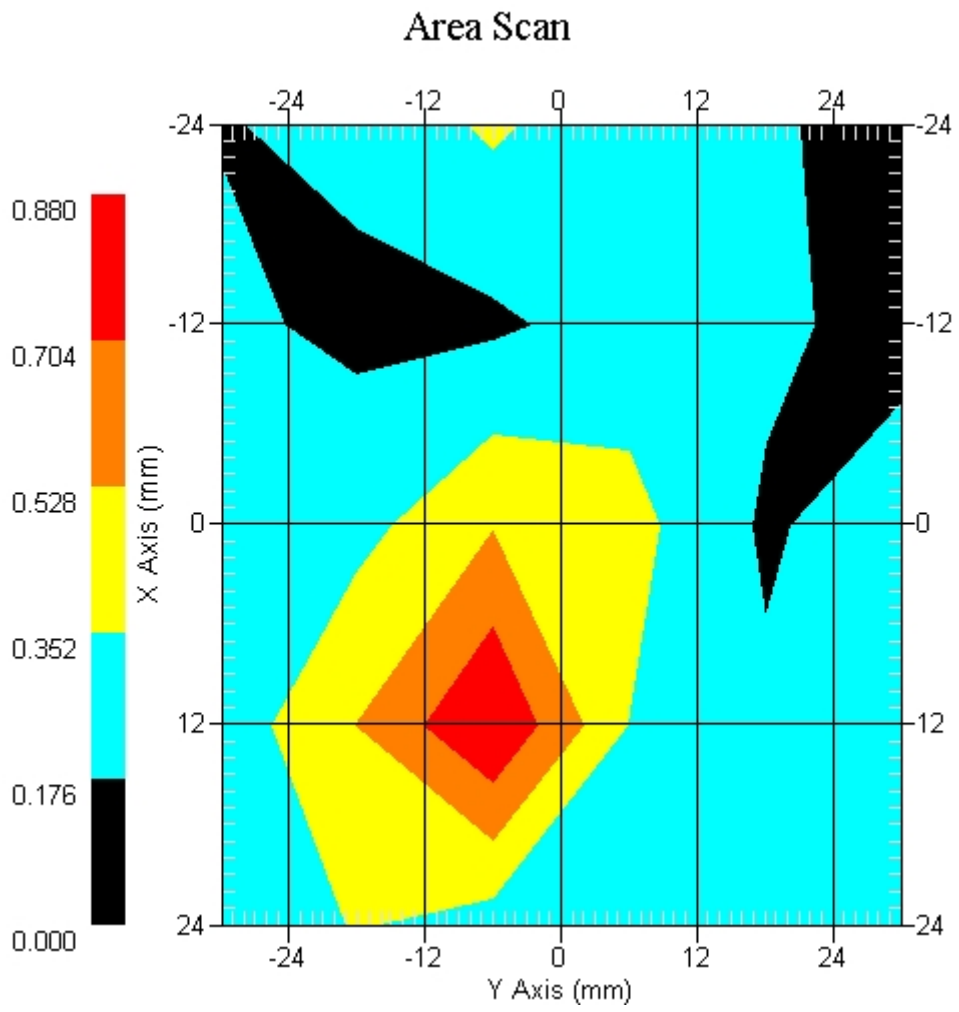

Measurement Data

Crest Factor : 1
 Tissue Temp. : 21.50 °C
 Ambient Temp. : 22.40 °C
 Area Scan : 5x6x1 : Measurement x=12mm, y=12mm, z=4mm
 Zoom Scan : 7x7x7 : Measurement x=5mm, y=5mm, z=5mm
 Power Drift-Start : 0.517 W/kg
 Power Drift-Finish: 0.535 W/kg
 Power Drift (%) : 3.486

DUT Position : Touch EUT Back
 Channel : 44

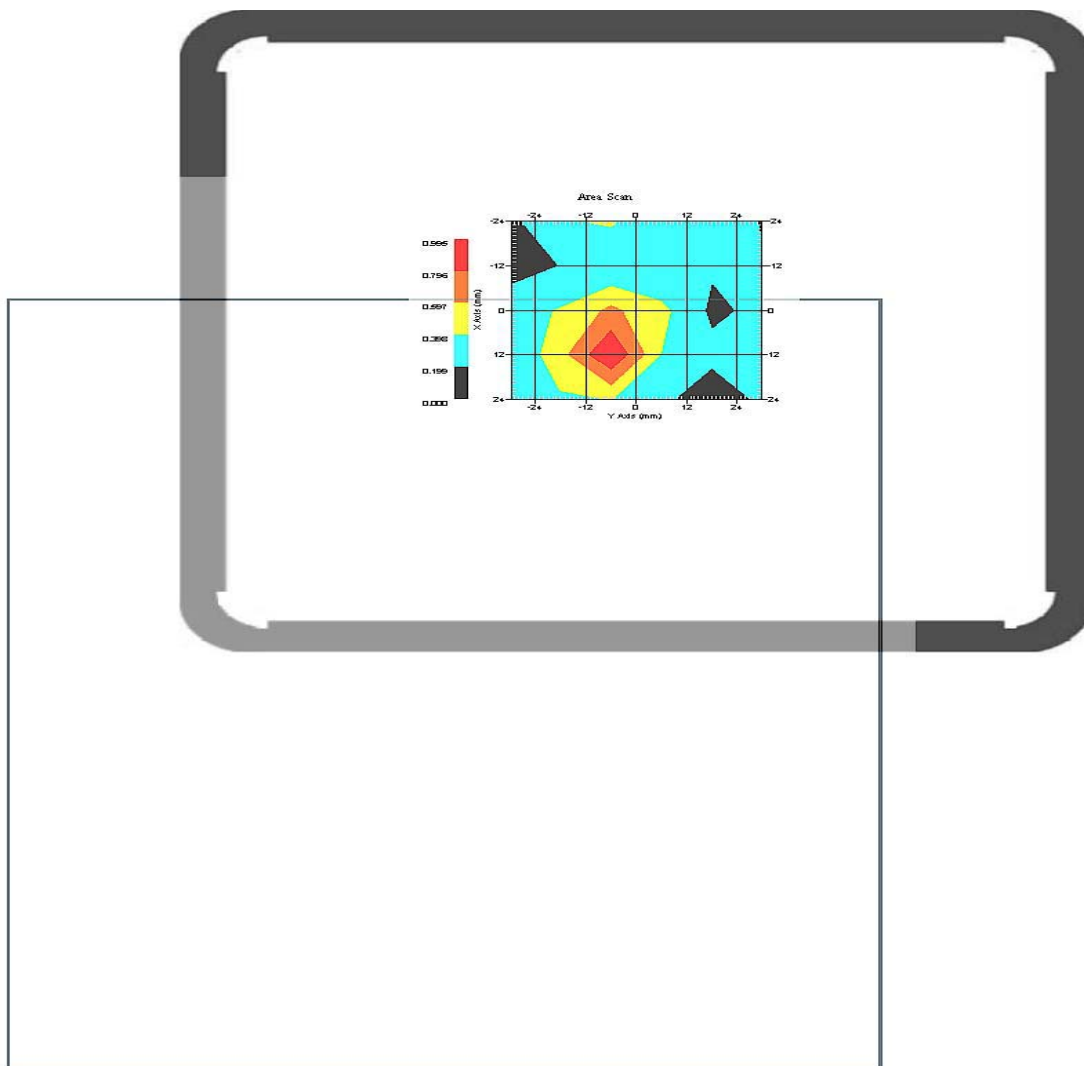

1 gram SAR value : 0.871 W/kg
 10 gram SAR value : 0.450 W/kg
 Area Scan Peak SAR : 0.994 W/kg
 Zoom Scan Peak SAR : 1.931 W/kg

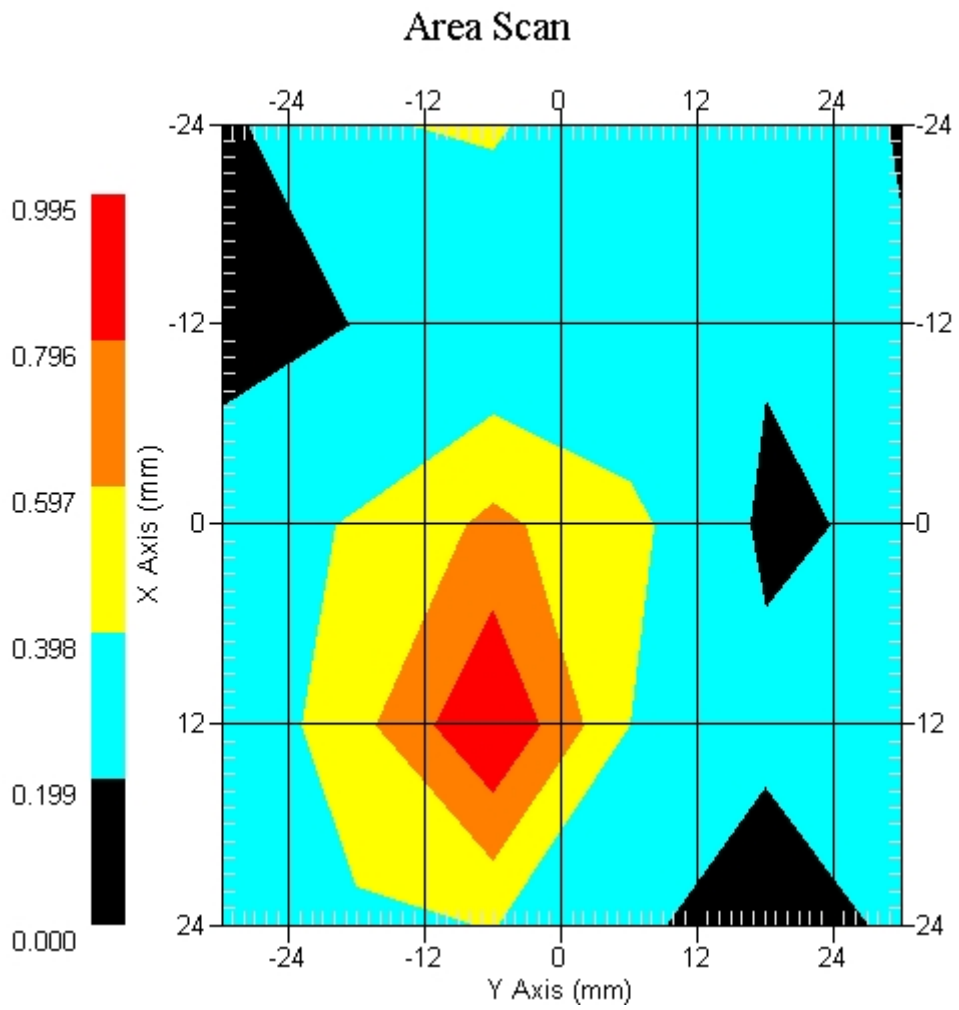

Measurement Data

Crest Factor : 1
Tissue Temp. : 21.50 °C
Ambient Temp. : 22.40 °C
Area Scan : 5x6x1 : Measurement x=12mm, y=12mm, z=4mm
Zoom Scan : 7x7x7 : Measurement x=5mm, y=5mm, z=5mm
Power Drift-Start : 0.546 W/kg
Power Drift-Finish: 0.558 W/kg
Power Drift (%) : 2.194

DUT Position : Touch EUT Back
Channel : 48

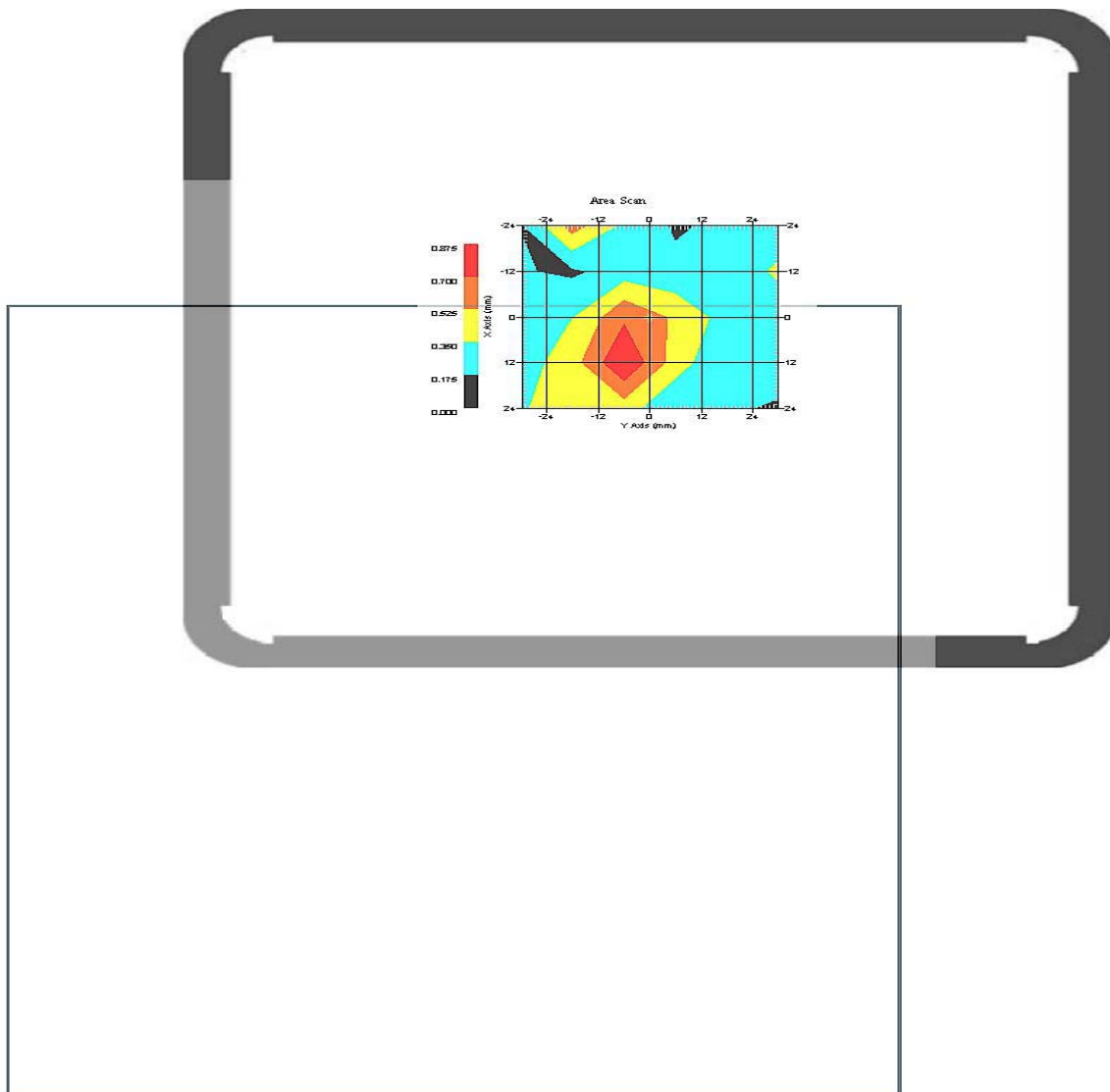

1 gram SAR value : 0.885 W/kg
10 gram SAR value : 0.451 W/kg
Area Scan Peak SAR : 0.873 W/kg
Zoom Scan Peak SAR : 1.831 W/kg

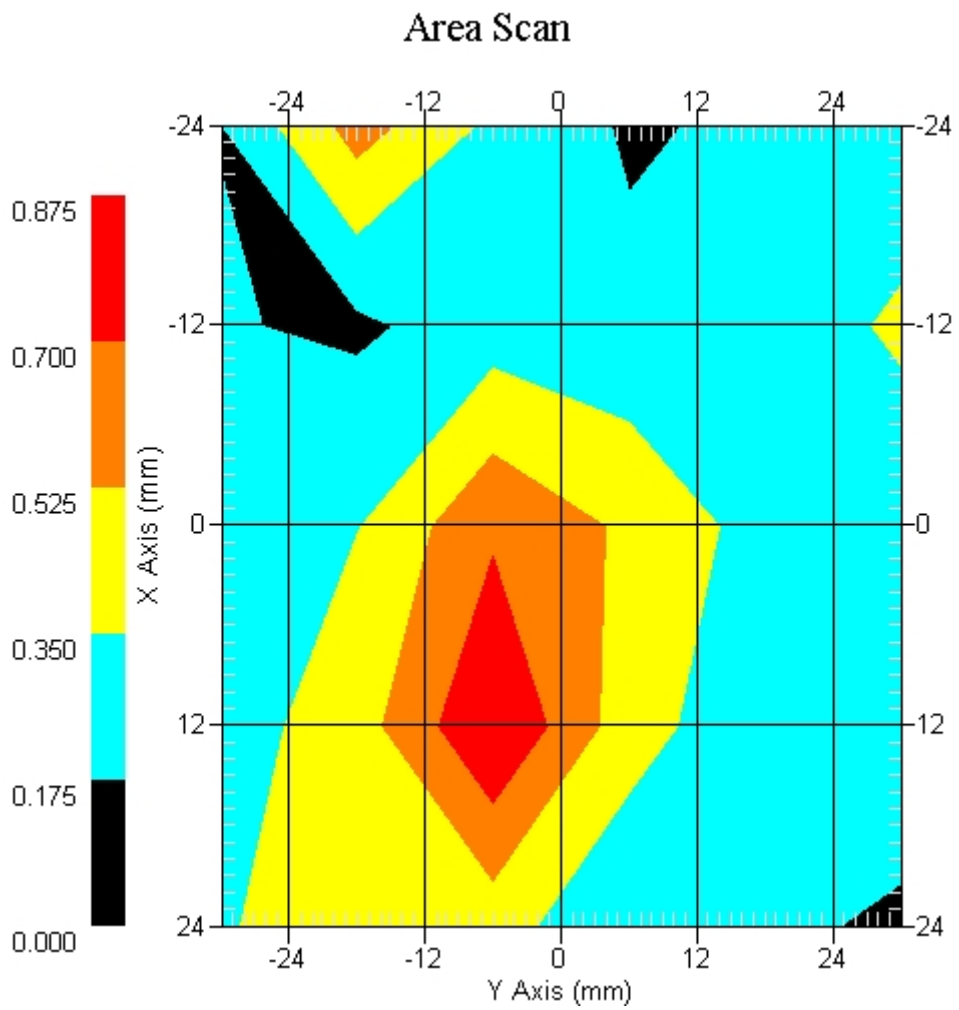

ALSAS-10U VER 2.3.2 APREL Laboratories

SAR Test Report -5.2GHz Band: 802.11n HT0 (40MHz)

Report Date : 11-Apr-2007
Measurement Date : 11-Apr-2007

Product Data

Device Name : ASUS
Type : Other
Model : F9S, F9E, F9D
Frequency : 5200.00 MHz
Drift Time : 0 min(s)
Length : 305 mm
Width : 245 mm
Depth : 9.4 mm
Antenna Type : Internal

Phantom Data

Type : Uni-Phantom
Size (mm) : 280 x 280 x 200
Location : Center

Tissue Data

Type : BODY
Serial No. : 326-B
Frequency : 5200.00 MHz
Last Calib. Date : 11-Apr-2007
Temperature : 21.50 °C
Ambient Temp. : 22.40 °C
Humidity : 56.00 RH%
Epsilon : 50.62 F/m
Sigma : 5.254 S/m
Density : 1000.00 kg/cu. m

Probe Data

Name : Probe 264
Model : E020
Type : E-Field Triangle
Serial No. : 264
Last Calib. Date : 21-Mar-2006
Frequency : 5200.00 MHz
Duty Cycle Factor: 1
Conversion Factor: 4.5
Probe Sensitivity: 0.61 0.61 0.61 $\mu\text{V}/(\text{V}/\text{m})^2$
Compression Point: 95.00 mV
Offset : 1.56 mm

Measurement Data

Crest Factor : 1
 Tissue Temp. : 21.50 °C
 Ambient Temp. : 22.40 °C
 Area Scan : 5x6x1 : Measurement x=12mm, y=12mm, z=4mm
 Zoom Scan : 7x7x7 : Measurement x=5mm, y=5mm, z=5mm
 Power Drift-Start : 0.414 W/kg
 Power Drift-Finish: 0.423 W/kg
 Power Drift (%) : 2.178

DUT Position : Touch EUT Back
 Channel : 38

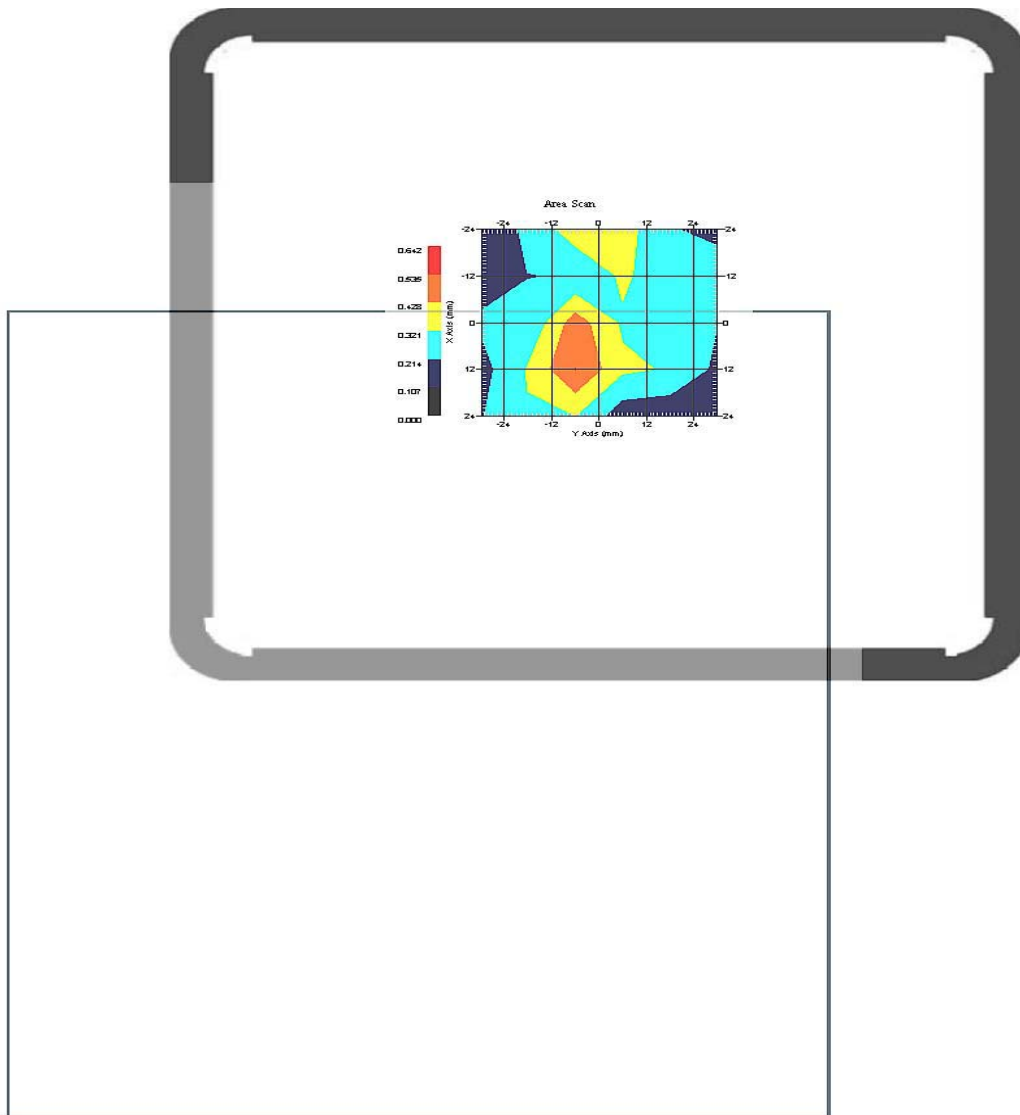

1 gram SAR value : 0.600 W/kg
 10 gram SAR value : 0.371 W/kg
 Area Scan Peak SAR : 0.537 W/kg
 Zoom Scan Peak SAR : 1.421 W/kg

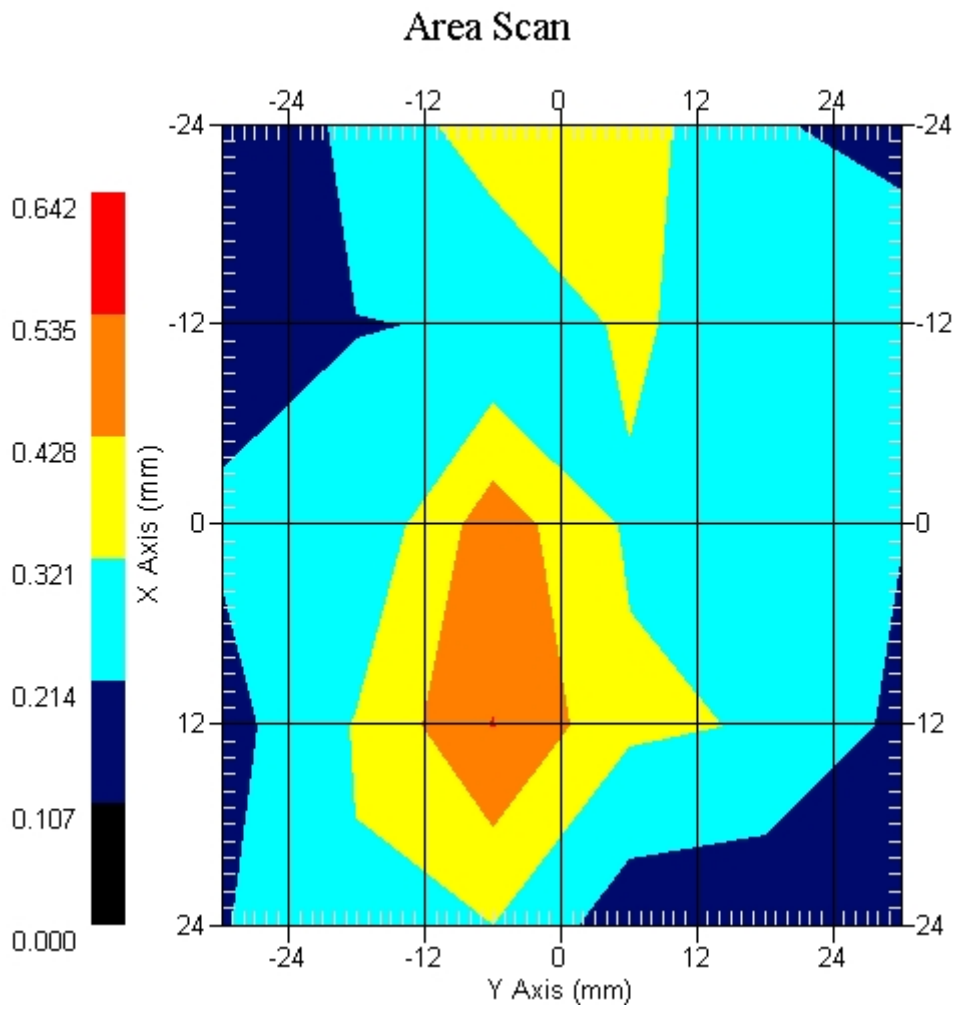

ALSAS-10U VER 2.3.2 APREL Laboratories

SAR Test Report -5.2GHz Band: 802.11n HT8 (20MHz)

Report Date : 11-Apr-2007
Measurement Date : 11-Apr-2007

Product Data

Device Name : ASUS
Type : Other
Model : F9S, F9E, F9D
Frequency : 5200.00 MHz
Drift Time : 0 min(s)
Length : 305 mm
Width : 245 mm
Depth : 9.4 mm
Antenna Type : Internal

Phantom Data

Type : Uni-Phantom
Size (mm) : 280 x 280 x 200
Location : Center

Tissue Data

Type : BODY
Serial No. : 326-B
Frequency : 5200.00 MHz
Last Calib. Date : 11-Apr-2007
Temperature : 21.50 °C
Ambient Temp. : 22.40 °C
Humidity : 56.00 RH%
Epsilon : 50.62 F/m
Sigma : 5.254 S/m
Density : 1000.00 kg/cu. m

Probe Data

Name : Probe 264
Model : E020
Type : E-Field Triangle
Serial No. : 264
Last Calib. Date : 21-Mar-2006
Frequency : 5200.00 MHz
Duty Cycle Factor: 1
Conversion Factor: 4.5
Probe Sensitivity: 0.61 0.61 0.61 $\mu\text{V}/(\text{V}/\text{m})^2$
Compression Point: 95.00 mV
Offset : 1.56 mm

Measurement Data

Crest Factor : 1
 Tissue Temp. : 21.50 °C
 Ambient Temp. : 22.40 °C
 Area Scan : 5x6x1 : Measurement x=12mm, y=12mm, z=4mm
 Zoom Scan : 7x7x7 : Measurement x=5mm, y=5mm, z=5mm
 Power Drift-Start : 0.335 W/kg
 Power Drift-Finish: 0.321 W/kg
 Power Drift (%) : -4.154

DUT Position : Touch EUT Back
 Channel : 36

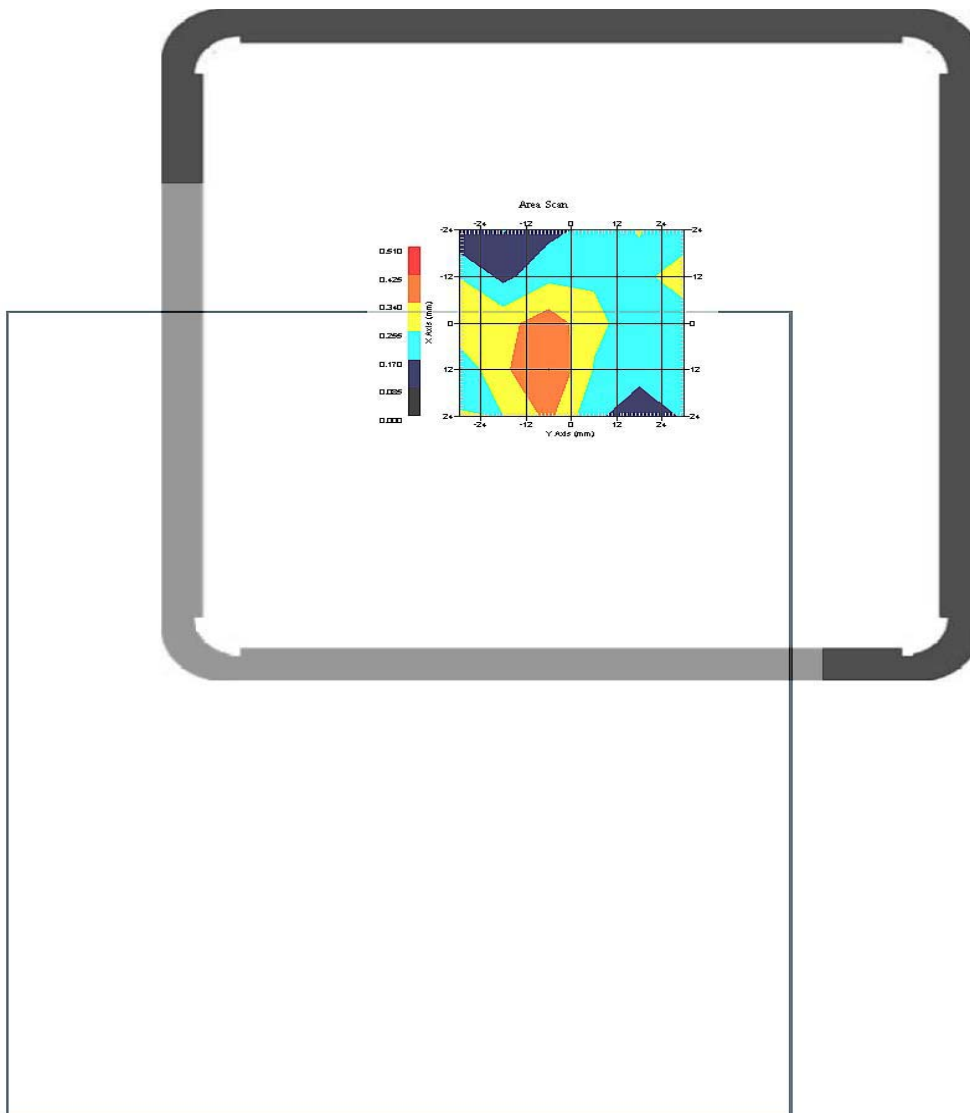

1 gram SAR value : 0.445 W/kg
 10 gram SAR value : 0.264 W/kg
 Area Scan Peak SAR : 0.426 W/kg
 Zoom Scan Peak SAR : 1.180 W/kg

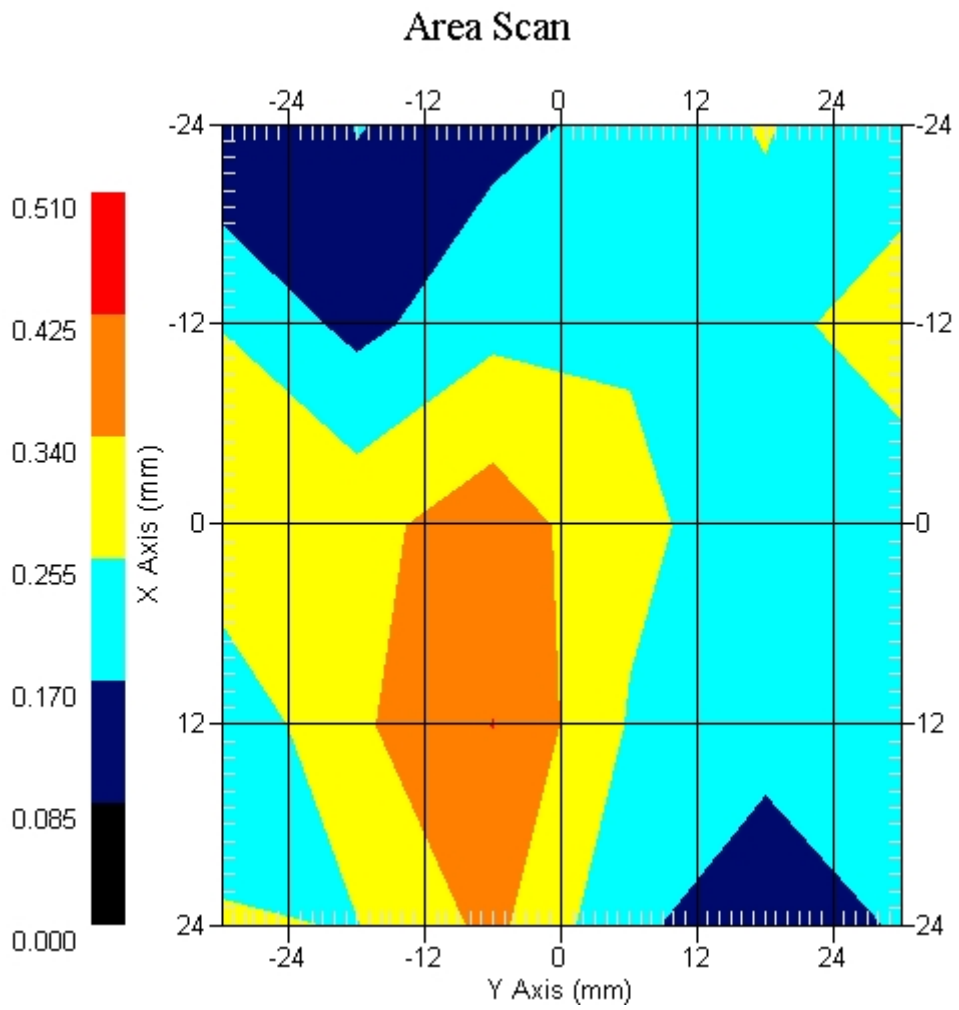

Measurement Data

Crest Factor : 1
Tissue Temp. : 21.50 °C
Ambient Temp. : 22.40 °C
Area Scan : 6x6x1 : Measurement x=12mm, y=12mm, z=4mm
Zoom Scan : 7x7x7 : Measurement x=5mm, y=5mm, z=5mm
Power Drift-Start : 0.589 W/kg
Power Drift-Finish: 0.578 W/kg
Power Drift (%) : -1.896

DUT Position : Touch EUT Back
Channel : 44

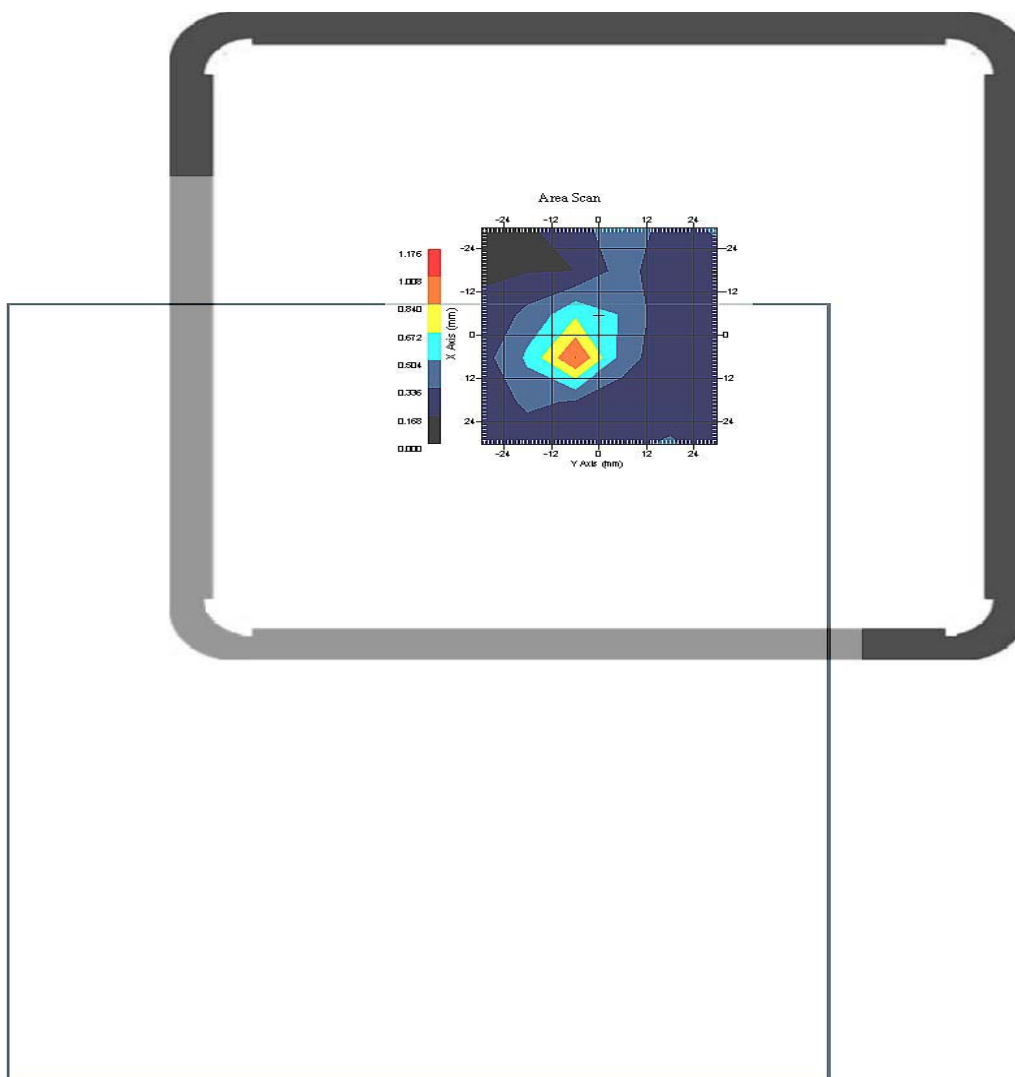

1 gram SAR value : 0.913 W/kg
10 gram SAR value : 0.470 W/kg
Area Scan Peak SAR : 1.009 W/kg
Zoom Scan Peak SAR : 2.231 W/kg

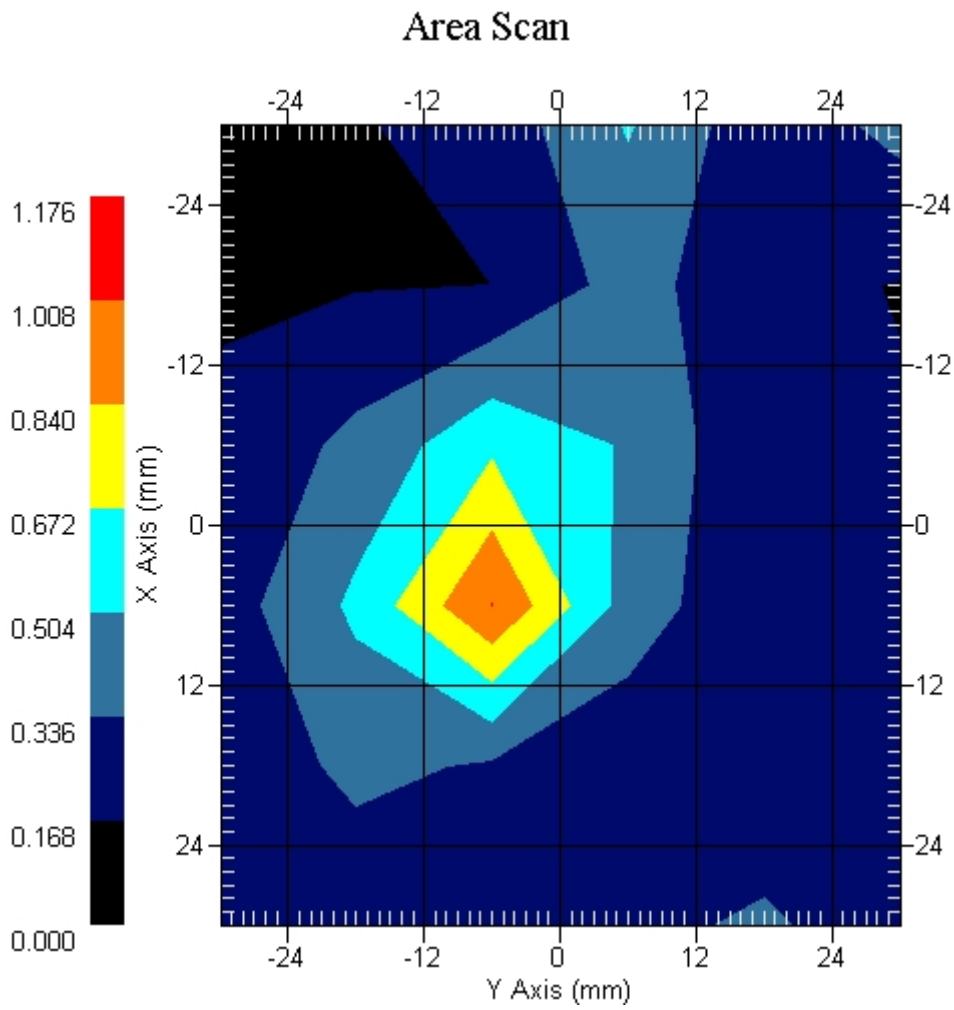

Measurement Data

Crest Factor : 1
Tissue Temp. : 21.50 °C
Ambient Temp. : 22.40 °C
Area Scan : 6x6x1 : Measurement x=12mm, y=12mm, z=4mm
Zoom Scan : 7x7x7 : Measurement x=5mm, y=5mm, z=5mm
Power Drift-Start : 0.557 W/kg
Power Drift-Finish: 0.574 W/kg
Power Drift (%) : 3.058

DUT Position : Touch EUT Back
Channel : 48

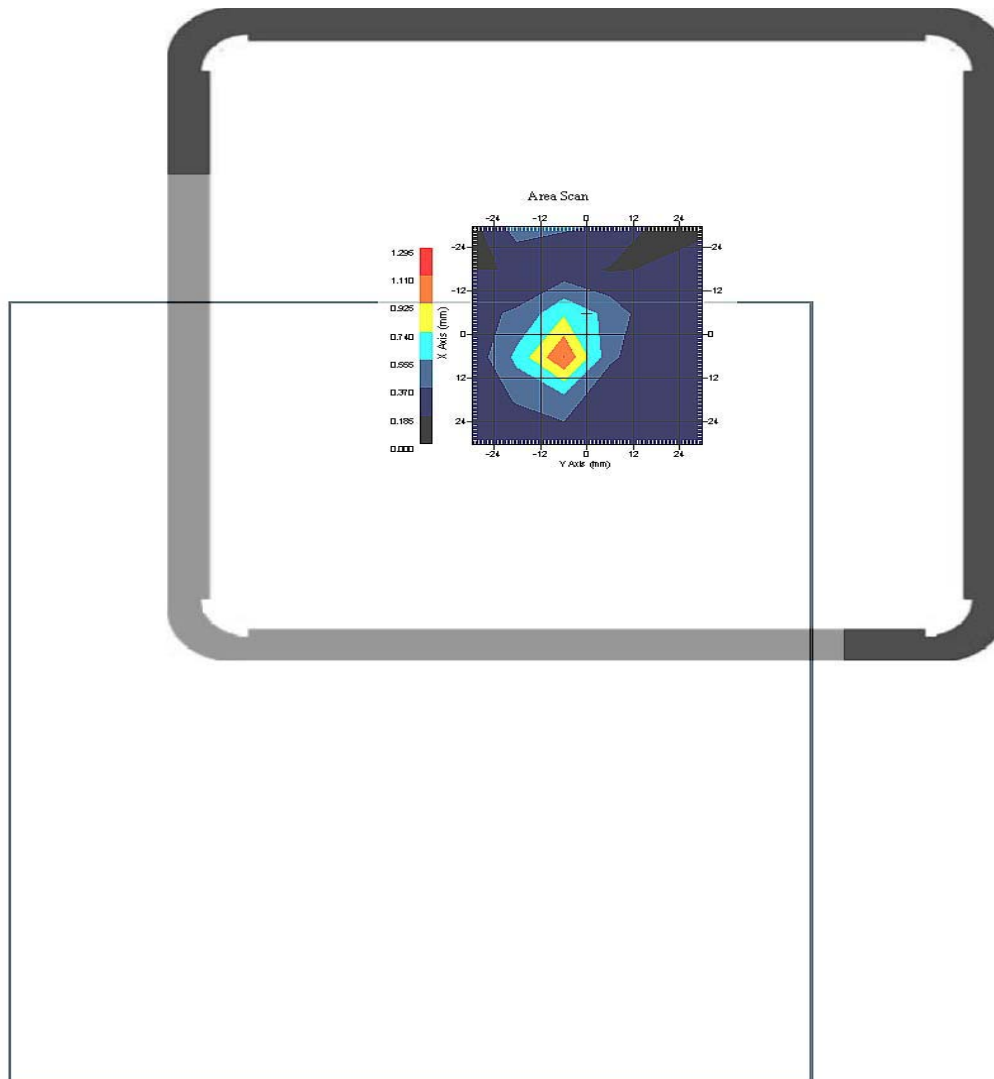

1 gram SAR value : 0.938 W/kg
10 gram SAR value : 0.506 W/kg
Area Scan Peak SAR : 1.112 W/kg
Zoom Scan Peak SAR : 1.941 W/kg

