

Eee PC User's Manual

Windows® XP Edition

Eee PC 1000 Series

Eee PC 904 Series

Eee PC 901 Series

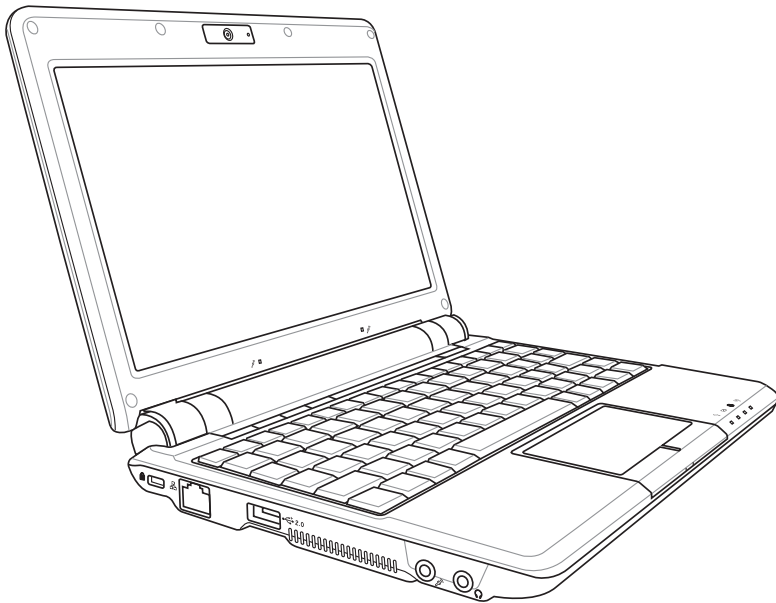

Table of Contents

Chapter 1: Introducing the Eee PC

About This User's Manual	1-2
Notes for This Manual	1-3
Safety Precautions	1-4
Transportation Precautions	1-5
Charging Your Batteries.....	1-5
Airplane Precautions	1-5
Preparing your Eee PC.....	1-6

Chapter 2: Knowing the Parts

Top Side	2-2
Bottom Side.....	2-6
Right Side	2-8
Left Side	2-10
Rear Side.....	2-11

Chapter 3: Getting Started

Power System	3-2
Using AC Power.....	3-2
Using Battery Power	3-3
Battery Care	3-4
Power Mode	3-4
Emergency Shutdown & Reset	3-5
Touchpad Usage.....	3-6
Single-finger gesture input.....	3-6
Multi-finger gesture input.....	3-7
Keyboard Usage.....	3-8
Special Function Keys	3-8
First-time Startup	3-13
Desktop.....	3-16
ASUS EeePC Tray Utility.....	3-17
Enabling and Disabling Devices.....	3-17
Adjusting the display resolution.....	3-18
Shutdown.....	3-19

Table of Contents

Chapter 4: Using the Eee PC

Network Connection.....	4-2
Configuring a wireless network connection.....	4-2
Configuring a network connection.....	4-4
Browsing web pages.....	4-10
ASUS Update.....	4-11
Updating the BIOS through the Internet.....	4-11
Updating the BIOS through a BIOS file.....	4-13
Bluetooth Connection(on selected models).....	4-14
ASUS Instant Key.....	4-16
Super Hybrid Engine.....	4-17
Super Hybrid Engine Modes.....	4-17
YOStore (on selected models).....	4-18
Video Conferencing.....	4-20

Chapter 5: Support DVD & System Recovery

Support DVD information.....	5-2
Running the support DVD.....	5-2
Drivers menu.....	5-2
Utilities menu.....	5-3
Contact.....	5-4
Other information.....	5-4
System Recovery.....	5-5
Using the Support DVD.....	5-5

Appendix

Declarations and Safety Statements.....	A-2
Copyright Information.....	A-12
Limitation of Liability.....	A-13
Service and Support.....	A-13

About This User's Manual

Notes for This Manual

Safety Precautions

Preparing Your Eee PC

1
**Introducing
the Eee PC**

About This User's Manual

You are reading the Eee PC User's Manual. This User's Manual provides information regarding the various components in the Eee PC and how to use them. The following are major sections of this User's Manual:

1. Introducing the Eee PC

Introduces the Eee PC and this User's Manual.

2. Knowing the Parts

Provides information on the Eee PC's components.

3. Getting Started

Provides information on getting started with the Eee PC.

4. Using the Eee PC

Provides information on using the Eee PC's utilities.

5. System Recovery

Gives you information on system recovery.

6. Installing Windows® XP

Gives you information on how to install Windows® XP on your Eee PC and the content of the support CD.

7. Appendix

Gives you safety statements.



There may be differences between your Eee PC and the drawings shown in this manual. Please accept your Eee PC as being correct.

Notes for This Manual

A few notes and warnings are used throughout this guide, allowing you to complete certain tasks safely and effectively. These notes have different degrees of importance as follows:



WARNING! Important information that must be followed for safe operation.



IMPORTANT! Vital information that must be followed to prevent damage to data, components, or persons.



TIP: Tips for completing tasks.



NOTE: Information for special situations.

Safety Precautions

The following safety precautions will increase the life of the Eee PC. Follow all precautions and instructions. Except as described in this manual, refer all servicing to qualified personnel. Do not use damaged power cords, accessories, or other peripherals. Do not use strong solvents such as thinners, benzene, or other chemicals on or near the surface.



Disconnect the AC power and remove the battery pack(s) before cleaning. Wipe the Eee PC using a clean cellulose sponge or chamois cloth dampened with a solution of nonabrasive detergent and a few drops of warm water and remove any extra moisture with a dry cloth.



DO NOT place on uneven or unstable work surfaces. Seek servicing if the casing has been damaged.



DO NOT place or drop objects on top and do not shove any foreign objects into the Eee PC.



DO NOT expose to dirty or dusty environments. DO NOT operate during a gas leak.



DO NOT expose to strong magnetic or electrical fields.



DO NOT press or touch the display panel. Do not place together with small items that may scratch or enter the Eee PC.



DO NOT expose to or use near liquids, rain, or moisture. DO NOT use the modem during electrical storms.



DO NOT leave the Eee PC on your lap or any part of the body to prevent discomfort or injury from heat exposure.



Battery safety warning: DO NOT throw the battery in fire. DO NOT short circuit the contacts. DO NOT disassemble the battery.



SAFE TEMP: This Eee PC should only be used in environments with ambient temperatures between 5°C (41°F) and 35°C (95°F)



INPUT RATING: Refer to the rating label on the bottom of the Eee PC and be sure that your power adapter complies with the rating.



DO NOT throw the Eee PC in municipal waste. Check local regulations for disposal of electronic products.



DO NOT carry or cover a Eee PC that is powered ON with any materials that will reduce air circulation such as a carrying bag.

Transportation Precautions

To prepare the Eee PC for transport, you should close the display panel to protect the keyboard and display panel.

The Eee PC's surface is easily dulled if not properly cared for. Be careful not to rub or scrape surfaces when transporting your Eee PC. You can put your Eee PC in a carrying case for protection from dirt, water, shock, and scratches.



For the model that comes with a hard disk drive, you should turn it OFF and **disconnect all external peripherals to prevent damage to the connectors** when you prepare for transport. The hard disk drive's head retracts when the power is turned OFF to prevent scratching of the hard disk surface during transport. Never transport it while the power is still ON.

Charging Your Batteries

If you intend to use battery power, be sure to fully charge your battery pack and any optional battery packs before going on long trips. Remember that the power adapter charges the battery pack as long as it is plugged into the computer and an AC power source. Be aware that it takes much longer to charge the battery pack when the Eee PC is in use.

Airplane Precautions

Contact your airline if you want to use the Eee PC on the airplane. Most airlines have restrictions for using electronic devices. Most airlines allow electronic use only between and not during takeoffs and landings.



There are three main types of airport security devices: X-ray machines (used on items placed on conveyor belts), magnetic detectors (used on people walking through security checks), and magnetic wands (hand-held devices used on people or individual items). You can send your Eee PC and diskettes through airport X-ray machines. However, it is recommended that you do not send your Eee PC or diskettes through airport magnetic detectors or expose them to magnetic wands.

Preparing your Eee PC

These are only quick instructions for using your Eee PC. Read the following chapters for detailed information.

1. Install the battery pack

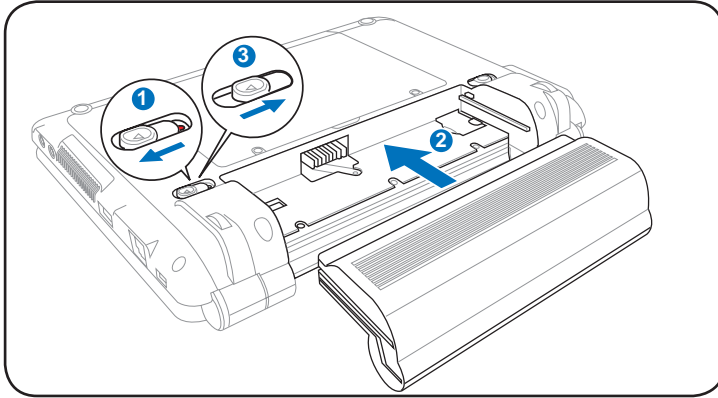

2. Connect the AC power adapter

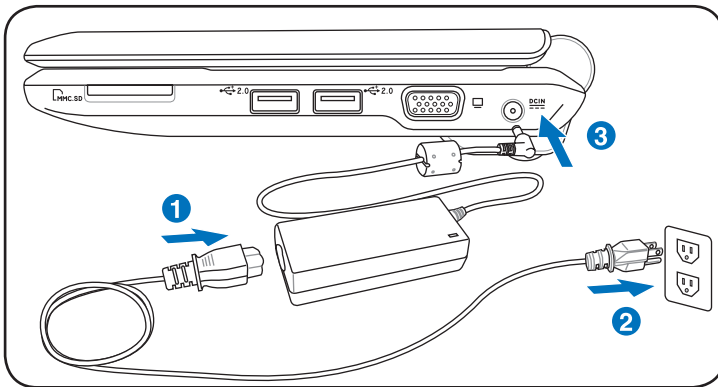

Your Eee PC may come with either a two or three-prong plug depending on territory. If a three-prong plug is provided, you must use a grounded AC outlet or use a properly grounded adapter to ensure safe operation of the Eee PC.

3. Open the display panel

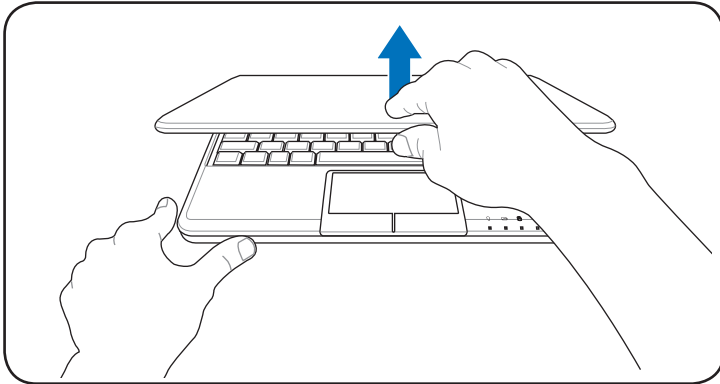

4. Turn ON the Eee PC

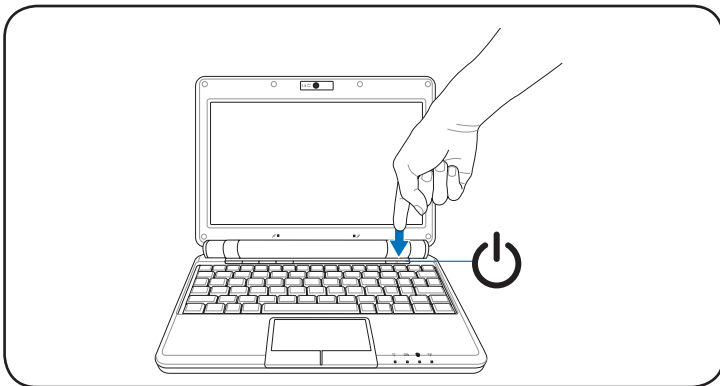

When you open the display panel, do not force it down to the table or else the hinges may break! Never lift the Eee PC by the display panel!

Top Side

Bottom Side

Right Side

Left Side

Rear Side

Knowing the Parts **2**

Top Side

Refer to the illustration below to identify the components on this side of the Eee PC.



The top side may vary in appearance depending on model.

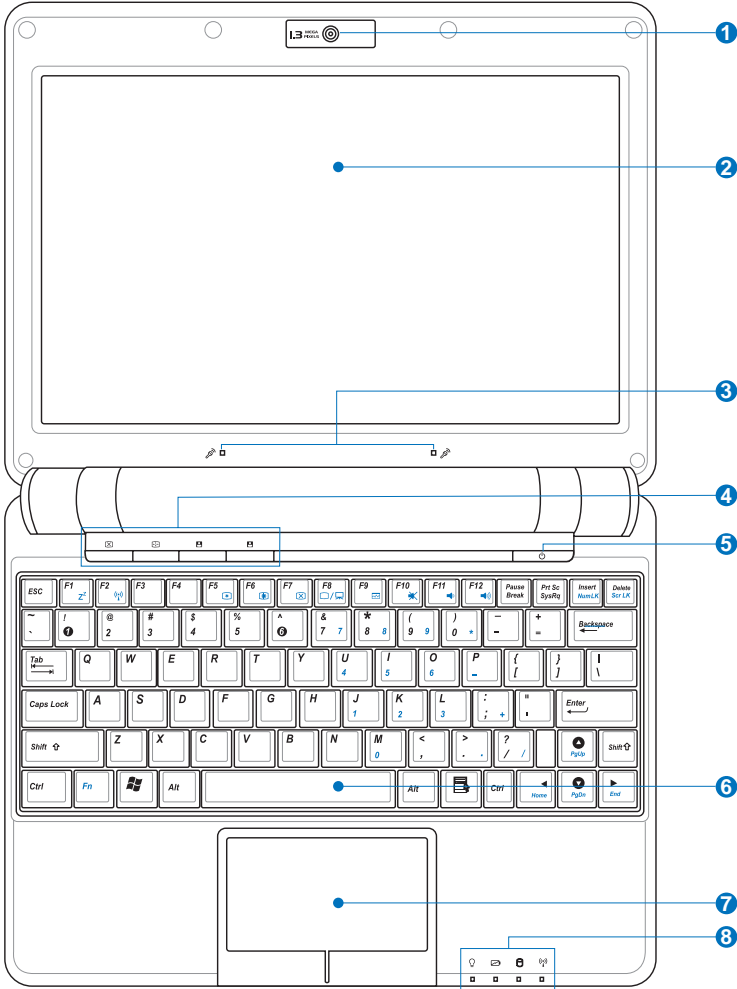

The keyboard differs for each territory.

1  **Built-in Camera**

The built-in camera allows picture taking or video recording.

2  **Display Panel**

The display panel functions the same as a desktop monitor. The Eee PC uses an active matrix TFT LCD, which provides excellent viewing like that of desktop monitors. Unlike desktop monitors, the LCD panel does not produce any radiation or flickering, so it is easier on the eyes. Use a soft cloth without chemical liquids (use plain water if necessary) to clean the display panel.

3  **Array Microphone (Built-in)**

The built-in array microphone is more clear and echo-free compared with traditional single microphones and can be used for video conferencing, voice narrations, audio recordings, and multimedia applications.

4  **Instant Keys**

Instant keys allow you to launch frequently used applications with one push of a button.

 **Backlight Key**

Pressing this key turns off the LCD monitor backlight. Any action on the keyboard, mouse or touchpad will activate monitor again.

 **Resolution Key**

The Resolution key allows you to adjust display resolution. Press this key repeatedly to switch resolution.

 **User-defined Key**

This key is reserved for customized definition. The default definition is for Super Hybrid Engine function.

User-defined Key

This key is reserved for customized definition. The default definition is for launching Skype.



Only models with built-in wireless LAN and Bluetooth support the user-defined key for Skype.

5 **Power Switch**

The power switch allows powering ON and OFF the Eee PC and recovering from STR. Press the switch once to turn ON and hold it to turn OFF the Eee PC. The power switch only works when the display panel is opened.

6 **Keyboard**

The keyboard provides keys with comfortable travel (depth at which the keys can be depressed) and palm rest for both hands.

7 **Touchpad and Buttons**

The touchpad and its buttons comprises a pointing device that provides the same functions as a desktop mouse. Multi-finger gesture input is available to allow easy web and document navigation.

8 **Status Indicators (front)**

Power Indicator

The power indicator lights when the Eee PC is turned ON and blinks slowly when the Eee PC is in the Save-to-RAM (Suspend) mode. This indicator is OFF when the Eee PC is turned OFF.

Battery Charge Indicator

The battery charge indicator (LED) shows the status of the battery's power as follows:

Powered ON

	AC Mode	Battery Mode
Battery charge is between 100%–80%	Orange ON	Green ON
Battery charge is between 80%–10%	Orange Blinking Slowly	Green Blinking Slowly
Battery charge is less than 10%	Orange Blinking Quickly	Green Blinking Quickly

Standby Mode / Powered OFF

	AC Mode	Battery Mode
Battery charge is between 100%–80%	Orange ON	Off
Battery charge is between 80%–10%	Orange Blinking Slowly	Off
Battery charge is less than 10%	Orange Blinking Quickly	Off



The Battery Charge Indicator will not light when the battery is removed from your Eee PC.

Solid-State disk (SSD)/Hard disk (HDD) Indicator

The solid-state disk drive/hard disk drive indicator blinks when data is written to or read from the disk drive.

Wireless/Bluetooth Indicator

This is only applicable on models with built-in wireless LAN/Bluetooth. When the built-in wireless LAN/Bluetooth is enabled, this indicator lights.

Bottom Side

Refer to the illustration below to identify the components on this side of the Eee PC.



The bottom side may vary in appearance depending on model.

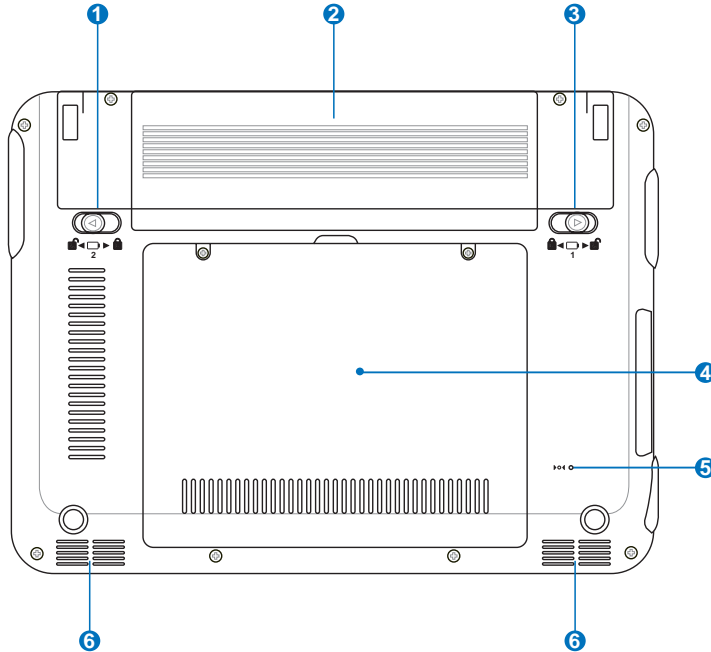

The bottom of the Eee PC can get very hot. Be careful when handling the Eee PC while it is in operation or recently been in operation. High temperatures are normal during charging or operation. DO NOT use on soft surfaces such as beds or sofas ,which may block the vents. DO NOT PUT THE Eee PC ON YOUR LAP OR OTHER PARTS OF THE BODY TO AVOID INJURY FROM THE HEAT.

1 Battery Lock - Spring

The spring battery lock keeps the battery pack secure. When the battery pack is inserted, it will automatically lock. When removing the battery pack, this spring lock must be retained in the unlocked position.

2 **Battery Pack**

The battery pack is automatically charged when connected to an AC power source and maintains power to the Eee PC when AC power is not connected. This allows use when moving temporarily between locations. Battery time varies by usage and by the specifications for this Eee PC. The battery pack cannot be disassembled and must be purchased as a single unit.

3 **Battery Lock - Manual**

The manual battery lock is used to keep the battery pack secured. Move the manual lock to the unlocked position to insert or remove the battery pack. Move the manual lock to the locked position after inserting the battery pack.

4 **Solid-State Disk/Hard disk drive & Memory Compartment**

The solid-state disk drive/ hard disk drive and memory are secured in a dedicated compartment.

5 **Reset Button (Emergency)**

In case your operating system cannot properly turn OFF or restart, the reset button can be depressed with a pin or a straightened paper clip to restart the Eee PC.



The reset button is available on selected models.

6 **Audio Speaker System**

The built-in stereo speaker system allows you to hear audio without additional attachments. The multimedia sound system features an integrated digital audio controller that produces rich, vibrant sound (results improved with external stereo headphones or speakers). Audio features are software controlled.

Right Side

Refer to the illustration below to identify the components on this side of the Eee PC.

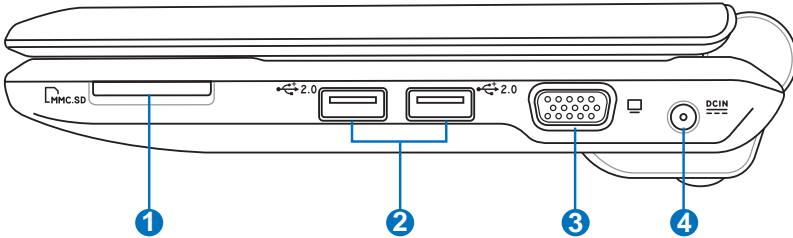

1 Memory Card Slot

The built-in memory card reader can read MMC/SD cards from devices such as digital cameras, MP3 players, mobile phones, and PDAs.

2 USB Port (2.0/1.1)

The USB (Universal Serial Bus) port is compatible with USB 2.0 or USB 1.1 devices such as keyboards, pointing devices, cameras, and storage devices, connected in a series up to 12Mbits/sec (USB 1.1) and 480Mbits/sec (USB 2.0). USB allows many devices to run simultaneously on a single computer, with some peripherals acting as additional plug-in sites or hubs. Also, the USB supports hot-swapping function.

3 Display (Monitor) Output

The 15-pin D-sub monitor port supports a standard VGA-compatible device such as a monitor or projector to allow viewing on a larger external display.

4 **Power (DC) Input**

The supplied power adapter converts AC power to DC power for use with this jack. Power supplied through this jack supplies power to the Eee PC and charges the internal battery pack. To prevent damage to the Eee PC and battery pack, always use the supplied power adapter.



CAUTION: MAY BECOME WARM TO HOT WHEN IN USE. BE SURE NOT TO COVER THE ADAPTER AND KEEP IT AWAY FROM YOUR BODY.

Left Side

Refer to the illustration below to identify the components on this side of the Eee PC.

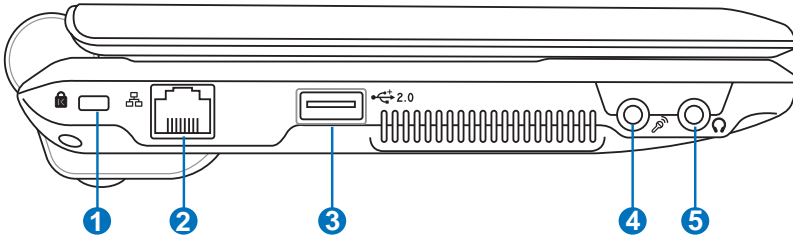

1 Kensington® Lock Port

The Kensington® lock port allows the Eee PC to be secured using Kensington® compatible security products. These security products usually include a metal cable and lock that prevent the Eee PC to be removed from a fixed object.

2 LAN Port

The eight-pin RJ-45 LAN port (10/100M bit) supports a standard Ethernet cable for connection to a local network. The built-in connector allows convenient use without additional adapters.

3 USB Port (2.0/1.1)

The USB (Universal Serial Bus) port is compatible with USB 2.0 or USB 1.1 devices such as keyboards, pointing devices, cameras, and storage devices, connected in a series up to 12Mbits/sec (USB 1.1) and 480Mbits/sec (USB 2.0). USB allows many devices to run simultaneously on a single computer, with some peripherals acting as additional plug-in sites or hubs. Also, it supports hot-swapping function.

4 Microphone Jack

The microphone jack is designed to connect the microphone used for Skype, voice narrations, or simple audio recordings.

5 🎧 Headphone Output Jack

The 1/8" stereo headphone jack (3.55mm) connects the Eee PC's audio out signal to amplified speakers or headphones. Using this jack automatically disables the built-in speakers.

Rear Side

Refer to the illustration below to identify the components on this side of the Eee PC.

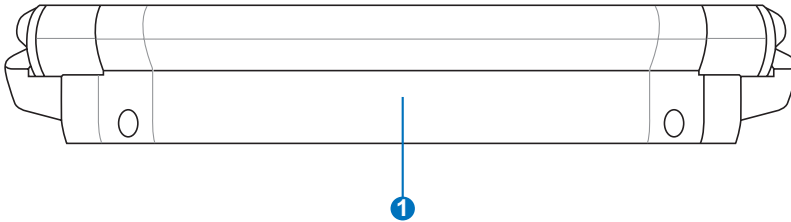

1 🔋 Battery Pack

The battery pack is automatically charged when connected to an AC power source and maintains power to the Eee PC when AC power is not connected. This allows use when moving temporarily between locations. Battery time varies by usage and by the specifications for this Eee PC. The battery pack cannot be disassembled and must be purchased as a single unit.

Power System

Touchpad Usage

Keyboard Usage

First Run Wizard

Operating Mode

Shutdown

Getting Started **3**

Power System

Using AC Power

The Eee PC power comprises two parts, the power adapter and the battery power system. The power adapter converts AC power from a wall outlet to the DC power required by the Eee PC. Your Eee PC comes with a universal AC-DC adapter for connection to any 100V-120V as well as 220V-240V outlets without setting switches or using power converters. Different countries may require an adapter to connect the provided US-standard AC power cord to a different standard. Most hotels will provide universal outlets to support different power cords as well as voltages. It is always best to ask an experienced traveler about AC outlet voltages before travelling.

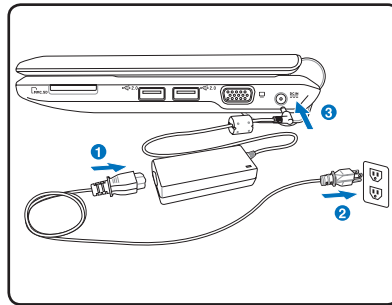

With the AC power cord connected to the AC-DC converter, connect the AC power cord to an AC outlet (preferably with surge-protection) and then connect the DC plug to the Eee PC. Connecting the AC-DC adapter to the AC outlet first allows you to test the AC outlet's power and the AC-DC converter itself for compatibility problems before connecting the DC power to the Eee PC. The power indicator on the adapter (if available) will light if the power is within accepted ranges.



THE POWER ADAPTER MAY BECOME WARM TO HOT WHEN IN USE. BE SURE NOT TO COVER THE ADAPTER AND KEEP IT AWAY FROM YOUR BODY.



This Eee PC may come with either a two or three-prong plug depending on territory to fit your wall outlet. If a three-prong plug is provided, you must use a grounded AC outlet or use a properly grounded adapter to ensure safe operation of the Eee PC.



Damage may occur if you use a different adapter to power the Eee PC or use the Eee PC's adapter to power other electrical devices. If there is smoke, burning scent, or extreme heat coming from the AC-DC adapter, seek servicing. Seek servicing if you suspect a faulty AC-DC adapter. You may damage both your battery pack(s) and the Eee PC with a faulty AC-DC adapter.

Using Battery Power

The Eee PC is designed to work with a removable battery pack. The battery pack consists of a set of battery cells housed together. A fully charged pack will provide several hours of battery life. Additional battery packs are optional and can be purchased separately through an Eee PC retailer.



Remember to fully charge the battery before first use and whenever it is depleted to prolong battery life. The battery reaches its maximum capacity after a few charging and discharging cycles.

Installing and Removing the Battery Pack

Your Eee PC may not have its battery pack installed. If not, use the following procedures to install the battery pack.



Never attempt to remove the battery pack while the Eee PC is turned ON, as this may result in the loss of working data.

To install the battery pack:

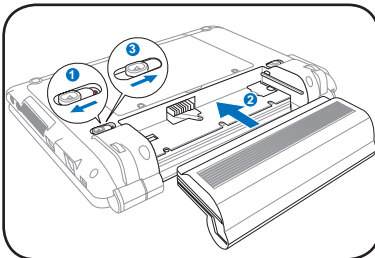

To remove the battery pack:

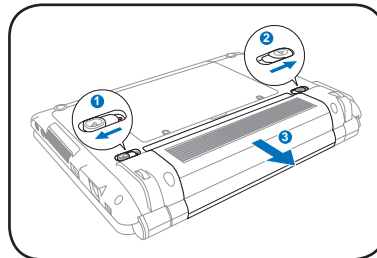

Only use battery packs and power adapters supplied with this Eee PC or specifically approved by the manufacturer or retailer for use with this model or else damage may occur to the Eee PC.

Battery Care

The Eee PC's battery pack, like all rechargeable batteries, has a limit on the number times it can be recharged. The battery pack's useful life will depend on your environment temperature, humidity, and how your Eee PC is used. It is ideal that the battery be used in a temperature range between 5°C and 35°C (41°F and 95°F). You must also take into account that the Eee PC's internal temperature is higher than the outside temperature. Any temperatures above or below this range will shorten the life of the battery. But in any case, the battery pack's usage time will eventually decrease and a new battery pack must be purchased from an authorized dealer for this Eee PC. Because batteries also have a shelf life, it is not recommended to buy extras for storing.



For safety reasons, **DO NOT** throw the battery in fire, **DO NOT** short circuit the contacts, and **DO NOT** disassemble the battery. If there is any abnormal operation or damage to the battery pack caused by impact, turn **OFF** the Eee PC and contact an authorized service center.



Power Mode

Your Eee PC is equipped with a smart power system. The power-saving Battery mode lowers down the CPU frequency and decreases the power consumption to maximize the battery life. The AC mode enables the CPU to run at the full speed and to obtain the best performance. When applying or removing the power adapter, the AC mode and Battery mode will be shown on the display as a reminder.



Battery Mode



AC Mode

Emergency Shutdown & Reset

In case your operating system cannot properly turn OFF or restart, there are additional ways to shutdown and reset your Eee PC:

Shutdown: Hold the power button  until the system shuts down.

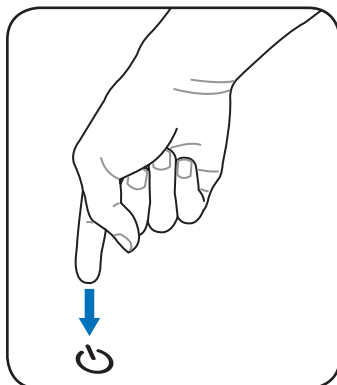

Reset: Press the reset button .

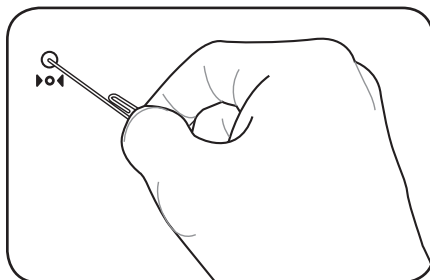

Use a pin or a straightened paper clip to press the reset button.



DO NOT use emergency shutdown/reset while data is being written or read; doing so can result in loss or destruction of your data.



The reset button is available on selected models.

Touchpad Usage

Single-finger gesture input

Clicking/Tapping - With the pointer over an item, press the left button or use your fingertip to touch the touchpad lightly, keeping your finger on the touchpad until the item is selected. The selected item will change color. The following 2 illustrations produce the same results.

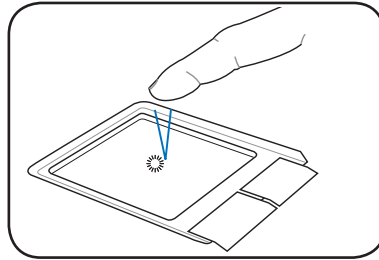
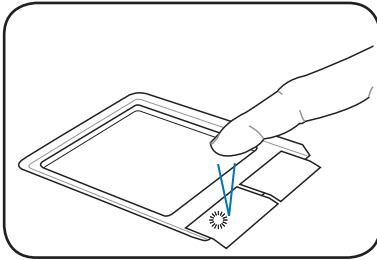

Double-clicking/Double-tapping - This is a common skill for launching a program directly from the corresponding icon you select. Move the pointer over the icon you wish to execute, press the left button or tap the pad twice in rapid succession, and the system launches the corresponding program. If the interval between the clicks or taps is too long, the operation will not be executed. The following 2 illustrations produce the same results.

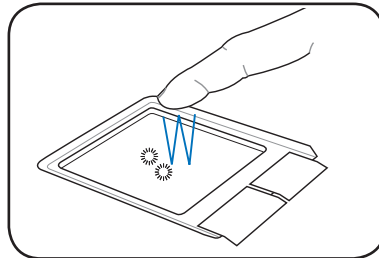
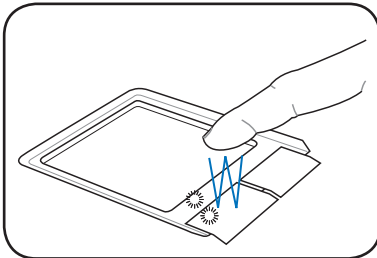

Dragging - Dragging means to pick up an item and place it anywhere on the screen you wish. You can move the pointer over the item you select, and while keeping the left button depressed, moving the pointer to the desired location, then release the button. Or, you can simply double-tap on the item and hold while dragging the item with your fingertip. The following illustrations produce the same results.

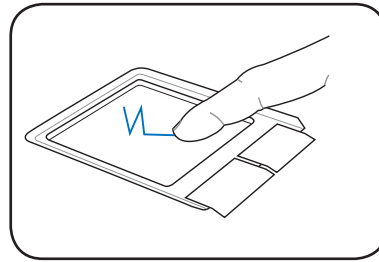
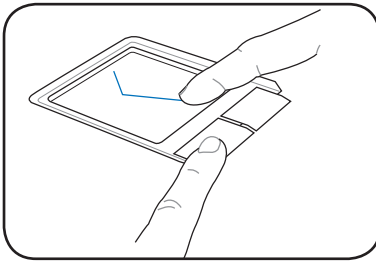

Multi-finger gesture input

Two-finger scrolling - Use two fingertips to slide up or down on the touchpad to scroll a window up or down. If your display window includes several sub-windows, move the pointer on that pane before scrolling.

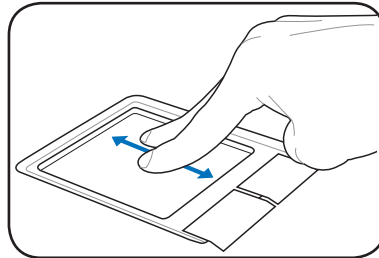

Keyboard Usage

Special Function Keys

The following defines the colored hot keys on the Eee PC's keyboard. The colored commands can only be accessed by first pressing and holding the function key while pressing a key with a colored command. Some function icons appear in the Notification area after activation.



The Hot Key locations on the function keys may vary depending on model but the functions should remain the same. Follow the icons whenever your hot key locations do not match the manual.

A.



zzZ Icon (F1): Places the Eee PC in suspend mode (Save-to-RAM).



Radio Tower (F2): Wireless Models Only: Toggles the internal wireless LAN or Bluetooth (on selected models) ON or OFF with an on-screen-display. When enabled, the corresponding wireless indicator will light.



The default setting is WLAN ON / Bluetooth OFF.



Sun Down Icon (F5): Decreases the display brightness.



Sun Up Icon (F6): Increases the display brightness.



Crossed Screen Icon (F7): Turns off the display backlight.



LCD/Monitor Icons (F8): Toggles between the Eee PC's LCD display and an external monitor in this series: LCD Only -> CRT Only (External Monitor) -> LCD + CRT Clone -> LCD + CRT Extend.



LCD + CRT Clone mode only supports a maximum resolution of 1024 x 600 pixels.



Set your Eee PC to **High Performance** or **Super Performance** mode if you want to use a higher resolution with a connected external monitor.



Connect an external monitor before booting up the Eee PC.



Task Manager Icon (F9): Initiates the Task Manager to view the application process or terminates applications.



Crossed Speaker Icon (F10): Mutes the speaker.



Volume Down Icon (F11): Decreases speaker volume.



Volume Up Icon (F12): Increases the speaker volume.



Num Lk (Insert): Toggles the numeric keypad (number lock) ON and OFF. Allows use of a larger portion of the keyboard for number entering.



Scr Lk (Delete): Toggles the "Scroll Lock" ON and OFF. Allows you to use a larger portion of the keyboard for cell navigation.



Pg Up (↑): Press to scroll up in documents or the web browser.



Pg Dn (↓): Press to scroll down in documents or the web browser.



Home (←): Press to move the pointer to the beginning of the line.



End (→): Press to move the pointer to the end of the line.



Windows icon: Displays the start menu.



Menu with pointer icon : Activates the properties menu and is equivalent to right-clicking the touchpad/mouse on an object.

B.



zzZ Icon (F1): Places the Eee PC in suspend mode (Save-to-RAM).



Radio Tower (F2): Wireless Models Only: Toggles the internal wireless LAN or Bluetooth (on selected models) ON or OFF with an on-screen-display. When enabled, the corresponding wireless indicator will light.



The default setting is WLAN ON / Bluetooth OFF.



Sun Down Icon (F5): Decreases the display brightness.



Sun Up Icon (F6): Increases the display brightness.



Crossed Screen Icon (F7): Turns off the display backlight.



LCD/Monitor Icons (F8): Toggles between the Eee PC's LCD display and an external monitor in this series: LCD Only -> CRT Only (External Monitor) -> LCD + CRT Clone -> LCD + CRT Extend.



LCD + CRT Clone mode only supports a maximum resolution of 1024 x 600 pixels.



Set your Eee PC to **High Performance** or **Super Performance** mode if you want to use a higher resolution with a connected external monitor.



Connect an external monitor before booting up the Eee PC.



Task Manager Icon (F9): Initiates the Task Manager to view the application process or terminates applications.



Crossed Speaker Icon (F10): Mutes the speaker.



Volume Down Icon (F11): Decreases speaker volume.



Volume Up Icon (F12): Increases the speaker volume.



Num Lk (Insert): Toggles the numeric keypad (number lock) ON and OFF. Allows use of a larger portion of the keyboard for number entering.



Scr Lk (Delete): Toggles the “Scroll Lock” ON and OFF. Allows you to use a larger portion of the keyboard for cell navigation.



Pg Up (↑): Press to scroll up in documents or the web browser.



Pg Dn (↓): Press to scroll down in documents or the web browser.



Home (←): Press to move the pointer to the beginning of the line.



End (→): Press to move the pointer to the end of the line.



Windows icon: Displays the start menu.



Menu with pointer icon : Activates the properties menu and is equivalent to right-clicking the touchpad/mouse on an object.

First-time Startup

For the first time you start your Eee PC, the Windows wizard will launch automatically and lead you through setting up your preferences and some basic information.

Follow the wizard instructions to finish the initialization:

1. The **Welcome** message appears. Click **Next** to continue.



2. Select your system settings by specifying the region you are in, the language you use and the keyboard type you use. Click **Next** to continue.

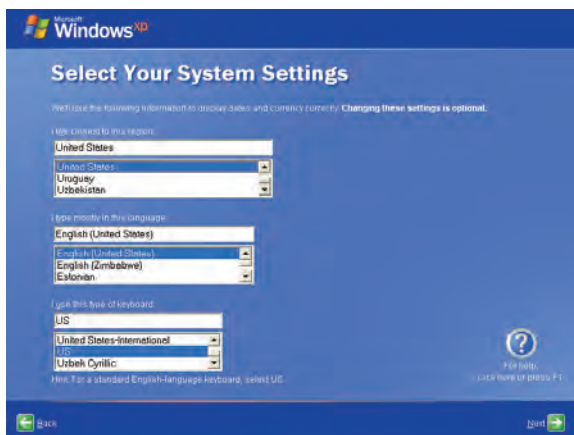

- 3 Select the time zone you are in and click **Next** to continue.

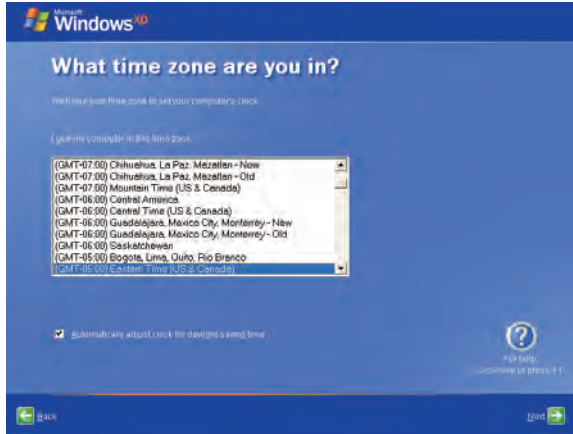

- 4 Read the end user license agreement and click **Yes, I accept**. Click **Next** to continue.



5. Click **Help protect my PC by turning on Automatic Updates now** to get the latest important updates and click **Next** to continue.



6. Type your computer's name in the **Computer name** box and click **Next** to continue.



7. Follow the on-screen instructions to register with Microsoft and finish the initialization.

Desktop

There are several shortcuts on the desktop. Double-click them to launch the corresponding applications and enter the specified folders. Some applications would form minimized icons in the Notification area.

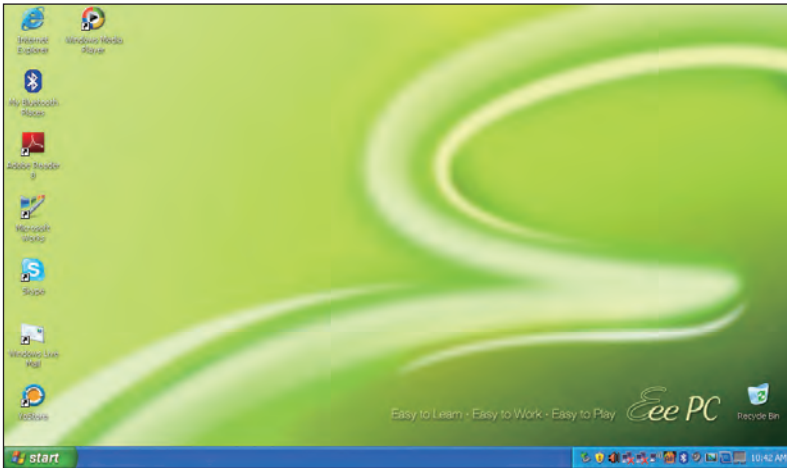

ASUS EeePC Tray Utility

The preloaded ASUS EeePC Tray utility allows you to turn off some devices to minimize the power consumption and helps you adjust the display resolution easily.

Enabling and Disabling Devices

To disable or enable devices

1. Right-click the ASUS EeePC Tray Utility icon in the Notification area and the utility shows the available options:
 - Disable WLAN:** Turns on and off the wireless LAN connection.
 - Disable Blue Tooth:** Turns on and off the Bluetooth connection.
 - Disable Camera:** Enable or disable the built-in camera.

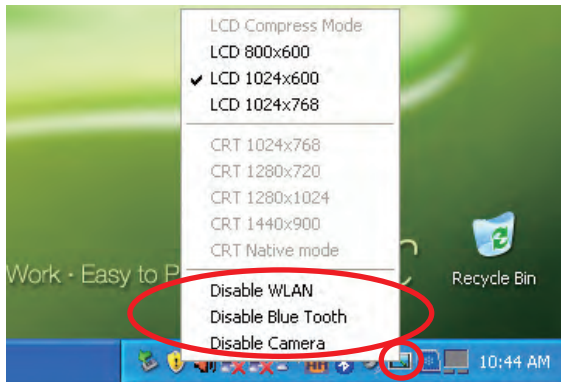

2. Select an option to turn it on or off based on your needs. The unavailable options are dimmed.



Bluetooth is available on selected models.

Adjusting the display resolution

Click the ASUS EeePC Tray Utility icon in the Notification area to adjust the display resolution. Select the resolution based on your needs.

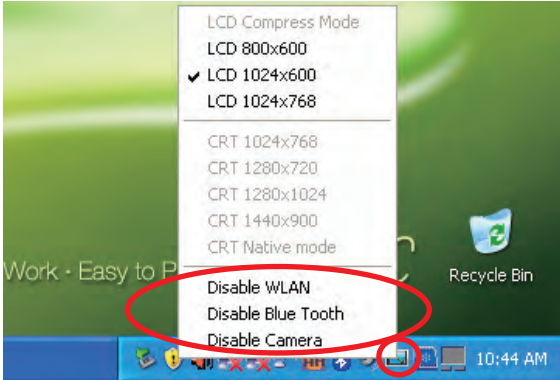

The CRT-related options are unavailable when there is no connected external monitors.

When you select **LCD 1024 x 768**, move the pointer to scroll up and down the screen.



Scroll up to see the top of the screen..

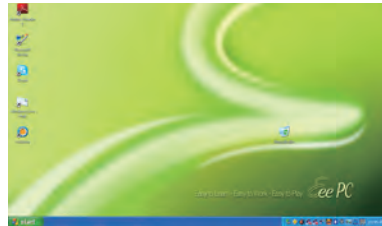

Scroll down to see the bottom of the screen.



You need not scroll up and down the screen when you select **LCD Compress Mode**.



When the display mode of your Eee PC is **CRT Only** and the power mode is **Power Saving**, DO NOT use a resolution higher than 1024 x 600 pixels. Doing so would make the connected external monitor function abnormally.

Shutdown

Do the following instructions to turn down your Eee PC.

1. Click the **start** button to display the start menu.
2. Click **Turn Off Computer**.



3. Select **Turn Off** to power off your Eee PC.

