

SAR Test Report

Product Name : Eee PC

Model No. : Eee PC 1018PB

Applicant : ASUSTEK COMPUTER INC.

Address : No.150, Li-Te Rd., Peitou, Taipei, Taiwan, R.O.C

Date of Receipt : 2010/04/22

Issued Date : 2010/04/30

Report No. : 104393R-HPUSP09V01

Report Version : V1.0

The test results relate only to the samples tested.

The test report shall not be reproduced except in full without the written approval of QuieTek Corporation.

Test Report Certification

Issued Date: 2010/04/30

Report No.:104393R-HPUSP09V01



Product Name : Eee PC
 Applicant : ASUSTEK COMPUTER INC.
 Address : No.150, Li-Te Rd., Peitou, Taipei, Taiwan, R.O.C
 Manufacturer : 1. PEGATRON CORP TAOYUAN MFG
 2. PROTEK(SHANGHAI)LTD
 3. FULIN ELECTRONICAL TECHONOLOGY (CHANGSHU) CO LTD
 4. FUXIANG PRECISION INDUSTRIAL (KUNSHAN) CO LTD
 Model No. : Eee PC 1018PB
 Trade Name : ASUS
 FCC ID : MSQE18NE785H
 IC ID : 3568A-E18NE785H
 Applicable Standard : FCC Oet65 Supplement C June 2001
 IEEE Std. 1528-2003
 47CFR § 2.1093
 Test Result : Max. SAR Measurement (1g)
0.088 W/kg
 Application Type : Certification

The test results relate only to the samples tested.

The test report shall not be reproduced except in full without the written approval of Quietek Corporation.

Documented By : Anny Chou
 (Adm. Assistant / Anny Chou)

Tested By : Jung Chang
 (Engineer / Jung Chang)

Approved By : Vincent Lin
 (Manager / Vincent Lin)

TABLE OF CONTENTS

Description	Page
1. General Information.....	5
1.1 EUT Description	5
1.2 Antenna List	5
1.3 Test Environment	6
2. SAR Measurement System.....	7
2.1 DASY5 System Description	7
2.1.1 Applications	8
2.1.2 Area Scans.....	8
2.1.3 Zoom Scan (Cube Scan Averaging).....	8
2.1.4 Uncertainty of Inter-/Extrapolation and Averaging	8
2.2 DASY5 E-Field Probe	9
2.2.1 Isotropic E-Field Probe Specification	9
2.3 Boundary Detection Unit and Probe Mounting Device	10
2.4 DATA Acquisition Electronics (DAE) and Measurement Server	10
2.5 Robot.....	11
2.6 Light Beam Unit.....	11
2.7 Device Holder	12
2.8 SAM Twin Phantom	12
3. Tissue Simulating Liquid	13
3.1 The composition of the tissue simulating liquid	13
3.2 Tissue Calibration Result	13
3.3 Tissue Dielectric Parameters for Head and Body Phantoms	14
4. SAR Measurement Procedure.....	15
4.1 SAR System Validation.....	15
4.1.1 Validation Dipoles.....	15
4.1.2 Validation Result	15
4.2 SAR Measurement Procedure.....	16
5. SAR Exposure Limits	17
6. Test Equipment List.....	18
7. Measurement Uncertainty.....	19
8. Peak Conducted Power Measurement	20
9. Test Results.....	21
9.1 SAR Test Results Summary	21

Appendix..... 22

Appendix A. SAR System Validation Data

Appendix B. SAR measurement Data

Appendix C. Test Setup Photographs & EUT Photographs

Appendix D. Probe Calibration Data

Appendix E. Dipole Calibration Data

1. General Information

1.1 EUT Description

Product Name	Eee PC
Trade Name	ASUS
Model No.	Eee PC 1018PB
FCC ID	MSQE18NE785H
IC ID	3568A-E18NE785H
TX Frequency	2412MHz ~ 2462MHz
WLAN Module	MFR : AZWAVE , M/N: AW-NE785H
Antenna Type	PIFA
Number of Channel	11
Type of Modulation	DSSS/OFDM
Device Category	Portable
RF Exposure Environment	Uncontrolled
Max. Output Power (Conducted)	802.11b: 19.05 dBm 802.11g: 21.55 dBm

NOTE: The EUT is including two models for different marketing requirement and capacity.

1.2 Antenna List

No.	Manufacturer	Part No.	Peak Gain
1	ACON	APP6P-700415(MAIN) APP6P-700416(AUX)	2.12 dBi for 2.4 GHz
2	YAGEO	CAN43130WIAS01651(MAIN) CAN43130WIAS01652(AUX)	1.92 dBi for 2.4 GHz

NOTE: Only the higher gain antenna was tested and recorded in this report.

1.3 Test Environment

Ambient conditions in the laboratory:

Items	Required	Actual
Temperature (°C)	18-25	21.3± 2
Humidity (%RH)	30-70	56

Site Description:

Accredited by TAF
 Accredited Number: 0914
 Effective through: December 12, 2011



Site Name: Quietek Corporation

Site Address: No. 5-22, Ruei-Shu Valley, Ruei-Ping Tsuen,
 Lin-Kou Shiang, Taipei,
 Taiwan, R.O.C.
 TEL : 886-2-8601-3788 / FAX : 886-2-8601-3789
 E-Mail : service@quietek.com

2. SAR Measurement System

2.1 DASY5 System Description

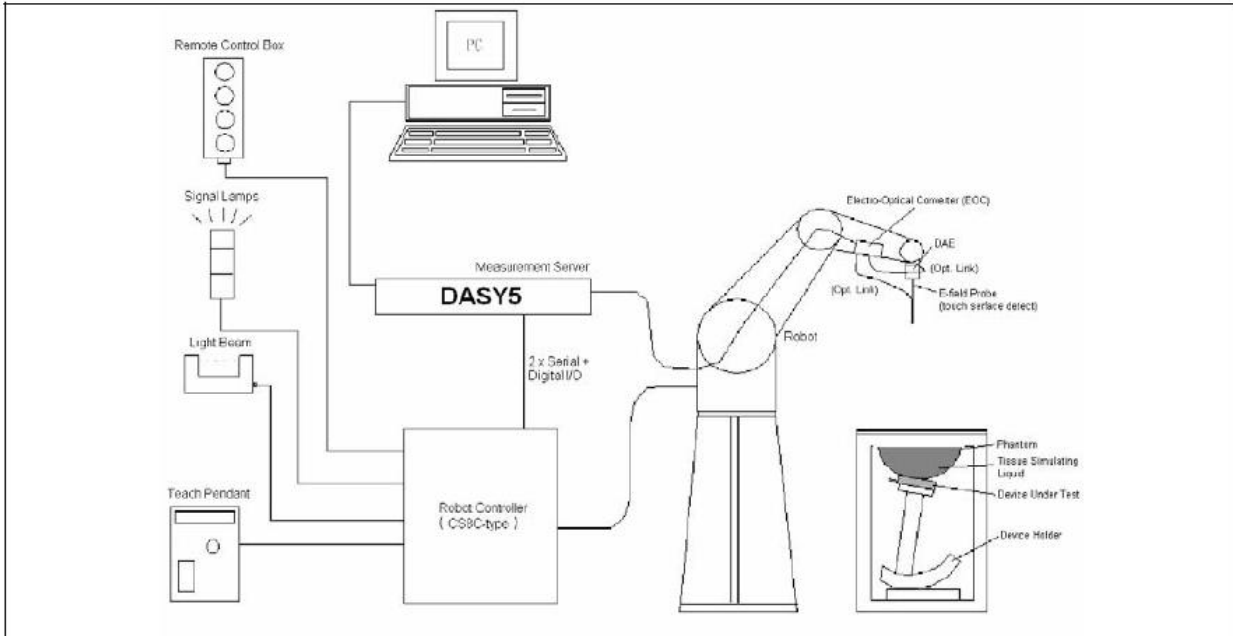

The DASY5 system for performing compliance tests consists of the following items:

- A standard high precision 6-axis robot with controller, teach pendant and software. An arm extension for accommodating the data acquisition electronics (DAE).
- A data acquisition electronics (DAE) which performs the signal amplification, signal multiplexing, AD-conversion, offset measurements, mechanical surface detection, collision detection, etc. The unit is battery powered with standard or rechargeable batteries. The signal is optically transmitted to the EOC.
- The Electro-optical converter (EOC) performs the conversion from optical to electrical signals for the digital communication to the DAE. To use optical surface detection, a special version of the EOC is required. The EOC signal is transmitted to the measurement server.
- The Light Beam used is for probe alignment. This improves the (absolute) accuracy of the probe positioning.
- A computer running WinXP and the DASY5 software.
- Remote control and teach pendant as well as additional circuitry for robot safety such as warning lamps, etc.
- The phantom, the device holder and other accessories according to the targeted measurement.

2.1.1 Applications

Predefined procedures and evaluations for automated compliance testing with all worldwide standards, e.g., IEEE 1528, OET 65, IEC 62209-1, IEC 62209-2, EN 50360, EN 50383 and others.

2.1.2 Area Scans

Area scans are defined prior to the measurement process being executed with a user defined variable spacing between each measurement point (integral) allowing low uncertainty measurements to be conducted. Scans defined for FCC applications utilize a 10mm² step integral, with 1mm interpolation used to locate the peak SAR area used for zoom scan assessments.

When an Area Scan has measured all reachable points, it computes the field maxima found in the scanned area, within a range of the global maximum. The range (in dB) is specified in the standards for compliance testing. For example, a 2 dB range is required in IEEE 1528-2003, EN 50361 and IEC 62209 standards, whereby 3 dB is a requirement when compliance is assessed in accordance with the ARIB standard (Japan).

2.1.3 Zoom Scan (Cube Scan Averaging)

Zoom Scans are used to assess the peak spatial SAR values within a cubic averaging volume containing 1 g and 10 g of simulated tissue. A density of 1000 kg/m³ is used to represent the head and body tissue density and not the phantom liquid density, in order to be consistent with the definition of the liquid dielectric properties, i.e. the side length of the 1 g cube is 10mm, with the side length of the 10 g cube 21,5mm.

The zoom scan integer steps can be user defined so as to reduce uncertainty, but normal practice for typical test applications utilize a physical step of 7x7x7 (5mmx5mmx5mm) providing a volume of 30mm in the X & Y axis, and 30mm in the Z axis.

2.1.4 Uncertainty of Inter-/Extrapolation and Averaging

In order to evaluate the uncertainty of the interpolation, extrapolation and averaged SAR calculation algorithms of the Postprocessor, DASY5 allows the generation of measurement grids which are artificially predefined by analytically based test functions. Therefore, the grids of area scans and zoom scans can be filled with uncertainty test data, according to the SAR benchmark functions of IEEE 1528. The three analytical functions shown in equations as below are used to describe the possible range of the expected SAR distributions for the tested handsets. The field gradients are covered by the spatially flat

distribution f1, the spatially steep distribution f3 and f2 accounts for H-field cancellation on the phantom/tissue surface.

$$f_1(x, y, z) = Ae^{-\frac{z}{2a}} \cos^2 \left(\frac{\pi \sqrt{x'^2 + y'^2}}{5a} \right)$$

$$f_2(x, y, z) = Ae^{-\frac{z}{a}} \frac{a^2}{a^2 + x'^2} \left(3 - e^{-\frac{2z}{a}} \right) \cos^2 \left(\frac{\pi y'}{2 \cdot 3a} \right)$$

$$f_3(x, y, z) = A \frac{a^2}{\frac{a^2}{4} + x'^2 + y'^2} \left(e^{-\frac{2z}{a}} + \frac{a^2}{2(a + 2z)^2} \right)$$

2.2 DASY5 E-Field Probe

The SAR measurement is conducted with the dosimetric probe manufactured by SPEAG. The probe is specially designed and calibrated for use in liquid with high permittivity. The dosimetric probe has special calibration in liquid at different frequency. SPEAG conducts the probe calibration in compliance with international and national standards (e.g. IEEE 1528, EN 62209-1, IEC 62209, etc.) under ISO 17025. The calibration data are in Appendix D.

2.2.1 Isotropic E-Field Probe Specification

Model	Ex3DV4	
Construction	Symmetrical design with triangular core Built-in shielding against static charges PEEK enclosure material (resistant to organic solvents, e.g., DGBE)	
Frequency	10 MHz to 6 GHz Linearity: ± 0.2 dB (30 MHz to 6 GHz)	
Directivity	± 0.3 dB in HSL (rotation around probe axis) ± 0.5 dB in tissue material (rotation normal to probe axis)	
Dynamic Range	10 µW/g to 100 mW/g Linearity: ± 0.2 dB (noise: typically < 1 µW/g)	
Dimensions	Overall length: 330 mm (Tip: 20 mm) Tip diameter: 2.5 mm (Body: 12 mm) Typical distance from probe tip to dipole centers: 1 mm	
Application	High precision dosimetric measurements in any exposure scenario (e.g., very strong gradient fields). Only probe which enables compliance testing for frequencies up to 6 GHz with precision of better 30%.	

2.3 Boundary Detection Unit and Probe Mounting Device

The DASY probes use a precise connector and an additional holder for the probe, consisting of a plastic tube and a flexible silicon ring to center the probe. The connector at the DAE is flexibly mounted and held in the default position with magnets and springs. Two switching systems in the connector mount detect frontal and lateral probe collisions and trigger the necessary software response.



2.4 DATA Acquisition Electronics (DAE) and Measurement Server

The data acquisition electronics (DAE) consists of a highly sensitive electrometer-grade preamplifier with auto-zeroing, a channel and gain-switching multiplexer, a fast 16 bit AD-converter and a command decoder and control logic unit.

Transmission to the measurement server is accomplished through an optical downlink for data and status information as well as an optical uplink for commands and the clock.

The input impedance of the DAE4 is 200M Ohm; the inputs are symmetrical and floating. Common mode rejection is above 80dB.



The DASY5 measurement server is based on a PC/104 CPU board with a 400MHz intel ULV Celeron, 128MB chipdisk and 128MB RAM. The necessary circuits for communication with the DAE electronics box, as well as the 16 bit AD converter system for optical detection and digital I/O interface are contained on the DASY5 I/O board, which is directly connected to the PC/104 bus of the CPU board.



2.5 Robot

The DASY5 system uses the high precision robots TX90 XL type out of the newer series from Stäubli SA (France). For the 6-axis controller DASY5 system, the CS8C robot controller version from Stäubli is used.

The XL robot series have many features that are important for our application:

- High precision (repeatability 0.02 mm)
- High reliability (industrial design)
- Jerk-free straight movements
- Low ELF interference (the closed metallic construction shields against motor control fields)
- 6-axis controller



2.6 Light Beam Unit

The light beam switch allows automatic "tooling" of the probe. During the process, the actual position of the probe tip with respect to the robot arm is measured, as well as the probe length and the horizontal probe offset. The software then corrects all movements, such that the robot coordinates are valid for the probe tip.

The repeatability of this process is better than 0.1 mm. If a position has been taught with an aligned probe, the same position will be reached with another aligned probe within 0.1 mm, even if the other probe has different dimensions. During probe rotations, the probe tip will keep its actual position.



2.7 Device Holder

The DASY5 device holder is designed to cope with different positions given in the standard. It has two scales for the device rotation (with respect to the body axis) and the device inclination (with respect to the line between the ear reference points). The rotation center for both scales is the ear reference point (EPR).

Thus the device needs no repositioning when changing the angles.

The DASY5 device holder has been made out of low-loss POM material having the following dielectric parameters: relative permittivity $\epsilon_r = 3$ and loss tangent $\delta = 0.02$. The amount of dielectric material has been reduced in the closest vicinity of the device, since measurements have suggested that the influence of the clamp on the test results could thus be lowered.



2.8 SAM Twin Phantom

The SAM twin phantom is a fiberglass shell phantom with 2mm shell thickness (except the ear region where shell thickness increases to 6mm). It has three measurement areas:

- Left head
- Right head
- Flat phantom



The bottom plate contains three pair of bolts for locking the device holder. The device holder positions are adjusted to the standard measurement positions in the three sections. A white cover is provided to tap the phantom during off-periods to prevent water evaporation and changes in the liquid parameters. On the phantom top, three reference markers are provided to identify the phantom position with respect to the robot.

3. Tissue Simulating Liquid

3.1 The composition of the tissue simulating liquid

INGREDIENT (% Weight)	900MHz Head	1800MHz Head	2450MHz Head	2450MHz Body
Water	--	--	46.7	73.2
Salt	--	--	0.00	0.04
Sugar	--	--	0.00	0.00
HEC	--	--	0.00	0.00
Preventol	--	--	0.00	0.00
DGBE	--	--	53.3	26.7

3.2 Tissue Calibration Result

The dielectric parameters of the liquids were verified prior to the SAR evaluation using APREL Dielectric Probe Kit and Anritsu MS4623B Vector Network Analyzer.

Head Tissue Simulant Measurement				
Frequency [MHz]	Description	Dielectric Parameters		Tissue Temp. [°C]
		ϵ_r	σ [s/m]	
2450MHz	Reference result ± 5% window	40.1 38.095 to 42.105	1.78 1.691 to 1.869	N/A
	30-Apr-10	40.62	1.84	20.1

Body Tissue Simulant Measurement				
Frequency [MHz]	Description	Dielectric Parameters		Tissue Temp. [°C]
		ϵ_r	σ [s/m]	
2412 MHz	Reference result ± 5% window	52.7 50.065 to 55.335	1.95 1.8525 to 2.0475	N/A
	Low channel	54.21	1.86	20.1
2437 MHz	Mid channel	53.46	1.88	20.1
2462 MHz	High channel	52.04	1.92	20.1

3.3 Tissue Dielectric Parameters for Head and Body Phantoms

The head tissue dielectric parameters recommended by the IEEE SCC-34/SC-2 in P1528 have been incorporated in the following table. These head parameters are derived from planar layer models simulating the highest expected SAR for the dielectric properties and tissue thickness variations in a human head. Other head and body tissue parameters that have not been specified in P1528 are derived from the tissue dielectric parameters computed from the 4-Cole-Cole equations described in Reference [12] and extrapolated according to the head parameters specified in P1528.

Target Frequency (MHz)	Head		Body	
	ϵ_r	σ (S/m)	ϵ_r	σ (S/m)
150	52.3	0.76	61.9	0.80
300	45.3	0.87	58.2	0.92
450	43.5	0.87	56.7	0.94
835	41.5	0.90	55.2	0.97
900	41.5	0.97	55.0	1.05
915	41.5	0.98	55.0	1.06
1450	40.5	1.20	54.0	1.30
1610	40.3	1.29	53.8	1.40
1800 – 2000	40.0	1.40	53.3	1.52
2450	39.2	1.80	52.7	1.95
3000	38.5	2.40	52.0	2.73
5800	35.3	5.27	48.2	6.00

(ϵ_r = relative permittivity, σ = conductivity and $\rho = 1000 \text{ kg/m}^3$)

4. SAR Measurement Procedure

4.1 SAR System Validation

4.1.1 Validation Dipoles

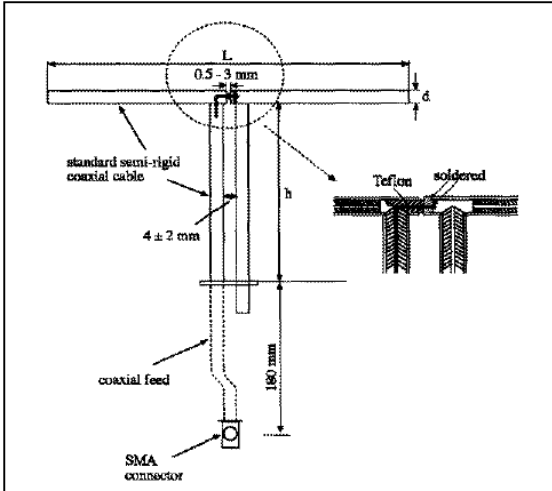

The dipoles used is based on the IEEE-1528 standard, and is complied with mechanical and electrical specifications in line with the requirements of both IEEE and FCC Supplement C. the table below provides details for the mechanical and electrical specifications for the dipoles.

Frequency	L (mm)	h (mm)	d (mm)
2450MHz	53.5	30.4	3.6

4.1.2 Validation Result

System Performance Check at 2450MHz				
Validation Kit: ASL-D-2450-S-2				
Frequency [MHz]	Description	SAR [w/kg] 1g	SAR [w/kg] 10g	Tissue Temp. [°C]
2450 MHz	Reference result ± 10% window	48.07 43.263 to 52.877	25.65 23.085 to 28.215	N/A
	30-Apr-10	49.2	24.68	20.1

Note: All SAR values are normalized to 1W forward power.

4.2 SAR Measurement Procedure

The ALSAS-10U calculates SAR using the following equation,

$$SAR = \frac{\sigma |E|^2}{\rho}$$

σ : represents the simulated tissue conductivity

ρ : represents the tissue density

The EUT is set to transmit at the required power in line with product specification, at each frequency relating to the LOW, MID, and HIGH channel settings.

Pre-scans are made on the device to establish the location for the transmitting antenna, using a large area scan in either air or tissue simulation fluid.

The EUT is placed against the Universal Phantom where the maximum area scan dimensions are larger than the physical size of the resonating antenna. When the scan size is not large enough to cover the peak SAR distribution, it is modified by either extending the area scan size in both the X and Y directions, or the device is shifted within the predefined area.

The area scan is then run to establish the peak SAR location (interpolated resolution set at 1mm²)which is then used to orient the center of the zoom scan. The zoom scan is then executed and the 1g and 10g averages are derived from the zoom scan volume (interpolated resolution set at 1mm³).

5. SAR Exposure Limits

SAR assessments have been made in line with the requirements of IEEE-1528, FCC Supplement C, and comply with ANSI/IEEE C95.1-1992 “Uncontrolled Environments” limits. These limits apply to a location which is deemed as “Uncontrolled Environment” which can be described as a situation where the general public may be exposed to an RF source with no prior knowledge or control over their exposure.

Limits for General Population/Uncontrolled Exposure (W/kg)

Type Exposure	Uncontrolled Environment Limit
Spatial Peak SAR (1g cube tissue for brain or body)	1.60 W/kg
Spatial Average SAR (whole body)	0.08 W/kg
Spatial Peak SAR (10g for hands, feet, ankles and wrist)	4.00 W/kg

6. Test Equipment List

Instrument	Manufacturer	Model No.	Serial No.	Last Calibration	Next Calibration
Stäubli Robot TX60L	Stäubli	TX60L	F09/5BL1A1/A06	May. 2009	only once
Controller	Speag	CS8c	N/A	May. 2009	only once
Aprel Reference Dipole 2450Mhz	Aprel	ALS-D-2450-S-2	QTK-319	May. 2008	May. 2010
SAM Twin Phantom	Speag	QD000 P40 CA	Tp 1515	N/A	N/A
Device Holder	Speag	N/A	N/A	N/A	N/A
Data Acquisition Electronic	Speag	DAE4	910	Sep. 2009	Sep. 2010
E-Field Probe	Speag	EX3DV4	3602	May. 2009	May. 2010
SAR Software	Speag	DASY5	V5.0 Build 125	N/A	N/A
Aprel Dipole Spaccer	Aprel	ALS-DS-U	QTK-295	N/A	N/A
Power Amplifier	Mini-Circuit	ZHL-42	D051404-20	N/A	N/A
Directional Coupler	Agilent	778D-012	50550	N/A	N/A
Universal Radio Communication Tester	R&S	CMU 200	104846	May. 2009	May. 2010
Vector Network	Anritsu	MS4623B	992801	Aug. 2009	Aug. 2010
Signal Generator	Anritsu	MG3692A	042319	Jun. 2009	Jun. 2010
Power Meter	Anritsu	ML2487A	6K00001447	Apr. 2010	Apr. 2011
Wide Bandwidth Sensor	Anritsu	MA2491	030677	Apr. 2010	Apr. 2011

7. Measurement Uncertainty

Uncertainty								
Error Description	Uncertainty value	Prob. Dist.	Div.	(c_i) 1g	(c_i) 10g	Std. Unc. (1g)	Std. Unc. (10g)	(v_i) v_{eff}
Measurement System								
Probe Calibration	±5.9 %	N	1	1	1	±5.9 %	±5.9 %	∞
Axial Isotropy	±4.7 %	R	√3	0.7	0.7	±1.9 %	±1.9 %	∞
Hemispherical Isotropy	±9.6 %	R	√3	0.7	0.7	±3.9 %	±3.9 %	∞
Boundary Effects	±1.0 %	R	√3	1	1	±0.6 %	±0.6 %	∞
Linearity	±4.7 %	R	√3	1	1	±2.7 %	±2.7 %	∞
System Detection Limits	±1.0 %	R	√3	1	1	±0.6 %	±0.6 %	∞
Readout Electronics	±0.3 %	N	1	1	1	±0.3 %	±0.3 %	∞
Response Time	±0.8 %	R	√3	1	1	±0.5 %	±0.5 %	∞
Integration Time	±2.6 %	R	√3	1	1	±1.5 %	±1.5 %	∞
RF Ambient Noise	±3.0 %	R	√3	1	1	±1.7 %	±1.7 %	∞
RF Ambient Reflections	±3.0 %	R	√3	1	1	±1.7 %	±1.7 %	∞
Probe Positioner	±0.4 %	R	√3	1	1	±0.2 %	±0.2 %	∞
Probe Positioning	±2.9 %	R	√3	1	1	±1.7 %	±1.7 %	∞
Max. SAR Eval.	±1.0 %	R	√3	1	1	±0.6 %	±0.6 %	∞
Test Sample Related								
Device Positioning	±2.9 %	N	1	1	1	±2.9 %	±2.9 %	145
Device Holder	±3.6 %	N	1	1	1	±3.6 %	±3.6 %	5
Power Drift	±5.0 %	R	√3	1	1	±2.9 %	±2.9 %	∞
Phantom and Setup								
Phantom Uncertainty	±4.0 %	R	√3	1	1	±2.3 %	±2.3 %	∞
Liquid Conductivity (target)	±5.0 %	R	√3	0.64	0.43	±1.8 %	±1.2 %	∞
Liquid Conductivity (meas.)	±2.5 %	N	1	0.64	0.43	±1.6 %	±1.1 %	∞
Liquid Permittivity (target)	±5.0 %	R	√3	0.6	0.49	±1.7 %	±1.4 %	∞
Liquid Permittivity (meas.)	±2.5 %	N	1	0.6	0.49	±1.5 %	±1.2 %	∞
Combined Std. Uncertainty						±10.9 %	±10.7 %	387
Expanded STD Uncertainty						±21.9 %	±21.4 %	

8. Peak Conducted Power Measurement

Test Mode	Channel No.	Frequency (MHz)	Conducted Power (dBm)
802.11b	01	2412	19.05
	06	2437	18.60
	11	2462	18.58
802.11g	01	2412	21.34
	06	2437	21.55
	11	2462	18.70
802.11n(20M)	01	2412	21.45
	06	2437	21.72
	11	2462	16.77
802.11n(40M)	03	2422	14.18
	06	2437	17.15
	09	2452	13.24

9. Test Results

9.1 SAR Test Results Summary

SAR MEASUREMENT						
Ambient Temperature (°C) : 21.3 ±2				Relative Humidity (%) : 56		
Liquid Temperature (°C) : 20.1 ±2				Depth of Liquid (cm) : >15		
Product: Eee PC						
Test Mode: 802.11b						
Test Position Body	Antenna Position	Frequency		Conducted Power (dBm)	SAR 1g (W/kg)	Limit (W/kg)
		Channel	MHz			
Bottom	Fixed	6	2437	18.60	0.061	1.6
Test Mode: 802.11g						
Bottom	Fixed	1	2412	21.34	0.023	1.6
Bottom	Fixed	6	2437	21.55	0.088	1.6
Bottom	Fixed	11	2462	18.70	0.075	1.6
Test Mode: 802.11n (20M)						
Bottom	Fixed	6	2437	21.72	0.063	1.6
Test Mode: 802.11n (40M)						
Bottom	Fixed	6	2437	17.15	0.060	1.6

Appendix**Appendix A. SAR System Validation Data****Appendix B. SAR measurement Data****Appendix C. Test Setup Photographs & EUT Photographs****Appendix D. Probe Calibration Data****Appendix E. Dipole Calibration Data**

Appendix A. SAR System Validation Data

Date/Time: 4/30/2010

Test Laboratory: Quietek

System Performance Check_2450MHz-Head

DUT: Dipole 2450 MHz; Type: ALS-D-2450-S-2; Serial: QTK-319

Communication System: CW; Frequency: 2450 MHz; Duty Cycle: 1:1

Medium parameters used: $f = 2450 \text{ MHz}$; $\sigma = 1.84 \text{ mho/m}$; $\epsilon_r = 40.6$; $\rho = 1000 \text{ kg/m}^3$

Phantom section: Flat Section

Ambient Temperature ($^{\circ}\text{C}$) : 21.3, Liquid Temperature ($^{\circ}\text{C}$) : 20.1

DASY4 Configuration:

- Probe: EX3DV4 - SN3602; ConvF(7.1, 7.1, 7.1); Calibrated: 5/20/2009
- Sensor-Surface: 2mm (Mechanical Surface Detection)
- Electronics: DAE4 Sn1207; Calibrated: 4/7/2009
- Phantom: SAM Left Table; Type: SAM
- Measurement SW: DASY5, V5.0 Build 125; SEMCAD X Version 13.4 Build 125

2450MHz_Head/Area Scan (7x7x1): Measurement grid: $dx=15\text{mm}$, $dy=15\text{mm}$
 Maximum value of SAR (measured) = 14.5 mW/g

2450MHz_Head/Zoom Scan (7x7x7) (5x5x7)/Cube 0: Measurement grid: $dx=8\text{mm}$, $dy=8\text{mm}$, $dz=5\text{mm}$
 Reference Value = 89.6 V/m; Power Drift = 0.048 dB
 Peak SAR (extrapolated) = 26.5 W/kg
SAR(1 g) = 12.3 mW/g; SAR(10 g) = 6.17 mW/g
 Maximum value of SAR (measured) = 20.5 mW/g

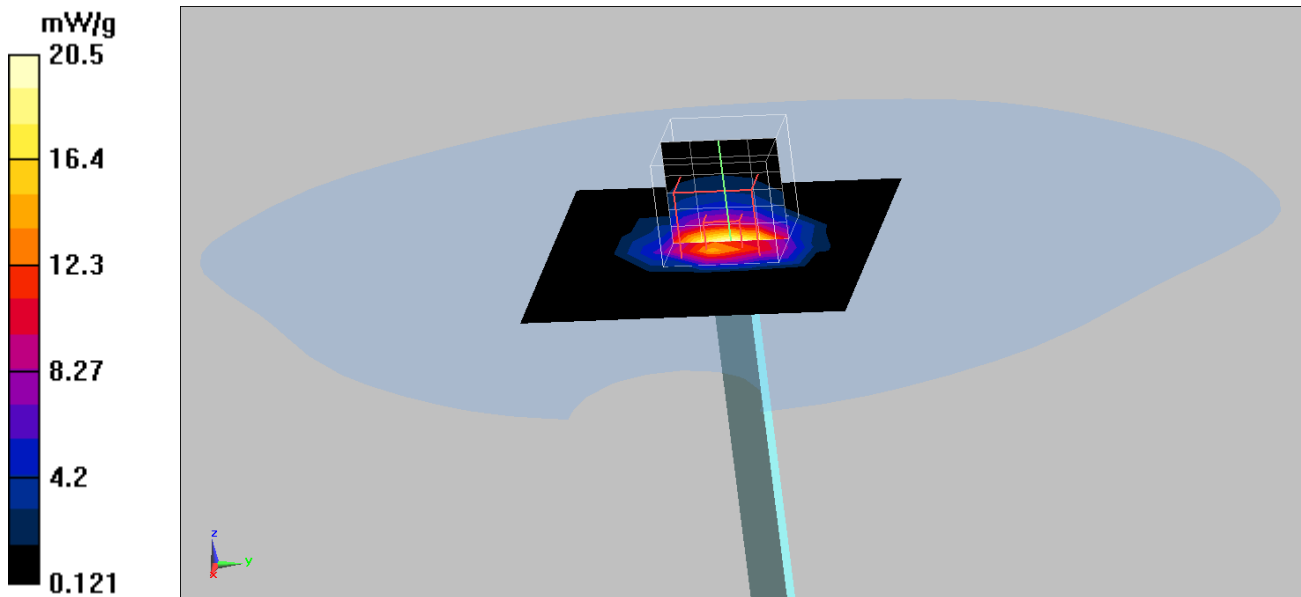

Appendix B. SAR measurement Data

Date/Time: 4/30/2010

Test Laboratory: Quietek

802.11b_6

DUT: Eee PC; Type: Eee PC 1018PB

Communication System: 802.11b; Frequency: 2437 MHz; Duty Cycle: 1:1
 Medium parameters used: $f = 2437$ MHz; $\sigma = 1.88$ mho/m; $\epsilon_r = 53.5$; $\rho = 1000$ kg/m³
 Phantom section: Flat Section
 Ambient Temperature (°C) : 21.3, Liquid Temperature (°C) : 20.1
 DASY4 Configuration:

- Probe: EX3DV4 - SN3602; ConvF(6.9, 6.9, 6.9); Calibrated: 5/20/2009
- Sensor-Surface: 4mm (Mechanical Surface Detection)
- Electronics: DAE4 Sn910; Calibrated: 9/18/2009
- Phantom: SAM Left Table; Type: SAM;
- Measurement SW: DASY5, V5.0 Build 125; SEMCAD X Version 13.4 Build 125

Body/Area Scan (5x10x1): Measurement grid: dx=13mm, dy=13mm
 Maximum value of SAR (measured) = 0.085 mW/g

Body/Zoom Scan (7x7x7) (7x7x7)/Cube 0: Measurement grid: dx=5mm, dy=5mm, dz=5mm
 Reference Value = 5.44 V/m; Power Drift = 0.125 dB
 Peak SAR (extrapolated) = 0.307 W/kg
SAR(1 g) = 0.061 mW/g; SAR(10 g) = 0.022 mW/g
 Maximum value of SAR (measured) = 0.118 mW/g

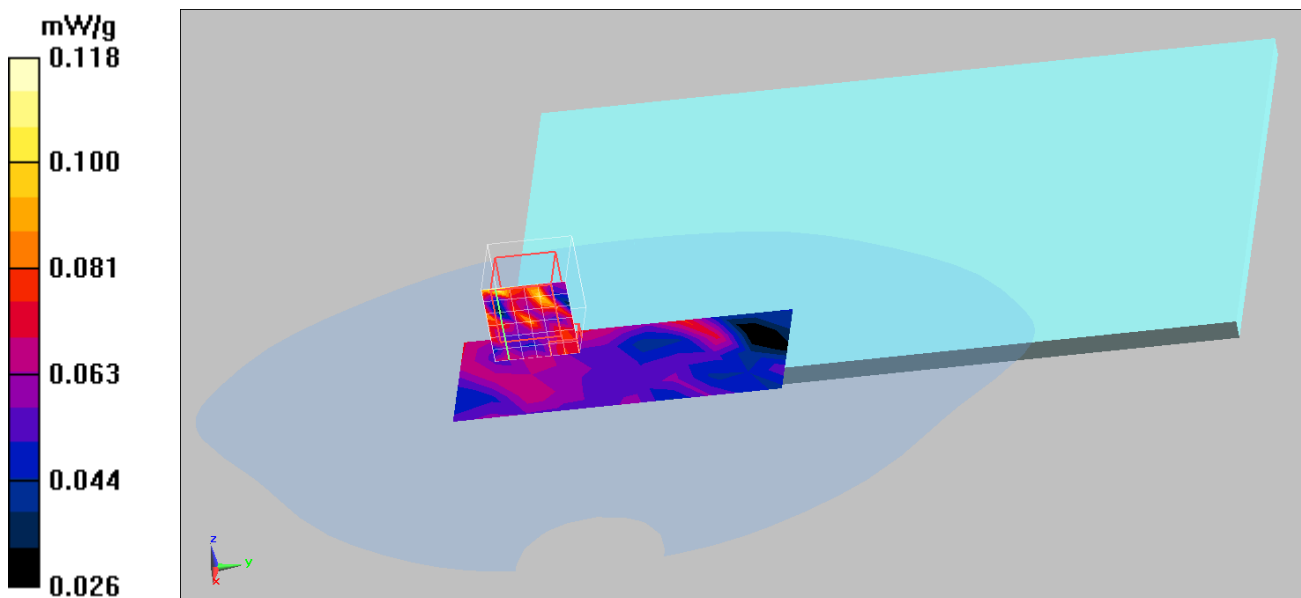

Date/Time: 4/30/2010

Test Laboratory: Quietek

802.11g_1

DUT: Eee PC; Type: Eee PC 1018PB

Communication System: 802.11g; Frequency: 2412 MHz; Duty Cycle: 1:1
 Medium parameters used: $f = 2412$ MHz; $\sigma = 1.86$ mho/m; $\epsilon_r = 54.2$; $\rho = 1000$ kg/m³
 Phantom section: Flat Section .
 Ambient Temperature (°C) : 21.3, Liquid Temperature (°C) : 20.1
 DASY4 Configuration:

- Probe: EX3DV4 - SN3602; ConvF(6.9, 6.9, 6.9); Calibrated: 5/20/2009
- Sensor-Surface: 4mm (Mechanical Surface Detection)
- Electronics: DAE4 Sn910; Calibrated: 9/18/2009
- Phantom: SAM Left Table; Type: SAM;
- Measurement SW: DASY5, V5.0 Build 125; SEMCAD X Version 13.4 Build 125

Body/Area Scan (5x10x1): Measurement grid: dx=13mm, dy=13mm
 Maximum value of SAR (measured) = 0.088 mW/g

Body/Zoom Scan (7x7x7) (7x7x7)/Cube 0: Measurement grid: dx=5mm, dy=5mm, dz=5mm
 Reference Value = 4.78 V/m; Power Drift = -0.185 dB
 Peak SAR (extrapolated) = 0.216 W/kg
SAR(1 g) = 0.023 mW/g; SAR(10 g) = 0.00789 mW/g
 Maximum value of SAR (measured) = 0.095 mW/g

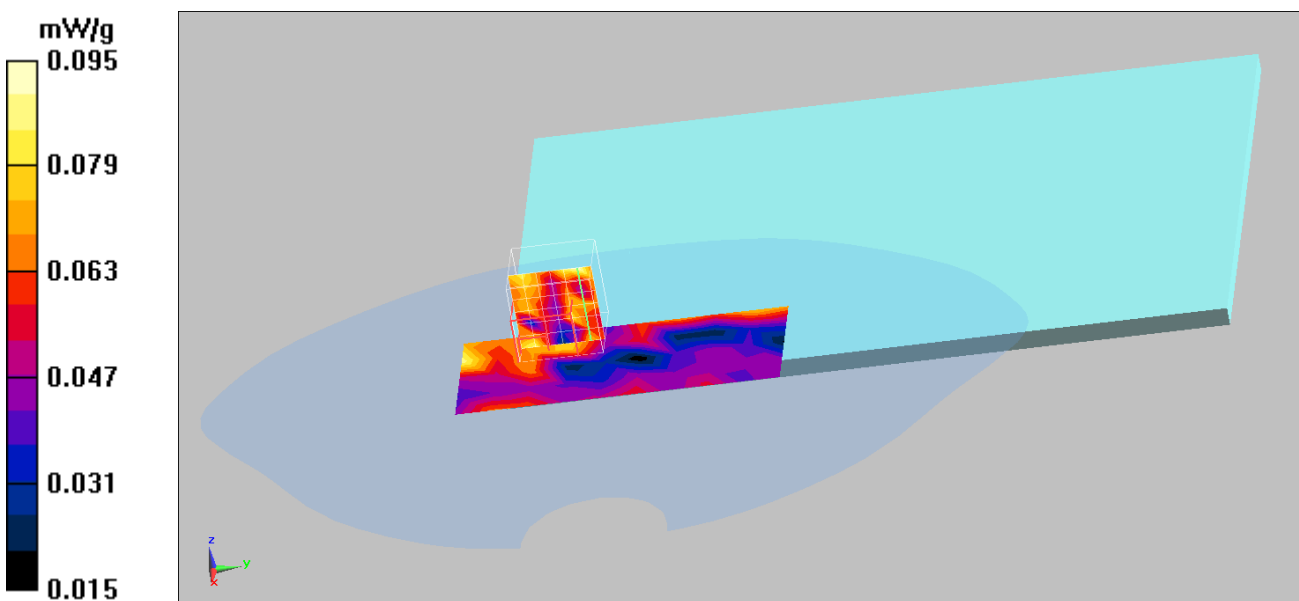

Date/Time: 4/30/2010

Test Laboratory: Quietek

802.11g_6

DUT: Eee PC; Type: Eee PC 1018PB

Communication System: 802.11g; Frequency: 2437 MHz; Duty Cycle: 1:1
 Medium parameters used: $f = 2437$ MHz; $\sigma = 1.88$ mho/m; $\epsilon_r = 53.5$; $\rho = 1000$ kg/m³
 Phantom section: Flat Section
 Ambient Temperature (°C) : 21.3, Liquid Temperature (°C) : 20.1
 DASY4 Configuration:

- Probe: EX3DV4 - SN3602; ConvF(6.9, 6.9, 6.9); Calibrated: 5/20/2009
- Sensor-Surface: 4mm (Mechanical Surface Detection)
- Electronics: DAE4 Sn910; Calibrated: 9/18/2009
- Phantom: SAM Left Table; Type: SAM;
- Measurement SW: DASY5, V5.0 Build 125; SEMCAD X Version 13.4 Build 125

Body/Area Scan (5x10x1): Measurement grid: dx=13mm, dy=13mm
 Maximum value of SAR (measured) = 0.114 mW/g

Body/Zoom Scan (7x7x7) (7x7x7)/Cube 0: Measurement grid: dx=5mm, dy=5mm, dz=5mm
 Reference Value = 6.9 V/m; Power Drift = -0.133 dB
 Peak SAR (extrapolated) = 0.317 W/kg
SAR(1 g) = 0.088 mW/g; SAR(10 g) = 0.063 mW/g
 Maximum value of SAR (measured) = 0.120 mW/g

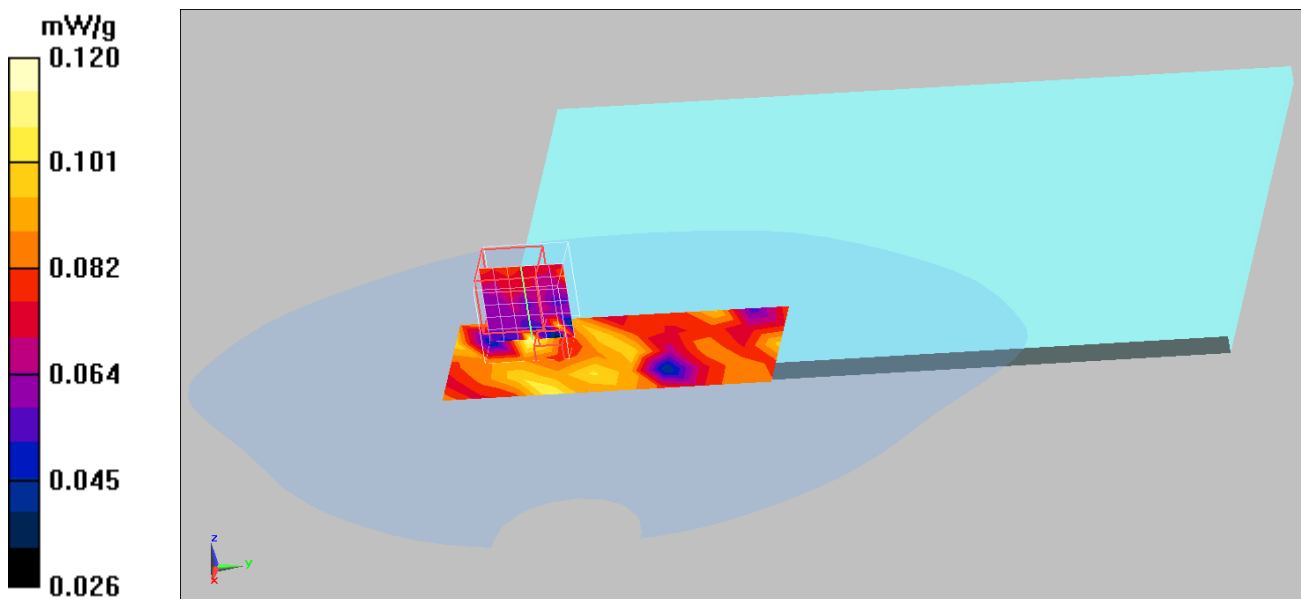

Date/Time: 4/30/2010

Test Laboratory: Quietek

802.11g_11

DUT: Eee PC; Type: Eee PC 1018PB

Communication System: 802.11g; Frequency: 2462 MHz; Duty Cycle: 1:1
 Medium parameters used: $f = 2462 \text{ MHz}$; $\sigma = 1.92 \text{ mho/m}$; $\epsilon_r = 52$; $\rho = 1000 \text{ kg/m}^3$
 Phantom section: Flat Section
 Ambient Temperature ($^{\circ}\text{C}$) : 21.3, Liquid Temperature ($^{\circ}\text{C}$) : 20.1
 DASY4 Configuration:

- Probe: EX3DV4 - SN3602; ConvF(6.9, 6.9, 6.9); Calibrated: 5/20/2009
- Sensor-Surface: 4mm (Mechanical Surface Detection)
- Electronics: DAE4 Sn910; Calibrated: 9/18/2009
- Phantom: SAM Left Table; Type: SAM;
- Measurement SW: DASY5, V5.0 Build 125; SEMCAD X Version 13.4 Build 125

Body/Area Scan (5x10x1): Measurement grid: $dx=13\text{mm}$, $dy=13\text{mm}$
 Maximum value of SAR (measured) = 0.080 mW/g

Body/Zoom Scan (7x7x7) (7x7x7)/Cube 0: Measurement grid: $dx=5\text{mm}$, $dy=5\text{mm}$, $dz=5\text{mm}$
 Reference Value = 5.74 V/m; Power Drift = -0.174 dB
 Peak SAR (extrapolated) = 0.319 W/kg
SAR(1 g) = 0.075 mW/g; SAR(10 g) = 0.029 mW/g
 Maximum value of SAR (measured) = 0.091 mW/g

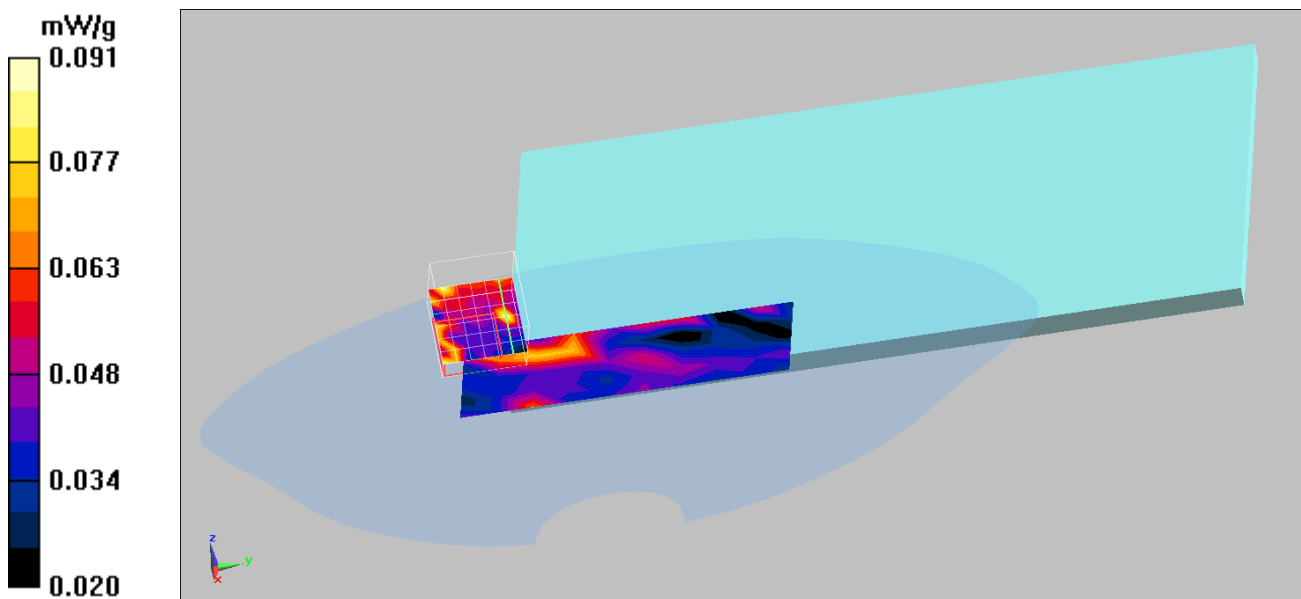

Date/Time: 4/30/2010

Test Laboratory: Quietek

802.11n_6_20M

DUT: Eee PC; Type: Eee PC 1018PB

Communication System: 802.11n; Frequency: 2437 MHz; Duty Cycle: 1:1
 Medium parameters used: $f = 2437$ MHz; $\sigma = 1.88$ mho/m; $\epsilon_r = 53.5$; $\rho = 1000$ kg/m³
 Phantom section: Flat Section
 Ambient Temperature (°C) : 21.3, Liquid Temperature (°C) : 20.1
 DASY4 Configuration:

- Probe: EX3DV4 - SN3602; ConvF(6.9, 6.9, 6.9); Calibrated: 5/20/2009
- Sensor-Surface: 4mm (Mechanical Surface Detection)
- Electronics: DAE4 Sn910; Calibrated: 9/18/2009
- Phantom: SAM Left Table; Type: SAM;
- Measurement SW: DASY5, V5.0 Build 125; SEMCAD X Version 13.4 Build 125

Body/Area Scan (5x10x1): Measurement grid: dx=13mm, dy=13mm
 Maximum value of SAR (measured) = 0.078 mW/g

Body/Zoom Scan (7x7x7) (7x7x7)/Cube 0: Measurement grid: dx=5mm, dy=5mm, dz=5mm
 Reference Value = 5.59 V/m; Power Drift = -0.119 dB
 Peak SAR (extrapolated) = 0.371 W/kg
SAR(1 g) = 0.063 mW/g; SAR(10 g) = 0.048 mW/g
 Maximum value of SAR (measured) = 0.088 mW/g

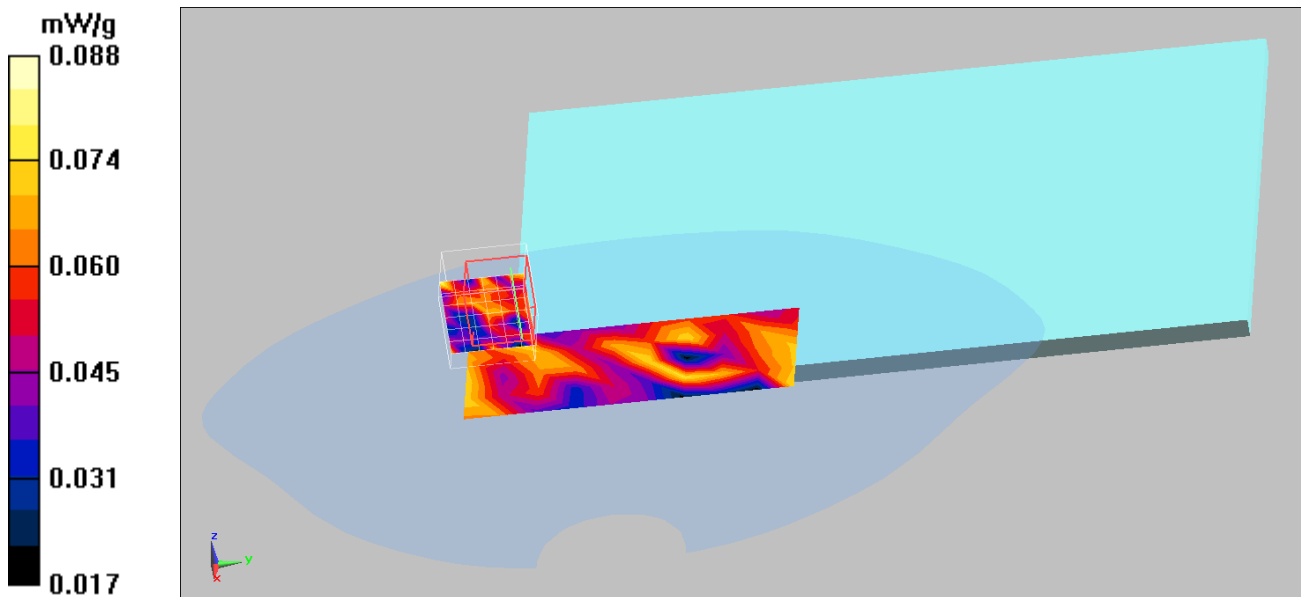

Date/Time: 4/28/2010

Test Laboratory: Quietek

802.11n_6_40M

DUT: Eee PC; Type: Eee PC 1018PB

Communication System: 802.11n; Frequency: 2437 MHz; Duty Cycle: 1:1
 Medium parameters used: $f = 2437$ MHz; $\sigma = 1.88$ mho/m; $\epsilon_r = 53.5$; $\rho = 1000$ kg/m³
 Phantom section: Flat Section
 Ambient Temperature (°C) : 21.3, Liquid Temperature (°C) : 20.1
 DASY4 Configuration:

- Probe: EX3DV4 - SN3602; ConvF(6.9, 6.9, 6.9); Calibrated: 5/20/2009
- Sensor-Surface: 4mm (Mechanical Surface Detection)
- Electronics: DAE4 Sn910; Calibrated: 9/18/2009
- Phantom: SAM Left Table; Type: SAM;
- Measurement SW: DASY5, V5.0 Build 125; SEMCAD X Version 13.4 Build 125

Body/Area Scan (5x10x1): Measurement grid: dx=13mm, dy=13mm
 Maximum value of SAR (measured) = 0.079 mW/g

Body/Zoom Scan (7x7x7) (7x7x7)/Cube 0: Measurement grid: dx=5mm, dy=5mm, dz=5mm
 Reference Value = 5.25 V/m; Power Drift = -0.159 dB
 Peak SAR (extrapolated) = 0.304 W/kg
SAR(1 g) = 0.060 mW/g; SAR(10 g) = 0.024 mW/g
 Maximum value of SAR (measured) = 0.091 mW/g

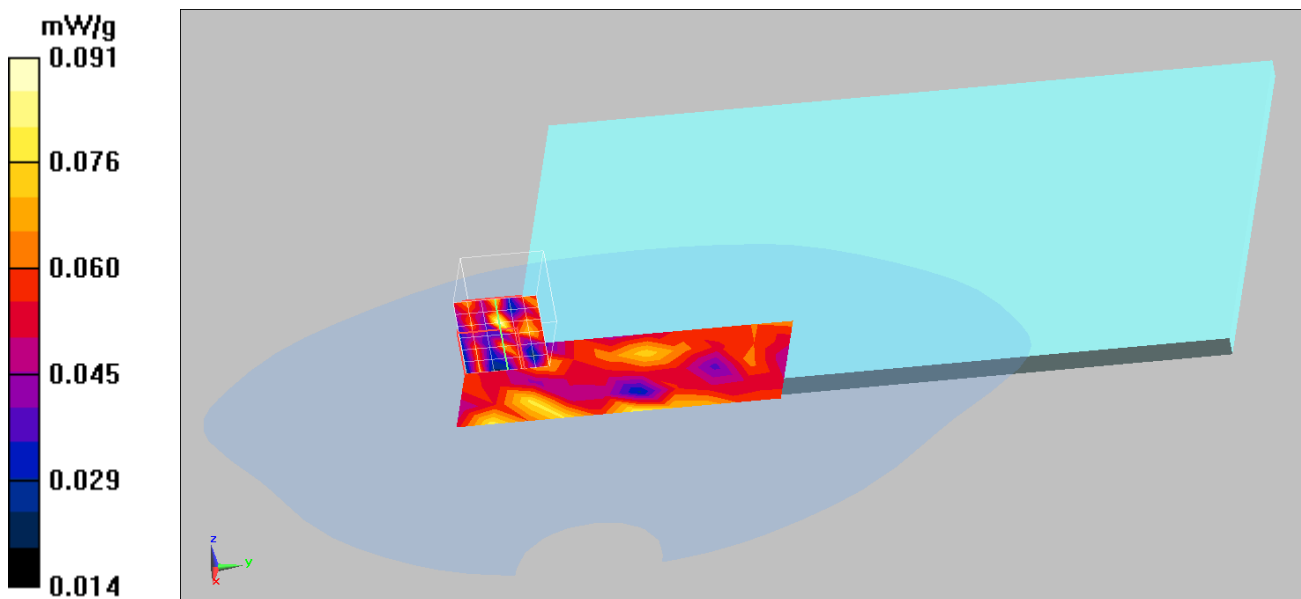

802.11g EUT Bottom, Z-Axis plot

Channel: 6

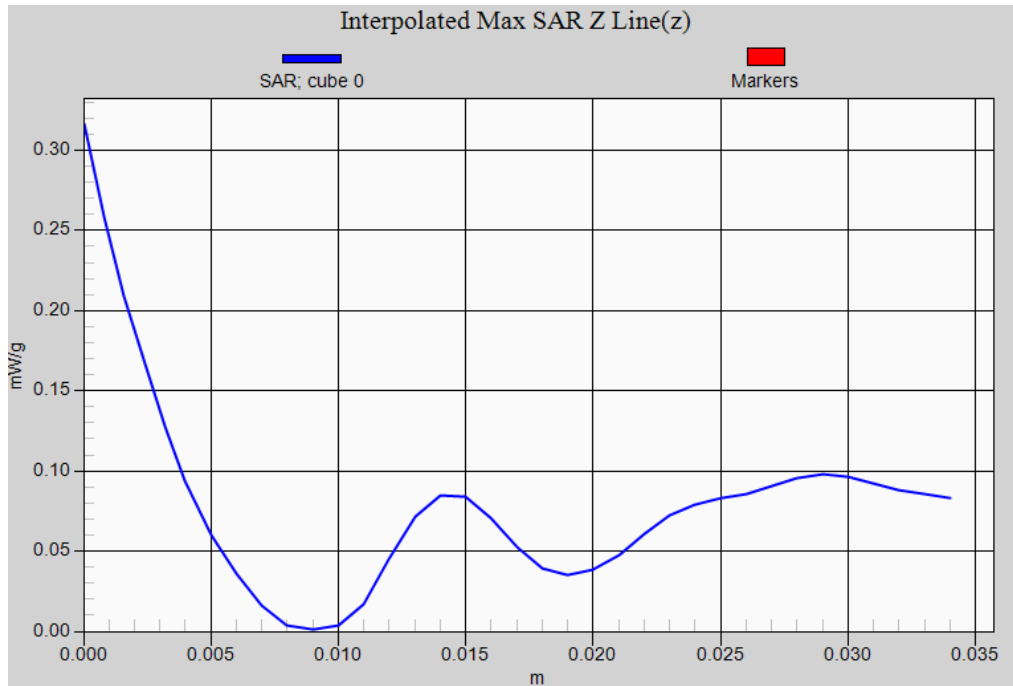



Appendix D. Probe Calibration Data

**Miniature Isotropic RF Probe
S/N: 3602**



Accredited by the Swiss Accreditation Service (SAS)
The Swiss Accreditation Service is one of the signatories to the EA
Multilateral Agreement for the recognition of calibration certificates

Accreditation No.: **SCS 108**

Client **Quietek (Auden)**

Certificate No: **EX3-3602_May09**

CALIBRATION CERTIFICATE

Object **EX3DV4 - SN:3602**

Calibration procedure(s) **QA CAL-01.v6, QA CAL-14.v3 and QA CAL-23.v3
Calibration procedure for dosimetric E-field probes**

Calibration date: **May 20, 2009**

Condition of the calibrated item **In Tolerance**

This calibration certificate documents the traceability to national standards, which realize the physical units of measurements (SI).
The measurements and the uncertainties with confidence probability are given on the following pages and are part of the certificate.

All calibrations have been conducted in the closed laboratory facility: environment temperature $(22 \pm 3)^\circ\text{C}$ and humidity $< 70\%$.

Calibration Equipment used (M&TE critical for calibration)

Primary Standards	ID #	Cal Date (Certificate No.)	Scheduled Calibration
Power meter E4419B	GB41283874	1-Apr-09 (No. 217-01030)	Apr-10
Power sensor E4412A	MY41495277	1-Apr-09 (No. 217-01030)	Apr-10
Power sensor E4412A	MY41498087	1-Apr-09 (No. 217-01030)	Apr-10
Reference 3 dB Attenuator	SN: S5054 (3c)	31-Mar-09 (No. 217-01028)	Mar-10
Reference 20 dB Attenuator	SN: S5086 (20b)	31-Mar-09 (No. 217-01028)	Mar-10
Reference 30 dB Attenuator	SN: S5129 (30b)	31-Mar-09 (No. 217-01027)	Mar-10
Reference Probe ES3DV2	SN: 3013	2-Jan-09 (No. ES3-3013_Jan09)	Jan-10
DAE4	SN: 660	9-Sep-08 (No. DAE4-660_Sep08)	Sep-09

Secondary Standards	ID #	Check Date (in house)	Scheduled Check
RF generator HP 8648C	US3642U01700	4-Aug-99 (in house check Oct-07)	In house check: Oct-09
Network Analyzer HP 8753E	US37390585	18-Oct-01 (in house check Oct-08)	In house check: Oct-09

	Name	Function	Signature
Calibrated by:	Katja Pokovic	Technical Manager	
Approved by:	Niels Kuster	Quality Manager	

Issued: May 20, 2009

This calibration certificate shall not be reproduced except in full without written approval of the laboratory.



Accredited by the Swiss Accreditation Service (SAS)
The Swiss Accreditation Service is one of the signatories to the EA
Multilateral Agreement for the recognition of calibration certificates

Accreditation No.: **SCS 108**

Glossary:

TSL	tissue simulating liquid
NORM _{x,y,z}	sensitivity in free space
ConvF	sensitivity in TSL / NORM _{x,y,z}
DCP	diode compression point
Polarization φ	φ rotation around probe axis
Polarization ϑ	ϑ rotation around an axis that is in the plane normal to probe axis (at measurement center), i.e., $\vartheta = 0$ is normal to probe axis

Calibration is Performed According to the Following Standards:

- IEEE Std 1528-2003, "IEEE Recommended Practice for Determining the Peak Spatial-Averaged Specific Absorption Rate (SAR) in the Human Head from Wireless Communications Devices: Measurement Techniques", December 2003
- IEC 62209-1, "Procedure to measure the Specific Absorption Rate (SAR) for hand-held devices used in close proximity to the ear (frequency range of 300 MHz to 3 GHz)", February 2005

Methods Applied and Interpretation of Parameters:

- NORM_{x,y,z}**: Assessed for E-field polarization $\vartheta = 0$ ($f \leq 900$ MHz in TEM-cell; $f > 1800$ MHz: R22 waveguide). NORM_{x,y,z} are only intermediate values, i.e., the uncertainties of NORM_{x,y,z} does not effect the E²-field uncertainty inside TSL (see below ConvF).
- NORM(f)_{x,y,z}** = NORM_{x,y,z} * frequency response (see Frequency Response Chart). This linearization is implemented in DASY4 software versions later than 4.2. The uncertainty of the frequency response is included in the stated uncertainty of ConvF.
- DCP_{x,y,z}**: DCP are numerical linearization parameters assessed based on the data of power sweep (no uncertainty required). DCP does not depend on frequency nor media.
- ConvF and Boundary Effect Parameters**: Assessed in flat phantom using E-field (or Temperature Transfer Standard for $f \leq 800$ MHz) and inside waveguide using analytical field distributions based on power measurements for $f > 800$ MHz. The same setups are used for assessment of the parameters applied for boundary compensation (alpha, depth) of which typical uncertainty values are given. These parameters are used in DASY4 software to improve probe accuracy close to the boundary. The sensitivity in TSL corresponds to NORM_{x,y,z} * ConvF whereby the uncertainty corresponds to that given for ConvF. A frequency dependent ConvF is used in DASY version 4.4 and higher which allows extending the validity from ± 50 MHz to ± 100 MHz.
- Spherical isotropy (3D deviation from isotropy)**: in a field of low gradients realized using a flat phantom exposed by a patch antenna.
- Sensor Offset**: The sensor offset corresponds to the offset of virtual measurement center from the probe tip (on probe axis). No tolerance required.

Probe EX3DV4

SN:3602

Manufactured:	March 23, 2009
Calibrated:	May 20, 2009

Calibrated for DASY Systems

(Note: non-compatible with DASY2 system!)

DASY - Parameters of Probe: EX3DV4 SN:3602

Sensitivity in Free Space^A

Diode Compression^B

NormX	0.41 ± 10.1%	$\mu\text{V}/(\text{V}/\text{m})^2$	DCP X	87 mV
NormY	0.40 ± 10.1%	$\mu\text{V}/(\text{V}/\text{m})^2$	DCP Y	89 mV
NormZ	0.52 ± 10.1%	$\mu\text{V}/(\text{V}/\text{m})^2$	DCP Z	89 mV

Sensitivity in Tissue Simulating Liquid (Conversion Factors)

Please see Page 8.

Boundary Effect

TSL **900 MHz** **Typical SAR gradient: 5 % per mm**

Sensor Center to Phantom Surface Distance		2.0 mm	3.0 mm
SAR _{loc} [%]	Without Correction Algorithm	10.2	6.1
SAR _{loc} [%]	With Correction Algorithm	0.9	0.6

TSL **1810 MHz** **Typical SAR gradient: 10 % per mm**

Sensor Center to Phantom Surface Distance		2.0 mm	3.0 mm
SAR _{ba} [%]	Without Correction Algorithm	6.7	2.9
SAR _{ba} [%]	With Correction Algorithm	0.5	0.3

Sensor Offset

Probe Tip to Sensor Center **1.0 mm**

The reported uncertainty of measurement is stated as the standard uncertainty of measurement multiplied by the coverage factor k=2, which for a normal distribution corresponds to a coverage probability of approximately 95%.

^A The uncertainties of NormX,Y,Z do not affect the E²-field uncertainty inside TSL. (see Page 8).

^B Numerical linearization parameter: uncertainty not required.

Frequency Response of E-Field

(TEM-Cell:ifi110 EXX, Waveguide: R22)

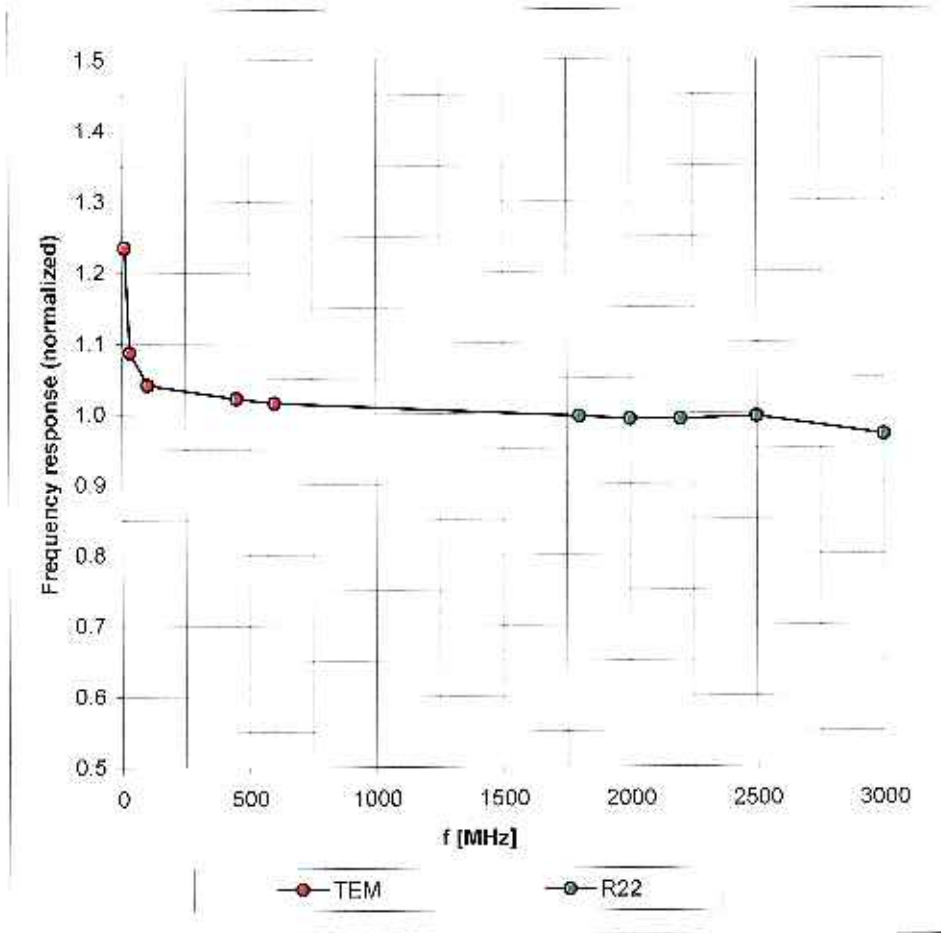

Uncertainty of Frequency Response of E-field: $\pm 6.3\%$ (k=2)

Receiving Pattern (ϕ), $\vartheta = 0^\circ$

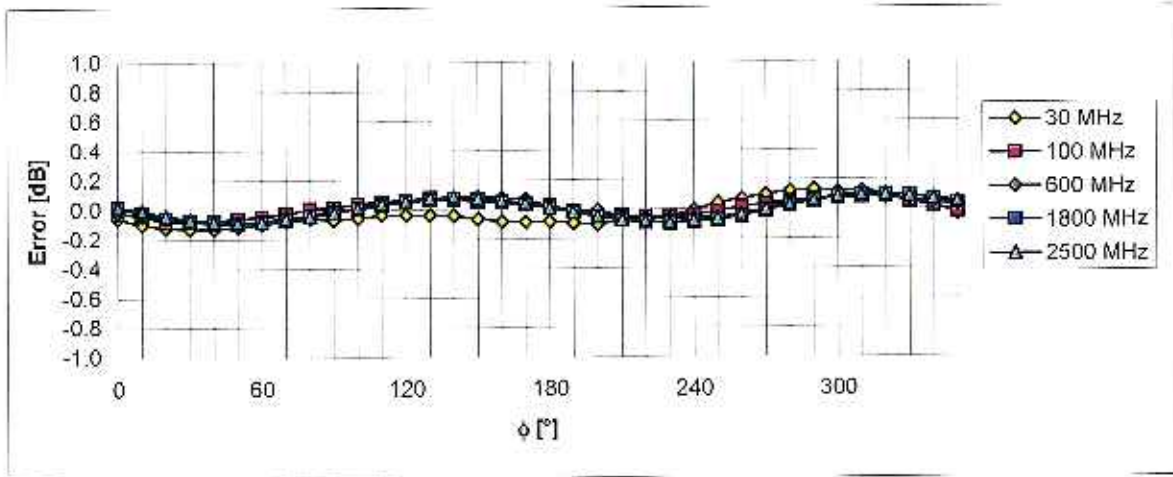
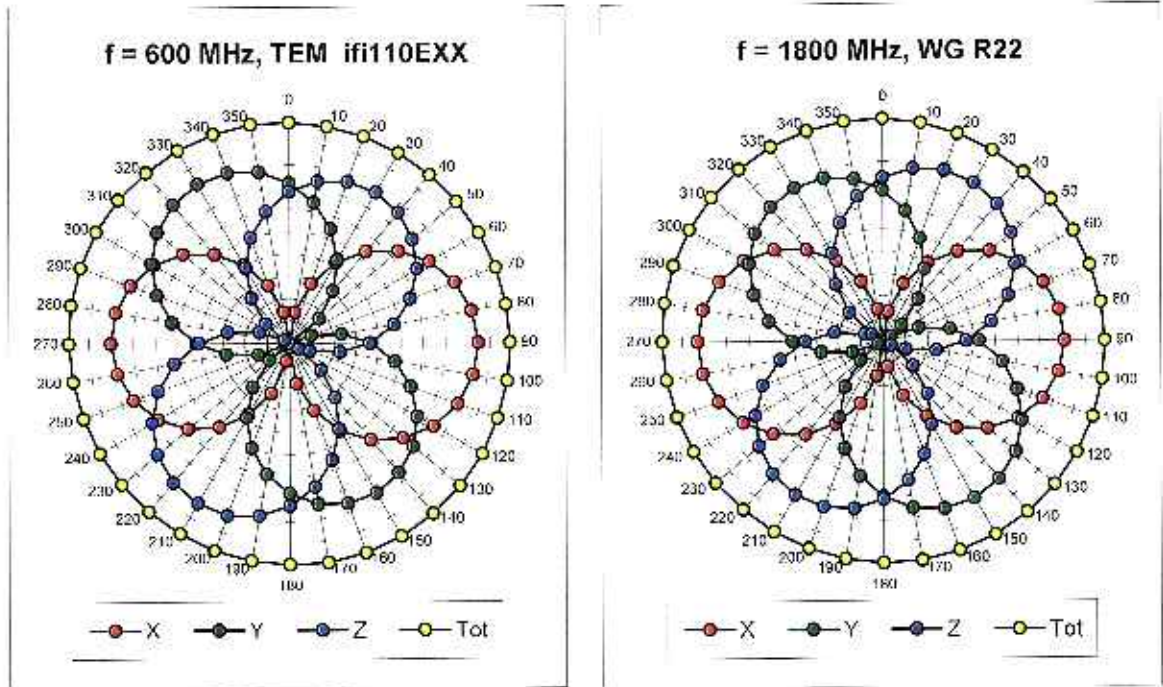

Uncertainty of Axial Isotropy Assessment: $\pm 0.5\%$ (k=2)

Dynamic Range f(SAR_{head}) (Waveguide R22, f = 1800 MHz)

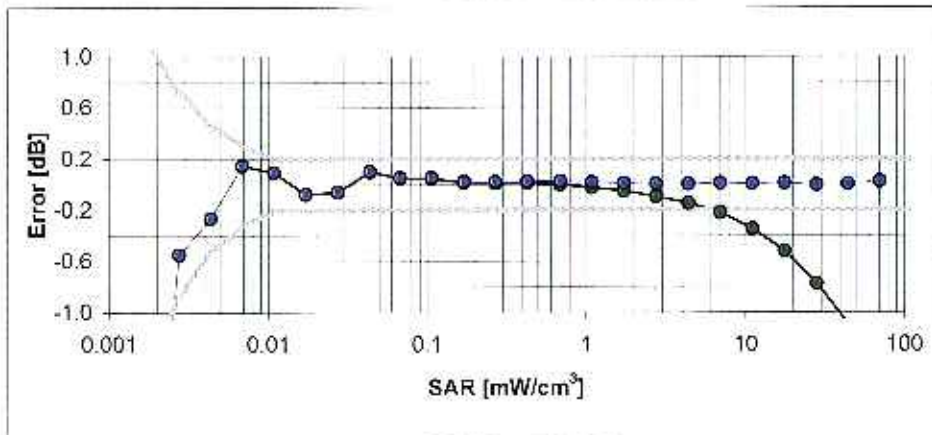
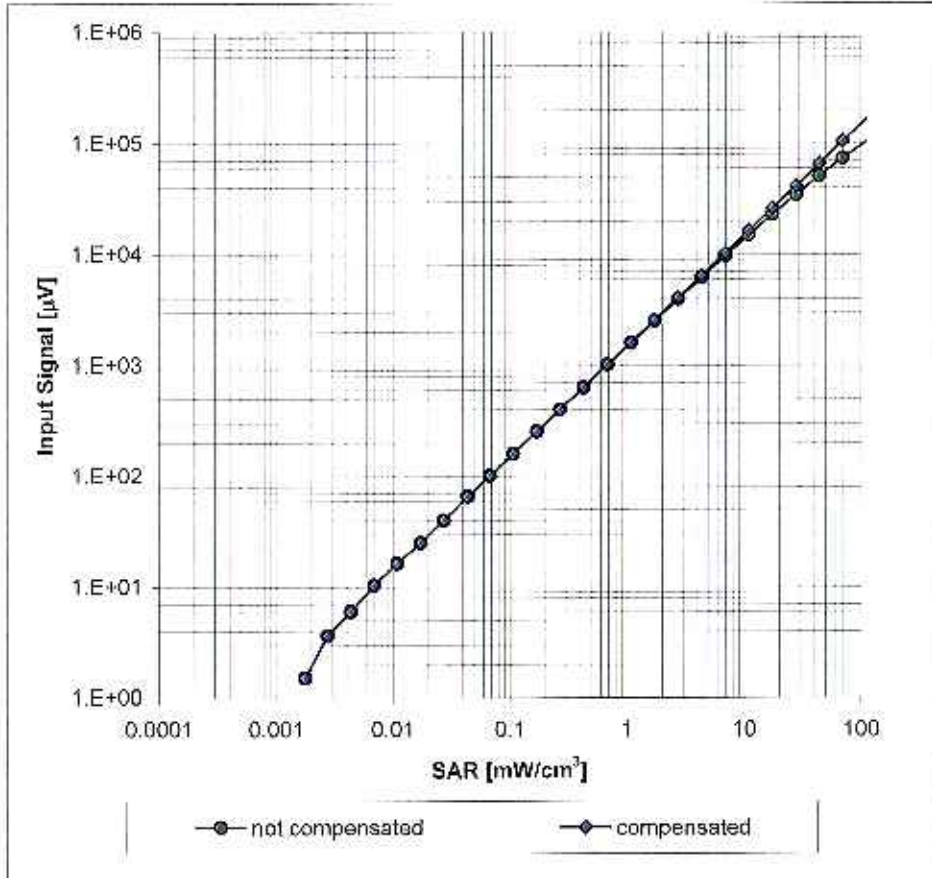

Uncertainty of Linearity Assessment: ± 0.6% (k=2)

Conversion Factor Assessment

f [MHz]	Validity [MHz] ^c	TSL	Permittivity	Conductivity	Alpha	Depth	ConvF	Uncertainty
835	± 50 / ± 100	Head	41.5 ± 5%	0.90 ± 5%	0.56	0.71	9.14	± 11.0% (k=2)
900	± 50 / ± 100	Head	41.5 ± 5%	0.97 ± 5%	0.65	0.65	8.86	± 11.0% (k=2)
1810	± 50 / ± 100	Head	40.0 ± 5%	1.40 ± 5%	0.84	0.55	7.81	± 11.0% (k=2)
1950	± 50 / ± 100	Head	40.0 ± 5%	1.40 ± 5%	0.84	0.56	7.55	± 11.0% (k=2)
2450	± 50 / ± 100	Head	39.2 ± 5%	1.80 ± 5%	0.46	0.70	7.10	± 11.0% (k=2)
2600	± 50 / ± 100	Head	39.0 ± 5%	1.96 ± 5%	0.41	0.77	7.10	± 11.0% (k=2)
3500	± 50 / ± 100	Head	37.9 ± 5%	2.91 ± 5%	0.42	1.00	6.26	± 13.1% (k=2)
5200	± 50 / ± 100	Head	36.0 ± 5%	4.66 ± 5%	0.43	1.75	4.79	± 13.1% (k=2)
5300	± 50 / ± 100	Head	35.9 ± 5%	4.76 ± 5%	0.43	1.75	4.43	± 13.1% (k=2)
5500	± 50 / ± 100	Head	35.6 ± 5%	4.96 ± 5%	0.50	1.75	4.44	± 13.1% (k=2)
5600	± 50 / ± 100	Head	35.5 ± 5%	5.07 ± 5%	0.50	1.75	4.42	± 13.1% (k=2)
5800	± 50 / ± 100	Head	35.3 ± 5%	5.27 ± 5%	0.52	1.75	4.21	± 13.1% (k=2)
835	± 50 / ± 100	Body	55.2 ± 5%	0.97 ± 5%	0.72	0.65	9.32	± 11.0% (k=2)
900	± 50 / ± 100	Body	55.0 ± 5%	1.05 ± 5%	0.55	0.74	8.97	± 11.0% (k=2)
1810	± 50 / ± 100	Body	53.3 ± 5%	1.52 ± 5%	0.70	0.65	7.97	± 11.0% (k=2)
1950	± 50 / ± 100	Body	53.3 ± 5%	1.52 ± 5%	0.48	0.78	7.68	± 11.0% (k=2)
2450	± 50 / ± 100	Body	52.7 ± 5%	1.95 ± 5%	0.42	0.79	6.90	± 11.0% (k=2)
2600	± 50 / ± 100	Body	52.5 ± 5%	2.16 ± 5%	0.28	1.23	6.81	± 11.0% (k=2)
3500	± 50 / ± 100	Body	51.3 ± 5%	3.31 ± 5%	0.35	1.22	5.75	± 13.1% (k=2)
5200	± 50 / ± 100	Body	49.0 ± 5%	5.30 ± 5%	0.50	1.80	4.43	± 13.1% (k=2)
5300	± 50 / ± 100	Body	48.5 ± 5%	5.42 ± 5%	0.52	1.80	4.23	± 13.1% (k=2)
5500	± 50 / ± 100	Body	48.6 ± 5%	5.65 ± 5%	0.55	1.80	4.08	± 13.1% (k=2)
5600	± 50 / ± 100	Body	48.5 ± 5%	5.77 ± 5%	0.55	1.80	3.95	± 13.1% (k=2)
5800	± 50 / ± 100	Body	48.2 ± 5%	6.00 ± 5%	0.61	1.80	4.00	± 13.1% (k=2)

^c The validity of ± 100 MHz only applies for DASY v4.4 and higher (see Page 2). The uncertainty is the RSS of the ConvF uncertainty at calibration frequency and the uncertainty for the indicated frequency band.

Deviation from Isotropy in HSL

Error (ϕ , θ), $f = 900$ MHz

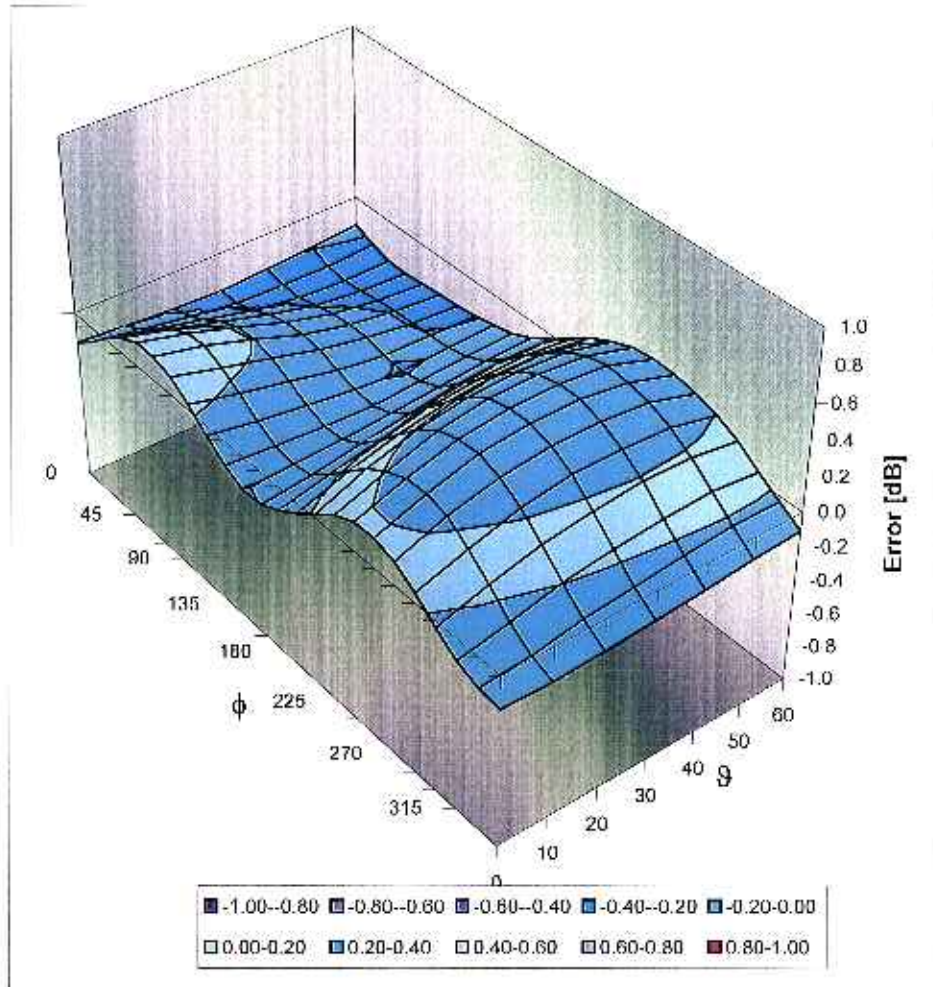

Uncertainty of Spherical Isotropy Assessment: $\pm 2.6\%$ ($k=2$)



Appendix E. Dipole Calibration

Validation Dipole 2450 MHz

M/N: ALS-D-2450-S-2

S/N: QTK-319

NCL CALIBRATION LABORATORIES

Calibration File No: DC-891

CERTIFICATE OF CALIBRATION

It is certified that the equipment identified below has been calibrated in the **NCL CALIBRATION LABORATORIES** by qualified personnel following recognized procedures and using transfer standards traceable to NRC/NIST.

Quietek Validation Dipole

Manufacturer: APREL Laboratories

Part number: ALS-D-2450-S-2

Frequency: 2.45 GHz

Serial No: QTK-319

Customer: Quietek

Project Number: QTKB-Dipole-CAL-5336

Calibrated: 9th May 2008
Released on: 9th May 2008

This Calibration Certificate is Incomplete Unless Accompanied with the Calibration Results Summary

Released By: _____

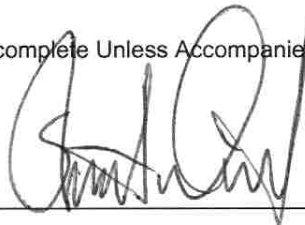

NCL CALIBRATION LABORATORIES

51 SPECTRUM WAY
NEPEAN, ONTARIO
CANADA K2R 1E6

Division of APREL Lab.
TEL: (613) 820-4988
FAX: (613) 820-4161

Calibration Results Summary

The following results relate the Calibrated Dipole and should be used as a quick reference for the user.

Mechanical Dimensions

Length: 53.5 mm
Height: 30.4 mm

Electrical Specification

SWR: 1.19 U
Return Loss: -20.8 dB
Impedance: 49.4 Ω

System Validation Results

Frequency	1 Gram	10 Gram	Peak
2.45 GHz	48.07	25.65	95.6

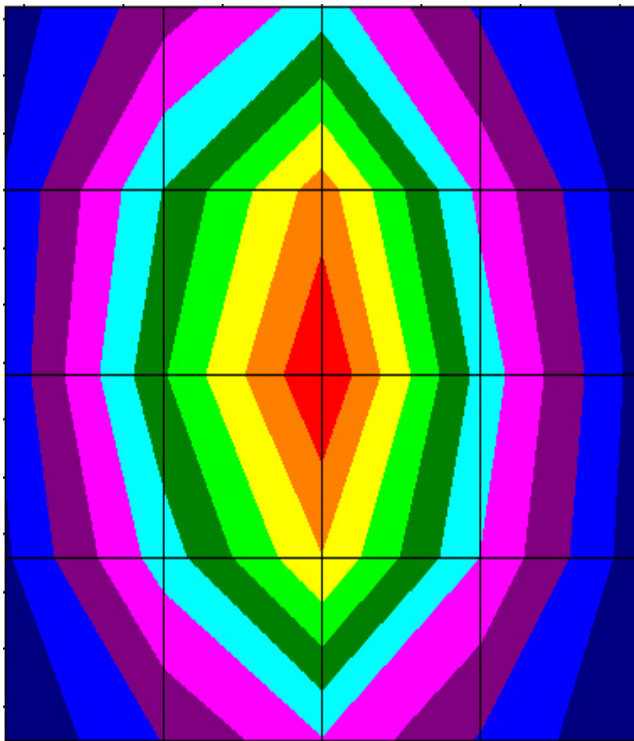

Conditions

Dipole 319 is a recalibration.

Ambient Temperature of the Laboratory: 22 °C +/- 0.5°C
Temperature of the Tissue: 21 °C +/- 0.5°C

References

SSI-TP-018-ALSAS Dipole Calibration Procedure

SSI-TP-016 Tissue Calibration Procedure

IEEE 1528 “Recommended Practice for Determining the Peak Spatial-Average Specific Absorption Rate (SAR) in the Human Body Due to Wireless Communications Devices: Experimental Techniques”

IEC 62209 “Human exposure to radio frequency fields from hand-held and body-mounted wireless communication devices – Human models, instrumentation, and procedures –Part 1 & Part 2: Procedure to determine the specific absorption rate (SAR) for mobile wireless communication devices used in close proximity to the human body (frequency range of 30 MHz to 6 GHz)

We the undersigned attest that to the best of our knowledge the calibration of this device has been accurately conducted and that all information contained within this report has been reviewed for accuracy.



Stuart Nicol



C. Teodorian

Dipole Calibration Results

Mechanical Verification

IEEE Length	IEEE Height	Measured Length	Measured Height
51.5 mm	30.4 mm	53.5 mm	30.4 mm

Tissue Validation

Head Tissue 2450 MHz	Measured
Dielectric constant, ϵ_r	40.1
Conductivity, σ [S/m]	1.78

Electrical Calibration

Test	Result
S11 R/L	-20.8 dB
SWR	1.2 U
Impedance	49.4 Ω

The Following Graphs are the results as displayed on the Vector Network Analyzer.

S11 Parameter Return Loss

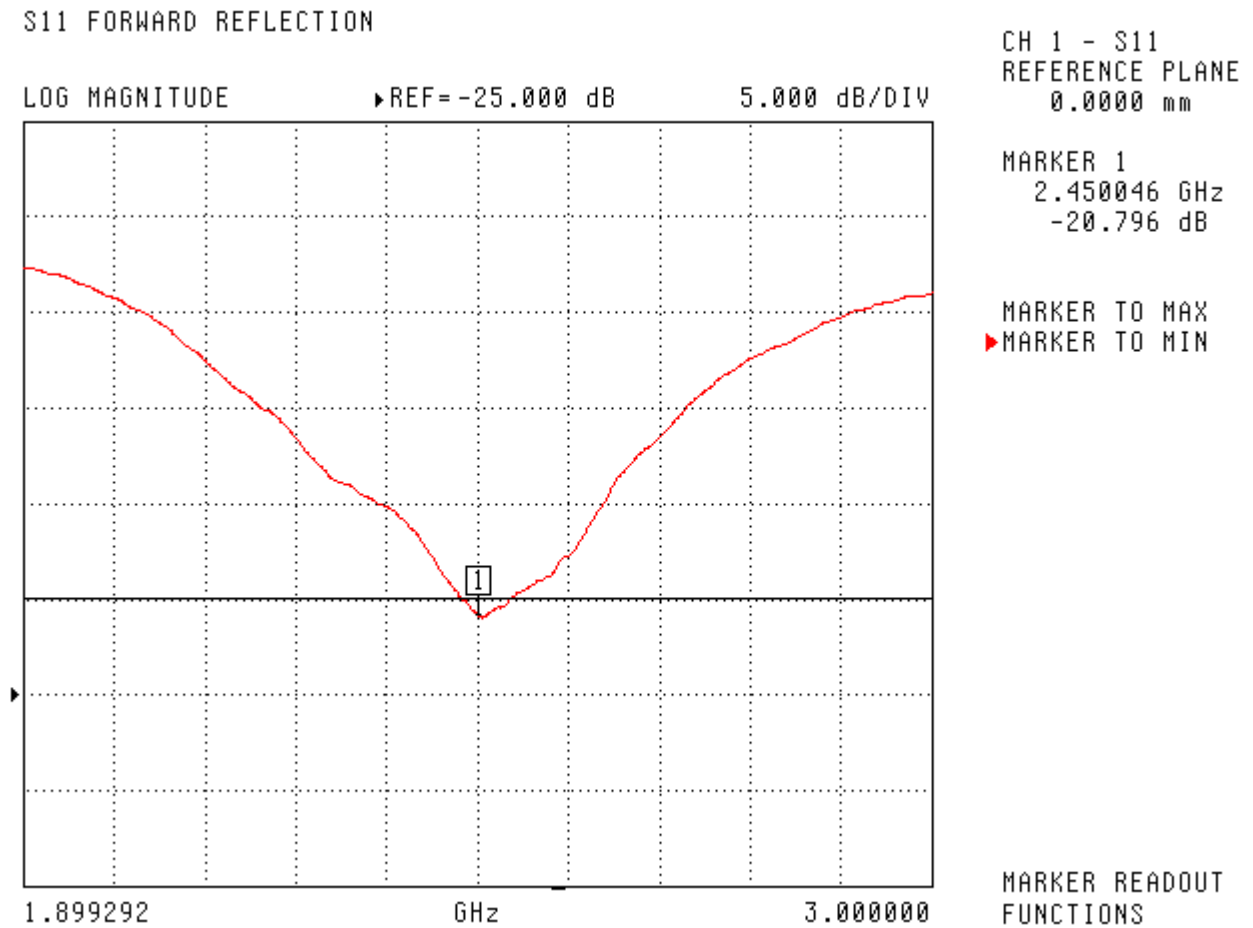

SWR

S11 FORWARD REFLECTION

SWR

REF=500.000 mU

1.000 U/DIV

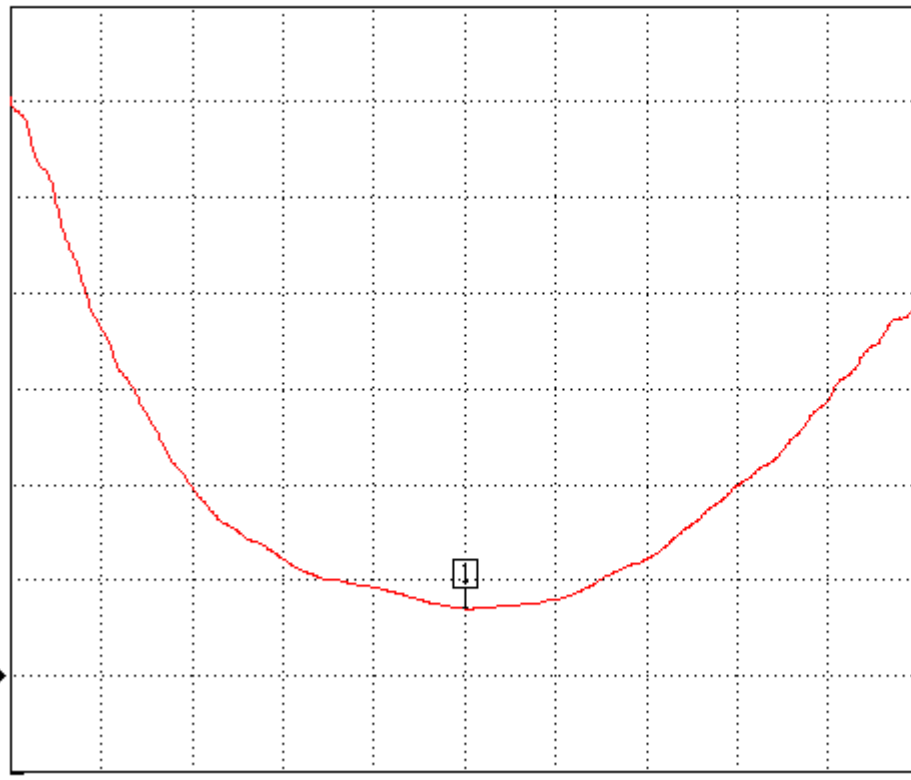

CH 1 - S11
REFERENCE PLANE
0.0000 mm

MARKER 1
2.450046 GHz
1.199 U

MARKER TO MAX
▶ MARKER TO MIN

1.899292

GHz

3.000000

MARKER READOUT
FUNCTIONS

Smith Chart Dipole Impedance

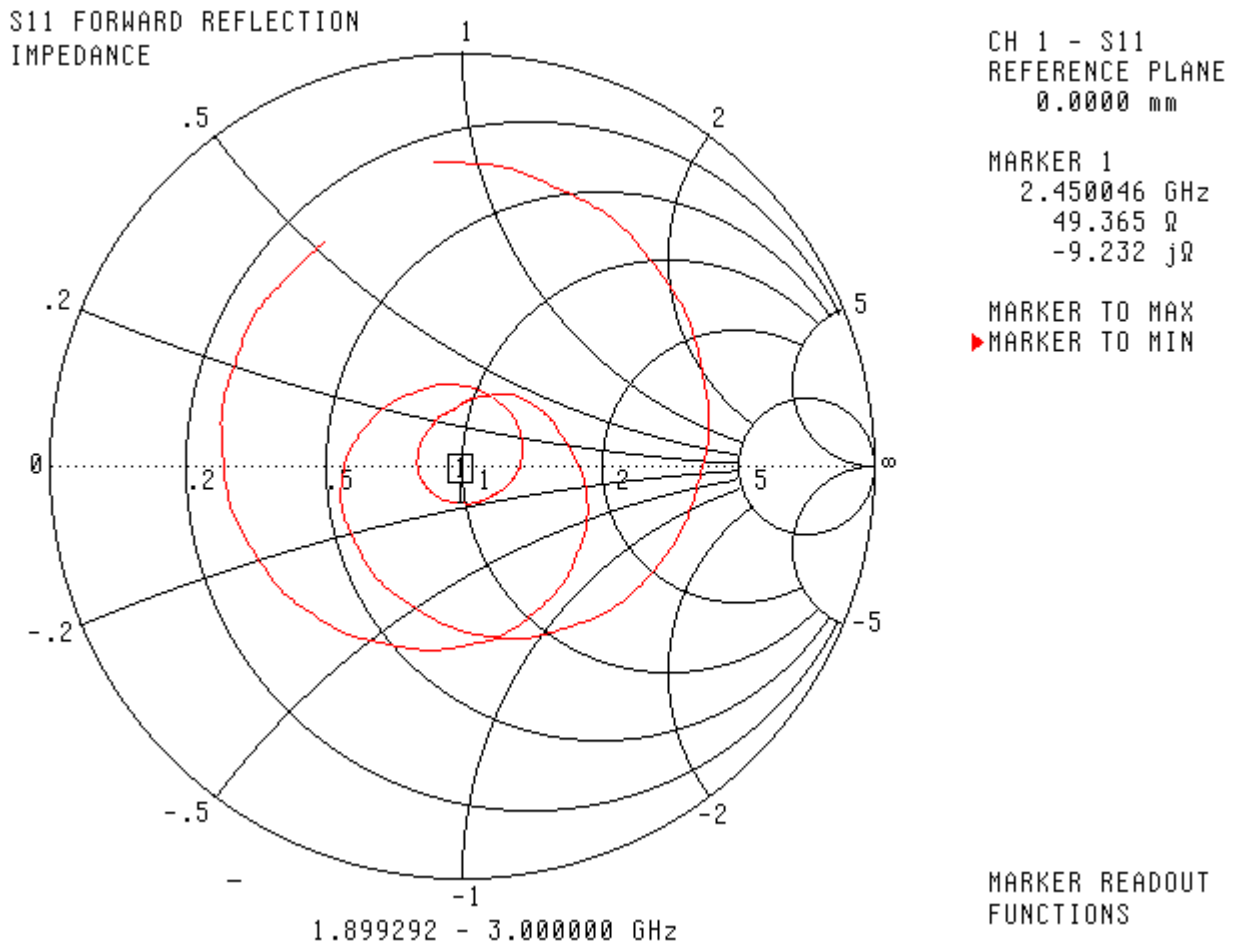

System Validation Results Using the Electrically Calibrated Dipole

Frequency	1 Gram	10 Gram	Peak Above Feed Point
2.45 GHz	48.07	25.65	95.6

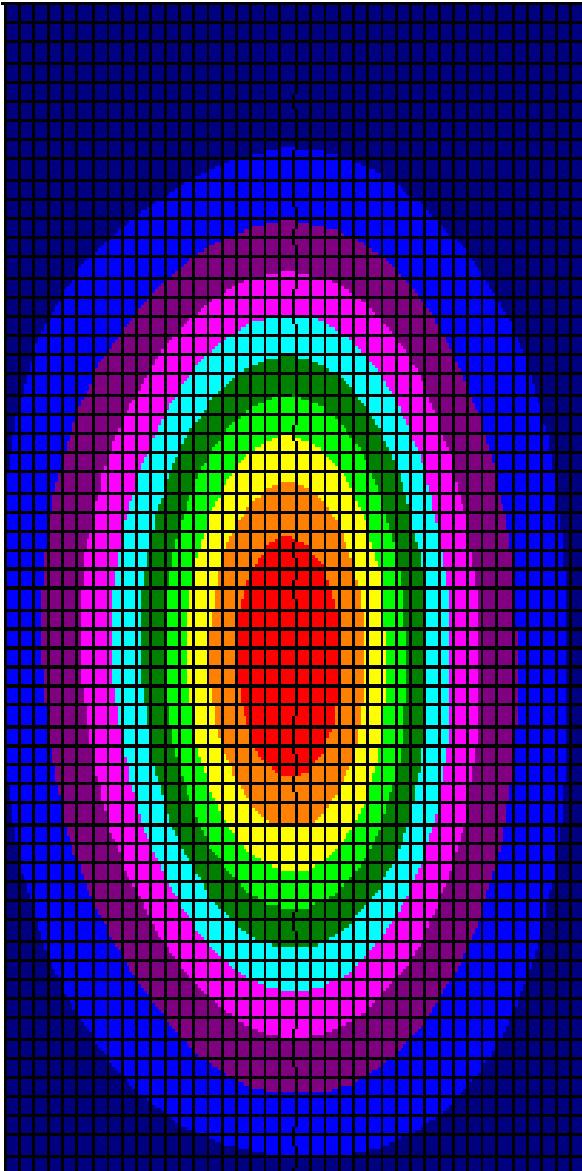

NCL Calibration Laboratories

Division of APREL Laboratories.

Test Equipment

The test equipment used during Probe Calibration, manufacturer, model number and, current calibration status are listed and located on the main APREL server R:\NCL\Calibration Equipment\Instrument List May 2008.