

## SAR Test Report

Product Name : Eee PC

Model No. : Eee PC 1015P, Eee PC 1015PE

Applicant : ASUSTEK COMPUTER INC.

Address : 4FL.,No.150, Li-Te Rd., Peitou, Taipei, Taiwan, R.O.C

Date of Receipt : 2010/03/25

Issued Date : 2010/04/08

Report No. : 103379R-HPUSP09V01

Report Version : V1.0

The test results relate only to the samples tested.

The test report shall not be reproduced except in full without the written approval of QuieTek Corporation.

---

# Test Report Certification

Issued Date: 2010/04/08

Report No.: 103379R-HPUSP09V01



Product Name : Eee PC  
 Applicant : ASUSTEK COMPUTER INC.  
 Address : 4FL.,No.150, Li-Te Rd., Peitou, Taipei, Taiwan, R.O.C  
 Manufacturer : PROTEK (SHANGHAI) LTD  
 Model No. : Eee PC 1015P, Eee PC 1015PE  
 Trade Name : ASUS  
 Transmitter Module : AZWAVE/RT3039  
 FCC ID : MSQE15NE762  
 Applicable Standard : FCC Oet65 Supplement C June 2001  
 IEEE Std. 1528-2003  
 47CFR § 2.1093  
 Test Result : Max. SAR Measurement (1g)  
**0.052** W/kg  
 Application Type : Certification

The test results relate only to the samples tested.

The test report shall not be reproduced except in full without the written approval of Quietek Corporation.

Documented By : Nicole Huang  
 ( Adm. Specialist / Nicole Huang )

Tested By : Jung Chang  
 ( Engineer / Jung Chang )

Approved By : Vincent Lin  
 ( Manager / Vincent Lin )

## TABLE OF CONTENTS

Description	Page
<b>1. General Information.....</b>	<b>5</b>
1.1 EUT Description .....	5
1.3 Test Environment .....	6
<b>2. SAR Measurement System.....</b>	<b>7</b>
2.1 DASY5 System Description .....	7
2.1.1 Applications .....	8
2.1.2 Area Scans.....	8
2.1.3 Zoom Scan (Cube Scan Averaging).....	8
2.1.4 Uncertainty of Inter-/Extrapolation and Averaging .....	8
2.2 DASY5 E-Field Probe .....	9
2.2.1 Isotropic E-Field Probe Specification .....	9
2.3 Boundary Detection Unit and Probe Mounting Device .....	10
2.4 DATA Acquisition Electronics (DAE) and Measurement Server .....	10
2.5 Robot.....	11
2.6 Light Beam Unit.....	11
2.7 Device Holder .....	12
2.8 SAM Twin Phantom .....	12
<b>3. Tissue Simulating Liquid .....</b>	<b>13</b>
3.1 The composition of the tissue simulating liquid .....	13
3.2 Tissue Calibration Result .....	13
3.3 Tissue Dielectric Parameters for Head and Body Phantoms .....	14
<b>4. SAR Measurement Procedure.....</b>	<b>15</b>
4.1 SAR System Validation.....	15
4.1.1 Validation Dipoles.....	15
4.1.2 Validation Result .....	15
4.2 SAR Measurement Procedure.....	16
<b>5. SAR Exposure Limits .....</b>	<b>17</b>
<b>6. Test Equipment List.....</b>	<b>18</b>
<b>7. Measurement Uncertainty.....</b>	<b>19</b>
<b>8. Peak Conducted Power Measurement .....</b>	<b>20</b>
<b>9. Test Results .....</b>	<b>21</b>
9.1 SAR Test Results Summary .....	21
Appendix.....	22

Appendix A. SAR System Validation Data..... 22

Appendix B. SAR measurement Data..... 22

Appendix C. Test Setup Photographs & EUT Photographs..... 22

Appendix D. Probe Calibration Data ..... 22

Appendix E. Dipole Calibration Data ..... 22

## 1. General Information

### 1.1 EUT Description

Product Name	Eee PC
Trade Name	ASUS
Model No.	Eee PC 1015P, Eee PC 1015PE
FCC ID	MSQE09NE762
TX Frequency	2412MHz ~ 2462MHz
Transmitter Module	AZWAVE/RT3039
Antenna Type	PIFA
Number of Channel	11
Type of Modulation	DSSS/OFDM
Device Category	Portable
RF Exposure Environment	Uncontrolled
Max. Output Power (Conducted)	802.11b: 18.99 dBm 802.11g: 19.20 dBm

### Antenna List

No.	Manufacturer	Part No.	Peak Gain
1	ACON	APP6P-700398	4.13dBi for 2.4 GHz

**1.3 Test Environment**

Ambient conditions in the laboratory:

Items	Required	Actual
Temperature (°C)	18-25	21.5± 2
Humidity (%RH)	30-70	54

Site Description:

Accredited by TAF  
 Accredited Number: 0914  
 Effective through: December 12, 2011



Site Name: Quietek Corporation

Site Address: No. 5-22, Ruei-Shu Valley, Ruei-Ping Tsuen,  
 Lin-Kou Shiang, Taipei,  
 Taiwan, R.O.C.  
 TEL : 886-2-8601-3788 / FAX : 886-2-8601-3789  
 E-Mail : [service@quietek.com](mailto:service@quietek.com)

## 2. SAR Measurement System

### 2.1 DASY5 System Description

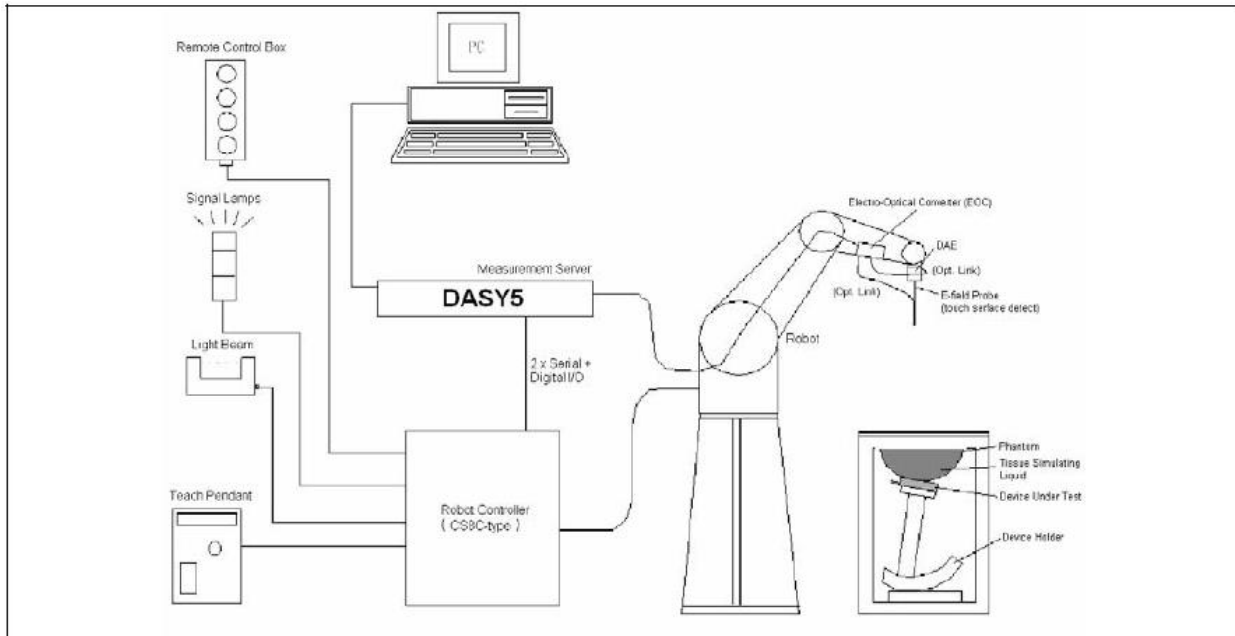

The DASY5 system for performing compliance tests consists of the following items:

- A standard high precision 6-axis robot with controller, teach pendant and software. An arm extension for accommodating the data acquisition electronics (DAE).
- A data acquisition electronics (DAE) which performs the signal amplification, signal multiplexing, AD-conversion, offset measurements, mechanical surface detection, collision detection, etc. The unit is battery powered with standard or rechargeable batteries. The signal is optically transmitted to the EOC.
- The Electro-optical converter (EOC) performs the conversion from optical to electrical signals for the digital communication to the DAE. To use optical surface detection, a special version of the EOC is required. The EOC signal is transmitted to the measurement server.
- The Light Beam used is for probe alignment. This improves the (absolute) accuracy of the probe positioning.
- A computer running WinXP and the DASY5 software.
- Remote control and teach pendant as well as additional circuitry for robot safety such as warning lamps, etc.
- The phantom, the device holder and other accessories according to the targeted measurement.

**2.1.1 Applications**

Predefined procedures and evaluations for automated compliance testing with all worldwide standards, e.g., IEEE 1528, OET 65, IEC 62209-1, IEC 62209-2, EN 50360, EN 50383 and others.

**2.1.2 Area Scans**

Area scans are defined prior to the measurement process being executed with a user defined variable spacing between each measurement point (integral) allowing low uncertainty measurements to be conducted. Scans defined for FCC applications utilize a 10mm<sup>2</sup> step integral, with 1mm interpolation used to locate the peak SAR area used for zoom scan assessments.

When an Area Scan has measured all reachable points, it computes the field maxima found in the scanned area, within a range of the global maximum. The range (in dB) is specified in the standards for compliance testing. For example, a 2 dB range is required in IEEE 1528-2003, EN 50361 and IEC 62209 standards, whereby 3 dB is a requirement when compliance is assessed in accordance with the ARIB standard (Japan).

**2.1.3 Zoom Scan (Cube Scan Averaging)**

Zoom Scans are used to assess the peak spatial SAR values within a cubic averaging volume containing 1 g and 10 g of simulated tissue. A density of 1000 kg/m<sup>3</sup> is used to represent the head and body tissue density and not the phantom liquid density, in order to be consistent with the definition of the liquid dielectric properties, i.e. the side length of the 1 g cube is 10mm, with the side length of the 10 g cube 21,5mm.

The zoom scan integer steps can be user defined so as to reduce uncertainty, but normal practice for typical test applications utilize a physical step of 7x7x7 (5mmx5mmx5mm) providing a volume of 30mm in the X & Y axis, and 30mm in the Z axis.

**2.1.4 Uncertainty of Inter-/Extrapolation and Averaging**

In order to evaluate the uncertainty of the interpolation, extrapolation and averaged SAR calculation algorithms of the Postprocessor, DASY5 allows the generation of measurement grids which are artificially predefined by analytically based test functions. Therefore, the grids of area scans and zoom scans can be filled with uncertainty test data, according to the SAR benchmark functions of IEEE 1528. The three analytical functions shown in equations as below are used to describe the possible range of the expected SAR distributions for the tested handsets. The field gradients are covered by the spatially flat



distribution f1, the spatially steep distribution f3 and f2 accounts for H-field cancellation on the phantom/tissue surface.

$$f_1(x, y, z) = Ae^{-\frac{z}{2a}} \cos^2 \left( \frac{\pi \sqrt{x'^2 + y'^2}}{2 \cdot 5a} \right)$$

$$f_2(x, y, z) = Ae^{-\frac{z}{a}} \frac{a^2}{a^2 + x'^2} \left( 3 - e^{-\frac{2z}{a}} \right) \cos^2 \left( \frac{\pi y'}{2 \cdot 3a} \right)$$

$$f_3(x, y, z) = A \frac{a^2}{\frac{a^2}{4} + x'^2 + y'^2} \left( e^{-\frac{2z}{a}} + \frac{a^2}{2(a + 2z)^2} \right)$$

**2.2 DASY5 E-Field Probe**

The SAR measurement is conducted with the dosimetric probe manufactured by SPEAG. The probe is specially designed and calibrated for use in liquid with high permittivity. The dosimetric probe has special calibration in liquid at different frequency. SPEAG conducts the probe calibration in compliance with international and national standards (e.g. IEEE 1528, EN 62209-1, IEC 62209, etc.) under ISO 17025. The calibration data are in Appendix D.

**2.2.1 Isotropic E-Field Probe Specification**

<b>Model</b>	Ex3DV4	
<b>Construction</b>	Symmetrical design with triangular core Built-in shielding against static charges PEEK enclosure material (resistant to organic solvents, e.g., DGBE)	
<b>Frequency</b>	10 MHz to 6 GHz Linearity: ± 0.2 dB (30 MHz to 6 GHz)	
<b>Directivity</b>	± 0.3 dB in HSL (rotation around probe axis) ± 0.5 dB in tissue material (rotation normal to probe axis)	
<b>Dynamic Range</b>	10 µW/g to 100 mW/g Linearity: ± 0.2 dB (noise: typically < 1 µW/g)	
<b>Dimensions</b>	Overall length: 330 mm (Tip: 20 mm) Tip diameter: 2.5 mm (Body: 12 mm) Typical distance from probe tip to dipole centers: 1 mm	
<b>Application</b>	High precision dosimetric measurements in any exposure scenario (e.g., very strong gradient fields). Only probe which enables compliance testing for frequencies up to 6 GHz with precision of better 30%.	

**2.3 Boundary Detection Unit and Probe Mounting Device**

The DASY probes use a precise connector and an additional holder for the probe, consisting of a plastic tube and a flexible silicon ring to center the probe. The connector at the DAE is flexibly mounted and held in the default position with magnets and springs. Two switching systems in the connector mount detect frontal and lateral probe collisions and trigger the necessary software response.

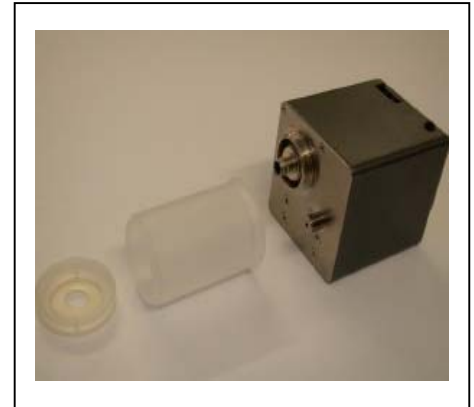

**2.4 DATA Acquisition Electronics (DAE) and Measurement Server**

The data acquisition electronics (DAE) consists of a highly sensitive electrometer-grade preamplifier with auto-zeroing, a channel and gain-switching multiplexer, a fast 16 bit AD-converter and a command decoder and control logic unit.

Transmission to the measurement server is accomplished through an optical downlink for data and status information as well as an optical uplink for commands and the clock.

The input impedance of the DAE4 is 200M Ohm; the inputs are symmetrical and floating. Common mode rejection is above 80dB.



The DASY5 measurement server is based on a PC/104 CPU board with a 400MHz intel ULV Celeron, 128MB chipdisk and 128MB RAM. The necessary circuits for communication with the DAE electronics box, as well as the 16 bit AD converter system for optical detection and digital I/O interface are contained on the DASY5 I/O board, which is directly connected to the PC/104 bus of the CPU board.



## 2.5 Robot

The DASY5 system uses the high precision robots TX90 XL type out of the newer series from Stäubli SA (France). For the 6-axis controller DASY5 system, the CS8C robot controller version from Stäubli is used.

The XL robot series have many features that are important for our application:

- High precision (repeatability 0.02 mm)
- High reliability (industrial design)
- Jerk-free straight movements
- Low ELF interference (the closed metallic construction shields against motor control fields)
- 6-axis controller



## 2.6 Light Beam Unit

The light beam switch allows automatic "tooling" of the probe. During the process, the actual position of the probe tip with respect to the robot arm is measured, as well as the probe length and the horizontal probe offset. The software then corrects all movements, such that the robot coordinates are valid for the probe tip.

The repeatability of this process is better than 0.1 mm. If a position has been taught with an aligned probe, the same position will be reached with another aligned probe within 0.1 mm, even if the other probe has different dimensions. During probe rotations, the probe tip will keep its actual position.



**2.7 Device Holder**

The DASY5 device holder is designed to cope with different positions given in the standard. It has two scales for the device rotation (with respect to the body axis) and the device inclination (with respect to the line between the ear reference points). The rotation center for both scales is the ear reference point (EPR).

Thus the device needs no repositioning when changing the angles.

The DASY5 device holder has been made out of low-loss POM material having the following dielectric parameters: relative permittivity  $\epsilon_r = 3$  and loss tangent  $\delta = 0.02$ . The amount of dielectric material has been reduced in the closest vicinity of the device, since measurements have suggested that the influence of the clamp on the test results could thus be lowered.



**2.8 SAM Twin Phantom**

The SAM twin phantom is a fiberglass shell phantom with 2mm shell thickness (except the ear region where shell thickness increases to 6mm). It has three measurement areas:

- Left head
- Right head
- Flat phantom



The bottom plate contains three pair of bolts for locking the device holder. The device holder positions are adjusted to the standard measurement positions in the three sections. A white cover is provided to tap the phantom during off-periods to prevent water evaporation and changes in the liquid parameters. On the phantom top, three reference markers are provided to identify the phantom position with respect to the robot.

### 3. Tissue Simulating Liquid

#### 3.1 The composition of the tissue simulating liquid

INGREDIENT (% Weight)	900MHz Head	1800MHz Head	2450MHz Head	2450MHz Body
<b>Water</b>	--	--	46.7	73.2
<b>Salt</b>	--	--	0.00	0.04
<b>Sugar</b>	--	--	0.00	0.00
<b>HEC</b>	--	--	0.00	0.00
<b>Preventol</b>	--	--	0.00	0.00
<b>DGBE</b>	--	--	53.3	26.7

#### 3.2 Tissue Calibration Result

The dielectric parameters of the liquids were verified prior to the SAR evaluation using APREL Dielectric Probe Kit and Anritsu MS4623B Vector Network Analyzer.

<b>Head Tissue Simulant Measurement</b>				
Frequency [MHz]	Description	Dielectric Parameters		Tissue Temp. [°C]
		$\epsilon_r$	$\sigma$ [s/m]	
2450MHz	Reference result ± 5% window	40.1 38.095 to 42.105	1.78 1.691 to 1.869	N/A
	08-Apr-10	41.12	1.82	20.2

<b>Body Tissue Simulant Measurement</b>				
Frequency [MHz]	Description	Dielectric Parameters		Tissue Temp. [°C]
		$\epsilon_r$	$\sigma$ [s/m]	
2450MHz	Reference result ± 5% window	52.7 50.065 to 55.335	1.95 1.8525 to 2.0475	N/A
	08-Apr-10	52.63	1.90	20.2
2412 MHz	Low channel	54.82	1.86	20.2
2437 MHz	Mid channel	53.61	1.88	20.2
2462 MHz	High channel	51.94	1.93	20.2

**3.3 Tissue Dielectric Parameters for Head and Body Phantoms**

The head tissue dielectric parameters recommended by the IEEE SCC-34/SC-2 in P1528 have been incorporated in the following table. These head parameters are derived from planar layer models simulating the highest expected SAR for the dielectric properties and tissue thickness variations in a human head. Other head and body tissue parameters that have not been specified in P1528 are derived from the tissue dielectric parameters computed from the 4-Cole-Cole equations described in Reference [12] and extrapolated according to the head parameters specified in P1528.

Target Frequency (MHz)	Head		Body	
	$\epsilon_r$	$\sigma$ (S/m)	$\epsilon_r$	$\sigma$ (S/m)
150	52.3	0.76	61.9	0.80
300	45.3	0.87	58.2	0.92
450	43.5	0.87	56.7	0.94
835	41.5	0.90	55.2	0.97
900	41.5	0.97	55.0	1.05
915	41.5	0.98	55.0	1.06
1450	40.5	1.20	54.0	1.30
1610	40.3	1.29	53.8	1.40
1800 – 2000	40.0	1.40	53.3	1.52
2450	39.2	1.80	52.7	1.95
3000	38.5	2.40	52.0	2.73
5800	35.3	5.27	48.2	6.00

( $\epsilon_r$  = relative permittivity,  $\sigma$  = conductivity and  $\rho = 1000 \text{ kg/m}^3$ )

## 4. SAR Measurement Procedure

### 4.1 SAR System Validation

#### 4.1.1 Validation Dipoles

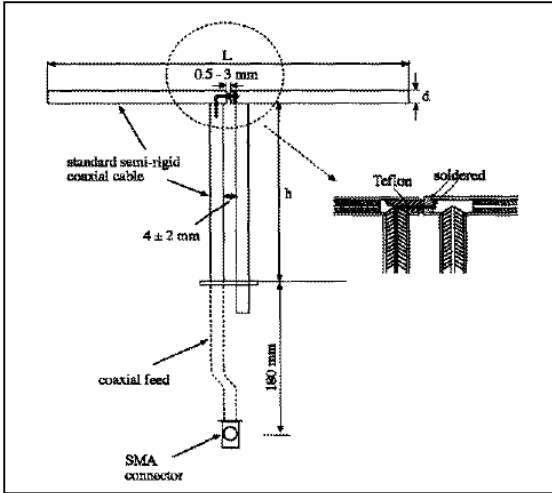

The dipoles used is based on the IEEE-1528 standard, and is complied with mechanical and electrical specifications in line with the requirements of both IEEE and FCC Supplement C. the table below provides details for the mechanical and electrical specifications for the dipoles.

Frequency	L (mm)	h (mm)	d (mm)
2450MHz	53.5	30.4	3.6

#### 4.1.2 Validation Result

System Performance Check at 2450MHz				
Validation Kit: ASL-D-2450-S-2				
Frequency [MHz]	Description	SAR [w/kg] 1g	SAR [w/kg] 10g	Tissue Temp. [°C]
2450 MHz	Reference result ± 10% window	48.07 43.263 to 52.877	25.65 23.085 to 28.215	N/A
	08-Apr-10	50.4	24.72	20.2
Note: All SAR values are normalized to 1W forward power.				

**4.2 SAR Measurement Procedure**

The ALSAS-10U calculates SAR using the following equation,

$$SAR = \frac{\sigma |E|^2}{\rho}$$

$\sigma$ : represents the simulated tissue conductivity

$\rho$ : represents the tissue density

The EUT is set to transmit at the required power in line with product specification, at each frequency relating to the LOW, MID, and HIGH channel settings.

Pre-scans are made on the device to establish the location for the transmitting antenna, using a large area scan in either air or tissue simulation fluid.

The EUT is placed against the Universal Phantom where the maximum area scan dimensions are larger than the physical size of the resonating antenna. When the scan size is not large enough to cover the peak SAR distribution, it is modified by either extending the area scan size in both the X and Y directions, or the device is shifted within the predefined area.

The area scan is then run to establish the peak SAR location (interpolated resolution set at 1mm<sup>2</sup> )which is then used to orient the center of the zoom scan. The zoom scan is then executed and the 1g and 10g averages are derived from the zoom scan volume (interpolated resolution set at 1mm<sup>3</sup> ).



**5. SAR Exposure Limits**

SAR assessments have been made in line with the requirements of IEEE-1528, FCC Supplement C, and comply with ANSI/IEEE C95.1-1992 “Uncontrolled Environments” limits. These limits apply to a location which is deemed as “Uncontrolled Environment” which can be described as a situation where the general public may be exposed to an RF source with no prior knowledge or control over their exposure.

**Limits for General Population/Uncontrolled Exposure (W/kg)**

<b>Type Exposure</b>	<b>Uncontrolled Environment Limit</b>
Spatial Peak SAR (1g cube tissue for brain or body)	<b>1.60 W/kg</b>
Spatial Average SAR (whole body)	<b>0.08 W/kg</b>
Spatial Peak SAR (10g for hands, feet, ankles and wrist)	<b>4.00 W/kg</b>

## 6. Test Equipment List

Instrument	Manufacturer	Model No.	Serial No.	Last Calibration	Next Calibration
Stäubli Robot TX60L	Stäubli	TX60L	F09/5BL1A1/A06	May. 2009	only once
Controller	Speag	CS8c	N/A	May. 2009	only once
Aprel Reference Dipole 2450Mhz	Aprel	ALS-D-2450-S-2	QTK-319	May. 2008	May. 2010
SAM Twin Phantom	Speag	QD000 P40 CA	Tp 1515	N/A	N/A
Device Holder	Speag	N/A	N/A	N/A	N/A
Data Acquisition Electronic	Speag	DAE4	1204	Apr. 2010	Apr. 2011
E-Field Probe	Speag	EX3DV4	3602	May. 2009	May. 2010
SAR Software	Speag	DASY5	V5.0 Build 125	N/A	N/A
Aprel Dipole Spaccer	Aprel	ALS-DS-U	QTK-295	N/A	N/A
Power Amplifier	Mini-Circuit	ZHL-42	D051404-20	N/A	N/A
Directional Coupler	Agilent	778D-012	50550	N/A	N/A
Universal Radio Communication Tester	R&S	CMU 200	104846	May. 2009	May. 2010
Vector Network	Anritsu	MS4623B	992801	Aug. 2009	Aug. 2010
Signal Generator	Anritsu	MG3692A	042319	Jun. 2009	Jun. 2010
Power Meter	Anritsu	ML2487A	6K00001447	Apr. 2010	Apr. 2011
Wide Bandwidth Sensor	Anritsu	MA2491	030677	Apr. 2010	Apr. 2011

7. Measurement Uncertainty

Uncertainty								
Error Description	Uncertainty value	Prob. Dist.	Div.	( $c_i$ ) 1g	( $c_i$ ) 10g	Std. Unc. (1g)	Std. Unc. (10g)	( $v_i$ ) $v_{eff}$
<b>Measurement System</b>								
Probe Calibration	±5.9 %	N	1	1	1	±5.9 %	±5.9 %	∞
Axial Isotropy	±4.7 %	R	√3	0.7	0.7	±1.9 %	±1.9 %	∞
Hemispherical Isotropy	±9.6 %	R	√3	0.7	0.7	±3.9 %	±3.9 %	∞
Boundary Effects	±1.0 %	R	√3	1	1	±0.6 %	±0.6 %	∞
Linearity	±4.7 %	R	√3	1	1	±2.7 %	±2.7 %	∞
System Detection Limits	±1.0 %	R	√3	1	1	±0.6 %	±0.6 %	∞
Readout Electronics	±0.3 %	N	1	1	1	±0.3 %	±0.3 %	∞
Response Time	±0.8 %	R	√3	1	1	±0.5 %	±0.5 %	∞
Integration Time	±2.6 %	R	√3	1	1	±1.5 %	±1.5 %	∞
RF Ambient Noise	±3.0 %	R	√3	1	1	±1.7 %	±1.7 %	∞
RF Ambient Reflections	±3.0 %	R	√3	1	1	±1.7 %	±1.7 %	∞
Probe Positioner	±0.4 %	R	√3	1	1	±0.2 %	±0.2 %	∞
Probe Positioning	±2.9 %	R	√3	1	1	±1.7 %	±1.7 %	∞
Max. SAR Eval.	±1.0 %	R	√3	1	1	±0.6 %	±0.6 %	∞
<b>Test Sample Related</b>								
Device Positioning	±2.9 %	N	1	1	1	±2.9 %	±2.9 %	145
Device Holder	±3.6 %	N	1	1	1	±3.6 %	±3.6 %	5
Power Drift	±5.0 %	R	√3	1	1	±2.9 %	±2.9 %	∞
<b>Phantom and Setup</b>								
Phantom Uncertainty	±4.0 %	R	√3	1	1	±2.3 %	±2.3 %	∞
Liquid Conductivity (target)	±5.0 %	R	√3	0.64	0.43	±1.8 %	±1.2 %	∞
Liquid Conductivity (meas.)	±2.5 %	N	1	0.64	0.43	±1.6 %	±1.1 %	∞
Liquid Permittivity (target)	±5.0 %	R	√3	0.6	0.49	±1.7 %	±1.4 %	∞
Liquid Permittivity (meas.)	±2.5 %	N	1	0.6	0.49	±1.5 %	±1.2 %	∞
Combined Std. Uncertainty						±10.9 %	±10.7 %	387
Expanded STD Uncertainty						±21.9 %	±21.4 %	

**8. Peak Conducted Power Measurement**

Test Mode	Channel No.	Frequency (MHz)	Conducted Power (dBm)
802.11b	01	2412	18.46
	06	2437	18.99
	11	2462	18.55
802.11g	01	2412	18.97
	06	2437	19.20
	11	2462	19.10
802.11n(20M)	01	2412	19.21
	06	2437	19.66
	11	2462	19.22
802.11n(40M)	03	2422	17.67
	06	2437	18.27
	09	2452	18.33

**9. Test Results**

**9.1 SAR Test Results Summary**

<b>SAR MEASUREMENT</b>						
Ambient Temperature (°C) : 21.5 ±2				Relative Humidity (%): 54		
Liquid Temperature (°C) : 20.2 ±2				Depth of Liquid (cm):>15		
Product: Eee PC						
Test Mode: 802.11g						
Test Position Body	Antenna Position	Frequency		Conducted Power (dBm)	SAR 1g (W/kg)	Limit (W/kg)
		Channel	MHz			
Bottom	Fixed	6	2437	19.20	0.050	1.6
Test Mode: 802.11b						
Bottom	Fixed	1	2412	18.46	0.039	1.6
Bottom	Fixed	6	2437	18.99	0.052	1.6
Bottom	Fixed	11	2462	18.55	0.043	1.6
Test Mode: 802.11n (20M)						
Bottom	Fixed	6	2437	19.66	0.038	1.6
Test Mode: 802.11n (40M)						
Bottom	Fixed	6	2437	18.27	0.038	1.6

**Appendix****Appendix A. SAR System Validation Data****Appendix B. SAR measurement Data****Appendix C. Test Setup Photographs & EUT Photographs****Appendix D. Probe Calibration Data****Appendix E. Dipole Calibration Data**

Appendix A. SAR System Validation Data

Date/Time: 4/8/2010

Test Laboratory: Quietek

**System Performance Check\_2450MHz-Head**

**DUT: Dipole 2450 MHz; Type: ALS-D-2450-S-2; Serial: QTK-319**

Communication System: CW; Frequency: 2450 MHz; Duty Cycle: 1:1

Medium parameters used:  $f = 2450$  MHz;  $\sigma = 1.82$  mho/m;  $\epsilon_r = 41.1$ ;  $\rho = 1000$  kg/m<sup>3</sup>

Phantom section: Flat Section

DASY4 Configuration:

- Probe: EX3DV4 - SN3602; ConvF(7.1, 7.1, 7.1); Calibrated: 5/20/2009
- Sensor-Surface: 2mm (Mechanical Surface Detection)
- Electronics: DAE4 Sn1207; Calibrated: 4/7/2009
- Phantom: SAM Left Table; Type: SAM
- Measurement SW: DASY5, V5.0 Build 125; SEMCAD X Version 13.4 Build 125

**2450MHz\_Head/Area Scan (7x7x1):** Measurement grid: dx=15mm, dy=15mm  
 Maximum value of SAR (measured) = 14.7 mW/g

**2450MHz\_Head/Zoom Scan (7x7x7) (5x5x7)/Cube 0:** Measurement grid: dx=8mm, dy=8mm, dz=5mm

Reference Value = 90.8 V/m; Power Drift = 0.096 dB

Peak SAR (extrapolated) = 28.1 W/kg

**SAR(1 g) = 12.6 mW/g; SAR(10 g) = 6.18 mW/g**

Maximum value of SAR (measured) = 20.7 mW/g

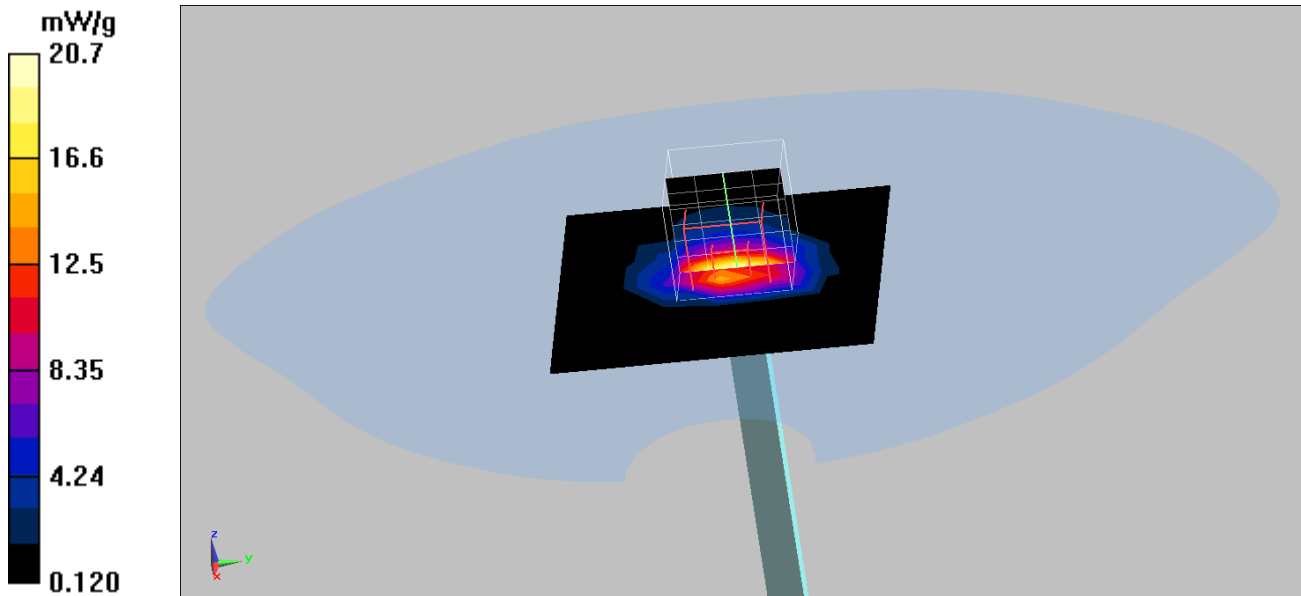

**Appendix B. SAR measurement Data**

Date/Time: 4/8/2010

Test Laboratory: Quietek

**802.11g\_6**

**DUT: Eee PC; Type: Eee PC 1015P, Eee PC 1015PE**

Communication System: 802.11b,g,n; Frequency: 2437 MHz;Duty Cycle: 1:1

Medium parameters used:  $f = 2437$  MHz;  $\sigma = 1.88$  mho/m;  $\epsilon_r = 53.6$ ;  $\rho = 1000$  kg/m<sup>3</sup>

Phantom section: Flat Section

Ambient Temperature (°C) : 21.5, Liquid Temperature (°C) : 20.2

DASY4 Configuration:

- Probe: EX3DV4 - SN3602; ConvF(6.9, 6.9, 6.9); Calibrated: 5/20/2009
- Sensor-Surface: 4mm (Mechanical Surface Detection)
- Electronics: DAE4 Sn1207; Calibrated: 4/7/2009
- Phantom: SAM Left Table; Type: SAM;
- Measurement SW: DASY5, V5.0 Build 125; SEMCAD X Version 13.4 Build 125

**Body/Area Scan (5x11x1):** Measurement grid: dx=13mm, dy=13mm

Maximum value of SAR (measured) = 0.043 mW/g

**Body/Zoom Scan (7x7x7) (7x7x7)/Cube 0:** Measurement grid: dx=5mm, dy=5mm, dz=5mm

Reference Value = 4.35 V/m; Power Drift = -0.045 dB

Peak SAR (extrapolated) = 0.059 W/kg

**SAR(1 g) = 0.050 mW/g; SAR(10 g) = 0.046 mW/g**

Maximum value of SAR (measured) = 0.059 mW/g

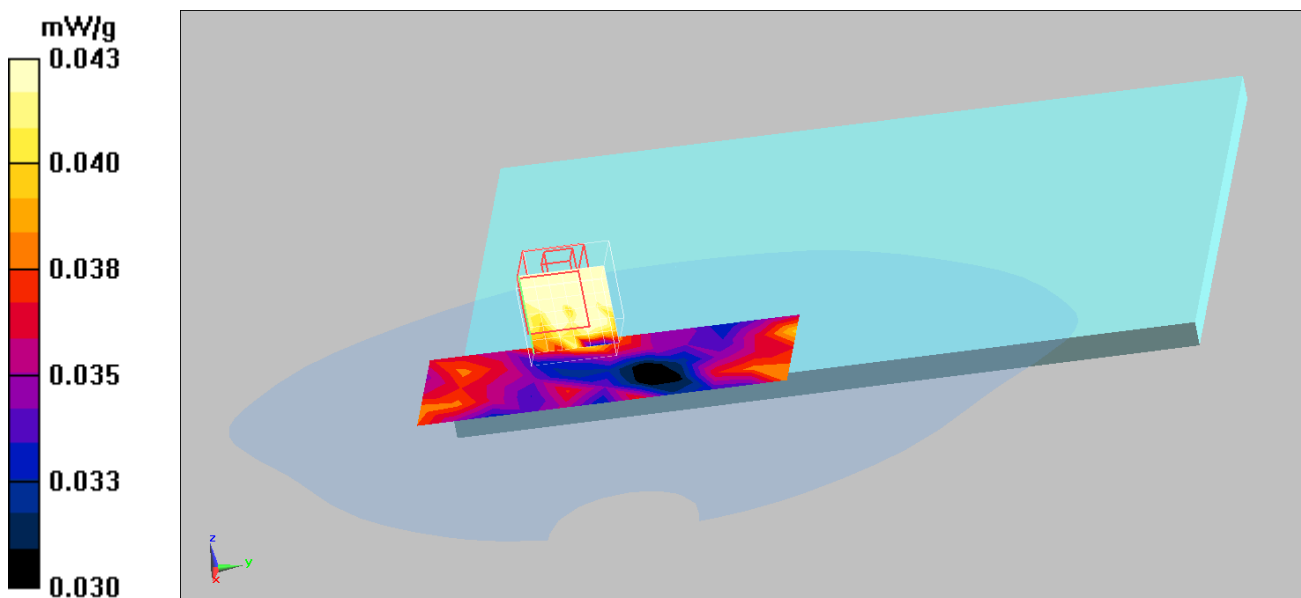



Date/Time: 4/8/2010

Test Laboratory: Quietek

**802.11b\_1**

**DUT: Eee PC; Type: Eee PC 1015P, Eee PC 1015PE**

Communication System: 802.11b,g,n; Frequency: 2412 MHz;Duty Cycle: 1:1

Medium parameters used:  $f = 2412$  MHz;  $\sigma = 1.86$  mho/m;  $\epsilon_r = 54.8$ ;  $\rho = 1000$  kg/m<sup>3</sup>

Phantom section: Flat Section

Ambient Temperature (°C) : 21.5, Liquid Temperature (°C) : 20.2

DASY4 Configuration:

- Probe: EX3DV4 - SN3602; ConvF(6.9, 6.9, 6.9); Calibrated: 5/20/2009
- Sensor-Surface: 4mm (Mechanical Surface Detection)
- Electronics: DAE4 Sn1207; Calibrated: 4/7/2009
- Phantom: SAM Left Table; Type: SAM;
- Measurement SW: DASY5, V5.0 Build 125; SEMCAD X Version 13.4 Build 125

**Body/Area Scan (5x11x1):** Measurement grid: dx=13mm, dy=13mm

Maximum value of SAR (measured) = 0.031 mW/g

**Body/Zoom Scan (7x7x7) (7x7x7)/Cube 0:** Measurement grid: dx=5mm, dy=5mm, dz=5mm

Reference Value = 3.59 V/m; Power Drift = 0.105 dB

Peak SAR (extrapolated) = 0.045 W/kg

**SAR(1 g) = 0.039 mW/g; SAR(10 g) = 0.035 mW/g**

Maximum value of SAR (measured) = 0.045 mW/g

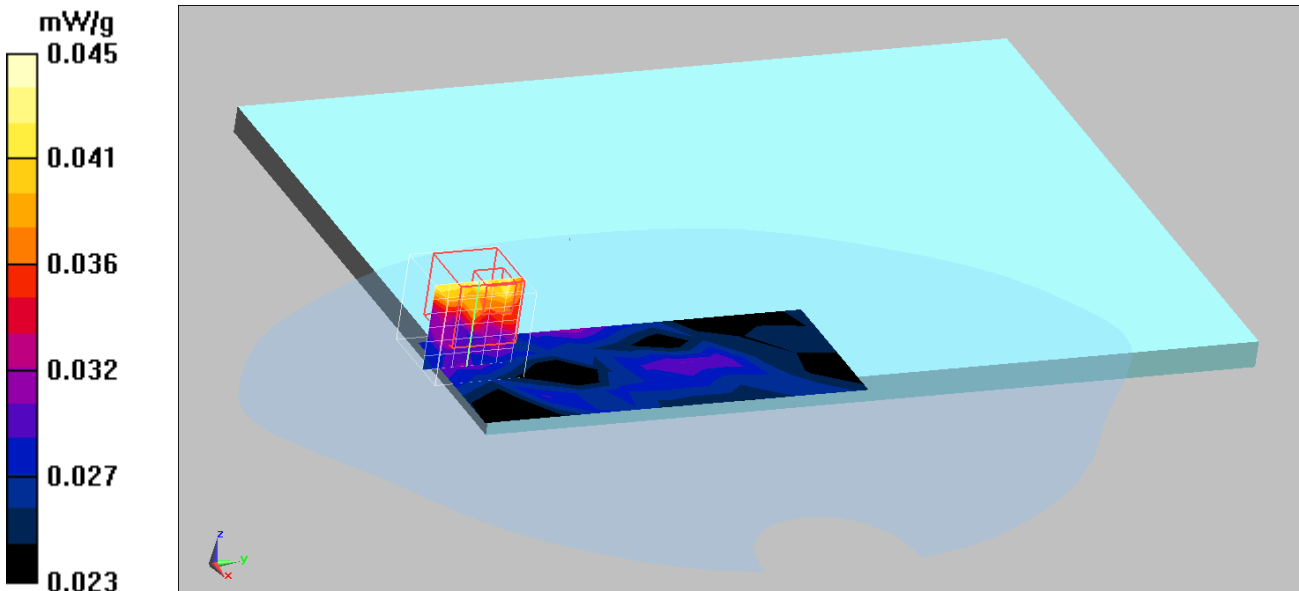

Date/Time: 4/8/2010

Test Laboratory: Quietek

**802.11b\_6**

**DUT: Eee PC; Type: Eee PC 1015P, Eee PC 1015PE**

Communication System: 802.11b,g,n; Frequency: 2437 MHz;Duty Cycle: 1:1

Medium parameters used:  $f = 2437$  MHz;  $\sigma = 1.88$  mho/m;  $\epsilon_r = 53.6$ ;  $\rho = 1000$  kg/m<sup>3</sup>

Phantom section: Flat Section

Ambient Temperature (°C) : 21.5, Liquid Temperature (°C) : 20.2

DASY4 Configuration:

- Probe: EX3DV4 - SN3602; ConvF(6.9, 6.9, 6.9); Calibrated: 5/20/2009
- Sensor-Surface: 4mm (Mechanical Surface Detection)
- Electronics: DAE4 Sn1207; Calibrated: 4/7/2009
- Phantom: SAM Left Table; Type: SAM;
- Measurement SW: DASY5, V5.0 Build 125; SEMCAD X Version 13.4 Build 125

**Body/Area Scan (5x11x1):** Measurement grid: dx=13mm, dy=13mm

Maximum value of SAR (measured) = 0.040 mW/g

**Body/Zoom Scan (7x7x7) (7x7x7)/Cube 0:** Measurement grid: dx=5mm, dy=5mm, dz=5mm

Reference Value = 4.18 V/m; Power Drift = -0.070 dB

Peak SAR (extrapolated) = 0.072 W/kg

**SAR(1 g) = 0.052 mW/g; SAR(10 g) = 0.042 mW/g**

Maximum value of SAR (measured) = 0.053 mW/g

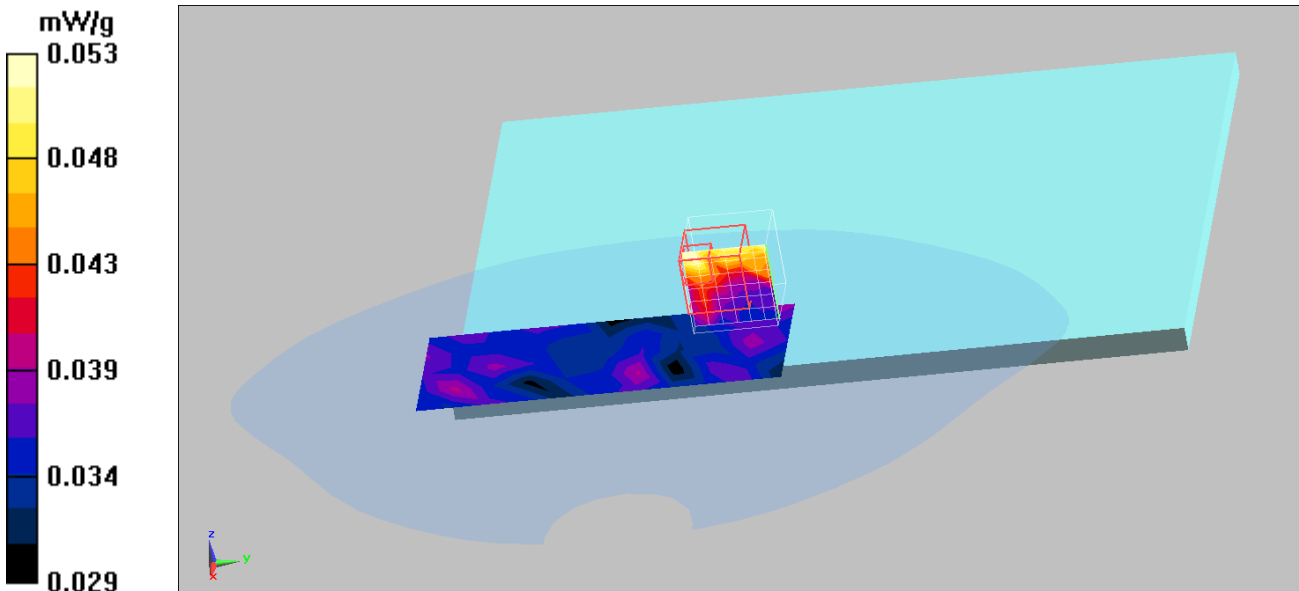

Date/Time: 4/8/2010

Test Laboratory: Quietek

**802.11b\_11**

**DUT: Eee PC; Type: Eee PC 1015P, Eee PC 1015PE**

Communication System: 802.11b,g,n; Frequency: 2462 MHz;Duty Cycle: 1:1

Medium parameters used:  $f = 2462$  MHz;  $\sigma = 1.93$  mho/m;  $\epsilon_r = 51.9$ ;  $\rho = 1000$  kg/m<sup>3</sup>

Phantom section: Flat Section

Ambient Temperature (°C) : 21.5, Liquid Temperature (°C) : 20.2

DASY4 Configuration:

- Probe: EX3DV4 - SN3602; ConvF(6.9, 6.9, 6.9); Calibrated: 5/20/2009
- Sensor-Surface: 4mm (Mechanical Surface Detection)
- Electronics: DAE4 Sn1207; Calibrated: 4/7/2009
- Phantom: SAM Left Table; Type: SAM;
- Measurement SW: DASY5, V5.0 Build 125; SEMCAD X Version 13.4 Build 125

**Body/Area Scan (5x11x1):** Measurement grid: dx=13mm, dy=13mm

Maximum value of SAR (measured) = 0.036 mW/g

**Body/Zoom Scan (7x7x7) (7x7x7)/Cube 0:** Measurement grid: dx=5mm, dy=5mm, dz=5mm

Reference Value = 3.86 V/m; Power Drift = 0.149 dB

Peak SAR (extrapolated) = 0.049 W/kg

**SAR(1 g) = 0.043 mW/g; SAR(10 g) = 0.039 mW/g**

Maximum value of SAR (measured) = 0.049 mW/g

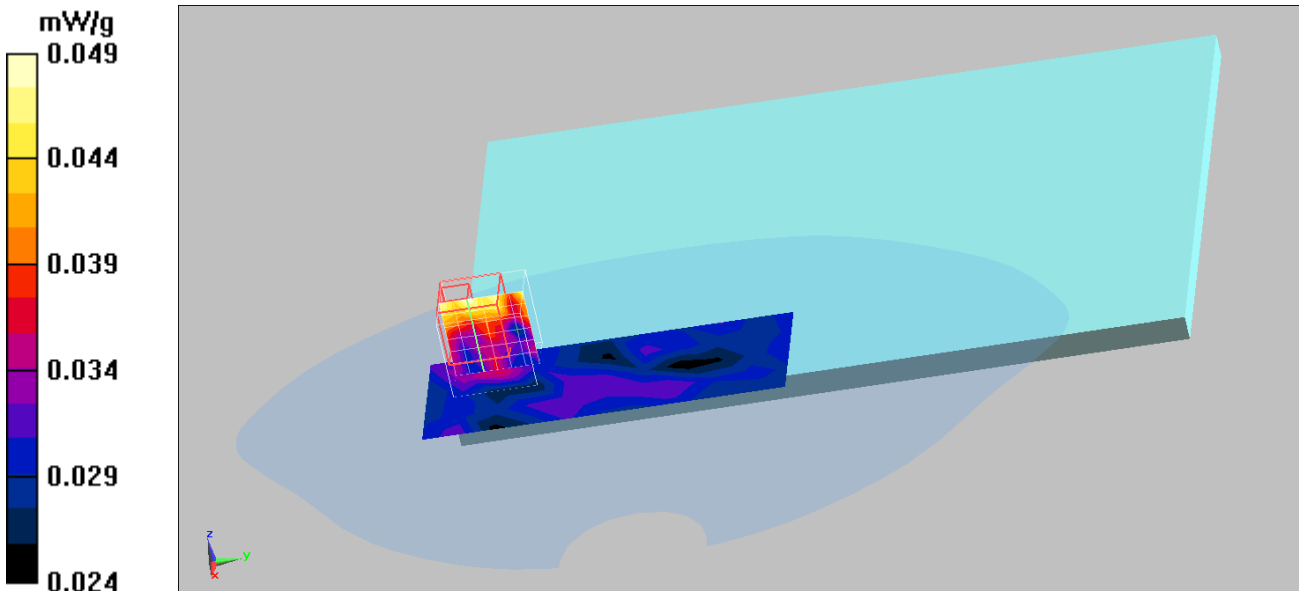

Date/Time: 4/8/2010

Test Laboratory: Quietek

**802.11b\_6 20M**

**DUT: Eee PC; Type: Eee PC 1015P, Eee PC 1015PE**

Communication System: 802.11b,g,n; Frequency: 2437 MHz;Duty Cycle: 1:1

Medium parameters used:  $f = 2437$  MHz;  $\sigma = 1.88$  mho/m;  $\epsilon_r = 53.6$ ;  $\rho = 1000$  kg/m<sup>3</sup>

Phantom section: Flat Section

Ambient Temperature (°C) : 21.5, Liquid Temperature (°C) : 20.2

DASY4 Configuration:

- Probe: EX3DV4 - SN3602; ConvF(6.9, 6.9, 6.9); Calibrated: 5/20/2009
- Sensor-Surface: 4mm (Mechanical Surface Detection)
- Electronics: DAE4 Sn1207; Calibrated: 4/7/2009
- Phantom: SAM Left Table; Type: SAM;
- Measurement SW: DASY5, V5.0 Build 125; SEMCAD X Version 13.4 Build 125

**Body/Area Scan (5x11x1):** Measurement grid: dx=13mm, dy=13mm

Maximum value of SAR (measured) = 0.035 mW/g

**Body/Zoom Scan (7x7x7) (7x7x7)/Cube 0:** Measurement grid: dx=5mm, dy=5mm, dz=5mm

Reference Value = 3.71 V/m; Power Drift = 0.074 dB

Peak SAR (extrapolated) = 0.045 W/kg

**SAR(1 g) = 0.038 mW/g; SAR(10 g) = 0.035 mW/g**

Maximum value of SAR (measured) = 0.045 mW/g

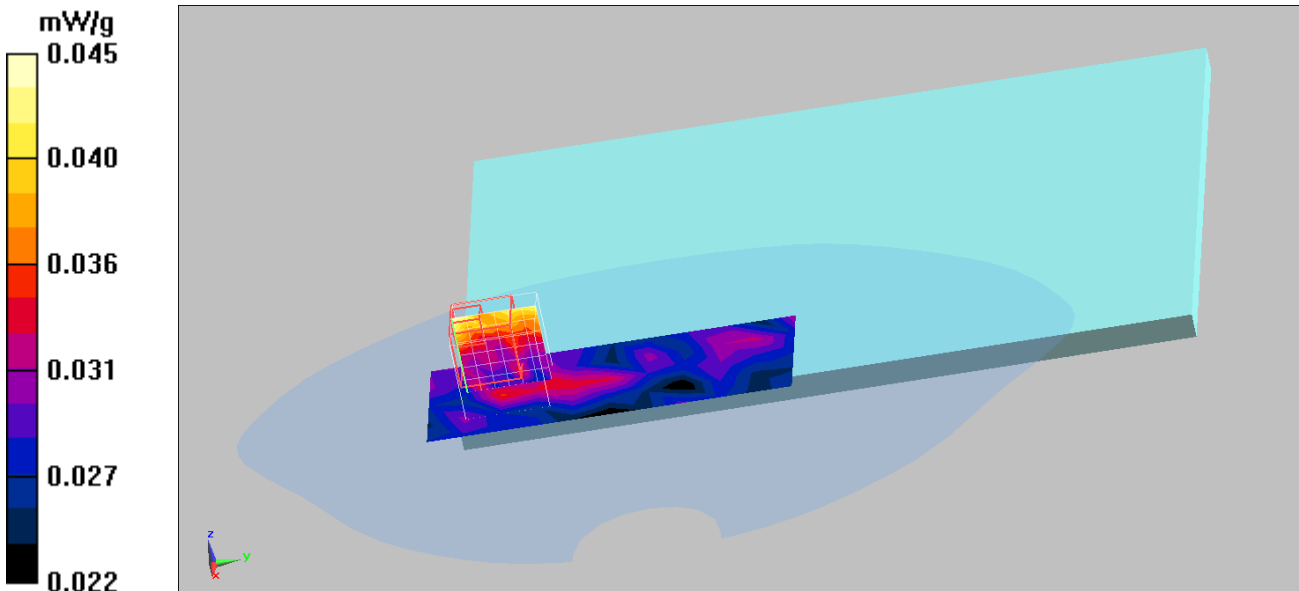

Date/Time: 4/8/2010

Test Laboratory: Quietek

**802.11b\_6 40M**

**DUT: Eee PC; Type: Eee PC 1015P, Eee PC 1015PE**

Communication System: 802.11b,g,n; Frequency: 2437 MHz;Duty Cycle: 1:1

Medium parameters used:  $f = 2437$  MHz;  $\sigma = 1.88$  mho/m;  $\epsilon_r = 53.6$ ;  $\rho = 1000$  kg/m<sup>3</sup>

Phantom section: Flat Section

Ambient Temperature (°C) : 21.5, Liquid Temperature (°C) : 20.2

DASY4 Configuration:

- Probe: EX3DV4 - SN3602; ConvF(6.9, 6.9, 6.9); Calibrated: 5/20/2009
- Sensor-Surface: 4mm (Mechanical Surface Detection)
- Electronics: DAE4 Sn1207; Calibrated: 4/7/2009
- Phantom: SAM Left Table; Type: SAM;
- Measurement SW: DASY5, V5.0 Build 125; SEMCAD X Version 13.4 Build 125

**Body/Area Scan (5x11x1):** Measurement grid: dx=13mm, dy=13mm

Maximum value of SAR (measured) = 0.031 mW/g

**Body/Zoom Scan (7x7x7) (7x7x7)/Cube 0:** Measurement grid: dx=5mm, dy=5mm, dz=5mm

Reference Value = 3.56 V/m; Power Drift = 0.141 dB

Peak SAR (extrapolated) = 0.044 W/kg

**SAR(1 g) = 0.038 mW/g; SAR(10 g) = 0.033 mW/g**

Maximum value of SAR (measured) = 0.044 mW/g

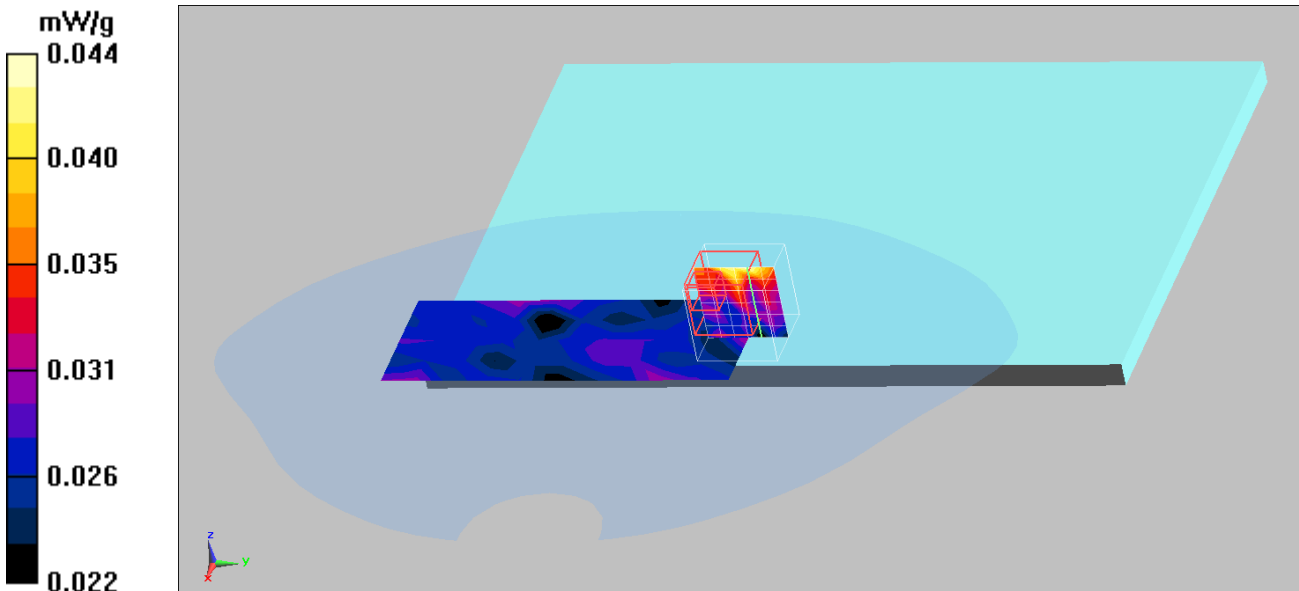

802.11b EUT Bottom, Z-Axis plot

Channel: 6

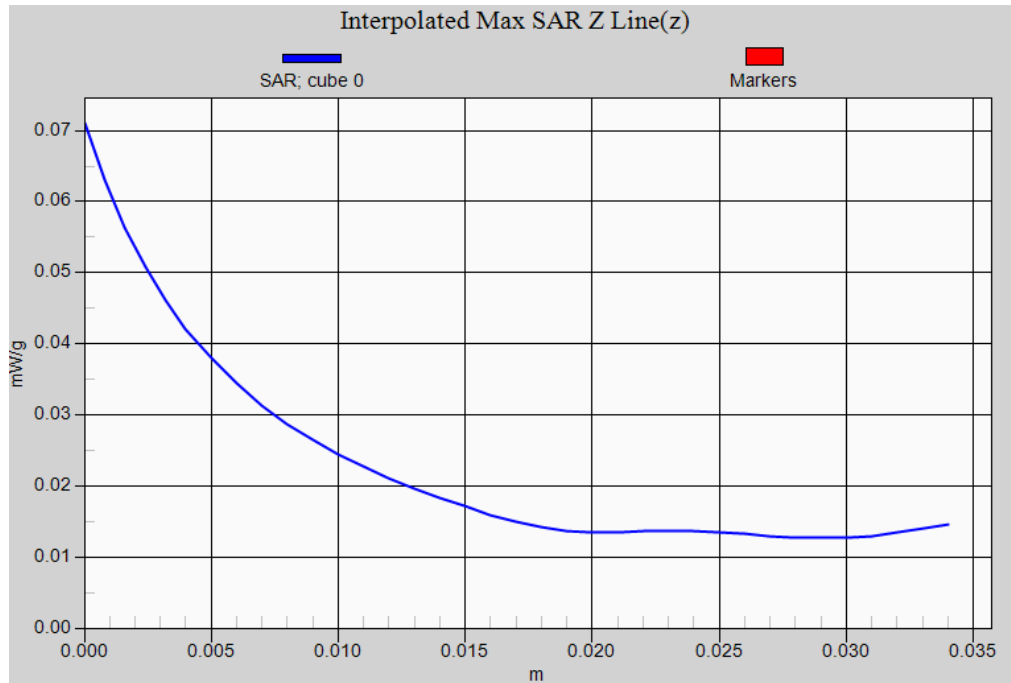



## **Appendix D. Probe Calibration Data**

**Miniature Isotropic RF Probe  
S/N: 3602**



Accredited by the Swiss Accreditation Service (SAS)  
The Swiss Accreditation Service is one of the signatories to the EA  
Multilateral Agreement for the recognition of calibration certificates

Accreditation No.: **SCS 108**

Client **Quietek (Auden)**

Certificate No: **EX3-3602\_May09**

## CALIBRATION CERTIFICATE

Object **EX3DV4 - SN:3602**

Calibration procedure(s) **QA CAL-01.v6, QA CAL-14.v3 and QA CAL-23.v3  
Calibration procedure for dosimetric E-field probes**

Calibration date: **May 20, 2009**

Condition of the calibrated item **In Tolerance**

This calibration certificate documents the traceability to national standards, which realize the physical units of measurements (SI).  
The measurements and the uncertainties with confidence probability are given on the following pages and are part of the certificate.

All calibrations have been conducted in the closed laboratory facility: environment temperature  $(22 \pm 3)^\circ\text{C}$  and humidity  $< 70\%$ .

Calibration Equipment used (M&TE critical for calibration)

Primary Standards	ID #	Cal Date (Certificate No.)	Scheduled Calibration
Power meter E4419B	GB41283874	1-Apr-09 (No. 217-01030)	Apr-10
Power sensor E4412A	MY41495277	1-Apr-09 (No. 217-01030)	Apr-10
Power sensor E4412A	MY41498087	1-Apr-09 (No. 217-01030)	Apr-10
Reference 3 dB Attenuator	SN: S5054 (3c)	31-Mar-09 (No. 217-01028)	Mar-10
Reference 20 dB Attenuator	SN: S5086 (20b)	31-Mar-09 (No. 217-01028)	Mar-10
Reference 30 dB Attenuator	SN: S5129 (30b)	31-Mar-09 (No. 217-01027)	Mar-10
Reference Probe ES3DV2	SN: 3013	2-Jan-09 (No. ES3-3013_Jan09)	Jan-10
DAE4	SN: 660	9-Sep-08 (No. DAE4-660_Sep08)	Sep-09

Secondary Standards	ID #	Check Date (in house)	Scheduled Check
RF generator HP 8648C	US3642U01700	4-Aug-99 (in house check Oct-07)	In house check: Oct-09
Network Analyzer HP 8753E	US37390585	18-Oct-01 (in house check Oct-08)	In house check: Oct-09

	Name	Function	Signature
Calibrated by:	Katja Pokovic	Technical Manager	
Approved by:	Niels Kuster	Quality Manager	

Issued: May 20, 2009

This calibration certificate shall not be reproduced except in full without written approval of the laboratory.





Accredited by the Swiss Accreditation Service (SAS)

The Swiss Accreditation Service is one of the signatories to the EA  
Multilateral Agreement for the recognition of calibration certificates

Accreditation No.: **SCS 108**

### Glossary:

TSL	tissue simulating liquid
NORM <sub>x,y,z</sub>	sensitivity in free space
ConvF	sensitivity in TSL / NORM <sub>x,y,z</sub>
DCP	diode compression point
Polarization $\varphi$	$\varphi$ rotation around probe axis
Polarization $\vartheta$	$\vartheta$ rotation around an axis that is in the plane normal to probe axis (at measurement center), i.e., $\vartheta = 0$ is normal to probe axis

### Calibration is Performed According to the Following Standards:

- IEEE Std 1528-2003, "IEEE Recommended Practice for Determining the Peak Spatial-Averaged Specific Absorption Rate (SAR) in the Human Head from Wireless Communications Devices: Measurement Techniques", December 2003
- IEC 62209-1, "Procedure to measure the Specific Absorption Rate (SAR) for hand-held devices used in close proximity to the ear (frequency range of 300 MHz to 3 GHz)", February 2005

### Methods Applied and Interpretation of Parameters:

- NORM<sub>x,y,z</sub>**: Assessed for E-field polarization  $\vartheta = 0$  ( $f \leq 900$  MHz in TEM-cell;  $f > 1800$  MHz: R22 waveguide). NORM<sub>x,y,z</sub> are only intermediate values, i.e., the uncertainties of NORM<sub>x,y,z</sub> does not effect the E<sup>2</sup>-field uncertainty inside TSL (see below ConvF).
- NORM(f)<sub>x,y,z</sub>** = NORM<sub>x,y,z</sub> \* frequency response (see Frequency Response Chart). This linearization is implemented in DASY4 software versions later than 4.2. The uncertainty of the frequency response is included in the stated uncertainty of ConvF.
- DCP<sub>x,y,z</sub>**: DCP are numerical linearization parameters assessed based on the data of power sweep (no uncertainty required). DCP does not depend on frequency nor media.
- ConvF and Boundary Effect Parameters**: Assessed in flat phantom using E-field (or Temperature Transfer Standard for  $f \leq 800$  MHz) and inside waveguide using analytical field distributions based on power measurements for  $f > 800$  MHz. The same setups are used for assessment of the parameters applied for boundary compensation (alpha, depth) of which typical uncertainty values are given. These parameters are used in DASY4 software to improve probe accuracy close to the boundary. The sensitivity in TSL corresponds to NORM<sub>x,y,z</sub> \* ConvF whereby the uncertainty corresponds to that given for ConvF. A frequency dependent ConvF is used in DASY version 4.4 and higher which allows extending the validity from  $\pm 50$  MHz to  $\pm 100$  MHz.
- Spherical isotropy (3D deviation from isotropy)**: in a field of low gradients realized using a flat phantom exposed by a patch antenna.
- Sensor Offset**: The sensor offset corresponds to the offset of virtual measurement center from the probe tip (on probe axis). No tolerance required.

# Probe EX3DV4

## SN:3602

Manufactured:	March 23, 2009
Calibrated:	May 20, 2009

Calibrated for DASY Systems

(Note: non-compatible with DASY2 system!)

## DASY - Parameters of Probe: EX3DV4 SN:3602

### Sensitivity in Free Space<sup>A</sup>

NormX	<b>0.41</b> ± 10.1%	$\mu\text{V}/(\text{V}/\text{m})^2$
NormY	<b>0.40</b> ± 10.1%	$\mu\text{V}/(\text{V}/\text{m})^2$
NormZ	<b>0.52</b> ± 10.1%	$\mu\text{V}/(\text{V}/\text{m})^2$

### Diode Compression<sup>B</sup>

DCP X	<b>87</b> mV
DCP Y	<b>89</b> mV
DCP Z	<b>89</b> mV

### Sensitivity in Tissue Simulating Liquid (Conversion Factors)

Please see Page 8.

### Boundary Effect

**TSL**                      **900 MHz**      **Typical SAR gradient: 5 % per mm**

Sensor Center to Phantom Surface Distance		<b>2.0 mm</b>	<b>3.0 mm</b>
SAR <sub>loc</sub> [%]	Without Correction Algorithm	10.2	6.1
SAR <sub>loc</sub> [%]	With Correction Algorithm	0.9	0.6

**TSL**                      **1810 MHz**      **Typical SAR gradient: 10 % per mm**

Sensor Center to Phantom Surface Distance		<b>2.0 mm</b>	<b>3.0 mm</b>
SAR <sub>ba</sub> [%]	Without Correction Algorithm	6.7	2.9
SAR <sub>ba</sub> [%]	With Correction Algorithm	0.5	0.3

### Sensor Offset

Probe Tip to Sensor Center                      **1.0 mm**

**The reported uncertainty of measurement is stated as the standard uncertainty of measurement multiplied by the coverage factor k=2, which for a normal distribution corresponds to a coverage probability of approximately 95%.**

<sup>A</sup> The uncertainties of NormX,Y,Z do not affect the E<sup>2</sup>-field uncertainty inside TSL. (see Page 8).

<sup>B</sup> Numerical linearization parameter: uncertainty not required.

## Frequency Response of E-Field

(TEM-Cell:ifi110 EXX, Waveguide: R22)

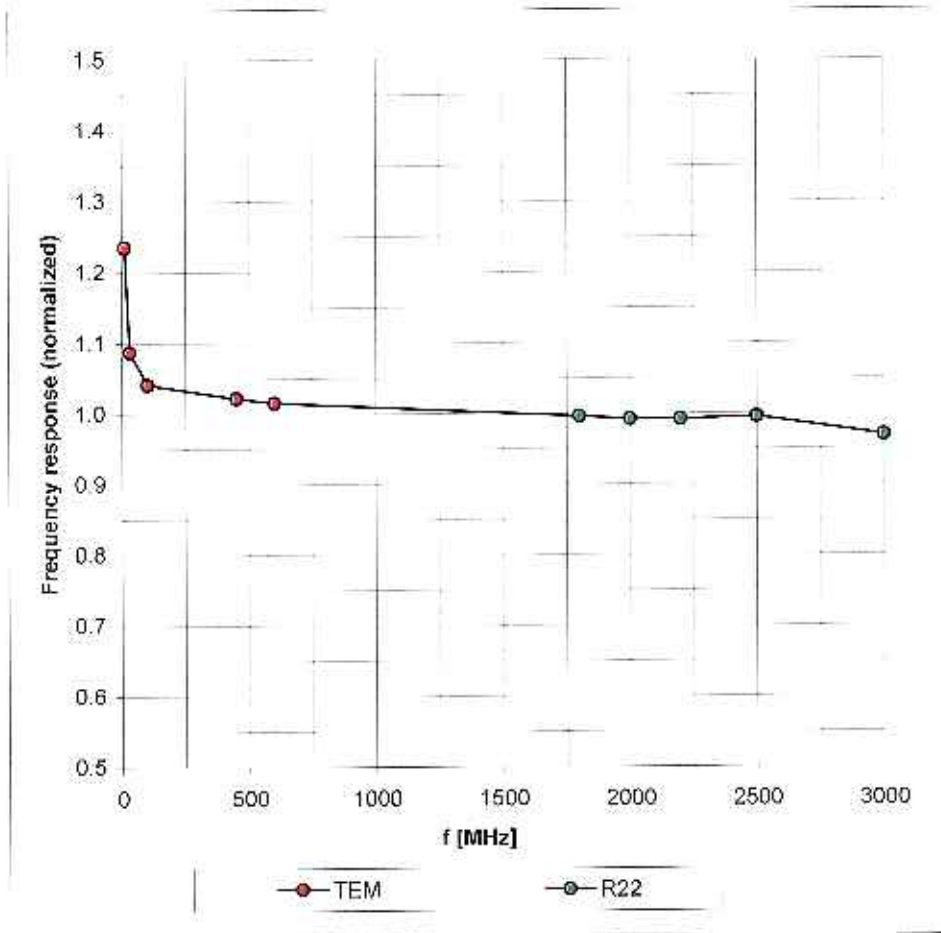

Uncertainty of Frequency Response of E-field:  $\pm 6.3\%$  ( $k=2$ )

### Receiving Pattern ( $\phi$ ), $\vartheta = 0^\circ$

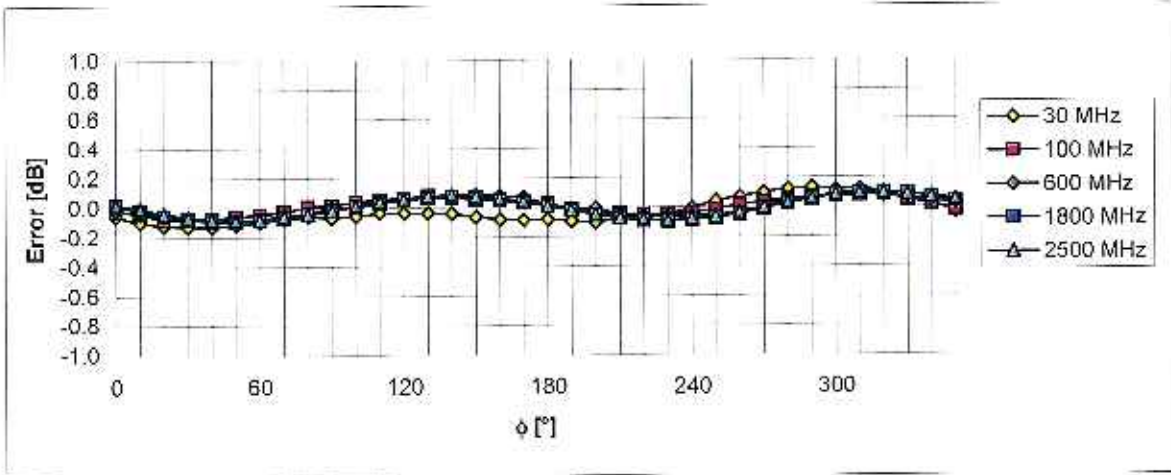
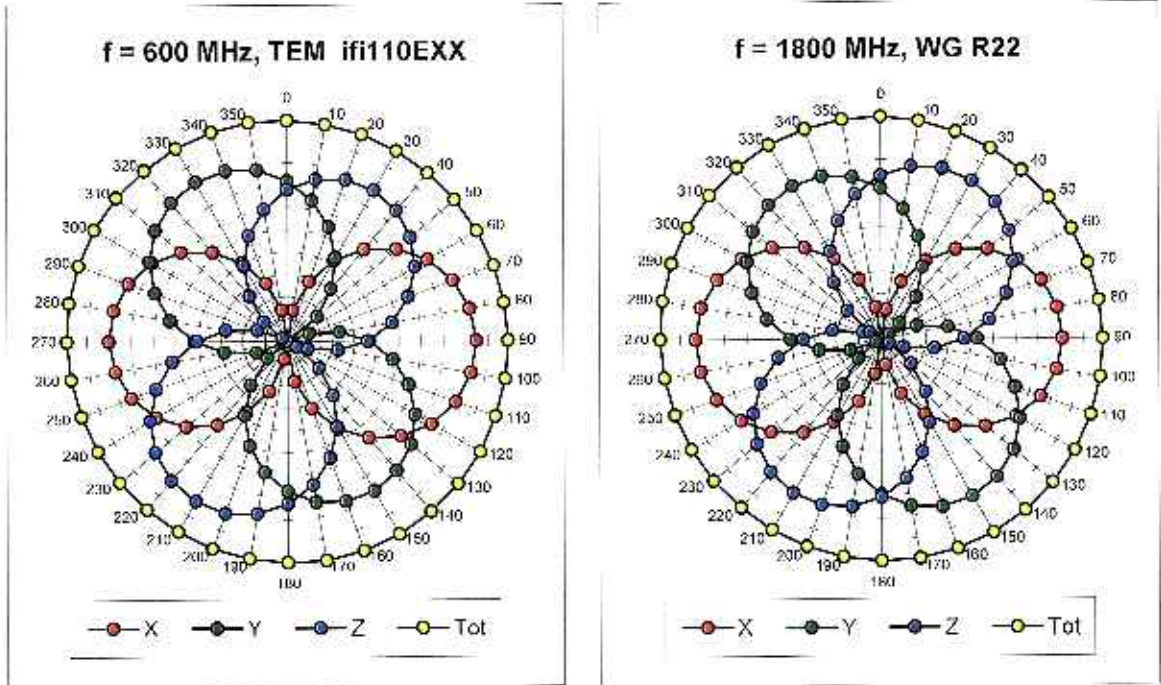

Uncertainty of Axial Isotropy Assessment:  $\pm 0.5\%$  ( $k=2$ )

### Dynamic Range f(SAR<sub>head</sub>) (Waveguide R22, f = 1800 MHz)

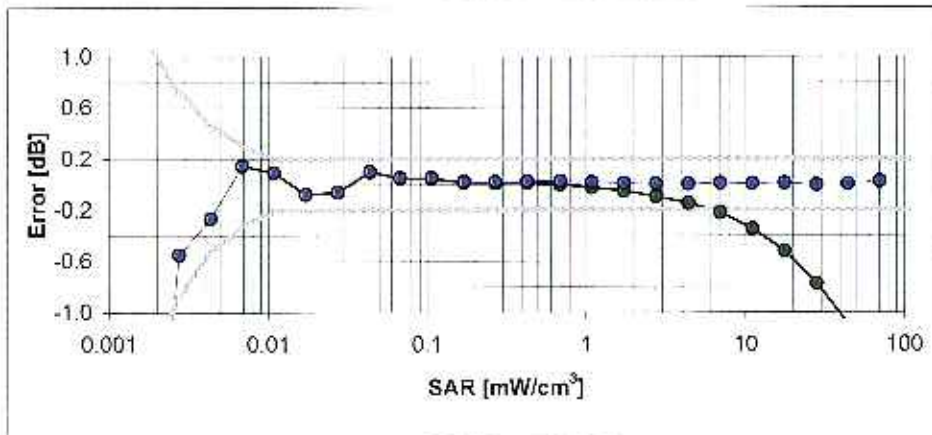
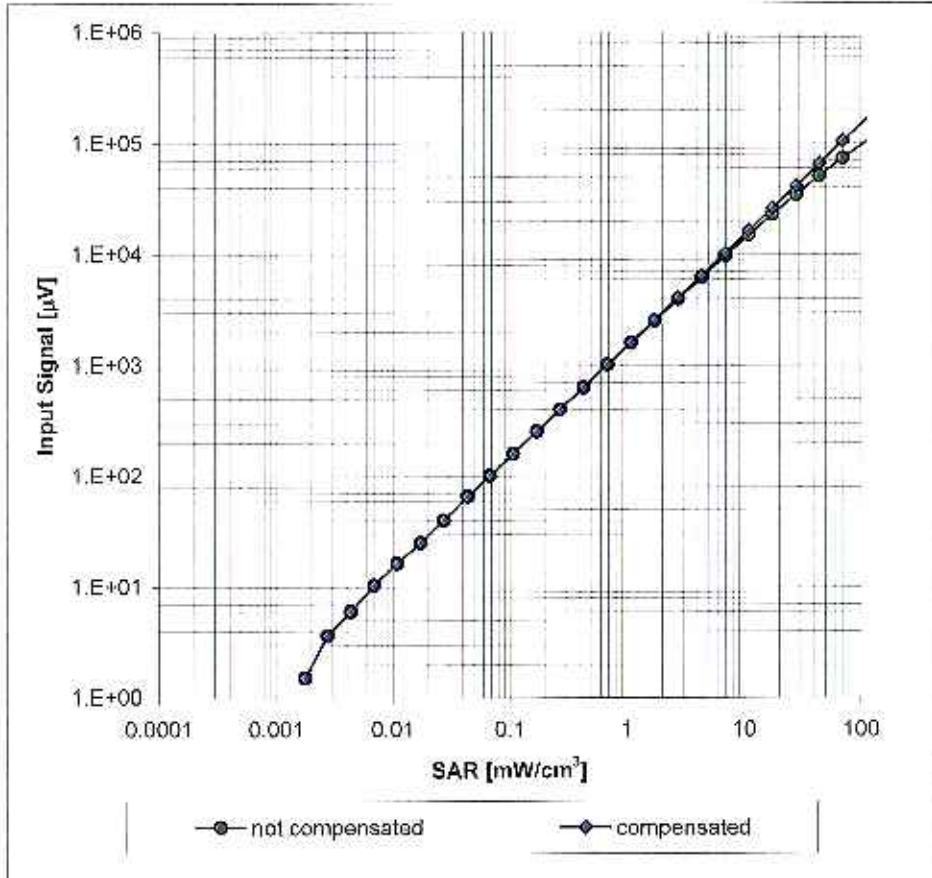

Uncertainty of Linearity Assessment:  $\pm 0.6\%$  (k=2)

## Conversion Factor Assessment

f [MHz]	Validity [MHz] <sup>c</sup>	TSL	Permittivity	Conductivity	Alpha	Depth	ConvF	Uncertainty
835	± 50 / ± 100	Head	41.5 ± 5%	0.90 ± 5%	0.56	0.71	9.14	± 11.0% (k=2)
900	± 50 / ± 100	Head	41.5 ± 5%	0.97 ± 5%	0.65	0.65	8.86	± 11.0% (k=2)
1810	± 50 / ± 100	Head	40.0 ± 5%	1.40 ± 5%	0.84	0.55	7.81	± 11.0% (k=2)
1950	± 50 / ± 100	Head	40.0 ± 5%	1.40 ± 5%	0.84	0.56	7.55	± 11.0% (k=2)
2450	± 50 / ± 100	Head	39.2 ± 5%	1.80 ± 5%	0.46	0.70	7.10	± 11.0% (k=2)
2600	± 50 / ± 100	Head	39.0 ± 5%	1.96 ± 5%	0.41	0.77	7.10	± 11.0% (k=2)
3500	± 50 / ± 100	Head	37.9 ± 5%	2.91 ± 5%	0.42	1.00	6.26	± 13.1% (k=2)
5200	± 50 / ± 100	Head	36.0 ± 5%	4.66 ± 5%	0.43	1.75	4.79	± 13.1% (k=2)
5300	± 50 / ± 100	Head	35.9 ± 5%	4.76 ± 5%	0.43	1.75	4.43	± 13.1% (k=2)
5500	± 50 / ± 100	Head	35.6 ± 5%	4.96 ± 5%	0.50	1.75	4.44	± 13.1% (k=2)
5600	± 50 / ± 100	Head	35.5 ± 5%	5.07 ± 5%	0.50	1.75	4.42	± 13.1% (k=2)
5800	± 50 / ± 100	Head	35.3 ± 5%	5.27 ± 5%	0.52	1.75	4.21	± 13.1% (k=2)
835	± 50 / ± 100	Body	55.2 ± 5%	0.97 ± 5%	0.72	0.65	9.32	± 11.0% (k=2)
900	± 50 / ± 100	Body	55.0 ± 5%	1.05 ± 5%	0.55	0.74	8.97	± 11.0% (k=2)
1810	± 50 / ± 100	Body	53.3 ± 5%	1.52 ± 5%	0.70	0.65	7.97	± 11.0% (k=2)
1950	± 50 / ± 100	Body	53.3 ± 5%	1.52 ± 5%	0.48	0.78	7.68	± 11.0% (k=2)
2450	± 50 / ± 100	Body	52.7 ± 5%	1.95 ± 5%	0.42	0.79	6.90	± 11.0% (k=2)
2600	± 50 / ± 100	Body	52.5 ± 5%	2.16 ± 5%	0.28	1.23	6.81	± 11.0% (k=2)
3500	± 50 / ± 100	Body	51.3 ± 5%	3.31 ± 5%	0.35	1.22	5.75	± 13.1% (k=2)
5200	± 50 / ± 100	Body	49.0 ± 5%	5.30 ± 5%	0.50	1.80	4.43	± 13.1% (k=2)
5300	± 50 / ± 100	Body	48.5 ± 5%	5.42 ± 5%	0.52	1.80	4.23	± 13.1% (k=2)
5500	± 50 / ± 100	Body	48.6 ± 5%	5.65 ± 5%	0.55	1.80	4.08	± 13.1% (k=2)
5600	± 50 / ± 100	Body	48.5 ± 5%	5.77 ± 5%	0.55	1.80	3.95	± 13.1% (k=2)
5800	± 50 / ± 100	Body	48.2 ± 5%	6.00 ± 5%	0.61	1.80	4.00	± 13.1% (k=2)

<sup>c</sup> The validity of ± 100 MHz only applies for DASY v4.4 and higher (see Page 2). The uncertainty is the RSS of the ConvF uncertainty at calibration frequency and the uncertainty for the indicated frequency band.

### Deviation from Isotropy in HSL

Error ( $\phi$ ,  $\theta$ ),  $f = 900$  MHz

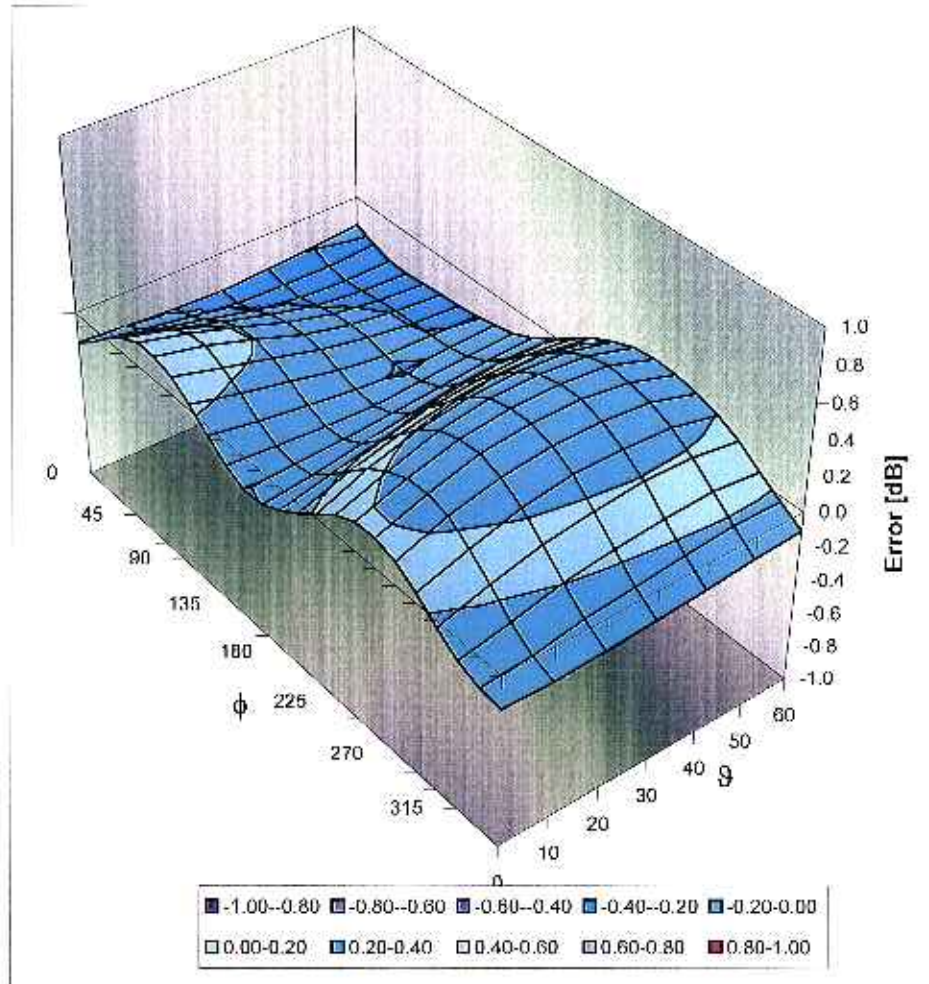

Uncertainty of Spherical Isotropy Assessment:  $\pm 2.6\%$  ( $k=2$ )





## **Appendix E. Dipole Calibration**

**Validation Dipole 2450 MHz**

**M/N: ALS-D-2450-S-2**

**S/N: QTK-319**

# NCL CALIBRATION LABORATORIES

Calibration File No: DC-891

## CERTIFICATE OF CALIBRATION

It is certified that the equipment identified below has been calibrated in the **NCL CALIBRATION LABORATORIES** by qualified personnel following recognized procedures and using transfer standards traceable to NRC/NIST.

Quietek Validation Dipole

Manufacturer: APREL Laboratories

Part number: ALS-D-2450-S-2

Frequency: 2.45 GHz

Serial No: QTK-319

Customer: Quietek

Project Number: QTKB-Dipole-CAL-5336

Calibrated: 9<sup>th</sup> May 2008  
Released on: 9<sup>th</sup> May 2008

This Calibration Certificate is Incomplete Unless Accompanied with the Calibration Results Summary

Released By: \_\_\_\_\_

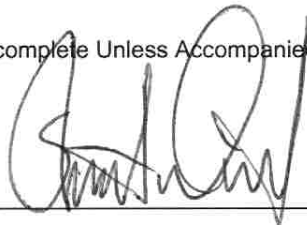

**NCL CALIBRATION LABORATORIES**

51 SPECTRUM WAY  
NEPEAN, ONTARIO  
CANADA K2R 1E6

Division of APREL Lab.  
TEL: (613) 820-4988  
FAX: (613) 820-4161

## Calibration Results Summary

The following results relate the Calibrated Dipole and should be used as a quick reference for the user.

### Mechanical Dimensions

**Length:** 53.5 mm  
**Height:** 30.4 mm

### Electrical Specification

**SWR:** 1.19 U  
**Return Loss:** -20.8 dB  
**Impedance:** 49.4  $\Omega$

### System Validation Results

Frequency	1 Gram	10 Gram	Peak
2.45 GHz	48.07	25.65	95.6

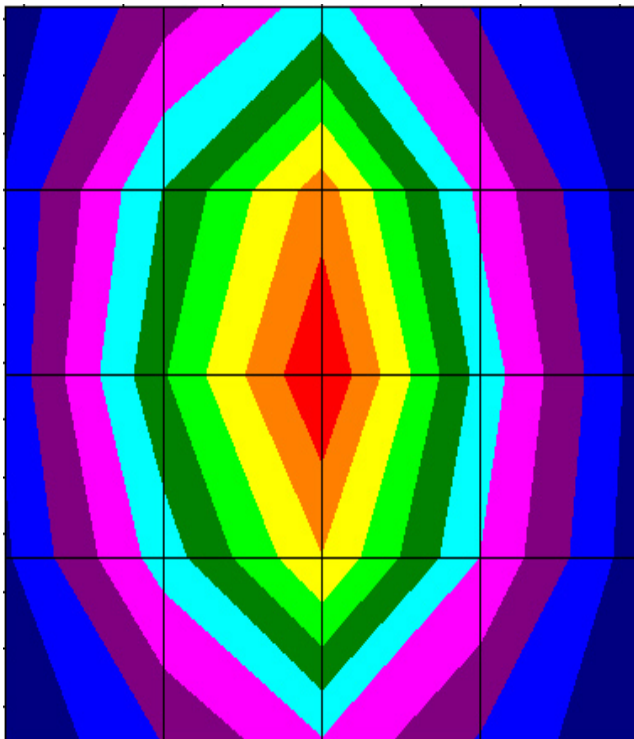

## Conditions

Dipole 319 is a recalibration.

**Ambient Temperature of the Laboratory:** 22 °C +/- 0.5°C  
**Temperature of the Tissue:** 21 °C +/- 0.5°C

## References

SSI-TP-018-ALSAS Dipole Calibration Procedure

SSI-TP-016 Tissue Calibration Procedure

IEEE 1528 “Recommended Practice for Determining the Peak Spatial-Average Specific Absorption Rate (SAR) in the Human Body Due to Wireless Communications Devices: Experimental Techniques”

IEC 62209 “Human exposure to radio frequency fields from hand-held and body-mounted wireless communication devices – Human models, instrumentation, and procedures –Part 1 & Part 2: Procedure to determine the specific absorption rate (SAR) for mobile wireless communication devices used in close proximity to the human body (frequency range of 30 MHz to 6 GHz)

We the undersigned attest that to the best of our knowledge the calibration of this device has been accurately conducted and that all information contained within this report has been reviewed for accuracy.



-----  
**Stuart Nicol**



-----  
**C. Teodorian**

## Dipole Calibration Results

### Mechanical Verification

<b>IEEE Length</b>	<b>IEEE Height</b>	<b>Measured Length</b>	<b>Measured Height</b>
51.5 mm	30.4 mm	53.5 mm	30.4 mm

### Tissue Validation

<b>Head Tissue 2450 MHz</b>	<b>Measured</b>
<b>Dielectric constant, <math>\epsilon_r</math></b>	40.1
<b>Conductivity, <math>\sigma</math> [S/m]</b>	1.78

**Electrical Calibration**

Test	Result
S11 R/L	-20.8 dB
SWR	1.2 U
Impedance	49.4 $\Omega$

The Following Graphs are the results as displayed on the Vector Network Analyzer.

**S11 Parameter Return Loss**

S11 FORWARD REFLECTION

LOG MAGNITUDE

REF = -25.000 dB

5.000 dB/DIV

CH 1 - S11  
REFERENCE PLANE  
0.0000 mm

MARKER 1  
2.450046 GHz  
-20.796 dB

MARKER TO MAX  
▶ MARKER TO MIN

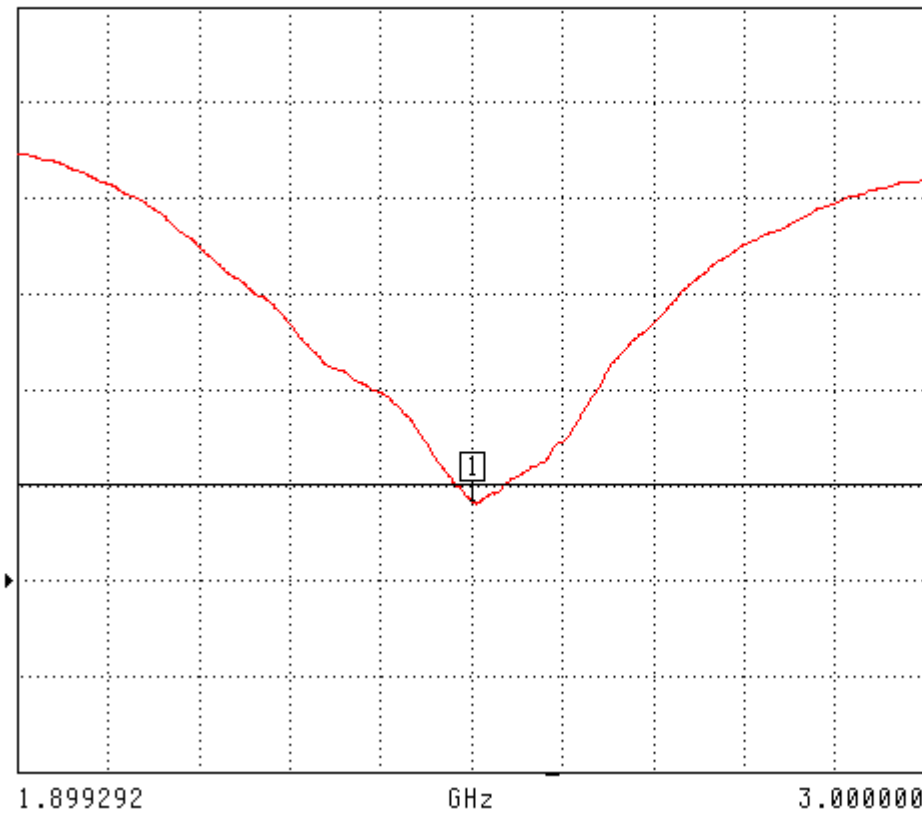

MARKER READOUT  
FUNCTIONS

SWR

S11 FORWARD REFLECTION

SWR

REF=500.000 mU

1.000 U/DIV

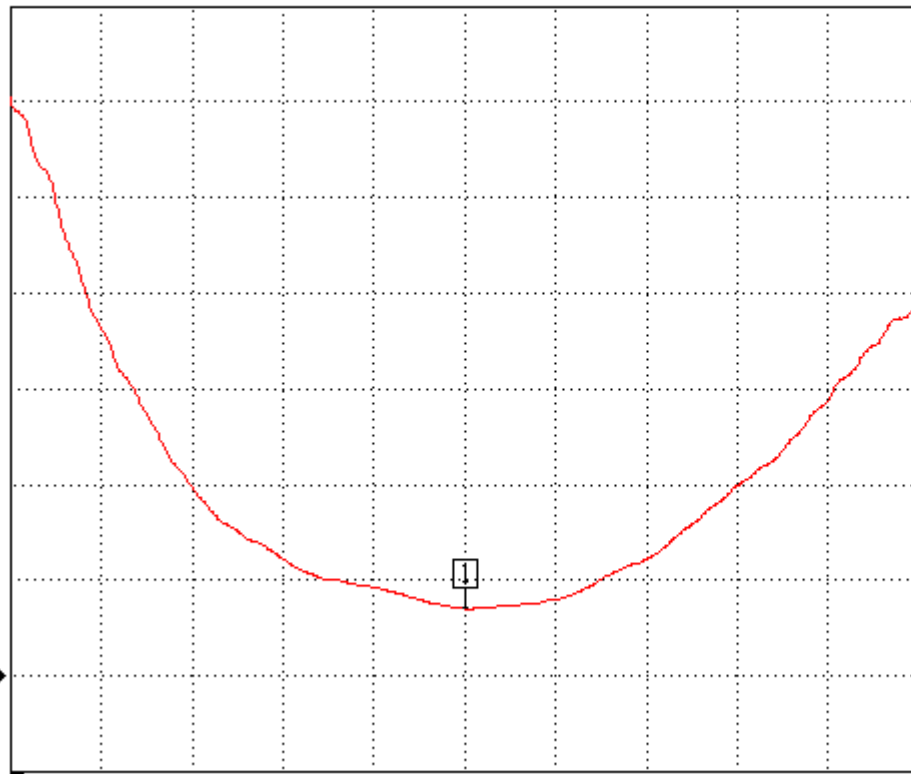

CH 1 - S11  
REFERENCE PLANE  
0.0000 mm

MARKER 1  
2.450046 GHz  
1.199 U

MARKER TO MAX  
▶ MARKER TO MIN

1.899292

GHz

3.000000

MARKER READOUT  
FUNCTIONS

## Smith Chart Dipole Impedance

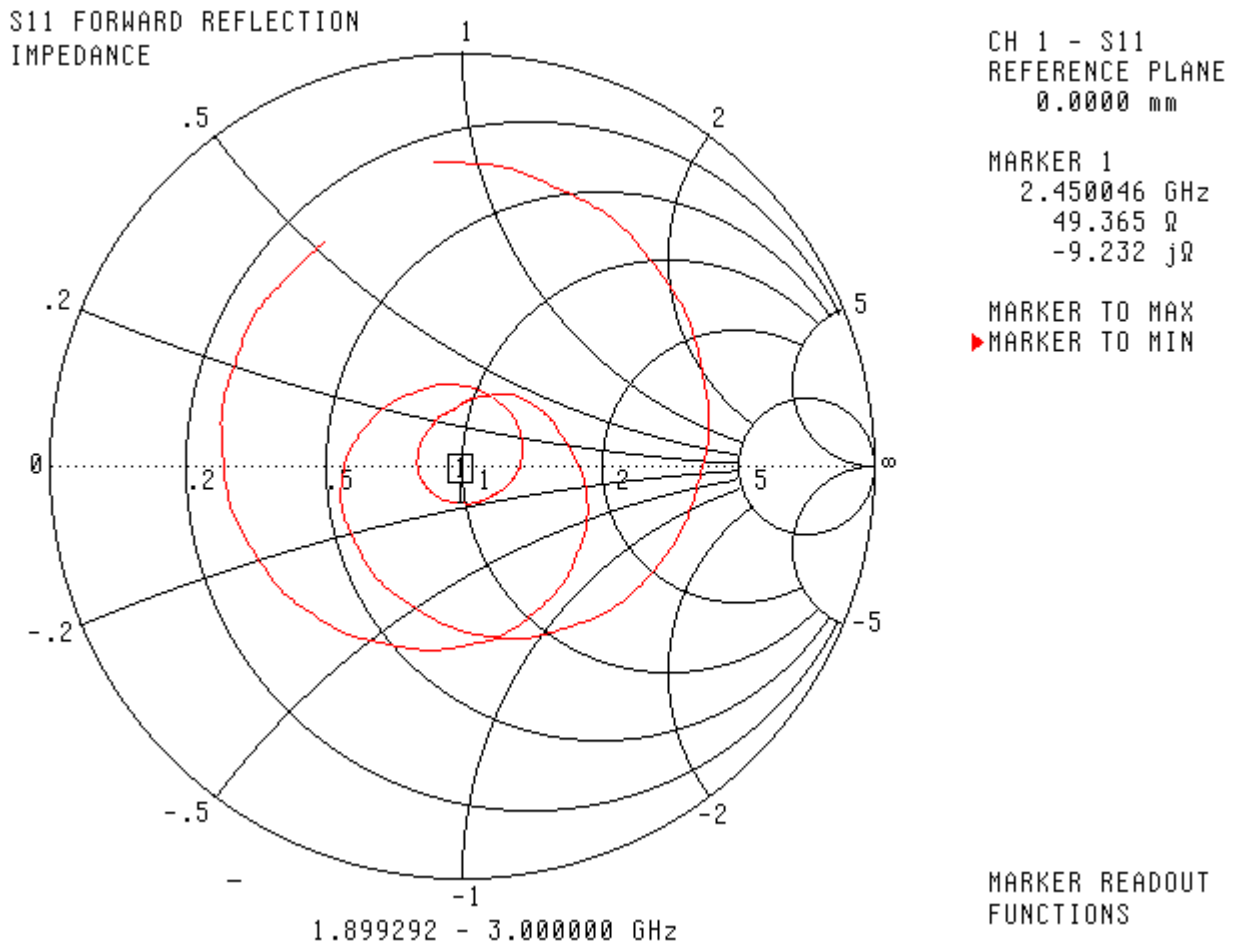



**System Validation Results Using the Electrically Calibrated Dipole**

<b>Frequency</b>	<b>1 Gram</b>	<b>10 Gram</b>	<b>Peak Above Feed Point</b>
2.45 GHz	48.07	25.65	95.6

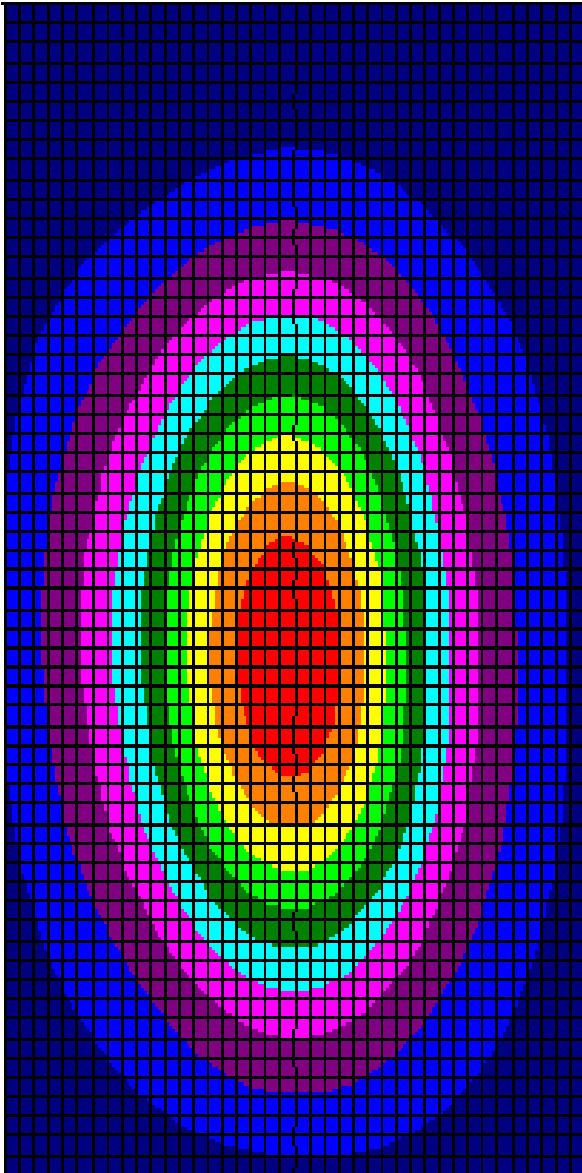

## **NCL Calibration Laboratories**

---

Division of APREL Laboratories.

### **Test Equipment**

The test equipment used during Probe Calibration, manufacturer, model number and, current calibration status are listed and located on the main APREL server R:\NCL\Calibration Equipment\Instrument List May 2008.