

FCC Part22H&24E Test Report

Industry Canada RSS-132/RSS-133

Product Name : Eee PC
Model No. : Eee PC 1005HAG,
Eee PC 1005HAGB
FCC ID : MSQE05GOBIII
IC ID : 3568A-E05GOBIII

Applicant : ASUSTEK COMPUTER INC.

Address : NO.150, Li-Te Dd., Peitou, Taipei, Taiwan, R.O.C

Date of Receipt : 2009/06/25
Issued Date : 2009/08/04
Report No. : 098S010R-HP-US-P07V01
Report Version : V1.0

The test results relate only to the samples tested.

The test results shown in the test report are traceable to the national/international standard through the calibration of the equipment and evaluated measurement uncertainty herein.

This report must not be used to claim product endorsement by CNLA, NVLAP, NIST or any agency of the Government.

The test report shall not be reproduced except in full without the written approval of QuieTek Corporation.

Test Report Certification

Issued Date : 2009/08/04

Report No. : 098S010R-HP-US-P07V01



Product Name : Eee PC
 Applicant : ASUSTEK COMPUTER INC.
 Address : NO.150, Li-Te Dd., Peitou, Taipei, Taiwan, R.O.C
 Manufacturer : PROTEK (SHANGHAI) LTD.
 Address : 3768 XIU YAN RD NANHUI DISTRICT SHANGHAI CHINA
 Model No. : Eee PC 1005HAG, Eee PC 1005HAGB
 FCC ID : MSQE05GOBII
 EUT Voltage : AC 100-240V, 50/60Hz
 Trade Name : ASUS
 Applicable Standard : FCC CFR Title 47 Part 2, TIA/EIA 603-C, RSS-GEN Issue 2
 FCC Part22 Subpart H, FCC Part24 Subpart E
 Industry Canada RSS-132, Issue 2
 Industry Canada RSS-133, Issue 5
 Test Result : Complied
 Performed Location : SuZhou EMC laboratory
 No.99 Hongye Rd., Suzhou Industrial Park Loufeng Hi-Tech
 Development Zone., SuZhou, China
 TEL: +86-512-6251-5088 / FAX: +86-512-6251-5098
 FCC Registration Number: 800392; IC Lab Code: 4075B

Documented By : Alice Ni
 (Alice Ni)

Reviewed By : Marlin Chen
 (Marlin Chen)

Approved By : Gene Chang
 (Gene Chang)

Laboratory Information

We , **Quietek Corporation**, are an independent EMC and safety consultancy that was established the whole facility in our laboratories. The test facility has been accredited by the following accreditation Bodies in compliance with ISO 17025, EN 45001 and Guide 25:

Taiwan R.O.C.	: BSMI, DGT, CNLA
Germany	: TUV Rheinland
Norway	: Nemko, DNV
USA	: FCC, NVLAP
Japan	: VCCI

The related certificate for our laboratories about the test site and management system can be downloaded from Quietek Corporation's Web Site : <http://tw.quietek.com/modules/myalbum/>
 The address and introduction of Quietek Corporation's laboratories can be founded in our Web site : <http://www.quietek.com/>
 If you have any comments, Please don't hesitate to contact us. Our contact information is as below:

HsinChu Testing Laboratory :

No.75-2, 3rd Lin, Wangye Keng, Yonghxing Tsuen, Qionglin Shiang, Hsinchu County 307, Taiwan, R.O.C.
 TEL:+886-3-592-8858 / FAX:+886-3-592-8859 E-Mail : service@quietek.com



LinKou Testing Laboratory :

No. 5, Ruei-Shu Valley, Ruei-Ping Tsuen, Lin-Kou Shiang, Taipei, Taiwan, R.O.C.
 TEL : +886-2-8601-3788 / FAX : 886-2-8601-3789 E-Mail : service@quietek.com



Suzhou Testing Laboratory :

No.99 Hongye Rd., Suzhou Industrial Park Loufeng Hi-Tech Development Zone., SuZhou, China
 TEL : +86-512-6251-5088 / FAX : 86-512-6251-5098 E-Mail : service@quietek.com



TABLE OF CONTENTS

Description	Page
1. General Information	6
1.1. EUT Description	6
1.2. Mode of Operation	7
1.3. Configuration of Tested System.....	9
1.4. EUT Exercise Software	10
2. Technical Test.....	11
2.1. Summary of Test Result	11
2.2. Test Environment.....	12
3. Peak Output Power	13
3.1. Test Equipment.....	13
3.2. Test Setup.....	14
3.3. Limit	14
3.4. Test Procedure	15
3.5. Uncertainty	19
3.6. Test Result.....	20
4. Modulation Characteristic	31
4.1. Test Equipment.....	31
4.2. Test Setup.....	31
4.3. Limit	32
4.4. Test Procedure	32
4.5. Uncertainty	32
4.6. Test Result.....	33
5. Occupied Bandwidth	39
5.1. Test Equipment.....	39
5.2. Test Setup.....	39
5.3. Limit	40
5.4. Test Procedure	40
5.5. Uncertainty	40
5.6. Test Result.....	41
6. Spurious Emission At Antenna Terminals (+/- 1MHz).....	65
6.1. Test Equipment.....	65
6.2. Test Setup.....	65
6.3. Limit	66
6.4. Test Procedure	66
6.5. Uncertainty.....	66

6.6. Test Result.....	67
7. Spurious Emission	81
7.1. Test Equipment.....	81
7.2. Test Setup.....	82
7.3. Limit	82
7.4. Test Procedure	83
7.5. Uncertainty	84
7.6. Test Result.....	85
8. Frequency Stability Under Temperature & Voltage Variations	97
8.1. Test Equipment.....	97
8.2. Test Setup.....	97
8.3. Limit	98
8.4. Test Procedure	98
8.5. Uncertainty	98
8.6. Test Result.....	99
9. Receiver Spurious Emission for RSS 132/133	111
9.1. Test Equipment.....	111
9.2. Test Setup.....	112
9.3. Limit	113
9.4. Test Procedure	113
9.5. Uncertainty	114
9.6. Test Result.....	115

1. General Information

1.1. EUT Description

Product Name		Eee PC		
Brand Name		ASUS		
Model No.		Eee PC 1005HAG, Eee PC 1005HAGB		
FCC ID		MSQE05GOBIII		
3G Module		GOBI2000		
Working Voltage		DC 3.3V		
Mode	GPRS/EDGE	Band	UL Frequency (MHz)	DL Frequency (MHz)
		850	824~849	869~894
		1900	1850~1910	1930~1990
	WCDMA R99 HSPA R5	Band	UL Frequency (MHz)	DL Frequency (MHz)
		II	1850~1910	1930~1990
		V	824~849	869~894
	CDMA2000 1X EVDO Release A	Band	UL Frequency (MHz)	DL Frequency (MHz)
		BC0	824~849	869~894
		BC1	1850~1910	1930~1990
Channel Control		Auto		
Antenna type		PIFA		
Antenna Gain		1.94dBi for 824~894MHz band; 0.66dBi for 1710~2170MHz band.		

Note: This product includes three models Eee PC 1005HAG and Eee PC 1005HAGB for different market. The motherboard and the material are the same. Eee PC 1005HAG was used for testing.

Component	
AC Adapter	<p>Manufacturer: PI ELECTRONICS (China Plant)</p> <p>Model: AD6630</p> <p>Input: 100-240V~, 50~60Hz, 1.0A</p> <p>Output: 19V, 2.1A</p>

1.2. Mode of Operation

Quietek has verified the construction and function in typical operation. All the test modes were carried out with the EUT in normal operation, which was shown in this test report and defined as:

Test Mode
Mode 1: GPRS850
Mode 2: GPRS1900
Mode 3: EDGE850
Mode 4: EDGE1900
Mode 5: WCDMA Band II
Mode 6: WCDMA Band V
Mode 7: HSDPA Band II
Mode 8: HSDPA Band V
Mode 9: CDMA2000 1X BC0
Mode 10: CDMA2000 1X BC1
Mode 11: CDMA2000 1XEV-DO BC0
Mode 12: CDMA2000 1XEV-DO BC1

Note:

1. Regards to the frequency band operation: the lowest, middle and highest frequency of channel were selected to perform the test, then shown on this report.
2. This device is a composite device in accordance with Part 15 Subpart B regulations.

Tested System Details

The types for all equipments, plus descriptions of all cables used in the tested system (including inserted cards) are:

Product		Manufacturer	Model No.	Serial No.	Power Cord
1	CMU200	R&S	CMU200	N/A	N/A

1.3. Configuration of Tested System

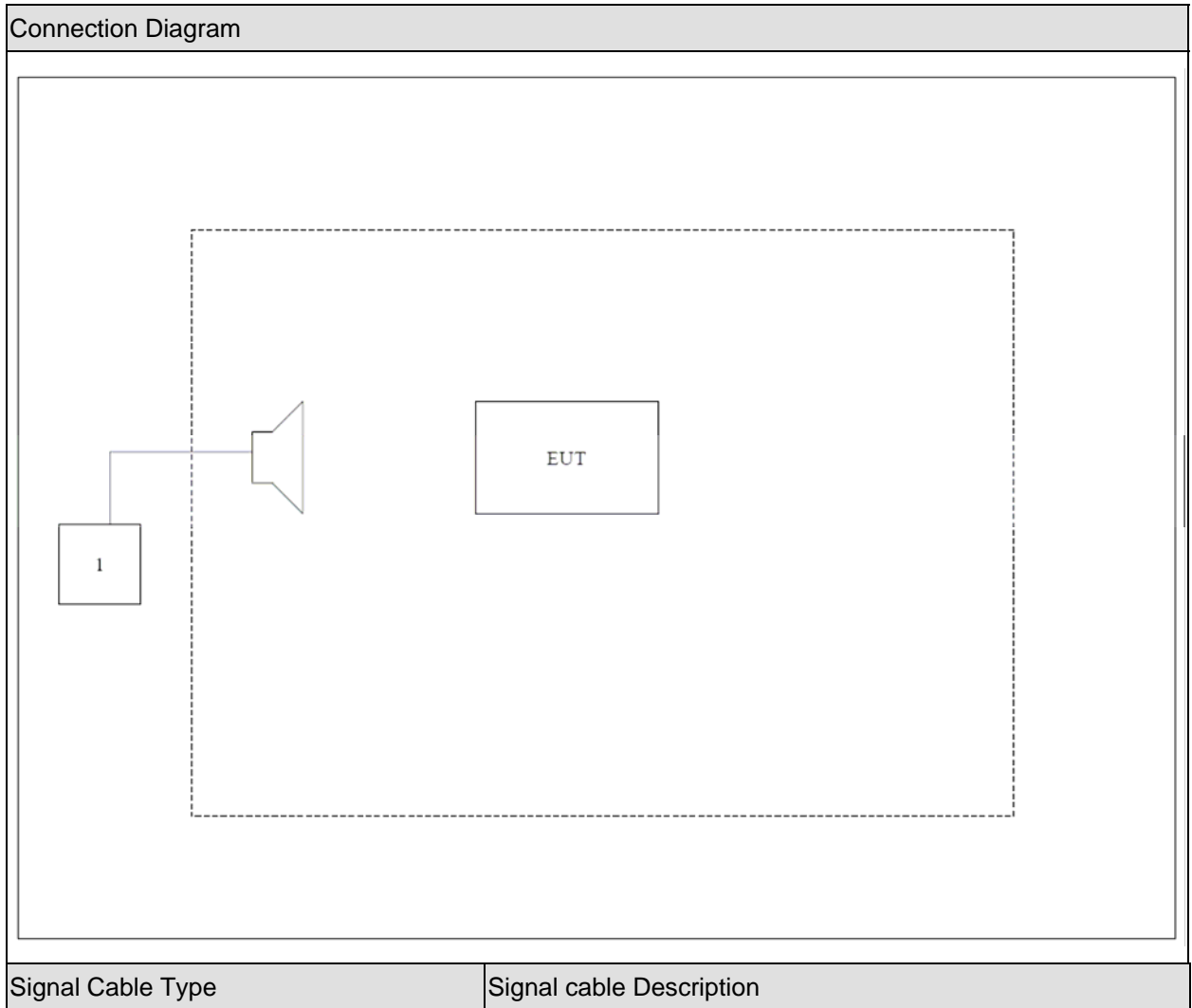

1.4. EUT Exercise Software

1	Setup the EUT and simulators as shown on above.
2	Turn on the power of all equipment.
3	EUT Communicate with CMU200, then select channel to test.

2. Technical Test

2.1. Summary of Test Result

- No deviations from the test standards
- Deviations from the test standards as below description:

For GSM850, WCDMA Band V and CDMA2000 BC0 (FCC Part 22H & Part 2)

Emission			
Performed Item	Normative References	Test Performed	Deviation
Peak Output Power	FCC Part 22.913(a)(2) and Part 2.1046	Yes	No
Modulation Characteristic	FCC Part 2.1047(d)	Yes	No
Occupied Bandwidth	FCC Part 2.1049	Yes	No
Spurious Emission At Antenna Terminals (+/- 1MHz)	FCC Part 22.917(a) and Part 2.1049	Yes	No
Spurious Emission	FCC Part 22.917(b) and Part 2.1051, 2.1053	Yes	No
Frequency Stability Under Temperature & Voltage Variations	FCC Part 22.355 and 2.1055	Yes	No

For PCS1900, WCDMA Band II and CDMA2000 BC1 (FCC Part 24E & Part 2)

Emission			
Performed Item	Normative References	Test Performed	Deviation
Peak Output Power	FCC Part 24.232(b) and Part 2.1046	Yes	No
Modulation Characteristic	FCC Part 2.1047(d)	Yes	No
Occupied Bandwidth	FCC Part 24.238(b) and Part 2.1049	Yes	No
Spurious Emission At Antenna Terminals (+/- 1MHz)	FCC Part 24.238(a) and Part 2.1049	Yes	No
Spurious Emission	FCC Part 24.238(b) and Part 2.1051, 2.1053	Yes	No
Frequency Stability Under Temperature & Voltage Variations	FCC Part 24.235 and 2.1055	Yes	No

2.2. Test Environment

Items	Required (IEC 68-1)	Actual
Temperature (°C)	15-35	23
Humidity (%RH)	25-75	52
Barometric pressure (mbar)	860-1060	950-1000

3. Peak Output Power

3.1. Test Equipment

Peak Output Power / AC-6

Instrument	Manufacturer	Type No.	Serial No	Cal. Date
Spectrum Analyzer	Agilent	E4446A	MY45300103	2009/06/10
Radio Communication Tester	R&S	CMU 200	106388	2008/10/21
Dual Directional Coupler	Agilent	778D	20160	2009/04/20
10dB Coaxial Coupler	Agilent	87300C	MY44300299	2009/04/20
PSG Analog S.G.	Agilent	E8257D	MY44321116	2009/06/11
Preamplifier	Quietek	AP-025C	QT-AP005	2008/11/24
Preamplifier	Quietek	AP-180C	CHM-0602013	2008/11/24
Bilog Type Antenna	Schaffner	CBL6141A	4278	2008/11/24
Half Wave Tuned Dipole Antenna	COM-POWER	AD-100	40137	2008/11/24
Broad-Band Horn Antenna	Schwarzbeck	BBHA9120D	496	2008/11/24
Broad-Band Horn Antenna	Schwarzbeck	BBHA9120D	499	2008/11/24
Coaxial Cable	Huber+Suhner	AC4-RL	06	2008/11/24
Coaxial Cable	Huber+Suhner	AC4-RH	07	2008/11/24
Coaxial Cable	Huber+Suhner	AC4-T	09	2008/11/24
Coaxial Cable	Huber+Suhner	AC4-RF-H	10	2008/11/24
Temperature/Humidity Meter	zhicheng	ZC1-2	QT-TH007	2009/03/31

3.2. Test Setup

Conducted Power Measurement:

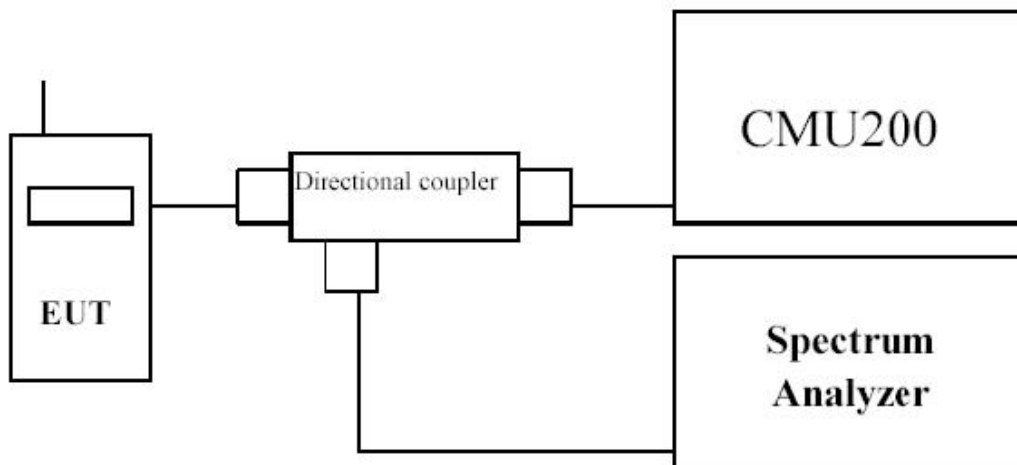

Radiated Power Measurement:

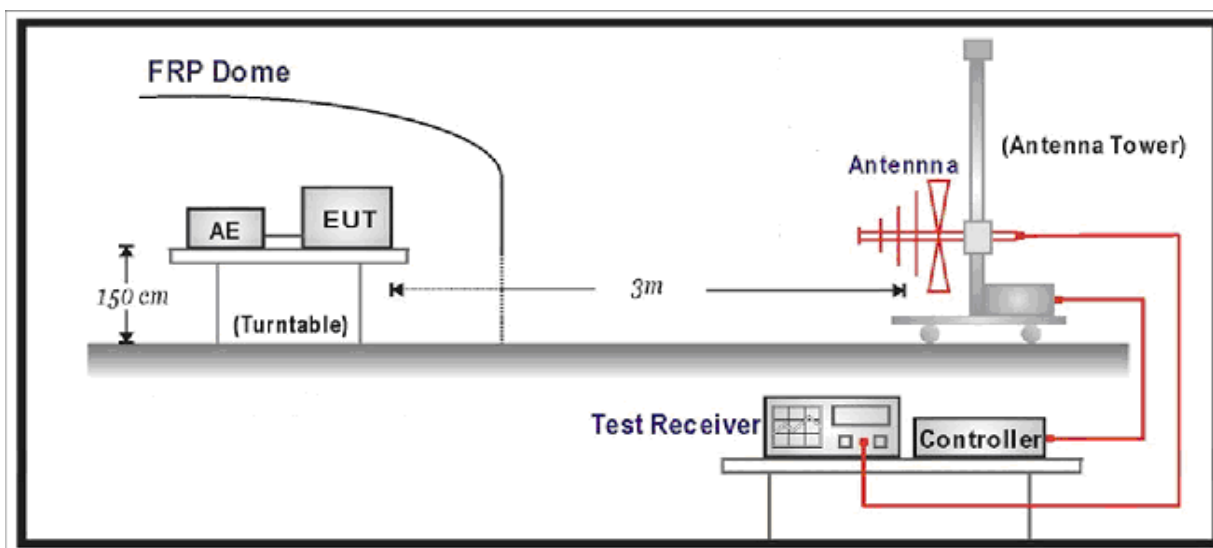

3.3. Limit

For FCC Part 22.913(a)(2):

The ERP of mobile transmitters and auxiliary test transmitters must not exceed 7 Watts.

For FCC Part 24.232(b):

The EIRP of mobile transmitters and auxiliary test transmitters must not exceed 2 Watts.

3.4. Test Procedure

Conducted Power Measurement:

- a) Place the EUT on a bench and set it in transmitting mode.
- b) Connect a low loss RF cable from the antenna port to a spectrum analyzer and CMU200 by a Directional Couple.
- c) EUT Communicate with CMU200, then selects a channel for testing.
- d) Add a correction factor to the display of spectrum, and then test.

Radiated Power Measurement:

- e) The EUT shall be placed at the specified height on a support, and in the position closest to normal use as declared by provider.
- f) The test antenna shall be oriented initially for vertical polarization and shall be chosen to correspond to the frequency of the transmitter
- g) The output of the test antenna shall be connected to the measuring receiver.
- h) The transmitter shall be switched on and the measuring receiver shall be tuned to the frequency of the transmitter under test.
- i) The test antenna shall be raised and lowered through the specified range of height until a maximum signal level is detected by the measuring receiver.
- j) The transmitter shall then be rotated through 360° in the horizontal plane, until the maximum signal level is detected by the measuring receiver.
- k) The test antenna shall be raised and lowered again through the specified range of height until a maximum signal level is detected by the measuring receiver.
- l) The maximum signal level detected by the measuring receiver shall be noted.
- m) The transmitter shall be replaced by a substitution antenna.
- n) The substitution antenna shall be orientated for vertical polarization and the length of the substitution antenna shall be adjusted to correspond to the frequency of the transmitter.
- o) The substitution antenna shall be connected to a calibrated signal generator.
- p) If necessary, the input attenuator setting of the measuring receiver shall be adjusted in order to increase the sensitivity of the measuring receiver.
- q) The test antenna shall be raised and lowered through the specified range of height to ensure that the maximum signal is received.
- r) The input signal to the substitution antenna shall be adjusted to the level that produces a level detected by the measuring receiver, that is equal to the level noted while the transmitter radiated power was measured, corrected for the change of input attenuator setting of the measuring receiver.
- s) The measurement shall be repeated with the test antenna and the substitution antenna

orientated for horizontal polarization.

- t) The measure of the effective radiated power is the larger of the two levels recorded at the input to the substitution antenna, corrected for gain of the substitution antenna if necessary.

Base station simulator settings for each test mode:

1. For GSM/GPRS/EDGE

Configure R&S CMU200 to support GMSK and 8PSK call respectively, and set one timeslot transmission for GMSK GSM/GPRS and 8PSK EDGE.

Measure and record power outputs for both modulations.

2. For WCDMA/HSDPA

Configure the CMU-200 to support all WCDMA tests in respect to the 3GPP 34.121.

Measure the EUT output power at 826.4MHz, 836.6MHz and 846.6MHz for WCDMA Band V and 1852.4MHz, 1880MHz and 1907.6MHz for WCDMA Band II.

For Rel 99

- Set a Test Mode 1 loop back with a 12.2kbps Reference Measurement Channel (RMC)
- Set and send continuously Up power control commands to the Gobi2000
- Measure the power at the Gobi2000 Module antenna connector by using CMU-200.

For HSDPA Rel 5

- Establish a Test Mode 1 look back with both 1 12.2kbps RMC channel and a H-Set1 Fixed Reference Channel (FRC). With the CMU-200 this is accomplished by setting the signal Channel Coding to "Fixed Reference Channel" and configuring for HSET-1 QKSP.
- Set beta values and HSDPA settings for HSDPA Sebtest1 according to Table C.10.1.4
- Send continuously Up power control commands to the Gobi2000
- Measure the power at the Gobi2000 Module antenna connector by using CMU-200 mean power.
- The mean power shall be averaged over at least one timeslot.
- Repeat the measurement for the HSDPA Subtest2, 3 and 4 as given in Table C.10.1.4

3GPP HSDPA Sub-test Setting from TS 34 121

Table C.10.1.4: β values for transmitter characteristics tests with HS-DPCCH

Sub-test	β_c	β_d	β_c/β_d	β_{HS}	CM (dB)	MPR (dB)
1	2/15	15/15	2/15	4/15	0.0	0.0
2	12/15	15/15	12/15	24/15	1.0	0.0
3	15/15	8/15	15/8	30/15	1.5	0.5
4	15/15	4/15	15/4	30/15	1.5	0.5

3. For CDMA 1x EV-DO

Configure the CMU-200 to support all CDMA2000 1x EV-DO tests.

Measure the EUT output power at 824.7MHz, 836.52MHz and 848.31MHz for US cell BC0 and 1851.25MHz, 1880MHz and 1908.75MHz for US PCS BC1.

For 1xRTT

Use CDMA2000 Rev 6 protocol in R&S CMU200.

1) Test for Reverse/Forward TCH RC1, Reverse/Forward TCH RC2, and RC3 Reverse FCH and demodulation of RC 3, 4 and 5.

a. Set up a call using Fundamental Channel Test Mode 1 (RC1, SO 2) with 9600 bps data rate only.

b. As per C.S0011 or TIA/EIA-98-F Table 4.4.5.2-1, set the test parameters as shown in Table 4-1.

c. Send continuously '0' power control bits to the Gobi2000 Module.

d. Measure the output power at Gobi2000 Module antenna connector as recorded on the power meter with values corrected for cables losses.

e. Repeat step b through d for Fundamental Channel Test Mode:

i. RC1, SO55

ii. RC2, SO9

iii. RC2, SO55

iv. RC3, SO55

2) Test for RC 3 Reverse FCH, RC3 Reverse SCH0 and demodulation of RC 3, 4 and 5.

a. Set up a call using Supplemental Channel Test Mode 3 (RC 3, SO 32) with 9600 bps Fundamental Channel and 9600 bps SCH0 data rate.

b. As per C.S0011 or TIA/EIA-98-F Table 4.4.5.2-2, set the test parameters as shown in Table 4-2.

c. Send alternating '0' and '1' power control bit to the Gobi2000 Module

- d. Determine the active channel configuration. If the desired channel configuration is not the active channel configuration, increase \hat{I}_{or} by 1 dB and repeat the verification. Repeat this step until the desired channel configuration becomes active.
- e. Measure the output power at the Gobi2000 Module antenna connector.
- f. Decrease \hat{I}_{or} by 0.5 dB.
- g. Determine the active channel configuration. If the active channel configuration is the desired channel configuration, measure the output power at the Gobi2000 Module antenna connector.
- h. Repeat step f and g until the output power no longer increases or the desired channel configuration is no longer active. Record the highest output power achieved with the desired channel configuration active.
- i. Repeat step a through h ten times and average the result.

Table 4-1 Parameters for Max. Power with a single traffic code channel, SR1

Parameter	Units	Value
\hat{I}_{or}	dBm/1.23 MHz	-104
(Pilot Ec) / Ior	dB	-7
(Traffic Ec) / Ior	dB	-7.4

Table 4-2 Parameters for Max. Power with multiple traffic code channel, SR1

Parameter	Units	Value
(Pilot Ec) / Ior	dB	-7
(Traffic Ec) / Ior	dB	-7.4

For 1xEV-DO

1) Use 1xEV-DO Rel 0 protocol in R&S CMU200.

a. FTAP

- Select Test Application Protocol to FTAP
- Set FTAP Rate to 307.2 kbps (2 Slot, QPSK)
- Generator Info -> Termination Parameters -> Max Forward Packet Duration -> 16 Slots

- Set \hat{I}_{or} to -60 dBm/1.23 MHz
- Send continuously '0' power control bits
- Measure the power at Gobi2000 Module antenna connector

b. RTAP

- Select Test Application Protocol to RTAP
- Set RTAP Rate to 9.6 kbps
- Generator Info -> Termination Parameters -> Max Forward Packet Duration -> 16

Slots

- Set \hat{I} or to -60 dBm/1.23 MHz
- Send continuously '0' power control bits
- Measure the power at Gobi2000 Module antenna connector
- Repeat above steps for RTAP Rate = 19.2 kbps, 38.4 kbps, 76.8 kbps and 153.6 kbps respectively

2) Use 1xEV-DO Rev A protocol in R&S CMU200.

a. FETAP

- Select Test Application Protocol to FETAP
- Set FETAP Rate to 307.2 kbps (2 Slot, QPSK)
- Generator Info -> Termination Parameters -> Max Forward Packet Duration -> 16

Slots

- Set \hat{I} or to -60 dBm/1.23 MHz
- Send continuously '0' power control bits
- Measure the power at Gobi2000 Module antenna connector

b. RETAP

- Select Test Application Protocol to RETAP
- F-Traffic Format -> 4 (1024, 2, 128) Canonical (307.2k, QPSK)
- Set R-Data Pkt Size to 128
- Protocol Subtype Config -> Release A Physical Layer Subtype -> Subtype 2 -> PL Subtype 2 Access Channel MAC Subtype -> Default (Subtype 0)
- Generator Info -> Termination Parameters -> Max Forward Packet Duration -> 16

Slots ->ACK R-Data After -> Subpacket 0 (All ACK)

- Set \hat{I} or to -60 dBm/1.23 MHz
- Send continuously '0' power control bits
- Measure the power at Gobi2000 Module antenna connector
- Repeat above steps for R-Data Pkt Size = 256, 512, 768, 1024, 1536, 2048, 3072, 4096, 6144, 8192, 12288 respectively.

3.5. Uncertainty

The measurement uncertainty is defined as for Conducted Power Measurement ± 1.2 dB, for Radiated Power Measurement ± 3.2 dB

3.6. Test Result

GSM/GPRS/EDGE

GPRS 850 (1 UL slot)

Channel No.	Frequency (MHz)	Modulation	Conducted Output Power (dBm)	ERP (dBm)	Limit (dBm)
128	824.2	GPRS	32.79	30.006	38.50
189	836.4	GPRS	32.68	30.857	38.50
251	848.8	GPRS	32.72	28.512	38.50

GPRS1900 (1 UL slot)

Channel No.	Frequency (MHz)	Modulation	Conducted Output Power (dBm)	EIRP (dBm)	Limit (dBm)
512	1850.2	GPRS	29.18	29.208	33.00
661	1880.0	GPRS	29.46	30.175	33.00
810	1909.8	GPRS	29.35	28.660	33.00

EDGE 850

Channel No.	Frequency (MHz)	Modulation	Conducted Output Power (dBm)	ERP (dBm)	Limit (dBm)
128	824.2	8PSK	27.32	25.186	38.50
189	836.4	8PSK	27.41	26.522	38.50
251	848.8	8PSK	27.24	25.464	38.50

EDGE 1900

Channel No.	Frequency (MHz)	Modulation	Conducted Output Power (dBm)	EIRP (dBm)	Limit (dBm)
512	1850.2	8PSK	25.85	27.047	33.00
661	1880.0	8PSK	26.07	27.395	33.00
810	1909.8	8PSK	25.93	26.070	33.00

Note: All conducted measurements are based on a peak detector.

WCDMA/HSDPA

Mode	3GPP Subtest	Band II (1900MHz) Channel						MPR
		Conducted Power (dBm)			ERP (dBm)			
		9262	9400	9538	9262	9400	9538	
WCDMA R99	1	24.32	24.07	24.01	25.145	25.439	24.69	N/A
Rel5 HSDPA	1	24.17	23.95	23.85	26.586	26.604	25.500	0
	2	23.86	23.80	23.75	---	---	---	0
	3	23.67	23.47	23.42	---	---	---	0.5
	4	23.36	23.14	23.21	---	---	---	0.5

Mode	3GPP Subtest	Band V (850MHz) Channel						MPR
		Conducted Power (dBm)			EIRP (dBm)			
		4132	4182	4233	4132	4182	4233	
WCDMA R99	1	24.25	24.17	24.05	20.548	21.754	21.013	N/A
Rel5 HSDPA	1	24.11	23.89	24.17	22.212	22.420	21.856	0
	2	23.86	23.77	23.45	---	---	---	0
	3	23.53	23.37	23.36	---	---	---	0.5
	4	23.59	22.98	23.23	---	---	---	0.5

Note: All conducted measurements are based on an average detector.

CDMA2000 1x EV-DO

Mode	Test Case			BC0 (850MHz) Channel					
	Num.	FWD RC/TAP	REV RC/TAP	Conducted Power (dBm)			EIRP (dBm)		
				1013	384	777	1013	384	777
1x	1	RC1	RC1 (SO2)	24.45	24.51	24.32	---	---	---
	2	RC1	RC1 (SO55)	24.44	24.48	24.37	---	---	---
	3	RC2	RC2 (SO9)	24.49	24.50	24.48	---	---	---
	4	RC2	RC2 (SO55)	24.38	24.47	24.43	---	---	---
	5	RC3	RC3 (SO55)	24.53	24.63	24.58	23.274	23.432	22.975
	6	RC3	RC3 (SO32)	24.52	24.43	24.36	---	---	---
1x EV-DO Rel0	7a	FTAP rate = 307kbps (2 slot, QPSK)	RTAP rate = 9.6kbps	24.53	24.57	24.48	21.254	22.654	22.915
	7b		RTAP rate = 19.2kbps	24.38	24.41	24.44	---	---	---
	7c		RTAP rate = 38.4kbps	24.38	24.42	24.29	---	---	---
	7d		RTAP rate = 76.8kbps	24.29	24.38	24.31	---	---	---
	7e		RTAP rate = 153.6kbps	24.33	24.27	24.36	---	---	---
1x EV-DO Rev A	8a	FETAP rate = 307kbps (2 slot, ACK channel is transmitted at all the slots)	RETAP – payload size = 128	24.33	24.29	24.32	---	---	---
	8b		RETAP – payload size = 256	24.37	24.38	24.41	---	---	---
	8c		RETAP – payload size = 512	24.38	24.33	24.29	---	---	---
	8d		RETAP – payload size = 768	24.37	24.36	24.45	---	---	---
	8e		RETAP – payload size = 1024	24.33	24.28	24.43	---	---	---
	8f		RETAP – payload size = 1536	24.31	24.42	24.53	---	---	---
	8g		RETAP – payload size = 2048	24.34	24.27	24.42	---	---	---
	8h		RETAP – payload size = 3072	24.33	24.27	24.41	---	---	---
	8i		RETAP – payload size = 4096	24.28	24.31	24.28	---	---	---
	8j		RETAP – payload size = 6144	24.48	24.53	24.56	22.104	22.576	22.975
	8k		RETAP – payload size = 8192	24.42	24.43	24.48	---	---	---
8l	RETAP – payload size = 12288	24.39	24.37	24.34	---	---	---		

Mode	Test Case			BC1 (1900MHz) Channel					
	Num.	FWD RC/TAP	REV RC/TAP	Conducted Power (dBm)			EIRP (dBm)		
				25	600	1175	25	600	1175
1x	1	RC1	RC1 (SO2)	24.43	24.55	24.46	---	---	---
	2	RC1	RC1 (SO55)	24.45	24.49	24.47	---	---	---
	3	RC2	RC2 (SO9)	24.46	24.47	24.44	---	---	---
	4	RC2	RC2 (SO55)	24.39	24.44	24.46	---	---	---
	5	RC3	RC3 (SO55)	24.62	24.66	24.55	26.923	26.572	25.864
	6	RC3	RC3 (SO32)	24.53	24.44	24.34	---	---	---
1x EV-DO Rel0	7a	FTAP rate = 307kbps (2 slot, QPSK)	RTAP rate = 9.6kbps	24.56	24.59	24.54	26.575	26.772	25.364
	7b		RTAP rate = 19.2kbps	24.39	24.44	24.47	---	---	---
	7c		RTAP rate = 38.4kbps	24.34	24.41	24.39	---	---	---
	7d		RTAP rate = 76.8kbps	24.26	24.34	24.36	---	---	---
	7e		RTAP rate = 153.6kbps	24.31	24.34	24.35	---	---	---
1x EV-DO Rev A	8a	FETAP rate = 307kbps (2 slot, ACK channel is transmitted at all the slots)	RETAP – payload size = 128	24.31	24.36	24.34	---	---	---
	8b		RETAP – payload size = 256	24.37	24.42	24.39	---	---	---
	8c		RETAP – payload size = 512	24.35	24.35	24.34	---	---	---
	8d		RETAP – payload size = 768	24.36	24.37	24.35	---	---	---
	8e		RETAP – payload size = 1024	24.31	24.29	24.32	---	---	---
	8f		RETAP – payload size = 1536	24.33	24.41	24.52	---	---	---
	8g		RETAP – payload size = 2048	24.32	24.24	24.41	---	---	---
	8h		RETAP – payload size = 3072	24.32	24.29	24.43	---	---	---
	8i		RETAP – payload size = 4096	24.33	24.39	24.42	---	---	---
	8j		RETAP – payload size = 6144	24.54	24.58	24.63	26.533	26.642	24.864
	8k		RETAP – payload size = 8192	24.46	24.47	24.53	---	---	---
8l	RETAP – payload size = 12288	24.34	24.43	24.36	---	---	---		

Note: All conducted measurements are based on an average detector.

Radiated Measurement

GPRS850

Frequency (MHz)	SA Reading (dBm)	Ant.Pol. (H/V)	SG Reading (dBm)	Cable Loss (dB)	Gain (dBd)	ERP (dBm)	Limit (dBm)	Margin (dB)
Low Channel 128								
824.20	17.866	H	32.586	2.56	-0.02	30.006	38.50	-8.494
824.20	16.452	V	30.219	2.56	-0.02	27.639	38.50	-10.861
Middle Channel 189								
836.40	18.697	H	33.347	2.59	0.10	30.857	38.50	-7.643
836.40	15.991	V	29.886	2.59	0.10	27.396	38.50	-11.104
High Channel 251								
848.80	16.342	H	30.922	2.54	0.13	28.512	38.50	-9.988
848.80	15.108	V	29.147	2.54	0.13	26.737	38.50	-11.763

GPRS1900

Frequency (MHz)	SA Reading (dBm)	Ant.Pol. (H/V)	SG Reading (dBm)	Cable Loss (dB)	Gain (dBi)	EIRP (dBm)	Limit (dBm)	Margin (dB)
Low Channel 512								
1850.20	36.987	H	22.358	3.55	10.40	29.208	33.00	-3.792
1850.20	36.780	V	22.052	3.55	10.40	28.902	33.00	-4.098
Middle Channel 661								
1880.00	37.919	H	23.275	3.53	10.43	30.175	33.00	-2.825
1880.00	37.130	V	22.412	3.53	10.43	29.312	33.00	-3.688
High Channel 810								
1909.80	36.461	H	21.780	3.56	10.44	28.660	33.00	-4.340
1909.80	35.419	V	20.738	3.56	10.44	27.618	33.00	-5.382

EDGE850

Frequency (MHz)	SA Reading (dBm)	Ant.Pol. (H/V)	SG Reading (dBm)	Cable Loss (dB)	Gain (dBd)	ERP (dBm)	Limit (dBm)	Margin (dB)
Low Channel 128								
824.20	13.046	H	27.766	2.56	-0.02	25.186	38.50	-13.314
824.20	12.776	V	26.543	2.56	-0.02	23.963	38.50	-14.537
Middle Channel 189								
836.40	14.362	H	29.012	2.59	0.10	26.522	38.50	-11.978
836.40	12.154	V	26.047	2.59	0.10	23.557	38.50	-14.943
High Channel 251								
848.80	13.294	H	27.874	2.54	0.13	25.464	38.50	-13.036
848.80	13.437	V	27.475	2.54	0.13	25.065	38.50	-13.435

EDGE1900

Frequency (MHz)	SA Reading (dBm)	Ant.Pol. (H/V)	SG Reading (dBm)	Cable Loss (dB)	Gain (dBi)	EIRP (dBm)	Limit (dBm)	Margin (dB)
Low Channel 512								
1850.20	34.826	H	20.197	3.55	10.40	27.047	33.00	-5.953
1850.20	33.798	V	19.070	3.55	10.40	25.920	33.00	-7.080
Middle Channel 661								
1880.00	35.139	H	20.495	3.53	10.43	27.395	33.00	-5.605
1880.00	34.168	V	19.449	3.53	10.43	26.349	33.00	-6.651
High Channel 810								
1909.80	33.871	H	19.190	3.56	10.44	26.070	33.00	-6.930
1909.80	32.859	V	18.178	3.56	10.44	25.058	33.00	-7.942

WCDMA FDD II

Frequency (MHz)	SA Reading (dBm)	Ant.Pol. (H/V)	SG Reading (dBm)	Cable Loss (dB)	Gain (dBi)	EIRP (dBm)	Limit (dBm)	Margin (dB)
Low Channel 9262								
1852.40	32.923	H	18.295	3.55	10.40	25.145	33.00	-7.855
1852.40	32.567	V	17.840	3.55	10.40	24.690	33.00	-8.310
Middle Channel 9400								
1880.00	33.182	H	18.539	3.53	10.43	25.439	33.00	-7.561
1880.00	32.213	V	17.497	3.53	10.43	24.397	33.00	-8.603
High Channel 9538								
1907.60	31.922	H	17.243	3.56	10.44	24.123	33.00	-8.877
1907.60	32.489	V	17.810	3.56	10.44	24.690	33.00	-8.310

WCDMA FDD V

Frequency (MHz)	SA Reading (dBm)	Ant.Pol. (H/V)	SG Reading (dBm)	Cable Loss (dB)	Gain (dBd)	ERP (dBm)	Limit (dBm)	Margin (dB)
Low Channel 4132								
826.40	8.398	H	23.128	2.56	-0.02	20.548	38.50	-17.952
826.40	9.010	V	22.843	2.56	-0.02	20.263	38.50	-18.237
Middle Channel 4182								
836.40	9.594	H	24.244	2.59	0.10	21.754	38.50	-16.746
836.40	8.546	V	22.465	2.59	0.10	19.975	38.50	-18.525
High Channel 4233								
846.60	8.843	H	23.423	2.54	0.13	21.013	38.50	-17.487
846.60	8.893	V	22.867	2.54	0.13	20.457	38.50	-18.043

HSDPA FDD II

Frequency (MHz)	SA Reading (dBm)	Ant.Pol. (H/V)	SG Reading (dBm)	Cable Loss (dB)	Gain (dBi)	EIRP (dBm)	Limit (dBm)	Margin (dB)
Low Channel 9262								
1852.40	34.361	H	19.736	3.55	10.40	26.586	33.00	-6.414
1852.40	32.415	V	17.692	3.55	10.40	24.542	33.00	-8.458
Middle Channel 9400								
1880.00	34.347	H	19.704	3.53	10.43	26.604	33.00	-6.396
1880.00	33.207	V	18.491	3.53	10.43	25.391	33.00	-7.609
High Channel 9538								
1907.60	33.235	H	18.620	3.56	10.44	25.500	33.00	-7.500
1907.60	32.038	V	17.361	3.56	10.44	24.241	33.00	-8.759

HSDPA FDD V

Frequency (MHz)	SA Reading (dBm)	Ant.Pol. (H/V)	SG Reading (dBm)	Cable Loss (dB)	Gain (dBd)	ERP (dBm)	Limit (dBm)	Margin (dB)
Low Channel 4132								
826.40	10.062	H	24.792	2.56	-0.02	22.212	38.50	-16.288
826.40	9.438	V	23.269	2.56	-0.02	20.689	38.50	-17.811
Middle Channel 4182								
836.40	10.260	H	24.910	2.59	0.10	22.420	38.50	-16.080
836.40	9.665	V	23.537	2.59	0.10	21.047	38.50	-17.453
High Channel 4233								
846.60	9.686	H	24.266	2.54	0.13	21.856	38.50	-16.644
846.60	9.787	V	23.763	2.54	0.13	21.353	38.50	-17.147

CDMA 1x BC0

Frequency (MHz)	SA Reading (dBm)	Ant.Pol. (H/V)	SG Reading (dBm)	Cable Loss (dB)	Gain (dBd)	ERP (dBm)	Limit (dBm)	Margin (dB)
Low Channel 1013								
824.70	10.824	H	25.854	2.56	-0.02	23.274	38.5	-15.226
824.70	8.983	V	24.403	2.56	-0.02	21.823	38.5	-16.677
Middle Channel 384								
836.52	10.964	H	25.922	2.59	0.1	23.432	38.5	-15.068
836.52	7.383	V	23.310	2.59	0.1	20.820	38.5	-17.680
High Channel 777								
848.31	9.774	H	25.385	2.54	0.13	22.975	38.5	-15.525
848.31	8.386	V	24.055	2.54	0.13	21.645	38.5	-16.855

CDMA 1x BC1

Frequency (MHz)	SA Reading (dBm)	Ant.Pol. (H/V)	SG Reading (dBm)	Cable Loss (dB)	Gain (dBi)	EIRP (dBm)	Limit (dBm)	Margin (dB)
Low Channel 25								
1851.25	34.482	H	20.073	3.55	10.4	26.923	33	-6.077
1851.25	33.334	V	17.975	3.55	10.4	24.825	33	-8.175
Middle Channel 600								
1880.00	34.285	H	19.672	3.53	10.43	26.572	33	-6.428
1880.00	33.338	V	17.822	3.53	10.43	24.722	33	-8.278
High Channel 1175								
1908.75	33.798	H	18.984	3.56	10.44	25.864	33	-7.136
1908.75	31.777	V	16.799	3.56	10.44	23.679	33	-9.321

CDMA2000 1x EV-DO R0 BC0

Frequency (MHz)	SA Reading (dBm)	Ant.Pol. (H/V)	SG Reading (dBm)	Cable Loss (dB)	Gain (dBd)	ERP (dBm)	Limit (dBm)	Margin (dB)
Low Channel 1013								
824.70	9.624	H	23.834	2.56	-0.02	21.254	38.5	-17.246
824.70	7.792	V	22.445	2.56	-0.02	19.865	38.5	-18.635
Middle Channel 384								
836.52	10.344	H	25.144	2.59	0.1	22.654	38.5	-15.846
836.52	9.358	V	23.211	2.59	0.1	20.721	38.5	-17.779
High Channel 777								
848.31	10.705	H	25.325	2.54	0.13	22.915	38.5	-15.585
848.31	9.832	V	23.534	2.54	0.13	21.124	38.5	-17.376

CDMA2000 1x EV-DO R0 BC1

Frequency (MHz)	SA Reading (dBm)	Ant.Pol. (H/V)	SG Reading (dBm)	Cable Loss (dB)	Gain (dBi)	EIRP (dBm)	Limit (dBm)	Margin (dB)
Low Channel 25								
1851.25	34.380	H	19.725	3.55	10.4	26.575	33	-6.425
1851.25	32.805	V	17.773	3.55	10.4	24.623	33	-8.377
Middle Channel 600								
1880.00	34.485	H	19.872	3.53	10.43	26.772	33	-6.228
1880.00	32.533	V	17.742	3.53	10.43	24.642	33	-8.358
High Channel 1175								
1908.75	33.498	H	18.484	3.56	10.44	25.364	33	-7.636
1908.75	30.857	V	16.499	3.56	10.44	23.379	33	-9.621

CDMA2000 1x EV-DO RA BC0

Frequency (MHz)	SA Reading (dBm)	Ant.Pol. (H/V)	SG Reading (dBm)	Cable Loss (dB)	Gain (dBd)	ERP (dBm)	Limit (dBm)	Margin (dB)
Low Channel 1013								
824.70	10.884	H	24.684	2.56	-0.02	22.104	38.5	-16.396
824.70	9.591	V	24.125	2.56	-0.02	21.545	38.5	-16.955
Middle Channel 384								
836.52	10.942	H	25.066	2.59	0.1	22.576	38.5	-15.924
836.52	9.393	V	23.332	2.59	0.1	20.842	38.5	-17.658
High Channel 777								
848.31	11.205	H	25.385	2.54	0.13	22.975	38.5	-15.525
848.31	9.831	V	23.735	2.54	0.13	21.325	38.5	-17.175

CDMA2000 1x EV-DO RA BC1

Frequency (MHz)	SA Reading (dBm)	Ant.Pol. (H/V)	SG Reading (dBm)	Cable Loss (dB)	Gain (dBi)	EIRP (dBm)	Limit (dBm)	Margin (dB)
Low Channel 25								
1851.25	34.680	H	19.683	3.55	10.4	26.533	33	-6.467
1851.25	31.804	V	16.884	3.55	10.4	23.734	33	-9.266
Middle Channel 600								
1880.00	34.286	H	19.742	3.53	10.43	26.642	33	-6.358
1880.00	33.318	V	18.626	3.53	10.43	25.526	33	-7.474
High Channel 1175								
1908.75	32.638	H	17.984	3.56	10.44	24.864	33	-8.136
1908.75	31.453	V	16.599	3.56	10.44	23.479	33	-9.521

4. Modulation Characteristic

4.1. Test Equipment

Modulation Characteristic / AC-6

Instrument	Manufacturer	Type No.	Serial No	Cal. Date
Spectrum Analyzer	Agilent	E4446A	MY45300103	2009/06/11
Radio Communication Tester	R&S	CMU 200	106388	2008/10/21
Dual Directional Coupler	Agilent	778D	20160	2009/04/20
10dB Coaxial Coupler	Agilent	87300C	MY44300299	2009/04/20
Coaxial Cable	Huber+Suhner	AC4-RF-H	10	2008/11/24
Temperature/Humidity Meter	zhicheng	ZC1-2	QT-TH007	2009/03/31

4.2. Test Setup

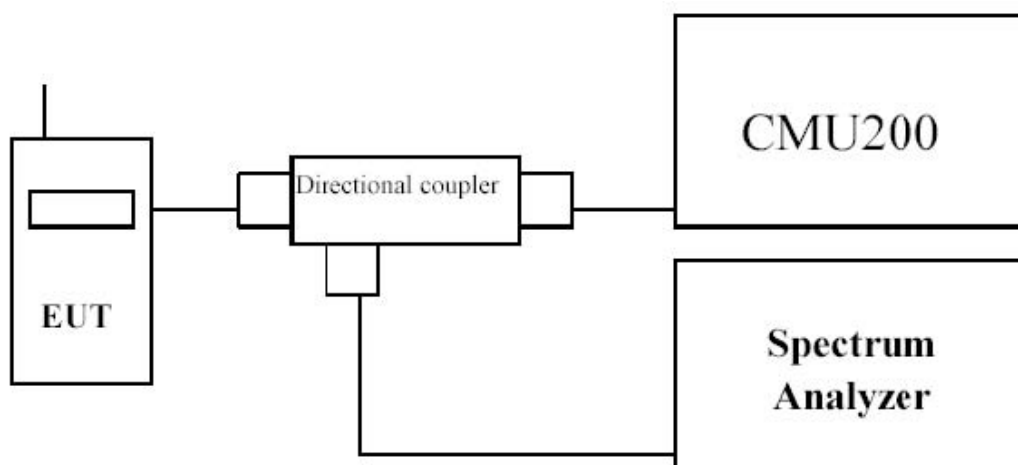

4.3. Limit

N/A

4.4. Test Procedure

GMSK is a form of binary signaling schemes which represent digital states as a shift between discrete sinusoidal frequencies called Frequency Shift Keying (FSK). Minimum Shift Keying (MSK) is continuous phase FSK with the smallest possible modulation index h .

Modulation index is defined as: $h = 2 * F * T_b$

where F = Peak frequency deviation in Hz and T_b = Bit period in seconds

Two discrete frequencies, representing two distinct digital states, with equal phases at switch time $t = 0$ requires a minimum value of $h = 0.5$. The Gaussian part of GMSK describes the fact that the digital pulses are filtered in the time domain. This results in bits which are sinusoidal rather than square. The effective spectrum is then compressed with the average carrier frequency in the center of the passband. This is a great advantage because of the significantly reduced bandwidth. GMSK is utilized because of these bandwidth conservation properties.

The bandwidth for GSM is a 60 MHz up-link at 1850-1910 MHz and down-link at 1930-1990 MHz. The 65 MHz is divided into 299 channels, each of which is 200 kHz wide. Slight spectral spillage is allowed into neighboring channels (which is minimized by GMSK). This separated transmit/receive frequencies scheme under GSM enables easier duplex filtering.

Within the bandwidth, individual channels are subdivided into multiframe (made of 26 frames), frames (made of 8 time slots), and time slots (made of 8 fields). The time slots are 0.57 ms long allowing 156.25 bits of information including overhead.

The modulation used in GPRS is the same used in GSM. A GSM channel contains eight timeslots, each timeslot is dedicated to one circuit switched call. For GPRS the timeslots are assigned on an as needed basis, and more than one timeslot can be assigned for a particular transmission depending on the network and the device.

4.5. Uncertainty

The measurement uncertainty is defined as 0.1%

4.6. Test Result

GPRS 850

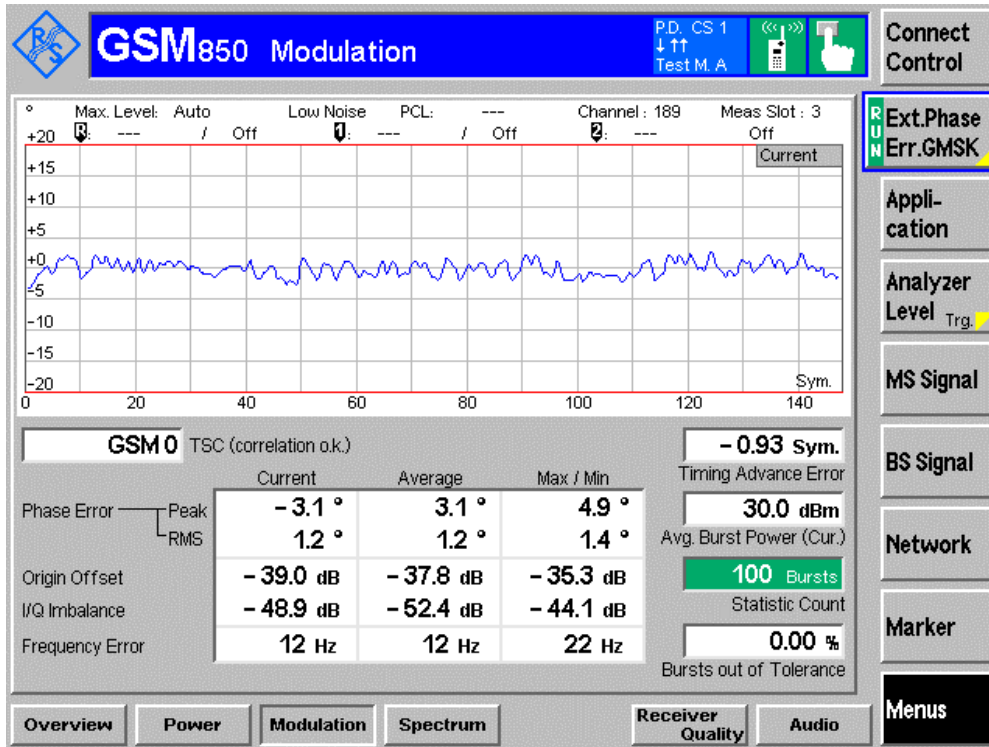

GPRS 1900

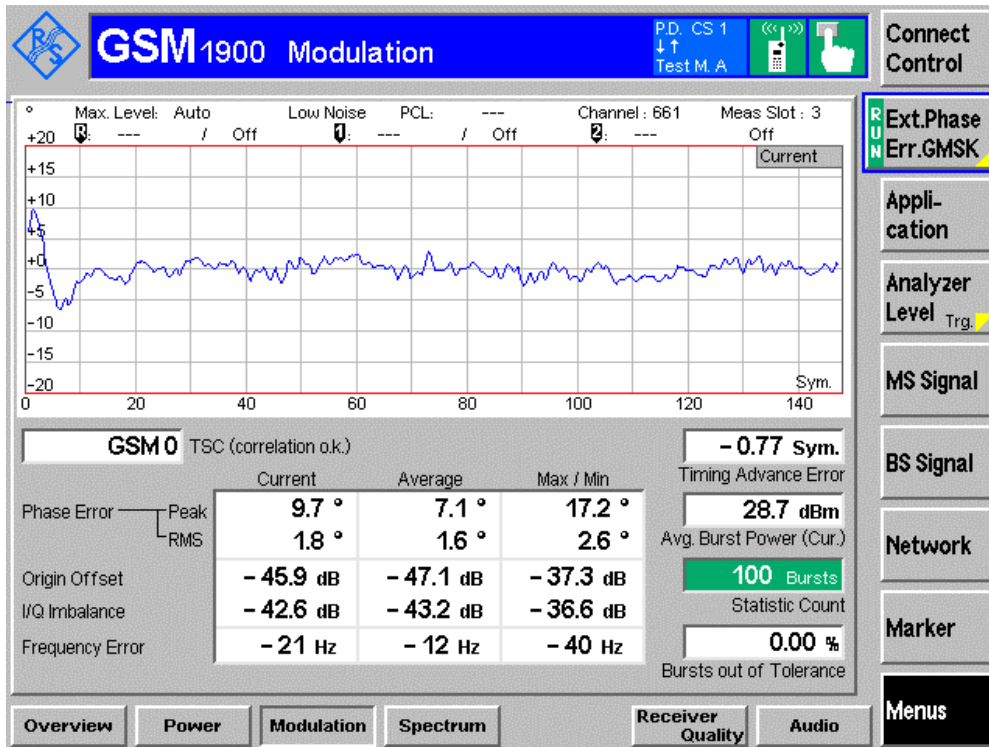

EDGE 850

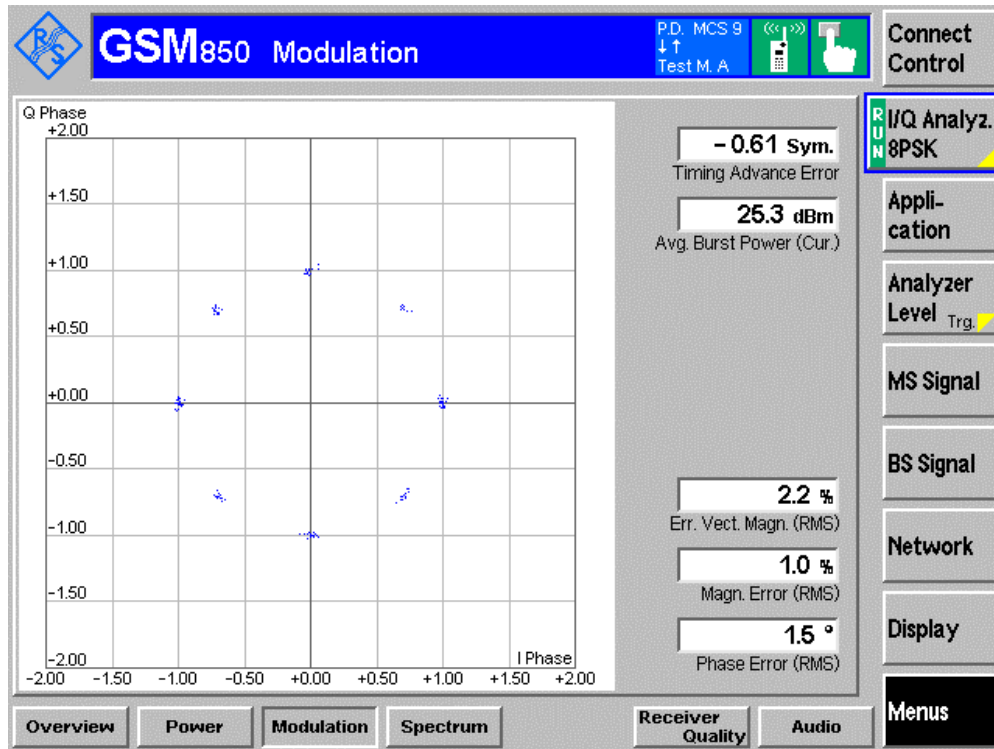

EDGE 1900

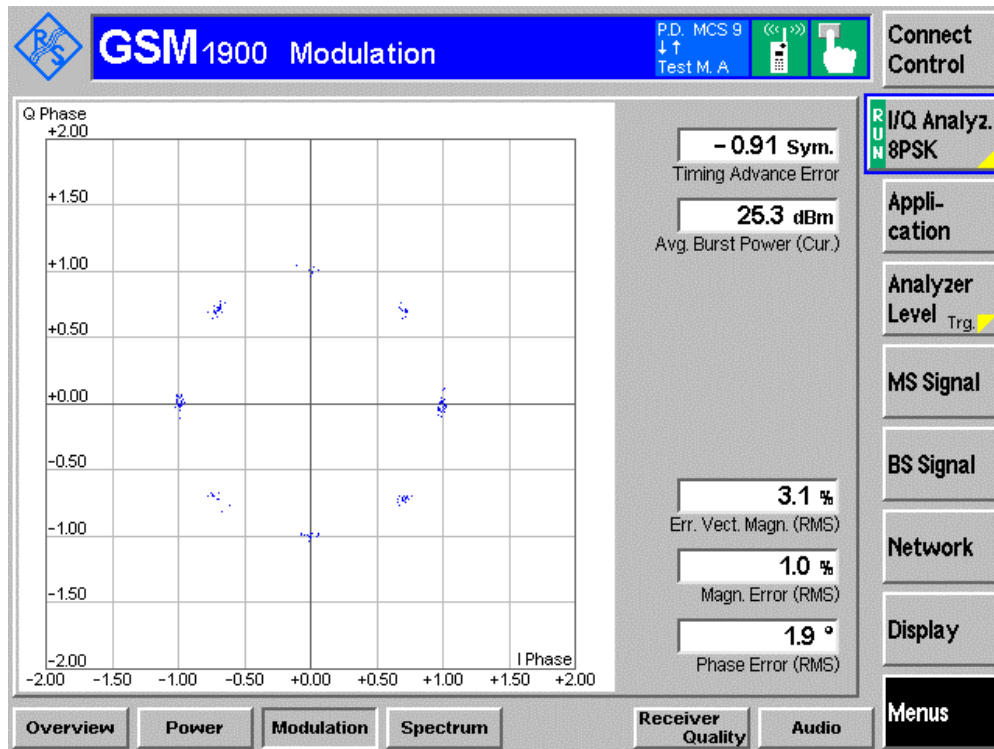

WCDMA FDD Band II

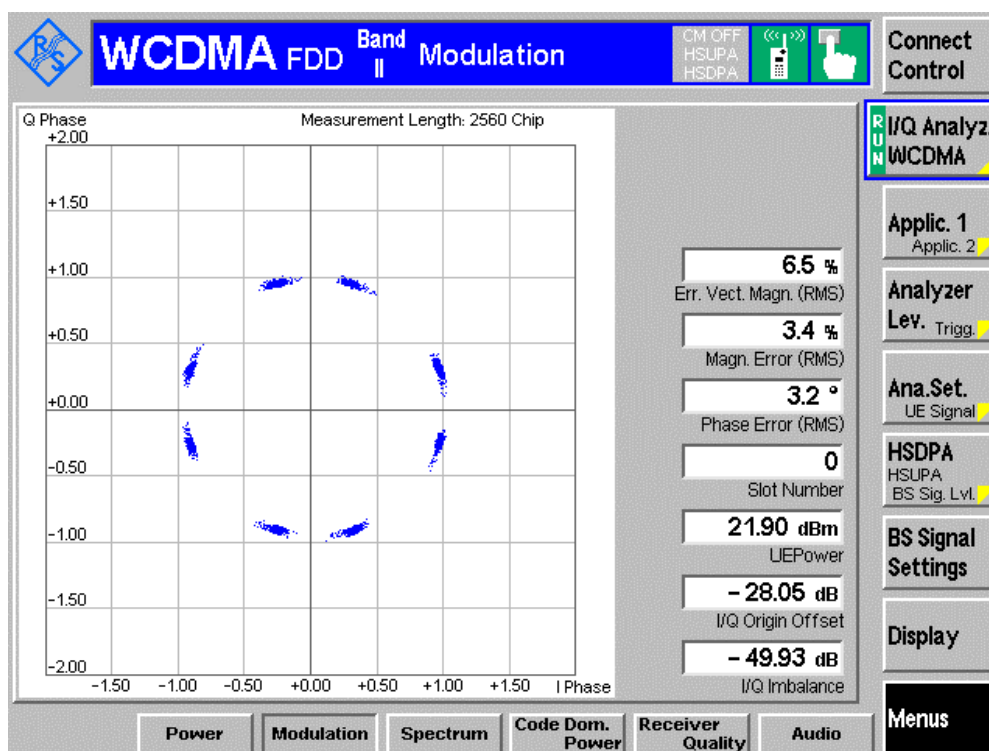

WCDMA FDD Band V

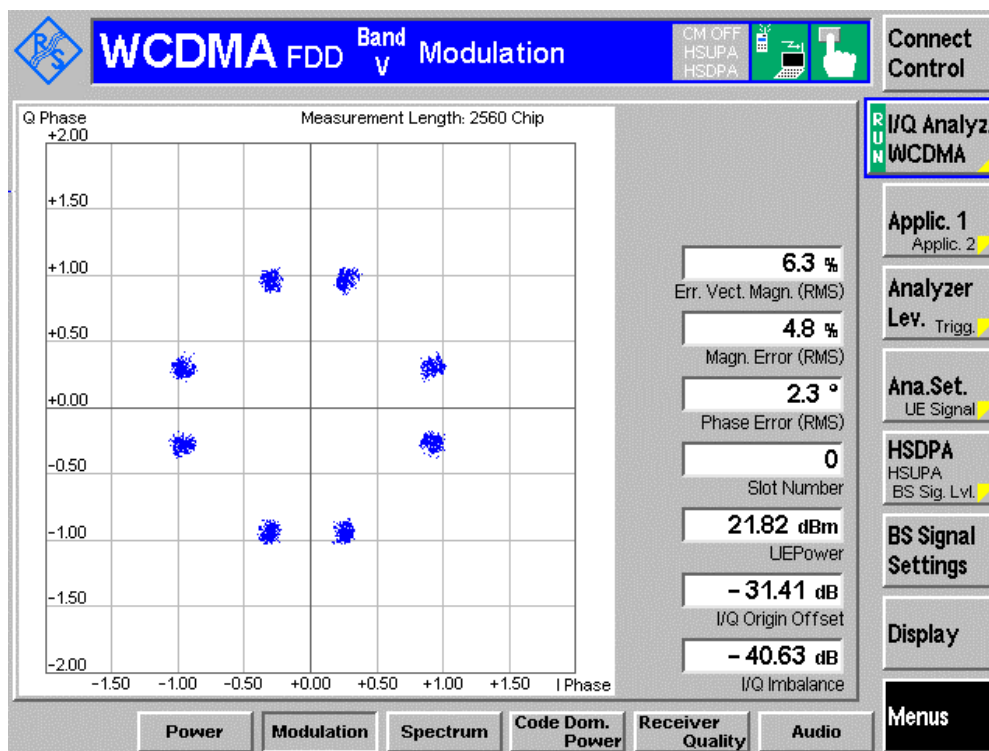

HSDPA FDD Band II

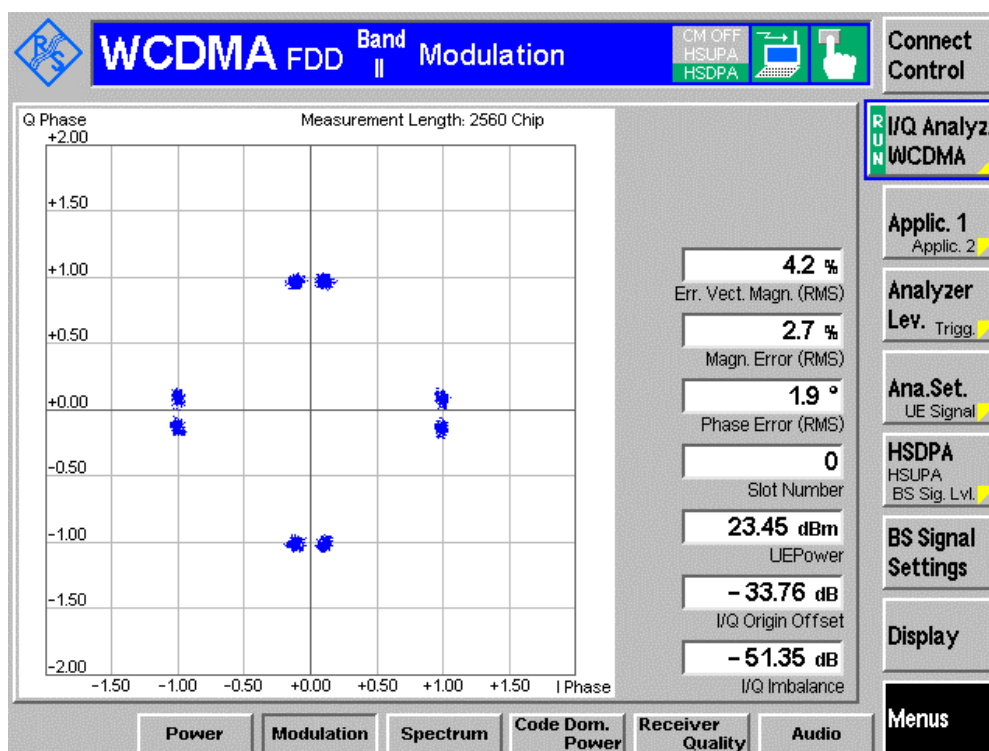

HSDPA FDD Band V

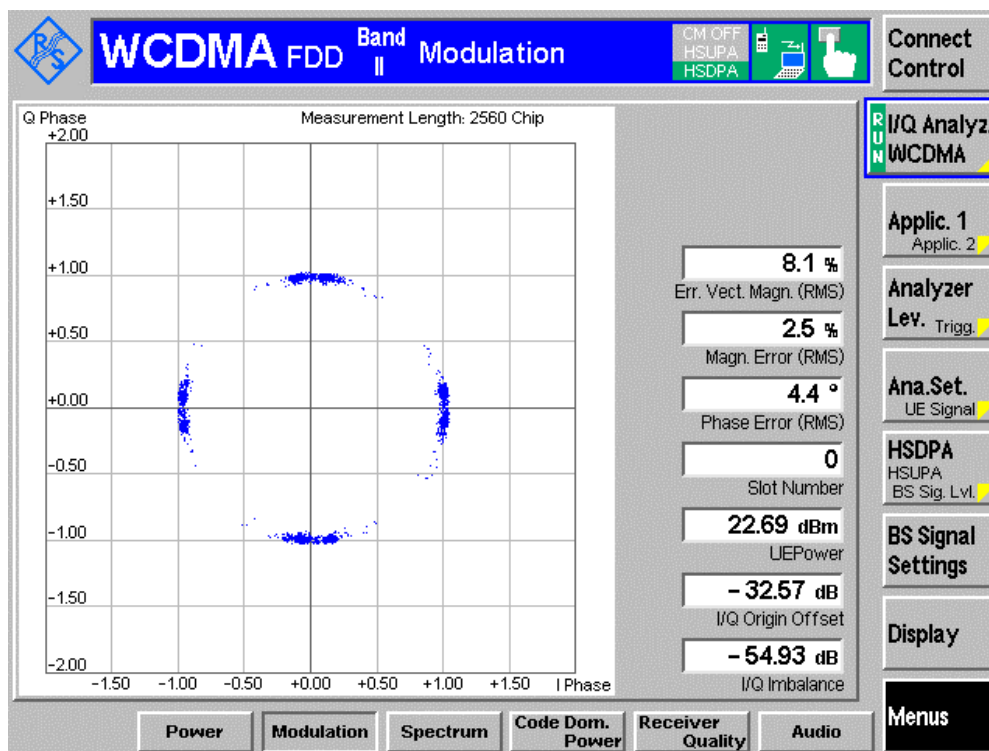

CDMA2000 1x BC0

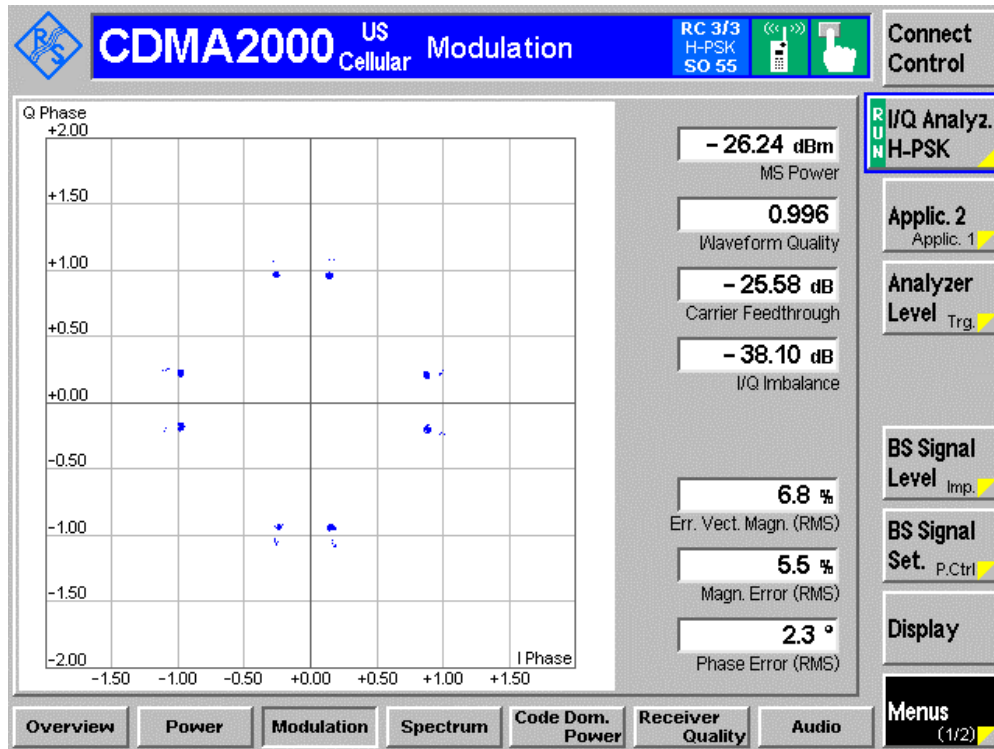

CDMA2000 1x BC1

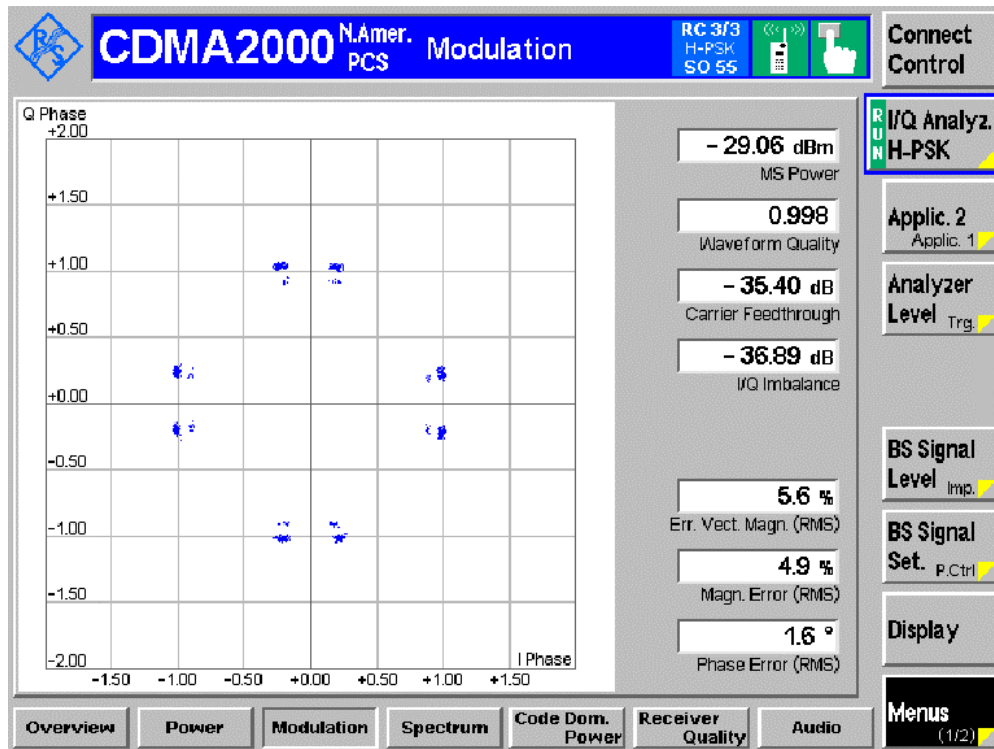

CDMA2000 1x EV-DO BC0

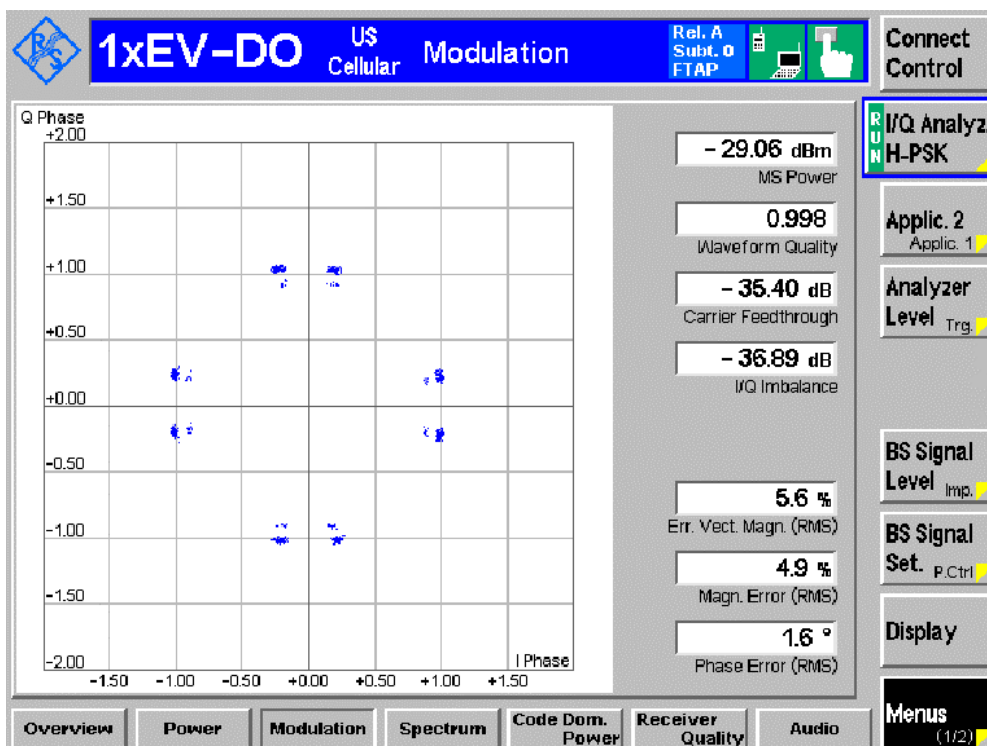

CDMA2000 1x EV-DO BC1

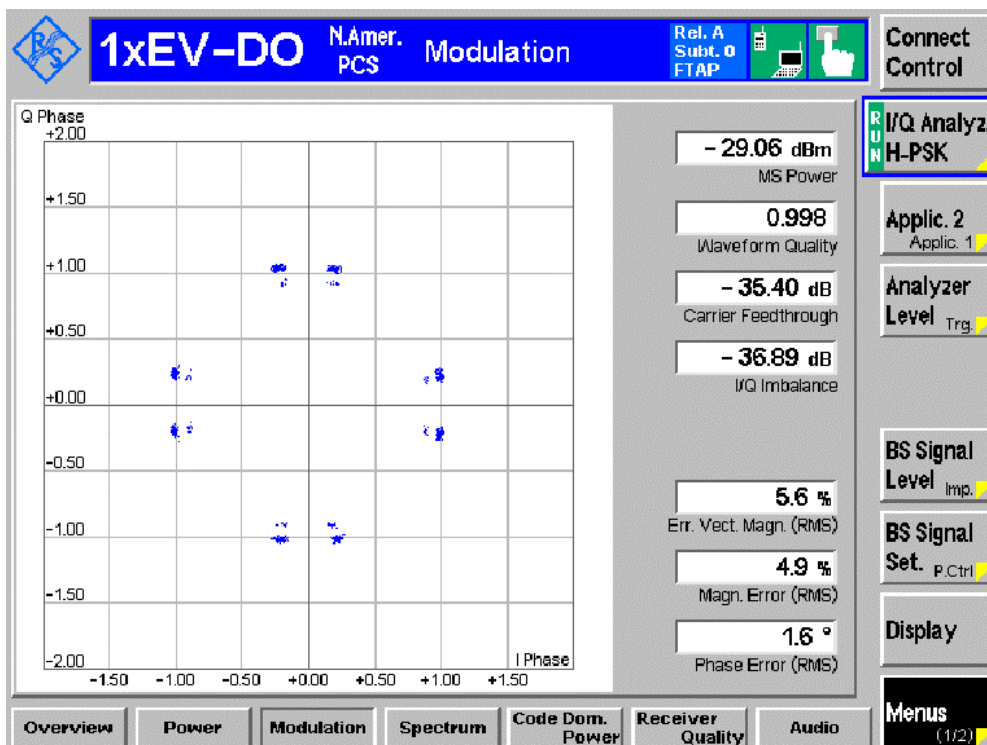

5. Occupied Bandwidth

5.1. Test Equipment

Occupied Bandwidth / AC-6

Instrument	Manufacturer	Type No.	Serial No	Cal. Date
Spectrum Analyzer	Agilent	E4446A	MY45300103	2009/06/11
Radio Communication Tester	R&S	CMU 200	106388	2008/10/21
Dual Directional Coupler	Agilent	778D	20160	2009/04/20
10dB Coaxial Coupler	Agilent	87300C	MY44300299	2009/04/20
Coaxial Cable	Huber+Suhner	AC4-RF-H	10	2008/11/24
Temperature/Humidity Meter	zhicheng	ZC1-2	QT-TH007	2009/03/31

5.2. Test Setup

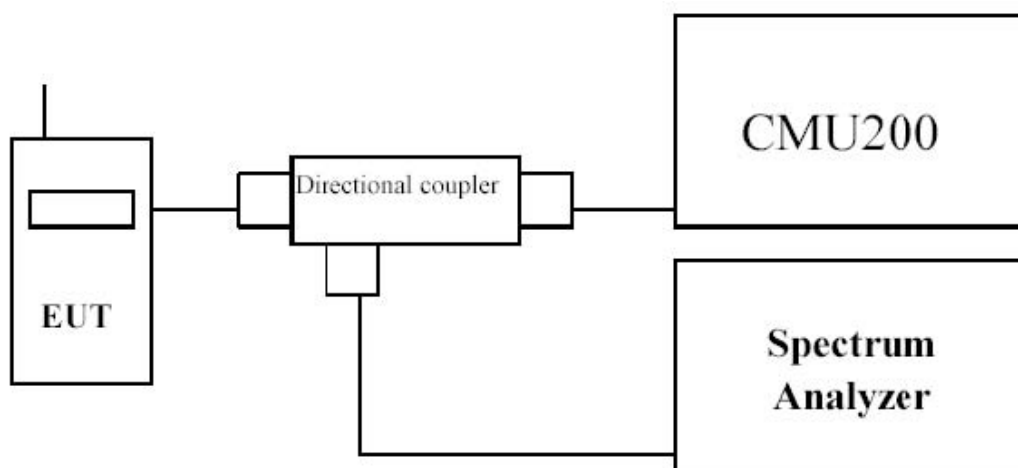

5.3. Limit

N/A

5.4. Test Procedure

Using Occupied Bandwidth measurement function of spectrum analyzer, and setting as follows:

For GPRS/EDGE 850/1900 test --- RBW = 3 kHz and VBW = 10 kHz

For WCDMA/HSDPA FDD Band II/V test --- RBW = 50 kHz and VBW = 200 kHz

For CDMA2000 1X EV-DO BC0/BC1 test --- RBW = 30 kHz and VBW = 100 kHz.

5.5. Uncertainty

The measurement uncertainty is defined as ± 10 Hz

5.6. Test Result

Product	Eee PC		
Test Item	Occupied Bandwidth		
Test Mode	Mode 1: GSM850 GPRS Link		
Date of Test	2009/07/11	Test Site	AC-6

Channel No.	Frequency (MHz)	-26dB Occupied Bandwidth (kHz)	99% Occupied Bandwidth (kHz)
128	824.20	318.25	245.37
189	836.40	320.18	249.69
251	848.80	308.14	242.89

Figure Channel 128 (824.20MHz)



Figure Channel 189 (836.40MHz)

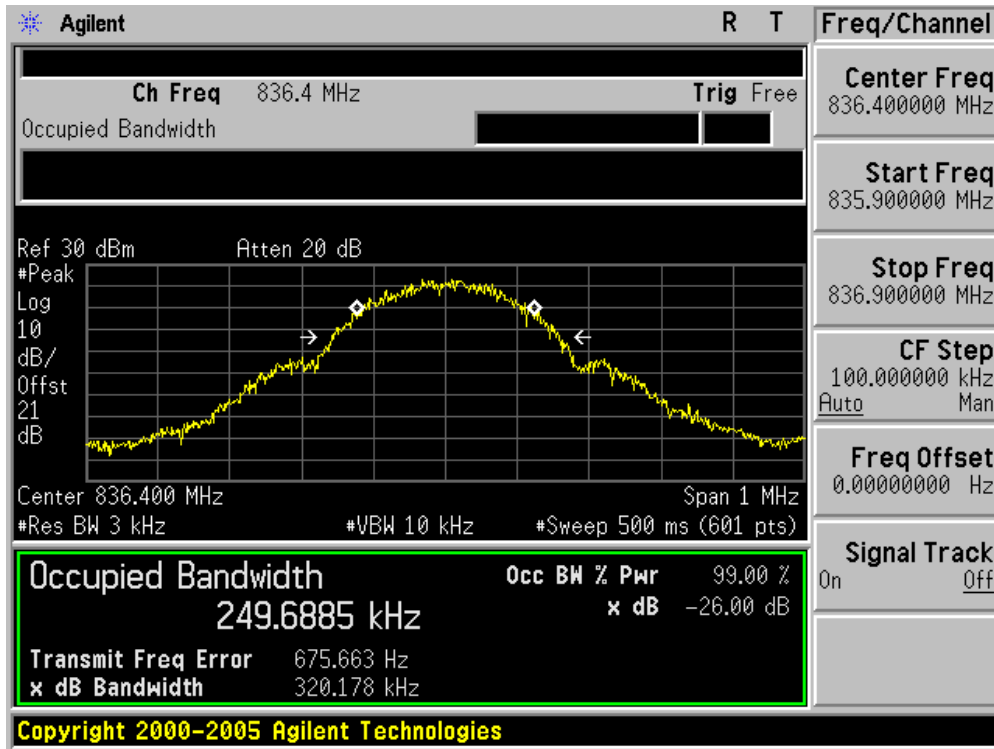
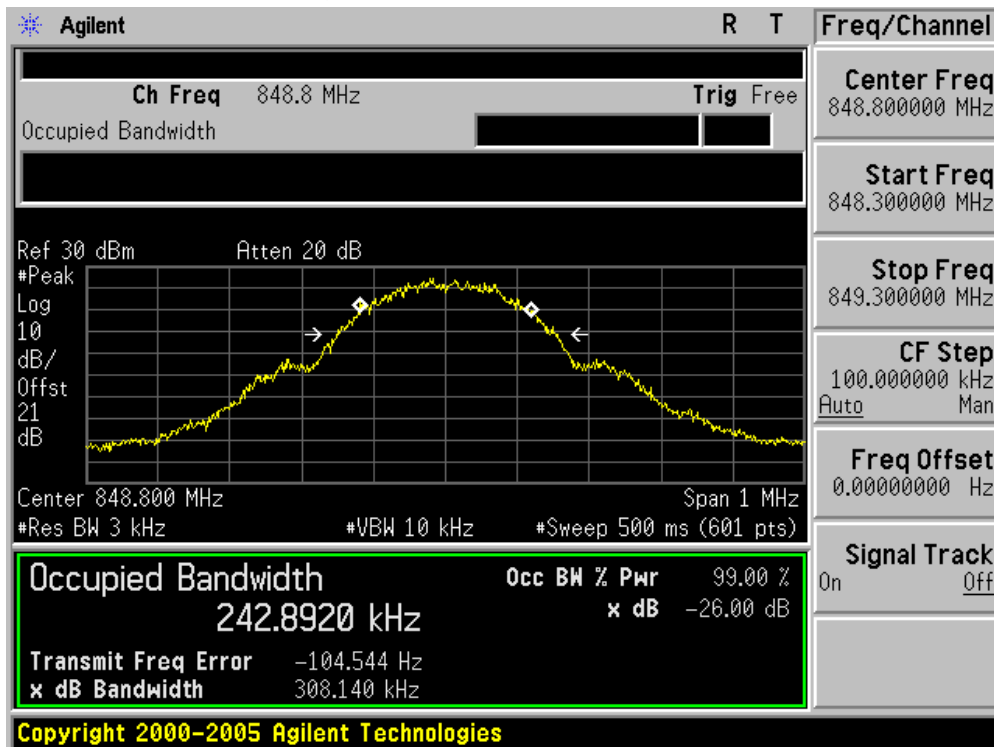

Figure Channel 251 (848.80MHz)



Product	Eee PC		
Test Item	Occupied Bandwidth		
Test Mode	Mode 2: PCS1900 GPRS Link		
Date of Test	2009/07/11	Test Site	AC-6

Channel No.	Frequency (MHz)	-26dB Occupied Bandwidth (kHz)	99% Occupied Bandwidth (kHz)
512	1850.20	301.434	244.9309
661	1880.00	312.820	243.3332
810	1909.80	316.684	243.3901

Figure Channel 512 (1850.20MHz)

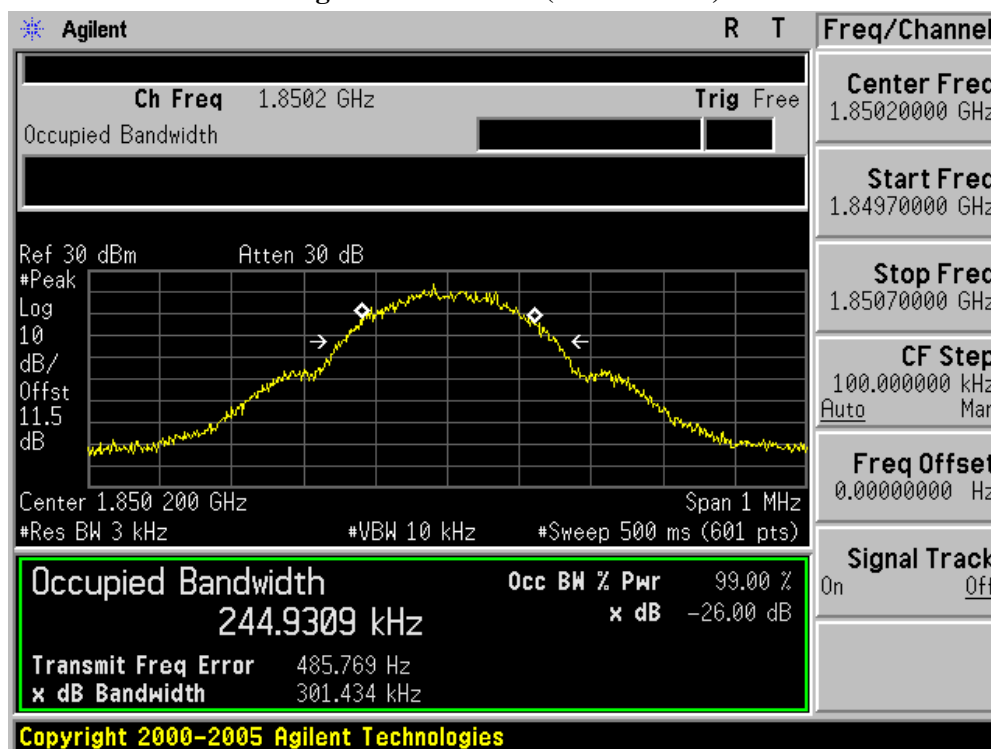

Figure Channel 661 (1880.00MHz)

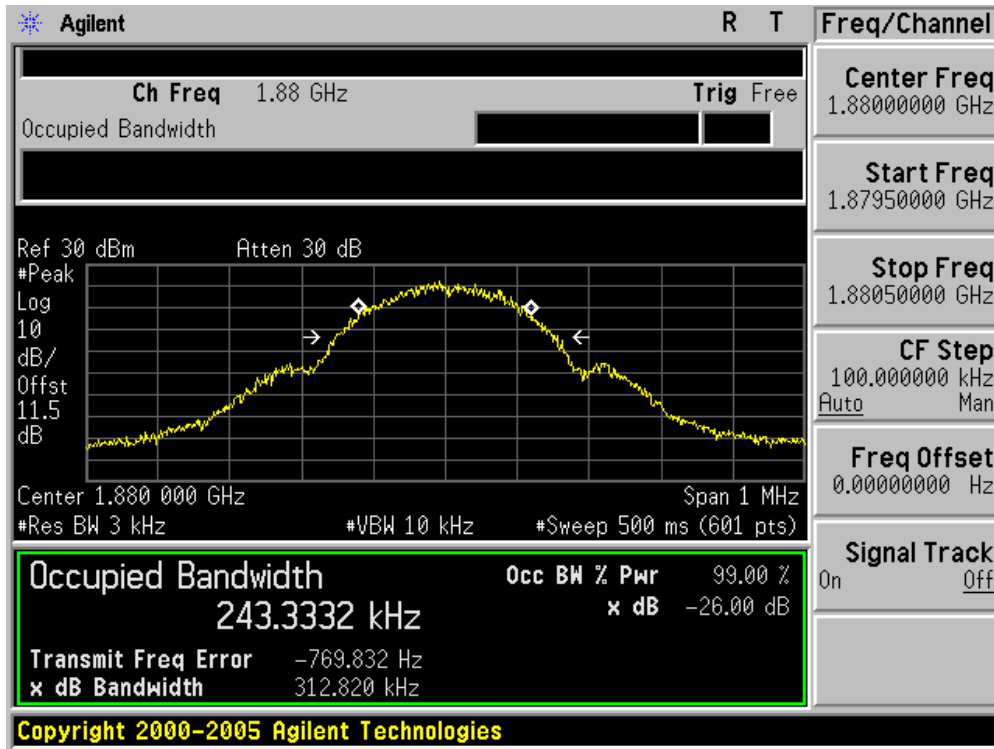
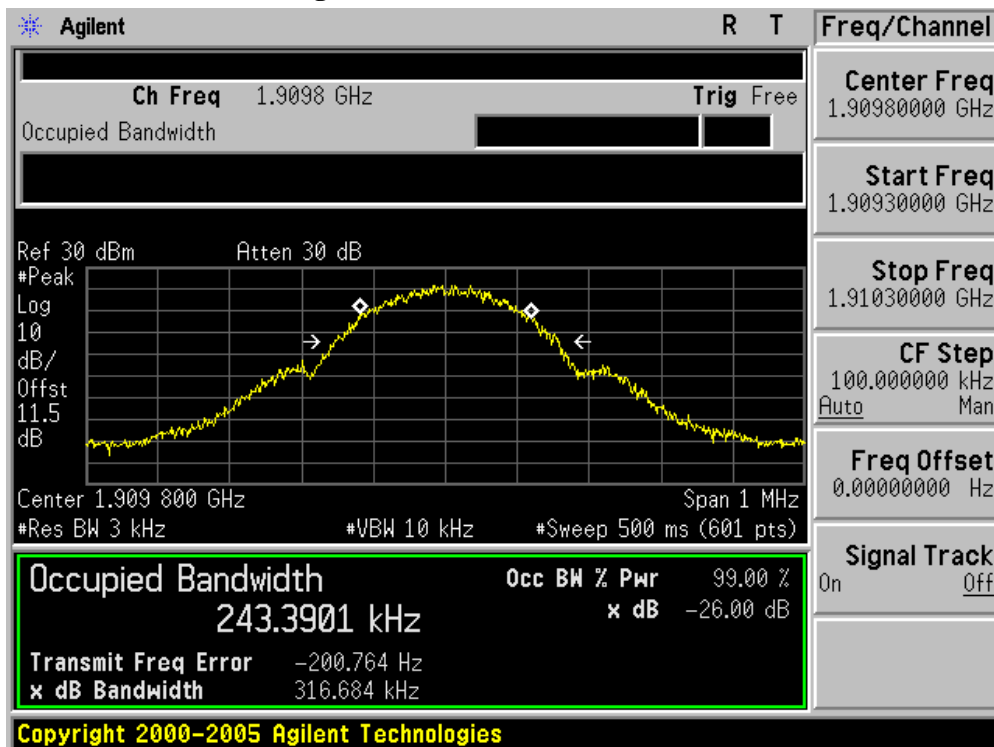

Figure Channel 810 (1909.80MHz)



Product	Eee PC		
Test Item	Occupied Bandwidth		
Test Mode	Mode 3: GSM850 EDGE Link		
Date of Test	2009/07/11	Test Site	AC-6

Channel No.	Frequency (MHz)	-26dB Occupied Bandwidth (kHz)	99% Occupied Bandwidth (kHz)
128	824.20	298.231	246.4663
189	836.40	299.157	244.3827
251	848.80	310.377	247.2000

Figure Channel 128 (824.20MHz)

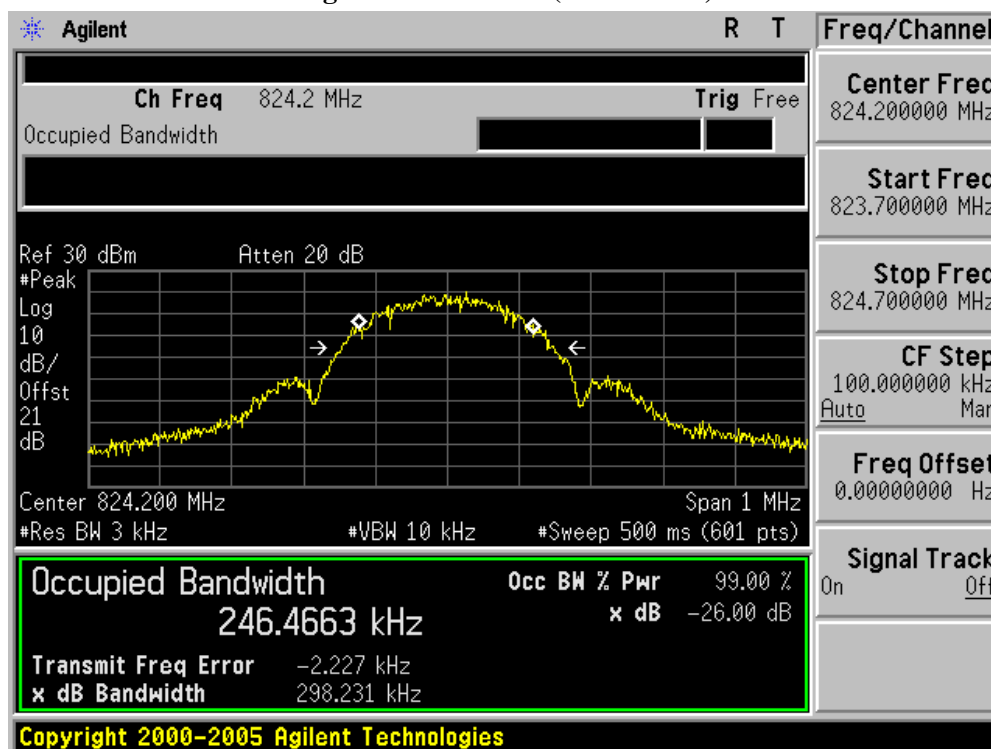

Figure Channel 189 (836.40MHz)

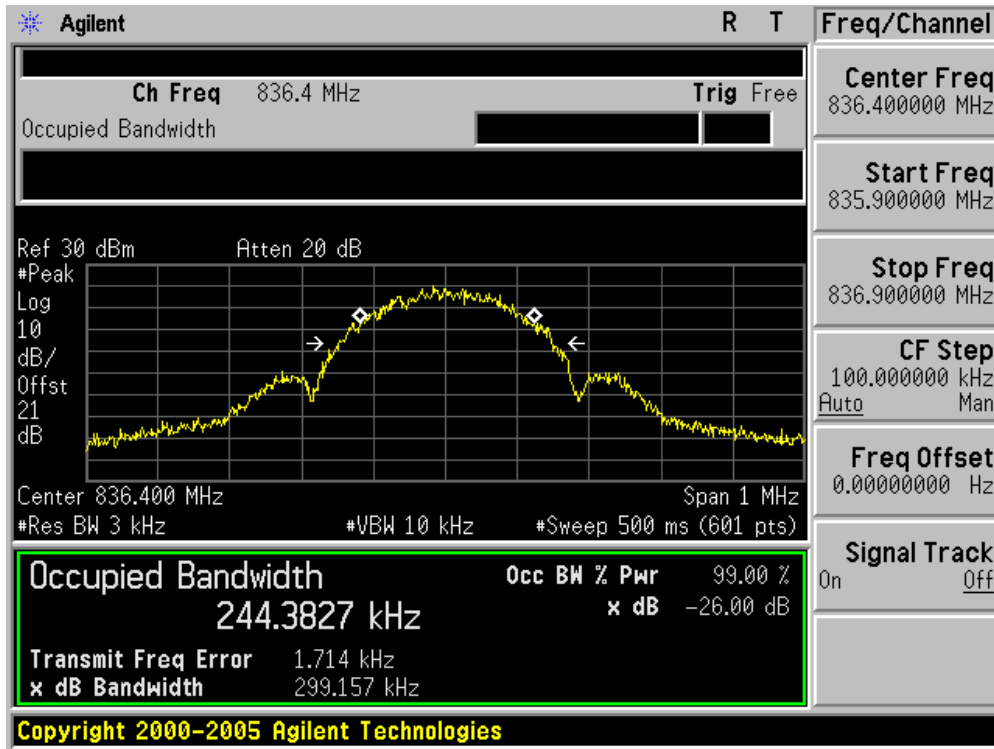
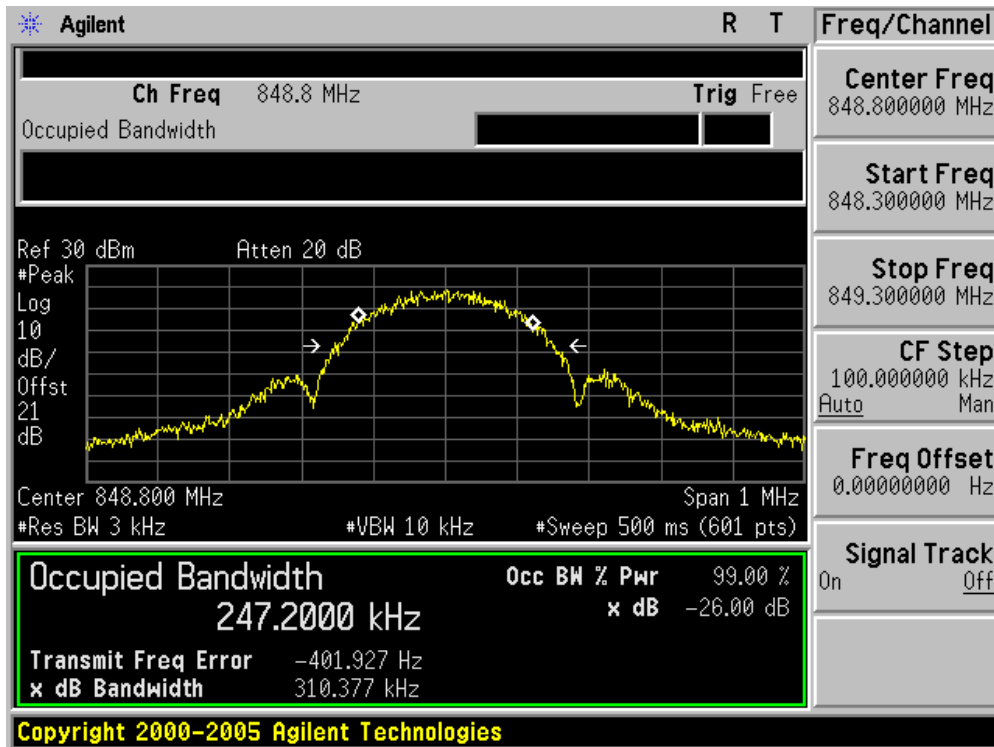

Figure Channel 251 (848.80MHz)



Product	Eee PC		
Test Item	Occupied Bandwidth		
Test Mode	Mode 4: PCS1900 EDGE Link		
Date of Test	2009/07/11	Test Site	AC-6

Channel No.	Frequency (MHz)	-26dB Occupied Bandwidth (kHz)	99% Occupied Bandwidth (kHz)
512	1850.20	300.806	245.7442
661	1880.00	307.604	243.3485
810	1909.80	309.775	249.5952

Figure Channel 512 (1850.20MHz)



Figure Channel 661 (1880.00MHz)



Figure Channel 810 (1909.80MHz)



Product	Eee PC		
Test Item	Occupied Bandwidth		
Test Mode	Mode 5: WCDMA Band II Link		
Date of Test	2009/07/11	Test Site	AC-6

Channel No.	Frequency (MHz)	-26dB Occupied Bandwidth (MHz)	99% Occupied Bandwidth (MHz)
9262	1852.4	4.627	4.1670
9400	1880.0	4.631	4.1587
9538	1907.6	4.666	4.1901

Figure Channel 9262 (1852.4MHz)

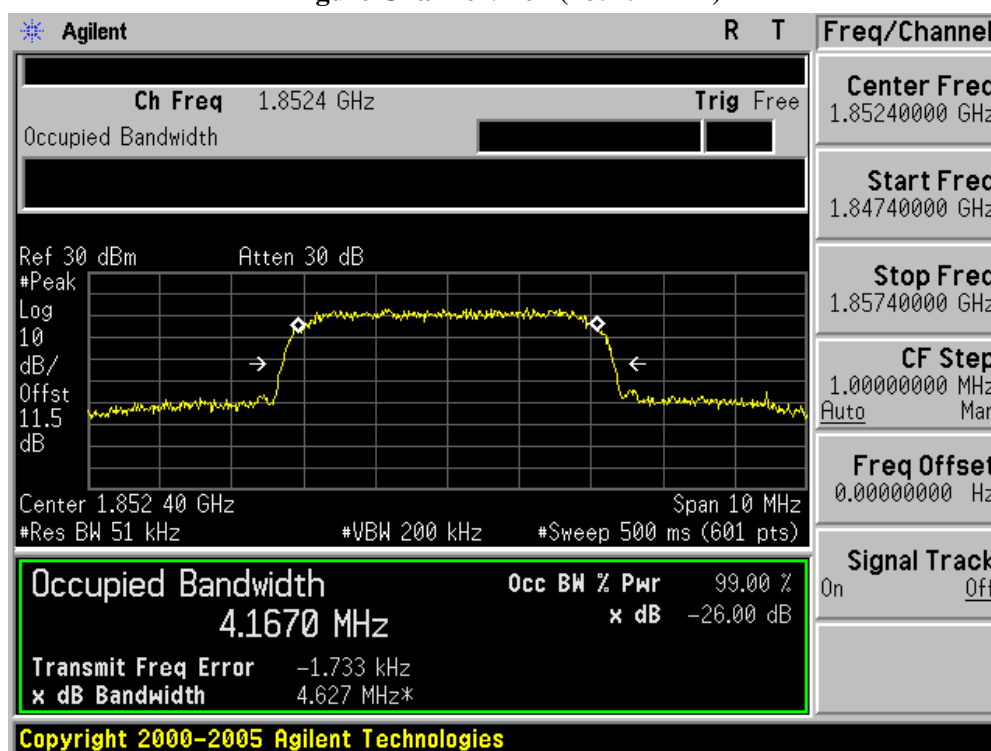

Figure Channel 9400 (1880.0MHz)

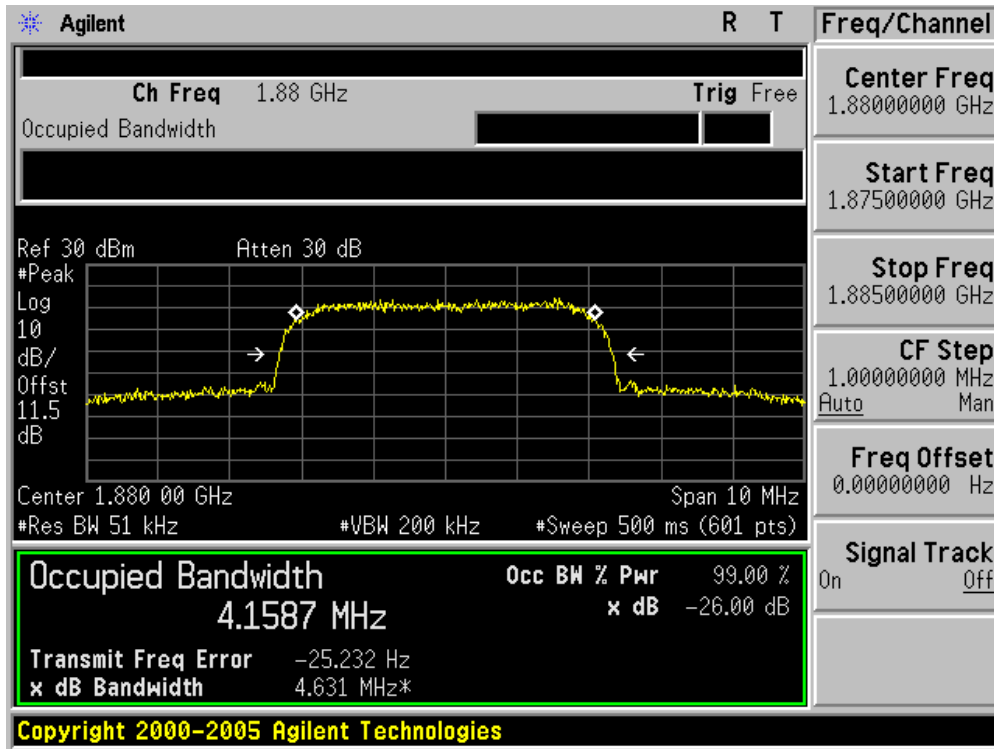
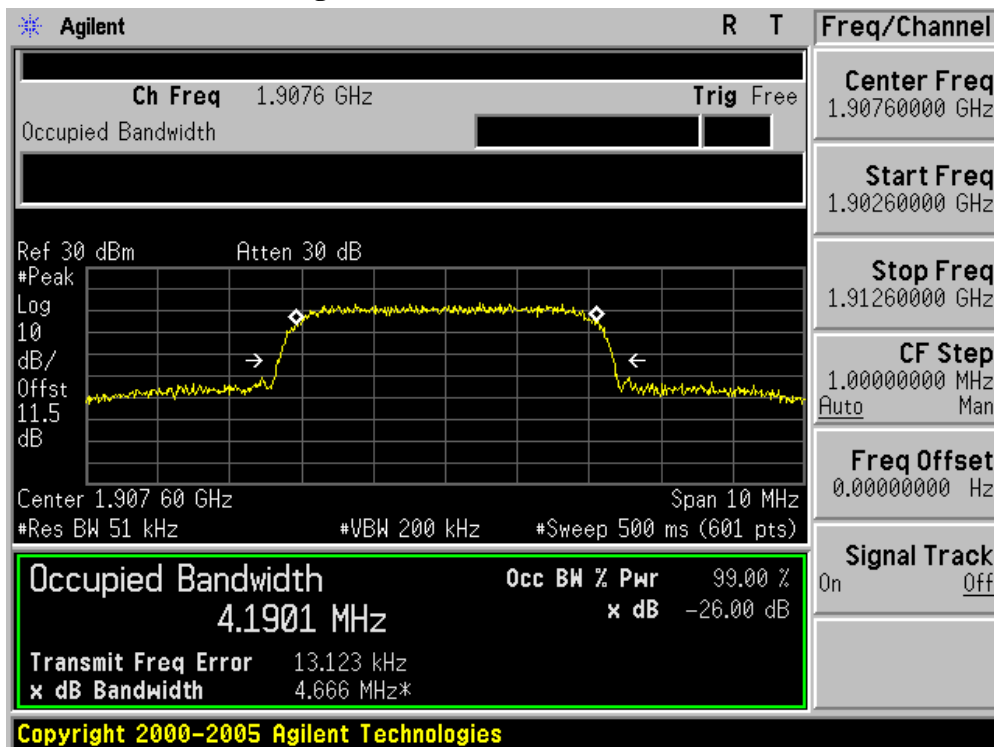

Figure Channel 9538 (1907.6MHz)



Product	Eee PC		
Test Item	Occupied Bandwidth		
Test Mode	Mode 6: WCDMA Band V Link		
Date of Test	2009/07/11	Test Site	AC-6

Channel No.	Frequency (MHz)	-26dB Occupied Bandwidth (MHz)	99% Occupied Bandwidth (MHz)
4132	826.4	4.645	4.1787
4182	836.4	4.631	4.1852
4233	846.6	4.632	4.1552

Figure Channel 4132 (826.4MHz)

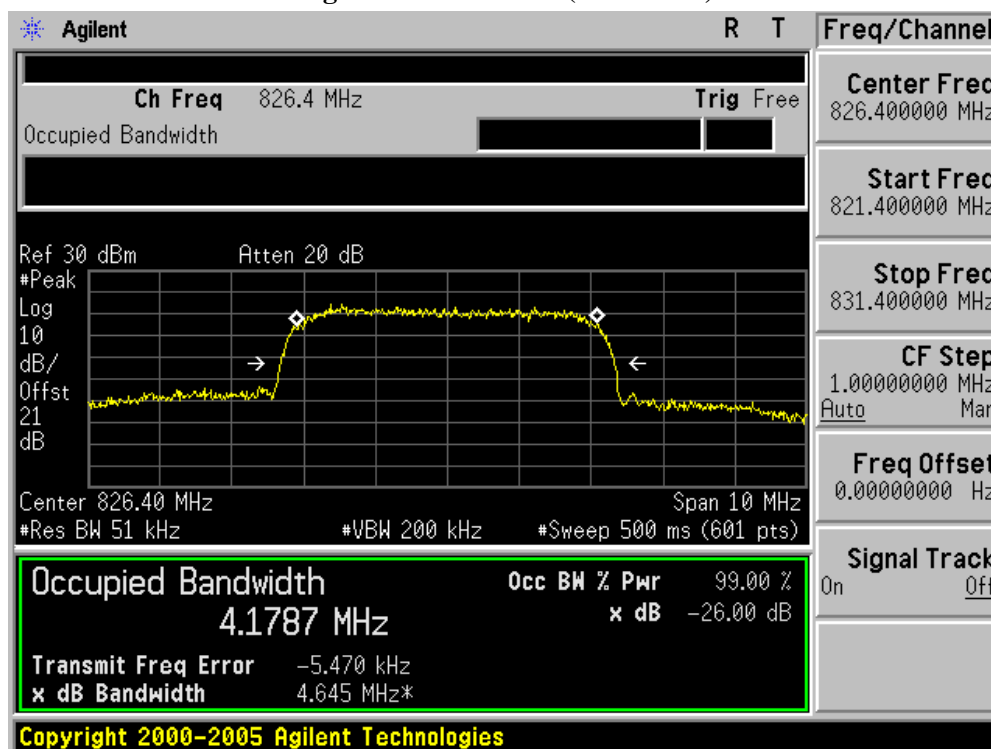

Figure Channel 4182 (836.40MHz)

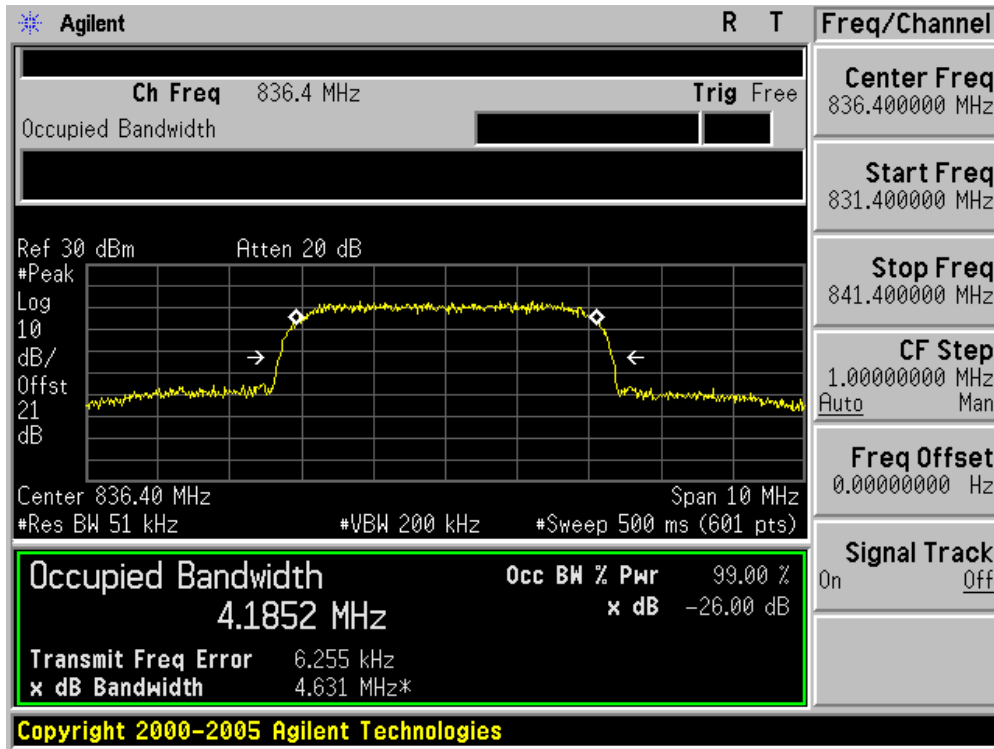
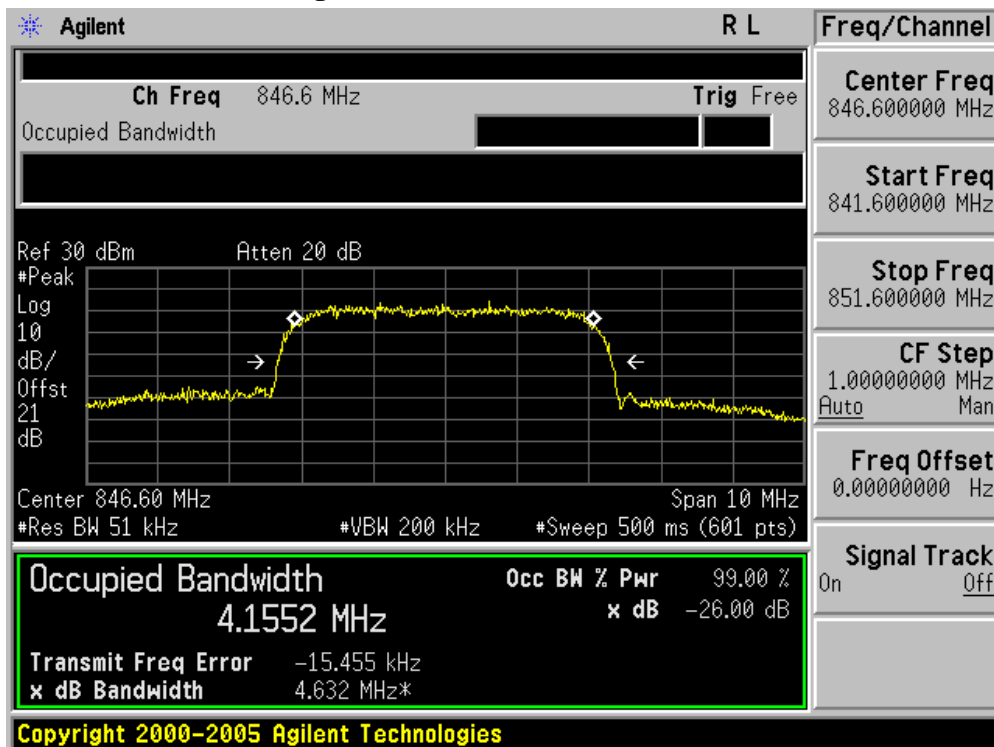

Figure Channel 4233 (846.60MHz)



Product	Eee PC		
Test Item	Occupied Bandwidth		
Test Mode	Mode 7: HSDPA Band II Link		
Date of Test	2009/07/11	Test Site	AC-6

Channel No.	Frequency (MHz)	-26dB Occupied Bandwidth (MHz)	99% Occupied Bandwidth (MHz)
9262	1852.4	4.624	4.1586
9400	1880.0	4.636	4.1755
9538	1907.6	4.628	4.1827

Figure Channel 9262 (1852.4MHz)

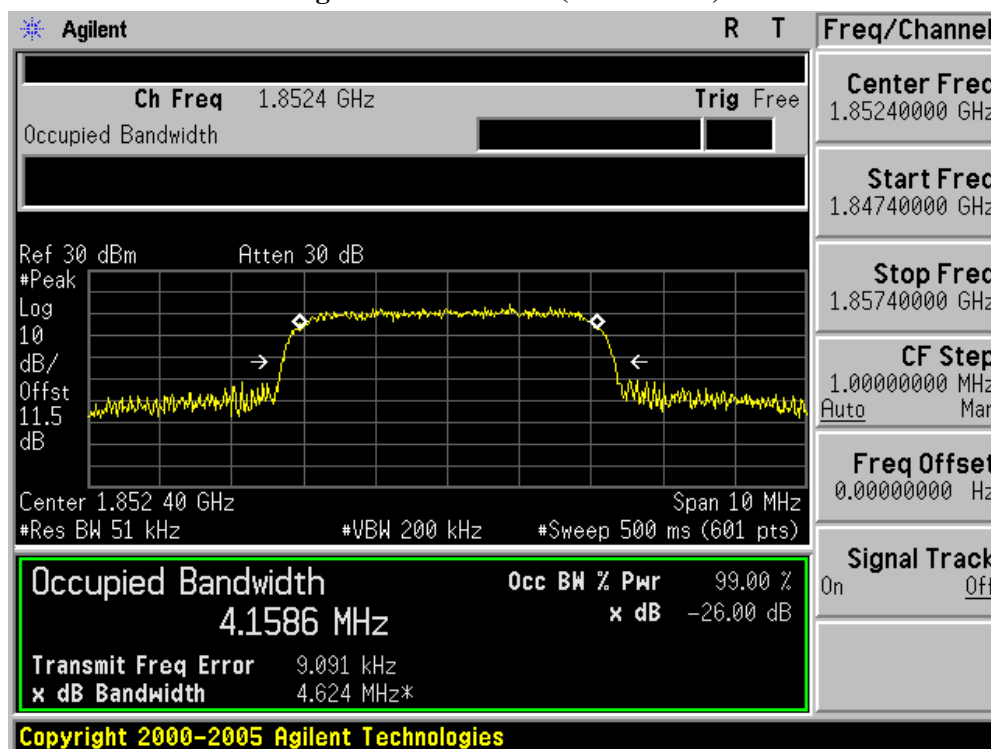

Figure Channel 9400 (1880MHz)

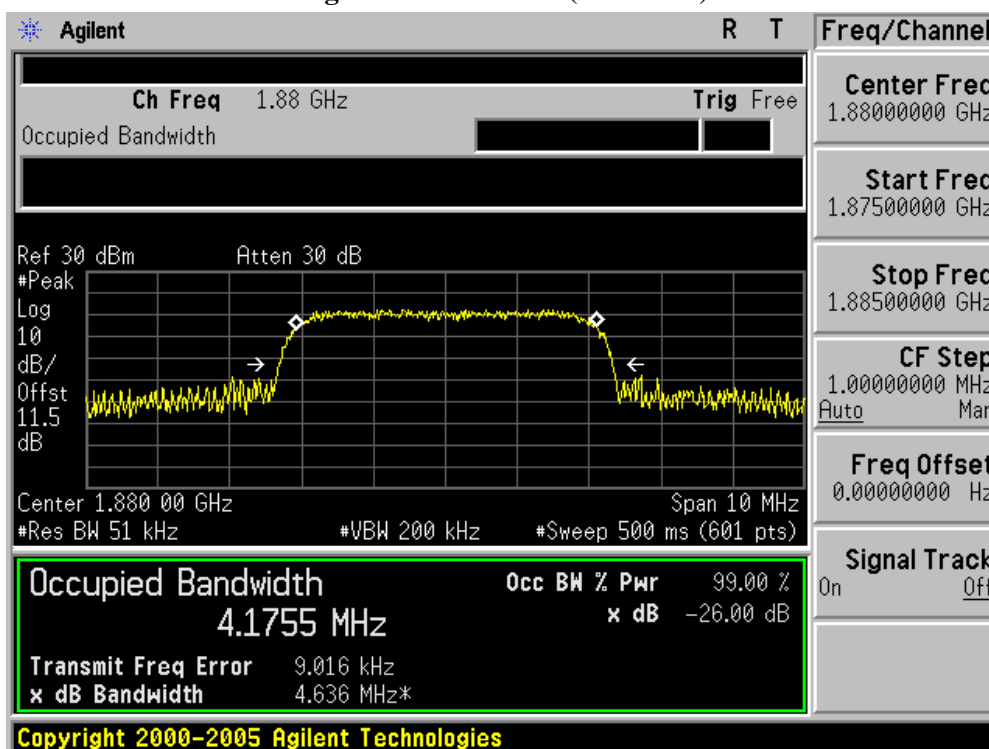
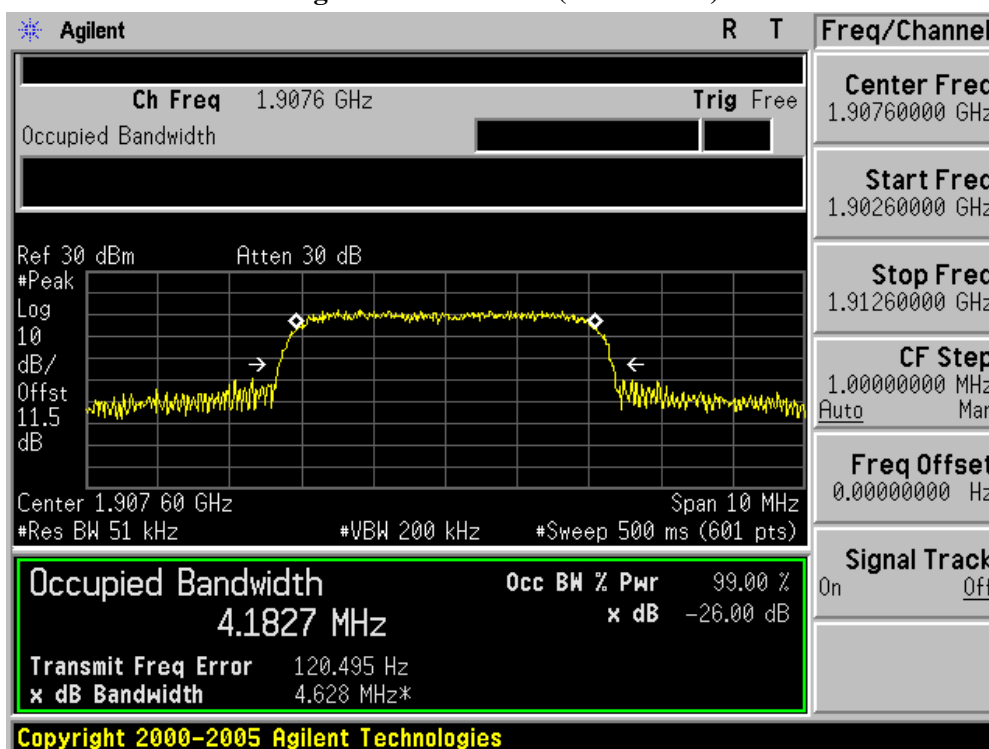

Figure Channel 9538 (1907.6MHz)



Product	Eee PC		
Test Item	Occupied Bandwidth		
Test Mode	Mode 8: HSDPA Band V Link		
Date of Test	2009/07/11	Test Site	AC-6

Channel No.	Frequency (MHz)	-26dB Occupied Bandwidth (MHz)	99% Occupied Bandwidth (MHz)
4132	826.4	4.629	4.1851
4182	836.4	4.630	4.1841
4233	846.6	4.623	4.1726

Figure Channel 4132 (826.4MHz)

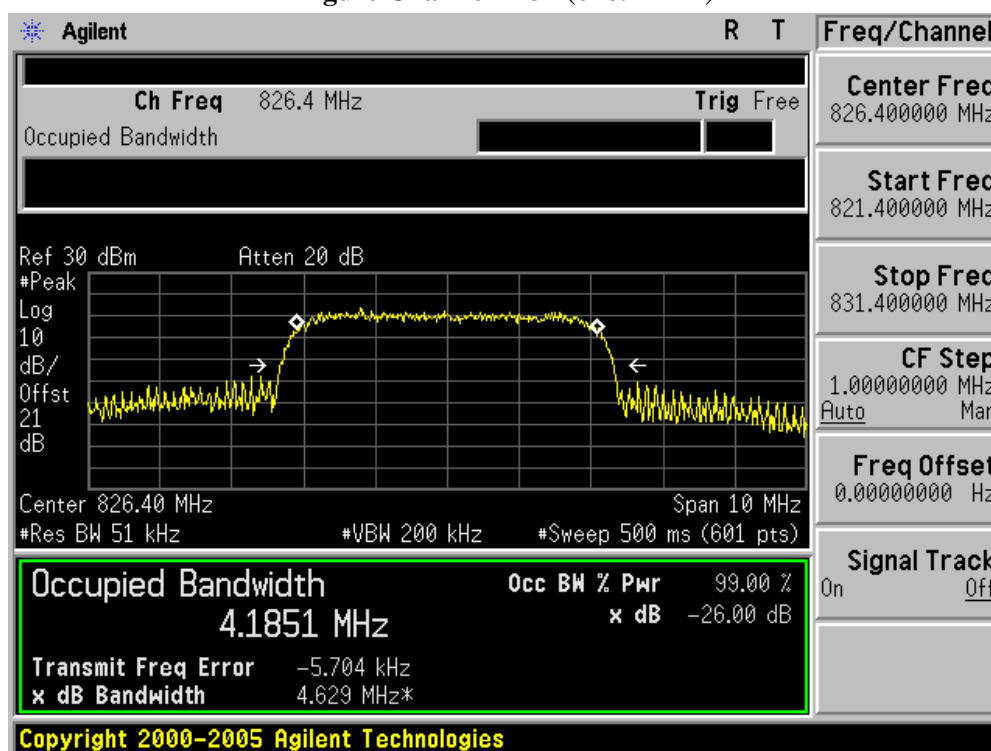

Figure Channel 4182 (836.40MHz)

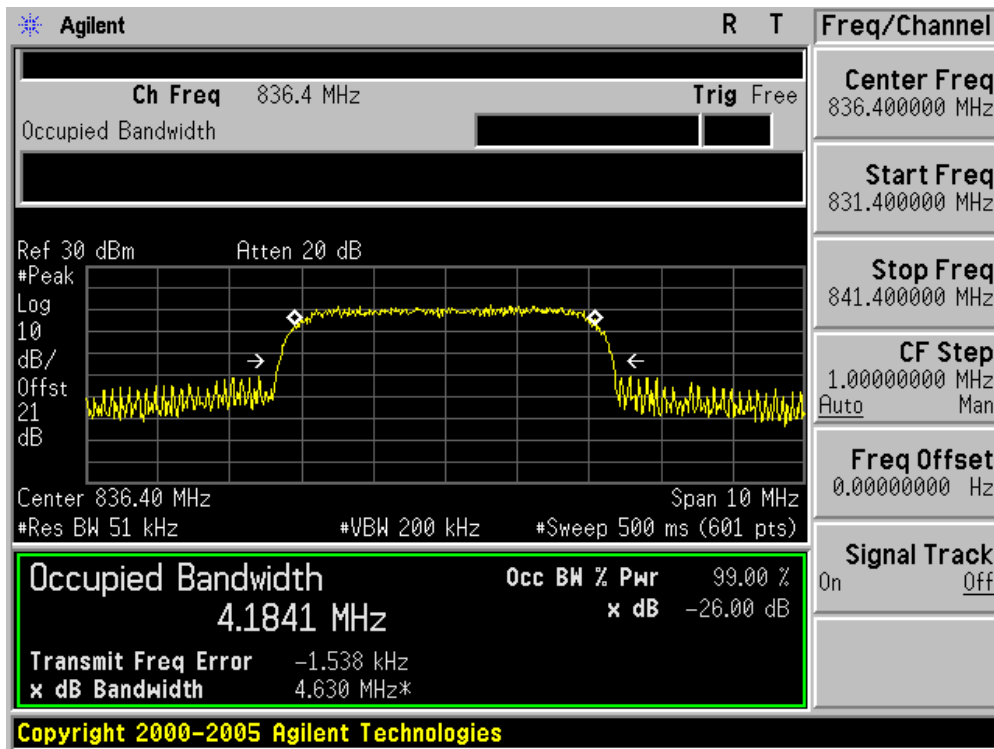
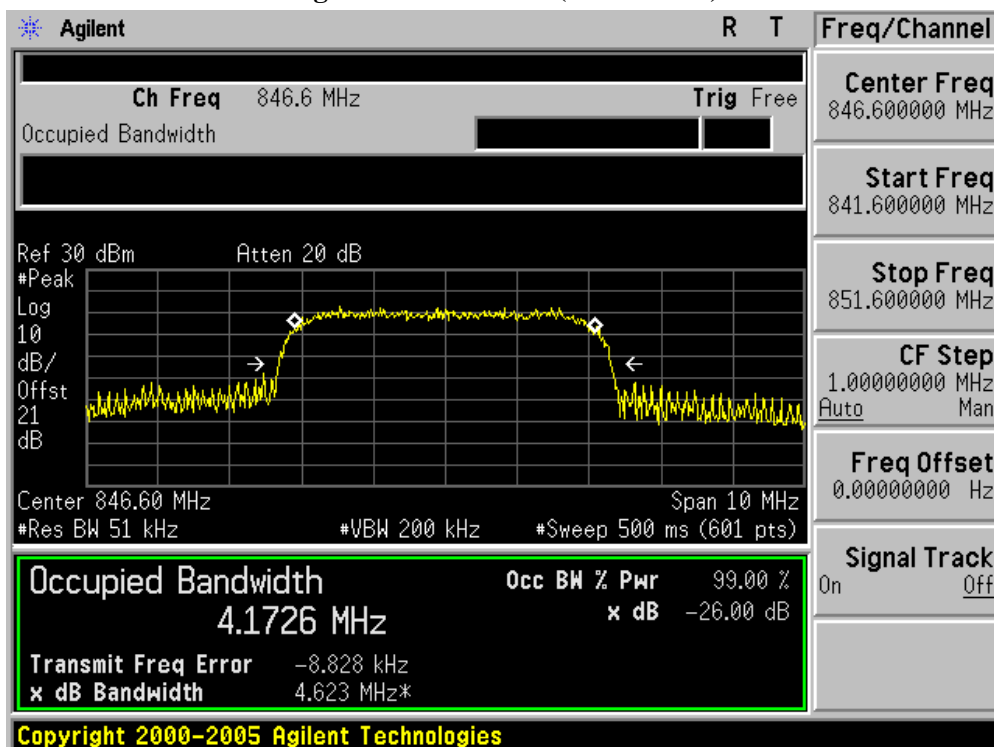

Figure Channel 4233 (846.60MHz)



Product	Eee PC		
Test Item	Occupied Bandwidth		
Test Mode	Mode 9: CDMA2000 1x BC0		
Date of Test	2009/07/11	Test Site	AC-6

Channel No.	Frequency (MHz)	-26dB Occupied Bandwidth (MHz)	99% Occupied Bandwidth (MHz)
1013	824.70	1.435	1.2738
384	836.52	1.437	1.2725
777	848.31	1.433	1.2751

Figure Channel 1013 (824.70MHz)

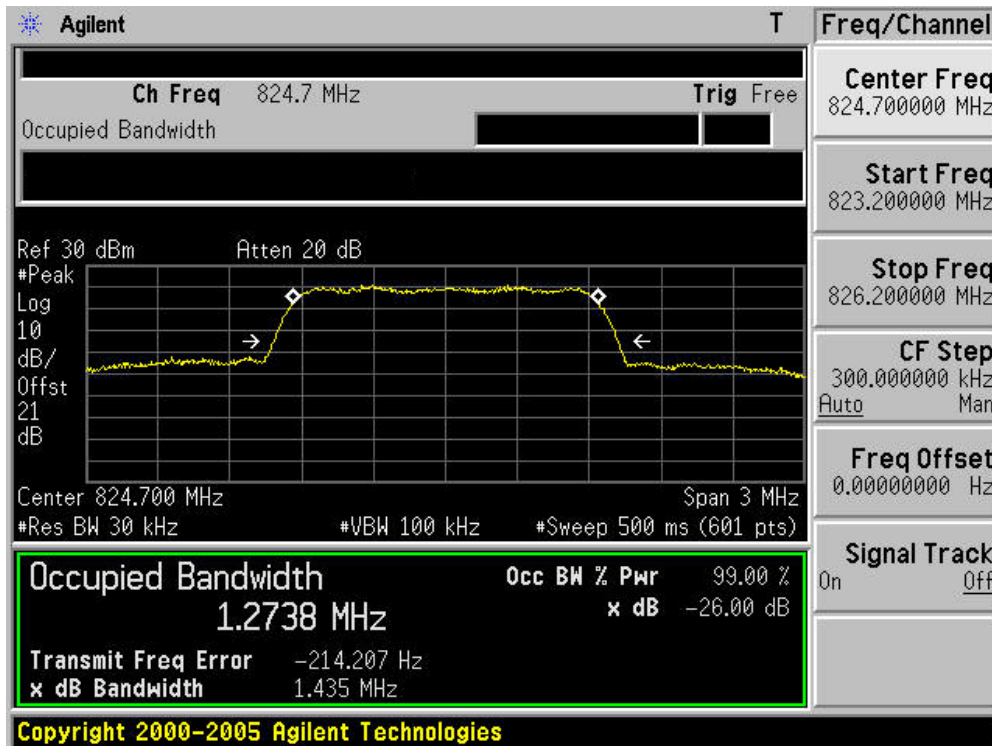

Figure Channel 384 (836.52MHz)

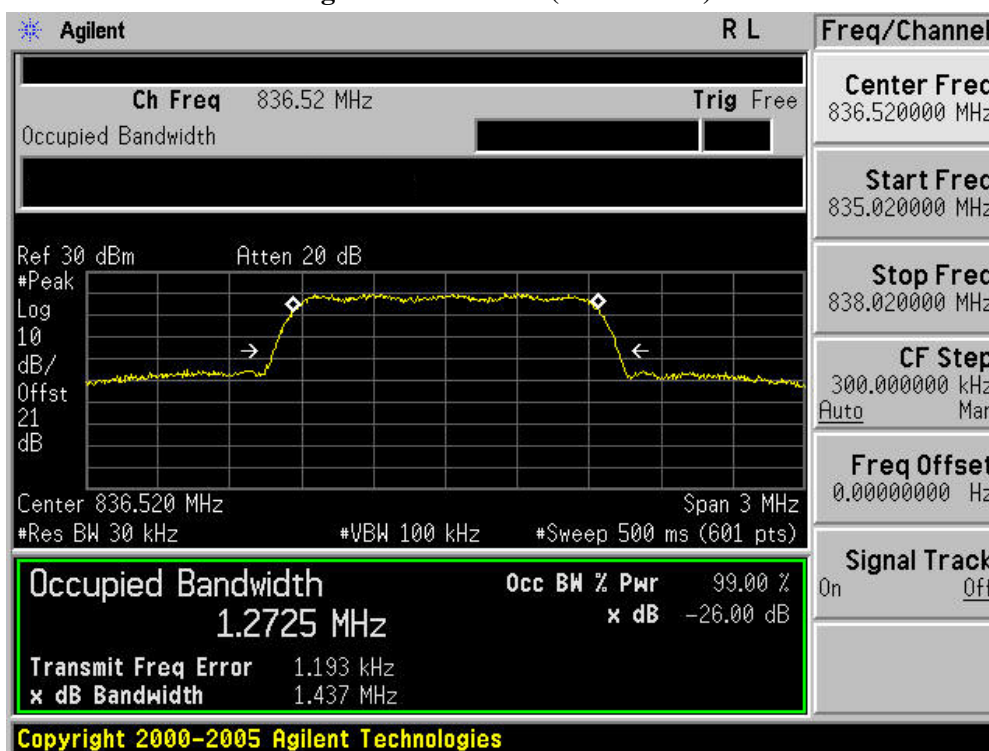
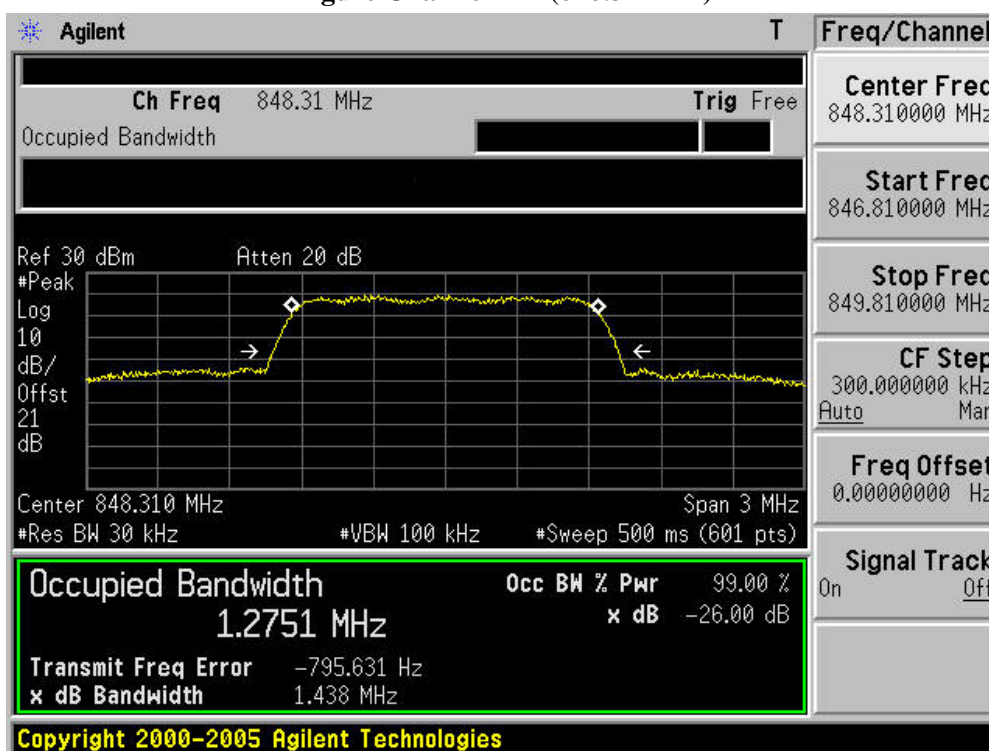

Figure Channel 777 (848.31MHz)



Product	Eee PC		
Test Item	Occupied Bandwidth		
Test Mode	Mode 10: CDMA2000 1x BC1		
Date of Test	2009/07/11	Test Site	AC-6

Channel No.	Frequency (MHz)	-26dB Occupied Bandwidth (MHz)	99% Occupied Bandwidth (MHz)
25	1851.25	1.431	1.2729
600	1880.00	1.431	1.2738
1175	1908.75	1.444	1.2785

Figure Channel 25 (1851.25MHz)

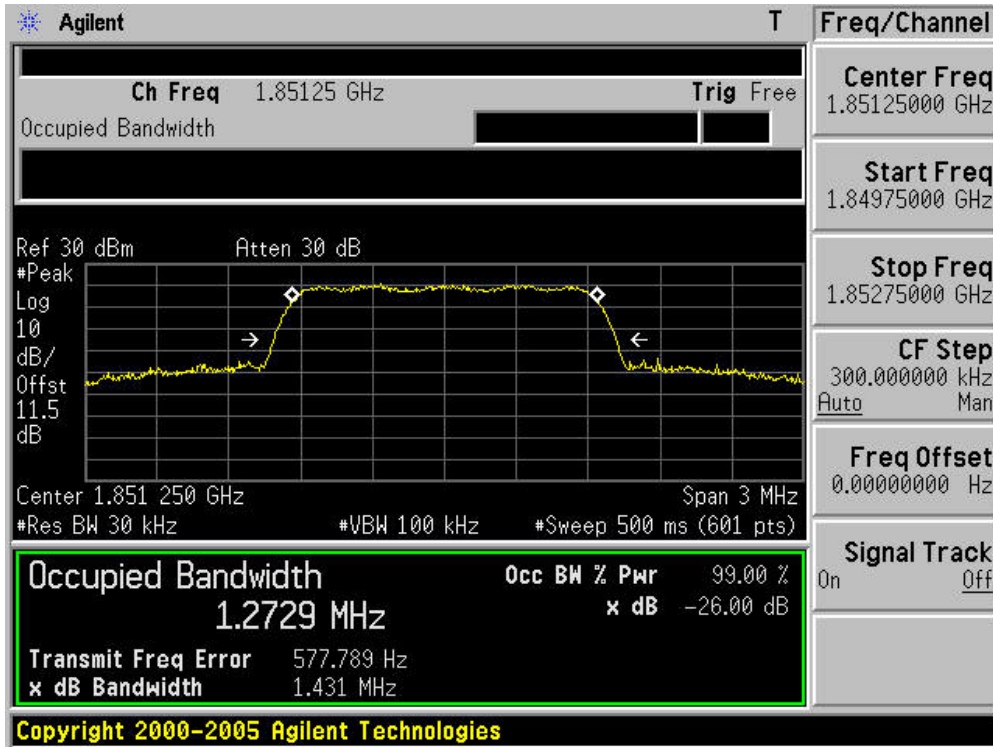

Figure Channel 600 (1880.00MHz)

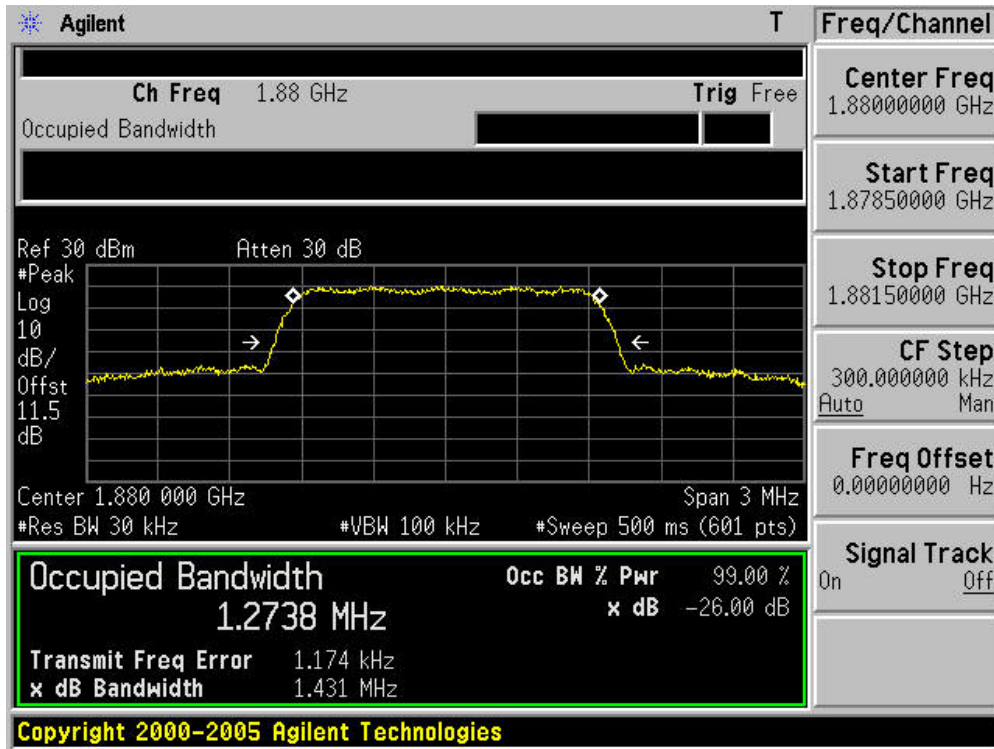
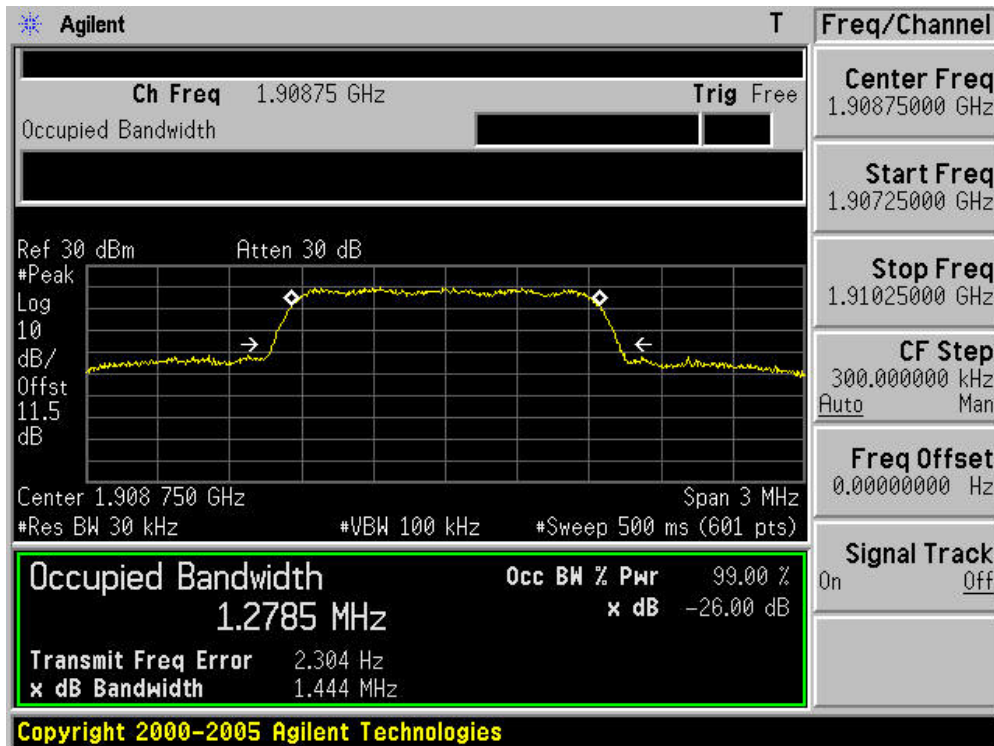

Figure Channel 1175 (1908.75MHz)



Product	Eee PC		
Test Item	Occupied Bandwidth		
Test Mode	Mode 11: CDMA2000 1x EV-DO Rev A BC0		
Date of Test	2009/07/11	Test Site	AC-6

Channel No.	Frequency (MHz)	-26dB Occupied Bandwidth (MHz)	99% Occupied Bandwidth (MHz)
1013	824.70	1.436	1.2719
384	836.52	1.437	1.2724
777	848.31	1.442	1.2767

Figure Channel 1013 (824.70MHz)

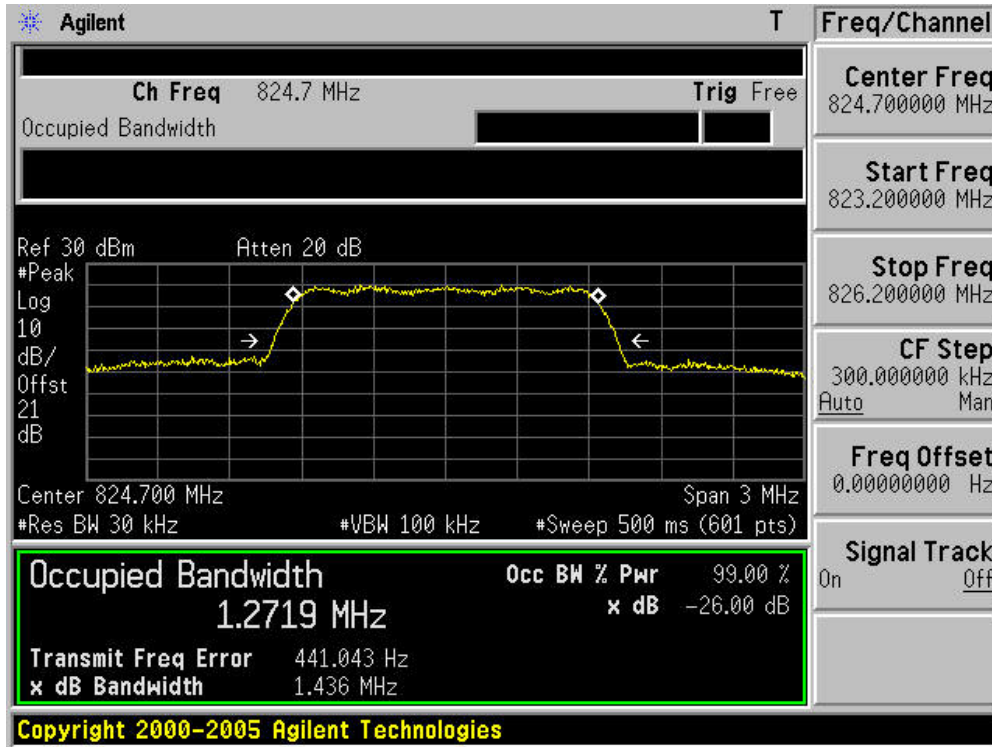

Figure Channel 384 (836.52MHz)

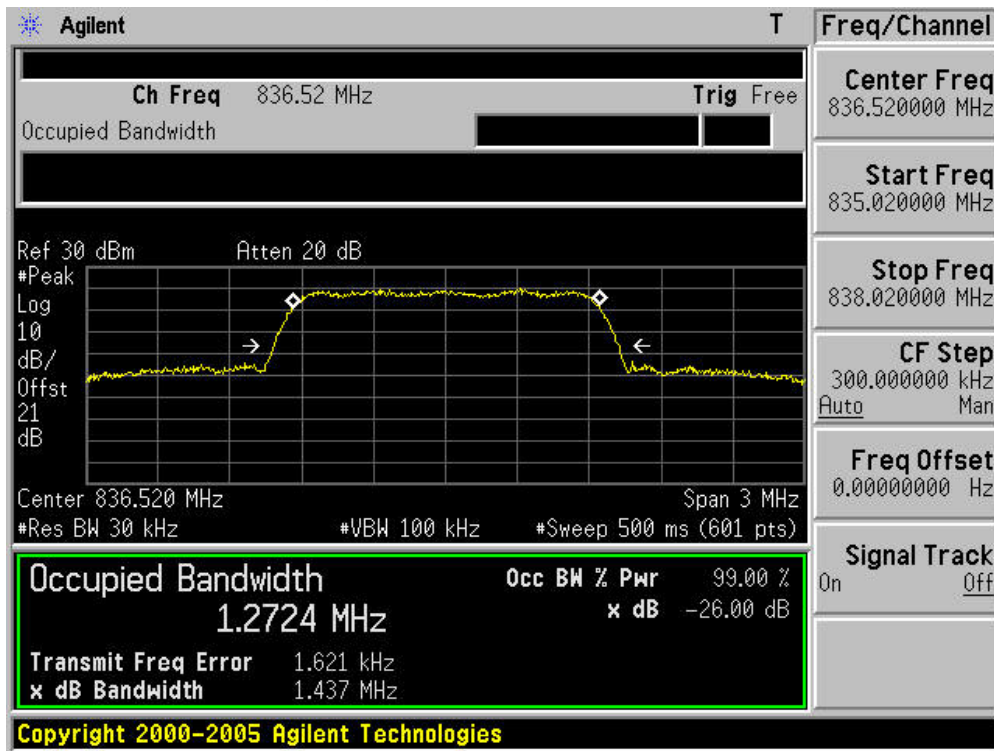
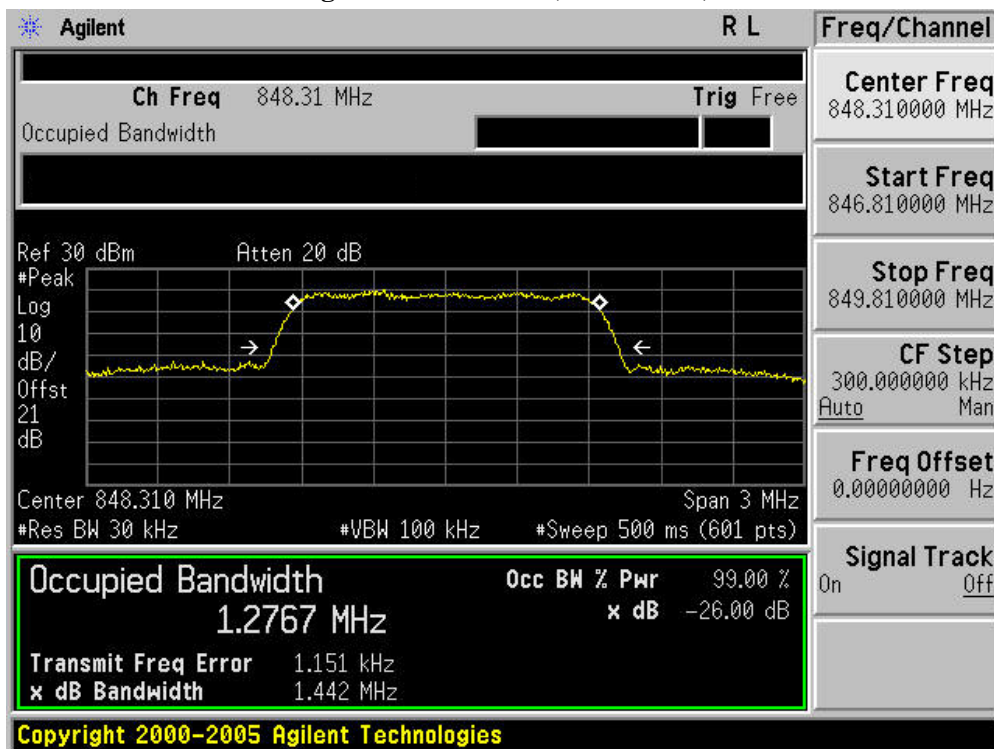

Figure Channel 777 (848.31MHz)



Product	Eee PC		
Test Item	Occupied Bandwidth		
Test Mode	Mode 12: CDMA2000 1x EV-DO Rev A BC1		
Date of Test	2009/07/11	Test Site	AC-6

Channel No.	Frequency (MHz)	-26dB Occupied Bandwidth (MHz)	99% Occupied Bandwidth (MHz)
25	1851.25	1.434	1.2743
600	1880.00	1.437	1.2727
1175	1908.75	1.439	1.2768

Figure Channel 25 (1851.25MHz)

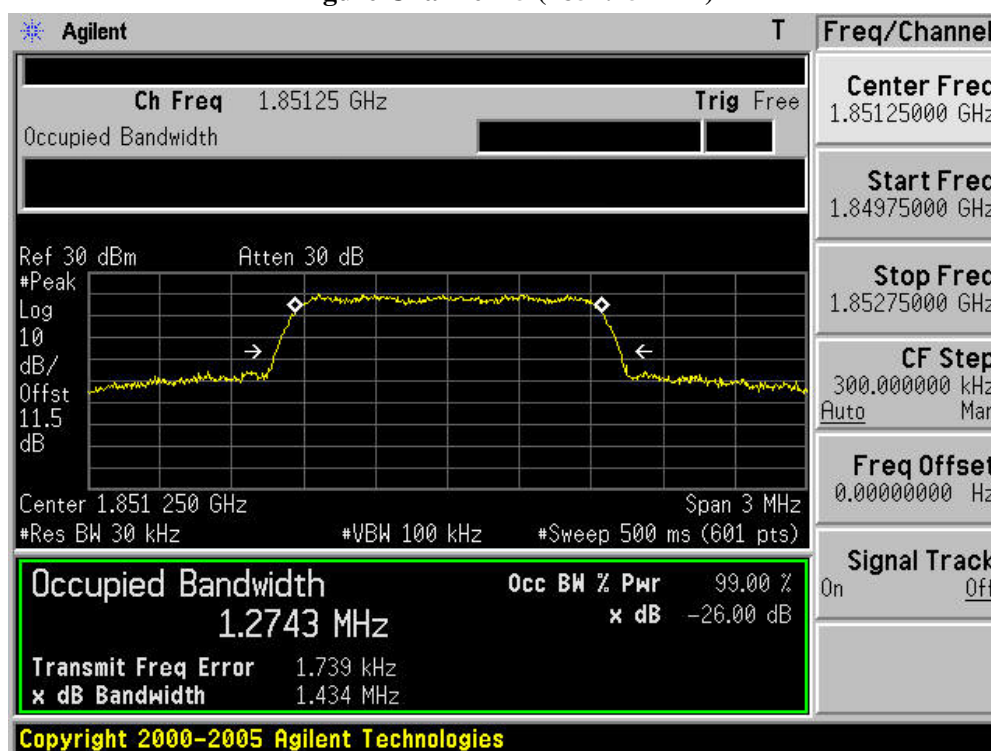

Figure Channel 600 (1880.00MHz)

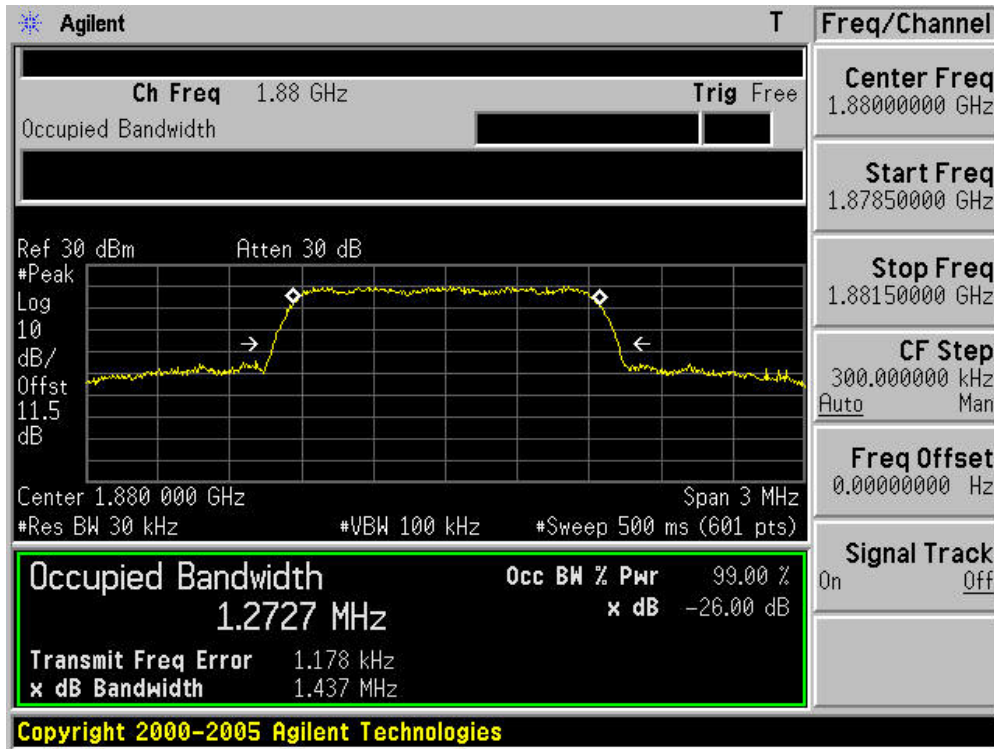
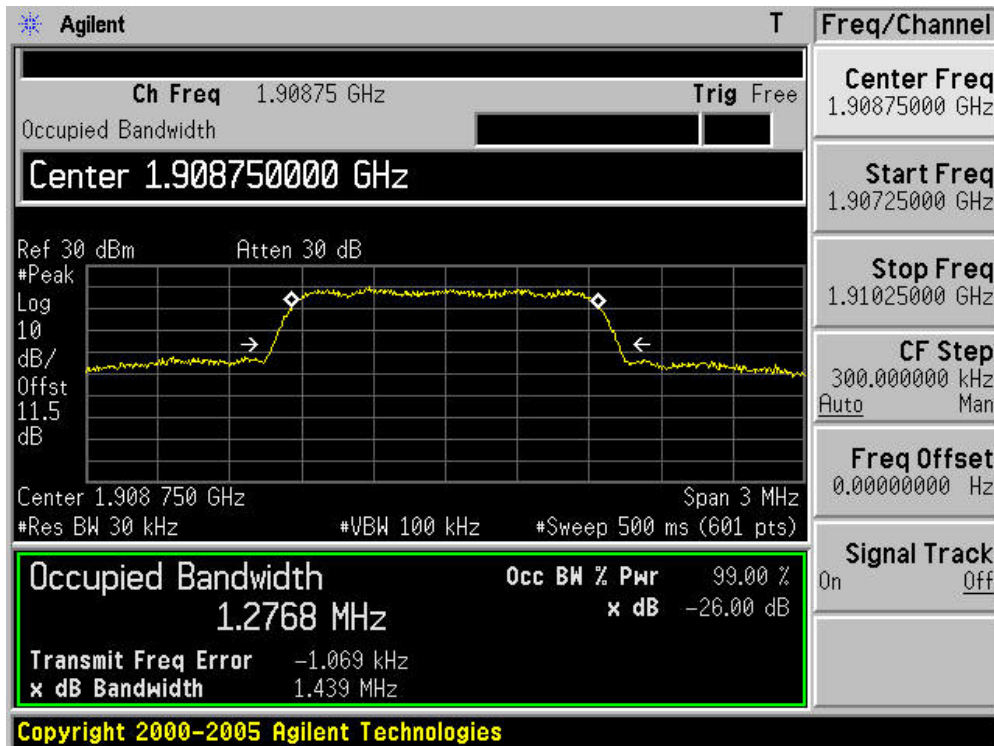

Figure Channel 1175 (1908.75MHz)



6. Spurious Emission At Antenna Terminals (+/- 1MHz)

6.1. Test Equipment

Spurious Emission At Antenna Terminals (+/- 1MHz) / AC-6

Instrument	Manufacturer	Type No.	Serial No	Cal. Date
Spectrum Analyzer	Agilent	E4446A	MY45300103	2009/06/11
Radio Communication Tester	R&S	CMU 200	106388	2008/10/21
Dual Directional Coupler	Agilent	778D	20160	2009/04/20
10dB Coaxial Coupler	Agilent	87300C	MY44300299	2009/04/20
Coaxial Cable	Huber+Suhner	AC4-RF-H	10	2008/11/24
Temperature/Humidity Meter	zhicheng	ZC1-2	QT-TH007	2009/03/31

6.2. Test Setup

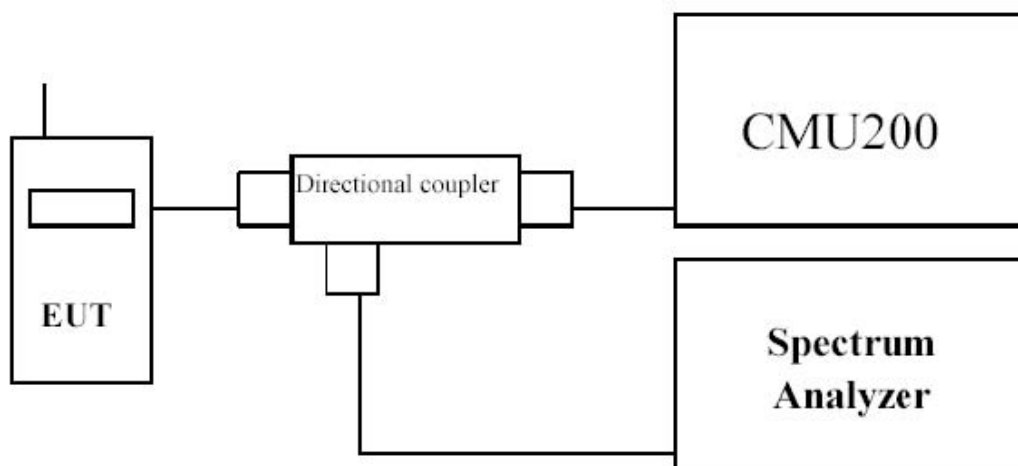

6.3. Limit

The power of any emission outside of the authorized operating frequency ranges must be attenuated below the transmitting power (P) by a factor of at least $43 + 10\log(P)$ dB.

6.4. Test Procedure

In the 1MHz bands immediately outside and adjacent to the frequency block a resolution bandwidth of at least one percent of the emission bandwidth of the fundamental emission of the transmitter may be employed to measure the out of band Emissions.

6.5. Uncertainty

The measurement uncertainty is defined as ± 1.2 dB.

6.6. Test Result

Product	Eee PC		
Test Item	Spurious Emission At Antenna Terminals (+/- 1MHz)		
Test Mode	Mode 1: GSM850 GPRS Link		
Date of Test	2009/07/11	Test Site	AC-6

Figure Channel 128 (824.20MHz)

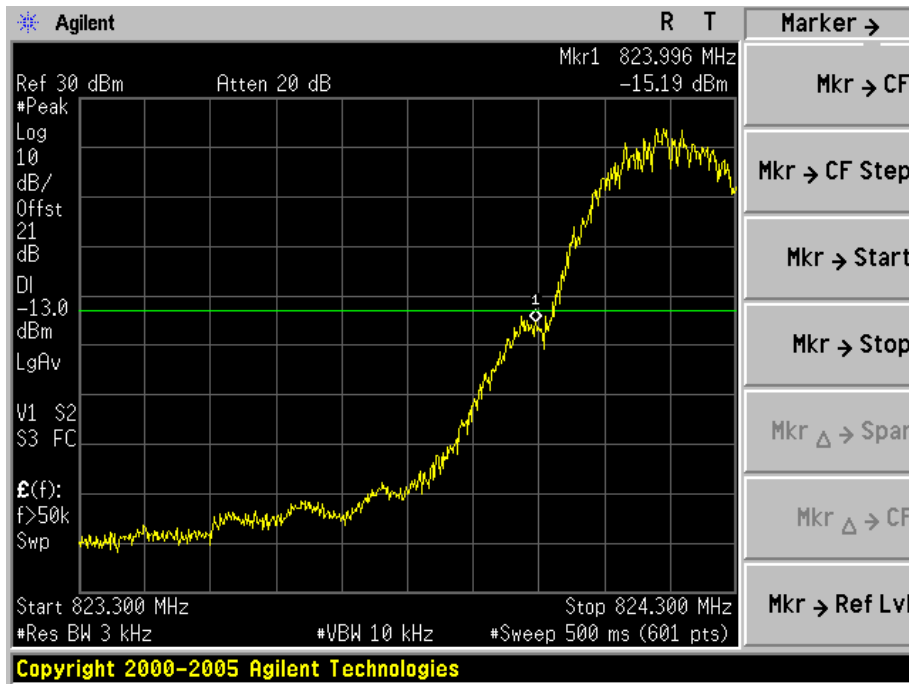
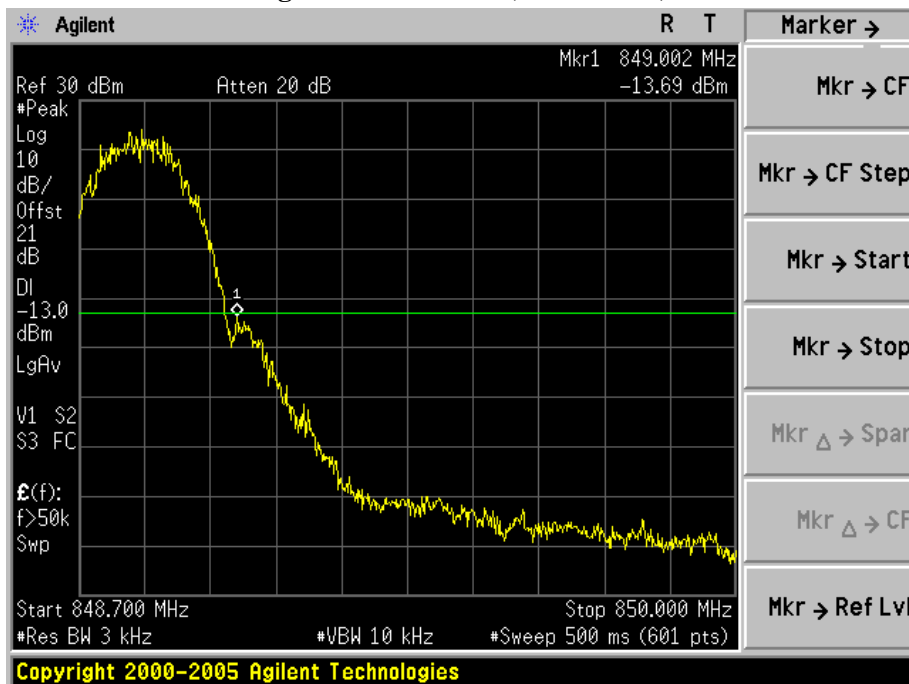

Figure Channel 251 (848.80MHz)



Product	Eee PC		
Test Item	Spurious Emission At Antenna Terminals (+/- 1MHz)		
Test Mode	Mode 2: GSM850 EDGE Link		
Date of Test	2009/07/11	Test Site	AC-6

Figure Channel 128 (824.20MHz)

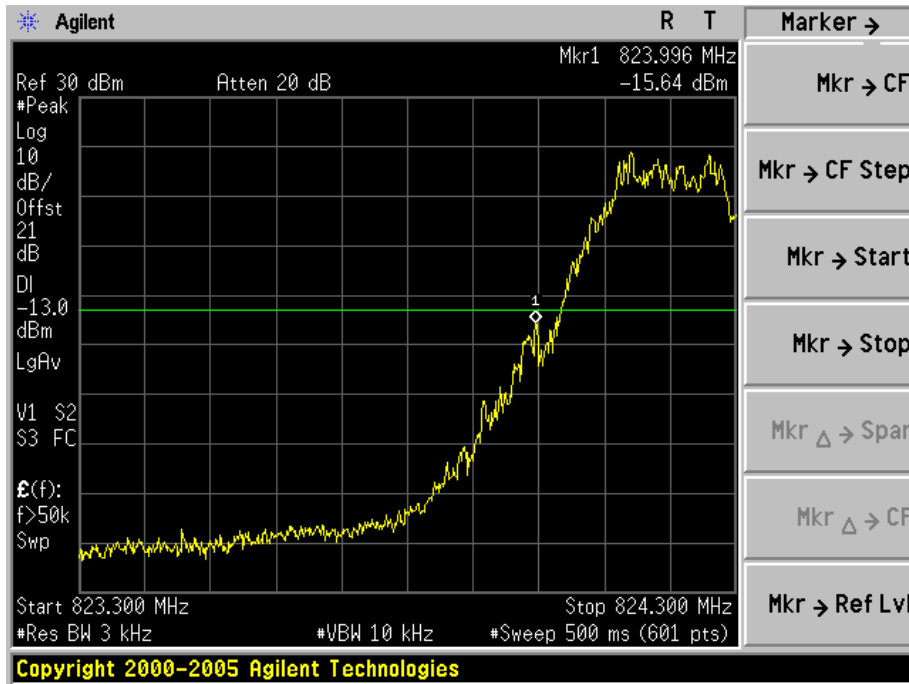
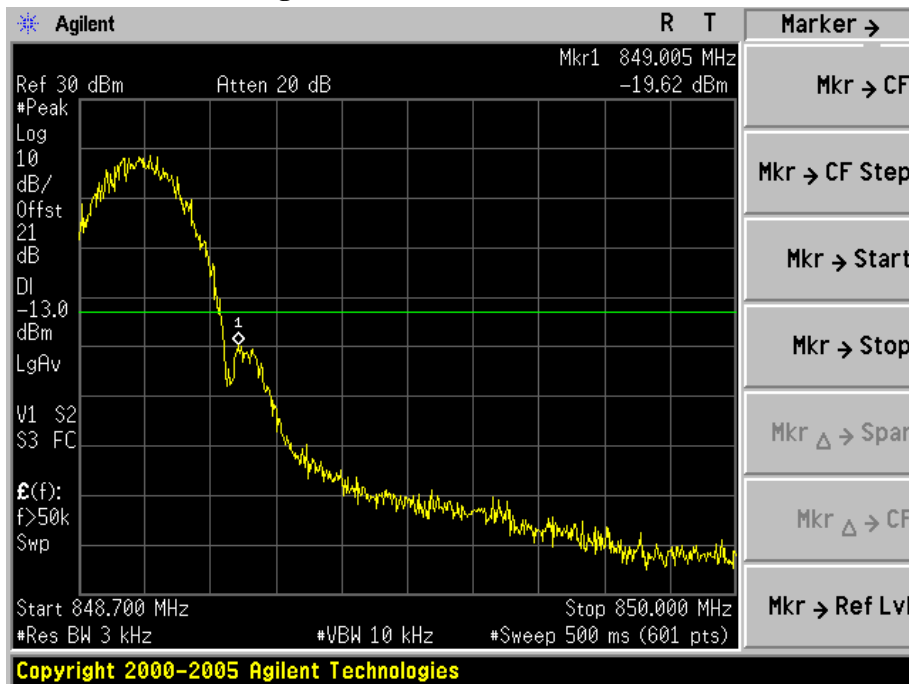

Figure Channel 251 (848.80MHz)



Product	Eee PC		
Test Item	Spurious Emission At Antenna Terminals (+/- 1MHz)		
Test Mode	Mode 3: PCS1900 GPRS Link		
Date of Test	2009/07/11	Test Site	AC-6

Figure Channel 512 (1850.20MHz)

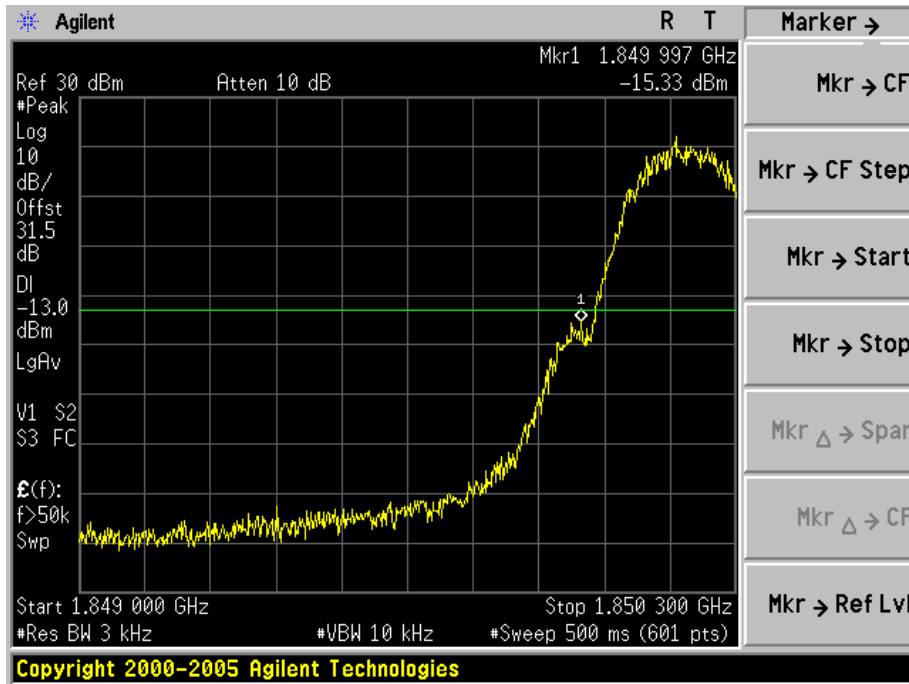
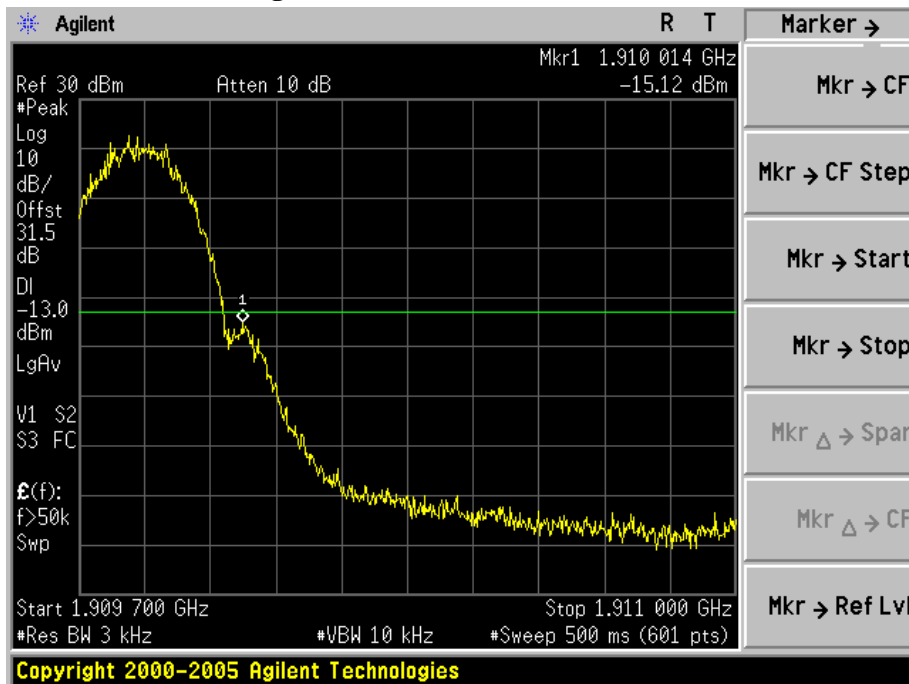

Figure Channel 810 (1909.80MHz)



Product	Eee PC		
Test Item	Spurious Emission At Antenna Terminals (+/- 1MHz)		
Test Mode	Mode 4: PCS1900 EDGE Link		
Date of Test	2009/07/11	Test Site	AC-6

Figure Channel 512 (1850.20MHz)

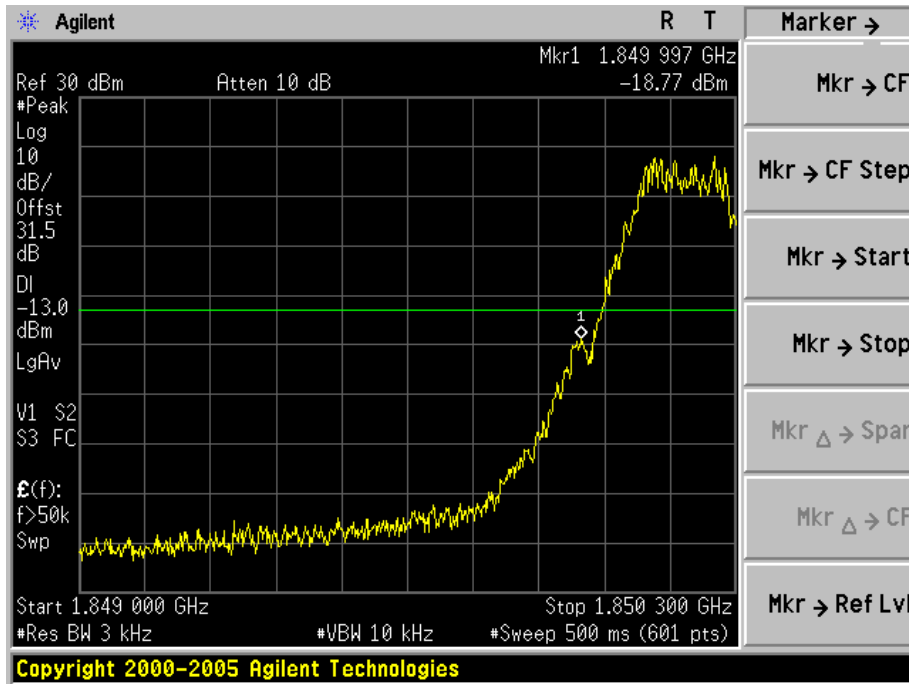
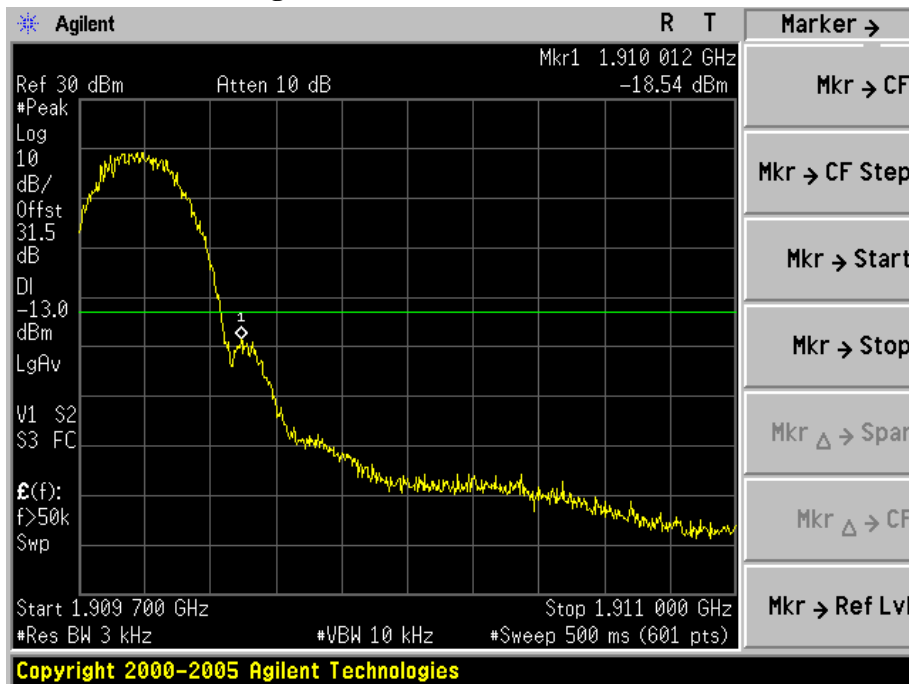

Figure Channel 810 (1909.80MHz)



Product	Eee PC		
Test Item	Spurious Emission At Antenna Terminals (+/- 1MHz)		
Test Mode	Mode 5: WCDMA Band II Link		
Date of Test	2009/07/11	Test Site	AC-6

Figure Channel 9262 (1852.4MHz)

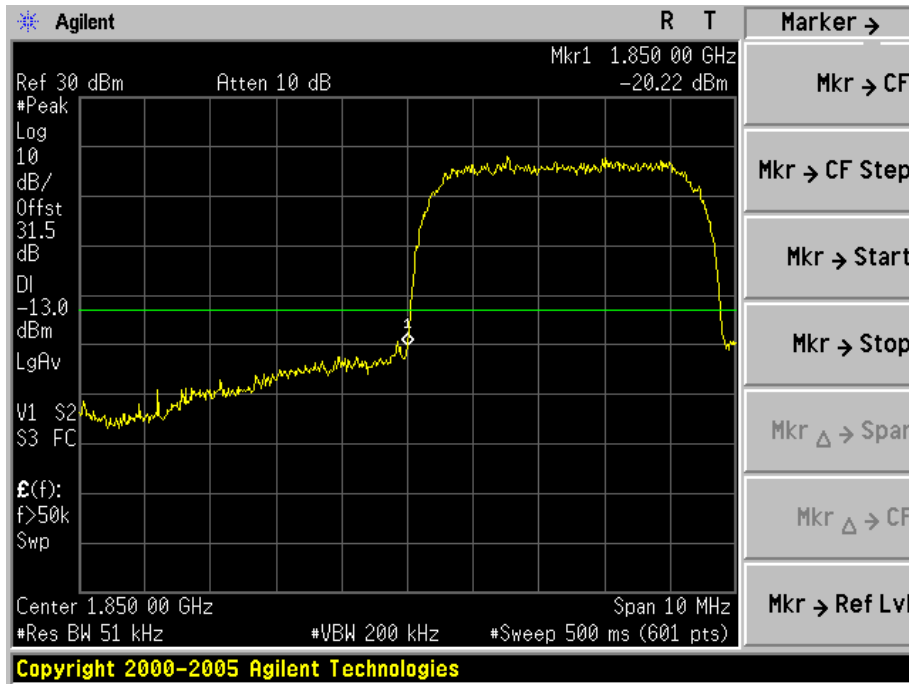
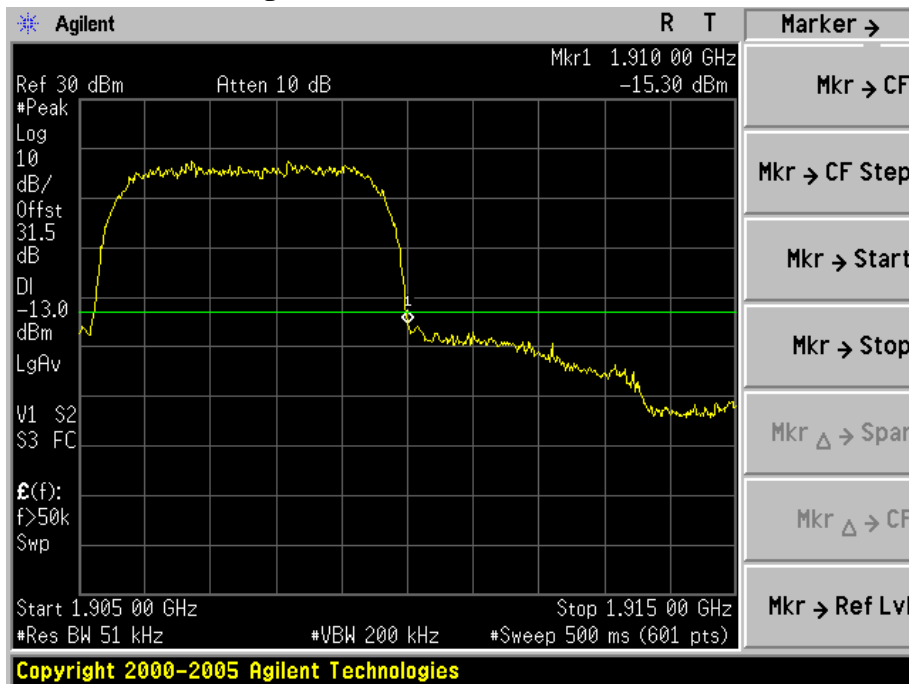

Figure Channel 9538 (1907.60MHz)



Product	Eee PC		
Test Item	Spurious Emission At Antenna Terminals (+/- 1MHz)		
Test Mode	Mode 6: WCDMA Band V Link		
Date of Test	2009/07/11	Test Site	AC-6

Figure Channel 4132 (826.4MHz)

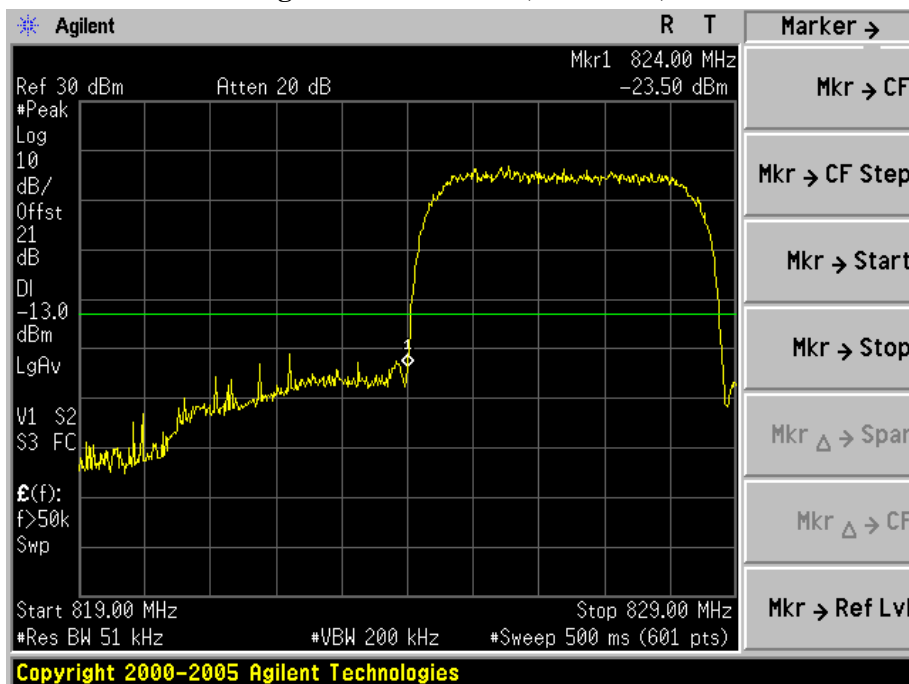
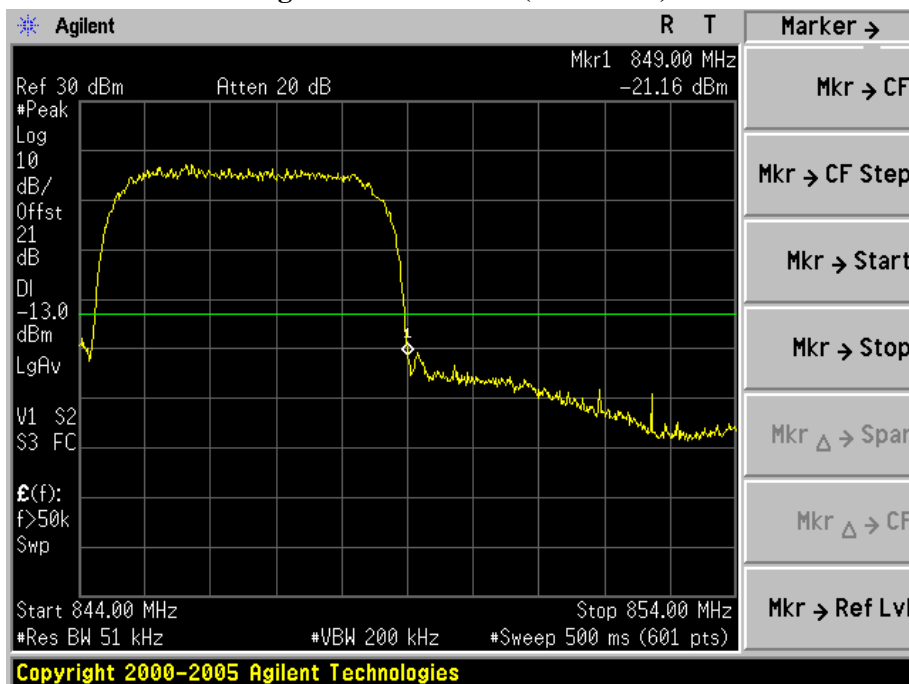

Figure Channel 4233 (846.6MHz)



Product	Eee PC		
Test Item	Spurious Emission At Antenna Terminals (+/- 1MHz)		
Test Mode	Mode 7: HSDPA Band II Link		
Date of Test	2009/07/11	Test Site	AC-6

Figure Channel 9262 (1852.4MHz)

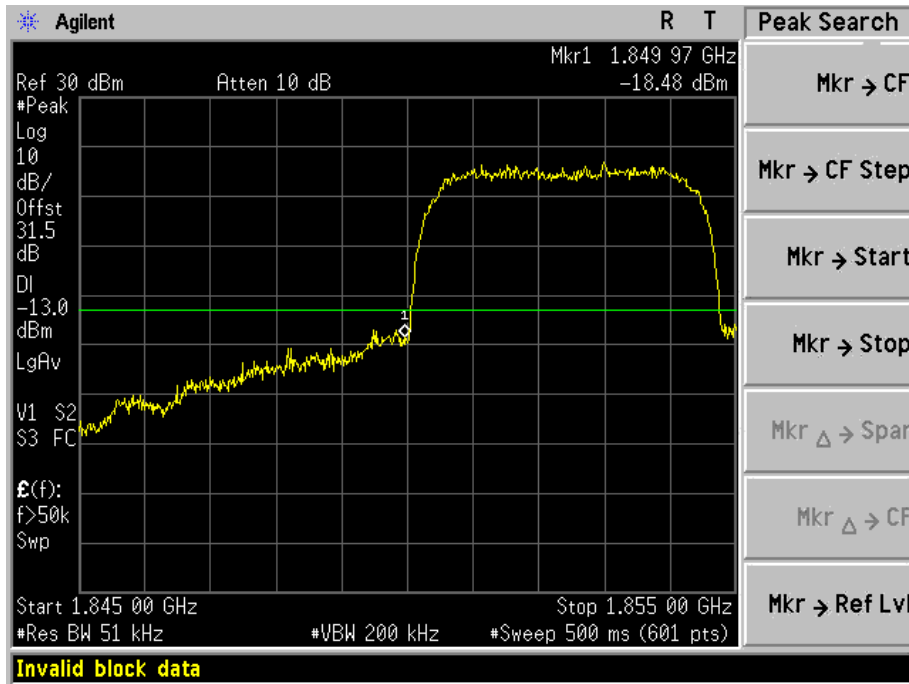
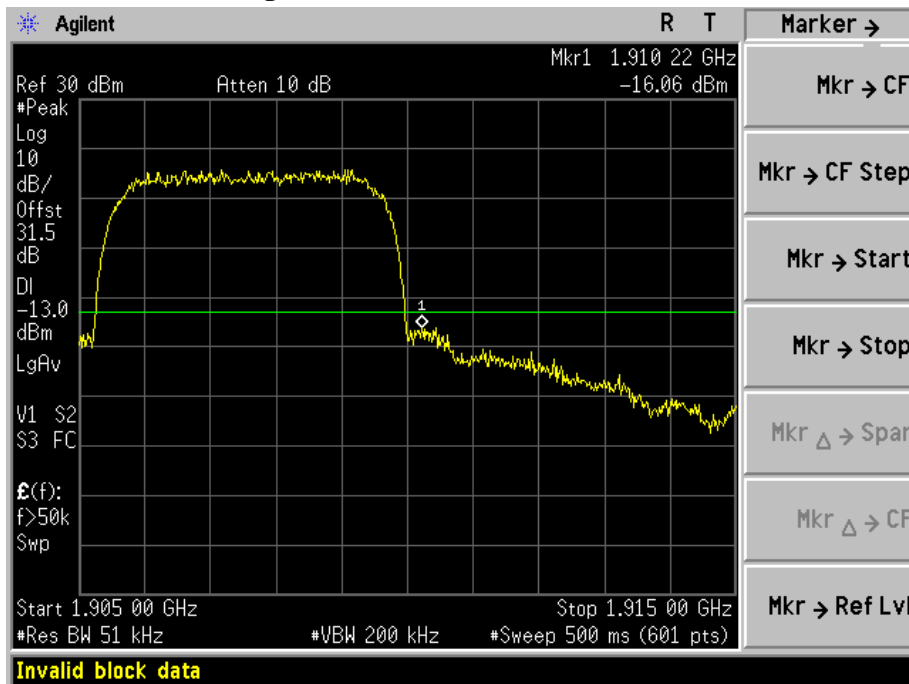

Figure Channel 9538 (1907.60MHz)



Product	Eee PC		
Test Item	Spurious Emission At Antenna Terminals (+/- 1MHz)		
Test Mode	Mode 8: HSDPA Band V Link		
Date of Test	2009/07/11	Test Site	AC-6

Figure Channel 4132 (826.4MHz)

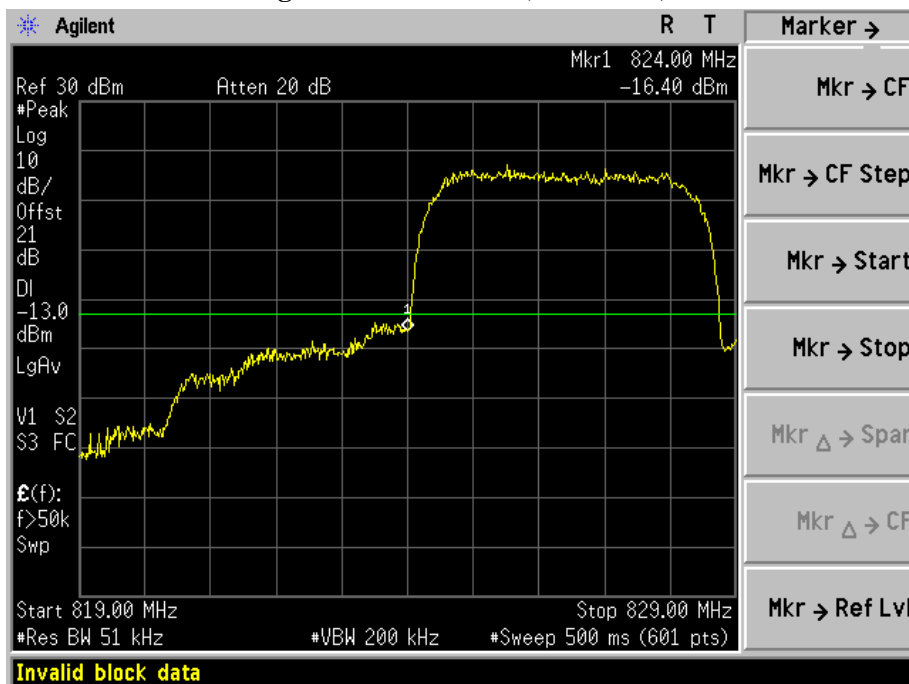
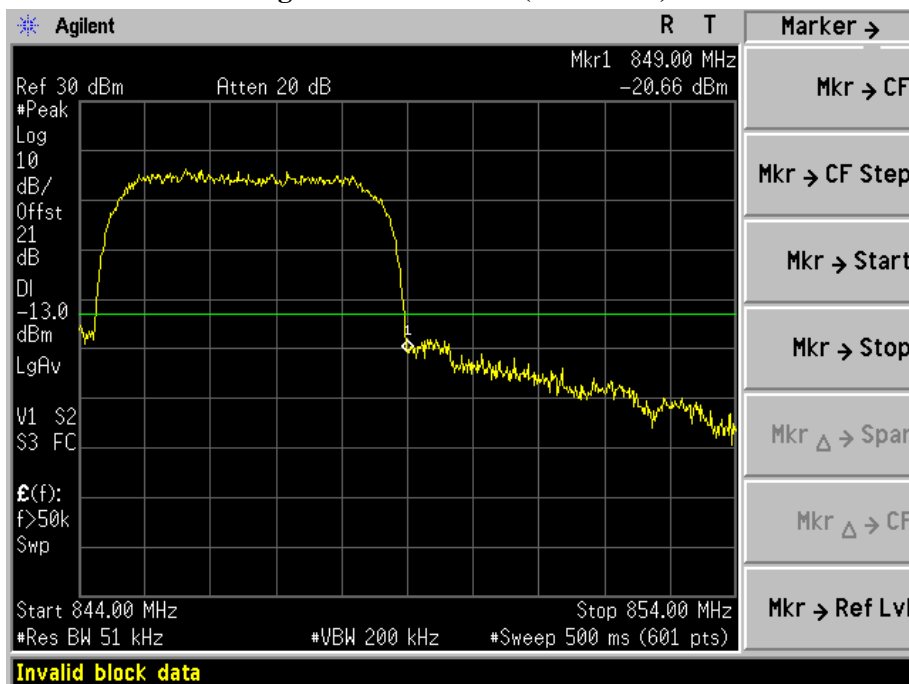

Figure Channel 4233 (846.6MHz)



Product	Eee PC		
Test Item	Spurious Emission At Antenna Terminals (+/- 1MHz)		
Test Mode	Mode 09: CDMA2000 1x BC0 Link		
Date of Test	2009/07/11	Test Site	AC-6

Figure Channel 1013 (824.7MHz)

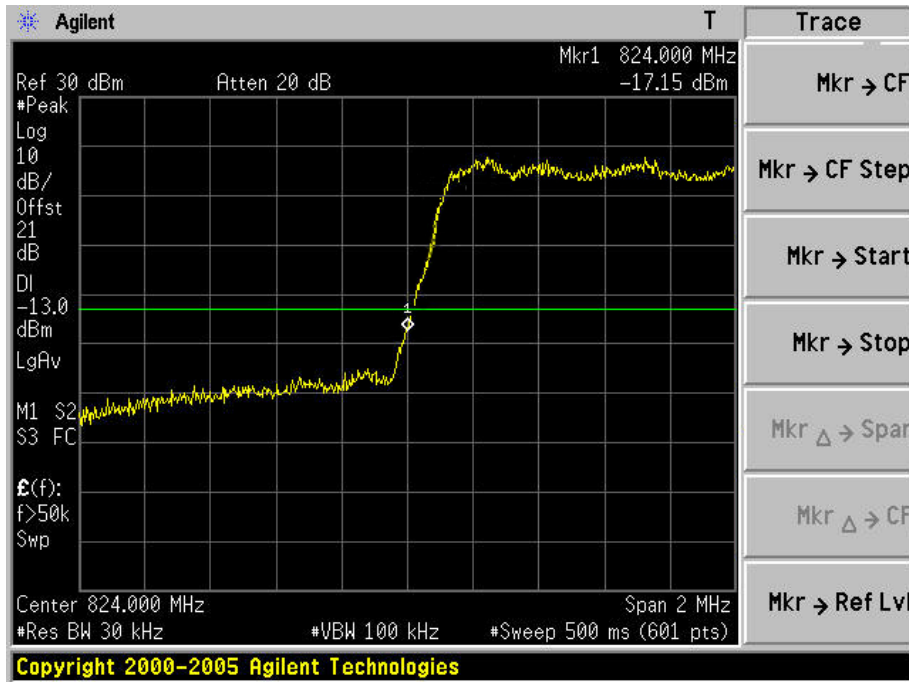
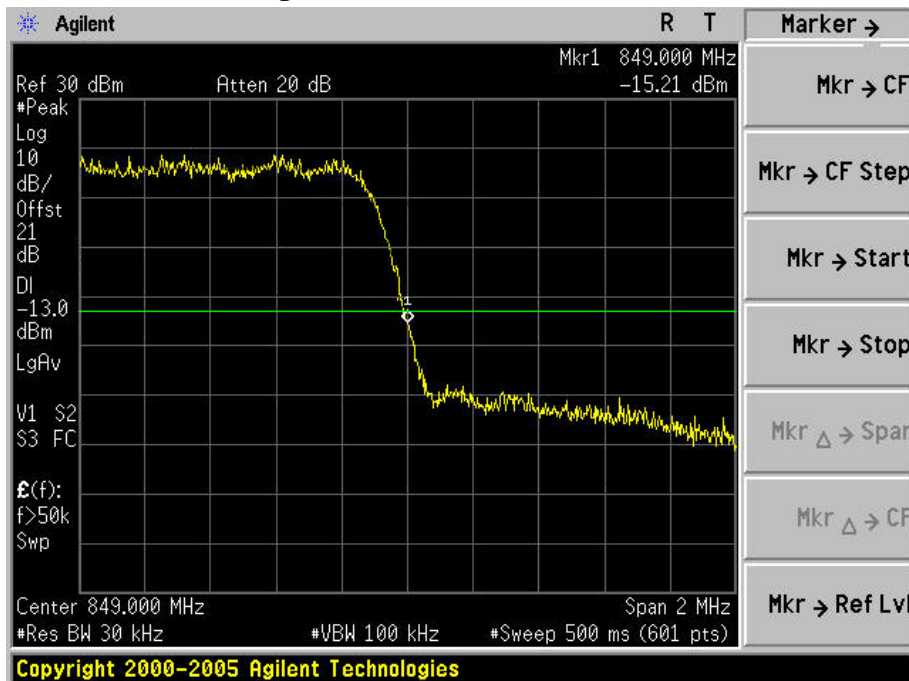

Figure Channel 777 (848.31MHz)



Product	Eee PC		
Test Item	Spurious Emission At Antenna Terminals (+/- 1MHz)		
Test Mode	Mode 10: CDMA2000 1x BC1 Link		
Date of Test	2009/07/11	Test Site	AC-6

Figure Channel 25 (1851.25MHz)

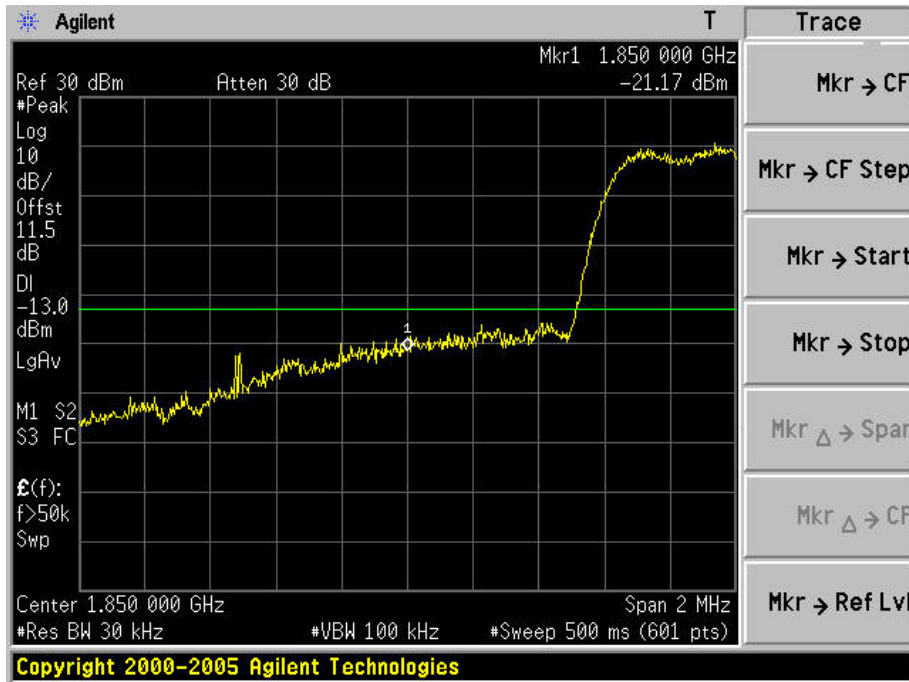
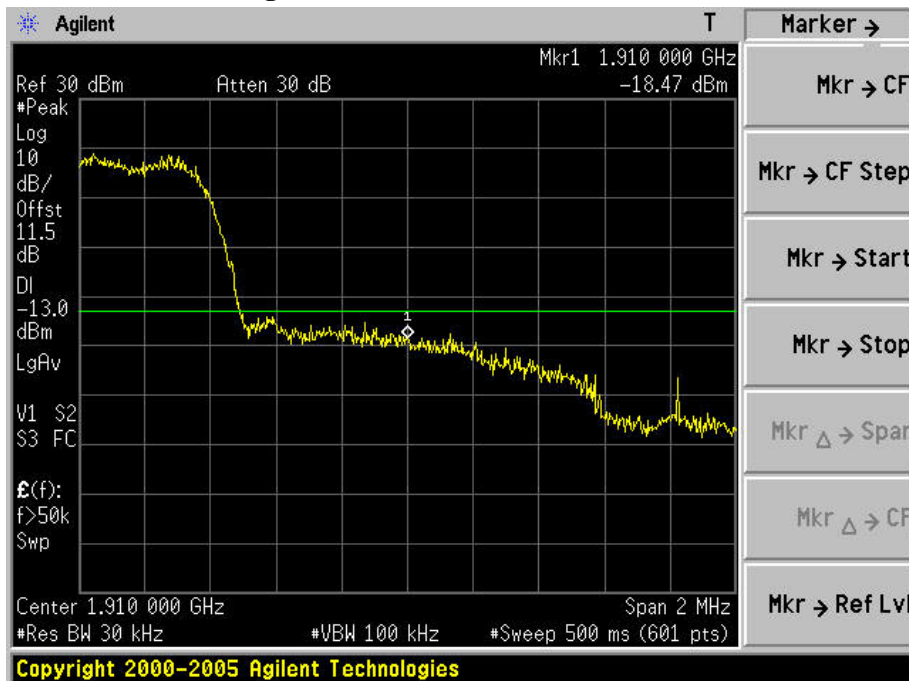

Figure Channel 1175 (1908.75MHz)



Product	Eee PC		
Test Item	Spurious Emission At Antenna Terminals (+/- 1MHz)		
Test Mode	Mode 11: CDMA2000 1x EV-DO BC0 Link --- Rel 0		
Date of Test	2009/07/11	Test Site	AC-6

Figure Channel 1013 (824.7MHz)

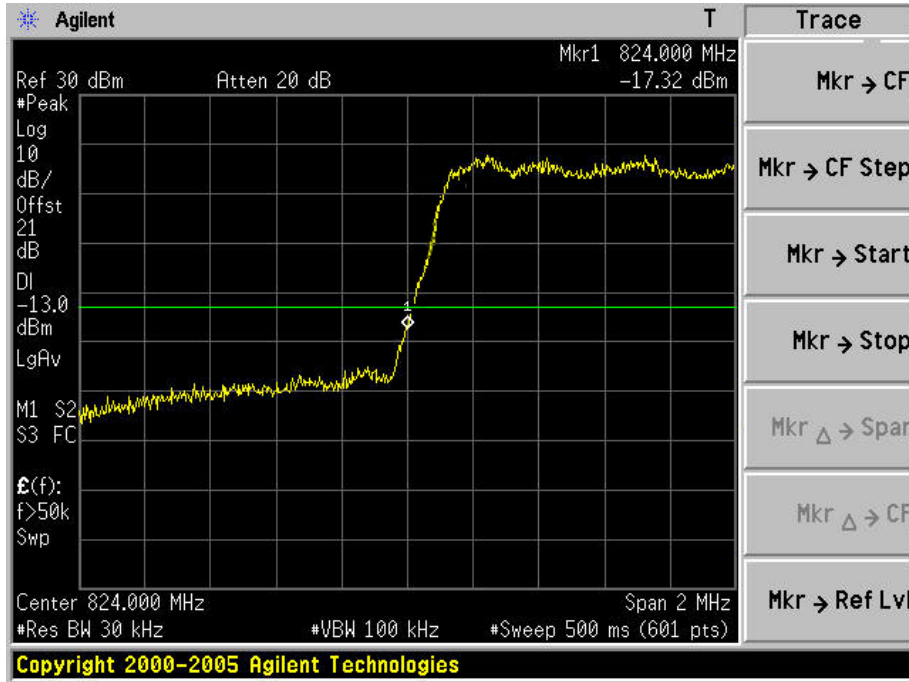
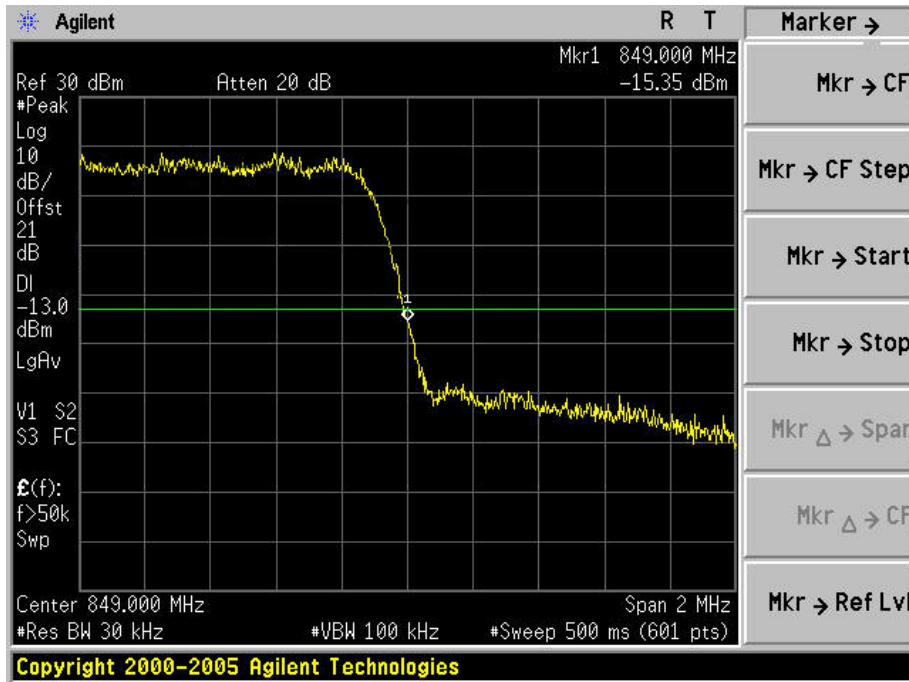

Figure Channel 777 (848.31MHz)



Product	Eee PC		
Test Item	Spurious Emission At Antenna Terminals (+/- 1MHz)		
Test Mode	Mode 12: CDMA2000 1x EV-DO BC0 Link --- Rev A		
Date of Test	2009/07/11	Test Site	AC-6

Figure Channel 1013 (824.7MHz)

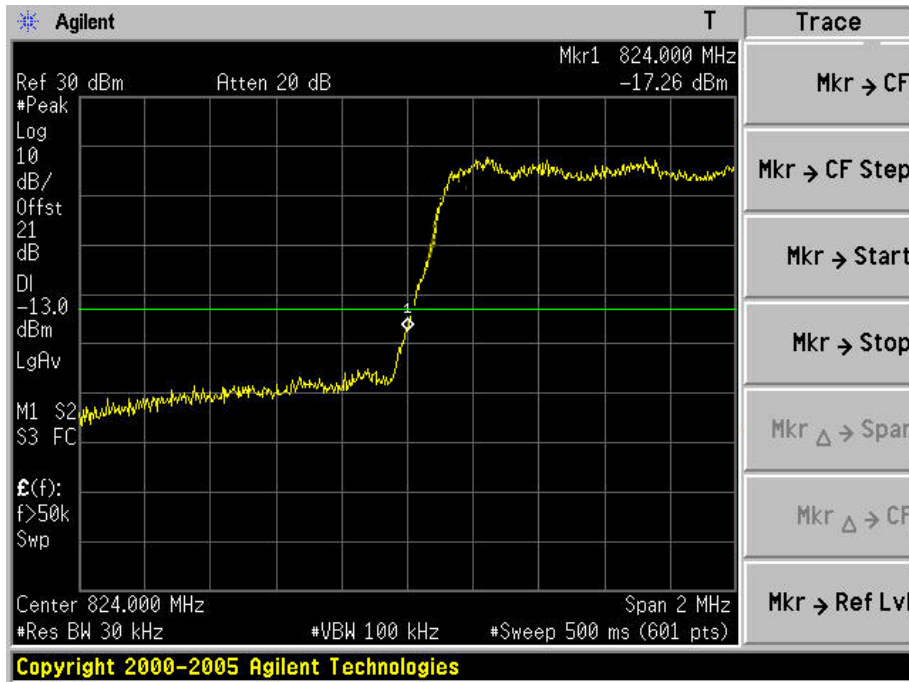
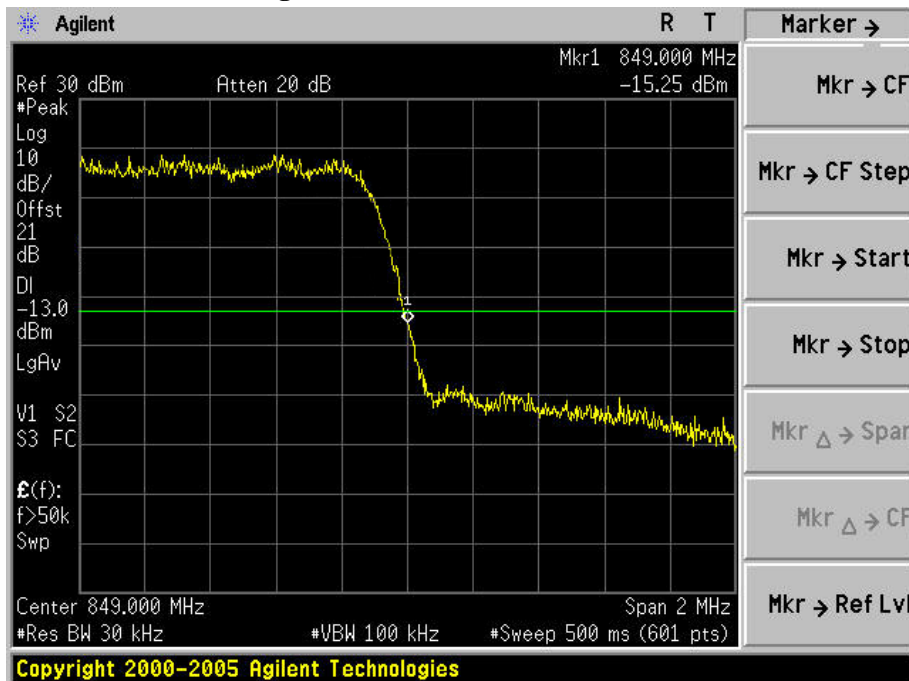

Figure Channel 777 (848.31MHz)



Product	Eee PC		
Test Item	Spurious Emission At Antenna Terminals (+/- 1MHz)		
Test Mode	Mode 13: CDMA2000 1x EV-DO BC1 Link --- Rel 0		
Date of Test	2009/07/11	Test Site	AC-6

Figure Channel 25 (1851.25MHz)



Figure Channel 1175 (1908.75MHz)

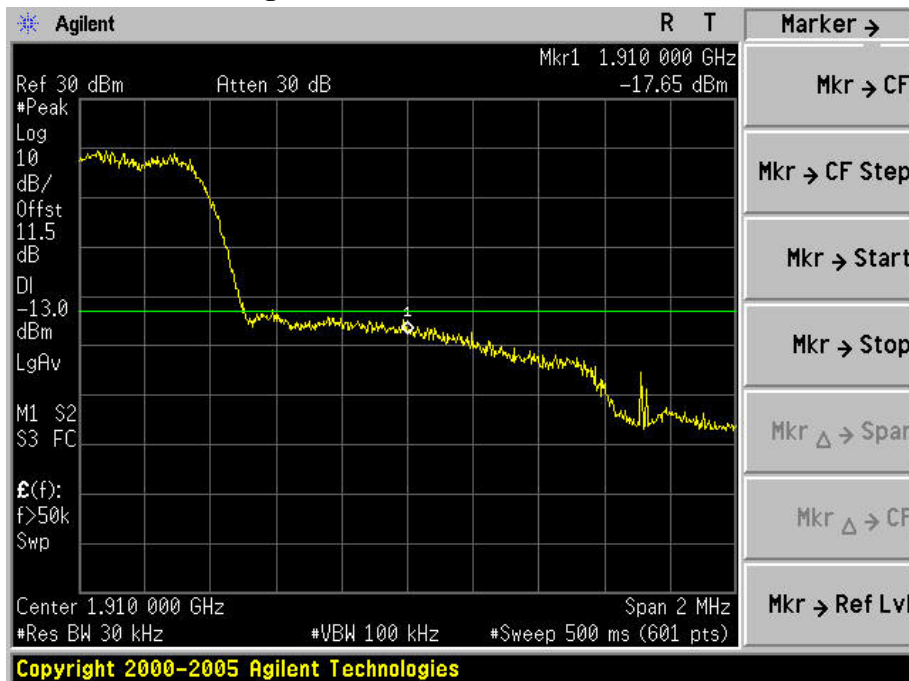

Product	Eee PC		
Test Item	Spurious Emission At Antenna Terminals (+/- 1MHz)		
Test Mode	Mode 14: CDMA2000 1x EV-DO BC1 Link --- Rev A		
Date of Test	2009/07/11	Test Site	AC-6

Figure Channel 25 (1851.25MHz)



Figure Channel 1175 (1908.75MHz)

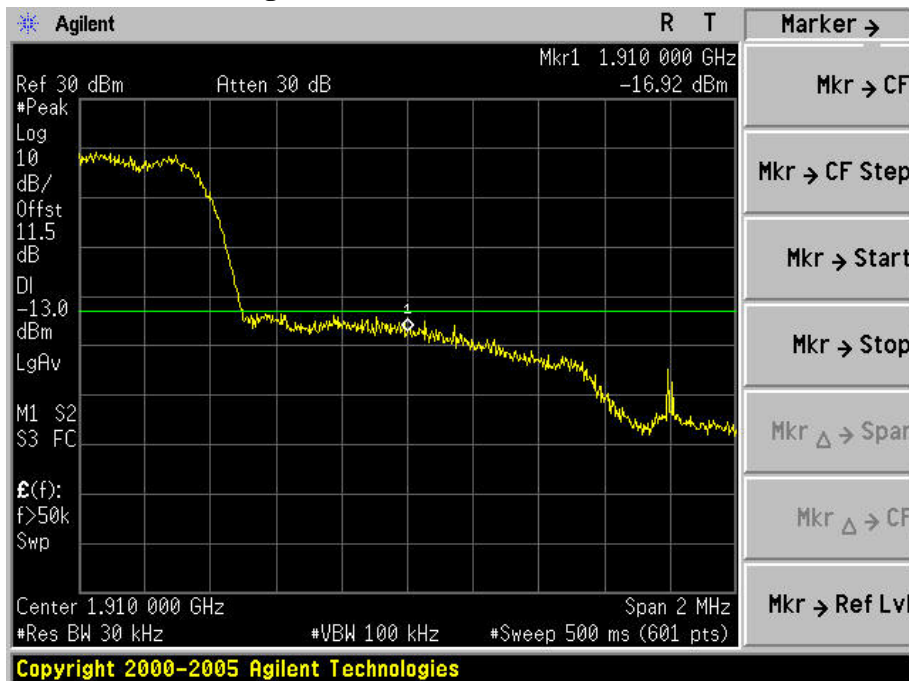

7. Spurious Emission

7.1. Test Equipment

Spurious Emission / AC-5

Instrument	Manufacturer	Type No.	Serial No	Cal. Date
Spectrum Analyzer	Agilent	N9010A	MY48030494	2009.04.23
Radio Communication Tester	R&S	CMU 200	106388	2008/10/21
PSG Analog S.G.	Agilent	E8257D	MY44321116	2009/06/10
Preamplifier	Quietek	AP-025C	QT-AP005	2008/11/24
Preamplifier	Miteq	NSP1800-25	1364185	2009.05.25
Bilog Antenna	Teseq GmbH	CBL6112D	27612	2009.02.25
Half Wave Tuned Dipole Antenna	COM-POWER	AD-100	40137	2008/11/24
Broad-Band Horn Antenna	Schwarzbeck	BBHA9120D	496	2008/11/24
Broad-Band Horn Antenna	Schwarzbeck	BBHA9120D	499	2008/11/24
Broad-Band Horn Antenna	Schwarzbeck	BBHA9170	294	2008/11/24
Broad-Band Horn Antenna	Schwarzbeck	BBHA9170	295	2008/11/24
Coaxial Cable	Huber+Suhner	SUCOFLEX 106	AC5-C1	2009.05.25
Coaxial Cable	Huber+Suhner	SUCOFLEX 102	AC5-C2	2009.05.25
Temperature/Humidity Meter	Zhicheng	ZC1-2	AC5-TH	2009.03.31

7.2. Test Setup

Conducted Spurious Measurement:

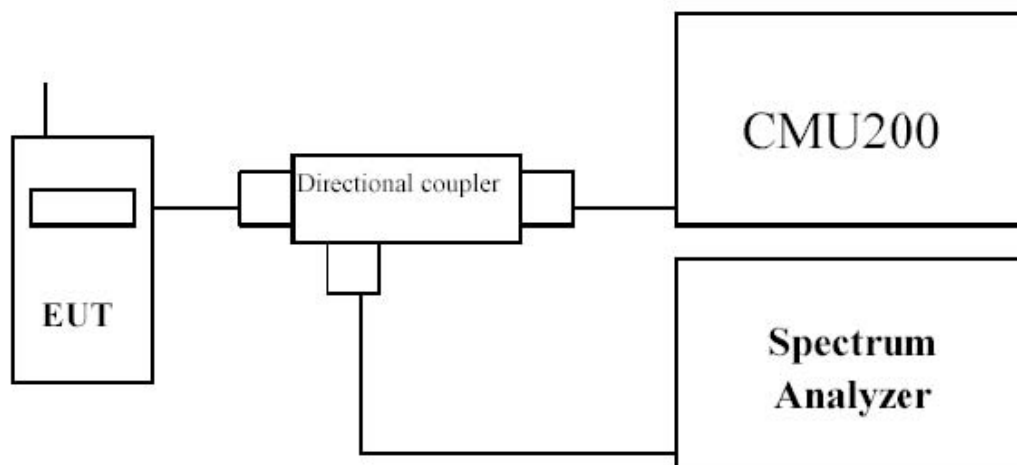

Radiated Spurious Measurement:

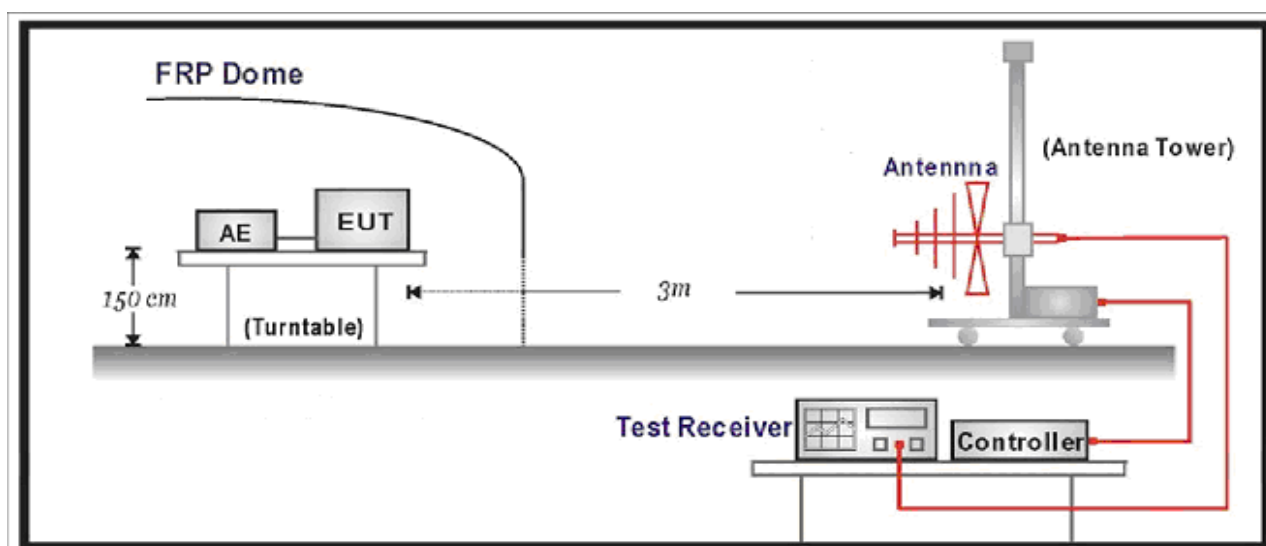

7.3. Limit

The power of any emission outside of the authorized operating frequency ranges must be attenuated below the transmitting power (P) by a factor of at least $43 + 10\log(P)$ dB.

7.4. Test Procedure

Conducted Spurious Measurement:

- a) Place the EUT on a bench and set it in transmitting mode.
- b) Connect a low loss RF cable from the antenna port to a spectrum analyzer and CMU200 by a Directional Couple.
- c) EUT Communicate with CMU200, then select a channel for testing.
- d) Add a correction factor to the display of spectrum, and then test.
- e) The resolution bandwidth of the spectrum analyzer was set at 1 MHz, sufficient scans were taken to show the out of band Emission if any up to 10th harmonic.

Radiated Spurious Measurement:

- a) The EUT shall be placed at the specified height on a support, and in the position closest to normal use as declared by provider.
- b) The test antenna shall be oriented initially for vertical polarization and shall be chosen to correspond to the frequency of the transmitter
- c) The output of the test antenna shall be connected to the measuring receiver.
- d) The transmitter shall be switched on and the measuring receiver shall be tuned to the frequency of the transmitter under test.
- e) The test antenna shall be raised and lowered through the specified range of height until a maximum signal level is detected by the measuring receiver.
- f) The transmitter shall then be rotated through 360° in the horizontal plane, until the maximum signal level is detected by the measuring receiver.
- g) The test antenna shall be raised and lowered again through the specified range of height until a maximum signal level is detected by the measuring receiver.
- u) The maximum signal level detected by the measuring receiver shall be noted.
- h) The transmitter shall be replaced by a substitution antenna.
- i) The substitution antenna shall be orientated for vertical polarization and the length of the substitution antenna shall be adjusted to correspond to the frequency of the transmitter.
- j) The substitution antenna shall be connected to a calibrated signal generator.
- k) If necessary, the input attenuator setting of the measuring receiver shall be adjusted in order to increase the sensitivity of the measuring receiver.
- l) The test antenna shall be raised and lowered through the specified range of height to ensure that the maximum signal is received.
- m) The input signal to the substitution antenna shall be adjusted to the level that produces a level detected by the measuring receiver, that is equal to the level noted while the

transmitter radiated power was measured, corrected for the change of input attenuator setting of the measuring receiver.

- n) The measurement shall be repeated with the test antenna and the substitution antenna orientated for horizontal polarization.
- o) The measure of the effective radiated power is the larger of the two levels recorded at the input to the substitution antenna, corrected for gain of the substitution antenna if necessary.
- p) The frequency range was checked up to 10th harmonic.

7.5. Uncertainty

The measurement uncertainty is defined as 3.2 dB for Radiated Power Measurement.

7.6. Test Result

Product	Eee PC		
Test Item	Spurious Emission		
Test Mode	Mode 1: GSM850 GPRS Link		
Date of Test	2009/07/12	Test Site	AC-6

Frequency (MHz)	SA Reading (dBm)	Ant.Pol. (H/V)	SG Reading (dBm)	Cable Loss (dB)	Gain (dBi)	EIRP (dBm)	Limit (dBm)	Margin (dB)
Low Channel 128 (824.20MHz)								
1648.40	-37.010	V	-52.889	3.28	9.75	-46.419	-13.00	-33.419
2472.60	-35.072	V	-46.873	4.10	10.48	-40.493	-13.00	-27.493
1648.40	-32.441	H	-48.337	3.28	9.75	-41.867	-13.00	-28.867
2472.60	-42.253	H	-54.075	4.10	10.48	-47.695	-13.00	-34.695
Middle Channel 189 (836.40MHz)								
1672.80	-30.624	V	-46.453	3.32	9.95	-39.823	-13.00	-26.823
2509.20	-31.637	V	-43.960	3.81	10.62	-37.150	-13.00	-24.150
1672.80	-25.762	H	-41.556	3.32	9.95	-34.926	-13.00	-21.926
2509.20	-30.713	H	-42.963	3.81	10.62	-36.153	-13.00	-23.153
High Channel 251 (848.80MHz)								
1697.60	-30.071	V	-45.729	3.35	10.06	-39.019	-13.00	-26.019
2546.40	-30.791	V	-42.815	4.19	10.68	-36.325	-13.00	-23.325
1697.60	-26.670	H	-42.234	3.35	10.06	-35.524	-13.00	-22.524
2546.40	-30.222	H	-42.100	4.19	10.68	-35.610	-13.00	-22.610

Product	Eee PC		
Test Item	Spurious Emission		
Test Mode	Mode 2: GSM1900 GPRS Link		
Date of Test	2009/07/12	Test Site	AC-6

Frequency (MHz)	SA Reading (dBm)	Ant.Pol. (H/V)	SG Reading (dBm)	Cable Loss (dB)	Gain (dBi)	EIRP (dBm)	Limit (dBm)	Margin (dB)
Low Channel 512 (1850.20MHz)								
5550.60	-40.617	V	-46.084	6.03	13.15	-38.964	-13.00	-25.964
5550.60	-44.693	H	-50.237	6.03	13.15	-43.117	-13.00	-30.117
Middle Channel 661 (1880.00MHz)								
3760.00	-47.076	V	-56.935	5.03	12.72	-49.245	-13.00	-36.245
5640.00	-33.007	V	-38.426	5.93	13.14	-31.216	-13.00	-18.216
3760.00	-49.088	H	-58.950	5.03	12.72	-51.260	-13.00	-38.260
5640.00	-40.624	H	-46.184	5.93	13.14	-38.974	-13.00	-25.974
High Channel 810 (1909.80MHz)								
5729.40	-39.947	V	-45.212	6.20	13.11	-38.302	-13.00	-25.302
5729.40	-43.705	H	-48.945	6.20	13.11	-42.035	-13.00	-29.035

Product	Eee PC		
Test Item	Spurious Emission		
Test Mode	Mode 3: GSM850 EDGE Link		
Date of Test	2009/07/12	Test Site	AC-6

Frequency (MHz)	SA Reading (dBm)	Ant.Pol. (H/V)	SG Reading (dBm)	Cable Loss (dB)	Gain (dBi)	EIRP (dBm)	Limit (dBm)	Margin (dB)
Low Channel 128 (824.20MHz)								
1648.40	-40.734	V	-56.613	3.28	9.75	-50.143	-13.00	-37.143
2472.60	-48.483	V	-60.284	4.10	10.48	-53.904	-13.00	-40.904
1648.40	-41.366	H	-57.262	3.28	9.75	-50.792	-13.00	-37.792
2472.60	-47.141	H	-58.963	4.10	10.48	-52.583	-13.00	-39.583
Middle Channel 189 (836.40MHz)								
1672.80	-43.058	V	-58.887	3.32	9.95	-52.257	-13.00	-39.257
2509.20	-45.567	V	-57.890	3.81	10.62	-51.080	-13.00	-38.080
1672.80	-33.364	H	-49.158	3.32	9.95	-42.528	-13.00	-29.528
2509.20	-43.147	H	-55.397	3.81	10.62	-48.587	-13.00	-35.587
High Channel 251 (848.80MHz)								
1697.60	-40.575	V	-56.233	3.35	10.06	-49.523	-13.00	-36.523
2546.40	-43.974	V	-55.998	4.19	10.68	-49.508	-13.00	-36.508
1697.60	-36.501	H	-52.065	3.35	10.06	-45.355	-13.00	-32.355
2546.40	-43.059	H	-54.937	4.19	10.68	-48.447	-13.00	-35.447

Product	Eee PC		
Test Item	Spurious Emission		
Test Mode	Mode 4: GSM1900 EDGE Link		
Date of Test	2009/07/12	Test Site	AC-6

Frequency (MHz)	SA Reading (dBm)	Ant.Pol. (H/V)	SG Reading (dBm)	Cable Loss (dB)	Gain (dBi)	EIRP (dBm)	Limit (dBm)	Margin (dB)
Low Channel 512 (1850.20MHz)								
5550.60	-46.907	V	-52.374	6.03	13.15	-45.254	-13.00	-32.254
5550.60	-48.062	H	-53.606	6.03	13.15	-46.486	-13.00	-33.486
Middle Channel 661 (1880.00MHz)								
3760.00	-46.478	V	-56.337	5.03	12.72	-48.647	-13.00	-35.647
5640.00	-41.535	V	-46.954	5.93	13.14	-39.744	-13.00	-26.744
3760.00	-49.828	H	-59.690	5.03	12.72	-52.000	-13.00	-39.000
5640.00	-40.073	H	-45.633	5.93	13.14	-38.423	-13.00	-25.423
High Channel 810 (1909.80MHz)								
5729.40	-47.456	V	-52.721	6.20	13.11	-45.811	-13.00	-32.811
5729.40	-48.412	H	-53.652	6.20	13.11	-46.742	-13.00	-33.742

Product	Eee PC		
Test Item	Spurious Emission		
Test Mode	Mode 5: WCDMA Band II Link		
Date of Test	2009/07/12	Test Site	AC-6

Frequency (MHz)	SA Reading (dBm)	Ant.Pol. (H/V)	SG Reading (dBm)	Cable Loss (dB)	Gain (dBi)	EIRP (dBm)	Limit (dBm)	Margin (dB)
Low Channel 9262 (1852.40MHz)								
3704.80	-29.157	V	-39.936	4.78	12.69	-32.026	-13.00	-19.026
3704.80	-26.207	H	-36.575	4.78	12.69	-28.665	-13.00	-15.665
Middle Channel 9400 (1880.00MHz)								
3760.00	-27.091	V	-36.808	5.03	12.72	-29.118	-13.00	-16.118
5640.00	-40.082	V	-45.518	5.93	13.14	-38.308	-13.00	-25.308
3760.00	-24.498	H	-34.360	5.03	12.72	-26.670	-13.00	-13.670
5640.00	-40.675	H	-46.235	5.93	13.14	-39.025	-13.00	-26.025
High Channel 9538 (1907.60MHz)								
3815.20	-22.113	V	-31.417	5.03	12.73	-23.717	-13.00	-10.717
3815.20	-22.150	H	-31.829	5.03	12.73	-24.129	-13.00	-11.129

Product	Eee PC		
Test Item	Spurious Emission		
Test Mode	Mode 6: WCDMA Band V Link		
Date of Test	2009/07/12	Test Site	AC-6

Frequency (MHz)	SA Reading (dBm)	Ant.Pol. (H/V)	SG Reading (dBm)	Cable Loss (dB)	Gain (dBi)	EIRP (dBm)	Limit (dBm)	Margin (dB)
Low Channel 4132 (826.40MHz)								
1652.80	-47.920	V	-63.715	3.28	9.75	-57.245	-13.00	-44.245
2479.20	-48.782	V	-60.609	4.10	10.48	-54.229	-13.00	-41.229
1652.80	-44.634	H	-60.425	3.28	9.75	-53.955	-13.00	-40.955
2479.20	-48.373	H	-60.198	4.10	10.48	-53.818	-13.00	-40.818
Middle Channel 4182 (836.40MHz)								
1672.80	-44.194	V	-59.981	3.32	9.95	-53.351	-13.00	-40.351
1672.80	-41.565	H	-57.307	3.32	9.95	-50.677	-13.00	-37.677
High Channel 4233 (846.60MHz)								
1693.20	-42.756	V	-58.456	3.35	10.06	-51.746	-13.00	-38.746
2539.80	-48.109	V	-60.128	4.19	10.68	-53.638	-13.00	-40.638
1693.20	-40.959	H	-56.571	3.35	10.06	-49.861	-13.00	-36.861
2539.80	-46.822	H	-58.714	4.19	10.68	-52.224	-13.00	-39.224

Product	Eee PC		
Test Item	Spurious Emission		
Test Mode	Mode 7: HSDPA Band II Link		
Date of Test	2009/07/12	Test Site	AC-6

Frequency (MHz)	SA Reading (dBm)	Ant.Pol. (H/V)	SG Reading (dBm)	Cable Loss (dB)	Gain (dBi)	EIRP (dBm)	Limit (dBm)	Margin (dB)
Low Channel 9262 (1852.40MHz)								
3704.80	-29.157	V	-39.936	4.78	12.69	-32.026	-13.00	-19.026
3704.80	-26.207	H	-36.575	4.78	12.69	-28.665	-13.00	-15.665
Middle Channel 9400 (1880.00MHz)								
3760.00	-27.091	V	-36.808	5.03	12.72	-29.118	-13.00	-16.118
5640.00	-40.082	V	-45.518	5.93	13.14	-38.308	-13.00	-25.308
3760.00	-24.498	H	-34.360	5.03	12.72	-26.670	-13.00	-13.670
5640.00	-40.675	H	-46.235	5.93	13.14	-39.025	-13.00	-26.025
High Channel 9538 (1907.60MHz)								
3815.20	-22.113	V	-31.417	5.03	12.73	-23.717	-13.00	-10.717
3815.20	-22.150	H	-31.829	5.03	12.73	-24.129	-13.00	-11.129

Product	Eee PC		
Test Item	Spurious Emission		
Test Mode	Mode 8: HSDPA Band V Link		
Date of Test	2009/07/12	Test Site	AC-6

Frequency (MHz)	SA Reading (dBm)	Ant.Pol. (H/V)	SG Reading (dBm)	Cable Loss (dB)	Gain (dBi)	EIRP (dBm)	Limit (dBm)	Margin (dB)
Low Channel 4132 (826.40MHz)								
1652.80	-48.642	V	-64.437	3.28	9.75	-57.967	-13.00	-44.967
2479.20	-28.330	V	-40.036	4.10	10.48	-33.656	-13.00	-20.656
1652.80	-43.345	H	-59.136	3.28	9.75	-52.666	-13.00	-39.666
2479.20	-48.343	H	-60.168	4.10	10.48	-53.788	-13.00	-40.788
Middle Channel 4182 (836.40MHz)								
1672.80	-42.910	V	-58.697	3.32	9.95	-52.067	-13.00	-39.067
2509.20	-41.450	V	-53.776	3.81	10.62	-46.966	-13.00	-33.966
1672.80	-38.066	H	-53.860	3.32	9.95	-47.230	-13.00	-34.230
2509.20	-44.484	H	-56.727	3.81	10.62	-49.917	-13.00	-36.917
High Channel 4233 (846.60MHz)								
1693.20	-42.883	V	-58.583	3.35	10.06	-51.873	-13.00	-38.873
2539.80	-46.901	V	-58.920	4.19	10.68	-52.430	-13.00	-39.430
1693.20	-40.171	H	-55.783	3.35	10.06	-49.073	-13.00	-36.073
2539.80	-32.908	H	-44.800	4.19	10.68	-38.310	-13.00	-25.310

Product	Eee PC		
Test Item	Spurious Emission		
Test Mode	Mode 09: CDMA2000 1x BC0 Link		
Date of Test	2009/07/12	Test Site	AC-6

Frequency (MHz)	SA Reading (dBm)	Ant.Pol. (H/V)	SG Reading (dBm)	Cable Loss (dB)	Gain (dBi)	EIRP (dBm)	Limit (dBm)	Margin (dB)
Low Channel 1013 (824.70MHz)								
1649.40	-36.934	V	-52.731	3.28	9.75	-46.261	-13.00	-33.261
2474.10	-42.083	V	-53.904	4.10	10.48	-47.524	-13.00	-34.524
1649.40	-36.049	H	-51.890	3.28	9.75	-45.420	-13.00	-32.420
2474.10	-40.819	H	-52.642	4.10	10.48	-46.262	-13.00	-33.262
Middle Channel 384 (836.52MHz)								
1673.04	-42.172	V	-57.957	3.32	9.95	-51.327	-13.00	-38.327
2509.56	-45.002	V	-57.323	3.81	10.62	-50.513	-13.00	-37.513
1673.04	-40.142	H	-55.882	3.32	9.95	-49.252	-13.00	-36.252
2509.56	-43.480	H	-55.722	3.81	10.62	-48.912	-13.00	-35.912
High Channel 777 (848.31MHz)								
1696.62	-38.476	V	-54.156	3.35	10.06	-47.446	-13.00	-34.446
2544.93	-40.194	V	-52.304	4.19	10.68	-45.814	-13.00	-32.814
1696.62	-33.952	H	-52.031	3.35	10.06	-45.321	-13.00	-32.321
2544.93	-35.006	H	-46.898	4.19	10.68	-40.408	-13.00	-27.408

Product	Eee PC		
Test Item	Spurious Emission		
Test Mode	Mode 10: CDMA2000 1x BC1 Link		
Date of Test	2009/07/12	Test Site	AC-6

Frequency (MHz)	SA Reading (dBm)	Ant.Pol. (H/V)	SG Reading (dBm)	Cable Loss (dB)	Gain (dBi)	EIRP (dBm)	Limit (dBm)	Margin (dB)
Low Channel 25 (1851.25MHz)								
3702.50	-37.585	V	-48.360	4.78	12.69	-40.450	-13.00	-27.450
5553.75	-41.746	V	-47.164	6.03	13.15	-40.044	-13.00	-27.044
3702.50	-36.155	H	-46.520	4.78	12.69	-38.610	-13.00	-25.610
5553.75	-38.842	H	-44.372	6.03	13.15	-37.252	-13.00	-24.252
Middle Channel 600 (1880MHz)								
3760.00	-46.085	V	-55.944	5.03	12.72	-48.254	-13.00	-35.254
5640.00	-48.539	V	-53.688	5.93	13.14	-46.478	-13.00	-33.478
3760.00	-42.680	H	-52.542	5.03	12.72	-44.852	-13.00	-31.852
5640.00	-42.774	H	-48.434	5.93	13.14	-41.224	-13.00	-28.224
High Channel 1175 (1908.75MHz)								
3817.50	-31.842	V	-41.122	5.03	12.73	-33.422	-13.00	-20.422
5726.25	-41.832	V	-47.078	6.20	13.11	-40.168	-13.00	-27.168
3817.50	-27.730	H	-37.011	5.03	12.73	-29.311	-13.00	-16.311
5726.25	-38.783	H	-44.013	6.20	13.11	-37.103	-13.00	-24.103

Product	Eee PC		
Test Item	Spurious Emission		
Test Mode	Mode 11: CDMA2000 1x EV-DO BC0 Link		
Date of Test	2009/07/12	Test Site	AC-6

Frequency (MHz)	SA Reading (dBm)	Ant.Pol. (H/V)	SG Reading (dBm)	Cable Loss (dB)	Gain (dBi)	EIRP (dBm)	Limit (dBm)	Margin (dB)
Low Channel 1013 (824.70MHz)								
1649.40	-36.918	V	-52.715	3.28	9.75	-46.245	-13.00	-33.245
2474.10	-42.085	V	-53.906	4.10	10.48	-47.526	-13.00	-34.526
1649.40	-35.031	H	-50.872	3.28	9.75	-44.402	-13.00	-31.402
2474.10	-39.841	H	-51.664	4.10	10.48	-45.284	-13.00	-32.284
Middle Channel 384 (836.52MHz)								
1673.04	-42.472	V	-57.957	3.32	9.95	-51.627	-13.00	-38.627
2509.56	-44.702	V	-57.323	3.81	10.62	-50.213	-13.00	-37.213
1673.04	-40.442	H	-55.882	3.32	9.95	-49.552	-13.00	-36.552
2509.56	-42.880	H	-55.722	3.81	10.62	-48.312	-13.00	-35.312
High Channel 777 (848.31MHz)								
1696.62	-39.572	V	-55.252	3.35	10.06	-48.542	-13.00	-35.542
2544.93	-40.184	V	-52.294	4.19	10.68	-45.804	-13.00	-32.804
1696.62	-33.962	H	-52.041	3.35	10.06	-45.331	-13.00	-32.331
2544.93	-36.016	H	-47.908	4.19	10.68	-41.418	-13.00	-28.418

Product	Eee PC		
Test Item	Spurious Emission		
Test Mode	Mode 12: CDMA2000 1x EV-DO BC1 Link		
Date of Test	2009/07/12	Test Site	AC-6

Frequency (MHz)	SA Reading (dBm)	Ant.Pol. (H/V)	SG Reading (dBm)	Cable Loss (dB)	Gain (dBi)	EIRP (dBm)	Limit (dBm)	Margin (dB)
Low Channel 25 (1851.25MHz)								
3702.50	-37.585	V	-48.360	4.78	12.69	-40.450	-13.00	-27.450
5553.75	-41.844	V	-47.262	6.03	13.15	-40.142	-13.00	-27.142
3702.50	-36.047	H	-46.412	4.78	12.69	-38.502	-13.00	-25.502
5553.75	-38.646	H	-44.176	6.03	13.15	-37.056	-13.00	-24.056
Middle Channel 600 (1880MHz)								
3760.00	-46.955	V	-56.814	5.03	12.72	-49.124	-13.00	-36.124
5640.00	-48.519	V	-53.668	5.93	13.14	-46.458	-13.00	-33.458
3760.00	-42.680	H	-52.542	5.03	12.72	-44.852	-13.00	-31.852
5640.00	-42.804	H	-48.464	5.93	13.14	-41.254	-13.00	-28.254
High Channel 1175 (1908.75MHz)								
3817.50	-31.172	V	-40.452	5.03	12.73	-32.752	-13.00	-19.752
5726.25	-41.824	V	-47.070	6.20	13.11	-40.160	-13.00	-27.160
3817.50	-28.149	H	-37.430	5.03	12.73	-29.730	-13.00	-16.730
5726.25	-38.383	H	-43.613	6.20	13.11	-36.703	-13.00	-23.703

8. Frequency Stability Under Temperature & Voltage Variations

8.1. Test Equipment

Frequency Stability Under Temperature & Voltage Variations / AC-6

Instrument	Manufacturer	Type No.	Serial No	Cal. Date
Spectrum Analyzer	Agilent	E4446A	MY45300103	2009/06/11
Radio Communication Tester	R&S	CMU 200	106388	2008/11/22
Dual Directional Coupler	Agilent	778D	20160	2009/04/20
10dB Coaxial Coupler	Agilent	87300C	MY44300299	2009/04/20
Coaxial Cable	Huber+Suhner	AC3-RF	08	2008/11/24
AC Power Supply	IDRC	CF-500TP	979422	2009/03/09
DC Power Supply	IDRC	CD-035-020PR	977272	2009/02/02
Programmable Temperature & Humidity Chamber	Gaoyu	TH-1P-B	WIT-05121302	2009/01/19
Temperature/Humidity Meter	zhicheng	ZC1-2	QT-TH003	2009/03/31

8.2. Test Setup

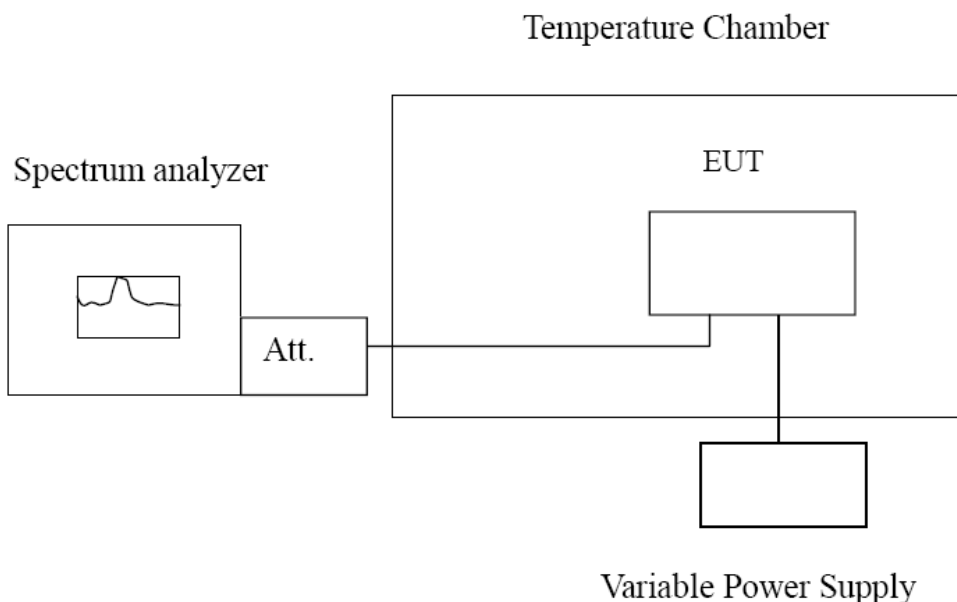

8.3. Limit

The frequency stability shall be sufficient to ensure that the fundamental emission stays within the authorized frequency block.

Limit	$< \pm 2.5 \text{ ppm}$
-------	-------------------------

8.4. Test Procedure

Frequency Stability Under Temperature Variations:

The equipment under test was connected to an external AC or DC power supply and input rated voltage. RF output was connected to a frequency counter or spectrum analyzer via feed through attenuators. The EUT was placed inside the temperature chamber. Set the spectrum analyzer RBW low enough to obtain the desired frequency resolution and measure EUT 20°C operating frequency as reference frequency. Turn EUT off and set the chamber temperature to -30°C. After the temperature stabilized for approximately 30 minutes recorded the frequency. Repeat step measure with 10°C increased per stage until the highest temperature of +50°C reached.

Frequency Stability Under Voltage Variations:

Set chamber temperature to 20°C. Use a variable AC power supply / DC power source to power the EUT and set the voltage to rated voltage. Set the spectrum analyzer RBW low enough to obtain the desired frequency resolution and recorded the frequency. Reduce the input voltage to specify extreme voltage variation ($\pm 15\%$) and endpoint, record the maximum frequency change.

8.5. Uncertainty

The measurement uncertainty is defined as $\pm 10 \text{ Hz}$.

8.6. Test Result

Product	Eee PC		
Test Item	Frequency Stability Under Temperature & Voltage Variations		
Test Mode	Mode 1: GSM850 GPRS Link		
Date of Test	2009/07/12	Test Site	AC-6

Frequency Stability under Temperature

Temperature Interval (°C)	Test Frequency (MHz)	Deviation (Hz)	Limit (kHz)
-30	836.40	-47	± 2091
-20	836.40	-33	± 2091
-10	836.40	-29	± 2091
0	836.40	-26	± 2091
10	836.40	-20	± 2091
20	836.40	-18	± 2091
30	836.40	-32	± 2091
40	836.40	-39	± 2091
50	836.40	-44	± 2091

Frequency Stability under Voltage

AC Voltage (V)	Test Frequency (MHz)	Deviation (Hz)	Limit (KHz)
138	836.40	-43	± 2091
120	836.40	-28	± 2091
102	836.40	-41	± 2091

Product	Eee PC		
Test Item	Frequency Stability Under Temperature & Voltage Variations		
Test Mode	Mode 2: GSM850 EDGE Link		
Date of Test	2009/07/12	Test Site	AC-6

Frequency Stability under Temperature

Temperature Interval (°C)	Test Frequency (MHz)	Deviation (Hz)	Limit (kHz)
-30	836.40	-44	± 2091
-20	836.40	-35	± 2091
-10	836.40	-20	± 2091
0	836.40	-27	± 2091
10	836.40	-31	± 2091
20	836.40	-28	± 2091
30	836.40	-25	± 2091
40	836.40	-40	± 2091
50	836.40	-46	± 2091

Frequency Stability under Voltage

AC Voltage (V)	Test Frequency (MHz)	Deviation (Hz)	Limit (KHz)
138	836.40	-41	± 2091
120	836.40	-30	± 2091
102	836.40	-46	± 2091

Product	Eee PC		
Test Item	Frequency Stability Under Temperature & Voltage Variations		
Test Mode	Mode 3: PCS1900 GPRS Link		
Date of Test	2009/07/12	Test Site	AC-6

Frequency Stability under Temperature

Temperature Interval (°C)	Test Frequency (MHz)	Deviation (Hz)	Limit (Hz)
-30	1880.00	-36	± 4700
-20	1880.00	-34	± 4700
-10	1880.00	-27	± 4700
0	1880.00	-31	± 4700
10	1880.00	-21	± 4700
20	1880.00	-17	± 4700
30	1880.00	-20	± 4700
40	1880.00	-28	± 4700
50	1880.00	-42	± 4700

Frequency Stability under Voltage

AC Voltage (V)	Test Frequency (MHz)	Deviation (Hz)	Limit (KHz)
138	1880.00	-37	± 4700
120	1880.00	-32	± 4700
102	1880.00	-42	± 4700

Product	Eee PC		
Test Item	Frequency Stability Under Temperature & Voltage Variations		
Test Mode	Mode 4: PCS1900 EDGE Link		
Date of Test	2009/07/12	Test Site	AC-6

Frequency Stability under Temperature

Temperature Interval (°C)	Test Frequency (MHz)	Deviation (Hz)	Limit (Hz)
-30	1880.00	-46	± 4700
-20	1880.00	-39	± 4700
-10	1880.00	-27	± 4700
0	1880.00	-33	± 4700
10	1880.00	-24	± 4700
20	1880.00	-18	± 4700
30	1880.00	-22	± 4700
40	1880.00	-28	± 4700
50	1880.00	-38	± 4700

Frequency Stability under Voltage

AC Voltage (V)	Test Frequency (MHz)	Deviation (Hz)	Limit (KHz)
138	1880.00	-45	± 4700
120	1880.00	-31	± 4700
102	1880.00	-40	± 4700

Product	Eee PC		
Test Item	Frequency Stability Under Temperature & Voltage Variations		
Test Mode	Mode 5: WCDMA Band II Link		
Date of Test	2009/07/12	Test Site	AC-6

Frequency Stability under Temperature

Temperature Interval (°C)	Test Frequency (MHz)	Deviation (Hz)	Limit (Hz)
-30	1880.00	-40	± 4700
-20	1880.00	-34	± 4700
-10	1880.00	-31	± 4700
0	1880.00	-24	± 4700
10	1880.00	-27	± 4700
20	1880.00	-19	± 4700
30	1880.00	-22	± 4700
40	1880.00	-29	± 4700
50	1880.00	-37	± 4700

Frequency Stability under Voltage

AC Voltage (V)	Test Frequency (MHz)	Deviation (Hz)	Limit (KHz)
138	1880.00	-30	± 4700
120	1880.00	-26	± 4700
102	1880.00	-41	± 4700

Product	Eee PC		
Test Item	Frequency Stability Under Temperature & Voltage Variations		
Test Mode	Mode 6: WCDMA Band V Link		
Date of Test	2009/07/12	Test Site	AC-6

Frequency Stability under Temperature

Temperature Interval (°C)	Test Frequency (MHz)	Deviation (Hz)	Limit (kHz)
-30	836.40	-43	± 2091
-20	836.40	-28	± 2091
-10	836.40	-36	± 2091
0	836.40	-32	± 2091
10	836.40	-25	± 2091
20	836.40	-19	± 2091
30	836.40	-33	± 2091
40	836.40	-24	± 2091
50	836.40	-37	± 2091

Frequency Stability under Voltage

AC Voltage (V)	Test Frequency (MHz)	Deviation (Hz)	Limit (KHz)
138	836.40	-39	± 2091
120	836.40	-34	± 2091
102	836.40	-42	± 2091

Product	Eee PC		
Test Item	Frequency Stability Under Temperature & Voltage Variations		
Test Mode	Mode 7: HSDPA Band II Link		
Date of Test	2009/07/12	Test Site	AC-6

Frequency Stability under Temperature

Temperature Interval (°C)	Test Frequency (MHz)	Deviation (Hz)	Limit (Hz)
-30	1880.00	-47	± 4700
-20	1880.00	-36	± 4700
-10	1880.00	-27	± 4700
0	1880.00	-23	± 4700
10	1880.00	-21	± 4700
20	1880.00	-25	± 4700
30	1880.00	-19	± 4700
40	1880.00	-28	± 4700
50	1880.00	-35	± 4700

Frequency Stability under Voltage

AC Voltage (V)	Test Frequency (MHz)	Deviation (Hz)	Limit (KHz)
138	1880.00	-44	± 4700
120	1880.00	-22	± 4700
102	1880.00	-40	± 4700

Product	Eee PC		
Test Item	Frequency Stability Under Temperature & Voltage Variations		
Test Mode	Mode 8: HSDPA Band V Link		
Date of Test	2009/07/12	Test Site	AC-6

Frequency Stability under Temperature

Temperature Interval (°C)	Test Frequency (MHz)	Deviation (Hz)	Limit (kHz)
-30	836.40	-45	± 2091
-20	836.40	-36	± 2091
-10	836.40	-25	± 2091
0	836.40	-27	± 2091
10	836.40	-29	± 2091
20	836.40	-18	± 2091
30	836.40	-16	± 2091
40	836.40	-28	± 2091
50	836.40	-35	± 2091

Frequency Stability under Voltage

AC Voltage (V)	Test Frequency (MHz)	Deviation (Hz)	Limit (KHz)
138	836.40	-41	± 2091
120	836.40	-28	± 2091
102	836.40	-44	± 2091

Product	Eee PC		
Test Item	Frequency Stability Under Temperature & Voltage Variations		
Test Mode	Mode 09: CDMA2000 1x BC0 Link		
Date of Test	2009/07/12	Test Site	AC-6

Frequency Stability under Temperature

Temperature Interval (°C)	Test Frequency (MHz)	Deviation (Hz)	Limit (Hz)
-30	836.52	-43	± 2091
-20	836.52	-34	± 2091
-10	836.52	-31	± 2091
0	836.52	-24	± 2091
10	836.52	-25	± 2091
20	836.52	-19	± 2091
30	836.52	-22	± 2091
40	836.52	-29	± 2091
50	836.52	-39	± 2091

Frequency Stability under Voltage

AC Voltage (V)	Test Frequency (MHz)	Deviation (Hz)	Limit (KHz)
138	836.52	-32	± 2091
120	836.52	-26	± 2091
102	836.52	-40	± 2091

Product	Eee PC		
Test Item	Frequency Stability Under Temperature & Voltage Variations		
Test Mode	Mode 10: CDMA2000 1x BC1 Link		
Date of Test	2009/07/12	Test Site	AC-6

Frequency Stability under Temperature

Temperature Interval (°C)	Test Frequency (MHz)	Deviation (Hz)	Limit (kHz)
-30	1880.00	-45	± 4700
-20	1880.00	-29	± 4700
-10	1880.00	-36	± 4700
0	1880.00	-32	± 4700
10	1880.00	-24	± 4700
20	1880.00	-11	± 4700
30	1880.00	-33	± 4700
40	1880.00	-26	± 4700
50	1880.00	-38	± 4700

Frequency Stability under Voltage

AC Voltage (V)	Test Frequency (MHz)	Deviation (Hz)	Limit (KHz)
138	1880.00	-34	± 2091
120	1880.00	-16	± 2091
102	1880.00	-32	± 2091

Product	Eee PC		
Test Item	Frequency Stability Under Temperature & Voltage Variations		
Test Mode	Mode 11: CDMA2000 1x EV-DO BC0 Link		
Date of Test	2009/07/12	Test Site	AC-6

Frequency Stability under Temperature

Temperature Interval (°C)	Test Frequency (MHz)	Deviation (Hz)	Limit (Hz)
-30	836.52	-42	± 2091
-20	836.52	-31	± 2091
-10	836.52	-30	± 2091
0	836.52	-22	± 2091
10	836.52	-21	± 2091
20	836.52	-15	± 2091
30	836.52	-22	± 2091
40	836.52	-24	± 2091
50	836.52	-34	± 2091

Frequency Stability under Voltage

AC Voltage (V)	Test Frequency (MHz)	Deviation (Hz)	Limit (KHz)
138	836.52	-28	± 2091
120	836.52	-23	± 2091
102	836.52	-36	± 2091

Product	Eee PC		
Test Item	Frequency Stability Under Temperature & Voltage Variations		
Test Mode	Mode 12: CDMA2000 1x EV-DO BC1 Link		
Date of Test	2009/07/12	Test Site	AC-6

Frequency Stability under Temperature

Temperature Interval (°C)	Test Frequency (MHz)	Deviation (Hz)	Limit (kHz)
-30	1880.00	-42	± 4700
-20	1880.00	-33	± 4700
-10	1880.00	-31	± 4700
0	1880.00	-27	± 4700
10	1880.00	-23	± 4700
20	1880.00	-14	± 4700
30	1880.00	-21	± 4700
40	1880.00	-27	± 4700
50	1880.00	-34	± 4700

Frequency Stability under Voltage

AC Voltage (V)	Test Frequency (MHz)	Deviation (Hz)	Limit (KHz)
138	1880.00	-34	± 4700
120	1880.00	-30	± 4700
102	1880.00	-37	± 4700

9. Receiver Spurious Emission for RSS 132/133

9.1. Test Equipment

Spurious Emission / AC-5

Instrument	Manufacturer	Type No.	Serial No	Cal. Date
Spectrum Analyzer	Agilent	N9010A	MY48030494	2009.04.23
Radio Communication Tester	R&S	CMU 200	106388	2008/10/21
Preamplifier	Quietek	AP-025C	QT-AP005	2008/11/24
Preamplifier	Miteq	NSP1800-25	1364185	2009.05.25
Bilog Antenna	Teseq GmbH	CBL6112D	27612	2009.02.25
Broad-Band Horn Antenna	Schwarzbeck	BBHA9120D	496	2008/11/24
Coaxial Cable	Huber+Suhner	SUCOFLEX 106	AC5-C1	2009.05.25
Coaxial Cable	Huber+Suhner	SUCOFLEX 102	AC5-C2	2009.05.25
Temperature/Humidity Meter	Zhicheng	ZC1-2	AC5-TH	2009.03.31

9.2. Test Setup

Under 1GHz Test Setup:

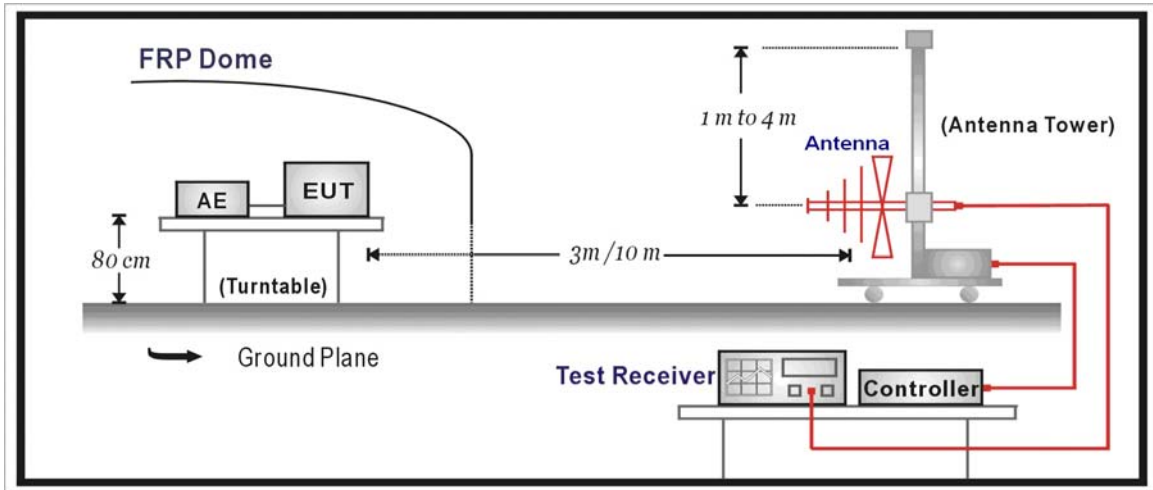

Above 1GHz Test Setup:

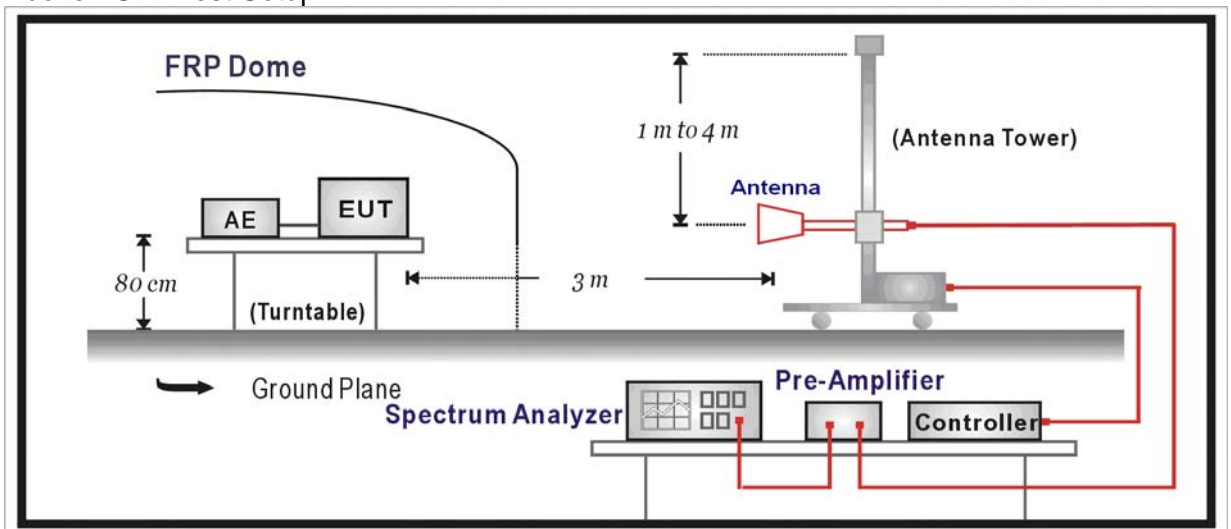

9.3. Limit

According to Standard RSS132/133 refer to RSS-Gen Issue 2.

Field Strength micro-volts/m at 3 meters		
Frequency (MHz)	Distance (m)	Level (dBuV/m)
30 - 88	3	40
88 - 216	3	43.5
216 - 960	3	46
Above 960	3	54

Note 1: The lower limit shall apply at the transition frequency.

Note 2: Distance refers to the distance in meters between the measuring instrument antenna and the closed point of any part of the device or system.

Note 3: E field strength (dBuV/m) = 20 log E field strength (uV/m)

9.4. Test Procedure

The EUT and its simulators are placed on a turn table which is 0.8 meter above ground. The turn table can rotate 360 degrees to determine the position of the maximum emission level. The EUT was positioned such that the distance from antenna to the EUT was 10 meters.

The antenna can move up and down between 1 meter and 4 meters to find out the maximum emission level.

Both horizontal and vertical polarization of the antenna are set on measurement. In order to find the maximum emission, all of the interface cables must be manipulated on radiated measurement.

On any frequency or frequencies below or equal to 1000 MHz, the radiated limits shown are based on measuring equipment employing a quasi-peak detector function and above 1000 MHz, the radiated limits shown are based measuring equipment employing an average detector function.

When average radiated emission measurement are included emission measurement Above 1000 MHz, there also is a limit on the radio frequency emissions, as measured using instrumentation with a peak detector function, corresponding to 20 dB above the maximum permitted average limit.

For class A, the measurement distance between the EUT and antenna is 10 meters for under 1GHz and above 1GHz.

For class B, the measurement distance between the EUT and antenna is 10 meters for under 1GHz and 3 meters for above 1GHz.

The bandwidth below 1GHz setting on the field strength meter (R&S Test Receiver ESCI) is 120 kHz and above 1GHz is 1MHz.

Note: When measurement above 1GHz, the horn antenna will bend down a little (as horn antenna have the narrow beamwidth) in order to find the maximum emission of EUT

9.5. Uncertainty

The measurement uncertainty is defined as 3.2 dB for Radiated Power Measurement.

9.6. Test Result

No significant emissions measurable. Plots reported here represent the worse case emissions.

Engineer : Robin	
Site : AC-5 (3m Semi-Anechoic Chamber)	Time : 2009/07/13 - 15:35
Limit : RSS_GEN_Radiation_03M_QP	Margin : 0
Probe : CBL6112D_(30-2000MHz) - HORIZONTAL	Power : AC 120V/60Hz
EUT : Eee PC	Note : GSM850 – GPRS (Using Peak detector)

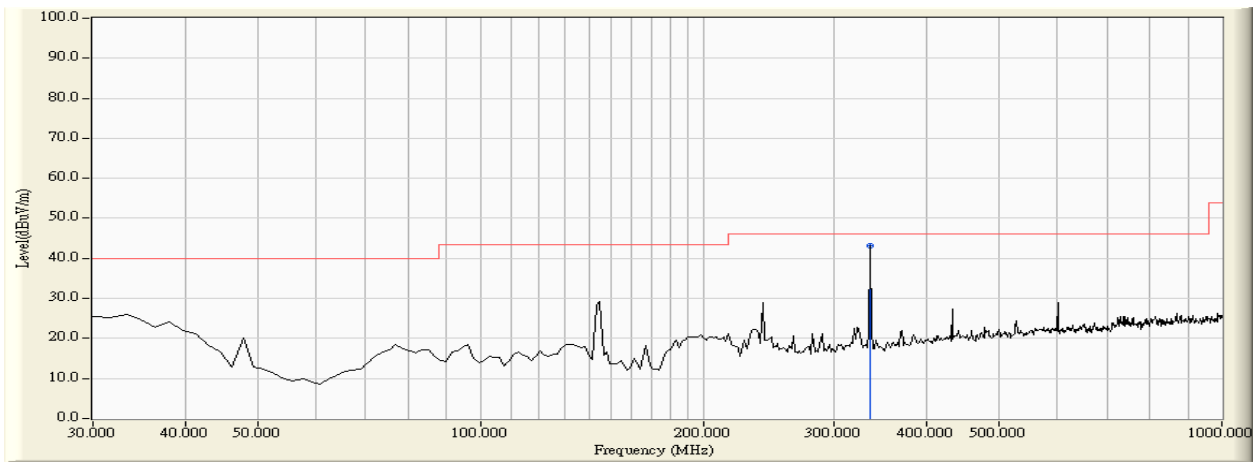

This plot is valid for low, mid & high channels (worst-case plot).

Engineer : Robin	
Site : AC-5 (3m Semi-Anechoic Chamber)	Time : 2009/07/13 - 15:39
Limit : RSS_GEN_Radiation_03M_QP	Margin : 0
Probe : CBL6112D_(30-2000MHz) - VERTICAL	Power : AC 120V/60Hz
EUT : Eee PC	Note : GSM850 – GPRS (Using Peak detector)

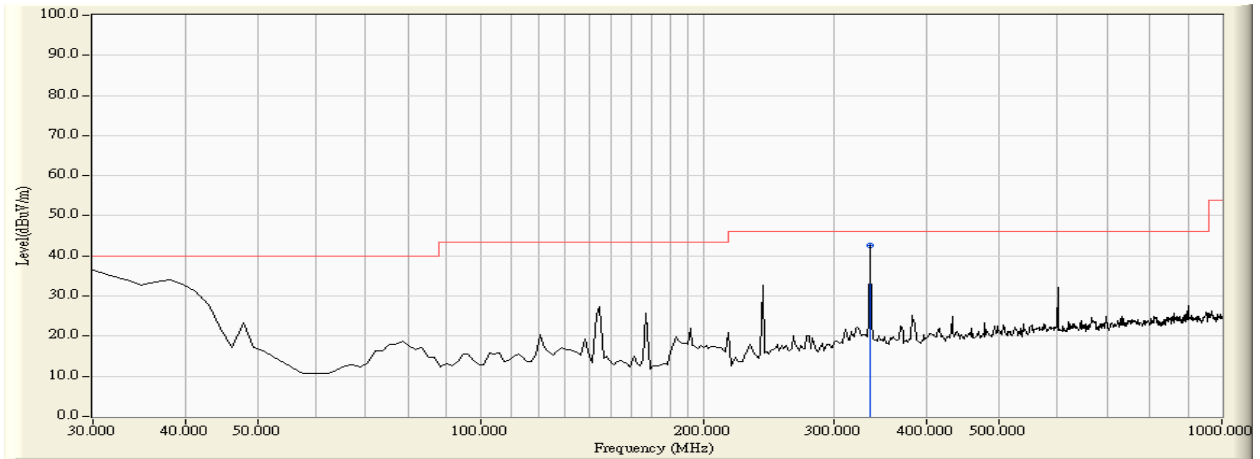

This plot is valid for low, mid & high channels (worst-case plot).

Engineer : Robin	
Site : AC-5 (3m Semi-Anechoic Chamber)	Time : 2009/07/13 - 15:28
Limit : RSS_GEN_Radiation_03M_PK	Margin : 0
Probe : BBHA9120D-737(1-18GHz) - HORIZONTAL	Power : AC 120V/60Hz
EUT : Eee PC	Note : GSM850 – GPRS (Using Peak detector)

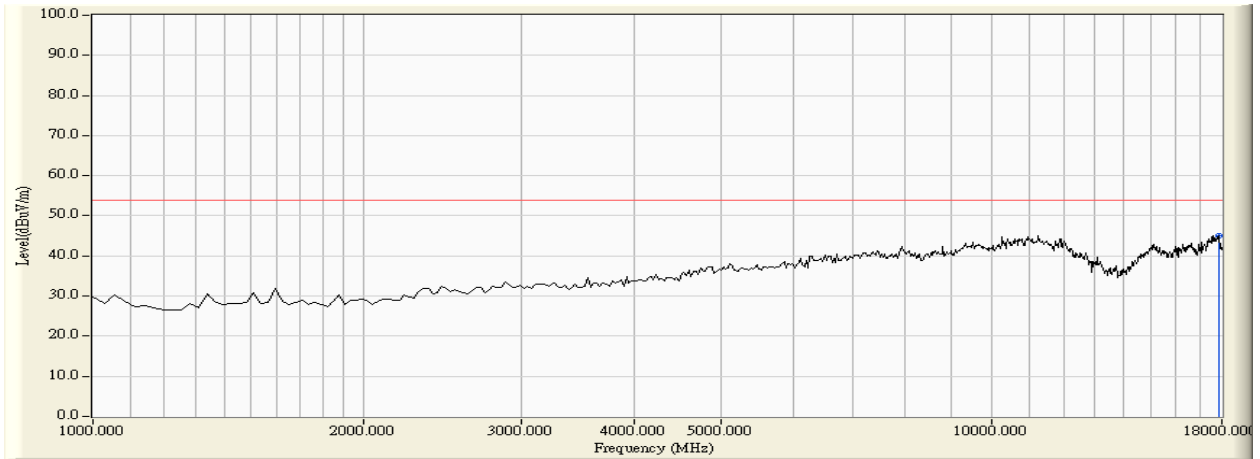

This plot is valid for low, mid & high channels (worst-case plot).

Engineer : Robin	
Site : AC-5 (3m Semi-Anechoic Chamber)	Time : 2009/07/13 - 15:25
Limit : RSS_GEN_Radiation_03M_PK	Margin : 0
Probe : BBHA9120D-737(1-18GHz) - VERTICAL	Power : AC 120V/60Hz
EUT : Eee PC	Note : GSM850 – GPRS (Using Peak detector)

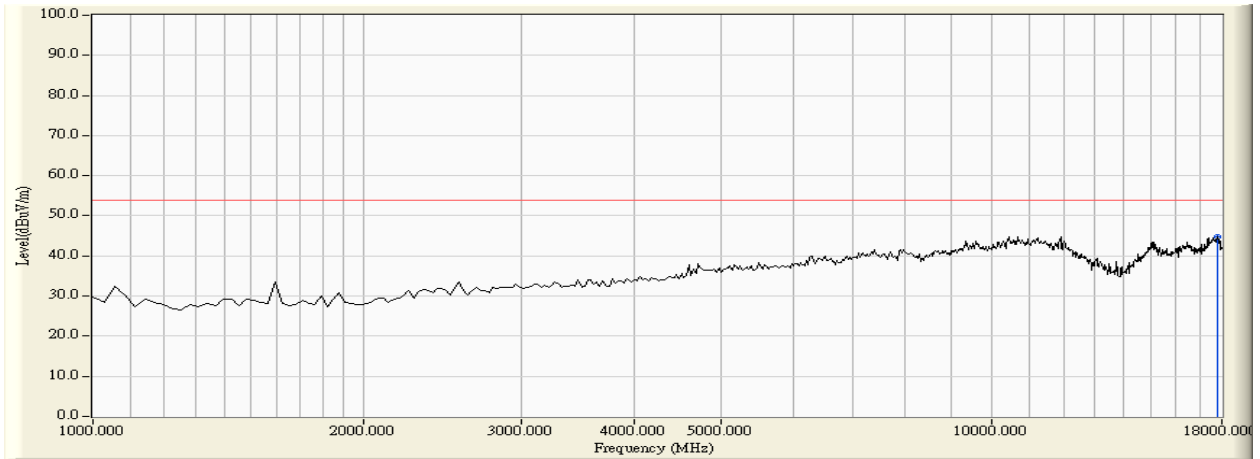

This plot is valid for low, mid & high channels (worst-case plot).

Engineer : Robin	
Site : AC-5 (3m Semi-Anechoic Chamber)	Time : 2009/07/13 - 15:36
Limit : RSS_GEN_Radiation_03M_QP	Margin : 0
Probe : CBL6112D_(30-2000MHz) - HORIZONTAL	Power : AC 120V/60Hz
EUT : Eee PC	Note : PCS1900 – GPRS (Using Peak detector)

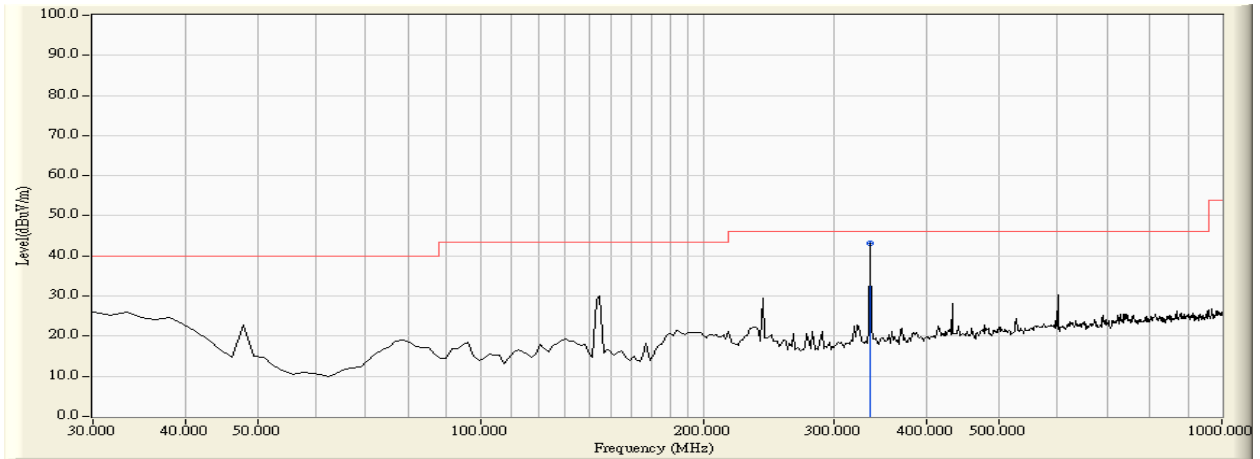

This plot is valid for low, mid & high channels (worst-case plot).

Engineer : Robin	
Site : AC-5 (3m Semi-Anechoic Chamber)	Time : 2009/07/13 - 15:38
Limit : RSS_GEN_Radiation_03M_QP	Margin : 0
Probe : CBL6112D_(30-2000MHz) - VERTICAL	Power : AC 120V/60Hz
EUT : Eee PC	Note : PCS1900 – GPRS (Using Peak detector)

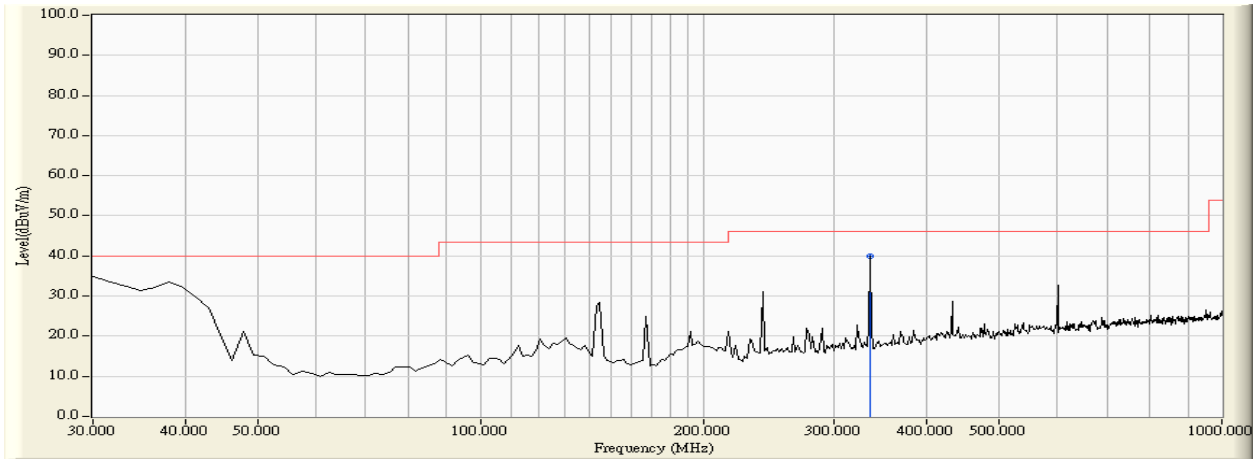

This plot is valid for low, mid & high channels (worst-case plot).

Engineer : Robin	
Site : AC-5 (3m Semi-Anechoic Chamber)	Time : 2009/07/13 - 15:28
Limit : RSS_GEN_Radiation_03M_PK	Margin : 0
Probe : BBHA9120D-737(1-18GHz) - HORIZONTAL	Power : AC 120V/60Hz
EUT : Eee PC	Note : PCS1900 – GPRS (Using Peak detector)

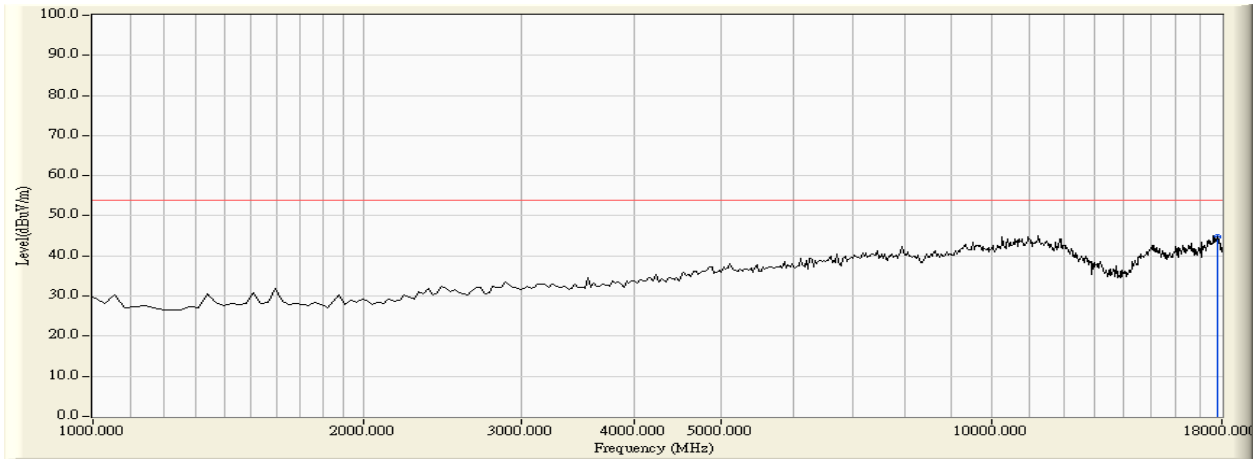

This plot is valid for low, mid & high channels (worst-case plot).

Engineer : Robin	
Site : AC-5 (3m Semi-Anechoic Chamber)	Time : 2009/07/13 - 15:25
Limit : RSS_GEN_Radiation_03M_PK	Margin : 0
Probe : BBHA9120D-737(1-18GHz) - VERTICAL	Power : AC 120V/60Hz
EUT : Eee PC	Note : PCS1900 – GPRS (Using Peak detector)

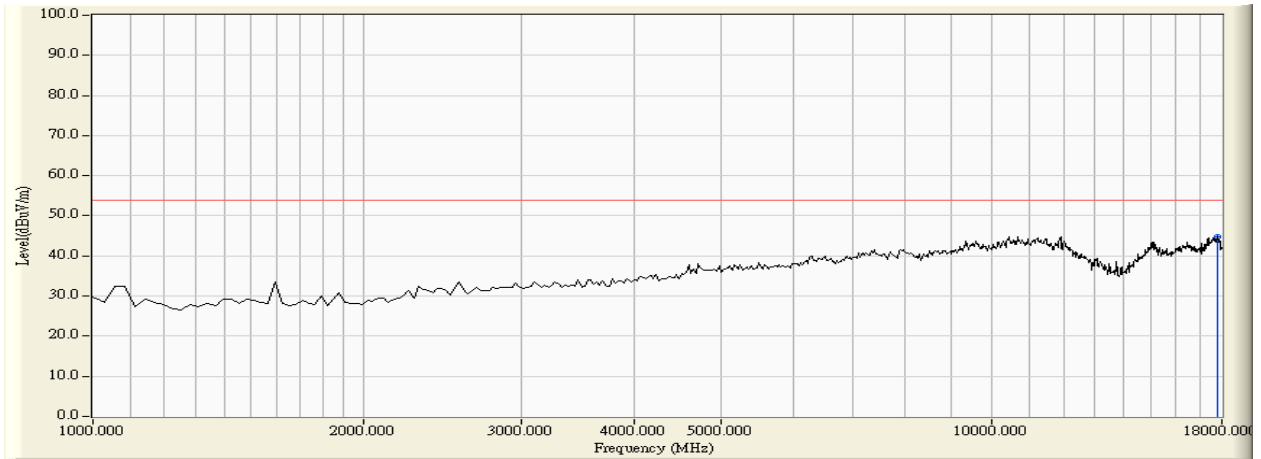

This plot is valid for low, mid & high channels (worst-case plot).

Engineer : Robin	
Site : AC-5 (3m Semi-Anechoic Chamber)	Time : 2009/07/13 - 15:36
Limit : RSS_GEN_Radiation_03M_QP	Margin : 0
Probe : CBL6112D_(30-2000MHz) - HORIZONTAL	Power : AC 120V/60Hz
EUT : Eee PC	Note : WCDMA Band II (Using Peak detector)

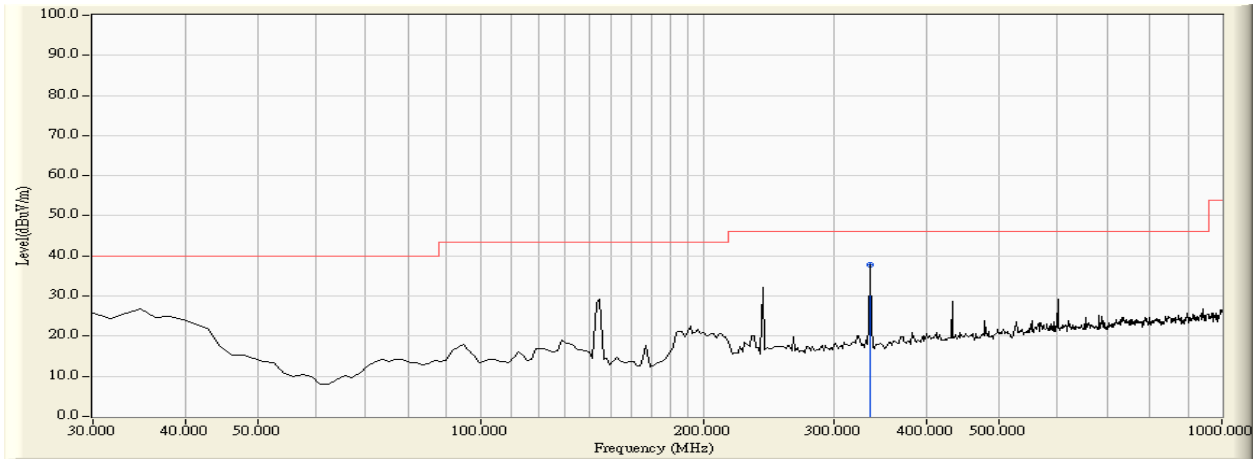

This plot is valid for low, mid & high channels (worst-case plot).

Engineer : Robin	
Site : AC-6 (3m Fully-Anechoic Chamber)	Time : 2009/07/13 - 15:38
Limit : FCC_SpartB_15.109_03M_QP	Margin : 0
Probe : CBL6112D_(30-2000MHz) - VERTICAL	Power : AC 120V/60Hz
EUT : Eee PC	Note : WCDMA Band II (Using Peak detector)

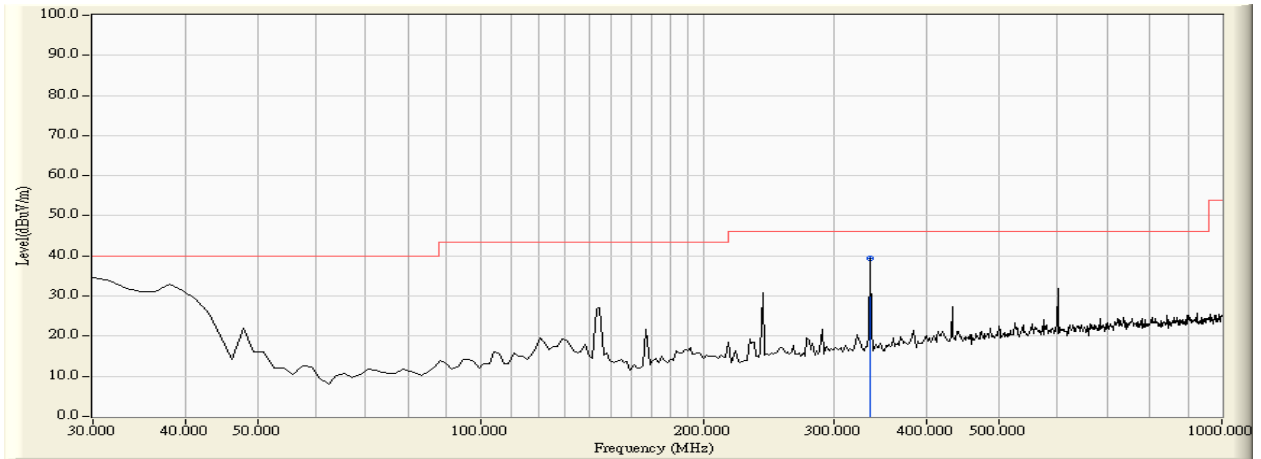

This plot is valid for low, mid & high channels (worst-case plot).

Engineer : Robin	
Site : AC-5 (3m Semi-Anechoic Chamber)	Time : 2009/07/13 - 15:27
Limit : RSS_GEN_Radiation_03M_PK	Margin : 0
Probe : BBHA9120D-737(1-18GHz) - HORIZONTAL	Power : AC 120V/60Hz
EUT : Eee PC	Note : WCDMA Band II (Using Peak detector)

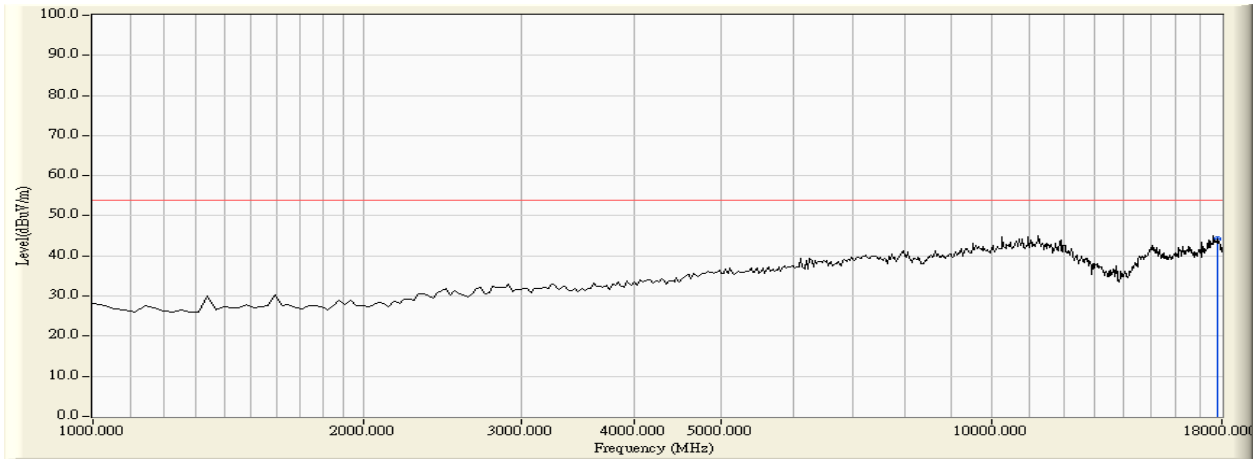

This plot is valid for low, mid & high channels (worst-case plot).

Engineer : Robin	
Site : AC-5 (3m Semi-Anechoic Chamber)	Time : 2009/07/13 - 15:26
Limit : RSS_GEN_Radiation_03M_PK	Margin : 0
Probe : BBHA9120D-737(1-18GHz) - VERTICAL	Power : AC 120V/60Hz
EUT : Eee PC	Note : WCDMA Band II (Using Peak detector)

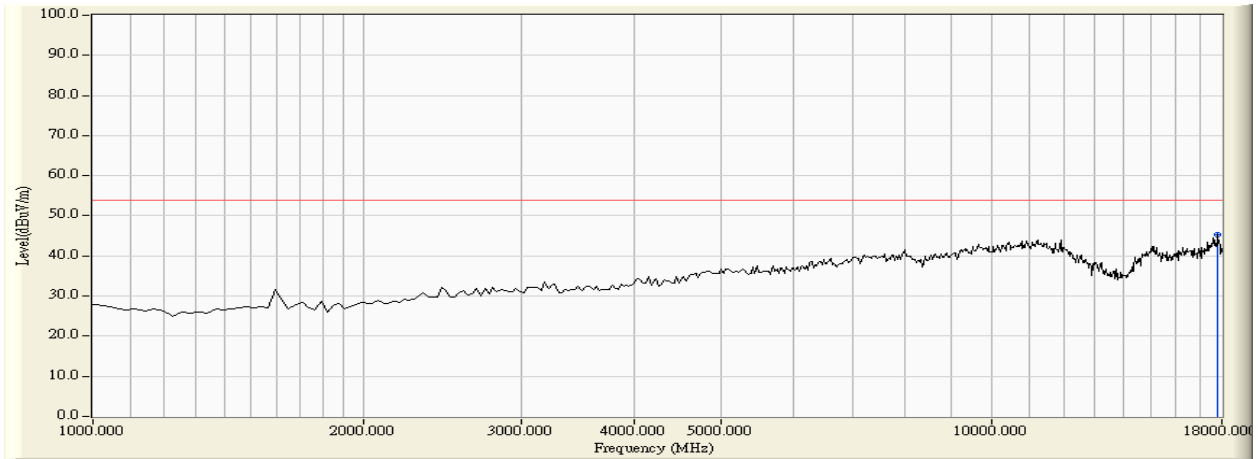

This plot is valid for low, mid & high channels (worst-case plot).

Engineer : Robin	
Site : AC-5 (3m Semi-Anechoic Chamber)	Time : 2009/07/13 - 15:37
Limit : RSS_GEN_Radiation_03M_QP	Margin : 0
Probe : CBL6112D_(30-2000MHz) - HORIZONTAL	Power : AC 120V/60Hz
EUT : Eee PC	Note : WCDMA Band V (Using Peak detector)

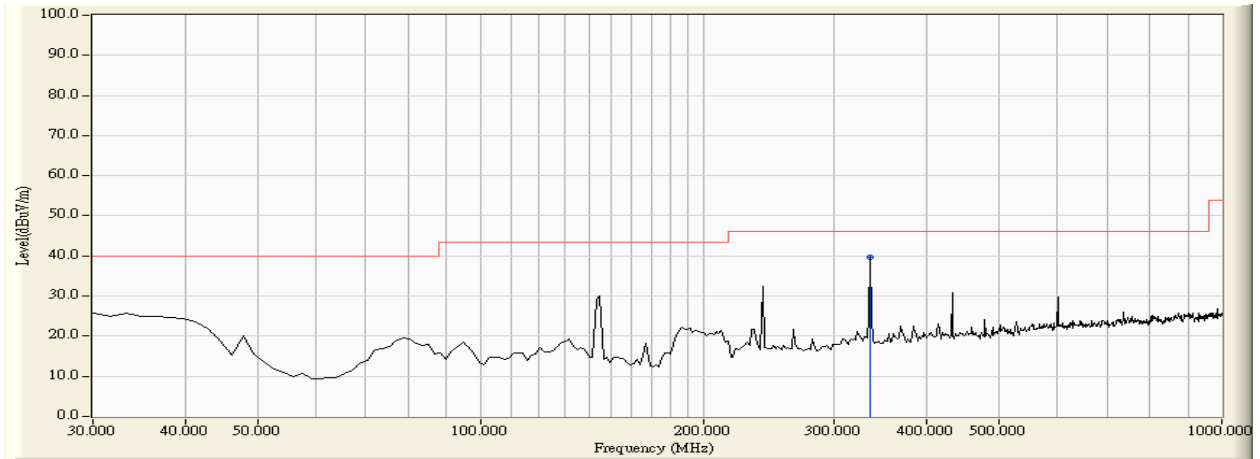

This plot is valid for low, mid & high channels (worst-case plot).

Engineer : Robin	
Site : AC-5 (3m Semi-Anechoic Chamber)	Time : 2009/07/13 - 15:38
Limit : RSS_GEN_Radiation_03M_QP	Margin : 0
Probe : CBL6112D_(30-2000MHz) - VERTICAL	Power : AC 120V/60Hz
EUT : Eee PC	Note : WCDMA Band V (Using Peak detector)

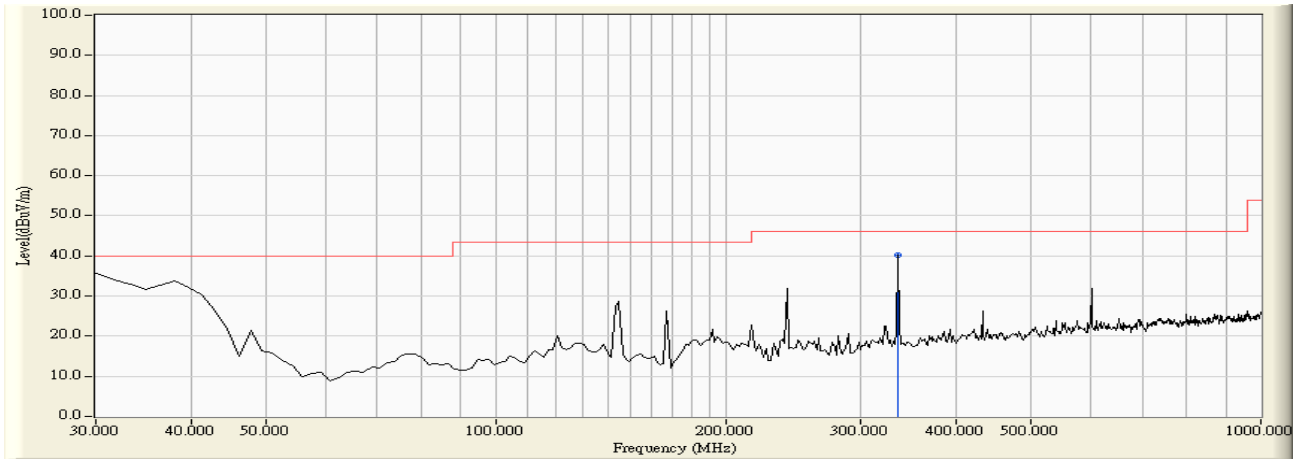

This plot is valid for low, mid & high channels (worst-case plot).

Engineer : Robin	
Site : AC-5 (3m Semi-Anechoic Chamber)	Time : 2009/07/13 - 15:27
Limit : RSS_GEN_Radiation_03M_PK	Margin : 0
Probe : BBHA9120D-737(1-18GHz) - HORIZONTAL	Power : AC 120V/60Hz
EUT : Eee PC	Note : WCDMA Band V (Using Peak detector)

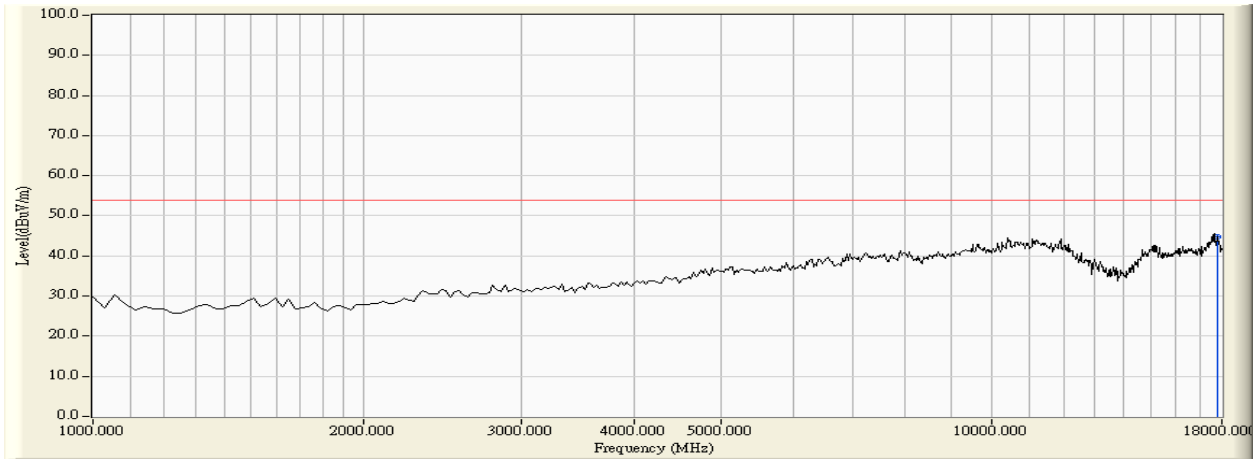

This plot is valid for low, mid & high channels (worst-case plot).

Engineer : Robin	
Site : AC-5 (3m Semi-Anechoic Chamber)	Time : 2009/07/13 - 15:26
Limit : RSS_GEN_Radiation_03M_PK	Margin : 0
Probe : BBHA9120D-737(1-18GHz) - VERTICAL	Power : AC 120V/60Hz
EUT : Eee PC	Note : WCDMA Band V (Using Peak detector)

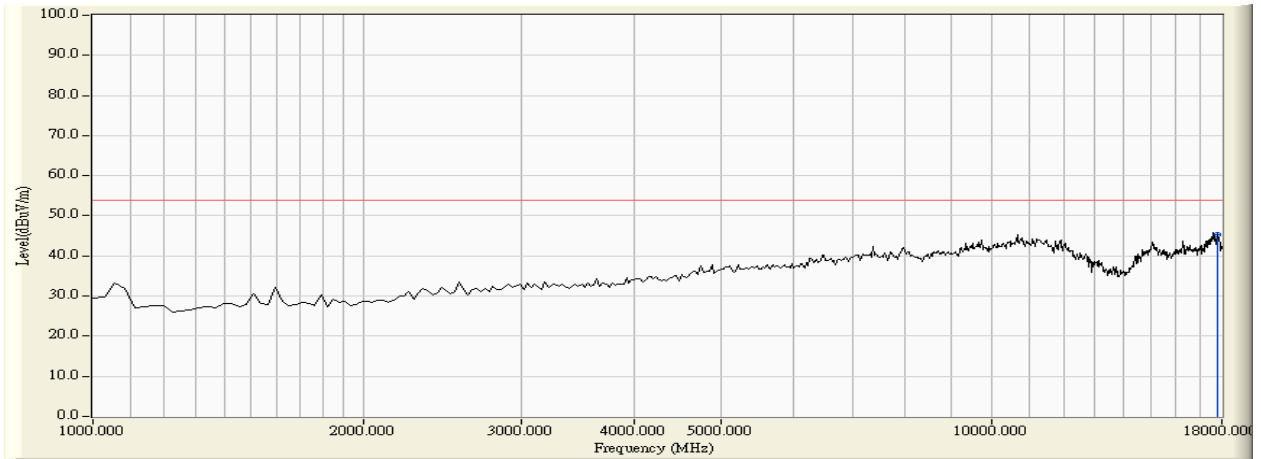

This plot is valid for low, mid & high channels (worst-case plot).