

# FCC Radio TEST Report

## FCC ID: MSQCPMS71001

This report concerns (check one) :  Original Grant  Class I Change

**Issued Date** : Dec. 24, 2007  
**Project No.** : 0708096A  
**Equipment** : WIRELESS OPTICAL LIPSTICK  
MOUSE  
**Model Name** : MS-71X4 (X=1~9)  
**Applicant** : ASUSTeK COMPUTER INC.  
No. 150 Li-Te Rd., Taipei City, Taiwan,  
R.O.C.  
**Manufacturer** : Paten Electronic Co.,LTD  
Da-Ning Industrial Zone Humen  
Dongguan Guangdong, CHINA

**Tested by:**

Neutron Engineering Inc. EMC Laboratory

**Date of Test:**

Aug. 22, 2007 ~ Sep. 05, 2007

Testing Engineer : Leo My for  
(Rush Kao)

Technical Manager : Jeff Yang  
(Jeff Yang)

Authorized Signatory : Andy Chiu  
(Andy Chiu)

### **NEUTRON ENGINEERING INC.**

No. 132-1, Lane 329, Sec. 2, Palain Rd.,  
Shijr City, Taipei, Taiwan  
TEL : (02) 2646-5426 FAX : (02) 2646-6815



**Declaration**

**Neutron** represents to the client that testing is done in accordance with standard procedures as applicable and that test instruments used has been calibrated with the standards traceable to National Measurement Laboratory (**NML**) of **R.O.C.**, or National Institute of Standards and Technology (**NIST**) of **U.S.A.**

**Neutron's** reports apply only to the specific samples tested under conditions. It is manufacture's responsibility to ensure that additional production units of this model are manufactured with the identical electrical and mechanical components. **Neutron** shall have no liability for any declarations, inferences or generalizations drawn by the client or others from **Neutron** issued reports.

**Neutron's** reports must not be used by the client to claim product endorsement by the authorities or any agency of the Government.

This report is the confidential property of the client. As a mutual protection to the clients, the public and **Neutron-self**, extracts from the test report shall not be reproduced except in full with **Neutron's** authorized written approval.

**Neutron's** laboratory quality assurance procedures are in compliance with the **ISO Guide 17025** requirements, and accredited by the conformity assessment authorities listed in this test report.

**Limitation**

For the use of the authority's logo is limited unless the Test Standard(s)/Scope(s)/Item(s) mentioned in this test report is (are) included in the conformity assessment authorities acceptance respective.

<b>Table of Contents</b>	<b>Page</b>
<b>1 . CERTIFICATION</b>	<b>4</b>
<b>2 . SUMMARY OF TEST RESULTS</b>	<b>5</b>
2.1 TEST FACILITY	6
2.2 MEASUREMENT UNCERTAINTY	6
<b>3 . GENERAL INFORMATION</b>	<b>7</b>
3.1 GENERAL DESCRIPTION OF EUT	7
3.2 DESCRIPTION OF TEST MODES	8
3.3 BLOCK DIGRAM SHOWING THE CONFIGURATION OF SYSTEM TESTED	9
3.4 DESCRIPTION OF SUPPORT UNITS	10
<b>4 . EMC EMISSION TEST</b>	<b>11</b>
4.1 CONDUCTED EMISSION MEASUREMENT	11
4.1.1 POWER LINE CONDUCTED EMISSION LIMITS	11
4.1.2 MEASUREMENT INSTRUMENTS LIST	11
4.1.3 TEST PROCEDURE	12
4.1.4 DEVIATION FROM TEST STANDARD	12
4.1.5 TEST SETUP	12
4.1.6 EUT OPERATING CONDITIONS	13
4.1.7 TEST RESULTS	14
4.2 RADIATED EMISSION MEASUREMENT	16
4.2.1 RADIATED EMISSION LIMITS	16
4.2.2 MEASUREMENT INSTRUMENTS LIST	17
4.2.3 TEST PROCEDURE	17
4.2.4 DEVIATION FROM TEST STANDARD	17
4.2.5 TEST SETUP	18
4.2.6 EUT OPERATING CONDITIONS	18
4.2.7 TEST RESULTS (Between 30 – 1000 MHz)	19
4.2.8 TEST RESULTS (Above 1000 MHz)	21
4.2.9 TEST RESULTS (2400 – 2483.5 MHz)	33
4.2.10 TEST RESULTS (Restricted Bands Requirements)	34
<b>5 . EUT TEST PHOTO</b>	<b>39</b>

## **1. CERTIFICATION**

Equipment : WIRELESS OPTICAL LIPSTICK MOUSE  
Brand Name : ASUS; VENTO BY ASUS  
Model No. : MS-71X4 (X=1~9)  
Applicant : ASUSTeK COMPUTER INC.  
Data of Test : Aug. 22, 2007 ~ Sep. 05, 2007  
Test Item : ENGINEERING SAMPLE  
Standards : FCC Part15, Subpart C(15.249) / RSS-210: 2004/ ANCI C63.4 : 2003

The above equipment has been tested and found compliance with the requirement of the relative standards by Neutron Engineering Inc. EMC Laboratory.

The test data, data evaluation, and equipment configuration contained in our test report (Ref No. NEI-FCCP-1-0708096A) were obtained utilizing the test procedures, test instruments, test sites that has been accredited by the Authority of NVLAP and TAF according to the ISO-17025 quality assessment standard and technical standard(s).

## 2. SUMMARY OF TEST RESULTS

Test procedures according to the technical standards:

FCC Part15, Subpart C			
Standard Section	Test Item	Judgment	Remark
15.207	Conducted Emission	PASS	
15.249	Radiated Spurious Emission	PASS	

**NOTE:**

(1) "N/A" denotes test is not applicable in this Test Report

**2.1 TEST FACILITY**

The test facilities used to collect the test data in this report is **C01/OS02** at the location of No.132-1, Lane 329, Sec. 2, Palain Road, Shijr City, Taipei, Taiwan.  
 Neutron's test firm number is 95335

**2.2 MEASUREMENT UNCERTAINTY**

The reported uncertainty of measurement  $y \pm U$ , where expended uncertainty **U** is based on a standard uncertainty multiplied by a coverage factor of **k=2**, providing a level of confidence of approximately **95 %**.

A. Conducted Measurement :

Test Site	Method	Measurement Frequency Range	U , (dB)	NOTE
C01	ANSI	150 KHz ~ 30MHz	1.94	

B. Radiated Measurement :

Test Site	Method	Measurement Frequency Range	Ant. H / V	U , (dB)	NOTE
OS-01	ANSI	30MHz ~ 200MHz	V	3.82	
		30MHz ~ 200MHz	H	3.60	
		200MHz ~ 1,000MHz	V	3.86	
		200MHz ~ 1,000MHz	H	3.94	
OS-02	ANSI	30MHz ~ 200MHz	V	2.48	
		30MHz ~ 200MHz	H	2.16	
		200MHz ~ 1,000MHz	V	2.50	
		200MHz ~ 1,000MHz	H	2.66	

3. GENERAL INFORMATION

3.1 GENERAL DESCRIPTION OF EUT

Equipment	WIRELESS OPTICAL LIPSTICK MOUSE	
Brand Name	ASUS; VENTO BY ASUS	
Model No.	MS-71X4 (X=1~9)	
OEM Brand/Model No.	N/A	
Model Difference	N/A	
Product Description	The EUT is a WIRELESS OPTICAL LIPSTICK MOUSE.	
	Operation Frequency:	CH01: 2402 MHz CH02: 2411 MHz CH03: 2432 MHz CH04: 2441 MHz CH05: 2462 MHz CH06: 2470 MHz
	Modulation Type:	GFSK
	Number Of Channel	6CH
	Antenna Designation:	Integral
	Antenna Gain(Peak)	0 dBi
	Output Power:	91.71 dBuV/m (AV Max.)
Based on the application, features, or specification exhibited in User's Manual, the EUT is considered as an ITE/Computing Device. More details of EUT technical specification, please refer to the User's Manual.		
Channel List	Please refer to the Product Description.	
Power Source	Battery supplied (Mouse)/ PC supplied (Dongle)	
Power Rating	DC 3.7V(MOUSE)/DC 5.0V(Dongle)	
Connecting I/O Port(s)	Please refer to the User's Manual	

Note:

1. For a more detailed features description, please refer to the manufacturer's specifications or the User's Manual.
2. Table for Filed Antenna

Ant.	Brand	Model Name	Antenna Type	Connector	Gain (dBi)
1	N/A	N/A	Printed Antenna	N/A	0



### 3.2 DESCRIPTION OF TEST MODES

To investigate the maximum EMI emission characteristics generated from EUT, the test system was pre-scanning tested based on the consideration of following EUT operation mode or test configuration mode which possible have effect on EMI emission level. Each of these EUT operation mode(s) or test configuration mode(s) mentioned above was evaluated respectively.

Pretest Test Mode	Description
Mode 1	CH01
Mode 2	CH04
Mode 3	CH06

For Conducted Test	
Final Test Mode	Description
Mode 2	CH04

For Radiated Test	
Final Test Mode	Description
Mode 1	CH01
Mode 2	CH04
Mode 3	CH06

Note:

(1) The mouse function is only transmitter /Dongle is only receiver mode



### 3.3 BLOCK DIGRAM SHOWING THE CONFIGURATION OF SYSTEM TESTED

#### Conducted

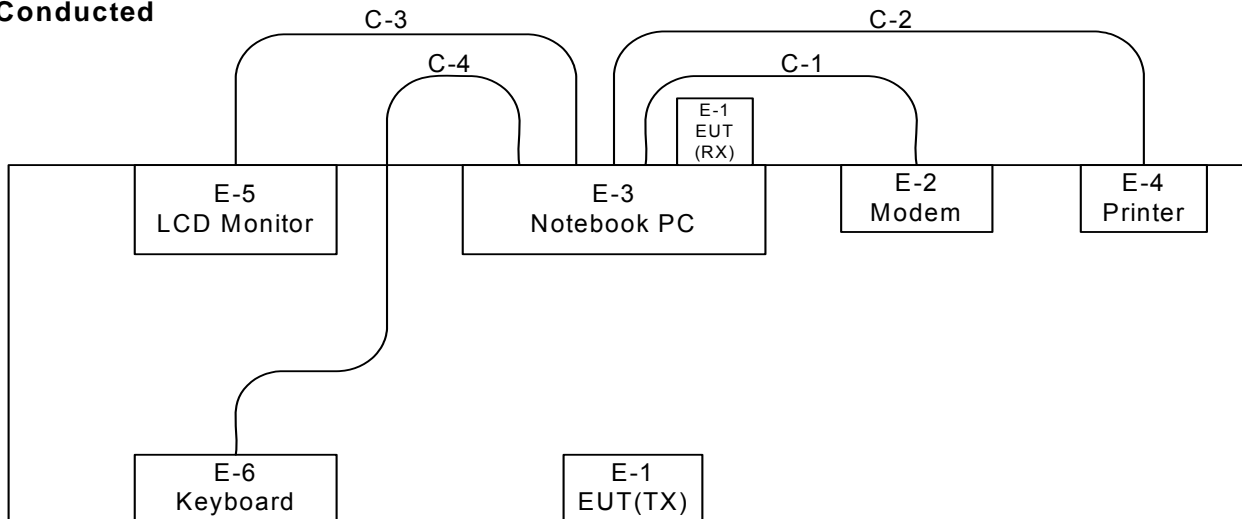

C-1 RS232 Cable  
C-2 Parallel Cable  
C-3 D-Sub Cable  
C-4 USB Cable

#### Radiated

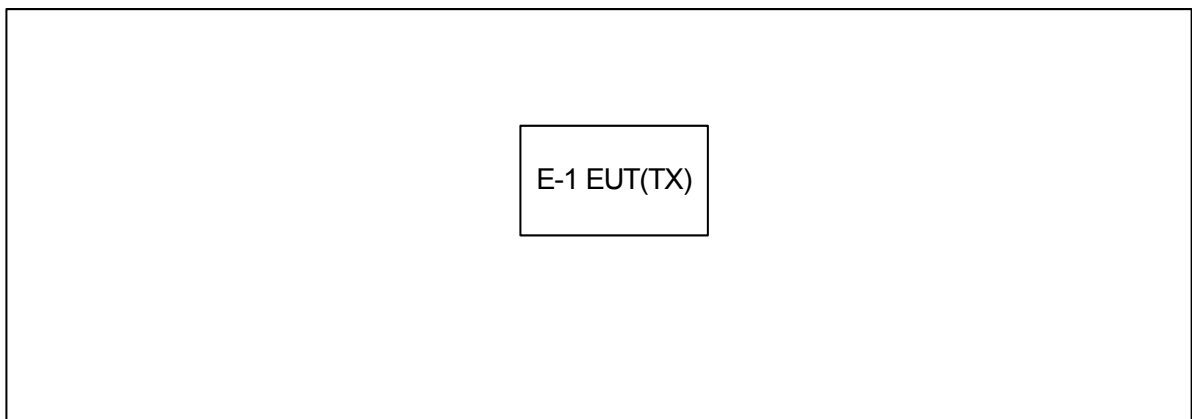

**3.4 DESCRIPTION OF SUPPORT UNITS**

The EUT has been tested as an independent unit together with other necessary accessories or support units. The following support units or accessories were used to form a representative test configuration during the tests.

Item	Equipment	Mfr/Brand	Model/Type No.	FCC ID	Series No.	Note
E-1	WIRELESS OPTICAL LIPSTICK MOUSE	ASUS	MS-71X4 (X=1~9)	MSQCPMS71001	N/A	EUT
E-2	Notebook PC	DELL	D600	DOC	7T390 A03	
E-3	Printer	SII	DPU-414	DOC	1045105A	
E-4	Modem	ACEEX	DM-1414V	DOC	8041708	
E-5	19" LCD Monitor	Samsung	SyncMaster 193P	DOC	DI19H4JXC05517A	
E-6	USB K/B	Logitech	Y-BL49	DOC	STW43302534	

Item	Shielded Type	Ferrite Core	Length	Note
C-1	NO	NO	1.8M	
C-2	NO	NO	1.8M	
C-3	YES	YES	1.8M	
C-4	YES	NO	1.5M	

Note:

- (1) The support equipment was authorized by Declaration of Confirmation.
- (2) For detachable type I/O cable should be specified the length in cm in 『Length』 column.

**4. EMC EMISSION TEST**

**4.1 CONDUCTED EMISSION MEASUREMENT**

**4.1.1 POWER LINE CONDUCTED EMISSION LIMITS** (Frequency Range 150KHz-30MHz)

FREQUENCY (MHz)	Class A (dBuV)		Class B (dBuV)		Standard
	Quasi-peak	Average	Quasi-peak	Average	
0.15 -0.5	79.00	66.00	66 - 56 *	56 - 46 *	CISPR
0.50 -5.0	73.00	60.00	56.00	46.00	CISPR
5.0 -30.0	73.00	60.00	60.00	50.00	CISPR

0.15 -0.5	79.00	66.00	66 - 56 *	56 - 46 *	FCC
0.50 -5.0	73.00	60.00	56.00	46.00	FCC
5.0 -30.0	73.00	60.00	60.00	50.00	FCC

Note:

- (1) The tighter limit applies at the band edges.
- (2) The limit of " \* " marked band means the limitation decreases linearly with the logarithm of the frequency in the range.

**4.1.2 MEASUREMENT INSTRUMENTS LIST**

Item	Kind of Equipment	Manufacturer	Type No.	Serial No.	Calibrated until
1	LISN	Rolf Heine	NNB-2/16Z	98053	Dec. 27, 2007
2	4L-V-LISN	Rolf Heine	NNB-4/63TL	02/10040	Apr. 08, 2008
3	Pulse Limiter	Electro-Metrics	EM-7600	112644	Nov. 28, 2007
4	50Ω Terminator	N/A	N/A	N/A	May.13, 2009
5	Test Cable	N/A	C01	N/A	Nov. 28, 2007
6	EMI Test Receiver	R&S	ESCI	100082	Mar. 08, 2008

Remark: " N/A" denotes No Model No. , Serial No. or No Calibration specified.

The following table is the setting of the receiver

Receiver Parameters	Setting
Attenuation	10 dB
Start Frequency	0.15 MHz
Stop Frequency	30 MHz
IF Bandwidth	9 kHz

#### 4.1.3 TEST PROCEDURE

- a. The EUT was placed 0.4 meters from the horizontal ground plane with EUT being connected to the power mains through a line impedance stabilization network (LISN). All other support equipments powered from additional LISN(s). The LISN provide 50 Ohm/ 50uH of coupling impedance for the measuring instrument.
- b. Interconnecting cables that hang closer than 40 cm to the ground plane shall be folded back and forth in the center forming a bundle 30 to 40 cm long.
- c. I/O cables that are not connected to a peripheral shall be bundled in the center. The end of the cable may be terminated, if required, using the correct terminating impedance. The overall length shall not exceed 1 m.
- d. LISN at least 80 cm from nearest part of EUT chassis.
- e. For the actual test configuration, please refer to the related Item –EUT Test Photos.

#### 4.1.4 DEVIATION FROM TEST STANDARD

No deviation

#### 4.1.5 TEST SETUP

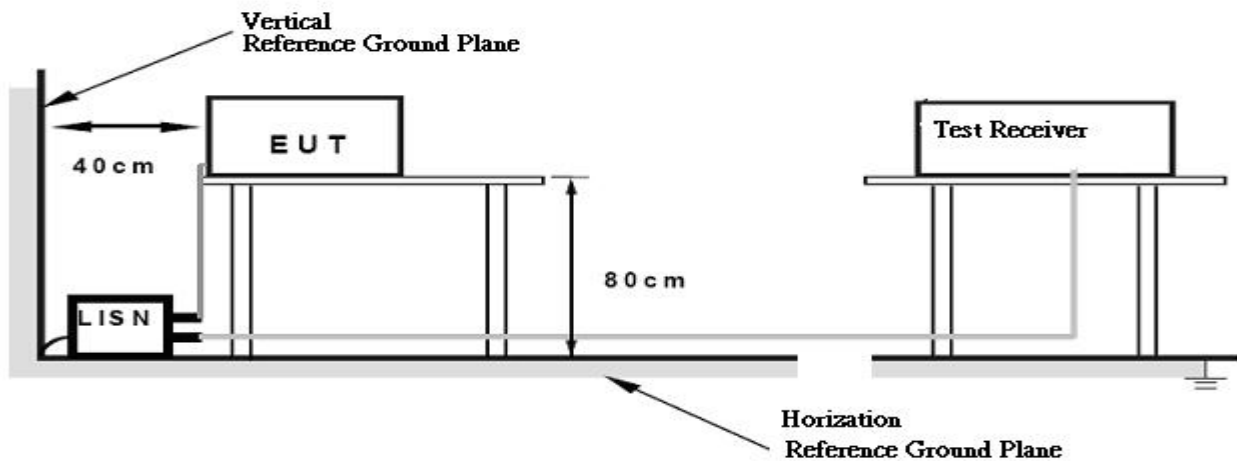

#### **4.1.6 EUT OPERATING CONDITIONS**

The EUT was configured for testing in a typical fashion (as a customer would normally use it). The EUT has been programmed to continuously transmit during test. This operating condition was tested and used to collect the included data.

4.1.7 TEST RESULTS

EUT :	WIRELESS OPTICAL LIPSTICK MOUSE	Model No. :	MS-71X4 (X=1~9)
Temperature :	26 °C	Relative Humidity :	57%
Pressure :	1009 hPa	Test Voltage :	AC 120V/60Hz
Test Mode :	CH04		

Freq. (MHz)	Terminal L/N	Measured(dBuV)		Limits(dBuV)		Margin (dB)	Note
		QP-Mode	AV-Mode	QP-Mode	AV-Mode		
0.15	Line	37.14	*	65.96	55.96	-28.82	(QP)
0.38	Line	33.77	*	58.30	48.30	-24.53	(QP)
1.08	Line	34.24	*	56.00	46.00	-21.76	(QP)
2.02	Line	35.44	*	56.00	46.00	-20.56	(QP)
4.03	Line	38.05	*	56.00	46.00	-17.95	(QP)
16.40	Line	35.96	*	60.00	50.00	-24.04	(QP)

Remark

- (1) All readings are QP Mode value unless otherwise stated AVG in column of 'Note'. If the QP Mode Measured value compliance with the QP Limits and lower than AVG Limits, the EUT shall be deemed to meet both QP & AVG Limits and then only QP Mode was measured, but AVG Mode didn't perform. In this case, a "\*" marked in AVG Mode column of Interference Voltage Measured.
- (2) Measuring frequency range from 150KHz to 30MHz.

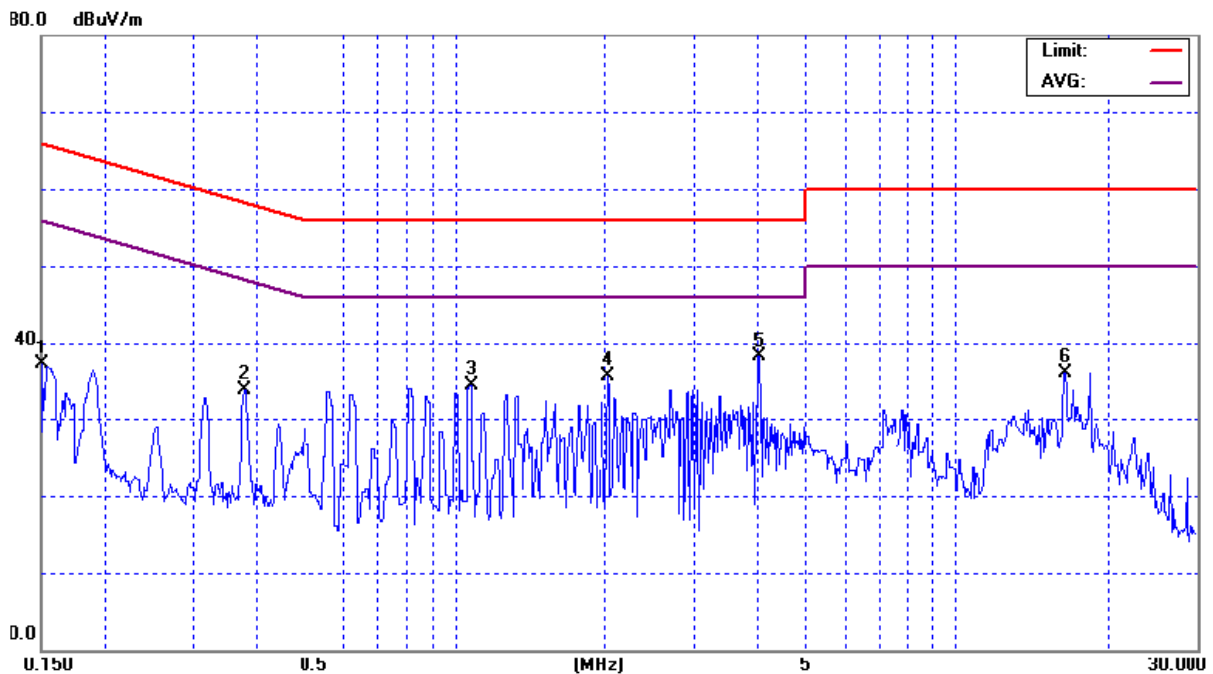

EUT :	WIRELESS OPTICAL LIPSTICK MOUSE	Model No. :	MS-71X4 (X=1~9)
Temperature :	26 °C	Relative Humidity :	57%
Pressure :	1009 hPa	Test Voltage :	AC 120V/60Hz
Test Mode :	CH04		

Freq. (MHz)	Terminal L/N	Measured(dBuV)		Limits(dBuV)		Margin (dB)	Note
		QP-Mode	AV-Mode	QP-Mode	AV-Mode		
0.19	Neutral	42.22	*	64.07	54.07	-21.85	(QP)
0.32	Neutral	34.72	*	59.81	49.81	-25.09	(QP)
0.38	Neutral	34.00	*	58.27	48.27	-24.27	(QP)
2.09	Neutral	31.86	*	56.00	46.00	-24.14	(QP)
4.02	Neutral	37.13	*	56.00	46.00	-18.87	(QP)
18.45	Neutral	35.45	*	60.00	50.00	-24.55	(QP)

Remark

- (1) All readings are QP Mode value unless otherwise stated AVG in column of 『Note』. If the QP Mode Measured value compliance with the QP Limits and lower than AVG Limits, the EUT shall be deemed to meet both QP & AVG Limits and then only QP Mode was measured, but AVG Mode didn't perform. In this case, a “ \* ” marked in AVG Mode column of Interference Voltage Measured.
- (2) Measuring frequency range from 150KHz to 30MHz.

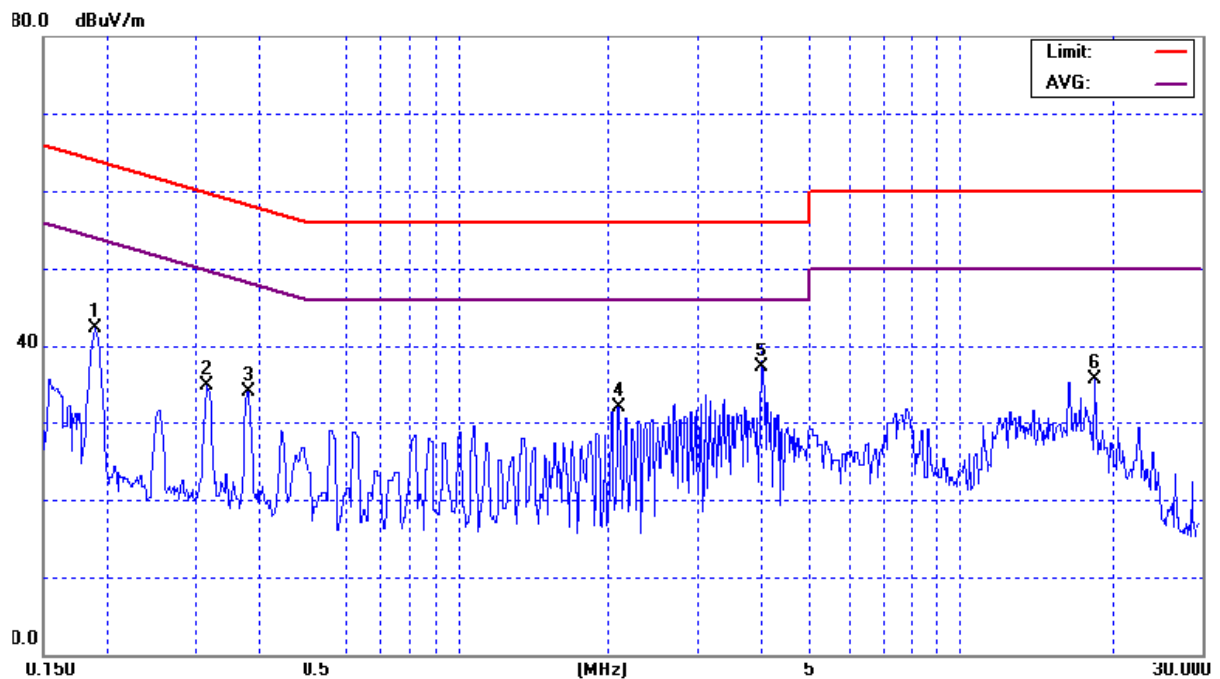



**4.2 RADIATED EMISSION MEASUREMENT**

**4.2.1 RADIATED EMISSION LIMITS ( FCC 15.209 )**

requecies (MHz)	Field Strength (micorvolts/meter)	Measurement Distance (meters)
0.009~0.490	2400/F(KHz)	300
0.490~1.705	24000/F(KHz)	30
1.705~30.0	30	30
30~88	100	3
88~216	150	3
216~960	200	3
Above 960	500	3

Harmonic emissions limits comply with below 54 dBuV/m at 3m. Other emissions radiated outside of the specified frequency bands, except for harmonics, shall be attenuated by at least 50 dB below the level of the fundamental or comply with the radiated emissions limits specified in section 15.209(a) limit in the table below has to be followed.

Note:

- (1) The tighter limit applies at the band edges.
- (2) Emission level (dBuV/m)=20log Emission level (uV/m).

**LIMITS OF RADIATED EMISSION MEASUREMENT ( FCC 15.209 )**

FREQUENCY (MHz)	Class A (dBuV/m) (at 3m)		Class B (dBuV/m) (at 3m)	
	PEAK	AVERAGE	PEAK	AVERAGE
Above 1000	80	60	74	54

Notes:

- (1) The limit for radiated test was performed according to FCC PART 15B.
- (2) The tighter limit applies at the band edges.
- (3) Emission level (dBuV/m)=20log Emission level (uV/m).

**LIMITS OF RADIATED EMISSION MEASUREMENT (FCC Part 15.249)**

FCC Part15 (15.249) , Subpart C	
Limit	Frequency Range (MHz)
Field strength of fundamental 50000 μV/m (94 dBμV/m) @ 3 m	2400-2483.5
Field strength of harmonics 500 μV/m (54 dBμV/m) @ 3 m	Above 2483.5

#### 4.2.2 MEASUREMENT INSTRUMENTS LIST

Item	Kind of Equipment	Manufacturer	Type No.	Serial No.	Calibrated until
1	Test Cable	N/A	SR03_C	N/A	Aug. 20, 2008
2	Log-Bicon Antenna	Schwarzbeck	VULB 9160	3176	Feb. 05, 2008
3	Test Cable	N/A	10M_OS01	N/A	Nov. 28, 2007
4	Test Cable	N/A	OS01-1/-2	N/A	Nov. 28, 2007
5	Pre-Amplifier	Anritsu	MH648A(OS01)	M98457	Nov. 28, 2007
6	Spectrum Analyzer	ADVAN TEST	R3261C	81720298	Sep. 11, 2007
7	EMI Test Receiver	R&S	ESCI	100082	Mar. 08, 2008
8	Test Receiver	PMM	PMM 9000	4210J01002	Mar. 14, 2008
9	Antenna Mast	Chance Most	CMTB-1.5	N/A	N/A
10	Turn Table	Chance Most	CMTB-1.5	N/A	N/A

Remark: " N/A" denotes No Model No. / Serial No. and No Calibration specified.

#### 4.2.3 TEST PROCEDURE

- a. The measuring distance of at 3 m shall be used for measurements at frequency up to 1GHz. For frequencies above 1GHz, any suitable measuring distance may be used.
- b. The EUT was placed on the top of a rotating table 0.8 meters above the ground at a 3m meter open area test site. The table was rotated 360 degrees to determine the position of the highest radiation.
- c. The height of the equipment or of the substitution antenna shall be 0.8 m; the height of the test antenna shall vary between 1 m to 4 m. Both horizontal and vertical polarizations of the antenna are set to make the measurement.
- d. The initial step in collecting conducted emission data is a spectrum analyzer peak detector mode pre-scanning the measurement frequency range. Significant peaks are then marked and then Quasi Peak detector mode re-measured.
- e. If the Peak Mode measured value compliance with and lower than Quasi Peak Mode Limit, the EUT shall be deemed to meet QP Limits and then no additional QP Mode measurement performed.
- f. For the actual test configuration, please refer to the related Item –EUT Test Photos.

#### 4.2.4 DEVIATION FROM TEST STANDARD

No deviation

#### 4.2.5 TEST SETUP

(A) Radiated Emission Test Set-Up, Frequency Below 1000MHz

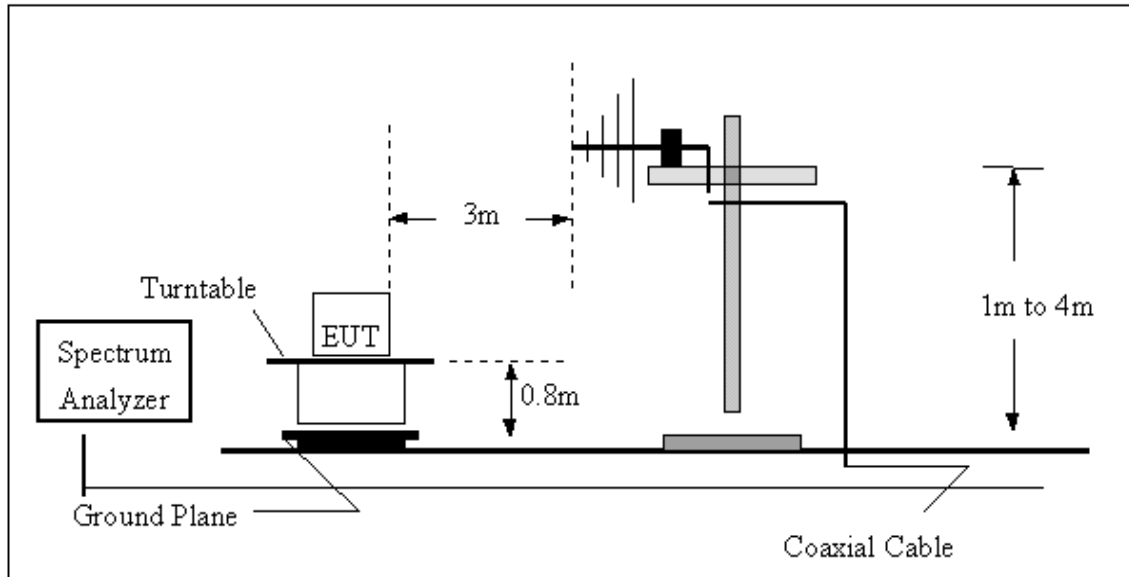

(B) Radiated Emission Test Set-Up Frequency Above 1 GHz

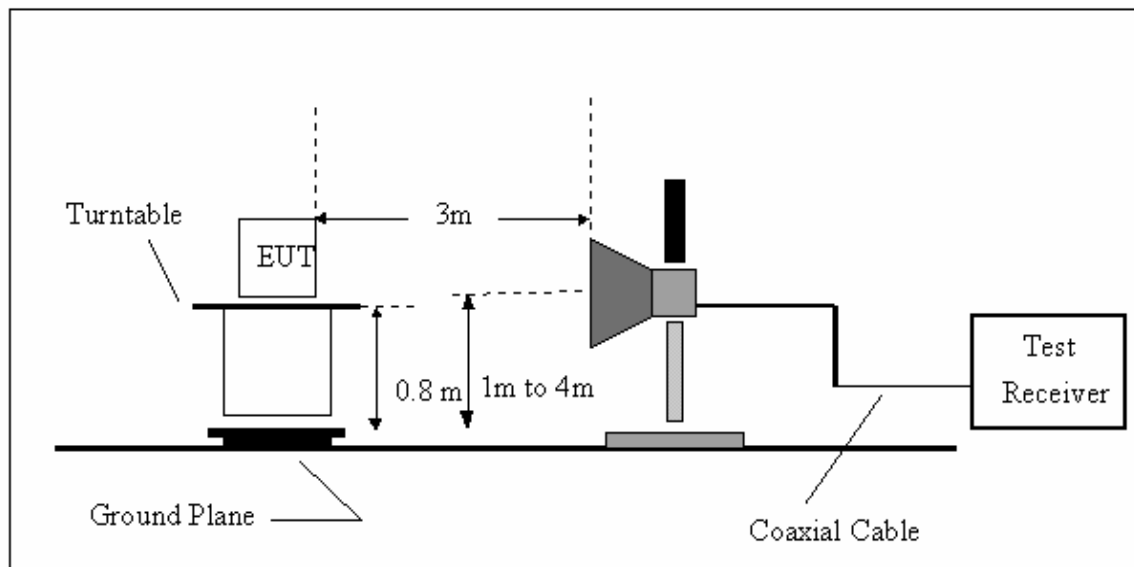

#### 4.2.6 EUT OPERATING CONDITIONS

The EUT tested system was configured as the statements of 4.1.6 Unless otherwise a special operating condition is specified in the follows during the testing.

4.2.7 TEST RESULTS (Between 30 – 1000 MHz)

EUT :	WIRELESS OPTICAL LIPSTICK MOUSE	Model No. :	MS-71X4 (X=1~9)
Temperature :	34°C	Relative Humidity :	54%
Pressure :	1003hPa	Test Power :	DC 3.7V
Test Mode :	CH04		

Freq. (MHz)	Ant. H/V	Reading(RA) (dBuV)	Corr.Factor(CF) (dB)	Measured(FS) (dBuV/m)	Limits(QP) (dBuV/m)	Margin (dB)	Note
239.50	V	42.05	-5.55	36.50	46.00	- 9.50	
286.70	V	40.29	-3.97	36.32	46.00	- 9.68	
336.50	V	40.26	-2.59	37.67	46.00	- 8.33	
365.53	V	38.69	-1.89	36.80	46.00	- 9.20	
432.00	V	32.37	-0.26	32.11	46.00	- 13.89	
528.30	V	34.81	1.93	36.74	46.00	- 9.26	

Remark :

- (1) All readings are Peak unless otherwise stated QP in column of 『Note』 . Peak denotes that the Peak reading compliance with the QP Limits and then QP Mode measurement didn't perform ◦
- (2) Measuring frequency range from 30MHz to 1000MHz or the 10th harmonic of highest fundamental frequency ◦ “F” denotes fundamental frequency; “ H” denotes spurious frequency. “E” denotes band edge frequency.
- (3) Radiated emissions measured in frequency range from 30 MHz to 1000 MHz were made with an instrument using Peak detector mode or QP detector mode of the emission ◦
- (4) Data of measurement within this frequency range shown “ - ” in the table above means the reading of emissions are attenuated more than 20dB below the permissible limits or the field strength is too small to be measured.

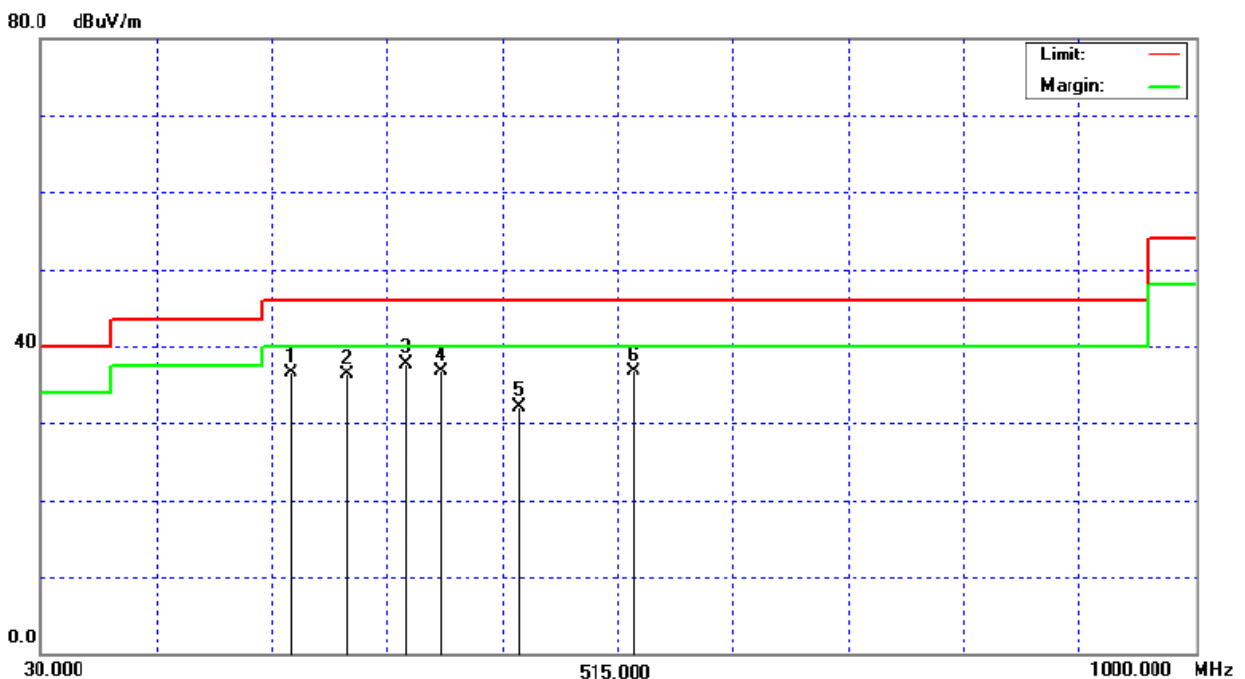

EUT :	WIRELESS OPTICAL LIPSTICK MOUSE	Model No. :	MS-71X4 (X=1~9)
Temperature :	34°C	Relative Humidity :	54%
Pressure :	1003hPa	Test Power :	DC 3.7V
Test Mode :	CH04		

Freq. (MHz)	Ant. H/V	Reading(RA) (dBuV)	Corr.Factor(CF) (dB)	Measured(FS) (dBuV/m)	Limits(QP) (dBuV/m)	Margin (dB)	Note
94.02	H	31.48	-8.19	23.29	43.50	- 20.21	
239.20	H	32.38	-5.56	26.82	46.00	- 19.18	
336.20	H	33.67	-2.60	31.07	46.00	- 14.93	
365.60	H	37.47	-1.89	35.58	46.00	- 10.42	
386.20	H	30.68	-1.37	29.31	46.00	- 16.69	
528.50	H	32.78	1.93	34.71	46.00	- 11.29	

Remark :

- (1) All readings are Peak unless otherwise stated QP in column of 『Note』 . Peak denotes that the Peak reading compliance with the QP Limits and then QP Mode measurement didn't perform ◦
- (2) Measuring frequency range from 30MHz to 1000MHz or the 10th harmonic of highest fundamental frequency ◦ "F" denotes fundamental frequency; " H" denotes spurious frequency. "E" denotes band edge frequency.
- (3) Radiated emissions measured in frequency range from 30 MHz to 1000 MHz were made with an instrument using Peak detector mode or QP detector mode of the emission ◦
- (4) Data of measurement within this frequency range shown " - " in the table above means the reading of emissions are attenuated more than 20dB below the permissible limits or the field strength is too small to be measured.

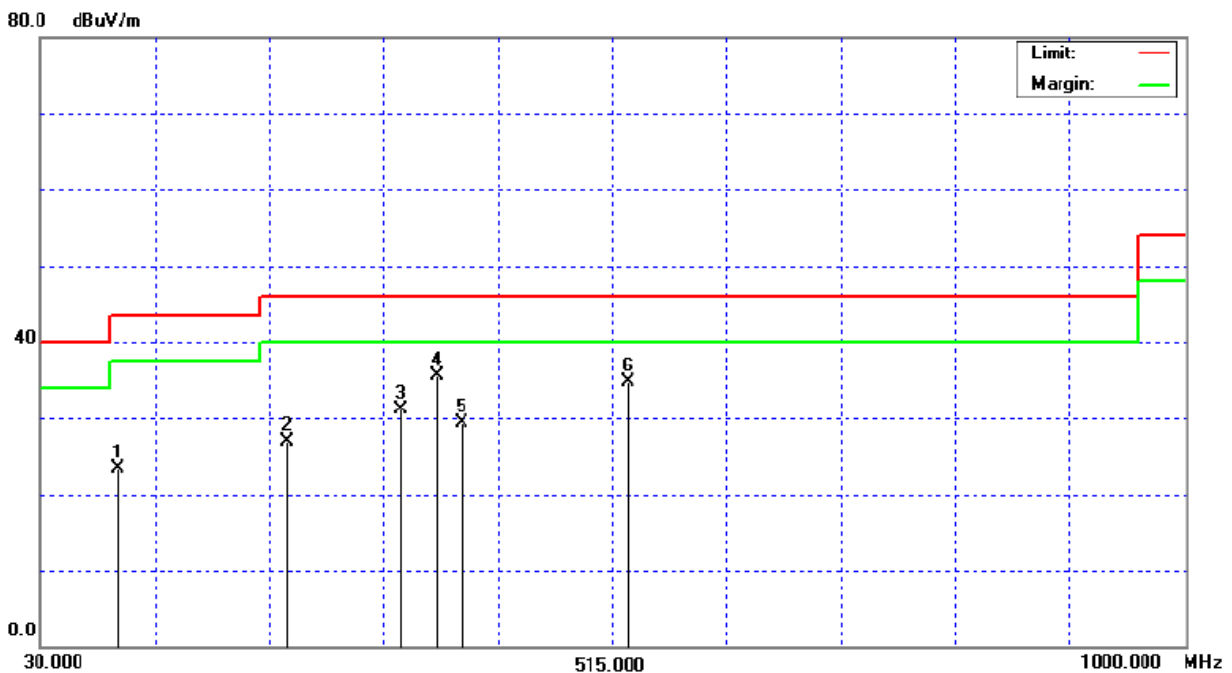

**4.2.8 TEST RESULTS (Above 1000 MHz)**

EUT :	WIRELESS OPTICAL LIPSTICK MOUSE	Model No. :	MS-71X4 (X=1~9)
Temperature :	33.6 °C	Relative Humidity :	69 %
Pressure :	1001 hPa	Test Power :	DC 3.7V
Test Mode :	CH01		

Freq. (MHz)	Ant.Pol. H/V	Reading		Ant./CF CF(dB)	Act.		Limit		Note
		Peak (dBuV)	AV (dBuV)		Peak (dBuV/m)	AV (dBuV/m)	Peak (dBuV/m)	AV (dBuV/m)	
2390.00	V	21.33	13.14	33.55	54.88	46.69	74.00	54.00	X/E
<b>2402.20</b>	<b>V</b>								<b>X/F</b>
4804.12	V	46.81	42.02	10.82	57.63	52.84	74.00	54.00	X/H
7206.50	V	38.73	33.22	19.37	58.10	52.59	74.00	54.00	X/H

Remark :

- (1) All readings are Peak unless otherwise stated QP in column of 『Note』 . Peak denotes that the Peak reading compliance with the QP Limits and then QP Mode measurement didn't perform ◦
- (2) Measuring frequency range from 30MHz to 1000MHz or the 10th harmonic of highest fundamental frequency ◦ "F" denotes fundamental frequency; "H" denotes spurious frequency. "E" denotes band edge frequency. (This judgment method includes the Band Edge Requirement.)
- (3) Radiated emissions measured in frequency range above 1000MHz were made with an instrument using Peak detector mode and AV detector mode of the emission ◦
- (4) Data of measurement within this frequency range shown " \* " in the table above means the reading of emissions are attenuated more than 20dB below the permissible limits or the field strength is too small to be measured.
- (5) A preamp and high pass filter were used for this test in order to provide sufficient measurement sensitivity.
- (6) EUT Orthogonal Axes :  
 "X" - denotes Laid on Table ; "Y" - denotes Vertical Stand ; "Z" - denotes Side Stand

Orthogonal Axes : X  
CH01 (Above 1000 MHz, Vertical)

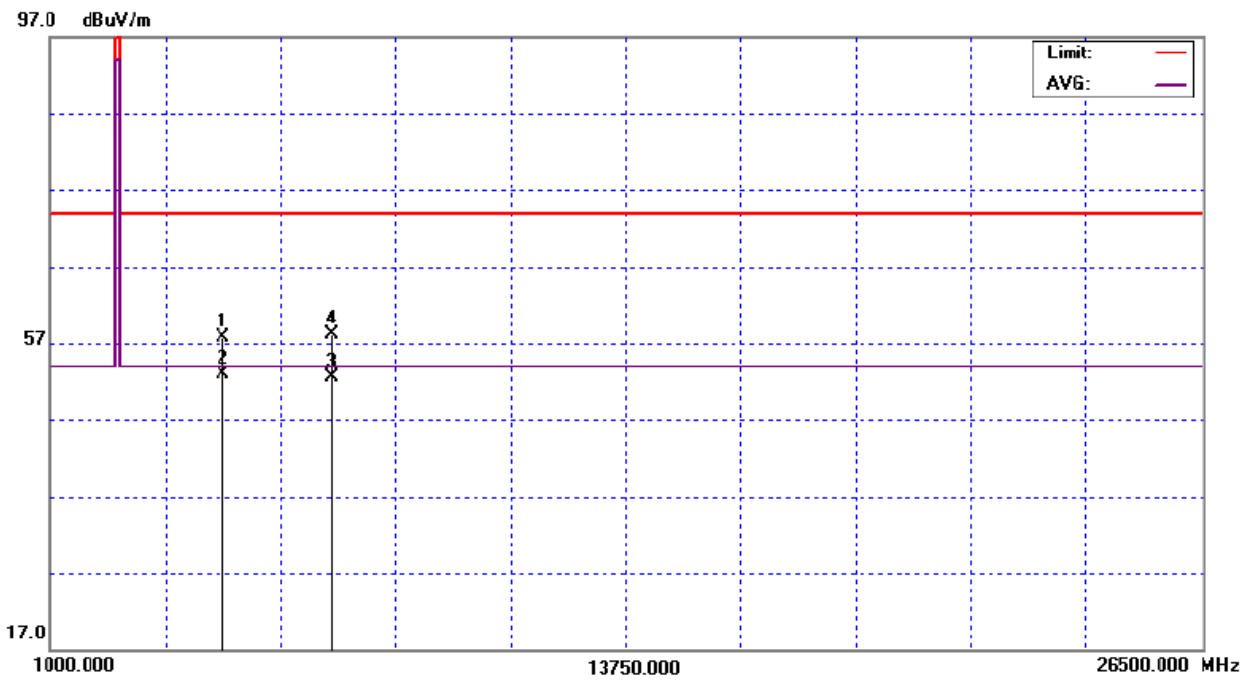
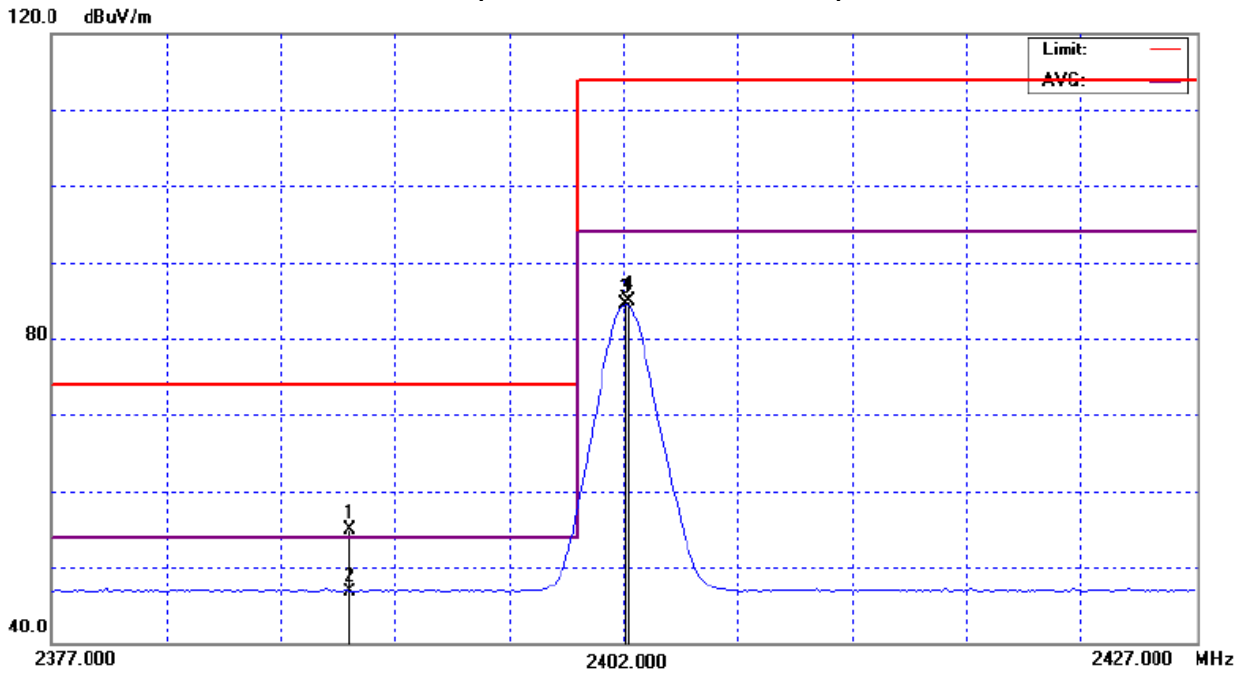



EUT :	WIRELESS OPTICAL LIPSTICK MOUSE	Model No. :	MS-71X4 (X=1~9)
Temperature :	33.6 °C	Relative Humidity :	69 %
Pressure :	1001 hPa	Test Power :	DC 3.7V
Test Mode :	CH01		

Freq. (MHz)	Ant.Pol. H/V	Reading		Ant./CF CF(dB)	Act.		Limit		Note
		Peak (dBuV)	AV (dBuV)		Peak (dBuV/m)	AV (dBuV/m)	Peak (dBuV/m)	AV (dBuV/m)	
2390.00	H	21.64	13.45	33.55	55.19	47.00	74.00	54.00	X/E
<b>2401.80</b>	<b>H</b>								<b>X/F</b>
4803.86	H	46.05	39.39	10.82	56.87	50.21	74.00	54.00	X/H
7205.66	H	39.75	33.31	19.37	59.12	52.68	74.00	54.00	X/H

Remark :

- (1) All readings are Peak unless otherwise stated QP in column of 『Note』 . Peak denotes that the Peak reading compliance with the QP Limits and then QP Mode measurement didn't perform ◦
- (2) Measuring frequency range from 30MHz to 1000MHz or the 10th harmonic of highest fundamental frequency ◦ "F" denotes fundamental frequency; "H" denotes spurious frequency. "E" denotes band edge frequency. (This judgment method includes the Band Edge Requirement.)
- (3) Radiated emissions measured in frequency range above 1000MHz were made with an instrument using Peak detector mode and AV detector mode of the emission ◦
- (4) Data of measurement within this frequency range shown " \* " in the table above means the reading of emissions are attenuated more than 20dB below the permissible limits or the field strength is too small to be measured.
- (5) A preamp and high pass filter were used for this test in order to provide sufficient measurement sensitivity.
- (6) EUT Orthogonal Axes :  
"X" - denotes Laid on Table ; "Y" - denotes Vertical Stand ; "Z" - denotes Side Stand

Orthogonal Axes : X  
CH01 (Above 1000 MHz, Horizontal)

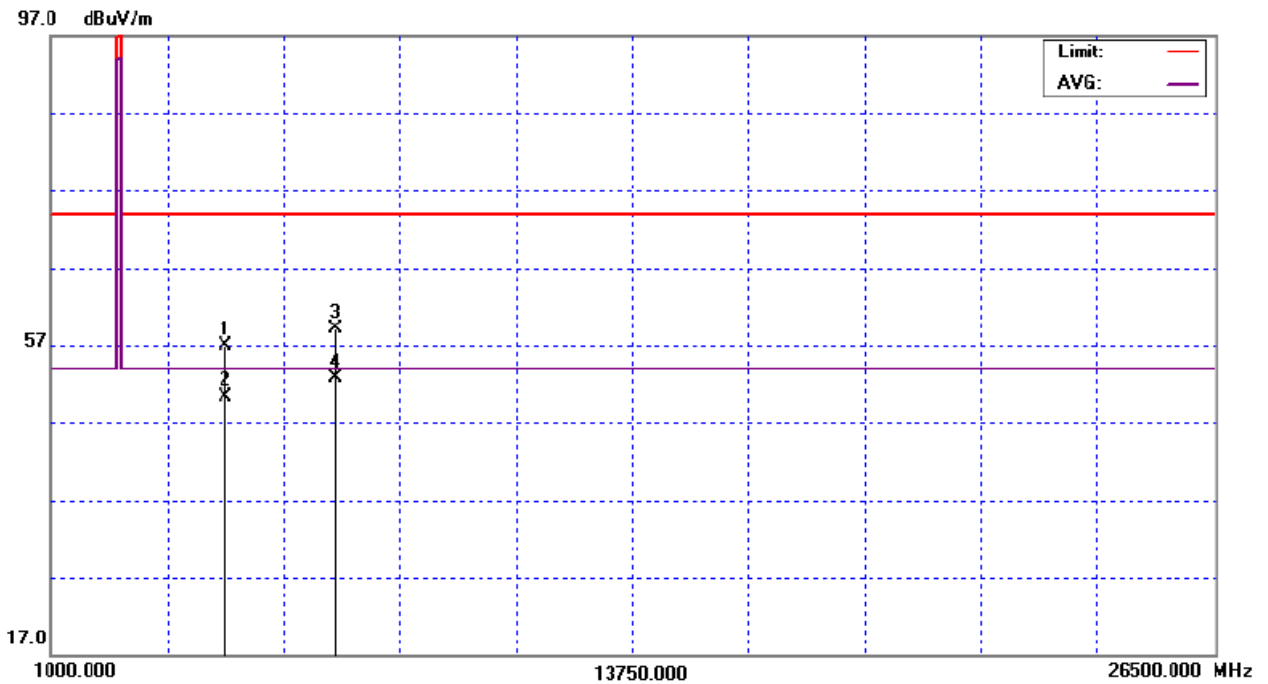
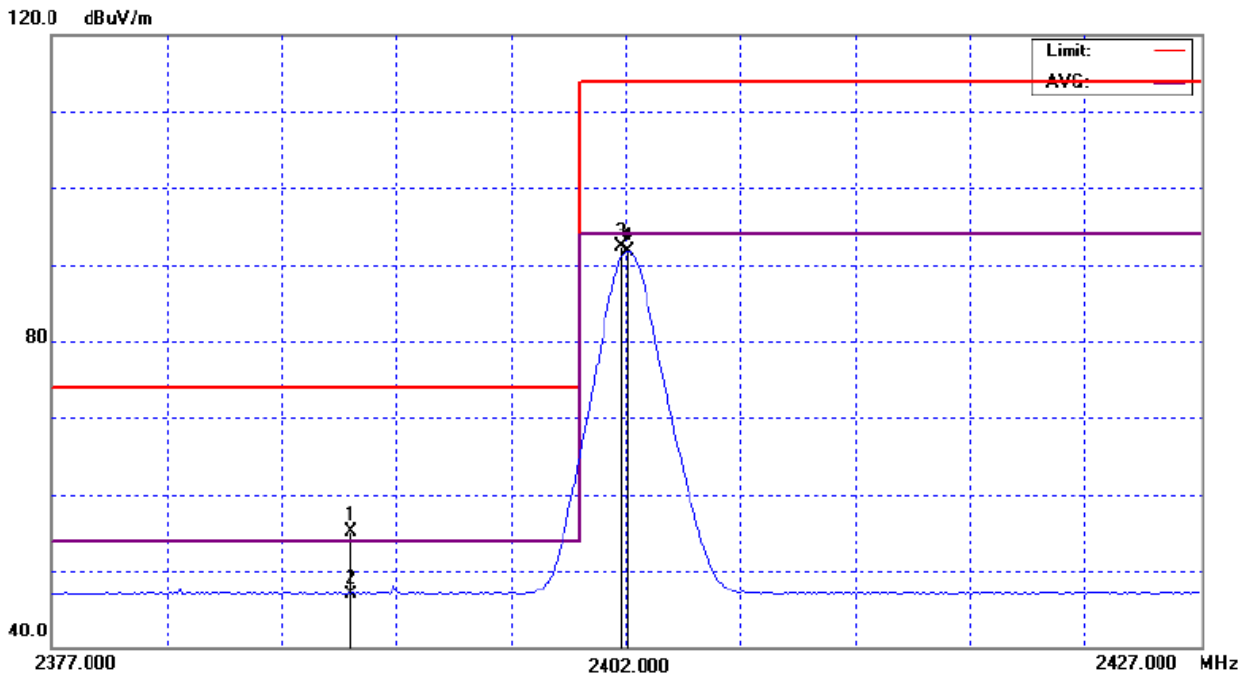

EUT :	WIRELESS OPTICAL LIPSTICK MOUSE	Model No. :	MS-71X4 (X=1~9)
Temperature :	33.6 °C	Relative Humidity :	69 %
Pressure :	1001 hPa	Test Power :	DC 3.7V
Test Mode :	CH04		

Freq. (MHz)	Ant.Pol. H/V	Reading		Ant./CF CF(dB)	Act.		Limit		Note
		Peak (dBuV)	AV (dBuV)		Peak (dBuV/m)	AV (dBuV/m)	Peak (dBuV/m)	AV (dBuV/m)	
<b>2441.10</b>	<b>V</b>								<b>X/F</b>
4882.12	V	40.39	45.53	10.94	51.33	56.47	74.00	54.00	X/E
7323.44	V	39.55	31.47	19.30	58.85	50.77	74.00	54.00	X/H

Remark :

- (1) All readings are Peak unless otherwise stated QP in column of 『Note』 . Peak denotes that the Peak reading compliance with the QP Limits and then QP Mode measurement didn't perform ◦
- (2) Measuring frequency range from 30MHz to 1000MHz or the 10th harmonic of highest fundamental frequency ◦ "F" denotes fundamental frequency; "H" denotes spurious frequency. "E" denotes band edge frequency. (This judgment method includes the Band Edge Requirement.)
- (3) Radiated emissions measured in frequency range above 1000MHz were made with an instrument using Peak detector mode and AV detector mode of the emission ◦
- (4) Data of measurement within this frequency range shown " \* " in the table above means the reading of emissions are attenuated more than 20dB below the permissible limits or the field strength is too small to be measured.
- (5) A preamp and high pass filter were used for this test in order to provide sufficient measurement sensitivity.
- (6) EUT Orthogonal Axes :  
 "X" - denotes Laid on Table ; "Y" - denotes Vertical Stand ; "Z" - denotes Side Stand

Orthogonal Axes : X  
CH04 (Above 1000 MHz, Vertical)

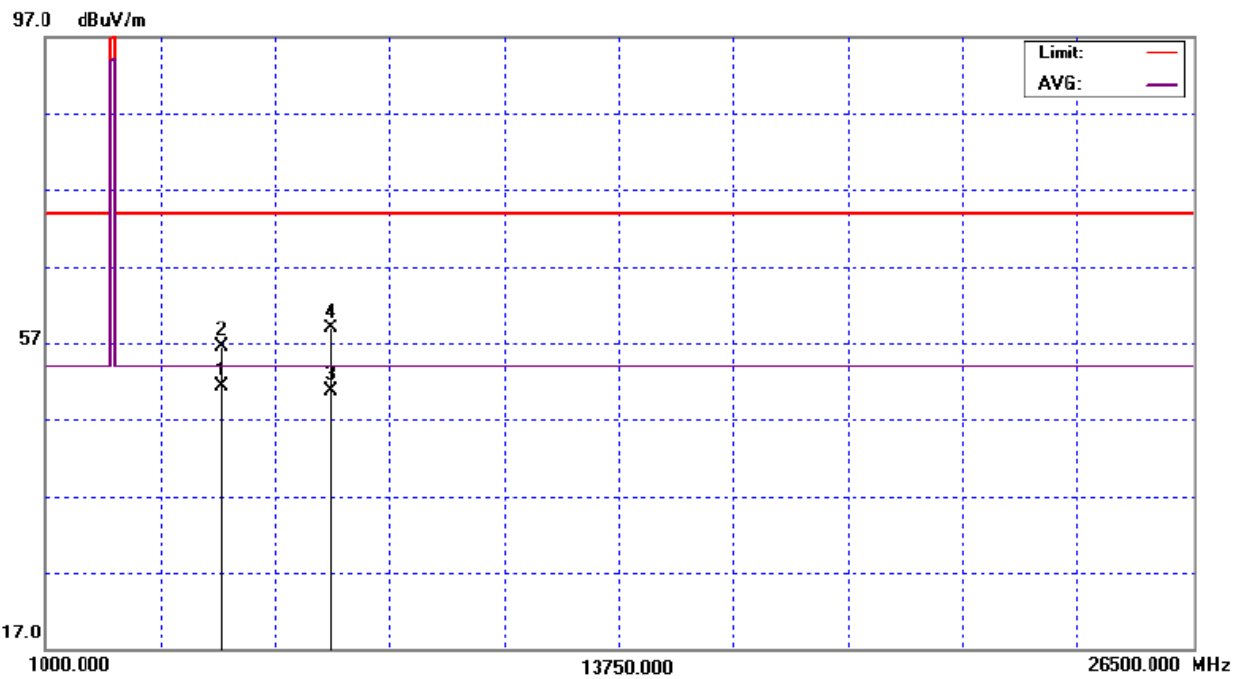
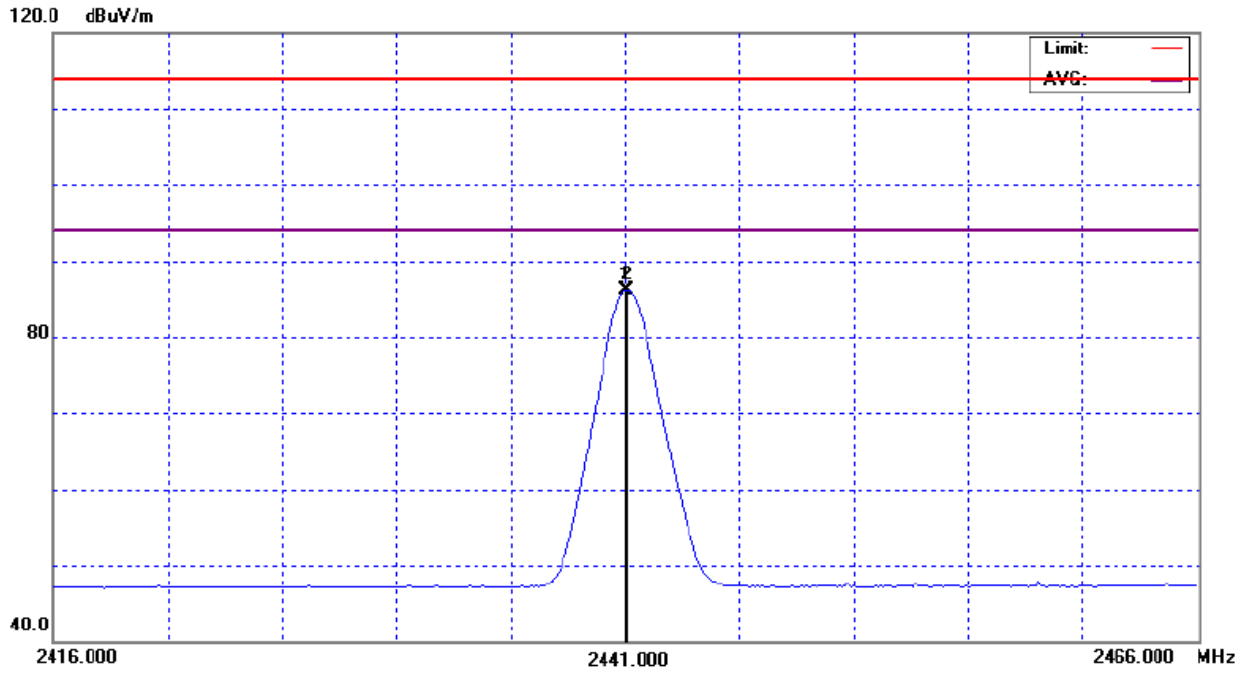

EUT :	WIRELESS OPTICAL LIPSTICK MOUSE	Model No. :	MS-71X4 (X=1~9)
Temperature :	33.6 °C	Relative Humidity :	69 %
Pressure :	1001 hPa	Test Power :	DC 3.7V
Test Mode :	CH04		

Freq. (MHz)	Ant.Pol. H/V	Reading		Ant./CF CF(dB)	Act.		Limit		Note
		Peak (dBuV)	AV (dBuV)		Peak (dBuV/m)	AV (dBuV/m)	Peak (dBuV/m)	AV (dBuV/m)	
<b>2441.10</b>	<b>H</b>								<b>X/F</b>
4882.30	H	47.38	41.69	10.94	58.32	52.63	74.00	54.00	X/H
7323.32	H	39.92	31.58	19.30	52.90	48.29	74.00	54.00	X/H

Remark :

- (1) All readings are Peak unless otherwise stated QP in column of 『Note』 . Peak denotes that the Peak reading compliance with the QP Limits and then QP Mode measurement didn't perform ◦
- (2) Measuring frequency range from 30MHz to 1000MHz or the 10th harmonic of highest fundamental frequency ◦ "F" denotes fundamental frequency; "H" denotes spurious frequency. "E" denotes band edge frequency. (This judgment method includes the Band Edge Requirement.)
- (3) Radiated emissions measured in frequency range above 1000MHz were made with an instrument using Peak detector mode and AV detector mode of the emission ◦
- (4) Data of measurement within this frequency range shown " \* " in the table above means the reading of emissions are attenuated more than 20dB below the permissible limits or the field strength is too small to be measured.
- (5) A preamp and high pass filter were used for this test in order to provide sufficient measurement sensitivity.
- (6) EUT Orthogonal Axes :  
"X" - denotes Laid on Table ; "Y" - denotes Vertical Stand ; "Z" - denotes Side Stand

Orthogonal Axes : X  
CH04 (Above 1000 MHz, Horizontal)

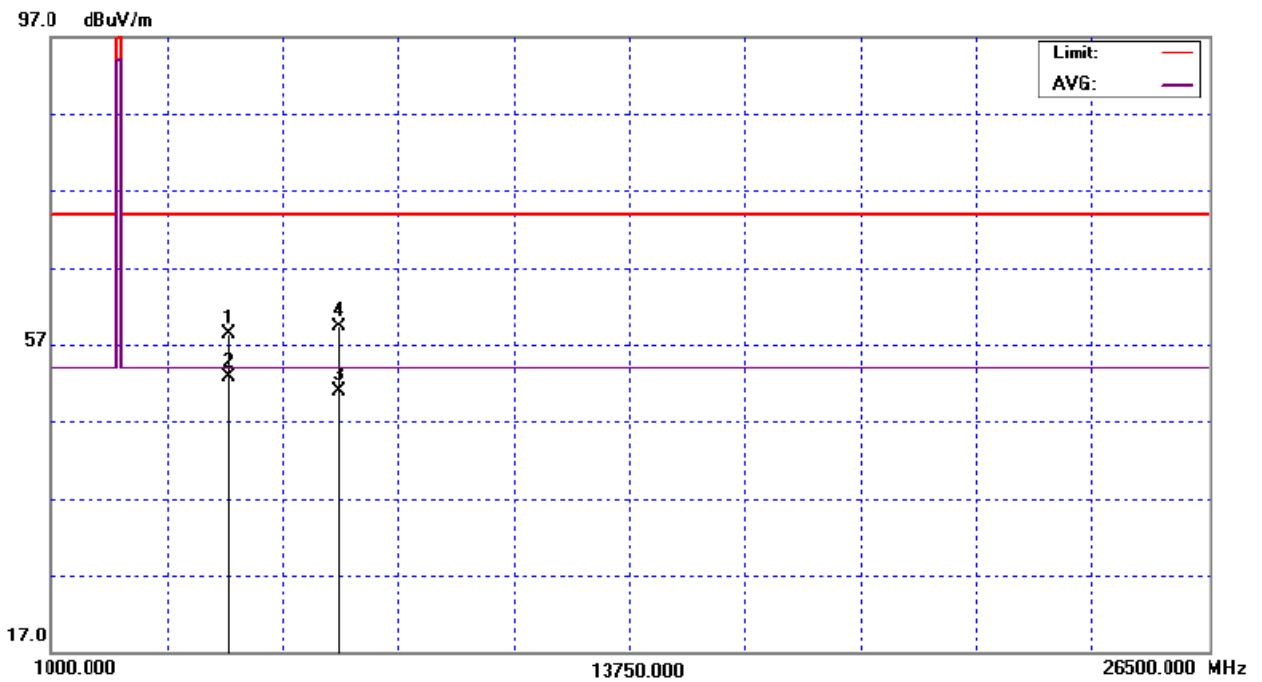
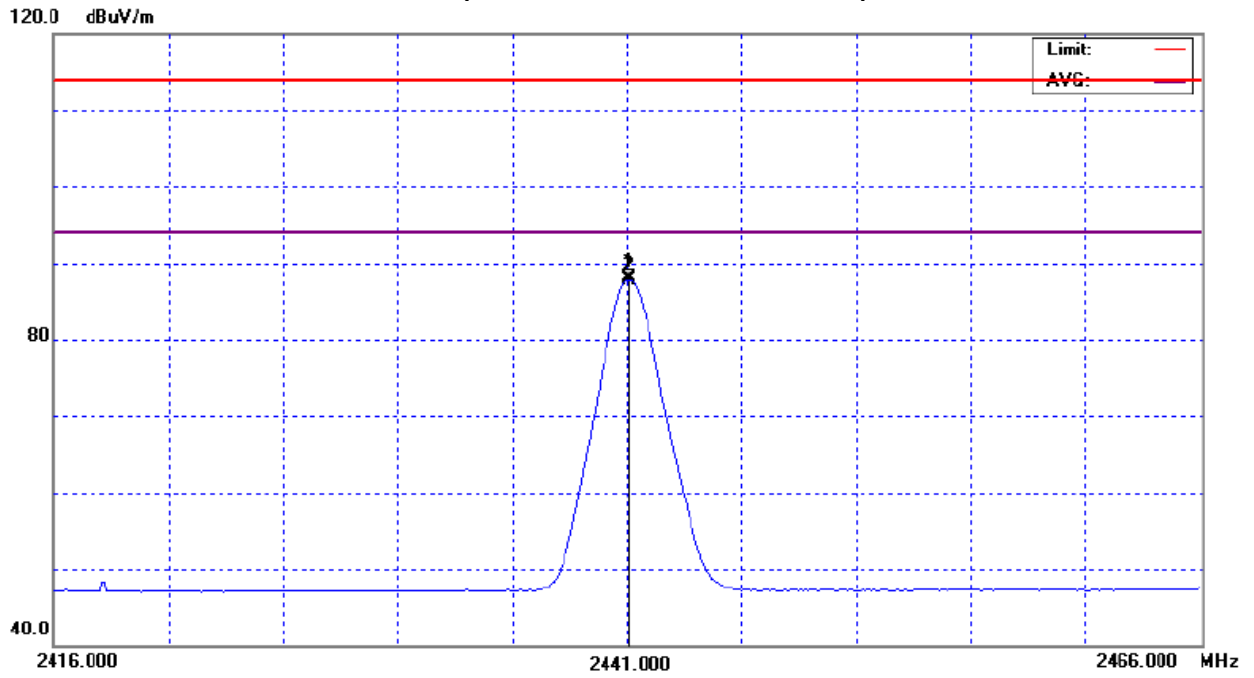

EUT :	WIRELESS OPTICAL LIPSTICK MOUSE	Model No. :	MS-71X4 (X=1~9)
Temperature :	33.6 °C	Relative Humidity :	69 %
Pressure :	1001 hPa	Test Power :	DC 3.7V
Test Mode :	CH06		

Freq. (MHz)	Ant.Pol. H/V	Reading		Ant./CF CF(dB)	Act.		Limit		Note
		Peak (dBuV)	AV (dBuV)		Peak (dBuV/m)	AV (dBuV/m)	Peak (dBuV/m)	AV (dBuV/m)	
<b>2470.10</b>	<b>V</b>								<b>X/F</b>
2483.50	V	22.56	13.27	34.07	56.63	47.34	74.00	54.00	X/E
4940.06	V	47.61	41.87	11.02	58.63	52.89	74.00	54.00	X/H
7409.94	V	38.29	31.88	19.25	57.54	51.13	74.00	54.00	X/H

Remark :

- (1) All readings are Peak unless otherwise stated QP in column of 『Note』 . Peak denotes that the Peak reading compliance with the QP Limits and then QP Mode measurement didn't perform ◦
- (2) Measuring frequency range from 30MHz to 1000MHz or the 10th harmonic of highest fundamental frequency ◦ "F" denotes fundamental frequency; "H" denotes spurious frequency. "E" denotes band edge frequency. (This judgment method includes the Band Edge Requirement.)
- (3) Radiated emissions measured in frequency range above 1000MHz were made with an instrument using Peak detector mode and AV detector mode of the emission ◦
- (4) Data of measurement within this frequency range shown " \* " in the table above means the reading of emissions are attenuated more than 20dB below the permissible limits or the field strength is too small to be measured.
- (5) A preamp and high pass filter were used for this test in order to provide sufficient measurement sensitivity.
- (6) EUT Orthogonal Axes :  
 "X" - denotes Laid on Table ; "Y" - denotes Vertical Stand ; "Z" - denotes Side Stand



Orthogonal Axes : X  
CH06 (Above 1000 MHz, Vertical)

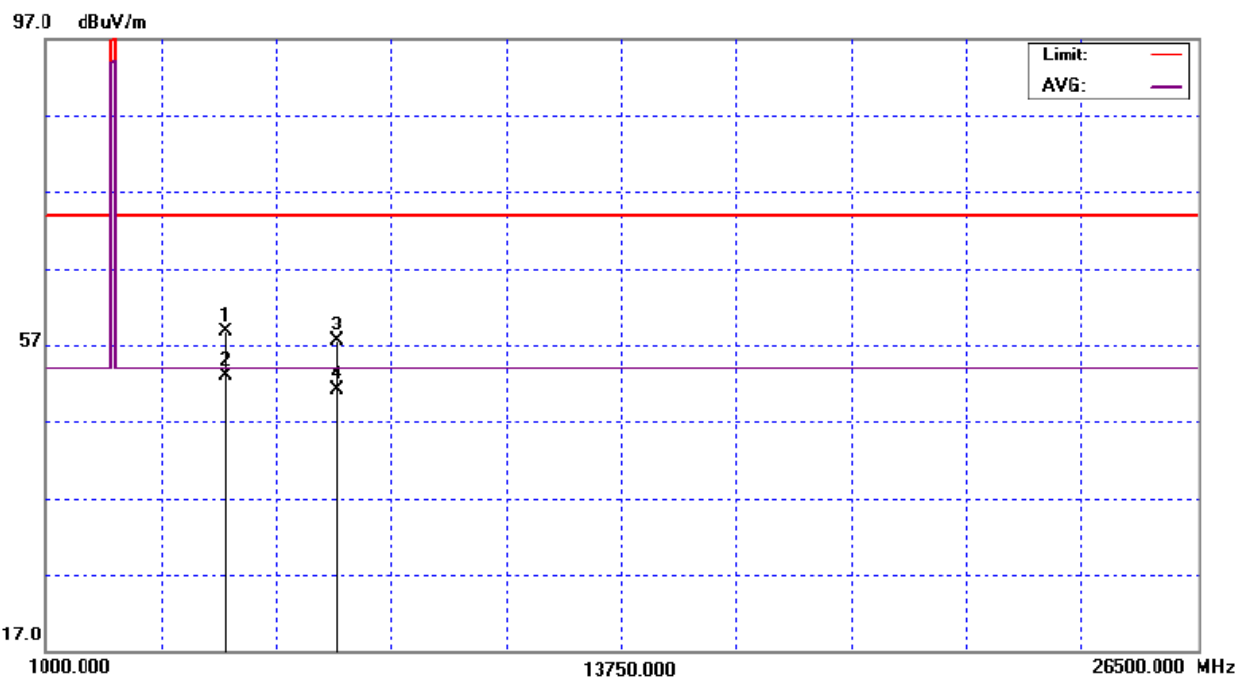
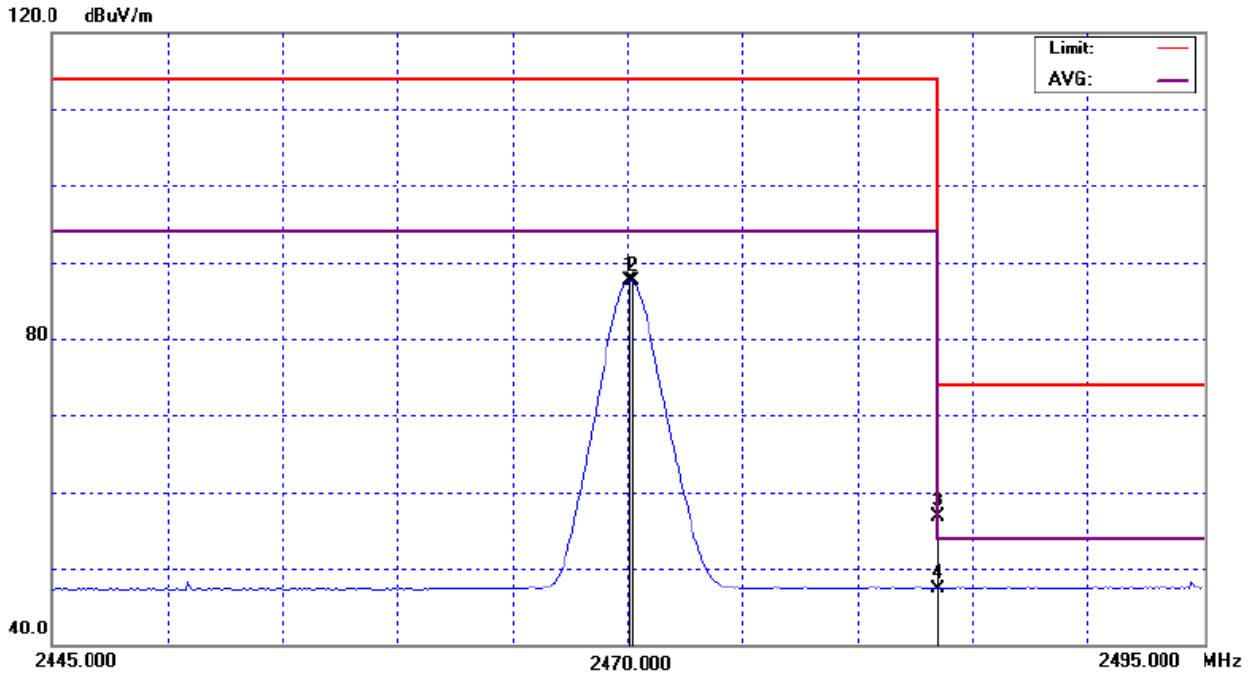

EUT :	WIRELESS OPTICAL LIPSTICK MOUSE	Model No. :	MS-71X4 (X=1~9)
Temperature :	33.6 °C	Relative Humidity :	69 %
Pressure :	1001 hPa	Test Power :	DC 3.7V
Test Mode :	CH06		

Freq. (MHz)	Ant.Pol. H/V	Reading		Ant./CF CF(dB)	Act.		Limit		Note
		Peak (dBuV)	AV (dBuV)		Peak (dBuV/m)	AV (dBuV/m)	Peak (dBuV/m)	AV (dBuV/m)	
<b>2470.10</b>	<b>H</b>								<b>X/F</b>
2483.50	H	23.37	13.24	34.07	57.44	47.31	74.00	54.00	X/E
4940.50	H	47.68	41.83	11.02	58.70	52.85	74.00	54.00	X/H
7410.46	H	39.58	31.86	19.25	58.83	51.11	74.00	54.00	X/H

Remark :

- (1) All readings are Peak unless otherwise stated QP in column of 『Note』 . Peak denotes that the Peak reading compliance with the QP Limits and then QP Mode measurement didn't perform ◦
- (2) Measuring frequency range from 30MHz to 1000MHz or the 10th harmonic of highest fundamental frequency ◦ "F" denotes fundamental frequency; "H" denotes spurious frequency. "E" denotes band edge frequency. (This judgment method includes the Band Edge Requirement.)
- (3) Radiated emissions measured in frequency range above 1000MHz were made with an instrument using Peak detector mode and AV detector mode of the emission ◦
- (4) Data of measurement within this frequency range shown " \* " in the table above means the reading of emissions are attenuated more than 20dB below the permissible limits or the field strength is too small to be measured.
- (5) A preamp and high pass filter were used for this test in order to provide sufficient measurement sensitivity.
- (6) EUT Orthogonal Axes :  
 "X" - denotes Laid on Table ; "Y" - denotes Vertical Stand ; "Z" - denotes Side Stand

**Orthogonal Axes : X  
CH06 (Above 1000 MHz, Horizontal)**

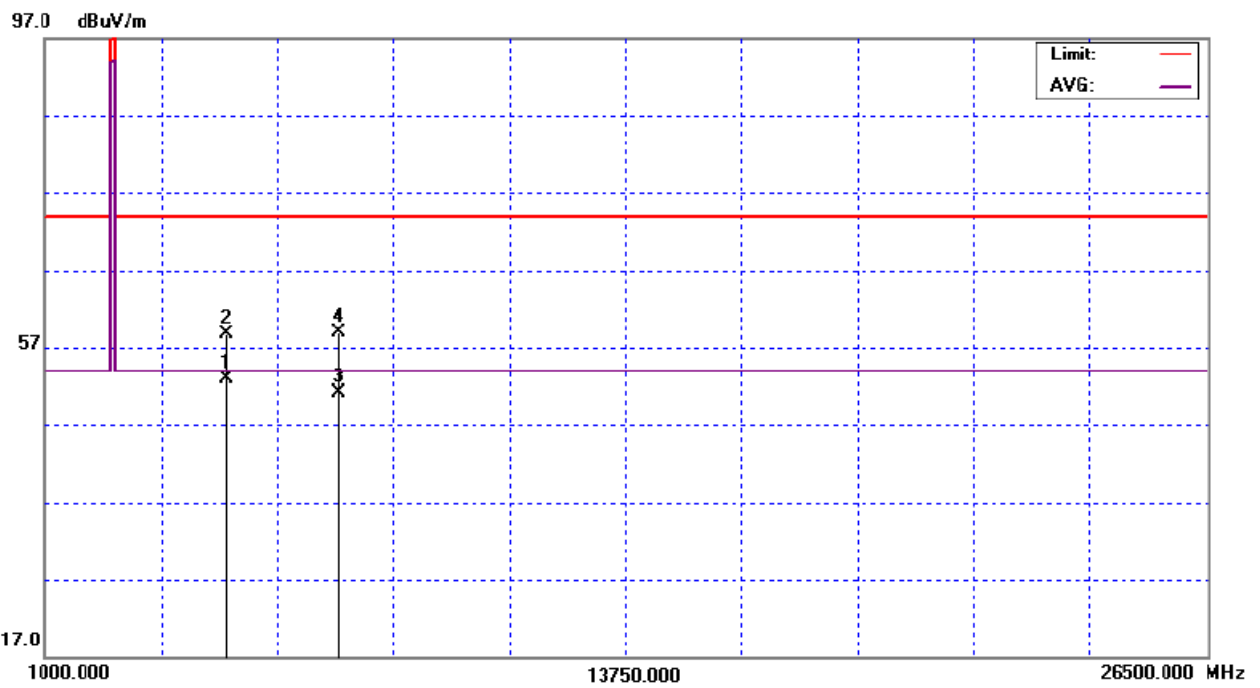
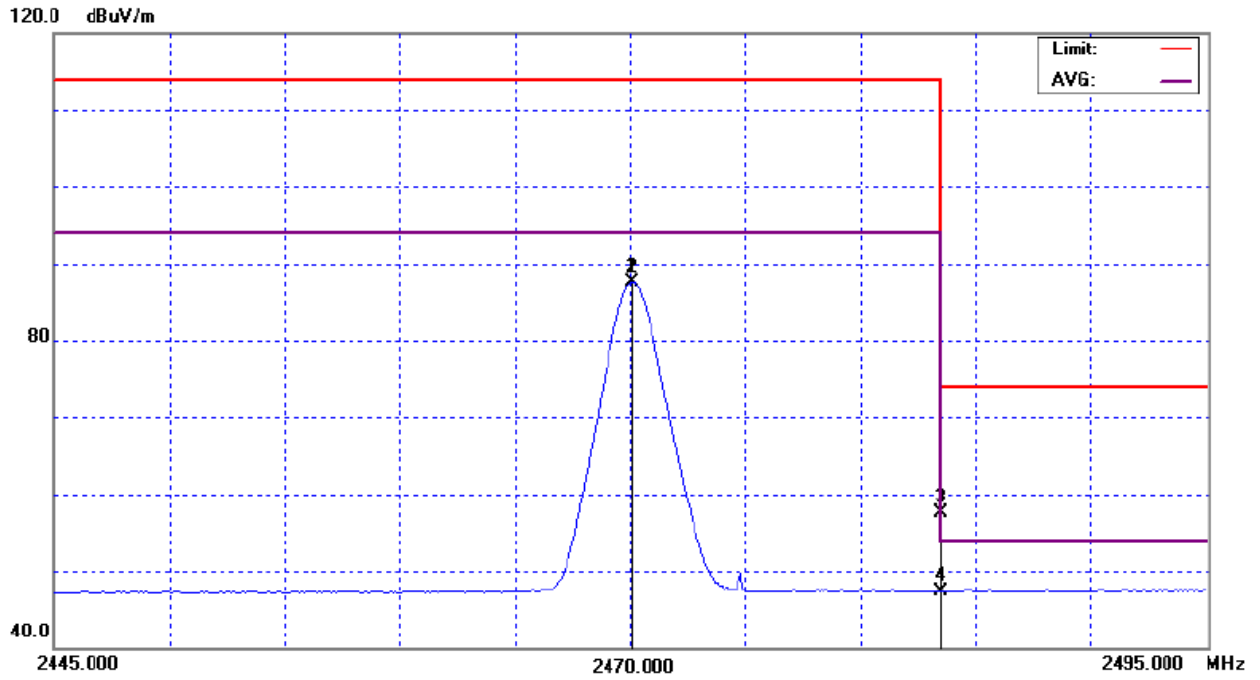

**4.2.9 TEST RESULTS (2400 – 2483.5 MHz)**

EUT :	WIRELESS OPTICAL LIPSTICK MOUSE	Model No. :	MS-71X4 (X=1~9)
Temperature :	33.6 °C	Relative Humidity :	69 %
Pressure :	1009 hPa	Test Power :	DC 3.7V
Test Mode :	TX CH 2402MHz/2441MHz/2470MHz		

Freq. (MHz)	Ant.Pol. (H/V)	Peak	AV	Ant./CL/ CF(dB)	Peak	AV	Peak	AV	NOTE
		Reading (dBuV) (dBuV)			Actual FS (dBuV/m) (dBuV/m)		Limit3m (dBuV/m) (dBuV/m)		
2402.20	V	50.81	51.32	33.62	84.43	84.94	114.00	94.00	CH01
2402.20	H	58.59	58.09	33.62	92.21	91.71	114.00	94.00	CH01
2441.10	V	52.31	52.27	33.83	86.14	86.10	114.00	94.00	CH04
2441.10	H	54.32	53.93	33.83	88.15	87.76	114.00	94.00	CH04
2470.10	V	53.47	53.41	33.99	87.46	87.40	114.00	94.00	CH06
2470.10	H	53.45	53.40	33.99	87.44	87.39	114.00	94.00	CH06

Remark :

- (1) All readings are Peak unless otherwise stated QP in column of 『Note』 . Peak denotes that the Peak reading compliance with the QP Limits and then QP Mode measurement didn't perform ◦
- (2) Radiated emissions measured in frequency range above 1000MHz were made with an instrument using Peak detector mode and AV detector mode of the emission ◦
- (3) Data of measurement within this frequency range shown “ \* ” in the table above means the reading of emissions are attenuated more than 20dB below the permissible limits or the field strength is too small to be measured.
- (4) EUT Orthogonal Axes :  
 “X” - denotes Laid on Table ; “Y” - denotes Vertical Stand ; “Z” - denotes Side Stand

**4.2.10 TEST RESULTS (Restricted Bands Requirements)**

EUT :	WIRELESS OPTICAL LIPSTICK MOUSE	Model No. :	MS-71X4 (X=1~9)
Temperature :	33.6 °C	Relative Humidity :	69 %
Pressure :	1009 hPa	Test Power :	DC 3.7V
Test Mode :	TX CH 2402MHz/2470MHz(Vertical)		
Note :	<p>The emission of the carrier radiated field strength is measured for (Peak and AV) as following:</p> <ol style="list-style-type: none"> <li>1. The transmitter was then configured with the worst case antenna and setup to transmit at the lowest channel (CH01). Then the field strength was measured at 2310-2390 MHz.</li> <li>2. The transmitter was configured with the worst case antenna and setup to transmit at the highest channel (CH06). Then the field strength was measured at 2483.5-2500 MHz.</li> </ol>		

Freq. (MHz)	Ant.Pol. H/V	Reading		Ant./CF CF(dB)	Act.		Limit		Note
		Peak (dBuV)	AV (dBuV)		Peak (dBuV/m)	AV (dBuV/m)	Peak (dBuV/m)	AV (dBuV/m)	
2390.00	V	21.33	13.14	33.55	54.88	46.69	74.00	54.00	CH01
2483.50	V	22.56	13.27	34.07	56.63	47.34	74.00	54.00	CH06

Remark :

- (1) Radiated emissions measured in frequency range above 1000MHz were made with an instrument using Peak detector mode and AV detector mode of the emission ◦
- (2) EUT Orthogonal Axes :  
 "X" - denotes Laid on Table ; "Y" - denotes Vertical Stand ; "Z" - denotes Side Stand

**TX CH01/06 (Restricted Bands Requirements, Vertical)**

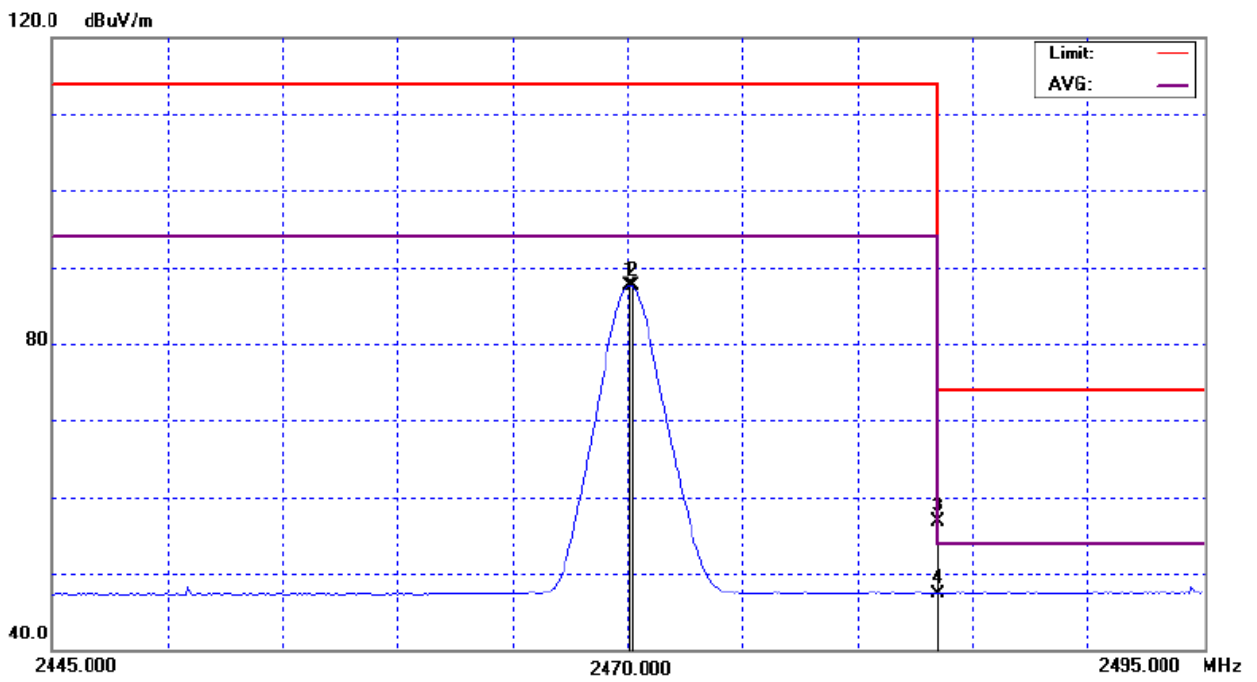
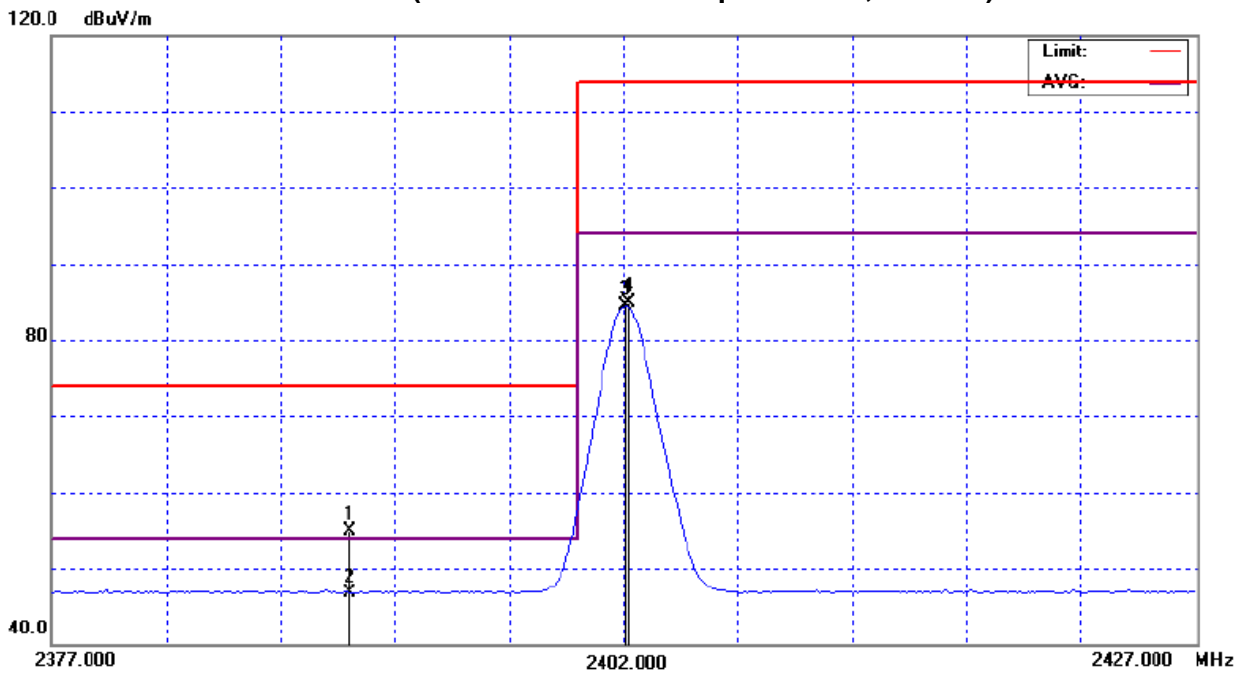

EUT :	WIRELESS OPTICAL LIPSTICK MOUSE	Model No. :	MS-71X4 (X=1~9)
Temperature :	33.6 °C	Relative Humidity :	69 %
Pressure :	1009 hPa	Test Power :	DC 3.7V
Test Mode :	TX CH 2402MHz/2470MHz (Horizontal)		
Note :	<p>The emission of the carrier radiated field strength is measured for (Peak and AV) as following:</p> <ol style="list-style-type: none"> <li>1. The transmitter was then configured with the worst case antenna and setup to transmit at the lowest channel (CH01). Then the field strength was measured at 2310-2390 MHz.</li> <li>2. The transmitter was configured with the worst case antenna and setup to transmit at the highest channel (CH06). Then the field strength was measured at 2483.5-2500 MHz.</li> </ol>		

Freq. (MHz)	Ant.Pol. H/V	Reading		Ant./CF CF(dB)	Act.		Limit		Note
		Peak (dBuV)	AV (dBuV)		Peak (dBuV/m)	AV (dBuV/m)	Peak (dBuV/m)	AV (dBuV/m)	
2390.00	H	21.64	13.45	33.62	55.26	47.07	74.00	54.00	CH01
2483.50	H	23.37	13.24	34.07	57.44	47.31	74.00	54.00	CH06

**Remark :**

- (1) Radiated emissions measured in frequency range above 1000MHz were made with an instrument using Peak detector mode and AV detector mode of the emission ◦
- (2) EUT Orthogonal Axes :  
 "X" - denotes Laid on Table ; "Y" - denotes Vertical Stand ; "Z" - denotes Side Stand

TX CH01 (Restricted Bands Requirements, Horizontal)

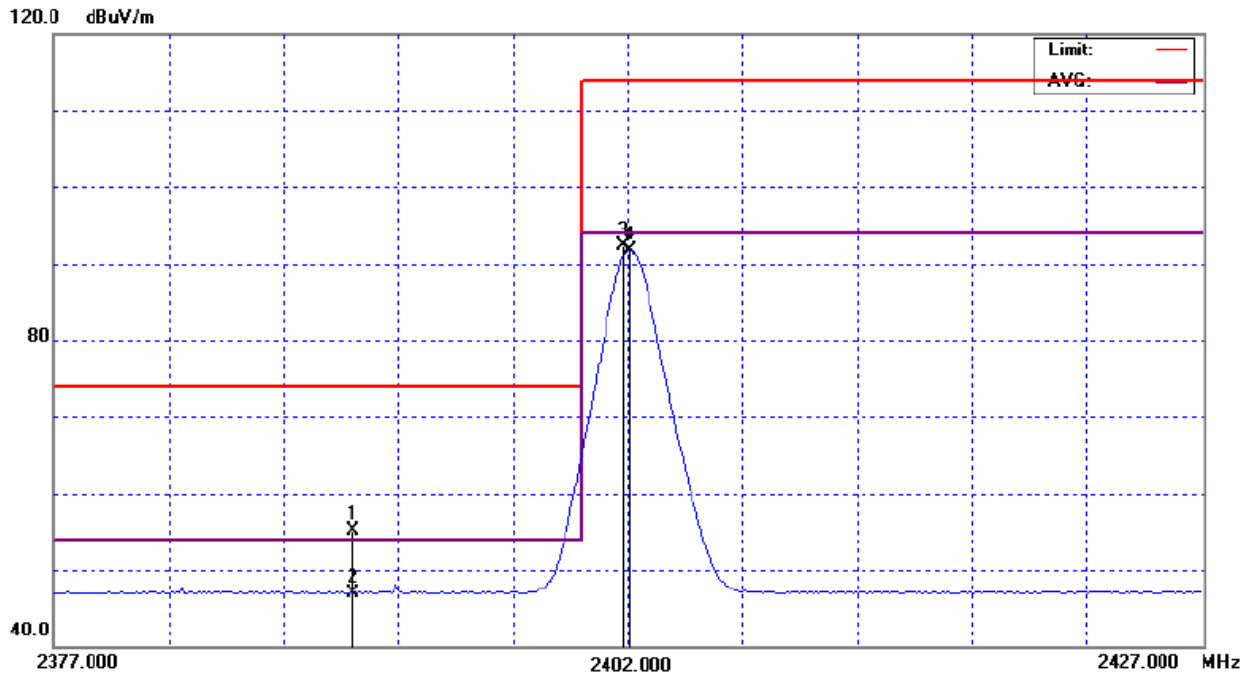

TX CH06 (Restricted Bands Requirements, Horizontal)

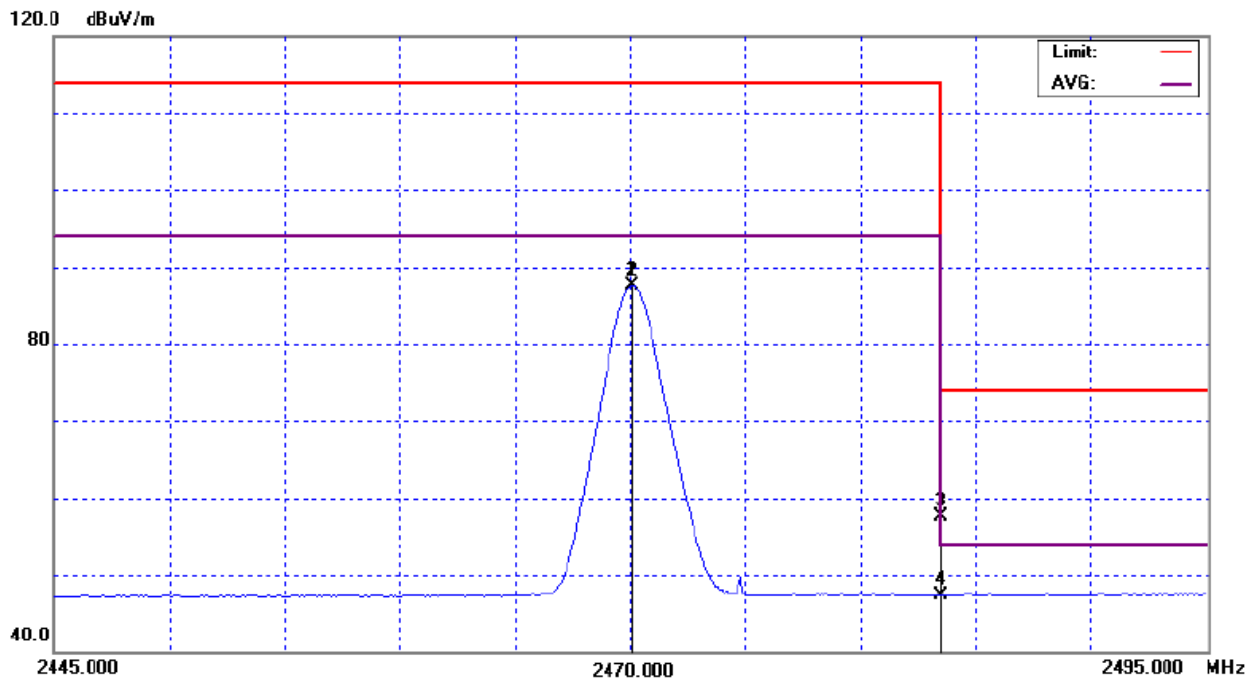



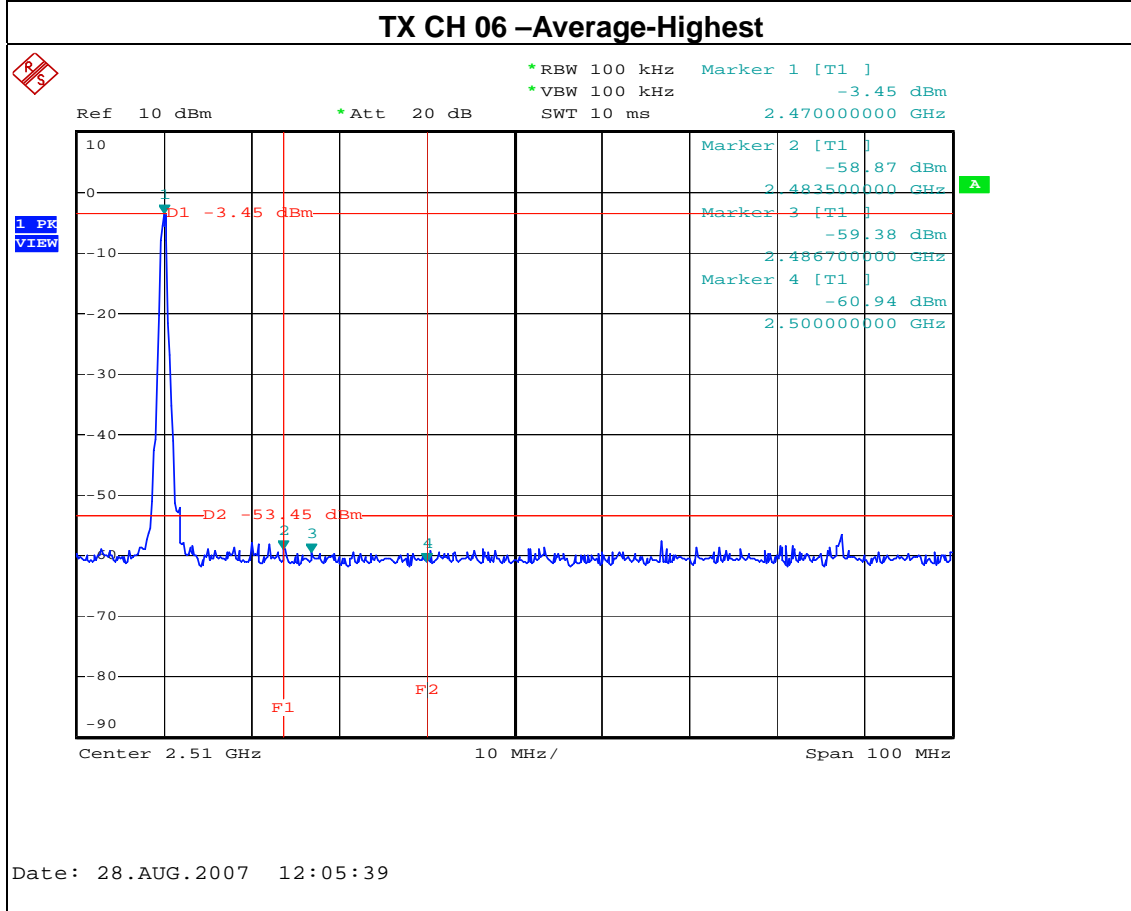
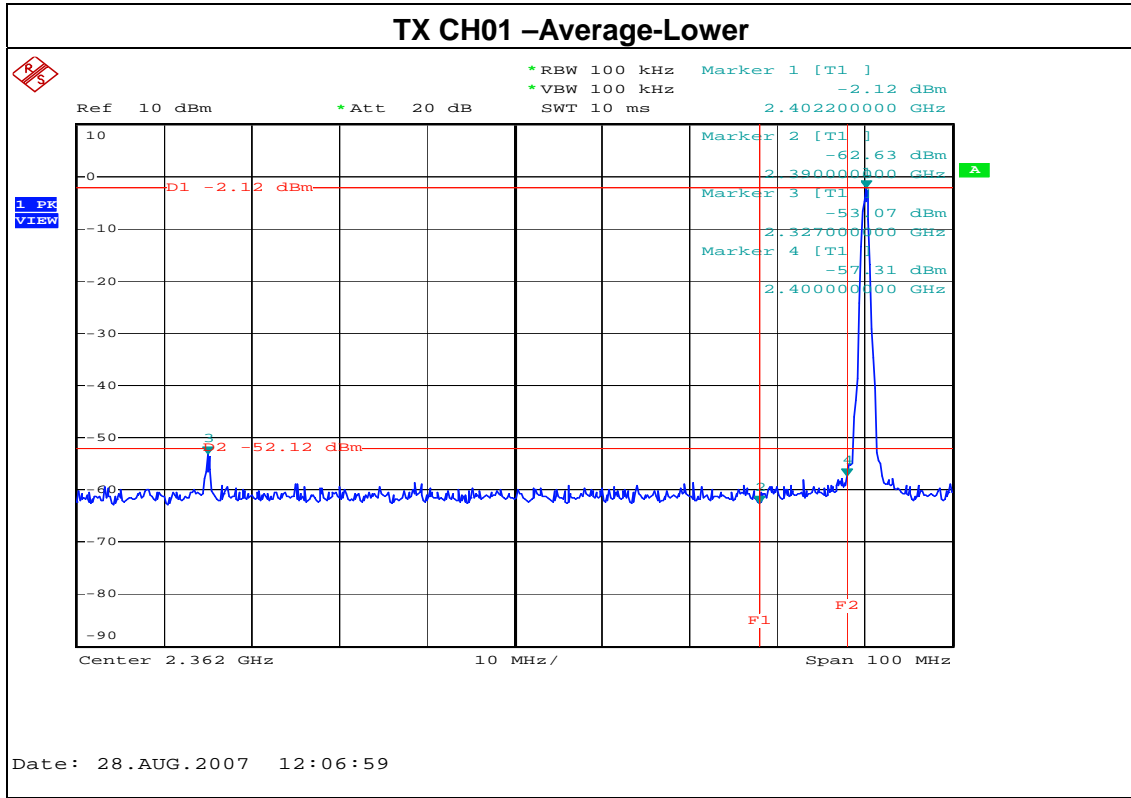

**5. EUT TEST PHOTO**

**Conducted Measurement Photos**



**Radiated Measurement Photos (TX)**

