

SAR Test Report

Product Name : Notebook P.C.

Model No. : Z61A,Z61Ae

Applicant : ASUSTeK COMPUTER INC.

Address : 4FL., No. 150, Li-Te Rd., Peitou, Taipei,
Taiwan, R.O.C.

Date of Receipt : 2005/06/21

Issued Date : 2005/07/13

Report No. : 056L132SF

The test results relate only to the samples tested.

The test report shall not be reproduced except in full without the written approval of Quietek Corporation.

Test Report Certification

Issued Date: 2005/07/13

Report No.:056L132SF



Product Name : Notebook P.C.
Applicant : ASUSTeK COMPUTER INC.
Address : 4FL., No. 150, Li-Te Rd., Peitou, Taipei, Taiwan, R.O.C.
Manufacturer : ASUSTeK COMPUTER INC.
Model No. : Z61A,Z61Ae
Applicable Standard : FCC Oet65 Supplement C June 2001

Test Result : Max. SAR Measurement (1g)
802.11b: 0.519 W/kg
802.11g: 0.302 W/kg

Application Type : Certification

The test results relate only to the samples tested.

The test report shall not be reproduced except in full without the written approval of Quietek Corporation.

Documented By : Rita Huang
(Rita Haung)

Tested By : Hsiu Ho
(Hsiu Ho)

Approved By : Gene Chang
(Gene Chang)

TABLE OF CONTENTS

Description	Page
1. General Information.....	5
1.1 EUT Description	5
1.2 Test Environment	5
2. SAR Measurement System	6
2.1 ALSAS-10U System Description	6
2.1.1 Applications	6
2.1.2 Area Scans.....	6
2.1.3 Zoom Scan (Cube Scan Averaging).....	7
2.1.4 ALSAS-10U Interpolation and Extrapolation Uncertainty.....	7
2.2 Isotropic E-Field Probe	7
2.2.1 Isotropic E-Field Probe Specification	9
2.3 Boundary Detection Unit and Probe Mounting Device	9
2.4 Daq-Paq (Analog to Digital Electronics).....	10
2.5 Axis Articulated Robot	10
2.6 ALSAS Universal Workstation.....	11
2.7 Universal Device Positioner.....	11
2.8 Phantom Types.....	11
2.8.1 APREL SAM Phantoms	12
2.8.2 APREL Laboratories Universal Phantom	12
3. Tissue Simulating Liquid	13
3.1 The composition of the tissue simulating liquid	13
3.2 Tissue Calibration Result	13
3.3 Tissue Dielectric Parameters for Head and Body Phantoms	14
4. SAR Measurement Procedure	15
4.1 SAR System Validation.....	15
4.1.1 Validation Dipoles.....	15
4.1.2 Validation Result	15
4.2 SAR Measurement Procedure	16
5. SAR Exposure Limits	17
6. Test Equipment List.....	18
7. Measurement Uncertainty	19
8. Test Results	20
8.1 SAR Test Results Summary	20
Appendix A. SAR System Validation Data.....	22
Appendix B. SAR measurement Data.....	22

Appendix C. Test Setup Photographs & EUT Photographs..... 22
Appendix D. Probe Calibration Data 22
Appendix E. Dipole Calibration Data 22

1. General Information

1.1 EUT Description

Product Name	Notebook P.C.
Model No.	Z61A,Z61Ae
Transmitter module	WM3B2200BG
FCC ID	MSQB2200BG
TX Frequency	2412MHz ~2462MHz
Type of Modulation	DSSS,OFDM
Antenna Type	Internal
Device Category	Portable
RF Exposure Environment	Uncontrolled
Transfer Rate	802.11b: 11Mbps 802.11g: 54Mbps
Max. Output Power (Conducted)	802.11b: 16.44dBm 802.11g: 14.31dBm

1.2 Test Environment

Ambient conditions in the laboratory (2005/07/08):

Items	Required	Actual
Temperature (°C)	18-25	23.4
Humidity (%RH)	30-70	52

2. SAR Measurement System

2.1 ALSAS-10U System Description

ALSAS-10-U is fully compliant with the technical and scientific requirements of IEEE 1528, IEC 62209, CENELEC, ARIB, ACA, and the Federal Communications Commission. The system comprises of a six axes articulated robot which utilizes a dedicated controller.

ALSAS-10U uses the latest methodologies and FDTD modeling to provide a platform which is repeatable with minimum uncertainty.

2.1.1 Applications

Predefined measurement procedures compliant with the guidelines of CENELEC, IEEE, IEC, FCC, etc are utilized during the assessment for the device. Automatic detection for all SAR maxima are embedded within the core architecture for the system, ensuring that peak locations used for centering the zoom scan are within a 1mm resolution and a 0.05mm repeatable position. System operation range currently available up-to 6 GHz in simulated tissue.

2.1.2 Area Scans

Area scans are defined prior to the measurement process being executed with a user defined variable spacing between each measurement point (integral) allowing low uncertainty measurements to be conducted. Scans defined for FCC applications utilize a 10mm² step integral, with 1mm interpolation used to locate the peak SAR area used for zoom scan assessments.

Where the system identifies multiple SAR peaks (which are within 25% of peak value) the system will provide the user with the option of assessing each peak location individually for zoom scan averaging.



2.1.3 Zoom Scan (Cube Scan Averaging)

The averaging zoom scan volume utilized in the ALSAS-10U software is in the shape of a cube and the side dimension of a 1 g or 10 g mass is dependent on the density of the liquid representing the simulated tissue. A density of 1000 kg/m³ is used to represent the head and body tissue density and not the phantom liquid density, in order to be consistent with the definition of the liquid dielectric properties, i.e. the side length of the 1 g cube is 10mm, with the side length of the 10 g cube 21,5mm.

When the cube intersects with the surface of the phantom, it is oriented so that 3 vertices touch the surface of the shell or the center of a face is tangent to the surface. The face of the cube closest to the surface is modified in order to conform to the tangent surface.

The zoom scan integer steps can be user defined so as to reduce uncertainty, but normal practice for typical test applications (including FCC) utilize a physical step of 5x5x8 (8mmx8mmx5mm) providing a volume of 32mm in the X & Y axis, and 35mm in the Z axis.

2.1.4 ALSAS-10U Interpolation and Extrapolation Uncertainty

The overall uncertainty for the methodology and algorithms the used during the SAR calculation was evaluated using the data from IEEE 1528 based on the example f3 algorithm:

$$f_3(x, y, z) = A \frac{a^2}{\frac{a^2}{4} + x'^2 + y'^2} \cdot \left(e^{-\frac{2z}{a}} + \frac{a^2}{2(a + 2z)^2} \right)$$

2.2 Isotropic E-Field Probe

The isotropic E-Field probe has been fully calibrated and assessed for isotropicity, and boundary effect within a controlled environment. Depending on the frequency for which the probe is calibrated the method utilized for calibration will change. A number of methods is used for calibrating probes, and these are outlined in the table below:

Calibration Frequency	Air Calibration	Tissue Calibration
2450MHz	Waveguide	Temperature

The E-Field probe utilizes a triangular sensor arrangement as detailed in the diagram below:

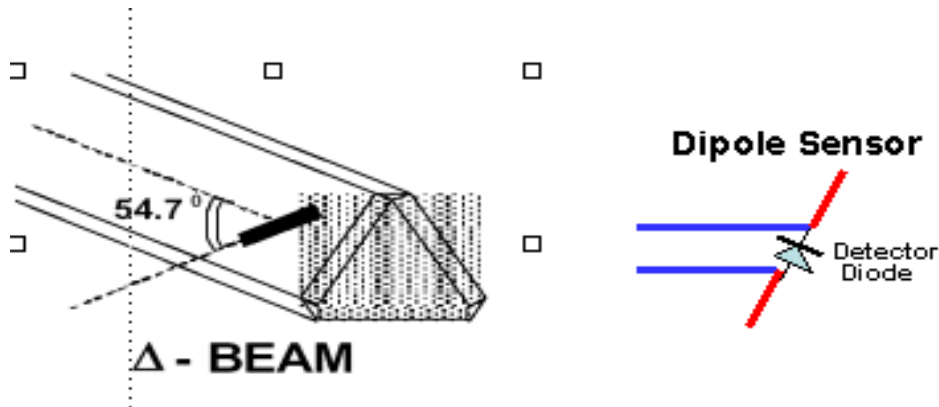

SAR is assessed with a calibrated probe which moves at a default height of 5mm from the center of the diode, which is mounted to the sensor, to the phantom surface (in the Z Axis). The 5mm offset height has been selected so as to minimize any resultant boundary effect due to the probe being in close proximity to the phantom surface.

The following algorithm is an example of the function used by the system for linearization of the output from the probe when measuring complex modulation schemes.

$$V_i = U_i + U_i^2 \cdot \frac{cf}{dcp_i}$$

2.2.1 Isotropic E-Field Probe Specification

Calibration in Air	Frequency Dependent Below 2GHz Calibration in air performed in a TEM Cell Above 2GHz Calibration in air performed in waveguide
Sensitivity	0.70 $\mu\text{V}/(\text{V}/\text{m})^2$ to 0.85 $\mu\text{V}/(\text{V}/\text{m})^2$
Dynamic Range	0.0005 W/kg to 100W/kg
Isotropic Response	Better than 0.2dB
Diode Compression point (DCP)	Calibration for Specific Frequency
Probe Tip Radius	< 5mm
Sensor Offset	1.56 (+/- 0.02mm)
Probe Length	290mm
Video Bandwidth	@ 500 Hz: 1dB @1.02 KHz: 3dB
Boundary Effect	Less than 2% for distance greater than 2.4mm
Spatial Resolution	Diameter less than 5mm Compliant with Standards

2.3 Boundary Detection Unit and Probe Mounting Device

ALSAS-10U incorporates a boundary detection unit with a sensitivity of 0.05mm for detecting all types of surfaces. The robust design allows for detection during probe tilt (probe normalize) exercises, and utilizes a second stage emergency stop. The signal electronics are fed directly into the robot controller for high accuracy surface detection in lateral and axial detection modes (X, Y, & Z).

The probe is mounted directly onto the Boundary Detection unit for accurate tooling and displacement calculations controlled by the robot kinematics. The probe is connect to an isolated probe interconnect where the output stage of the probe is fed directly into the amplifier stage of the Daq-Paq

2.4 Daq-Paq (Analog to Digital Electronics)

ALSAS-10U incorporates a fully calibrated Daq-Paq (analog to digital conversion system) which has a 4 channel input stage, sent via a 2 stage auto-set amplifier module. The input signal is amplified accordingly so as to offer a dynamic range from 5µV to 800mV. Integration of the fields measured is carried out at board level utilizing a Co-Processor which then sends the measured fields down into the main computational module in digitized form via an RS232 communications port. Probe linearity and duty cycle compensation is carried out within the main Daq-Paq module.

ADC	12 Bit
Amplifier Range	20mV to 200mV and 150mV to 800mV
Field Integration	Local Co-Processor utilizing proprietary integration algorithms
Number of Input Channels	4 in total 3 dedicated and 1 spare
Communication	Packet data via RS232

2.5 Axis Articulated Robot



ALSAS-10U utilizes a six axis articulated robot, which is controlled using a Pentium based real-time movement controller. The movement kinematics engine utilizes proprietary (Thermo CRS) interpolation and extrapolation algorithms, which allow full freedom of movement for each of the six joints within the working envelope. Utilization of joint 6 allows for full probe rotation with a tolerance better than 0.05mm around the central axis.

Robot/Controller Manufacturer	Thermo CRS
Number of Axis	Six independently controlled axis
Positioning Repeatability	0.05mm
Controller Type	Single phase Pentium based C500C
Robot Reach	710mm
Communication	RS232 and LAN compatible

2.6 ALSAS Universal Workstation

ALSAS Universal workstation allows for repeatability and fast adaptability. It allows users to do calibration, testing and measurements using different types of phantoms with one set up, which significantly speeds up the measurement process.

2.7 Universal Device Positioner

The universal device positioner allow complete freedom of movement of the EUT. Developed to hold a EUT in a free-space scenario any additional loading attributable to the material used in the construction of the positioner has been eliminated. Repeatability has been enhanced through the linear scales which form the design used to indicate positioning for any given test scenario in all major axes. A 15° tilt indicator is included for the of aid cheek to tilt movements for head SAR analysis. Overall uncertainty for measurements have been reduced due to the design of the Universal device positioner, which allows positioning of a device in as near to a free-space scenario as possible, and by providing the means for complete repeatability.



2.8 Phantom Types

The ALSAS-10U allows the integration of multiple phantom types. SAM Phantoms fully compliant with IEEE 1528, Universal Phantom, and Universal Flat.

2.8.1 APREL SAM Phantoms

The SAM phantoms developed using the IEEE SAM CAD file. They are fully compliant with the requirements for both IEEE 1528 and FCC Supplement C. Both the left and right SAM phantoms are interchangeable, transparent and include the IEEE 1528 grid with visible NF and MB lines.

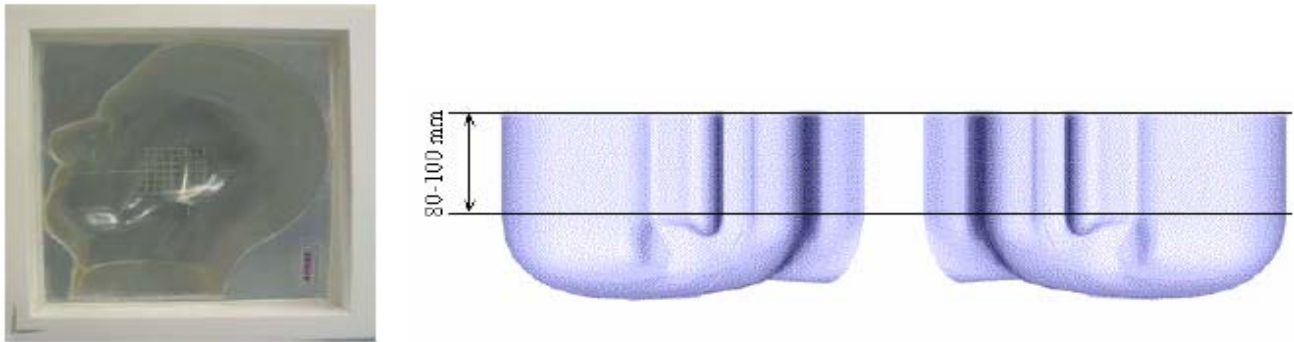

2.8.2 APREL Laboratories Universal Phantom

The Universal Phantom is used on the ALSAS-10U as a system validation phantom. The Universal Phantom has been fully validated both experimentally from 800MHz to 6GHz and numerically using XFDTD numerical software. The shell thickness is 2mm overall, with a 4mm spacer located at the NF/MB intersection providing an overall thickness of 6mm in line with the requirements of IEEE-1528.

The design allows for fast and accurate measurements, of handsets, by allowing the conservative SAR to be evaluated at on frequency for both left and right head experiments in one measurement.



3. Tissue Simulating Liquid

3.1 The composition of the tissue simulating liquid

INGREDIENT (% Weight)	2450MHz Head	2450MHz Body	-	-
Water	46.7	73.2	-	-
Salt	0.00	0.04	-	-
Sugar	0.00	0.00	-	-
HEC	0.00	0.00	-	-
Preventol	0.00	0.00	-	-
DGBE	53.3	26.7	-	-

3.2 Tissue Calibration Result

The dielectric parameters of the liquids were verified prior to the SAR evaluation using APREL Dielectric Probe Kit and Anritsu MS4623B Vector Network Analyzer

Head Tissue Simulant Measurement				
Frequency [MHz]	Description	Dielectric Parameters		Tissue Temp. [°C]
		ϵ_r	σ [s/m]	
2450MHz	Reference result ± 5% window	39.2 37.24 to 41.16	1.8 1.71 to 1.89	N/A
	11-Jul-05	38.9	1.82	22.9

Body Tissue Simulant Measurement				
Frequency [MHz]	Description	Dielectric Parameters		Tissue Temp. [°C]
		ϵ_r	σ [s/m]	
2450MHz	Reference result ± 5% window	52.7 50.065 to 55.335	1.95 1.8525 to 2.0475	N/A
	11-Jul-05	53.85	1.96	22.3
2412 MHz	Low channel	54.03	1.89	22.3
2437 MHz	Mid channel	53.92	1.92	22.3
2462 MHz	High channel	53.74	1.99	22.3

3.3 Tissue Dielectric Parameters for Head and Body Phantoms

The head tissue dielectric parameters recommended by the IEEE SCC-34/SC-2 in P1528 have been incorporated in the following table. These head parameters are derived from planar layer models simulating the highest expected SAR for the dielectric properties and tissue thickness variations in a human head. Other head and body tissue parameters that have not been specified in P1528 are derived from the tissue dielectric parameters computed from the 4-Cole-Cole equations described in Reference [12] and extrapolated according to the head parameters specified in P1528.

Target Frequency (MHz)	Head		Body	
	ϵ_r	σ (S/m)	ϵ_r	σ (S/m)
150	52.3	0.76	61.9	0.80
300	45.3	0.87	58.2	0.92
450	43.5	0.87	56.7	0.94
835	41.5	0.90	55.2	0.97
900	41.5	0.97	55.0	1.05
915	41.5	0.98	55.0	1.06
1450	40.5	1.20	54.0	1.30
1610	40.3	1.29	53.8	1.40
1800 – 2000	40.0	1.40	53.3	1.52
2450	39.2	1.80	52.7	1.95
3000	38.5	2.40	52.0	2.73
5800	35.3	5.27	48.2	6.00

(ϵ_r = relative permittivity, σ = conductivity and $\rho = 1000 \text{ kg/m}^3$)

4. SAR Measurement Procedure

4.1 SAR System Validation

4.1.1 Validation Dipoles

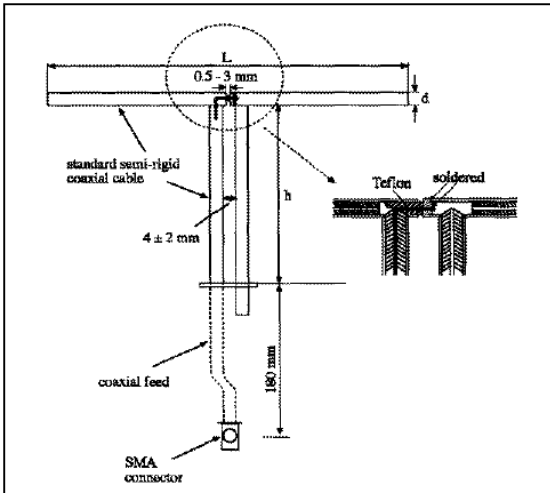

The dipoles used is based on the IEEE-1528 standard, and is complied with mechanical and electrical specifications in line with the requirements of both IEEE and FCC Supplement C. the table below provides details for the mechanical and electrical specifications for the dipoles.

Frequency	L (mm)	h (mm)	d (mm)
2450MHz	53.5	30.4	3.6

4.1.2 Validation Result

System Performance Check at 2450MHz				
Validation Kit: ASL-D-2450-S-2				
Frequency [MHz]	Description	SAR [w/kg] 1g	SAR [w/kg] 10g	Tissue Temp. [°C]
2450 MHz	Reference result ± 5% window	52.4 49.78 to 55.02	24 22.8 to 25.2	N/A
	11-Jul-05	53.006	24.532	22.9

Note: All SAR values are 1W forward power.

4.2 SAR Measurement Procedure

The ALSAS-10U calculates SAR using the following equation,

$$SAR = \frac{\sigma |E|^2}{\rho}$$

σ : represents the simulated tissue conductivity

ρ : represents the tissue density

The EUT is set to transmit at the required power in line with product specification, at each frequency relating to the LOW, MID, and HIGH channel settings.

Pre-scans are made on the device to establish the location for the transmitting antenna, using a large area scan in either air or tissue simulation fluid.

The EUT is placed against the Universal Phantom where the maximum area scan dimensions are larger than the physical size of the resonating antenna. When the scan size is not large enough to cover the peak SAR distribution, it is modified by either extending the area scan size in both the X and Y directions, or the device is shifted within the predefined area.

The area scan is then run to establish the peak SAR location (interpolated resolution set at 1mm²)which is then used to orient the center of the zoom scan. The zoom scan is then executed and the 1g and 10g averages are derived from the zoom scan volume (interpolated resolution set at 1mm³).

5. SAR Exposure Limits

SAR assessments have been made in line with the requirements of IEEE-1528, FCC Supplement C, and comply with ANSI/IEEE C95.1-1992 “Uncontrolled Environments” limits. These limits apply to a location which is deemed as “Uncontrolled Environment” which can be described as a situation where the general public may be exposed to an RF source with no prior knowledge or control over their exposure.

Limits for General Population/Uncontrolled Exposure (W/kg)

Type Exposure	Uncontrolled Environment Limit
Spatial Peak SAR (1g cube tissue for brain or body)	1.60 W/kg
Spatial Average SAR (whole body)	0.08 W/kg
Spatial Peak SAR (10g for hands, feet, ankles and wrist)	4.00 W/kg

6. Test Equipment List

Instrument	Manufacturer	Model No.	Serial No.	Last Calibration
Data Acquisition Package	Aprél	ALS-DAQ-PAQ-2	QTK-337	Nov. 2004
Aprél Laboratories Probe	Aprél	ALS-E020	264	Mar. 2005
Aprél Laboratories Probe	Aprél	ALS-E020	265	Mar. 2005
Aprél Reference Dipole 2450MHz	Aprél	ALS-D-2450-S-2	QTK-319	Jun. 2005
Boundary Detection Sensor System	Aprél	ALS-PMDPS-2	QTK-336	N/A
Dielectric Probe Kit	Aprél	ALS-PR-DIEL	QTK-296	N/A
Universal Work Station	Aprél	ALS-UWS	QTK-326	N/A
Device Holder 2.0	Aprél	ALS-H-E-SET-2	QTK-294	N/A
Left Ear SAM Phantom	Aprél	ALS-P-SAM-L	QTK-292	N/A
Right Ear SAM Phantom	Aprél	ALS-P-SAM-R	QTK-288	N/A
Universal Phantom	Aprél	ALS-P-UP-1	QTK-246	N/A
Aprél Dipole Spacer	Aprél	ALS-DS-U	QTK-295	N/A
SAR Software	Aprél	ALSAS-10	Ver. 2.0.0	N/A
CRS C500C Controller	Thermo	ALS-C500	RCF0404433	N/A
CRF F3 Robot	Thermo	ALS-F3	RAF0412222	N/A
Power Amplifier	Mini-Circuit	ZHL-42	D051404-20	N/A
Directional Coupler	Agilent	778D-012	50550	N/A
Universal Radio Communication Tester	Rohde & Schwarz	CMU 200	104846	Mar. 2005
Vector Network	Anritsu	MS4623B	992801	Mar 2005
Signal Generator	Anritsu	MG3692A	042319	Jun. 2005
Power Meter	Anritsu	ML2487A	6K00001447	Jan. 2005
Wide Bandwidth Sensor	Anritsu	MA2491	030677	Jan. 2005

7. Measurement Uncertainty

Exposure Assessment Measurement Uncertainty

Source of Uncertainty	Tolerance Value	Probability Distribution	Divisor	c_1^+ (1-g)	c_1^- (10-g)	Standard Uncertainty (1-g) %	Standard Uncertainty (10-g) %
Measurement System							
Probe Calibration	3.5	normal	1	1	1	3.5	3.5
Axial Isotropy	3.7	rectangular	$\sqrt{3}$	$(1-cp)^{1/2}$	$(1-cp)^{1/2}$	1.5	1.5
Hemispherical Isotropy	10.9	rectangular	$\sqrt{3}$	\sqrt{cp}	\sqrt{cp}	4.4	4.4
Boundary Effect	1.0	rectangular	$\sqrt{3}$	1	1	0.6	0.6
Linearity	4.7	rectangular	$\sqrt{3}$	1	1	2.7	2.7
Detection Limit	1.0	rectangular	$\sqrt{3}$	1	1	0.6	0.6
Readout Electronics	1.0	normal	1	1	1	1.0	1.0
Response Time	0.8	rectangular	$\sqrt{3}$	1	1	0.5	0.5
Integration Time	1.7	rectangular	$\sqrt{3}$	1	1	1.0	1.0
RF Ambient Condition	3.0	rectangular	$\sqrt{3}$	1	1	1.7	1.7
Probe Positioner Mech.	0.4	rectangular	$\sqrt{3}$	1	1	0.2	0.2
Restriction							
Probe Positioning with respect to Phantom Shell	2.9	rectangular	$\sqrt{3}$	1	1	1.7	1.7
Extrapolation and Integration	3.7	rectangular	$\sqrt{3}$	1	1	2.1	2.1
Test Sample Positioning	4.0	normal	1	1	1	4.0	4.0
Device Holder Uncertainty	2.0	normal	1	1	1	2.0	2.0
Drift of Output Power	4.7	rectangular	$\sqrt{3}$	1	1	2.7	2.7
Phantom and Setup							
Phantom Uncertainty(shape & thickness tolerance)	3.4	rectangular	$\sqrt{3}$	1	1	2.0	2.0
Liquid Conductivity(target)	5.0	rectangular	$\sqrt{3}$	0.7	0.5	2.0	1.4
Liquid Conductivity(meas.)	0.1	normal	1	0.7	0.5	0.1	0.0
Liquid Permittivity(target)	2.0	rectangular	$\sqrt{3}$	0.6	0.5	0.7	0.6
Liquid Permittivity(meas.)	2.6	normal	1	0.6	0.5	1.6	1.3
Combined Uncertainty		RSS				9.6	9.5
Combined Uncertainty (coverage factor=2)		Normal (k=2)				19.3	18.9

8. Test Results

8.1 SAR Test Results Summary

SAR MEASUREMENT						
Ambient Temperature (°C) : 23.4±2				Relative Humidity (%) : 52		
Liquid Temperature (°C) : 22.3±2				Depth of Liquid (cm) : >15		
Product: Notebook P.C.						
Test Mode: 802.11b (Main Antenna)						
Test Position Body	Antenna Position	Frequency		Conducted Power (dBm)	SAR 1g (W/kg)	Limit (W/kg)
		Channel	MHz			
EUT Front	Internal	Low	2412	16.20	0.506	1.6
EUT Front	Internal	Mid.	2437	16.44	0.519	1.6
EUT Front	Internal	High	2462	16.08	0.444	1.6
EUT Side	Internal	Low	2412	16.20	-	1.6
EUT Side	Internal	Mid.	2437	16.44	0.298	1.6
EUT Side	Internal	High	2462	16.08	-	1.6
EUT Back	Internal	Low	2412	16.20	-	1.6
EUT Back	Internal	Mid.	2437	16.44	0.024	1.6
EUT Back	Internal	High	2462	16.08	-	1.6
Test Mode: 802.11b (Aux. Antenna)						
EUT Front	Internal	Low	2412	16.20	-	1.6
EUT Front	Internal	Mid.	2437	16.44	0.326	1.6
EUT Front	Internal	High	2462	16.08	-	1.6
EUT Side	Internal	Low	2412	16.20	-	1.6
EUT Side	Internal	Mid.	2437	16.44	0.223-	1.6
EUT Side	Internal	High	2462	16.08	-	1.6
Note: The SAR measured at the middle channel for this configuration is at least 3 dB lower than SAR limit, testing at the high and low channels is option.						

SAR MEASUREMENT						
Ambient Temperature (°C) : 23.4±2				Relative Humidity (%) : 52		
Liquid Temperature (°C) : 22.3±2				Depth of Liquid (cm):>15		
Product: Notebook P.C.						
Test Mode: 802.11g (Main Antenna)						
Test Position Body	Antenna Position	Frequency		Conducted Power (dBm)	SAR 1g (W/kg)	Limit (W/kg)
		Channel	MHz			
Test Mode: 802.11g (Main Antenna)						
EUT Front	Internal	Low	2412	14.31	0.302	1.6
EUT Front	Internal	Mid.	2437	14.01	0.269	1.6
EUT Front	Internal	High	2462	13.93	0.176	1.6
EUT Side	Internal	Low	2412	14.31	-	1.6
EUT Side	Internal	Mid.	2437	14.01	0.286	1.6
EUT Side	Internal	High	2462	13.93	-	1.6
Test Mode: 802.11g (Aux. Antenna)						
EUT Front	Internal	Low	2412	14.31	-	1.6
EUT Front	Internal	Mid.	2437	14.01	0.239	1.6
EUT Front	Internal	High	2462	13.93	-	1.6
EUT Side	Internal	Low	2412	14.31	-	1.6
EUT Side	Internal	Mid.	2437	14.01	0.163	1.6
EUT Side	Internal	High	2462	13.93	-	1.6
Note: The SAR measured at the middle channel for this configuration is at least 3 dB lower than SAR limit, testing at the high and low channels is option.						

Appendix A. SAR System Validation Data

Appendix B. SAR measurement Data

Appendix C. Test Setup Photographs & EUT Photographs

Appendix D. Probe Calibration Data

Appendix E. Dipole Calibration Data

SAR System Validation Data

ALSAS-10U VER 2.1.0APREL Laboratories

SAR Test Report

Product Data

Device Name : Dipole-2450
Type : Dipole
Frequency : 2450.00 MHz
Max. Transmit Pwr : 1 W
Drift Time : 0 min(s)
Length : 51.5 mm
Width : 3.6 mm
Depth : 30.4 mm
Power Drift-Start : 34.846 W/kg
Power Drift-Finish: 35.771 W/kg
Power Drift (%) : 2.655

Phantom Data

Type : Uni-Phantom
Size (mm) : 280 x 280 x 200
Location : Center

Tissue Data

Type : HEAD
Serial No. : 325-H
Frequency : 2450 MHz
Last Calib. Date : 11-Jul-2005
Temperature : 22.9 °C
Ambient Temp. : 23.4 °C
Humidity : 52 RH%
Epsilon : 38.9 F/m
Sigma : 1.82 S/m
Density : 1000 kg/cu. m

Probe Data

Name : Probe 265
Model : E020
Type : E-Field Triangle
Serial No. : 265
Last Calib. Date : 23-Mar-2005
Frequency : 2450 MHz
Duty Cycle Factor: 1
Conversion Factor: 4.6
Probe Sensitivity: 1.20 1.20 1.20 $\mu\text{V}/(\text{V}/\text{m})^2$
Compression Point: 95 mV
Offset : 1.56 mm

Measurement Data

Crest Factor : 1
Tissue Temp. : 22.9°C
Ambient Temp. : 23.4°C
Area Scan : 5x7x1 : Measurement x=10mm, y=10mm, z=4mm
Zoom Scan : 7x7x7 : Measurement x=5mm, y=5mm, z=5mm

Frequency : 2450MHz

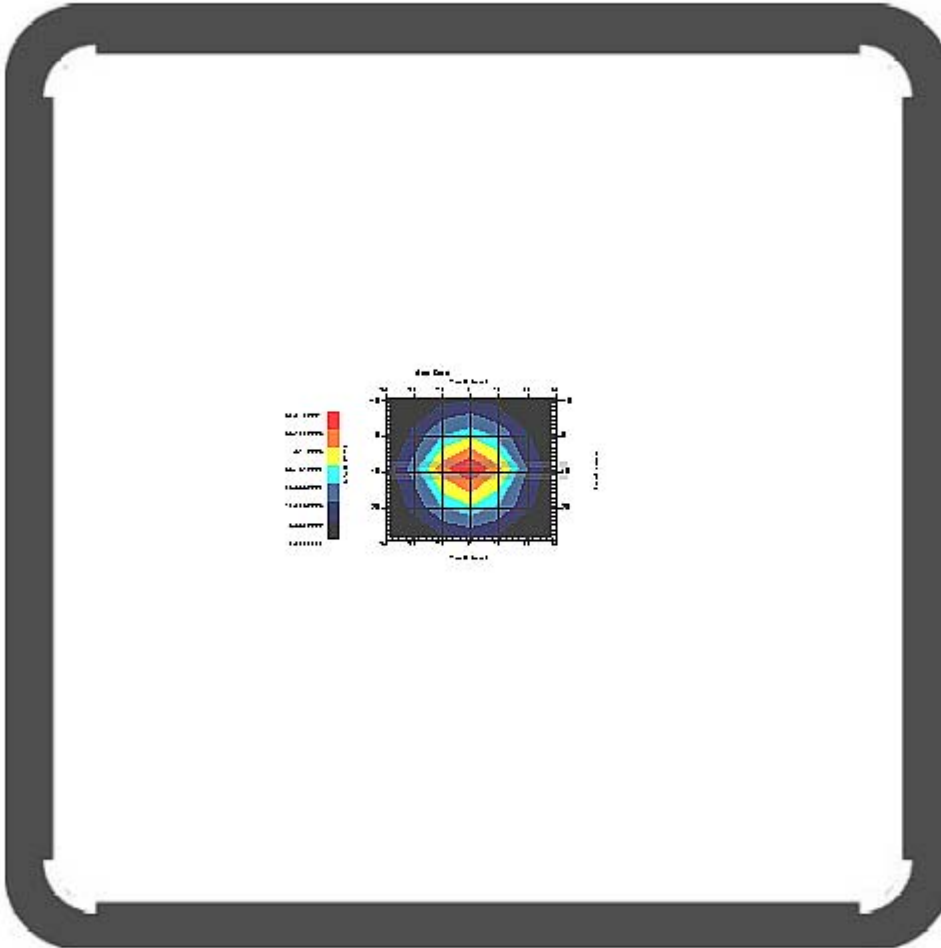

1 gram SAR value : 53.006 W/kg
10 gram SAR value : 24.532 W/kg
Area Scan Peak SAR : 62.034 W/kg
Zoom Scan Peak SAR : 105.920 W/kg

SAR-Z Axis
at Hotspot x:9.00 y:-2.00

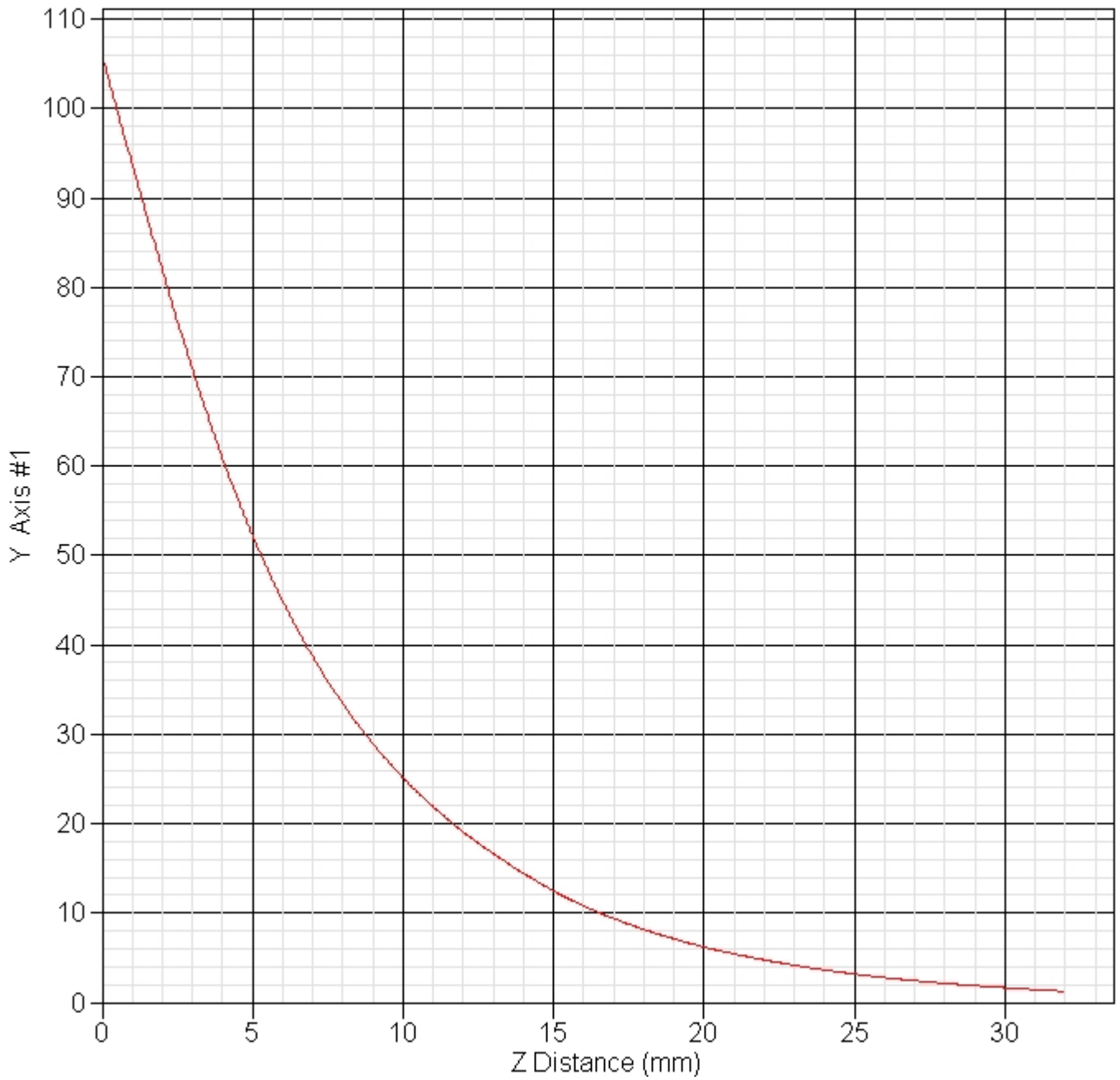

SAR 2.45GHz Measurement Data

ALSAS-10U VER 2.1.0APREL Laboratories

SAR Test Report

Product Data

Device Name : ASUS_W1
Serial No. : Z61A Z61Ae
Frequency : 2450.00 MHz
Drift Time : 0 min(s)
Length : 249 mm
Width : 222 mm
Depth : 25 mm
Antenna Type : Internal

Phantom Data

Type : Uni-Phantom
Size (mm) : 280 x 280 x 200
Location : Center

Tissue Data

Type : BODY
Serial No. : 325-B
Frequency : 2450 MHz
Last Calib. Date : 11-Jul-2005
Temperature : 22.3 °C
Ambient Temp. : 23.4 °C
Humidity : 52 RH%
Epsilon : 53.85 F/m
Sigma : 1.96 S/m
Density : 1000 kg/cu. m

Probe Data

Name : Probe 265
Model : E020
Type : E-Field Triangle
Serial No. : 265
Last Calib. Date : 23-Mar-2005
Frequency : 2450 MHz
Duty Cycle Factor: 1
Conversion Factor: 4.7
Probe Sensitivity: 1.20 1.20 1.20 $\mu\text{V}/(\text{V}/\text{m})^2$
Compression Point: 95 mV
Offset : 1.56 mm

Measurement Data

Crest Factor : 1
Tissue Temp. : 22.3°C
Ambient Temp. : 23.4°C
Area Scan : 6x6x1 : Measurement x=12mm, y=12mm, z=4mm
Zoom Scan : 7x7x7 : Measurement x=5mm, y=5mm, z=5mm
Power Drift-Start : 0.137 W/kg
Power Drift-Finish: 0.135 W/kg
Power Drift (%) : -1.459
DUT Position : Touch EUT Left Front(Main Antenna)
Frequency : 802.11b 2412MHz

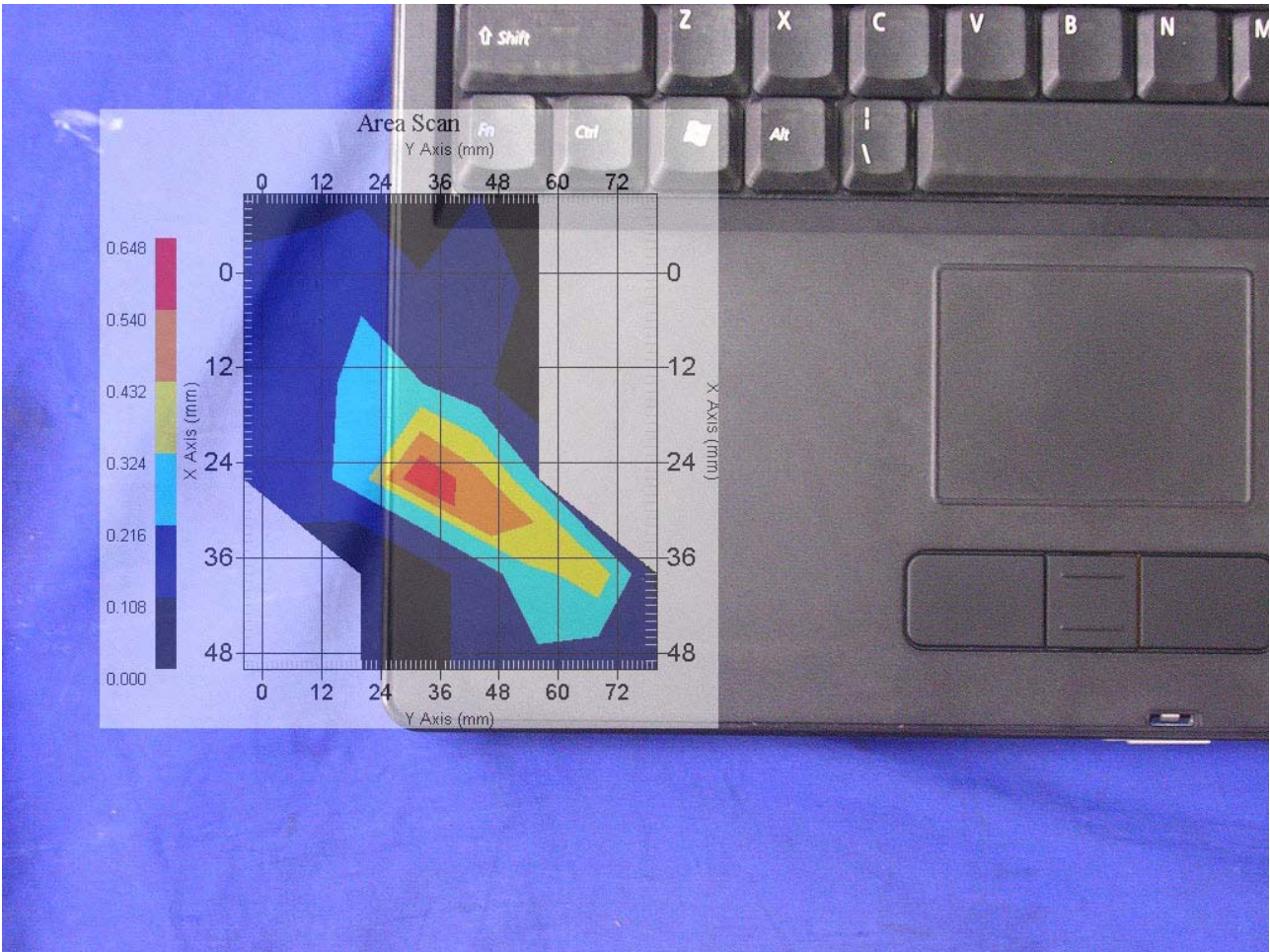

1 gram SAR value : 0.506 W/kg
10 gram SAR value : 0.297 W/kg
Area Scan Peak SAR : 0.642 W/kg
Zoom Scan Peak SAR : 1.030 W/kg

Measurement Data

Crest Factor : 1
Tissue Temp. : 22.3°C
Ambient Temp. : 23.4°C
Area Scan : 6x6x1 : Measurement x=12mm, y=12mm, z=4mm
Zoom Scan : 7x7x7 : Measurement x=5mm, y=5mm, z=5mm
Power Drift-Start : 0.115 W/kg
Power Drift-Finish: 0.112 W/kg
Power Drift (%) : -2.608
DUT Position : Touch EUT Left Front(Main Antenna)
Frequency : 802.11b 2437MHz

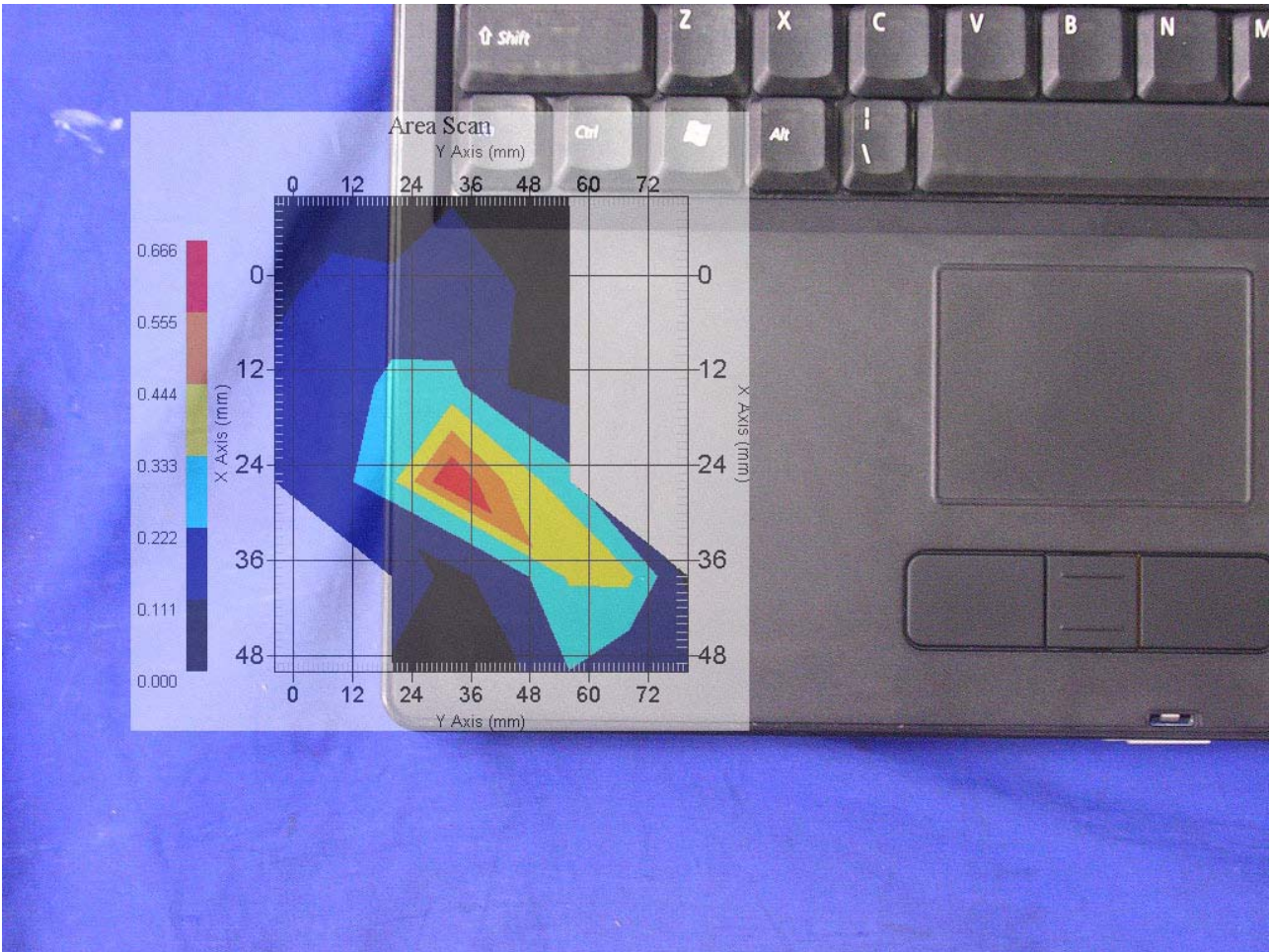

1 gram SAR value : 0.519 W/kg
10 gram SAR value : 0.278 W/kg
Area Scan Peak SAR : 0.661 W/kg
Zoom Scan Peak SAR : 0.953 W/kg

Measurement Data

Crest Factor : 1
Tissue Temp. : 22.3°C
Ambient Temp. : 23.4°C
Area Scan : 6x6x1 : Measurement x=12mm, y=12mm, z=4mm
Zoom Scan : 7x7x7 : Measurement x=5mm, y=5mm, z=5mm
Power Drift-Start : 0.109 W/kg
Power Drift-Finish: 0.106 W/kg
Power Drift (%) : -2.752
DUT Position : Touch EUT Left Front(Main Antenna)
Frequency : 802.11b 2462MHz

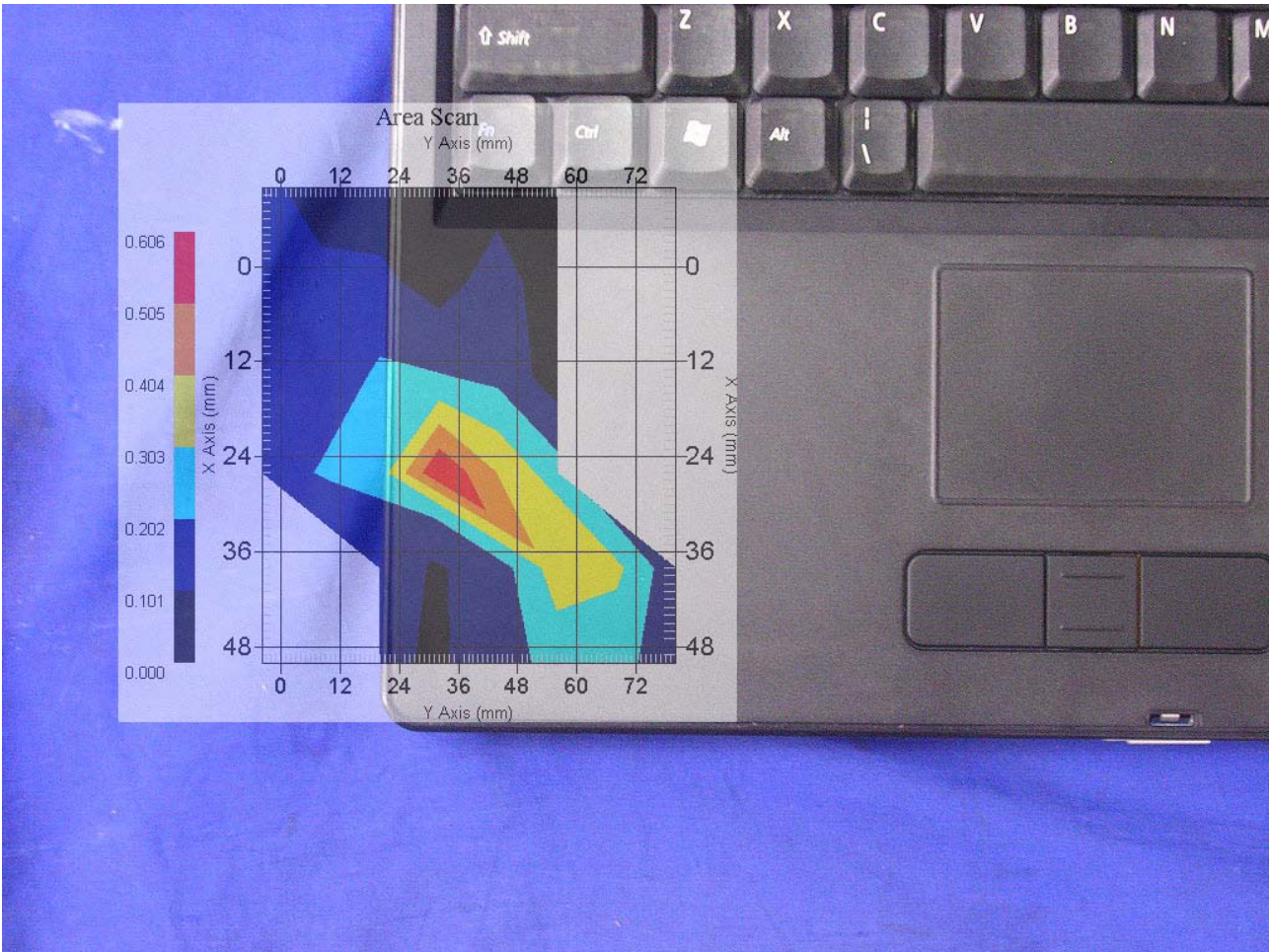

1 gram SAR value : 0.444 W/kg
10 gram SAR value : 0.227 W/kg
Area Scan Peak SAR : 0.600 W/kg
Zoom Scan Peak SAR : 1.080 W/kg

Measurement Data

Crest Factor : 1
Tissue Temp. : 22.3°C
Ambient Temp. : 23.4°C
Area Scan : 6x5x1 : Measurement x=12mm, y=12mm, z=4mm
Zoom Scan : 7x7x7 : Measurement x=5mm, y=5mm, z=5mm
Power Drift-Start : 0.134 W/kg
Power Drift-Finish: 0.140 W/kg
Power Drift (%) : 4.477
DUT Position : Touch EUT Left Side(Main Antenna)
Frequency : 802.11b 2437MHz

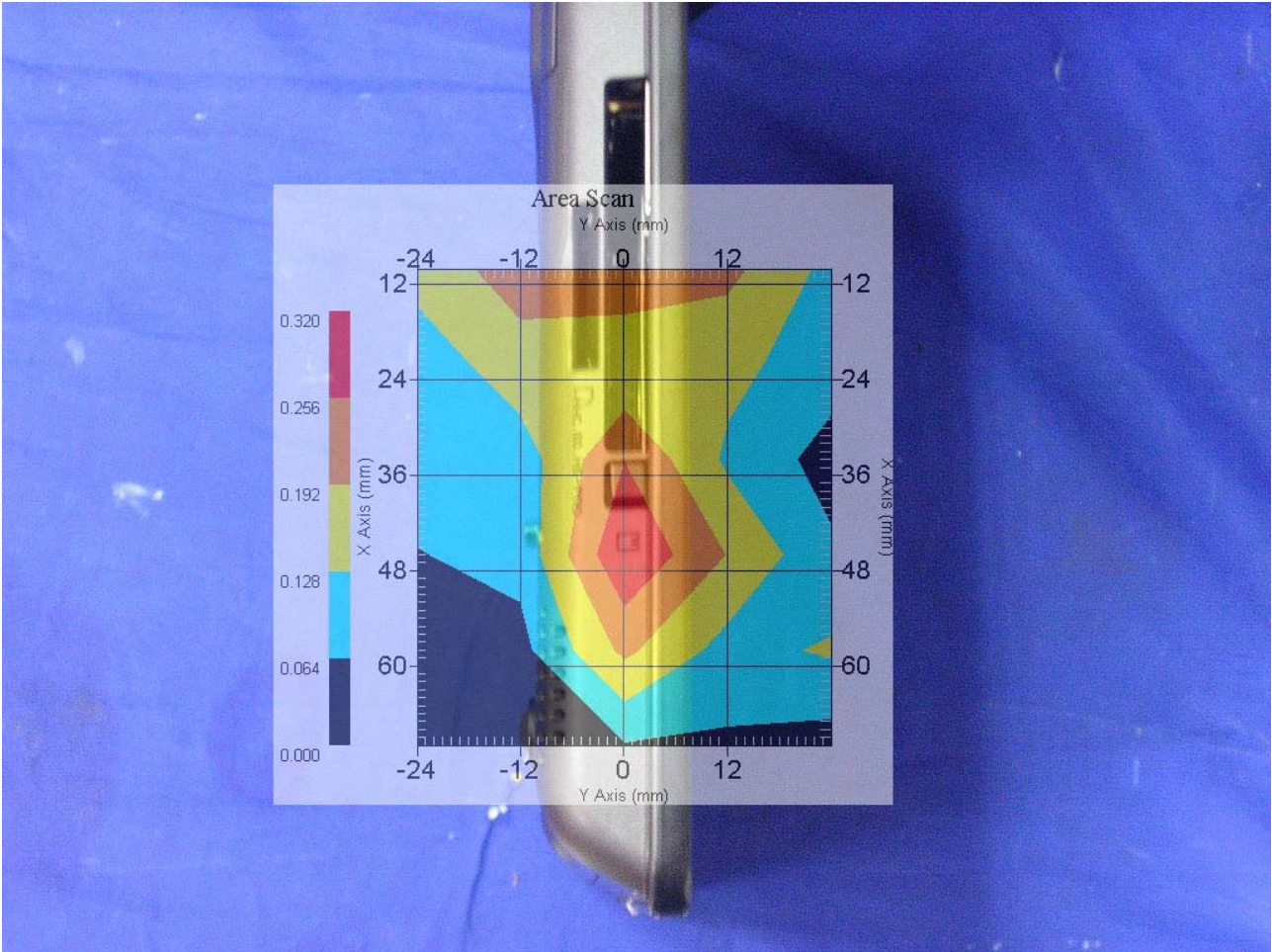

1 gram SAR value : 0.298 W/kg
10 gram SAR value : 0.164 W/kg
Area Scan Peak SAR : 0.315 W/kg
Zoom Scan Peak SAR : 0.650 W/kg

Measurement Data

Crest Factor : 1
Tissue Temp. : 22.3°C
Ambient Temp. : 23.4°C
Area Scan : 5x6x1 : Measurement x=12mm, y=12mm, z=4mm
Zoom Scan : 7x7x7 : Measurement x=5mm, y=5mm, z=5mm
Power Drift-Start : 0.010 W/kg
Power Drift-Finish: 0.010 W/kg
Power Drift (%) : 0.000
DUT Position : Touch EUT Back(Main Antenna)
Frequency : 802.11b 2437MHz

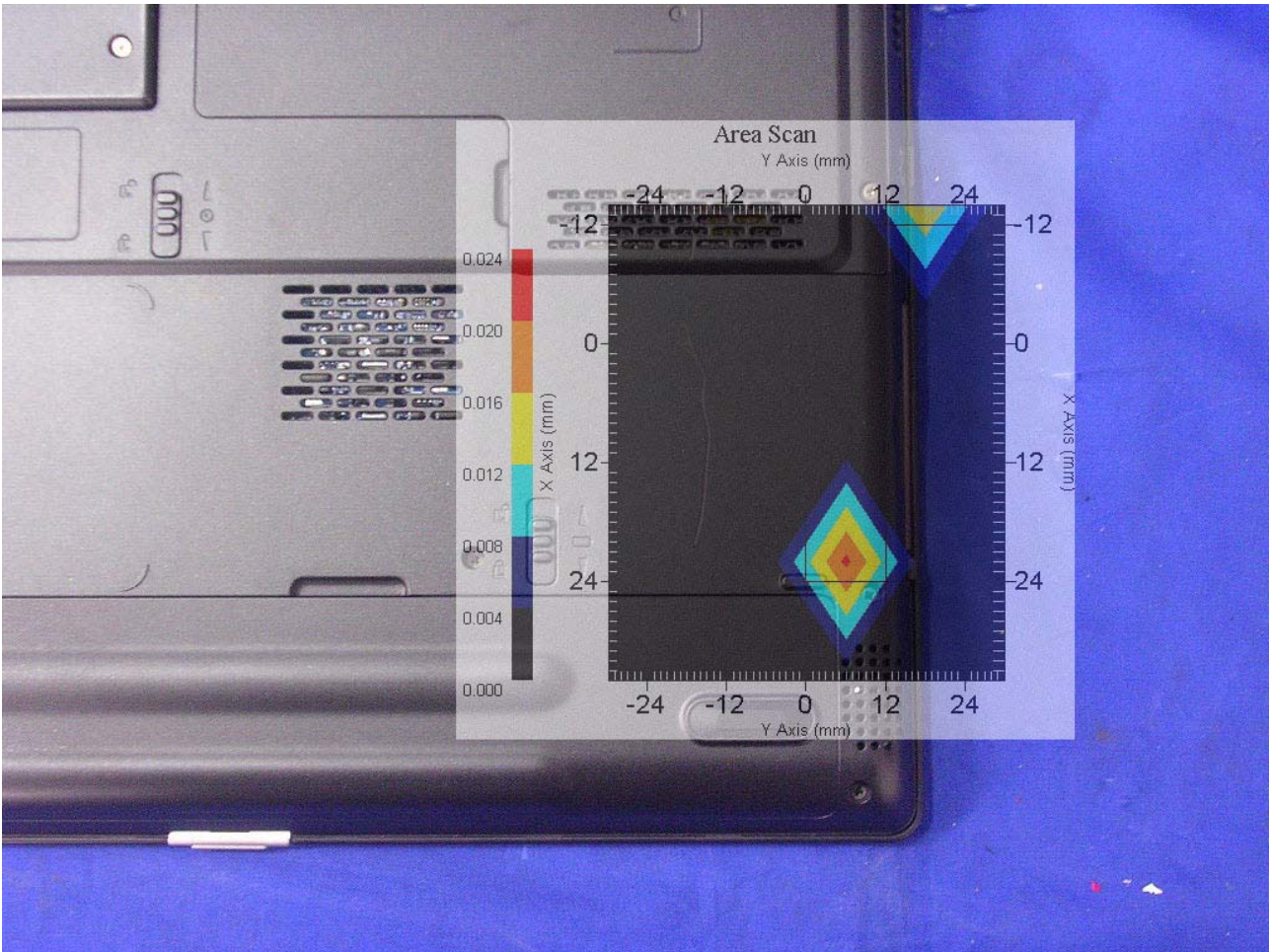

1 gram SAR value : 0.024 W/kg
10 gram SAR value : 0.008 W/kg
Area Scan Peak SAR : 0.021 W/kg
Zoom Scan Peak SAR : 0.075 W/kg

Measurement Data

Crest Factor : 1
Tissue Temp. : 22.3°C
Ambient Temp. : 23.4°C
Area Scan : 6x6x1 : Measurement x=12mm, y=12mm, z=4mm
Zoom Scan : 7x7x7 : Measurement x=5mm, y=5mm, z=5mm
Power Drift-Start : 0.059 W/kg
Power Drift-Finish: 0.058 W/kg
Power Drift (%) : -1.694
DUT Position : Touch EUT Right Front(Aux. Antenna)
Frequency : 802.11b 2437MHz

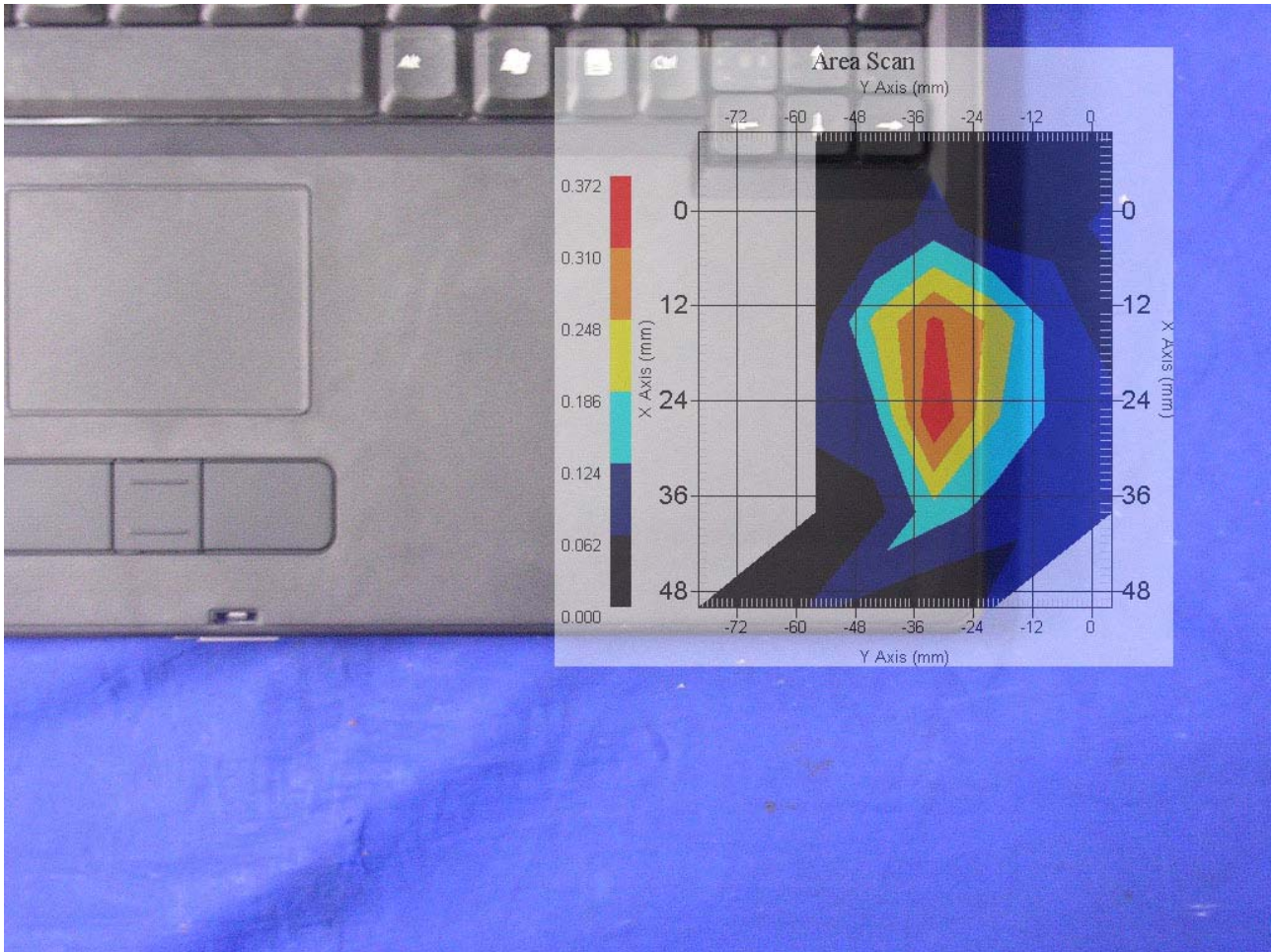

1 gram SAR value : 0.326 W/kg
10 gram SAR value : 0.172 W/kg
Area Scan Peak SAR : 0.369 W/kg
Zoom Scan Peak SAR : 0.580 W/kg

Measurement Data

Crest Factor : 1
 Tissue Temp. : 22.3°C
 Ambient Temp. : 23.4°C
 Area Scan : 6x5x1 : Measurement x=12mm, y=12mm, z=4mm
 Zoom Scan : 7x7x7 : Measurement x=5mm, y=5mm, z=5mm
 Power Drift-Start : 0.107 W/kg
 Power Drift-Finish: 0.104 W/kg
 Power Drift (%) : -2.803
 DUT Position : Touch EUT Right Side(Aux. Antenna)
 Frequency : 802.11b 2437MHz

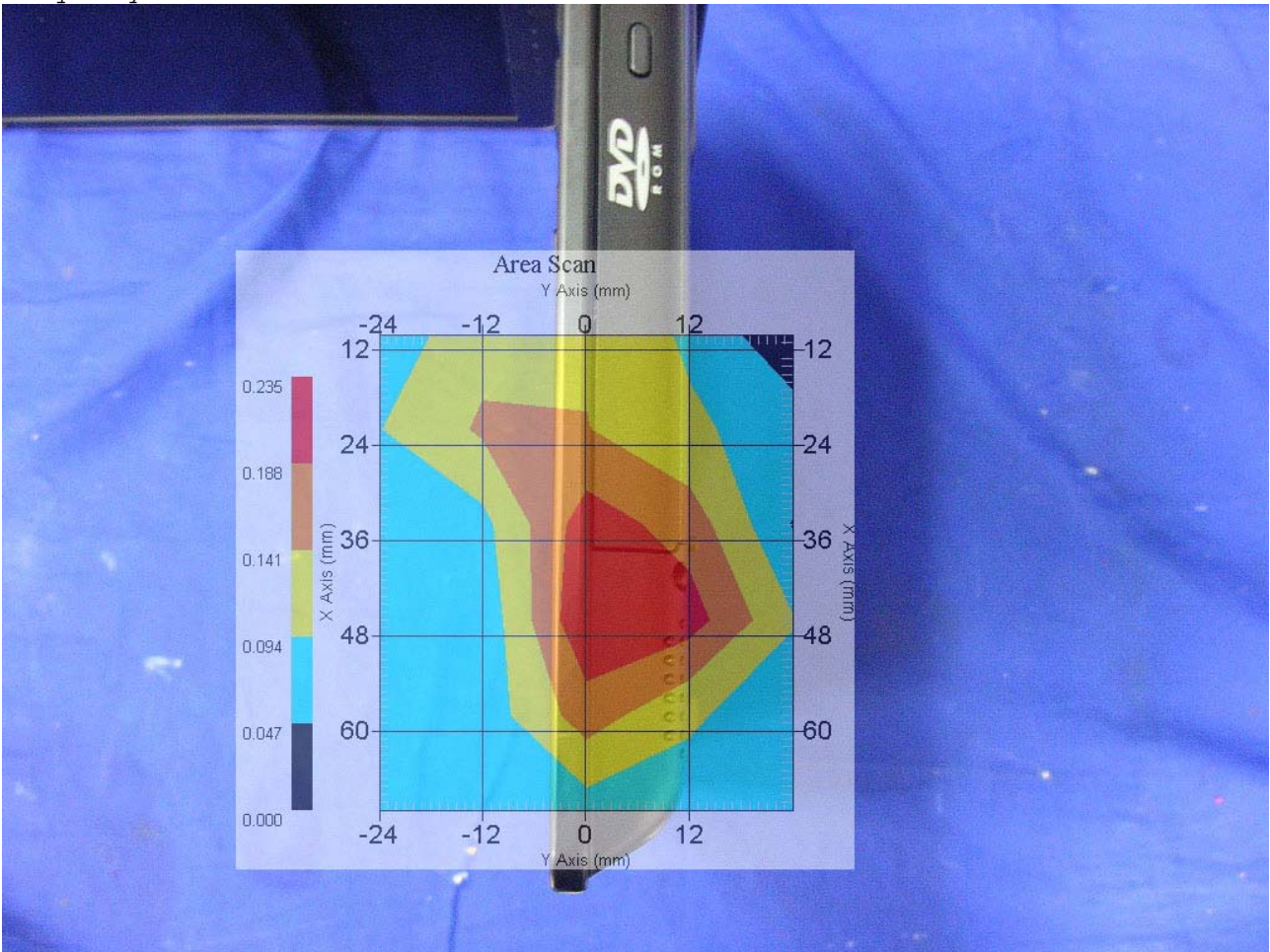

1 gram SAR value : 0.223 W/kg
 10 gram SAR value : 0.116 W/kg
 Area Scan Peak SAR : 0.230 W/kg
 Zoom Scan Peak SAR : 0.530 W/kg

Measurement Data

Crest Factor : 1
Tissue Temp. : 22.3°C
Ambient Temp. : 23.4°C
Area Scan : 6x6x1 : Measurement x=12mm, y=12mm, z=4mm
Zoom Scan : 7x7x7 : Measurement x=5mm, y=5mm, z=5mm
Power Drift-Start : 0.101 W/kg
Power Drift-Finish: 0.102 W/kg
Power Drift (%) : 0.990
DUT Position : Touch EUT Left Side(Main Antenna)
Frequency : 802.11g 2412MHz

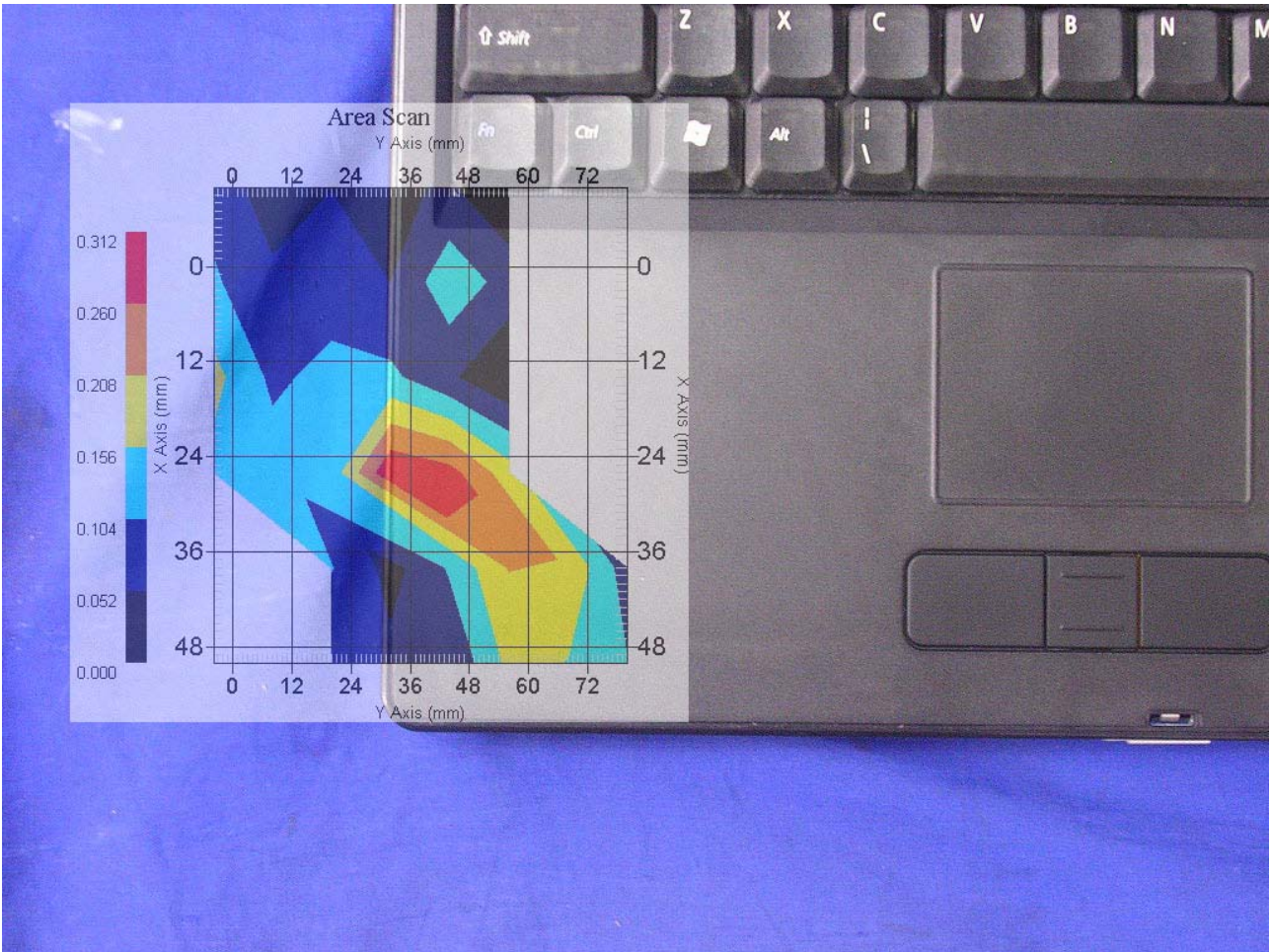

1 gram SAR value : 0.302 W/kg
10 gram SAR value : 0.170 W/kg
Area Scan Peak SAR : 0.305 W/kg
Zoom Scan Peak SAR : 0.600 W/kg

Measurement Data

Crest Factor : 1
Tissue Temp. : 22.3°C
Ambient Temp. : 23.4°C
Area Scan : 6x6x1 : Measurement x=12mm, y=12mm, z=4mm
Zoom Scan : 7x7x7 : Measurement x=5mm, y=5mm, z=5mm
Power Drift-Start : 0.085 W/kg
Power Drift-Finish: 0.085 W/kg
Power Drift (%) : 0.000
DUT Position : Touch EUT Left Side(Main Antenna)
Frequency : 802.11g 2437MHz

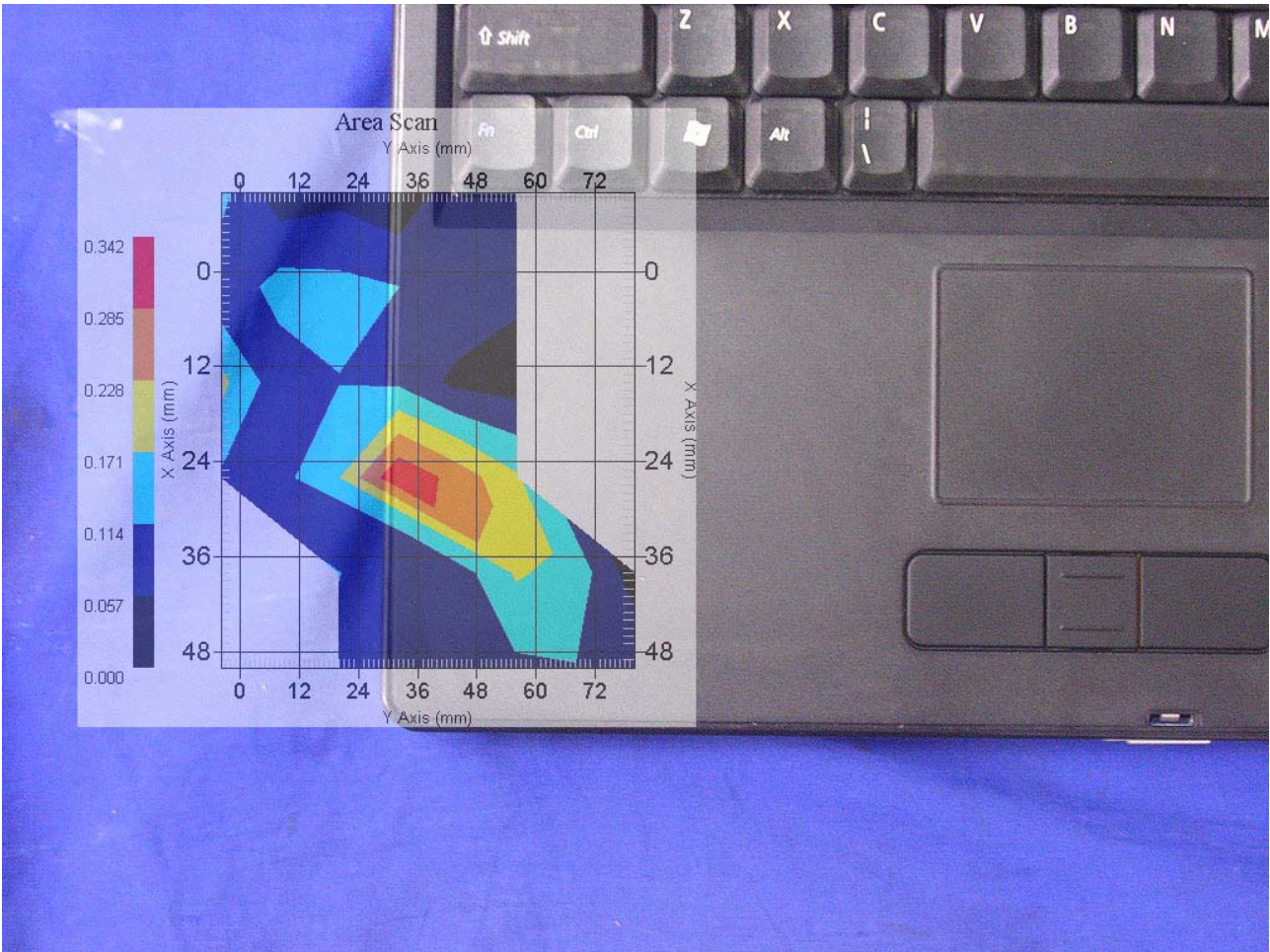

1 gram SAR value : 0.269 W/kg
10 gram SAR value : 0.198 W/kg
Area Scan Peak SAR : 0.333 W/kg
Zoom Scan Peak SAR : 0.540 W/kg

Measurement Data

Crest Factor : 1
Tissue Temp. : 22.3°C
Ambient Temp. : 23.4°C
Area Scan : 6x6x1 : Measurement x=12mm, y=12mm, z=4mm
Zoom Scan : 7x7x7 : Measurement x=5mm, y=5mm, z=5mm
Power Drift-Start : 0.075 W/kg
Power Drift-Finish: 0.074 W/kg
Power Drift (%) : -1.333
DUT Position : Touch EUT Left Side(Main Antenna)
Frequency : 802.11g 2462MHz

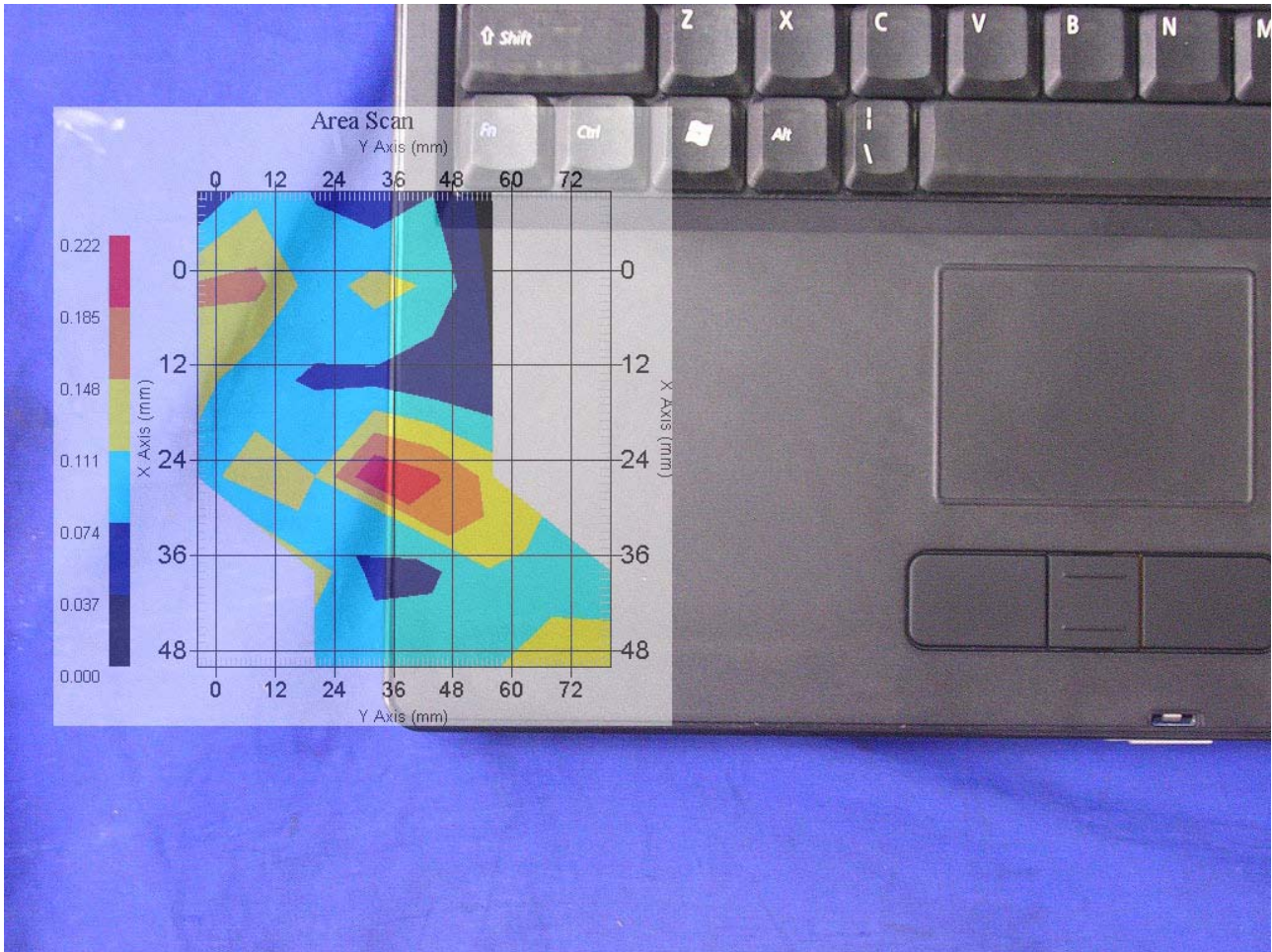

1 gram SAR value : 0.176 W/kg
10 gram SAR value : 0.117 W/kg
Area Scan Peak SAR : 0.218 W/kg
Zoom Scan Peak SAR : 0.370 W/kg

Measurement Data

Crest Factor : 1
Tissue Temp. : 22.3°C
Ambient Temp. : 23.4°C
Area Scan : 6x5x1 : Measurement x=12mm, y=12mm, z=4mm
Zoom Scan : 7x7x7 : Measurement x=5mm, y=5mm, z=5mm
Power Drift-Start : 0.085 W/kg
Power Drift-Finish: 0.085 W/kg
Power Drift (%) : 0.000
DUT Position : Touch EUT Left Side(Main Antenna)
Frequency : 802.11g 2437MHz

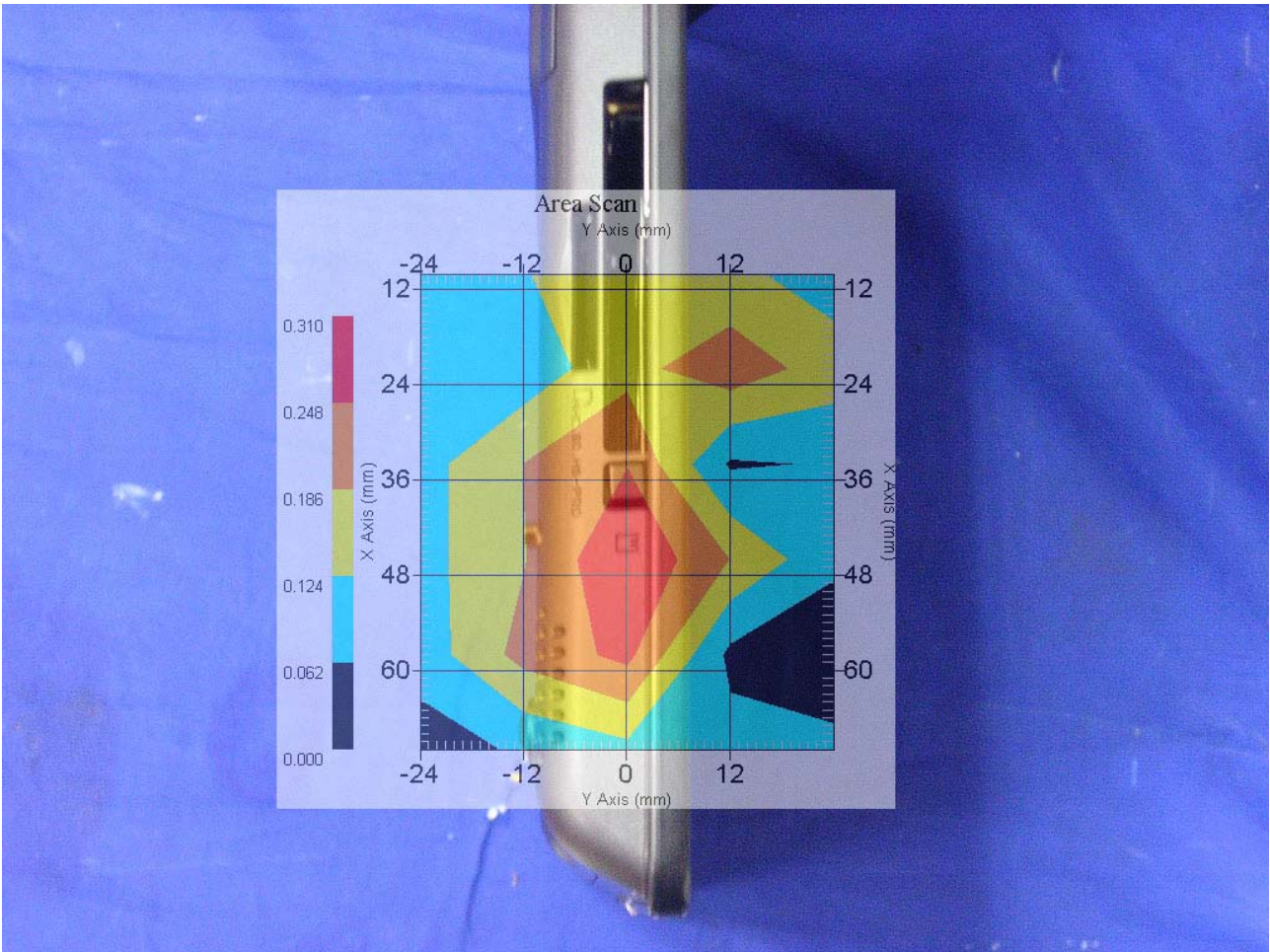

1 gram SAR value : 0.286 W/kg
10 gram SAR value : 0.164 W/kg
Area Scan Peak SAR : 0.307 W/kg
Zoom Scan Peak SAR : 0.510 W/kg

Measurement Data

Crest Factor : 1
Tissue Temp. : 22.3°C
Ambient Temp. : 23.4°C
Area Scan : 6x6x1 : Measurement x=12mm, y=12mm, z=4mm
Zoom Scan : 7x7x7 : Measurement x=5mm, y=5mm, z=5mm
Power Drift-Start : 0.047 W/kg
Power Drift-Finish: 0.046 W/kg
Power Drift (%) : -2.127
DUT Position : Touch EUT Right Front(Aux. Antenna)
Frequency : 802.11g 2437MHz

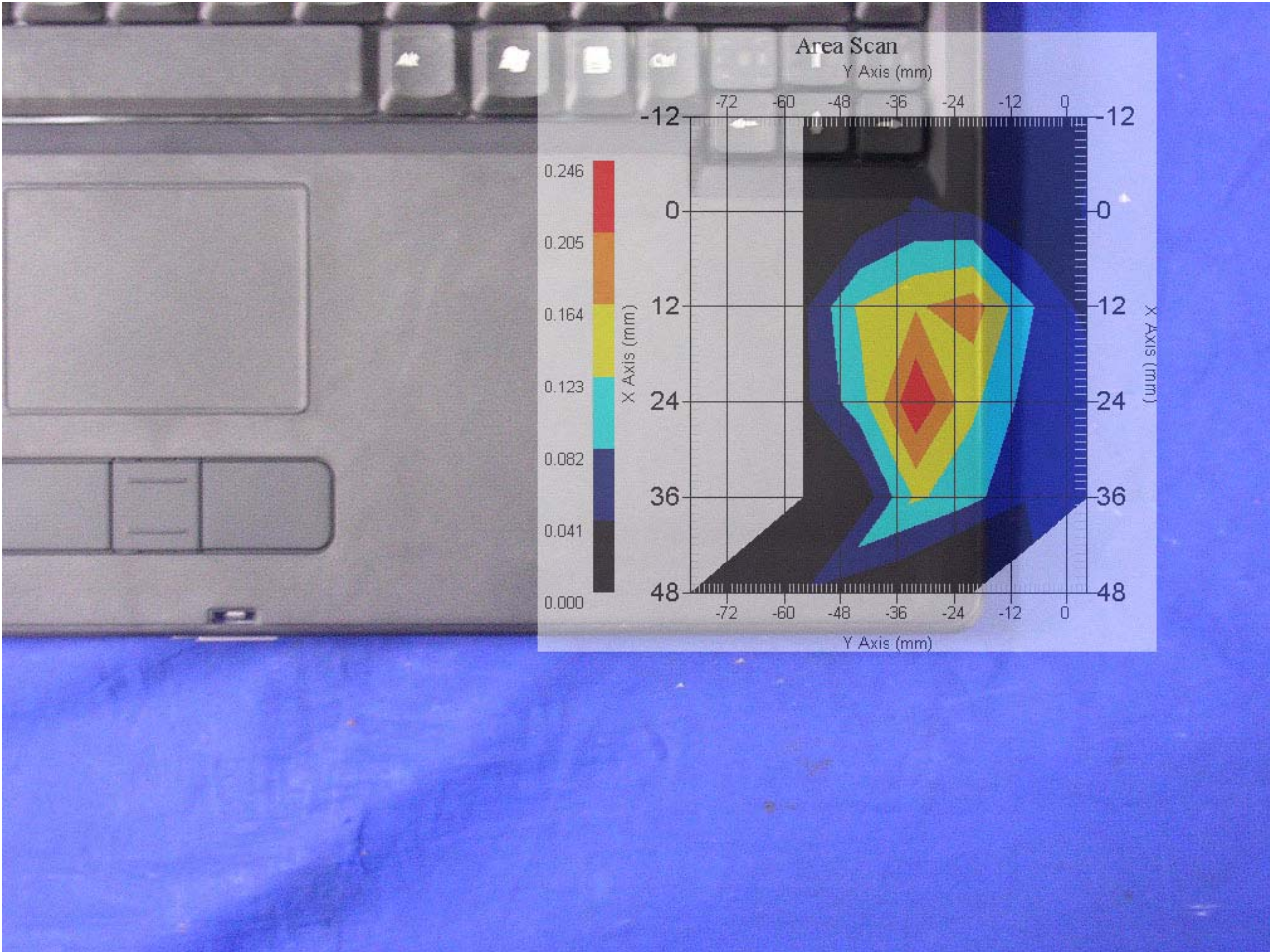

1 gram SAR value : 0.239 W/kg
10 gram SAR value : 0.105 W/kg
Area Scan Peak SAR : 0.242 W/kg
Zoom Scan Peak SAR : 0.560 W/kg

Measurement Data

Crest Factor : 1
 Tissue Temp. : 22.3°C
 Ambient Temp. : 23.4°C
 Area Scan : 6x5x1 : Measurement x=12mm, y=12mm, z=4mm
 Zoom Scan : 7x7x7 : Measurement x=5mm, y=5mm, z=5mm
 Power Drift-Start : 0.010 W/kg
 Power Drift-Finish: 0.010 W/kg
 Power Drift (%) : 0.000
 DUT Position : Touch EUT Right Side(Aux. Antenna)
 Frequency : 802.11g 2437MHz

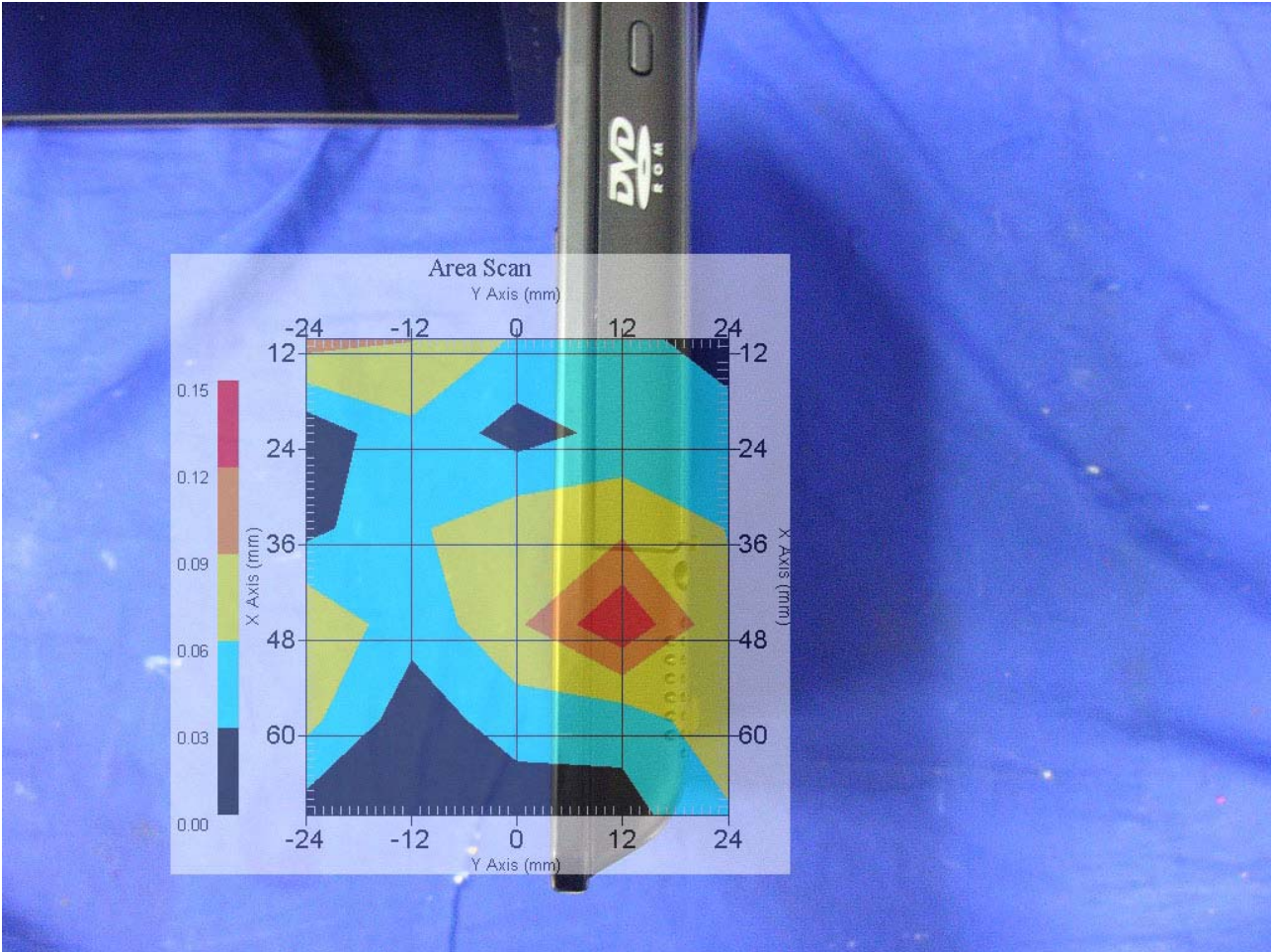

1 gram SAR value : 0.163 W/kg
 10 gram SAR value : 0.105 W/kg
 Area Scan Peak SAR : 0.146 W/kg
 Zoom Scan Peak SAR : 0.410 W/kg

EUT Left Front (Main Antenna) Z-Axis plot

Frequency : 802.11b 2437MHz

SAR-Z Axis
at Hotspot x:17.10 y:46.90

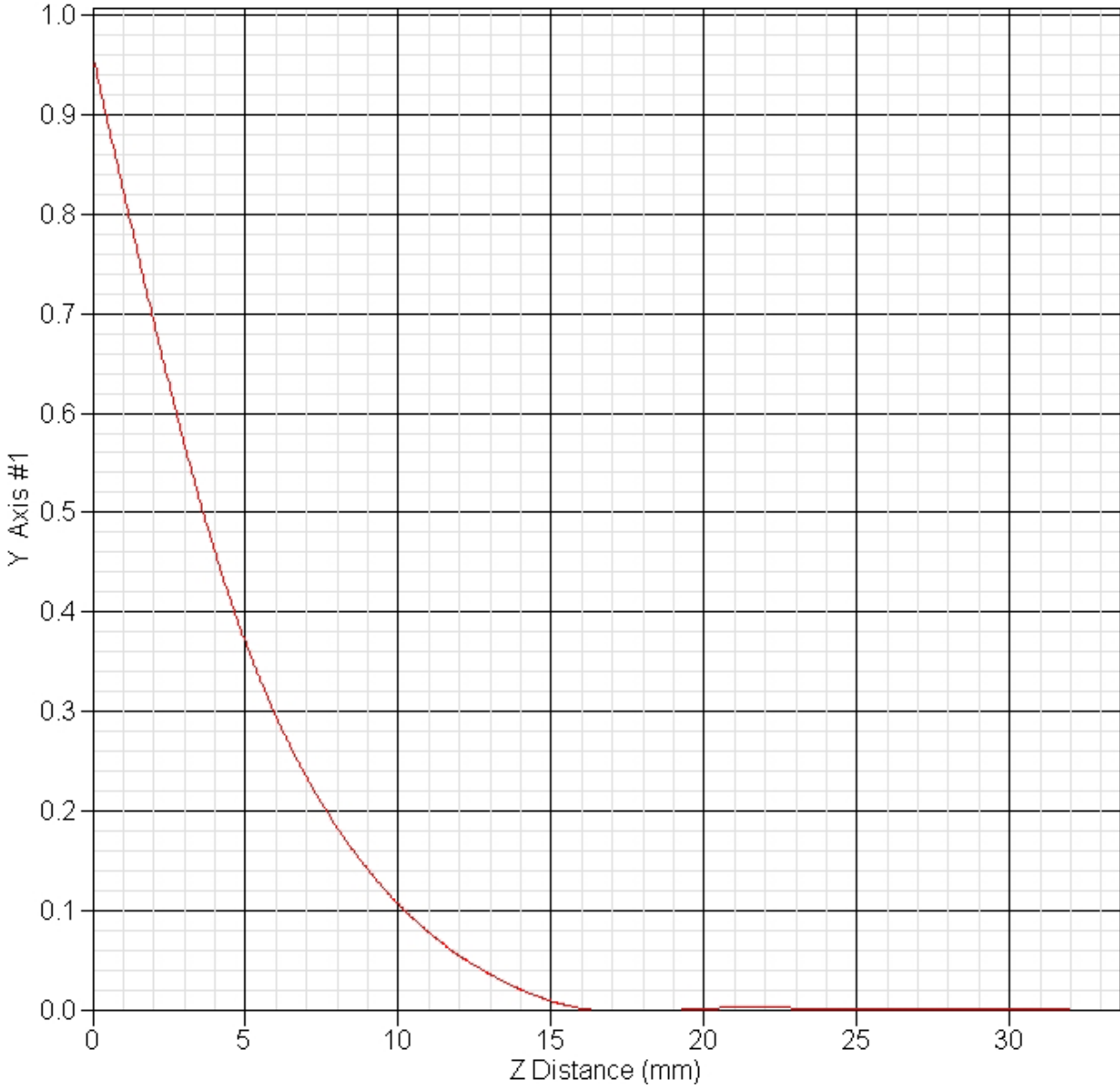

Test Setup Photographs

EUT Left Front (Main Antenna)

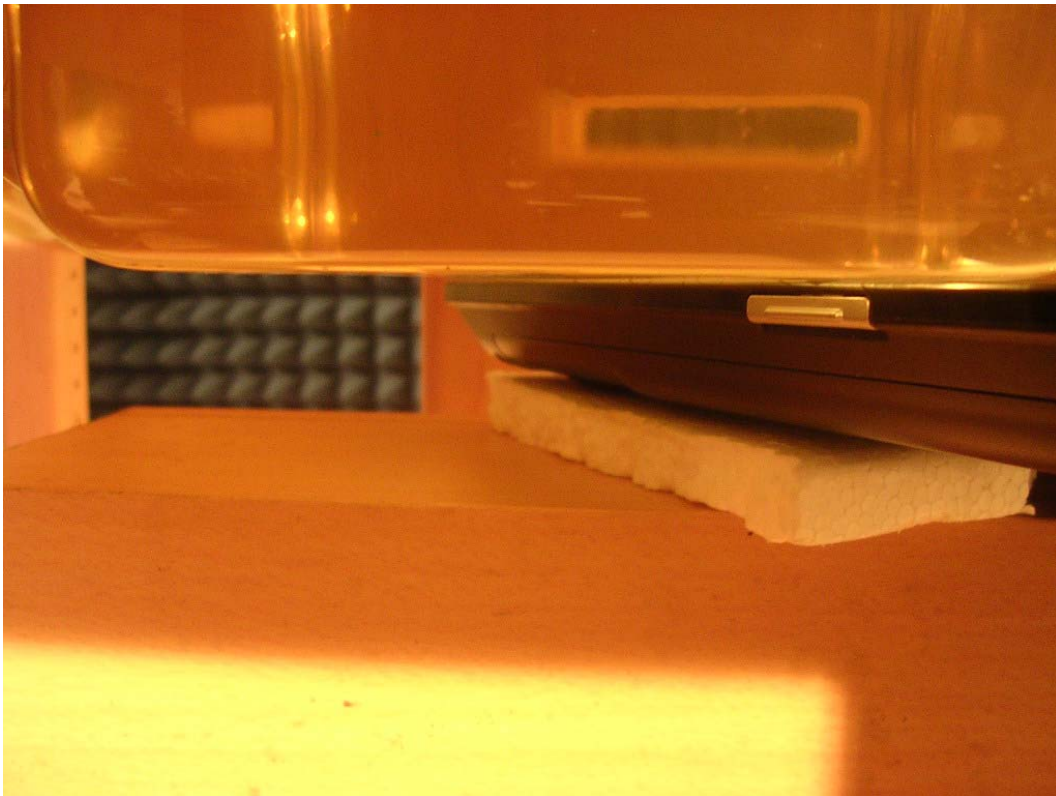

EUT Right Front (Auxiliary Antenna)



EUT Left Side (Main Antenna)

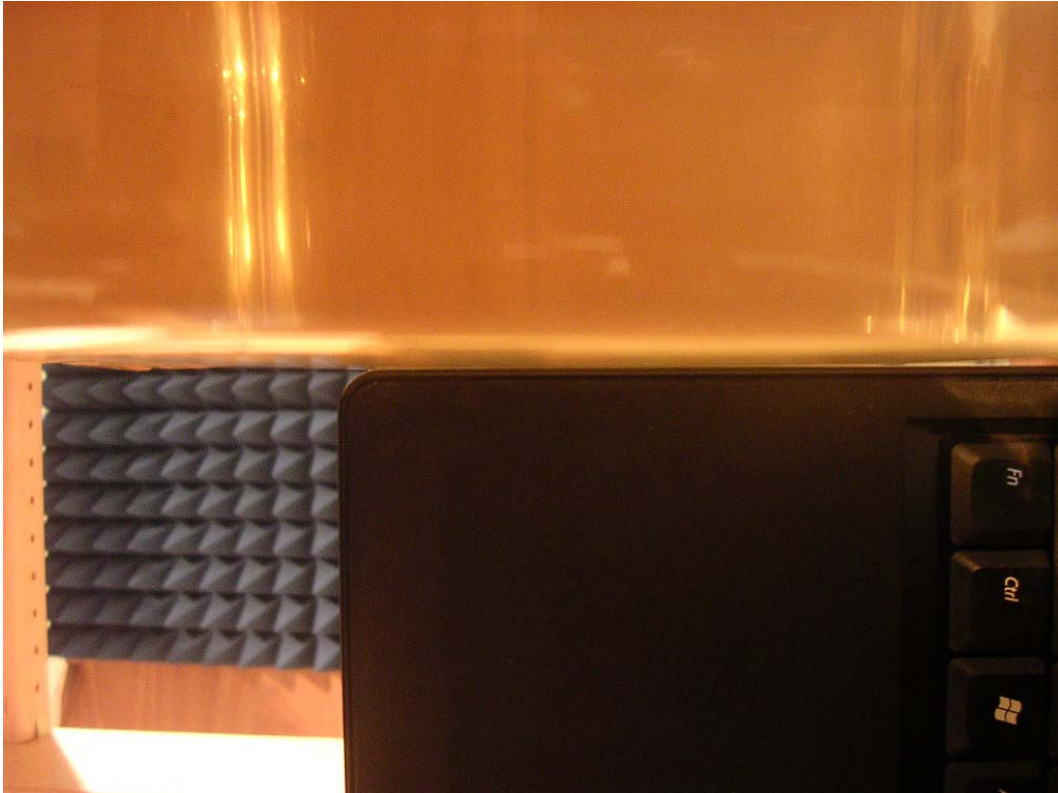

EUT Right Side (Auxiliary Antenna)



EUT Back(Main Antenna)

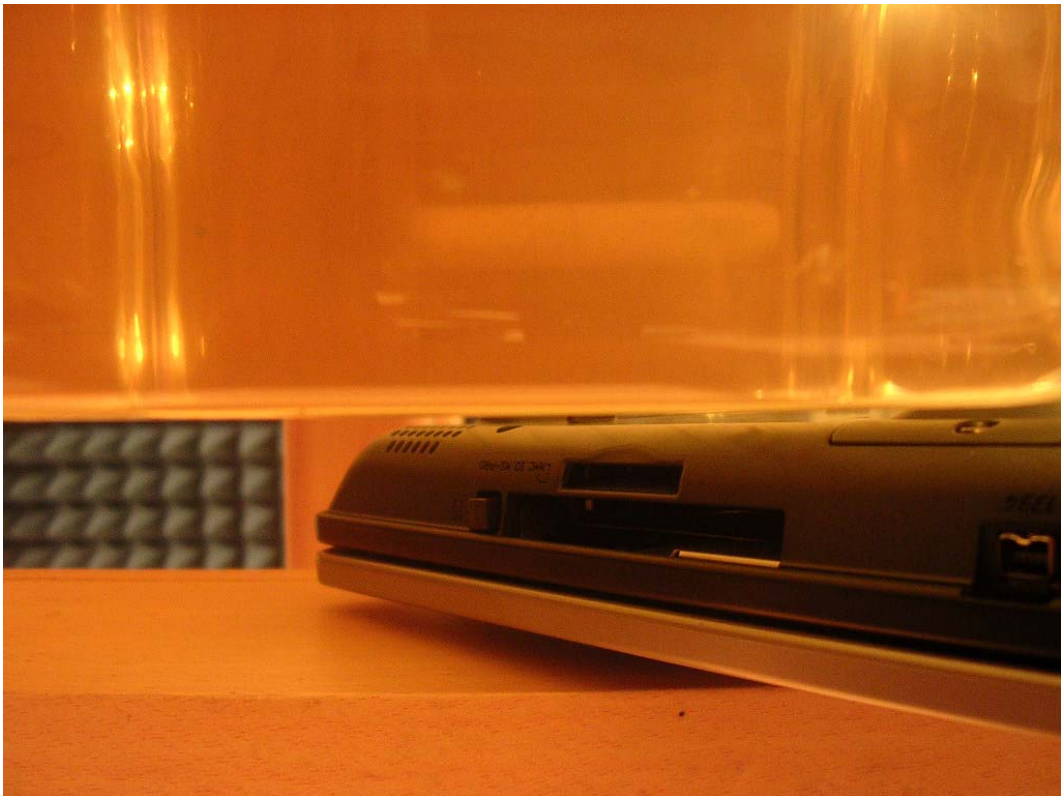

EUT Photographs





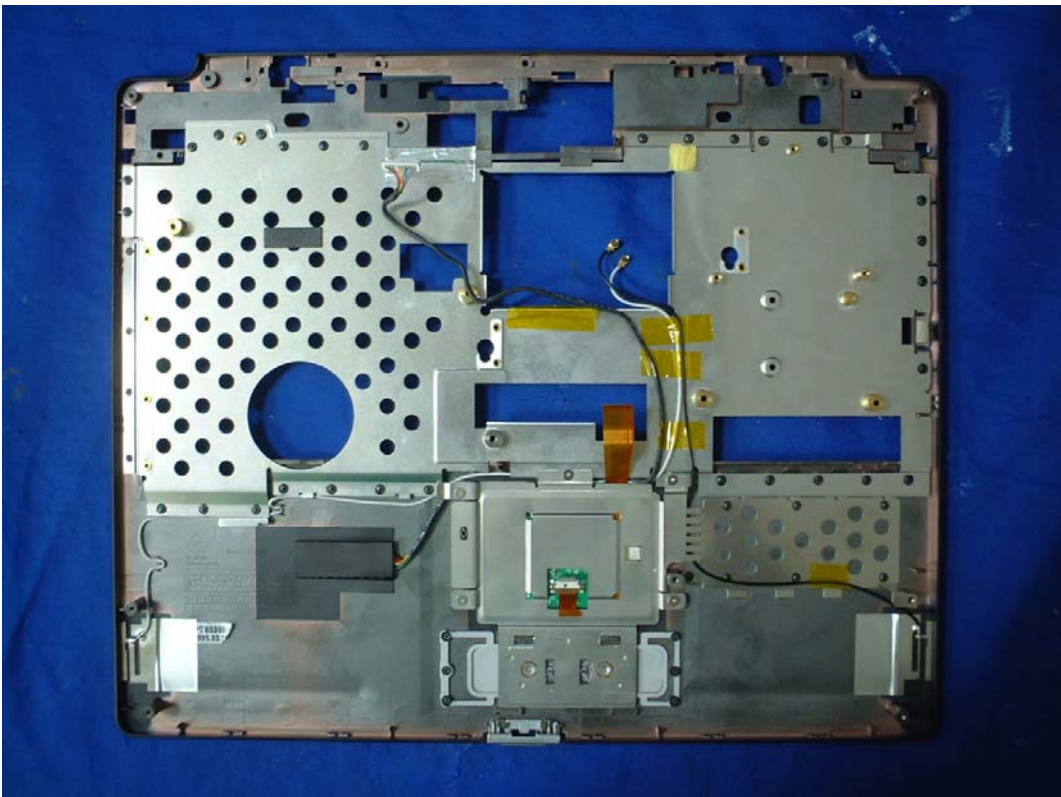

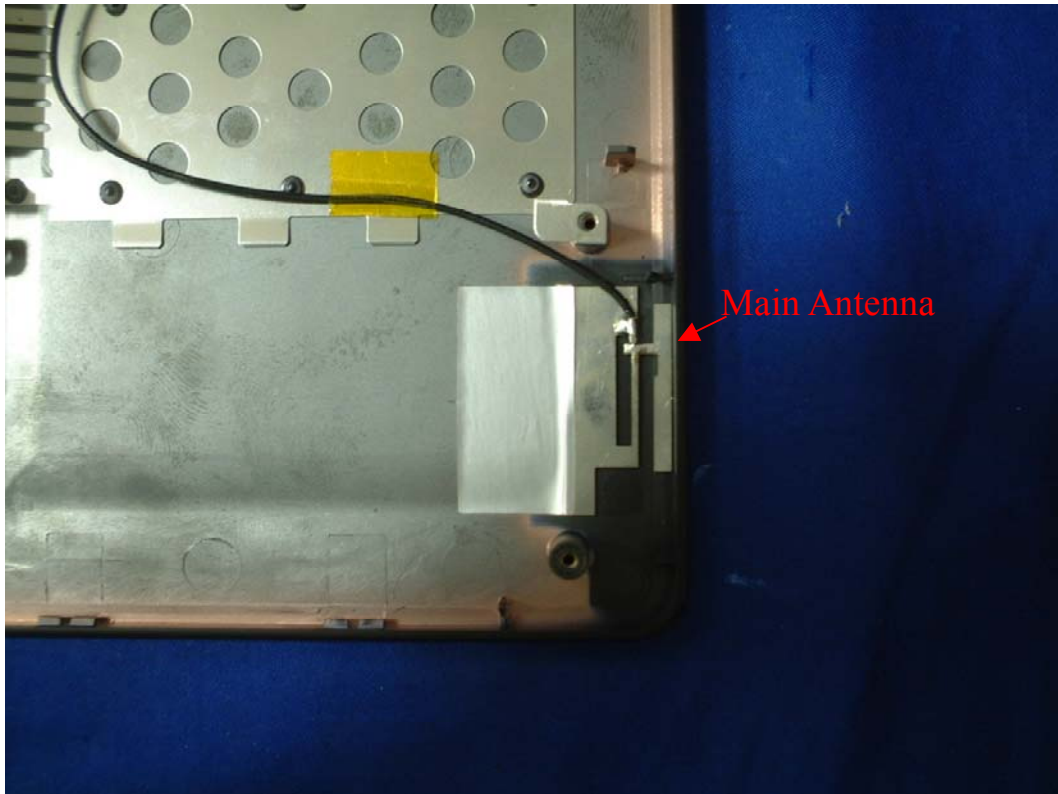

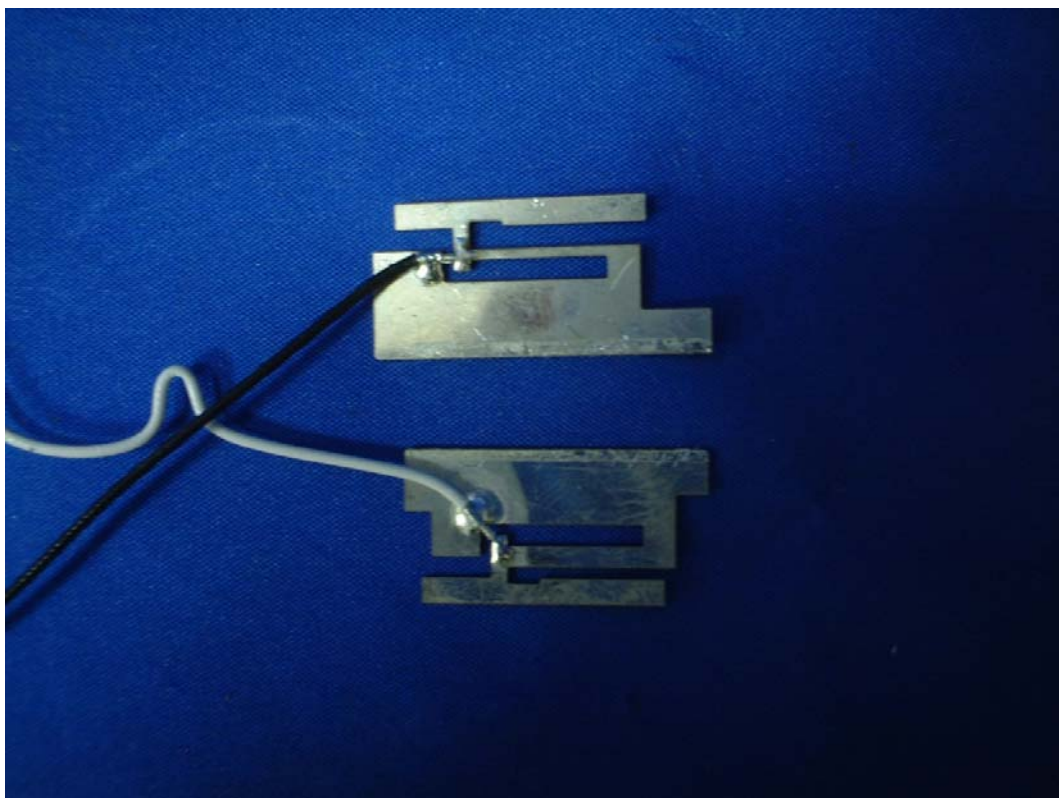



Appendix - Probe Calibration

Miniature Isotropic RF Probe

M/N: ALS-E-020

S/N: 265

2450MHz Head Calibration page2~11

2450MHz Body Calibration page12~21