

# FCC Test Report

## (PART 22)

**Report No.:** RF170210C14-5

**FCC ID:** MSQASUS-P00J

**Test Model:** ASUS\_P00J

**Received Date:** Feb. 10, 2017

**Test Date:** Feb. 25, 2017 ~ Mar. 16, 2017

**Issued Date:** Mar. 31, 2017

**Applicant:** ASUSTek COMPUTER INC.

**Address:** 4F, No. 150, LI-TE Rd., PEITOU, TAIPEI 112, TAIWAN

**Issued By:** Bureau Veritas Consumer Products Services (H.K.) Ltd., Taoyuan Branch

**Lab Address:** No. 47-2, 14th Ling, Chia Pau Vil., Lin Kou Dist., New Taipei City, Taiwan  
( R.O.C )

**Test Location (1):** No. 19, Hwa Ya 2nd Rd, Wen Hwa Tsuen, Kwei Shan Hsiang, Taoyuan  
Hsien 333, Taiwan, R.O.C.

**Test Location (2):** No.215, Sec. 3, Beixin Rd., Xindian Dist., New Taipei City 231, Taiwan,  
R.O.C



This report is for your exclusive use. Any copying or replication of this report to or for any other person or entity, or use of our name or trademark, is permitted only with our prior written permission. This report sets forth our findings solely with respect to the test samples identified herein. The results set forth in this report are not indicative or representative of the quality or characteristics of the lot from which a test sample was taken or any similar or identical product unless specifically and expressly noted. Our report includes all of the tests requested by you and the results thereof based upon the information that you provided to us. You have 60 days from date of issuance of this report to notify us of any material error or omission caused by our negligence, provided, however, that such notice shall be in writing and shall specifically address the issue you wish to raise. A failure to raise such issue within the prescribed time shall constitute your unqualified acceptance of the completeness of this report, the tests conducted and the correctness of the report contents. Unless specific mention, the uncertainty of measurement has been explicitly taken into account to declare the compliance or non-compliance to the specification. The report must not be used by the client to claim product certification, approval, or endorsement by TAF or any government agencies

## Table of Contents

<b>Release Control Record</b> .....	<b>3</b>
<b>1 Certificate of Conformity</b> .....	<b>4</b>
<b>2 Summary of Test Results</b> .....	<b>5</b>
2.1 Measurement Uncertainty .....	5
2.2 Test Site and Instruments .....	6
<b>3 General Information</b> .....	<b>8</b>
3.1 General Description of EUT .....	8
3.2 Configuration of System under Test .....	9
3.2.1 Description of Support Units .....	9
3.3 Test Mode Applicability and Tested Channel Detail .....	10
3.4 EUT Operating Conditions .....	11
3.5 General Description of Applied Standards .....	11
<b>4 Test Types and Results</b> .....	<b>12</b>
4.1 Output Power Measurement .....	12
4.1.1 Limits of Output Power Measurement .....	12
4.1.2 Test Procedures .....	12
4.1.3 Test Setup .....	13
4.1.4 Test Results .....	14
4.2 Frequency Stability Measurement .....	17
4.2.1 Limits of Frequency Stability Measurement .....	17
4.2.2 Test Procedure .....	17
4.2.3 Test Setup .....	17
4.2.4 Test Results .....	18
4.3 Occupied Bandwidth Measurement .....	22
4.3.1 Test Procedure .....	22
4.3.2 Test Setup .....	22
4.3.3 Test Result .....	23
4.4 Band Edge Measurement .....	25
4.4.1 Limits of Band Edge Measurement .....	25
4.4.2 Test Setup .....	25
4.4.3 Test Procedures .....	25
4.4.4 Test Results .....	26
4.5 Peak to Average Ratio .....	30
4.5.1 Limits of Peak to Average Ratio Measurement .....	30
4.5.2 Test Setup .....	30
4.5.3 Test Procedures .....	30
4.5.4 Test Results .....	31
4.6 Conducted Spurious Emissions .....	33
4.6.1 Limits of Conducted Spurious Emissions Measurement .....	33
4.6.2 Test Setup .....	33
4.6.3 Test Procedure .....	33
4.6.4 Test Results .....	34
4.7 Radiated Emission Measurement .....	38
4.7.1 Limits of Radiated Emission Measurement .....	38
4.7.2 Test Procedure .....	38
4.7.3 Deviation from Test Standard .....	38
4.7.4 Test Setup .....	38
4.7.5 Test Results .....	39
<b>5 Pictures of Test Arrangements</b> .....	<b>45</b>
<b>Appendix – Information on the Testing Laboratories</b> .....	<b>46</b>

### Release Control Record

Issue No.	Description	Date Issued
RF170210C14-5	Original Release	Mar. 31, 2017

## 1 Certificate of Conformity

**Product:** ASUS Tablet

**Brand:** ASUS

**Test Model:** ASUS\_P00J

**Sample Status:** Identical Prototype

**Applicant:** ASUSTek COMPUTER INC.

**Test Date:** Feb. 25, 2017 ~ Mar. 16, 2017

**Standards:** FCC Part 22, Subpart H

The above equipment has been tested by **Bureau Veritas Consumer Products Services (H.K.) Ltd., Taoyuan Branch**, and found compliance with the requirement of the above standards. The test record, data evaluation & Equipment Under Test (EUT) configurations represented herein are true and accurate accounts of the measurements of the sample's EMC characteristics under the conditions specified in this report.

**Prepared by :**  , **Date:** Mar. 31, 2017

Ivonne Wu / Supervisor

**Approved by :**  , **Date:** Mar. 31, 2017

David Huang / Project Engineer

## 2 Summary of Test Results

Applied Standard: FCC Part 22 & Part 2			
FCC Clause	Test Item	Result	Remarks
2.1046 22.913 (a)	Effective Radiated Power	Pass	Meet the requirement of limit.
---	Peak to Average Ratio	Pass	Meet the requirement of limit.
2.1055 22.355	Frequency Stability	Pass	Meet the requirement of limit.
2.1049	Occupied Bandwidth	Pass	Meet the requirement of limit.
22.917	Band Edge Measurements	Pass	Meet the requirement of limit.
2.1051 22.917	Conducted Spurious Emissions	Pass	Meet the requirement of limit.
2.1053 22.917	Radiated Spurious Emissions	Pass	Meet the requirement of limit. Minimum passing margin is -31.38 dB at 162.03 MHz.

### 2.1 Measurement Uncertainty

Where relevant, the following measurement uncertainty levels have been estimated for tests performed on the EUT as specified in CISPR 16-4-2:

Measurement	Frequency	Expanded Uncertainty (k=2) (±)
Conducted Emissions at mains ports	150 kHz ~ 30 MHz	2.44 dB
Radiated Emissions up to 1 GHz	30 MHz ~ 200 MHz	2.0153 dB
	200 MHz ~ 1000 MHz	2.0224 dB
Radiated Emissions above 1 GHz	1 GHz ~ 18 GHz	1.0121 dB
	18 GHz ~ 40 GHz	1.1508 dB

## 2.2 Test Site and Instruments

Description & Manufacturer	Model No.	Serial No.	Date of Calibration	Due Date of Calibration
Test Receiver Agilent Technologies	N9038A	MY52260177	Jun. 21, 2016	Jun. 20, 2017
Spectrum Analyzer ROHDE & SCHWARZ	FSU43	101261	Dec. 13, 2016	Dec. 12, 2017
BILOG Antenna SCHWARZBECK	VULB9168	9168-472	Dec. 16, 2016	Dec. 15, 2017
HORN Antenna ETS-Lindgren	3117	00143293	Dec. 29, 2016	Dec. 28, 2017
Double Ridge Guide Horn Antenna EMCO	3115	5619	Dec. 27, 2016	Dec. 26, 2017
BILOG Antenna SCHWARZBECK	VULB 9168	9168-153	Dec. 13, 2016	Dec. 12, 2017
HORN Antenna SCHWARZBECK	BBHA 9170	9170-480	Dec. 14, 2016	Dec. 13, 2017
Fixed Attenuator Mini-Circuits	BW-N10W5+	NA	Jul. 08, 2016	Jul. 07, 2017
MXG Vector signal generator Agilent	N5182B	MY53050430	Oct. 19, 2016	Oct. 18, 2017
Preamplifier Agilent	310N	187226	Jun. 24, 2016	Jun. 23, 2017
Preamplifier Agilent	83017A	MY39501357	Jun. 24, 2016	Jun. 23, 2017
Power Meter Anritsu	ML2495A	1232002	Sep. 08, 2016	Sep. 07, 2017
Power Sensor Anritsu	MA2411B	1207325	Sep. 08, 2016	Sep. 07, 2017
RF signal cable ETS-LINDGREN	5D-FB	Cable-CH1-01(R FC-SMS-100-SM S-120+RFC-SMS -100-SMS-400)	Jun. 24, 2016	Jun. 23, 2017
RF signal cable ETS-LINDGREN	8D-FB	Cable-CH1-02(R FC-SMS-100-SM S-24)	Jun. 24, 2016	Jun. 23, 2017
Software BV ADT	E3 8.130425b	NA	NA	NA
Antenna Tower MF	NA	NA	NA	NA
Turn Table MF	NA	NA	NA	NA
Antenna Tower & Turn Table Controller MF	MF-7802	NA	NA	NA
Fixed Attenuator Mini-Circuits	BW-N10W5+	NA	Jul. 08, 2016	Jul. 07, 2017
Communications Tester-Wireless Agilent	8960 Series 10	MY53201073	Jul. 03, 2015	Jul. 02, 2017
Radio Communication Analyzer Anritsu	MT8820C	6201300640	Aug. 10, 2015	Aug. 09, 2017

- Note:
1. The calibration interval of the above test instruments is 12 / 24 months and the calibrations are traceable to NML/ROC and NIST/USA.
  2. The test was performed in HsinTien Chamber 1.
  3. The horn antenna and preamplifier (model: 83017A) are used only for the measurement of emission frequency above 1 GHz if tested.
  4. The FCC Site Registration No. is 149147.
  5. The IC Site Registration No. is IC7450I-1.

### 3 General Information

#### 3.1 General Description of EUT

<b>Product</b>	ASUS Tablet	
<b>Brand</b>	ASUS	
<b>Test Model</b>	ASUS_P00J	
<b>Status of EUT</b>	Identical Prototype	
<b>Power Supply Rating</b>	5.0 Vdc (adapter or host equipment) 3.85 Vdc (Li-ion battery)	
<b>Modulation Type</b>	LTE	QPSK, 16QAM
<b>Frequency Range</b>	LTE 5 (Channel Bandwidth: 1.4 MHz)	824.7 ~ 848.3 MHz
	LTE 5 (Channel Bandwidth: 3 MHz)	825.5 ~ 847.5 MHz
	LTE 5 (Channel Bandwidth: 5 MHz)	826.5 ~ 846.5 MHz
	LTE 5 (Channel Bandwidth: 10 MHz)	829 ~ 844 MHz
<b>Max. ERP Power</b>	LTE 5 (Channel Bandwidth: 1.4 MHz)	321.96 mW
	LTE 5 (Channel Bandwidth: 3 MHz)	322.85 mW
	LTE 5 (Channel Bandwidth: 5 MHz)	319.74 mW
	LTE 5 (Channel Bandwidth: 10 MHz)	322.26 mW
<b>Emission Designator</b>	LTE 5 (Channel Bandwidth: 1.4 MHz)	1M09W7D
	LTE 5 (Channel Bandwidth: 3 MHz)	2M70G7D
	LTE 5 (Channel Bandwidth: 5 MHz)	4M49W7D
	LTE 5 (Channel Bandwidth: 10 MHz)	8M97W7D
<b>Antenna Type</b>	Fixed Internal Antenna	
<b>Accessory Device</b>	Refer to Note as below	
<b>Data Cable Supplied</b>	Refer to Note as below	

Note:

1. The EUT's accessories list refers to Ext. Pho.
2. The above EUT information is declared by manufacturer and for more detailed features description, please refer to the manufacturer's specifications or user's manual.



### 3.2 Configuration of System under Test

#### <Radiated Emission Test>

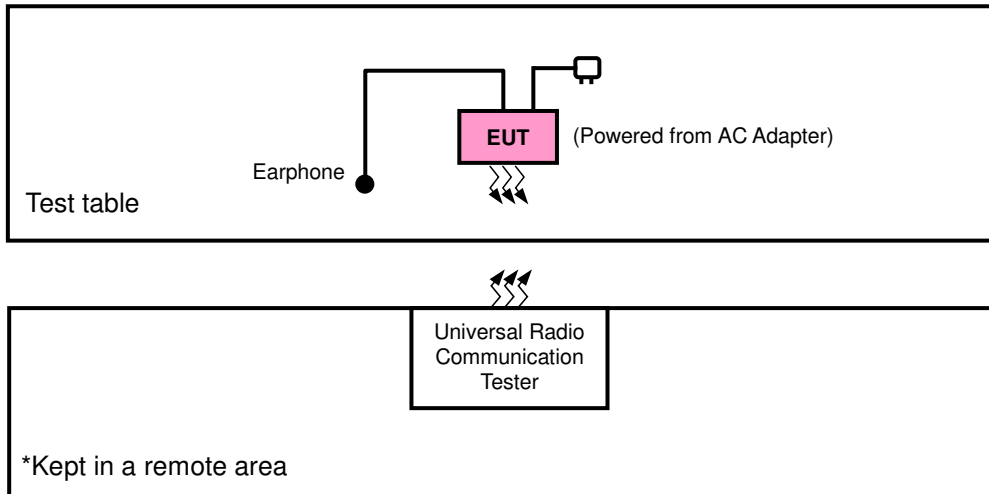

#### <E.R.P. Test>

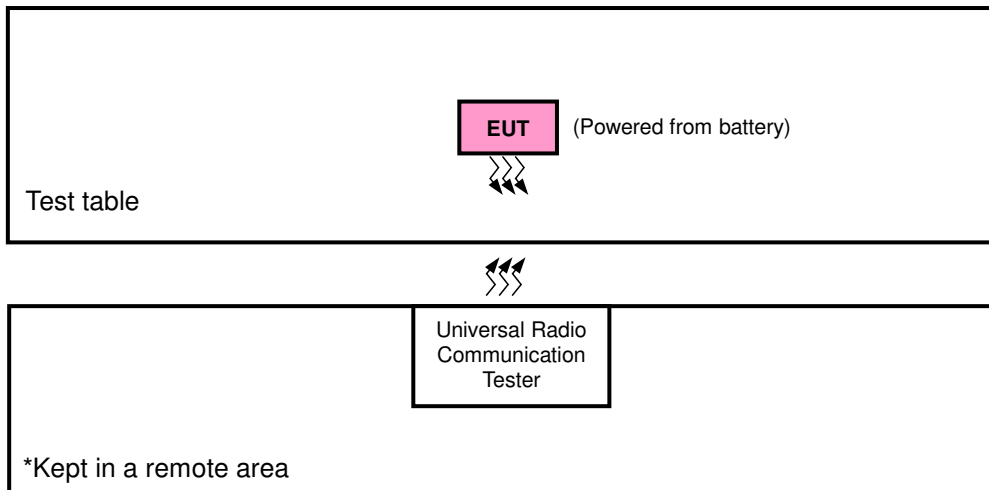

#### 3.2.1 Description of Support Units

The EUT has been tested as an independent unit together with other necessary accessories or support units. The following support units or accessories were used to form a representative test configuration during the tests.

No.	Product	Brand	Model No.	Serial No.	FCC ID
1.	Earphone	Funkey	FK-130102	N/A	N/A

No.	Signal Cable Description Of The Above Support Units
1.	N/A

Note:

1. All power cords of the above support units are non-shielded (1.8m).

### 3.3 Test Mode Applicability and Tested Channel Detail

Pre-Scan has been conducted to determine the worst-case mode from all possible combinations between available modulations, data rates, XYZ axis, and antenna ports.

The worst case was found when positioned as the table below. Following channel(s) was (were) selected for the final test as listed below:

Band	ERP	Radiated Emission
LTE Band 5	Y-plane	Y-axis

#### LTE Band 5

EUT Configure Mode	Test Item	Available Channel	Tested Channel	Channel Bandwidth	Modulation	Mode
-	ERP	20407 to 20643	20407, 20525, 20643	1.4 MHz	QPSK, 16QAM	1 RB / 2 RB Offset
		20415 to 20635	20415, 20525, 20635	3 MHz	QPSK, 16QAM	1 RB / 7 RB Offset
		20425 to 20625	20425, 20525, 20625	5 MHz	QPSK, 16QAM	1 RB / 12 RB Offset
		20450 to 20600	20450, 20525, 20600	10 MHz	QPSK, 16QAM	1 RB / 24 RB Offset
-	Frequency Stability	20407 to 20643	20407, 20643	1.4 MHz	QPSK	1 RB / 2 RB Offset
		20415 to 20635	20415, 20635	3 MHz	QPSK	1 RB / 7 RB Offset
		20425 to 20625	20425, 20625	5 MHz	QPSK	1 RB / 12 RB Offset
		20450 to 20600	20450, 20600	10 MHz	QPSK	1 RB / 24 RB Offset
-	Occupied Bandwidth	20407 to 20643	20407, 20525, 20643	1.4 MHz	QPSK, 16QAM	6 RB / 0 RB Offset
		20415 to 20635	20415, 20525, 20635	3 MHz	QPSK, 16QAM	15 RB / 0 RB Offset
		20425 to 20625	20425, 20525, 20625	5 MHz	QPSK, 16QAM	25 RB / 0 RB Offset
		20450 to 20600	20450, 20525, 20600	10 MHz	QPSK, 16QAM	50 RB / 0 RB Offset
-	Band Edge	20407 to 20643	20407	1.4MHz	QPSK	1 RB / 0 RB Offset
			20643	1.4MHz	QPSK	6 RB / 0 RB Offset
		20415 to 20635	20415	3 MHz	QPSK	1 RB / 5 RB Offset
			20635	3 MHz	QPSK	6 RB / 0 RB Offset
		20425 to 20625	20415	3 MHz	QPSK	1 RB / 0 RB Offset
			20635	3 MHz	QPSK	15 RB / 0 RB Offset
		20425 to 20625	20425	5 MHz	QPSK	1 RB / 14 RB Offset
			20625	5 MHz	QPSK	15 RB / 0 RB Offset
		20450 to 20600	20425	5 MHz	QPSK	1 RB / 0 RB Offset
			20625	5 MHz	QPSK	25 RB / 0 RB Offset
		20450 to 20600	20450	10 MHz	QPSK	1 RB / 24 RB Offset
			20600	10 MHz	QPSK	25 RB / 0 RB Offset
20450 to 20600	20450	10 MHz	QPSK	1 RB / 0 RB Offset		
	20600	10 MHz	QPSK	50 RB / 0 RB Offset		
20450 to 20600	20450	10 MHz	QPSK	1 RB / 49 RB Offset		
	20600	10 MHz	QPSK	50 RB / 0 RB Offset		

EUT Configure Mode	Test Item	Available Channel	Tested Channel	Channel Bandwidth	Modulation	Mode
-	Peak to Average Ratio	20407 to 20643	20407, 20525, 20643	1.4 MHz	QPSK, 16QAM	1 RB / 2 RB Offset
		20415 to 20635	20415, 20525, 20635	3 MHz	QPSK, 16QAM	1 RB / 7 RB Offset
		20425 to 20625	20425, 20525, 20625	5 MHz	QPSK, 16QAM	1 RB / 12 RB Offset
		20450 to 20600	20450, 20525, 20600	10 MHz	QPSK, 16QAM	1 RB / 24 RB Offset
-	Conducted Emission	20407 to 20643	20407, 20525, 20643	1.4 MHz	QPSK	1 RB / 2 RB Offset
		20415 to 20635	20415, 20525, 20635	3 MHz	QPSK	1 RB / 7 RB Offset
		20425 to 20625	20425, 20525, 20625	5 MHz	QPSK	1 RB / 12 RB Offset
		20450 to 20600	20450, 20525, 20600	10 MHz	QPSK	1 RB / 24 RB Offset
-	Radiated Emission	20450 to 20600	20450, 20525, 20600	10 MHz	QPSK	1 RB / 24 RB Offset

**Note:** This device was tested under all bandwidths, RB configurations and modulations. The worst case was found in QPSK modulation.

#### **Test Condition:**

Test Item	Environmental Conditions	Input Power	Tested By
ERP	25 deg. C, 65 % RH	3.85 Vdc	Karl Lee
Frequency Stability	25 deg. C, 65 % RH	3.85 Vdc	Anson Lin
Occupied Bandwidth	25 deg. C, 65 % RH	3.85 Vdc	Anson Lin
Band Edge	25 deg. C, 65 % RH	3.85 Vdc	Anson Lin
Peak to Average Ratio	25 deg. C, 65 % RH	3.85 Vdc	Anson Lin
Condcudeted Emission	25 deg. C, 65 % RH	3.85 Vdc	Anson Lin
Radiated Emission	25 deg. C, 65 % RH	120 Vac, 60 Hz	Karl Lee

### **3.4 EUT Operating Conditions**

The EUT makes a call to the communication simulator. The communication simulator station system controlled a EUT to export maximum output power under transmission mode and specific channel frequency.

### **3.5 General Description of Applied Standards**

The EUT is a RF Product. According to the specifications of the manufacturer, it must comply with the requirements of the following standards:

**FCC 47 CFR Part 2**

**FCC 47 CFR Part 22**

**KDB 971168 D01 Power Meas License Digital Systems v02r02**

**ANSI/TIA/EIA-603-D 2010**

**Note:** All test items have been performed and recorded as per the above standards.

## 4 Test Types and Results

### 4.1 Output Power Measurement

#### 4.1.1 Limits of Output Power Measurement

Mobile / Portable station are limited to 7 watts e.r.p.

#### 4.1.2 Test Procedures

##### **EIRP / ERP Measurement:**

- a. All measurements were done at low, middle and high operational frequency range. RBW and VBW is 10 MHz for LTE mode.
- b. Substitution method is used for E.I.R.P measurement. In the semi-anechoic chamber, EUT placed on the 0.8 m height of Turn Table, rotated the table around 360 degrees to search the maximum radiation power and receiver antenna shall be rotated vertical and horizontal polarization and moved height from 1 m to 4 m to find the maximum polar radiated power. The "Read Value" is the spectrum reading the maximum power value.
- c. The substitution horn antenna is substituted for EUT at the same position and signals generator export the CW signal to the substitution antenna via a tx cable. Rotated the Turn Table and moved receiving antenna to find the maximum radiation power. Adjust output power level of S.G to get a Value of spectrum reading equal to "Read Value" of step b. Record the power level of S.G.
- d.  $EIRP = \text{Output power level of S.G} - \text{TX cable loss} + \text{Antenna gain of substitution horn}$ . E.R.P power can be calculated form E.I.R.P power by subtracting the gain of dipole,  $E.R.P \text{ power} = E.I.P.R \text{ power} - 2.15 \text{ dBi}$ .

##### **Conducted Power Measurement:**

The EUT was set up for the maximum power with LTE link data modulation and link up with simulator. Set the EUT to transmit under low, middle and high channel and record the power level shown on simulator.

### 4.1.3 Test Setup

#### EIRP / ERP Measurement:

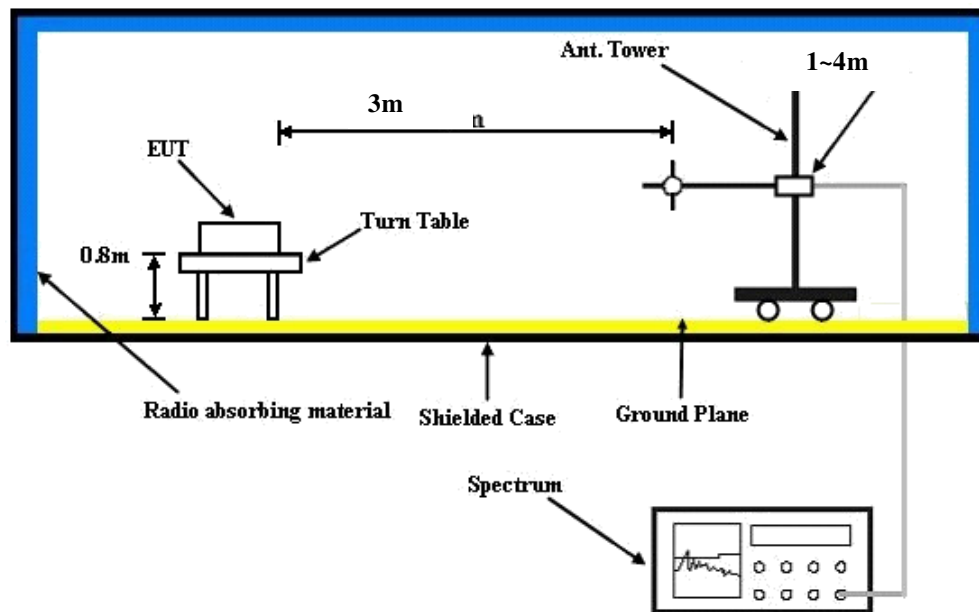

For the actual test configuration, please refer to the attached file (Test Setup Photo).

#### Conducted Power Measurement:

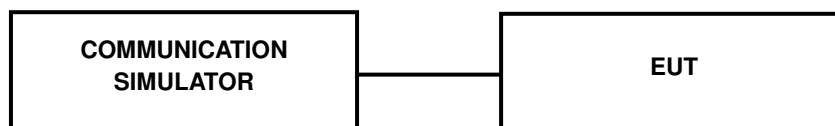

4.1.4 Test Results

Conducted Output Power (dBm)

Band / BW	RB Size	RB Offset	QPSK			3GPP MPR (dB)	16QAM			3GPP MPR (dB)
			Low Ch 20407	Mid Ch 20525	High Ch 20643		Low Ch 20407	Mid Ch 20525	High Ch 20643	
			824.7 MHz	836.5 MHz	848.3 MHz		824.7 MHz	836.5 MHz	848.3 MHz	
5 / 1.4M	1	0	23.84	23.77	23.94	0	22.80	22.73	22.90	1
	1	2	23.95	23.88	24.05	0	22.91	22.84	23.01	1
	1	5	23.90	23.83	24.00	0	22.86	22.79	22.96	1
	3	0	22.93	22.86	23.03	0	21.89	21.82	21.99	1
	3	1	22.94	22.87	23.04	0	21.90	21.83	22.00	1
	3	3	22.88	22.81	22.98	0	21.84	21.77	21.94	1
	6	0	22.89	22.82	22.99	1	21.85	21.78	21.95	2

Band / BW	RB Size	RB Offset	QPSK			3GPP MPR (dB)	16QAM			3GPP MPR (dB)
			Low Ch 20415	Mid Ch 20525	High Ch 20635		Low Ch 20415	Mid Ch 20525	High Ch 20635	
			825.5 MHz	836.5 MHz	847.5 MHz		825.5 MHz	836.5 MHz	847.5 MHz	
5 / 3M	1	0	23.93	23.86	24.03	0	22.89	22.82	22.99	1
	1	7	24.04	23.97	24.14	0	23.00	22.93	23.10	1
	1	14	23.99	23.92	24.09	0	22.95	22.88	23.05	1
	8	0	23.02	22.95	23.12	1	21.98	21.91	22.08	2
	8	3	23.03	22.96	23.13	1	21.99	21.92	22.09	2
	8	7	22.97	22.90	23.07	1	21.93	21.86	22.03	2
	15	0	22.98	22.91	23.08	1	21.94	21.87	22.04	2

Band / BW	RB Size	RB Offset	QPSK			3GPP MPR (dB)	16QAM			3GPP MPR (dB)
			Low Ch 20425	Mid Ch 20525	High Ch 20625		Low Ch 20425	Mid Ch 20525	High Ch 20625	
			826.5 MHz	836.5 MHz	846.5 MHz		826.5 MHz	836.5 MHz	846.5 MHz	
5 / 5M	1	0	24.02	23.95	24.12	0	22.98	22.91	23.08	1
	1	12	24.13	24.06	24.23	0	23.09	23.02	23.19	1
	1	24	24.08	24.01	24.18	0	23.04	22.97	23.14	1
	12	0	23.11	23.04	23.21	1	22.07	22.00	22.17	2
	12	6	23.12	23.05	23.22	1	22.08	22.01	22.18	2
	12	13	23.06	22.99	23.16	1	22.02	21.95	22.12	2
	25	0	23.07	23.00	23.17	1	22.03	21.96	22.13	2

Band / BW	RB Size	RB Offset	QPSK			3GPP MPR (dB)	16QAM			3GPP MPR (dB)
			Low Ch 20450	Mid Ch 20525	High Ch 20600		Low Ch 20450	Mid Ch 20525	High Ch 20600	
			829.0 MHz	836.5 MHz	844.0 MHz		829.0 MHz	836.5 MHz	844.0 MHz	
5 / 10M	1	0	24.15	24.08	24.25	0	23.11	23.04	23.21	1
	1	24	24.26	24.19	24.36	0	23.22	23.15	23.32	1
	1	49	24.21	24.14	24.31	0	23.17	23.10	23.27	1
	25	0	23.24	23.17	23.34	1	22.20	22.13	22.30	2
	25	12	23.25	23.18	23.35	1	22.21	22.14	22.31	2
	25	25	23.19	23.12	23.29	1	22.15	22.08	22.25	2
	50	0	23.20	23.13	23.30	1	22.16	22.09	22.26	2

**ERP Power (dBm)**

LTE Band 5							
Channel Bandwidth: 1.4 MHz / QPSK							
Plane	Channel	Frequency (MHz)	LVL (dBm)	Correction Factor (dB)	ERP (dBm)	ERP (mW)	Polarization (H/V)
Y	20407	824.7	-3.98	31.208	25.08	321.96	H
	20525	836.5	-4.10	31.3	25.05	319.89	
	20643	848.3	-4.02	31.222	25.05	320.04	
	20407	824.7	-9.26	31.504	20.09	102.19	V
	20525	836.5	-8.90	31.117	20.07	101.55	
	20643	848.3	-9.62	31.922	20.15	103.56	
Channel Bandwidth: 1.4 MHz / 16QAM							
Y	20407	824.7	-5.06	31.208	24.00	251.07	H
	20525	836.5	-5.04	31.3	24.11	257.63	
	20643	848.3	-5.02	31.222	24.05	254.21	
	20407	824.7	-10.26	31.504	19.09	81.17	V
	20525	836.5	-9.95	31.117	19.02	79.74	
	20643	848.3	-10.65	31.922	19.12	81.70	

LTE Band 5							
Channel Bandwidth: 3 MHz / QPSK							
Plane	Channel	Frequency (MHz)	LVL (dBm)	Correction Factor (dB)	ERP (dBm)	ERP (mW)	Polarization (H/V)
Y	20415	825.5	-4.00	31.208	25.06	320.48	H
	20525	836.5	-4.06	31.3	25.09	322.85	
	20635	847.5	-4.02	31.222	25.05	320.04	
	20415	825.5	-9.24	31.504	20.11	102.66	V
	20525	836.5	-8.94	31.117	20.03	100.62	
	20635	847.5	-9.71	31.922	20.06	101.44	
Channel Bandwidth: 3 MHz / 16QAM							
Y	20415	825.5	-5.01	31.208	24.05	253.98	H
	20525	836.5	-5.13	31.3	24.02	252.35	
	20635	847.5	-5.03	31.222	24.04	253.63	
	20415	825.5	-10.29	31.504	19.06	80.61	V
	20525	836.5	-9.92	31.117	19.05	80.30	
	20635	847.5	-10.64	31.922	19.13	81.88	

LTE Band 5							
Channel Bandwidth: 5 MHz / QPSK							
Plane	Channel	Frequency (MHz)	LVL (dBm)	Correction Factor (dB)	ERP (dBm)	ERP (mW)	Polarization (H/V)
Y	20425	826.5	-4.01	31.208	25.05	319.74	H
	20525	836.5	-4.14	31.3	25.01	316.96	
	20625	846.5	-4.06	31.222	25.01	317.10	
	20425	826.5	-9.28	31.504	20.07	101.72	V
	20525	836.5	-8.97	31.117	20.00	99.93	
	20625	846.5	-9.74	31.922	20.03	100.74	
Channel Bandwidth: 5 MHz / 16QAM							
Y	20425	826.5	-4.96	31.208	24.10	256.92	H
	20525	836.5	-5.12	31.3	24.03	252.93	
	20625	846.5	-5.01	31.222	24.06	254.80	
	20425	826.5	-10.26	31.504	19.09	81.17	V
	20525	836.5	-9.95	31.117	19.02	79.74	
	20625	846.5	-10.68	31.922	19.09	81.13	

LTE Band 5							
Channel Bandwidth: 10 MHz / QPSK							
Plane	Channel	Frequency (MHz)	LVL (dBm)	Correction Factor (dB)	ERP (dBm)	ERP (mW)	Polarization (H/V)
Y	20450	829.0	-4.03	31.208	25.03	318.27	H
	20525	836.5	-4.10	31.3	25.05	319.89	
	20600	844.0	-3.99	31.222	25.08	322.26	
	20450	829.0	-9.21	31.504	20.14	103.37	V
	20525	836.5	-8.93	31.117	20.04	100.86	
	20600	844.0	-9.58	31.922	20.19	104.52	
Channel Bandwidth: 10 MHz / 16QAM							
Y	20450	829.0	-5.00	31.208	24.06	254.57	H
	20525	836.5	-5.12	31.3	24.03	252.93	
	20600	844.0	-4.89	31.222	24.18	261.94	
	20450	829.0	-10.31	31.504	19.04	80.24	V
	20525	836.5	-9.95	31.117	19.02	79.74	
	20600	844.0	-10.61	31.922	19.16	82.45	



## 4.2 Frequency Stability Measurement

### 4.2.1 Limits of Frequency Stability Measurement

1.5 ppm is for base and fixed station. 2.5 ppm is for mobile station.

### 4.2.2 Test Procedure

- Device is placed at the oven room. The oven room could control the temperatures and humidity. Power warm up is at least 15 min and power applied should perform before recording frequency error.
- EUT is connected the external power supply to control the DC input power. The test voltage range is from minimum to maximum working voltage. Each step shall be record the frequency error rate.
- The temperature range step is 10 degrees in this test items. All temperature levels shall be hold the  $\pm 0.5$  °C during the measurement testing. The each temperature step shall be at least 0.5 hours, consider the EUT could be test under the stability condition.

**NOTE:** The frequency error was recorded frequency error from the communication simulator.

### 4.2.3 Test Setup

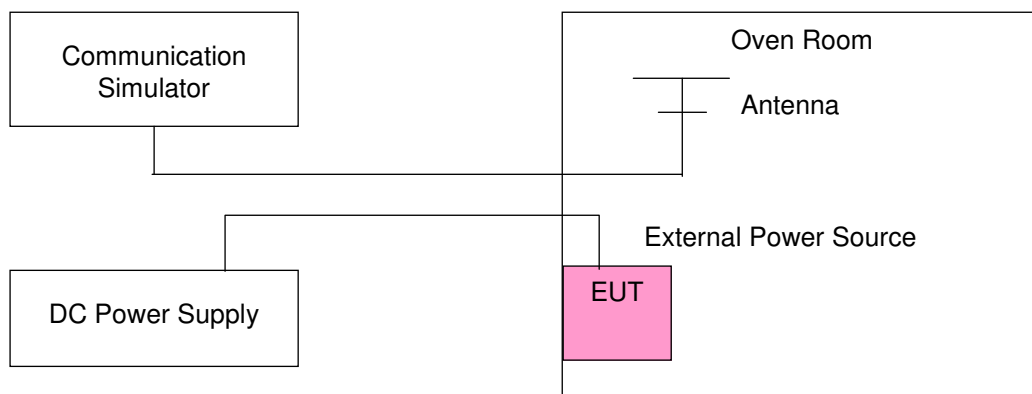

#### 4.2.4 Test Results

##### Frequency Error vs. Voltage

Voltage (Volts)	LTE Band 5				Limit (ppm)
	Channel Bandwidth: 1.4 MHz				
	Low Channel		High Channel		
	Frequency (MHz)	Frequency Error (ppm)	Frequency (MHz)	Frequency Error (ppm)	
3.85	824.700004	0.004	848.300004	0.004	2.5
3.6	824.700004	0.005	848.300002	0.002	2.5
4.4	824.700002	0.003	848.300001	0.001	2.5

**Note:** The applicant defined the normal working voltage of the battery is from 3.6 Vdc to 4.4 Vdc.

##### Frequency Error vs. Temperature

Temp. (°C)	LTE Band 5				Limit (ppm)
	Channel Bandwidth: 1.4 MHz				
	Low Channel		High Channel		
	Frequency (MHz)	Frequency Error (ppm)	Frequency (MHz)	Frequency Error (ppm)	
-30	824.700002	0.003	848.300002	0.003	2.5
-20	824.700002	0.002	848.300003	0.003	2.5
-10	824.700002	0.002	848.300002	0.002	2.5
0	824.700002	0.002	848.300002	0.002	2.5
10	824.700003	0.003	848.300003	0.003	2.5
20	824.699996	-0.004	848.299998	-0.002	2.5
30	824.699998	-0.003	848.299998	-0.002	2.5
40	824.699997	-0.003	848.299997	-0.004	2.5
50	824.699998	-0.003	848.299999	-0.001	2.5
55	824.699999	-0.001	848.299997	-0.003	2.5

## Frequency Error vs. Voltage

Voltage (Volts)	LTE Band 5				Limit (ppm)
	Channel Bandwidth: 3 MHz				
	Low Channel		High Channel		
	Frequency (MHz)	Frequency Error (ppm)	Frequency (MHz)	Frequency Error (ppm)	
3.85	825.500003	0.003	847.500001	0.002	2.5
3.6	825.500001	0.002	847.500002	0.002	2.5
4.4	825.500002	0.002	847.500002	0.002	2.5

**Note:** The applicant defined the normal working voltage of the battery is from 3.6 Vdc to 4.4 Vdc.

## Frequency Error vs. Temperature

Temp. (°C)	LTE Band 5				Limit (ppm)
	Channel Bandwidth: 3 MHz				
	Low Channel		High Channel		
	Frequency (MHz)	Frequency Error (ppm)	Frequency (MHz)	Frequency Error (ppm)	
-30	825.500003	0.003	847.500002	0.002	2.5
-20	825.500002	0.003	847.500002	0.002	2.5
-10	825.500003	0.004	847.500001	0.001	2.5
0	825.500001	0.002	847.500003	0.004	2.5
10	825.500001	0.001	847.500003	0.003	2.5
20	825.499996	-0.005	847.499998	-0.002	2.5
30	825.499998	-0.002	847.499996	-0.005	2.5
40	825.499998	-0.002	847.499998	-0.002	2.5
50	825.499996	-0.004	847.499998	-0.002	2.5
55	825.499999	-0.001	847.499998	-0.003	2.5

Frequency Error vs. Voltage

Voltage (Volts)	LTE Band 5				Limit (ppm)
	Channel Bandwidth: 5 MHz				
	Low Channel		High Channel		
	Frequency (MHz)	Frequency Error (ppm)	Frequency (MHz)	Frequency Error (ppm)	
3.85	826.500001	0.001	846.500002	0.002	2.5
3.6	826.500003	0.004	846.500001	0.002	2.5
4.4	826.500004	0.005	846.500003	0.003	2.5

**Note:** The applicant defined the normal working voltage of the battery is from 3.6 Vdc to 4.4 Vdc.

Frequency Error vs. Temperature

Temp. (°C)	LTE Band 5				Limit (ppm)
	Channel Bandwidth: 5 MHz				
	Low Channel		High Channel		
	Frequency (MHz)	Frequency Error (ppm)	Frequency (MHz)	Frequency Error (ppm)	
-30	826.500002	0.003	846.500003	0.003	2.5
-20	826.500002	0.003	846.500002	0.003	2.5
-10	826.500001	0.002	846.500003	0.003	2.5
0	826.500001	0.001	846.500003	0.004	2.5
10	826.500002	0.002	846.500001	0.002	2.5
20	826.499998	-0.002	846.499997	-0.004	2.5
30	826.499999	-0.001	846.499997	-0.004	2.5
40	826.499998	-0.003	846.499996	-0.005	2.5
50	826.499997	-0.004	846.499999	-0.001	2.5
55	826.499996	-0.004	846.499997	-0.003	2.5

Frequency Error vs. Voltage

Voltage (Volts)	LTE Band 5				Limit (ppm)
	Channel Bandwidth: 10 MHz				
	Low Channel		High Channel		
	Frequency (MHz)	Frequency Error (ppm)	Frequency (MHz)	Frequency Error (ppm)	
3.85	829.000004	0.004	844.000001	0.002	2.5
3.6	829.000003	0.004	844.000002	0.002	2.5
4.4	829.000004	0.004	844.000002	0.002	2.5

**Note:** The applicant defined the normal working voltage of the battery is from 3.6 Vdc to 4.4 Vdc.

Frequency Error vs. Temperature

Temp. (°C)	LTE Band 5				Limit (ppm)
	Channel Bandwidth: 10 MHz				
	Low Channel		High Channel		
	Frequency (MHz)	Frequency Error (ppm)	Frequency (MHz)	Frequency Error (ppm)	
-30	829.000002	0.003	844.000002	0.002	2.5
-20	829.000003	0.003	844.000003	0.003	2.5
-10	829.000001	0.001	844.000003	0.004	2.5
0	829.000002	0.002	844.000001	0.002	2.5
10	829.000001	0.001	844.000003	0.004	2.5
20	828.999999	-0.002	843.999999	-0.001	2.5
30	828.999998	-0.002	843.999998	-0.002	2.5
40	828.999997	-0.004	843.999997	-0.003	2.5
50	828.999998	-0.002	843.999998	-0.002	2.5
55	828.999998	-0.002	843.999997	-0.003	2.5

### 4.3 Occupied Bandwidth Measurement

#### 4.3.1 Test Procedure

The EUT makes a call to the communication simulator. All measurements were done at low, middle and high operational frequency range. The communication simulator station system controlled a EUT to export maximum output power under transmission mode and specific channel frequency. Use OBW measurement function of Spectrum analyzer to measure 99 % occupied bandwidth.

#### 4.3.2 Test Setup

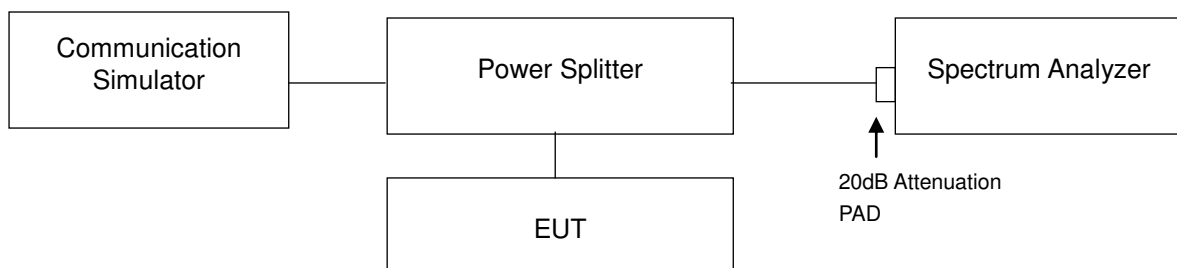

### 4.3.3 Test Result

LTE Band 5							
Channel Bandwidth: 1.4 MHz				Channel Bandwidth: 3 MHz			
Channel	Frequency (MHz)	99 % Occupied Bandwidth (MHz)		Channel	Frequency (MHz)	99 % Occupied Bandwidth (MHz)	
		QPSK	16QAM			QPSK	16QAM
20407	824.7	1.0873	1.0887	20415	825.5	2.6987	2.6959
20525	836.5	1.0870	1.0901	20525	836.5	2.7010	2.6950
20643	848.3	1.0865	1.0875	20635	847.5	2.7014	2.6948

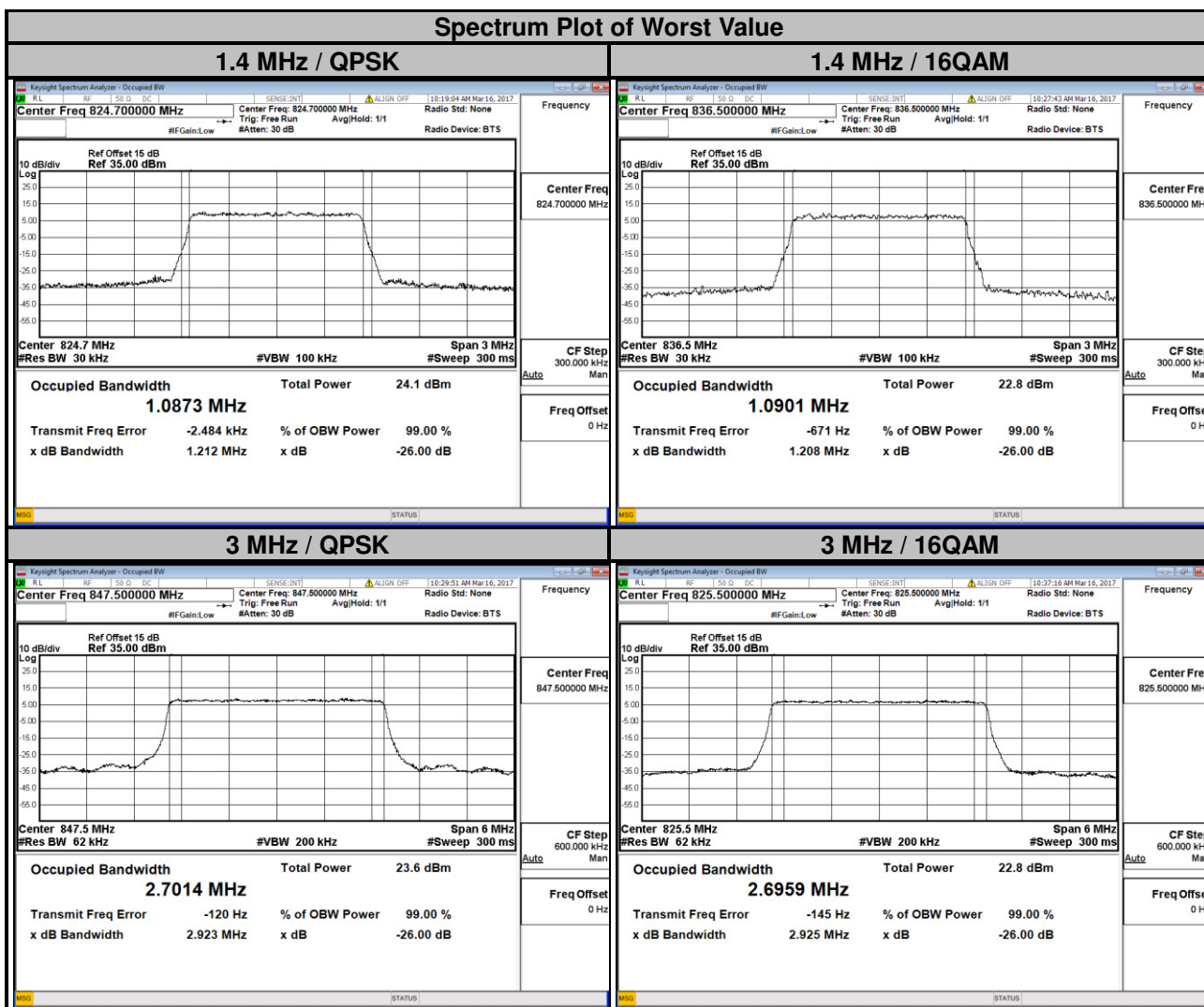

### LTE Band 5

Channel Bandwidth: 5 MHz				Channel Bandwidth: 10 MHz			
Channel	Frequency (MHz)	99 % Occupied Bandwidth (MHz)		Channel	Frequency (MHz)	99 % Occupied Bandwidth (MHz)	
		QPSK	16QAM			QPSK	16QAM
20425	826.5	4.4870	4.4911	20450	829.0	8.9701	8.9698
20525	836.5	4.4856	4.4884	20525	836.5	8.9528	8.9544
20625	846.5	4.4852	4.4882	20600	844.0	8.9690	8.9738

### Spectrum Plot of Worst Value

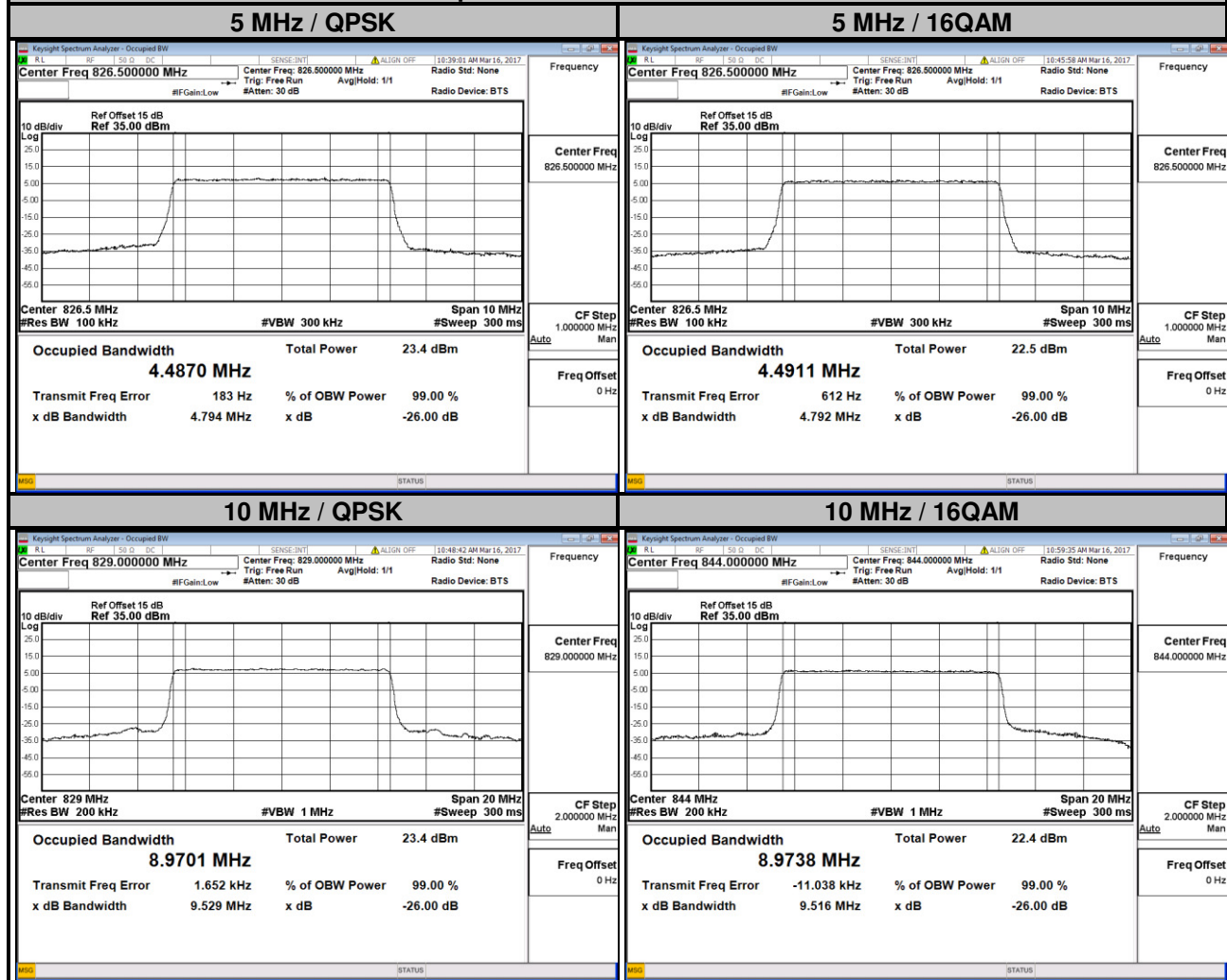



## 4.4 Band Edge Measurement

### 4.4.1 Limits of Band Edge Measurement

Power of any emission outside of the authorized operating frequency ranges must be attenuated below the transmitting power (P) by a factor of at least  $43 + 10 \log(P)$  dB. In the 1 MHz bands immediately outside and adjacent to the frequency block a resolution bandwidth of at least one percent of the emission bandwidth of the fundamental emission of the transmitter may be employed.

### 4.4.2 Test Setup

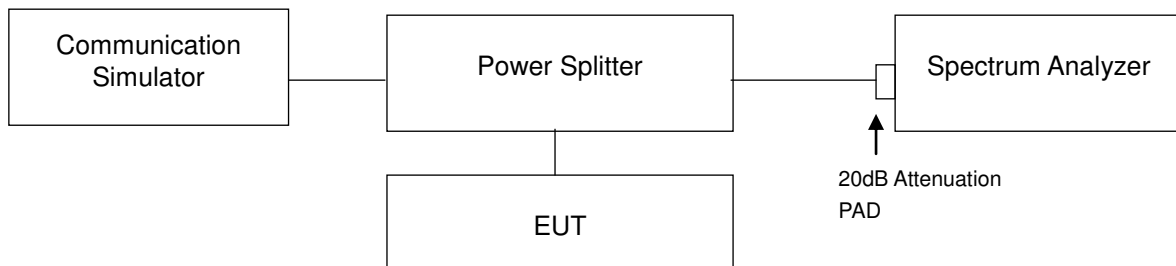

### 4.4.3 Test Procedures

- a. All measurements were done at low and high operational frequency range.
- b. The center frequency of spectrum is the band edge frequency and span is 1 MHz. RB of the spectrum is 13 kHz and VB of the spectrum is 51 kHz (LTE Bandwidth 1.4 MHz).
- c. The center frequency of spectrum is the band edge frequency and span is 1 MHz. RB of the spectrum is 30 kHz and VB of the spectrum is 100 kHz (LTE Bandwidth 3 MHz).
- d. The center frequency of spectrum is the band edge frequency and span is 1 MHz. RB of the spectrum is 100 kHz and VB of the spectrum is 300 kHz (LTE Bandwidth 5 MHz/10 MHz).
- e. Record the max trace plot into the test report.

4.4.4 Test Results

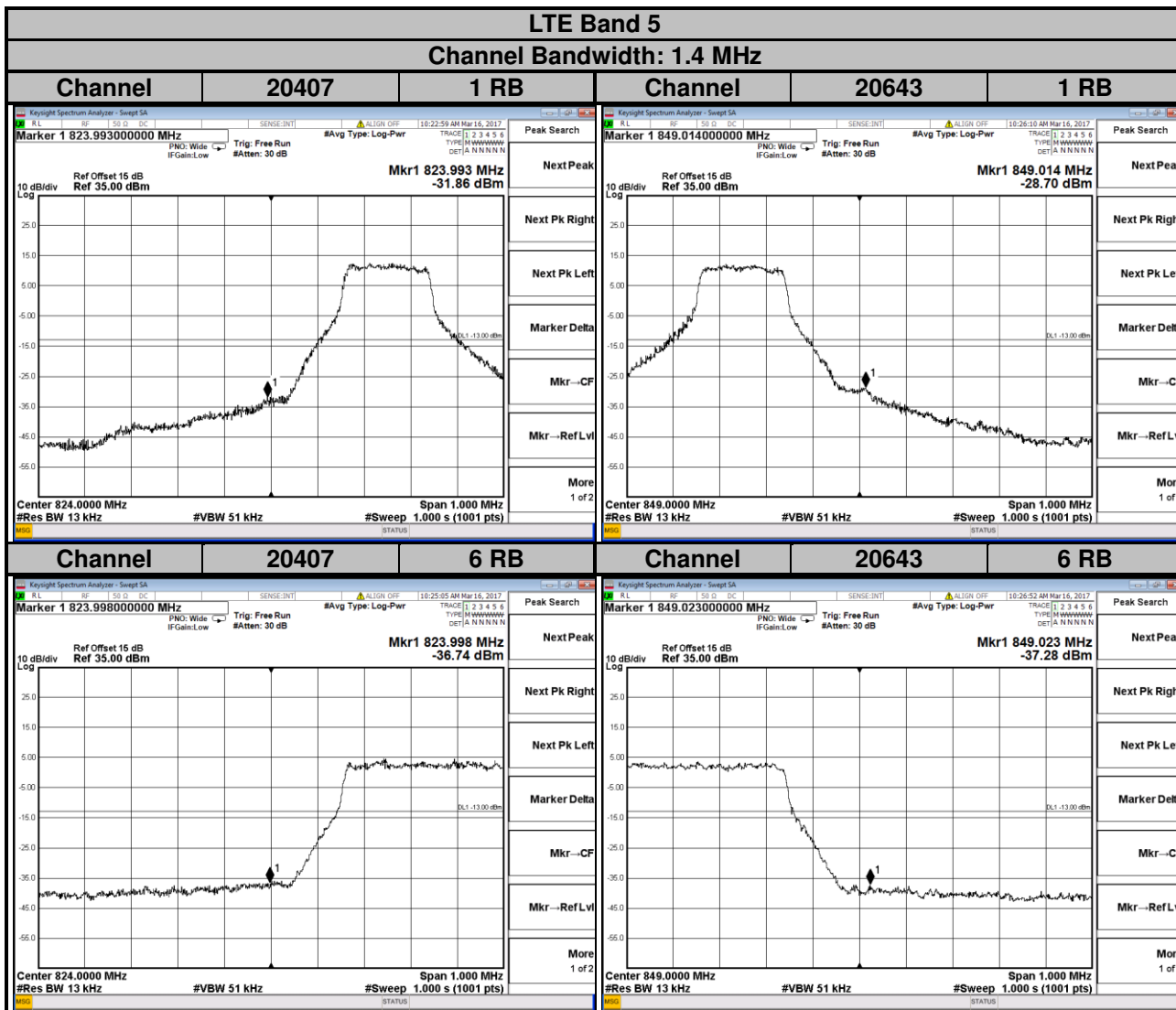

**LTE Band 5**  
**Channel Bandwidth: 3 MHz**

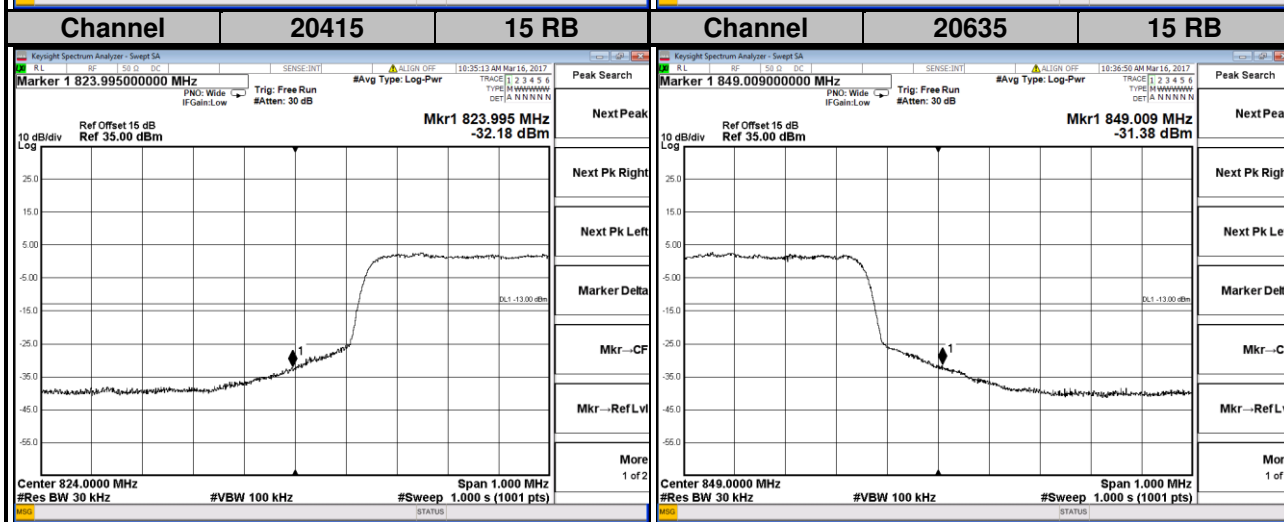
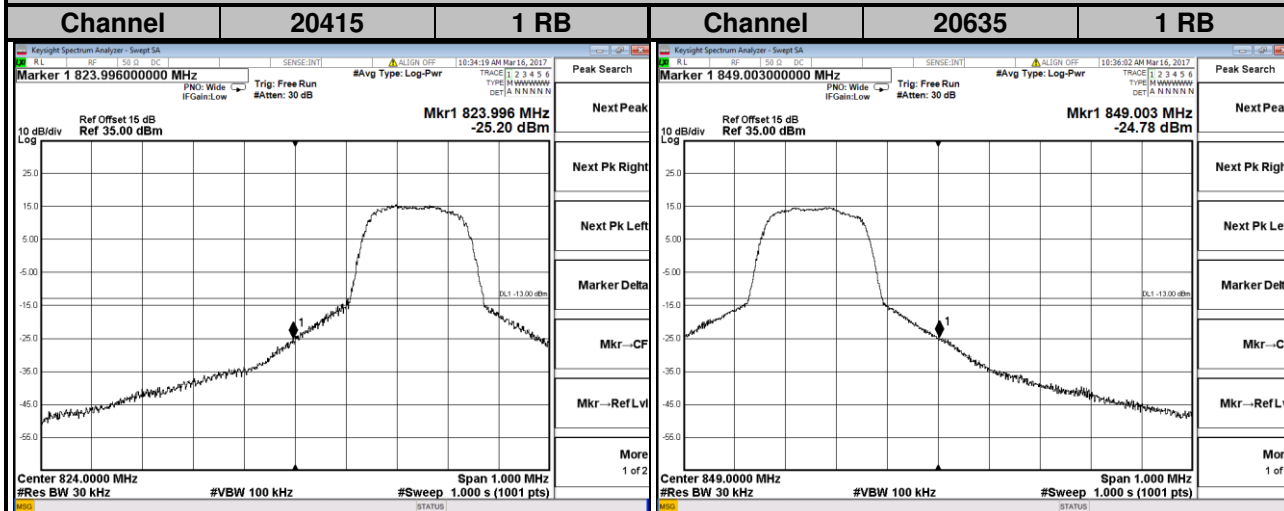

**LTE Band 5**  
**Channel Bandwidth: 5 MHz**

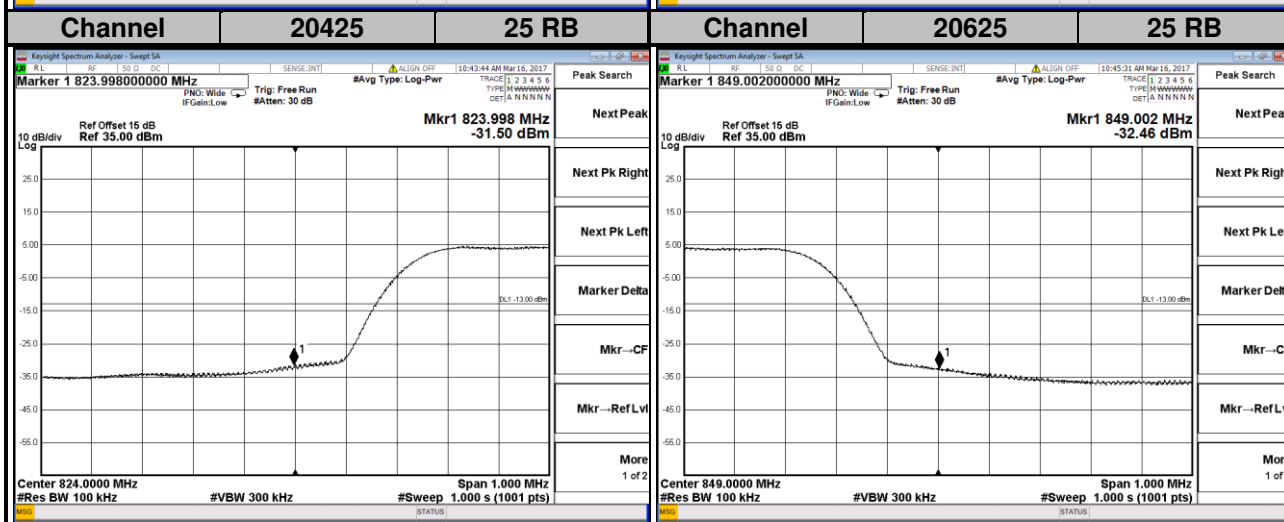
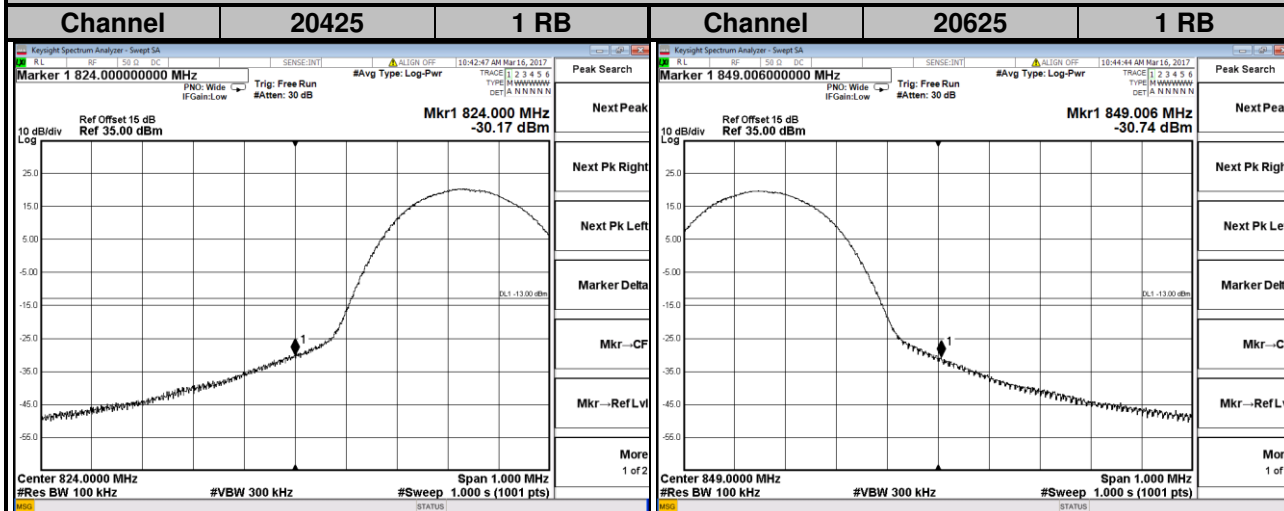

**LTE Band 5**  
**Channel Bandwidth: 10 MHz**

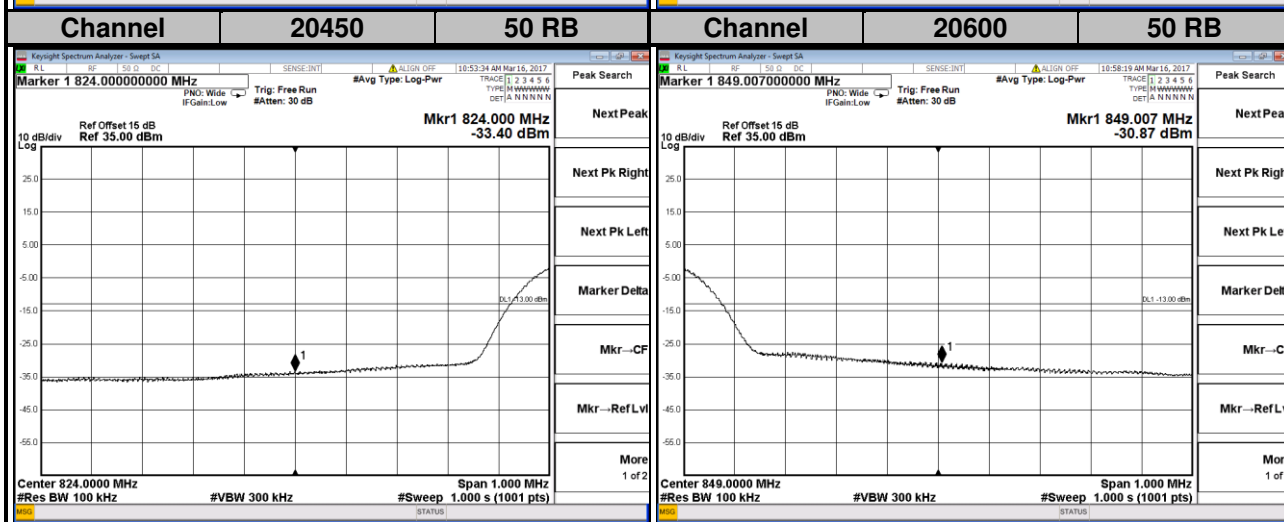
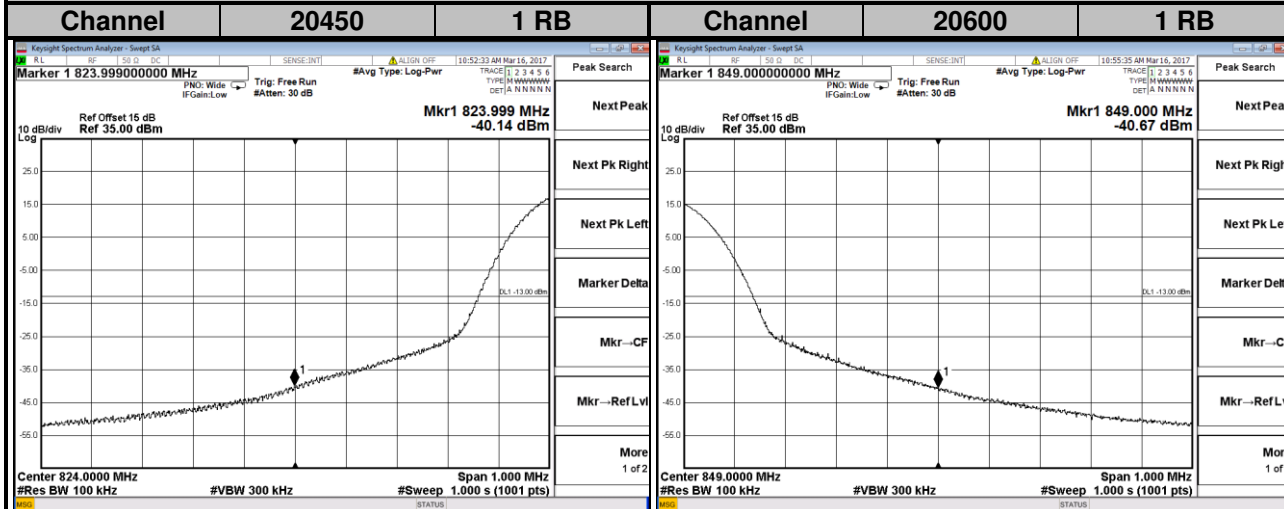

## 4.5 Peak to Average Ratio

### 4.5.1 Limits of Peak to Average Ratio Measurement

In measuring transmissions in this band using an average power technique, the peak to-average ratio (PAR) of the transmission may not exceed 13 dB.

### 4.5.2 Test Setup

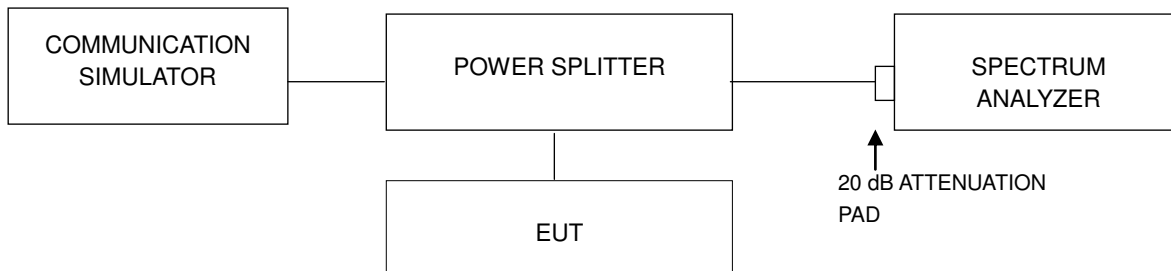

### 4.5.3 Test Procedures

1. Set resolution/measurement bandwidth  $\geq$  signal's occupied bandwidth;
2. Set the number of counts to a value that stabilizes the measured CCDF curve;
3. Record the maximum PAPR level associated with a probability of 0.1 %.

4.5.4 Test Results

LTE Band 5							
Channel Bandwidth: 1.4 MHz				Channel Bandwidth: 3 MHz			
Channel	Frequency (MHz)	Peak to Average Ratio (dB)		Channel	Frequency (MHz)	Peak to Average Ratio (dB)	
		QPSK	16QAM			QPSK	16QAM
20407	824.7	3.94	4.62	20415	825.5	3.78	4.55
20525	836.5	4.37	5.09	20525	836.5	4.33	5.04
20643	848.3	3.46	4.25	20635	847.5	3.44	4.19

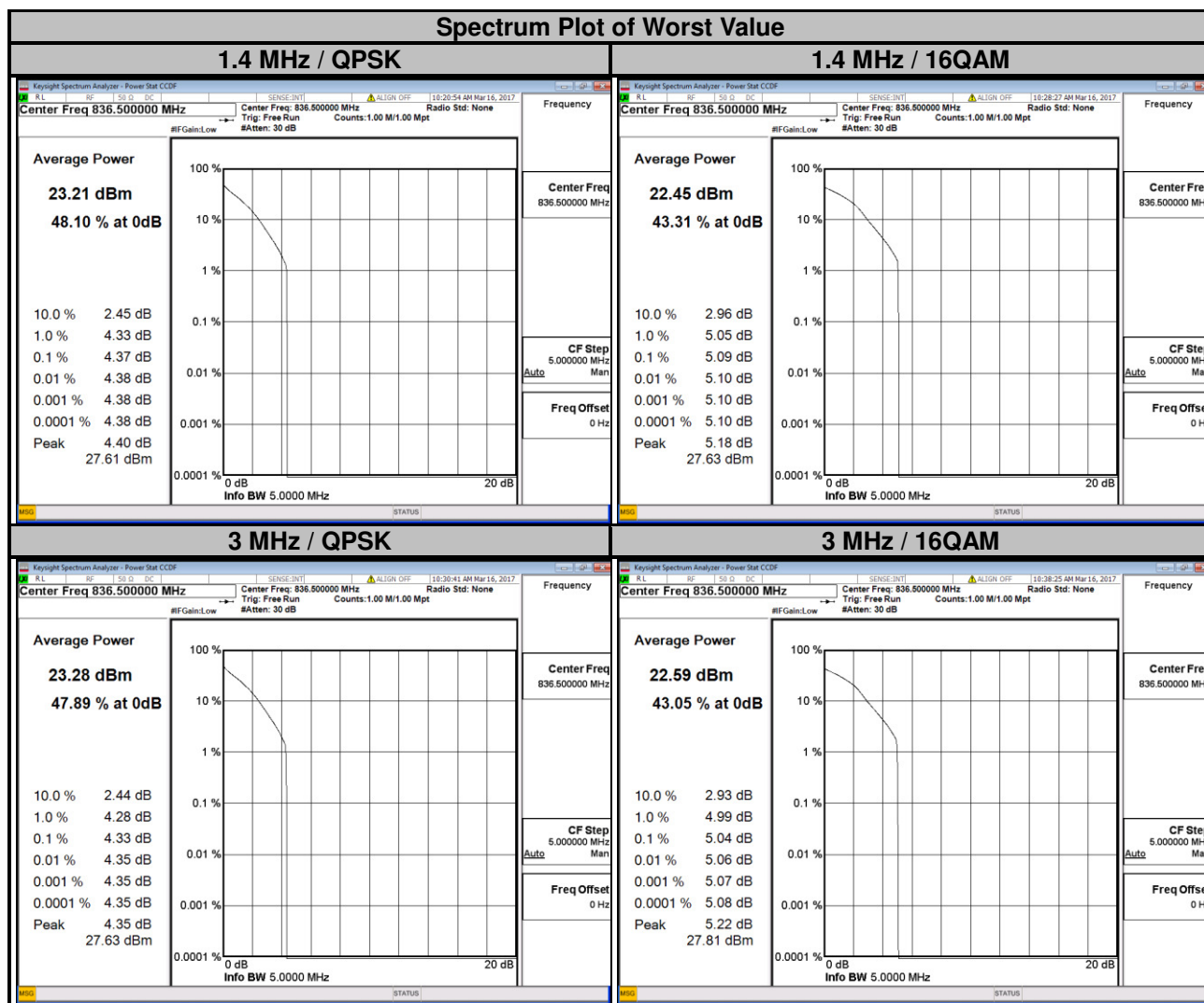

### LTE Band 5

Channel Bandwidth: 5 MHz				Channel Bandwidth: 10 MHz			
Channel	Frequency (MHz)	Peak to Average Ratio (dB)		Channel	Frequency (MHz)	Peak to Average Ratio (dB)	
		QPSK	16QAM			QPSK	16QAM
20425	826.5	3.82	4.58	20450	829.0	3.79	4.52
20525	836.5	4.43	5.12	20525	836.5	4.28	5.04
20625	846.5	3.47	4.19	20600	844.0	3.40	4.13

### Spectrum Plot of Worst Value

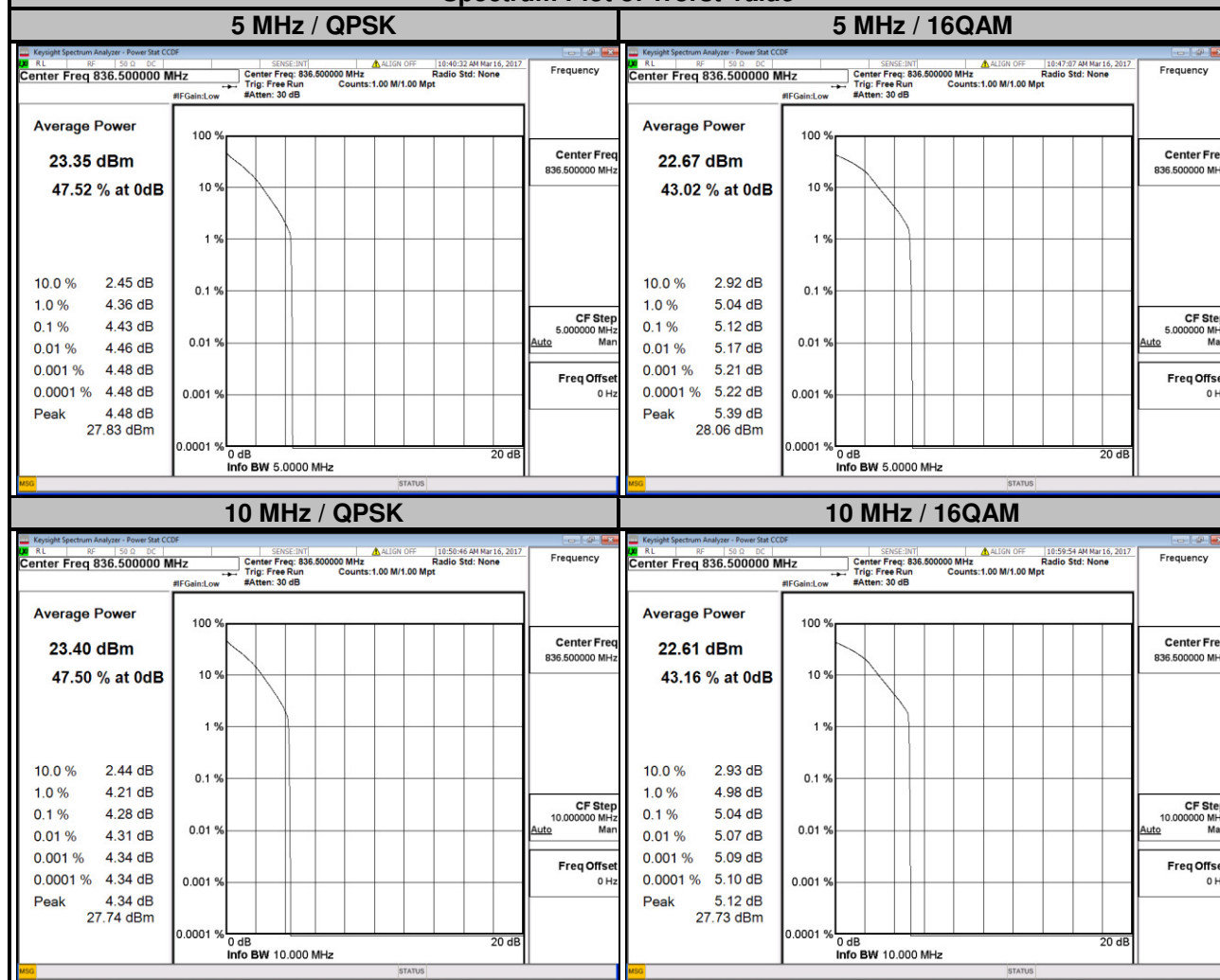



## 4.6 Conducted Spurious Emissions

### 4.6.1 Limits of Conducted Spurious Emissions Measurement

The power of any emission outside of the authorized operating frequency ranges must be attenuated below the transmitting power (P) by a factor of at least  $43 + 10 \log(P)$  dB. The emission limit equal to  $-13$  dBm.

### 4.6.2 Test Setup

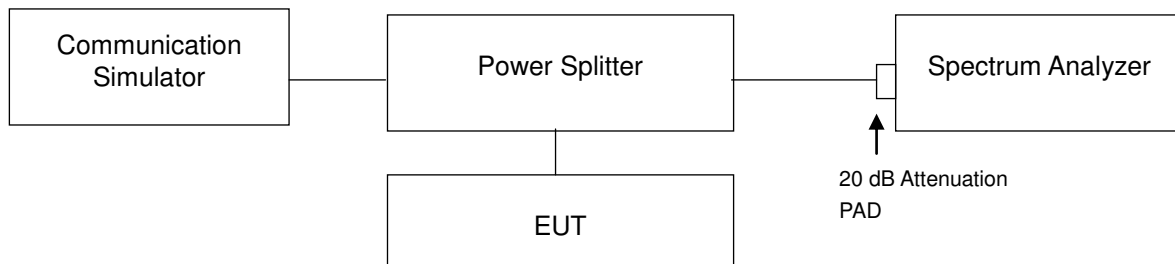

### 4.6.3 Test Procedure

- The EUT makes a phone call to the communication simulator. All measurements were done at low, middle and high operational frequency range.
- Measuring frequency range is from 9 kHz to 9 GHz. 20 dB attenuation pad is connected with spectrum. RBW=1 MHz and VBW=3 MHz is used for conducted emission measurement.

### 4.6.4 Test Results

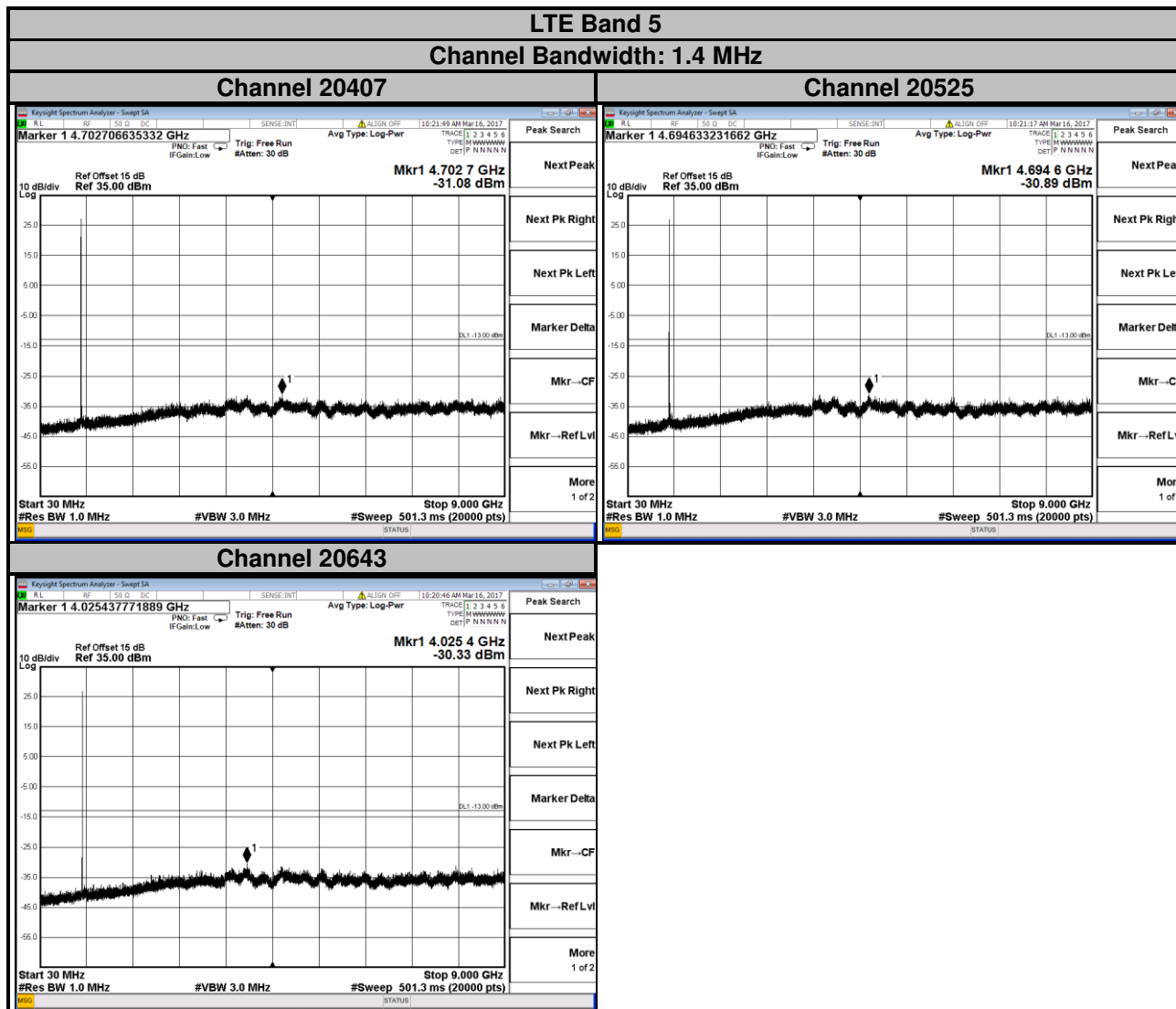

**LTE Band 5**  
**Channel Bandwidth: 3 MHz**

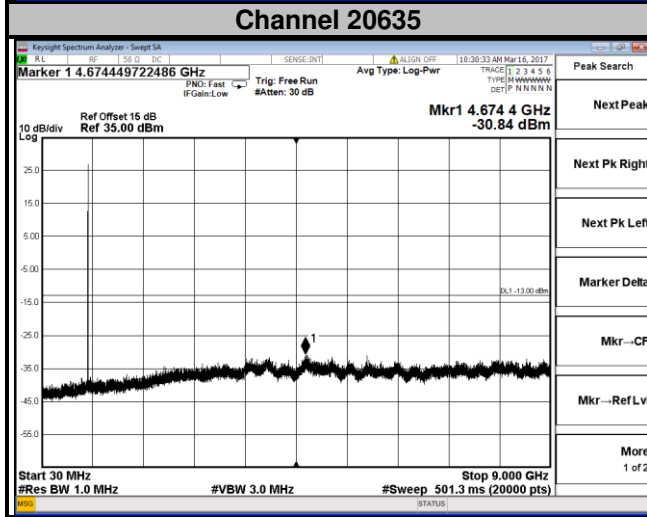
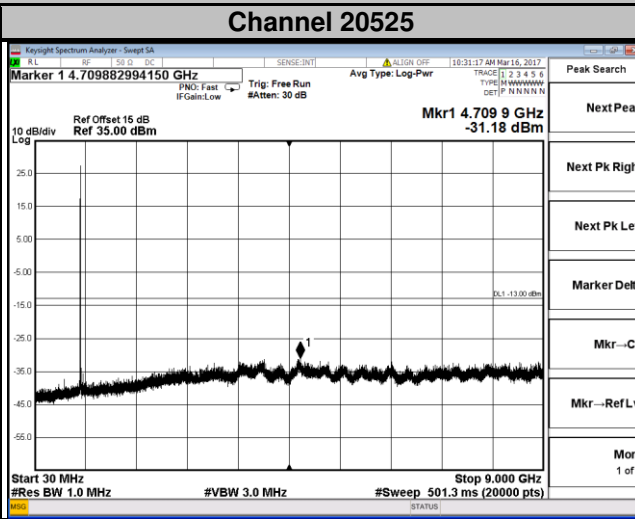
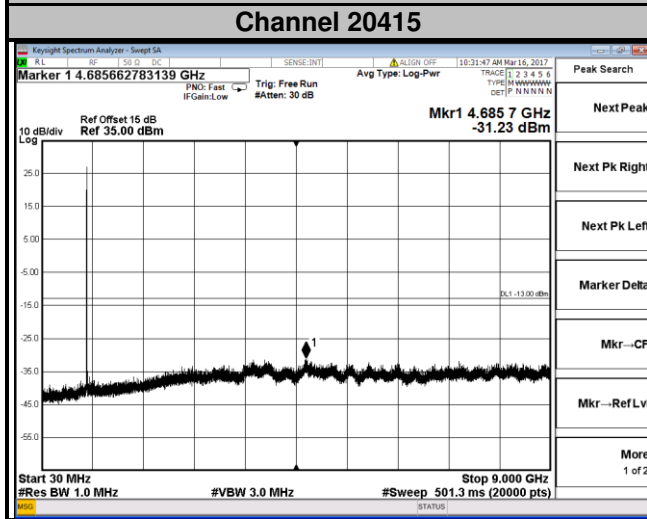

**LTE Band 5**  
**Channel Bandwidth: 5 MHz**

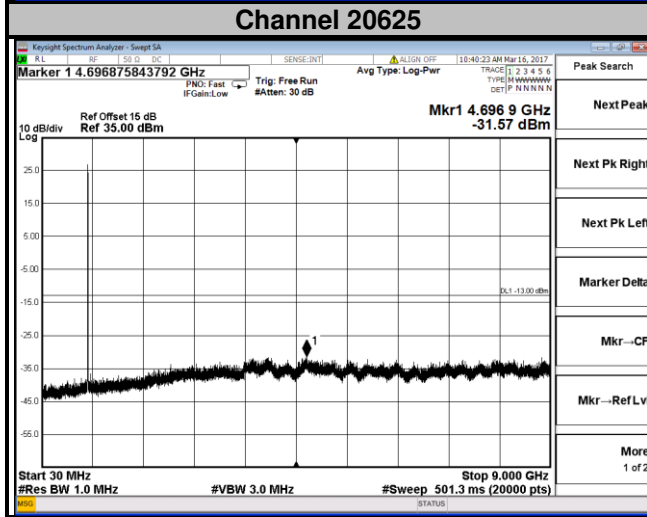
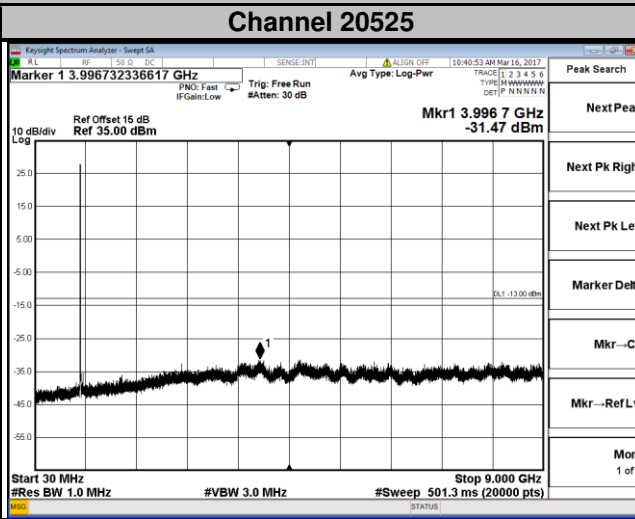
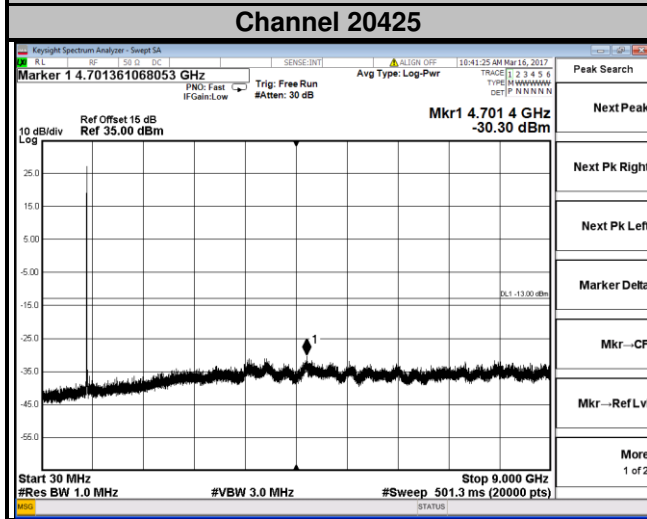

**LTE Band 5**  
**Channel Bandwidth: 10 MHz**

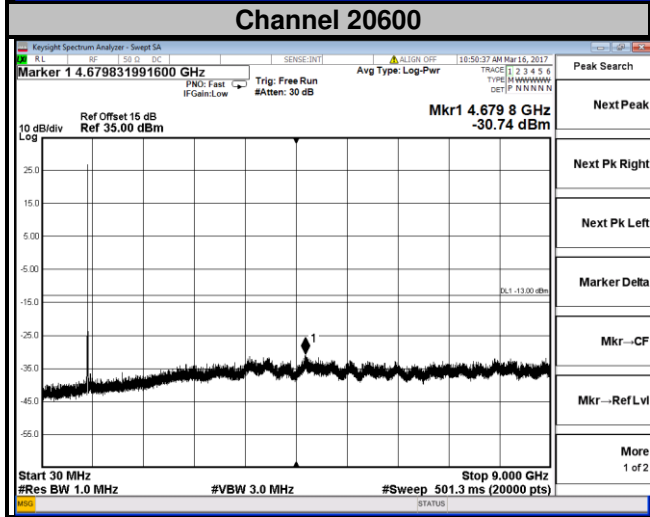
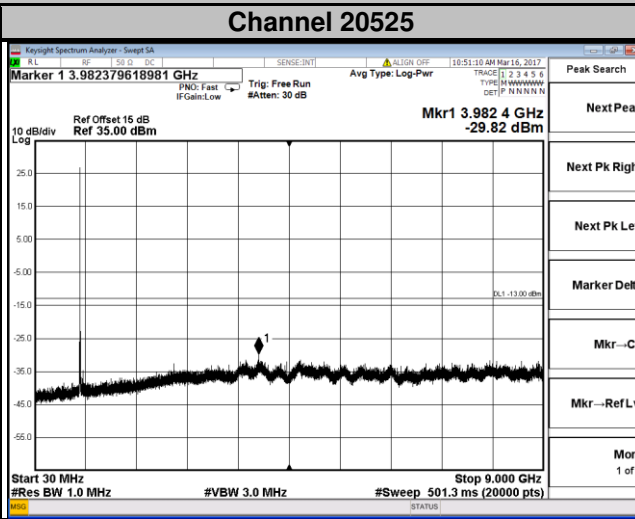
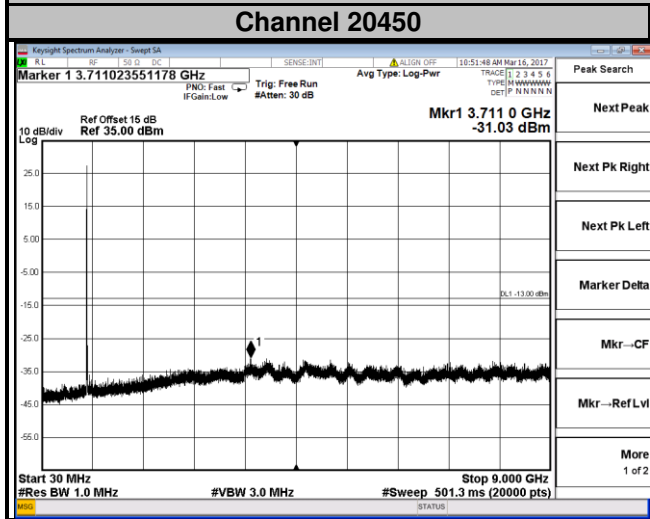

## 4.7 Radiated Emission Measurement

### 4.7.1 Limits of Radiated Emission Measurement

The power of any emission outside of the authorized operating frequency ranges must be attenuated below the transmitting power (P) by a factor of at least  $43 + 10 \log(P)$  dB. The emission limit is equal to -13 dBm.

### 4.7.2 Test Procedure

- Substitution method is used for E.I.R.P measurement. In the semi-anechoic chamber, EUT placed on the 0.8 m height of Turn Table, rotated the table around 360 degrees to search the maximum radiation power and receiver antenna shall be rotated vertical and horizontal polarization and moved height from 1 m to 4 m to find the maximum polar radiated power. The "Read Value" is the spectrum reading the maximum power value.
- The substitution horn antenna is substituted for EUT at the same position and signals generator export the CW signal to the substitution antenna via a TX cable. Rotated the Turn Table and moved receiving antenna to find the maximum radiation power. Adjust output power level of S.G to get a Value of spectrum reading equal to "Read Value" of step a. Record the power level of S.G
- $EIRP = \text{Output power level of S.G} - \text{TX cable loss} + \text{Antenna gain of substitution horn.}$
- E.R.P power can be calculated form E.I.R.P power by subtracting the gain of dipole,  $E.R.P \text{ power} = E.I.P.R \text{ power} - 2.15 \text{ dBi.}$

**NOTE:** The resolution bandwidth and video bandwidth of test receiver/spectrum analyzer is 1 MHz/3 MHz.

### 4.7.3 Deviation from Test Standard

No deviation.

### 4.7.4 Test Setup

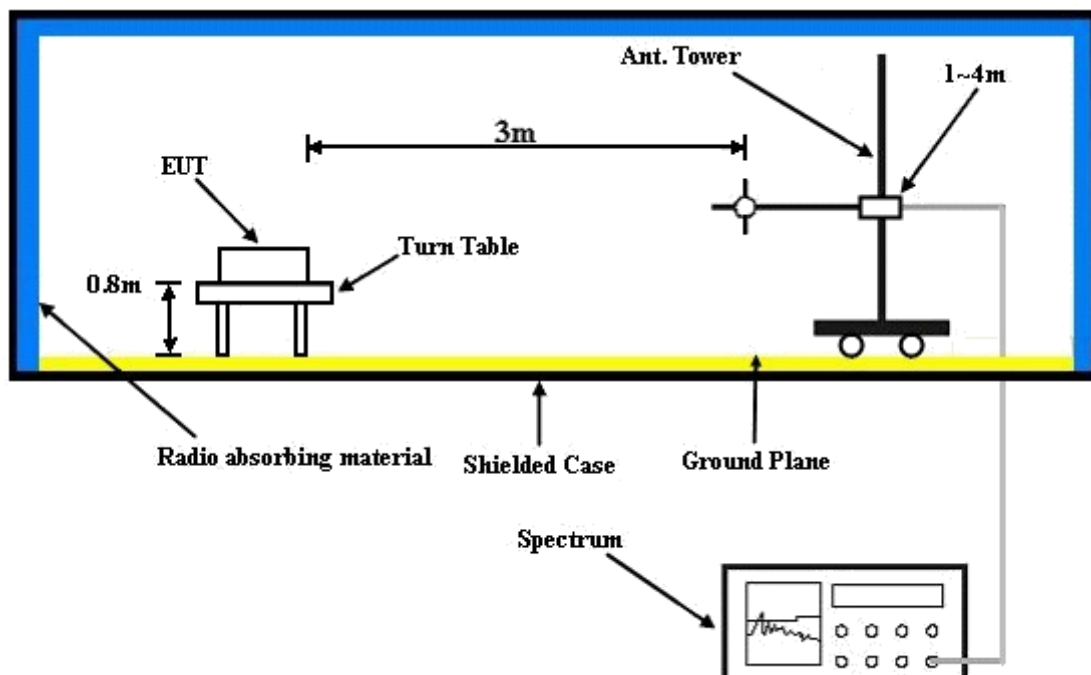

For the actual test configuration, please refer to the attached file (Test Setup Photo).

4.7.5 Test Results

LTE Band 5

Channel Bandwidth: 10 MHz / QPSK

Low Channel



Bureau Veritas Consumer Products Services Ltd., Taoyuan Branch

A D T

Data: 5

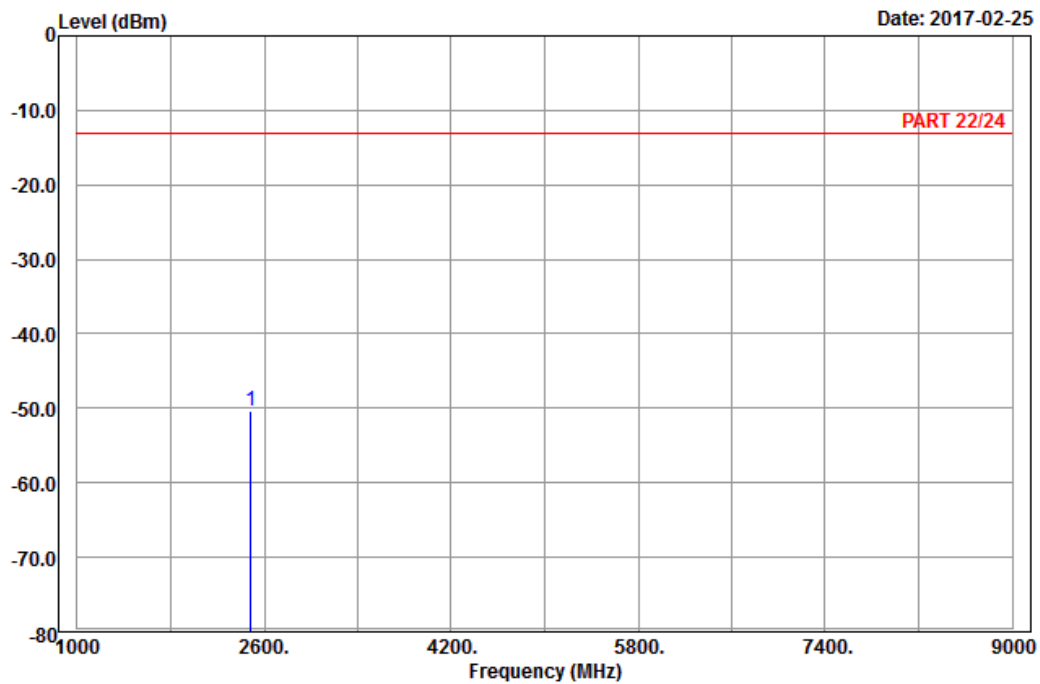

Site : 966 chamber 1  
 Condition: PART 22/24 Horizontal  
 Remark : LTE\_Band 5\_Link\_CH20450  
 Tested by: Karl Lee

Freq	Level	Read Level	Limit Line	Over Limit	Factor	Remark
MHz	dBm	dBm	dBm	dB	dB	
1 pp 2487.00	-50.42	-61.46	-13.00	-37.42	11.04	Peak



A D T

Data: 6

Date: 2017-02-25

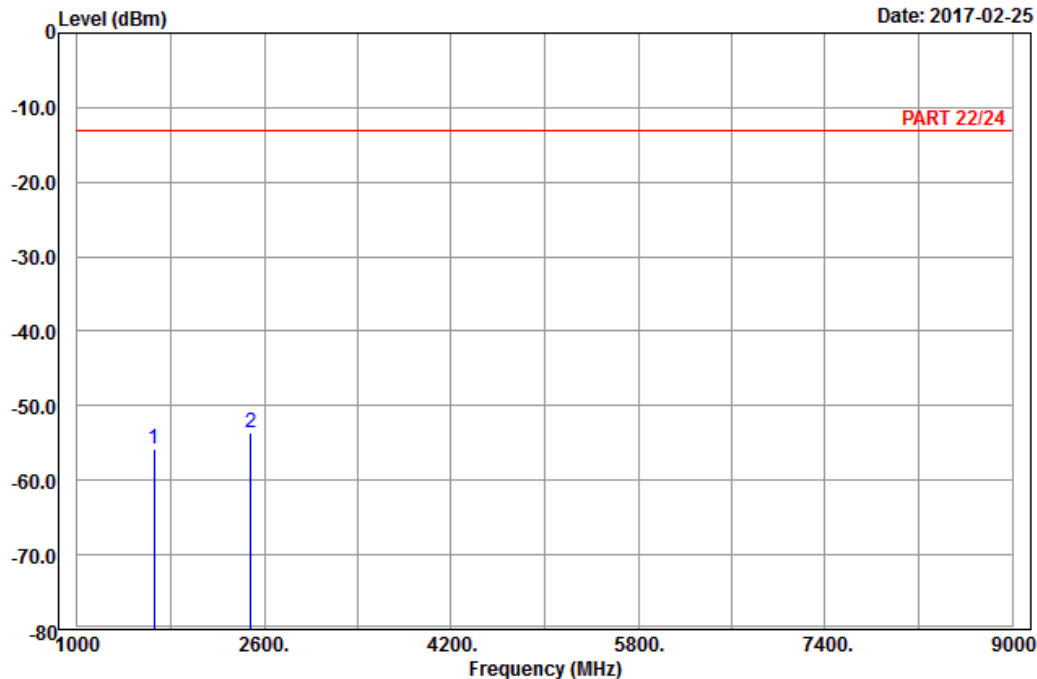

Site : 966 chamber 1  
 Condition: PART 22/24 Vertical  
 Remark : LTE\_Band 5\_Link\_CH20450  
 Tested by: Karl Lee

	Freq	Level	Read Level	Limit Line	Over Limit	Factor	Remark
	MHz	dBm	dBm	dBm	dB	dB	
1	1658.00	-55.80	-63.71	-13.00	-42.80	7.91	Peak
2 pp	2487.00	-53.63	-64.67	-13.00	-40.63	11.04	Peak



Middle Channel



Bureau Veritas Consumer Products Services Ltd., Taoyuan Branch

A D T

Data: 9

Date: 2017-02-25

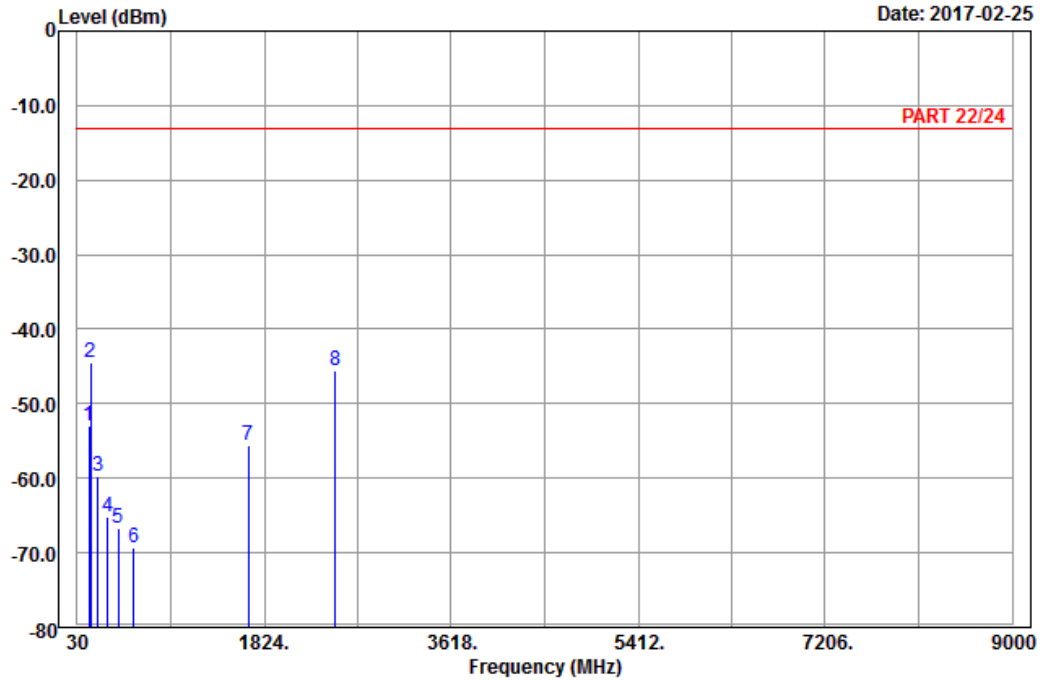

Site : 966 chamber 1  
 Condition: PART 22/24 Horizontal  
 Remark : LTE\_Band 5\_Link\_CH20525  
 Tested by: Karl Lee

	Freq	Level	Read Level	Limit Line	Over Limit	Factor	Remark
	MHz	dBm	dBm	dBm	dB	dB	
1	140.70	-52.88	-45.16	-13.00	-39.88	-7.72	Peak
2	pp 162.03	-44.38	-36.91	-13.00	-31.38	-7.47	Peak
3	227.10	-59.71	-53.89	-13.00	-46.71	-5.82	Peak
4	322.40	-65.27	-59.57	-13.00	-52.27	-5.70	Peak
5	420.40	-66.73	-63.54	-13.00	-53.73	-3.19	Peak
6	575.10	-69.36	-68.74	-13.00	-56.36	-0.62	Peak
7	1673.00	-55.54	-63.45	-13.00	-42.54	7.91	Peak
8	2509.50	-45.57	-56.85	-13.00	-32.57	11.28	Peak



Bureau Veritas Consumer Products Services Ltd., Taoyuan Branch

A D T

Data: 10

Date: 2017-02-25

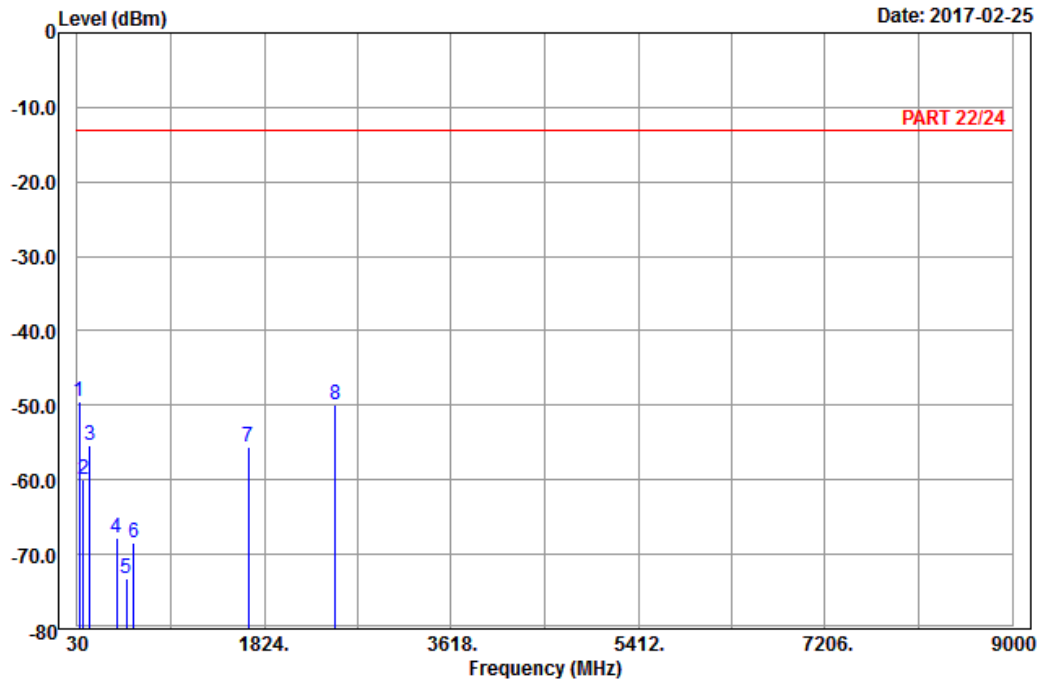

Site : 966 chamber 1  
 Condition: PART 22/24 Vertical  
 Remark : LTE\_Band 5\_Link\_CH20525  
 Tested by: Karl Lee

	Freq	Level	Read Level	Limit Line	Over Limit	Factor	Remark
	MHz	dBm	dBm	dBm	dB	dB	
1	pp	47.01	-49.51	-36.40	-13.00	-36.51	-13.11 Peak
2		89.94	-59.99	-49.32	-13.00	-46.99	-10.67 Peak
3		149.61	-55.26	-47.33	-13.00	-42.26	-7.93 Peak
4		410.60	-67.83	-64.86	-13.00	-54.83	-2.97 Peak
5		500.20	-73.17	-67.89	-13.00	-60.17	-5.28 Peak
6		569.50	-68.35	-67.49	-13.00	-55.35	-0.86 Peak
7		1673.00	-55.57	-63.48	-13.00	-42.57	7.91 Peak
8		2509.50	-49.87	-61.15	-13.00	-36.87	11.28 Peak

High Channel



Bureau Veritas Consumer Products Services Ltd., Taoyuan Branch

A D T

Data: 5

Date: 2017-02-25

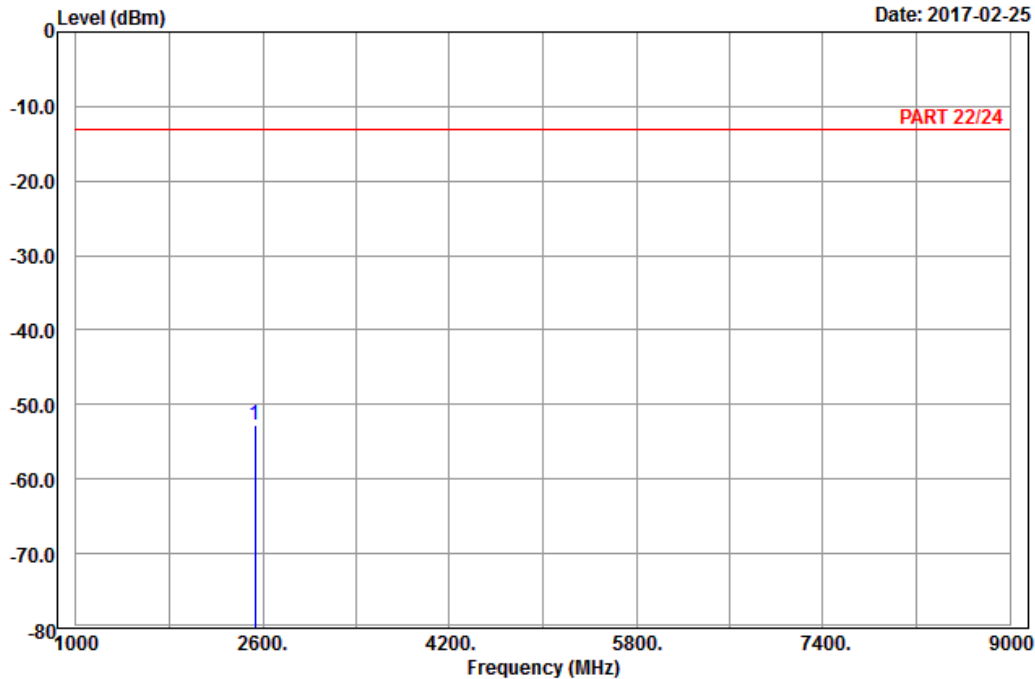

Site : 966 chamber 1  
 Condition: PART 22/24 Horizontal  
 Remark : LTE\_Band 5\_Link\_CH20600  
 Tested by: Karl Lee

	Freq	Level	Read Level	Limit Line	Over Limit	Factor	Remark
	MHz	dBm	dBm	dBm	dB	dB	
1	pp 2532.00	-52.67	-64.05	-13.00	-39.67	11.38	Peak



Bureau Veritas Consumer Products Services Ltd., Taoyuan Branch

A D T

Data: 6

Date: 2017-02-25

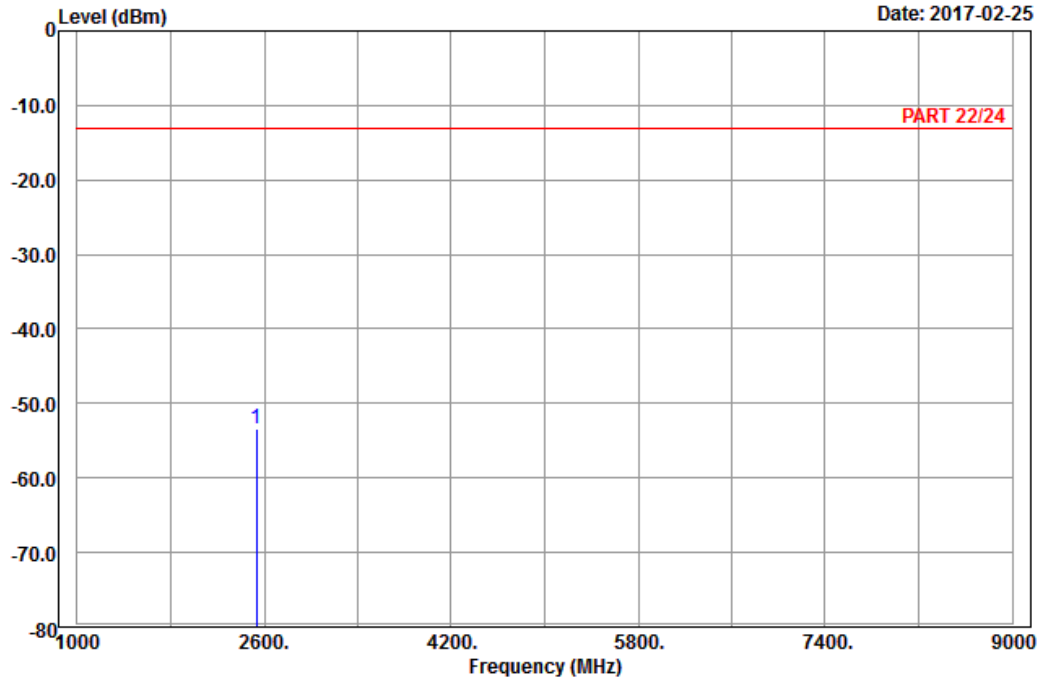

Site : 966 chamber 1  
 Condition: PART 22/24 Vertical  
 Remark : LTE\_Band 5\_Link\_CH20600  
 Tested by: Karl Lee

	Freq	Level	Read Level	Limit Line	Over Limit	Factor	Remark
	MHz	dBm	dBm	dBm	dB	dB	
1	pp 2532.00	-53.37	-64.75	-13.00	-40.37	11.38	Peak

## 5 Pictures of Test Arrangements

Please refer to the attached file (Test Setup Photo).

## Appendix – Information on the Testing Laboratories

We, Bureau Veritas Consumer Products Services (H.K.) Ltd., Taoyuan Branch, were founded in 1988 to provide our best service in EMC, Radio, Telecom and Safety consultation. Our laboratories are accredited and approved according to ISO/IEC 17025.

If you have any comments, please feel free to contact us at the following:

**Linko EMC/RF Lab**

Tel: 886-2-26052180

Fax: 886-2-26051924

**Hsin Chu EMC/RF/Telecom Lab**

Tel: 886-3-6668565

Fax: 886-3-6668323

**Hwa Ya EMC/RF/Safety**

Tel: 886-3-3183232

Fax: 886-3-3270892

**Email:** [service.adt@tw.bureauveritas.com](mailto:service.adt@tw.bureauveritas.com)

**Web Site:** [www.bureauveritas-adt.com](http://www.bureauveritas-adt.com)

The address and road map of all our labs can be found in our web site also.

--- END ---