

## FCC Test Report

**Report No.:** RF170210C14-2

**FCC ID:** MSQASUS-P00J

**Test Model:** ASUS\_P00J

**Received Date:** Feb. 10, 2017

**Test Date:** Feb. 23, 2017 ~ Mar. 12, 2017

**Issued Date:** Mar. 31, 2017

**Applicant:** ASUSTek COMPUTER INC.

**Address:** 4F, No. 150, LI-TE Rd., PEITOU, TAIPEI 112, TAIWAN

**Issued By:** Bureau Veritas Consumer Products Services (H.K.) Ltd., Taoyuan Branch

**Lab Address:** No. 47-2, 14th Ling, Chia Pau Vil., Lin Kou Dist., New Taipei City, Taiwan  
( R.O.C )

**Test Location (1):** No. 19, Hwa Ya 2nd Rd, Wen Hwa Tsuen, Kwei Shan Hsiang, Taoyuan  
Hsien 333, Taiwan, R.O.C.

**Test Location (2):** No.215, Sec. 3, Beixin Rd., Xindian Dist., New Taipei City 231, Taiwan,  
R.O.C



This report is for your exclusive use. Any copying or replication of this report to or for any other person or entity, or use of our name or trademark, is permitted only with our prior written permission. This report sets forth our findings solely with respect to the test samples identified herein. The results set forth in this report are not indicative or representative of the quality or characteristics of the lot from which a test sample was taken or any similar or identical product unless specifically and expressly noted. Our report includes all of the tests requested by you and the results thereof based upon the information that you provided to us. You have 60 days from date of issuance of this report to notify us of any material error or omission caused by our negligence, provided, however, that such notice shall be in writing and shall specifically address the issue you wish to raise. A failure to raise such issue within the prescribed time shall constitute your unqualified acceptance of the completeness of this report, the tests conducted and the correctness of the report contents. Unless specific mention, the uncertainty of measurement has been explicitly taken into account to declare the compliance or non-compliance to the specification.

## Table of Contents

<b>Release Control Record</b> .....	<b>4</b>
<b>1 Certificate of Conformity</b> .....	<b>5</b>
<b>2 Summary of Test Results</b> .....	<b>6</b>
2.1 Measurement Uncertainty .....	6
2.2 Modification Record .....	6
<b>3 General Information</b> .....	<b>7</b>
3.1 General Description of EUT .....	7
3.2 Description of Test Modes .....	8
3.2.1 Test Mode Applicability and Tested Channel Detail .....	9
3.3 Duty Cycle of Test Signal .....	11
3.4 Description of Support Units .....	12
3.4.1 Configuration of System under Test .....	12
3.5 General Description of Applied Standards .....	12
<b>4 Test Types and Results</b> .....	<b>13</b>
4.1 Radiated Emission and Bandedge Measurement .....	13
4.1.1 Limits of Radiated Emission and Bandedge Measurement .....	13
4.1.2 Test Instruments .....	14
4.1.3 Test Procedures .....	15
4.1.4 Deviation from Test Standard .....	15
4.1.5 Test Set Up .....	16
4.1.6 EUT Operating Conditions .....	16
4.1.7 Test Results .....	17
4.2 Conducted Emission Measurement .....	30
4.2.1 Limits of Conducted Emission Measurement .....	30
4.2.2 Test Instruments .....	30
4.2.3 Test Procedures .....	31
4.2.4 Deviation from Test Standard .....	31
4.2.5 Test Setup .....	31
4.2.6 EUT Operating Conditions .....	31
4.2.7 Test Results .....	32
4.3 6 dB Bandwidth Measurement .....	34
4.3.1 Limits of 6 dB Bandwidth Measurement .....	34
4.3.2 Test Setup .....	34
4.3.3 Test Instruments .....	34
4.3.4 Test Procedure .....	34
4.3.5 Deviation from Test Standard .....	34
4.3.6 EUT Operating Conditions .....	34
4.3.7 Test Result .....	35
4.4 Conducted Output Power Measurement .....	37
4.4.1 Limits of Conducted Output Power Measurement .....	37
4.4.2 Test Setup .....	37
4.4.3 Test Instruments .....	37
4.4.4 Test Procedures .....	37
4.4.5 Deviation from Test Standard .....	37
4.4.6 EUT Operating Conditions .....	37
4.4.7 Test Results .....	38
4.5 Power Spectral Density Measurement .....	39
4.5.1 Limits of Power Spectral Density Measurement .....	39
4.5.2 Test Setup .....	39
4.5.3 Test Instruments .....	39
4.5.4 Test Procedure .....	39
4.5.5 Deviation from Test Standard .....	39
4.5.6 EUT Operating Condition .....	39

4.5.7 Test Results .....	40
4.6 Conducted Out of Band Emission Measurement .....	42
4.6.1 Limits of Conducted Out of Band Emission Measurement.....	42
4.6.2 Test Setup.....	42
4.6.3 Test Instruments .....	42
4.6.4 Test Procedure .....	42
4.6.5 Deviation from Test Standard .....	42
4.6.6 EUT Operating Condition .....	42
4.6.7 Test Results .....	43
<b>5 Pictures of Test Arrangements.....</b>	<b>51</b>
<b>Appendix – Information on the Testing Laboratories .....</b>	<b>52</b>

### Release Control Record

Issue No.	Description	Date Issued
RF170210C14-2	Original Release	Mar. 31, 2017

## 1 Certificate of Conformity

**Product:** ASUS Tablet

**Brand:** ASUS

**Test Model:** ASUS\_P00J

**Sample Status:** Identical Prototype

**Applicant:** ASUSTek COMPUTER INC.

**Test Date:** Feb. 23, 2017 ~ Mar. 12, 2017

**Standards:** 47 CFR FCC Part 15, Subpart C (Section 15.247)  
ANSI C63.10:2013

The above equipment has been tested by **Bureau Veritas Consumer Products Services (H.K.) Ltd., Taoyuan Branch**, and found compliance with the requirement of the above standards. The test record, data evaluation & Equipment Under Test (EUT) configurations represented herein are true and accurate accounts of the measurements of the sample's EMC characteristics under the conditions specified in this report.

**Prepared by :**  , **Date:** Mar. 31, 2017

Ivonne Wu / Supervisor

**Approved by :**  , **Date:** Mar. 31, 2017

David Huang / Project Engineer

## 2 Summary of Test Results

47 CFR FCC Part 15, Subpart C (Section 15.247)			
FCC Clause	Test Item	Result	Remarks
15.207	AC Power Conducted Emission	Pass	Meet the requirement of limit. Minimum passing margin is -8.33 dB at 0.47915 MHz.
15.205 / 15.209 / 15.247(d)	Radiated Emissions and Band Edge Measurement	Pass	Meet the requirement of limit. Minimum passing margin is -3.01 dB at 4924 MHz.
15.247(d)	Antenna Port Emission	Pass	Meet the requirement of limit.
15.247(a)(2)	6 dB Bandwidth	Pass	Meet the requirement of limit.
15.247(b)	Conducted power	Pass	Meet the requirement of limit.
15.247(e)	Power Spectral Density	Pass	Meet the requirement of limit.
15.203	Antenna Requirement	Pass	No antenna connector is used.

### 2.1 Measurement Uncertainty

Where relevant, the following measurement uncertainty levels have been estimated for tests performed on the EUT:

The listed uncertainties are the worst case uncertainty for the entire range of measurement. Please note that the uncertainty values are provided for informational purposes only and are not used in determining the PASS/FAIL results.

Measurement	Frequency	Expanded Uncertainty (k=2) ( $\pm$ )
Conducted Emissions at mains ports	150 kHz ~ 30 MHz	2.44 dB
Radiated Emissions up to 1 GHz	30 MHz ~ 200 MHz	2.0153 dB
	200 MHz ~ 1000 MHz	2.0224 dB
Radiated Emissions above 1 GHz	1 GHz ~ 18 GHz	1.0121 dB
	18 GHz ~ 40 GHz	1.1508 dB

### 2.2 Modification Record

There were no modifications required for compliance.

### 3 General Information

#### 3.1 General Description of EUT

<b>Product</b>	ASUS Tablet
<b>Brand</b>	ASUS
<b>Test Model</b>	ASUS_P00J
<b>Status of EUT</b>	Identical Prototype
<b>Power Supply Rating</b>	5.0 Vdc (adapter or host equipment) 3.85 Vdc (Li-ion battery)
<b>Modulation Type</b>	CCK, DQPSK, DBPSK for DSSS 64QAM, 16QAM, QPSK, BPSK for OFDM
<b>Modulation Technology</b>	DSSS, OFDM
<b>Transfer Rate</b>	802.11b: 11.0 / 5.5 / 2.0 / 1.0 Mbps 802.11g: 54.0 / 48.0 / 36.0 / 24.0 / 18.0 / 12.0 / 9.0 / 6.0 Mbps 802.11n: up to MCS7
<b>Operating Frequency</b>	2412 ~ 2462 MHz
<b>Number of Channel</b>	11 for 802.11b, 802.11g, 802.11n (HT20) 7 for 802.11n (HT40)
<b>Output Power</b>	132.739 mW
<b>Antenna Type</b>	PIFA antenna with -0.94 dBi gain
<b>Antenna Connector</b>	N/A
<b>Accessory Device</b>	Refer to Note as below
<b>Data Cable Supplied</b>	Refer to Note as below

Note:

1. The EUT provides one completed transmitter and receiver.

Modulation Mode	TX Function
802.11b	1TX
802.11g	1TX
802.11n (HT20)	1TX
802.11n (HT40)	1TX

2. The EUT's accessories list refers to Ext. Pho.
3. The above EUT information is declared by manufacturer and for more detailed features description, please refer to the manufacturer's specifications or user's manual.

### 3.2 Description of Test Modes

11 channels are provided for 802.11b, 802.11g and 802.11n (HT20):

Channel	Frequency (MHz)	Channel	Frequency (MHz)
1	2412	7	2442
2	2417	8	2447
3	2422	9	2452
4	2427	10	2457
5	2432	11	2462
6	2437		

7 channels are provided for 802.11n (HT40):

Channel	Frequency (MHz)	Channel	Frequency (MHz)
3	2422	7	2442
4	2427	8	2447
5	2432	9	2452
6	2437		



### 3.2.1 Test Mode Applicability and Tested Channel Detail

EUT Configure Mode	Applicable To				Description
	RE $\geq$ 1G	RE<1G	PLC	APCM	
-	√	√	√	√	-

Where **RE $\geq$ 1G**: Radiated Emission above 1 GHz      **RE<1G**: Radiated Emission below 1 GHz  
**PLC**: Power Line Conducted Emission      **APCM**: Antenna Port Conducted Measurement

**NOTE:** The EUT had been pre-tested on the positioned of each 3 axis. The worst case was found when positioned on **Y-plane**.  
**NOTE:** “-” means no effect.

#### **Radiated Emission Test (Above 1 GHz):**

- Pre-Scan has been conducted to determine the worst-case mode from all possible combinations between available modulations, data rates and antenna ports (if EUT with antenna diversity architecture).
- Following channel(s) was (were) selected for the final test as listed below.

EUT Configure Mode	Mode	Available Channel	Tested Channel	Modulation Technology	Modulation Type	Data Rate (Mbps)
-	802.11b	1 to 11	1, 6, 11	DSSS	DBPSK	1.0
-	802.11g	1 to 11	1, 6, 11	OFDM	BPSK	6.0
-	802.11n (HT20)	1 to 11	1, 6, 11	OFDM	BPSK	MCS0
-	802.11n (HT40)	3 to 9	3, 6, 9	OFDM	BPSK	MCS0

#### **Radiated Emission Test (Below 1 GHz):**

- Pre-Scan has been conducted to determine the worst-case mode from all possible combinations between available modulations, data rates and antenna ports (if EUT with antenna diversity architecture).
- Following channel(s) was (were) selected for the final test as listed below.

EUT Configure Mode	Mode	Available Channel	Tested Channel	Modulation Technology	Modulation Type	Data Rate (Mbps)
-	802.11b	1 to 11	11	DSSS	DBPSK	1.0

#### **Power Line Conducted Emission Test:**

- Pre-Scan has been conducted to determine the worst-case mode from all possible combinations between available modulations, data rates and antenna ports (if EUT with antenna diversity architecture).
- Following channel(s) was (were) selected for the final test as listed below.

EUT Configure Mode	Mode	Available Channel	Tested Channel	Modulation Technology	Modulation Type	Data Rate (Mbps)
-	802.11b	1 to 11	11	DSSS	DBPSK	1.0

### **Bandedge Measurement:**

- Pre-Scan has been conducted to determine the worst-case mode from all possible combinations between available modulations, data rates and antenna ports (if EUT with antenna diversity architecture).
- Following channel(s) was (were) selected for the final test as listed below.

EUT Configure Mode	Mode	Available Channel	Tested Channel	Modulation Technology	Modulation Type	Data Rate (Mbps)
-	802.11b	1 to 11	1, 11	DSSS	DBPSK	1.0
-	802.11g	1 to 11	1, 11	OFDM	BPSK	6.0
-	802.11n (HT20)	1 to 11	1, 11	OFDM	BPSK	MCS0
-	802.11n (HT40)	3 to 9	3, 9	OFDM	BPSK	MCS0

### **Antenna Port Conducted Measurement:**

- This item includes all test value of each mode, but only includes spectrum plot of worst value of each mode.
- Pre-Scan has been conducted to determine the worst-case mode from all possible combinations between available modulations, data rates and antenna ports (if EUT with antenna diversity architecture).
- Following channel(s) was (were) selected for the final test as listed below.

EUT Configure Mode	Mode	Available Channel	Tested Channel	Modulation Technology	Modulation Type	Data Rate (Mbps)
-	802.11b	1 to 11	1, 6, 11	DSSS	DBPSK	1.0
-	802.11g	1 to 11	1, 6, 11	OFDM	BPSK	6.0
-	802.11n (HT20)	1 to 11	1, 6, 11	OFDM	BPSK	MCS0
-	802.11n (HT40)	3 to 9	3, 6, 9	OFDM	BPSK	MCS0

### **Test Condition:**

Applicable To	Environmental Conditions	Input Power	Tested by
RE $\geq$ 1G	25 deg. C, 65 % RH	120 Vac, 60 Hz	Charles Hsiao
RE $<$ 1G	25 deg. C, 65 % RH	120 Vac, 60 Hz	Charles Hsiao
PLC	25 deg. C, 65 % RH	120 Vac, 60 Hz	Toby Tian
APCM	25 deg. C, 65 % RH	3.85 Vdc	Wayne Lin

### 3.3 Duty Cycle of Test Signal

**802.11b:** Duty cycle of test signal is < 98 %

**802.11g:** Duty cycle =  $2.027/2.123 = 0.955$ , Duty factor =  $10 * \log(1/0.955) = 0.20$

**802.11n (HT20):** Duty cycle =  $1.891/1.987 = 0.952$ , Duty factor =  $10 * \log(1/0.952) = 0.21$

**802.11n (HT40):** Duty cycle =  $0.929/1.034 = 0.898$ , Duty factor =  $10 * \log(1/0.898) = 0.47$

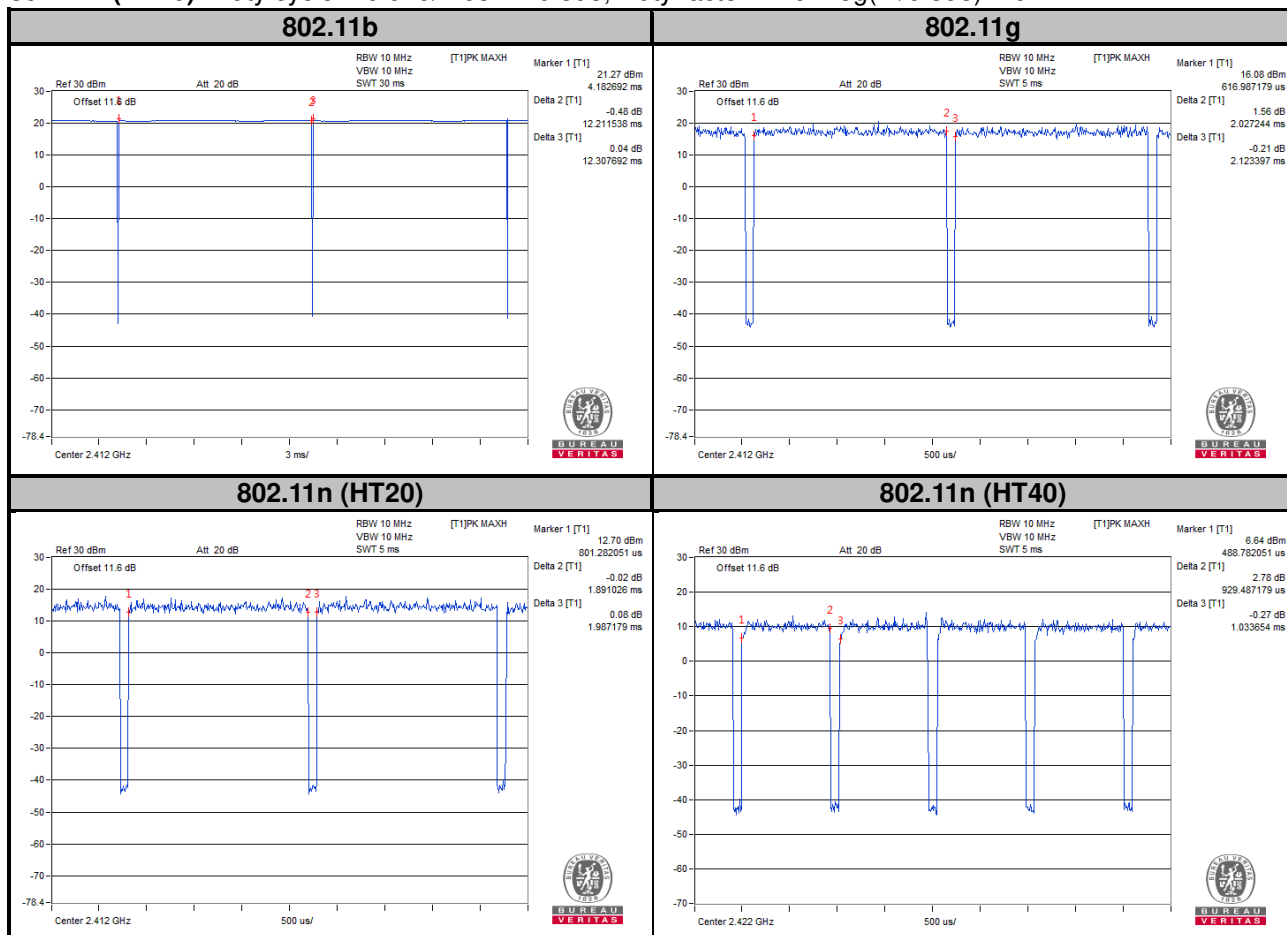

### 3.4 Description of Support Units

The EUT has been tested as an independent unit together with other necessary accessories or support units. The following support units or accessories were used to form a representative test configuration during the tests.

No.	Product	Brand	Model No.	Serial No.	FCC ID
1.	Earphone	Funkey	FK-130102	N/A	N/A

No.	Signal Cable Description Of The Above Support Units
1.	N/A

Note:

1. All power cords of the above support units are non-shielded (1.8m).

#### 3.4.1 Configuration of System under Test

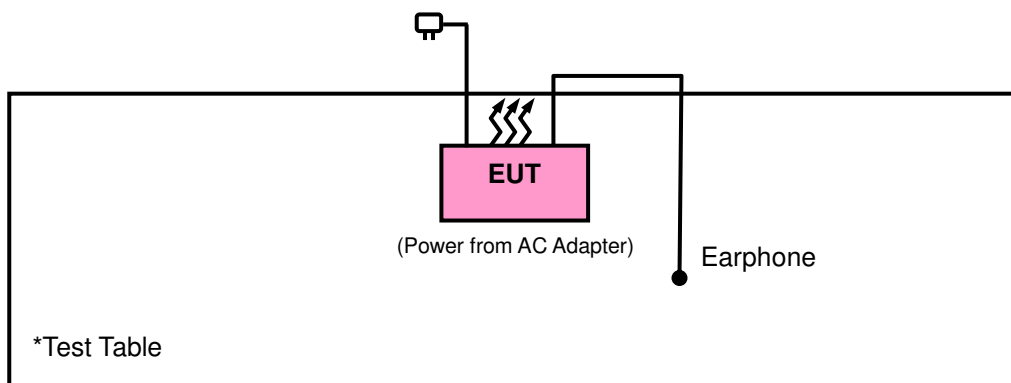

### 3.5 General Description of Applied Standards

The EUT is a RF Product. According to the specifications of the manufacturer, it must comply with the requirements of the following standards:

**FCC Part 15, Subpart C (15.247)**

**558074 D01 DTS Meas Guidance v03r05**

ANSI C63.10-2013

All test items have been performed and recorded as per the above standards.

**NOTE:** The EUT has been verified to comply with the requirements of FCC Part 15, Subpart B, Class B (DoC). The test report has been issued separately.

## 4 Test Types and Results

### 4.1 Radiated Emission and Bandedge Measurement

#### 4.1.1 Limits of Radiated Emission and Bandedge Measurement

Radiated emissions which fall in the restricted bands must comply with the radiated emission limits specified as below table. Other emissions shall be at least 20 dB below the highest level of the desired power:

Frequencies (MHz)	Field Strength (microvolts/meter)	Measurement Distance (meters)
0.009 ~ 0.490	2400/F (kHz)	300
0.490 ~ 1.705	24000/F (kHz)	30
1.705 ~ 30.0	30	30
30 ~ 88	100	3
88 ~ 216	150	3
216 ~ 960	200	3
Above 960	500	3

**NOTE:**

1. The lower limit shall apply at the transition frequencies.
2. Emission level (dBuV/m) = 20 log Emission level (uV/m).
3. For frequencies above 1000 MHz, the field strength limits are based on average detector, however, the peak field strength of any emission shall not exceed the maximum permitted average limits, specified above by more than 20 dB under any condition of modulation.

## 4.1.2 Test Instruments

Description & Manufacturer	Model No.	Serial No.	Date of Calibration	Due Date of Calibration
Test Receiver Agilent Technologies	N9038A	MY52260177	Jun. 21, 2016	Jun. 20, 2017
Spectrum Analyzer ROHDE & SCHWARZ	FSU43	101261	Dec. 13, 2016	Dec. 12, 2017
BILOG Antenna SCHWARZBECK	VULB9168	9168-472	Dec. 16, 2016	Dec. 15, 2017
HORN Antenna ETS-Lindgren	3117	00143293	Dec. 29, 2016	Dec. 28, 2017
HORN Antenna SCHWARZBECK	BBHA 9170	9170-480	Dec. 14, 2016	Dec. 13, 2017
Fixed Attenuator Mini-Circuits	BW-N10W5+	NA	Jul. 08, 2016	Jul. 07, 2017
Bluetooth Tester	CBT	100980	Apr. 27, 2015	Apr. 26, 2017
Loop Antenna	EM-6879	269	Aug. 11, 2016	Aug. 10, 2017
Preamplifier Agilent	310N	187226	Jun. 24, 2016	Jun. 23, 2017
Preamplifier Agilent	83017A	MY39501357	Jun. 24, 2016	Jun. 23, 2017
Power Meter Anritsu	ML2495A	1232002	Sep. 08, 2016	Sep. 07, 2017
Power Sensor Anritsu	MA2411B	1207325	Sep. 08, 2016	Sep. 07, 2017
RF signal cable ETS-LINDGREN	5D-FB	Cable-CH1-01(R FC-SMS-100-SM S-120+RFC-SMS -100-SMS-400)	Jun. 24, 2016	Jun. 23, 2017
RF signal cable ETS-LINDGREN	8D-FB	Cable-CH1-02(R FC-SMS-100-SM S-24)	Jun. 24, 2016	Jun. 23, 2017
Software BV ADT	E3 8.130425b	NA	NA	NA
Antenna Tower MF	NA	NA	NA	NA
Turn Table MF	NA	NA	NA	NA
Antenna Tower & Turn Table Controller MF	MF-7802	NA	NA	NA
Fixed Attenuator Mini-Circuits	BW-N10W5+	NA	Jul. 08, 2016	Jul. 07, 2017

- Note: 1. The calibration interval of the above test instruments is 12 months and the calibrations are traceable to NML/ROC and NIST/USA.
2. The test was performed in HsinTien Chamber 1.
3. The horn antenna and preamplifier (model: 83017A) are used only for the measurement of emission frequency above 1 GHz if tested.
4. The FCC Site Registration No. is 149147.
5. The IC Site Registration No. is IC7450I-1.

#### 4.1.3 Test Procedures

- a. The EUT was placed on the top of a rotating table 0.8 meters (for below 1 GHz) / 1.5 meters (for above 1 GHz) above the ground at 3 meter chamber room for test. The table was rotated 360 degrees to determine the position of the highest radiation.
- b. The EUT was set 3 meters away from the interference-receiving antenna, which was mounted on the top of a variable-height antenna tower.
- c. The height of antenna is varied from one meter to four meters above the ground to determine the maximum value of the field strength. Both horizontal and vertical polarizations of the antenna are set to make the measurement.
- d. For each suspected emission, the EUT was arranged to its worst case and then the antenna was tuned to heights from 1 meter to 4 meters and the rotatable table was turned from 0 degrees to 360 degrees to find the maximum reading.
- e. The test-receiver system was set to quasi-peak detect function and specified bandwidth with maximum hold mode when the test frequency is below 1 GHz.
- f. The test-receiver system was set to peak and average detected function and specified bandwidth with maximum hold mode when the test frequency is above 1 GHz. If the peak reading value also meets average limit, measurement with the average detector is unnecessary.

**Note:**

1. The resolution bandwidth and video bandwidth of test receiver/spectrum analyzer is 120 kHz & 360 KHz for Quasi-peak detection (QP) at frequency below 1 GHz.
2. The resolution bandwidth of test receiver/spectrum analyzer is 1 MHz and the video bandwidth is 3 MHz for Peak detection (PK) at frequency above 1 GHz.
3. The resolution bandwidth of test receiver/spectrum analyzer is 1 MHz and the video bandwidth is 1/T for RMS Average (Duty cycle < 98 %) for Peak detection at frequency above 1 GHz.
4. The resolution bandwidth of test receiver/spectrum analyzer is 1 MHz and the video bandwidth is 10 Hz (Duty cycle  $\geq$  98 %) for Average detection (AV) at frequency above 1 GHz.
5. All modes of operation were investigated and the worst-case emissions are reported.

#### 4.1.4 Deviation from Test Standard

No deviation.

#### 4.1.5 Test Set Up

##### <Frequency Range below 1 GHz>

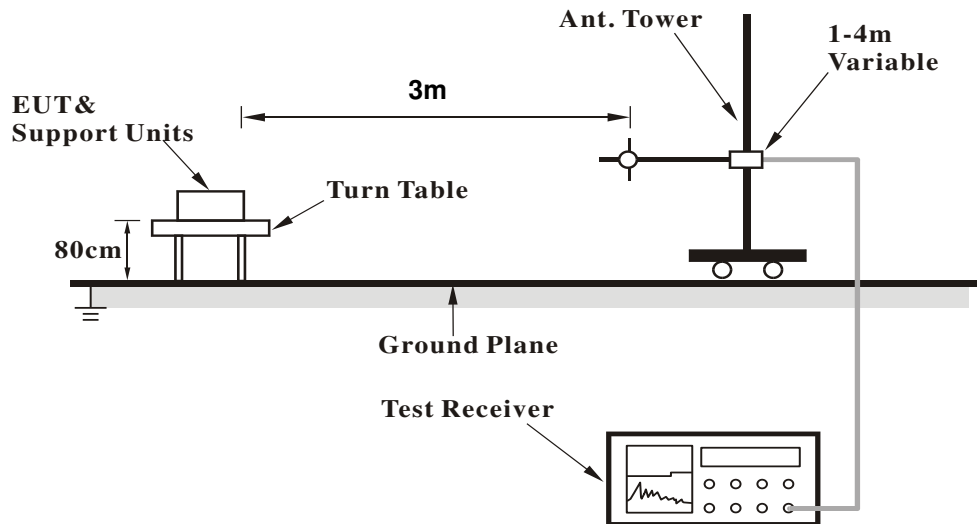

##### <Frequency Range above 1 GHz>

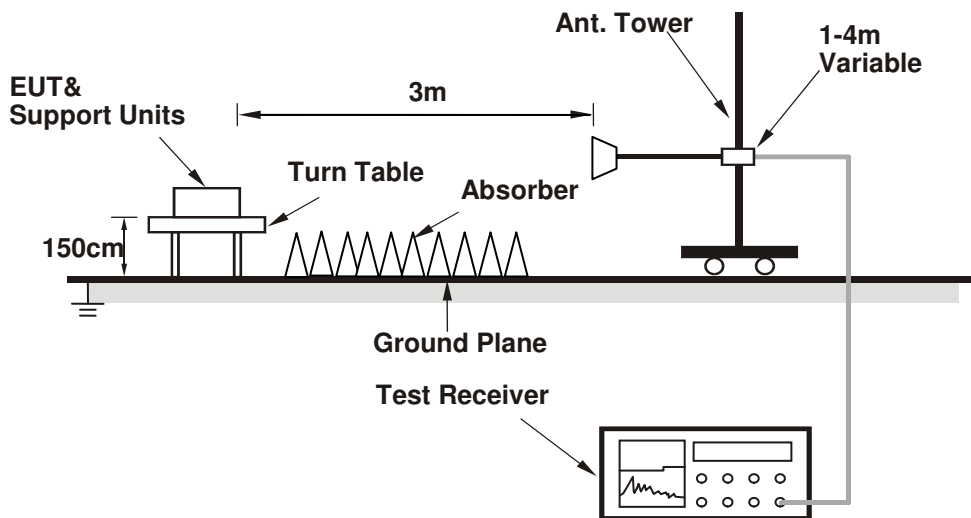

For the actual test configuration, please refer to the attached file (Test Setup Photo).

#### 4.1.6 EUT Operating Conditions

- Placed the EUT on a testing table.
- Use the software to control the EUT under transmission condition continuously at specific channel frequency.



4.1.7 Test Results

Above 1 GHz Data :

802.11b

EUT Test Condition		Measurement Detail	
Channel	Channel 1	Frequency Range	1 GHz ~ 25 GHz
Input Power	120 Vac, 60 Hz	Detector Function	Peak (PK) Average (AV)
Environmental Conditions	25 deg. C, 65 % RH	Tested By	Charles Hsiao

Antennal Polarity & Test Distance: Horizontal at 3 m										
Frequency (MHz)	Emission Level (dBuV/m)	Read Level (dBuV)	Limit (dBuV/m)	Margin (dB)	Antenna Factor (dB/m)	Cable Loss (dB)	Preamp Factor (dB)	Antenna Height (cm)	Table Angle (Degree)	Remark
2383.62	41.74	40.05	54	-12.26	31.78	5.4	35.49	298	44	Average
2389.2	52.6	50.89	74	-21.4	31.8	5.4	35.49	298	44	Peak
2412	99.92	98.15			31.81	5.43	35.47	298	44	Average
2412	102.63	100.86			31.81	5.43	35.47	298	44	Peak
4824	50.84	42.71	54	-3.16	33.97	8.26	34.1	213	291	Average
4824	56.78	48.65	74	-17.22	33.97	8.26	34.1	213	291	Peak
7236	50.64	40.11	54	-3.36	35.55	9.94	34.96	225	354	Average
7236	56.66	46.13	74	-17.34	35.55	9.94	34.96	225	354	Peak
Antennal Polarity & Test Distance: Vertical at 3 m										
Frequency (MHz)	Emission Level (dBuV/m)	Read Level (dBuV)	Limit (dBuV/m)	Margin (dB)	Antenna Factor (dB/m)	Cable Loss (dB)	Preamp Factor (dB)	Antenna Height (cm)	Table Angle (Degree)	Remark
2383.71	51.55	49.86	74	-22.45	31.78	5.4	35.49	187	54	Peak
2385.24	40.64	38.95	54	-13.36	31.78	5.4	35.49	187	54	Average
2412	95.93	94.16			31.81	5.43	35.47	187	54	Average
2412	98.14	96.37			31.81	5.43	35.47	187	54	Peak
4824	50.9	42.77	54	-3.1	33.97	8.26	34.1	103	322	Average
4824	56.84	48.71	74	-17.16	33.97	8.26	34.1	103	322	Peak
7236	49.94	39.41	54	-4.06	35.55	9.94	34.96	176	4	Average
7236	56.35	45.82	74	-17.65	35.55	9.94	34.96	176	4	Peak

Remarks:

- Emission Level = Read Level + Antenna Factor + Cable Loss - Preamp Factor  
Margin value = Emission level – Limit value
- 2412 MHz: Fundamental frequency.

EUT Test Condition		Measurement Detail	
Channel	Channel 6	Frequency Range	1 GHz ~ 25 GHz
Input Power	120 Vac, 60 Hz	Detector Function	Peak (PK) Average (AV)
Environmental Conditions	25 deg. C, 65 % RH	Tested By	Charles Hsiao

Antennal Polarity & Test Distance: Horizontal at 3 m										
Frequency (MHz)	Emission Level (dBuV/m)	Read Level (dBuV)	Limit (dBuV/m)	Margin (dB)	Antenna Factor (dB/m)	Cable Loss (dB)	Preamp Factor (dB)	Antenna Height (cm)	Table Angle (Degree)	Remark
2380.2	41.05	39.39	54	-12.95	31.78	5.37	35.49	298	44	Average
2388.48	51.64	49.93	74	-22.36	31.8	5.4	35.49	298	44	Peak
2437	98.46	96.61			31.85	5.46	35.46	298	44	Average
2437	101.09	99.24			31.85	5.46	35.46	298	44	Peak
2487.76	52.74	50.73	74	-21.26	31.9	5.53	35.42	298	44	Peak
2492.36	41.65	39.63	54	-12.35	31.9	5.53	35.41	298	44	Average
4874	50.84	42.65	54	-3.16	33.98	8.27	34.06	208	293	Average
4874	56.52	48.33	74	-17.48	33.98	8.27	34.06	208	293	Peak

Antennal Polarity & Test Distance: Vertical at 3 m										
Frequency (MHz)	Emission Level (dBuV/m)	Read Level (dBuV)	Limit (dBuV/m)	Margin (dB)	Antenna Factor (dB/m)	Cable Loss (dB)	Preamp Factor (dB)	Antenna Height (cm)	Table Angle (Degree)	Remark
2375.88	50.97	49.31	74	-23.03	31.78	5.37	35.49	187	54	Peak
2383.71	40.38	38.69	54	-13.62	31.78	5.4	35.49	187	54	Average
2437	94.46	92.61			31.85	5.46	35.46	187	54	Average
2437	97.77	95.92			31.85	5.46	35.46	187	54	Peak
2486.68	51.96	49.97	74	-22.04	31.88	5.53	35.42	187	54	Peak
2488.24	40.72	38.71	54	-13.28	31.9	5.53	35.42	187	54	Average
4874	50.74	42.55	54	-3.26	33.98	8.27	34.06	116	322	Average
4874	56.55	48.36	74	-17.45	33.98	8.27	34.06	116	322	Peak

Remarks:

- Emission Level = Read Level + Antenna Factor + Cable Loss - Preamp Factor  
Margin value = Emission level – Limit value
- 2437 MHz: Fundamental frequency.

EUT Test Condition		Measurement Detail	
Channel	Channel 11	Frequency Range	1 GHz ~ 25 GHz
Input Power	120 Vac, 60 Hz	Detector Function	Peak (PK) Average (AV)
Environmental Conditions	25 deg. C, 65 % RH	Tested By	Charles Hsiao

Antennal Polarity & Test Distance: Horizontal at 3 m										
Frequency (MHz)	Emission Level (dBuV/m)	Read Level (dBuV)	Limit (dBuV/m)	Margin (dB)	Antenna Factor (dB/m)	Cable Loss (dB)	Preamp Factor (dB)	Antenna Height (cm)	Table Angle (Degree)	Remark
2462	99.33	97.4			31.87	5.5	35.44	298	44	Average
2462	102.13	100.2			31.87	5.5	35.44	298	44	Peak
2487.44	43.46	41.47	54	-10.54	31.88	5.53	35.42	298	44	Average
2487.72	53.4	51.39	74	-20.6	31.9	5.53	35.42	298	44	Peak
4924	50.99	42.74	54	-3.01	33.99	8.28	34.02	206	293	Average
4924	56.86	48.61	74	-17.14	33.99	8.28	34.02	206	293	Peak
7386	49.92	39.5	54	-4.08	35.52	9.95	35.05	209	357	Average
7386	55.84	45.42	74	-18.16	35.52	9.95	35.05	209	357	Peak
Antennal Polarity & Test Distance: Vertical at 3 m										
Frequency (MHz)	Emission Level (dBuV/m)	Read Level (dBuV)	Limit (dBuV/m)	Margin (dB)	Antenna Factor (dB/m)	Cable Loss (dB)	Preamp Factor (dB)	Antenna Height (cm)	Table Angle (Degree)	Remark
2462	95.77	93.84			31.87	5.5	35.44	187	54	Average
2462	98.13	96.2			31.87	5.5	35.44	187	54	Peak
2485.6	51.83	49.84	74	-22.17	31.88	5.53	35.42	187	54	Peak
2497.4	40.63	38.61	54	-13.37	31.9	5.53	35.41	187	54	Average
4924	50.54	42.29	54	-3.46	33.99	8.28	34.02	115	318	Average
4924	56.94	48.69	74	-17.06	33.99	8.28	34.02	115	318	Peak
7386	47.82	37.4	54	-6.18	35.52	9.95	35.05	148	4	Average
7386	54.82	44.4	74	-19.18	35.52	9.95	35.05	148	4	Peak

Remarks:

- Emission Level = Read Level + Antenna Factor + Cable Loss - Preamp Factor  
Margin value = Emission level – Limit value
- 2462 MHz: Fundamental frequency.

802.11g

EUT Test Condition		Measurement Detail	
Channel	Channel 1	Frequency Range	1 GHz ~ 25 GHz
Input Power	120 Vac, 60 Hz	Detector Function	Peak (PK) Average (AV)
Environmental Conditions	25 deg. C, 65 % RH	Tested By	Charles Hsiao

Antennal Polarity & Test Distance: Horizontal at 3 m										
Frequency (MHz)	Emission Level (dBuV/m)	Read Level (dBuV)	Limit (dBuV/m)	Margin (dB)	Antenna Factor (dB/m)	Cable Loss (dB)	Preamp Factor (dB)	Antenna Height (cm)	Table Angle (Degree)	Remark
2389.92	50.17	48.44	54	-3.83	31.8	5.4	35.47	298	44	Average
2389.92	64.6	62.87	74	-9.4	31.8	5.4	35.47	298	44	Peak
2412	94.3	92.53			31.81	5.43	35.47	298	44	Average
2412	102.71	100.94			31.81	5.43	35.47	298	44	Peak
4824	40.16	32.03	54	-13.84	33.97	8.26	34.1	149	106	Average
4824	49.37	41.24	74	-24.63	33.97	8.26	34.1	149	106	Peak

Antennal Polarity & Test Distance: Vertical at 3 m										
Frequency (MHz)	Emission Level (dBuV/m)	Read Level (dBuV)	Limit (dBuV/m)	Margin (dB)	Antenna Factor (dB/m)	Cable Loss (dB)	Preamp Factor (dB)	Antenna Height (cm)	Table Angle (Degree)	Remark
2389.83	45.37	43.64	54	-8.63	31.8	5.4	35.47	187	54	Average
2389.83	61.52	59.79	74	-12.48	31.8	5.4	35.47	187	54	Peak
2412	90.25	88.48			31.81	5.43	35.47	187	54	Average
2412	98.4	96.63			31.81	5.43	35.47	187	54	Peak
4824	38.43	30.3	54	-15.57	33.97	8.26	34.1	129	174	Average
4824	47.15	39.02	74	-26.85	33.97	8.26	34.1	129	174	Peak

Remarks:

- Emission Level = Read Level + Antenna Factor + Cable Loss - Preamp Factor  
Margin value = Emission level – Limit value
- 2412 MHz: Fundamental frequency.

EUT Test Condition		Measurement Detail	
Channel	Channel 6	Frequency Range	1 GHz ~ 25 GHz
Input Power	120 Vac, 60 Hz	Detector Function	Peak (PK) Average (AV)
Environmental Conditions	25 deg. C, 65 % RH	Tested By	Charles Hsiao

Antennal Polarity & Test Distance: Horizontal at 3 m										
Frequency (MHz)	Emission Level (dBuV/m)	Read Level (dBuV)	Limit (dBuV/m)	Margin (dB)	Antenna Factor (dB/m)	Cable Loss (dB)	Preamp Factor (dB)	Antenna Height (cm)	Table Angle (Degree)	Remark
2384.16	52.32	50.63	74	-21.68	31.78	5.4	35.49	298	44	Peak
2384.88	41.88	40.19	54	-12.12	31.78	5.4	35.49	298	44	Average
2437	94.7	92.85			31.85	5.46	35.46	298	44	Average
2437	102.11	100.26			31.85	5.46	35.46	298	44	Peak
2489.12	42.91	40.9	54	-11.09	31.9	5.53	35.42	298	44	Average
2489.8	53.49	51.48	74	-20.51	31.9	5.53	35.42	298	44	Peak
Antennal Polarity & Test Distance: Vertical at 3 m										
Frequency (MHz)	Emission Level (dBuV/m)	Read Level (dBuV)	Limit (dBuV/m)	Margin (dB)	Antenna Factor (dB/m)	Cable Loss (dB)	Preamp Factor (dB)	Antenna Height (cm)	Table Angle (Degree)	Remark
2384.61	40.74	39.05	54	-13.26	31.78	5.4	35.49	187	54	Average
2389.11	51.39	49.68	74	-22.61	31.8	5.4	35.49	187	54	Peak
2437	90.6	88.75			31.85	5.46	35.46	187	54	Average
2437	98.69	96.84			31.85	5.46	35.46	187	54	Peak
2493.32	52.28	50.26	74	-21.72	31.9	5.53	35.41	187	54	Peak
2499.84	40.62	38.6	54	-13.38	31.9	5.53	35.41	187	54	Average

Remarks:

- Emission Level = Read Level + Antenna Factor + Cable Loss - Preamp Factor  
Margin value = Emission level – Limit value
- 2437 MHz: Fundamental frequency.

EUT Test Condition		Measurement Detail	
Channel	Channel 11	Frequency Range	1 GHz ~ 25 GHz
Input Power	120 Vac, 60 Hz	Detector Function	Peak (PK) Average (AV)
Environmental Conditions	25 deg. C, 65 % RH	Tested By	Charles Hsiao

Antennal Polarity & Test Distance: Horizontal at 3 m										
Frequency (MHz)	Emission Level (dBuV/m)	Read Level (dBuV)	Limit (dBuV/m)	Margin (dB)	Antenna Factor (dB/m)	Cable Loss (dB)	Preamp Factor (dB)	Antenna Height (cm)	Table Angle (Degree)	Remark
2462	94.55	92.62			31.87	5.5	35.44	298	44	Average
2462	102	100.07			31.87	5.5	35.44	298	44	Peak
2483.56	50.92	48.96	54	-3.08	31.88	5.5	35.42	298	44	Average
2483.68	67.13	65.17	74	-6.87	31.88	5.5	35.42	298	44	Peak
4924	38.44	30.19	54	-15.56	33.99	8.28	34.02	137	182	Average
4924	47.02	38.77	74	-26.98	33.99	8.28	34.02	137	182	Peak

Antennal Polarity & Test Distance: Vertical at 3 m										
Frequency (MHz)	Emission Level (dBuV/m)	Read Level (dBuV)	Limit (dBuV/m)	Margin (dB)	Antenna Factor (dB/m)	Cable Loss (dB)	Preamp Factor (dB)	Antenna Height (cm)	Table Angle (Degree)	Remark
2462	90.55	88.62			31.87	5.5	35.44	187	54	Average
2462	98.88	96.95			31.87	5.5	35.44	187	54	Peak
2484	41.27	39.31	54	-12.73	31.88	5.5	35.42	187	54	Average
2484	52.28	50.32	74	-21.72	31.88	5.5	35.42	187	54	Peak
4924	38.72	30.47	54	-15.28	33.99	8.28	34.02	134	110	Average
4924	47.08	38.83	74	-26.92	33.99	8.28	34.02	134	110	Peak

Remarks:

- Emission Level = Read Level + Antenna Factor + Cable Loss - Preamp Factor  
Margin value = Emission level – Limit value
- 2462 MHz: Fundamental frequency.

802.11n (HT20)

EUT Test Condition		Measurement Detail	
Channel	Channel 1	Frequency Range	1 GHz ~ 25 GHz
Input Power	120 Vac, 60 Hz	Detector Function	Peak (PK) Average (AV)
Environmental Conditions	25 deg. C, 65 % RH	Tested By	Charles Hsiao

**Antennal Polarity & Test Distance: Horizontal at 3 m**

Frequency (MHz)	Emission Level (dBuV/m)	Read Level (dBuV)	Limit (dBuV/m)	Margin (dB)	Antenna Factor (dB/m)	Cable Loss (dB)	Preamp Factor (dB)	Antenna Height (cm)	Table Angle (Degree)	Remark
2389.65	59.11	57.4	74	-14.89	31.8	5.4	35.49	298	44	Peak
2389.92	42.63	40.9	54	-11.37	31.8	5.4	35.47	298	44	Average
2412	91.44	89.67			31.81	5.43	35.47	298	44	Average
2412	98.23	96.46			31.81	5.43	35.47	298	44	Peak
4824	39.11	30.98	54	-14.89	33.97	8.26	34.1	143	127	Average
4824	49.76	41.63	74	-24.24	33.97	8.26	34.1	143	127	Peak

**Antennal Polarity & Test Distance: Vertical at 3 m**

Frequency (MHz)	Emission Level (dBuV/m)	Read Level (dBuV)	Limit (dBuV/m)	Margin (dB)	Antenna Factor (dB/m)	Cable Loss (dB)	Preamp Factor (dB)	Antenna Height (cm)	Table Angle (Degree)	Remark
2389.92	41.18	39.45	54	-12.82	31.8	5.4	35.47	187	54	Average
2389.92	53.92	52.19	74	-20.08	31.8	5.4	35.47	187	54	Peak
2412	87.69	85.92			31.81	5.43	35.47	187	54	Average
2412	94.58	92.81			31.81	5.43	35.47	187	54	Peak
4824	38.89	30.76	54	-15.11	33.97	8.26	34.1	164	113	Average
4824	48.21	40.08	74	-25.79	33.97	8.26	34.1	164	113	Peak

Remarks:

- Emission Level = Read Level + Antenna Factor + Cable Loss - Preamp Factor  
Margin value = Emission level – Limit value
- 2412 MHz: Fundamental frequency.

EUT Test Condition		Measurement Detail	
Channel	Channel 6	Frequency Range	1 GHz ~ 25 GHz
Input Power	120 Vac, 60 Hz	Detector Function	Peak (PK) Average (AV)
Environmental Conditions	25 deg. C, 65 % RH	Tested By	Charles Hsiao

Antennal Polarity & Test Distance: Horizontal at 3 m										
Frequency (MHz)	Emission Level (dBuV/m)	Read Level (dBuV)	Limit (dBuV/m)	Margin (dB)	Antenna Factor (dB/m)	Cable Loss (dB)	Preamp Factor (dB)	Antenna Height (cm)	Table Angle (Degree)	Remark
2384.79	52.99	51.3	74	-21.01	31.78	5.4	35.49	298	44	Peak
2385.51	41.43	39.72	54	-12.57	31.8	5.4	35.49	298	44	Average
2437	91.46	89.61			31.85	5.46	35.46	298	44	Average
2437	98.58	96.73			31.85	5.46	35.46	298	44	Peak
2488.44	52.68	50.67	74	-21.32	31.9	5.53	35.42	298	44	Peak
2488.52	42.43	40.42	54	-11.57	31.9	5.53	35.42	298	44	Average

Antennal Polarity & Test Distance: Vertical at 3 m										
Frequency (MHz)	Emission Level (dBuV/m)	Read Level (dBuV)	Limit (dBuV/m)	Margin (dB)	Antenna Factor (dB/m)	Cable Loss (dB)	Preamp Factor (dB)	Antenna Height (cm)	Table Angle (Degree)	Remark
2341.14	51.5	49.93	74	-22.5	31.74	5.33	35.5	187	54	Peak
2384.34	40.52	38.83	54	-13.48	31.78	5.4	35.49	187	54	Average
2437	87.49	85.64			31.85	5.46	35.46	187	54	Average
2437	94.2	92.35			31.85	5.46	35.46	187	54	Peak
2490.48	40.73	38.72	54	-13.27	31.9	5.53	35.42	187	54	Average
2498.52	52.49	50.47	74	-21.51	31.9	5.53	35.41	187	54	Peak

Remarks:

- Emission Level = Read Level + Antenna Factor + Cable Loss - Preamp Factor  
Margin value = Emission level – Limit value
- 2437 MHz: Fundamental frequency.



EUT Test Condition		Measurement Detail	
Channel	Channel 11	Frequency Range	1 GHz ~ 25 GHz
Input Power	120 Vac, 60 Hz	Detector Function	Peak (PK) Average (AV)
Environmental Conditions	25 deg. C, 65 % RH	Tested By	Charles Hsiao

Antennal Polarity & Test Distance: Horizontal at 3 m										
Frequency (MHz)	Emission Level (dBuV/m)	Read Level (dBuV)	Limit (dBuV/m)	Margin (dB)	Antenna Factor (dB/m)	Cable Loss (dB)	Preamp Factor (dB)	Antenna Height (cm)	Table Angle (Degree)	Remark
2462	91.32	89.39			31.87	5.5	35.44	298	44	Average
2462	98.62	96.69			31.87	5.5	35.44	298	44	Peak
2483.64	44.5	42.54	54	-9.5	31.88	5.5	35.42	298	44	Average
2483.88	58.9	56.94	74	-15.1	31.88	5.5	35.42	298	44	Peak
4924	39.24	30.99	54	-14.76	33.99	8.28	34.02	167	241	Average
4924	48.13	39.88	74	-25.87	33.99	8.28	34.02	167	241	Peak

Antennal Polarity & Test Distance: Vertical at 3 m										
Frequency (MHz)	Emission Level (dBuV/m)	Read Level (dBuV)	Limit (dBuV/m)	Margin (dB)	Antenna Factor (dB/m)	Cable Loss (dB)	Preamp Factor (dB)	Antenna Height (cm)	Table Angle (Degree)	Remark
2462	87.52	85.59			31.87	5.5	35.44	187	54	Average
2462	94.63	92.7			31.87	5.5	35.44	187	54	Peak
2483.68	51.75	49.79	74	-22.25	31.88	5.5	35.42	187	54	Peak
2484.52	40.8	38.81	54	-13.2	31.88	5.53	35.42	187	54	Average
4924	39.52	31.27	54	-14.48	33.99	8.28	34.02	124	167	Average
4924	48.59	40.34	74	-25.41	33.99	8.28	34.02	124	167	Peak

Remarks:

- Emission Level = Read Level + Antenna Factor + Cable Loss - Preamp Factor  
Margin value = Emission level – Limit value
- 2462 MHz: Fundamental frequency.

802.11n (HT40)

EUT Test Condition		Measurement Detail	
Channel	Channel 3	Frequency Range	1 GHz ~ 25 GHz
Input Power	120 Vac, 60 Hz	Detector Function	Peak (PK) Average (AV)
Environmental Conditions	25 deg. C, 65 % RH	Tested By	Charles Hsiao

**Antennal Polarity & Test Distance: Horizontal at 3 m**

Frequency (MHz)	Emission Level (dBuV/m)	Read Level (dBuV)	Limit (dBuV/m)	Margin (dB)	Antenna Factor (dB/m)	Cable Loss (dB)	Preamp Factor (dB)	Antenna Height (cm)	Table Angle (Degree)	Remark
2389.11	50.96	49.25	54	-3.04	31.8	5.4	35.49	298	44	Average
2389.11	65.34	63.63	74	-8.66	31.8	5.4	35.49	298	44	Peak
2422	92.8	91			31.83	5.43	35.46	298	44	Average
2422	99.66	97.86			31.83	5.43	35.46	298	44	Peak
2483.64	53.29	51.33	74	-20.71	31.88	5.5	35.42	298	44	Peak
2483.92	41.9	39.94	54	-12.1	31.88	5.5	35.42	298	44	Average

**Antennal Polarity & Test Distance: Vertical at 3 m**

Frequency (MHz)	Emission Level (dBuV/m)	Read Level (dBuV)	Limit (dBuV/m)	Margin (dB)	Antenna Factor (dB/m)	Cable Loss (dB)	Preamp Factor (dB)	Antenna Height (cm)	Table Angle (Degree)	Remark
2389.02	63.07	61.36	74	-10.93	31.8	5.4	35.49	187	54	Peak
2389.38	48.44	46.73	54	-5.56	31.8	5.4	35.49	187	54	Average
2422	88.33	86.53			31.83	5.43	35.46	187	54	Average
2422	95.74	93.94			31.83	5.43	35.46	187	54	Peak
2488.48	52.26	50.25	74	-21.74	31.9	5.53	35.42	187	54	Peak
2499.52	41.08	39.06	54	-12.92	31.9	5.53	35.41	187	54	Average

Remarks:

- Emission Level = Read Level + Antenna Factor + Cable Loss - Preamp Factor  
Margin value = Emission level – Limit value
- 2422 MHz: Fundamental frequency.

EUT Test Condition		Measurement Detail	
Channel	Channel 6	Frequency Range	1 GHz ~ 25 GHz
Input Power	120 Vac, 60 Hz	Detector Function	Peak (PK) Average (AV)
Environmental Conditions	25 deg. C, 65 % RH	Tested By	Charles Hsiao

Antennal Polarity & Test Distance: Horizontal at 3 m										
Frequency (MHz)	Emission Level (dBuV/m)	Read Level (dBuV)	Limit (dBuV/m)	Margin (dB)	Antenna Factor (dB/m)	Cable Loss (dB)	Preamp Factor (dB)	Antenna Height (cm)	Table Angle (Degree)	Remark
2388.48	54.75	53.04	74	-19.25	31.8	5.4	35.49	298	44	Peak
2389.47	42.77	41.06	54	-11.23	31.8	5.4	35.49	298	44	Average
2437	92.66	90.81			31.85	5.46	35.46	298	44	Average
2437	99.36	97.51			31.85	5.46	35.46	298	44	Peak
2483.64	44.69	42.73	54	-9.31	31.88	5.5	35.42	298	44	Average
2484.84	58.25	56.26	74	-15.75	31.88	5.53	35.42	298	44	Peak

Antennal Polarity & Test Distance: Vertical at 3 m										
Frequency (MHz)	Emission Level (dBuV/m)	Read Level (dBuV)	Limit (dBuV/m)	Margin (dB)	Antenna Factor (dB/m)	Cable Loss (dB)	Preamp Factor (dB)	Antenna Height (cm)	Table Angle (Degree)	Remark
2389.74	52.84	51.13	74	-21.16	31.8	5.4	35.49	187	54	Peak
2389.83	41.21	39.48	54	-12.79	31.8	5.4	35.47	187	54	Average
2437	88.29	86.44			31.85	5.46	35.46	187	54	Average
2437	95.89	94.04			31.85	5.46	35.46	187	54	Peak
2486.96	52.01	50.02	74	-21.99	31.88	5.53	35.42	187	54	Peak
2499.88	41.21	39.19	54	-12.79	31.9	5.53	35.41	187	54	Average

Remarks:

- Emission Level = Read Level + Antenna Factor + Cable Loss - Preamp Factor  
Margin value = Emission level – Limit value
- 2437 MHz: Fundamental frequency.

EUT Test Condition		Measurement Detail	
Channel	Channel 9	Frequency Range	1 GHz ~ 25 GHz
Input Power	120 Vac, 60 Hz	Detector Function	Peak (PK) Average (AV)
Environmental Conditions	25 deg. C, 65 % RH	Tested By	Charles Hsiao

Antennal Polarity & Test Distance: Horizontal at 3 m										
Frequency (MHz)	Emission Level (dBuV/m)	Read Level (dBuV)	Limit (dBuV/m)	Margin (dB)	Antenna Factor (dB/m)	Cable Loss (dB)	Preamp Factor (dB)	Antenna Height (cm)	Table Angle (Degree)	Remark
2388.57	52.59	50.88	74	-21.41	31.8	5.4	35.49	298	44	Peak
2388.75	40.97	39.26	54	-13.03	31.8	5.4	35.49	298	44	Average
2452	92.86	90.99			31.85	5.46	35.44	298	44	Average
2452	99.47	97.6			31.85	5.46	35.44	298	44	Peak
2483.72	50.33	48.37	54	-3.67	31.88	5.5	35.42	298	44	Average
2484.4	67.66	65.67	74	-6.34	31.88	5.53	35.42	298	44	Peak
Antennal Polarity & Test Distance: Vertical at 3 m										
Frequency (MHz)	Emission Level (dBuV/m)	Read Level (dBuV)	Limit (dBuV/m)	Margin (dB)	Antenna Factor (dB/m)	Cable Loss (dB)	Preamp Factor (dB)	Antenna Height (cm)	Table Angle (Degree)	Remark
2373.27	51.55	49.89	74	-22.45	31.78	5.37	35.49	187	54	Peak
2388.84	40.79	39.08	54	-13.21	31.8	5.4	35.49	187	54	Average
2452	88.23	86.36			31.85	5.46	35.44	187	54	Average
2452	95.56	93.69			31.85	5.46	35.44	187	54	Peak
2483.52	54.05	52.09	74	-19.95	31.88	5.5	35.42	187	54	Peak
2483.8	42.2	40.24	54	-11.8	31.88	5.5	35.42	187	54	Average

Remarks:

- Emission Level = Read Level + Antenna Factor + Cable Loss - Preamp Factor  
Margin value = Emission level – Limit value
- 2452 MHz: Fundamental frequency.

**9 kHz ~ 30 MHz DATA:**

The amplitude of spurious emissions attenuated more than 20 dB below the permissible value is not required to be report.

**30 MHz ~ 1 GHz WORST-CASE DATA:**

**802.11b**

EUT Test Condition		Measurement Detail	
Channel	Channel 11	Frequency Range	30 MHz ~ 1 GHz
Input Power	120 Vac, 60 Hz	Detector Function	Peak (PK) Quasi-peak (QP)
Environmental Conditions	25 deg. C, 65 % RH	Tested By	Charles Hsiao

Antennal Polarity & Test Distance: Horizontal at 3 m										
Frequency (MHz)	Emission Level (dBuV/m)	Read Level (dBuV)	Limit (dBuV/m)	Margin (dB)	Antenna Factor (dB/m)	Cable Loss (dB)	Preamp Factor (dB)	Antenna Height (cm)	Table Angle (Degree)	Remark
142.05	23.49	44.9	43.5	-20.01	9.48	1.38	32.27	142	5	Peak
160.95	31.53	51.55	43.5	-11.97	10.73	1.52	32.27	160	159	Peak
195.24	24.03	44.02	43.5	-19.47	10.68	1.61	32.28	106	9	Peak
524	20.25	28.99	46	-25.75	20.7	2.7	32.14	121	333	Peak
576.5	20.63	29.91	46	-25.37	20.1	2.82	32.2	154	196	Peak
736.8	24.39	30.06	46	-21.61	23.3	3.16	32.13	164	300	Peak

Antennal Polarity & Test Distance: Vertical at 3 m										
Frequency (MHz)	Emission Level (dBuV/m)	Read Level (dBuV)	Limit (dBuV/m)	Margin (dB)	Antenna Factor (dB/m)	Cable Loss (dB)	Preamp Factor (dB)	Antenna Height (cm)	Table Angle (Degree)	Remark
47.01	26.21	48.79	40	-13.79	8.74	0.9	32.22	105	141	Peak
152.85	21.24	41.66	43.5	-22.26	10.33	1.52	32.27	185	255	Peak
192.54	14.25	34.4	43.5	-29.25	10.51	1.61	32.27	160	164	Peak
671	23.49	29.38	46	-22.51	23.18	3.05	32.12	164	246	Peak
724.2	24.41	30.01	46	-21.59	23.36	3.16	32.12	180	147	Peak
865.6	26.33	30.19	46	-19.67	24.4	3.44	31.7	131	326	Peak

Remarks:

- Emission Level = Read Level + Antenna Factor + Cable Loss - Preamp Factor  
Margin value = Emission level – Limit value

## 4.2 Conducted Emission Measurement

### 4.2.1 Limits of Conducted Emission Measurement

Frequency (MHz)	Conducted Limit (dBuV)	
	Quasi-peak	Average
0.15 - 0.5	66 - 56	56 - 46
0.50 - 5.0	56	46
5.0 - 30.0	60	50

Note: 1. The lower limit shall apply at the transition frequencies.

2. The limit decreases in line with the logarithm of the frequency in the range of 0.15 to 0.50 MHz.

### 4.2.2 Test Instruments

Description & Manufacturer	Model No.	Serial No.	Date of Calibration	Due Date of Calibration
Test Receiver ROHDE & SCHWARZ	ESCI	100613	Nov. 21, 2016	Nov. 20, 2017
RF signal cable (with 10dB PAD) Woken	5D-FB	Cable-cond1-01	Dec. 22, 2016	Dec. 21, 2017
LISN ROHDE & SCHWARZ (EUT)	ESH3-Z5	835239/001	Mar. 10, 2017	Mar. 09, 2018
LISN ROHDE & SCHWARZ (Peripheral)	ESH3-Z5	100311	Jul. 28, 2016	Jul. 27, 2017
Software ADT	BV ADT_Cond_ V7.3.7.3	NA	NA	NA

Note: 1. The calibration interval of the above test instruments is 12 months and the calibrations are traceable to NML/ROC and NIST/USA.

2. The test was performed in HwaYa Shielded Room 1.

3. The VCCI Site Registration No. is C-2040.

#### 4.2.3 Test Procedures

- a. The EUT was placed 0.4 meters from the conducting wall of the shielded room with EUT being connected to the power mains through a line impedance stabilization network (LISN). Other support units were connected to the power mains through another LISN. The two LISNs provide 50 ohm/50 uH of coupling impedance for the measuring instrument.
- b. Both lines of the power mains connected to the EUT were checked for maximum conducted interference.
- c. The frequency range from 150 kHz to 30 MHz was searched. Emission levels under (Limit – 20 dB) was not recorded.

**NOTE:** All modes of operation were investigated and the worst-case emissions are reported.

#### 4.2.4 Deviation from Test Standard

No deviation.

#### 4.2.5 Test Setup

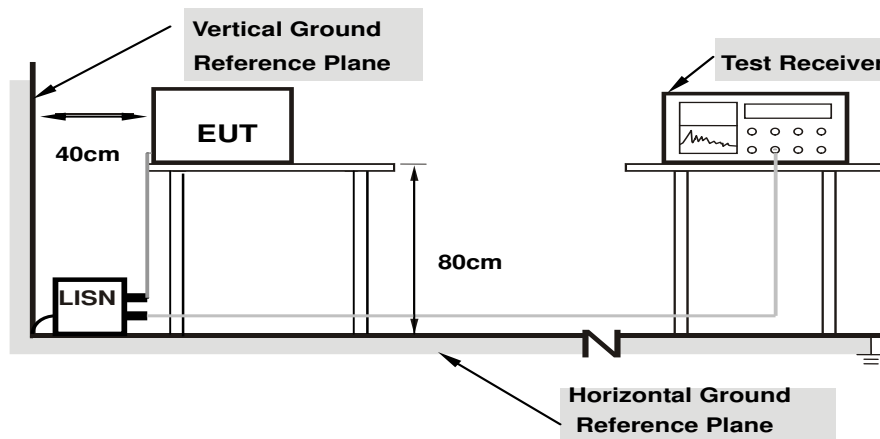

**Note: 1.Support units were connected to second LISN.**

For the actual test configuration, please refer to the attached file (Test Setup Photo).

#### 4.2.6 EUT Operating Conditions

- a. Placed the EUT on a testing table.
- b. Use the software to control the EUT under transmission condition continuously at specific channel frequency.

#### 4.2.7 Test Results

Frequency Range	150kHz ~ 30MHz	Detector Function & Resolution Bandwidth	Quasi-Peak (QP) / Average (AV), 9kHz
Input Power	120Vac, 60Hz	Environmental Conditions	25°C, 65%RH
Tested by	Toby Tian	Test Date	2017/3/12

Phase Of Power : Line (L)										
No	Frequency (MHz)	Correction Factor (dB)	Reading Value (dBuV)		Emission Level (dBuV)		Limit (dBuV)		Margin (dB)	
			Q.P.	AV.	Q.P.	AV.	Q.P.	AV.	Q.P.	AV.
1	0.15802	10.02	35.97	19.64	45.99	29.66	65.57	55.57	-19.58	-25.91
2	0.18910	10.03	30.28	13.75	40.31	23.78	64.08	54.08	-23.77	-30.30
3	0.27120	10.06	24.86	12.33	34.92	22.39	61.08	51.08	-26.16	-28.69
4	0.50581	10.13	31.60	23.26	41.73	33.39	56.00	46.00	-14.27	-12.61
5	1.16660	10.21	19.32	10.29	29.53	20.50	56.00	46.00	-26.47	-25.50
6	6.49593	10.54	19.97	11.93	30.51	22.47	60.00	50.00	-29.49	-27.53

Remarks:

1. Q.P. and AV. are abbreviations of quasi-peak and average individually.
2. The emission levels of other frequencies were very low against the limit.
3. Margin value = Emission level – Limit value
4. Correction factor = Insertion loss + Cable loss
5. Emission Level = Correction Factor + Reading Value

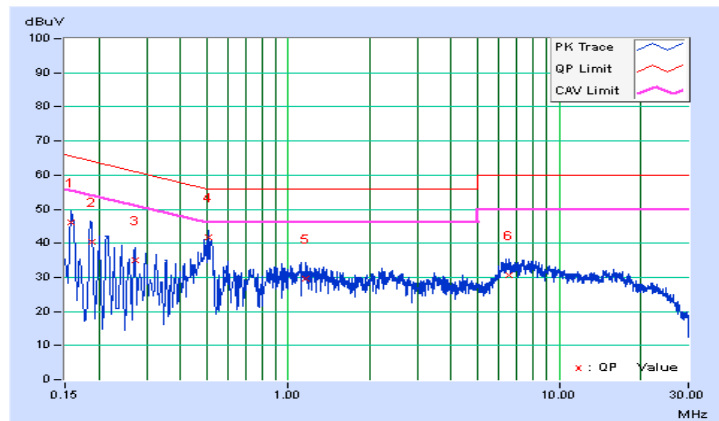



Frequency Range	150kHz ~ 30MHz	Detector Function & Resolution Bandwidth	Quasi-Peak (QP) / Average (AV), 9kHz
Input Power	120Vac, 60Hz	Environmental Conditions	25°C, 65%RH
Tested by	Toby Tian	Test Date	2017/3/12

Phase Of Power : Neutral (N)										
No	Frequency (MHz)	Correction Factor (dB)	Reading Value (dBuV)		Emission Level (dBuV)		Limit (dBuV)		Margin (dB)	
			Q.P.	AV.	Q.P.	AV.	Q.P.	AV.	Q.P.	AV.
1	0.16569	10.03	29.38	19.03	39.41	29.06	65.17	55.17	-25.76	-26.11
2	0.33768	10.10	23.70	14.65	33.80	24.75	59.26	49.26	-25.46	-24.51
3	0.47915	10.14	36.17	27.88	46.31	38.02	56.35	46.35	-10.04	-8.33
4	0.77169	10.18	24.59	14.84	34.77	25.02	56.00	46.00	-21.23	-20.98
5	1.17833	10.22	22.22	11.79	32.44	22.01	56.00	46.00	-23.56	-23.99
6	6.77745	10.60	22.14	13.92	32.74	24.52	60.00	50.00	-27.26	-25.48

Remarks:

1. Q.P. and AV. are abbreviations of quasi-peak and average individually.
2. The emission levels of other frequencies were very low against the limit.
3. Margin value = Emission level – Limit value
4. Correction factor = Insertion loss + Cable loss
5. Emission Level = Correction Factor + Reading Value

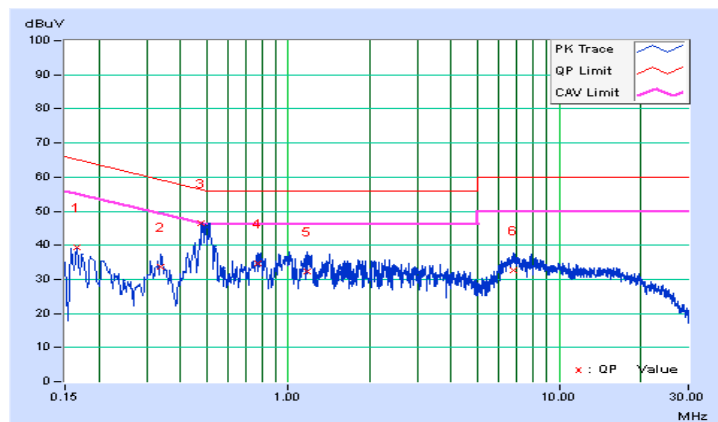

### 4.3 6 dB Bandwidth Measurement

#### 4.3.1 Limits of 6 dB Bandwidth Measurement

The minimum of 6 dB Bandwidth Measurement is 0.5 MHz.

#### 4.3.2 Test Setup

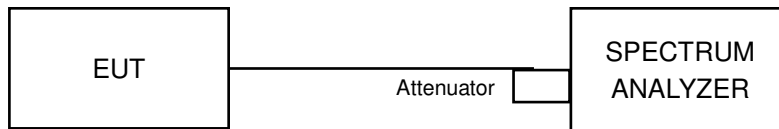

#### 4.3.3 Test Instruments

Refer to section 4.1.2 to get information of above instrument.

#### 4.3.4 Test Procedure

- a. Set resolution bandwidth (RBW) = 100 kHz
- b. Set the video bandwidth (VBW)  $\geq 3 \times$  RBW, Detector = Peak.
- c. Trace mode = max hold.
- d. Sweep = auto couple.
- e. Measure the maximum width of the emission that is constrained by the frequencies associated with the two amplitude points (upper and lower) that are attenuated by 6 dB relative to the maximum level measured in the fundamental emission

#### 4.3.5 Deviation from Test Standard

No deviation.

#### 4.3.6 EUT Operating Conditions

The software provided by client to enable the EUT under transmission condition continuously at lowest, middle and highest channel frequencies individually.

## 4.3.7 Test Result

## 802.11b

Channel	Frequency (MHz)	6 dB Bandwidth (MHz)	Minimum Limit (MHz)	Pass / Fail
1	2412	8.59	0.5	Pass
6	2437	8.57	0.5	Pass
11	2462	8.58	0.5	Pass

## 802.11g

Channel	Frequency (MHz)	6 dB Bandwidth (MHz)	Minimum Limit (MHz)	Pass / Fail
1	2412	16.42	0.5	Pass
6	2437	16.42	0.5	Pass
11	2462	16.41	0.5	Pass

## 802.11n (HT20)

Channel	Frequency (MHz)	6 dB Bandwidth (MHz)	Minimum Limit (MHz)	Pass / Fail
1	2412	17.65	0.5	Pass
6	2437	17.64	0.5	Pass
11	2462	17.63	0.5	Pass

## 802.11n (HT40)

Channel	Frequency (MHz)	6 dB Bandwidth (MHz)	Minimum Limit (MHz)	Pass / Fail
3	2422	35.57	0.5	Pass
6	2437	35.47	0.5	Pass
9	2452	35.25	0.5	Pass

### Spectrum Plot of Worst Value

#### 802.11b

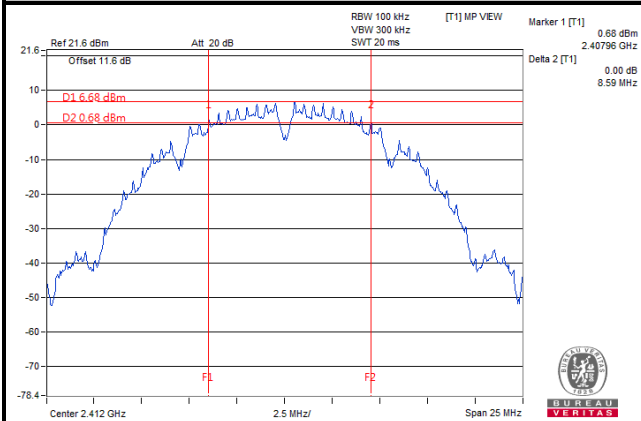

#### 802.11g

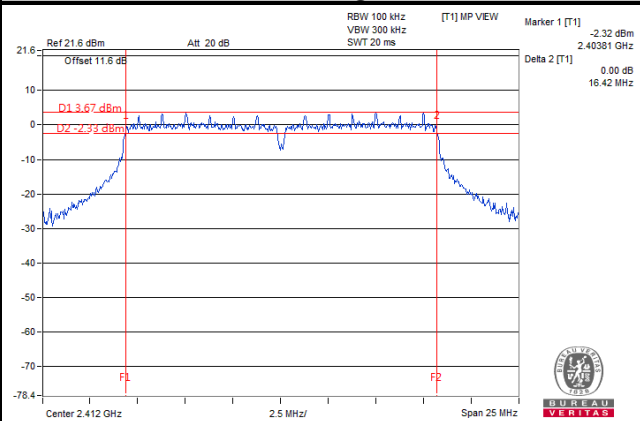

#### 802.11n (HT20)

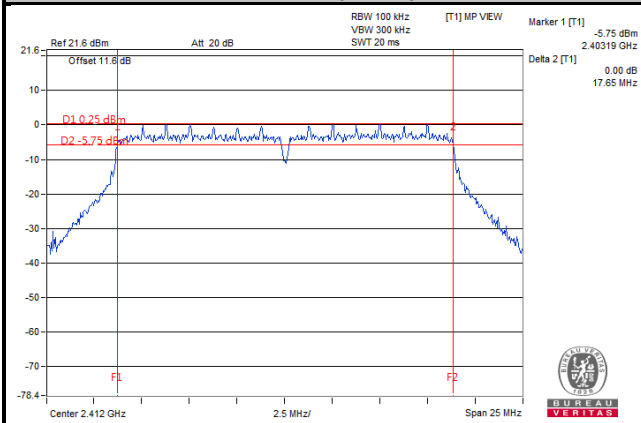

#### 802.11n (HT40)

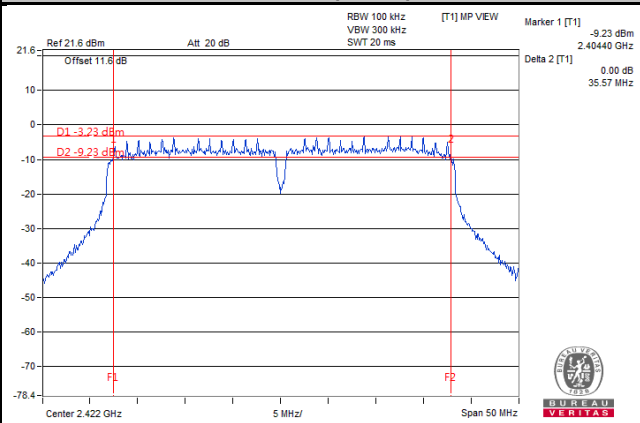

#### 4.4 Conducted Output Power Measurement

##### 4.4.1 Limits of Conducted Output Power Measurement

For systems using digital modulation in the 2400–2483.5 MHz bands: 1 Watt (30 dBm)

##### 4.4.2 Test Setup

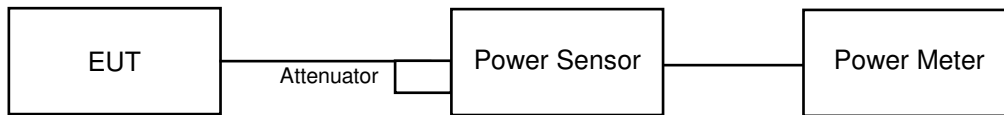

##### 4.4.3 Test Instruments

Refer to section 4.1.2 to get information of above instrument.

##### 4.4.4 Test Procedures

A peak power sensor was used on the output port of the EUT. A power meter was used to read the response of the peak power sensor. Record the power level.

##### 4.4.5 Deviation from Test Standard

No deviation.

##### 4.4.6 EUT Operating Conditions

The software provided by client to enable the EUT under transmission condition continuously at lowest, middle and highest channel frequencies individually.

#### 4.4.7 Test Results

##### 802.11b

Channel	Frequency (MHz)	Peak Power (mW)	Peak Power (dBm)	Limit (dBm)	Pass / Fail
1	2412	54.954	17.40	30	Pass
6	2437	58.21	17.65	30	Pass
11	2462	53.703	17.30	30	Pass

##### 802.11g

Channel	Frequency (MHz)	Peak Power (mW)	Peak Power (dBm)	Limit (dBm)	Pass / Fail
1	2412	127.057	21.04	30	Pass
6	2437	132.739	21.23	30	Pass
11	2462	125.314	20.98	30	Pass

##### 802.11n (HT20)

Channel	Frequency (MHz)	Peak Power (mW)	Peak Power (dBm)	Limit (dBm)	Pass / Fail
1	2412	112.98	20.53	30	Pass
6	2437	115.08	20.61	30	Pass
11	2462	113.501	20.55	30	Pass

##### 802.11n (HT40)

Channel	Frequency (MHz)	Peak Power (mW)	Peak Power (dBm)	Limit (dBm)	Pass / Fail
3	2422	89.125	19.50	30	Pass
6	2437	107.152	20.30	30	Pass
9	2452	113.24	20.54	30	Pass

## 4.5 Power Spectral Density Measurement

### 4.5.1 Limits of Power Spectral Density Measurement

The Maximum of Power Spectral Density Measurement is 8 dBm.

### 4.5.2 Test Setup

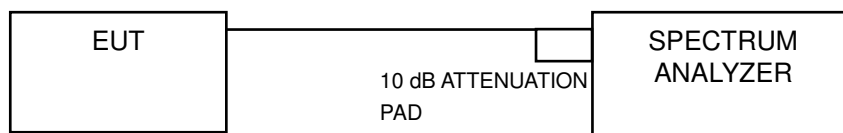

### 4.5.3 Test Instruments

Refer to section 4.1.2 to get information of above instrument.

### 4.5.4 Test Procedure

- Set analyzer center frequency to DTS channel center frequency.
- Set the span to 1.5 times the DTS bandwidth.
- Set the RBW to:  $3 \text{ kHz} \leq \text{RBW} \leq 100 \text{ kHz}$ .
- Set the VBW  $\geq 3 \times \text{RBW}$ .
- Detector = peak.
- Sweep time = auto couple.
- Trace mode = max hold.
- Allow trace to fully stabilize.
- Use the peak marker function to determine the maximum amplitude level within the RBW.

### 4.5.5 Deviation from Test Standard

No deviation.

### 4.5.6 EUT Operating Condition

The software provided by client to enable the EUT under transmission condition continuously at lowest, middle and highest channel frequencies individually.

#### 4.5.7 Test Results

##### 802.11b

Channel	Frequency (MHz)	PSD (dBm)	Limit (dBm)	Pass / Fail
1	2412	-8.58	8	Pass
6	2437	-8.05	8	Pass
11	2462	-8.83	8	Pass

##### 802.11g

Channel	Frequency (MHz)	PSD (dBm)	Limit (dBm)	Pass / Fail
1	2412	-10.51	8	Pass
6	2437	-9.91	8	Pass
11	2462	-10.68	8	Pass

##### 802.11n (HT20)

Channel	Frequency (MHz)	PSD (dBm)	Limit (dBm)	Pass / Fail
1	2412	-14.06	8	Pass
6	2437	-13.87	8	Pass
11	2462	-13.93	8	Pass

##### 802.11n (HT40)

Channel	Frequency (MHz)	PSD (dBm)	Limit (dBm)	Pass / Fail
3	2422	-18.32	8	Pass
6	2437	-17.74	8	Pass
9	2452	-17.69	8	Pass



### Spectrum Plot of Worst Value

#### 802.11b

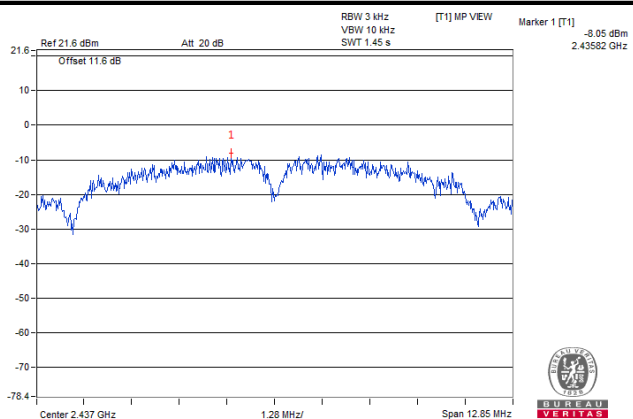

#### 802.11g

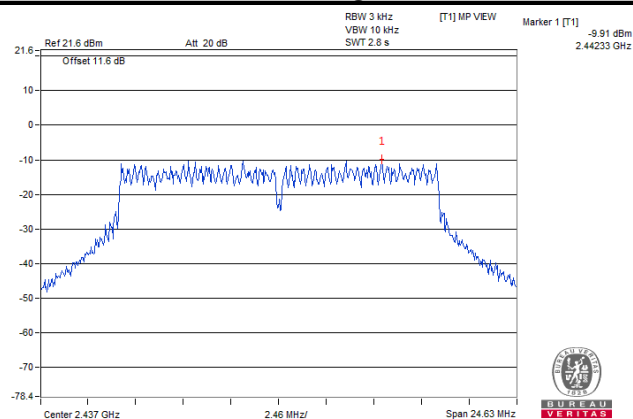

#### 802.11n (HT20)

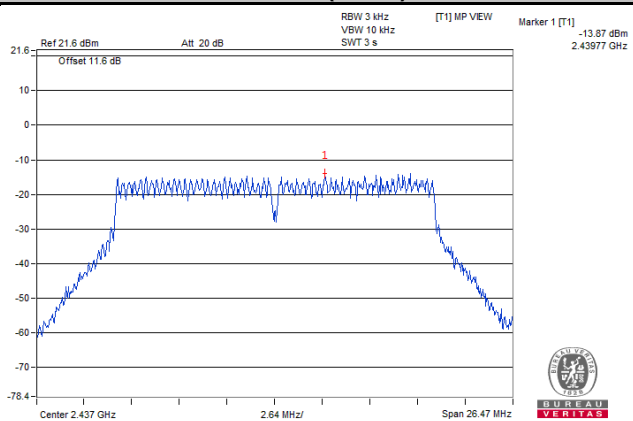

#### 802.11n (HT40)

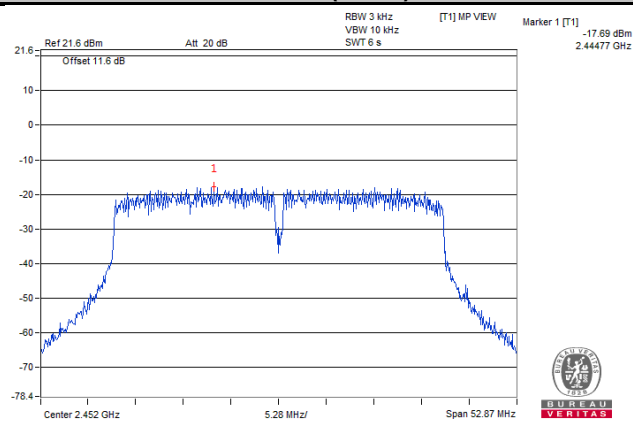

## 4.6 Conducted Out of Band Emission Measurement

### 4.6.1 Limits of Conducted Out of Band Emission Measurement

Below 20 dB of the highest emission level of operating band (in 100 kHz Resolution Bandwidth).

### 4.6.2 Test Setup

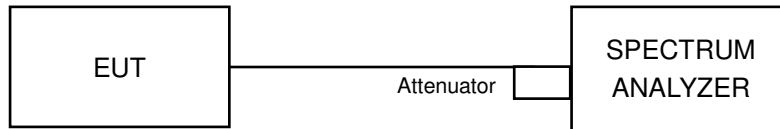

### 4.6.3 Test Instruments

Refer to section 4.1.2 to get information of above instrument.

### 4.6.4 Test Procedure

#### MEASUREMENT PROCEDURE REF

1. Set the RBW = 100 kHz.
2. Set the VBW  $\geq$  300 kHz.
3. Detector = peak.
4. Sweep time = auto couple.
5. Trace mode = max hold.
6. Allow trace to fully stabilize.
7. Use the peak marker function to determine the maximum power level in any 100 kHz band segment within the fundamental EBW.

#### MEASUREMENT PROCEDURE OOBE

1. Set RBW = 100 kHz.
2. Set VBW  $\geq$  300 kHz.
3. Detector = peak.
4. Sweep = auto couple.
5. Trace Mode = max hold.
6. Allow trace to fully stabilize.
7. Use the peak marker function to determine the maximum amplitude level.

### 4.6.5 Deviation from Test Standard

No deviation.

### 4.6.6 EUT Operating Condition

The software provided by client to enable the EUT under transmission condition continuously at lowest, middle and highest channel frequencies individually.

### 4.6.7 Test Results

The spectrum plots are attached on the following images. D1 line indicates the highest level, and D2 line indicates the 20 dB offset below D1. It shows compliance with the requirement.

#### 802.11b

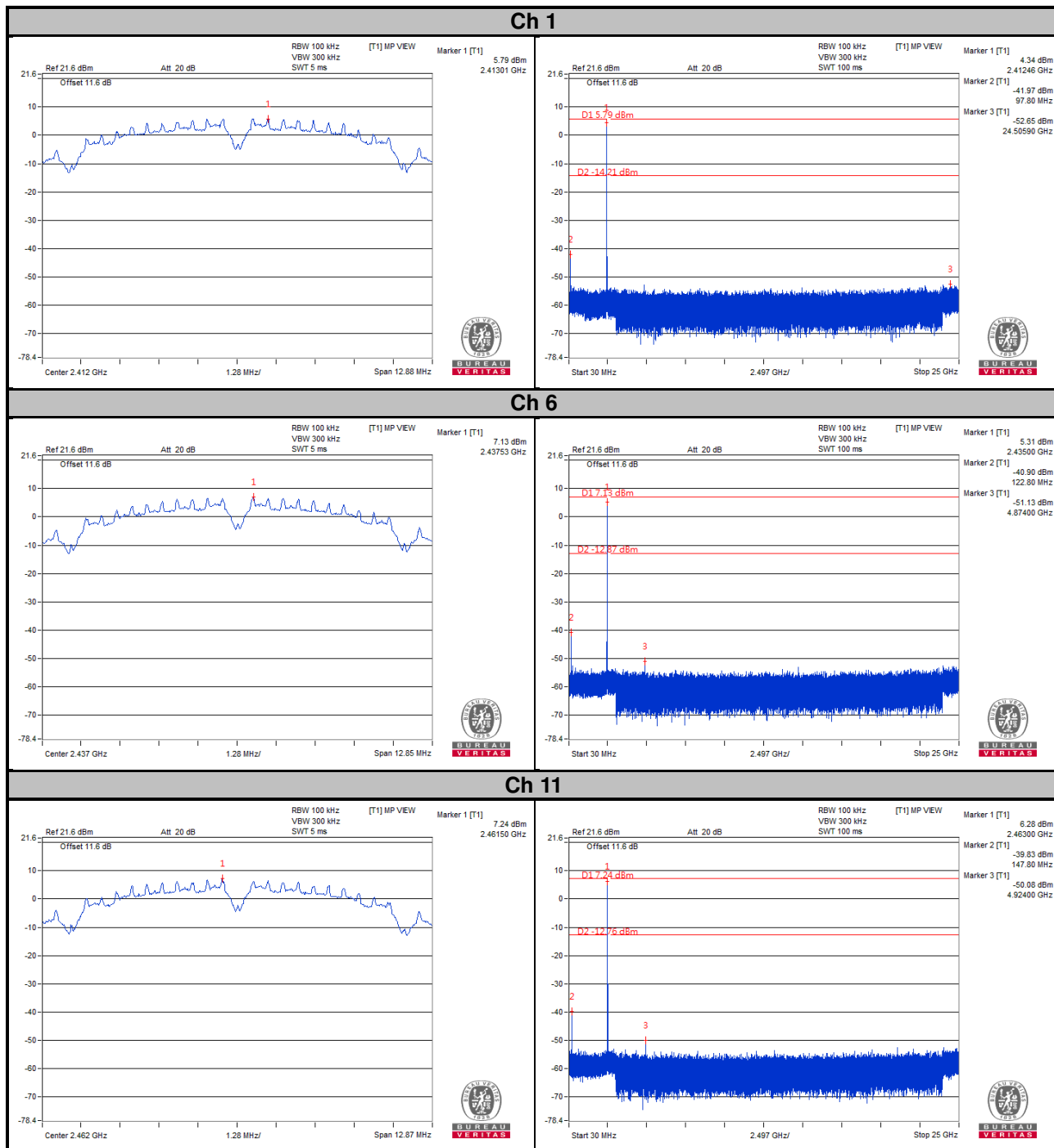

### Ch 1 Band Edge

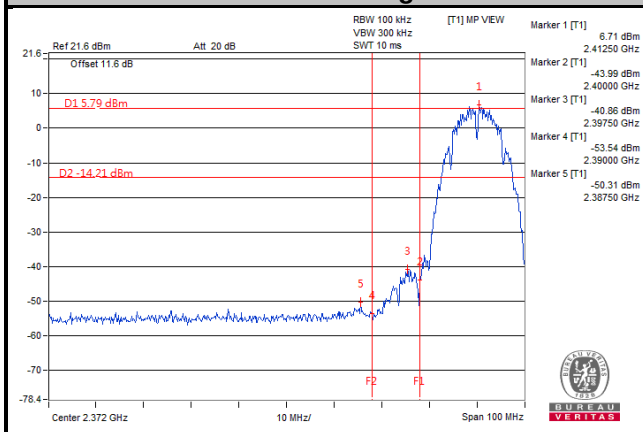

### Ch 11 Band Edge

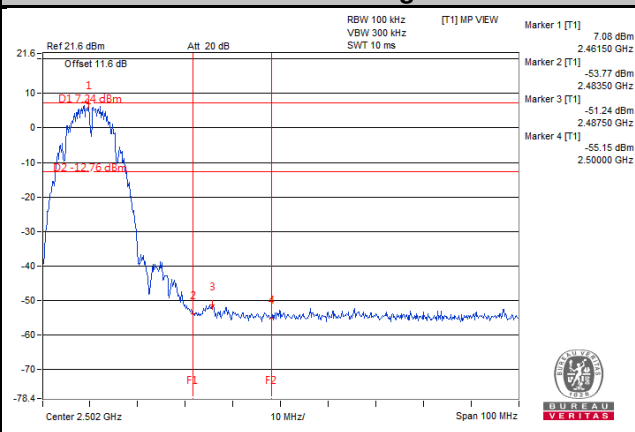

# 802.11g

## Ch 1

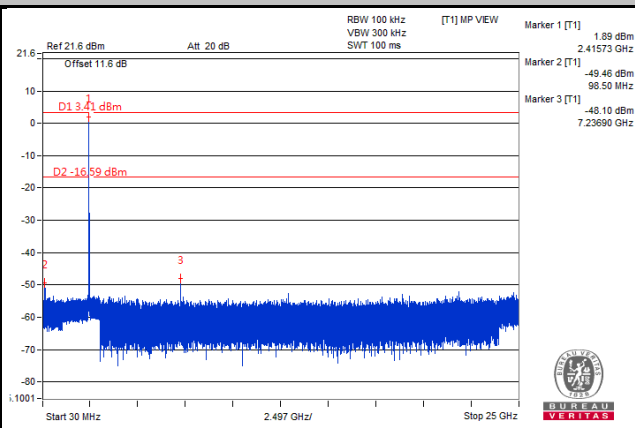
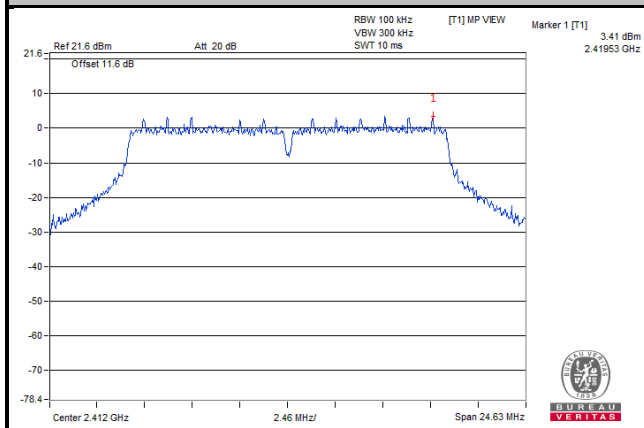

## Ch 6

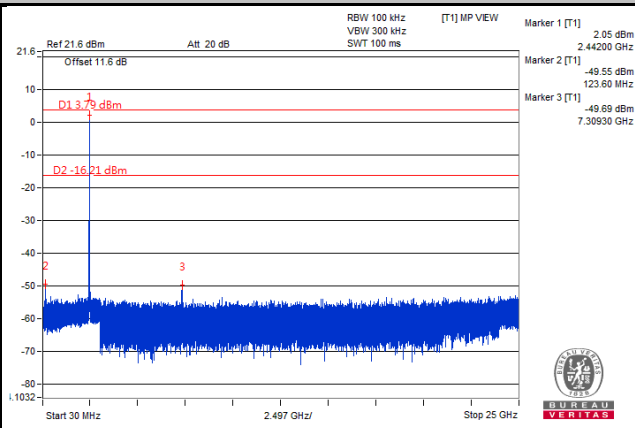
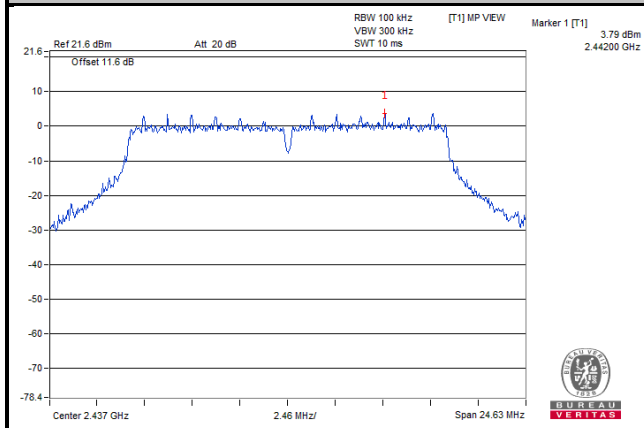

## Ch 11

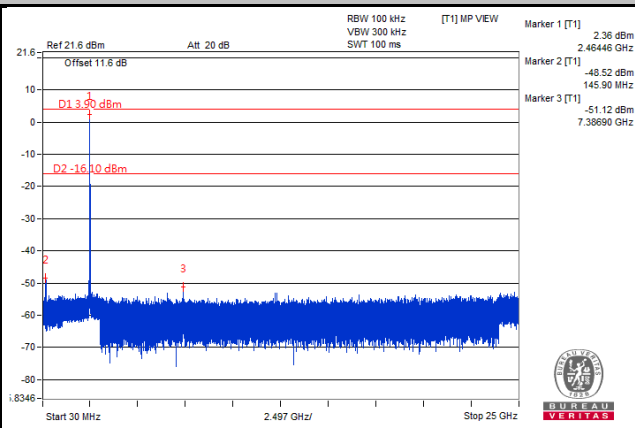
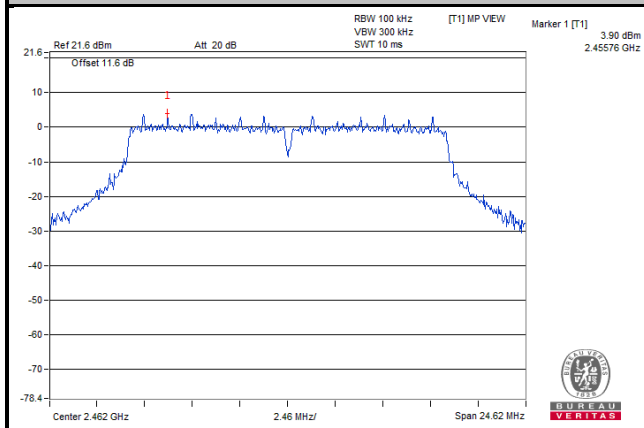

### Ch 1 Band Edge

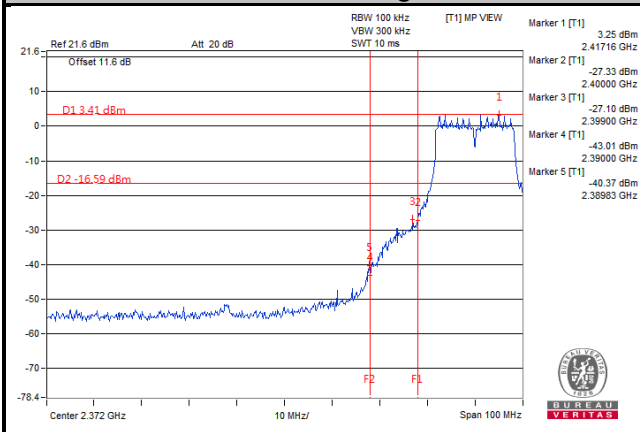

### Ch 11 Band Edge

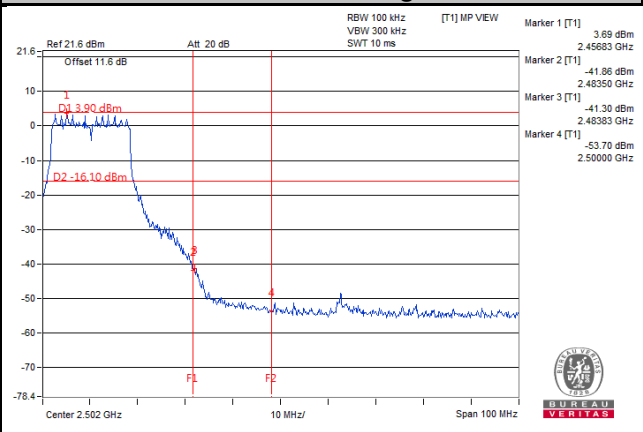

# 802.11n (HT20)

## Ch 1

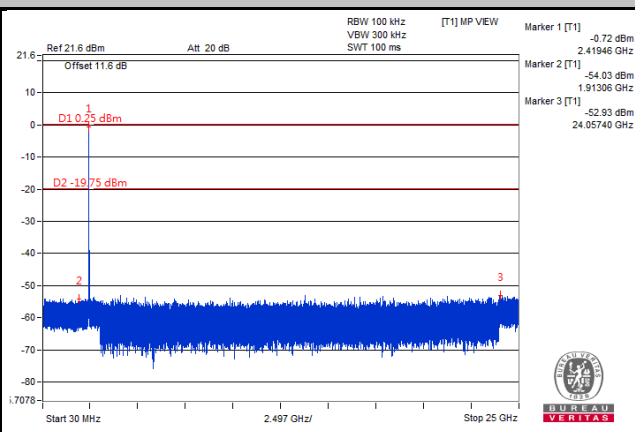
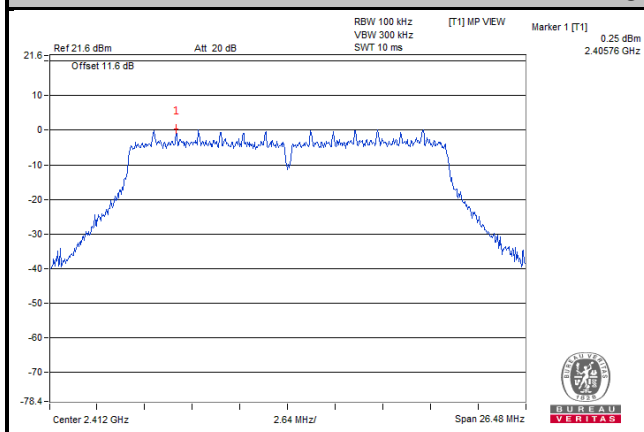

## Ch 6

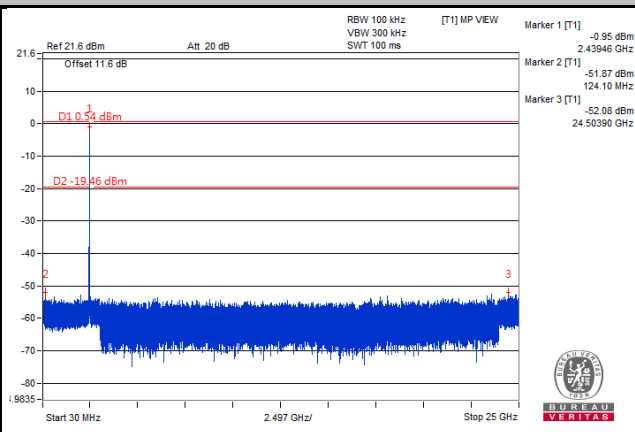
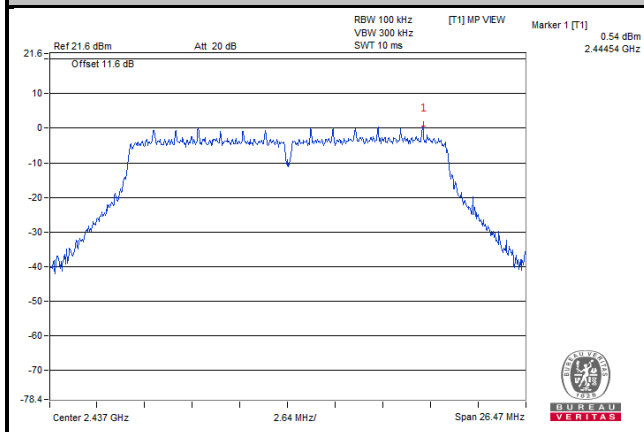

## Ch 11

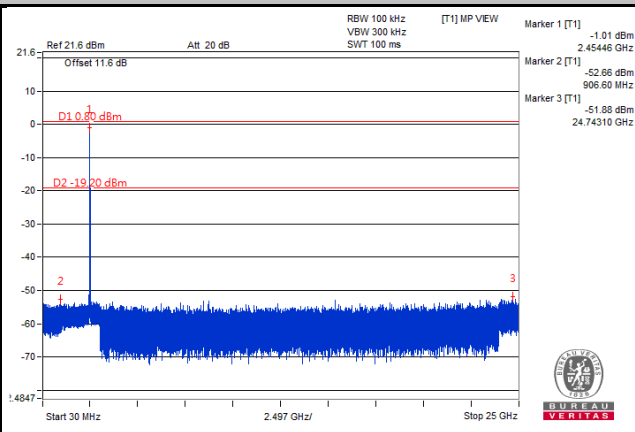
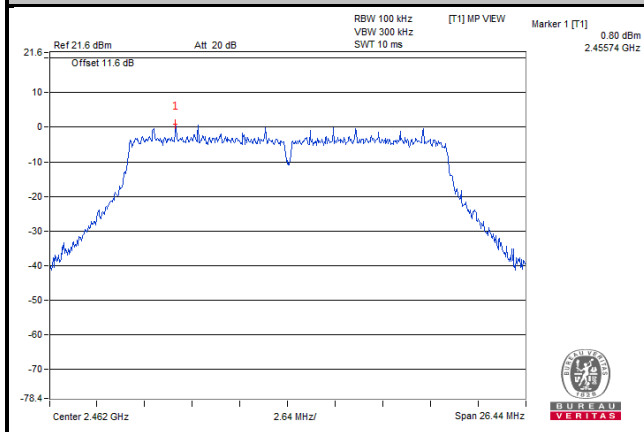

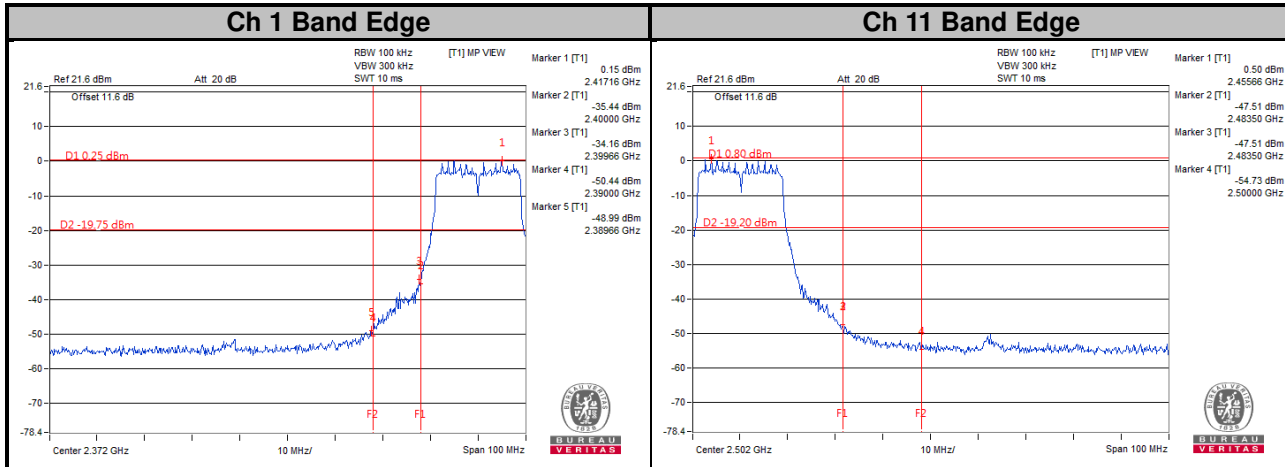



# 802.11n (HT40)

## Ch 3

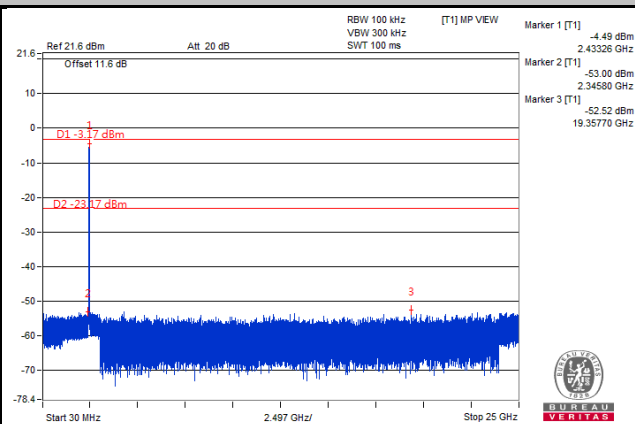
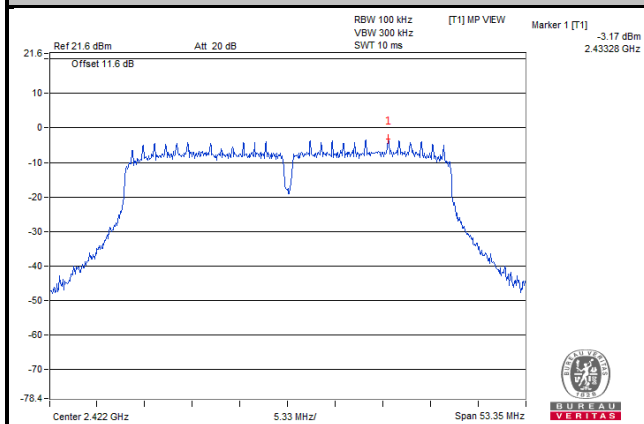

## Ch 6

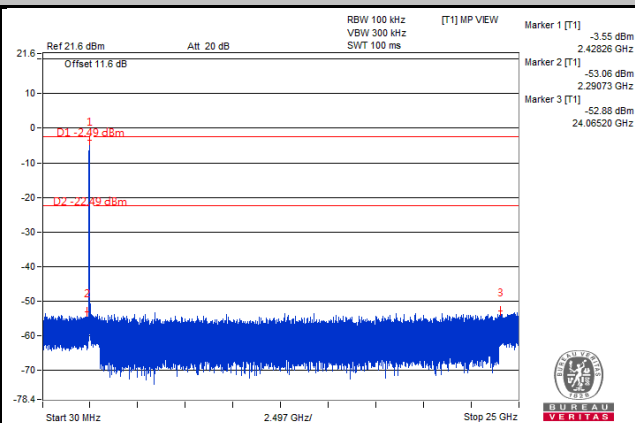
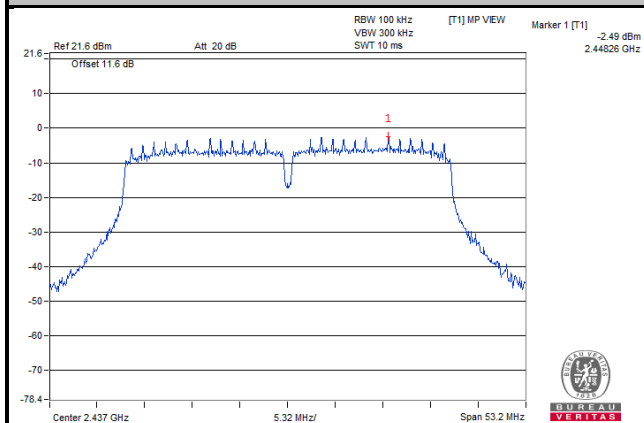

## Ch 9

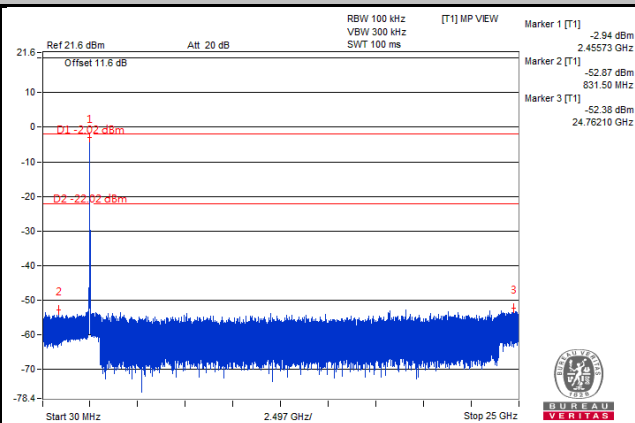
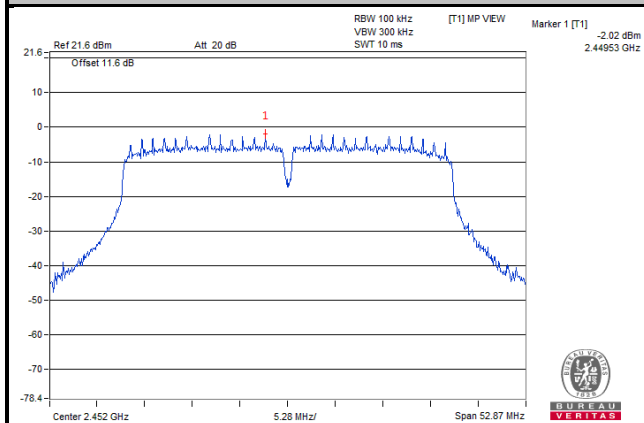

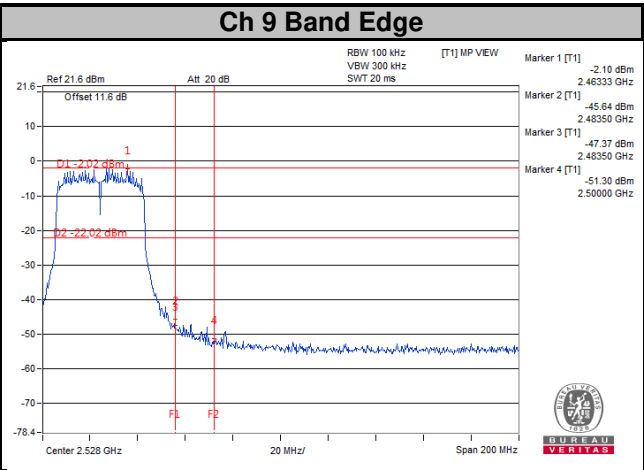
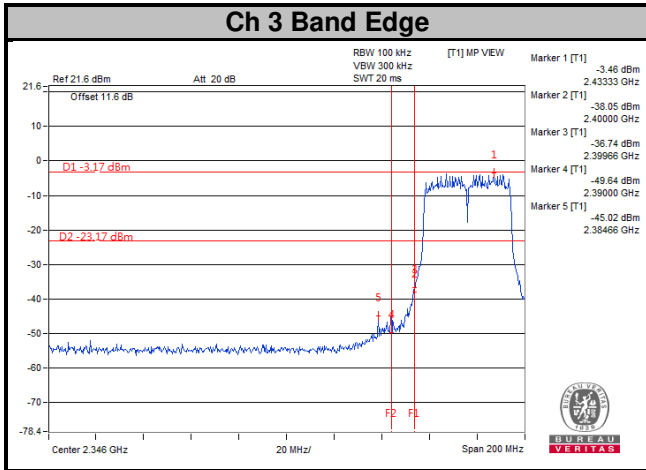

## 5 Pictures of Test Arrangements

Please refer to the attached file (Test Setup Photo).

## Appendix – Information on the Testing Laboratories

We, Bureau Veritas Consumer Products Services (H.K.) Ltd., Taoyuan Branch, were founded in 1988 to provide our best service in EMC, Radio, Telecom and Safety consultation. Our laboratories are accredited and approved according to ISO/IEC 17025.

If you have any comments, please feel free to contact us at the following:

**Linko EMC/RF Lab**

Tel: 886-2-26052180

Fax: 886-2-26051924

**Hsin Chu EMC/RF/Telecom Lab**

Tel: 886-3-6668565

Fax: 886-3-6668323

**Hwa Ya EMC/RF/Safety Lab**

Tel: 886-3-3183232

Fax: 886-3-3270892

**Email:** [service.adt@tw.bureauveritas.com](mailto:service.adt@tw.bureauveritas.com)

**Web Site:** [www.bureauveritas-adt.com](http://www.bureauveritas-adt.com)

The address and road map of all our labs can be found in our web site also.

--- END ---