



FCC TEST REPORT

REPORT NO.: RF970911A02
MODEL NO.: AIR3
RECEIVED: Sep. 11, 2008
TESTED: Sep. 30 ~ Oct. 17, 2008
ISSUED: Oct. 24, 2008

APPLICANT : ASUSTeK COMPUTER INC.

ADDRESS : NO. 15, LI-TE RD., PEITOU, TAIPEI, TAIWAN, R.O.C.

ISSUED BY : Advance Data Technology Corporation

LAB LOCATION: No. 47, 14th Ling, Chia Pau Tsuen, Lin Kou Hsiang,
Taipei Hsien, Taiwan, R.O.C.

This test report consists of 52 pages in total. It may be duplicated completely for legal use with the approval of the applicant. It should not be reproduced except in full, without the written approval of our laboratory. The client should not use it to claim product endorsement by TAF or any government agencies. The test results in the report only apply to the tested sample.



Table of Contents

1	CERTIFICATION	4
2	SUMMARY OF TEST RESULTS	5
2.1	MEASUREMENT UNCERTAINTY	5
3	GENERAL INFORMATION.....	6
3.1	GENERAL DESCRIPTION OF EUT.....	6
3.2	DESCRIPTION OF TEST MODES.....	7
3.2.1	CONFIGURATION OF SYSTEM UNDER TEST	7
3.2.2	TEST MODE APPLICABILITY AND TESTED CHANNEL DETAIL	8
3.3	GENERAL DESCRIPTION OF APPLIED STANDARDS.....	9
3.4	DESCRIPTION OF SUPPORT UNITS.....	9
4	TEST TYPES AND RESULTS	10
4.1	CONDUCTED EMISSION MEASUREMENT	10
4.1.1	LIMITS OF CONDUCTED EMISSION MEASUREMENT.....	10
4.1.2	TEST INSTRUMENTS	11
4.1.3	TEST PROCEDURES.....	11
4.1.4	DEVIATION FROM TEST STANDARD	12
4.1.5	TEST SETUP	12
4.1.6	EUT OPERATING CONDITIONS.....	12
4.1.7	TEST RESULTS.....	13
4.2	RADIATED EMISSION MEASUREMENT	15
4.2.1	LIMITS OF RADIATED EMISSION MEASUREMENT.....	15
4.2.2	TEST INSTRUMENTS	16
4.2.3	TEST PROCEDURES.....	17
4.2.4	DEVIATION FROM TEST STANDARD	17
4.2.5	TEST SETUP	18
4.2.6	EUT OPERATING CONDITIONS.....	18
4.2.7	TEST RESULTS.....	19
4.3	6dB BANDWIDTH MEASUREMENT	26
4.3.1	LIMITS OF 6DB BANDWIDTH MEASUREMENT	26
4.3.2	TEST INSTRUMENTS	26
4.3.3	TEST PROCEDURE	26
4.3.4	DEVIATION FROM TEST STANDARD	26
4.3.5	TEST SETUP	27
4.3.6	EUT OPERATING CONDITIONS.....	27
4.3.7	TEST RESULTS.....	28
4.4	MAXIMUM PEAK OUTPUT POWER	32
4.4.1	LIMITS OF MAXIMUM PEAK OUTPUT POWER MEASUREMENT	32
4.4.2	TEST INSTRUMENTS	32
4.4.3	TEST PROCEDURES.....	33
4.4.4	DEVIATION FROM TEST STANDARD	33
4.4.5	TEST SETUP	33
4.4.6	EUT OPERATING CONDITIONS.....	33
4.4.7	TEST RESULTS.....	34
4.5	POWER SPECTRAL DENSITY MEASUREMENT.....	35



4.5.1	LIMITS OF POWER SPECTRAL DENSITY MEASUREMENT	35
4.5.2	TEST INSTRUMENTS	35
4.5.3	TEST PROCEDURE	35
4.5.4	DEVIATION FROM TEST STANDARD	35
4.5.5	TEST SETUP	35
4.5.6	EUT OPERATING CONDITIONS	35
4.5.7	TEST RESULTS	36
4.6	BAND EDGES MEASUREMENT	40
4.6.1	LIMITS OF BAND EDGES MEASUREMENT	40
4.6.2	TEST INSTRUMENTS	40
4.6.3	TEST PROCEDURE	40
4.6.4	DEVIATION FROM TEST STANDARD	40
4.6.5	EUT OPERATING CONDITION	40
4.6.6	TEST RESULTS	41
4.7	ANTENNA REQUIREMENT	49
4.7.1	STANDARD APPLICABLE	49
4.7.2	ANTENNA CONNECTED CONSTRUCTION	49
5	PHOTOGRAPHS OF THE TEST CONFIGURATION	50
6	INFORMATION ON THE TESTING LABORATORIES	51
7	APPENDIX A – MODIFICATIONS RECORDERS FOR ENGINEERING CHANGES TO THE EUT BY THE LAB	52



1 CERTIFICATION

PRODUCT: ASUS Internet Radio
BRAND NAME: ASUS
MODEL NO.: AIR3
APPLICANT: ASUSTeK COMPUTER INC.
TESTED: Sep. 30 ~ Oct. 17, 2008
TEST SAMPLE: ENGINEERING SAMPLE
STANDARDS: FCC Part 15, Subpart C (Section 15.247)
ANSI C63.4-2003

The above equipment has been tested by **Advance Data Technology Corporation**, and found compliance with the requirement of the above standards. The test record, data evaluation & Equipment Under Test (EUT) configurations represented herein are true and accurate accounts of the measurements of the sample's EMC characteristics under the conditions specified in this report.

PREPARED BY : Annie Chang , **DATE:** Oct. 24, 2008
(Annie Chang / Senior Specialist)

TECHNICAL ACCEPTANCE : Jamison Chan , **DATE:** Oct. 24, 2008
Responsible for RF (Jamison Chan / Supervisor)

APPROVED BY : Ken Liu , **DATE:** Oct. 24, 2008
(Ken Liu / Deputy Manager)

2 SUMMARY OF TEST RESULTS

The EUT has been tested according to the following specifications:

APPLIED STANDARD: FCC Part 15, Subpart C			
Standard Section	Test Type and Limit	Result	Remark
15.207	AC Power Conducted Emission	PASS	Meet the requirement of limit. Minimum passing margin is -20.17dB at 0.588MHz.
15.247(a)(2)	Spectrum Bandwidth of a Direct Sequence Spread Spectrum System Limit : min. 500kHz	PASS	Meet the requirement of limit.
15.247(b)	Maximum Peak Output Power Limit: max. 30dBm	PASS	Meet the requirement of limit.
15.247(d)	Transmitter Radiated Emissions Limit: Table 15.209	PASS	Meet the requirement of limit. Minimum passing margin is -4.73dB at 203.01MHz.
15.247(e)	Power Spectral Density Limit: max. 8dBm	PASS	Meet the requirement of limit.
15.247(d)	Band Edge Measurement Limit: 20 dB less than the peak value of fundamental frequency	PASS	Meet the requirement of limit.

2.1 MEASUREMENT UNCERTAINTY

Where relevant, the following measurement uncertainty levels have been estimated for tests performed on the EUT as specified in CISPR 16-4-2:

Measurement	Frequency	Uncertainty
Conducted emissions	9kHz ~ 30MHz	2.44 dB
Radiated emissions	30MHz ~ 1GHz	3.72 dB
	1GHz ~ 40GHz	2.89 dB

This uncertainty represents an expanded uncertainty expressed at approximately the 95% confidence level using a coverage factor of k=2.

3 GENERAL INFORMATION

3.1 GENERAL DESCRIPTION OF EUT

PRODUCT	ASUS Internet Radio
MODEL NO.	AIR3
FCC ID	MSQAIR3
POWER SUPPLY	20Vdc from AC adapter
MODULATION TYPE	CCK, DQPSK, DBPSK for DSSS 64QAM, 16QAM, QPSK, BPSK for OFDM
MODULATION TECHNOLOGY	DSSS, OFDM
TRANSFER RATE	802.11b: 11/5.5/2/1Mbps 802.11g: 54/48/36/24/18/12/9/6Mbps
OPERATING FREQUENCY	2412MHz ~ 2462MHz
NUMBER OF CHANNEL	11
MAXIMUM OUTPUT POWER	30.479mW for 802.11b 23.988mW for 802.11g
ANTENNA TYPE	Dipole antenna (R-SMA connector) with 3.2dBi gain
DATA CABLE	Shielded S-Video Cable (1.5m) Shielded Audio Cable (1.5m)
I/O PORTS	Refer to user's manual
ACCESSORY DEVICE	Refer to note 2 as below

NOTE:

- The EUT is an ASUS Internet Radio with WLAN IEEE802.11b/g (Brand: Senao, Model: NUB-3701).
- The EUT equipped the following accessories:

Item	Brand	Model No.	Spec.
Adapter	LI SHIN	0225C2040	AC I/P: 100-240V, 50-60Hz, 1.7A DC O/P: 20V, 2.0A
Remote controller	BONTECH	Remote Controller 90201100-3411LF	-

- The above EUT information was declared by the manufacturer and for more detailed features description, please refer to the manufacturer's specifications or User's Manual.

3.2 DESCRIPTION OF TEST MODES

11 channels are provided to this EUT.

CHANNEL	FREQ. (MHz)	CHANNEL	FREQ. (MHz)
1	2412	7	2442
2	2417	8	2447
3	2422	9	2452
4	2427	10	2457
5	2432	11	2462
6	2437		

3.2.1 CONFIGURATION OF SYSTEM UNDER TEST

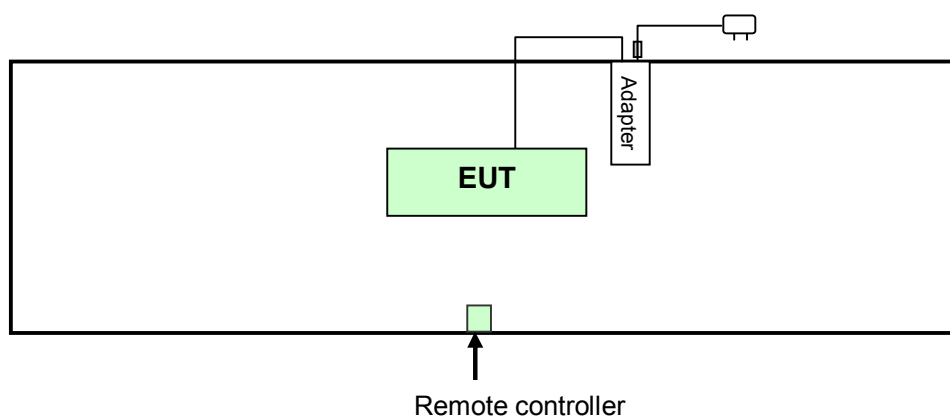

3.2.2 TEST MODE APPLICABILITY AND TESTED CHANNEL DETAIL

EUT Configure Mode	Applicable to				Description
	PLC	RE<1G	RE≥1G	APCM	
-	√	√	√	√	-

Where PLC: Power Line Conducted Emission RE<1G RE: Radiated Emission below 1GHz
 RE≥1G: Radiated Emission above 1GHz APCM: Antenna Port Conducted Measurement

POWER LINE CONDUCTED EMISSION TEST:

- Pre-Scan has been conducted to determine the worst-case mode from all possible combinations between available modulations, data rates and antenna ports (if EUT with antenna diversity architecture).
- Following channel(s) was (were) selected for the final test as listed below.

MODE	AVAILABLE CHANNEL	TESTED CHANNEL	MODULATION TECHNOLOGY	MODULATION TYPE	DATA RATE (Mbps)
802.11b	1 to 11	11	DSSS	DBPSK	1

RADIATED EMISSION TEST (BELOW 1 GHz):

- Pre-Scan has been conducted to determine the worst-case mode from all possible combinations between available modulations, data rates and antenna ports (if EUT with antenna diversity architecture).
- Following channel(s) was (were) selected for the final test as listed below.

MODE	AVAILABLE CHANNEL	TESTED CHANNEL	MODULATION TECHNOLOGY	MODULATION TYPE	DATA RATE (Mbps)
802.11b	1 to 11	11	DSSS	DBPSK	1

RADIATED EMISSION TEST (ABOVE 1 GHz):

- Pre-Scan has been conducted to determine the worst-case mode from all possible combinations between available modulations, data rates and antenna ports (if EUT with antenna diversity architecture).
- Following channel(s) was (were) selected for the final test as listed below.

MODE	AVAILABLE CHANNEL	TESTED CHANNEL	MODULATION TECHNOLOGY	MODULATION TYPE	DATA RATE (Mbps)
802.11b	1 to 11	1, 6, 11	DSSS	DBPSK	1
802.11g	1 to 11	1, 6, 11	OFDM	BPSK	6

BANDEDGE MEASUREMENT:

- Pre-Scan has been conducted to determine the worst-case mode from all possible combinations between available modulations, data rates and antenna ports (if EUT with antenna diversity architecture).
- Following channel(s) was (were) selected for the final test as listed below.

MODE	AVAILABLE CHANNEL	TESTED CHANNEL	MODULATION TECHNOLOGY	MODULATION TYPE	DATA RATE (Mbps)
802.11b	1 to 11	1, 11	DSSS	DBPSK	1
802.11g	1 to 11	1, 11	OFDM	BPSK	6



ANTENNA PORT CONDUCTED MEASUREMENT:

- Pre-Scan has been conducted to determine the worst-case mode from all possible combinations between available modulations, data rates and antenna ports (if EUT with antenna diversity architecture).
- Following channel(s) was (were) selected for the final test as listed below.

MODE	AVAILABLE CHANNEL	TESTED CHANNEL	MODULATION TECHNOLOGY	MODULATION TYPE	DATA RATE (Mbps)
802.11b	1 to 11	1, 6, 11	DSSS	DBPSK	1
802.11g	1 to 11	1, 6, 11	OFDM	BPSK	6

3.3 GENERAL DESCRIPTION OF APPLIED STANDARDS

The EUT is a RF product. According to the specifications of the manufacturer, it must comply with the requirements of the following standards:

FCC Part 15, Subpart C (15.247)
ANSI C63.4-2003

All test items have been performed and recorded as per the above standards.

3.4 DESCRIPTION OF SUPPORT UNITS

The EUT has been tested as an independent unit together without any necessary accessory or support unit.

4 TEST TYPES AND RESULTS

4.1 CONDUCTED EMISSION MEASUREMENT

4.1.1 LIMITS OF CONDUCTED EMISSION MEASUREMENT

FREQUENCY OF EMISSION (MHz)	CONDUCTED LIMIT (dB μ V)	
	Quasi-peak	Average
0.15 ~ 0.5	66 to 56	56 to 46
0.5 ~ 5	56	46
5 ~ 30	60	50

- NOTE:**
1. The lower limit shall apply at the transition frequencies.
 2. The limit decreases in line with the logarithm of the frequency in the range of 0.15 to 0.50 MHz.
 3. All emanations from a class A/B digital device or system, including any network of conductors and apparatus connected thereto, shall not exceed the level of field strengths specified above.



4.1.2 TEST INSTRUMENTS

DESCRIPTION & MANUFACTURER	MODEL NO.	SERIAL NO.	CALIBRATED DATE	CALIBRATED UNTIL
ROHDE & SCHWARZ Test Receiver	ESCS 30	838251/021	Dec. 20, 2007	Dec. 19, 2008
ROHDE & SCHWARZ Artificial Mains Network (for EUT)	ESH3-Z5	100218	Nov. 21, 2007	Nov. 20, 2008
LISN With Adapter (for EUT)	AD10	C10Ada-001	Nov. 22, 2007	Nov. 21, 2008
ROHDE & SCHWARZ Artificial Mains Network (for peripherals)	ESH3-Z5	100219	Nov. 09, 2007	Nov. 08, 2008
ROHDE & SCHWARZ Artificial Mains Network (for peripherals)	ESH3-Z5	100220	Oct. 26, 2007	Oct. 25, 2008
Software	ADT_Cond_V7.3.5	NA	NA	NA
Software	ADT_ISN_V7.3.5	NA	NA	NA
RF cable (JYEBAO)	5D-FB	Cable-C10.01	Feb. 27, 2008	Feb. 26, 2009
SUHNTER Terminator (For ROHDE & SCHWARZ LISN)	65BNC-5001	E1-010773	Feb. 14, 2008	Feb. 13, 2009

- NOTE:**
1. The calibration interval of the above test instruments is 12 months and the calibrations are traceable to NML/ROC and NIST/USA.
 2. The test was performed in Shielded Room No. 10.
 3. The VCCI Site Registration No. C-1852.

4.1.3 TEST PROCEDURES

- a. The EUT was placed 0.4 meters from the conducting wall of the shielded room with EUT being connected to the power mains through a line impedance stabilization network (LISN). Other support units were connected to the power mains through another LISN. The two LISNs provide 50 ohm/ 50uH of coupling impedance for the measuring instrument.
- b. Both lines of the power mains connected to the EUT were checked for maximum conducted interference.
- c. The frequency range from 150kHz to 30MHz was searched. Emission levels under (Limit - 20dB) were not recorded.

4.1.4 DEVIATION FROM TEST STANDARD

No deviation.

4.1.5 TEST SETUP

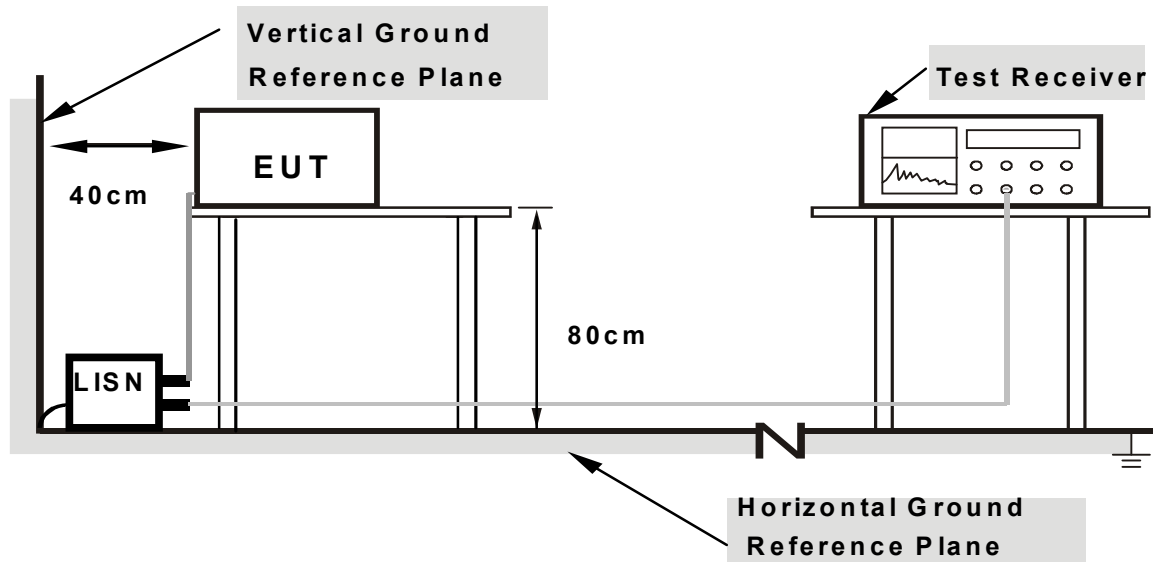

- Note:**
1. Support units were connected to second LISN.
 2. Both of LISNs (AMN) are 80 cm from EUT and at least 80 from other units and other metal planes

For the actual test configuration, please refer to the attached file (Test Setup Photo).

4.1.6 EUT OPERATING CONDITIONS

- a. Connected the EUT with an AC adapter placed on testing table.
- b. EUT ran a test program (Provided by client) to enable all functions.
- c. Set the EUT under transmission/receiving condition continuously at specific channel frequency.
- d. Steps c-d were repeated.

4.1.7 TEST RESULTS

CONDUCTED DATA: 802.11b DSSS MODULATION

MODULATION TYPE	DBPSK	CHANNEL	11
INPUT POWER	120Vac, 60 Hz	6dB BANDWIDTH	9 kHz
ENVIRONMENTAL CONDITIONS	26deg. C, 78% RH, 1001hPa	PHASE	Line 1
TRANSFER RATE	1Mbps	TESTED BY	Jun Wu

No	Freq. [MHz]	Corr. Factor (dB)	Reading Value		Emission Level		Limit		Margin	
			[dB (uV)]		[dB (uV)]		[dB (uV)]		(dB)	
			Q.P.	AV.	Q.P.	AV.	Q.P.	AV.	Q.P.	AV.
1	0.162	0.18	44.15	-	44.33	-	65.38	55.38	-21.04	-
2	0.213	0.22	37.95	-	38.17	-	63.11	53.11	-24.94	-
3	0.535	0.23	30.71	-	30.94	-	56.00	46.00	-25.06	-
4	0.588	0.24	35.59	-	35.83	-	56.00	46.00	-20.17	-
5	9.277	0.71	16.90	-	17.61	-	60.00	50.00	-42.39	-
6	13.906	1.03	24.50	-	25.53	-	60.00	50.00	-34.47	-

- REMARKS:**
1. Q.P. and AV. are abbreviations of quasi-peak and average individually.
 2. "-": The Quasi-peak reading value also meets average limit and measurement with the average detector is unnecessary.
 3. The emission levels of other frequencies were very low against the limit.
 4. Margin value = Emission level - Limit value
 5. Correction factor = Insertion loss + Cable loss
 6. Emission Level = Correction Factor + Reading Value.

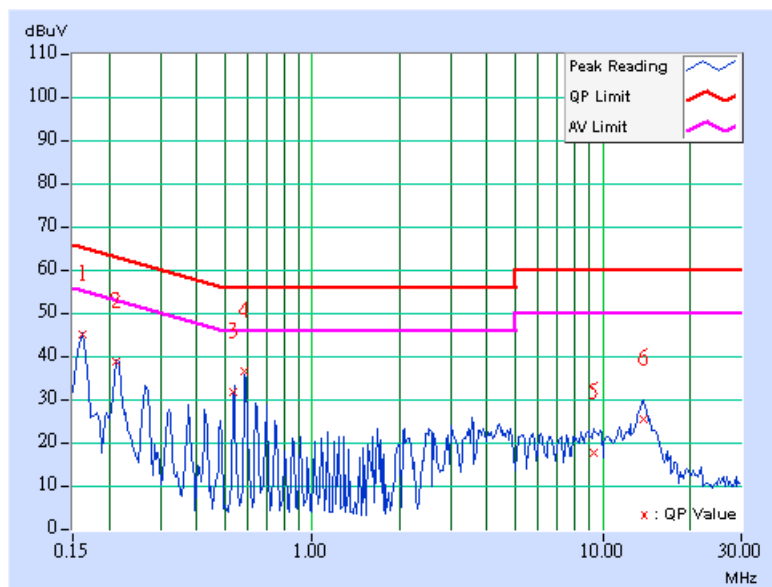

MODULATION TYPE	DBPSK	CHANNEL	11
INPUT POWER	120Vac, 60 Hz	6dB BANDWIDTH	9 kHz
ENVIRONMENTAL CONDITIONS	26deg. C, 78% RH, 1001hPa	PHASE	Line 2
TRANSFER RATE	1Mbps	TESTED BY	Jun Wu

No	Freq. [MHz]	Corr. Factor (dB)	Reading Value		Emission Level		Limit		Margin	
			[dB (uV)]		[dB (uV)]		[dB (uV)]		(dB)	
			Q.P.	AV.	Q.P.	AV.	Q.P.	AV.	Q.P.	AV.
1	0.162	0.18	43.77	-	43.95	-	65.38	55.38	-21.43	-
2	0.213	0.22	38.63	-	38.85	-	63.11	53.11	-24.26	-
3	0.537	0.22	35.19	-	35.41	-	56.00	46.00	-20.59	-
4	0.642	0.23	33.01	-	33.24	-	56.00	46.00	-22.76	-
5	5.602	0.43	18.64	-	19.07	-	60.00	50.00	-40.93	-
6	13.930	0.87	24.06	-	24.93	-	60.00	50.00	-35.07	-

- REMARKS:**
1. Q.P. and AV. are abbreviations of quasi-peak and average individually.
 2. "-": The Quasi-peak reading value also meets average limit and measurement with the average detector is unnecessary.
 3. The emission levels of other frequencies were very low against the limit.
 4. Margin value = Emission level - Limit value
 5. Correction factor = Insertion loss + Cable loss
 6. Emission Level = Correction Factor + Reading Value.

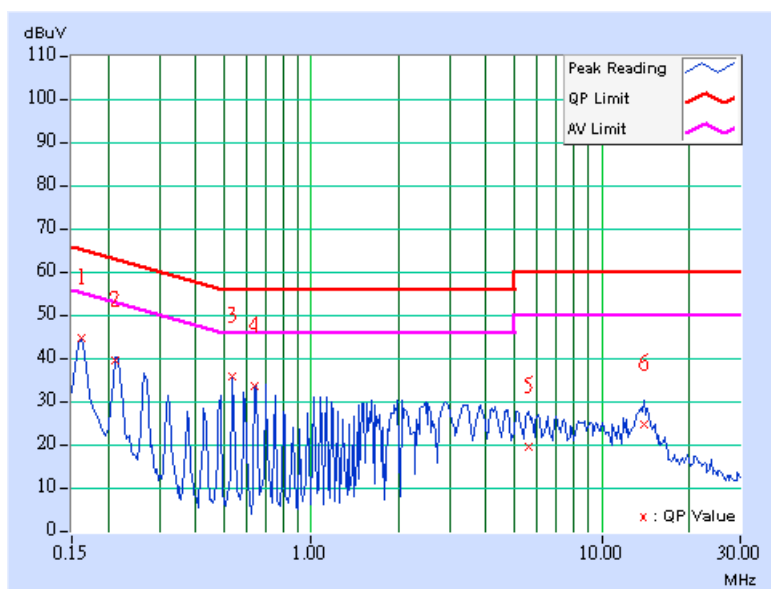

4.2 RADIATED EMISSION MEASUREMENT

4.2.1 LIMITS OF RADIATED EMISSION MEASUREMENT

Emissions radiated outside of the specified bands, shall be according to the general radiated limits in 15.209 as following:

Frequencies (MHz)	Field strength (microvolts/meter)	Measurement distance (meters)
0.009-0.490	2400/F(kHz)	300
0.490-1.705	24000/F(kHz)	30
1.705-30.0	30	30
30-88	100	3
88-216	150	3
216-960	200	3
Above 960	500	3

NOTE:

1. The lower limit shall apply at the transition frequencies.
2. Emission level (dBuV/m) = 20 log Emission level (uV/m).
3. As shown in 15.35(b), for frequencies above 1000MHz, the field strength limits are based on average detector, however, the peak field strength of any emission shall not exceed the maximum permitted average limits, specified above by more than 20dB under any condition of modulation.



4.2.2 TEST INSTRUMENTS

DESCRIPTION & MANUFACTURER	MODEL NO.	SERIAL NO.	CALIBRATED DATE	CALIBRATED UNTIL
HP Preamplifier	8447D	2432A03504	May 09, 2008	May 08, 2009
HP Preamplifier	8449B	3008A01924	Sep. 03, 2008	Sep. 02, 2009
HP Preamplifier	8449B	3008A01292	Aug. 06, 2008	Aug. 05, 2009
ROHDE & SCHWARZ TEST RECEIVER	ESI7	836697/012	Dec. 06, 2007	Dec. 05, 2008
Schwarzbeck Antenna	VULB 9168	137	May 02, 2008	May 01, 2009
Schwarzbeck Antenna	VHBA 9123	480	Apr. 23, 2008	Apr. 22, 2009
EMCO Horn Antenna	3115	6714	Oct. 19, 2007	Oct. 18, 2008
EMCO Horn Antenna	3115	9312-4192	Apr. 21, 2008	Apr. 20, 2009
ADT. Turn Table	TT100	0306	NA	NA
ADT. Tower	AT100	0306	NA	NA
Software	ADT_Radiated_V 7.6.15	NA	NA	NA
SUHNER RF cable	SF104-26.5	CABLE-CH6-17m -01	Nov. 05, 2007	Nov. 04, 2008
ROHDE & SCHWARZ Spectrum Analyzer	FSP 40	100035	Mar. 26, 2008	Mar. 25, 2009

- NOTE:**
1. The calibration interval of the above test instruments is 12 months. And the calibrations are traceable to NML/ROC and NIST/USA.
 2. The horn antenna and HP preamplifier (model: 8449B) are used only for the measurement of emission frequency above 1GHz if tested.
 3. The test was performed in Chamber No. 6.
 4. The Industry Canada Reference No. IC 3789-6.
 5. The FCC Site Registration No. is 447212.

4.2.3 TEST PROCEDURES

- a. The EUT was placed on the top of a rotating table 0.8 meters above the ground at a 3 meters semi-anechoic chamber. The table was rotated 360 degrees to determine the position of the highest radiation.
- b. The EUT was set 3 meters away from the interference-receiving antenna, which was mounted on the top of a variable-height antenna tower.
- c. The antenna is a broadband antenna, and its height is varied from one meter to four meters above the ground to determine the maximum value of the field strength. Both horizontal and vertical polarizations of the antenna are set to make the measurement.
- d. For each suspected emission, the EUT was arranged to its worst case and then the antenna was tuned to heights from 1 meter to 4 meters and the rotatable table was turned from 0 degrees to 360 degrees to find the maximum reading.
- e. The test-receiver system was set to quasi-peak detect function and specified bandwidth with maximum hold mode when the test frequency is below 1 GHz.
- f. If the emission level of the EUT in peak mode was lower than the limit specified, then testing could be stopped and the peak values of the EUT would be reported. Otherwise the emissions would be re-tested one by one using peak, quasi-peak method or average method as specified and then reported in data sheet.

NOTE:

1. The resolution bandwidth of test receiver/spectrum analyzer is 120kHz for Quasi-peak detection at frequency below 1GHz.
2. The resolution bandwidth is 1MHz and video bandwidth of test receiver/spectrum analyzer is 3MHz for Peak detection at frequency above 1GHz. The resolution bandwidth of test receiver/spectrum analyzer is 1 MHz for Average detection (AV) at frequency above 1GHz.
3. The resolution bandwidth of test receiver/spectrum analyzer is 1 MHz and the video bandwidth is 10 Hz for Average detection (AV) at frequency above 1GHz.

4.2.4 DEVIATION FROM TEST STANDARD

No deviation.

4.2.5 TEST SETUP

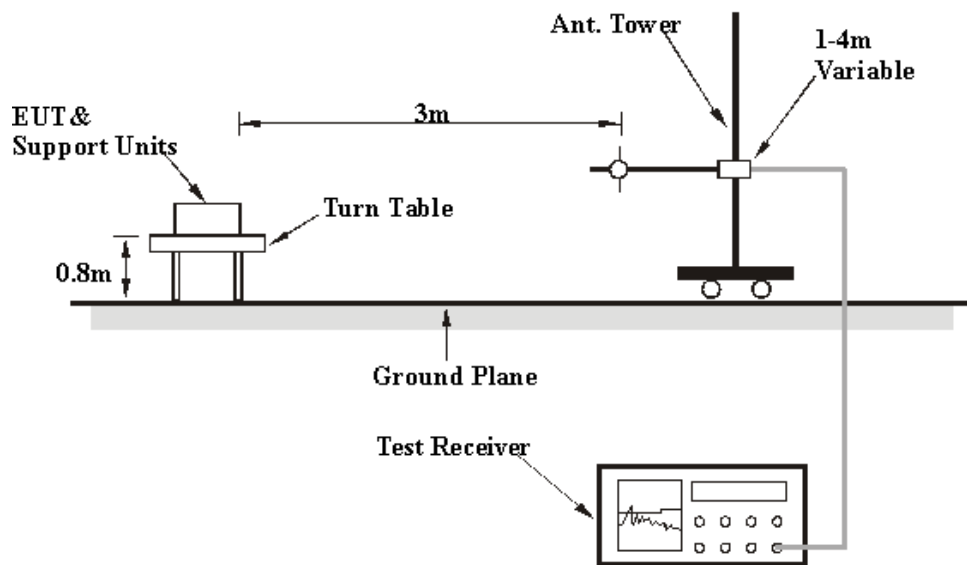

For the actual test configuration, please refer to the attached file (Test Setup Photo).

4.2.6 EUT OPERATING CONDITIONS

Same as item 4.1.6.

4.2.7 TEST RESULTS

RADIATED DATA: 802.11b DSSS MODULATION (BELOW 1GHz)

EUT TEST CONDITION		MEASUREMENT DETAIL	
CHANNEL	Channel 11	FREQUENCY RANGE	Below 1000MHz
INPUT POWER	120Vac, 60 Hz	DETECTOR FUNCTION	Quasi-Peak
ENVIRONMENTAL CONDITIONS	20deg. C, 82% RH, 1004hPa	TESTED BY	Chad Lee

ANTENNA POLARITY & TEST DISTANCE: HORIZONTAL AT 3 M								
NO.	FREQ. (MHz)	EMISSION LEVEL (dBuV/m)	LIMIT (dBuV/m)	MARGIN (dB)	ANTENNA HEIGHT (m)	TABLE ANGLE (Degree)	RAW VALUE (dBuV)	CORRECTION FACTOR (dB/m)
1	162.18	35.35 QP	43.50	-8.15	1.54 H	61	21.29	14.06
2	228.28	36.44 QP	46.00	-9.56	1.08 H	316	22.78	13.66
3	263.27	35.90 QP	46.00	-10.10	1.11 H	343	20.50	15.40
4	368.24	32.33 QP	46.00	-13.67	1.08 H	133	14.41	17.92
5	479.04	32.55 QP	46.00	-13.45	1.42 H	196	11.78	20.77
6	552.91	32.21 QP	46.00	-13.79	1.83 H	148	9.79	22.42

ANTENNA POLARITY & TEST DISTANCE: VERTICAL AT 3 M								
NO.	FREQ. (MHz)	EMISSION LEVEL (dBuV/m)	LIMIT (dBuV/m)	MARGIN (dB)	ANTENNA HEIGHT (m)	TABLE ANGLE (Degree)	RAW VALUE (dBuV)	CORRECTION FACTOR (dB/m)
1	127.19	34.55 QP	43.50	-8.95	1.05 V	100	20.94	13.61
2	203.01	38.77 QP	43.50	-4.73	1.66 V	244	26.91	11.86
3	234.11	32.86 QP	46.00	-13.14	1.42 V	67	18.78	14.08
4	311.86	32.52 QP	46.00	-13.48	1.08 V	331	16.21	16.31
5	329.36	33.17 QP	46.00	-12.83	1.33 V	1	16.38	16.79
6	368.24	32.22 QP	46.00	-13.78	1.48 V	58	14.30	17.92

- REMARKS:**
1. Emission level (dBuV/m) = Raw Value (dBuV) + Correction Factor (dB/m).
 2. Correction Factor (dB/m) = Antenna Factor (dB/m) + Cable Factor (dB).
 3. The other emission levels were very low against the limit.
 4. Margin value = Emission level – Limit value.



RADIATED DATA: 802.11b DSSS MODULATION (ABOVE 1GHz)

EUT TEST CONDITION		MEASUREMENT DETAIL	
CHANNEL	Channel 1	FREQUENCY RANGE	1 ~ 25GHz
INPUT POWER	120Vac, 60 Hz	DETECTOR FUNCTION	Peak (PK) Average (AV)
ENVIRONMENTAL CONDITIONS	25deg. C, 85% RH, 998hPa	TESTED BY	Chad Lee

ANTENNA POLARITY & TEST DISTANCE: HORIZONTAL AT 3 M

NO.	FREQ. (MHz)	EMISSION LEVEL (dBuV/m)	LIMIT (dBuV/m)	MARGIN (dB)	ANTENNA HEIGHT (m)	TABLE ANGLE (Degree)	RAW VALUE (dBuV)	CORRECTION FACTOR (dB/m)
1	2390.00	58.38 PK	74.00	-15.62	1.18 H	335	25.08	33.30
2	2390.00	45.34 AV	54.00	-8.66	1.18 H	335	12.04	33.30
3	*2412.00	92.67 PK			1.18 H	335	59.27	33.40
4	*2412.00	89.19 AV			1.18 H	335	55.79	33.40
5	#3216.00	54.15 PK	72.67	-18.52	1.05 H	55	17.86	36.29
6	#3216.00	49.97 AV	69.19	-19.22	1.05 H	55	13.68	36.29
7	4824.00	50.42 PK	74.00	-23.58	1.00 H	85	9.99	40.43
8	4824.00	38.37 AV	54.00	-15.63	1.00 H	85	-2.06	40.43

ANTENNA POLARITY & TEST DISTANCE: VERTICAL AT 3 M

NO.	FREQ. (MHz)	EMISSION LEVEL (dBuV/m)	LIMIT (dBuV/m)	MARGIN (dB)	ANTENNA HEIGHT (m)	TABLE ANGLE (Degree)	RAW VALUE (dBuV)	CORRECTION FACTOR (dB/m)
1	2390.00	56.14 PK	74.00	-17.86	1.24 V	194	22.84	33.30
2	2390.00	45.35 AV	54.00	-8.65	1.24 V	194	12.05	33.30
3	*2412.00	103.60 PK			1.24 V	194	70.20	33.40
4	*2412.00	99.08 AV			1.24 V	194	65.68	33.40
5	#3216.00	56.72 PK	83.60	-26.88	1.32 V	288	20.43	36.29
6	#3216.00	53.11 AV	79.08	-25.97	1.32 V	288	16.82	36.29
7	4824.00	52.01 PK	74.00	-21.99	1.00 V	77	11.58	40.43
8	4824.00	38.19 AV	54.00	-15.81	1.00 V	77	-2.24	40.43

- REMARKS:**
1. Emission level (dBuV/m) = Raw Value (dBuV) + Correction Factor (dB/m).
 2. Correction Factor (dB/m) = Antenna Factor (dB/m) + Cable Factor (dB).
 3. The other emission levels were very low against the limit.
 4. Margin value = Emission level – Limit value.
 5. “ * “: Fundamental frequency.
 6. “#”:The radiated frequency is out the restricted band.



EUT TEST CONDITION		MEASUREMENT DETAIL	
CHANNEL	Channel 6	FREQUENCY RANGE	1 ~ 25GHz
INPUT POWER	120Vac, 60 Hz	DETECTOR FUNCTION	Peak (PK) Average (AV)
ENVIRONMENTAL CONDITIONS	25deg. C, 85% RH, 998hPa	TESTED BY	Chad Lee

ANTENNA POLARITY & TEST DISTANCE: HORIZONTAL AT 3 M								
NO.	FREQ. (MHz)	EMISSION LEVEL (dBuV/m)	LIMIT (dBuV/m)	MARGIN (dB)	ANTENNA HEIGHT (m)	TABLE ANGLE (Degree)	RAW VALUE (dBuV)	CORRECTION FACTOR (dB/m)
1	*2437.00	91.94 PK			1.03 H	93	58.43	33.51
2	*2437.00	88.45 AV			1.03 H	93	54.94	33.51
3	#3249.00	55.05 PK	71.94	-16.89	1.02 H	307	18.70	36.35
4	#3249.00	50.72 AV	68.45	-17.73	1.02 H	307	14.37	36.35
5	4874.00	52.85 PK	74.00	-21.15	1.51 H	148	12.29	40.56
6	4874.00	42.65 AV	54.00	-11.35	1.51 H	148	2.09	40.56

ANTENNA POLARITY & TEST DISTANCE: VERTICAL AT 3 M								
NO.	FREQ. (MHz)	EMISSION LEVEL (dBuV/m)	LIMIT (dBuV/m)	MARGIN (dB)	ANTENNA HEIGHT (m)	TABLE ANGLE (Degree)	RAW VALUE (dBuV)	CORRECTION FACTOR (dB/m)
1	*2437.00	103.21 PK			1.00 V	312	69.70	33.51
2	*2437.00	98.76 AV			1.00 V	312	65.25	33.51
3	#3249.00	55.67 PK	83.21	-27.54	1.04 V	55	19.32	36.35
4	#3249.00	51.04 AV	78.76	-27.72	1.04 V	55	14.69	36.35
5	4874.00	52.72 PK	74.00	-21.28	1.00 V	84	12.16	40.56
6	4874.00	41.11 AV	54.00	-12.89	1.00 V	84	0.55	40.56

- REMARKS:**
1. Emission level (dBuV/m) = Raw Value (dBuV) + Correction Factor (dB/m).
 2. Correction Factor (dB/m) = Antenna Factor (dB/m) + Cable Factor (dB).
 3. The other emission levels were very low against the limit.
 4. Margin value = Emission level – Limit value.
 5. “ * “: Fundamental frequency.
 6. “#”:The radiated frequency is out the restricted band.



EUT TEST CONDITION		MEASUREMENT DETAIL	
CHANNEL	Channel 11	FREQUENCY RANGE	1 ~ 25GHz
INPUT POWER	120Vac, 60 Hz	DETECTOR FUNCTION	Peak (PK) Average (AV)
ENVIRONMENTAL CONDITIONS	25deg. C, 85% RH, 998hPa	TESTED BY	Chad Lee

ANTENNA POLARITY & TEST DISTANCE: HORIZONTAL AT 3 M								
NO.	FREQ. (MHz)	EMISSION LEVEL (dBuV/m)	LIMIT (dBuV/m)	MARGIN (dB)	ANTENNA HEIGHT (m)	TABLE ANGLE (Degree)	RAW VALUE (dBuV)	CORRECTION FACTOR (dB/m)
1	*2462.00	94.70 PK			1.05 H	92	61.08	33.62
2	*2462.00	89.91 AV			1.05 H	92	56.29	33.62
3	2483.50	56.70 PK	74.00	-17.30	1.05 H	92	22.98	33.72
4	2483.50	44.78 AV	54.00	-9.22	1.05 H	92	11.06	33.72
5	#3282.00	54.73 PK	74.70	-19.97	1.01 H	306	18.31	36.42
6	#3282.00	50.02 AV	69.91	-19.89	1.01 H	306	13.60	36.42
7	4924.00	54.12 PK	74.00	-19.88	1.36 H	144	13.44	40.68
8	4924.00	45.92 AV	54.00	-8.08	1.36 H	144	5.24	40.68
ANTENNA POLARITY & TEST DISTANCE: VERTICAL AT 3 M								
NO.	FREQ. (MHz)	EMISSION LEVEL (dBuV/m)	LIMIT (dBuV/m)	MARGIN (dB)	ANTENNA HEIGHT (m)	TABLE ANGLE (Degree)	RAW VALUE (dBuV)	CORRECTION FACTOR (dB/m)
1	*2462.00	106.36 PK			1.00 V	163	72.74	33.62
2	*2462.00	101.36 AV			1.00 V	163	67.74	33.62
3	2483.50	59.72 PK	74.00	-14.28	1.00 V	163	26.00	33.72
4	2483.50	47.32 AV	54.00	-6.68	1.00 V	163	13.60	33.72
5	#3282.00	55.92 PK	86.36	-30.44	1.22 V	203	19.50	36.42
6	#3282.00	52.78 AV	81.36	-28.58	1.22 V	203	16.36	36.42
7	4924.00	52.22 PK	74.00	-21.78	1.06 V	182	11.54	40.68
8	4924.00	38.29 AV	54.00	-15.71	1.06 V	182	-2.39	40.68

- REMARKS:**
1. Emission level (dBuV/m) = Raw Value (dBuV) + Correction Factor (dB/m).
 2. Correction Factor (dB/m) = Antenna Factor (dB/m) + Cable Factor (dB).
 3. The other emission levels were very low against the limit.
 4. Margin value = Emission level – Limit value.
 5. “ * “: Fundamental frequency.
 6. “#”:The radiated frequency is out the restricted band.



RADIATED DATA: 802.11g OFDM MODULATION (ABOVE 1GHz)

EUT TEST CONDITION		MEASUREMENT DETAIL	
CHANNEL	Channel 1	FREQUENCY RANGE	1 ~ 25GHz
INPUT POWER	120Vac, 60 Hz	DETECTOR FUNCTION	Peak (PK) Average (AV)
ENVIRONMENTAL CONDITIONS	20deg. C, 85% RH, 1005hPa	TESTED BY	Chad Lee

ANTENNA POLARITY & TEST DISTANCE: HORIZONTAL AT 3 M

NO.	FREQ. (MHz)	EMISSION LEVEL (dBuV/m)	LIMIT (dBuV/m)	MARGIN (dB)	ANTENNA HEIGHT (m)	TABLE ANGLE (Degree)	RAW VALUE (dBuV)	CORRECTION FACTOR (dB/m)
1	2390.00	55.49 PK	74.00	-18.51	1.45 H	284	22.19	33.30
2	2390.00	44.83 AV	54.00	-9.17	1.45 H	284	11.53	33.30
3	*2412.00	101.16 PK			1.45 H	284	67.76	33.40
4	*2412.00	96.77 AV			1.45 H	284	63.37	33.40
5	#3216.00	51.42 PK	81.16	-29.74	1.01 H	194	15.13	36.29
6	#3216.00	45.92 AV	76.77	-30.85	1.01 H	194	9.63	36.29
7	4824.00	51.47 PK	74.00	-22.53	1.37 H	238	11.04	40.43
8	4824.00	42.24 AV	54.00	-11.76	1.37 H	238	1.81	40.43

ANTENNA POLARITY & TEST DISTANCE: VERTICAL AT 3 M

NO.	FREQ. (MHz)	EMISSION LEVEL (dBuV/m)	LIMIT (dBuV/m)	MARGIN (dB)	ANTENNA HEIGHT (m)	TABLE ANGLE (Degree)	RAW VALUE (dBuV)	CORRECTION FACTOR (dB/m)
1	2390.00	56.88 PK	74.00	-17.12	1.14 V	165	23.58	33.30
2	2390.00	45.69 AV	54.00	-8.31	1.14 V	165	12.39	33.30
3	*2412.00	105.37 PK			1.14 V	165	71.97	33.40
4	*2412.00	94.58 AV			1.14 V	165	61.18	33.40
5	#3216.00	54.57 PK	85.37	-30.80	1.21 V	78	18.28	36.29
6	#3216.00	50.18 AV	74.58	-24.40	1.21 V	78	13.89	36.29
7	4824.00	49.35 PK	74.00	-24.65	1.20 V	15	8.92	40.43
8	4824.00	35.21 AV	54.00	-18.79	1.20 V	15	-5.22	40.43

- REMARKS:**
1. Emission level (dBuV/m) = Raw Value (dBuV) + Correction Factor (dB/m).
 2. Correction Factor (dB/m) = Antenna Factor (dB/m) + Cable Factor (dB).
 3. The other emission levels were very low against the limit.
 4. Margin value = Emission level – Limit value.
 5. “ * “: Fundamental frequency.
 6. “#”:The radiated frequency is out the restricted band.



EUT TEST CONDITION		MEASUREMENT DETAIL	
CHANNEL	Channel 6	FREQUENCY RANGE	1 ~ 25GHz
INPUT POWER	120Vac, 60 Hz	DETECTOR FUNCTION	Peak (PK) Average (AV)
ENVIRONMENTAL CONDITIONS	20deg. C, 85% RH, 1005hPa	TESTED BY	Chad Lee

ANTENNA POLARITY & TEST DISTANCE: HORIZONTAL AT 3 M

NO.	FREQ. (MHz)	EMISSION LEVEL (dBuV/m)	LIMIT (dBuV/m)	MARGIN (dB)	ANTENNA HEIGHT (m)	TABLE ANGLE (Degree)	RAW VALUE (dBuV)	CORRECTION FACTOR (dB/m)
1	*2437.00	100.49 PK			1.00 H	268	66.98	33.51
2	*2437.00	89.68 AV			1.00 H	268	56.17	33.51
3	#3249.00	52.75 PK	80.49	-27.74	1.19 H	304	16.40	36.35
4	#3249.00	47.77 AV	69.68	-21.91	1.19 H	304	11.42	36.35
5	4874.00	49.21 PK	74.00	-24.79	1.08 H	162	8.65	40.56
6	4874.00	35.44 AV	54.00	-18.56	1.08 H	162	-5.12	40.56

ANTENNA POLARITY & TEST DISTANCE: VERTICAL AT 3 M

NO.	FREQ. (MHz)	EMISSION LEVEL (dBuV/m)	LIMIT (dBuV/m)	MARGIN (dB)	ANTENNA HEIGHT (m)	TABLE ANGLE (Degree)	RAW VALUE (dBuV)	CORRECTION FACTOR (dB/m)
1	*2437.00	107.01 PK			1.06 V	321	73.50	33.51
2	*2437.00	96.07 AV			1.06 V	321	62.56	33.51
3	#3249.00	56.63 PK	87.01	-30.38	1.17 V	80	20.28	36.35
4	#3249.00	53.54 AV	76.07	-22.53	1.17 V	80	17.19	36.35
5	4874.00	49.62 PK	74.00	-24.38	1.00 V	57	9.06	40.56
6	4874.00	34.99 AV	54.00	-19.01	1.00 V	57	-5.57	40.56

- REMARKS:**
1. Emission level (dBuV/m) = Raw Value (dBuV) + Correction Factor (dB/m).
 2. Correction Factor (dB/m) = Antenna Factor (dB/m) + Cable Factor (dB).
 3. The other emission levels were very low against the limit.
 4. Margin value = Emission level – Limit value.
 5. “ * “: Fundamental frequency.
 6. “#”:The radiated frequency is out the restricted band.



EUT TEST CONDITION		MEASUREMENT DETAIL	
CHANNEL	Channel 11	FREQUENCY RANGE	1 ~ 25GHz
INPUT POWER	120Vac, 60 Hz	DETECTOR FUNCTION	Peak (PK) Average (AV)
ENVIRONMENTAL CONDITIONS	20deg. C, 85% RH, 1005hPa	TESTED BY	Chad Lee

ANTENNA POLARITY & TEST DISTANCE: HORIZONTAL AT 3 M								
NO.	FREQ. (MHz)	EMISSION LEVEL (dBuV/m)	LIMIT (dBuV/m)	MARGIN (dB)	ANTENNA HEIGHT (m)	TABLE ANGLE (Degree)	RAW VALUE (dBuV)	CORRECTION FACTOR (dB/m)
1	*2462.00	101.16 PK			1.38 H	102	67.54	33.62
2	*2462.00	90.51 AV			1.38 H	102	56.89	33.62
3	2483.50	58.35 PK	74.00	-15.65	1.38 H	102	24.63	33.72
4	2483.50	45.86 AV	54.00	-8.14	1.38 H	102	12.14	33.72
5	#3282.00	53.31 PK	81.16	-27.85	1.18 H	302	16.89	36.42
6	#3282.00	48.35 AV	70.51	-22.16	1.18 H	302	11.93	36.42
7	4924.00	50.04 PK	74.00	-23.96	1.10 H	101	9.36	40.68
8	4924.00	35.15 AV	54.00	-18.85	1.10 H	101	-5.53	40.68
ANTENNA POLARITY & TEST DISTANCE: VERTICAL AT 3 M								
NO.	FREQ. (MHz)	EMISSION LEVEL (dBuV/m)	LIMIT (dBuV/m)	MARGIN (dB)	ANTENNA HEIGHT (m)	TABLE ANGLE (Degree)	RAW VALUE (dBuV)	CORRECTION FACTOR (dB/m)
1	*2462.00	107.65 PK			1.28 V	318	74.03	33.62
2	*2462.00	96.63 AV			1.28 V	318	63.01	33.62
3	2483.50	63.51 PK	74.00	-10.49	1.28 V	318	29.79	33.72
4	2483.50	48.52 AV	54.00	-5.48	1.28 V	318	14.80	33.72
5	#3282.00	55.72 PK	87.65	-31.93	1.00 V	178	19.30	36.42
6	#3282.00	53.08 AV	76.63	-23.55	1.00 V	178	16.66	36.42
7	4924.00	49.23 PK	74.00	-24.77	1.00 V	55	8.55	40.68
8	4924.00	35.42 AV	54.00	-18.58	1.00 V	55	-5.26	40.68

- REMARKS:**
1. Emission level (dBuV/m) = Raw Value (dBuV) + Correction Factor (dB/m).
 2. Correction Factor (dB/m) = Antenna Factor (dB/m) + Cable Factor (dB).
 3. The other emission levels were very low against the limit.
 4. Margin value = Emission level – Limit value.
 5. “ * “: Fundamental frequency.
 6. “#”:The radiated frequency is out the restricted band.



4.3 6dB BANDWIDTH MEASUREMENT

4.3.1 LIMITS OF 6dB BANDWIDTH MEASUREMENT

The minimum of 6dB Bandwidth Measurement is 0.5 MHz.

4.3.2 TEST INSTRUMENTS

DESCRIPTION & MANUFACTURER	MODEL NO.	SERIAL NO.	CALIBRATED DATE	CALIBRATED UNTIL
SPECTRUM ANALYZER	FSP 40	100035	Mar. 26, 2008	Mar. 25, 2009

NOTE: The calibration interval of the above test instruments is 12 months and the calibrations are traceable to NML/ROC and NIST/USA.

4.3.3 TEST PROCEDURE

The transmitter output was connected to the spectrum analyzer through an attenuator. The bandwidth of the fundamental frequency was measured by spectrum analyzer with 100 kHz RBW and 300kHz VBW. The 6dB bandwidth is defined as the total spectrum the power of which is higher than peak power minus 6dB.

4.3.4 DEVIATION FROM TEST STANDARD

No deviation.

4.3.5 TEST SETUP

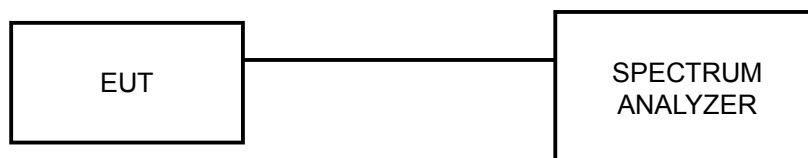

For the actual test configuration, please refer to the related Item – Photographs of the Test Configuration.

4.3.6 EUT OPERATING CONDITIONS

The software provided by client to enable the EUT under transmission condition continuously at lowest, middle and highest channel frequencies individually.

4.3.7 TEST RESULTS

802.11b DSSS MODULATION

MODULATION TYPE	DBPSK	CHANNEL	1, 6, 11
INPUT POWER	120Vac, 60 Hz	ENVIRONMENTAL CONDITIONS	20deg. C, 82% RH, 1001hPa
TRANSFER RATE	1Mbps	TESTED BY	Chad Lee

CHANNEL	CHANNEL FREQUENCY (MHz)	6dB BANDWIDTH (MHz)	MINIMUM LIMIT (MHz)	PASS/FAIL
1	2412	12.323	0.5	PASS
6	2437	12.187	0.5	PASS
11	2462	12.169	0.5	PASS

CH 1

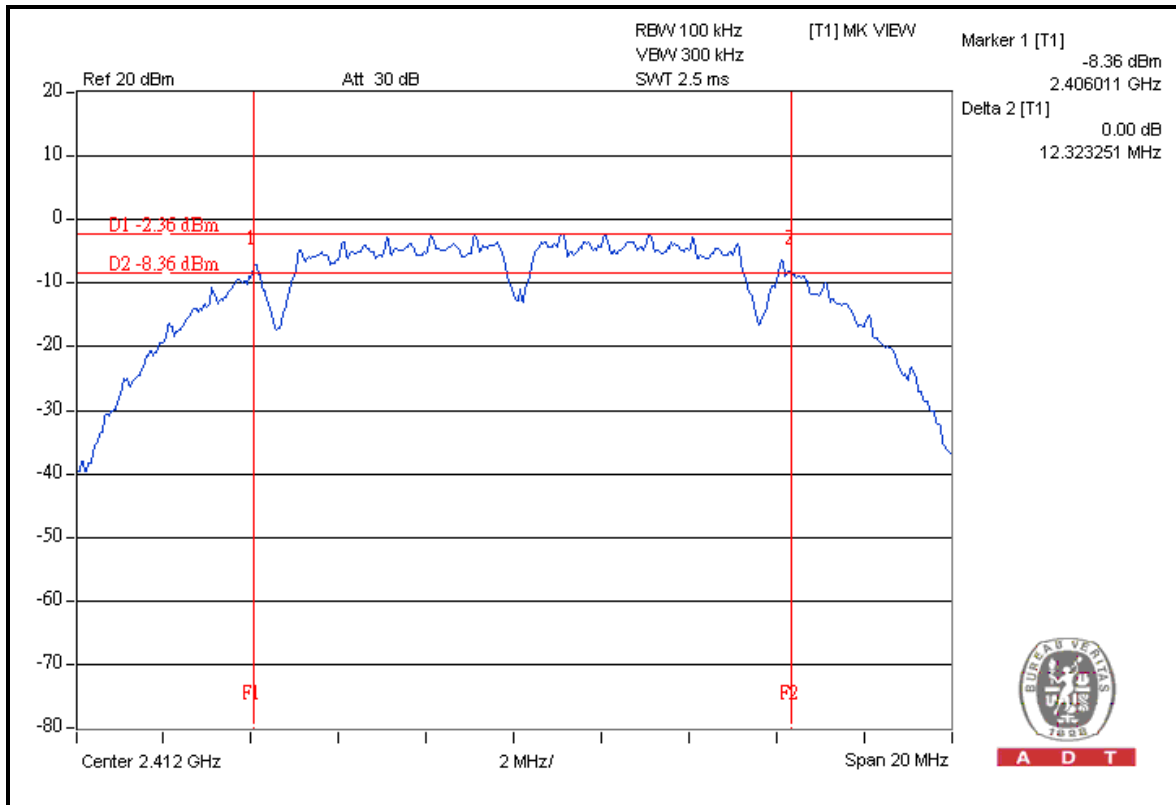

CH 6

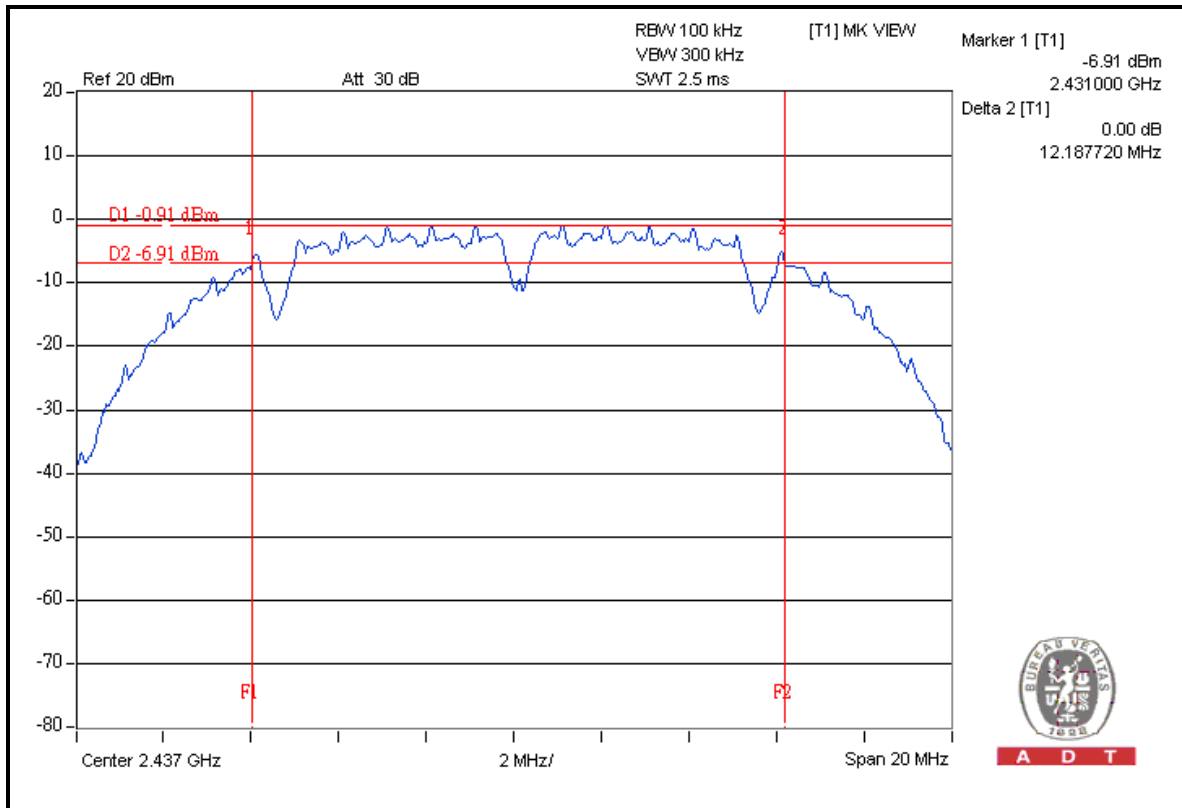

CH 11

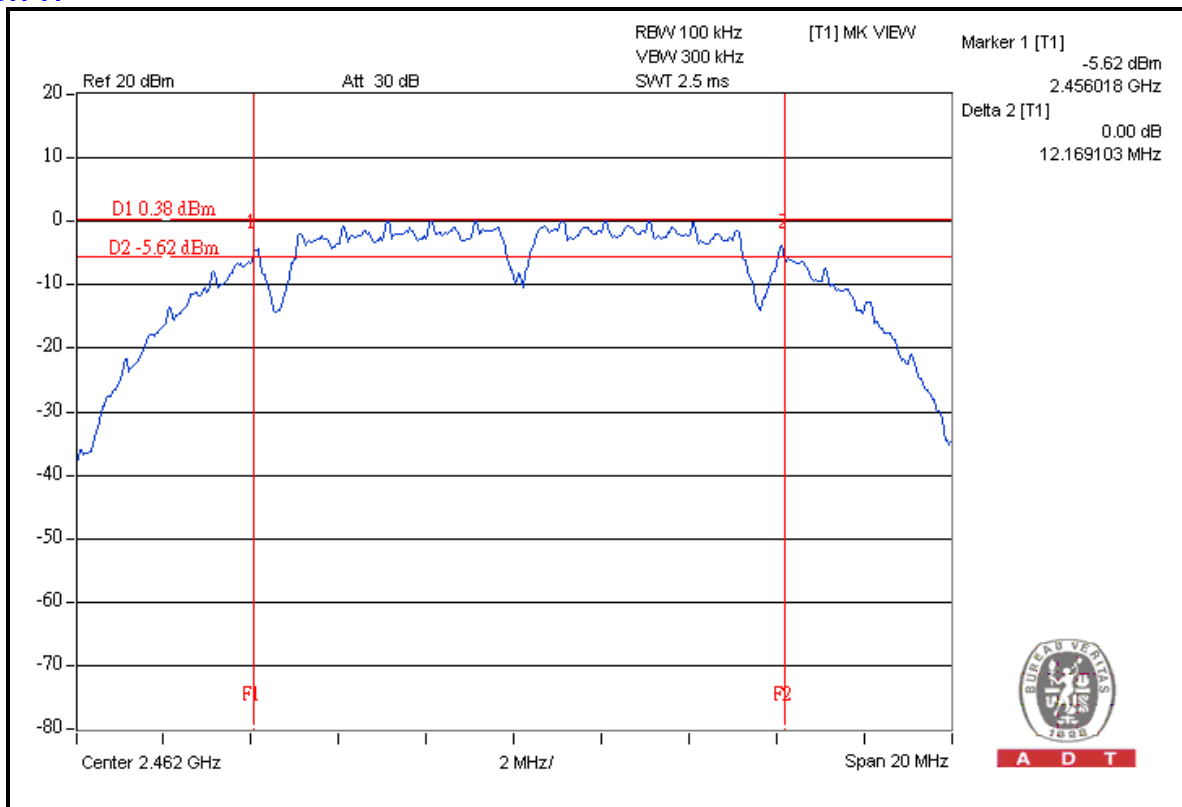



802.11g OFDM MODULATION

MODULATION TYPE	BPSK	CHANNEL	1, 6, 11
INPUT POWER	120Vac, 60 Hz	ENVIRONMENTAL CONDITIONS	20deg. C, 82% RH, 1001hPa
TRANSFER RATE	6Mbps	TESTED BY	Chad Lee

CHANNEL	CHANNEL FREQUENCY (MHz)	6dB BANDWIDTH (MHz)	MINIMUM LIMIT (MHz)	PASS/FAIL
1	2412	16.546	0.5	PASS
6	2437	16.590	0.5	PASS
11	2462	16.595	0.5	PASS

CH 1

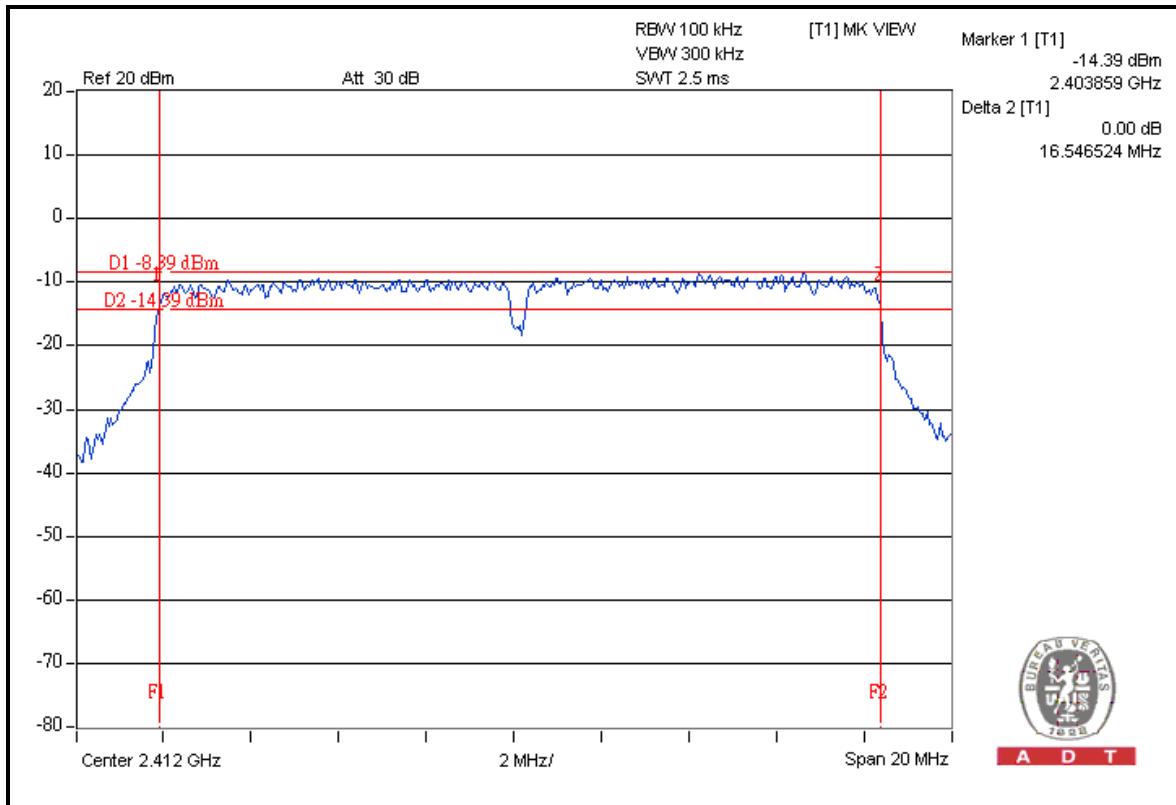

CH 6

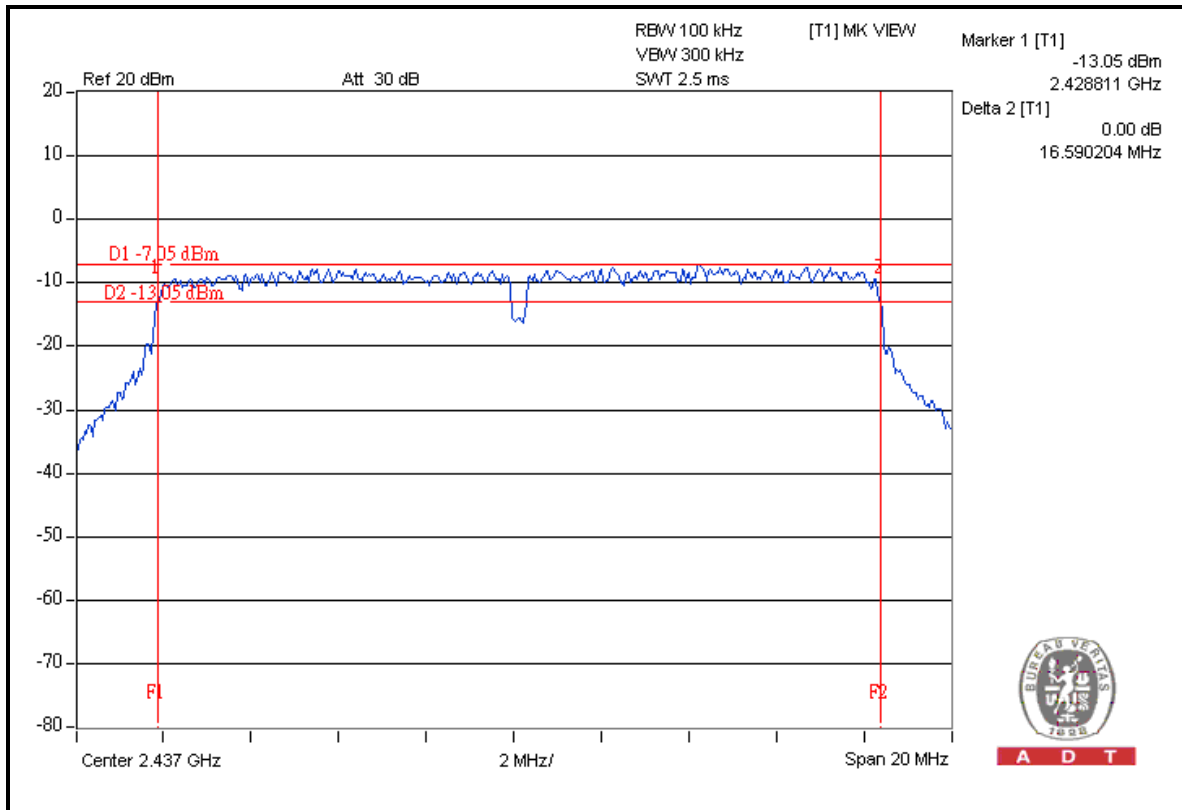

CH 11

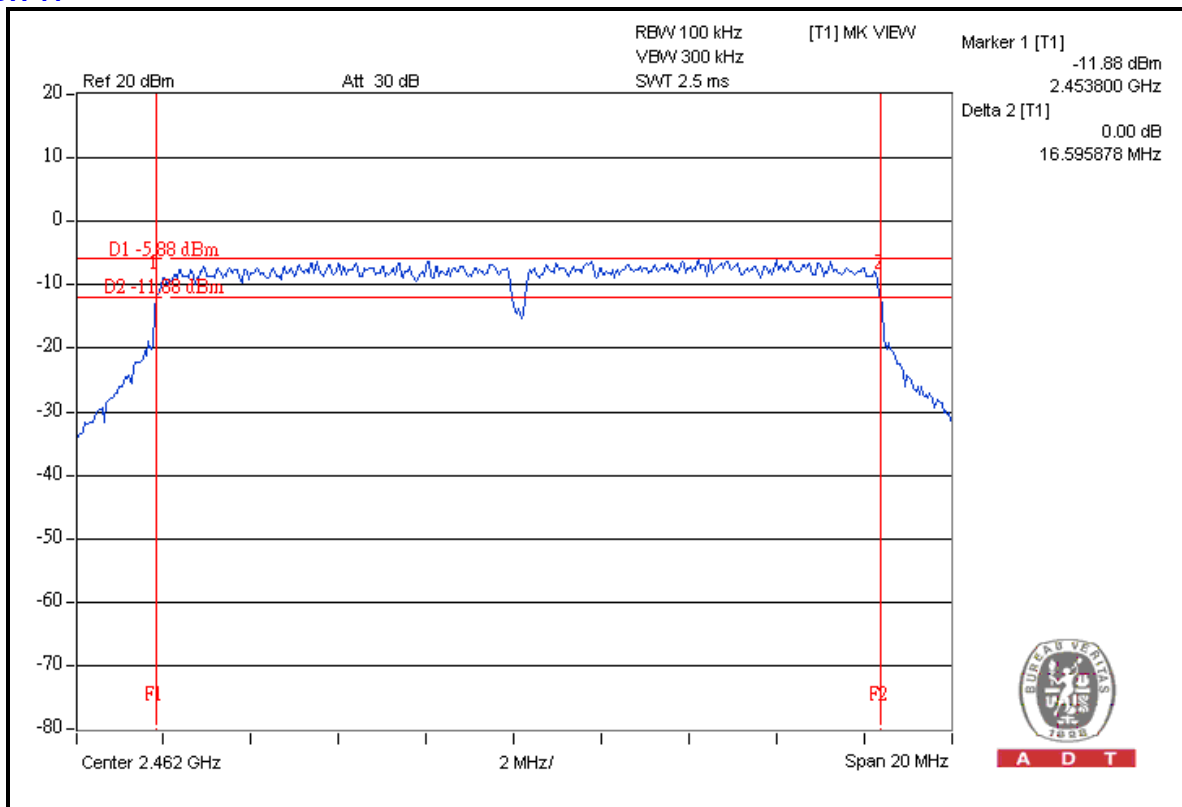



4.4 MAXIMUM PEAK OUTPUT POWER

4.4.1 LIMITS OF MAXIMUM PEAK OUTPUT POWER MEASUREMENT

The Maximum Peak Output Power Measurement is 30dBm.

4.4.2 TEST INSTRUMENTS

Description & Manufacturer	Model No.	Serial No.	Calibrated Date	Calibrated Until
ROHDE & SCHWARZ Spectrum Analyzer	FSP 40	100035	Mar. 26, 2008	Mar. 25, 2009
ROHDE & SCHWARZ Signal Generator	SMR 40	100231	Mar. 25, 2008	Mar. 24, 2009
Tektronix Oscilloscope	TDS1012	C019167	Jan. 16, 2008	Jan. 15, 2009
Narda Detector	4503A	FSCM99899	NA	NA

NOTE: The calibration interval of the above test instruments is 12 months and the calibrations are traceable to NML/ROC and NIST/USA.

4.4.3 TEST PROCEDURES

1. A detector was used on the output port of the EUT. An oscilloscope was used to peak the response of the detector.
2. Replaced the EUT by the signal generator. The center frequency of the S.G was adjusted to the center frequency of the measured channel.
3. Adjusted the power to have the same peak reading on oscilloscope. Record the power level.

4.4.4 DEVIATION FROM TEST STANDARD

No deviation.

4.4.5 TEST SETUP

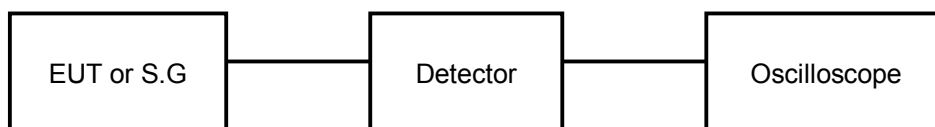

4.4.6 EUT OPERATING CONDITIONS

Same as 4.3.6.



4.4.7 TEST RESULTS

802.11b DSSS MODULATION

MODULATION TYPE	DBPSK	CHANNEL	1, 6, 11
INPUT POWER	120Vac, 60 Hz	ENVIRONMENTAL CONDITIONS	20deg. C, 82% RH, 1001hPa
TRANSFER RATE	1Mbps	TESTED BY	Chad Lee

CHANNEL	CHANNEL FREQUENCY (MHz)	PEAK POWER OUTPUT (dBm)	PEAK POWER OUTPUT (mW)	PEAK POWER LIMIT (dBm)	PASS/FAIL
1	2412	12.19	16.558	30	PASS
6	2437	13.61	22.961	30	PASS
11	2462	14.84	30.479	30	PASS

802.11g OFDM MODULATION

MODULATION TYPE	BPSK	CHANNEL	1, 6, 11
INPUT POWER	120Vac, 60 Hz	ENVIRONMENTAL CONDITIONS	20deg. C, 82% RH, 1001hPa
TRANSFER RATE	6Mbps	TESTED BY	Chad Lee

CHANNEL	CHANNEL FREQUENCY (MHz)	PEAK POWER OUTPUT (dBm)	PEAK POWER OUTPUT (mW)	PEAK POWER LIMIT (dBm)	PASS/FAIL
1	2412	10.88	12.246	30	PASS
6	2437	12.28	16.904	30	PASS
11	2462	13.80	23.988	30	PASS

4.5 POWER SPECTRAL DENSITY MEASUREMENT

4.5.1 LIMITS OF POWER SPECTRAL DENSITY MEASUREMENT

The Maximum of Power Spectral Density Measurement is 8dBm.

4.5.2 TEST INSTRUMENTS

DESCRIPTION & MANUFACTURER	MODEL NO.	SERIAL NO.	CALIBRATED DATE	CALIBRATED UNTIL
SPECTRUM ANALYZER	FSP 40	100035	Mar. 26, 2008	Mar. 25, 2009

NOTE: The calibration interval of the above test instruments is 12 months and the calibrations are traceable to NML/ROC and NIST/USA.

4.5.3 TEST PROCEDURE

The transmitter output was connected to the spectrum analyzer through an attenuator, the bandwidth of the fundamental frequency was measured with the spectrum analyzer using 3kHz RBW and 30kHz VBW, set sweep time = span/3kHz. The power spectral density was measured and recorded.

The sweep time is allowed to be longer than span/3kHz for a full response of the mixer in the spectrum analyzer.

4.5.4 DEVIATION FROM TEST STANDARD

No deviation.

4.5.5 TEST SETUP

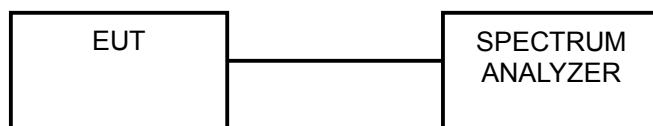

4.5.6 EUT OPERATING CONDITIONS

Same as 4.3.6.



4.5.7 TEST RESULTS

802.11b DSSS MODULATION

MODULATION TYPE	DBPSK	CHANNEL	1, 6, 11
INPUT POWER	120Vac, 60 Hz	ENVIRONMENTAL CONDITIONS	20deg. C, 82% RH, 1001hPa
TRANSFER RATE	1Mbps	TESTED BY	Chad Lee

CHANNEL	CHANNEL FREQUENCY (MHz)	RF POWER LEVEL IN 3 kHz BW (dBm)	MAXIMUM LIMIT (dBm)	PASS/FAIL
1	2412	-20.47	8	PASS
6	2437	-19.10	8	PASS
11	2462	-17.80	8	PASS

CH 1

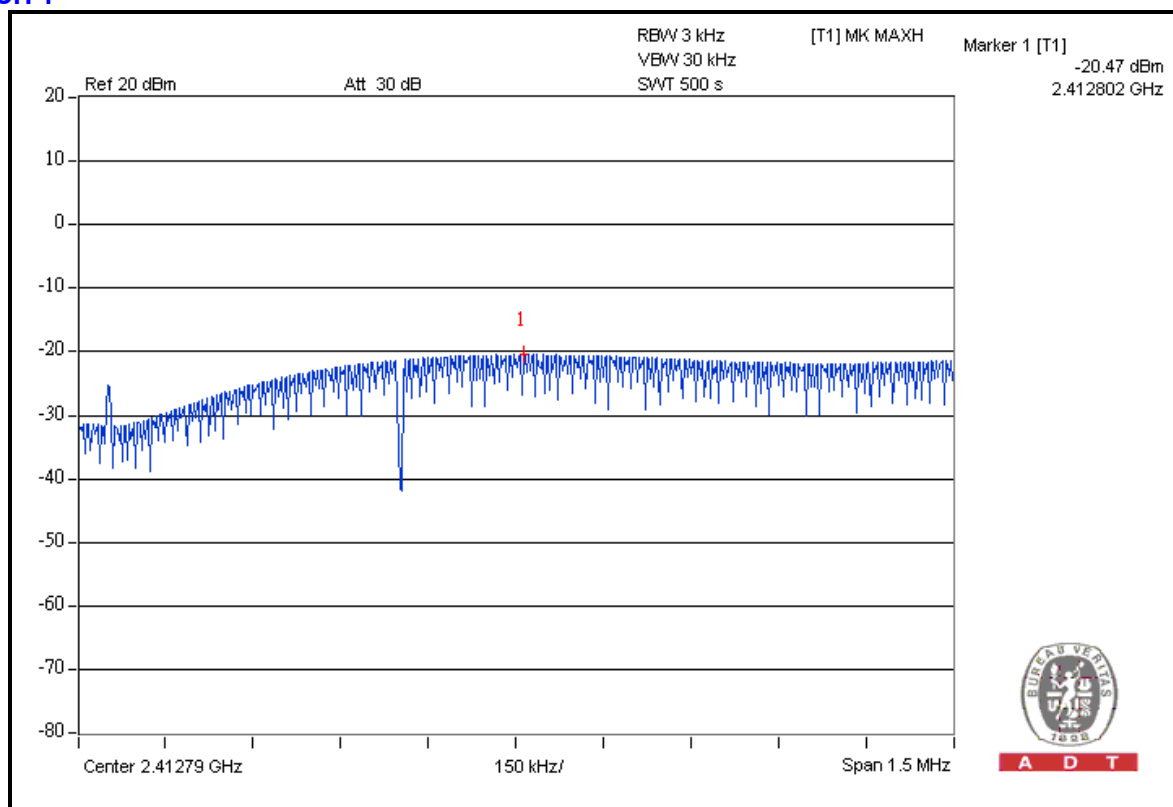

CH 6

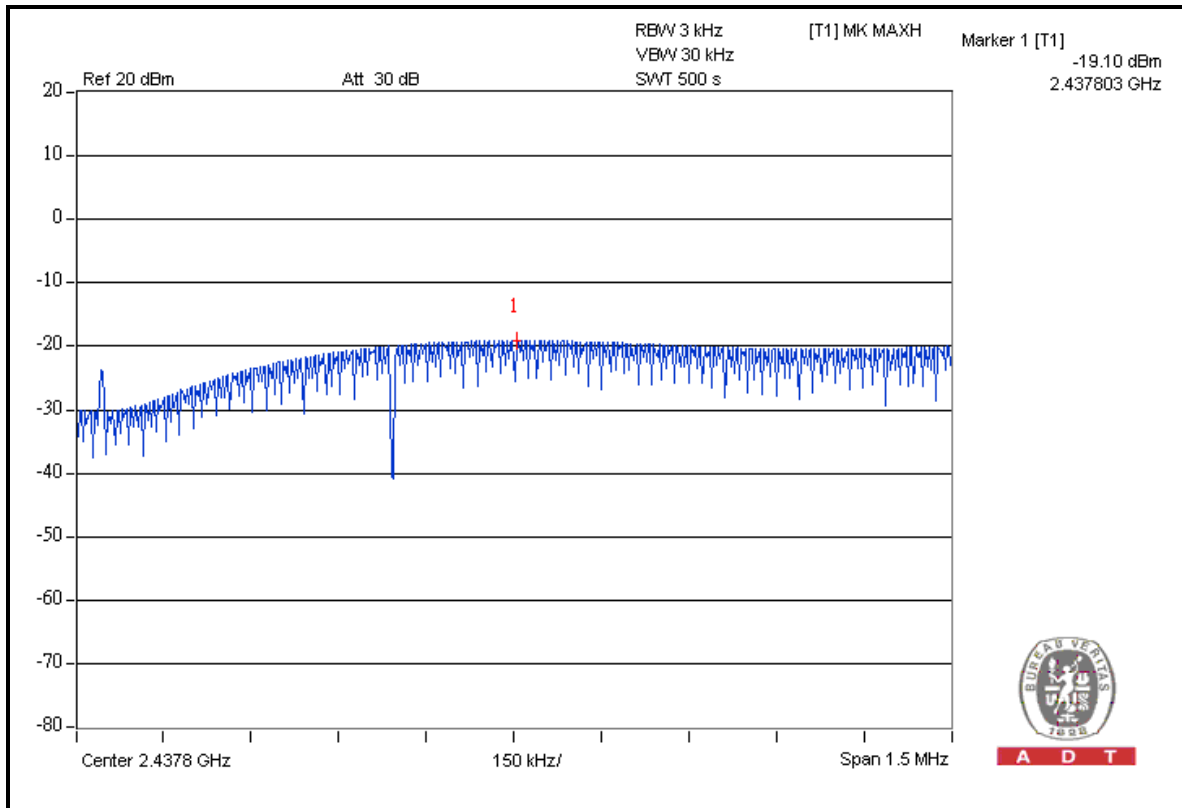

CH 11

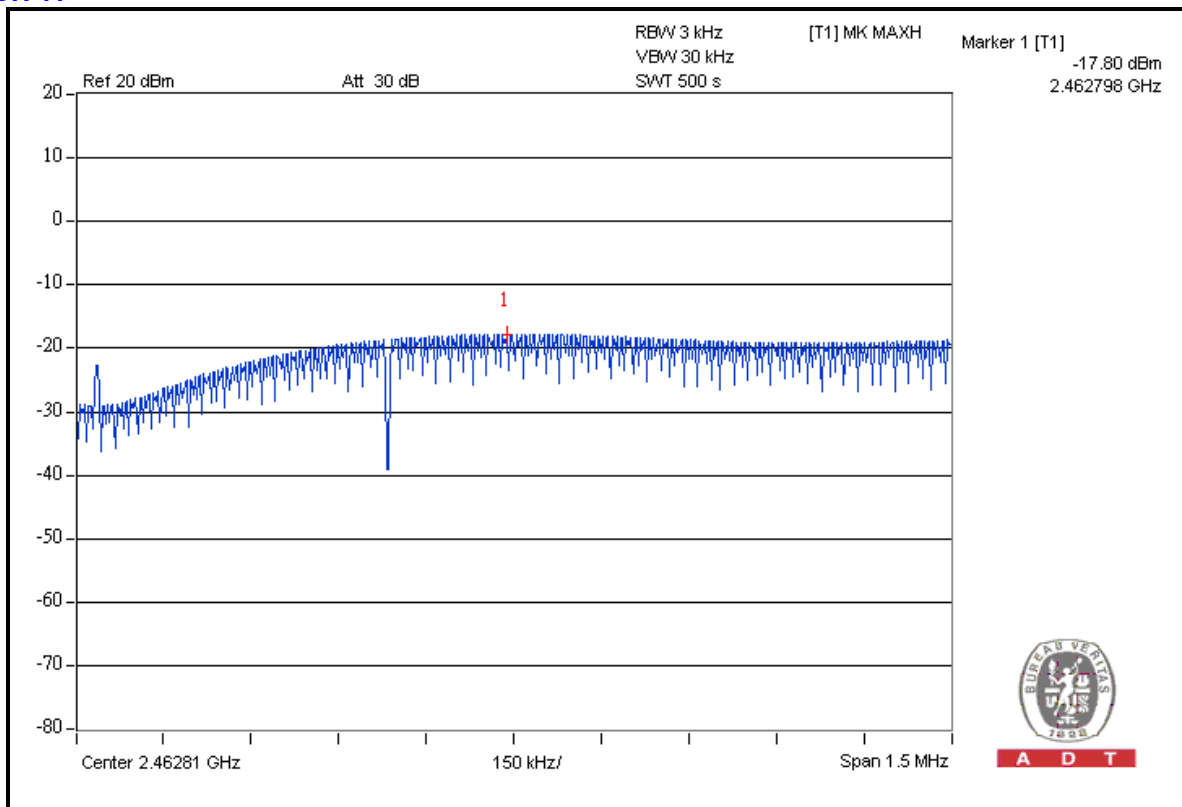

802.11g OFDM MODULATION

MODULATION TYPE	BPSK	CHANNEL	1, 6, 11
INPUT POWER	120Vac, 60 Hz	ENVIRONMENTAL CONDITIONS	20deg. C, 82% RH, 1001hPa
TRANSFER RATE	6Mbps	TESTED BY	Chad Lee

CHANNEL	CHANNEL FREQUENCY (MHz)	RF POWER LEVEL IN 3 kHz BW (dBm)	MAXIMUM LIMIT (dBm)	PASS/FAIL
1	2412	-22.83	8	PASS
6	2437	-21.61	8	PASS
11	2462	-20.28	8	PASS

CH 1

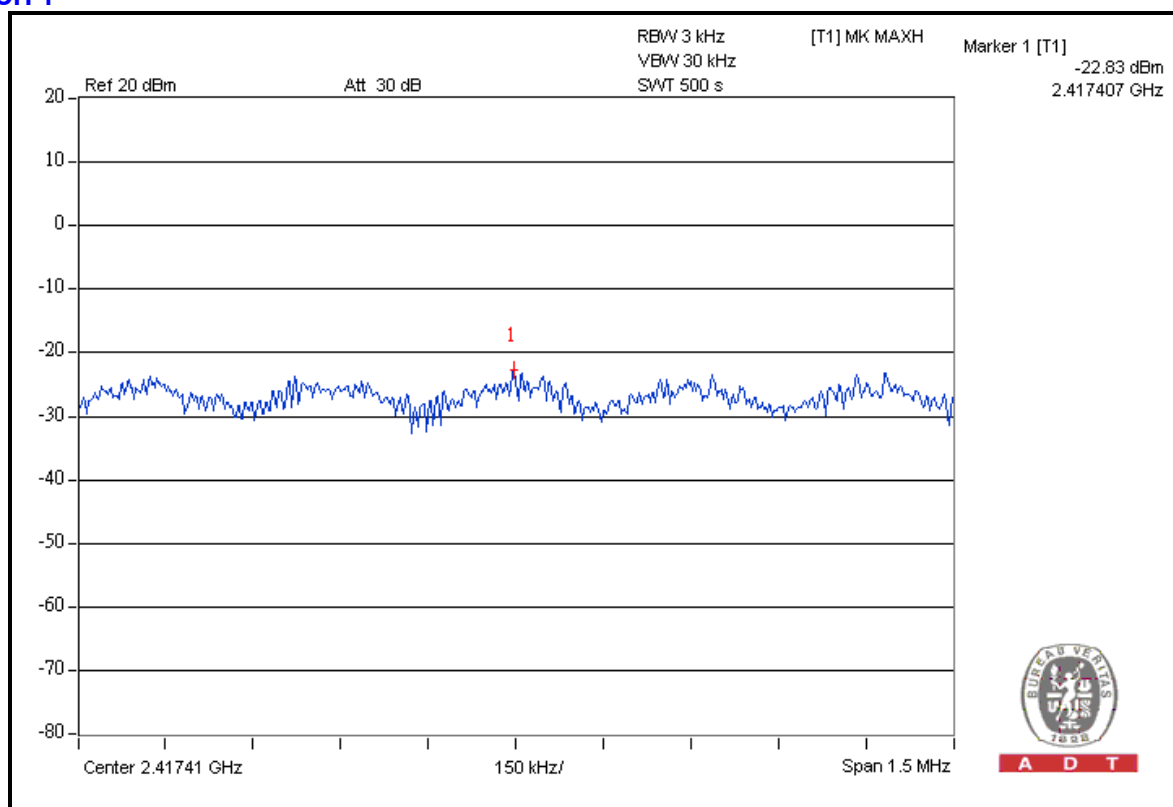

CH 6

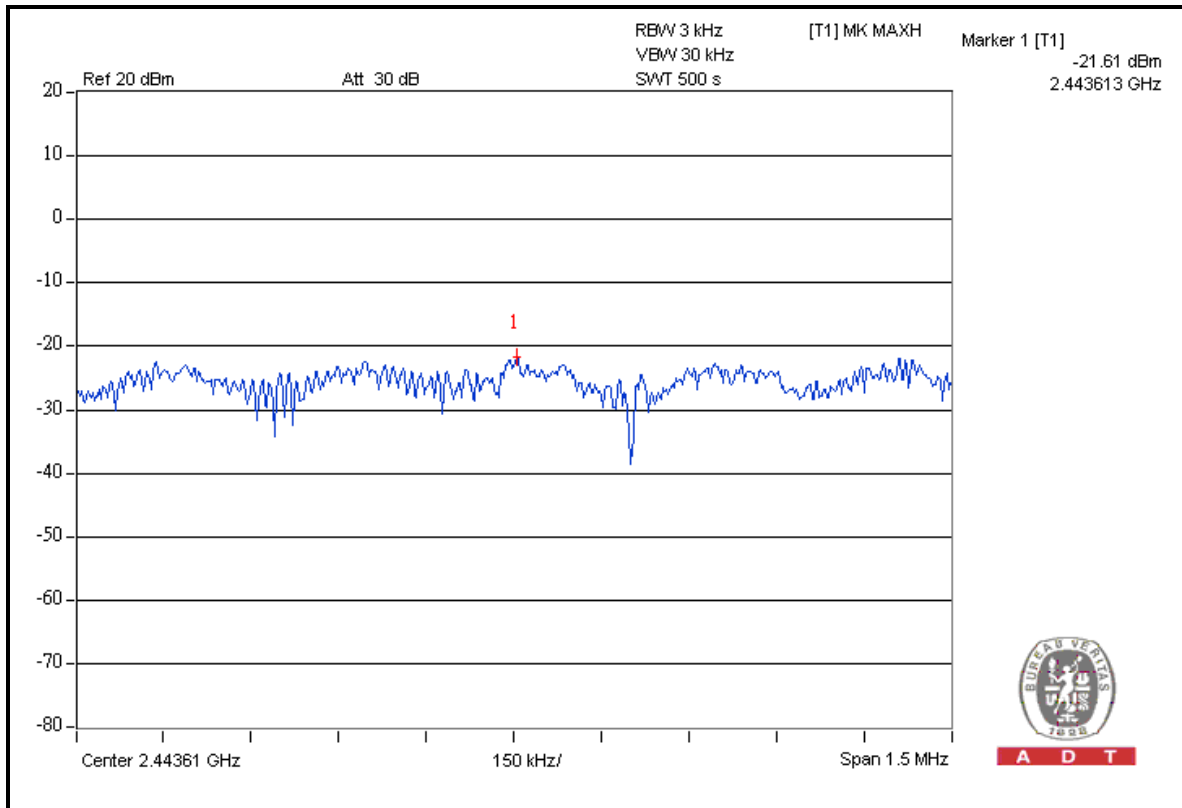

CH 11

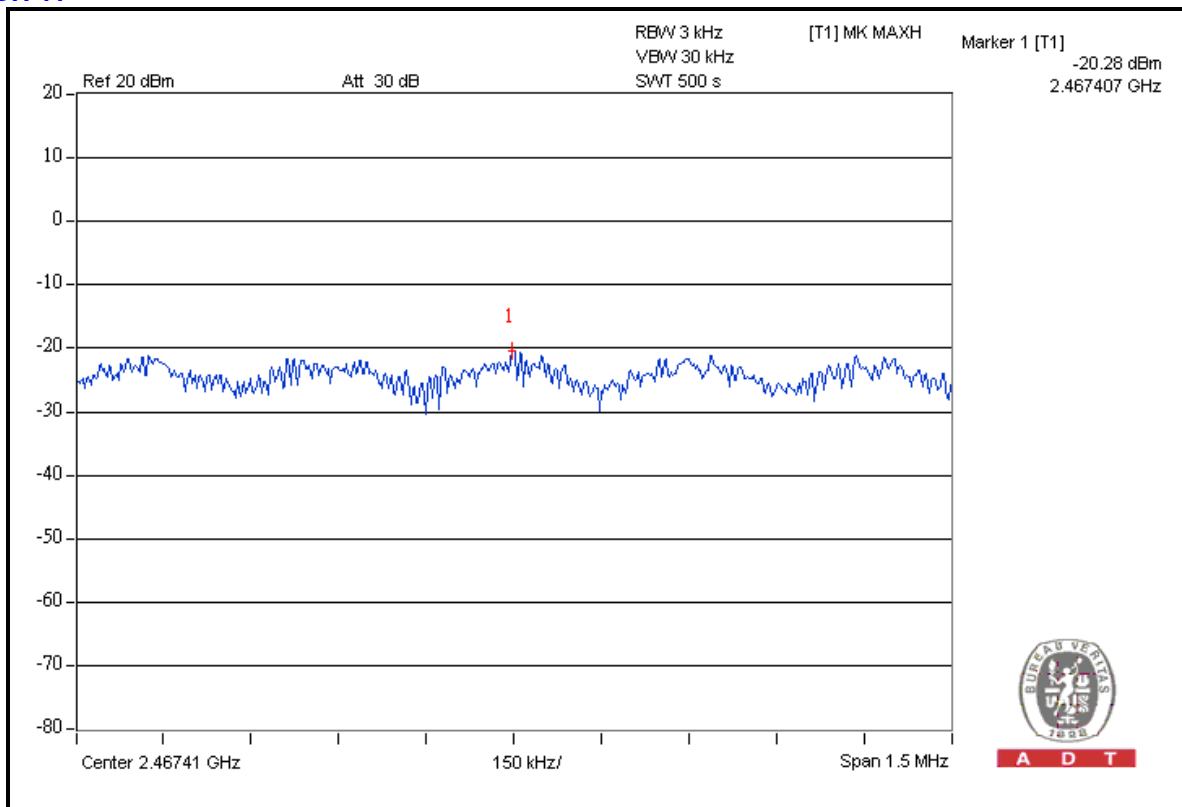



4.6 BAND EDGES MEASUREMENT

4.6.1 LIMITS OF BAND EDGES MEASUREMENT

Below -20dB of the highest emission level of operating band (in 100kHz Resolution Bandwidth).

4.6.2 TEST INSTRUMENTS

DESCRIPTION & MANUFACTURER	MODEL NO.	SERIAL NO.	CALIBRATED DATE	CALIBRATED UNTIL
SPECTRUM ANALYZER	FSP 40	100035	Mar. 26, 2008	Mar. 25, 2009

NOTE: The calibration interval of the above test instruments is 12 months and the calibrations are traceable to NML/ROC and NIST/USA.

4.6.3 TEST PROCEDURE

The transmitter output was connected to the spectrum analyzer via a low lose cable. Set both RBW and VBW of spectrum analyzer to 100kHz and 300kHz with suitable frequency span including 100MHz bandwidth from band edge. The band edges was measured and recorded.

The spectrum plots (Peak RBW=100kHz, VBW=300kHz; Average RBW=1MHz, VBW= 10Hz) are attached on the following pages.

4.6.4 DEVIATION FROM TEST STANDARD

No deviation.

4.6.5 EUT OPERATING CONDITION

Same as 4.3.6.

4.6.6 TEST RESULTS

The spectrum plots are attached on the following 12 images. D1 line indicates the highest level, and D2 line indicates the 20dB offset below D1. It shows compliance with the requirement in part 15.247(d).

802.11b DSSS MODULATION

NOTE 1: The band edge emission plot on the next page shows 46.04dBc between carrier maximum power and local maximum emission in restrict band (2.3658GHz). The emission of carrier strength list in the test result of channel 1 at the item 4.2.7 is 103.60dBuV/m (Peak), so the maximum field strength in restrict band is $103.60 - 46.04 = 57.56$ dBuV/m which is under 74dBuV/m limit.

The band edge emission plot of on the next page shows 57.24dBc between carrier maximum power and local maximum emission in restrict band (2.3900GHz). The emission of carrier strength list in the test result of channel 1 at the item 4.2.7 is 99.08dBuV/m (Average), so the maximum field strength in restrict band is $99.08 - 57.24 = 41.84$ dBuV/m which is under 54dBuV/m limit.

NOTE 2: The band edge emission plot on the next second page shows 49.44dBc between carrier maximum power and local maximum emission in restrict band (2.4936GHz). The emission of carrier strength list in the test result of channel 11 at the item 4.2.7 is 106.36dBuV/m (Peak), so the maximum field strength in restrict band is $106.36 - 49.44 = 56.92$ dBuV/m which is under 74dBuV/m limit.

The band edge emission plot on the next third page shows 56.01dBc between carrier maximum power and local maximum emission in restrict band (2.4878GHz). The emission of carrier strength list in the test result of channel 11 at the item 4.2.7 is 101.36dBuV/m (Average), so the maximum field strength in restrict band is $101.36 - 56.01 = 45.35$ dBuV/m which is under 54dBuV/m limit.

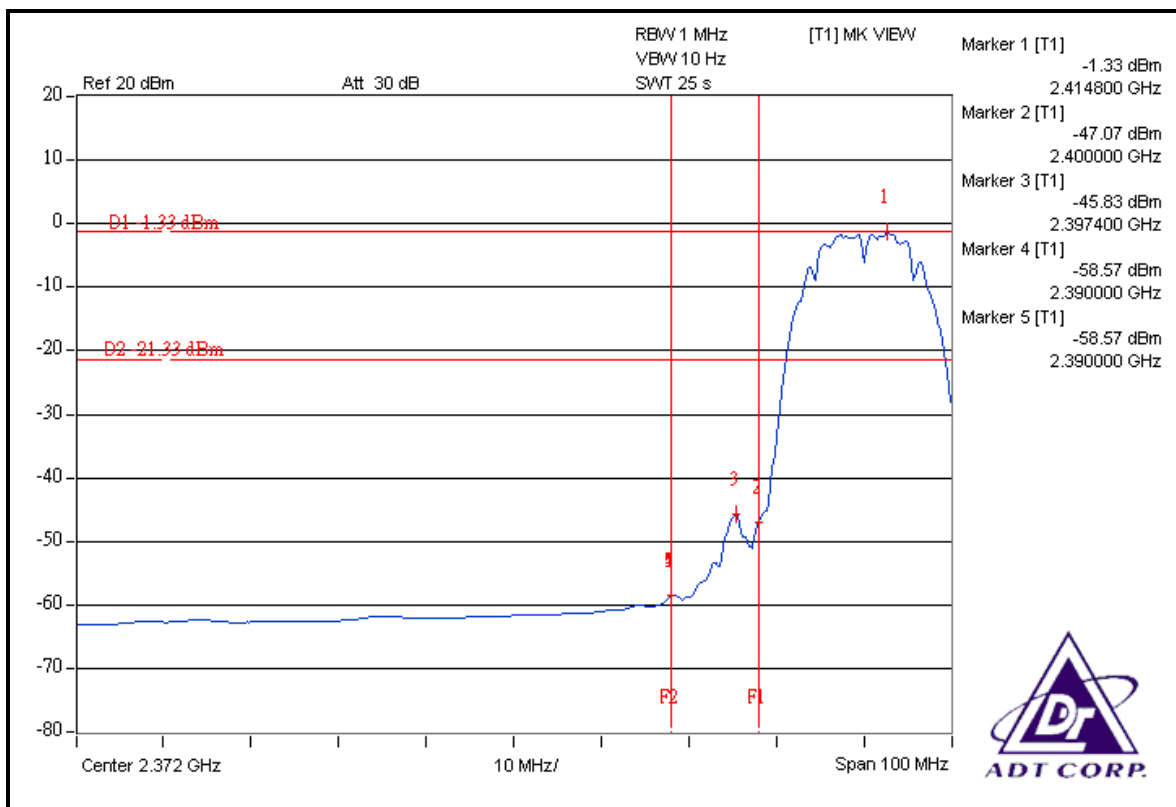
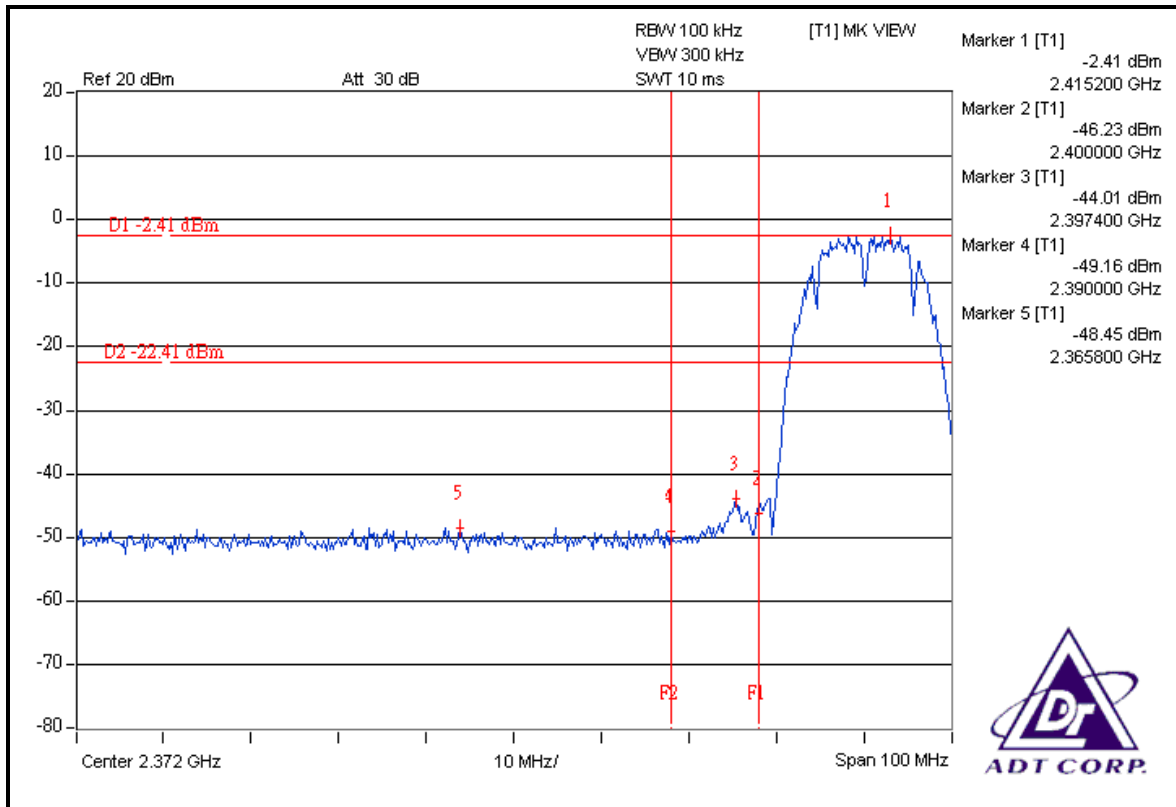

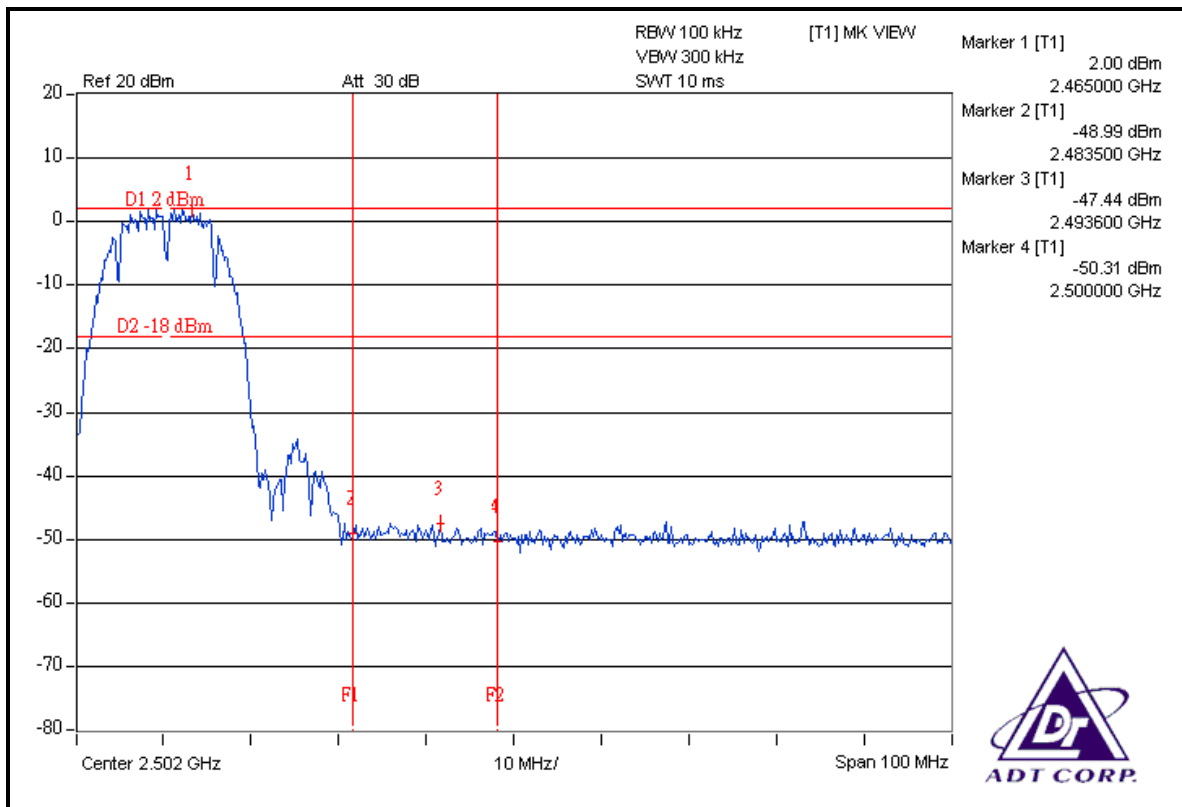
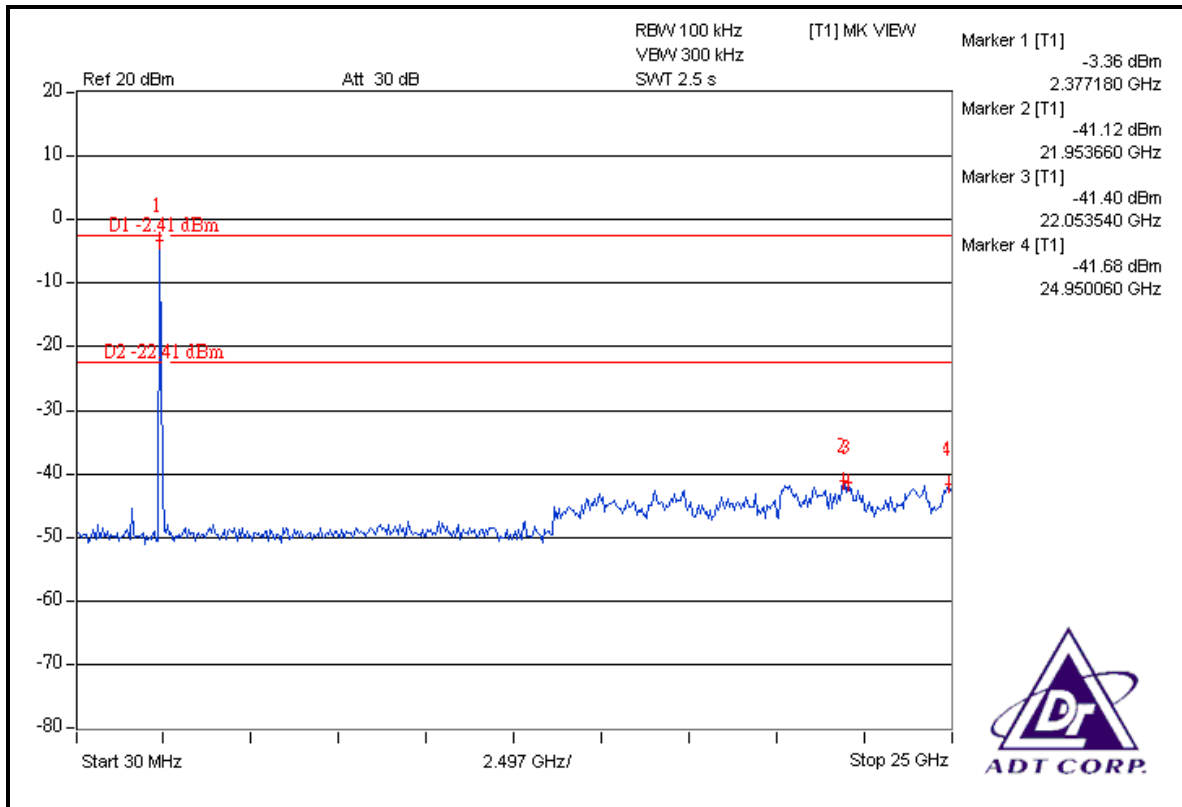

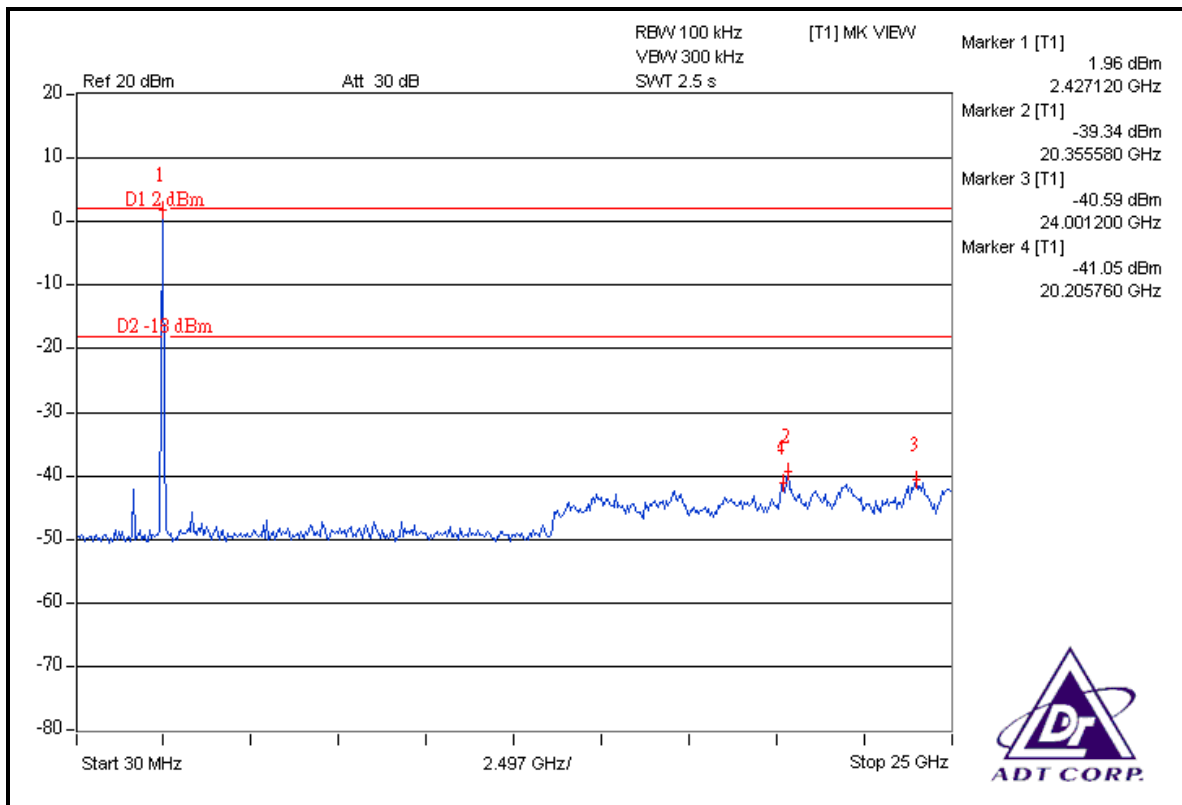
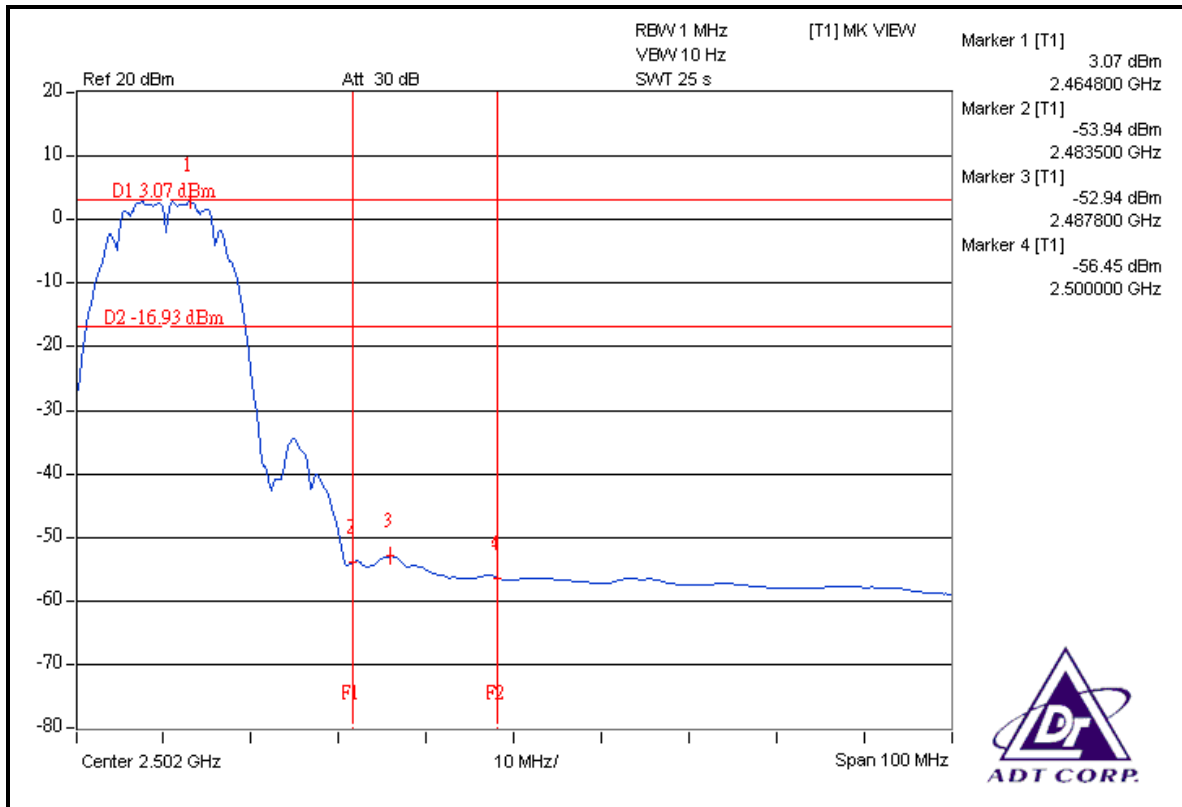

802.11g OFDM MODULATION

NOTE 1: The band edge emission plot on the next page shows 39.11dBc between carrier maximum power and local maximum emission in restrict band (2.3368GHz). The emission of carrier strength list in the test result of channel 1 at the item 4.2.7 is 105.37dBuV/m (Peak), so the maximum field strength in restrict band is $105.37 - 39.11 = 66.26$ dBuV/m which is under 74dBuV/m limit.

The band edge emission plot of on the next page shows 52.06dBc between carrier maximum power and local maximum emission in restrict band (2.3900GHz). The emission of carrier strength list in the test result of channel 1 at the item 4.2.7 is 96.77dBuV/m (Average), so the maximum field strength in restrict band is $96.77 - 52.06 = 44.71$ dBuV/m which is under 54dBuV/m limit.

NOTE 2: The band edge emission plot on the next second page shows 41.69dBc between carrier maximum power and local maximum emission in restrict band (2.4852GHz). The emission of carrier strength list in the test result of channel 11 at the item 4.2.7 is 107.65dBuV/m (Peak), so the maximum field strength in restrict band is $107.65 - 41.69 = 65.96$ dBuV/m which is under 74dBuV/m limit.

The band edge emission plot on the next third page shows 49.44dBc between carrier maximum power and local maximum emission in restrict band (2.4835GHz). The emission of carrier strength list in the test result of channel 11 at the item 4.2.7 is 96.63dBuV/m (Average), so the maximum field strength in restrict band is $96.63 - 49.44 = 47.19$ dBuV/m which is under 54dBuV/m limit.

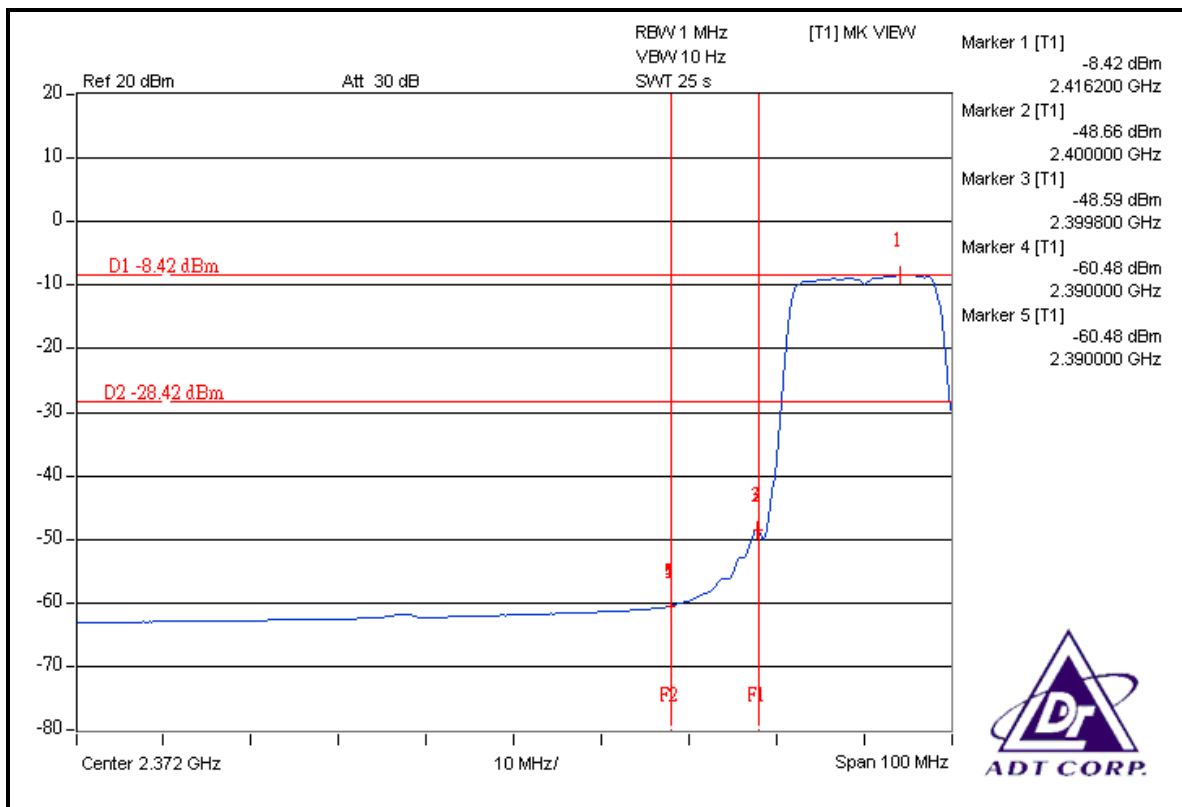
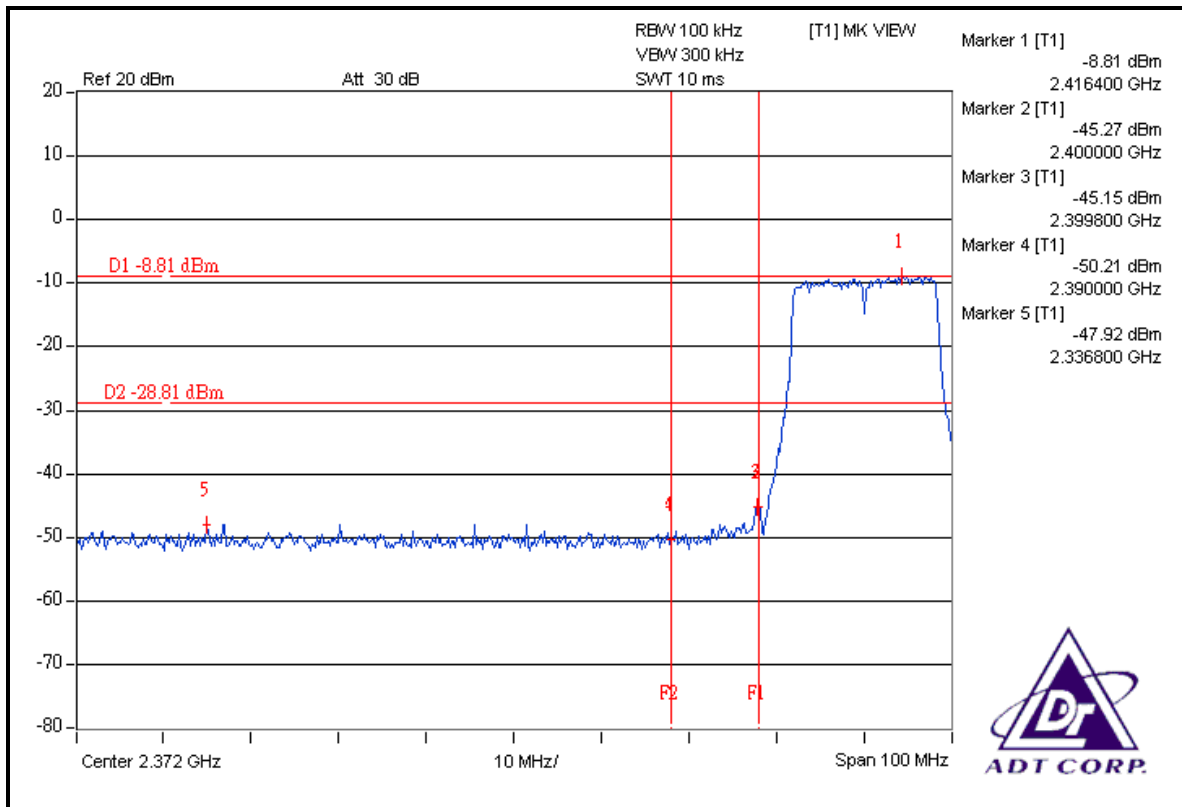

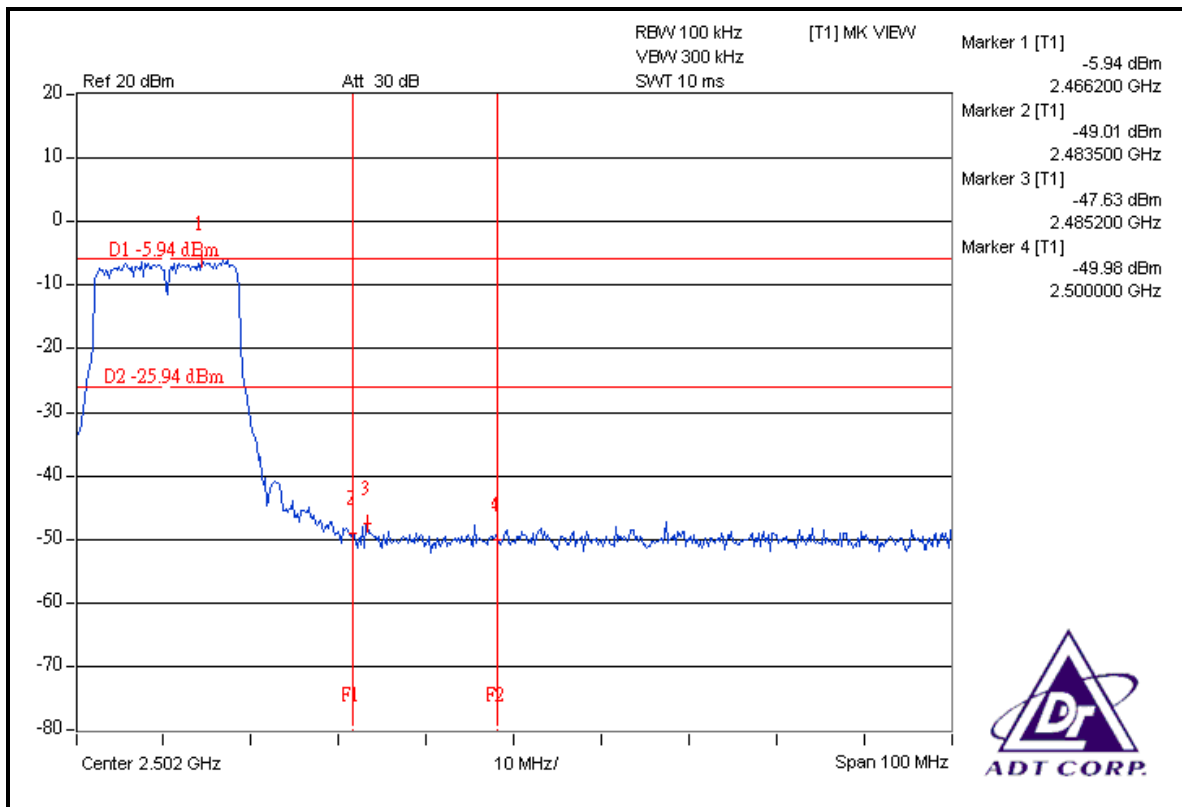
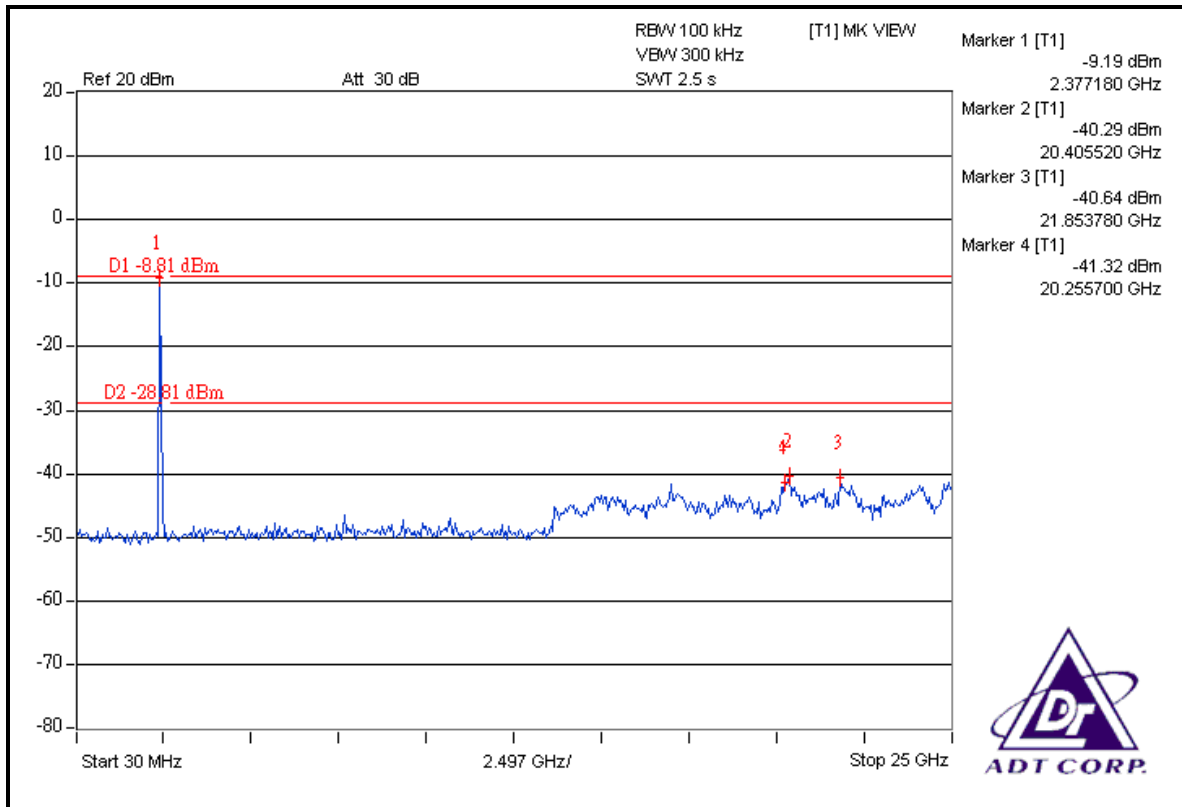

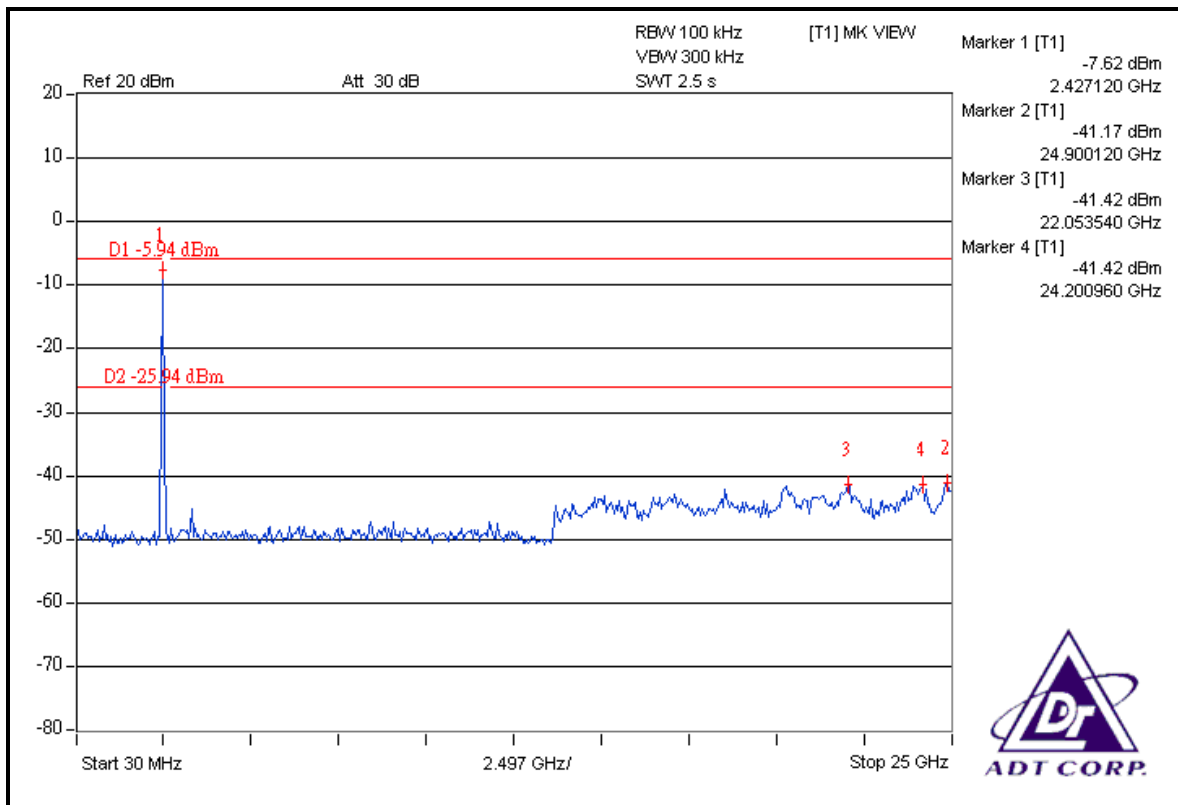
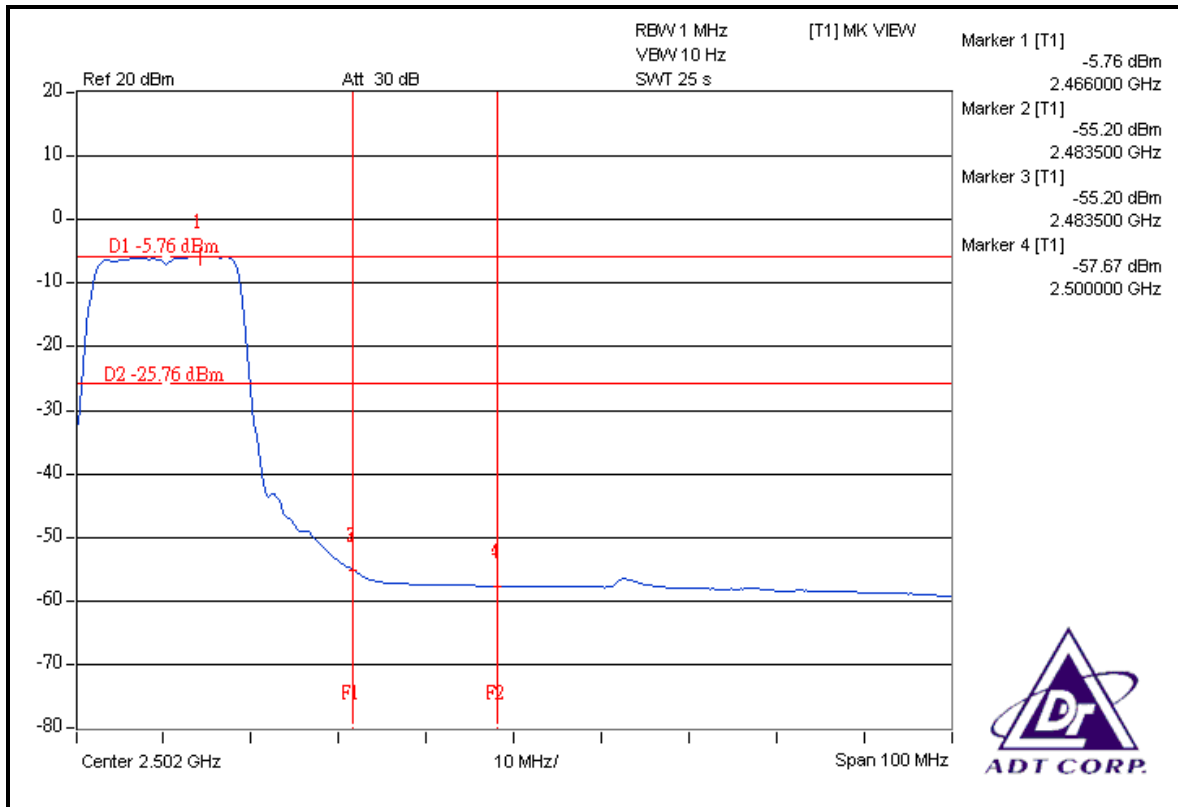



4.7 ANTENNA REQUIREMENT

4.7.1 STANDARD APPLICABLE

For intentional device, according to FCC 47 CFR Section 15.203, an intentional radiator shall be designed to ensure that no antenna other than that furnished by the responsible party shall be used with the device.

And according to FCC 47 CFR Section 15.247 (b), if transmitting antennas of directional gain greater than 6dBi are used, the power shall be reduced by the amount in dB that the directional gain of the antenna exceeds 6dBi.

4.7.2 ANTENNA CONNECTED CONSTRUCTION

The antenna type used in this product is Dipole antenna with R-SMA connector. The maximum Gain of the antenna is 3.2dBi gain.



5 PHOTOGRAPHS OF THE TEST CONFIGURATION

Please refer to the attached file (Test Setup Photo).



6 INFORMATION ON THE TESTING LABORATORIES

We, ADT Corp., were founded in 1988 to provide our best service in EMC, Radio, Telecom and Safety consultation. Our laboratories are accredited and approved by the following approval agencies according to ISO/IEC 17025.

USA	FCC, UL
Germany	TUV Rheinland
Japan	VCCI
Norway	NEMKO
Canada	INDUSTRY CANADA, CSA
R.O.C.	TAF, BSMI, NCC
Netherlands	Telefication
Singapore	GOST-ASIA(MOU)
Russia	CERTIS(MOU)

Copies of accreditation certificates of our laboratories obtained from approval agencies can be downloaded from our web site: www.adt.com.tw/index.5/phtml.
If you have any comments, please feel free to contact us at the following:

Linko EMC/RF Lab

Tel: 886-2-26052180

Fax: 886-2-26051924

Hsin Chu EMC/RF Lab

Tel: 886-3-5935343

Fax: 886-3-5935342

Hwa Ya EMC/RF/Safety/Telecom Lab

Tel: 886-3-3183232

Fax: 886-3-3185050

Web Site: www.adt.com.tw

The address and road map of all our labs can be found in our web site also.



7 APPENDIX A – MODIFICATIONS RECORDERS FOR ENGINEERING CHANGES TO THE EUT BY THE LAB

No any modifications are made to the EUT by the lab during the test.

---END---