



DYNAMIC FREQUENCY SELECTION

DFS Test Report

APPLICANT : ASUSTeK COMPUTER INC.
EQUIPMENT : ASUS Phone(Mobile Phone)
BRAND NAME : ASUS
MODEL NAME : ASUS_AI2401_E
FCC ID : MSQAI2401
STANDARD : FCC Part 15 Subpart E
CLASSIFICATION : (NII) Unlicensed National Information Infrastructure
TEST DATE(S) : Oct. 22, 2023 ~ Dec. 04, 2023

We, Sporton International Inc. (ShenZhen), would like to declare that the tested sample has been evaluated in accordance with the procedures and shown to be compliant with the applicable technical standards.

The test results in this report apply exclusively to the tested model / sample. Without written approval of Sporton International Inc. (ShenZhen), the test report shall not be reproduced except in full.

Jason Jia

Approved by: Jason Jia



Sporton International Inc. (ShenZhen)

1/F, 2/F, Bldg 5, Shiling Industrial Zone, Xinwei Village, Xili, Nanshan, Shenzhen, 518055

People's Republic of China



TABLE OF CONTENTS

REVISION HISTORY..... 3

SUMMARY OF DYNAMIC FREQUENCY SELECTION TEST..... 4

1 GENERAL DESCRIPTION 5

 1.1. Applicant 5

 1.2. Manufacturer 5

 1.3. Feature of Equipment Under Test 5

 1.4. Product Specification of Equipment Under Test 6

 1.5. Modification of EUT 7

 1.6. Testing Site 7

 1.7. Applied Standards 7

 1.8. Support Unit used in test configuration and system 8

2 REQUIREMENTS AND PARAMETERS FOR DFS TEST 9

 2.1. Summary of Dynamic Frequency Selection Test 9

 2.2. Applicability of DFS Requirements 10

 2.3. Interference Threshold values, Master or Client incorporating In-Service Monitoring 11

 2.4. DFS Response requirement values 11

 2.5. Short Pulse Radar Test Waveforms 12

3 CALIBRATION SETUP AND DFS TEST RESULTS 13

 3.1. Calibration of Radar Waveform 13

 3.2. In-Service Monitoring: Channel Move Time, Channel Closing Transmission Time and Non-Occupancy Period..... 16

4 VERIFY CHANNEL PUNCTURING..... 25

 4.1 According to KDB inquiry for DFS test cases 25

 4.2 Test results 26

5 LIST OF MEASURING EQUIPMENT 45

6 MEASUREMENT UNCERTAINTY 46

APPENDIX A. SETUP PHOTOGRAPHS



REVISION HISTORY

REPORT NO.	VERSION	DESCRIPTION	ISSUED DATE
FZ391308	Rev. 01	Initial issue of report	Jan. 18, 2024



SUMMARY OF DYNAMIC FREQUENCY SELECTION TEST

UNII	Bandwidth and Channel	Description	Measured	Limit	Result	Remark
U-NII-2C 5470 MHz ~ 5725 MHz	80MHz (CH106) 5530MHz	Channel Move Time	0.535218sec	< 10 sec	Pass	1
			0.838028sec	< 10 sec	Pass	2
		Channel Closing Transmission time	200ms + 3.2ms (aggregate)	< 200 ms + aggregate of 60 ms over remaining 10 s period	Pass	1
			200ms + 8.8ms (aggregate)	< 200 ms + aggregate of 60 ms over remaining 10 s period	Pass	2
		Non-Occupancy Period and Client Beacon Test	No transmission or Beacons occurred	≥ 30 minutes	Pass	-
U-NII-2A 5250 MHz ~ 5350 MHz	160MHz (CH50) 5250MHz	Channel Move Time	0.527218sec	< 10 sec	Pass	1
			0.852428sec	< 10 sec	Pass	2
		Channel Closing Transmission time	200ms + 15.2ms (aggregate)	< 200 ms + aggregate of 60 ms over remaining 10 s period	Pass	1
			200ms + 9.2ms (aggregate)	< 200 ms + aggregate of 60 ms over remaining 10 s period	Pass	2
		Non-Occupancy Period and Client Beacon Test	No transmission or Beacons occurred	≥ 30 minutes	Pass	-

Note:

- Since the product is client without radar detection function, only Channel Move Time, Channel Closing Transmission Time and Non-Occupancy Period Test are required to be performed.
- Remark 1 for test results of MIMO Ant.5+4 and Remark 2 for MIMO Ant.5+6.

Conformity Assessment Condition:

- The test results (PASS/FAIL) with all measurement uncertainty excluded are presented against the regulation limits or in accordance with the requirements stipulated by the applicant/manufacturer who shall bear all the risks of non-compliance that may potentially occur if measurement uncertainty is taken into account.
- The measurement uncertainty please refer to each test result in the section "Measurement Uncertainty"

Disclaimer:

The product specifications of the EUT presented in the test report that may affect the test assessments are declared by the manufacturer who shall take full responsibility for the authenticity.



1 General Description

1.1. Applicant

ASUSTeK COMPUTER INC.

1F., No. 15, Lide Rd., Beitou Dist., Taipei City 112, Taiwan

1.2. Manufacturer

ASUSTeK COMPUTER INC.

1F., No. 15, Lide Rd., Beitou Dist., Taipei City 112, Taiwan

1.3. Feature of Equipment Under Test

Product Feature	
Equipment	ASUS Phone(Mobile Phone)
Brand Name	ASUS
Model Name	ASUS_AI2401_E
FCC ID	MSQAI2401
IMEI Code	356313810100872/356313810100880
HW Version	R2.0
SW Version	Android 14
EUT Stage	Identical Prototype

Remark:

- The above EUT's information was declared by manufacturer. Please refer to the specifications or user's manual for more detailed description.
- There are four SKUs of EUT for this project. The differences between them are summary below, According to the difference, we evaluate SKU1 to perform full test.

Sample list				
	SKU1	SKU2	SKU3	SKU4
Model	ASUS_AI2401_E	ASUS_AI2401_E	ASUS_AI2401_E	ASUS_AI2401_E
Config.	US(Pro)	US(Enrty)	US(Pro)	US(Enrty)
RF module board	US(Pro)	US(Enrty)	US(Pro)	US(Enrty)
LCD+Touch front frame module	AI2401 FRONT CASE ASSY	AI2401 FRONT CASE ASSY	AI2401 FRONT CASE ASSY	AI2401 FRONT CASE ASSY
DDR	16G(HYNIX) HYNIX / H58G76BK8HX095	16G(Micron) Micron / MT62F2G64D8ZA-023 WT:C	16G(HYNIX) HYNIX / H58G76BK8HX095	16G(Micron) Micron / MT62F2G64D8ZA-023 WT:C
UFS	1TB(Samsung) Samsung / KLUGGARHHD-B0G1	512G(HYNIX) (UFS4.0) HYNIX / HN8T274EJKX130	1TB(Samsung) Samsung / KLUGGARHHD-B0G1	512G(HYNIX) (UFS4.0) HYNIX / HN8T274EJKX130
MB	AI2401_MB	AI2401_MB	AI2401_MB	AI2401_MB
Back cover SKU	WW Pro(Mini LED)	WW Entry(LGF)	WW Pro(Mini LED)	WW Entry(LGF)
Battery	SCUD / C21P2301	SCUD / C21P2301	SCUD / C21P2301	SCUD / C21P2301
Main 50+13M	SHINETECH / DDN03B	RAYPRUS / CASDJ-000A	RAYPRUS / CASDJ-000A	SHINETECH / DDN03B
Tele 32M	Kunshan Q-TECH / C3HS01	SHINETECH / DHG01B	SHINETECH / DHG01B	Kunshan Q-TECH / C3HS01



Front 32M	TSPRECISION / TVHF3046	RAYPRUS / CASG-000A	RAYPRUS / CASG-000A	TSPRECISION / TVHF3046
PCB	COMPEQ	COMPEQ	COMPEQ	COMPEQ
CPU	QUALCOMM SM-8650 MPSP1629	QUALCOMM SM-8650 MPSP1629	QUALCOMM SM-8650 MPSP1629	QUALCOMM SM-8650 MPSP1629
WPC antenna	ASAP	INPAQ	INPAQ	ASAP
NFC antenna	ASAP	INPAQ	INPAQ	ASAP
WWAN/WLAN /BT/GPS antenna	INPAQ	ASAP	ASAP	INPAQ

1.4. Product Specification of Equipment Under Test

Product Specification subjective to this standard	
DFS Function	Client without radar detection function
Tx/Rx Channel Frequency Range	5260 MHz ~ 5320 MHz 5500 MHz ~ 5700 MHz
EUT support WLAN function	802.11a 802.11n HT20/HT40 802.11ac VHT20/VHT40/VHT80/VHT160 802.11ax HE20/HE40/HE80/HE160 802.11be EHT20/EHT40/EHT80/EHT160
Type of Modulation	802.11a/n: OFDM (BPSK / QPSK / 16QAM / 64QAM) 802.11ac: OFDM (BPSK / QPSK / 16QAM / 64QAM / 256QAM) 802.11ax: OFDM (BPSK / QPSK / 16QAM / 64QAM / 256QAM / 1024QAM) 802.11be: OFDM (BPSK / QPSK / 16QAM / 64QAM / 256QAM / 1024QAM / 4096QAM)

Note:

1. WLAN operation in 5600 MHz ~ 5650 MHz is notched.
2. The device support channel puncturing function as below:

<80M BW Puncturing 20MHz>:

Bandwidth	Tones		Index		For test modes configure
80MHz	242	484	62	66	1
80MHz	242	484	61	66	2
80MHz	484	242	65	64	3
80MHz	484	242	65	63	4

<160M BW Puncturing 40MHz>:

Bandwidth	Tones		Index		For test modes configure
160MHz	484-Left	996-Right	66-Left	67-Right	1
160MHz	484-Left	996-Right	65-Left	67-Right	2
160MHz	996-Left	484-Right	67-Left	66-Right	3
160MHz	996-Left	484-Right	67-Left	65-Right	4



<160M BW Puncturing 20MHz>:

Bandwidth	Tones			Index			For test modes configure
160MHz	242-Left	484-Left	996-Right	62-Left	66-Left	67-Right	1
160MHz	242-Left	484-Left	996-Right	61-Left	66-Left	67-Right	2
160MHz	484-Left	242-Left	996-Right	65-Left	64-Left	67-Right	3
160MHz	484-Left	242-Left	996-Right	65-Left	63-Left	67-Right	4
160MHz	996-Left	242-Right	484-Right	67-Left	62-Right	66-Right	5
160MHz	996-Left	242-Right	484-Right	67-Left	61-Right	66-Right	6
160MHz	996-Left	484-Right	242-Right	67-Left	65-Right	64-Right	7
160MHz	996-Left	484-Right	242-Right	67-Left	65-Right	63-Right	8

1.5. Modification of EUT

No modifications are made to the EUT during all test items.

1.6. Testing Site

Sporton International Inc. (ShenZhen) is accredited to ISO/IEC 17025:2017 by American Association for Laboratory Accreditation with Certificate Number 5145.01.

Test Firm	Sporton International Inc. (ShenZhen)		
Test Site Location	1/F, 2/F, Bldg 5, Shiling Industrial Zone, Xinwei Village, Xili, Nanshan, Shenzhen, 518055 People's Republic of China TEL: +86-755-86379589 FAX: +86-755-86379595		
Test Site No.	Sporton Site No.	FCC Designation No.	FCC Test Firm Registration No.
	DFS01-SZ	CN1256	421272

1.7. Applied Standards

According to the specifications of the manufacturer, the EUT must comply with the requirements of the following standards:

- FCC Part 15 Subpart E
- FCC KDB 905462 D02 UNII DFS Compliance Procedures New Rules v02
- FCC KDB 905462 D03 UNII Clients Without Radar Detection New Rules v01r02

Remark: All test items were verified and recorded according to the standards and without any deviation during the test.



1.8. Support Unit used in test configuration and system

Item	Equipment	Trade Name	Model Name	FCC ID	HW / FW Version	Power Cord
1.	WLAN AP	ASUS	RT-AX88U	MSQ-RTAXHP00	N/A	AC I/P: Unshielded, 1.8 m DC O/P: Shielded, 2 m
2.	Notebook	Lenovo	G450	N/A	N/A	AC I/P: Unshielded, 1.2 m DC O/P: Shielded, 1.8 m



2 Requirements and Parameters for DFS Test

2.1. Summary of Dynamic Frequency Selection Test

Bandwidth and Channel	Test Items	Limit
80MHz 5530MHz (CH106)		
80MHz (CH106) 5530MHz	Channel Move Time	< 10 sec
	Channel Closing Transmission time	< 200 ms + aggregate of 60 ms over remaining 10 s period
	Non-Occupancy Period and Client Beacon Test	≥ 30 minutes

Bandwidth and Channel	Test Items	Limit
160MHz 5250MHz (CH50)		
160MHz (CH50) 5250MHz	Channel Move Time	< 10 sec
	Channel Closing Transmission time	< 200 ms + aggregate of 60 ms over remaining 10 s period
	Non-Occupancy Period and Client Beacon Test	≥ 30 minutes



2.2. Applicability of DFS Requirements

EUT is client and operates as client without radar detection function.

Table 1: Applicability of DFS Requirements Prior to Use of a Channel

Requirement	Operational Mode		
	Master	Client Without Radar Detection	Client With Radar Detection
Non-Occupancy Period	Yes	Not required	Yes
DFS Detection Threshold	Yes	Not required	Yes
Channel Availability Check Time	Yes	Not required	Not required
U-NII Detection Bandwidth	Yes	Not required	Yes

Table 2: Applicability of DFS requirements during normal operation

Requirement	Operational Mode		
	Master	Client Without Radar Detection	Client With Radar Detection
DFS Detection Threshold	Yes	Not required	Yes
Channel Closing Transmission Time	Yes	Yes	Yes
Channel Move Time	Yes	Yes	Yes
U-NII Detection Bandwidth	Yes	Not required	Yes
Client Beacon Test	N/A	Yes	Yes

Additional requirements for devices with multiple bandwidth modes	Operational Mode	
	Master or Client With Radar Detection	Client Without Radar Detection
U-NII Detection Bandwidth and Statistical Performance Check	All BW modes must be tested	Not required
Channel Move Time and Channel Closing Transmission Time	Test using widest BW mode available	Test using the widest BW mode available for the link
All other tests	Any single BW mode	Not required

Note

Frequencies selected for statistical performance check (Section 7.8.4) should include several frequencies within the radar detection bandwidth and frequencies near the edge of the radar detection bandwidth. For 802.11 devices it is suggested to select frequencies in each of the bonded 20 MHz channels and the channel center frequency.

2.3. Interference Threshold values, Master or Client incorporating In-Service Monitoring

Maximum Transmit Power	Value (see notes 1 and 2)
≥ 200 milliwatt	-64 dBm
< 200 milliwatt	-62 dBm

Note 1: This is the level at the input of the receiver assuming a 0 dBi receive antenna.

Note 2: Throughout these test procedures an additional 1 dB has been added to the amplitude of the test transmission waveforms to account for variations in measurement equipment. This will ensure that the test signal is at or above the detection threshold level to trigger a DFS response.

2.4. DFS Response requirement values

Parameter	Value
<i>Non-occupancy period</i>	Minimum 30 minutes
<i>Channel Availability Check Time</i>	60 seconds
<i>Channel Move Time</i>	10 seconds See Note 1.
<i>Channel Closing Transmission Time</i>	200 milliseconds + an aggregate of 60 milliseconds over remaining 10 second period. See Notes 1 and 2.
<i>U-NII Detection Bandwidth</i>	Minimum 100% of the 99% power bandwidth See Note 3.

Note 1: The instant that the *Channel Move Time* and the *Channel Closing Transmission Time* begins is as follows:

- For the Short pulse radar Test Signals this instant is the end of the *Burst*.
- For the Frequency Hopping radar Test Signal, this instant is the end of the last radar *Burst* generated.
- For the Long Pulse radar Test Signal this instant is the end of the 12 second period defining the radar transmission.

Note 2: The *Channel Closing Transmission Time* is comprised of 200 milliseconds starting at the beginning of the *Channel Move Time* plus any additional intermittent control signals required to facilitate *Channel* changes (an aggregate of 60 milliseconds) during the remainder of the 10 second period. The aggregate duration of control signals will not count quiet periods in between transmissions.

Note 3: During the *U-NII Detection Bandwidth* detection test, radar type 0 is used and for each frequency step the minimum percentage of detection is 90%. Measurements are performed with no data traffic.



2.5. Short Pulse Radar Test Waveforms

As the EUT is a Client Device with no Radar Detection, only one type radar pulse is required for the testing. Radar Pulse type 0 was used in the evaluation of the Client device for the purpose of measuring the Channel Move Time and the Channel Closing Transmission Time.

Radar Type	Pulse Width (μsec)	PRI (μsec)	Number of Pulses	Minimum Percentage of Successful Detection	Minimum Trials
0	1	1428	18	60%	30
1	1	Test A Test B	Roundup $\left\{ \left(\frac{1}{360} \right) \cdot \left(\frac{19 \cdot 10^6}{PRI_{\mu sec}} \right) \right\}$	60%	30
2	1-5	150-230	23-29	60%	30
3	6-10	200-500	16-18	60%	30
4	11-20	200-500	12-16	60%	30
Aggregate (Radar Types 1-4)				80%	120

Test A: 15 unique PRI values randomly selected from the list of 23 PRI values in Table 5a
Test B: 15 unique PRI values randomly selected within the range of 518-3066 μsec, with a minimum increment of 1 μsec, excluding PRI values selected in Test A

A minimum of 30 unique waveforms are required for each of the short pulse radar types 2 through 4. For short pulse radar type 1, the same waveform is used a minimum of 30 times. If more than 30 waveforms are used for short pulse radar types 2 through 4, then each additional waveform must also be unique and not repeated from the previous waveforms.

If more than 30 waveforms are used for Short Pulse Radar Type 1, then each additional waveform is generated with Test B and must also be unique and not repeated from the previous waveforms in Tests A or B.

The aggregate is the average of the percentage of successful detections of short pulse radar types 1-4.

3 Calibration Setup and DFS Test Results

3.1. Calibration of Radar Waveform

3.1.1 Radar Waveform Calibration Procedure

The Interference Radar Detection Threshold Level that had been taken into account the output power range and antenna gain. The following equipment setup was used to calibrate the radiated Radar Waveform. A vector signal generator was utilized to establish the test signal level for radar type 0. During this process there were no transmissions by either the Master or Client Device. The spectrum analyzer was switched to the zero span (Time Domain) at the frequency of the Radar Waveform generator. Peak detection was used. The spectrum analyzer resolution bandwidth (RBW) and video bandwidth (VBW) were set to 3 MHz to measure the type 0 radar waveform. The spectrum analyzer had offset to compensate and RF cable loss.

3.1.2 Test Setup

Conducted Test Setup

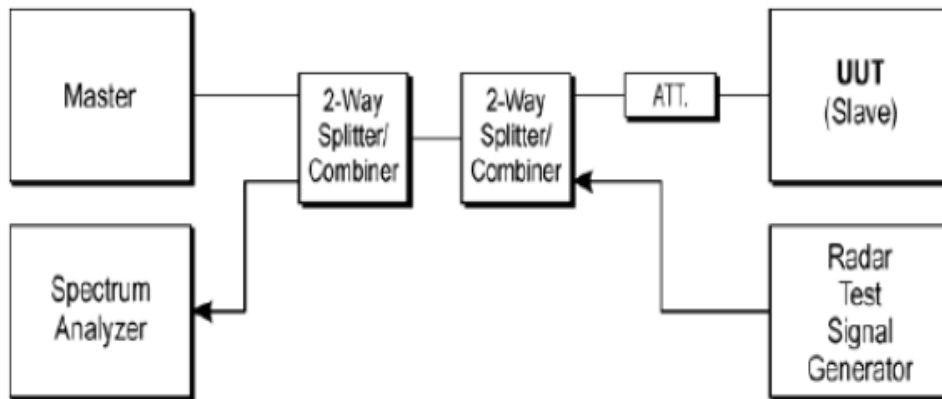

3.1.3 Calibration Deviation

There is no deviation with the original standard.

3.1.4 Radar Waveform Calibration Result

<MIMO Ant. 5+4>:

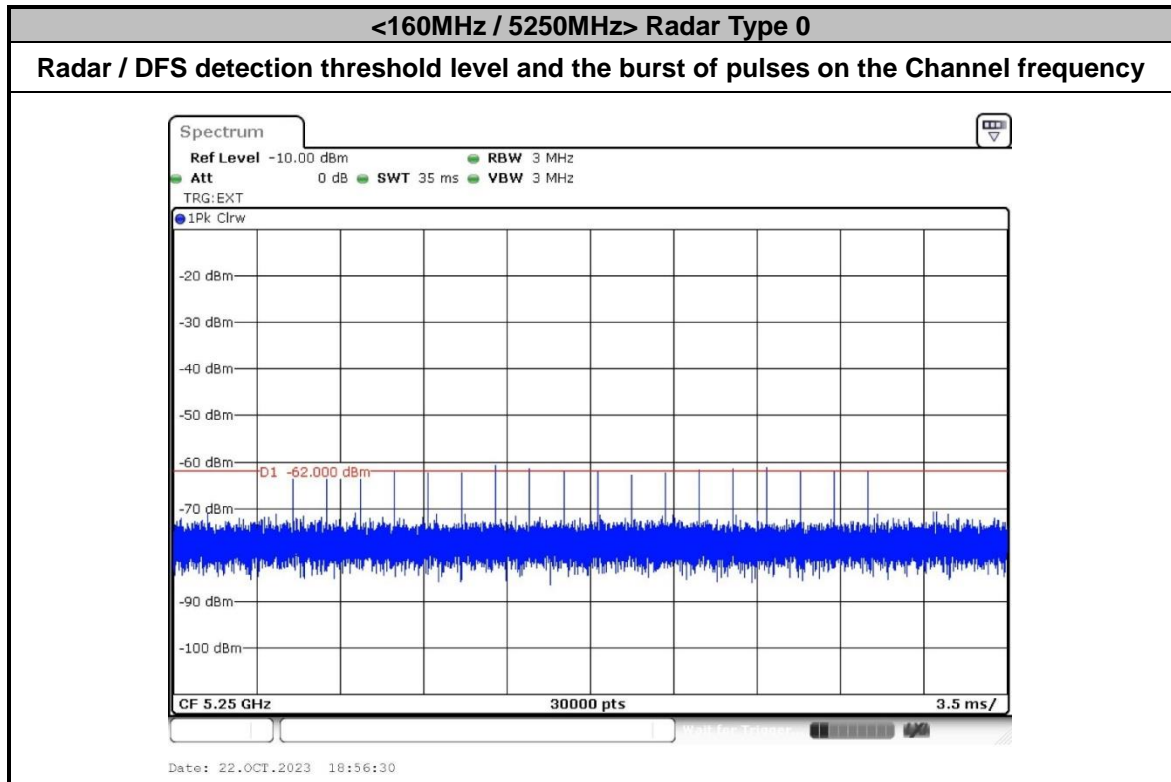
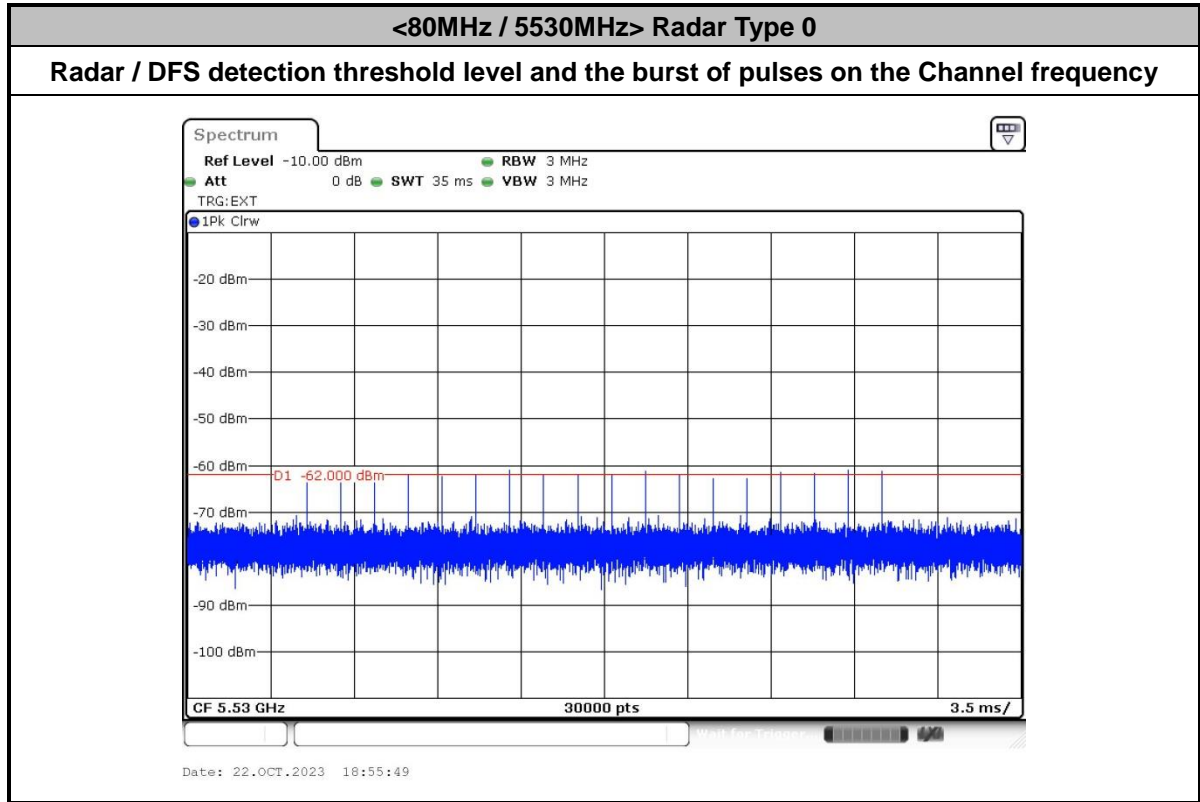



<MIMO Ant. 5+6>:

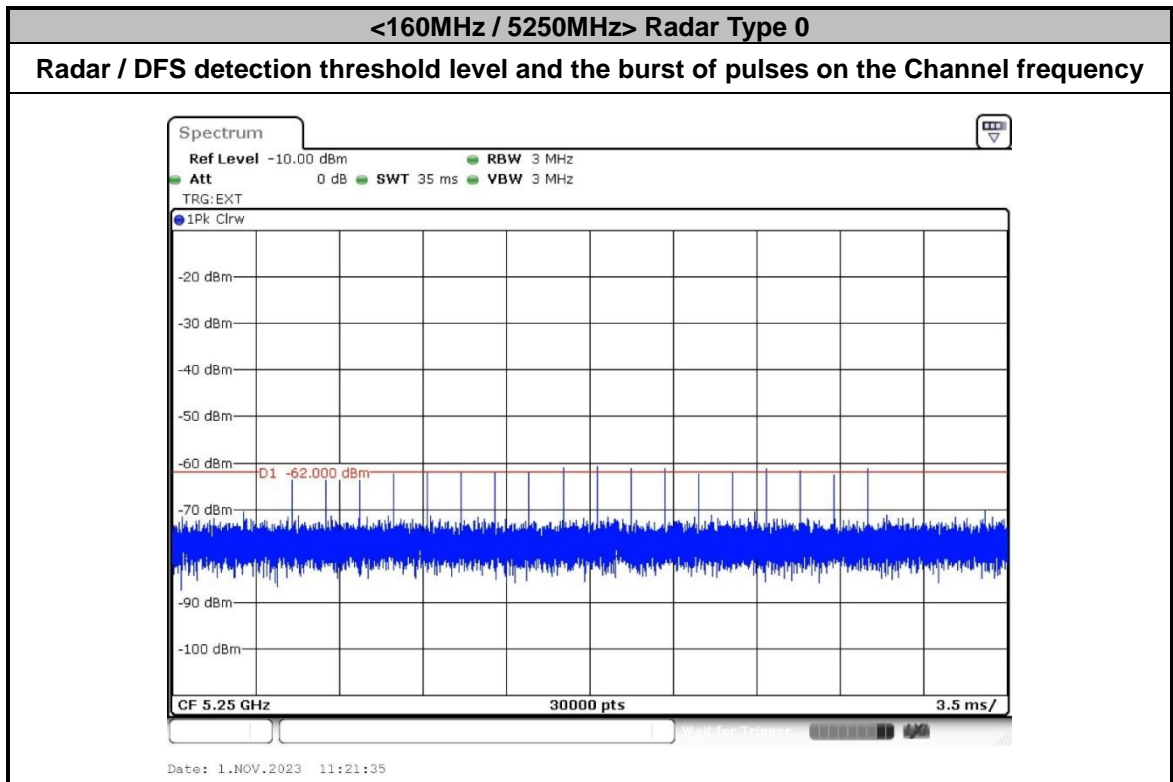
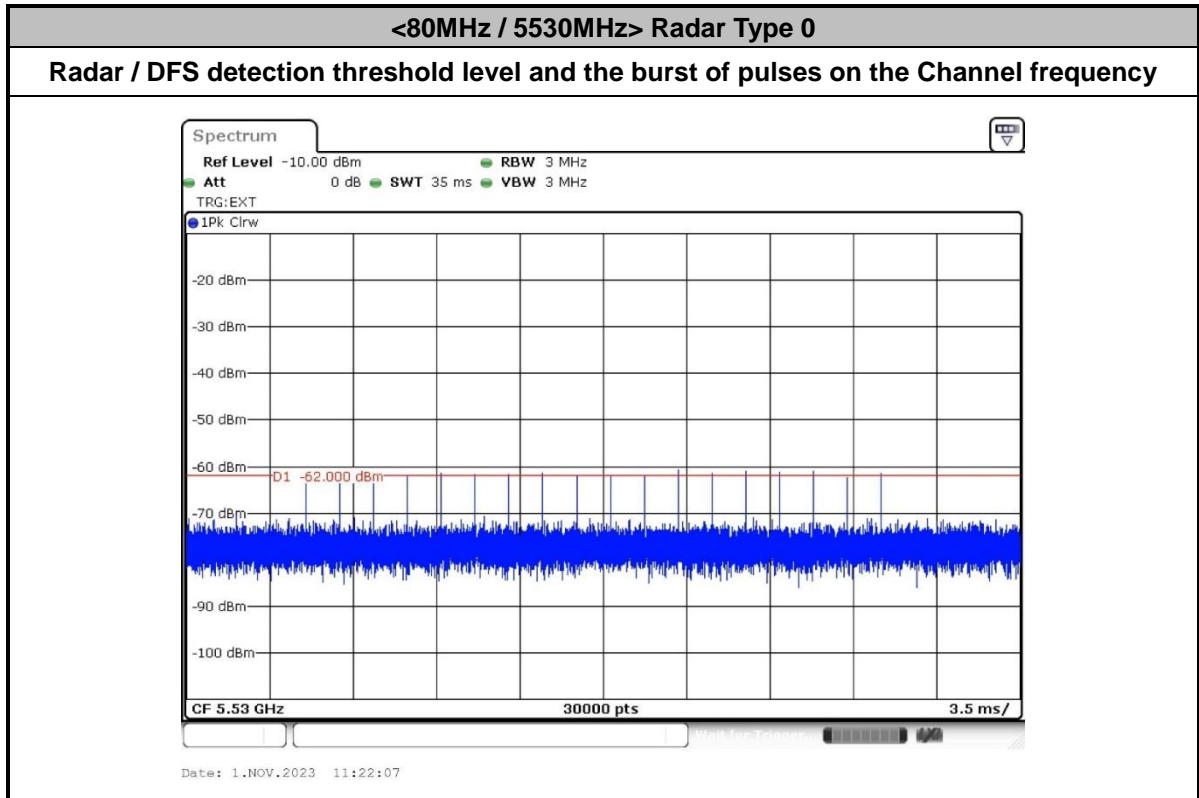

3.2. In-Service Monitoring: Channel Move Time, Channel Closing Transmission Time and Non-Occupancy Period

3.2.1 Limit of In-Service Monitoring

The EUT has In-Service Monitoring function to continuously monitor the radar signals, If radar is detected, it must leave the channel (Shutdown). The Channel Move Time to cease all transmissions on the current Channel upon detection of a Radar Waveform above the DFS Detection Threshold within 10 sec. The total duration of *Channel Closing Transmission Time* is comprised of 200 milliseconds starting at the beginning of the *Channel Move Time* plus any additional intermittent control signals required to facilitate *Channel* changes (an aggregate of 60 milliseconds) during the remainder of the 10 second period. The aggregate duration of control signals will not count quiet periods in between transmissions.

Non-Occupancy Period time is 30 minute during which a Channel will not be utilized after a Radar Waveform is detected on that Channel. The non-associated Client Beacon Test is during the 30 minutes observation time. The EUT should not make any transmissions in the DFS band after EUT power up.

3.2.2 Test Procedures

1. The radar pulse generator is setup to provide a pulse at frequency that the Master and Client are operating. A type 0 radar pulse with a 1us pulse width and a 1428 us PRI is used for the testing.
2. The vector signal generator is adjusted to provide the radar burst (18 pulses) at a level of approximately -62dBm at the antenna of the Master device.
3. A trigger is provided from the pulse generator to the DFS monitoring system in order to capture the traffic and the occurrence of the radar pulse.
4. A U-NII device operating as a Client Device will associate with the Master at Channel. The MPEG file "TestFile.mpg" specified by the FCC is streamed from the "file computer" through the Master to the Client Device and played in full motion video using Media Player Classic Ver. 6.4.8.6 in order to properly load the network for the entire period of the test.
5. When a radar Burst with a level equal to the DFS Detection Threshold + 1dB is generated on the Operating Channel of the U-NII device. At time T0 the Radar Waveform generator sends a Burst of pulse of the radar waveform at Detection Threshold + 1dB.
6. Observe the transmissions of the EUT at the end of the radar Burst on the Operating Channel. Measure and record the transmissions from the EUT during the observation time (Channel Move Time). One 12 seconds plot is reported for the Short Pulse Radar Types 0. The plot for the Short Pulse Radar Types start at the end of the radar burst. The Channel Move Time will be calculated based on the zoom in 600ms plot of the Short Pulse Radar Type.
7. Measurement of the aggregate duration of the Channel Closing Transmission Time method. With the spectrum analyzer set to zero span tuned to the center frequency of the EUT operating channel at the radar simulated frequency, peak detection, and max hold, the dwell time per bin is given by: **Dwell (0.4ms)= S (12000ms) / B (30000)**; where Dwell is the dwell time per spectrum analyzer sampling bin, S is the sweep time and B is the number of spectrum analyzer sampling bins. An upper bound of the aggregate duration of the intermittent control signals of Channel Closing Transmission Time is calculated by: **C (ms)= N X Dwell (0.4 ms)**; where C is the Closing Time, N is the number of spectrum analyzer sampling bins (intermittent control signals) showing

a U-NII transmission and Dwell is the dwell time per bin.

8. Measure the EUT for more than 30 minutes following the channel move time to verify that no transmissions or beacons occur on this Channel.

3.2.3 Test Setup

UUT is a Client without Radar detection and Radar Test Waveforms are injected into the Master.

Conducted Test Setup

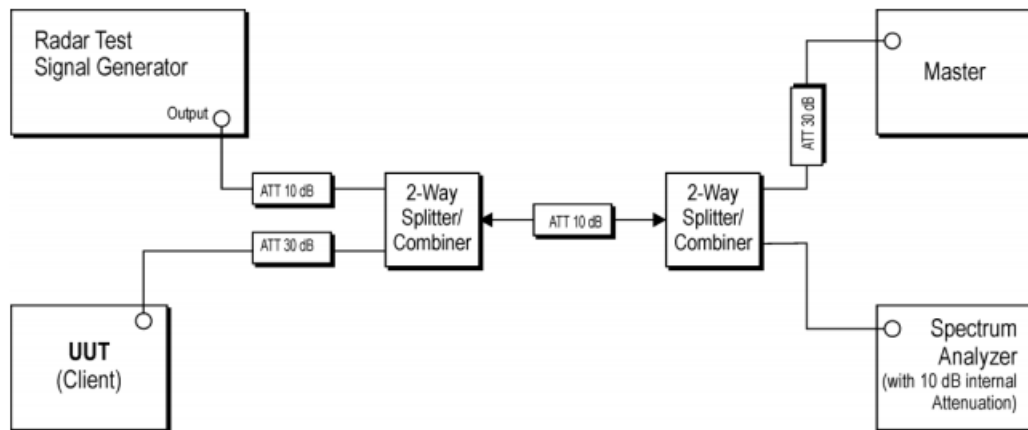

3.2.4 Test Deviation

There is no deviation with the original standard.



3.2.5 Result of Channel Move Time, Channel Closing Transmission Time and Non-Occupancy Period for Client Beacon Test

Test Mode :	Client without radar detection	Temperature :	24.5°C
Test Engineer :	Tang Zhaoyang	Relative Humidity :	46%

<MIMO Ant. 5+4>:

BW / Channel	Test Item	Test Result	Limit	Pass/Fail
80MHz (5530MHz)	Channel Move Time	0.535218 s	< 10s	Pass
	Channel Closing Transmission Time	200ms + 3.2 ms	< 260ms	Pass
	Non-Occupancy Period	≥ 30 min	≥ 30 min	Pass

BW / Channel	Test Item	Test Result	Limit	Pass/Fail
160MHz / 5250 MHz	Channel Move Time	0.527218 s	< 10s	Pass
	Channel Closing Transmission Time	200ms + 15.2 ms	< 260ms	Pass
	Non-Occupancy Period	≥ 30 min	≥ 30 min	Pass

<MIMO Ant. 5+6>:

BW / Channel	Test Item	Test Result	Limit	Pass/Fail
80MHz (5530MHz)	Channel Move Time	0.838028 s	< 10s	Pass
	Channel Closing Transmission Time	200ms + 8.8 ms	< 260ms	Pass
	Non-Occupancy Period	≥ 30 min	≥ 30 min	Pass

BW / Channel	Test Item	Test Result	Limit	Pass/Fail
160MHz / 5250 MHz	Channel Move Time	0.852428 s	< 10s	Pass
	Channel Closing Transmission Time	200ms + 9.2 ms	< 260ms	Pass
	Non-Occupancy Period	≥ 30 min	≥ 30 min	Pass

Note: The Channel Closing Transmission Time is comprised of 200 milliseconds starting at the beginning of the Channel Move Time plus any additional intermittent control signals required to facilitate a Channel move (an aggregate of 60 milliseconds) during the remainder of the 10 seconds period. The aggregate duration of control signals will not count quiet periods in between transmissions.



3.2.6 Channel Move Time, Channel Closing Transmission Time and Non-Occupancy Period for Client Beacon Test Plots

<MIMO Ant. 5+4>:

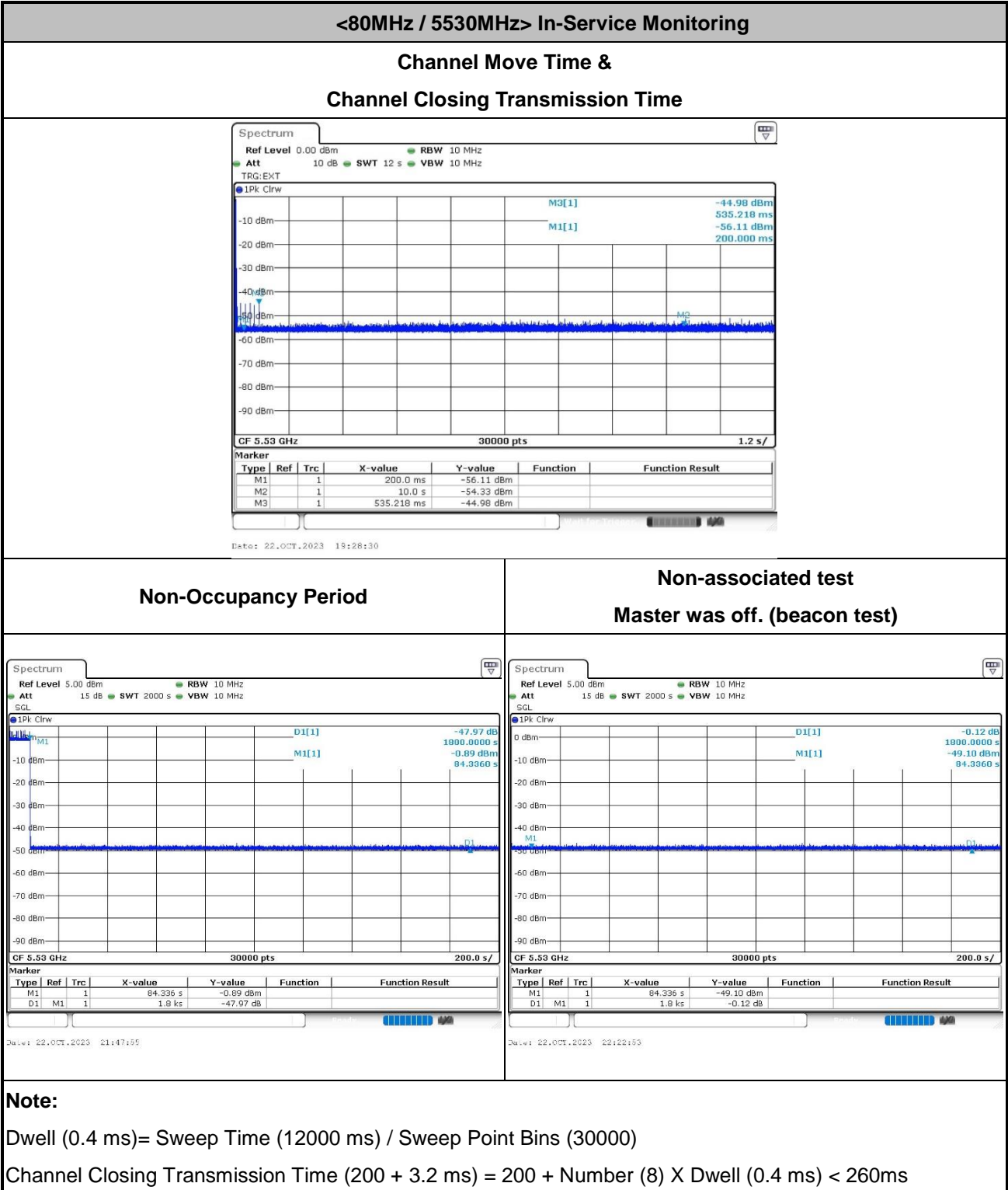



<160MHz / 5250> In-Service Monitoring

Channel Move Time &
Channel Closing Transmission Time

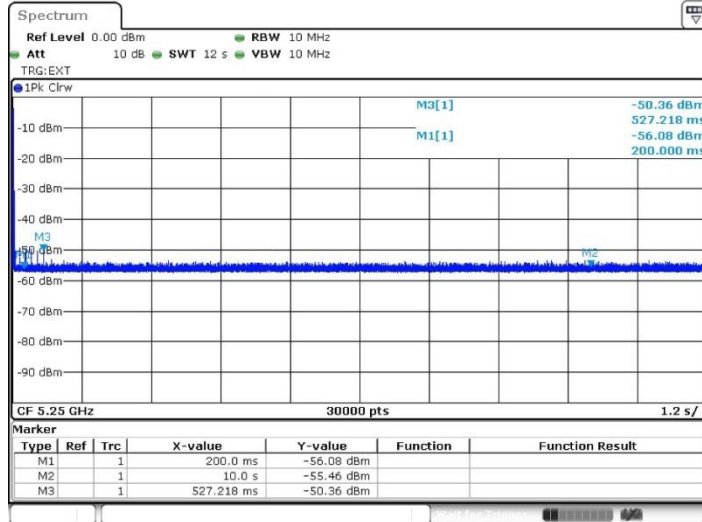

Date: 22.OCT.2023 19:42:28

Non-Occupancy Period

Non-associated test
Master was off. (beacon test)

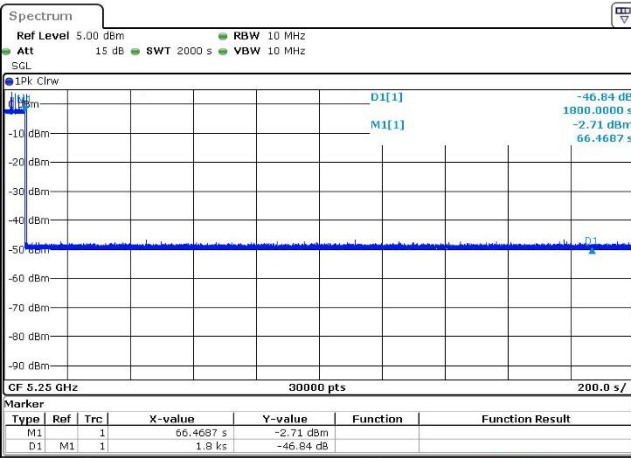

Date: 22.OCT.2023 20:33:34

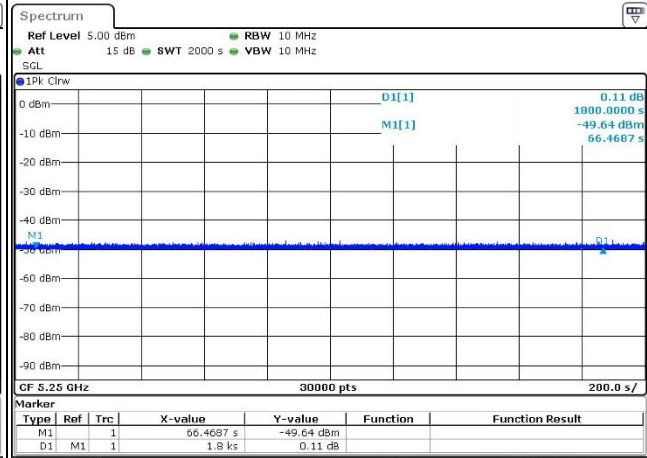

Date: 22.OCT.2023 21:00:43

Note:

Dwell (0.4 ms)= Sweep Time (12000 ms) / Sweep Point Bins (30000)

Channel Closing Transmission Time (200 + 15.2ms) = 200 + Number (38) X Dwell (0.4 ms) < 260ms



<MIMO Ant. 5+6>:

<80MHz / 5530MHz> In-Service Monitoring

Channel Move Time &
Channel Closing Transmission Time

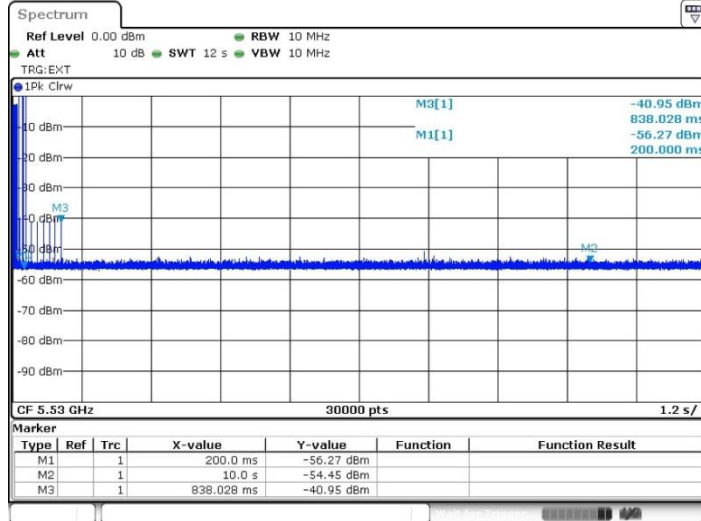

Date: 1.NOV.2023 11:45:43

Non-Occupancy Period

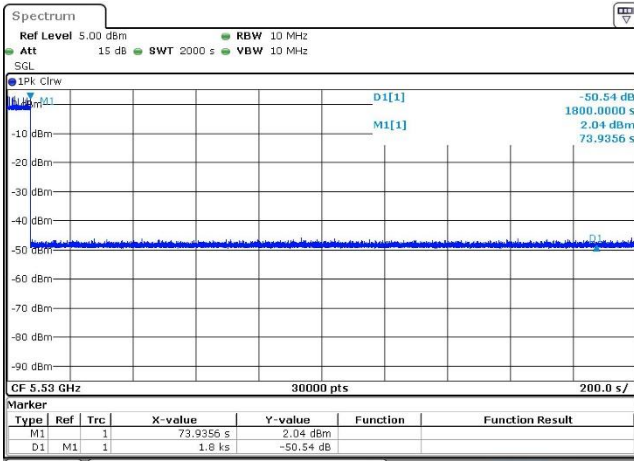

Date: 1.NOV.2023 15:44:17

Non-associated test
Master was off. (beacon test)

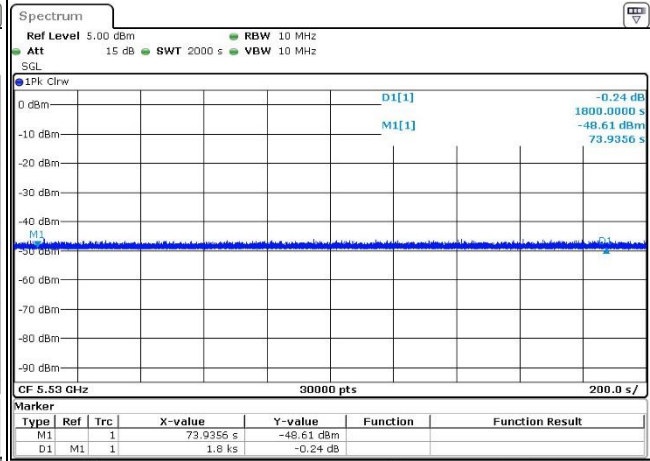

Date: 1.NOV.2023 16:19:08

Note:

Dwell (0.4 ms)= Sweep Time (12000 ms) / Sweep Point Bins (30000)

Channel Closing Transmission Time (200 + 8.8 ms) = 200 + Number (22) X Dwell (0.4 ms) < 260ms



<160MHz / 5250> In-Service Monitoring

Channel Move Time &
Channel Closing Transmission Time

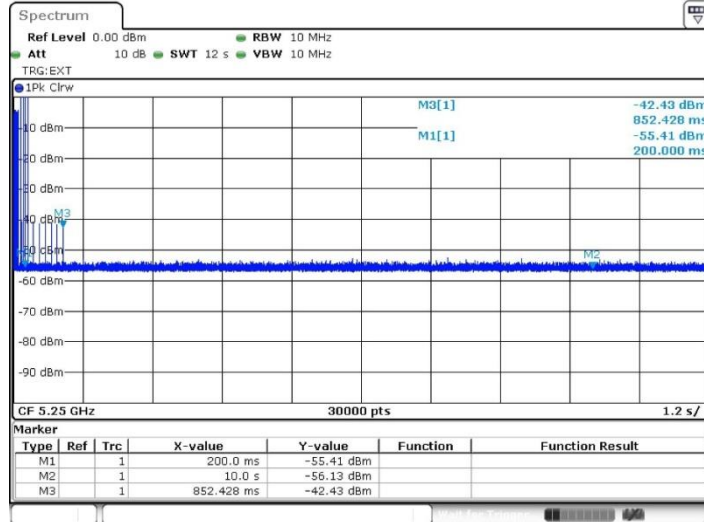

Date: 1.NOV.2023 11:50:19

Non-Occupancy Period

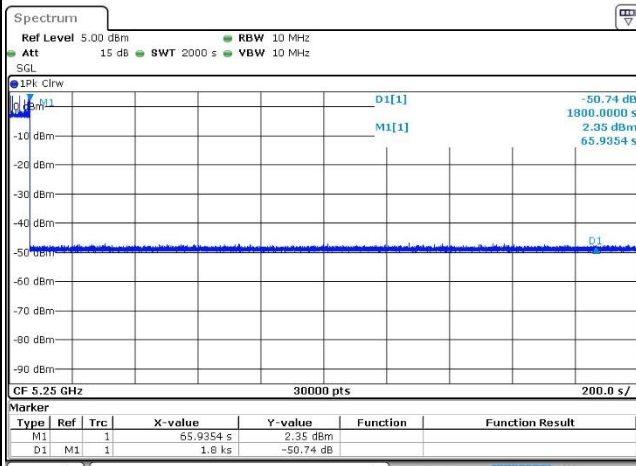

Date: 1.NOV.2023 14:26:35

Non-associated test
Master was off. (beacon test)

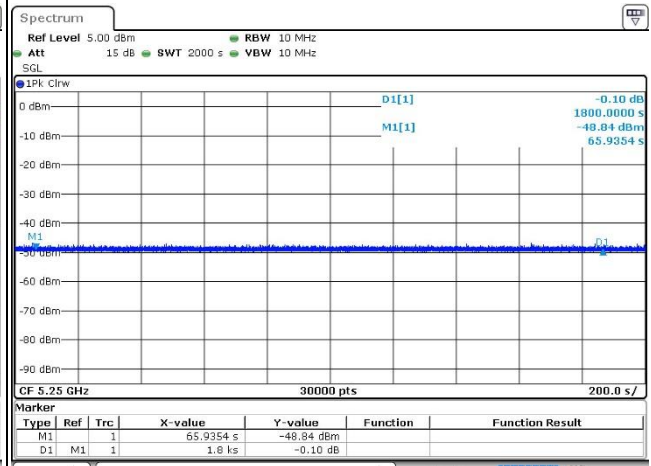

Date: 1.NOV.2023 15:04:07

Note:

Dwell (0.4 ms)= Sweep Time (12000 ms) / Sweep Point Bins (30000)

Channel Closing Transmission Time (200 + 9.2ms) = 200 + Number (23) X Dwell (0.4 ms) < 260ms

3.2.7 Data Traffic and Noise Floor Plots

<MIMO Ant. 5+4>:

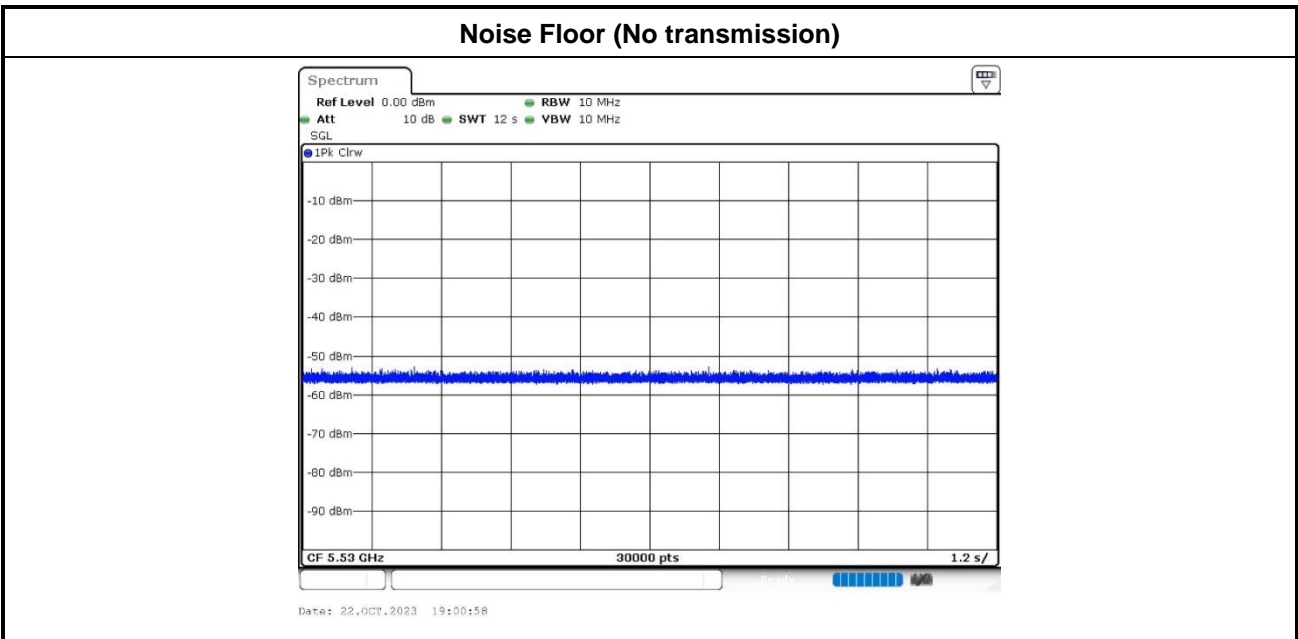
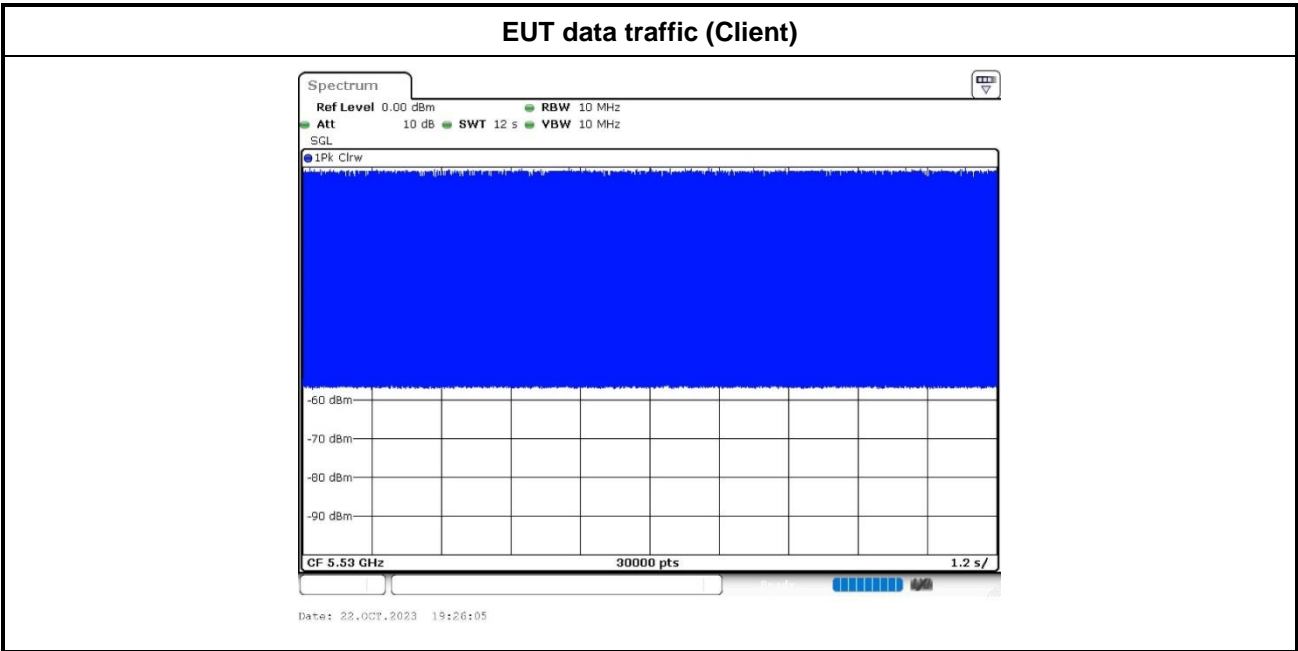



<MIMO Ant. 5+6>:

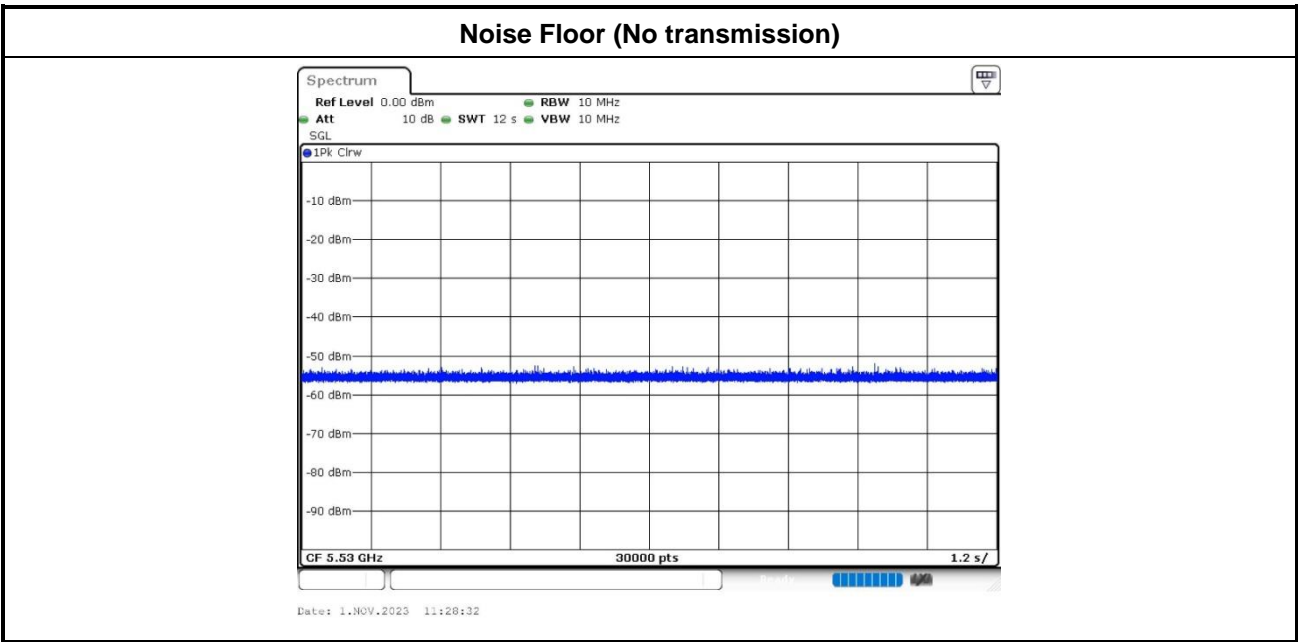
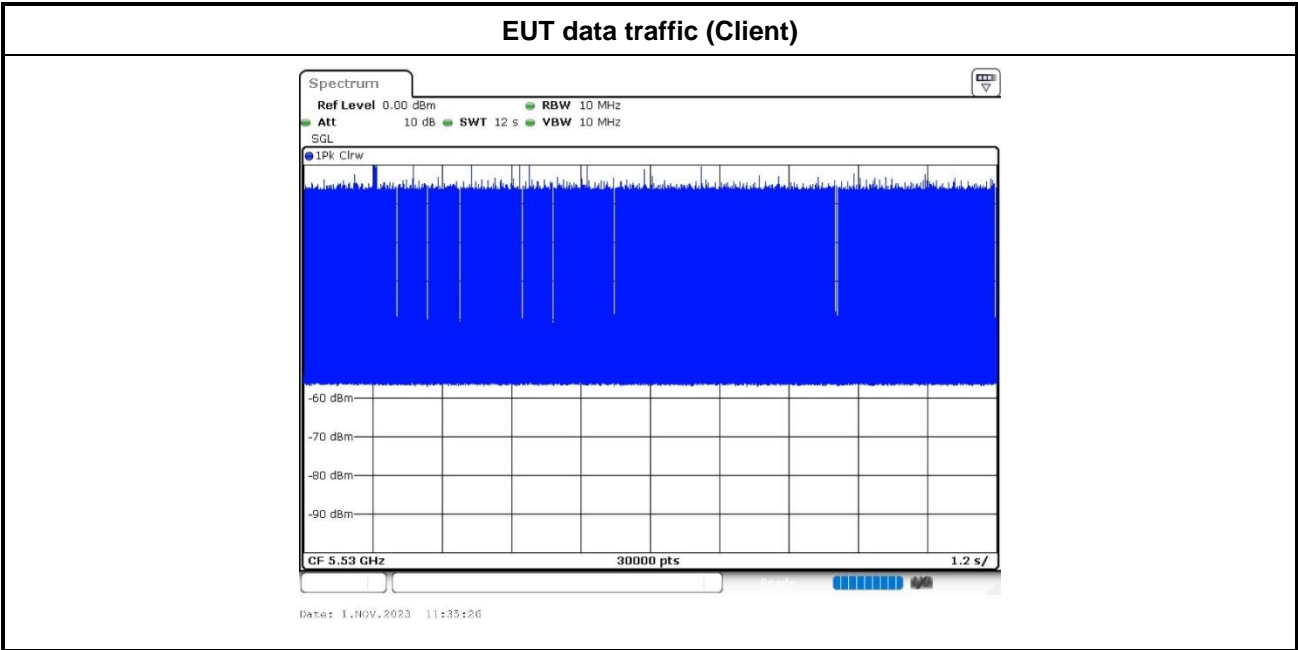



4 Verify channel puncturing

4.1 According to KDB inquiry for DFS test cases

- a. Check 99% OBW or 26dB emissions bandwidth of non-punctured channel.
- b. DUT transmitting by using FTM (Factory Test Mode) control and the BW should be within the non-punctured channels, and punctured regions should meet -27 dBm/MHz EIRP AVG.

4.1.1 Combinations of channel puncturing

80 MHz punctured by 20MHz; 160 MHz punctured by 20MHz, 160 MHz punctured by 40MHz



4.2 Test results

4.2.1 Non-Punctured Channel 99% Occupied Bandwidth Check

<MIMO Ant. 5+4>:

Test Mode	Antenna	Freq (MHz)	Puncturing	Index	OCB [MHz]	FL [MHz]	FH [MHz]	Within OBW(MHz)
11BE80MIMO	Ant5	5290	Puncturing 20M	1	58.741	5270.22	5328.961	5270-5330
	Ant4	5290	Puncturing 20M	1	58.821	5270.34	5329.161	5270-5330
	Ant5	5530	Puncturing 20M	4	58.861	5491.039	5549.9	5490-5550
	Ant4	5530	Puncturing 20M	4	58.981	5490.919	5549.9	5490-5550
11BE160MIMO	Ant5	5250	Puncturing 20M	2	19.061	5170.8492	5189.9101	5170-5190
		5250	Puncturing 20M		117.483	5211.389	5328.871	5210-5330
	Ant4	5250	Puncturing 20M	2	18.941	5170.9291	5189.8701	5170-5190
		5250	Puncturing 20M		117.483	5211.149	5328.631	5210-5330
	Ant5	5250	Puncturing 40M	2	38.122	5171.049	5209.1708	5170-5210
		5250	Puncturing 40M		78.002	5250.949	5328.951	5250-5330
	Ant4	5250	Puncturing 40M	2	38.282	5170.969	5209.2507	5170-5210
		5250	Puncturing 40M		78.162	5250.789	5328.951	5250-5330

<MIMO Ant. 5+6>:

Test Mode	Antenna	Freq (MHz)	Puncturing	Index	OCB [MHz]	FL [MHz]	FH [MHz]	Within OBW(MHz)
11BE80MIMO	Ant5	5290	Puncturing 20M	1	58.981	5270.18	5329.161	5270-5330
	Ant6	5290	Puncturing 20M	1	59.141	5270.18	5329.321	5270-5330
	Ant5	5530	Puncturing 20M	4	58.981	5490.999	5549.98	5490-5550
	Ant6	5530	Puncturing 20M	4	58.981	5490.999	5549.98	5490-5550
11BE160MIMO	Ant5	5250	Puncturing 20M	2	18.941	5170.9291	5189.8701	5170-5190
		5250	Puncturing 20M		117.483	5211.389	5328.871	5210-5330
	Ant6	5250	Puncturing 20M	2	18.901	5170.9291	5189.8302	5170-5190
		5250	Puncturing 20M		117.243	5211.149	5328.392	5210-5330
	Ant5	5250	Puncturing 40M	2	38.442	5170.8891	5209.3307	5170-5210
		5250	Puncturing 40M		78.002	5250.949	5328.951	5250-5330
	Ant6	5250	Puncturing 40M	2	38.362	5170.8891	5209.2507	5170-5210
		5250	Puncturing 40M		78.002	5250.949	5328.951	5250-5330

Note: "L"+"H"= one channel Puncturing BW, only the worst results are shown in the report.



Example:

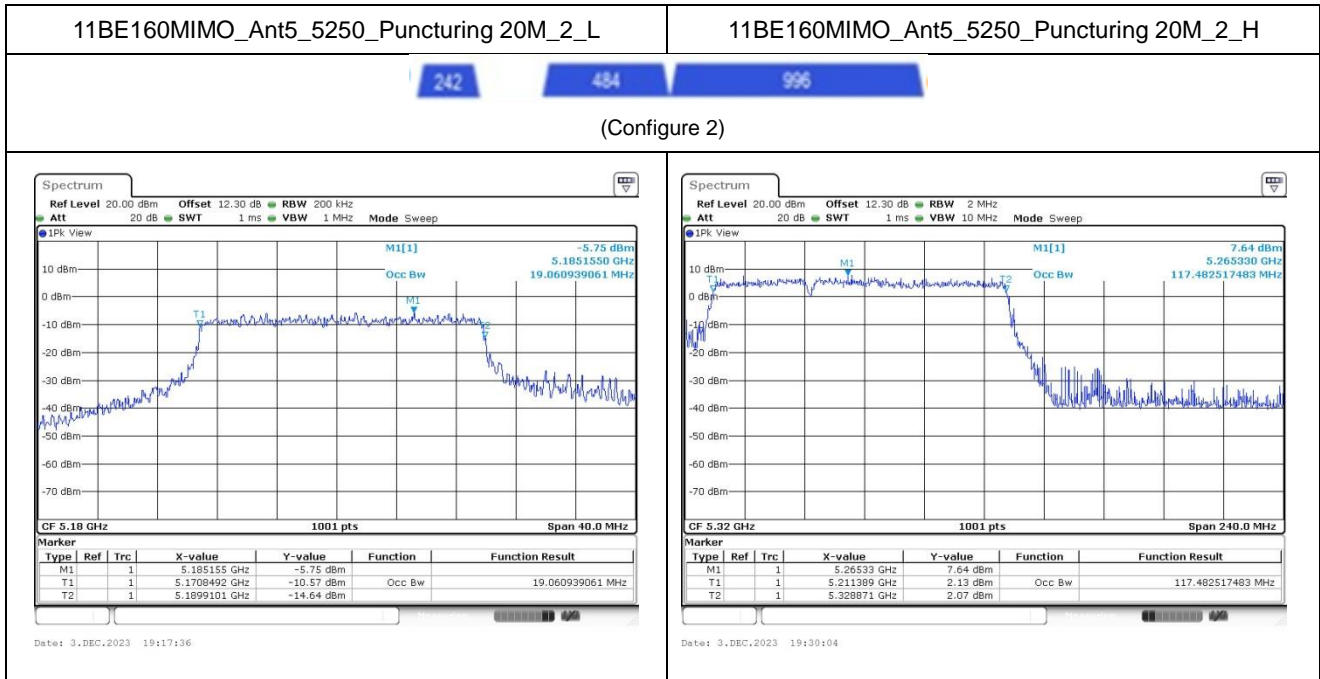



Test Graphs:

<MIMO Ant. 5+4>:

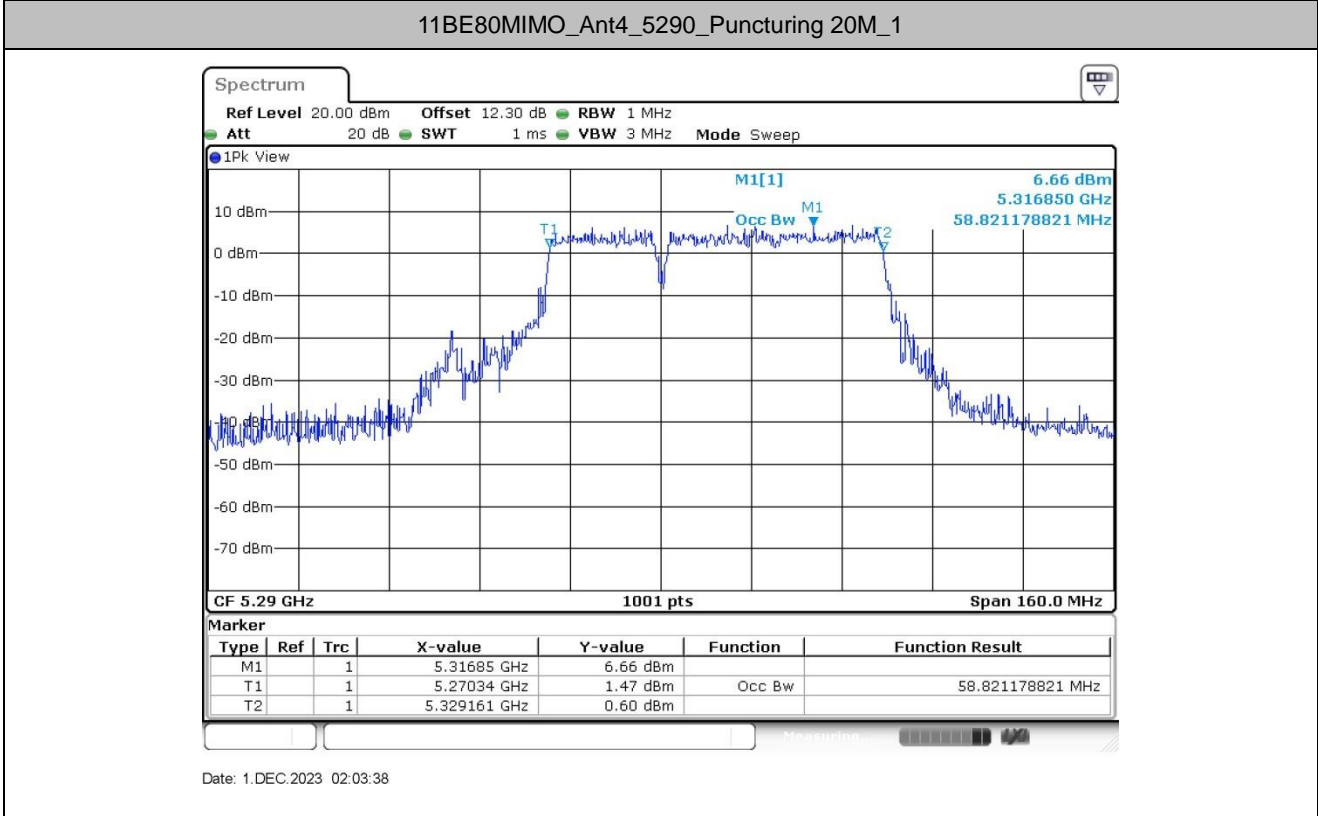
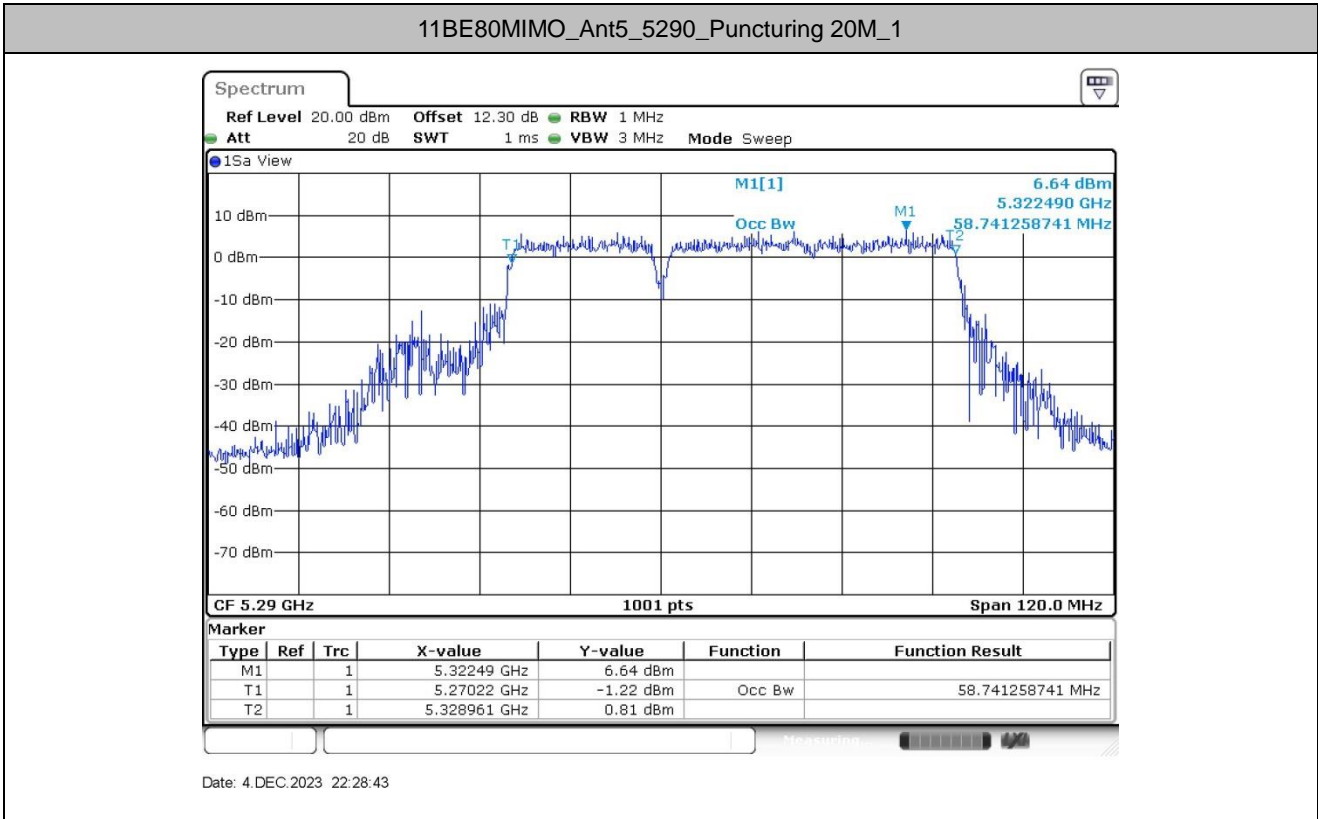



11BE80MIMO_Ant5_5530_Puncturing 20M_4

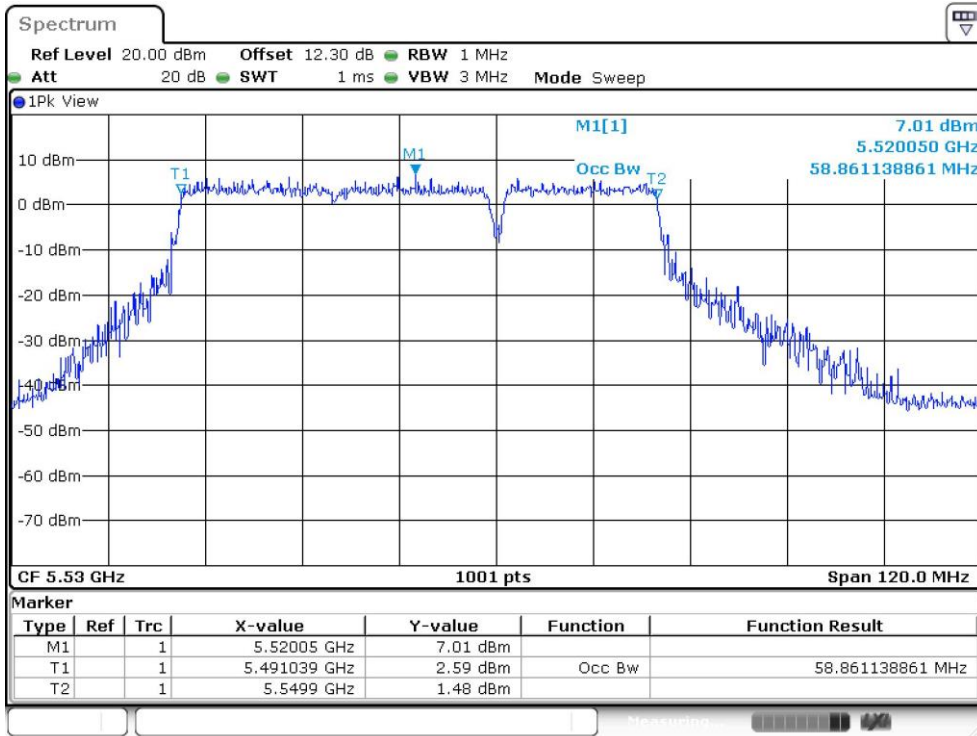

Date: 3.DEC.2023 17:51:02

11BE80MIMO_Ant4_5530_Puncturing 20M_4

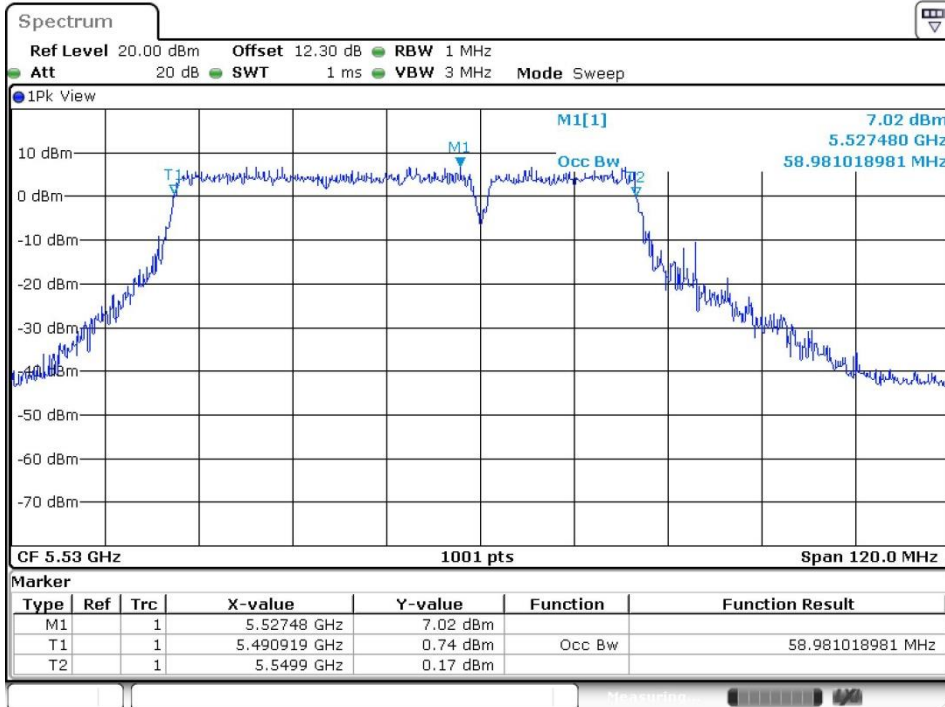

Date: 3.DEC.2023 17:51:22



11BE160MIMO_Ant5_5250_Puncturing 20M_2_L

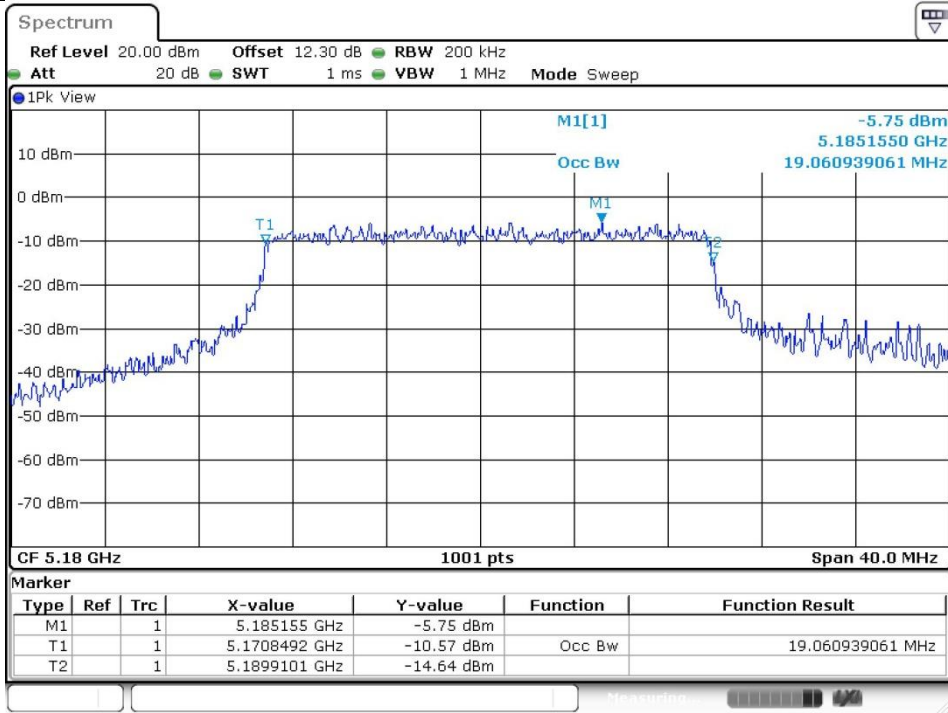

Date: 3.DEC.2023 19:17:36

11BE160MIMO_Ant4_5250_Puncturing 20M_2_L

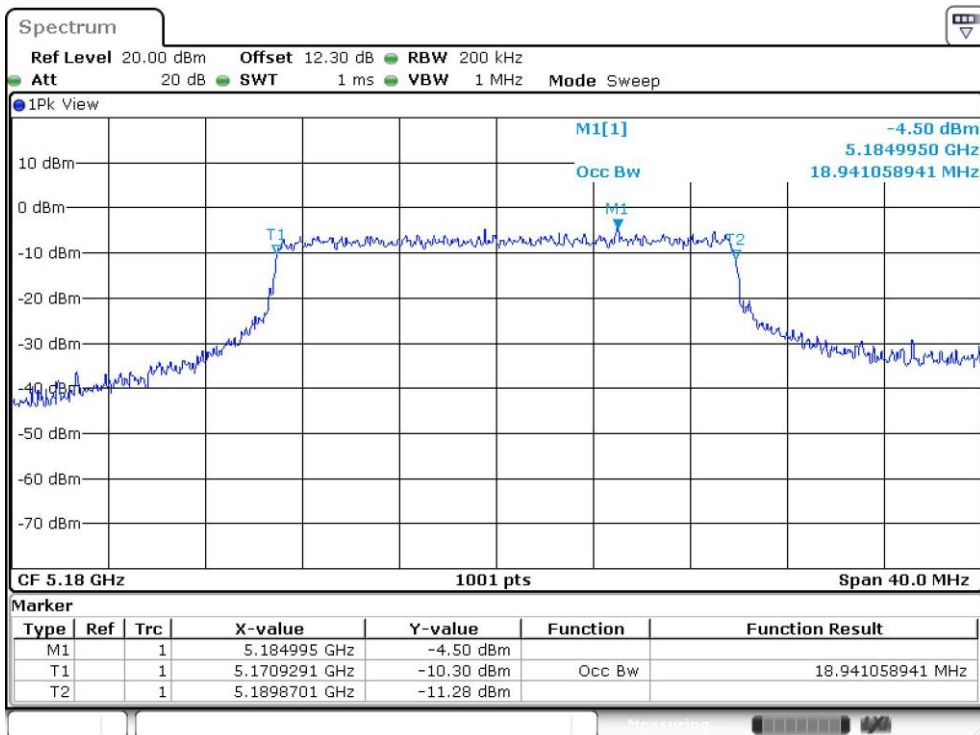

Date: 3.DEC.2023 19:14:50



11BE160MIMO_Ant5_5250_Puncturing 20M_2_H

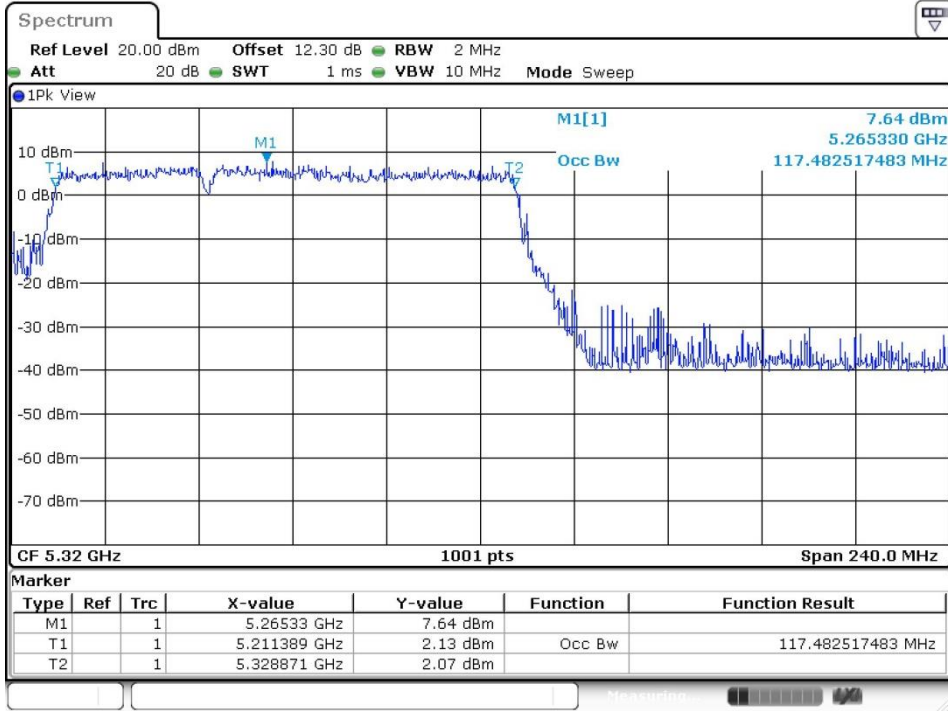

Date: 3.DEC.2023 19:30:04

11BE160MIMO_Ant4_5250_Puncturing 20M_2_H

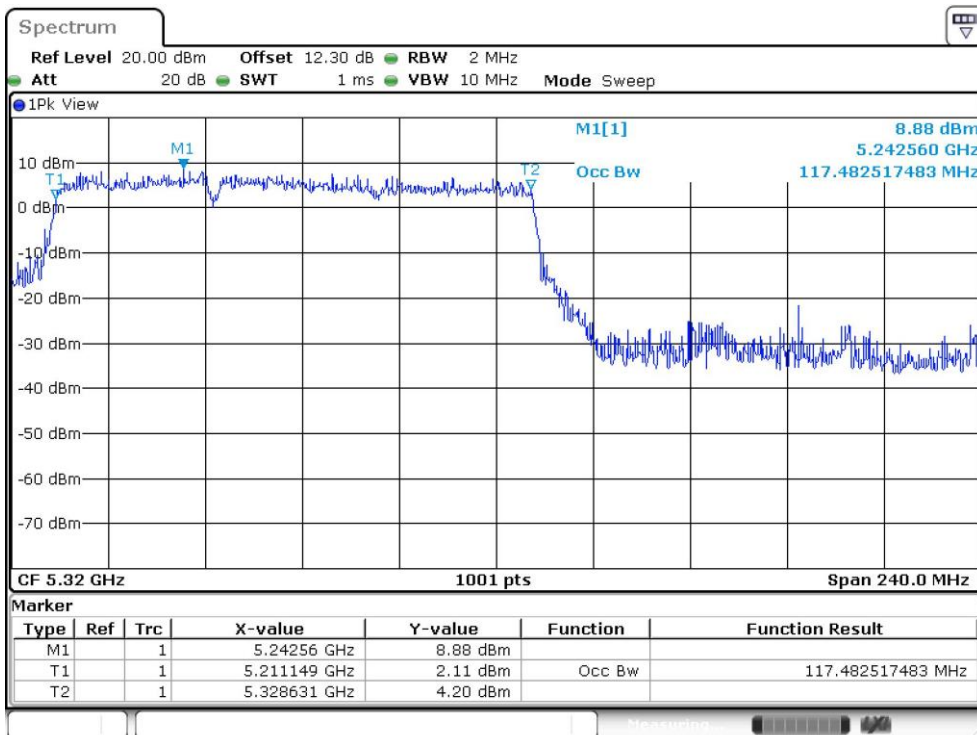

Date: 3.DEC.2023 19:33:28



11BE160MIMO_Ant5_5250_Puncturing 40M_2_L

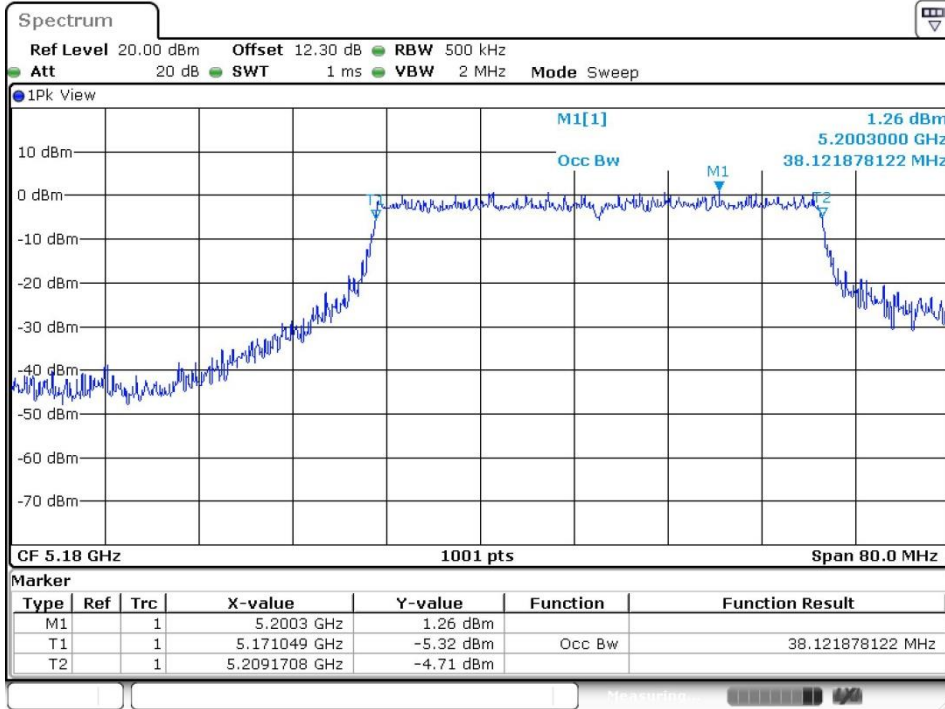

Date: 3.DEC.2023 19:43:44

11BE160MIMO_Ant4_5250_Puncturing 40M_2_L

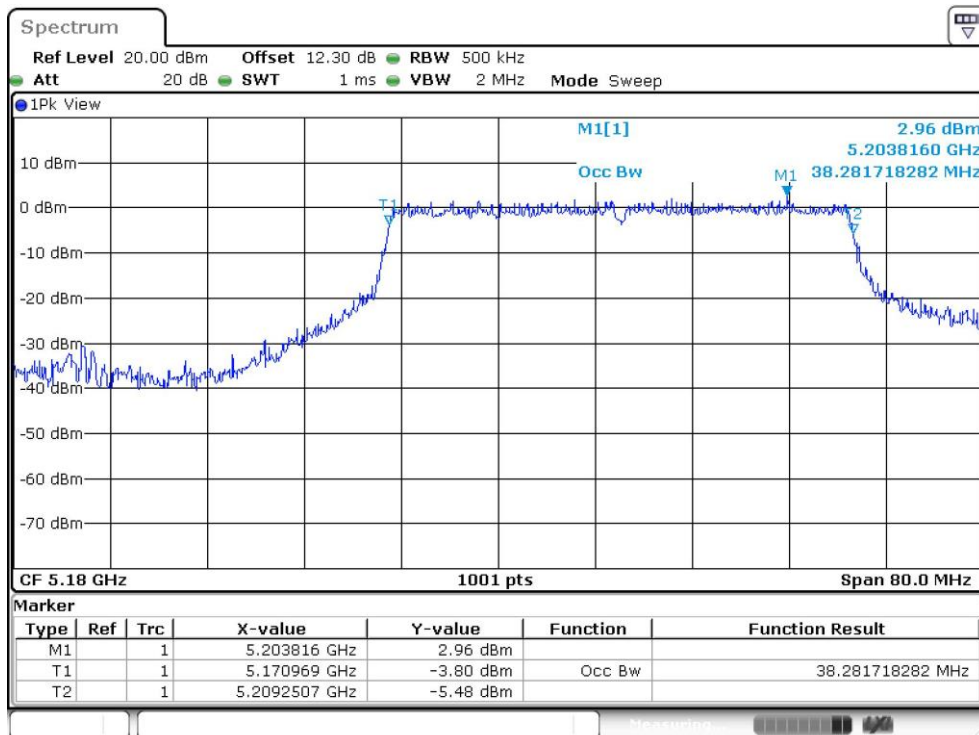

Date: 3.DEC.2023 19:42:51



11BE160MIMO_Ant5_5250_Puncturing 40M_2_H

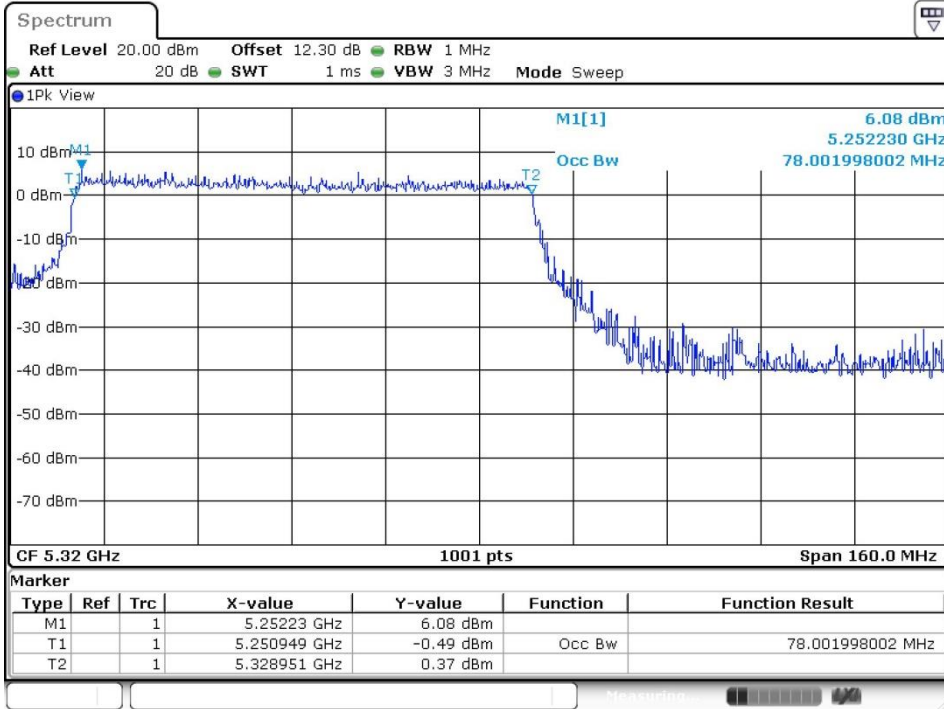

Date: 3.DEC.2023 19:45:11

11BE160MIMO_Ant4_5250_Puncturing 40M_2_H

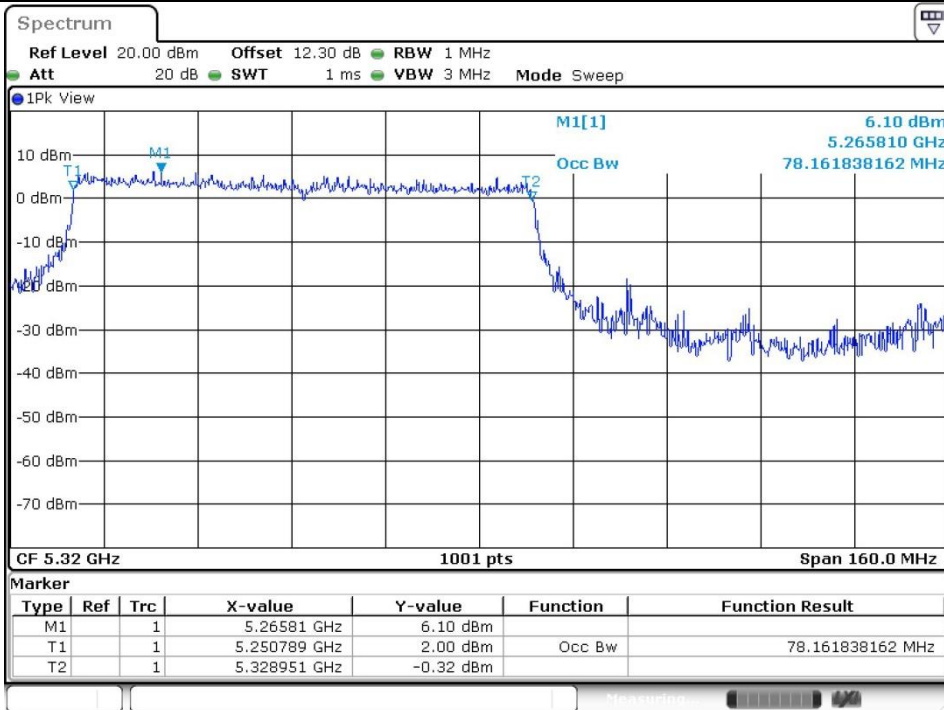

Date: 3.DEC.2023 19:45:31



<MIMO Ant. 5+6>:

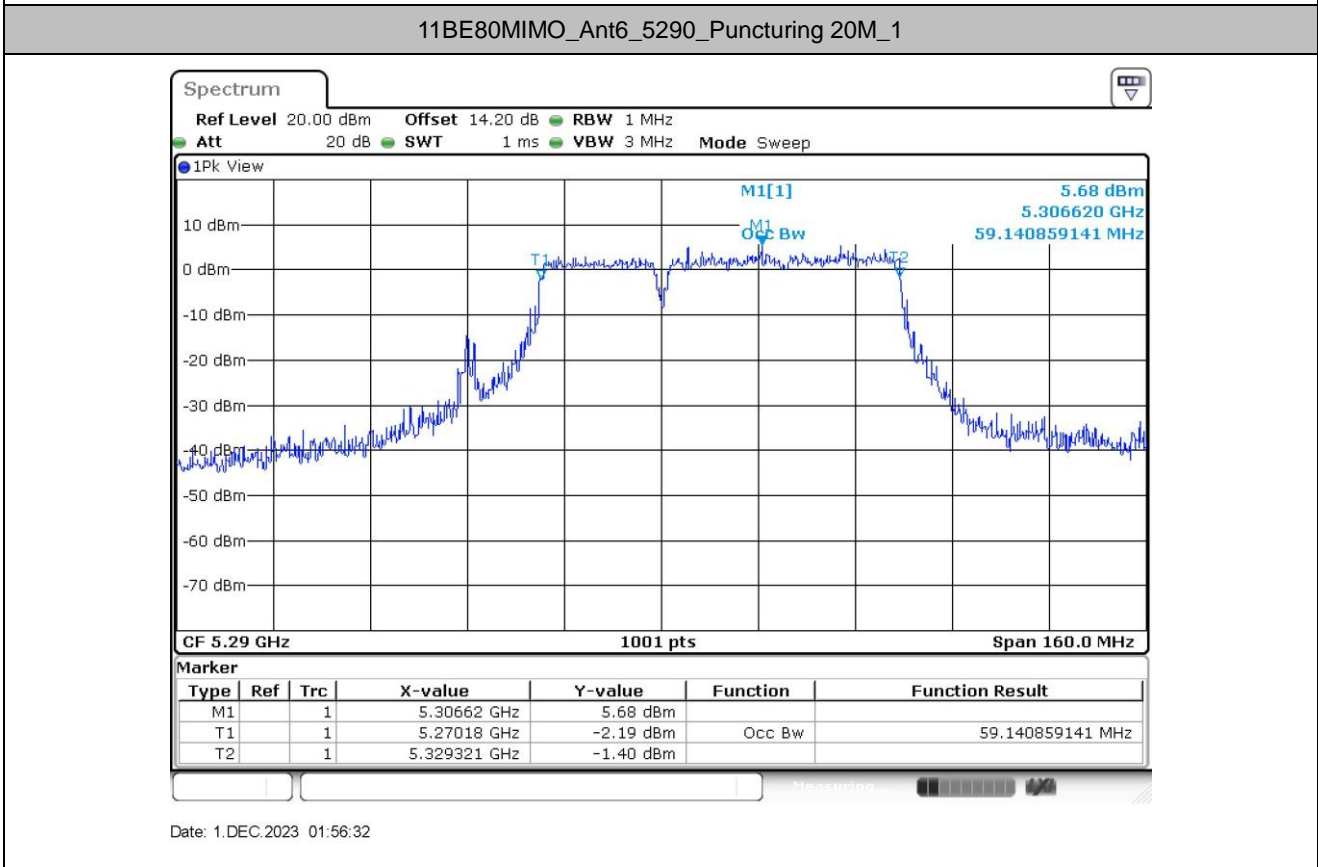
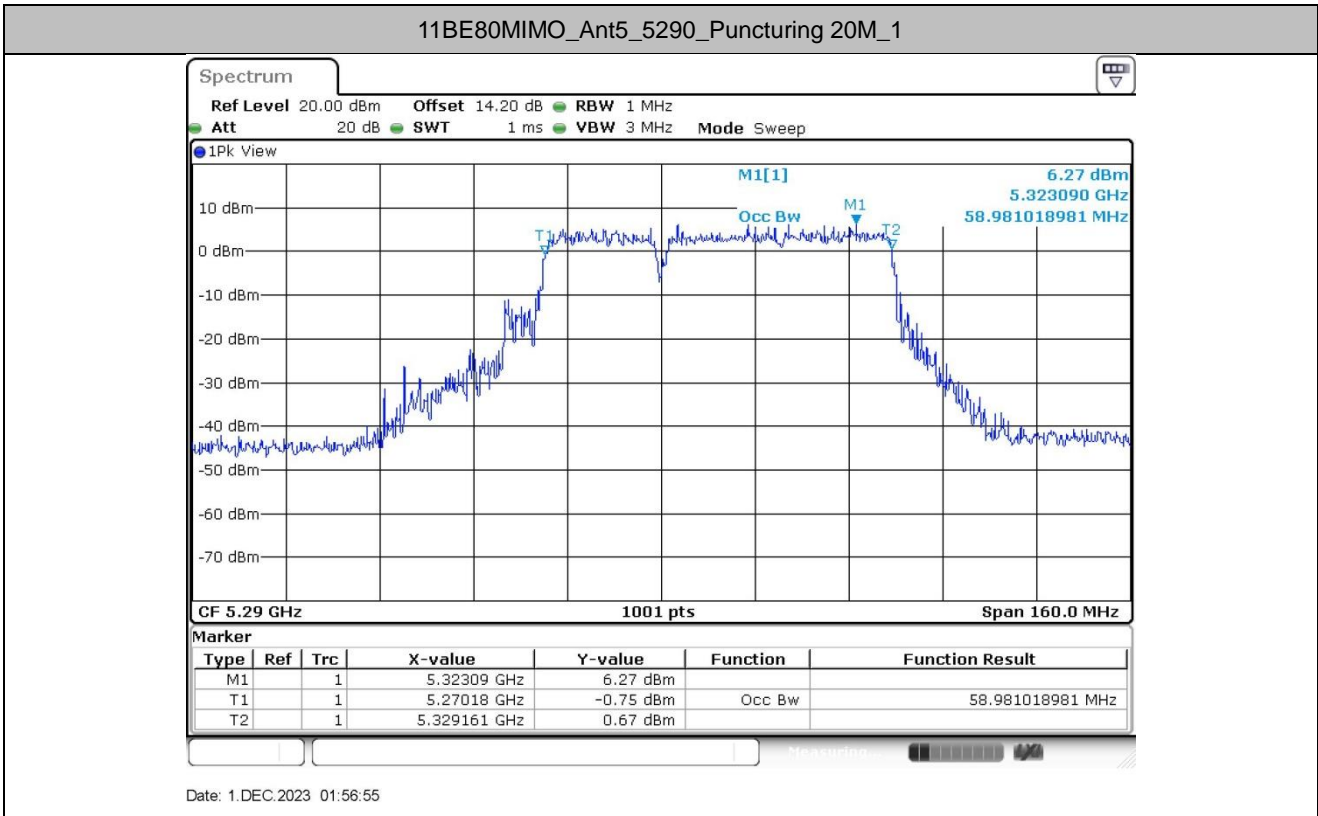



11BE80MIMO_Ant5_5530_Puncturing 20M_4

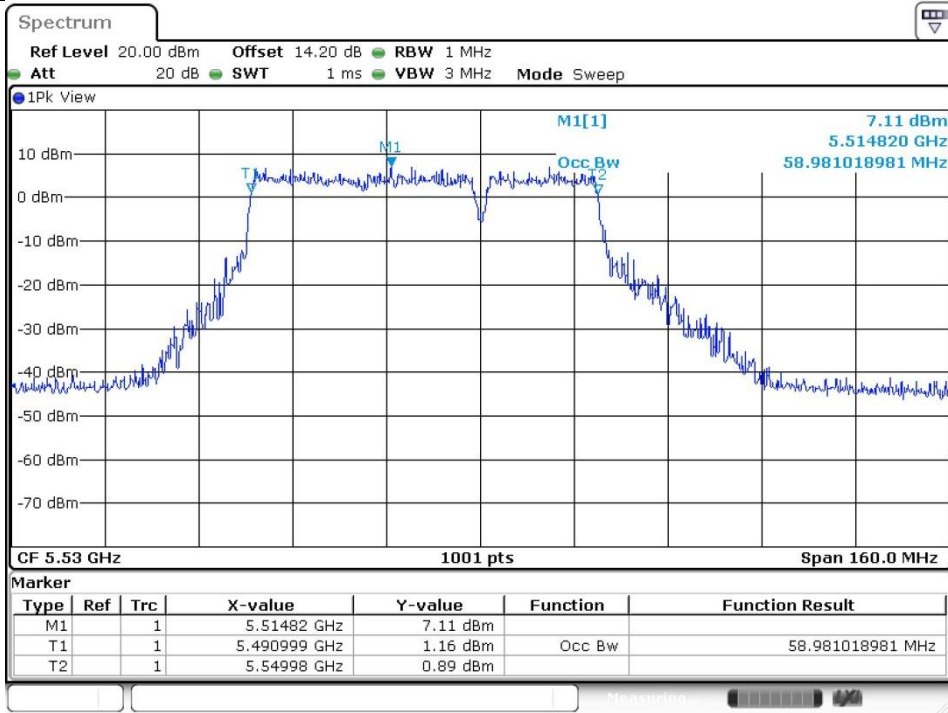

Date: 1.DEC.2023 01:41:56

11BE80MIMO_Ant6_5530_Puncturing 20M_4

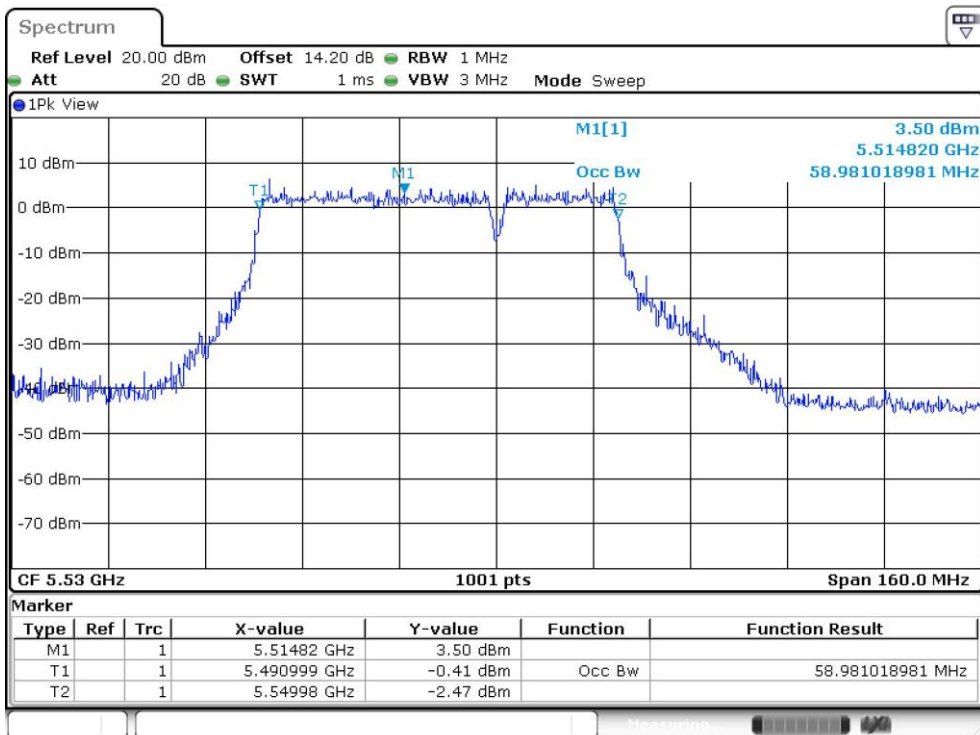

Date: 1.DEC.2023 01:43:16



11BE160MIMO_Ant5_5250_Puncturing 20M_2_L

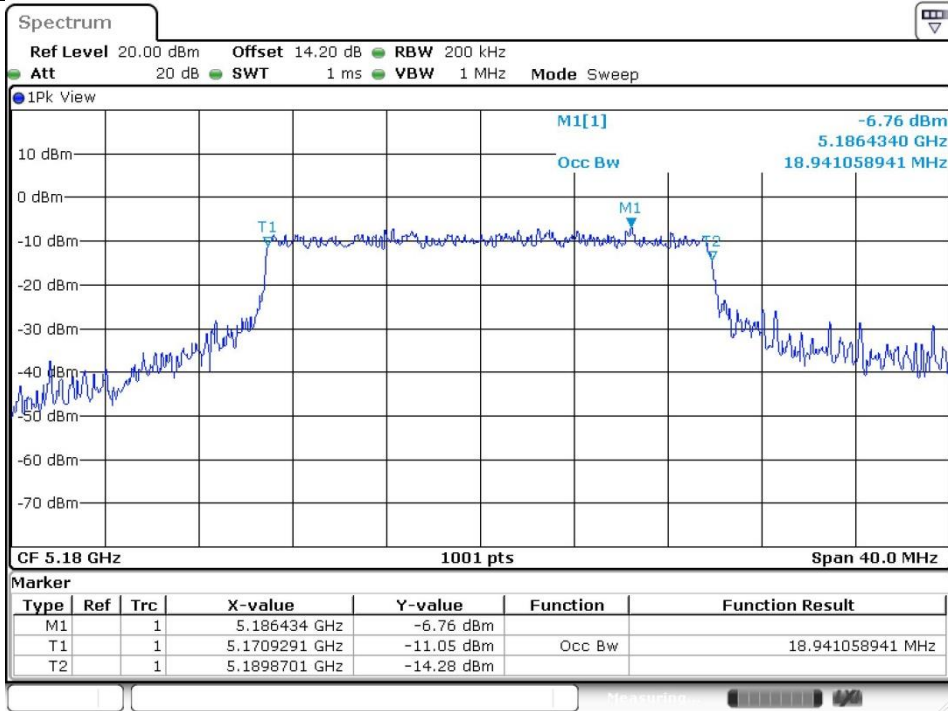

Date: 1.DEC.2023 01:38:41

11BE160MIMO_Ant6_5250_Puncturing 20M_2_L

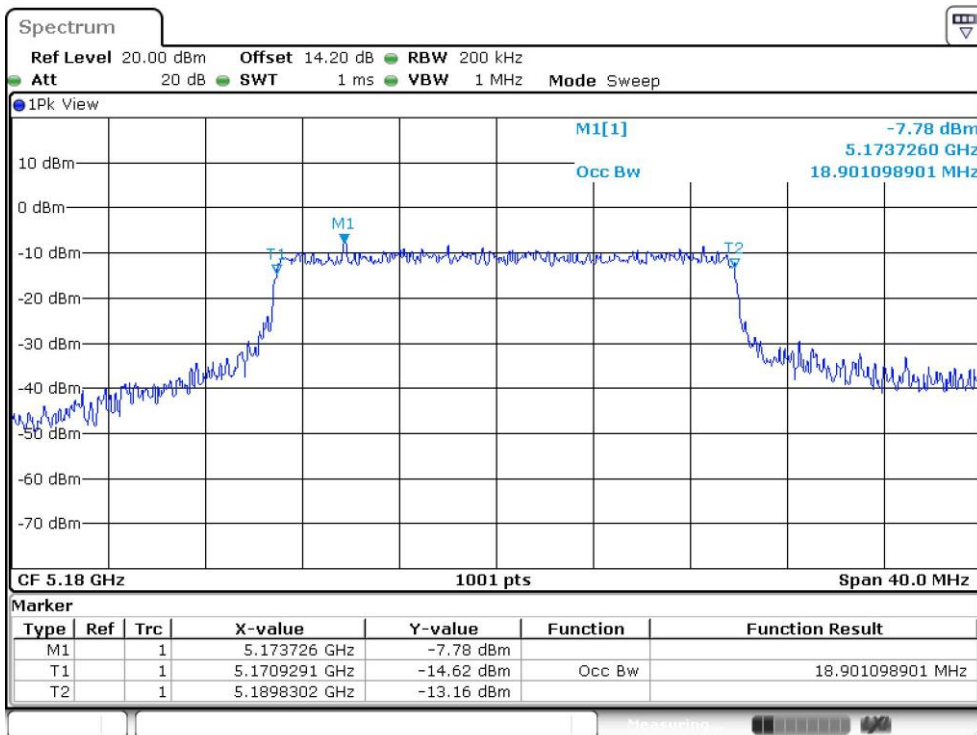

Date: 1.DEC.2023 01:24:08



11BE160MIMO_Ant5_5250_Puncturing 20M_2_H

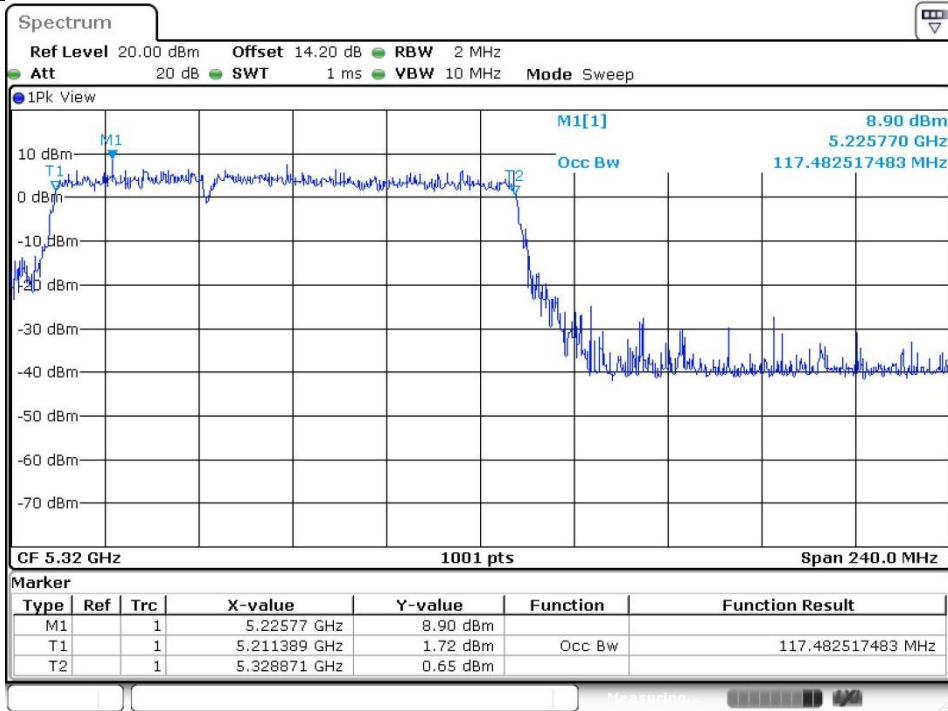

Date: 1.DEC.2023 01:22:34

11BE160MIMO_Ant6_5250_Puncturing 20M_2_H

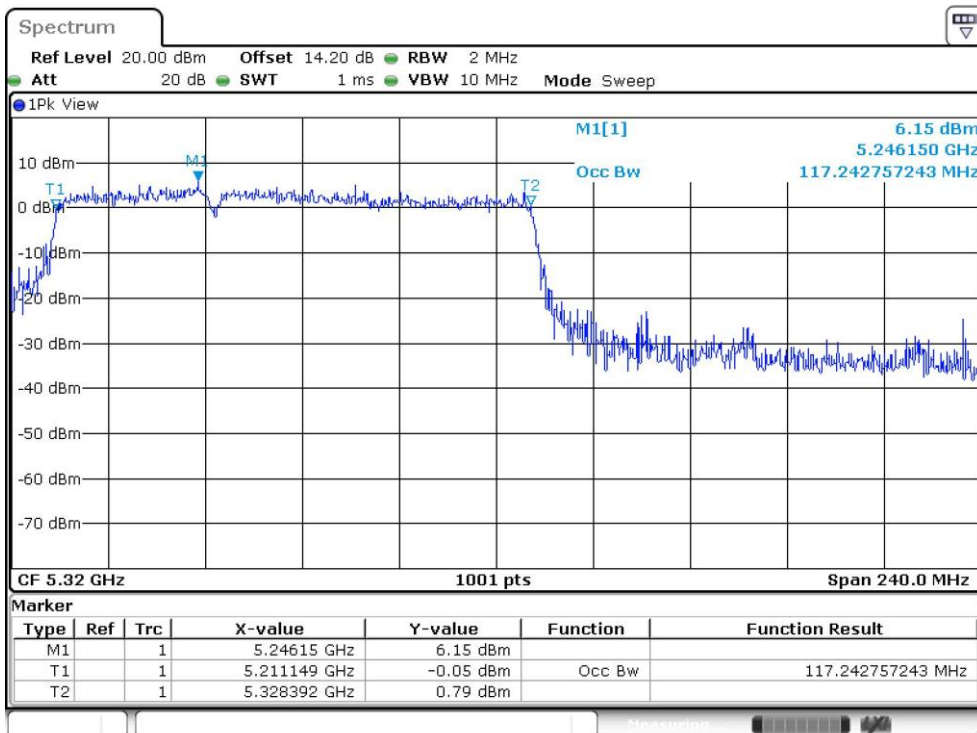

Date: 1.DEC.2023 01:19:07



11BE160MIMO_Ant5_5250_Puncturing 40M_2_L

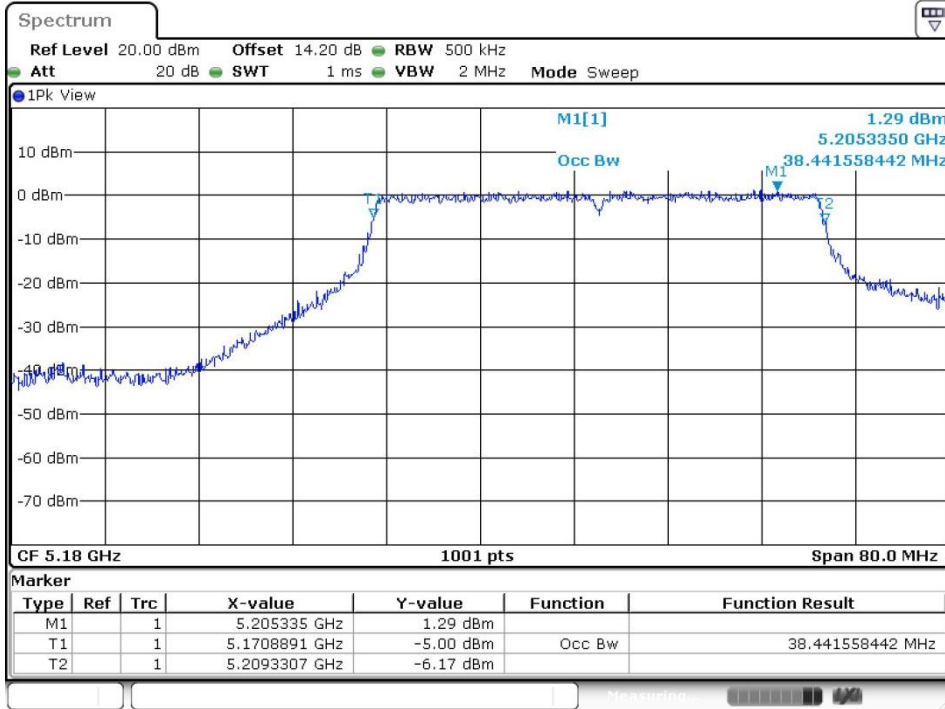

Date: 1.DEC.2023 01:26:28

11BE160MIMO_Ant6_5250_Puncturing 40M_2_L

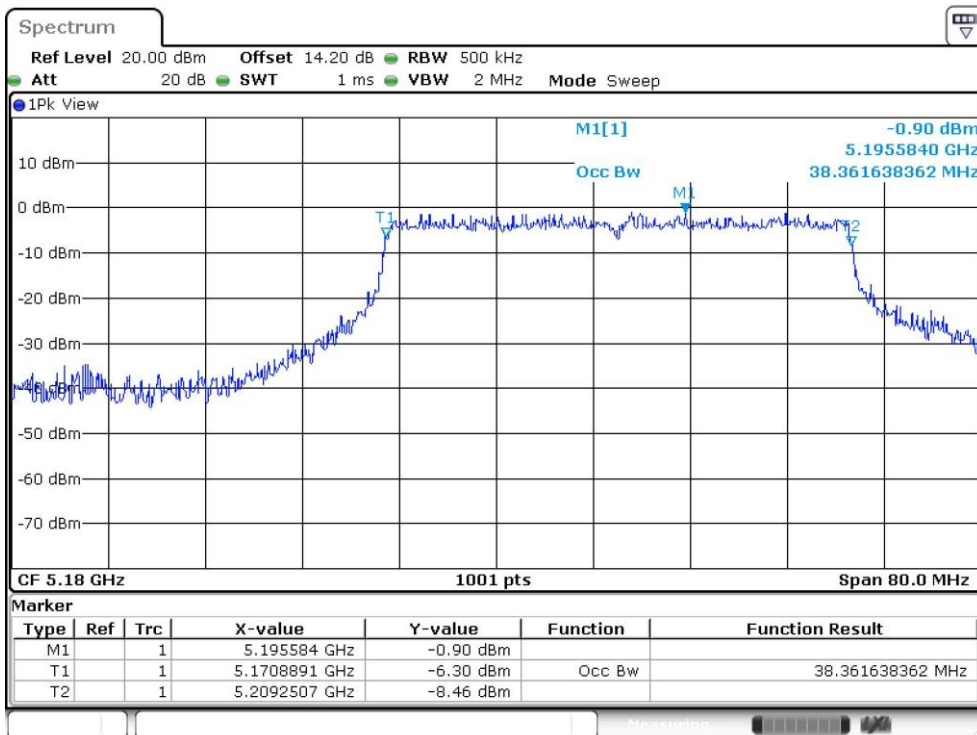

Date: 1.DEC.2023 01:27:44



11BE160MIMO_Ant5_5250_Puncturing 40M_2_H

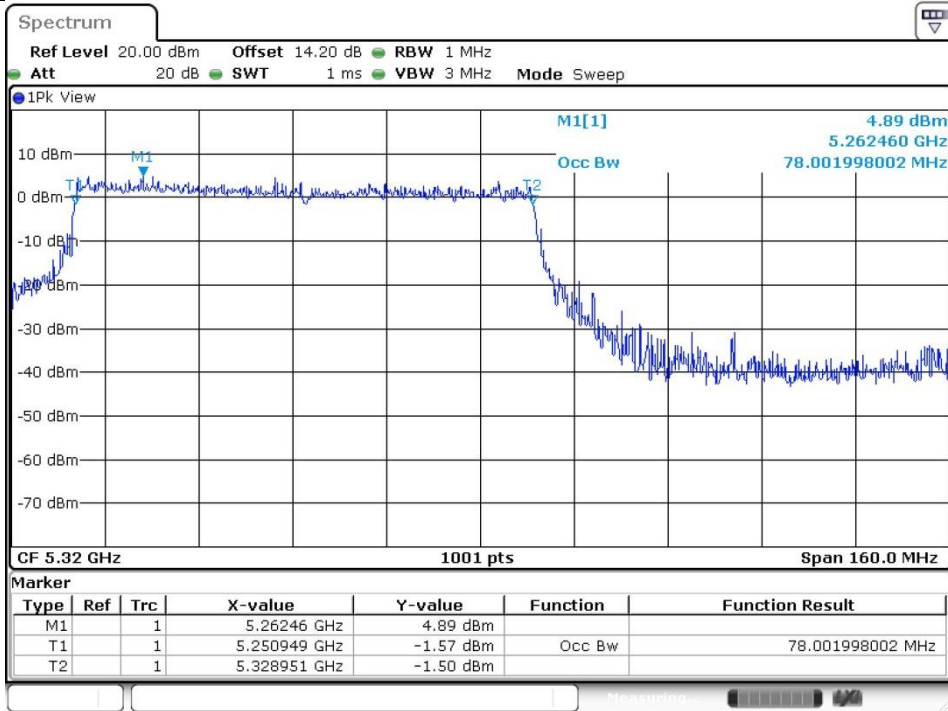

Date: 1.DEC.2023 01:29:47

11BE160MIMO_Ant6_5250_Puncturing 40M_2_H

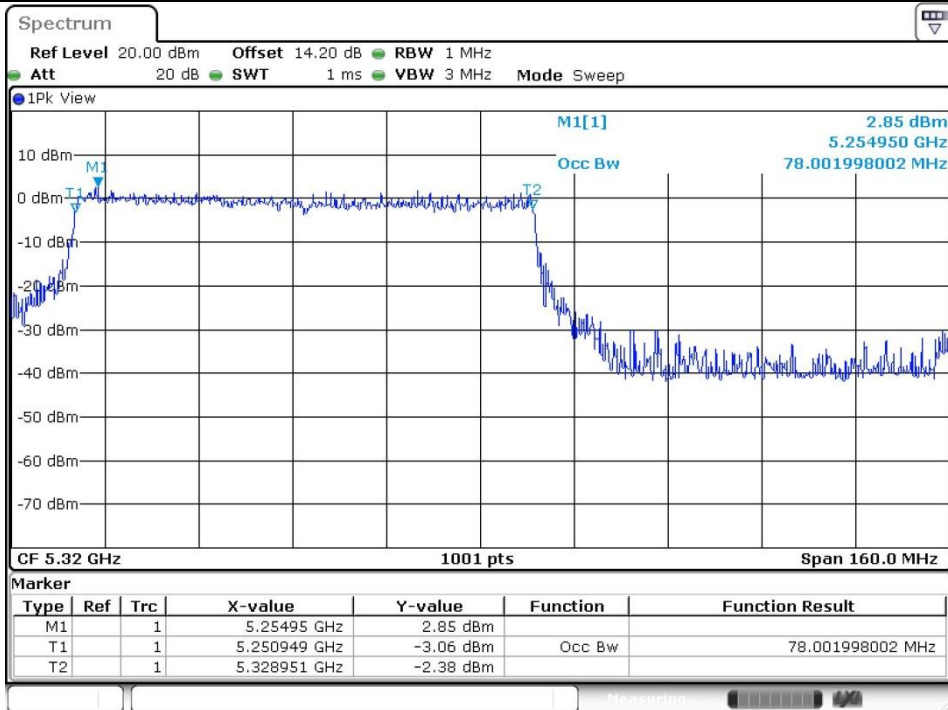

Date: 1.DEC.2023 01:29:23



4.2.2 Punctured Channel E.I.R.P Check

Check the punctured regions meet -27 dBm/MHz EIRP AVG.

<MIMO Ant. 5+4>:

Mode	TX Freq	Puncturing	SA Freq	antenna	EIRP Power (dBm)	EIRP limit (dBm)
11be 80 MIMO	5290	Puncturing20-1	5260	Ant5	-32.19	-27
				Ant4	-31.52	-27
	5530	Puncturing20-4	5560	Ant5	-37.27	-27
				Ant4	-37.06	-27
11be 160 MIMO	5250	Puncturing20-2	5200	Ant5	-35.73	-27
				Ant4	-34.41	-27
	5250	Puncturing40-2	5230	Ant5	-38.90	-27
				Ant4	-36.58	-27

<MIMO Ant. 5+6>:

Mode	TX Freq	Puncturing	SA Freq	antenna	EIRP Power (dBm)	EIRP limit (dBm)
11be 80 MIMO	5290	Puncturing20-1	5260	Ant5	-35.93	-27
				Ant6	-37.71	-27
	5530	Puncturing20-4	5560	Ant5	-36.74	-27
				Ant6	-38.59	-27
11be 160 MIMO	5250	Puncturing20-2	5200	Ant5	-35.31	-27
				Ant6	-36.23	-27
	5250	Puncturing40-2	5230	Ant5	-39.03	-27
				Ant6	-39.40	-27

Note: The Antenna Gain is compensated in the graph.



Test Graphs:

<MIMO Ant. 5+4(5)>:

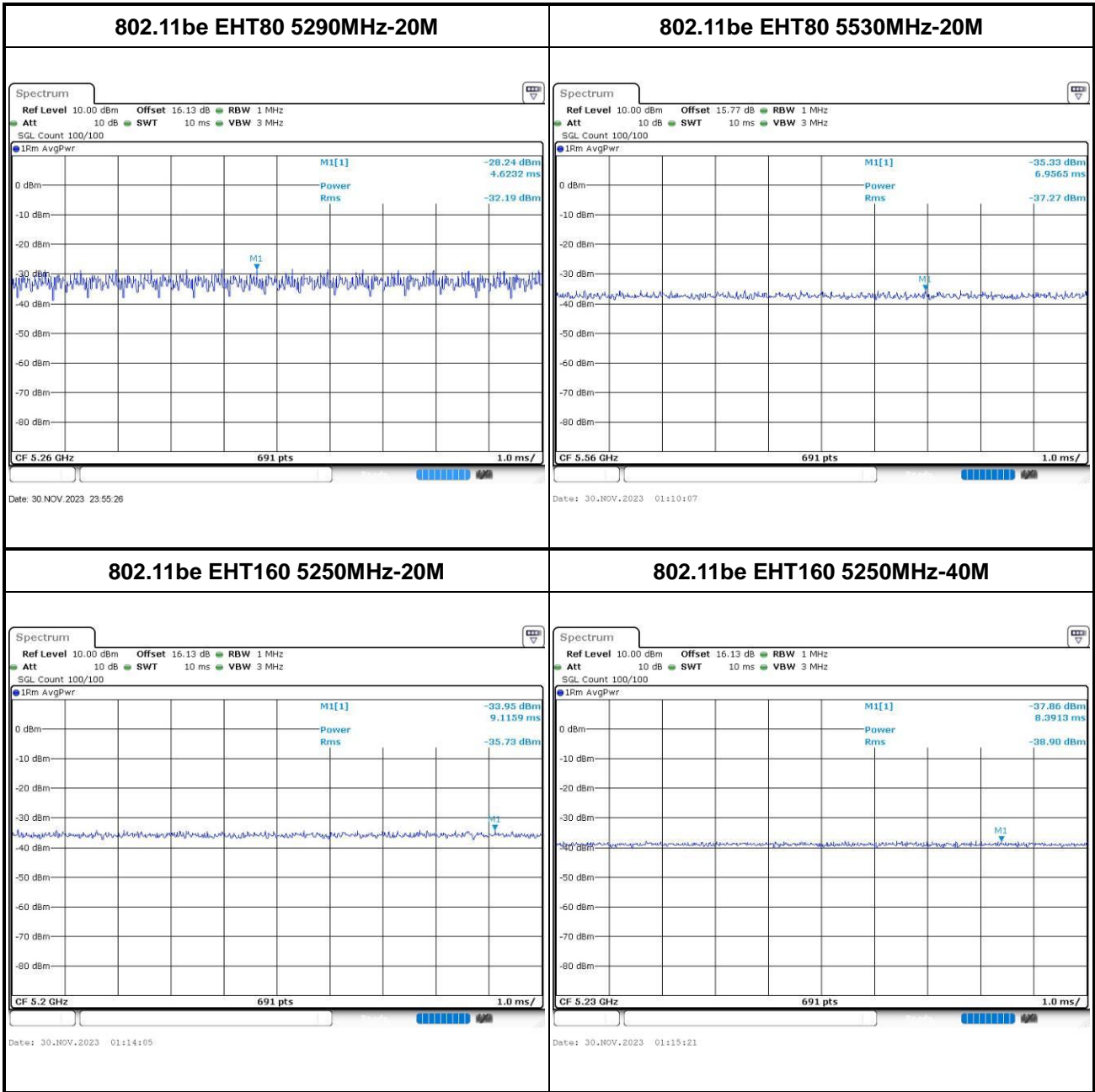



<MIMO Ant. 5+4(4)>:

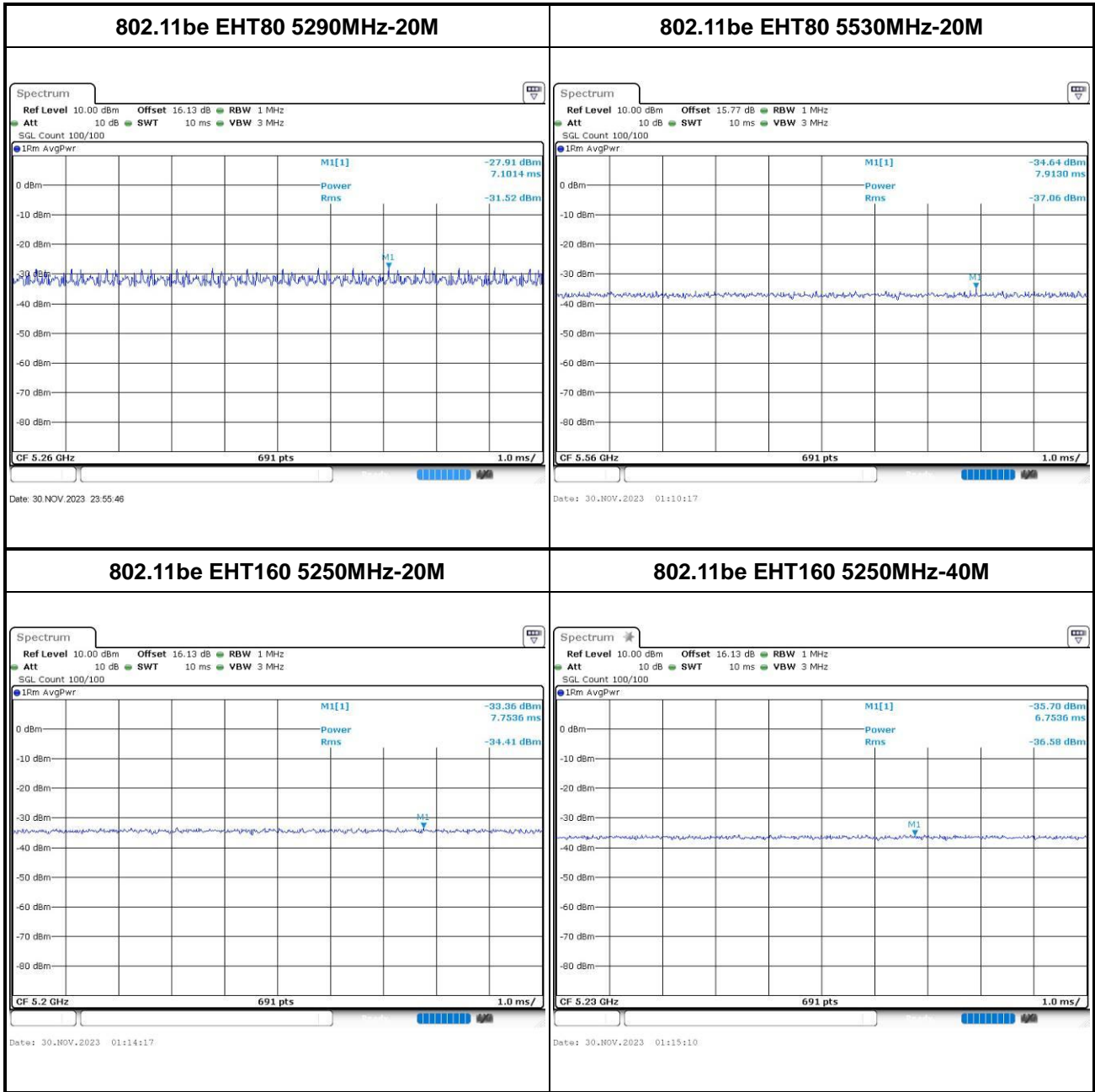



<MIMO Ant. 5+6(5)>:

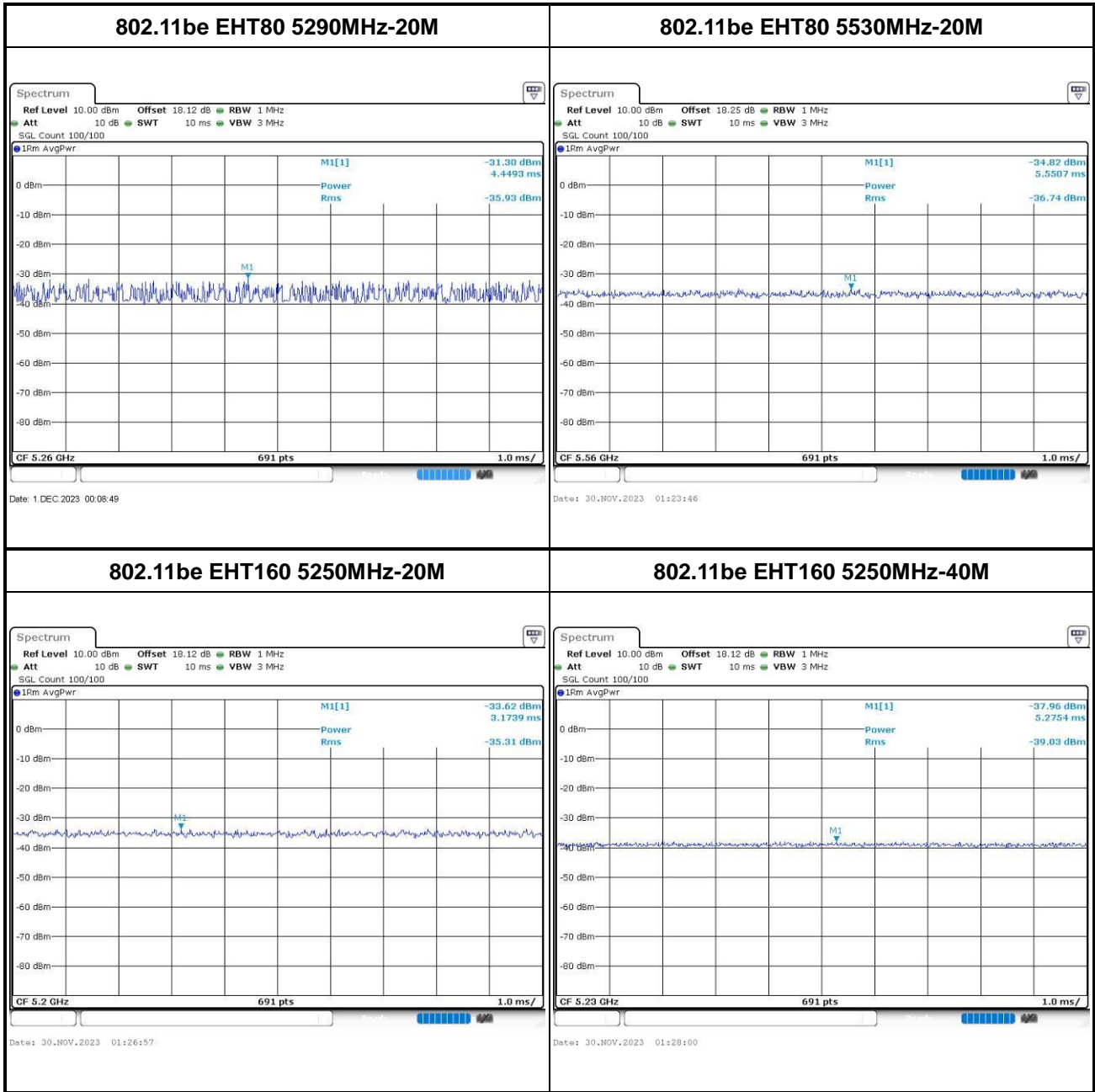



<MIMO Ant. 5+6(6)>:

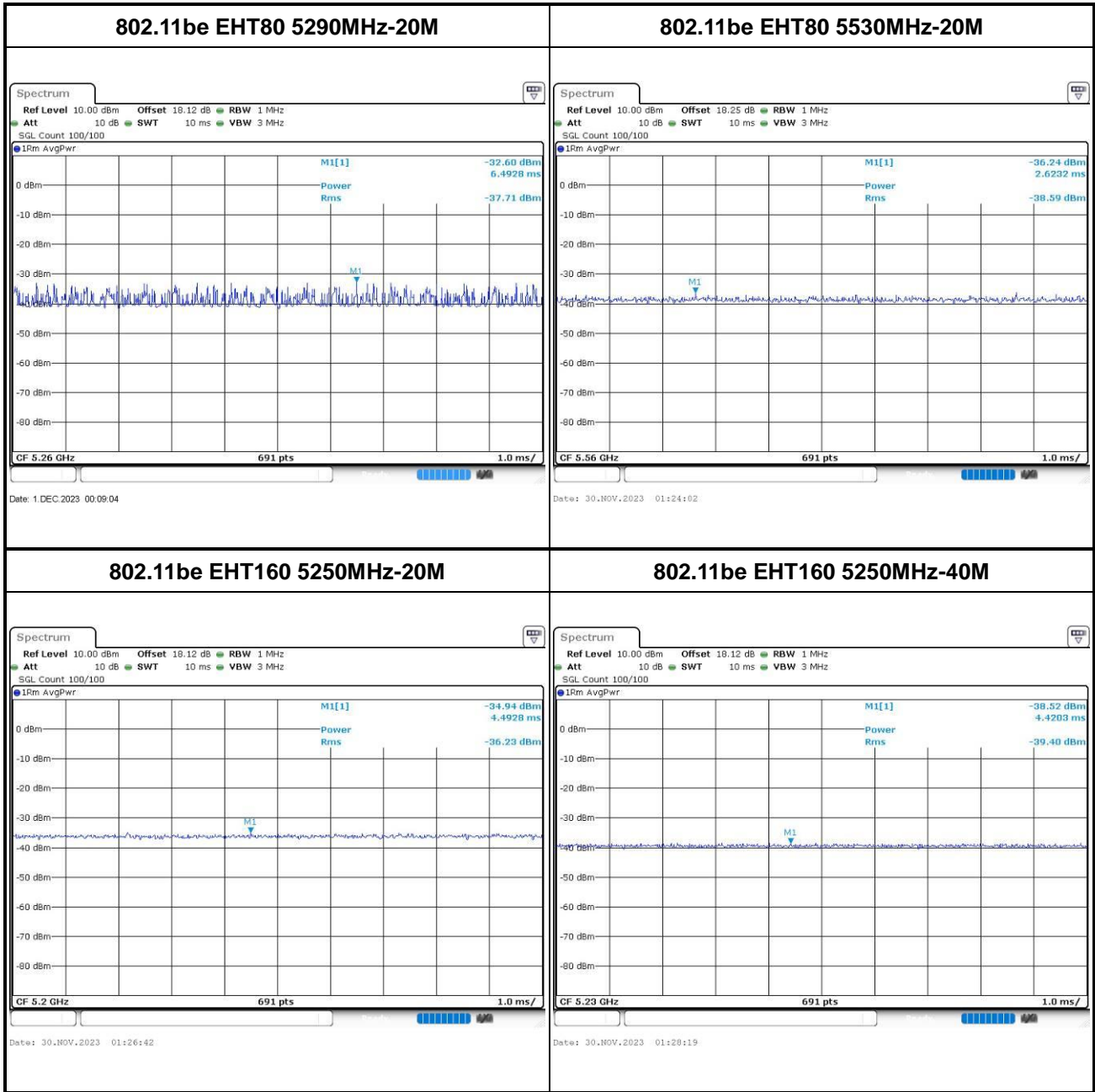



5 List of Measuring Equipment

Instrument	Manufacturer	Model No.	Serial No.	Characteristics	Calibration Date	Test Date	Due Date	Remark
Signal Analyzer	R&S	FSV7	101473	10Hz~7GHz	Dec. 27, 2022	Oct. 22, 2023~ Dec. 04, 2023	Dec. 26, 2023	Conducted (DFS01-SZ)
MXG-B RF Vector Signal Generator	Keysight	N5182B	MY56200424	9kHz~6GHz	Apr. 04, 2023	Oct. 22, 2023~ Dec. 04, 2023	Apr. 03, 2024	Conducted (DFS01-SZ)
Combiner	TOJOIN	PS-2AM-0460	SZE1401100 7	0.4~6GHz	Sep. 05, 2023	Oct. 22, 2023~ Dec. 04, 2023	Sep. 04, 2024	Conducted (DFS01-SZ)

NCR: No Calibration Required



6 Measurement Uncertainty

The measurement uncertainties shown below were calculated in accordance with the requirements of ANSI 63.10-2013. All the measurement uncertainty value were shown with a coverage K=2 to indicate 95% level of confidence. The measurement data show herein meets or exceeds the CISPR measurement uncertainty values specified in CISPR 16-4-2 and can be compared directly to specified limit to determine compliance.

Uncertainty of Conducted Measurement

Test Item	Uncertainty
Conducted Generated signal Levels	±0.62 dB
Conducted Time	0.38%

----- THE END -----