

802.11be_20MHz_CF 6135MHz_Interference_6135MHz_-74.25dBm_Ceased

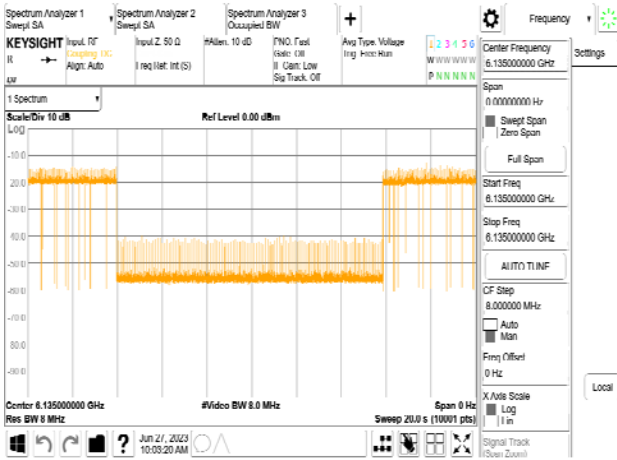

802.11be_20MHz_CF 6455MHz_Interference_6455MHz_-75.49dBm_Ceased

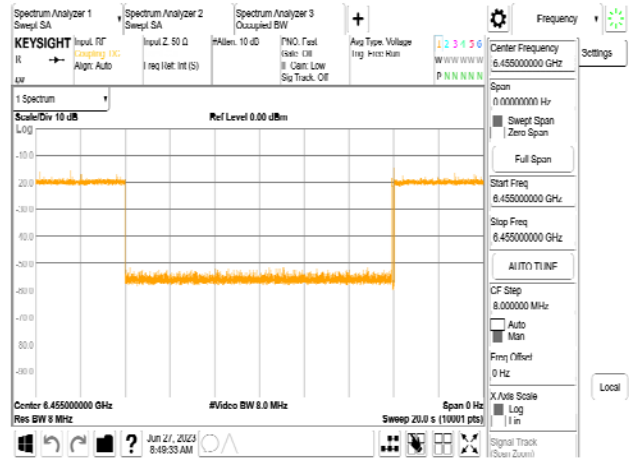

802.11be_20MHz_CF 6135MHz_Interference_6135MHz_-75.25dBm_Minimal

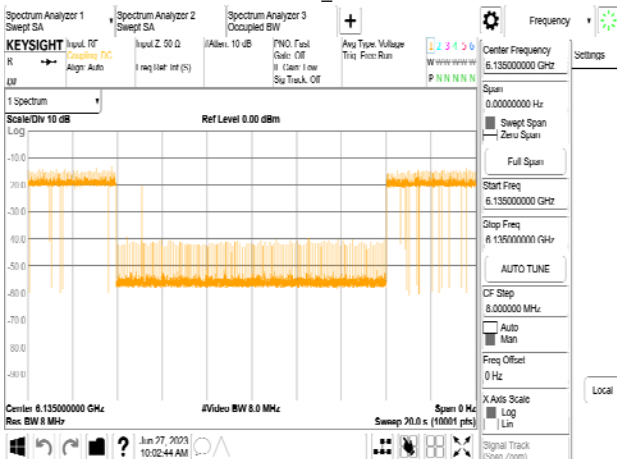

802.11be_20MHz_CF 6455MHz_Interference_6455MHz_-76.49dBm_Minimal

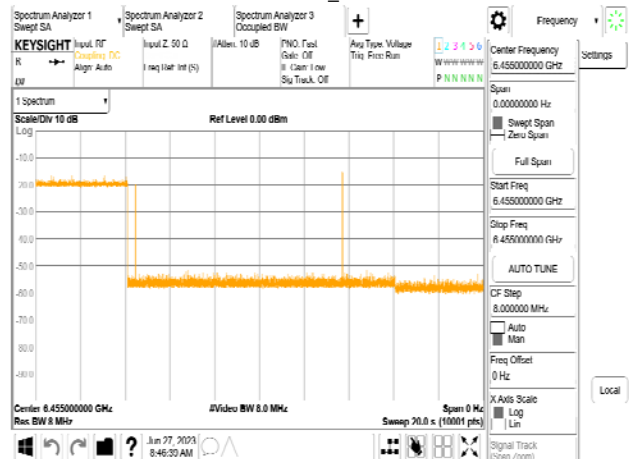

802.11be_20MHz_CF 6135MHz_Interference_6135MHz_-82.25dBm_Normal



802.11be_20MHz_CF 6455MHz_Interference_6455MHz_-82.49dBm_Normal

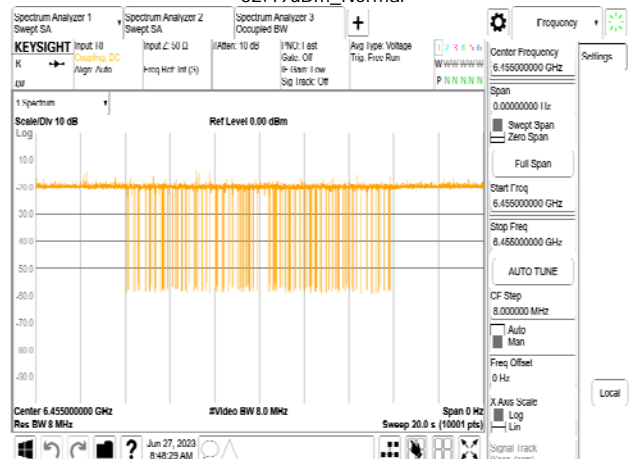

Unless otherwise stated the results shown in this test report refer only to the sample(s) tested and such sample(s) are retained for 90 days only.

除非另有說明，此報告結果僅對測試之樣品負責，同時此樣品僅保留90天。本報告未經本公司書面許可，不可部份複製。

This document is issued by the Company subject to its General Conditions of Service printed overleaf, available on request or accessible at <http://www.sgs.com.tw/Terms-and-Conditions> and for electronic format documents, subject to Terms and Conditions for Electronic Documents at <http://www.sgs.com.tw/Terms-and-Conditions>. Attention is drawn to the limitation of liability, indemnification and jurisdiction issues defined therein. Any holder of this document is advised that information contained hereon reflects the Company's findings at the time of its intervention only and within the limits of Client's instructions, if any. The Company's sole responsibility is to its Client and this document does not exonerate parties to a transaction from exercising all their rights and obligations under the transaction documents. This document cannot be reproduced except in full, without prior written approval of the Company. Any unauthorized alteration, forgery or falsification of the content or appearance of this document is unlawful and offenders may be prosecuted to the fullest extent of the law.

802.11be_20MHz_CF 6695MHz_Interference_6695MHz_-76.47dBm_Ceased

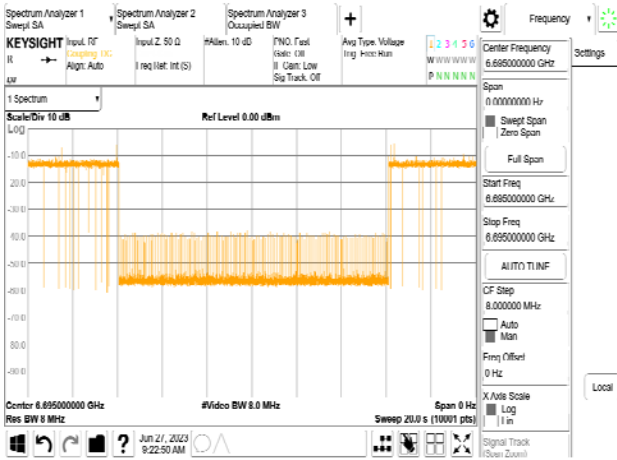

802.11be_20MHz_CF 7015MHz_Interference_7015MHz_-71.75dBm_Ceased

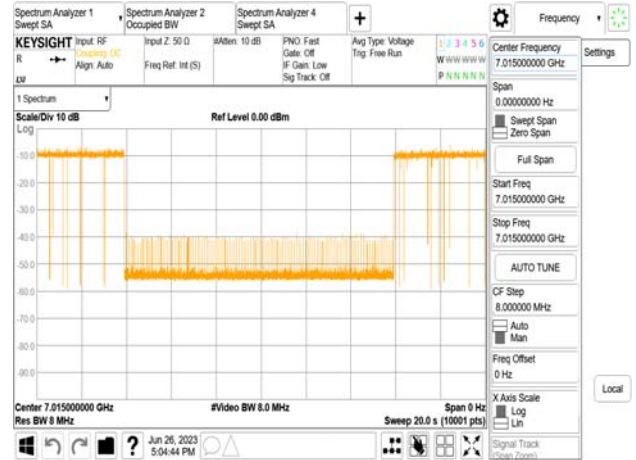

802.11be_20MHz_CF 6695MHz_Interference_6695MHz_-78.47dBm_Minimal

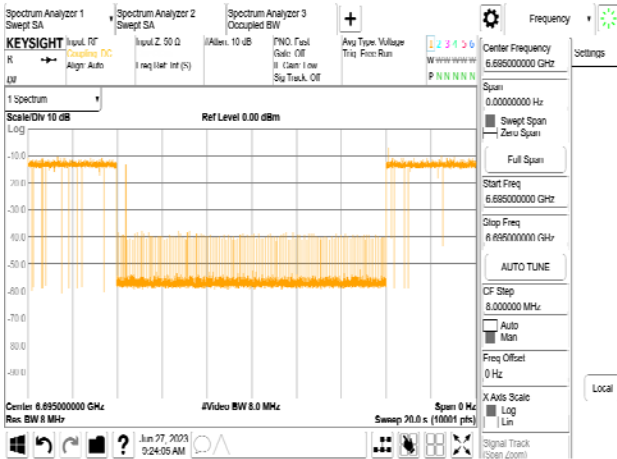

802.11be_20MHz_CF 7015MHz_Interference_7015MHz_-74.75dBm_Minimal

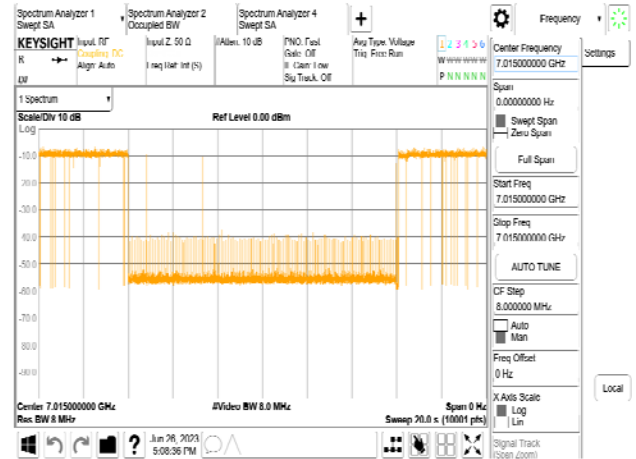

802.11be_20MHz_CF 6695MHz_Interference_6695MHz_-83.47dBm_Normal

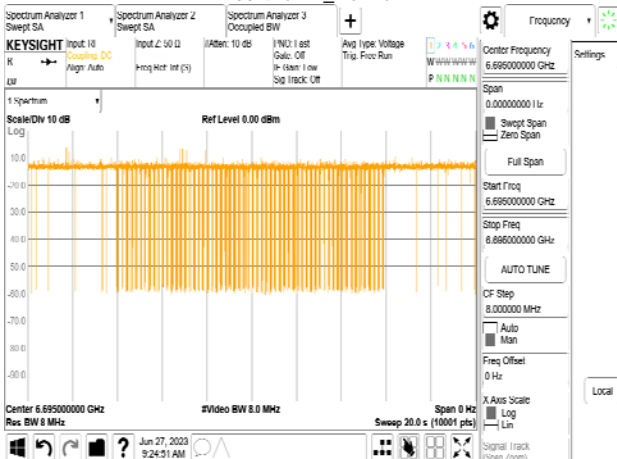

802.11be_20MHz_CF 7015MHz_Interference_7015MHz_-79.75dBm_Normal



Unless otherwise stated the results shown in this test report refer only to the sample(s) tested and such sample(s) are retained for 90 days only.

除非另有說明，此報告結果僅對測試之樣品負責，同時此樣品僅保留90天。本報告未經本公司書面許可，不可部份複製。

This document is issued by the Company subject to its General Conditions of Service printed overleaf, available on request or accessible at <http://www.sgs.com.tw/Terms-and-Conditions> and for electronic format documents, subject to Terms and Conditions for Electronic Documents at <http://www.sgs.com.tw/Terms-and-Conditions>. Attention is drawn to the limitation of liability, indemnification and jurisdiction issues defined therein. Any holder of this document is advised that information contained hereon reflects the Company's findings at the time of its intervention only and within the limits of Client's instructions, if any. The Company's sole responsibility is to its Client and this document does not exonerate parties to a transaction from exercising all their rights and obligations under the transaction documents. This document cannot be reproduced except in full, without prior written approval of the Company. Any unauthorized alteration, forgery or falsification of the content or appearance of this document is unlawful and offenders may be prosecuted to the fullest extent of the law.

802.11be_320MHz_CF 6265MHz_Interference_6110MHz_-71.48dBm_Ceased

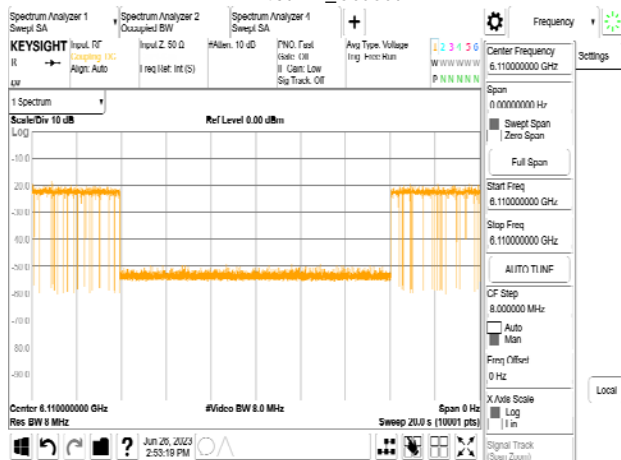

802.11be_320MHz_CF 6265MHz_Interference_6265MHz_-67.29dBm_Ceased

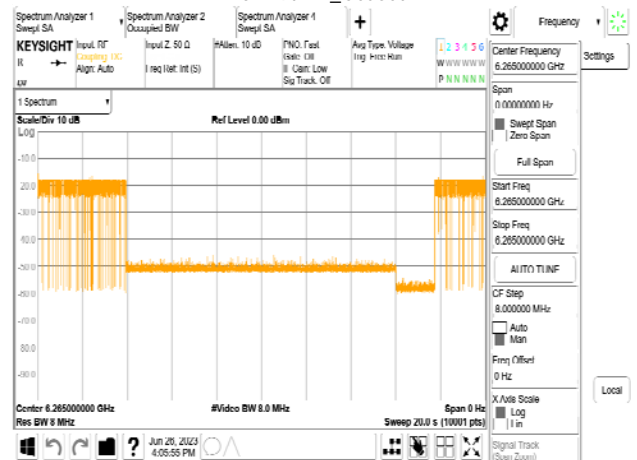

802.11be_320MHz_CF 6265MHz_Interference_6110MHz_-73.48dBm_Minimal

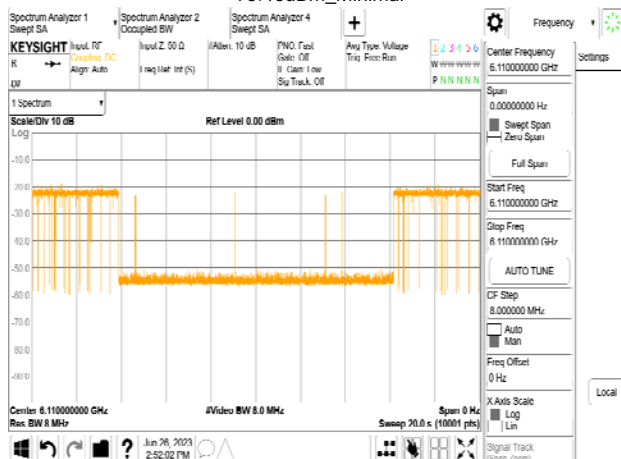

802.11be_320MHz_CF 6265MHz_Interference_6265MHz_-70.29dBm_Minimal

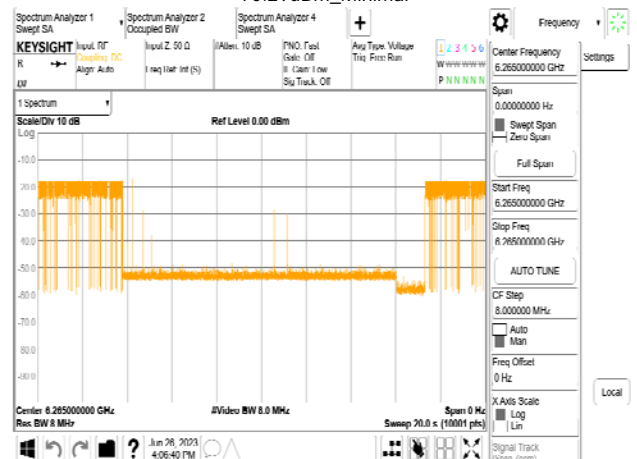

802.11be_320MHz_CF 6265MHz_Interference_6110MHz_-76.48dBm_Normal



802.11be_320MHz_CF 6265MHz_Interference_6265MHz_-81.29dBm_Normal

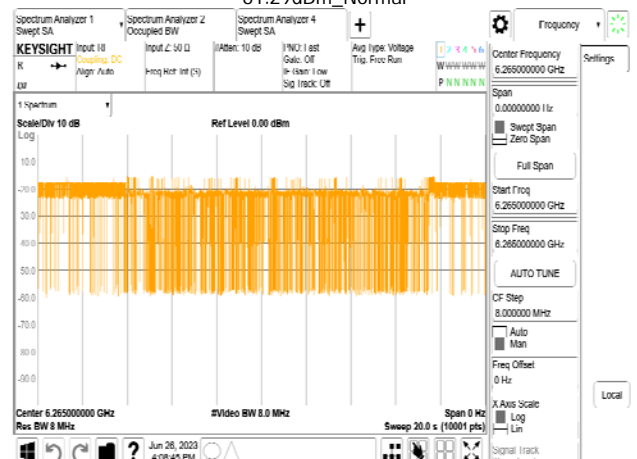

Unless otherwise stated the results shown in this test report refer only to the sample(s) tested and such sample(s) are retained for 90 days only.

除非另有說明，此報告結果僅對測試之樣品負責，同時此樣品僅保留90天。本報告未經本公司書面許可，不可部份複製。

This document is issued by the Company subject to its General Conditions of Service printed overleaf, available on request or accessible at <http://www.sgs.com.tw/Terms-and-Conditions> and for electronic format documents, subject to Terms and Conditions for Electronic Documents at <http://www.sgs.com.tw/Terms-and-Conditions>. Attention is drawn to the limitation of liability, indemnification and jurisdiction issues defined therein. Any holder of this document is advised that information contained hereon reflects the Company's findings at the time of its intervention only and within the limits of Client's instructions, if any. The Company's sole responsibility is to its Client and this document does not exonerate parties to a transaction from exercising all their rights and obligations under the transaction documents. This document cannot be reproduced except in full, without prior written approval of the Company. Any unauthorized alteration, forgery or falsification of the content or appearance of this document is unlawful and offenders may be prosecuted to the fullest extent of the law.

802.11be_320MHz_CF 6265MHz_Interference_6420MHz_-71.28dBm_Ceased

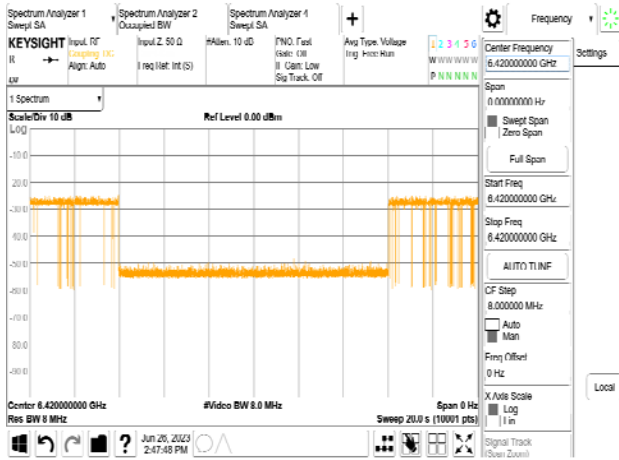

802.11be_320MHz_CF 6585MHz_Interference_6430MHz_-72.43dBm_Ceased

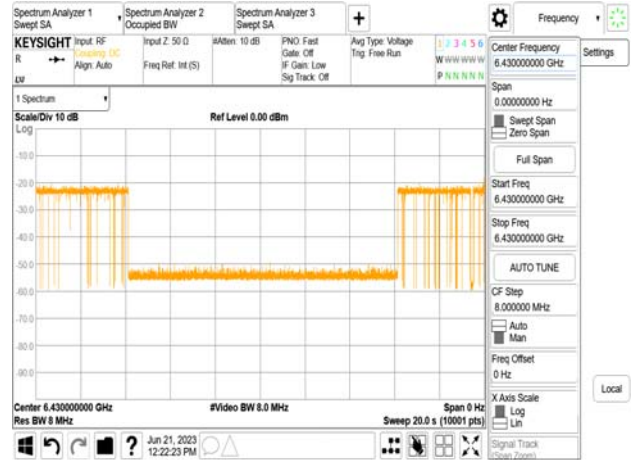

802.11be_320MHz_CF 6265MHz_Interference_6420MHz_-74.28dBm_Minimal

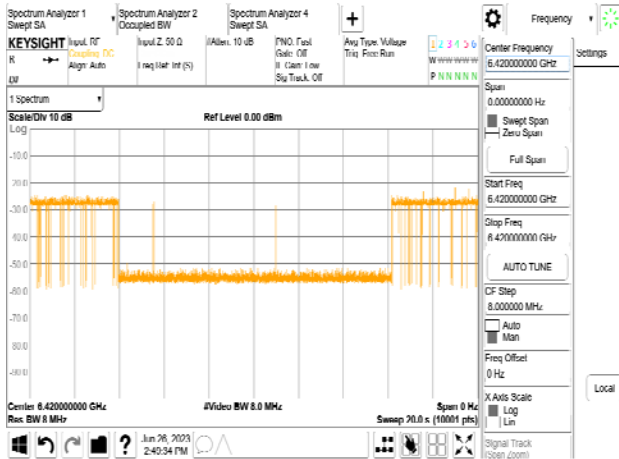

802.11be_320MHz_CF 6585MHz_Interference_6430MHz_-76.43dBm_Minimal

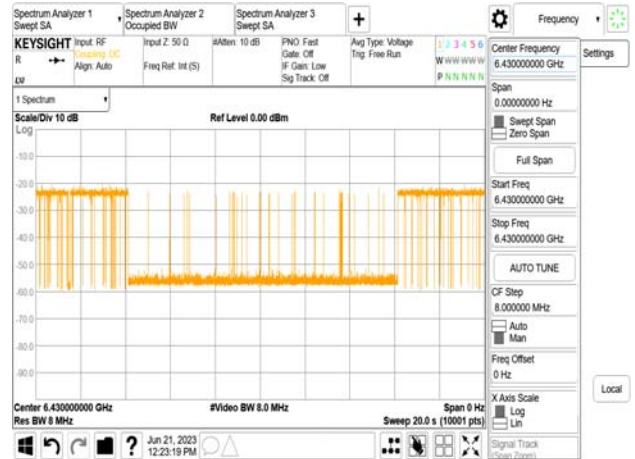

802.11be_320MHz_CF 6265MHz_Interference_6420MHz_-77.28dBm_Normal

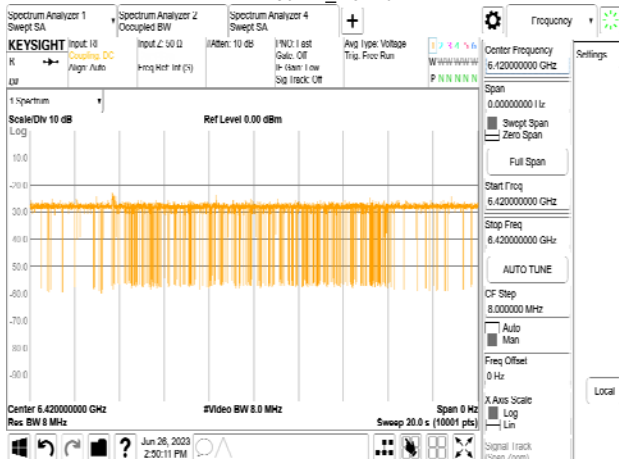

802.11be_320MHz_CF 6585MHz_Interference_6430MHz_-79.43dBm_Normal

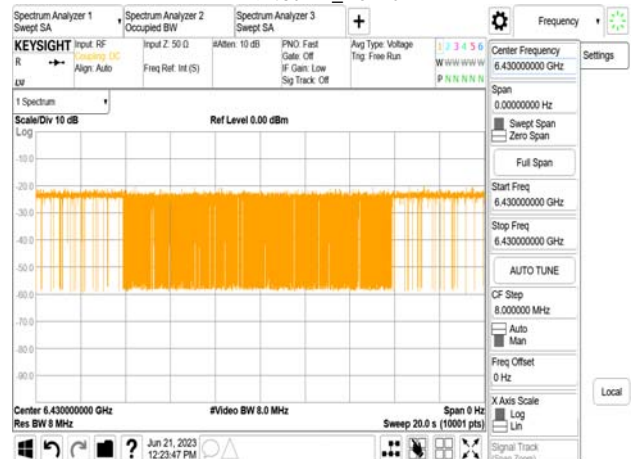

Unless otherwise stated the results shown in this test report refer only to the sample(s) tested and such sample(s) are retained for 90 days only.

除非另有說明，此報告結果僅對測試之樣品負責，同時此樣品僅保留90天。本報告未經本公司書面許可，不可部份複製。

This document is issued by the Company subject to its General Conditions of Service printed overleaf, available on request or accessible at <http://www.sgs.com.tw/Terms-and-Conditions> and for electronic format documents, subject to Terms and Conditions for Electronic Documents at <http://www.sgs.com.tw/Terms-and-Conditions>. Attention is drawn to the limitation of liability, indemnification and jurisdiction issues defined therein. Any holder of this document is advised that information contained hereon reflects the Company's findings at the time of its intervention only and within the limits of Client's instructions, if any. The Company's sole responsibility is to its Client and this document does not exonerate parties to a transaction from exercising all their rights and obligations under the transaction documents. This document cannot be reproduced except in full, without prior written approval of the Company. Any unauthorized alteration, forgery or falsification of the content or appearance of this document is unlawful and offenders may be prosecuted to the fullest extent of the law.

802.11be_320MHz_CF 6585MHz_Interference_6585MHz_-69.32dBm_Ceased

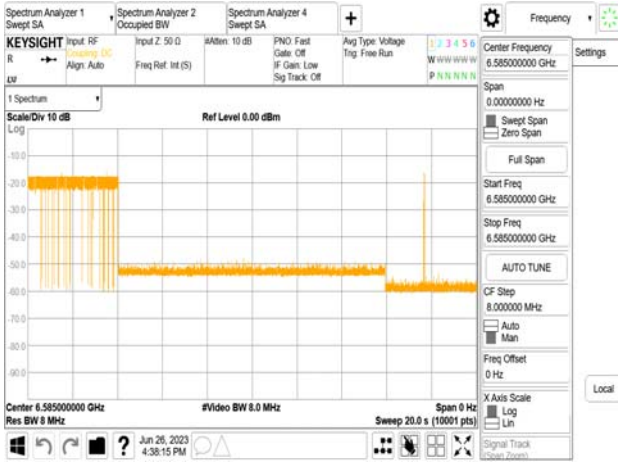

802.11be_320MHz_CF 6585MHz_Interference_6740MHz_-73.37dBm_Ceased

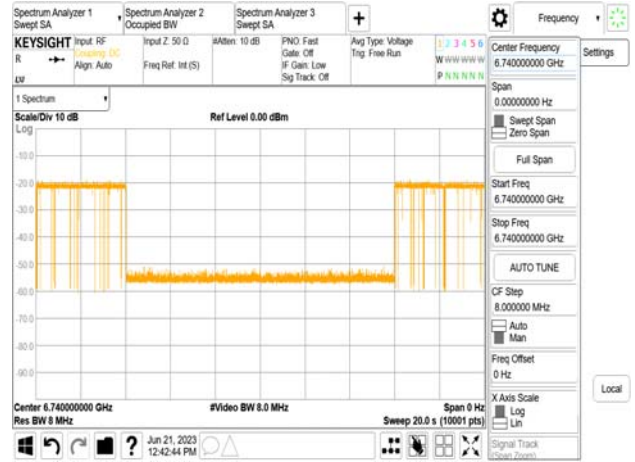

802.11be_320MHz_CF 6585MHz_Interference_6585MHz_-71.32dBm_Minimal

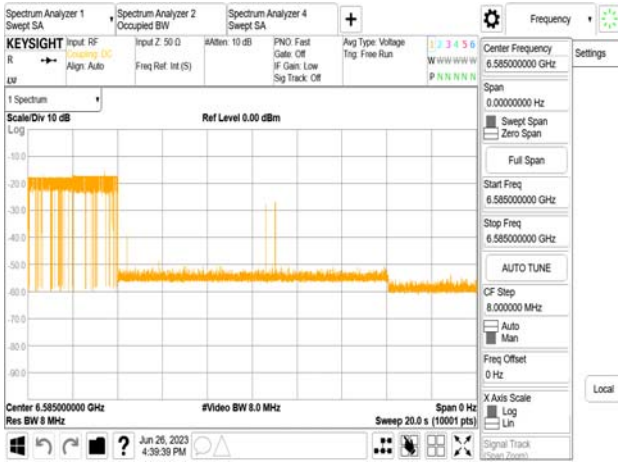

802.11be_320MHz_CF 6585MHz_Interference_6740MHz_-77.37dBm_Minimal

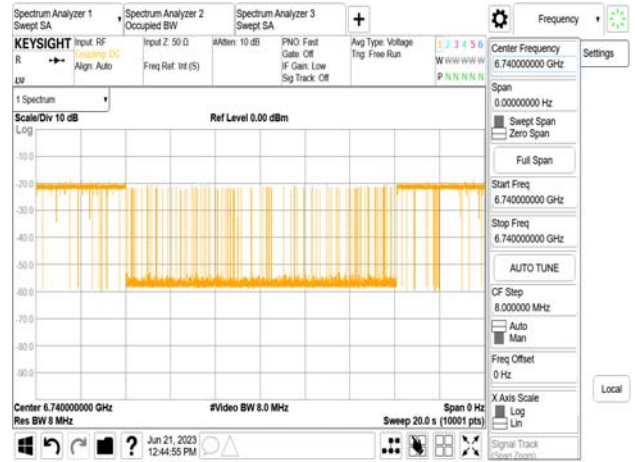

802.11be_320MHz_CF 6585MHz_Interference_6585MHz_-78.32dBm_NormaldBm_Normal

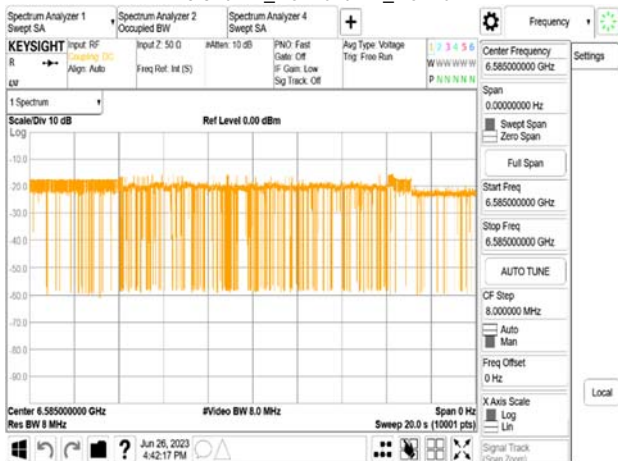

802.11be_320MHz_CF 6585MHz_Interference_6740MHz_-79.37dBm_Normal

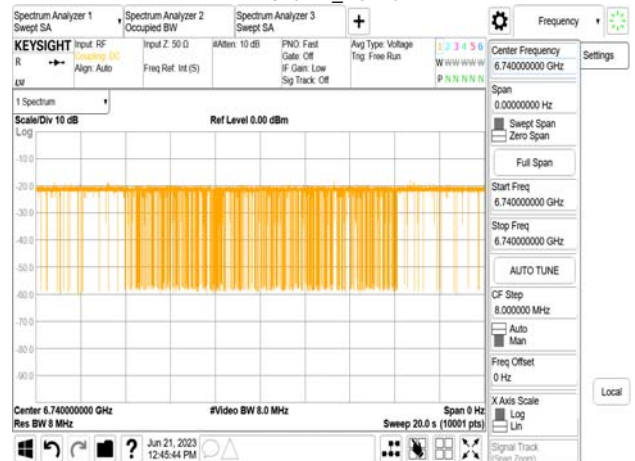

Unless otherwise stated the results shown in this test report refer only to the sample(s) tested and such sample(s) are retained for 90 days only.

除非另有說明，此報告結果僅對測試之樣品負責，同時此樣品僅保留90天。本報告未經本公司書面許可，不可部份複製。

This document is issued by the Company subject to its General Conditions of Service printed overleaf, available on request or accessible at <http://www.sgs.com.tw/Terms-and-Conditions> and for electronic format documents, subject to Terms and Conditions for Electronic Documents at <http://www.sgs.com.tw/Terms-and-Conditions>. Attention is drawn to the limitation of liability, indemnification and jurisdiction issues defined therein. Any holder of this document is advised that information contained hereon reflects the Company's findings at the time of its intervention only and within the limits of Client's instructions, if any. The Company's sole responsibility is to its Client and this document does not exonerate parties to a transaction from exercising all their rights and obligations under the transaction documents. This document cannot be reproduced except in full, without prior written approval of the Company. Any unauthorized alteration, forgery or falsification of the content or appearance of this document is unlawful and offenders may be prosecuted to the fullest extent of the law.

802.11be_320MHz_CF 6745MHz_Interference_6590MHz_-72.36dBm_Ceased

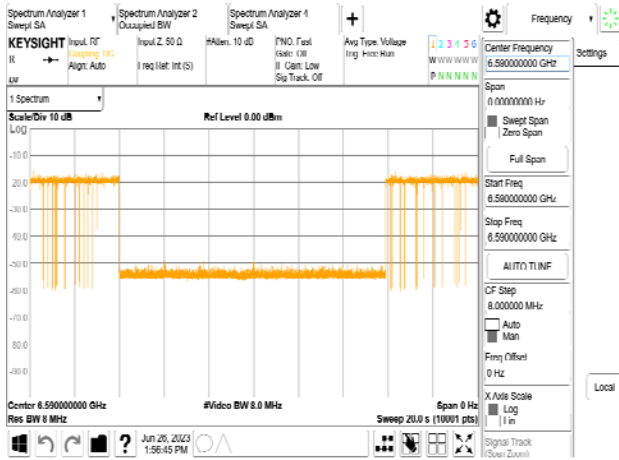

802.11be_320MHz_CF 6745MHz_Interference_6745MHz_-68.42dBm_Ceased

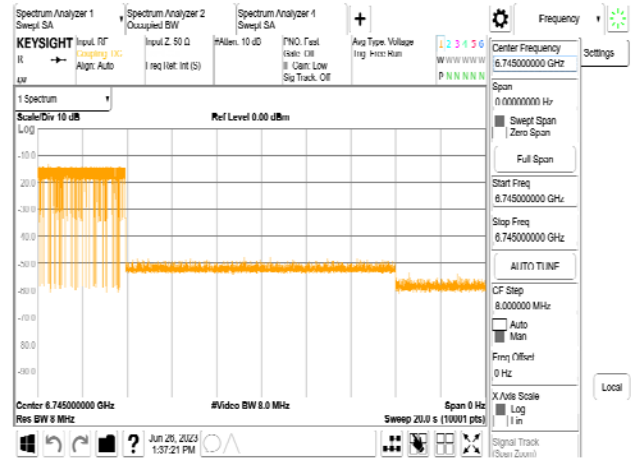

802.11be_320MHz_CF 6745MHz_Interference_6590MHz_-76.36dBm_Minimal



802.11be_320MHz_CF 6745MHz_Interference_6745MHz_-73.42dBm_Minimal

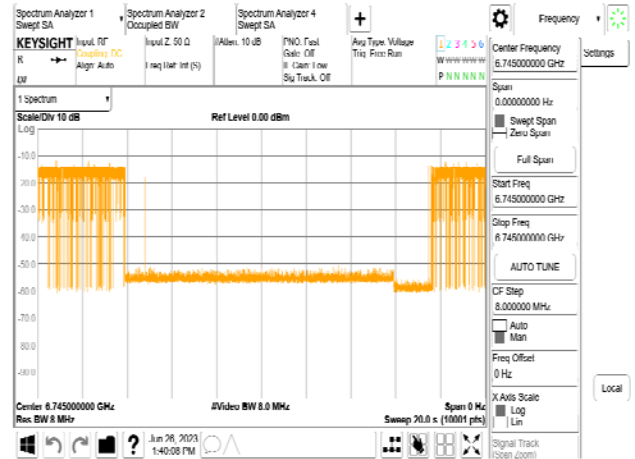

802.11be_320MHz_CF 6745MHz_Interference_6590MHz_-80.36dBm_Normal

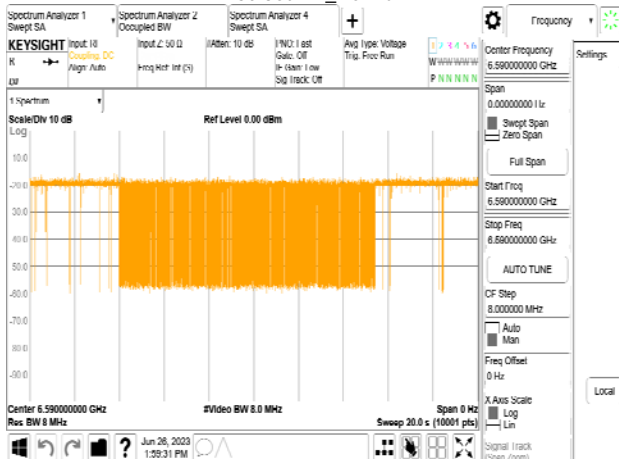

802.11be_320MHz_CF 6745MHz_Interference_6745MHz_-78.42dBm_Normal

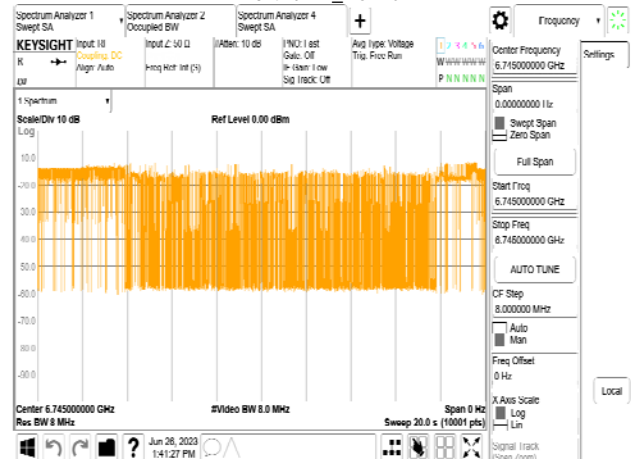

Unless otherwise stated the results shown in this test report refer only to the sample(s) tested and such sample(s) are retained for 90 days only.

除非另有說明，此報告結果僅對測試之樣品負責，同時此樣品僅保留90天。本報告未經本公司書面許可，不可部份複製。

This document is issued by the Company subject to its General Conditions of Service printed overleaf, available on request or accessible at <http://www.sgs.com.tw/Terms-and-Conditions> and for electronic format documents, subject to Terms and Conditions for Electronic Documents at <http://www.sgs.com.tw/Terms-and-Conditions>. Attention is drawn to the limitation of liability, indemnification and jurisdiction issues defined therein. Any holder of this document is advised that information contained hereon reflects the Company's findings at the time of its intervention only and within the limits of Client's instructions, if any. The Company's sole responsibility is to its Client and this document does not exonerate parties to a transaction from exercising all their rights and obligations under the transaction documents. This document cannot be reproduced except in full, without prior written approval of the Company. Any unauthorized alteration, forgery or falsification of the content or appearance of this document is unlawful and offenders may be prosecuted to the fullest extent of the law.

802.11be_320MHz_CF 6745MHz_Interference_6900MHz_-73.32dBm_Ceased

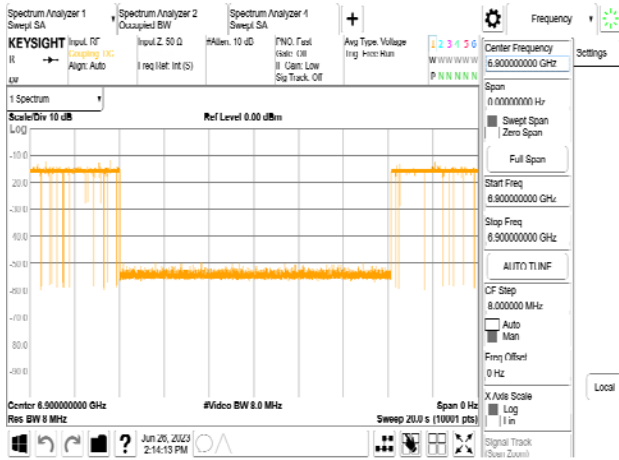

802.11be_320MHz_CF 6905MHz_Interference_6750MHz_-70.92dBm_Ceased

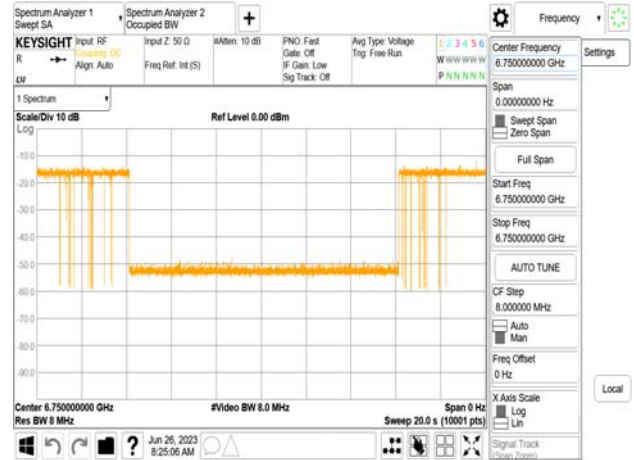

802.11be_320MHz_CF 6745MHz_Interference_6900MHz_-75.32dBm_Minimal

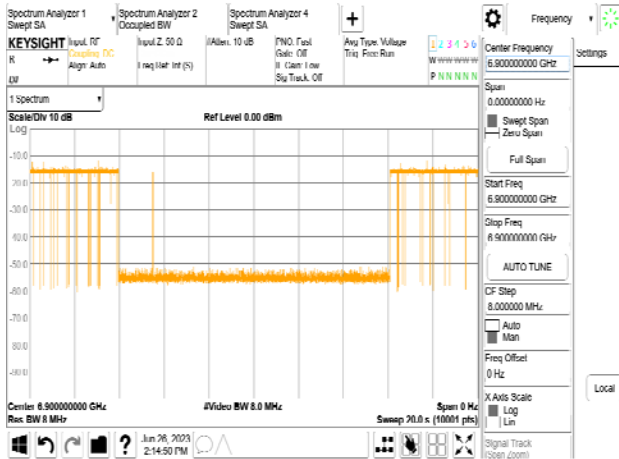

802.11be_320MHz_CF 6905MHz_Interference_6750MHz_-76.92dBm_Minimal



802.11be_320MHz_CF 6745MHz_Interference_6900MHz_-79.32dBm_Normal

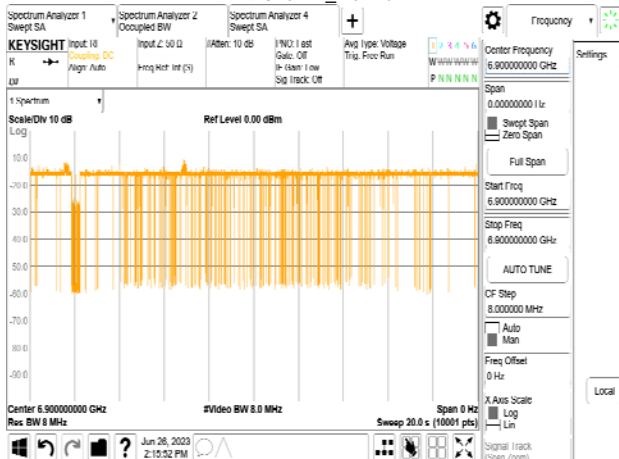

802.11be_320MHz_CF 6905MHz_Interference_6750MHz_-79.92dBm_Normal

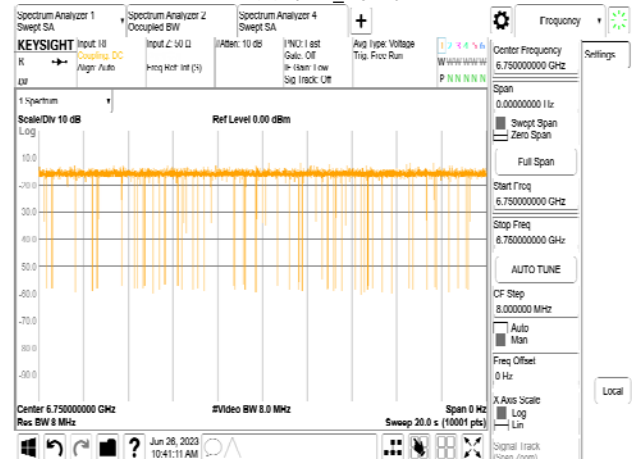

Unless otherwise stated the results shown in this test report refer only to the sample(s) tested and such sample(s) are retained for 90 days only.

除非另有說明，此報告結果僅對測試之樣品負責，同時此樣品僅保留90天。本報告未經本公司書面許可，不可部份複製。

This document is issued by the Company subject to its General Conditions of Service printed overleaf, available on request or accessible at <http://www.sgs.com.tw/Terms-and-Conditions> and for electronic format documents, subject to Terms and Conditions for Electronic Documents at <http://www.sgs.com.tw/Terms-and-Conditions>. Attention is drawn to the limitation of liability, indemnification and jurisdiction issues defined therein. Any holder of this document is advised that information contained hereon reflects the Company's findings at the time of its intervention only and within the limits of Client's instructions, if any. The Company's sole responsibility is to its Client and this document does not exonerate parties to a transaction from exercising all their rights and obligations under the transaction documents. This document cannot be reproduced except in full, without prior written approval of the Company. Any unauthorized alteration, forgery or falsification of the content or appearance of this document is unlawful and offenders may be prosecuted to the fullest extent of the law.

802.11be_320MHz_CF 6905MHz_Interference_6905MHz_-69.76dBm_Ceased

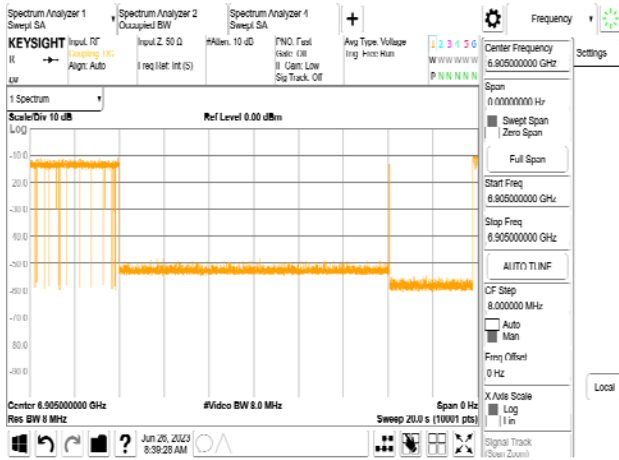

802.11be_320MHz_CF 6905MHz_Interference_7060MHz_-70.96dBm_Ceased

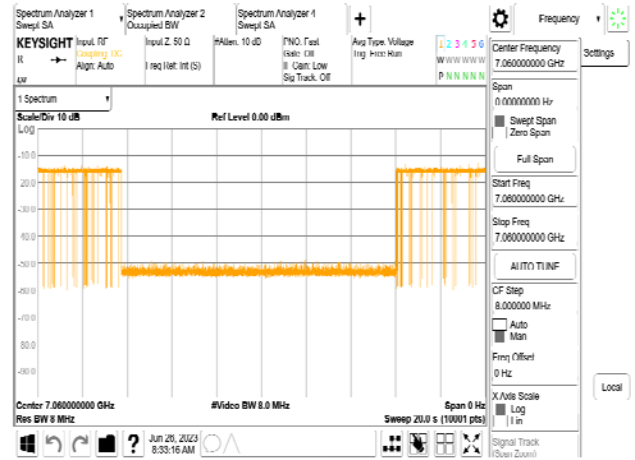

802.11be_320MHz_CF 6905MHz_Interference_6905MHz_-71.76dBm_Minimal



802.11be_320MHz_CF 6905MHz_Interference_7060MHz_-74.96dBm_Minimal

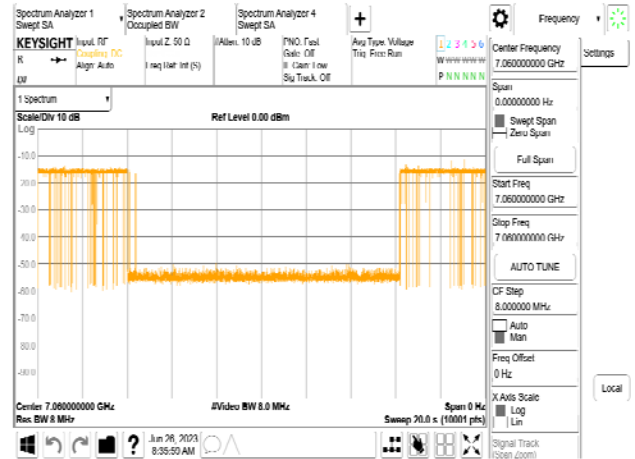

802.11be_320MHz_CF 6905MHz_Interference_6905MHz_-77.76dBm_Normal

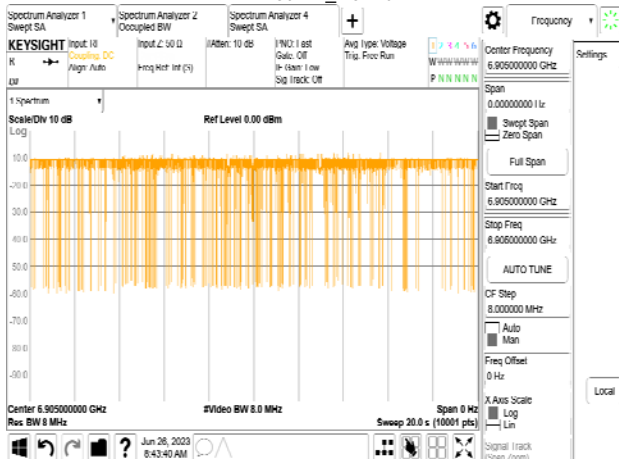

802.11be_320MHz_CF 6905MHz_Interference_7060MHz_-78.96dBm_Normal

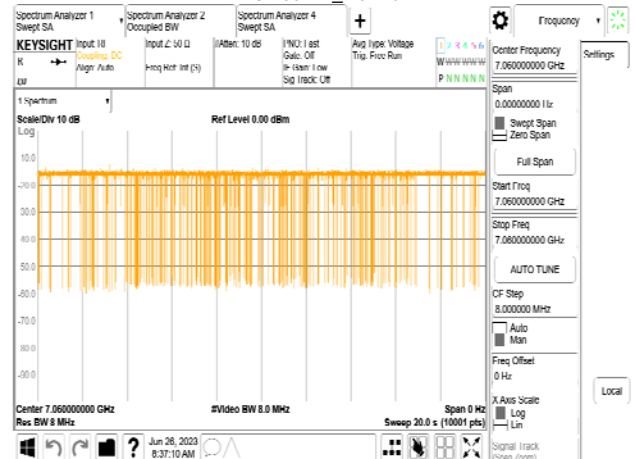

Unless otherwise stated the results shown in this test report refer only to the sample(s) tested and such sample(s) are retained for 90 days only.

除非另有說明，此報告結果僅對測試之樣品負責，同時此樣品僅保留90天。本報告未經本公司書面許可，不可部份複製。

This document is issued by the Company subject to its General Conditions of Service printed overleaf, available on request or accessible at <http://www.sgs.com.tw/Terms-and-Conditions> and for electronic format documents, subject to Terms and Conditions for Electronic Documents at <http://www.sgs.com.tw/Terms-and-Conditions>. Attention is drawn to the limitation of liability, indemnification and jurisdiction issues defined therein. Any holder of this document is advised that information contained hereon reflects the Company's findings at the time of its intervention only and within the limits of Client's instructions, if any. The Company's sole responsibility is to its Client and this document does not exonerate parties to a transaction from exercising all their rights and obligations under the transaction documents. This document cannot be reproduced except in full, without prior written approval of the Company. Any unauthorized alteration, forgery or falsification of the content or appearance of this document is unlawful and offenders may be prosecuted to the fullest extent of the law.

14 DEMONSTRATION OF PROPER POWER ADJUSTMENT BASED ON ASSOCIATED AP

14.1 Standard Applicable

A client device may connect to a Standard Power AP with a maximum power level of 30 dBm EIRP. A client may also connect to a Low Power indoor AP, but the power level is limited to a maximum of 24 dBm EIRP. If a client has the flexibility to connect to both APs, verification is needed to show that it can distinguish between the two configurations, and then control the power levels accordingly.

14.2 Measurement Procedure

1. Connect equipment as shown in Figure 6 below.
2. Adjust Atten 2 to Std Power AP so as to facilitate error free communication with the Client (Atten 1 should be set to High on the RF path to the Low Power AP).
3. Configure the Client and APs so that they associate and start sending data (stream data). It is important that the client is configured to transmit at its highest power level. Initially, because the attenuation on Atten 1 is set high, the Client will only associate with the Std Power AP.
4. Verify transmission between Client and Std Power AP. Additional attenuators may be required to protect measurement equipment. Measure the Client RF power using any of the methods in C63.10 for NII devices. Note – if the client RF power has been certified to never operate above 24 dBm EIRP then this test is not necessary.
5. Gradually increase Atten 2 while at the same time decreasing Atten 1. This simulates the Client moving from outdoors to indoors. At some level of attenuation the Client should associate with the Low Power indoor AP. Verify transmission between Client and Low Power AP.
6. Measure the RF power of the Client device using the same method as in step 4. Verify the power is no more than 24 dBm EIRP.

Note – measuring Client RF power reliably from a directional coupler measurement port may be tricky. Due to coupling, some energy from the AP will show up on the measurement port. Signal isolation techniques on the measurement analyzer will need to be used.

Unless otherwise stated the results shown in this test report refer only to the sample(s) tested and such sample(s) are retained for 90 days only.
除非另有說明，此報告結果僅對測試之樣品負責，同時此樣品僅保留90天。本報告未經本公司書面許可，不可部份複製。

This document is issued by the Company subject to its General Conditions of Service printed overleaf, available on request or accessible at <http://www.sgs.com.tw/Terms-and-Conditions> and for electronic format documents, subject to Terms and Conditions for Electronic Documents at <http://www.sgs.com.tw/Terms-and-Conditions>. Attention is drawn to the limitation of liability, indemnification and jurisdiction issues defined therein. Any holder of this document is advised that information contained hereon reflects the Company's findings at the time of its intervention only and within the limits of Client's instructions, if any. The Company's sole responsibility is to its Client and this document does not exonerate parties to a transaction from exercising all their rights and obligations under the transaction documents. This document cannot be reproduced except in full, without prior written approval of the Company. Any unauthorized alteration, forgery or falsification of the content or appearance of this document is unlawful and offenders may be prosecuted to the fullest extent of the law.

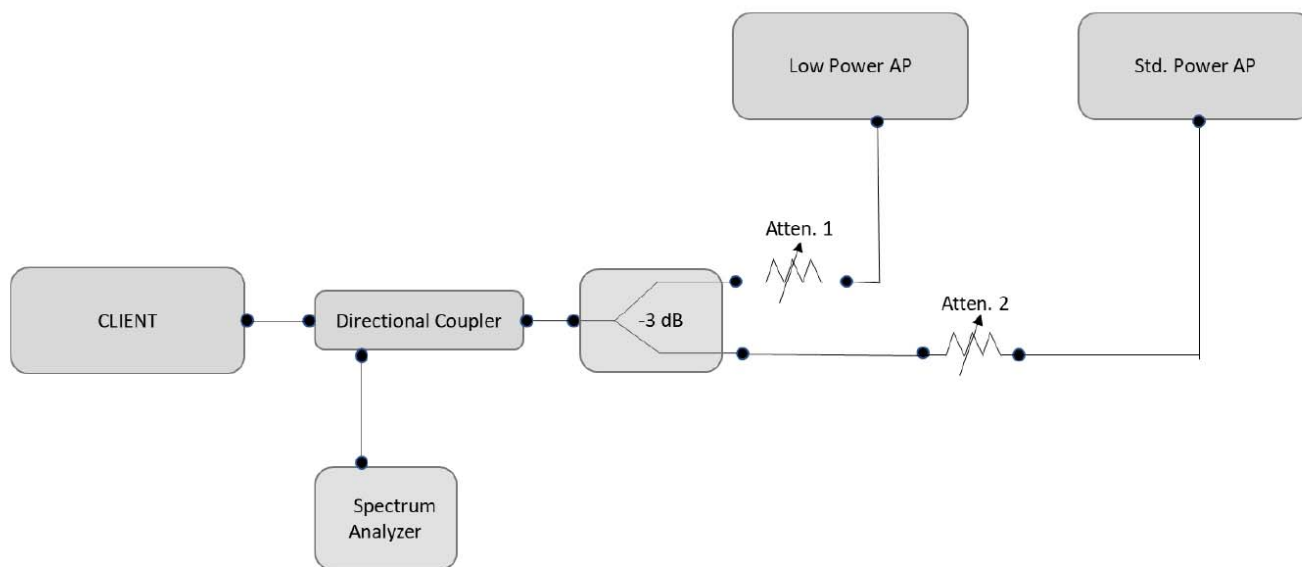

Figure 6. Test setup for conducted testing

14.4 Measurement Result

N/A, Device only associates with indoor AP

Unless otherwise stated the results shown in this test report refer only to the sample(s) tested and such sample(s) are retained for 90 days only.

除非另有說明，此報告結果僅對測試之樣品負責，同時此樣品僅保留90天。本報告未經本公司書面許可，不可部份複製。

This document is issued by the Company subject to its General Conditions of Service printed overleaf, available on request or accessible at <http://www.sgs.com.tw/Terms-and-Conditions> and for electronic format documents, subject to Terms and Conditions for Electronic Documents at <http://www.sgs.com.tw/Terms-and-Conditions>. Attention is drawn to the limitation of liability, indemnification and jurisdiction issues defined therein. Any holder of this document is advised that information contained hereon reflects the Company's findings at the time of its intervention only and within the limits of Client's instructions, if any. The Company's sole responsibility is to its Client and this document does not exonerate parties to a transaction from exercising all their rights and obligations under the transaction documents. This document cannot be reproduced except in full, without prior written approval of the Company. Any unauthorized alteration, forgery or falsification of the content or appearance of this document is unlawful and offenders may be prosecuted to the fullest extent of the law.

15 TRANSMISSION IN THE ABSENCE OF DATA

15.1 Standard Applicable

According to §15.407(c)

The device shall automatically discontinue transmission in case of either absence of information to transmit or operational failure. These provisions are not intended to preclude the transmission of control or signaling information or the use of repetitive codes used by certain digital technologies to complete frame or burst intervals. Applicants shall include in their application for equipment authorization a description of how this requirement is met.

15.2 Result

While the EUT is not transmitting any information, the EUT can automatically discontinue transmission and become standby mode for power saving. The EUT can detect the controlling signal of ASK message transmitting from remote device and verify whether it shall resend or discontinue transmission.

Unless otherwise stated the results shown in this test report refer only to the sample(s) tested and such sample(s) are retained for 90 days only.
除非另有說明，此報告結果僅對測試之樣品負責，同時此樣品僅保留90天。本報告未經本公司書面許可，不可部份複製。

This document is issued by the Company subject to its General Conditions of Service printed overleaf, available on request or accessible at <http://www.sgs.com.tw/Terms-and-Conditions> and for electronic format documents, subject to Terms and Conditions for Electronic Documents at <http://www.sgs.com.tw/Terms-and-Conditions>. Attention is drawn to the limitation of liability, indemnification and jurisdiction issues defined therein. Any holder of this document is advised that information contained hereon reflects the Company's findings at the time of its intervention only and within the limits of Client's instructions, if any. The Company's sole responsibility is to its Client and this document does not exonerate parties to a transaction from exercising all their rights and obligations under the transaction documents. This document cannot be reproduced except in full, without prior written approval of the Company. Any unauthorized alteration, forgery or falsification of the content or appearance of this document is unlawful and offenders may be prosecuted to the fullest extent of the law.

16 ANTENNA REQUIREMENT

16.1 Standard Applicable

An intentional radiator shall be designed to ensure that no antenna other than that furnished by the responsible party shall be used with the device. The use of a permanently attached antenna or of an antenna that uses a unique coupling to the intentional radiator shall be considered sufficient to comply with the provisions of this section. The manufacturer may design the unit so that a broken antenna can be replaced by the user, but the use of a standard antenna jack or electrical connector is prohibited. This requirement does not apply to carrier current devices or to devices operated under the provisions of §§ 15.211, 15.213, 15.217, 15.219, 15.221, or § 15.236. Further, this requirement does not apply to intentional radiators that must be professionally installed, such as perimeter protection systems and some field disturbance sensors, or to other intentional radiators which, in accordance with § 15.31(d), must be measured at the installation site. However, the installer shall be responsible for ensuring that the proper antenna is employed so that the limits in this part are not exceeded.

16.2 Antenna Connected Construction

The antenna complies with this requirement and no consideration of replacement. Please see EUT photo for details.

~ End of Report ~

Unless otherwise stated the results shown in this test report refer only to the sample(s) tested and such sample(s) are retained for 90 days only.
除非另有說明，此報告結果僅對測試之樣品負責，同時此樣品僅保留90天。本報告未經本公司書面許可，不可部份複製。

This document is issued by the Company subject to its General Conditions of Service printed overleaf, available on request or accessible at <http://www.sgs.com.tw/Terms-and-Conditions> and for electronic format documents, subject to Terms and Conditions for Electronic Documents at <http://www.sgs.com.tw/Terms-and-Conditions>. Attention is drawn to the limitation of liability, indemnification and jurisdiction issues defined therein. Any holder of this document is advised that information contained hereon reflects the Company's findings at the time of its intervention only and within the limits of Client's instructions, if any. The Company's sole responsibility is to its Client and this document does not exonerate parties to a transaction from exercising all their rights and obligations under the transaction documents. This document cannot be reproduced except in full, without prior written approval of the Company. Any unauthorized alteration, forgery or falsification of the content or appearance of this document is unlawful and offenders may be prosecuted to the fullest extent of the law.