

**ELECTROMAGNETIC EMISSIONS  
COMPLIANCE REPORT**

**Applicant:** ASUSTeK COMPUTER INC.  
1F., No.15, Lide Rd., Beitou District, Taipei City 112, Taiwan

**Manufacturer:** ASUSTeK COMPUTER INC.  
1F., No.15, Lide Rd., Beitou District, Taipei City 112, Taiwan

**Product Name:** ASUS Phone (Mobile Phone)

**Brand Name:** ASUS

**Model No.:** ASUS\_AI2302

**Report Number:** TERF2305001075ER

**FCC ID** MSQA12302

**Issue Date:** July 17, 2023

**Date of Test:** May 03, 2023 ~ July 04, 2023

**Date of EUT Received:** April 24, 2023

Approved By \_\_\_\_\_

**Blue Yang**

**We hereby certify that:**

The above equipment was tested by SGS Taiwan Ltd. Central RF Lab The test data, data evaluation, test procedures, and equipment configurations shown in this report were made in accordance with the procedures given in ANSI C63.26-2015 and the energy emitted by the sample EUT comply with FCC rule part 2 , 22H & 24E & 27 C.

The results of this report relate only to the sample identified in this report.

Unless otherwise stated the results shown in this test report refer only to the sample(s) tested and such sample(s) are retained for 90 days only.  
除非另有說明，此報告結果僅對測試之樣品負責，同時此樣品僅保留90天。本報告未經本公司書面許可，不可部份複製。

This document is issued by the Company subject to its General Conditions of Service printed overleaf, available on request or accessible at <http://www.sgs.com.tw/Terms-and-Conditions> and for electronic format documents, subject to Terms and Conditions for Electronic Documents at <http://www.sgs.com.tw/Terms-and-Conditions>. Attention is drawn to the limitation of liability, indemnification and jurisdiction issues defined therein. Any holder of this document is advised that information contained hereon reflects the Company's findings at the time of its intervention only and within the limits of Client's instructions, if any. The Company's sole responsibility is to its Client and this document does not exonerate parties to a transaction from exercising all their rights and obligations under the transaction documents. This document cannot be reproduced except in full, without prior written approval of the Company. Any unauthorized alteration, forgery or falsification of the content or appearance of this document is unlawful and offenders may be prosecuted to the fullest extent of the law.

## Revision History

Report Number	Revision	Description	Issue Date	Revised By	Remark
TERF2305001075ER	00	Original.	July 17, 2023	Tiffany Kao	

**Note:**

- 1、The remark "" indicates modification of the report upon requests from certification body.

Unless otherwise stated the results shown in this test report refer only to the sample(s) tested and such sample(s) are retained for 90 days only.  
 除非另有說明，此報告結果僅對測試之樣品負責，同時此樣品僅保留90天。本報告未經本公司書面許可，不可部份複製。

This document is issued by the Company subject to its General Conditions of Service printed overleaf, available on request or accessible at <http://www.sgs.com.tw/Terms-and-Conditions> and for electronic format documents, subject to Terms and Conditions for Electronic Documents at <http://www.sgs.com.tw/Terms-and-Conditions>. Attention is drawn to the limitation of liability, indemnification and jurisdiction issues defined therein. Any holder of this document is advised that information contained hereon reflects the Company's findings at the time of its intervention only and within the limits of Client's instructions, if any. The Company's sole responsibility is to its Client and this document does not exonerate parties to a transaction from exercising all their rights and obligations under the transaction documents. This document cannot be reproduced except in full, without prior written approval of the Company. Any unauthorized alteration, forgery or falsification of the content or appearance of this document is unlawful and offenders may be prosecuted to the fullest extent of the law.

## Contents

<b>1</b>	<b>GENERAL PRODUCT INFORMATION .....</b>	<b>4</b>
<b>2</b>	<b>SYSTEM TEST CONFIGURATION .....</b>	<b>9</b>
<b>3</b>	<b>Test Configuration .....</b>	<b>11</b>
<b>4</b>	<b>SUMMARY OF TEST RESULTS .....</b>	<b>12</b>
<b>5</b>	<b>DESCRIPTION OF TEST MODES .....</b>	<b>13</b>
<b>6</b>	<b>MEASUREMENT UNCERTAINTY .....</b>	<b>14</b>
<b>7</b>	<b>MEASUREMENT EQUIPMENT USED.....</b>	<b>15</b>
<b>8</b>	<b>MAXIMUM OUTPUT POWER .....</b>	<b>17</b>
<b>9</b>	<b>OCCUPIED BANDWIDTH MEASUREMENT .....</b>	<b>25</b>
<b>10</b>	<b>OUT OF BAND EMISSION AT ANTENNA TERMINALS .....</b>	<b>35</b>
<b>11</b>	<b>FIELD STRENGTH OF SPURIOUS RADIATION MEASUREMENT.....</b>	<b>56</b>
<b>12</b>	<b>FREQUENCY STABILITY MEASUREMENT .....</b>	<b>88</b>
<b>13</b>	<b>PEAK TO AVERAGE RATIO .....</b>	<b>92</b>

Unless otherwise stated the results shown in this test report refer only to the sample(s) tested and such sample(s) are retained for 90 days only.

除非另有說明，此報告結果僅對測試之樣品負責，同時此樣品僅保留90天。本報告未經本公司書面許可，不可部份複製。

This document is issued by the Company subject to its General Conditions of Service printed overleaf, available on request or accessible at <http://www.sgs.com.tw/Terms-and-Conditions> and for electronic format documents, subject to Terms and Conditions for Electronic Documents at <http://www.sgs.com.tw/Terms-and-Conditions>. Attention is drawn to the limitation of liability, indemnification and jurisdiction issues defined therein. Any holder of this document is advised that information contained hereon reflects the Company's findings at the time of its intervention only and within the limits of Client's instructions, if any. The Company's sole responsibility is to its Client and this document does not exonerate parties to a transaction from exercising all their rights and obligations under the transaction documents. This document cannot be reproduced except in full, without prior written approval of the Company. Any unauthorized alteration, forgery or falsification of the content or appearance of this document is unlawful and offenders may be prosecuted to the fullest extent of the law.

## 1 GENERAL PRODUCT INFORMATION

### 1.1 Product Description

Product Name:	ASUS Phone (Mobile Phone)
Brand Name:	ASUS
Model No.:	ASUS_AI2302
Hardware Version:	N/A
Firmware Version:	WW_33.0204.0204.16
EUT Series No.:	R4AIB7N00566GZ3
Power Supply:	3.89 Vdc from Battery or 5 / 9 / 12 / 15 / 20 Vdc from AC Adapter
Test Software (Name/Version)	Default

### 1.2 Operation Frequency Range

Operating Frequency (MHz)	
GSM/GPRS/EDGE 850	824.2 - 848.8
GSM/GPRS/EDGE 1900	1850.2 - 1909.8

Operating Frequency (MHz)	
WCDMA / HSPA+ Band II	1852.4 - 1907.6
WCDMA / HSPA+ Band IV	1712.4 - 1752.6
WCDMA / HSPA+ Band V	826.4 - 846.6

Unless otherwise stated the results shown in this test report refer only to the sample(s) tested and such sample(s) are retained for 90 days only.

除非另有說明，此報告結果僅對測試之樣品負責，同時此樣品僅保留90天。本報告未經本公司書面許可，不可部份複製。

This document is issued by the Company subject to its General Conditions of Service printed overleaf, available on request or accessible at <http://www.sgs.com.tw/Terms-and-Conditions> and for electronic format documents, subject to Terms and Conditions for Electronic Documents at <http://www.sgs.com.tw/Terms-and-Conditions>. Attention is drawn to the limitation of liability, indemnification and jurisdiction issues defined therein. Any holder of this document is advised that information contained hereon reflects the Company's findings at the time of its intervention only and within the limits of Client's instructions, if any. The Company's sole responsibility is to its Client and this document does not exonerate parties to a transaction from exercising all their rights and obligations under the transaction documents. This document cannot be reproduced except in full, without prior written approval of the Company. Any unauthorized alteration, forgery or falsification of the content or appearance of this document is unlawful and offenders may be prosecuted to the fullest extent of the law.

### 1.3 Antenna Designation

Antenna Type	Antenna Model No.
PIFA	Ant1
	Ant2
	Ant3
	Ant4

**Note:** Transmission in frequencies in this test report are only available by the above antenna(s).

Modulation	Frequency (MHz)	Peak Antenna Gain (dBi)			
		Ant1	Ant2	Ant3	Ant4
GSM/GPRS/EDGE 850	824.2 - 848.8	-3.74		-4.68	
GSM/GPRS/EDGE 1900	1850.2 - 1909.8		-3.6		-3.16
WCDMA / HSPA+ Band II	1852.4 - 1907.6		-3.6		-3.16
WCDMA / HSPA+ Band IV	1712.4 - 1752.6		-2.74		-4.05
WCDMA / HSPA+ Band V	826.4 - 846.6	-3.74		-4.68	

**Note:** Antenna information is provided by the applicant.

Unless otherwise stated the results shown in this test report refer only to the sample(s) tested and such sample(s) are retained for 90 days only.

除非另有說明，此報告結果僅對測試之樣品負責，同時此樣品僅保留90天。本報告未經本公司書面許可，不可部份複製。

This document is issued by the Company subject to its General Conditions of Service printed overleaf, available on request or accessible at <http://www.sgs.com.tw/Terms-and-Conditions> and for electronic format documents, subject to Terms and Conditions for Electronic Documents at <http://www.sgs.com.tw/Terms-and-Conditions>. Attention is drawn to the limitation of liability, indemnification and jurisdiction issues defined therein. Any holder of this document is advised that information contained hereon reflects the Company's findings at the time of its intervention only and within the limits of Client's instructions, if any. The Company's sole responsibility is to its Client and this document does not exonerate parties to a transaction from exercising all their rights and obligations under the transaction documents. This document cannot be reproduced except in full, without prior written approval of the Company. Any unauthorized alteration, forgery or falsification of the content or appearance of this document is unlawful and offenders may be prosecuted to the fullest extent of the law.

**1.4 Type of Emission & Max ERP/EIRP Power Measurement Result:**

Mode	ERP / EIRP (dBm)		W	99%	Type of Emission
GSM 850	27.41	ERP	0.551	0.2480	248KGXW
GPRS 850	27.30	ERP	0.537	0.2500	250KGXW
EDGE 850	21.63	ERP	0.146	0.2465	246KG7W
GSM 1900	25.75	EIRP	0.376	0.2443	244KGXW
GPRS 1900	25.72	EIRP	0.373	0.2485	249KGXW
EDGE 1900	22.19	EIRP	0.166	0.2490	249KG7W
Mode	ERP / EIRP (dBm)		W	99%	Type of Emission
WCDMA Band II	19.78	EIRP	0.095	4.1548	4M15F9W
HSDPA Band II	18.68	EIRP	0.074	4.1543	4M15F9W
HSUPA Band II	18.57	EIRP	0.072	4.1500	4M15F9W
WCDMA Band IV	20.82	EIRP	0.121	4.1526	4M15F9W
HSDPA Band IV	19.66	EIRP	0.092	4.1516	4M15F9W
HSUPA Band IV	19.65	EIRP	0.092	4.1601	4M16F9W
WCDMA Band V	17.53	ERP	0.057	4.1432	4M14F9W
HSDPA Band V	16.34	ERP	0.043	4.1425	4M14F9W
HSUPA Band V	16.45	ERP	0.044	4.1441	4M14F9W

Unless otherwise stated the results shown in this test report refer only to the sample(s) tested and such sample(s) are retained for 90 days only.

除非另有說明，此報告結果僅對測試之樣品負責，同時此樣品僅保留90天。本報告未經本公司書面許可，不可部份複製。

This document is issued by the Company subject to its General Conditions of Service printed overleaf, available on request or accessible at <http://www.sgs.com.tw/Terms-and-Conditions> and for electronic format documents, subject to Terms and Conditions for Electronic Documents at <http://www.sgs.com.tw/Terms-and-Conditions>. Attention is drawn to the limitation of liability, indemnification and jurisdiction issues defined therein. Any holder of this document is advised that information contained hereon reflects the Company's findings at the time of its intervention only and within the limits of Client's instructions, if any. The Company's sole responsibility is to its Client and this document does not exonerate parties to a transaction from exercising all their rights and obligations under the transaction documents. This document cannot be reproduced except in full, without prior written approval of the Company. Any unauthorized alteration, forgery or falsification of the content or appearance of this document is unlawful and offenders may be prosecuted to the fullest extent of the law.

**1.5 Test Methodology of Applied Standards**

FCC 47 CFR Part 2, 22H, 24E, 27C  
ANSI C63.26-2015

KDB971168 D01 Power Meas license Digital System v03r01

KDB941225 D01 SAR test for 3G devices v03r01 (SAR Measurement Procedures for 3G Devices, WCDMA/ HSPA) was used for EUT and Base station setting.

KDB412172 D01 Determining ERP and EIRP v01r01

TS 151 010-1 is used to set, and measure the output power.

**1.6 Test Facility**

Laboratory	Test Site Address	Test Site Name	FCC Designation number	IC CAB identifier
SGS Taiwan Ltd. Central RF Lab. (TAF code 3702)	No.134, Wu Kung Road, New Taipei Industrial Park, Wuku District, New Taipei City, Taiwan.	SAC 1	TW0027	TW3702
		SAC 2		
		SAC 3		
		Conduction 1		
		Conducted 1		
		Conducted 2		
		Conducted 3		
		Conducted 4		
		Conducted 5		
	Conducted 6			
	No.2, Keji 1st Rd., Guishan District, Taoyuan City, Taiwan 333	Conduction C	TW0028	
		SAC C		
		SAC D		
		SAC G		
		Conducted A		
		Conducted B		
		Conducted C		
		Conducted D		
		Conducted E		
Conducted F				
Conducted G				

**Note:** Test site name is remarked on the equipment list in each section of this report as an indication where measurements occurred in specific test site and address.

Unless otherwise stated the results shown in this test report refer only to the sample(s) tested and such sample(s) are retained for 90 days only.  
除非另有說明，此報告結果僅對測試之樣品負責，同時此樣品僅保留90天。本報告未經本公司書面許可，不可部份複製。

This document is issued by the Company subject to its General Conditions of Service printed overleaf, available on request or accessible at <http://www.sgs.com.tw/Terms-and-Conditions> and for electronic format documents, subject to Terms and Conditions for Electronic Documents at <http://www.sgs.com.tw/Terms-and-Conditions>. Attention is drawn to the limitation of liability, indemnification and jurisdiction issues defined therein. Any holder of this document is advised that information contained hereon reflects the Company's findings at the time of its intervention only and within the limits of Client's instructions, if any. The Company's sole responsibility is to its Client and this document does not exonerate parties to a transaction from exercising all their rights and obligations under the transaction documents. This document cannot be reproduced except in full, without prior written approval of the Company. Any unauthorized alteration, forgery or falsification of the content or appearance of this document is unlawful and offenders may be prosecuted to the fullest extent of the law.

### 1.7 Special Accessories

No special accessories were used during testing.

### 1.8 Equipment Modifications

There was no modifications incorporated into the EUT.

### 1.9 Radiated Emission Test Sites For Measurements From 9 kHz To 30 MHz

Radiated emission below 30MHz is measured in a 9m\*6m\*6m semi-anechoic chamber, the measurements correspond to those obtained at an open-field test site.

There is a comparison data of both open-field test site and semi-Anechoic chamber, and the result came out very similar.

Unless otherwise stated the results shown in this test report refer only to the sample(s) tested and such sample(s) are retained for 90 days only.  
除非另有說明，此報告結果僅對測試之樣品負責，同時此樣品僅保留90天。本報告未經本公司書面許可，不可部份複製。

This document is issued by the Company subject to its General Conditions of Service printed overleaf, available on request or accessible at <http://www.sgs.com.tw/Terms-and-Conditions> and for electronic format documents, subject to Terms and Conditions for Electronic Documents at <http://www.sgs.com.tw/Terms-and-Conditions>. Attention is drawn to the limitation of liability, indemnification and jurisdiction issues defined therein. Any holder of this document is advised that information contained hereon reflects the Company's findings at the time of its intervention only and within the limits of Client's instructions, if any. The Company's sole responsibility is to its Client and this document does not exonerate parties to a transaction from exercising all their rights and obligations under the transaction documents. This document cannot be reproduced except in full, without prior written approval of the Company. Any unauthorized alteration, forgery or falsification of the content or appearance of this document is unlawful and offenders may be prosecuted to the fullest extent of the law.



## 2 SYSTEM TEST CONFIGURATION

### 2.1 EUT Configuration

The EUT configuration for testing is installed on RF field strength measurement to meet the Commissions requirement and operating in a manner which intends to maximize its emission characteristics in a continuous normal application.

### 2.2 EUT Exercise

The EUT (Transmitter) was operated in the continuous transmission mode employed with the simulator of the Base Station that fixates at test default channels to fix the Tx frequency which was for the purpose of the measurements.

### 2.3 Test Procedure

#### 2.3.1 Conducted Measurement at Antenna Port

The EUT is placed on a table which is 0.8 m above ground plane. A low loss of RF cable was used to connect the antenna port of EUT to measurement equipment.

#### 2.3.2 Radiated Emissions (ERP/EIRP)

The EUT is placed on a turn table, for emission measurements below 1 GHz is 0.8 m above ground plane, for emission measurements above 1 GHz, the table height shall be 1.5 m. The turn table shall rotate 360 degrees to determine the position of maximum emission level. EUT is set 3m away from the receiving antenna which varied from 1m to 4m to find out the highest emission. And also, each emission was to be maximized by changing the polarization of receiving antenna both Horizontal and Vertical. In order to find out the max. emission, the relative positions of this transmitter (EUT) was rotated through three orthogonal axes and measurement procedures for electric field radiated emissions above 1 GHz the EUT measurement is to be made "while keeping the antenna in the 'cone of radiation' from that area and pointed at the area both in azimuth and elevation, with polarization oriented for maximum response." is still within the 3dB illumination BW of the measurement antenna.

### 2.4 Measurement Results Explanation Example

#### For all conducted test items:

The offset level is set in the spectrum analyzer to compensate the RF cable loss and attenuation factor between EUT conducted port and spectrum analyzer. With the offset compensation, the spectrum analyzer reading level is exactly EUT RF output level.

#### Note:

The spectrum analyzer offset is derived from RF cable loss and attenuator factor.

## 2.5 Final Amplifier Voltage and Current Information:

Test mode	DC voltage (V)	DC current (mA)
GSM 850	3.89	623
GPRS 850	3.89	631
EDGE 850	3.89	604
GSM 1900	3.89	615
GPRS 1900	3.89	634
EDGE 1900	3.89	611
WCDMA B2	3.89	625
HSUPA B2	3.89	628
HSDPA B2	3.89	637
WCDMA B4	3.89	624
HSUPA B4	3.89	619
HSDPA B4	3.89	608
WCDMA B5	3.89	622
HSUPA B5	3.89	639
HSDPA B5	3.89	616

Unless otherwise stated the results shown in this test report refer only to the sample(s) tested and such sample(s) are retained for 90 days only.  
 除非另有說明，此報告結果僅對測試之樣品負責，同時此樣品僅保留90天。本報告未經本公司書面許可，不可部份複製。

This document is issued by the Company subject to its General Conditions of Service printed overleaf, available on request or accessible at <http://www.sgs.com.tw/Terms-and-Conditions> and for electronic format documents, subject to Terms and Conditions for Electronic Documents at <http://www.sgs.com.tw/Terms-and-Conditions>. Attention is drawn to the limitation of liability, indemnification and jurisdiction issues defined therein. Any holder of this document is advised that information contained hereon reflects the Company's findings at the time of its intervention only and within the limits of Client's instructions, if any. The Company's sole responsibility is to its Client and this document does not exonerate parties to a transaction from exercising all their rights and obligations under the transaction documents. This document cannot be reproduced except in full, without prior written approval of the Company. Any unauthorized alteration, forgery or falsification of the content or appearance of this document is unlawful and offenders may be prosecuted to the fullest extent of the law.

### 3 TEST CONFIGURATION

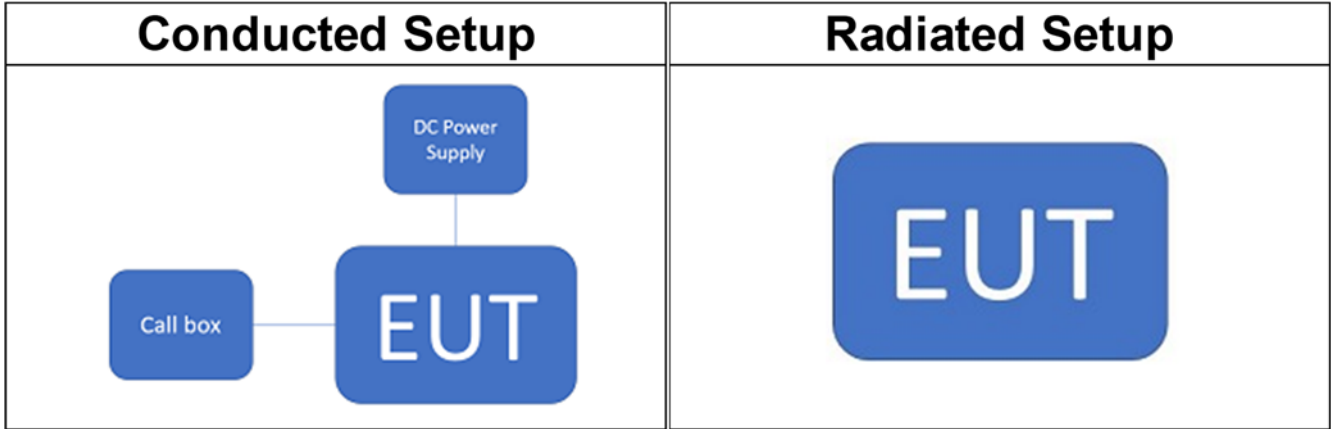

**Note:** Radio Communication Analyzer is placed in remote side for radiated test.

#### 3.1 Control Unit(s)

N/A

Unless otherwise stated the results shown in this test report refer only to the sample(s) tested and such sample(s) are retained for 90 days only.

除非另有說明，此報告結果僅對測試之樣品負責，同時此樣品僅保留90天。本報告未經本公司書面許可，不可部份複製。

This document is issued by the Company subject to its General Conditions of Service printed overleaf, available on request or accessible at <http://www.sgs.com.tw/Terms-and-Conditions> and for electronic format documents, subject to Terms and Conditions for Electronic Documents at <http://www.sgs.com.tw/Terms-and-Conditions>. Attention is drawn to the limitation of liability, indemnification and jurisdiction issues defined therein. Any holder of this document is advised that information contained hereon reflects the Company's findings at the time of its intervention only and within the limits of Client's instructions, if any. The Company's sole responsibility is to its Client and this document does not exonerate parties to a transaction from exercising all their rights and obligations under the transaction documents. This document cannot be reproduced except in full, without prior written approval of the Company. Any unauthorized alteration, forgery or falsification of the content or appearance of this document is unlawful and offenders may be prosecuted to the fullest extent of the law.

## 4 SUMMARY OF TEST RESULTS

FCC Rules	Description Of Test	Result
§2.1046(a)	RF Power Output	Compliant
§22.913(a)(5) §24.232(c) §27.50(d)(4)	ERP/ EIRP measurement	Compliant
§2.1049(h)	99% & 26dB Occupied Bandwidth	Compliant
§2.1051 §22.917(a) §24.238(a) §27.53(h)	Out of Band Emissions at Antenna Terminals and Band Edge / Emission mask requirements	Compliant
§2.1053 §22.917(a) §24.238(a) §27.53(h)	Field Strength of Spurious Radiation	Compliant
§24.232(d) §27.50(a)(1)(B)	Peak to Average Ratio	Compliant
§2.1055(a)(1) §22.355 §24.235 §27.54	Frequency Stability	Compliant

Unless otherwise stated the results shown in this test report refer only to the sample(s) tested and such sample(s) are retained for 90 days only.

除非另有說明，此報告結果僅對測試之樣品負責，同時此樣品僅保留90天。本報告未經本公司書面許可，不可部份複製。

This document is issued by the Company subject to its General Conditions of Service printed overleaf, available on request or accessible at <http://www.sgs.com.tw/Terms-and-Conditions> and for electronic format documents, subject to Terms and Conditions for Electronic Documents at <http://www.sgs.com.tw/Terms-and-Conditions>. Attention is drawn to the limitation of liability, indemnification and jurisdiction issues defined therein. Any holder of this document is advised that information contained hereon reflects the Company's findings at the time of its intervention only and within the limits of Client's instructions, if any. The Company's sole responsibility is to its Client and this document does not exonerate parties to a transaction from exercising all their rights and obligations under the transaction documents. This document cannot be reproduced except in full, without prior written approval of the Company. Any unauthorized alteration, forgery or falsification of the content or appearance of this document is unlawful and offenders may be prosecuted to the fullest extent of the law.

## 5 DESCRIPTION OF TEST MODES

### 5.1 The Worst Test Modes and Channel Details

1. The EUT has been tested under operating condition.
2. The field strength of radiated emission was measured as the EUT positioned in different orthogonal planes (E1/E2/H) based on actual usage of the EUT to pre-scan the emissions for determining the worst case scenario.

### 5.2 Measurement Configuration

RADIATED EMISSION	GSM Bands	Test Channel		
		L	M	H
ERP	850	v	v	v
EIRP	1900	v	v	v
FREQUENCY STABILITY	850	-	v	-
	1900	-	v	-
OCCUPIED BANDWIDTH	850	v	v	v
	1900	v	v	v
PEAK TO AVERAGE RATIO	850	v	v	v
	1900	v	v	v
BAND EDGE	850	v	-	v
	1900	v	-	v
CONDCUDED EMISSION	850	v	v	v
	1900	v	v	v
RADIATED EMISSION	850	v	v	v
	1900	v	v	v
	1900	v	v	v

Test Items	WCDMA / HSPA Bands	Test Channel		
		L	M	H
ERP	Band V	v	v	v
EIRP	Bnad II	v	v	v
	Band IV	v	v	v
FREQUENCY STABILITY	Bnad II	-	v	-
	Band IV	-	v	-
	Band V	-	v	-
OCCUPIED BANDWIDTH	Bnad II	v	v	v
	Band IV	v	v	v
	Band V	v	v	v
PEAK TO AVERAGE RATIO	Bnad II	v	v	v
	Band IV	v	v	v
	Band V	v	v	v
BAND EDGE	Bnad II	v	-	v
	Band IV	v	-	v
	Band V	v	-	v
CONDCUDED EMISSION	Bnad II	v	v	v
	Band IV	v	v	v
	Band V	v	v	v
RADIATED EMISSION	Bnad II	v	v	v
	Band IV	v	v	v
	Band V	v	v	v

Unless otherwise stated the results shown in this test report refer only to the sample(s) tested and such sample(s) are retained for 90 days only.  
 除非另有說明，此報告結果僅對測試之樣品負責，同時此樣品僅保留90天。本報告未經本公司書面許可，不可部份複製。

This document is issued by the Company subject to its General Conditions of Service printed overleaf, available on request or accessible at <http://www.sgs.com.tw/Terms-and-Conditions> and for electronic format documents, subject to Terms and Conditions for Electronic Documents at <http://www.sgs.com.tw/Terms-and-Conditions>. Attention is drawn to the limitation of liability, indemnification and jurisdiction issues defined therein. Any holder of this document is advised that information contained hereon reflects the Company's findings at the time of its intervention only and within the limits of Client's instructions, if any. The Company's sole responsibility is to its Client and this document does not exonerate parties to a transaction from exercising all their rights and obligations under the transaction documents. This document cannot be reproduced except in full, without prior written approval of the Company. Any unauthorized alteration, forgery or falsification of the content or appearance of this document is unlawful and offenders may be prosecuted to the fullest extent of the law.

## 6 MEASUREMENT UNCERTAINTY

Test Items	Uncertainty
RF Power Output	+/- 1 dB
ERP/ EIRP measurement	+/- 2.93 dB
	+/- 2.93 dB
Emission Bandwidth	+/- 1.53 Hz
Out of Band Emissions at Antenna Terminals and Band Edge	+/- 1.68 dB
Peak to Average Ratio	+/- 1 dB
Frequency Stability vs. Temperature	+/- 1.53 Hz
Frequency Stability vs. Voltage	+/- 1.53 Hz
Temperature	+/- 0.7 °C
Humidity	+/- 3 %
DC / AC Power Source	+/- 1 %

Radiated Spurious Emission Measurement Uncertainty		
Polarization: Vertical	+/- 2.8 dB	9kHz~30MHz
	+/- 4.82 dB	30MHz - 1000MHz
	+/- 4.37 dB	1GHz - 18GHz
	+/- 4.21 dB	18GHz - 40GHz
Polarization: Horizontal	+/- 2.8 dB	9kHz~30MHz
	+/- 4.54 dB	30MHz - 1000MHz
	+/- 4.37 dB	1GHz - 18GHz
	+/- 4.21 dB	18GHz - 40GHz

This uncertainty represents an expanded uncertainty expressed at approximately the 95% confidence level using a coverage factor of k=2.

Unless otherwise stated the results shown in this test report refer only to the sample(s) tested and such sample(s) are retained for 90 days only.

除非另有說明，此報告結果僅對測試之樣品負責，同時此樣品僅保留90天。本報告未經本公司書面許可，不可部份複製。

This document is issued by the Company subject to its General Conditions of Service printed overleaf, available on request or accessible at <http://www.sgs.com.tw/Terms-and-Conditions> and for electronic format documents, subject to Terms and Conditions for Electronic Documents at <http://www.sgs.com.tw/Terms-and-Conditions>. Attention is drawn to the limitation of liability, indemnification and jurisdiction issues defined therein. Any holder of this document is advised that information contained hereon reflects the Company's findings at the time of its intervention only and within the limits of Client's instructions, if any. The Company's sole responsibility is to its Client and this document does not exonerate parties to a transaction from exercising all their rights and obligations under the transaction documents. This document cannot be reproduced except in full, without prior written approval of the Company. Any unauthorized alteration, forgery or falsification of the content or appearance of this document is unlawful and offenders may be prosecuted to the fullest extent of the law.

## 7 MEASUREMENT EQUIPMENT USED

### 7.1 Conducted Measurement

Conducted Emission Test Site: Conducted 4					
EQUIPMENT TYPE	MFR	MODEL NUMBER	SERIAL NUMBER	LAST CAL.	CAL DUE.
PXA Spectrum Analyzer	Agilent	N9030A	MY53120760	05/03/2023	05/02/2024
Radio Communication Analyzer	Anritsu	MT8815B	6200711454	04/23/2023	04/22/2024
Test Software	WORLD PALLAS	Dr.E	Ver. 3.0	N.C.R	N.C.R
Temperature Chamber	Giant Force	GTH-150-40-CP-AR	MAA0512-018	05/24/2023	05/23/2024
DC Power Supply	Gwinstek	SPS-3610	GEV856733	12/03/2022	12/02/2023
Attenuator	Mini-Circuit	BW-S10W2+	4	12/13/2022	12/12/2023
DC Block	Mini-Circuits	BLK-18-S+	1	12/13/2022	12/12/2023
Power Divider	RF-LAMBAD	RFLT2W1G18G	11-JSPF412-018	12/13/2022	12/12/2023

Unless otherwise stated the results shown in this test report refer only to the sample(s) tested and such sample(s) are retained for 90 days only.

除非另有說明，此報告結果僅對測試之樣品負責，同時此樣品僅保留90天。本報告未經本公司書面許可，不可部份複製。

This document is issued by the Company subject to its General Conditions of Service printed overleaf, available on request or accessible at <http://www.sgs.com.tw/Terms-and-Conditions> and for electronic format documents, subject to Terms and Conditions for Electronic Documents at <http://www.sgs.com.tw/Terms-and-Conditions>. Attention is drawn to the limitation of liability, indemnification and jurisdiction issues defined therein. Any holder of this document is advised that information contained hereon reflects the Company's findings at the time of its intervention only and within the limits of Client's instructions, if any. The Company's sole responsibility is to its Client and this document does not exonerate parties to a transaction from exercising all their rights and obligations under the transaction documents. This document cannot be reproduced except in full, without prior written approval of the Company. Any unauthorized alteration, forgery or falsification of the content or appearance of this document is unlawful and offenders may be prosecuted to the fullest extent of the law.

7.2 Radiated Measurement

Radiated Emission Test Site: SAC 2					
EQUIPMENT TYPE	MFR	MODEL NUMBER	SERIAL NUMBER	LAST CAL.	CAL DUE.
Bi-log Antenna	SCHWARZBECK	VULB9168	1208	07/07/2022	07/06/2023
Horn Antenna	RF SPIN	DRH18-E	210303A18-ES	02/24/2023	02/23/2024
Bi-log Antenna	SCHWARZBECK	VULB9168	9168-1278	03/09/2023	03/08/2024
Horn Antenna	SCHWARZBECK	BBHA9120D	603	05/11/2023	05/10/2024
Horn Antenna	SCHWARZBECK	BBHA9170	184	12/30/2022	12/29/2023
Horn Antenna	SCHWARZBECK	BBHA9170	185	08/22/2022	08/21/2023
Test Software	Audix	e3	Ver. 9.210322	N.C.R	N.C.R
EXA Spectrum Analyzer	KEYSIGHT	N9010B	MY60242392	12/20/2022	12/19/2023
Signal Generator	R&S	SMBV100A	263084	12/29/2022	12/28/2023
Radio Communication Analyser	Anritsu	MT8815A	6200429620	01/11/2023	01/10/2024
Pre-Amplifier	EMCI	EMC330N	980826	08/31/2022	08/30/2023
Pre-Amplifier	EMCI	EMC118A45SEE	980867	08/31/2022	08/30/2023
Pre-Amplifier	EMCI	EMC184045B	980135	10/27/2022	10/26/2023
Bandreject Filter 635-920	Micro-Tronics	WI	4	12/13/2022	12/12/2023
Bandreject Filter 1700-2000	Micro-Tronics	EWT	M3	12/13/2022	12/12/2023
1GHz High Pass Filter	Micro-Tronics	HPM50108	32	12/13/2022	12/12/2023
2GHz High Pass Filter	Micro-Tronics	HPM50110	36	12/13/2022	12/12/2023
Coaxial Cables	EMCI	EMCCFD400-NM-NM-10000	RX Cable below 1G (220238)	08/31/2022	08/30/2023
Coaxial Cables	EMCI	EMC104-SM-SM-600	RX Cable below 1G (220237)	08/31/2022	08/30/2023
Coaxial Cables	EMCI	EMC105-SM-SM-2000	RX Cable below 1G (220910)	08/31/2022	08/30/2023
Coaxial Cables	EMCI	EMC104-SM-SM-10000	RX Cable above 1G (220236)	08/31/2022	08/30/2023
Coaxial Cables	EMCI	EMC105-SM-SM-1000	RX Cable above 1G (201211)	08/31/2022	08/30/2023
Coaxial Cables	EMCI	EMC105-SM-SM-1500	RX Cable above 1G (220906)	08/31/2022	08/30/2023
Coaxial Cables	EMCI	EMC105-SM-SM-2000	RX Cable above 1G (220909)	08/31/2022	08/30/2023
Coaxial Cables	EMCI	EMCCFD400-NM-NM-10000	RX Cable below 30M (220238)	08/31/2022	08/30/2023
Coaxial Cables	EMCI	EMC105-SM-SM-2000	RX Cable below 30M (220910)	08/31/2022	08/30/2023
Coaxial Cable	Huber Suhner	SUCOFLEX 104	160125	12/13/2022	12/12/2023
Coaxial Cable	Huber Suhner	SUCOFLEX 106	76096/6	12/13/2022	12/12/2023
Coaxial Cable	Huber Suhner	SUCOFLEX 102	MY2630/2	12/13/2022	12/12/2023
Coaxial Cable	Huber Suhner	SUCOFLEX 102	MY22962/2	12/13/2022	12/12/2023
Coaxial Cable	Huber Suhner	SUCOFLEX 102	SN 520430/2	12/13/2022	12/12/2023
Site Cal	SGS	SAC 2	N/A	08/31/2022	08/30/2023

Unless otherwise stated the results shown in this test report refer only to the sample(s) tested and such sample(s) are retained for 90 days only.

除非另有說明，此報告結果僅對測試之樣品負責，同時此樣品僅保留90天。本報告未經本公司書面許可，不可部份複製。

This document is issued by the Company subject to its General Conditions of Service printed overleaf, available on request or accessible at <http://www.sgs.com.tw/Terms-and-Conditions> and for electronic format documents, subject to Terms and Conditions for Electronic Documents at <http://www.sgs.com.tw/Terms-and-Conditions>. Attention is drawn to the limitation of liability, indemnification and jurisdiction issues defined therein. Any holder of this document is advised that information contained herein reflects the Company's findings at the time of its intervention only and within the limits of Client's instructions, if any. The Company's sole responsibility is to its Client and this document does not exonerate parties to a transaction from exercising all their rights and obligations under the transaction documents. This document cannot be reproduced except in full, without prior written approval of the Company. Any unauthorized alteration, forgery or falsification of the content or appearance of this document is unlawful and offenders may be prosecuted to the fullest extent of the law.



## 8 MAXIMUM OUTPUT POWER

### 8.1 Standard Applicable

A base station simulator was used to establish communication with the EUT. Its parameters were set to transmit the maximum power on the EUT. The measured power in the radio frequency on the transmitter output terminals.

According to FCC §2.1046

#### FCC 22.913(a)

(5) mobile transmitters and auxiliary test transmitters must not exceed 7 watts.

#### FCC 24.232(c)

Mobile and portable stations are limited to 2 W EIRP.

#### FCC 27.50(d)

(4) Mobile, and portable (hand-held) stations operating in the 1710-1755 MHz, 1695-1710 MHz and 1755-1780 MHz bands are limited to 1W EIRP.

### 8.2 Test Set-up

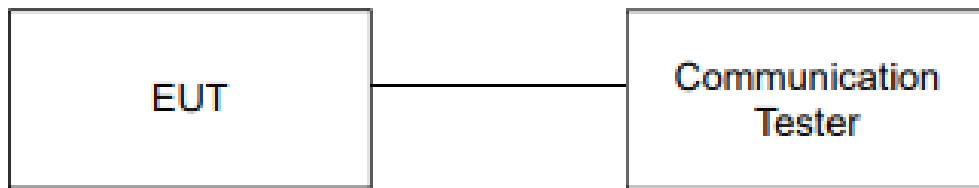

**Note:** Measurement setup for testing on Antenna connector

### 8.3 Output Power Measurement Applicable Guidance

The transmitter output was connected to a calibrated attenuator, the other end of which was connected to a power meter.

Transmitter output was read off the power meter in dBm.

The power output at the transmitter antenna port was determined by adding the value of the attenuator to the power meter reading.

TS 151 010-1 is reference to conduct the test measurement of output power.

The Procedure of KDB941225 (SAR Measurement Procedures for 3G devices, (WCDMA/HSPA) was used for EUT and RMC 12.2kps is used for Base station setting.

KDB 971168 D01 Power Meas License Digital System as the supplemental test methodology to adjust the proper setting obtaining the measurement results.

Conducted average power is obtained from the simulator telecommunication test set.

Unless otherwise stated the results shown in this test report refer only to the sample(s) tested and such sample(s) are retained for 90 days only.  
除非另有說明，此報告結果僅對測試之樣品負責，同時此樣品僅保留90天。本報告未經本公司書面許可，不可部份複製。

This document is issued by the Company subject to its General Conditions of Service printed overleaf, available on request or accessible at <http://www.sgs.com.tw/Terms-and-Conditions> and for electronic format documents, subject to Terms and Conditions for Electronic Documents at <http://www.sgs.com.tw/Terms-and-Conditions>. Attention is drawn to the limitation of liability, indemnification and jurisdiction issues defined therein. Any holder of this document is advised that information contained hereon reflects the Company's findings at the time of its intervention only and within the limits of Client's instructions, if any. The Company's sole responsibility is to its Client and this document does not exonerate parties to a transaction from exercising all their rights and obligations under the transaction documents. This document cannot be reproduced except in full, without prior written approval of the Company. Any unauthorized alteration, forgery or falsification of the content or appearance of this document is unlawful and offenders may be prosecuted to the fullest extent of the law.

#### 8.4 Determining ERP and/or EIRP from conducted RF output power measurements

According to KDB 412172 D01 Power Approach,

$$EIRP = P_T + G_T - L_C,$$

$$ERP = EIRP - 2.15,$$

Where:

- ERP or EIRP = effective radiated power or equivalent isotropically radiated power (expressed in the same units as  $P_T$ , typically dBW, dBm, or power spectral density (PSD)<sup>2</sup>), relative to either a dipole antenna (ERP) or an isotropic antenna (EIRP);
- $P_T$  = transmitter output power, expressed in dBW, dBm, or PSD;
- $G_T$  = gain of the transmitting antenna, in dBd (ERP) or dBi (EIRP);
- $L_C$  = signal attenuation in the connecting cable between the transmitter and antenna, in dB.

Unless otherwise stated the results shown in this test report refer only to the sample(s) tested and such sample(s) are retained for 90 days only.

除非另有說明，此報告結果僅對測試之樣品負責，同時此樣品僅保留90天。本報告未經本公司書面許可，不可部份複製。

This document is issued by the Company subject to its General Conditions of Service printed overleaf, available on request or accessible at <http://www.sgs.com.tw/Terms-and-Conditions> and for electronic format documents, subject to Terms and Conditions for Electronic Documents at <http://www.sgs.com.tw/Terms-and-Conditions>. Attention is drawn to the limitation of liability, indemnification and jurisdiction issues defined therein. Any holder of this document is advised that information contained hereon reflects the Company's findings at the time of its intervention only and within the limits of Client's instructions, if any. The Company's sole responsibility is to its Client and this document does not exonerate parties to a transaction from exercising all their rights and obligations under the transaction documents. This document cannot be reproduced except in full, without prior written approval of the Company. Any unauthorized alteration, forgery or falsification of the content or appearance of this document is unlawful and offenders may be prosecuted to the fullest extent of the law.

SGS Taiwan Ltd. No.134,Wu Kung Road, New Taipei Industrial Park, Wuku District, New Taipei City, Taiwan/新北市五股區新北產業園區五工路 134 號

## 8.5 Measurement Results

### 8.5.1 GSM

GSM/GPRS/EDGE (GMSK; 8-PSK) Result:

EUT Mode	Freq. (MHz)	CH	Conducted Avg. Power (dBm)	Antenna Gain (dBi)	ERP (dBm)	EIRP (dBm)	Limit (dBm)	Margin (dB)
GSM 850	824.2	128	33.18	-3.74	27.29	29.44	38.50	-9.06
	836.6	190	33.30	-3.74	27.41	29.56	38.50	-8.94
	848.8	251	33.21	-3.74	27.32	29.47	38.50	-9.03
GSM 1900	1850.2	512	29.12	-3.60	23.37	25.52	33.00	-7.48
	1880.0	661	28.94	-3.60	23.19	25.34	33.00	-7.66
	1909.8	810	29.35	-3.60	23.60	25.75	33.00	-7.25
GPRS 850	824.2	128	33.19	-3.74	27.30	29.45	38.50	-9.05
	836.6	190	33.16	-3.74	27.27	29.42	38.50	-9.08
	848.8	251	33.18	-3.74	27.29	29.44	38.50	-9.06
GPRS 1900	1850.2	512	29.07	-3.60	23.32	25.47	33.00	-7.53
	1880.0	661	28.88	-3.60	23.13	25.28	33.00	-7.72
	1909.8	810	29.32	-3.60	23.57	25.72	33.00	-7.28
EDGE 850	824.2	128	27.43	-3.74	21.54	23.69	38.50	-14.81
	836.6	190	27.39	-3.74	21.50	23.65	38.50	-14.85
	848.8	251	27.52	-3.74	21.63	23.78	38.50	-14.72
EDGE 1900	1850.2	512	25.79	-3.60	20.04	22.19	33.00	-10.81
	1880.0	661	25.37	-3.60	19.62	21.77	33.00	-11.23
	1909.8	810	24.32	-3.60	18.57	20.72	33.00	-12.28

Unless otherwise stated the results shown in this test report refer only to the sample(s) tested and such sample(s) are retained for 90 days only.

除非另有說明，此報告結果僅對測試之樣品負責，同時此樣品僅保留90天。本報告未經本公司書面許可，不可部份複製。  
This document is issued by the Company subject to its General Conditions of Service printed overleaf, available on request or accessible at <http://www.sgs.com.tw/Terms-and-Conditions> and for electronic format documents, subject to Terms and Conditions for Electronic Documents at <http://www.sgs.com.tw/Terms-and-Conditions>. Attention is drawn to the limitation of liability, indemnification and jurisdiction issues defined therein. Any holder of this document is advised that information contained hereon reflects the Company's findings at the time of its intervention only and within the limits of Client's instructions, if any. The Company's sole responsibility is to its Client and this document does not exonerate parties to a transaction from exercising all their rights and obligations under the transaction documents. This document cannot be reproduced except in full, without prior written approval of the Company. Any unauthorized alteration, forgery or falsification of the content or appearance of this document is unlawful and offenders may be prosecuted to the fullest extent of the law.

EUT Mode	Frequency (MHz)	CH	Average Burst Power (1DN 1UP) Class 8 (dBm)	Average Burst Power (1DN 2UP) Class 10 (dBm)
GPRS 850	824.2	128	33.19	32.83
	836.6	190	33.16	32.94
	848.8	251	33.18	32.89
GPRS 1900	1850.2	512	29.07	28.53
	1880.0	661	28.88	28.33
	1909.8	810	29.32	28.77
EDGE 850	824.2	128	27.43	26.89
	836.6	190	27.39	26.93
	848.8	251	27.52	26.84
EDGE 1900	1850.2	512	25.79	24.29
	1880.0	661	25.37	24.88
	1909.8	810	24.32	23.47

Unless otherwise stated the results shown in this test report refer only to the sample(s) tested and such sample(s) are retained for 90 days only.  
 除非另有說明，此報告結果僅對測試之樣品負責，同時此樣品僅保留90天。本報告未經本公司書面許可，不可部份複製。

This document is issued by the Company subject to its General Conditions of Service printed overleaf, available on request or accessible at <http://www.sgs.com.tw/Terms-and-Conditions> and for electronic format documents, subject to Terms and Conditions for Electronic Documents at <http://www.sgs.com.tw/Terms-and-Conditions>. Attention is drawn to the limitation of liability, indemnification and jurisdiction issues defined therein. Any holder of this document is advised that information contained hereon reflects the Company's findings at the time of its intervention only and within the limits of Client's instructions, if any. The Company's sole responsibility is to its Client and this document does not exonerate parties to a transaction from exercising all their rights and obligations under the transaction documents. This document cannot be reproduced except in full, without prior written approval of the Company. Any unauthorized alteration, forgery or falsification of the content or appearance of this document is unlawful and offenders may be prosecuted to the fullest extent of the law.

### 8.5.2 WCDMA & HSPA Measurement Results:

The following tests were completed according to the test requirements outlined in section 5.2 of the 3GPP TS34.121-1 specification. The EUT supports power Class 3, which has a nominal maximum output power of 24 dBm. RMC 12.2kps is used for this testing.

#### WCDMA/HSUPA/HSDPA Band II Result:

EUT Mode	Freq. (MHz)	CH	Conducted Avg. Power (dBm)	Antenna Gain (dBi)	ERP (dBm)	EIRP (dBm)	Limit (dBm)	Margin (dB)
WCDMA	1852.4	9262	23.26	-3.60	17.51	19.66	33.00	-13.34
	1880.0	9400	23.38	-3.60	17.63	<b>19.78</b>	33.00	-13.22
	1907.6	9538	23.32	-3.60	17.57	19.72	33.00	-13.28
HSDPA	1852.4	9262	22.12	-3.60	16.37	18.52	33.00	-14.48
	1880.0	9400	22.23	-3.60	16.48	18.63	33.00	-14.37
	1907.6	9538	22.28	-3.60	16.53	<b>18.68</b>	33.00	-14.32
HSUPA	1852.4	9262	22.12	-3.60	16.37	18.52	33.00	-14.48
	1880.0	9400	22.17	-3.60	16.42	<b>18.57</b>	33.00	-14.43
	1907.6	9538	22.07	-3.60	16.32	18.47	33.00	-14.53

#### WCDMA/HSUPA/HSDPA Band IV Result:

EUT Mode	Freq. (MHz)	CH	Conducted Avg. Power (dBm)	Antenna Gain (dBi)	ERP (dBm)	EIRP (dBm)	Limit (dBm)	Margin (dB)
WCDMA	1712.4	1312	23.56	-2.74	18.67	<b>20.82</b>	30.00	-9.18
	1732.6	1413	23.50	-2.74	18.61	20.76	30.00	-9.24
	1752.6	1513	23.35	-2.74	18.46	20.61	30.00	-9.39
HSDPA	1712.4	1312	22.33	-2.74	17.44	19.59	30.00	-10.41
	1732.6	1413	22.40	-2.74	17.51	<b>19.66</b>	30.00	-10.34
	1752.6	1513	22.28	-2.74	17.39	19.54	30.00	-10.46
HSUPA	1712.4	1312	22.36	-2.74	17.47	19.62	30.00	-10.38
	1732.6	1413	22.39	-2.74	17.50	<b>19.65</b>	30.00	-10.35
	1752.6	1513	22.17	-2.74	17.28	19.43	30.00	-10.57

Unless otherwise stated the results shown in this test report refer only to the sample(s) tested and such sample(s) are retained for 90 days only.

除非另有說明，此報告結果僅對測試之樣品負責，同時此樣品僅保留90天。本報告未經本公司書面許可，不可部份複製。

This document is issued by the Company subject to its General Conditions of Service printed overleaf, available on request or accessible at <http://www.sgs.com.tw/Terms-and-Conditions> and for electronic format documents, subject to Terms and Conditions for Electronic Documents at <http://www.sgs.com.tw/Terms-and-Conditions>. Attention is drawn to the limitation of liability, indemnification and jurisdiction issues defined therein. Any holder of this document is advised that information contained hereon reflects the Company's findings at the time of its intervention only and within the limits of Client's instructions, if any. The Company's sole responsibility is to its Client and this document does not exonerate parties to a transaction from exercising all their rights and obligations under the transaction documents. This document cannot be reproduced except in full, without prior written approval of the Company. Any unauthorized alteration, forgery or falsification of the content or appearance of this document is unlawful and offenders may be prosecuted to the fullest extent of the law.

WCDMA/HSUPA/HSDPA Band V Result:

EUT Mode	Freq. (MHz)	CH	Conducted Avg. Power (dBm)	Antenna Gain (dBi)	ERP (dBm)	EIRP (dBm)	Limit (dBm)	Margin (dB)
WCDMA	826.4	4132	23.39	-3.74	17.50	19.65	38.50	-18.85
	836.6	4183	23.42	-3.74	17.53	<b>19.68</b>	38.50	-18.82
	846.6	4233	23.35	-3.74	17.46	19.61	38.50	-18.89
HSDPA	826.4	4132	22.21	-3.74	16.32	18.47	38.50	-20.03
	836.6	4183	22.23	-3.74	16.34	<b>18.49</b>	38.50	-20.01
	846.6	4233	22.15	-3.74	16.26	18.41	38.50	-20.09
HSUPA	826.4	4132	22.34	-3.74	16.45	<b>18.60</b>	38.50	-19.90
	836.6	4183	22.28	-3.74	16.39	18.54	38.50	-19.96
	846.6	4233	22.10	-3.74	16.21	18.36	38.50	-20.14

Unless otherwise stated the results shown in this test report refer only to the sample(s) tested and such sample(s) are retained for 90 days only.

除非另有說明，此報告結果僅對測試之樣品負責，同時此樣品僅保留90天。本報告未經本公司書面許可，不可部份複製。

This document is issued by the Company subject to its General Conditions of Service printed overleaf, available on request or accessible at <http://www.sgs.com.tw/Terms-and-Conditions> and for electronic format documents, subject to Terms and Conditions for Electronic Documents at <http://www.sgs.com.tw/Terms-and-Conditions>. Attention is drawn to the limitation of liability, indemnification and jurisdiction issues defined therein. Any holder of this document is advised that information contained hereon reflects the Company's findings at the time of its intervention only and within the limits of Client's instructions, if any. The Company's sole responsibility is to its Client and this document does not exonerate parties to a transaction from exercising all their rights and obligations under the transaction documents. This document cannot be reproduced except in full, without prior written approval of the Company. Any unauthorized alteration, forgery or falsification of the content or appearance of this document is unlawful and offenders may be prosecuted to the fullest extent of the law.

### 8.5.3 HSPA (HSDPA & HSUPA) Release 6:

The following 4 Sub-Tests were completed according to the test requirements outlined in section 5.2A of the 3GPP TS34.121-1 specification. All TX RMS power requirements for Power Class 3 were met according to table 5.2AA.5 and 5.2B.5 All UE channels and power ratio's are set according to table C10.1.4 & C11.1.3 in the 3GPP TS34.121-1. RMC 12.2kps is used for this testing.

### 8.5.4 HSDPA SUB-TEST Setting

Table C.10.1.4:  $\beta$  values for transmitter characteristics tests with HS-DPCCH(FOR HSDPA)

Sub-test	$\beta_c$	$\beta_d$	$\beta_d$ (SF)	$\beta_c/\beta_d$	$\beta_{HS}$ (Note 1, Note 2)	CM (dB) (Note 3)	MPR (dB) (Note 3)	RMC (Kbps)
1	2/15	15/15	64	2/15	4/15	0.0	0.0	12.2
2	12/15 (Note 4)	15/15 (Note 4)	64	12/15 (Note 4)	24/15	1.0	0.0	12.2
3	15/15	8/15	64	15/8	30/15	1.5	0.5	12.2
4	15/15	4/15	64	15/4	30/15	1.5	0.5	12.2

**Note:** The recommended HSDPA MPRs are implemented as per following sub-tests.

Mode	Sub test	Avg. Power (dBm) Channel			Mode	Sub test	Avg. Power (dBm) Channel		
		9262	9400	9538			1312	1413	1513
HSDPA II	1	22.12	22.23	22.28	HSDPA IV	1	22.33	22.40	22.28
	2	22.08	22.30	22.17		2	22.36	22.33	22.29
	3	21.67	21.82	21.72		3	21.96	21.91	21.63
	4	21.68	21.74	21.61		4	21.89	21.78	21.73

Mode	Sub test	Avg. Power (dBm) Channel		
		4132	4183	4233
HSDPA V	1	22.21	22.23	22.15
	2	22.24	22.22	22.19
	3	21.76	21.77	21.63
	4	21.77	21.80	21.74

Unless otherwise stated the results shown in this test report refer only to the sample(s) tested and such sample(s) are retained for 90 days only.

除非另有說明，此報告結果僅對測試之樣品負責，同時此樣品僅保留90天。本報告未經本公司書面許可，不可部份複製。

This document is issued by the Company subject to its General Conditions of Service printed overleaf, available on request or accessible at <http://www.sgs.com.tw/Terms-and-Conditions> and for electronic format documents, subject to Terms and Conditions for Electronic Documents at <http://www.sgs.com.tw/Terms-and-Conditions>. Attention is drawn to the limitation of liability, indemnification and jurisdiction issues defined therein. Any holder of this document is advised that information contained hereon reflects the Company's findings at the time of its intervention only and within the limits of Client's instructions, if any. The Company's sole responsibility is to its Client and this document does not exonerate parties to a transaction from exercising all their rights and obligations under the transaction documents. This document cannot be reproduced except in full, without prior written approval of the Company. Any unauthorized alteration, forgery or falsification of the content or appearance of this document is unlawful and offenders may be prosecuted to the fullest extent of the law.

### 8.5.5 HSPA SUB-TEST Setting

Table C.11.1.3:  $\beta$  values for transmitter characteristics tests with HS-DPCCH and E-DCH(FOR HSUPA)

Sub-test	$\beta_c$	$\beta_d$	$\beta_d$ (SF)	$\beta_c/\beta_d$	$\beta_{HS}$	$\beta_{ec}$	$\beta_{ed}$	$\beta_{ed}$ (SF)	$\beta_{ed}$ (Code s)	CM (dB)	MPR (dB)	AG Index	E-TFCI	RMC (Kbps)
1	11/15 (Note 3)	15/15 (Note 3)	64	11/15 (Note 3)	22/15	209/225	1309/225	4	1	1.0	0.0	20	75	12.2
2	6/15	15/15	64	6/15	12/15	12/15	94/75	4	1	3.0	2.0	12	67	12.2
3	15/15	9/15	64	15/9	30/15	30/15	$\beta_{ed1}$ : 47/15 $\beta_{ed2}$ : 47/15	4 4	2	2.0	1.0	15	92	12.2
4	2/15	15/15	64	2/15	4/15	2/15	56/75	4	1	3.0	2.0	17	71	12.2
5	15/15 (Note 4)	15/15 (Note 4)	64	15/15 (Note 4)	30/15	24/15	134/15	4	1	1.0	0.0	21	81	12.2

**Note:** The recommended HSUPA MPRs are implemented as per following sub-tests.

Mode	Sub test	Avg. Power (dBm) Channel			Mode	Sub test	Avg. Power (dBm) Channel		
		9262	9400	9538			1312	1413	1513
HSUPA II	1	22.12	22.17	22.07	HSUPA IV	1	22.36	22.39	22.17
	2	20.15	20.09	20.13		2	20.38	20.28	20.17
	3	21.06	21.30	21.16		3	21.38	21.26	21.30
	4	20.12	20.31	20.27		4	20.42	20.32	20.31
	5	22.05	22.18	22.06		5	22.30	22.47	22.26

Mode	Sub test	Avg. Power (dBm) Channel		
		4132	4183	4233
HSUPA V	1	22.34	22.28	22.10
	2	20.27	20.31	20.27
	3	21.22	21.18	21.13
	4	20.16	20.23	20.20
	5	22.27	22.19	22.06

### 8.5.6 WCDMA/HSDPA/HSUPA band II, IV, V

The EUT output power was controlled by simulator and enter max rated power 24dBm. The EUT is going to be set to max output power to 24dBm then record the read. The min. power was measures by a function key "minimum power" then record the read. It is -52.3dBm. The power variation can be 0.1dB step by setting.

Unless otherwise stated the results shown in this test report refer only to the sample(s) tested and such sample(s) are retained for 90 days only.

除非另有說明，此報告結果僅對測試之樣品負責，同時此樣品僅保留90天。本報告未經本公司書面許可，不可部份複製。

This document is issued by the Company subject to its General Conditions of Service printed overleaf, available on request or accessible at <http://www.sgs.com.tw/Terms-and-Conditions> and for electronic format documents, subject to Terms and Conditions for Electronic Documents at <http://www.sgs.com.tw/Terms-and-Conditions>. Attention is drawn to the limitation of liability, indemnification and jurisdiction issues defined therein. Any holder of this document is advised that information contained hereon reflects the Company's findings at the time of its intervention only and within the limits of Client's instructions, if any. The Company's sole responsibility is to its Client and this document does not exonerate parties to a transaction from exercising all their rights and obligations under the transaction documents. This document cannot be reproduced except in full, without prior written approval of the Company. Any unauthorized alteration, forgery or falsification of the content or appearance of this document is unlawful and offenders may be prosecuted to the fullest extent of the law.



## 9 OCCUPIED BANDWIDTH MEASUREMENT

### 9.1 Standard Applicable

The occupied bandwidth is the frequency bandwidth such that, below its lower and above its upper frequency limits, the mean powers radiated are each equal to 0.5 percent of the total mean power.

### 9.2 Test Set-up

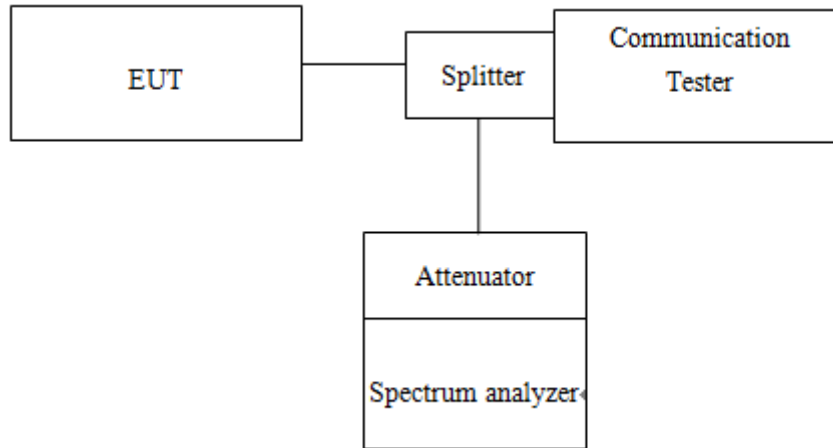

### 9.3 Measurement Procedure

#### 99% & 26dB Bandwidth with detector peak

The EUT's output RF connector was connected with a short cable to the spectrum analyzer, RBW was set to about 1% of emission BW, VBW= 3 times RBW, -26dBc display line was placed on the screen (or 26dB bandwidth), the occupied bandwidth is the delta frequency between the two points where the display line intersects the signal trace. Then set RBW to 99% bandwidth, RBW= 1%, VBW= 3 \* RBW, with span > 2 \* Signal BW, set % Power = 99%.

### 9.4 Measurement Result

Freq. (MHz)	CH	99% BW (MHz)			26 dB BW (MHz)		
		GSM 850	GPRS 850	EDGE 850	GSM 850	GPRS 850	EDGE 850
824.2	128	0.24803	0.24742	0.24645	0.3164	0.3184	0.3115
836.6	190	0.24277	0.25001	0.24284	0.3148	0.3120	0.3154
848.8	251	0.24094	0.24686	0.24326	0.3123	0.3218	0.3158

Unless otherwise stated the results shown in this test report refer only to the sample(s) tested and such sample(s) are retained for 90 days only.  
除非另有說明，此報告結果僅對測試之樣品負責，同時此樣品僅保留90天。本報告未經本公司書面許可，不可部份複製。

This document is issued by the Company subject to its General Conditions of Service printed overleaf, available on request or accessible at <http://www.sgs.com.tw/Terms-and-Conditions> and for electronic format documents, subject to Terms and Conditions for Electronic Documents at <http://www.sgs.com.tw/Terms-and-Conditions>. Attention is drawn to the limitation of liability, indemnification and jurisdiction issues defined therein. Any holder of this document is advised that information contained hereon reflects the Company's findings at the time of its intervention only and within the limits of Client's instructions, if any. The Company's sole responsibility is to its Client and this document does not exonerate parties to a transaction from exercising all their rights and obligations under the transaction documents. This document cannot be reproduced except in full, without prior written approval of the Company. Any unauthorized alteration, forgery or falsification of the content or appearance of this document is unlawful and offenders may be prosecuted to the fullest extent of the law.

Freq. (MHz)	CH	99% BW (MHz)			26 dB BW (MHz)		
		GSM 1900	GPRS 1900	EDGE 1900	GSM 1900	GPRS 1900	EDGE 1900
1850.2	512	0.24368	0.24617	0.24550	0.3144	0.3172	0.3082
1880.0	661	0.24433	0.24851	0.24763	0.3208	0.3188	0.3123
1909.8	810	0.24155	0.24247	0.24896	0.3124	0.3215	0.3094

Freq. (MHz)	CH	99% BW (MHz)			26 dB BW (MHz)		
		WCDMA II	HSDPA II	HSUPA II	WCDMA II	HSDPA II	HSUPA II
1852.40	9262	4.15190	4.15430	4.15000	4.693	4.689	4.691
1880.00	9400	4.15030	4.15230	4.13840	4.703	4.693	4.704
1907.60	9538	4.15480	4.12570	4.14070	4.694	4.683	4.695
Freq. (MHz)	CH	99% BW (MHz)			26 dB BW (MHz)		
		WCDMA IV	HSDPA IV	HSUPA IV	WCDMA IV	HSDPA IV	HSUPA IV
1712.40	1312	4.15260	4.14220	4.16010	4.720	4.690	4.705
1732.60	1413	4.14130	4.15160	4.14250	4.698	4.685	4.666
1752.60	1513	4.15040	4.14560	4.14420	4.710	4.686	4.696

Freq. (MHz)	CH	99% BW (MHz)			26 dB BW (MHz)		
		WCDMA V	HSDPA V	HSUPA V	WCDMA V	HSDPA V	HSUPA V
826.40	4132	4.14320	4.14250	4.14410	4.691	4.686	4.685
836.60	4183	4.14250	4.13970	4.12770	4.692	4.684	4.679
846.60	4233	4.13530	4.13030	4.13140	4.692	4.677	4.695

Unless otherwise stated the results shown in this test report refer only to the sample(s) tested and such sample(s) are retained for 90 days only.

除非另有說明，此報告結果僅對測試之樣品負責，同時此樣品僅保留90天。本報告未經本公司書面許可，不可部份複製。  
 This document is issued by the Company subject to its General Conditions of Service printed overleaf, available on request or accessible at <http://www.sgs.com.tw/Terms-and-Conditions> and for electronic format documents, subject to Terms and Conditions for Electronic Documents at <http://www.sgs.com.tw/Terms-and-Conditions>. Attention is drawn to the limitation of liability, indemnification and jurisdiction issues defined therein. Any holder of this document is advised that information contained hereon reflects the Company's findings at the time of its intervention only and within the limits of Client's instructions, if any. The Company's sole responsibility is to its Client and this document does not exonerate parties to a transaction from exercising all their rights and obligations under the transaction documents. This document cannot be reproduced except in full, without prior written approval of the Company. Any unauthorized alteration, forgery or falsification of the content or appearance of this document is unlawful and offenders may be prosecuted to the fullest extent of the law.

GSM\_850MHz\_LowCH128-824.2

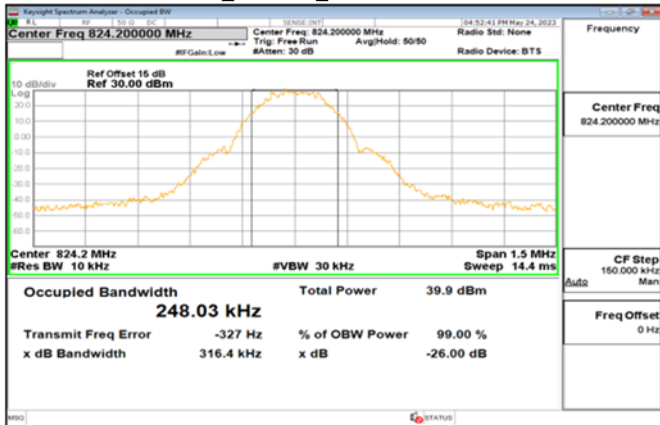

GPRS\_850MHz\_LowCH128-824.2

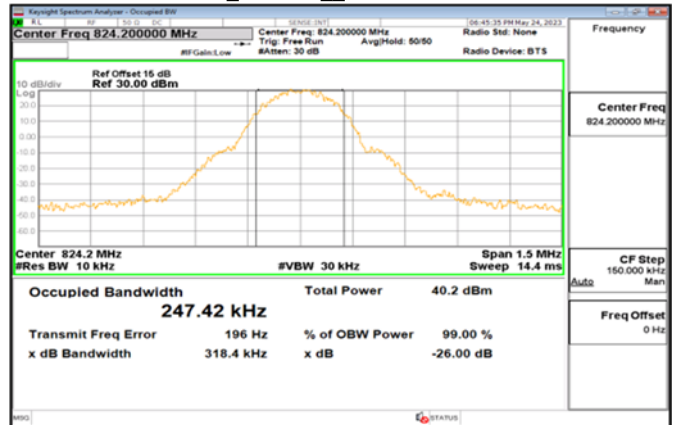

GSM\_850MHz\_MidCH190-836.6

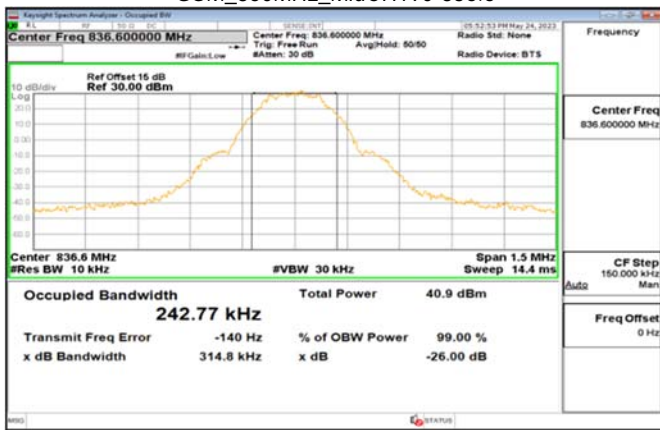

GPRS\_850MHz\_MidCH190-836.6

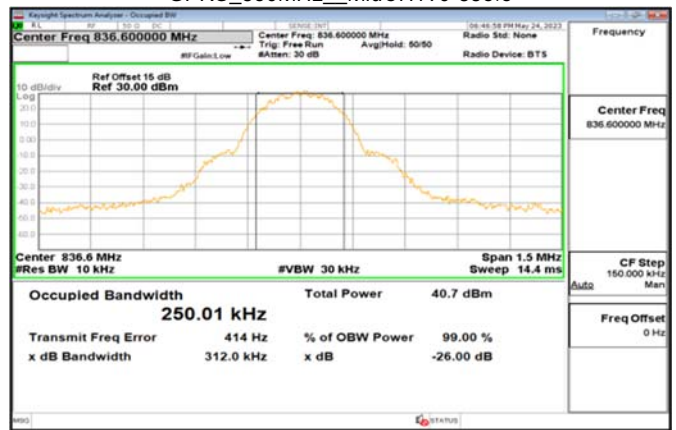

GPRS\_850MHz\_HighCH251-848.8

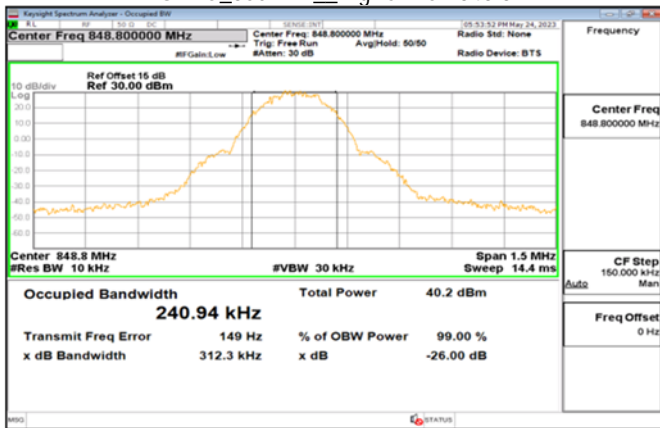

EDGE\_850MHz\_HighCH251-848.8

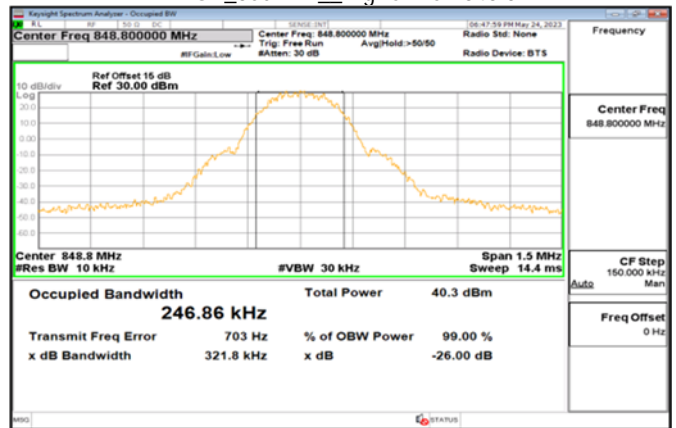

Unless otherwise stated the results shown in this test report refer only to the sample(s) tested and such sample(s) are retained for 90 days only.

除非另有說明，此報告結果僅對測試之樣品負責，同時此樣品僅保留90天。本報告未經本公司書面許可，不可部份複製。

This document is issued by the Company subject to its General Conditions of Service printed overleaf, available on request or accessible at <http://www.sgs.com.tw/Terms-and-Conditions> and for electronic format documents, subject to Terms and Conditions for Electronic Documents at <http://www.sgs.com.tw/Terms-and-Conditions>. Attention is drawn to the limitation of liability, indemnification and jurisdiction issues defined therein. Any holder of this document is advised that information contained hereon reflects the Company's findings at the time of its intervention only and within the limits of Client's instructions, if any. The Company's sole responsibility is to its Client and this document does not exonerate parties to a transaction from exercising all their rights and obligations under the transaction documents. This document cannot be reproduced except in full, without prior written approval of the Company. Any unauthorized alteration, forgery or falsification of the content or appearance of this document is unlawful and offenders may be prosecuted to the fullest extent of the law.

EDGE\_850MHz\_LowCH128-824.2

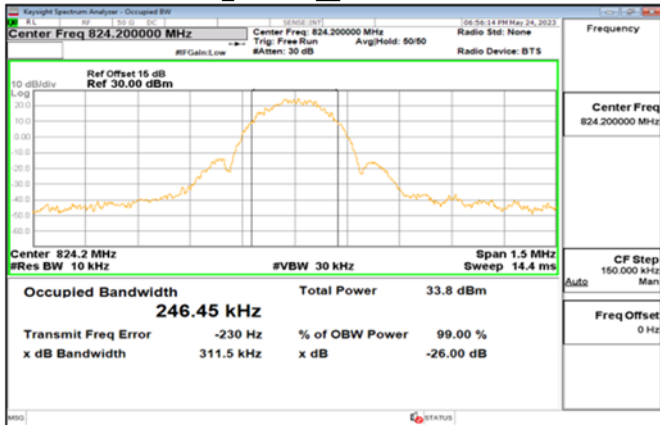

GSM\_1900MHz\_LowCH512-1850.2

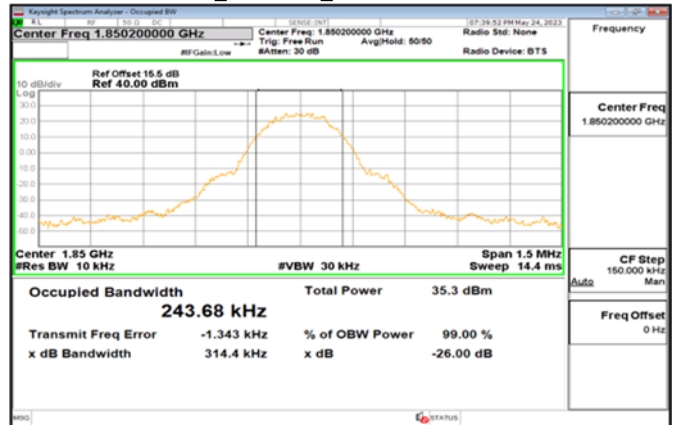

EDGE\_850MHz\_MidCH190-836.6

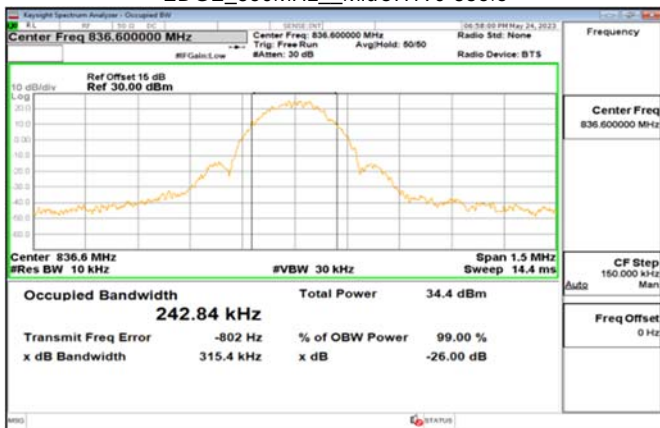

GSM\_1900MHz\_MidCH661-1880

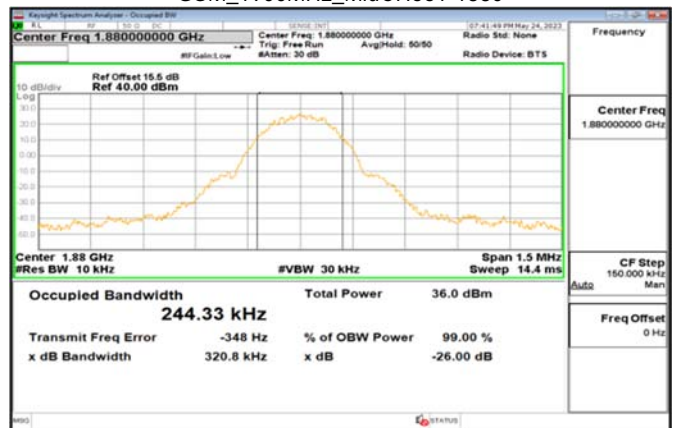

GSM\_1900MHz\_HighCH810-1909.8

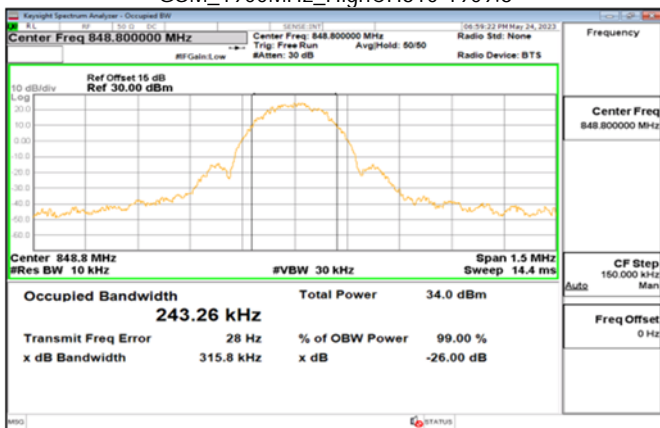

GPRS\_1900MHz\_HighCH810-1909.8

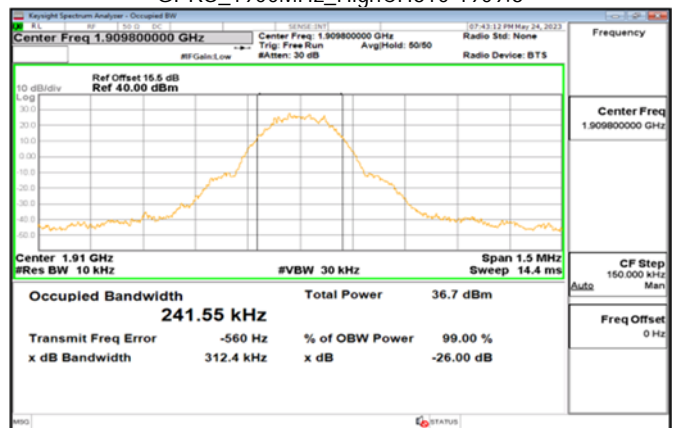

Unless otherwise stated the results shown in this test report refer only to the sample(s) tested and such sample(s) are retained for 90 days only.

除非另有說明，此報告結果僅對測試之樣品負責，同時此樣品僅保留90天。本報告未經本公司書面許可，不可部份複製。

This document is issued by the Company subject to its General Conditions of Service printed overleaf, available on request or accessible at <http://www.sgs.com.tw/Terms-and-Conditions> and for electronic format documents, subject to Terms and Conditions for Electronic Documents at <http://www.sgs.com.tw/Terms-and-Conditions>. Attention is drawn to the limitation of liability, indemnification and jurisdiction issues defined therein. Any holder of this document is advised that information contained hereon reflects the Company's findings at the time of its intervention only and within the limits of Client's instructions, if any. The Company's sole responsibility is to its Client and this document does not exonerate parties to a transaction from exercising all their rights and obligations under the transaction documents. This document cannot be reproduced except in full, without prior written approval of the Company. Any unauthorized alteration, forgery or falsification of the content or appearance of this document is unlawful and offenders may be prosecuted to the fullest extent of the law.



GPRS\_1900MHz\_LowCH512-1850.2

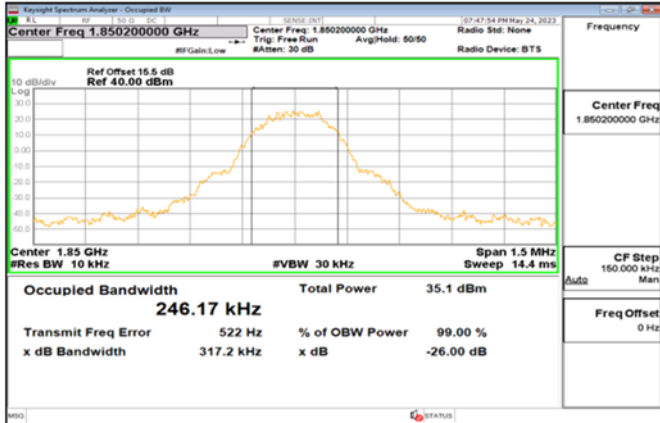

EDGE\_1900MHz\_LowCH512-1850.2

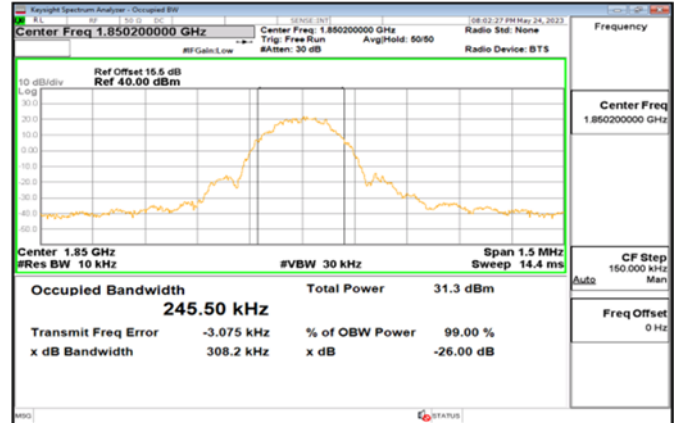

GPRS\_1900MHz\_MidCH661-1880

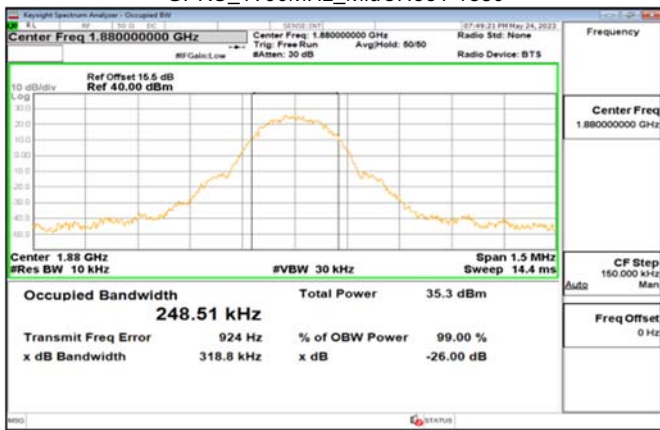

EDGE\_1900MHz\_MidCH661-1880



GPRS\_1900MHz\_HighCH810-1909.8

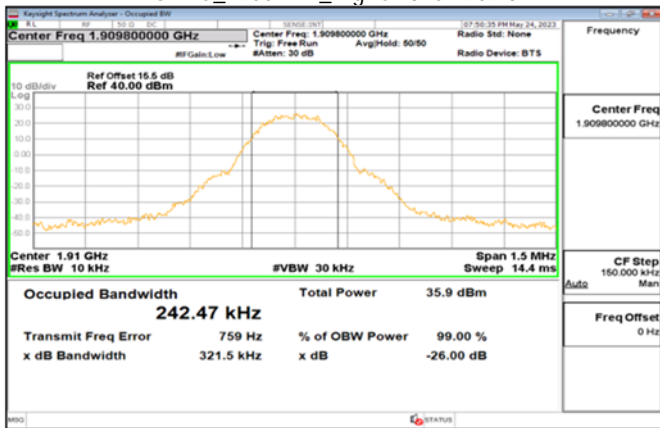

GPRS\_1900MHz\_HighCH810-1909.8

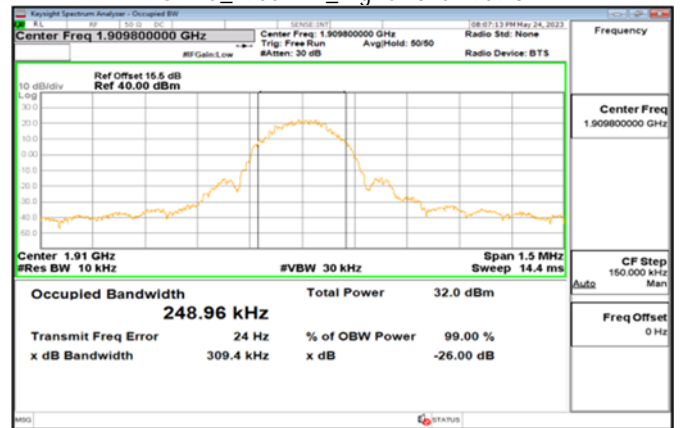

Unless otherwise stated the results shown in this test report refer only to the sample(s) tested and such sample(s) are retained for 90 days only.

除非另有說明，此報告結果僅對測試之樣品負責，同時此樣品僅保留90天。本報告未經本公司書面許可，不可部份複製。

This document is issued by the Company subject to its General Conditions of Service printed overleaf, available on request or accessible at <http://www.sgs.com.tw/Terms-and-Conditions> and for electronic format documents, subject to Terms and Conditions for Electronic Documents at <http://www.sgs.com.tw/Terms-and-Conditions>. Attention is drawn to the limitation of liability, indemnification and jurisdiction issues defined therein. Any holder of this document is advised that information contained hereon reflects the Company's findings at the time of its intervention only and within the limits of Client's instructions, if any. The Company's sole responsibility is to its Client and this document does not exonerate parties to a transaction from exercising all their rights and obligations under the transaction documents. This document cannot be reproduced except in full, without prior written approval of the Company. Any unauthorized alteration, forgery or falsification of the content or appearance of this document is unlawful and offenders may be prosecuted to the fullest extent of the law.

WCDMA\_B2\_LowCH9262-1852.4

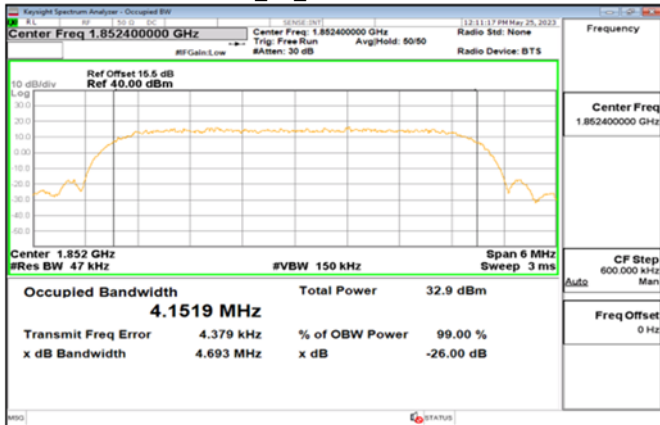

HSDPA\_B2\_LowCH9262-1852.4

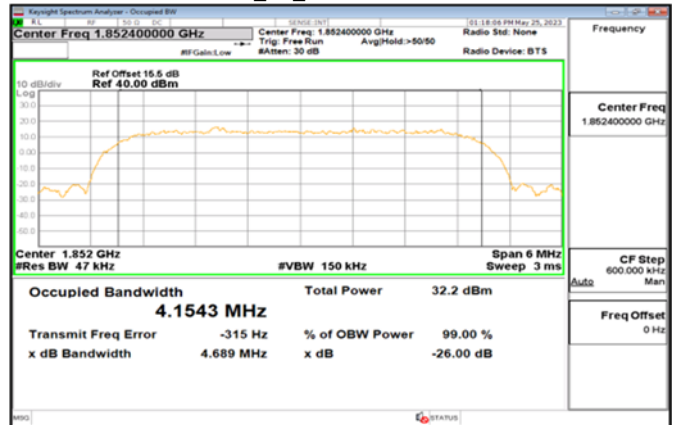

WCDMA\_B2\_MidCH9400-1880

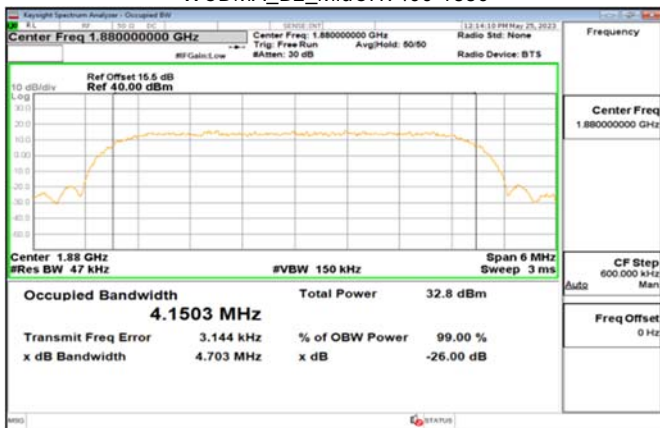

HSDPA\_B2\_MidCH9400-1880

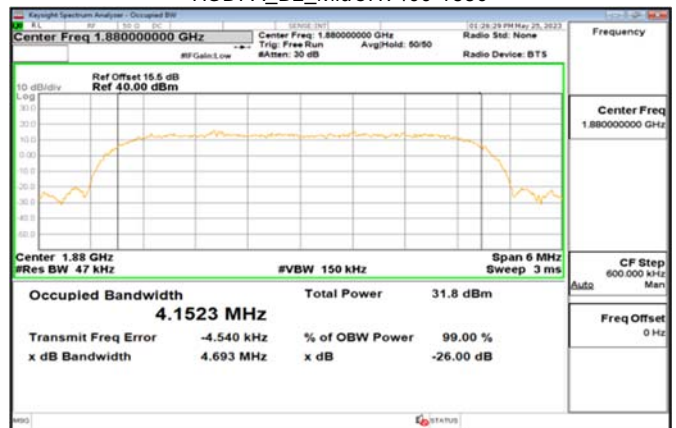

HSDPA\_B2\_HighCH9538-1907.6

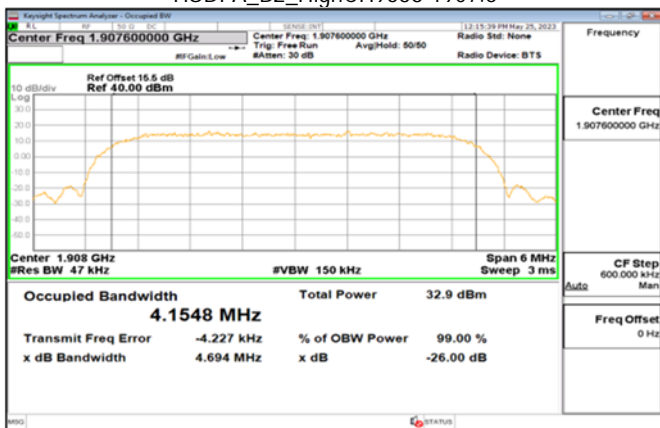

HSDPA\_B2\_HighCH9538-1907.6

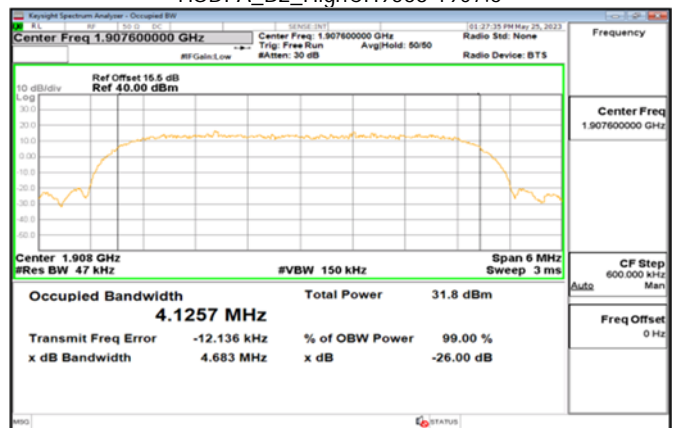

Unless otherwise stated the results shown in this test report refer only to the sample(s) tested and such sample(s) are retained for 90 days only.

除非另有說明，此報告結果僅對測試之樣品負責，同時此樣品僅保留90天。本報告未經本公司書面許可，不可部份複製。

This document is issued by the Company subject to its General Conditions of Service printed overleaf, available on request or accessible at <http://www.sgs.com.tw/Terms-and-Conditions> and for electronic format documents, subject to Terms and Conditions for Electronic Documents at <http://www.sgs.com.tw/Terms-and-Conditions>. Attention is drawn to the limitation of liability, indemnification and jurisdiction issues defined therein. Any holder of this document is advised that information contained hereon reflects the Company's findings at the time of its intervention only and within the limits of Client's instructions, if any. The Company's sole responsibility is to its Client and this document does not exonerate parties to a transaction from exercising all their rights and obligations under the transaction documents. This document cannot be reproduced except in full, without prior written approval of the Company. Any unauthorized alteration, forgery or falsification of the content or appearance of this document is unlawful and offenders may be prosecuted to the fullest extent of the law.

HSUPA\_B2\_LowCH9262-1852.4

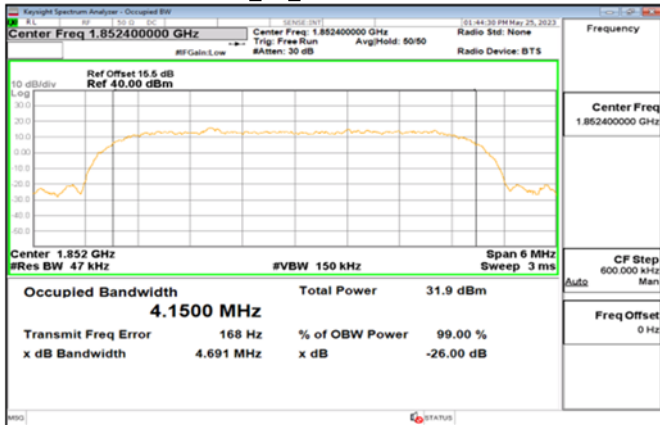

WCDMA\_B4\_LowCH1312-1712.4

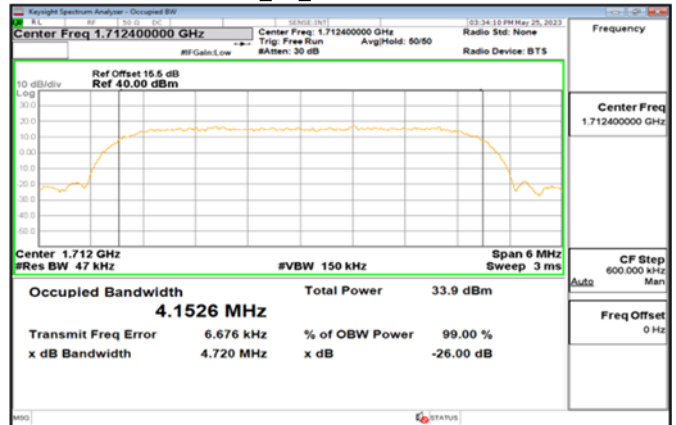

HSUPA\_B2\_MidCH9400-1880

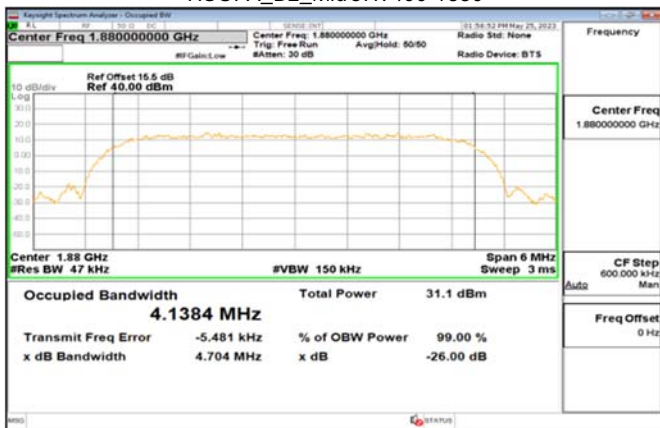

WCDMA\_B4\_MidCH1413-1732.6

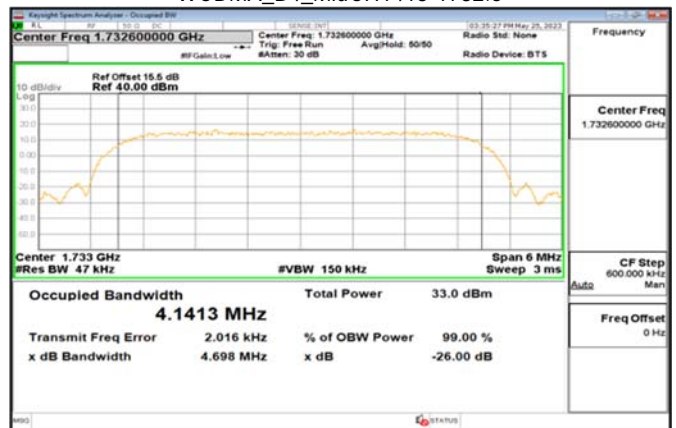

HSUPA\_B2\_HighCH9538-1907.6

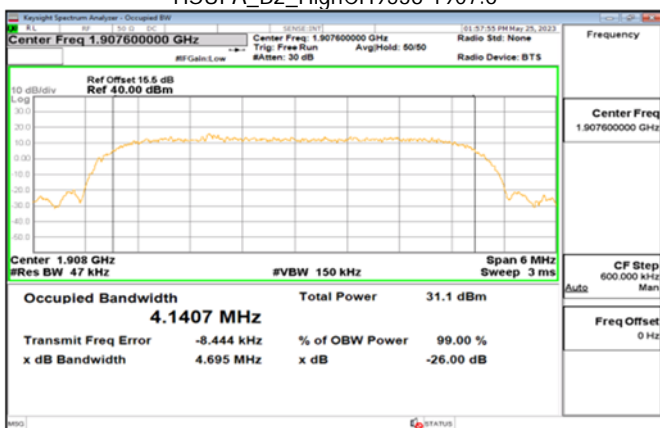

HSDPA\_B4\_HighCH1513-1752.6

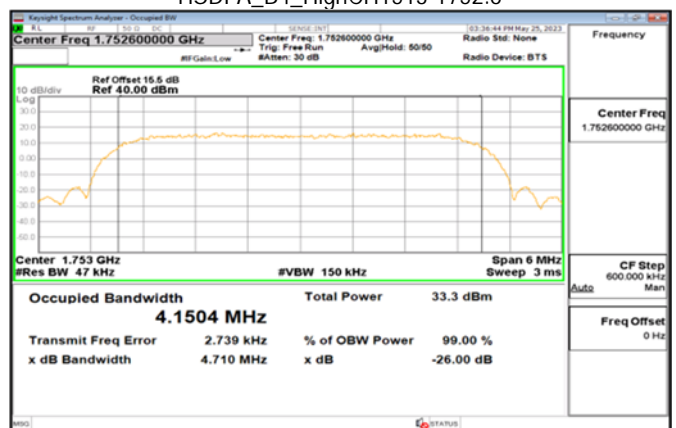

Unless otherwise stated the results shown in this test report refer only to the sample(s) tested and such sample(s) are retained for 90 days only.

除非另有說明，此報告結果僅對測試之樣品負責，同時此樣品僅保留90天。本報告未經本公司書面許可，不可部份複製。

This document is issued by the Company subject to its General Conditions of Service printed overleaf, available on request or accessible at <http://www.sgs.com.tw/Terms-and-Conditions> and for electronic format documents, subject to Terms and Conditions for Electronic Documents at <http://www.sgs.com.tw/Terms-and-Conditions>. Attention is drawn to the limitation of liability, indemnification and jurisdiction issues defined therein. Any holder of this document is advised that information contained hereon reflects the Company's findings at the time of its intervention only and within the limits of Client's instructions, if any. The Company's sole responsibility is to its Client and this document does not exonerate parties to a transaction from exercising all their rights and obligations under the transaction documents. This document cannot be reproduced except in full, without prior written approval of the Company. Any unauthorized alteration, forgery or falsification of the content or appearance of this document is unlawful and offenders may be prosecuted to the fullest extent of the law.



HSDPA\_B4\_LowCH1312-1712.4

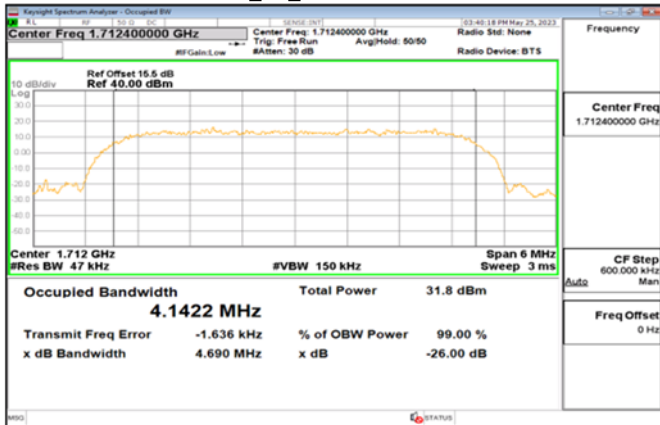

HSUPA\_B4\_LowCH1312-1712.4

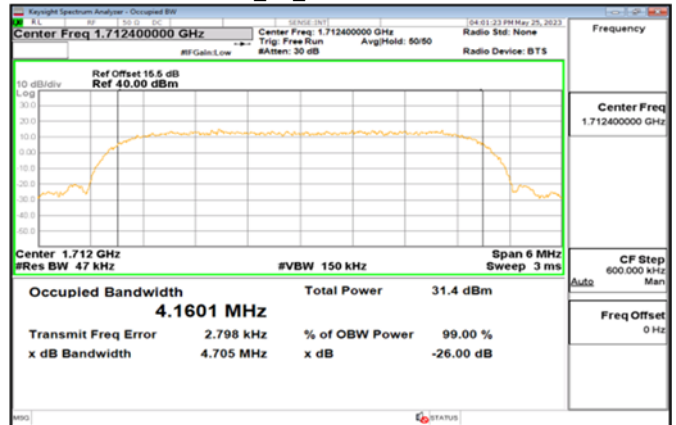

HSDPA\_B4\_MidCH1413-1732.6

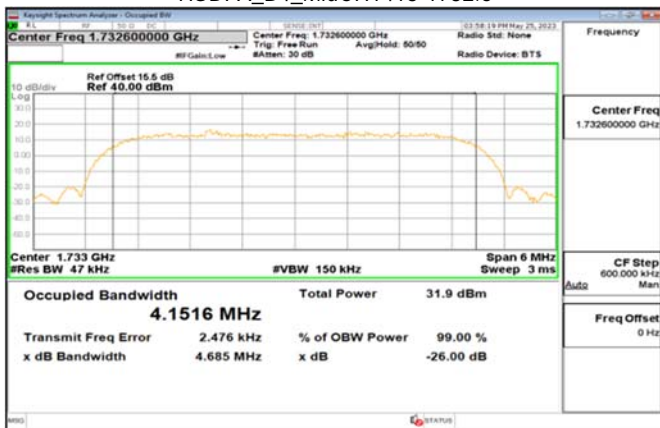

HSUPA\_B4\_MidCH1413-1732.6

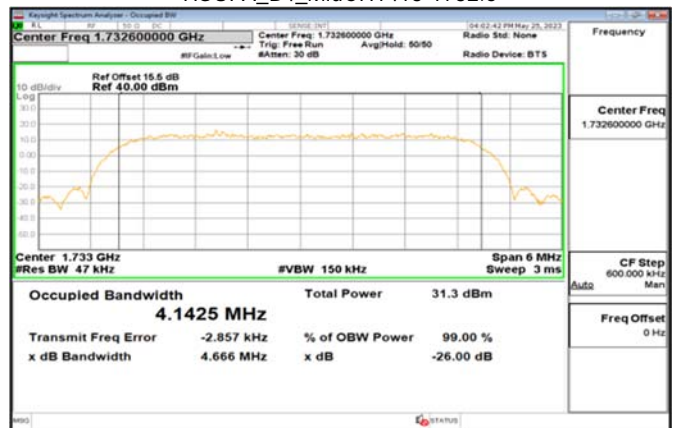

HSDPA\_B4\_HighCH1513-1752.6

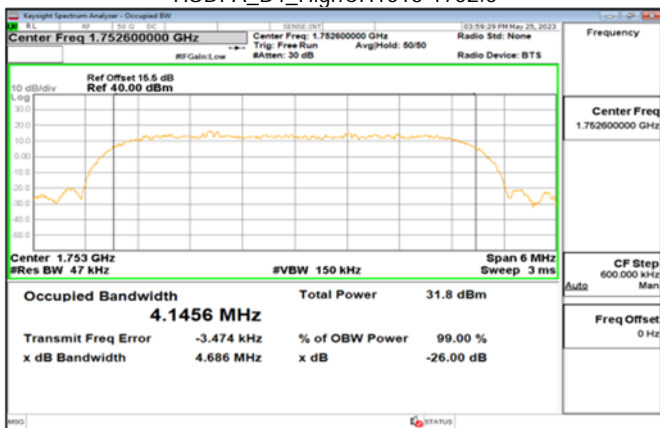

HSUPA\_B4\_HighCH1513-1752.6

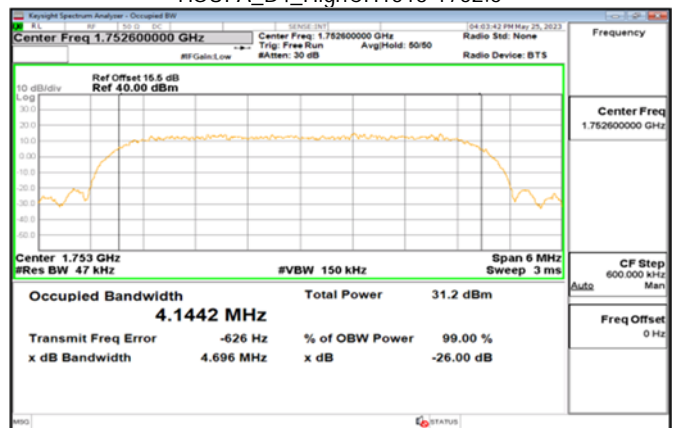

Unless otherwise stated the results shown in this test report refer only to the sample(s) tested and such sample(s) are retained for 90 days only.

除非另有說明，此報告結果僅對測試之樣品負責，同時此樣品僅保留90天。本報告未經本公司書面許可，不可部份複製。

This document is issued by the Company subject to its General Conditions of Service printed overleaf, available on request or accessible at <http://www.sgs.com.tw/Terms-and-Conditions> and for electronic format documents, subject to Terms and Conditions for Electronic Documents at <http://www.sgs.com.tw/Terms-and-Conditions>. Attention is drawn to the limitation of liability, indemnification and jurisdiction issues defined therein. Any holder of this document is advised that information contained hereon reflects the Company's findings at the time of its intervention only and within the limits of Client's instructions, if any. The Company's sole responsibility is to its Client and this document does not exonerate parties to a transaction from exercising all their rights and obligations under the transaction documents. This document cannot be reproduced except in full, without prior written approval of the Company. Any unauthorized alteration, forgery or falsification of the content or appearance of this document is unlawful and offenders may be prosecuted to the fullest extent of the law.



WCDMA\_B5\_LowCH4132-826.4

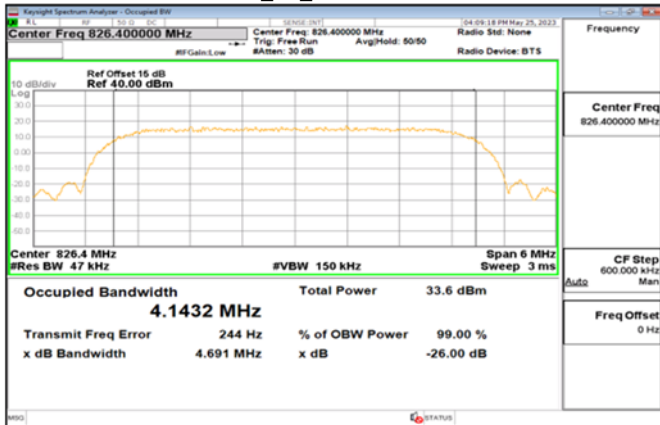

HSDPA\_B5\_LowCH4132-826.4

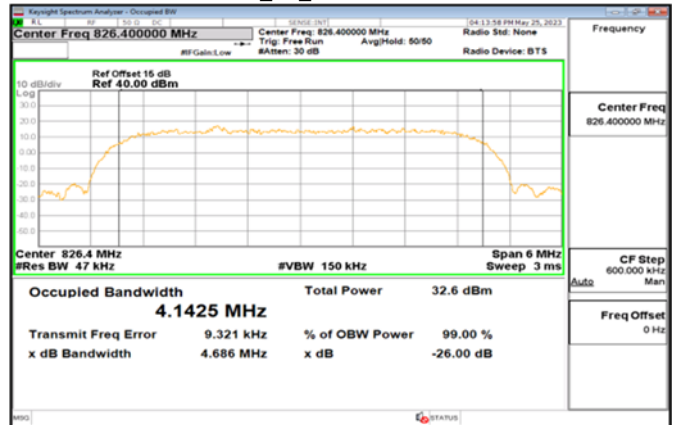

WCDMA\_B5\_MidCH4183-836.6

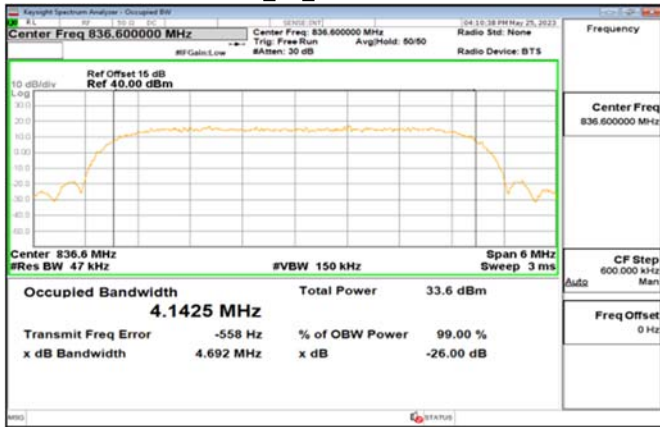

HSDPA\_B5\_MidCH4183-836.6

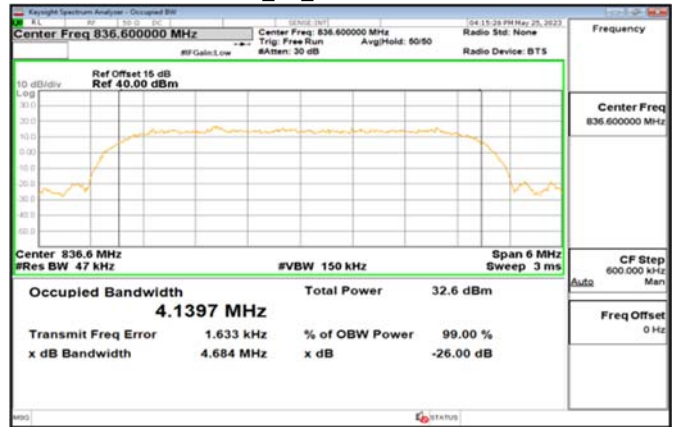

HSDPA\_B5\_HighCH4233-846.6

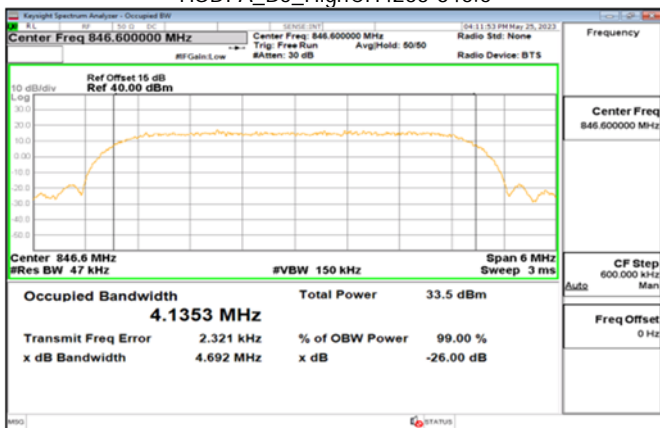

HSDPA\_B5\_HighCH4233-846.6

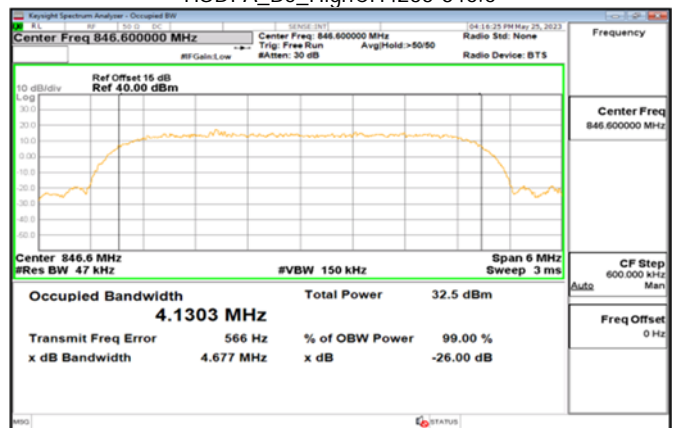

Unless otherwise stated the results shown in this test report refer only to the sample(s) tested and such sample(s) are retained for 90 days only.

除非另有說明，此報告結果僅對測試之樣品負責，同時此樣品僅保留90天。本報告未經本公司書面許可，不可部份複製。

This document is issued by the Company subject to its General Conditions of Service printed overleaf, available on request or accessible at <http://www.sgs.com.tw/Terms-and-Conditions> and for electronic format documents, subject to Terms and Conditions for Electronic Documents at <http://www.sgs.com.tw/Terms-and-Conditions>. Attention is drawn to the limitation of liability, indemnification and jurisdiction issues defined therein. Any holder of this document is advised that information contained hereon reflects the Company's findings at the time of its intervention only and within the limits of Client's instructions, if any. The Company's sole responsibility is to its Client and this document does not exonerate parties to a transaction from exercising all their rights and obligations under the transaction documents. This document cannot be reproduced except in full, without prior written approval of the Company. Any unauthorized alteration, forgery or falsification of the content or appearance of this document is unlawful and offenders may be prosecuted to the fullest extent of the law.

HSUPA\_B5\_LowCH4132-826.4

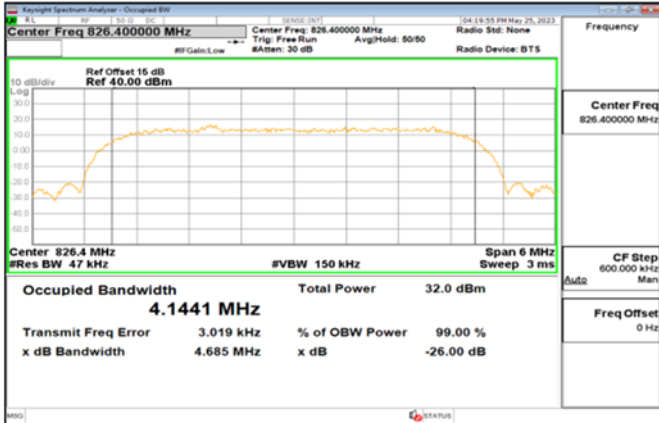

HSUPA\_B5\_MidCH4183-836.6

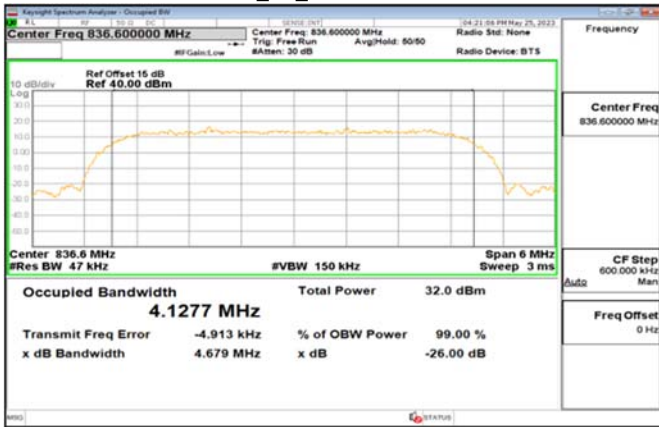

HSUPA\_B5\_HighCH4233-846.6

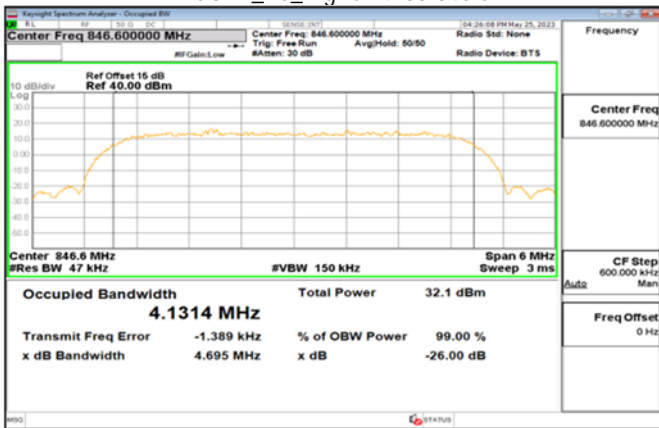

Unless otherwise stated the results shown in this test report refer only to the sample(s) tested and such sample(s) are retained for 90 days only.

除非另有說明，此報告結果僅對測試之樣品負責，同時此樣品僅保留90天。本報告未經本公司書面許可，不可部份複製。

This document is issued by the Company subject to its General Conditions of Service printed overleaf, available on request or accessible at <http://www.sgs.com.tw/Terms-and-Conditions> and for electronic format documents, subject to Terms and Conditions for Electronic Documents at <http://www.sgs.com.tw/Terms-and-Conditions>. Attention is drawn to the limitation of liability, indemnification and jurisdiction issues defined therein. Any holder of this document is advised that information contained hereon reflects the Company's findings at the time of its intervention only and within the limits of Client's instructions, if any. The Company's sole responsibility is to its Client and this document does not exonerate parties to a transaction from exercising all their rights and obligations under the transaction documents. This document cannot be reproduced except in full, without prior written approval of the Company. Any unauthorized alteration, forgery or falsification of the content or appearance of this document is unlawful and offenders may be prosecuted to the fullest extent of the law.

## 10 OUT OF BAND EMISSION AT ANTENNA TERMINALS

### 10.1 Standard Applicable

#### FCC §22.917(a), §24.238(a), §27.53(h)

Out of band emissions. The power of any emission outside of the authorized operating frequency ranges must be attenuated below the transmitting power (P) by a factor of at least  $43 + 10 \log(P)$  dB.

### 10.2 Test SET-UP

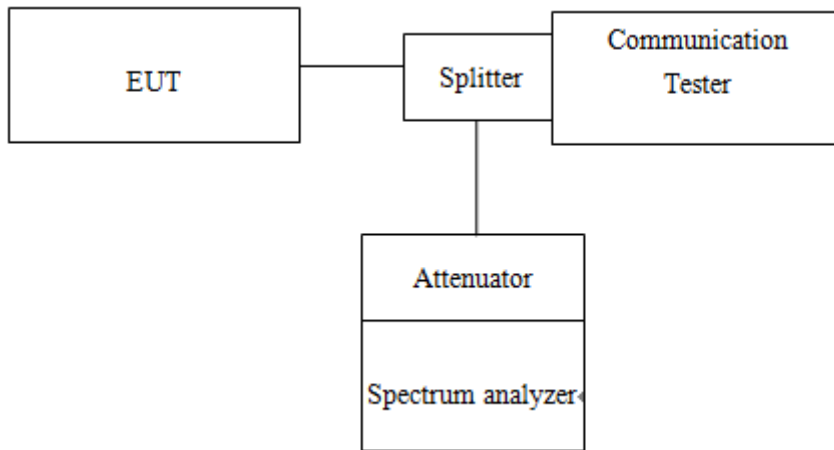

### 10.3 Measurement Procedure

#### 10.3.1 Conducted Emission

The RF output of the transceiver was connected to a spectrum analyzer through appropriate attenuation. The resolution bandwidth of the spectrum analyzer was set at 1MHz, sufficient scans were taken to show the out of band Emissions if any up to 10th harmonic.

1. To connect Antenna Port of EUT to Spectrum.
2. Set RBW = 1MHz & VBW = 1MHz on Spectrum.
3. Allow trace to fully stabilize
4. Repeat above procedures until all default test channel measured were complete.

#### 10.3.2 Band Edge

1. To connect Antenna Port of EUT to Spectrum.
2. The band edge of low and high channels for the highest RF powers was measured. Setting  $RBW \geq 1\% EBW$ .
3. Allow trace to fully stabilize
4. Repeat above procedures until all default test channel measured were complete.

### 10.4 Measurement Result:

Refer to next pages.

Unless otherwise stated the results shown in this test report refer only to the sample(s) tested and such sample(s) are retained for 90 days only.

除非另有說明，此報告結果僅對測試之樣品負責，同時此樣品僅保留90天。本報告未經本公司書面許可，不可部份複製。  
This document is issued by the Company subject to its General Conditions of Service printed overleaf, available on request or accessible at <http://www.sgs.com.tw/Terms-and-Conditions> and for electronic format documents, subject to Terms and Conditions for Electronic Documents at <http://www.sgs.com.tw/Terms-and-Conditions>. Attention is drawn to the limitation of liability, indemnification and jurisdiction issues defined therein. Any holder of this document is advised that information contained hereon reflects the Company's findings at the time of its intervention only and within the limits of Client's instructions, if any. The Company's sole responsibility is to its Client and this document does not exonerate parties to a transaction from exercising all their rights and obligations under the transaction documents. This document cannot be reproduced except in full, without prior written approval of the Company. Any unauthorized alteration, forgery or falsification of the content or appearance of this document is unlawful and offenders may be prosecuted to the fullest extent of the law.

Band Edge GSM\_850MHz\_LowCH128-824.2



Band Edge GPRS\_850MHz\_HighCH251-848.8



Band Edge GSM\_850MHz\_HighCH251-848.8



Band Edge EDGE\_850MHz\_LowCH128-824.2



Band Edge GPRS\_850MHz\_LowCH128-824.2



Band Edge EDGE\_850MHz\_HighCH251-848.8

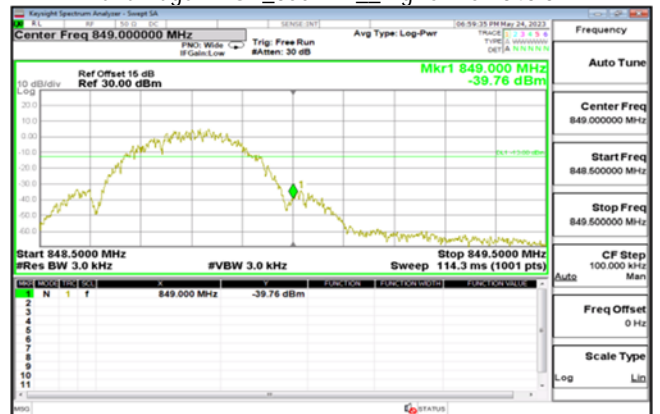

Unless otherwise stated the results shown in this test report refer only to the sample(s) tested and such sample(s) are retained for 90 days only.

除非另有說明，此報告結果僅對測試之樣品負責，同時此樣品僅保留90天。本報告未經本公司書面許可，不可部份複製。

This document is issued by the Company subject to its General Conditions of Service printed overleaf, available on request or accessible at <http://www.sgs.com.tw/Terms-and-Conditions> and for electronic format documents, subject to Terms and Conditions for Electronic Documents at <http://www.sgs.com.tw/Terms-and-Conditions>. Attention is drawn to the limitation of liability, indemnification and jurisdiction issues defined therein. Any holder of this document is advised that information contained hereon reflects the Company's findings at the time of its intervention only and within the limits of Client's instructions, if any. The Company's sole responsibility is to its Client and this document does not exonerate parties to a transaction from exercising all their rights and obligations under the transaction documents. This document cannot be reproduced except in full, without prior written approval of the Company. Any unauthorized alteration, forgery or falsification of the content or appearance of this document is unlawful and offenders may be prosecuted to the fullest extent of the law.



Band Edge GSM\_1900MHz\_LowCH512-1850.2



Band Edge GPRS\_1900MHz\_HighCH810-1909.8



Band Edge GSM\_1900MHz\_HighCH810-1909.8



Band Edge EDGE\_1900MHz\_LowCH512-1850.2



Band Edge GPRS\_1900MHz\_LowCH512-1850.2



Band Edge EDGE\_1900MHz\_HighCH810-1909.8



Unless otherwise stated the results shown in this test report refer only to the sample(s) tested and such sample(s) are retained for 90 days only.

除非另有說明，此報告結果僅對測試之樣品負責，同時此樣品僅保留90天。本報告未經本公司書面許可，不可部份複製。

This document is issued by the Company subject to its General Conditions of Service printed overleaf, available on request or accessible at <http://www.sgs.com.tw/Terms-and-Conditions> and for electronic format documents, subject to Terms and Conditions for Electronic Documents at <http://www.sgs.com.tw/Terms-and-Conditions>. Attention is drawn to the limitation of liability, indemnification and jurisdiction issues defined therein. Any holder of this document is advised that information contained hereon reflects the Company's findings at the time of its intervention only and within the limits of Client's instructions, if any. The Company's sole responsibility is to its Client and this document does not exonerate parties to a transaction from exercising all their rights and obligations under the transaction documents. This document cannot be reproduced except in full, without prior written approval of the Company. Any unauthorized alteration, forgery or falsification of the content or appearance of this document is unlawful and offenders may be prosecuted to the fullest extent of the law.

Band Edge WCDMA\_B2\_LowCH9262-1852.4

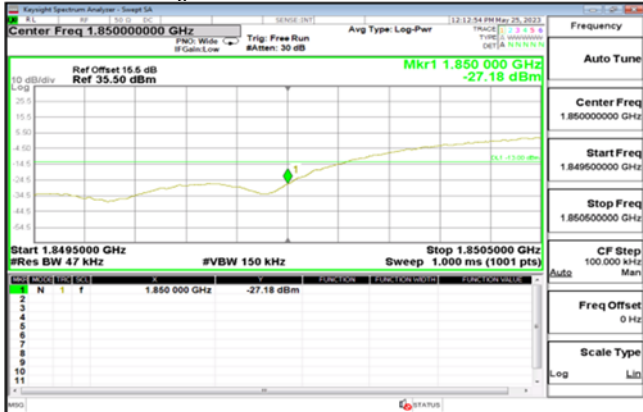

Band Edge HSDPA\_B2\_HighCH9538-1907.6



Band Edge WCDMA\_B2\_HighCH9538-1907.6

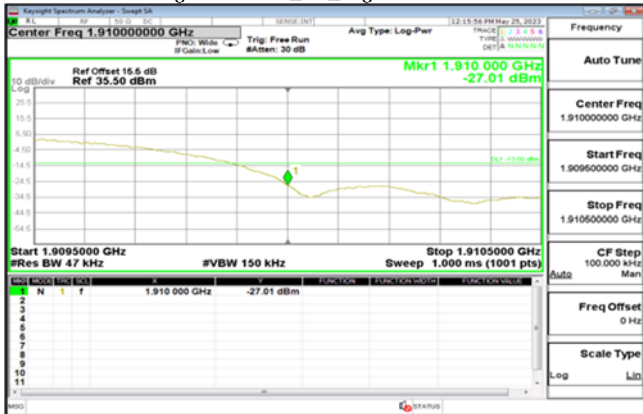

Band Edge HSUPA\_B2\_LowCH9262-1852.4

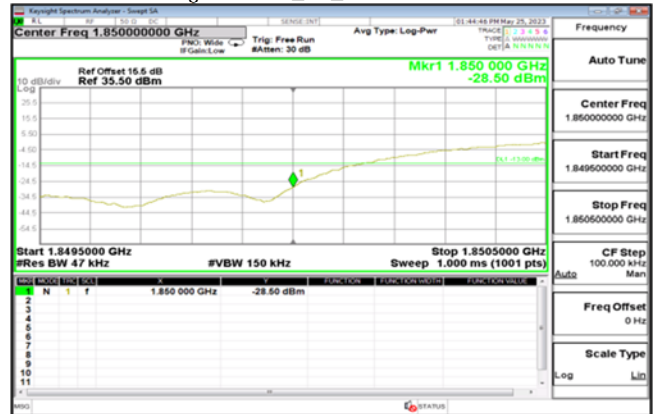

Band Edge HSDPA\_B2\_LowCH9262-1852.4

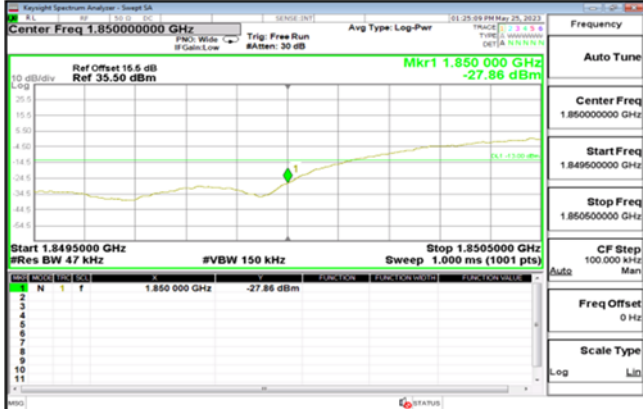

Band Edge HSUPA\_B2\_HighCH9538-1907.6

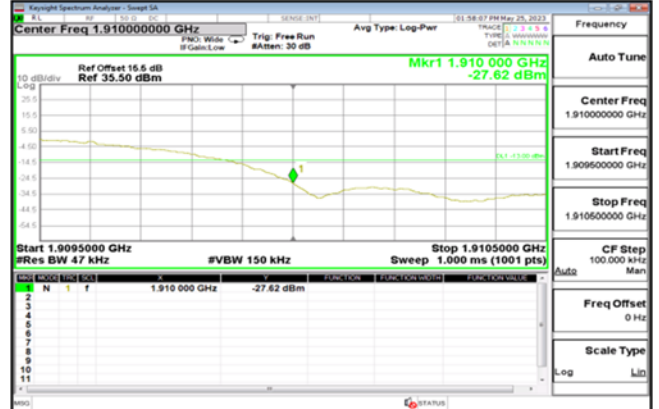

Unless otherwise stated the results shown in this test report refer only to the sample(s) tested and such sample(s) are retained for 90 days only.

除非另有說明，此報告結果僅對測試之樣品負責，同時此樣品僅保留90天。本報告未經本公司書面許可，不可部份複製。

This document is issued by the Company subject to its General Conditions of Service printed overleaf, available on request or accessible at <http://www.sgs.com.tw/Terms-and-Conditions> and for electronic format documents, subject to Terms and Conditions for Electronic Documents at <http://www.sgs.com.tw/Terms-and-Conditions>. Attention is drawn to the limitation of liability, indemnification and jurisdiction issues defined therein. Any holder of this document is advised that information contained hereon reflects the Company's findings at the time of its intervention only and within the limits of Client's instructions, if any. The Company's sole responsibility is to its Client and this document does not exonerate parties to a transaction from exercising all their rights and obligations under the transaction documents. This document cannot be reproduced except in full, without prior written approval of the Company. Any unauthorized alteration, forgery or falsification of the content or appearance of this document is unlawful and offenders may be prosecuted to the fullest extent of the law.

Band Edge WCDMA\_B4\_LowCH1312-1712.4

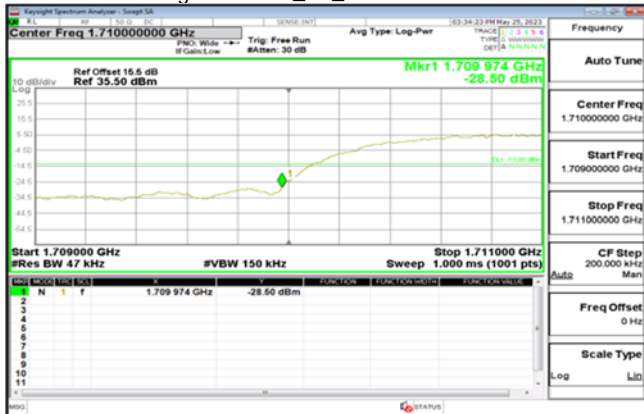

Band Edge HSDPA\_B4\_HighCH1513-1752.6

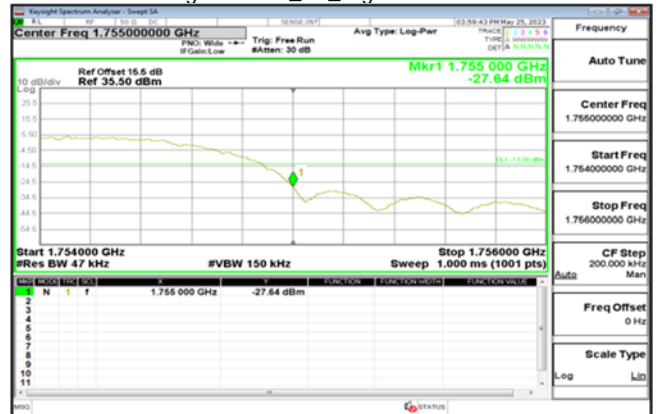

Band Edge WCDMA\_B4\_HighCH1513-1752.6

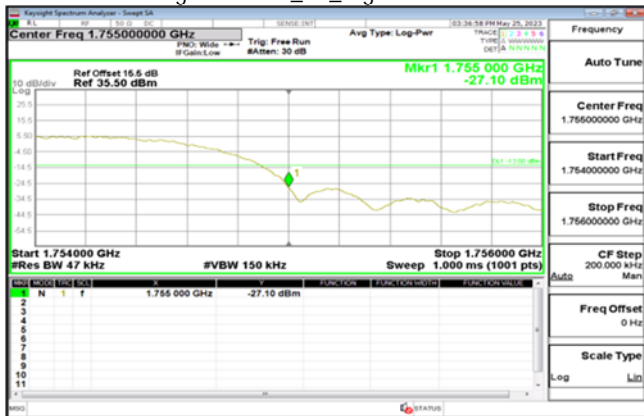

Band Edge HSUPA\_B4\_LowCH1312-1712.4

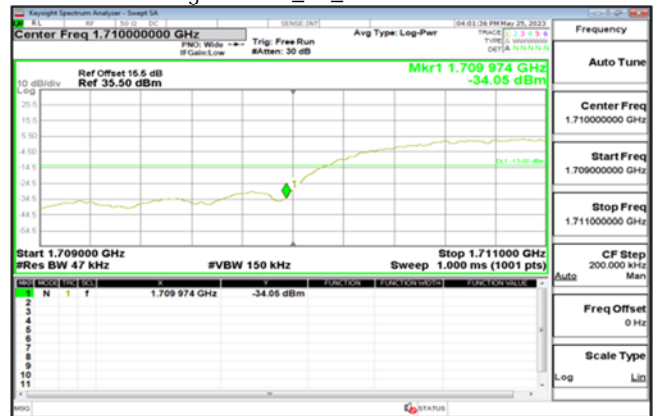

Band Edge HSDPA\_B4\_LowCH1312-1712.4

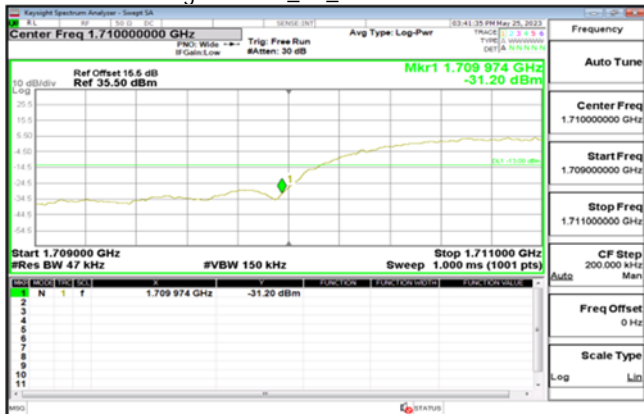

Band Edge HSUPA\_B4\_HighCH1513-1752.6

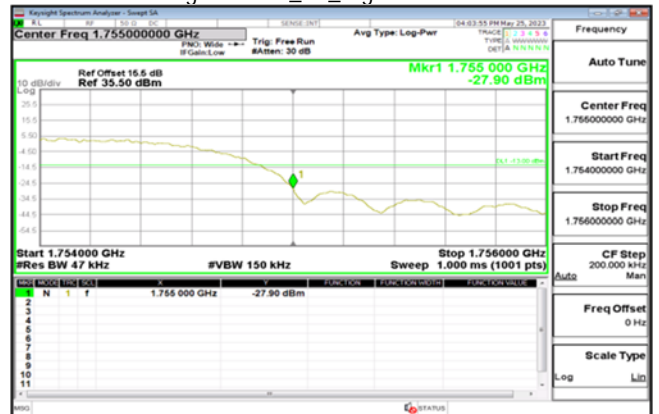

Unless otherwise stated the results shown in this test report refer only to the sample(s) tested and such sample(s) are retained for 90 days only.

除非另有說明，此報告結果僅對測試之樣品負責，同時此樣品僅保留90天。本報告未經本公司書面許可，不可部份複製。

This document is issued by the Company subject to its General Conditions of Service printed overleaf, available on request or accessible at <http://www.sgs.com.tw/Terms-and-Conditions> and for electronic format documents, subject to Terms and Conditions for Electronic Documents at <http://www.sgs.com.tw/Terms-and-Conditions>. Attention is drawn to the limitation of liability, indemnification and jurisdiction issues defined therein. Any holder of this document is advised that information contained hereon reflects the Company's findings at the time of its intervention only and within the limits of Client's instructions, if any. The Company's sole responsibility is to its Client and this document does not exonerate parties to a transaction from exercising all their rights and obligations under the transaction documents. This document cannot be reproduced except in full, without prior written approval of the Company. Any unauthorized alteration, forgery or falsification of the content or appearance of this document is unlawful and offenders may be prosecuted to the fullest extent of the law.

Band Edge WCDMA\_B5\_LowCH4132-826.4

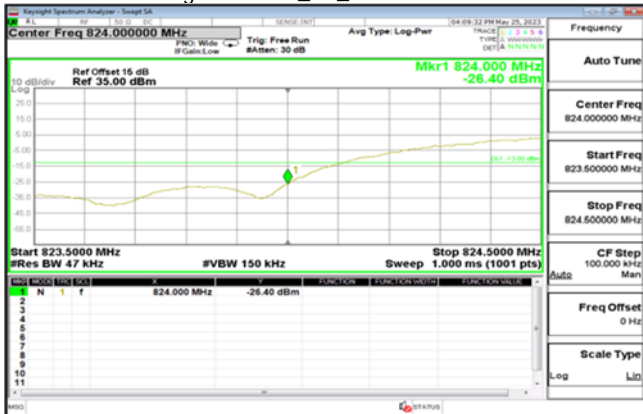

Band Edge HSDPA\_B5\_HighCH4233-846.6

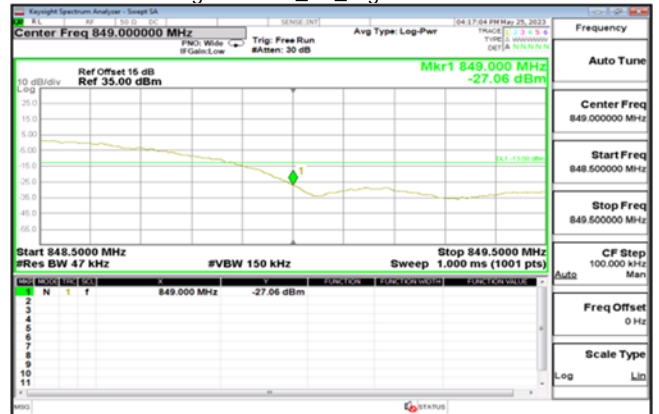

Band Edge WCDMA\_B5\_HighCH4233-846.6



Band Edge HSUPA\_B5\_LowCH4132-826.4

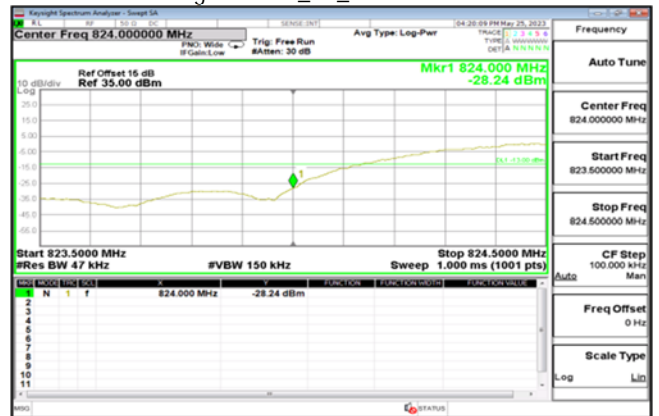

Band Edge HSDPA\_B5\_LowCH4132-826.4

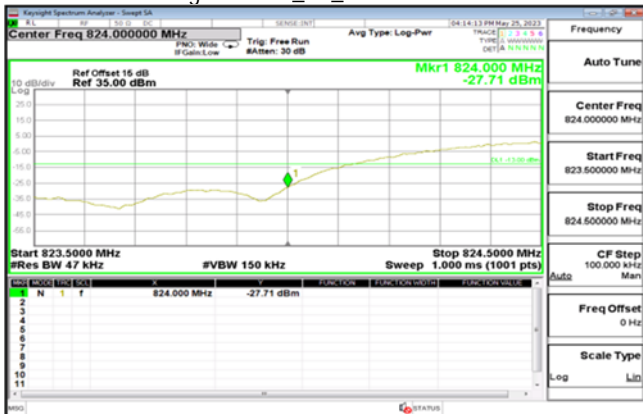

Band Edge HSUPA\_B5\_HighCH4233-846.6

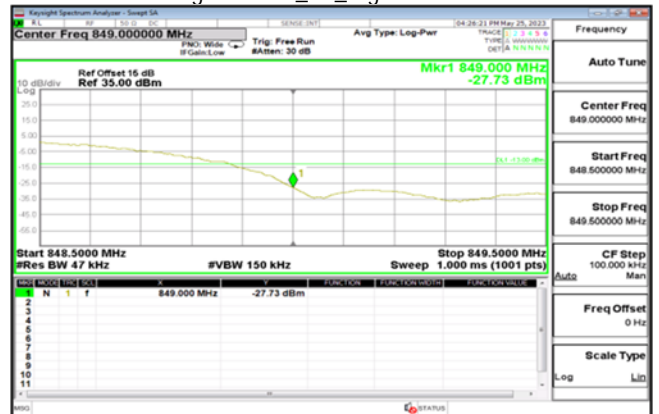

Unless otherwise stated the results shown in this test report refer only to the sample(s) tested and such sample(s) are retained for 90 days only.

除非另有說明，此報告結果僅對測試之樣品負責，同時此樣品僅保留90天。本報告未經本公司書面許可，不可部份複製。

This document is issued by the Company subject to its General Conditions of Service printed overleaf, available on request or accessible at <http://www.sgs.com.tw/Terms-and-Conditions> and for electronic format documents, subject to Terms and Conditions for Electronic Documents at <http://www.sgs.com.tw/Terms-and-Conditions>. Attention is drawn to the limitation of liability, indemnification and jurisdiction issues defined therein. Any holder of this document is advised that information contained hereon reflects the Company's findings at the time of its intervention only and within the limits of Client's instructions, if any. The Company's sole responsibility is to its Client and this document does not exonerate parties to a transaction from exercising all their rights and obligations under the transaction documents. This document cannot be reproduced except in full, without prior written approval of the Company. Any unauthorized alteration, forgery or falsification of the content or appearance of this document is unlawful and offenders may be prosecuted to the fullest extent of the law.