

HSDPA_B2_LowCH9262-1852.4

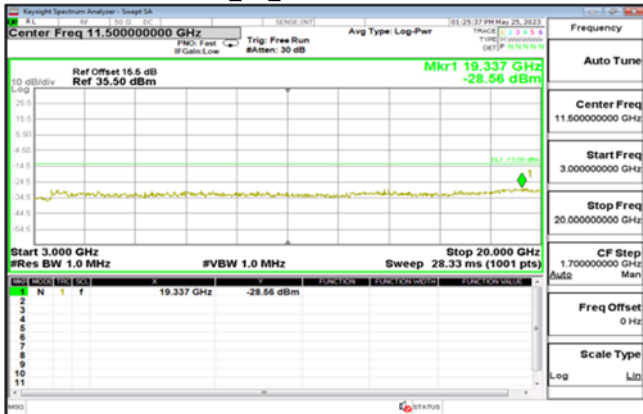

HSUPA_B2_LowCH9262-1852.4

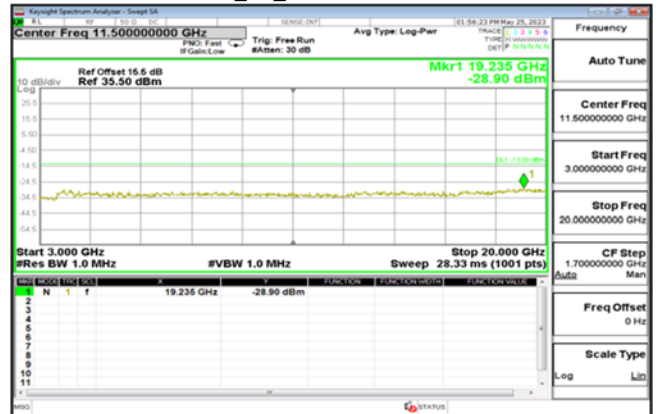

HSDPA_B2_MidCH9400-1880

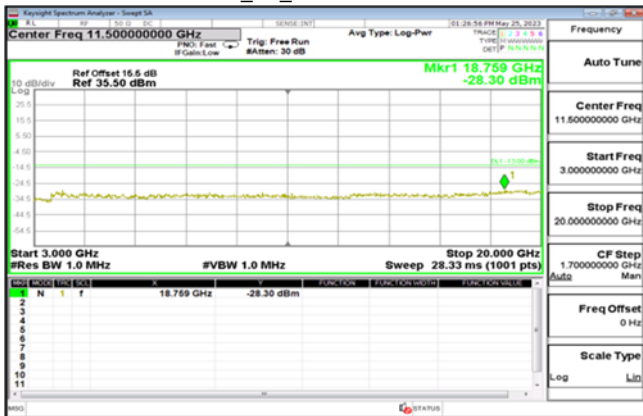

HSUPA_B2_MidCH9400-1880

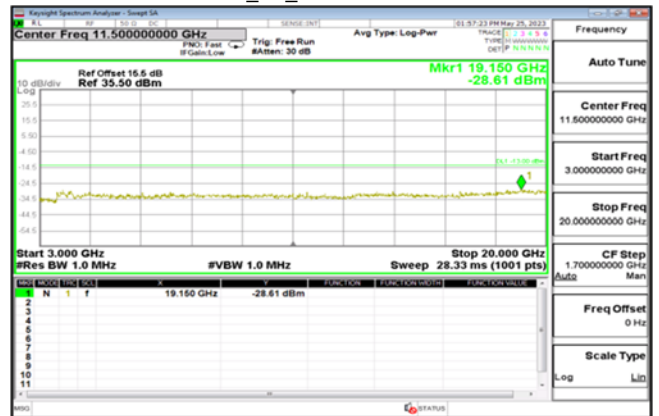

HSDPA_B2_HighCH9538-1907.6



HSUPA_B2_HighCH9538-1907.6



Unless otherwise stated the results shown in this test report refer only to the sample(s) tested and such sample(s) are retained for 90 days only.

除非另有說明，此報告結果僅對測試之樣品負責，同時此樣品僅保留90天。本報告未經本公司書面許可，不可部份複製。

This document is issued by the Company subject to its General Conditions of Service printed overleaf, available on request or accessible at <http://www.sgs.com.tw/Terms-and-Conditions> and for electronic format documents, subject to Terms and Conditions for Electronic Documents at <http://www.sgs.com.tw/Terms-and-Conditions>. Attention is drawn to the limitation of liability, indemnification and jurisdiction issues defined therein. Any holder of this document is advised that information contained hereon reflects the Company's findings at the time of its intervention only and within the limits of Client's instructions, if any. The Company's sole responsibility is to its Client and this document does not exonerate parties to a transaction from exercising all their rights and obligations under the transaction documents. This document cannot be reproduced except in full, without prior written approval of the Company. Any unauthorized alteration, forgery or falsification of the content or appearance of this document is unlawful and offenders may be prosecuted to the fullest extent of the law.

WCDMA_B4_LowCH1312-1712.4

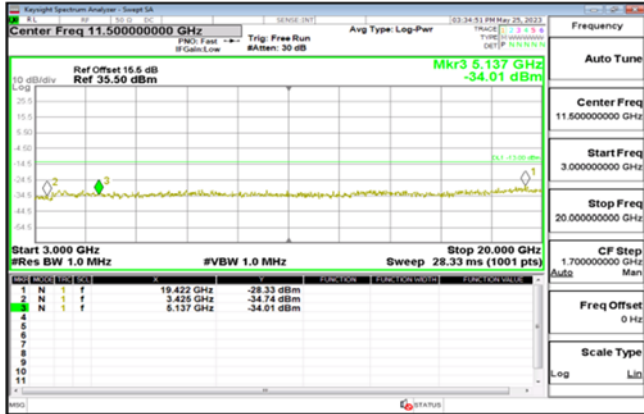

HSDPA_B4_LowCH1312-1712.4

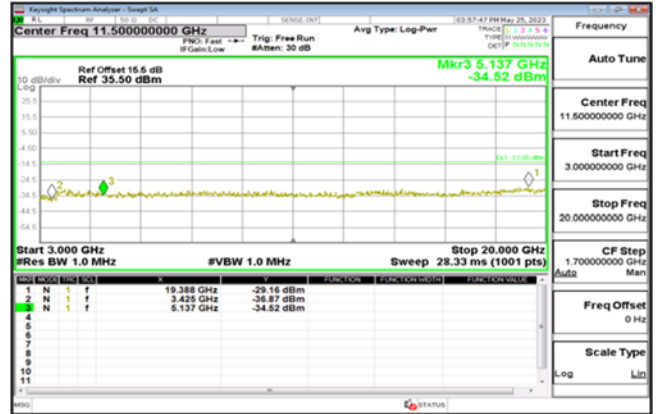

WCDMA_B4_MidCH1413-1732.6



HSDPA_B4_MidCH1413-1732.6

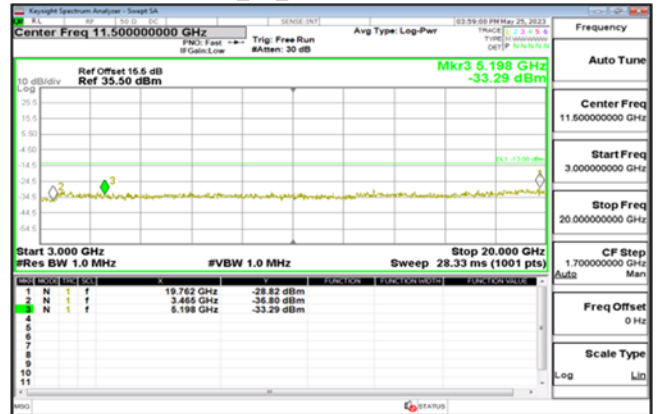

WCDMA_B4_HighCH1513-1752.6

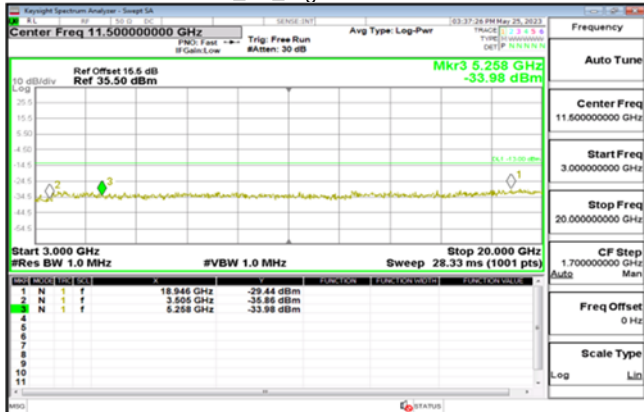

HSDPA_B4_HighCH1513-1752.6

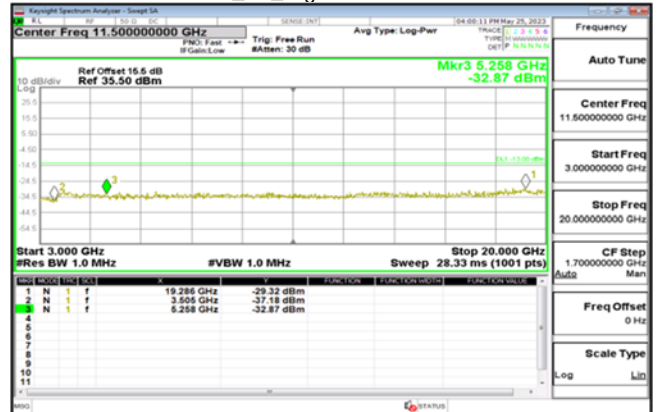

Unless otherwise stated the results shown in this test report refer only to the sample(s) tested and such sample(s) are retained for 90 days only.

除非另有說明，此報告結果僅對測試之樣品負責，同時此樣品僅保留90天。本報告未經本公司書面許可，不可部份複製。

This document is issued by the Company subject to its General Conditions of Service printed overleaf, available on request or accessible at <http://www.sgs.com.tw/Terms-and-Conditions> and for electronic format documents, subject to Terms and Conditions for Electronic Documents at <http://www.sgs.com.tw/Terms-and-Conditions>. Attention is drawn to the limitation of liability, indemnification and jurisdiction issues defined therein. Any holder of this document is advised that information contained hereon reflects the Company's findings at the time of its intervention only and within the limits of Client's instructions, if any. The Company's sole responsibility is to its Client and this document does not exonerate parties to a transaction from exercising all their rights and obligations under the transaction documents. This document cannot be reproduced except in full, without prior written approval of the Company. Any unauthorized alteration, forgery or falsification of the content or appearance of this document is unlawful and offenders may be prosecuted to the fullest extent of the law.

HSUPA_B4_LowCH1312-1712.4

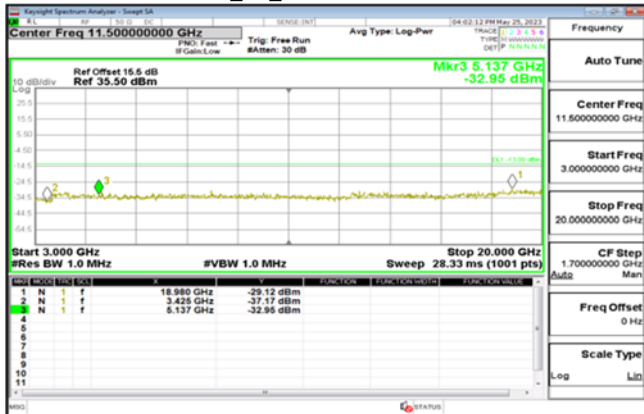

WCDMA_B5_LowCH4132-826.4

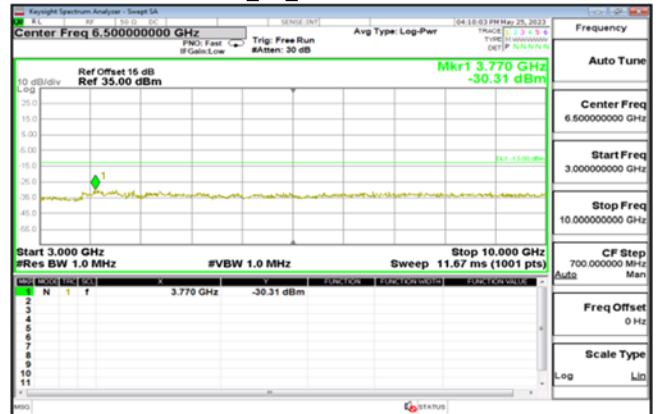

HSUPA_B4_MidCH1413-1732.6

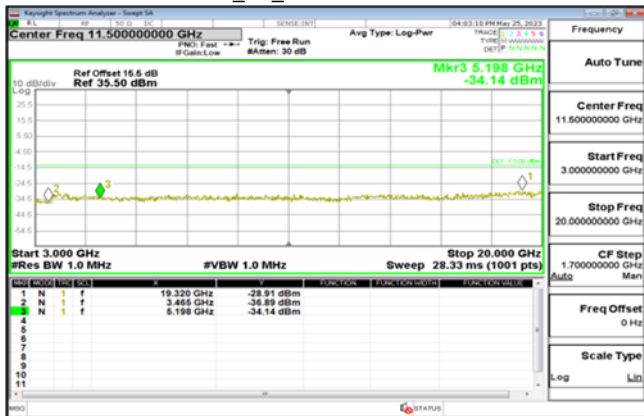

WCDMA_B5_MidCH4183-836.6



HSUPA_B4_HighCH1513-1752.6

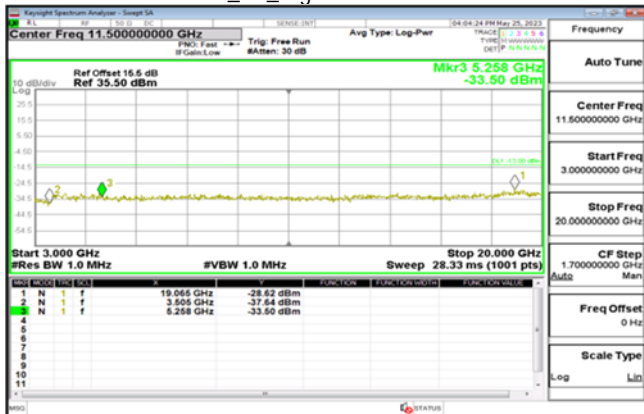

WCDMA_B5_HighCH4233-846.6

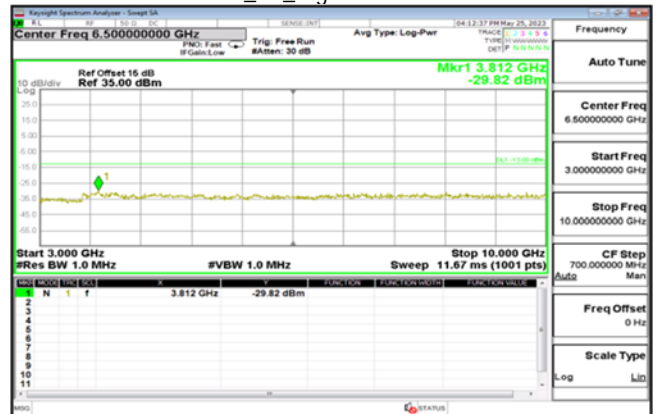

Unless otherwise stated the results shown in this test report refer only to the sample(s) tested and such sample(s) are retained for 90 days only.

除非另有說明，此報告結果僅對測試之樣品負責，同時此樣品僅保留90天。本報告未經本公司書面許可，不可部份複製。

This document is issued by the Company subject to its General Conditions of Service printed overleaf, available on request or accessible at <http://www.sgs.com.tw/Terms-and-Conditions> and for electronic format documents, subject to Terms and Conditions for Electronic Documents at <http://www.sgs.com.tw/Terms-and-Conditions>. Attention is drawn to the limitation of liability, indemnification and jurisdiction issues defined therein. Any holder of this document is advised that information contained hereon reflects the Company's findings at the time of its intervention only and within the limits of Client's instructions, if any. The Company's sole responsibility is to its Client and this document does not exonerate parties to a transaction from exercising all their rights and obligations under the transaction documents. This document cannot be reproduced except in full, without prior written approval of the Company. Any unauthorized alteration, forgery or falsification of the content or appearance of this document is unlawful and offenders may be prosecuted to the fullest extent of the law.

HSDPA_B5_LowCH4132-826.4

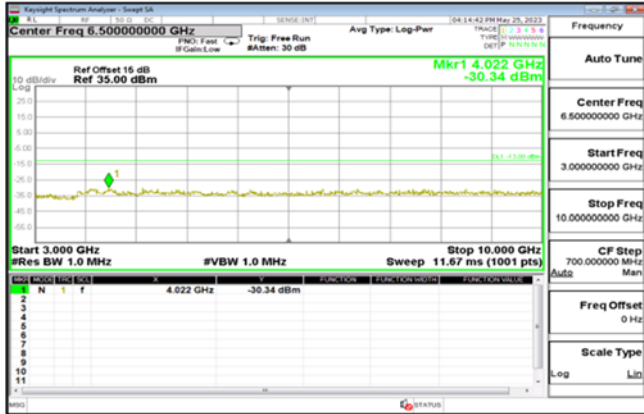

HSUPA_B5_LowCH4132-826.4

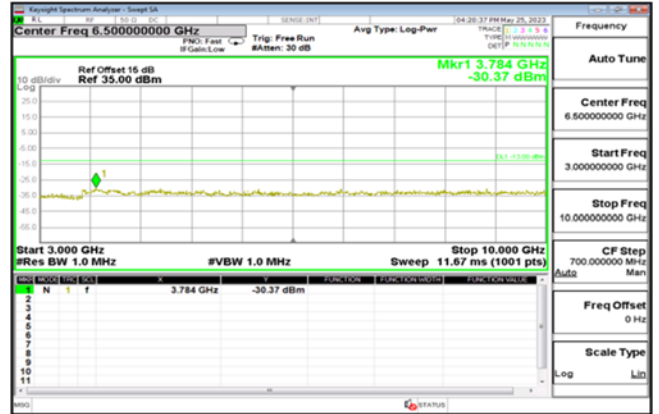

HSDPA_B5_MidCH4183-836.6

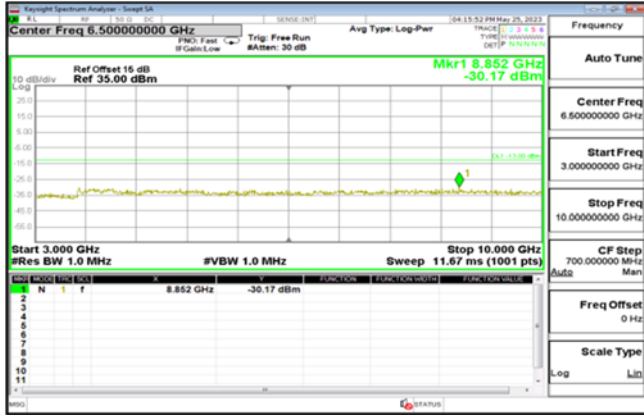

HSUPA_B5_MidCH4183-836.6

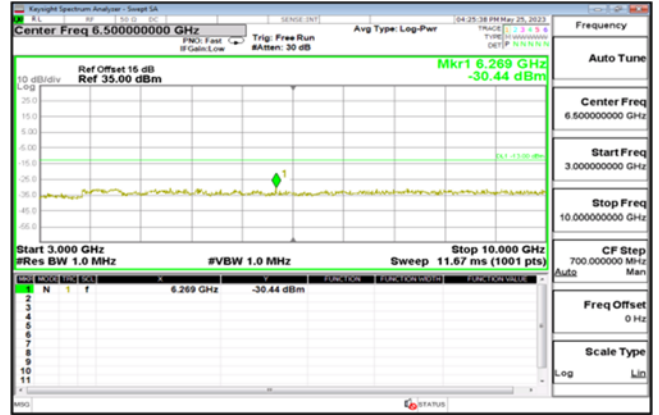

HSDPA_B5_HighCH4233-846.6

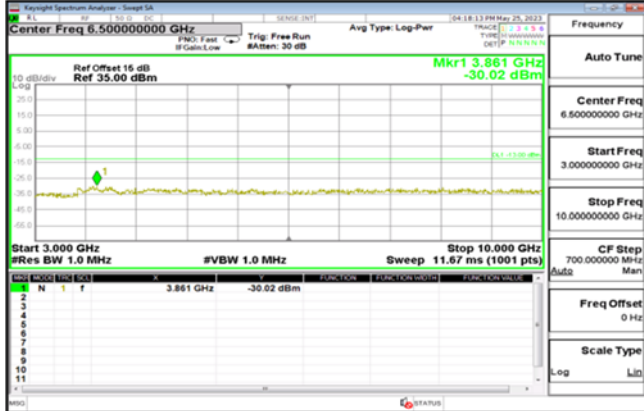

HSUP_B5_HighCH4233-846.6

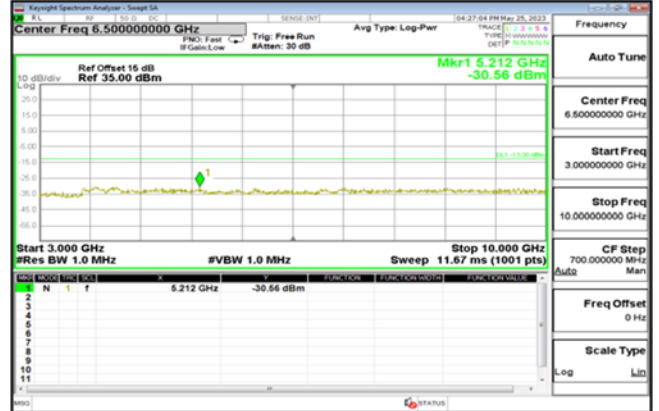

Unless otherwise stated the results shown in this test report refer only to the sample(s) tested and such sample(s) are retained for 90 days only.

除非另有說明，此報告結果僅對測試之樣品負責，同時此樣品僅保留90天。本報告未經本公司書面許可，不可部份複製。

This document is issued by the Company subject to its General Conditions of Service printed overleaf, available on request or accessible at <http://www.sgs.com.tw/Terms-and-Conditions> and for electronic format documents, subject to Terms and Conditions for Electronic Documents at <http://www.sgs.com.tw/Terms-and-Conditions>. Attention is drawn to the limitation of liability, indemnification and jurisdiction issues defined therein. Any holder of this document is advised that information contained hereon reflects the Company's findings at the time of its intervention only and within the limits of Client's instructions, if any. The Company's sole responsibility is to its Client and this document does not exonerate parties to a transaction from exercising all their rights and obligations under the transaction documents. This document cannot be reproduced except in full, without prior written approval of the Company. Any unauthorized alteration, forgery or falsification of the content or appearance of this document is unlawful and offenders may be prosecuted to the fullest extent of the law.

11 FIELD STRENGTH OF SPURIOUS RADIATION MEASUREMENT

11.1 Standard Applicable

According to FCC §2.1053,

FCC §22.917(a), §24.238(a), §27.53(h)

Out of band emissions. The power of any emission outside of the authorized operating frequency ranges must be attenuated below the transmitting power (P) by a factor of at least $43 + 10 \log(P)$ dB.

11.2 EUT Setup

Radiated Emission Test Set-Up, Frequency From 30MHz to 1000MHz.

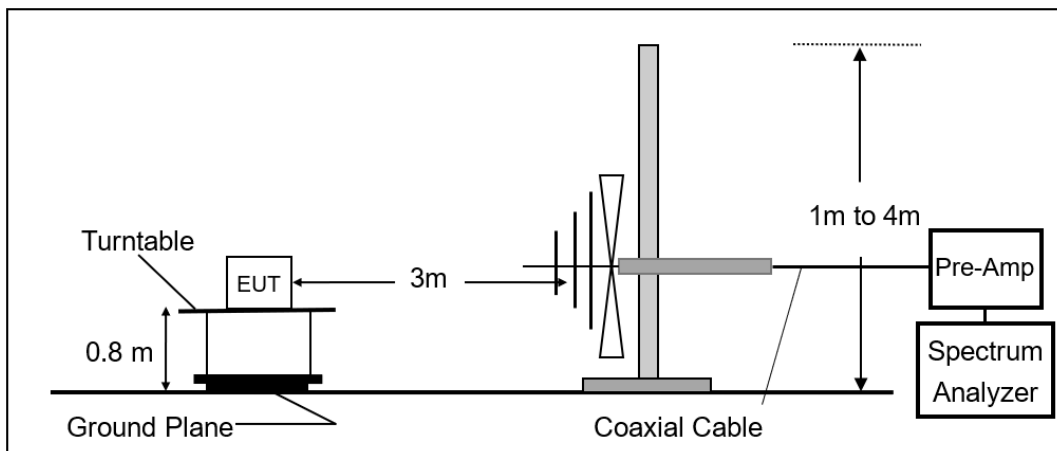

Radiated Emission Test Set-Up, Frequency Above 1GHz.

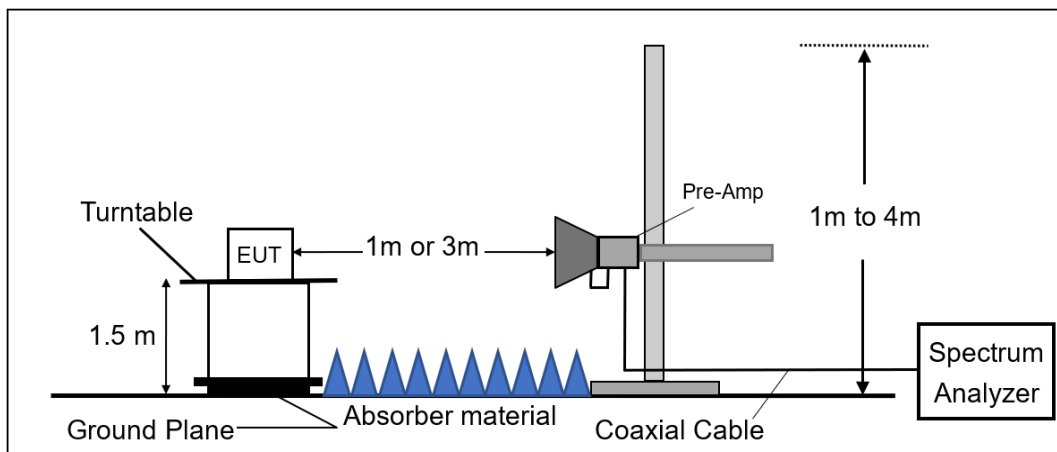

Unless otherwise stated the results shown in this test report refer only to the sample(s) tested and such sample(s) are retained for 90 days only.

除非另有說明，此報告結果僅對測試之樣品負責，同時此樣品僅保留90天。本報告未經本公司書面許可，不可部份複製。
This document is issued by the Company subject to its General Conditions of Service printed overleaf, available on request or accessible at <http://www.sgs.com.tw/Terms-and-Conditions> and for electronic format documents, subject to Terms and Conditions for Electronic Documents at <http://www.sgs.com.tw/Terms-and-Conditions>. Attention is drawn to the limitation of liability, indemnification and jurisdiction issues defined therein. Any holder of this document is advised that information contained hereon reflects the Company's findings at the time of its intervention only and within the limits of Client's instructions, if any. The Company's sole responsibility is to its Client and this document does not exonerate parties to a transaction from exercising all their rights and obligations under the transaction documents. This document cannot be reproduced except in full, without prior written approval of the Company. Any unauthorized alteration, forgery or falsification of the content or appearance of this document is unlawful and offenders may be prosecuted to the fullest extent of the law.

11.3 Measurement Procedure:

The EUT was placed on a non-conductive; the measurement antenna was placed at a distance of 3 meters from the EUT. During the tests, the antenna height and the EUT azimuth were varied in order to identify the maximum level of emissions from the EUT. This maximization process was repeated with the EUT positioned in each of its three orthogonal orientations.

The frequency range up to tenth harmonic was investigated for each of three fundamental frequencies (low, middle and high channels). Once spurious emission was identified, the power of the emission was determined using the substitution method.

The spurious emissions attenuation was calculated as the difference between radiated power at the fundamental frequency and the spurious emissions frequency.

$$\text{ERP (dBm)} = \text{SG Level(dBm)} + \text{Antenna Gain(dBd)} + \text{Cable Loss(dB)}$$

$$\text{EIRP (dBm)} = \text{SG Level(dBm)} + \text{Antenna Gain(dBi)} + \text{Cable Loss(dB)}$$

Unless otherwise stated the results shown in this test report refer only to the sample(s) tested and such sample(s) are retained for 90 days only.
除非另有說明，此報告結果僅對測試之樣品負責，同時此樣品僅保留90天。本報告未經本公司書面許可，不可部份複製。

This document is issued by the Company subject to its General Conditions of Service printed overleaf, available on request or accessible at <http://www.sgs.com.tw/Terms-and-Conditions> and for electronic format documents, subject to Terms and Conditions for Electronic Documents at <http://www.sgs.com.tw/Terms-and-Conditions>. Attention is drawn to the limitation of liability, indemnification and jurisdiction issues defined therein. Any holder of this document is advised that information contained hereon reflects the Company's findings at the time of its intervention only and within the limits of Client's instructions, if any. The Company's sole responsibility is to its Client and this document does not exonerate parties to a transaction from exercising all their rights and obligations under the transaction documents. This document cannot be reproduced except in full, without prior written approval of the Company. Any unauthorized alteration, forgery or falsification of the content or appearance of this document is unlawful and offenders may be prosecuted to the fullest extent of the law.

11.4 Measurement Result:

Report Number :TERF2305001075ER
 Operation Mode :GSM 850
 Test Mode :Tx
 EUT Pol :E1 Plane
 Test Frequency :824.2 MHz

Test Site :SAC 2
 Test Date :2023-06-27
 Temp./Humi. :25.9°C/55%
 Antenna Pol. :Vertical
 Engineer :Ricky Chen

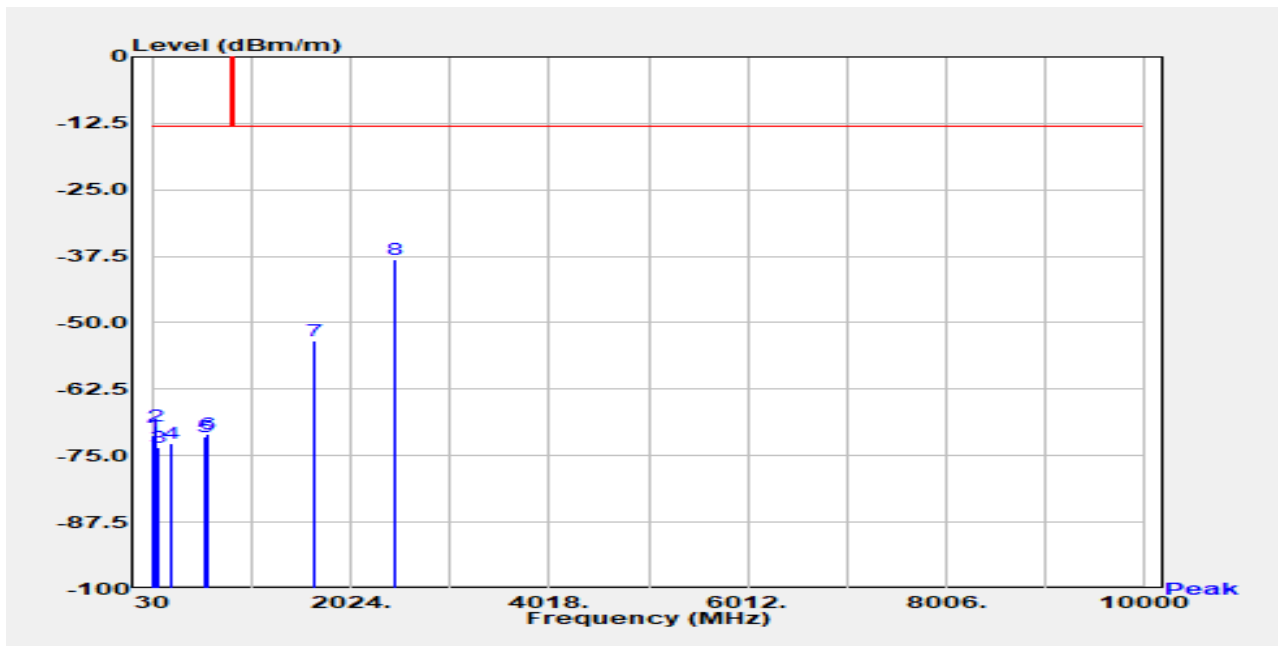

Freq. MHz	EIRP/ERP dBm	SG Output Level dBm	Antenna Gain dBi/dBd	Cable Loss dB	Limit dBm	Margin dB
31.940	-71.18	-58.89	-11.68	-0.61	-13.00	-58.18
75.590	-69.30	-66.06	-2.32	-0.92	-13.00	-56.30
102.750	-73.45	-73.73	1.37	-1.08	-13.00	-60.45
212.360	-72.61	-77.84	6.77	-1.54	-13.00	-59.61
550.890	-71.39	-75.70	6.72	-2.41	-13.00	-58.39
597.450	-70.97	-74.42	6.11	-2.65	-13.00	-57.97
1648.400	-53.49	-60.35	9.29	-4.43	-13.00	-40.49
2472.600	-38.01	-43.99	10.49	-5.52	-13.00	-25.01

Unless otherwise stated the results shown in this test report refer only to the sample(s) tested and such sample(s) are retained for 90 days only.

除非另有說明，此報告結果僅對測試之樣品負責，同時此樣品僅保留90天。本報告未經本公司書面許可，不可部份複製。

This document is issued by the Company subject to its General Conditions of Service printed overleaf, available on request or accessible at <http://www.sgs.com.tw/Terms-and-Conditions> and for electronic format documents, subject to Terms and Conditions for Electronic Documents at <http://www.sgs.com.tw/Terms-and-Conditions>. Attention is drawn to the limitation of liability, indemnification and jurisdiction issues defined therein. Any holder of this document is advised that information contained hereon reflects the Company's findings at the time of its intervention only and within the limits of Client's instructions, if any. The Company's sole responsibility is to its Client and this document does not exonerate parties to a transaction from exercising all their rights and obligations under the transaction documents. This document cannot be reproduced except in full, without prior written approval of the Company. Any unauthorized alteration, forgery or falsification of the content or appearance of this document is unlawful and offenders may be prosecuted to the fullest extent of the law.

Report Number :TERF2305001075ER
 Operation Mode :GSM 850
 Test Mode :Tx
 EUT Pol :E1 Plane
 Test Frequency :824.2 MHz

Test Site :SAC 2
 Test Date :2023-06-27
 Temp./Humi. :25.9°C/55%
 Antenna Pol. :Horizontal
 Engineer :Ricky Chen

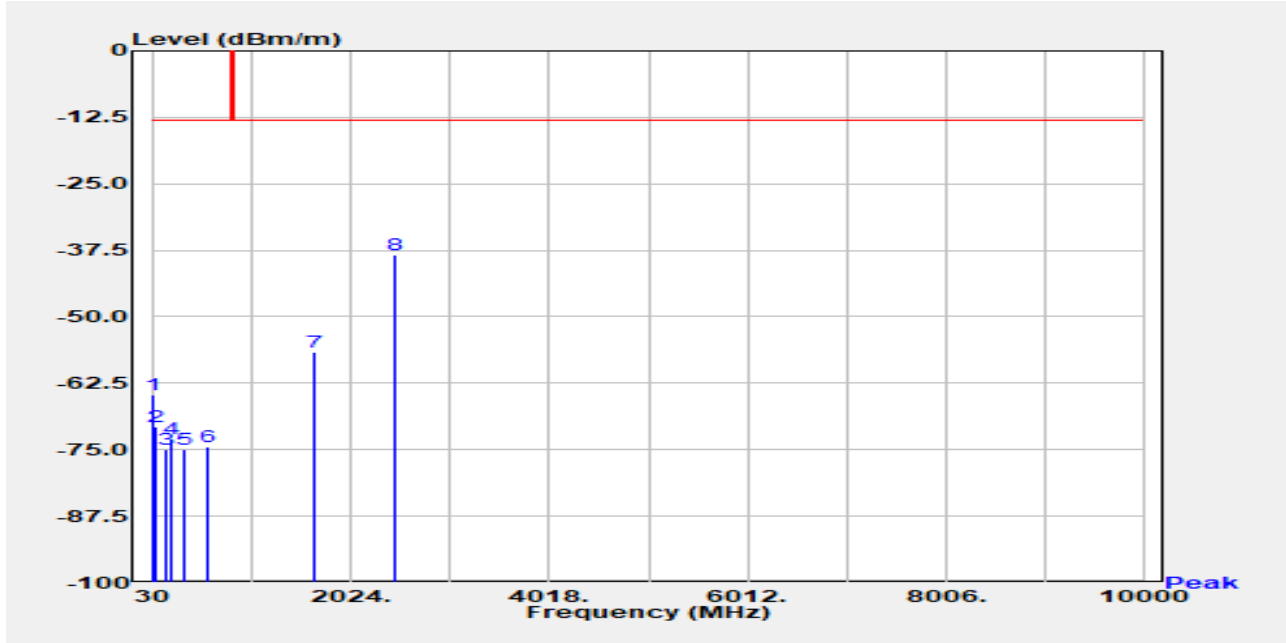

Freq. MHz	EIRP/ERP dBm	SG Output Level dBm	Antenna Gain dBi/dBd	Cable Loss dB	Limit dBm	Margin dB
31.940	-64.58	-52.29	-11.68	-0.61	-13.00	-51.58
69.770	-70.60	-65.17	-4.54	-0.89	-13.00	-57.60
182.290	-74.95	-77.48	3.97	-1.45	-13.00	-61.95
212.360	-72.92	-78.15	6.77	-1.54	-13.00	-59.92
350.100	-74.98	-79.50	6.61	-2.09	-13.00	-61.98
586.780	-74.50	-77.83	6.26	-2.93	-13.00	-61.50
1648.400	-56.75	-63.61	9.29	-4.43	-13.00	-43.75
2472.600	-38.23	-44.20	10.49	-5.52	-13.00	-25.23

Unless otherwise stated the results shown in this test report refer only to the sample(s) tested and such sample(s) are retained for 90 days only.

除非另有說明，此報告結果僅對測試之樣品負責，同時此樣品僅保留90天。本報告未經本公司書面許可，不可部份複製。
 This document is issued by the Company subject to its General Conditions of Service printed overleaf, available on request or accessible at <http://www.sgs.com.tw/Terms-and-Conditions> and for electronic format documents, subject to Terms and Conditions for Electronic Documents at <http://www.sgs.com.tw/Terms-and-Conditions>. Attention is drawn to the limitation of liability, indemnification and jurisdiction issues defined therein. Any holder of this document is advised that information contained hereon reflects the Company's findings at the time of its intervention only and within the limits of Client's instructions, if any. The Company's sole responsibility is to its Client and this document does not exonerate parties to a transaction from exercising all their rights and obligations under the transaction documents. This document cannot be reproduced except in full, without prior written approval of the Company. Any unauthorized alteration, forgery or falsification of the content or appearance of this document is unlawful and offenders may be prosecuted to the fullest extent of the law.

Report Number :TERF2305001075ER
 Operation Mode :GSM 850
 Test Mode :Tx
 EUT Pol :E1 Plane
 Test Frequency :836.6 MHz

Test Site :SAC 2
 Test Date :2023-06-27
 Temp./Humi. :25.9°C/55%
 Antenna Pol. :Vertical
 Engineer :Ricky Chen

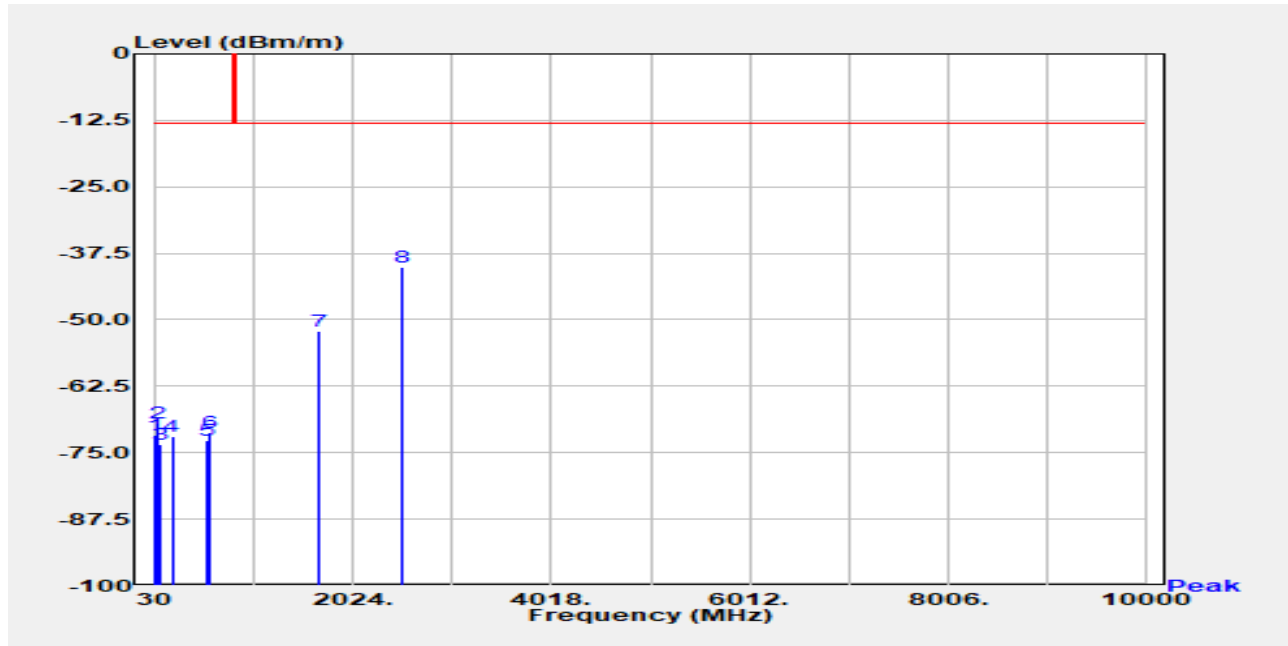

Freq. MHz	EIRP/ERP dBm	SG Output Level dBm	Antenna Gain dBi/dBd	Cable Loss dB	Limit dBm	Margin dB
30.970	-71.75	-59.31	-11.84	-0.60	-13.00	-58.75
75.590	-69.42	-66.17	-2.32	-0.92	-13.00	-56.42
103.720	-73.37	-73.52	1.23	-1.09	-13.00	-60.37
209.450	-71.87	-77.07	6.74	-1.54	-13.00	-58.87
550.890	-72.62	-76.93	6.72	-2.41	-13.00	-59.62
595.510	-71.30	-74.68	6.12	-2.74	-13.00	-58.30
1673.200	-52.01	-57.03	9.49	-4.47	-13.00	-39.01
2509.800	-40.00	-45.03	10.60	-5.57	-13.00	-27.00

Unless otherwise stated the results shown in this test report refer only to the sample(s) tested and such sample(s) are retained for 90 days only.

除非另有說明，此報告結果僅對測試之樣品負責，同時此樣品僅保留90天。本報告未經本公司書面許可，不可部份複製。

This document is issued by the Company subject to its General Conditions of Service printed overleaf, available on request or accessible at <http://www.sgs.com.tw/Terms-and-Conditions> and for electronic format documents, subject to Terms and Conditions for Electronic Documents at <http://www.sgs.com.tw/Terms-and-Conditions>. Attention is drawn to the limitation of liability, indemnification and jurisdiction issues defined therein. Any holder of this document is advised that information contained hereon reflects the Company's findings at the time of its intervention only and within the limits of Client's instructions, if any. The Company's sole responsibility is to its Client and this document does not exonerate parties to a transaction from exercising all their rights and obligations under the transaction documents. This document cannot be reproduced except in full, without prior written approval of the Company. Any unauthorized alteration, forgery or falsification of the content or appearance of this document is unlawful and offenders may be prosecuted to the fullest extent of the law.

Report Number :TERF2305001075ER
 Operation Mode :GSM 850
 Test Mode :Tx
 EUT Pol :E1 Plane
 Test Frequency :836.6 MHz

Test Site :SAC 2
 Test Date :2023-06-27
 Temp./Humi. :25.9°C/55%
 Antenna Pol. :Horizontal
 Engineer :Ricky Chen

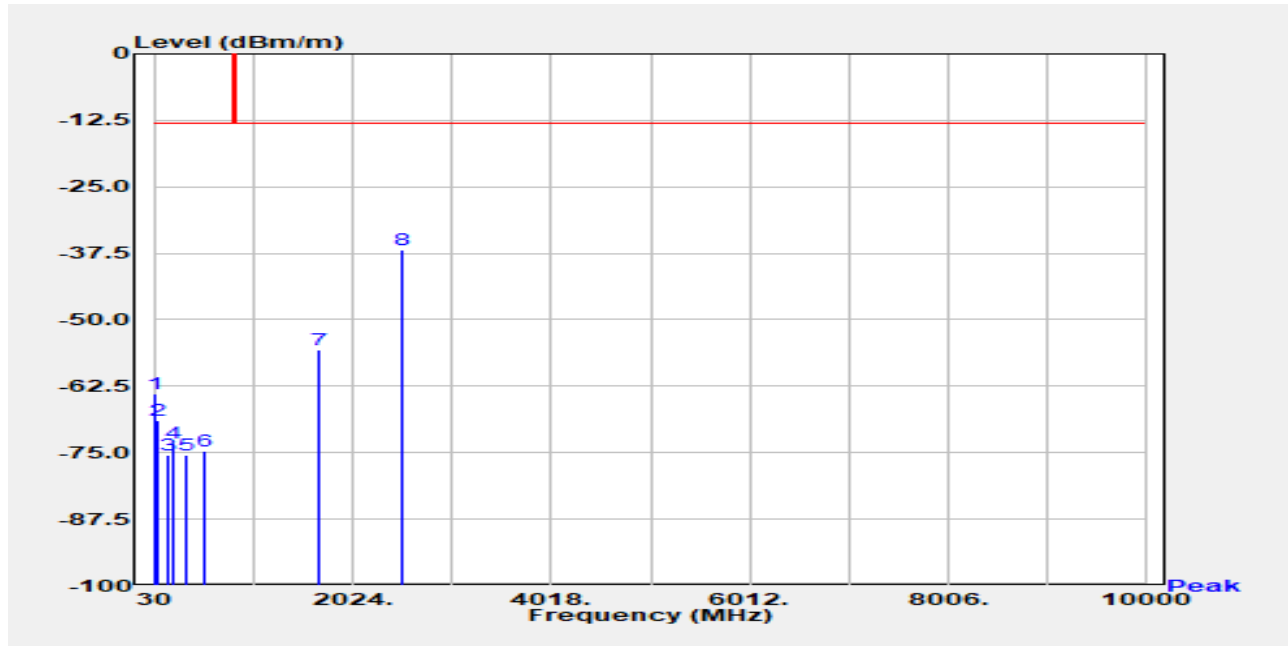

Freq. MHz	EIRP/ERP dBm	SG Output Level dBm	Antenna Gain dBi/dBd	Cable Loss dB	Limit dBm	Margin dB
35.820	-63.87	-52.50	-10.72	-0.65	-13.00	-50.87
75.590	-68.93	-65.68	-2.32	-0.92	-13.00	-55.93
177.440	-75.50	-77.27	3.20	-1.43	-13.00	-62.50
212.360	-73.10	-78.33	6.77	-1.54	-13.00	-60.10
344.280	-75.56	-80.02	6.56	-2.10	-13.00	-62.56
538.280	-74.71	-78.89	6.55	-2.37	-13.00	-61.71
1673.200	-55.54	-60.57	9.49	-4.47	-13.00	-42.54
2509.800	-36.94	-41.96	10.60	-5.57	-13.00	-23.94

Unless otherwise stated the results shown in this test report refer only to the sample(s) tested and such sample(s) are retained for 90 days only.

除非另有說明，此報告結果僅對測試之樣品負責，同時此樣品僅保留90天。本報告未經本公司書面許可，不可部份複製。

This document is issued by the Company subject to its General Conditions of Service printed overleaf, available on request or accessible at <http://www.sgs.com.tw/Terms-and-Conditions> and for electronic format documents, subject to Terms and Conditions for Electronic Documents at <http://www.sgs.com.tw/Terms-and-Conditions>. Attention is drawn to the limitation of liability, indemnification and jurisdiction issues defined therein. Any holder of this document is advised that information contained hereon reflects the Company's findings at the time of its intervention only and within the limits of Client's instructions, if any. The Company's sole responsibility is to its Client and this document does not exonerate parties to a transaction from exercising all their rights and obligations under the transaction documents. This document cannot be reproduced except in full, without prior written approval of the Company. Any unauthorized alteration, forgery or falsification of the content or appearance of this document is unlawful and offenders may be prosecuted to the fullest extent of the law.

Report Number :TERF2305001075ER
 Operation Mode :GSM 850
 Test Mode :Tx
 EUT Pol :E1 Plane
 Test Frequency :848.8 MHz

Test Site :SAC 2
 Test Date :2023-06-27
 Temp./Humi. :25.9°C/55%
 Antenna Pol. :Vertical
 Engineer :Ricky Chen

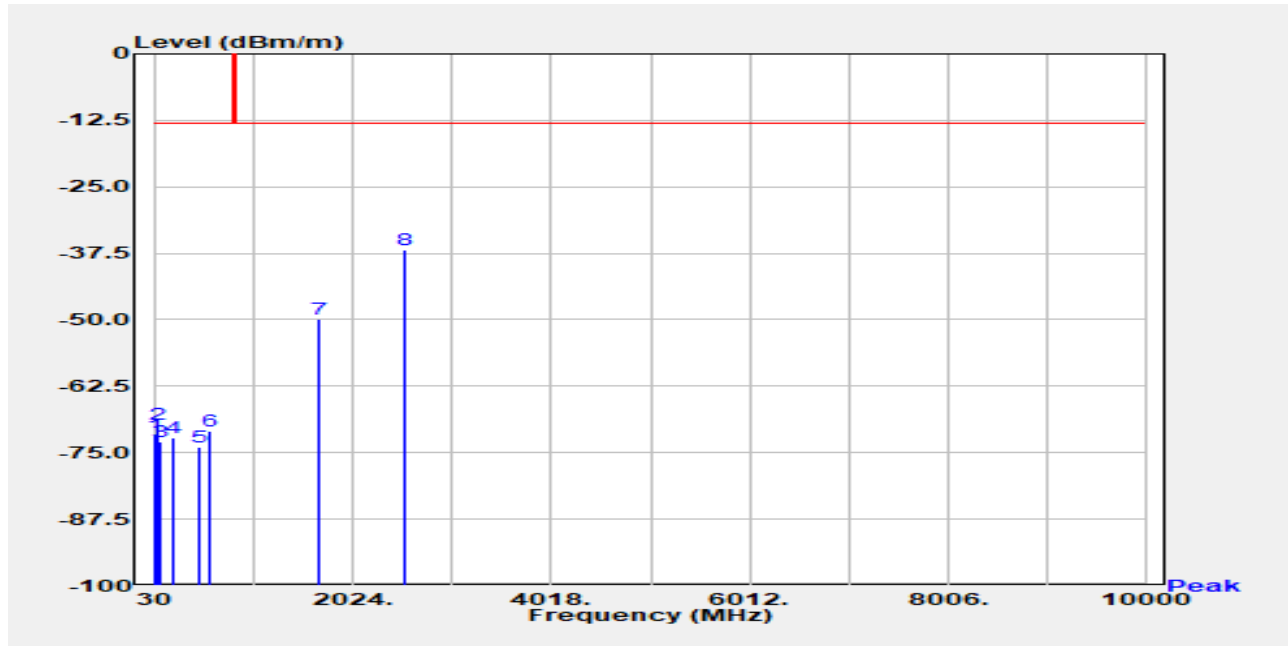

Freq. MHz	EIRP/ERP dBm	SG Output Level dBm	Antenna Gain dBi/dBd	Cable Loss dB	Limit dBm	Margin dB
31.940	-71.79	-59.50	-11.68	-0.61	-13.00	-58.79
75.590	-69.67	-66.43	-2.32	-0.92	-13.00	-56.67
102.750	-72.96	-73.25	1.37	-1.08	-13.00	-59.96
214.300	-72.19	-77.42	6.78	-1.55	-13.00	-59.19
496.570	-73.86	-78.05	6.55	-2.36	-13.00	-60.86
600.360	-70.86	-74.41	6.09	-2.54	-13.00	-57.86
1697.600	-49.78	-55.96	9.68	-4.50	-13.00	-36.78
2546.400	-36.78	-42.79	10.60	-5.59	-13.00	-23.78

Unless otherwise stated the results shown in this test report refer only to the sample(s) tested and such sample(s) are retained for 90 days only.

除非另有說明，此報告結果僅對測試之樣品負責，同時此樣品僅保留90天。本報告未經本公司書面許可，不可部份複製。

This document is issued by the Company subject to its General Conditions of Service printed overleaf, available on request or accessible at <http://www.sgs.com.tw/Terms-and-Conditions> and for electronic format documents, subject to Terms and Conditions for Electronic Documents at <http://www.sgs.com.tw/Terms-and-Conditions>. Attention is drawn to the limitation of liability, indemnification and jurisdiction issues defined therein. Any holder of this document is advised that information contained hereon reflects the Company's findings at the time of its intervention only and within the limits of Client's instructions, if any. The Company's sole responsibility is to its Client and this document does not exonerate parties to a transaction from exercising all their rights and obligations under the transaction documents. This document cannot be reproduced except in full, without prior written approval of the Company. Any unauthorized alteration, forgery or falsification of the content or appearance of this document is unlawful and offenders may be prosecuted to the fullest extent of the law.

Report Number :TERF2305001075ER
 Operation Mode :GSM 850
 Test Mode :Tx
 EUT Pol :E1 Plane
 Test Frequency :848.8 MHz

Test Site :SAC 2
 Test Date :2023-06-27
 Temp./Humi. :25.9°C/55%
 Antenna Pol. :Horizontal
 Engineer :Ricky Chen

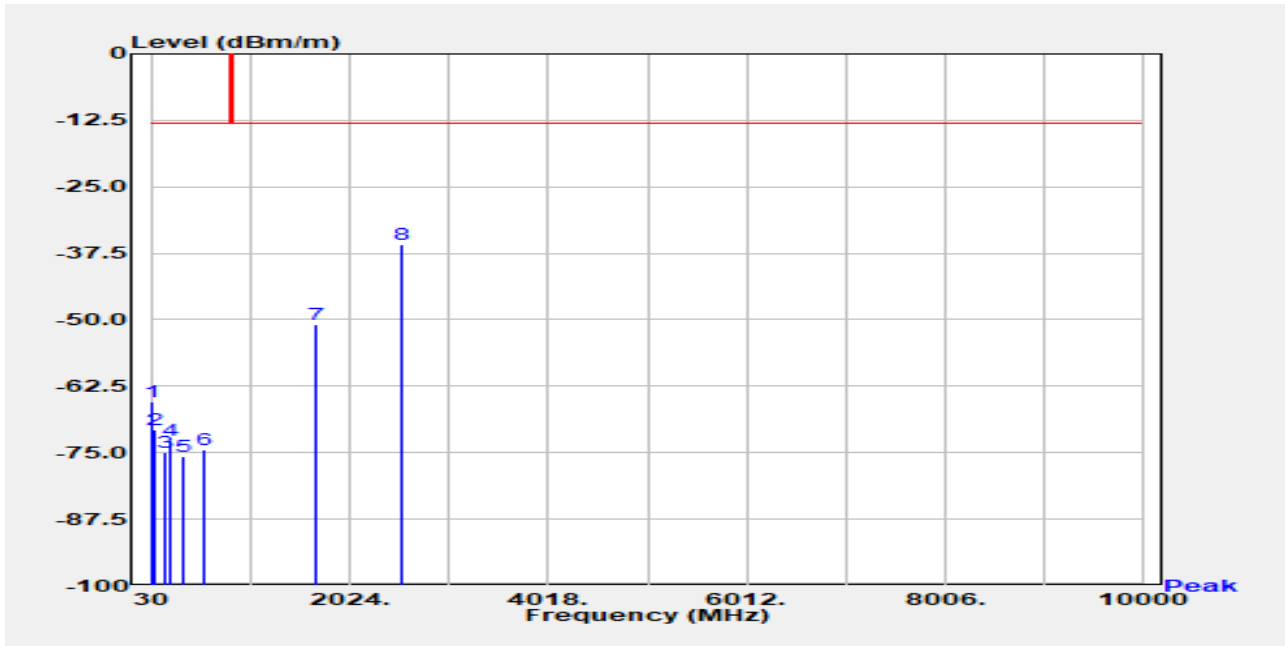

Freq. MHz	EIRP/ERP dBm	SG Output Level dBm	Antenna Gain dBi/dBd	Cable Loss dB	Limit dBm	Margin dB
33.880	-65.44	-53.50	-11.30	-0.63	-13.00	-52.44
69.770	-70.72	-65.29	-4.54	-0.89	-13.00	-57.72
179.380	-75.04	-77.12	3.51	-1.43	-13.00	-62.04
211.390	-72.79	-78.02	6.77	-1.54	-13.00	-59.79
354.950	-75.81	-80.46	6.73	-2.08	-13.00	-62.81
550.890	-74.33	-78.64	6.72	-2.41	-13.00	-61.33
1697.600	-50.81	-57.00	9.68	-4.50	-13.00	-37.81
2546.400	-35.86	-41.87	10.60	-5.59	-13.00	-22.86

Unless otherwise stated the results shown in this test report refer only to the sample(s) tested and such sample(s) are retained for 90 days only.

除非另有說明，此報告結果僅對測試之樣品負責，同時此樣品僅保留90天。本報告未經本公司書面許可，不可部份複製。

This document is issued by the Company subject to its General Conditions of Service printed overleaf, available on request or accessible at <http://www.sgs.com.tw/Terms-and-Conditions> and for electronic format documents, subject to Terms and Conditions for Electronic Documents at <http://www.sgs.com.tw/Terms-and-Conditions>. Attention is drawn to the limitation of liability, indemnification and jurisdiction issues defined therein. Any holder of this document is advised that information contained hereon reflects the Company's findings at the time of its intervention only and within the limits of Client's instructions, if any. The Company's sole responsibility is to its Client and this document does not exonerate parties to a transaction from exercising all their rights and obligations under the transaction documents. This document cannot be reproduced except in full, without prior written approval of the Company. Any unauthorized alteration, forgery or falsification of the content or appearance of this document is unlawful and offenders may be prosecuted to the fullest extent of the law.

Report Number :TERF2305001075ER
 Operation Mode :GSM 1900
 Test Mode :Tx
 EUT Pol :E1 Plane
 Test Frequency :1850.2 MHz

Test Site :SAC 2
 Test Date :2023-06-27
 Temp./Humi. :25.9°C/55%
 Antenna Pol. :Vertical
 Engineer :Ricky Chen

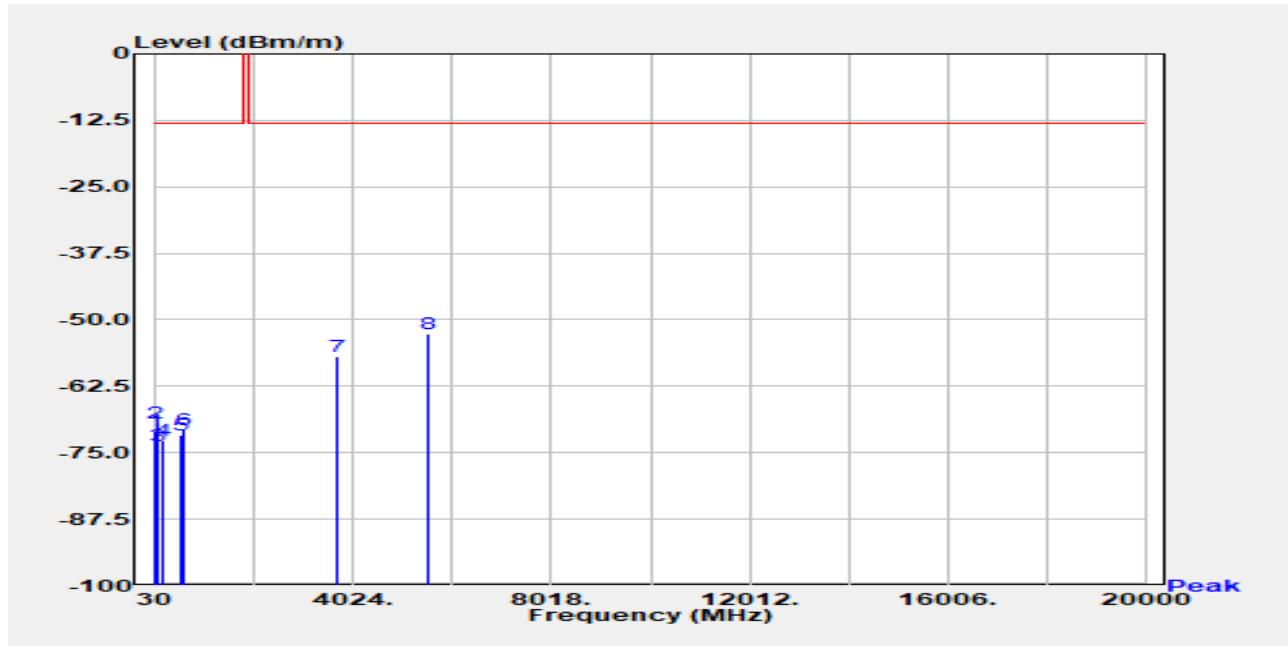

Freq. MHz	EIRP/ERP dBm	SG Output Level dBm	Antenna Gain dBi/dBd	Cable Loss dB	Limit dBm	Margin dB
31.940	-70.90	-58.61	-11.68	-0.61	-13.00	-57.90
75.590	-69.54	-66.29	-2.32	-0.92	-13.00	-56.54
101.780	-73.71	-73.94	1.30	-1.08	-13.00	-60.71
214.300	-72.59	-77.82	6.78	-1.55	-13.00	-59.59
551.860	-71.74	-75.98	6.70	-2.45	-13.00	-58.74
606.180	-70.77	-74.27	6.06	-2.56	-13.00	-57.77
3700.400	-56.91	-62.70	12.40	-6.61	-13.00	-43.91
5550.600	-52.74	-57.26	12.90	-8.39	-13.00	-39.74

Unless otherwise stated the results shown in this test report refer only to the sample(s) tested and such sample(s) are retained for 90 days only.

除非另有說明，此報告結果僅對測試之樣品負責，同時此樣品僅保留90天。本報告未經本公司書面許可，不可部份複製。

This document is issued by the Company subject to its General Conditions of Service printed overleaf, available on request or accessible at <http://www.sgs.com.tw/Terms-and-Conditions> and for electronic format documents, subject to Terms and Conditions for Electronic Documents at <http://www.sgs.com.tw/Terms-and-Conditions>. Attention is drawn to the limitation of liability, indemnification and jurisdiction issues defined therein. Any holder of this document is advised that information contained hereon reflects the Company's findings at the time of its intervention only and within the limits of Client's instructions, if any. The Company's sole responsibility is to its Client and this document does not exonerate parties to a transaction from exercising all their rights and obligations under the transaction documents. This document cannot be reproduced except in full, without prior written approval of the Company. Any unauthorized alteration, forgery or falsification of the content or appearance of this document is unlawful and offenders may be prosecuted to the fullest extent of the law.

Report Number :TERF2305001075ER
 Operation Mode :GSM 1900
 Test Mode :Tx
 EUT Pol :E1 Plane
 Test Frequency :1850.2 MHz

Test Site :SAC 2
 Test Date :2023-06-27
 Temp./Humi. :25.9°C/55%
 Antenna Pol. :Horizontal
 Engineer :Ricky Chen

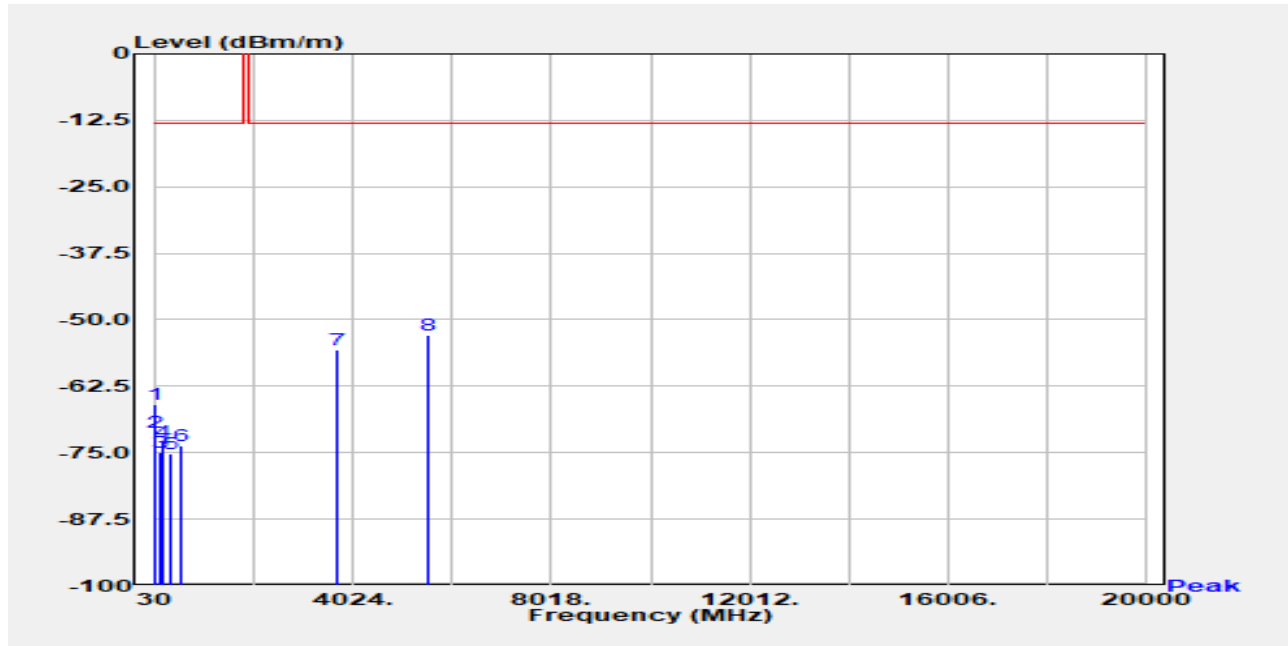

Freq. MHz	EIRP/ERP dBm	SG Output Level dBm	Antenna Gain dBi/dBd	Cable Loss dB	Limit dBm	Margin dB
34.850	-65.93	-54.16	-11.13	-0.64	-13.00	-52.93
70.740	-71.06	-65.87	-4.30	-0.89	-13.00	-58.06
177.440	-74.82	-76.59	3.20	-1.43	-13.00	-61.82
214.300	-72.97	-78.20	6.78	-1.55	-13.00	-59.97
365.620	-75.08	-79.67	6.67	-2.08	-13.00	-62.08
589.690	-73.65	-76.91	6.25	-2.98	-13.00	-60.65
3700.400	-55.59	-61.38	12.40	-6.61	-13.00	-42.59
5550.600	-52.91	-57.43	12.90	-8.39	-13.00	-39.91

Unless otherwise stated the results shown in this test report refer only to the sample(s) tested and such sample(s) are retained for 90 days only.

除非另有說明，此報告結果僅對測試之樣品負責，同時此樣品僅保留90天。本報告未經本公司書面許可，不可部份複製。

This document is issued by the Company subject to its General Conditions of Service printed overleaf, available on request or accessible at <http://www.sgs.com.tw/Terms-and-Conditions> and for electronic format documents, subject to Terms and Conditions for Electronic Documents at <http://www.sgs.com.tw/Terms-and-Conditions>. Attention is drawn to the limitation of liability, indemnification and jurisdiction issues defined therein. Any holder of this document is advised that information contained hereon reflects the Company's findings at the time of its intervention only and within the limits of Client's instructions, if any. The Company's sole responsibility is to its Client and this document does not exonerate parties to a transaction from exercising all their rights and obligations under the transaction documents. This document cannot be reproduced except in full, without prior written approval of the Company. Any unauthorized alteration, forgery or falsification of the content or appearance of this document is unlawful and offenders may be prosecuted to the fullest extent of the law.

Report Number :TERF2305001075ER
 Operation Mode :GSM 1900
 Test Mode :Tx
 EUT Pol :E1 Plane
 Test Frequency :1880 MHz

Test Site :SAC 2
 Test Date :2023-06-27
 Temp./Humi. :25.9°C/55%
 Antenna Pol. :Vertical
 Engineer :Ricky Chen

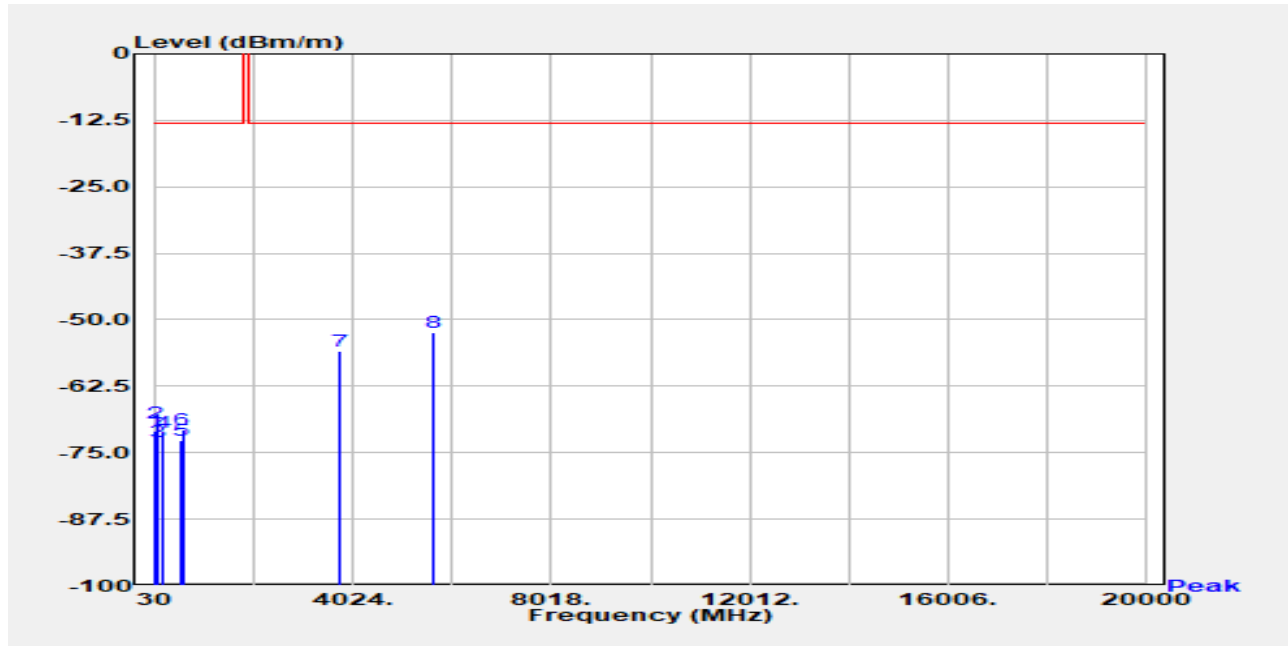

Freq. MHz	EIRP/ERP dBm	SG Output Level dBm	Antenna Gain dBi/dBd	Cable Loss dB	Limit dBm	Margin dB
31.940	-70.97	-58.68	-11.68	-0.61	-13.00	-57.97
75.590	-69.38	-66.13	-2.32	-0.92	-13.00	-56.38
102.750	-72.97	-73.25	1.37	-1.08	-13.00	-59.97
214.300	-71.28	-76.51	6.78	-1.55	-13.00	-58.28
555.740	-72.69	-76.69	6.62	-2.62	-13.00	-59.69
599.390	-70.64	-74.17	6.09	-2.57	-13.00	-57.64
3760.000	-55.79	-61.46	12.36	-6.69	-13.00	-42.79
5640.000	-52.42	-57.18	13.18	-8.42	-13.00	-39.42

Unless otherwise stated the results shown in this test report refer only to the sample(s) tested and such sample(s) are retained for 90 days only.

除非另有說明，此報告結果僅對測試之樣品負責，同時此樣品僅保留90天。本報告未經本公司書面許可，不可部份複製。

This document is issued by the Company subject to its General Conditions of Service printed overleaf, available on request or accessible at <http://www.sgs.com.tw/Terms-and-Conditions> and for electronic format documents, subject to Terms and Conditions for Electronic Documents at <http://www.sgs.com.tw/Terms-and-Conditions>. Attention is drawn to the limitation of liability, indemnification and jurisdiction issues defined therein. Any holder of this document is advised that information contained hereon reflects the Company's findings at the time of its intervention only and within the limits of Client's instructions, if any. The Company's sole responsibility is to its Client and this document does not exonerate parties to a transaction from exercising all their rights and obligations under the transaction documents. This document cannot be reproduced except in full, without prior written approval of the Company. Any unauthorized alteration, forgery or falsification of the content or appearance of this document is unlawful and offenders may be prosecuted to the fullest extent of the law.

Report Number :TERF2305001075ER
 Operation Mode :GSM 1900
 Test Mode :Tx
 EUT Pol :E1 Plane
 Test Frequency :1880 MHz

Test Site :SAC 2
 Test Date :2023-06-27
 Temp./Humi. :25.9°C/55%
 Antenna Pol. :Horizontal
 Engineer :Ricky Chen

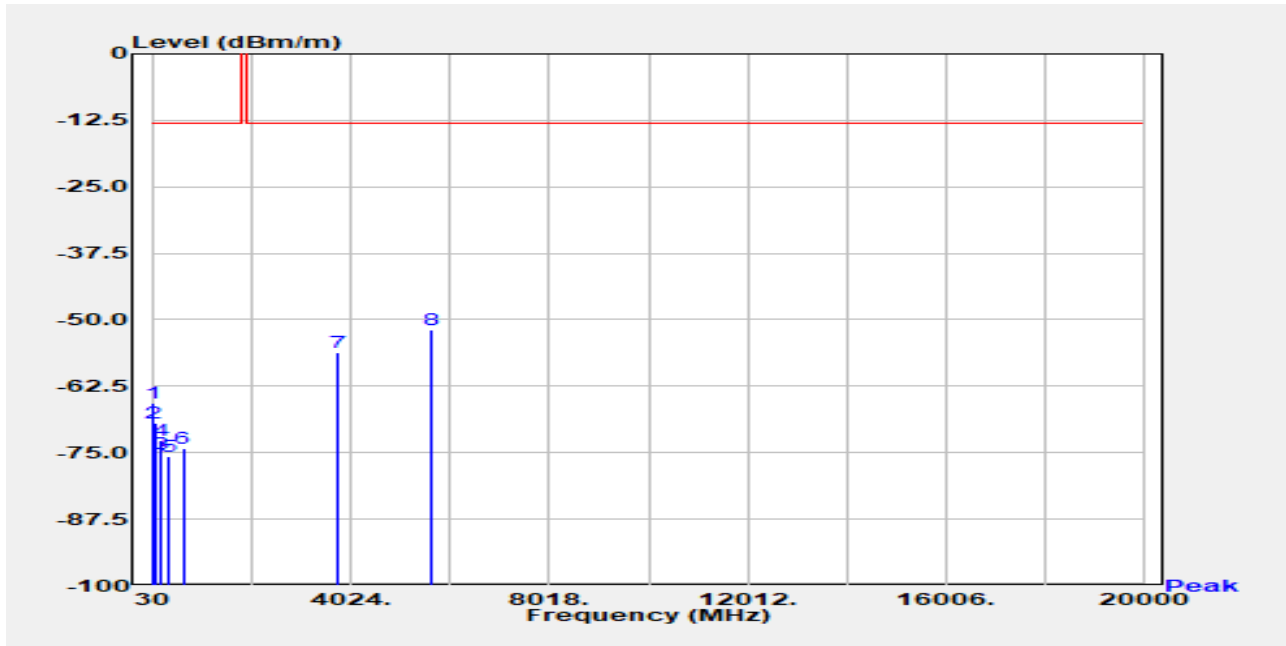

Freq. MHz	EIRP/ERP dBm	SG Output Level dBm	Antenna Gain dBi/dBd	Cable Loss dB	Limit dBm	Margin dB
35.820	-65.76	-54.39	-10.72	-0.65	-13.00	-52.76
75.590	-69.48	-66.24	-2.32	-0.92	-13.00	-56.48
182.290	-75.26	-77.79	3.97	-1.45	-13.00	-62.26
213.330	-72.77	-78.00	6.78	-1.55	-13.00	-59.77
348.160	-75.71	-80.23	6.60	-2.09	-13.00	-62.71
651.770	-74.29	-77.80	6.04	-2.53	-13.00	-61.29
3760.000	-56.03	-61.69	12.36	-6.69	-13.00	-43.03
5640.000	-51.98	-56.73	13.18	-8.42	-13.00	-38.98

Unless otherwise stated the results shown in this test report refer only to the sample(s) tested and such sample(s) are retained for 90 days only.

除非另有說明，此報告結果僅對測試之樣品負責，同時此樣品僅保留90天。本報告未經本公司書面許可，不可部份複製。

This document is issued by the Company subject to its General Conditions of Service printed overleaf, available on request or accessible at <http://www.sgs.com.tw/Terms-and-Conditions> and for electronic format documents, subject to Terms and Conditions for Electronic Documents at <http://www.sgs.com.tw/Terms-and-Conditions>. Attention is drawn to the limitation of liability, indemnification and jurisdiction issues defined therein. Any holder of this document is advised that information contained hereon reflects the Company's findings at the time of its intervention only and within the limits of Client's instructions, if any. The Company's sole responsibility is to its Client and this document does not exonerate parties to a transaction from exercising all their rights and obligations under the transaction documents. This document cannot be reproduced except in full, without prior written approval of the Company. Any unauthorized alteration, forgery or falsification of the content or appearance of this document is unlawful and offenders may be prosecuted to the fullest extent of the law.

Report Number :TERF2305001075ER
 Operation Mode :GSM 1900
 Test Mode :Tx
 EUT Pol :E1 Plane
 Test Frequency :1909.8 MHz

Test Site :SAC 2
 Test Date :2023-06-27
 Temp./Humi. :25.9°C/55%
 Antenna Pol. :Vertical
 Engineer :Ricky Chen

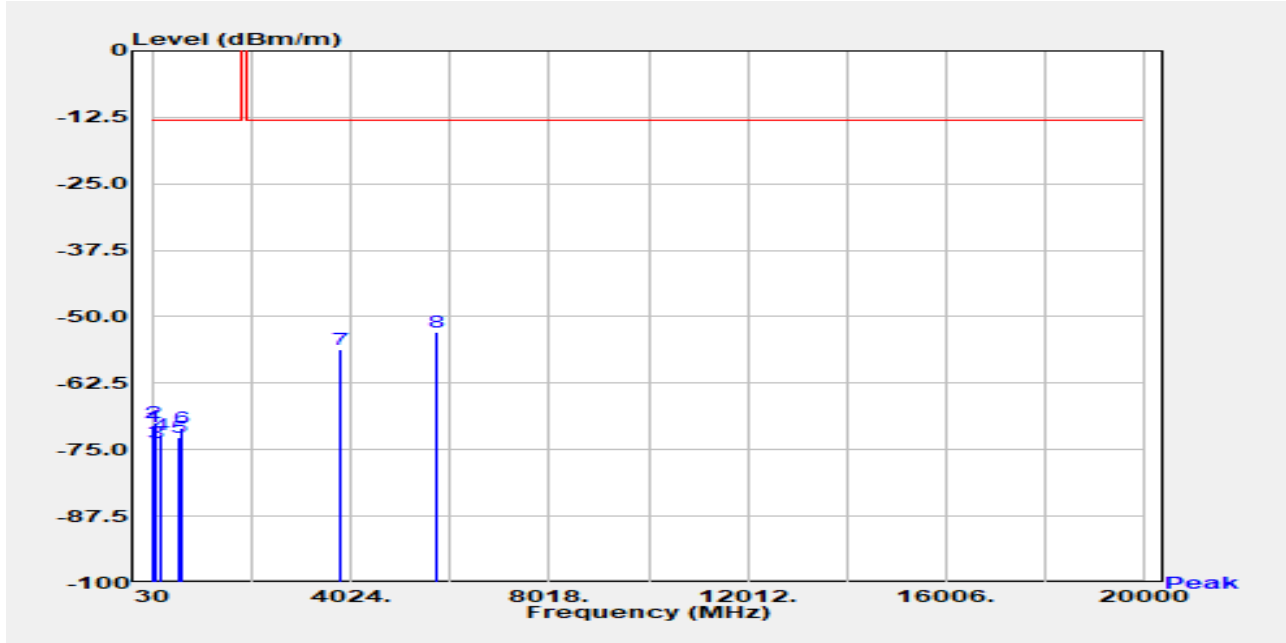

Freq. MHz	EIRP/ERP dBm	SG Output Level dBm	Antenna Gain dBi/dBd	Cable Loss dB	Limit dBm	Margin dB
31.940	-70.74	-58.45	-11.68	-0.61	-13.00	-57.74
75.590	-69.99	-66.74	-2.32	-0.92	-13.00	-56.99
102.750	-73.71	-74.00	1.37	-1.08	-13.00	-60.71
212.360	-72.11	-77.34	6.77	-1.54	-13.00	-59.11
556.710	-72.56	-76.51	6.61	-2.67	-13.00	-59.56
602.300	-70.87	-74.40	6.08	-2.55	-13.00	-57.87
3819.600	-56.17	-61.61	12.24	-6.79	-13.00	-43.17
5729.400	-52.85	-57.32	12.94	-8.47	-13.00	-39.85

Unless otherwise stated the results shown in this test report refer only to the sample(s) tested and such sample(s) are retained for 90 days only.

除非另有說明，此報告結果僅對測試之樣品負責，同時此樣品僅保留90天。本報告未經本公司書面許可，不可部份複製。

This document is issued by the Company subject to its General Conditions of Service printed overleaf, available on request or accessible at <http://www.sgs.com.tw/Terms-and-Conditions> and for electronic format documents, subject to Terms and Conditions for Electronic Documents at <http://www.sgs.com.tw/Terms-and-Conditions>. Attention is drawn to the limitation of liability, indemnification and jurisdiction issues defined therein. Any holder of this document is advised that information contained hereon reflects the Company's findings at the time of its intervention only and within the limits of Client's instructions, if any. The Company's sole responsibility is to its Client and this document does not exonerate parties to a transaction from exercising all their rights and obligations under the transaction documents. This document cannot be reproduced except in full, without prior written approval of the Company. Any unauthorized alteration, forgery or falsification of the content or appearance of this document is unlawful and offenders may be prosecuted to the fullest extent of the law.

Report Number :TERF2305001075ER
 Operation Mode :GSM 1900
 Test Mode :Tx
 EUT Pol :E1 Plane
 Test Frequency :1909.8 MHz

Test Site :SAC 2
 Test Date :2023-06-27
 Temp./Humi. :25.9°C/55%
 Antenna Pol. :Horizontal
 Engineer :Ricky Chen

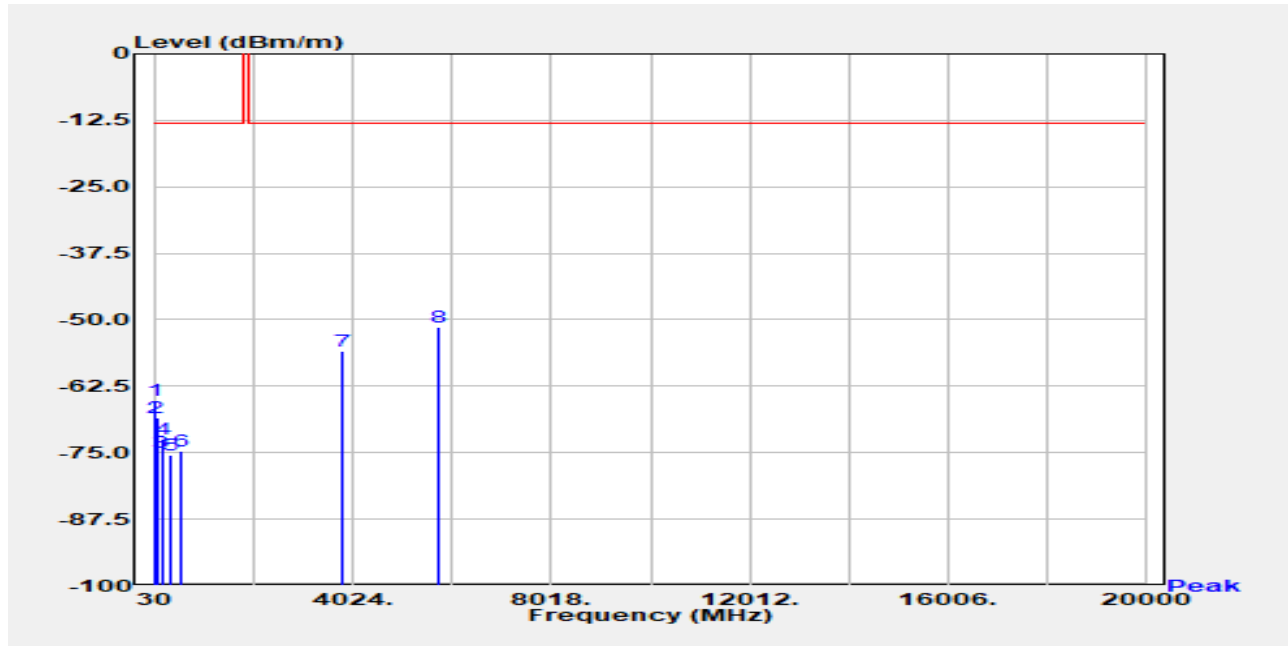

Freq. MHz	EIRP/ERP dBm	SG Output Level dBm	Antenna Gain dBi/dBd	Cable Loss dB	Limit dBm	Margin dB
35.820	-65.16	-53.78	-10.72	-0.65	-13.00	-52.16
75.590	-68.34	-65.09	-2.32	-0.92	-13.00	-55.34
181.320	-74.83	-77.28	3.90	-1.44	-13.00	-61.83
212.360	-72.50	-77.73	6.77	-1.54	-13.00	-59.50
343.310	-75.46	-79.88	6.51	-2.10	-13.00	-62.46
596.480	-74.64	-78.05	6.11	-2.70	-13.00	-61.64
3819.600	-55.89	-61.33	12.24	-6.79	-13.00	-42.89
5729.400	-51.37	-55.84	12.94	-8.47	-13.00	-38.37

Unless otherwise stated the results shown in this test report refer only to the sample(s) tested and such sample(s) are retained for 90 days only.

除非另有說明，此報告結果僅對測試之樣品負責，同時此樣品僅保留90天。本報告未經本公司書面許可，不可部份複製。

This document is issued by the Company subject to its General Conditions of Service printed overleaf, available on request or accessible at <http://www.sgs.com.tw/Terms-and-Conditions> and for electronic format documents, subject to Terms and Conditions for Electronic Documents at <http://www.sgs.com.tw/Terms-and-Conditions>. Attention is drawn to the limitation of liability, indemnification and jurisdiction issues defined therein. Any holder of this document is advised that information contained hereon reflects the Company's findings at the time of its intervention only and within the limits of Client's instructions, if any. The Company's sole responsibility is to its Client and this document does not exonerate parties to a transaction from exercising all their rights and obligations under the transaction documents. This document cannot be reproduced except in full, without prior written approval of the Company. Any unauthorized alteration, forgery or falsification of the content or appearance of this document is unlawful and offenders may be prosecuted to the fullest extent of the law.

Report Number :TERF2305001075ER
 Operation Mode :WCDMA B2
 Test Mode :Tx
 EUT Pol :E1 Plane
 Test Frequency :1852.4 MHz

Test Site :SAC 2
 Test Date :2023-06-27
 Temp./Humi. :25.9°C/55%
 Antenna Pol. :Vertical
 Engineer :Ricky Chen

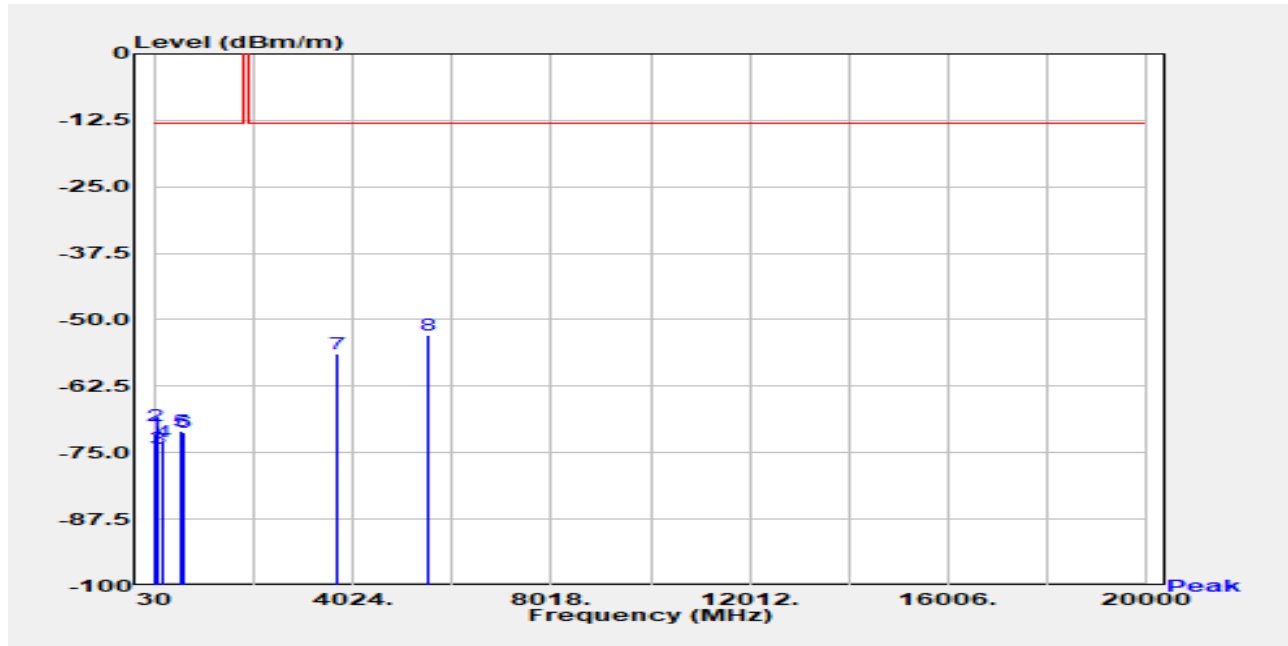

Freq. MHz	EIRP/ERP dBm	SG Output Level dBm	Antenna Gain dBi/dBd	Cable Loss dB	Limit dBm	Margin dB
31.940	-71.33	-59.04	-11.68	-0.61	-13.00	-58.33
75.590	-70.01	-66.76	-2.32	-0.92	-13.00	-57.01
102.750	-74.13	-74.41	1.37	-1.08	-13.00	-61.13
214.300	-72.88	-78.11	6.78	-1.55	-13.00	-59.88
556.710	-71.00	-74.94	6.61	-2.67	-13.00	-58.00
601.330	-71.13	-74.67	6.08	-2.55	-13.00	-58.13
3704.800	-56.48	-62.26	12.40	-6.62	-13.00	-43.48
5557.200	-52.82	-57.36	12.93	-8.39	-13.00	-39.82

Unless otherwise stated the results shown in this test report refer only to the sample(s) tested and such sample(s) are retained for 90 days only.

除非另有說明，此報告結果僅對測試之樣品負責，同時此樣品僅保留90天。本報告未經本公司書面許可，不可部份複製。

This document is issued by the Company subject to its General Conditions of Service printed overleaf, available on request or accessible at <http://www.sgs.com.tw/Terms-and-Conditions> and for electronic format documents, subject to Terms and Conditions for Electronic Documents at <http://www.sgs.com.tw/Terms-and-Conditions>. Attention is drawn to the limitation of liability, indemnification and jurisdiction issues defined therein. Any holder of this document is advised that information contained hereon reflects the Company's findings at the time of its intervention only and within the limits of Client's instructions, if any. The Company's sole responsibility is to its Client and this document does not exonerate parties to a transaction from exercising all their rights and obligations under the transaction documents. This document cannot be reproduced except in full, without prior written approval of the Company. Any unauthorized alteration, forgery or falsification of the content or appearance of this document is unlawful and offenders may be prosecuted to the fullest extent of the law.

Report Number :TERF2305001075ER
 Operation Mode :WCDMA B2
 Test Mode :Tx
 EUT Pol :E1 Plane
 Test Frequency :1852.4 MHz

Test Site :SAC 2
 Test Date :2023-06-27
 Temp./Humi. :25.9°C/55%
 Antenna Pol. :Horizontal
 Engineer :Ricky Chen

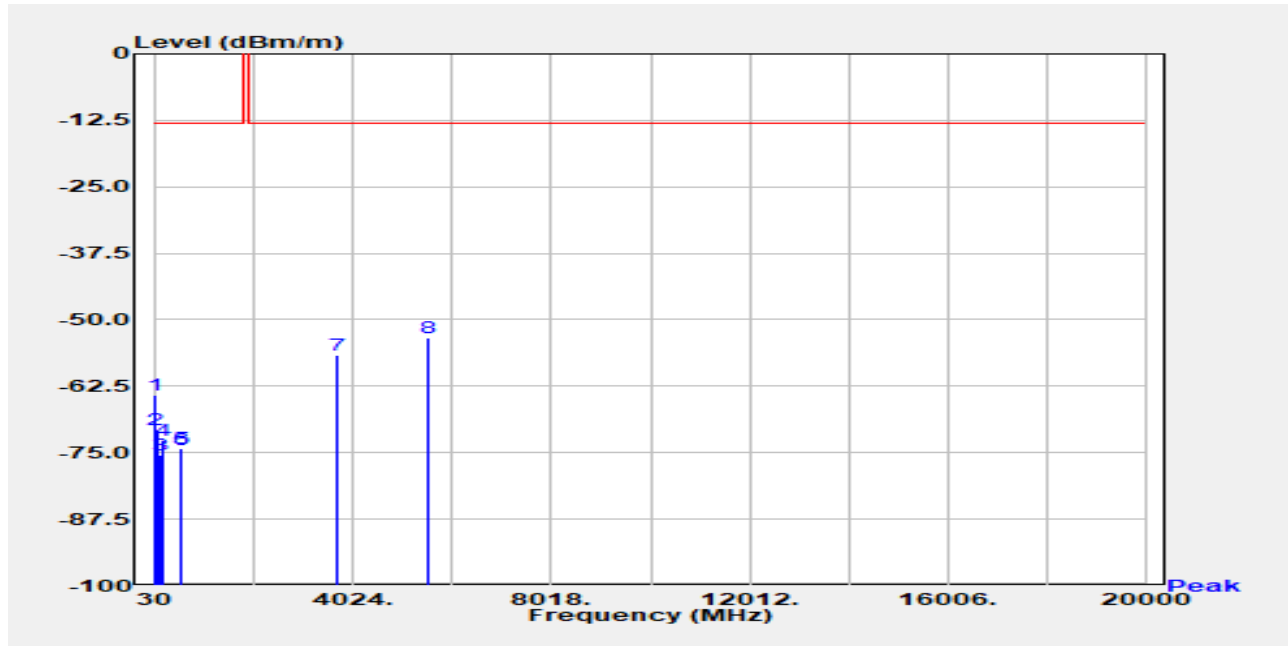

Freq. MHz	EIRP/ERP dBm	SG Output Level dBm	Antenna Gain dBi/dBd	Cable Loss dB	Limit dBm	Margin dB
35.820	-64.26	-52.89	-10.72	-0.65	-13.00	-51.26
75.590	-70.69	-67.44	-2.32	-0.92	-13.00	-57.69
177.440	-75.41	-77.19	3.20	-1.43	-13.00	-62.41
214.300	-72.70	-77.93	6.78	-1.55	-13.00	-59.70
550.890	-74.13	-78.44	6.72	-2.41	-13.00	-61.13
591.630	-74.42	-77.71	6.21	-2.92	-13.00	-61.42
3704.800	-56.69	-62.47	12.40	-6.62	-13.00	-43.69
5557.200	-53.44	-57.98	12.93	-8.39	-13.00	-40.44

Unless otherwise stated the results shown in this test report refer only to the sample(s) tested and such sample(s) are retained for 90 days only.

除非另有說明，此報告結果僅對測試之樣品負責，同時此樣品僅保留90天。本報告未經本公司書面許可，不可部份複製。

This document is issued by the Company subject to its General Conditions of Service printed overleaf, available on request or accessible at <http://www.sgs.com.tw/Terms-and-Conditions> and for electronic format documents, subject to Terms and Conditions for Electronic Documents at <http://www.sgs.com.tw/Terms-and-Conditions>. Attention is drawn to the limitation of liability, indemnification and jurisdiction issues defined therein. Any holder of this document is advised that information contained hereon reflects the Company's findings at the time of its intervention only and within the limits of Client's instructions, if any. The Company's sole responsibility is to its Client and this document does not exonerate parties to a transaction from exercising all their rights and obligations under the transaction documents. This document cannot be reproduced except in full, without prior written approval of the Company. Any unauthorized alteration, forgery or falsification of the content or appearance of this document is unlawful and offenders may be prosecuted to the fullest extent of the law.

Report Number :TERF2305001075ER
 Operation Mode :WCDMA B2
 Test Mode :Tx
 EUT Pol :E1 Plane
 Test Frequency :1880 MHz

Test Site :SAC 2
 Test Date :2023-06-27
 Temp./Humi. :25.9°C/55%
 Antenna Pol. :Vertical
 Engineer :Ricky Chen

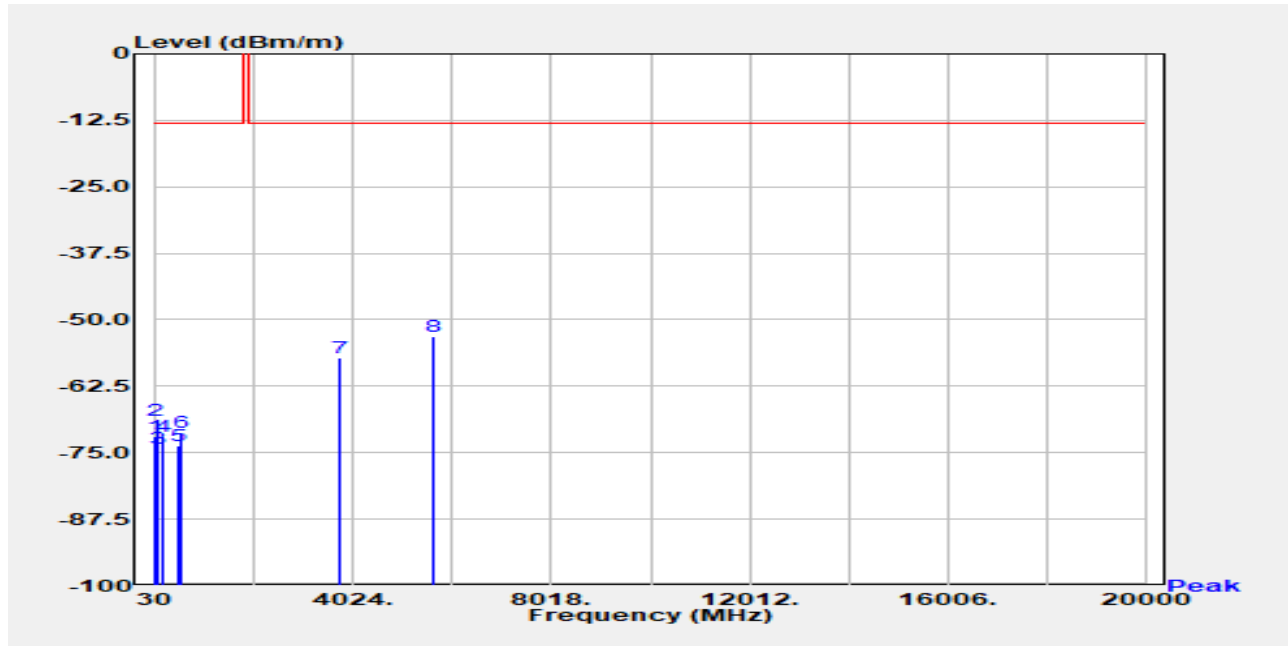

Freq. MHz	EIRP/ERP dBm	SG Output Level dBm	Antenna Gain dBi/dBd	Cable Loss dB	Limit dBm	Margin dB
31.940	-72.02	-59.73	-11.68	-0.61	-13.00	-59.02
75.590	-69.01	-65.76	-2.32	-0.92	-13.00	-56.01
102.750	-74.28	-74.56	1.37	-1.08	-13.00	-61.28
211.390	-72.01	-77.24	6.77	-1.54	-13.00	-59.01
520.820	-73.65	-78.03	6.46	-2.08	-13.00	-60.65
593.570	-71.28	-74.61	6.16	-2.83	-13.00	-58.28
3760.000	-57.24	-62.90	12.36	-6.69	-13.00	-44.24
5640.000	-53.16	-57.92	13.18	-8.42	-13.00	-40.16

Unless otherwise stated the results shown in this test report refer only to the sample(s) tested and such sample(s) are retained for 90 days only.

除非另有說明，此報告結果僅對測試之樣品負責，同時此樣品僅保留90天。本報告未經本公司書面許可，不可部份複製。

This document is issued by the Company subject to its General Conditions of Service printed overleaf, available on request or accessible at <http://www.sgs.com.tw/Terms-and-Conditions> and for electronic format documents, subject to Terms and Conditions for Electronic Documents at <http://www.sgs.com.tw/Terms-and-Conditions>. Attention is drawn to the limitation of liability, indemnification and jurisdiction issues defined therein. Any holder of this document is advised that information contained hereon reflects the Company's findings at the time of its intervention only and within the limits of Client's instructions, if any. The Company's sole responsibility is to its Client and this document does not exonerate parties to a transaction from exercising all their rights and obligations under the transaction documents. This document cannot be reproduced except in full, without prior written approval of the Company. Any unauthorized alteration, forgery or falsification of the content or appearance of this document is unlawful and offenders may be prosecuted to the fullest extent of the law.

Report Number :TERF2305001075ER
 Operation Mode :WCDMA B2
 Test Mode :Tx
 EUT Pol :E1 Plane
 Test Frequency :1880 MHz

Test Site :SAC 2
 Test Date :2023-06-27
 Temp./Humi. :25.9°C/55%
 Antenna Pol. :Horizontal
 Engineer :Ricky Chen

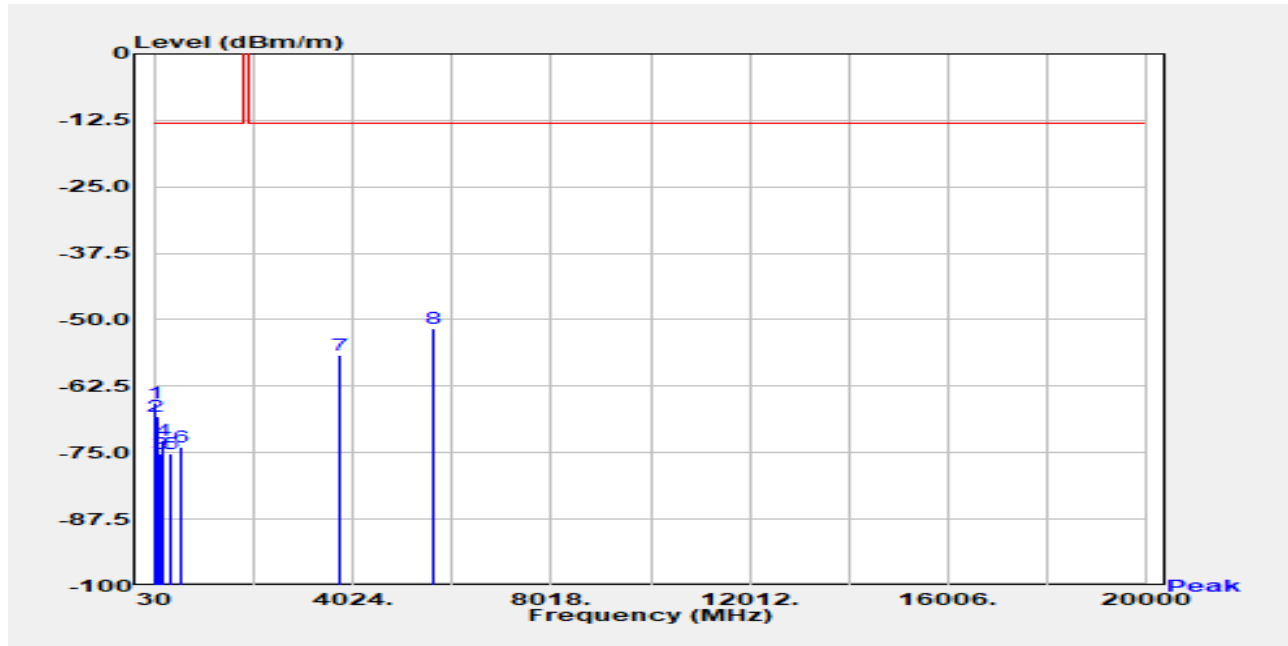

Freq. MHz	EIRP/ERP dBm	SG Output Level dBm	Antenna Gain dBi/dBd	Cable Loss dB	Limit dBm	Margin dB
33.880	-65.65	-53.72	-11.30	-0.63	-13.00	-52.65
75.590	-68.25	-65.00	-2.32	-0.92	-13.00	-55.25
178.410	-75.08	-77.06	3.40	-1.43	-13.00	-62.08
212.360	-72.63	-77.86	6.77	-1.54	-13.00	-59.63
355.920	-75.13	-79.79	6.74	-2.07	-13.00	-62.13
588.720	-74.01	-77.30	6.26	-2.97	-13.00	-61.01
3760.000	-56.69	-62.35	12.36	-6.69	-13.00	-43.69
5640.000	-51.51	-56.27	13.18	-8.42	-13.00	-38.51

Unless otherwise stated the results shown in this test report refer only to the sample(s) tested and such sample(s) are retained for 90 days only.

除非另有說明，此報告結果僅對測試之樣品負責，同時此樣品僅保留90天。本報告未經本公司書面許可，不可部份複製。

This document is issued by the Company subject to its General Conditions of Service printed overleaf, available on request or accessible at <http://www.sgs.com.tw/Terms-and-Conditions> and for electronic format documents, subject to Terms and Conditions for Electronic Documents at <http://www.sgs.com.tw/Terms-and-Conditions>. Attention is drawn to the limitation of liability, indemnification and jurisdiction issues defined therein. Any holder of this document is advised that information contained hereon reflects the Company's findings at the time of its intervention only and within the limits of Client's instructions, if any. The Company's sole responsibility is to its Client and this document does not exonerate parties to a transaction from exercising all their rights and obligations under the transaction documents. This document cannot be reproduced except in full, without prior written approval of the Company. Any unauthorized alteration, forgery or falsification of the content or appearance of this document is unlawful and offenders may be prosecuted to the fullest extent of the law.

Report Number :TERF2305001075ER
 Operation Mode :WCDMA B2
 Test Mode :Tx
 EUT Pol :E1 Plane
 Test Frequency :1907.6 MHz

Test Site :SAC 2
 Test Date :2023-06-27
 Temp./Humi. :25.9°C/55%
 Antenna Pol. :Vertical
 Engineer :Ricky Chen

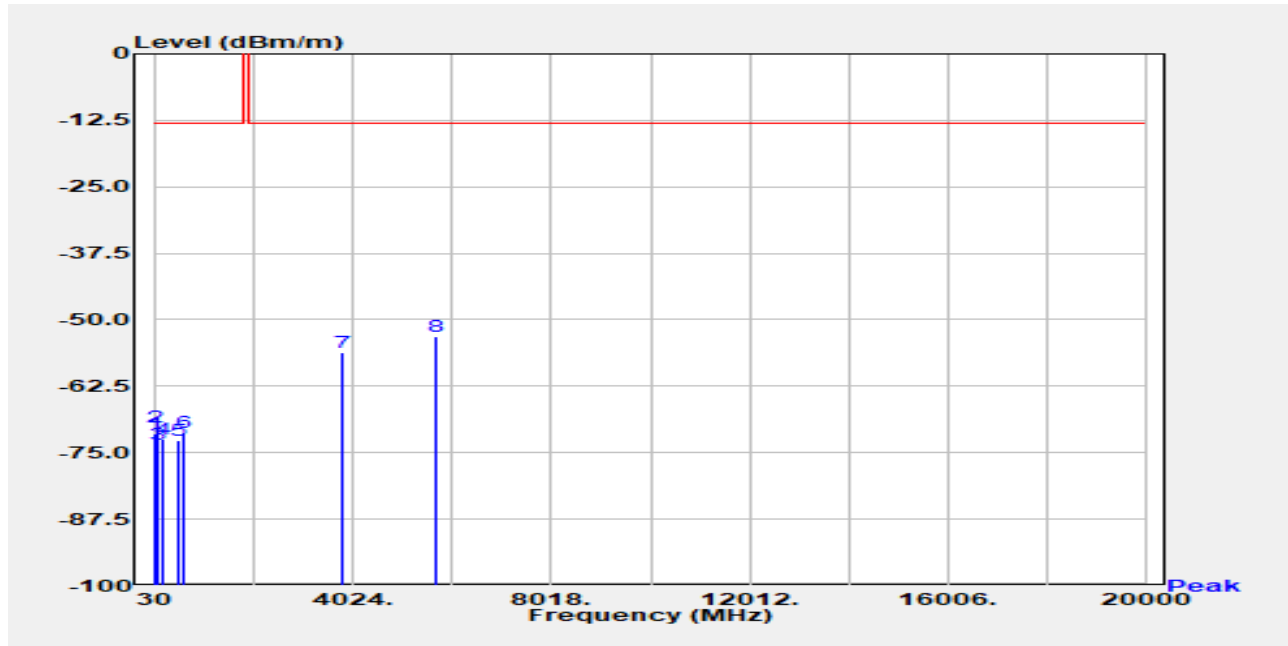

Freq. MHz	EIRP/ERP dBm	SG Output Level dBm	Antenna Gain dBi/dBd	Cable Loss dB	Limit dBm	Margin dB
31.940	-71.43	-59.14	-11.68	-0.61	-13.00	-58.43
75.590	-70.17	-66.92	-2.32	-0.92	-13.00	-57.17
102.750	-73.49	-73.78	1.37	-1.08	-13.00	-60.49
212.360	-72.43	-77.66	6.77	-1.54	-13.00	-59.43
516.940	-72.77	-77.02	6.40	-2.15	-13.00	-59.77
604.240	-71.10	-74.61	6.07	-2.56	-13.00	-58.10
3815.200	-56.26	-61.71	12.23	-6.78	-13.00	-43.26
5722.800	-53.03	-57.51	12.95	-8.47	-13.00	-40.03

Unless otherwise stated the results shown in this test report refer only to the sample(s) tested and such sample(s) are retained for 90 days only.

除非另有說明，此報告結果僅對測試之樣品負責，同時此樣品僅保留90天。本報告未經本公司書面許可，不可部份複製。

This document is issued by the Company subject to its General Conditions of Service printed overleaf, available on request or accessible at <http://www.sgs.com.tw/Terms-and-Conditions> and for electronic format documents, subject to Terms and Conditions for Electronic Documents at <http://www.sgs.com.tw/Terms-and-Conditions>. Attention is drawn to the limitation of liability, indemnification and jurisdiction issues defined therein. Any holder of this document is advised that information contained hereon reflects the Company's findings at the time of its intervention only and within the limits of Client's instructions, if any. The Company's sole responsibility is to its Client and this document does not exonerate parties to a transaction from exercising all their rights and obligations under the transaction documents. This document cannot be reproduced except in full, without prior written approval of the Company. Any unauthorized alteration, forgery or falsification of the content or appearance of this document is unlawful and offenders may be prosecuted to the fullest extent of the law.

Report Number :TERF2305001075ER
 Operation Mode :WCDMA B2
 Test Mode :Tx
 EUT Pol :E1 Plane
 Test Frequency :1907.6 MHz

Test Site :SAC 2
 Test Date :2023-06-27
 Temp./Humi. :25.9°C/55%
 Antenna Pol. :Horizontal
 Engineer :Ricky Chen

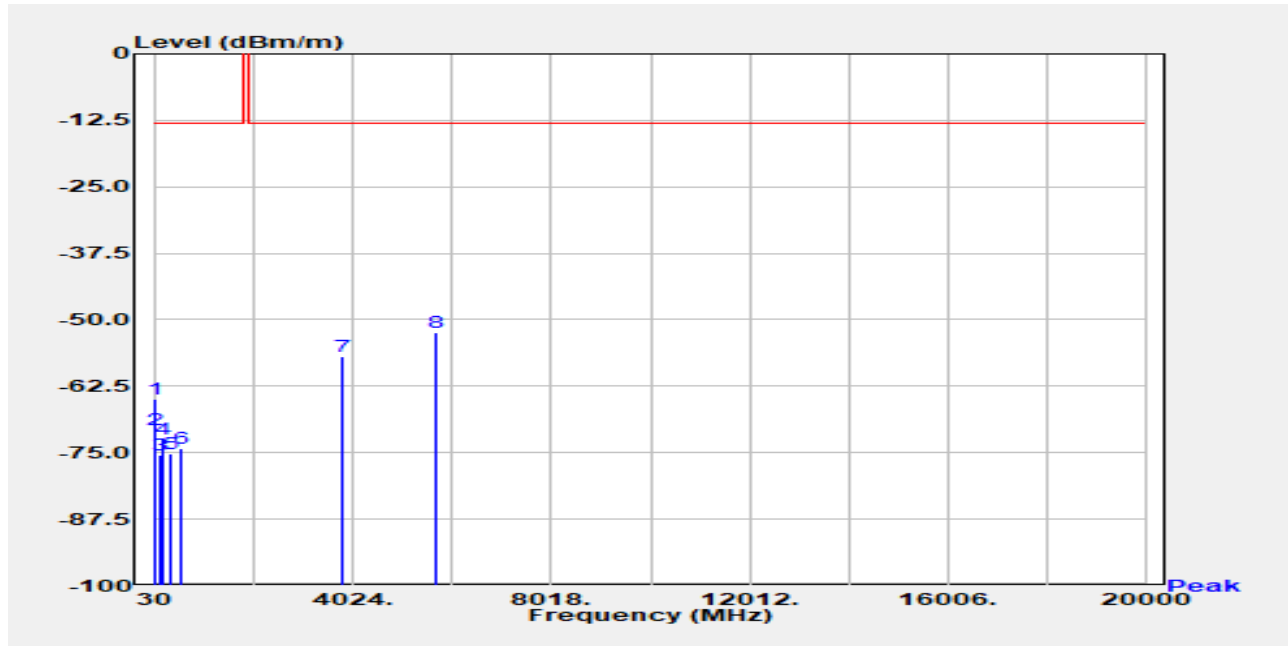

Freq. MHz	EIRP/ERP dBm	SG Output Level dBm	Antenna Gain dBi/dBd	Cable Loss dB	Limit dBm	Margin dB
35.820	-64.86	-53.49	-10.72	-0.65	-13.00	-51.86
74.620	-70.65	-67.04	-2.69	-0.92	-13.00	-57.65
174.530	-75.44	-76.68	2.67	-1.42	-13.00	-62.44
212.360	-72.49	-77.72	6.77	-1.54	-13.00	-59.49
361.740	-75.13	-79.80	6.73	-2.07	-13.00	-62.13
588.720	-74.09	-77.37	6.26	-2.97	-13.00	-61.09
3815.200	-56.97	-62.42	12.23	-6.78	-13.00	-43.97
5722.800	-52.30	-56.79	12.95	-8.47	-13.00	-39.30

Unless otherwise stated the results shown in this test report refer only to the sample(s) tested and such sample(s) are retained for 90 days only.

除非另有說明，此報告結果僅對測試之樣品負責，同時此樣品僅保留90天。本報告未經本公司書面許可，不可部份複製。

This document is issued by the Company subject to its General Conditions of Service printed overleaf, available on request or accessible at <http://www.sgs.com.tw/Terms-and-Conditions> and for electronic format documents, subject to Terms and Conditions for Electronic Documents at <http://www.sgs.com.tw/Terms-and-Conditions>. Attention is drawn to the limitation of liability, indemnification and jurisdiction issues defined therein. Any holder of this document is advised that information contained hereon reflects the Company's findings at the time of its intervention only and within the limits of Client's instructions, if any. The Company's sole responsibility is to its Client and this document does not exonerate parties to a transaction from exercising all their rights and obligations under the transaction documents. This document cannot be reproduced except in full, without prior written approval of the Company. Any unauthorized alteration, forgery or falsification of the content or appearance of this document is unlawful and offenders may be prosecuted to the fullest extent of the law.

Report Number :TERF2305001075ER
 Operation Mode :WCDMA B4
 Test Mode :Tx
 EUT Pol :E1 Plane
 Test Frequency :1712.4 MHz

Test Site :SAC 2
 Test Date :2023-06-27
 Temp./Humi. :25.9°C/55%
 Antenna Pol. :Vertical
 Engineer :Ricky Chen

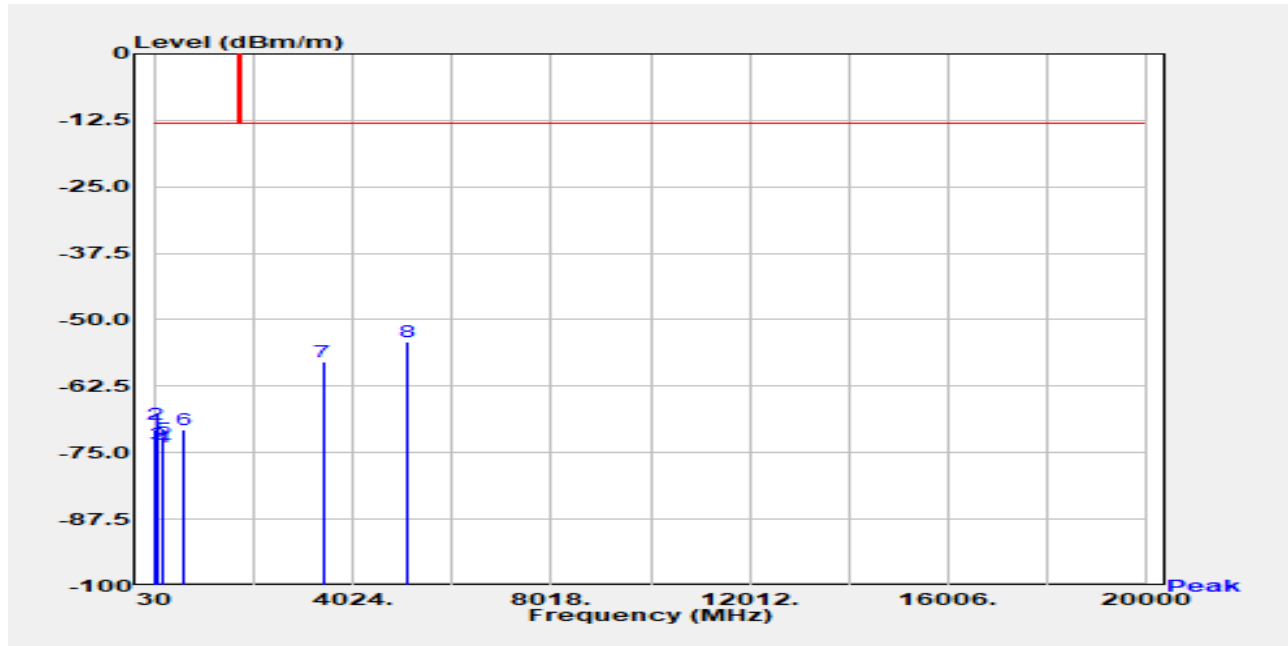

Freq. MHz	EIRP/ERP dBm	SG Output Level dBm	Antenna Gain dBi/dBd	Cable Loss dB	Limit dBm	Margin dB
30.970	-70.73	-58.29	-11.84	-0.60	-13.00	-57.73
75.590	-69.62	-66.37	-2.32	-0.92	-13.00	-56.62
102.750	-73.52	-73.80	1.37	-1.08	-13.00	-60.52
187.140	-73.86	-76.98	4.60	-1.48	-13.00	-60.86
214.300	-72.40	-77.63	6.78	-1.55	-13.00	-59.40
602.300	-70.63	-74.16	6.08	-2.55	-13.00	-57.63
3424.800	-57.91	-64.00	12.45	-6.36	-13.00	-44.91
5137.200	-54.26	-58.52	12.23	-7.96	-13.00	-41.26

Unless otherwise stated the results shown in this test report refer only to the sample(s) tested and such sample(s) are retained for 90 days only.

除非另有說明，此報告結果僅對測試之樣品負責，同時此樣品僅保留90天。本報告未經本公司書面許可，不可部份複製。
 This document is issued by the Company subject to its General Conditions of Service printed overleaf, available on request or accessible at <http://www.sgs.com.tw/Terms-and-Conditions> and for electronic format documents, subject to Terms and Conditions for Electronic Documents at <http://www.sgs.com.tw/Terms-and-Conditions>. Attention is drawn to the limitation of liability, indemnification and jurisdiction issues defined therein. Any holder of this document is advised that information contained hereon reflects the Company's findings at the time of its intervention only and within the limits of Client's instructions, if any. The Company's sole responsibility is to its Client and this document does not exonerate parties to a transaction from exercising all their rights and obligations under the transaction documents. This document cannot be reproduced except in full, without prior written approval of the Company. Any unauthorized alteration, forgery or falsification of the content or appearance of this document is unlawful and offenders may be prosecuted to the fullest extent of the law.

Report Number :TERF2305001075ER
 Operation Mode :WCDMA B4
 Test Mode :Tx
 EUT Pol :E1 Plane
 Test Frequency :1712.4 MHz

Test Site :SAC 2
 Test Date :2023-06-27
 Temp./Humi. :25.9°C/55%
 Antenna Pol. :Horizontal
 Engineer :Ricky Chen

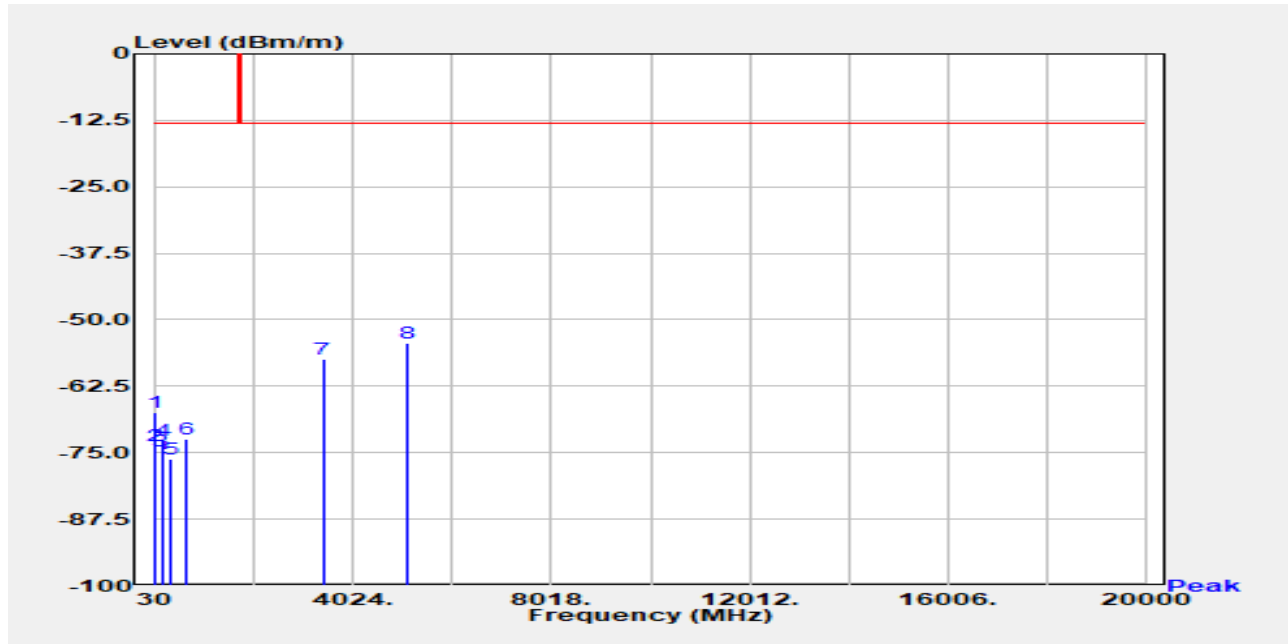

Freq. MHz	EIRP/ERP dBm	SG Output Level dBm	Antenna Gain dBi/dBd	Cable Loss dB	Limit dBm	Margin dB
34.850	-67.36	-55.59	-11.13	-0.64	-13.00	-54.36
69.770	-73.65	-68.22	-4.54	-0.89	-13.00	-60.65
181.320	-74.71	-77.17	3.90	-1.44	-13.00	-61.71
214.300	-72.64	-77.87	6.78	-1.55	-13.00	-59.64
347.190	-76.07	-80.58	6.60	-2.09	-13.00	-63.07
657.590	-72.37	-75.88	6.04	-2.53	-13.00	-59.37
3424.800	-57.49	-63.58	12.45	-6.36	-13.00	-44.49
5137.200	-54.39	-58.65	12.23	-7.96	-13.00	-41.39

Unless otherwise stated the results shown in this test report refer only to the sample(s) tested and such sample(s) are retained for 90 days only.

除非另有說明，此報告結果僅對測試之樣品負責，同時此樣品僅保留90天。本報告未經本公司書面許可，不可部份複製。

This document is issued by the Company subject to its General Conditions of Service printed overleaf, available on request or accessible at <http://www.sgs.com.tw/Terms-and-Conditions> and for electronic format documents, subject to Terms and Conditions for Electronic Documents at <http://www.sgs.com.tw/Terms-and-Conditions>. Attention is drawn to the limitation of liability, indemnification and jurisdiction issues defined therein. Any holder of this document is advised that information contained hereon reflects the Company's findings at the time of its intervention only and within the limits of Client's instructions, if any. The Company's sole responsibility is to its Client and this document does not exonerate parties to a transaction from exercising all their rights and obligations under the transaction documents. This document cannot be reproduced except in full, without prior written approval of the Company. Any unauthorized alteration, forgery or falsification of the content or appearance of this document is unlawful and offenders may be prosecuted to the fullest extent of the law.

Report Number :TERF2305001075ER
 Operation Mode :WCDMA B4
 Test Mode :Tx
 EUT Pol :E1 Plane
 Test Frequency :1732.6 MHz

Test Site :SAC 2
 Test Date :2023-06-27
 Temp./Humi. :25.9°C/55%
 Antenna Pol. :Vertical
 Engineer :Ricky Chen

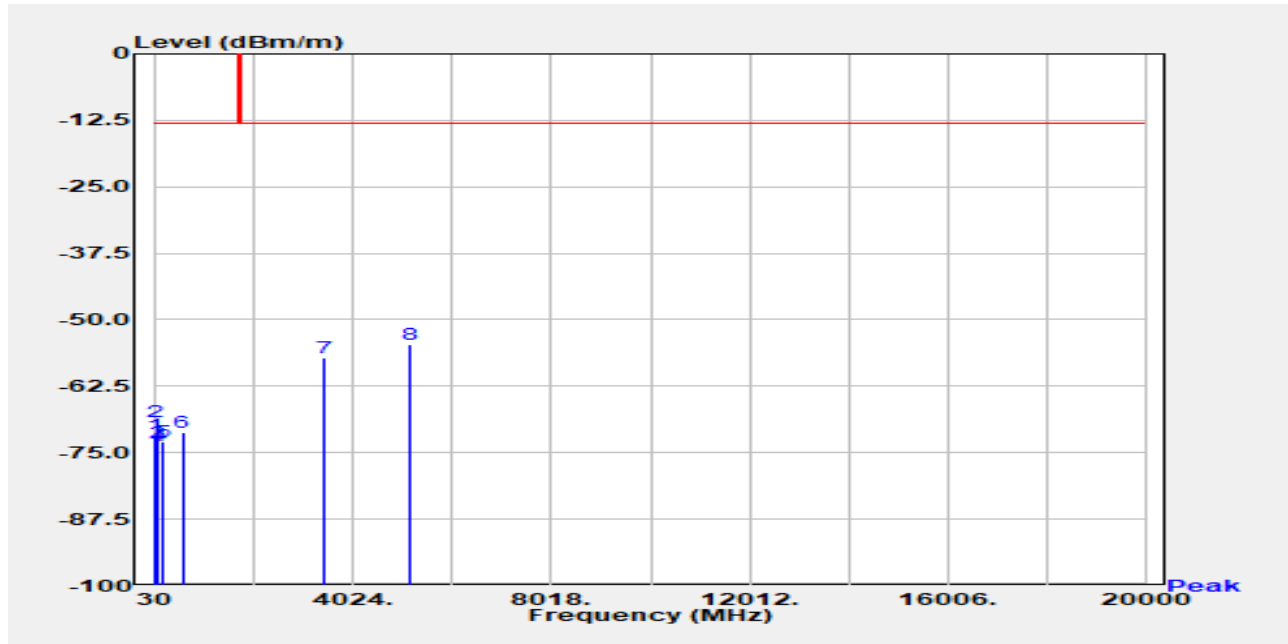

Freq. MHz	EIRP/ERP dBm	SG Output Level dBm	Antenna Gain dBi/dBd	Cable Loss dB	Limit dBm	Margin dB
31.940	-71.75	-59.45	-11.68	-0.61	-13.00	-58.75
75.590	-69.25	-66.00	-2.32	-0.92	-13.00	-56.25
86.260	-73.07	-73.43	1.35	-0.99	-13.00	-60.07
102.750	-73.75	-74.04	1.37	-1.08	-13.00	-60.75
210.420	-73.00	-78.23	6.77	-1.54	-13.00	-60.00
599.390	-71.23	-74.75	6.09	-2.57	-13.00	-58.23
3465.200	-57.16	-63.17	12.37	-6.37	-13.00	-44.16
5197.800	-54.55	-58.97	12.39	-7.97	-13.00	-41.55

Unless otherwise stated the results shown in this test report refer only to the sample(s) tested and such sample(s) are retained for 90 days only.

除非另有說明，此報告結果僅對測試之樣品負責，同時此樣品僅保留90天。本報告未經本公司書面許可，不可部份複製。

This document is issued by the Company subject to its General Conditions of Service printed overleaf, available on request or accessible at <http://www.sgs.com.tw/Terms-and-Conditions> and for electronic format documents, subject to Terms and Conditions for Electronic Documents at <http://www.sgs.com.tw/Terms-and-Conditions>. Attention is drawn to the limitation of liability, indemnification and jurisdiction issues defined therein. Any holder of this document is advised that information contained hereon reflects the Company's findings at the time of its intervention only and within the limits of Client's instructions, if any. The Company's sole responsibility is to its Client and this document does not exonerate parties to a transaction from exercising all their rights and obligations under the transaction documents. This document cannot be reproduced except in full, without prior written approval of the Company. Any unauthorized alteration, forgery or falsification of the content or appearance of this document is unlawful and offenders may be prosecuted to the fullest extent of the law.

Report Number :TERF2305001075ER
 Operation Mode :WCDMA B4
 Test Mode :Tx
 EUT Pol :E1 Plane
 Test Frequency :1732.6 MHz

Test Site :SAC 2
 Test Date :2023-06-27
 Temp./Humi. :25.9°C/55%
 Antenna Pol. :Horizontal
 Engineer :Ricky Chen

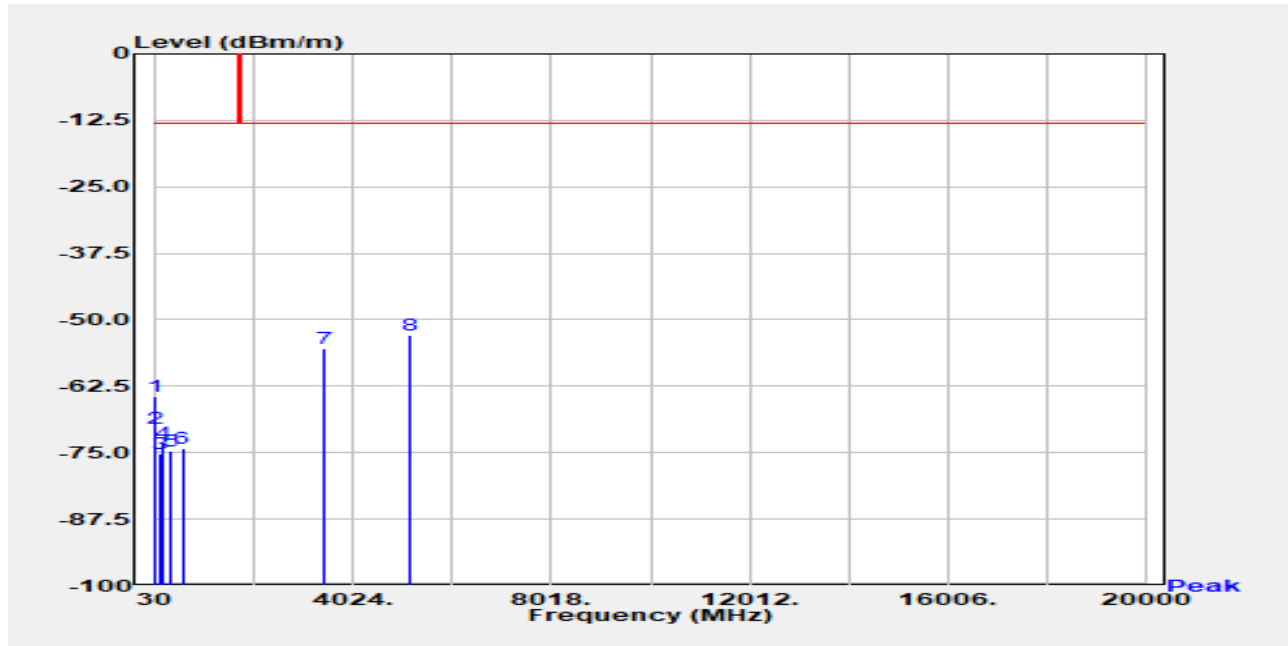

Freq. MHz	EIRP/ERP dBm	SG Output Level dBm	Antenna Gain dBi/dBd	Cable Loss dB	Limit dBm	Margin dB
35.820	-64.31	-52.94	-10.72	-0.65	-13.00	-51.31
68.800	-70.45	-64.68	-4.90	-0.88	-13.00	-57.45
178.410	-75.26	-77.23	3.40	-1.43	-13.00	-62.26
212.360	-73.14	-78.37	6.77	-1.54	-13.00	-60.14
375.320	-74.66	-78.98	6.40	-2.09	-13.00	-61.66
599.390	-74.15	-77.68	6.09	-2.57	-13.00	-61.15
3465.200	-55.37	-61.37	12.37	-6.37	-13.00	-42.37
5197.800	-52.99	-57.41	12.39	-7.97	-13.00	-39.99

Unless otherwise stated the results shown in this test report refer only to the sample(s) tested and such sample(s) are retained for 90 days only.

除非另有說明，此報告結果僅對測試之樣品負責，同時此樣品僅保留90天。本報告未經本公司書面許可，不可部份複製。

This document is issued by the Company subject to its General Conditions of Service printed overleaf, available on request or accessible at <http://www.sgs.com.tw/Terms-and-Conditions> and for electronic format documents, subject to Terms and Conditions for Electronic Documents at <http://www.sgs.com.tw/Terms-and-Conditions>. Attention is drawn to the limitation of liability, indemnification and jurisdiction issues defined therein. Any holder of this document is advised that information contained hereon reflects the Company's findings at the time of its intervention only and within the limits of Client's instructions, if any. The Company's sole responsibility is to its Client and this document does not exonerate parties to a transaction from exercising all their rights and obligations under the transaction documents. This document cannot be reproduced except in full, without prior written approval of the Company. Any unauthorized alteration, forgery or falsification of the content or appearance of this document is unlawful and offenders may be prosecuted to the fullest extent of the law.

Report Number :TERF2305001075ER
 Operation Mode :WCDMA B4
 Test Mode :Tx
 EUT Pol :E1 Plane
 Test Frequency :1752.6 MHz

Test Site :SAC 2
 Test Date :2023-06-27
 Temp./Humi. :25.9°C/55%
 Antenna Pol. :Vertical
 Engineer :Ricky Chen

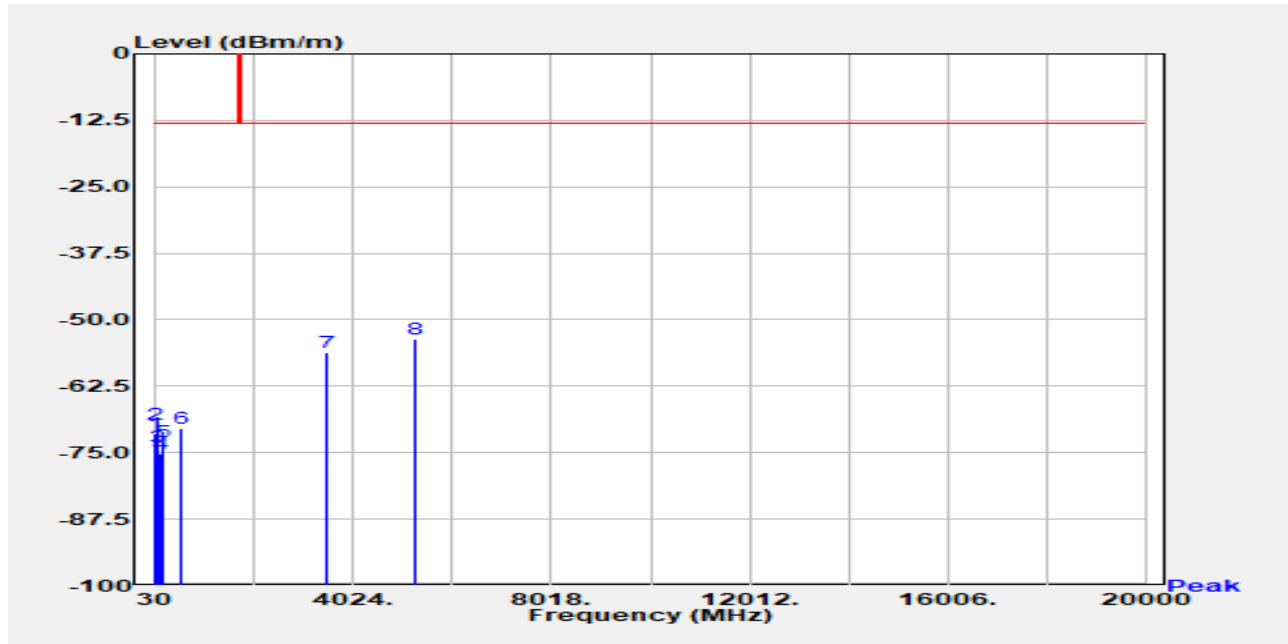

Freq. MHz	EIRP/ERP dBm	SG Output Level dBm	Antenna Gain dBi/dBd	Cable Loss dB	Limit dBm	Margin dB
31.940	-71.33	-59.04	-11.68	-0.61	-13.00	-58.33
75.590	-69.70	-66.45	-2.32	-0.92	-13.00	-56.70
103.720	-73.96	-74.10	1.23	-1.09	-13.00	-60.96
177.440	-75.25	-77.02	3.20	-1.43	-13.00	-62.25
211.390	-72.93	-78.16	6.77	-1.54	-13.00	-59.93
597.450	-70.40	-73.85	6.11	-2.65	-13.00	-57.40
3505.200	-56.16	-62.09	12.30	-6.38	-13.00	-43.16
5257.800	-53.64	-58.40	12.85	-8.09	-13.00	-40.64

Unless otherwise stated the results shown in this test report refer only to the sample(s) tested and such sample(s) are retained for 90 days only.

除非另有說明，此報告結果僅對測試之樣品負責，同時此樣品僅保留90天。本報告未經本公司書面許可，不可部份複製。
 This document is issued by the Company subject to its General Conditions of Service printed overleaf, available on request or accessible at <http://www.sgs.com.tw/Terms-and-Conditions> and for electronic format documents, subject to Terms and Conditions for Electronic Documents at <http://www.sgs.com.tw/Terms-and-Conditions>. Attention is drawn to the limitation of liability, indemnification and jurisdiction issues defined therein. Any holder of this document is advised that information contained hereon reflects the Company's findings at the time of its intervention only and within the limits of Client's instructions, if any. The Company's sole responsibility is to its Client and this document does not exonerate parties to a transaction from exercising all their rights and obligations under the transaction documents. This document cannot be reproduced except in full, without prior written approval of the Company. Any unauthorized alteration, forgery or falsification of the content or appearance of this document is unlawful and offenders may be prosecuted to the fullest extent of the law.

Report Number :TERF2305001075ER
 Operation Mode :WCDMA B4
 Test Mode :Tx
 EUT Pol :E1 Plane
 Test Frequency :1752.6 MHz

Test Site :SAC 2
 Test Date :2023-06-27
 Temp./Humi. :25.9°C/55%
 Antenna Pol. :Horizontal
 Engineer :Ricky Chen

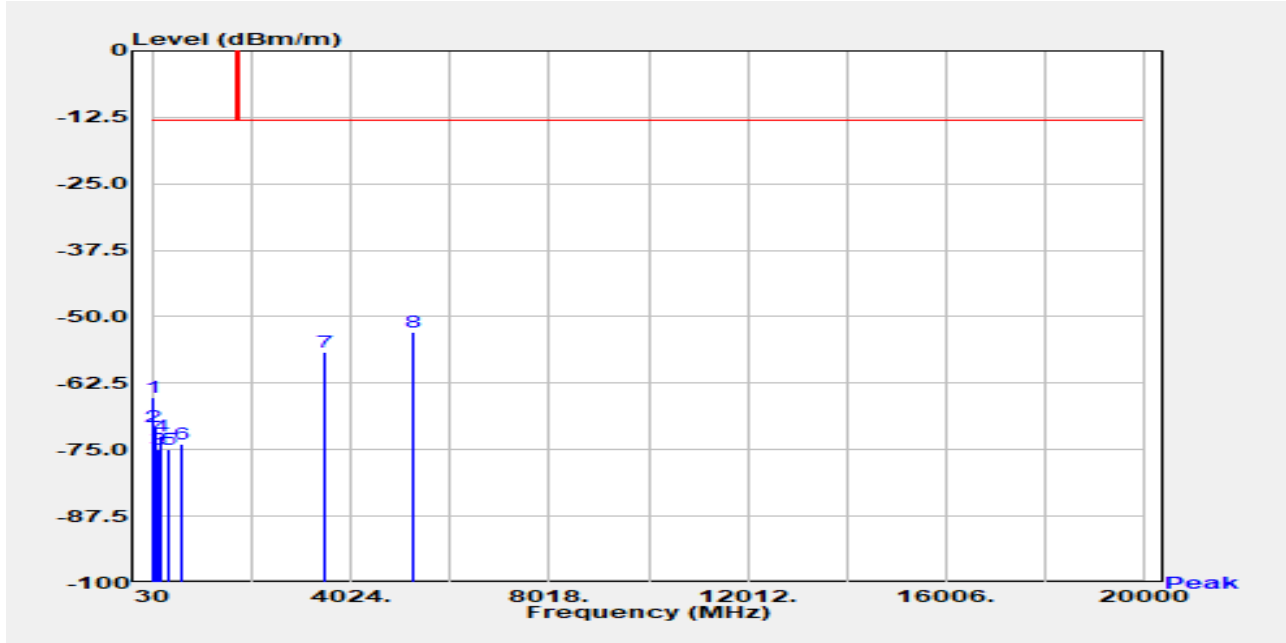

Freq. MHz	EIRP/ERP dBm	SG Output Level dBm	Antenna Gain dBi/dBd	Cable Loss dB	Limit dBm	Margin dB
33.880	-65.15	-53.22	-11.30	-0.63	-13.00	-52.15
75.590	-70.69	-67.44	-2.32	-0.92	-13.00	-57.69
178.410	-74.91	-76.88	3.40	-1.43	-13.00	-61.91
213.330	-72.46	-77.69	6.78	-1.55	-13.00	-59.46
366.590	-75.02	-79.59	6.65	-2.08	-13.00	-62.02
601.330	-73.94	-77.48	6.08	-2.55	-13.00	-60.94
3505.200	-56.73	-62.65	12.30	-6.38	-13.00	-43.73
5257.800	-52.85	-57.61	12.85	-8.09	-13.00	-39.85

Unless otherwise stated the results shown in this test report refer only to the sample(s) tested and such sample(s) are retained for 90 days only.

除非另有說明，此報告結果僅對測試之樣品負責，同時此樣品僅保留90天。本報告未經本公司書面許可，不可部份複製。

This document is issued by the Company subject to its General Conditions of Service printed overleaf, available on request or accessible at <http://www.sgs.com.tw/Terms-and-Conditions> and for electronic format documents, subject to Terms and Conditions for Electronic Documents at <http://www.sgs.com.tw/Terms-and-Conditions>. Attention is drawn to the limitation of liability, indemnification and jurisdiction issues defined therein. Any holder of this document is advised that information contained hereon reflects the Company's findings at the time of its intervention only and within the limits of Client's instructions, if any. The Company's sole responsibility is to its Client and this document does not exonerate parties to a transaction from exercising all their rights and obligations under the transaction documents. This document cannot be reproduced except in full, without prior written approval of the Company. Any unauthorized alteration, forgery or falsification of the content or appearance of this document is unlawful and offenders may be prosecuted to the fullest extent of the law.

Report Number :TERF2305001075ER
 Operation Mode :WCDMA B5
 Test Mode :Tx
 EUT Pol :E1 Plane
 Test Frequency :826.4 MHz

Test Site :SAC 2
 Test Date :2023-06-27
 Temp./Humi. :25.9°C/55%
 Antenna Pol. :Vertical
 Engineer :Ricky Chen

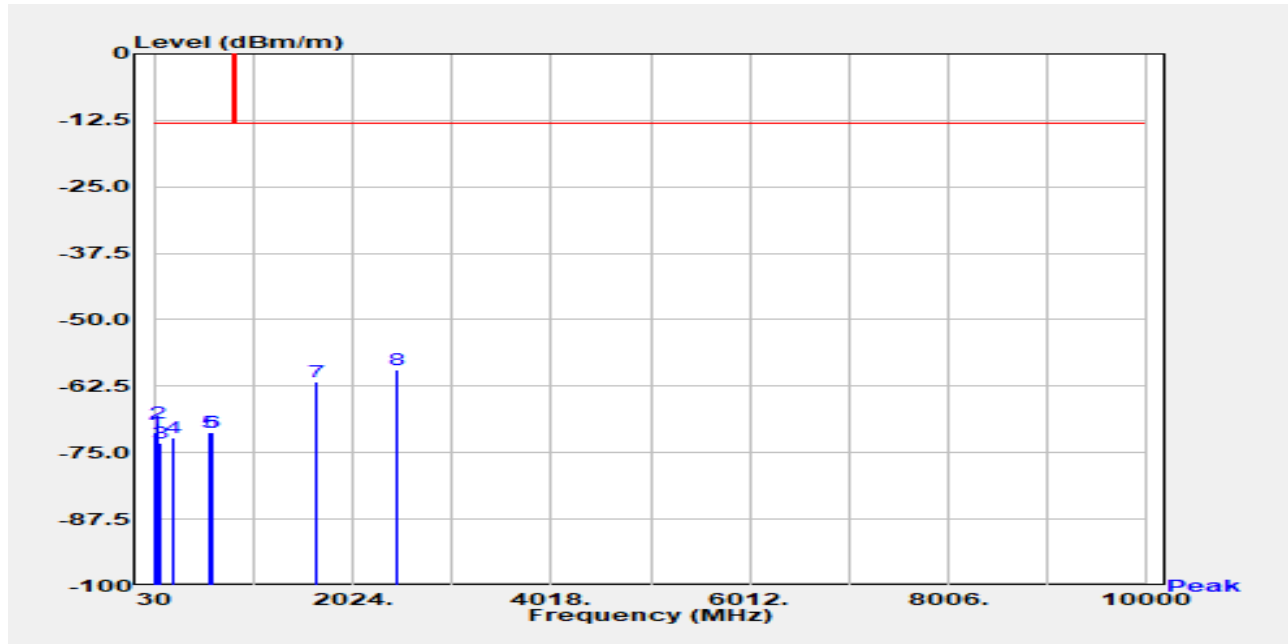

Freq. MHz	EIRP/ERP dBm	SG Output Level dBm	Antenna Gain dBi/dBd	Cable Loss dB	Limit dBm	Margin dB
31.940	-71.27	-58.97	-11.68	-0.61	-13.00	-58.27
75.590	-69.46	-66.21	-2.32	-0.92	-13.00	-56.46
102.750	-73.31	-73.59	1.37	-1.08	-13.00	-60.31
213.330	-72.12	-77.35	6.78	-1.55	-13.00	-59.12
590.660	-71.30	-74.58	6.23	-2.96	-13.00	-58.30
604.240	-71.24	-74.76	6.07	-2.56	-13.00	-58.24
1652.800	-61.76	-66.65	9.32	-4.44	-13.00	-48.76
2479.200	-59.42	-64.40	10.52	-5.53	-13.00	-46.42

Unless otherwise stated the results shown in this test report refer only to the sample(s) tested and such sample(s) are retained for 90 days only.

除非另有說明，此報告結果僅對測試之樣品負責，同時此樣品僅保留90天。本報告未經本公司書面許可，不可部份複製。

This document is issued by the Company subject to its General Conditions of Service printed overleaf, available on request or accessible at <http://www.sgs.com.tw/Terms-and-Conditions> and for electronic format documents, subject to Terms and Conditions for Electronic Documents at <http://www.sgs.com.tw/Terms-and-Conditions>. Attention is drawn to the limitation of liability, indemnification and jurisdiction issues defined therein. Any holder of this document is advised that information contained hereon reflects the Company's findings at the time of its intervention only and within the limits of Client's instructions, if any. The Company's sole responsibility is to its Client and this document does not exonerate parties to a transaction from exercising all their rights and obligations under the transaction documents. This document cannot be reproduced except in full, without prior written approval of the Company. Any unauthorized alteration, forgery or falsification of the content or appearance of this document is unlawful and offenders may be prosecuted to the fullest extent of the law.

Report Number :TERF2305001075ER
 Operation Mode :WCDMA B5
 Test Mode :Tx
 EUT Pol :E1 Plane
 Test Frequency :826.4 MHz

Test Site :SAC 2
 Test Date :2023-06-27
 Temp./Humi. :25.9°C/55%
 Antenna Pol. :Horizontal
 Engineer :Ricky Chen

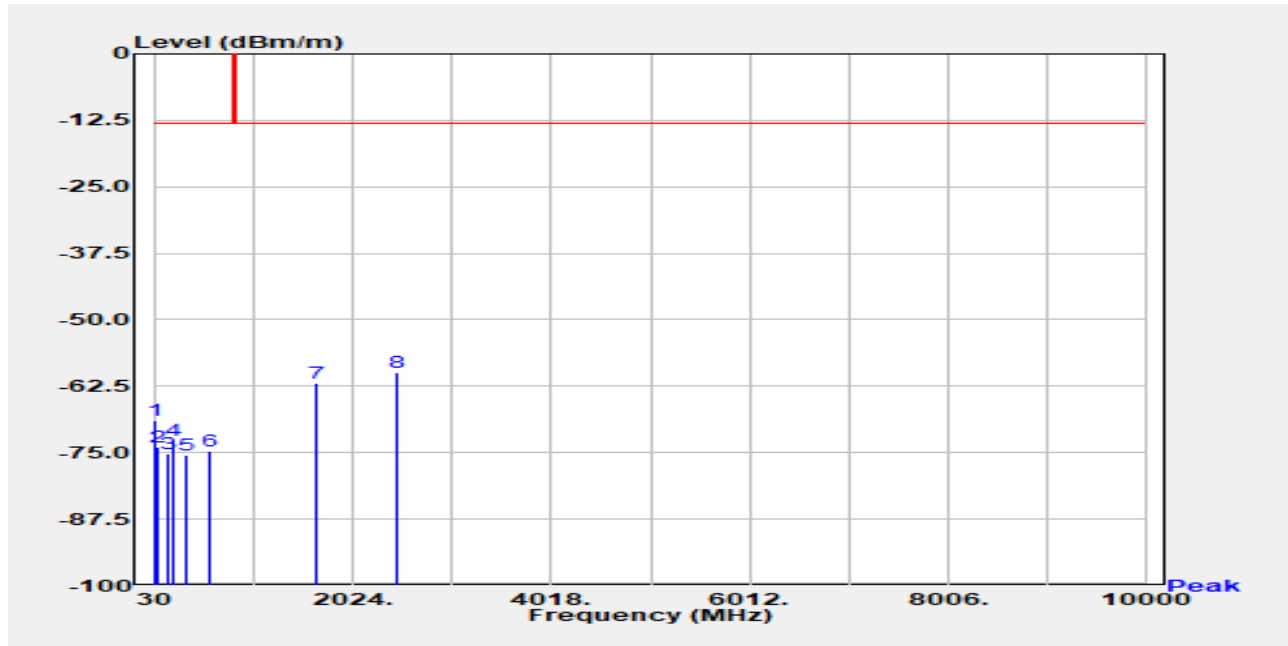

Freq. MHz	EIRP/ERP dBm	SG Output Level dBm	Antenna Gain dBi/dBd	Cable Loss dB	Limit dBm	Margin dB
35.820	-68.83	-57.46	-10.72	-0.65	-13.00	-55.83
75.590	-73.87	-70.63	-2.32	-0.92	-13.00	-60.87
181.320	-75.12	-77.57	3.90	-1.44	-13.00	-62.12
213.330	-72.58	-77.81	6.78	-1.55	-13.00	-59.58
346.220	-75.52	-80.02	6.59	-2.09	-13.00	-62.52
600.360	-74.64	-78.19	6.09	-2.54	-13.00	-61.64
1652.800	-61.84	-66.72	9.32	-4.44	-13.00	-48.84
2479.200	-59.89	-64.88	10.52	-5.53	-13.00	-46.89

Unless otherwise stated the results shown in this test report refer only to the sample(s) tested and such sample(s) are retained for 90 days only.

除非另有說明，此報告結果僅對測試之樣品負責，同時此樣品僅保留90天。本報告未經本公司書面許可，不可部份複製。

This document is issued by the Company subject to its General Conditions of Service printed overleaf, available on request or accessible at <http://www.sgs.com.tw/Terms-and-Conditions> and for electronic format documents, subject to Terms and Conditions for Electronic Documents at <http://www.sgs.com.tw/Terms-and-Conditions>. Attention is drawn to the limitation of liability, indemnification and jurisdiction issues defined therein. Any holder of this document is advised that information contained hereon reflects the Company's findings at the time of its intervention only and within the limits of Client's instructions, if any. The Company's sole responsibility is to its Client and this document does not exonerate parties to a transaction from exercising all their rights and obligations under the transaction documents. This document cannot be reproduced except in full, without prior written approval of the Company. Any unauthorized alteration, forgery or falsification of the content or appearance of this document is unlawful and offenders may be prosecuted to the fullest extent of the law.

Report Number :TERF2305001075ER
 Operation Mode :WCDMA B5
 Test Mode :Tx
 EUT Pol :E1 Plane
 Test Frequency :836.6 MHz

Test Site :SAC 2
 Test Date :2023-06-27
 Temp./Humi. :25.9°C/55%
 Antenna Pol. :Vertical
 Engineer :Ricky Chen

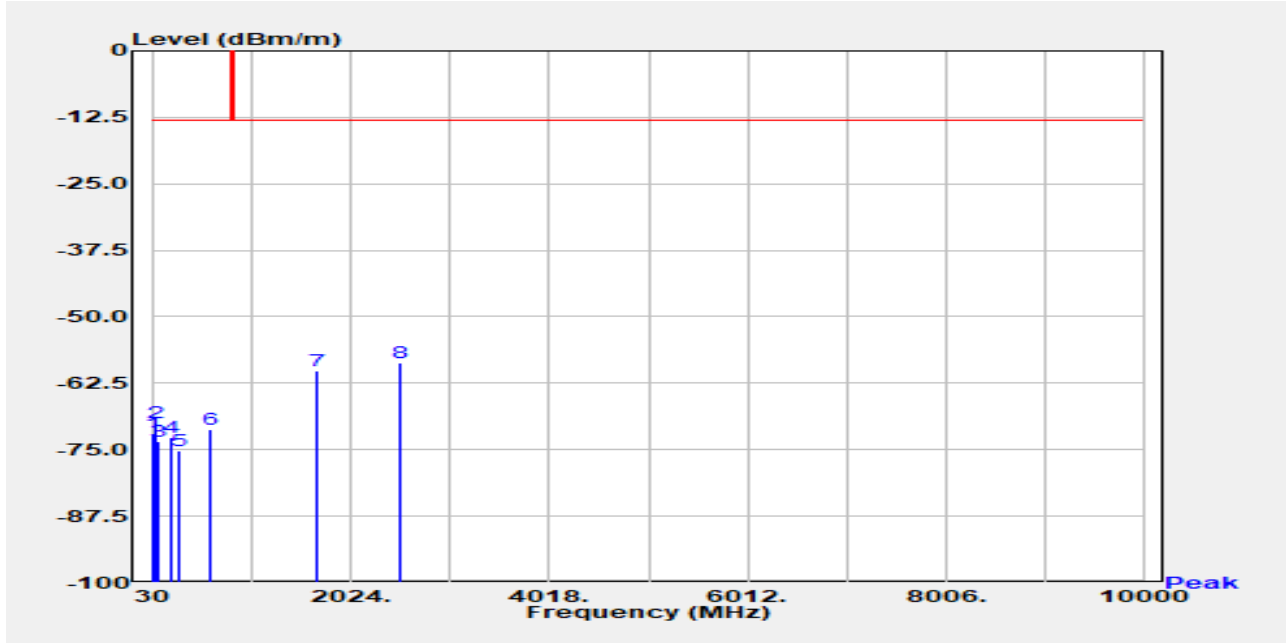

Freq. MHz	EIRP/ERP dBm	SG Output Level dBm	Antenna Gain dBi/dBd	Cable Loss dB	Limit dBm	Margin dB
31.940	-71.85	-59.56	-11.68	-0.61	-13.00	-58.85
75.590	-70.00	-66.76	-2.32	-0.92	-13.00	-57.00
103.720	-73.32	-73.46	1.23	-1.09	-13.00	-60.32
211.390	-72.59	-77.82	6.77	-1.54	-13.00	-59.59
295.780	-75.29	-79.57	6.14	-1.86	-13.00	-62.29
614.910	-71.20	-74.62	6.01	-2.60	-13.00	-58.20
1673.200	-60.09	-65.11	9.49	-4.47	-13.00	-47.09
2509.800	-58.70	-63.73	10.60	-5.57	-13.00	-45.70

Unless otherwise stated the results shown in this test report refer only to the sample(s) tested and such sample(s) are retained for 90 days only.

除非另有說明，此報告結果僅對測試之樣品負責，同時此樣品僅保留90天。本報告未經本公司書面許可，不可部份複製。

This document is issued by the Company subject to its General Conditions of Service printed overleaf, available on request or accessible at <http://www.sgs.com.tw/Terms-and-Conditions> and for electronic format documents, subject to Terms and Conditions for Electronic Documents at <http://www.sgs.com.tw/Terms-and-Conditions>. Attention is drawn to the limitation of liability, indemnification and jurisdiction issues defined therein. Any holder of this document is advised that information contained hereon reflects the Company's findings at the time of its intervention only and within the limits of Client's instructions, if any. The Company's sole responsibility is to its Client and this document does not exonerate parties to a transaction from exercising all their rights and obligations under the transaction documents. This document cannot be reproduced except in full, without prior written approval of the Company. Any unauthorized alteration, forgery or falsification of the content or appearance of this document is unlawful and offenders may be prosecuted to the fullest extent of the law.

Report Number :TERF2305001075ER
 Operation Mode :WCDMA B5
 Test Mode :Tx
 EUT Pol :E1 Plane
 Test Frequency :836.6 MHz

Test Site :SAC 2
 Test Date :2023-06-27
 Temp./Humi. :25.9°C/55%
 Antenna Pol. :Horizontal
 Engineer :Ricky Chen

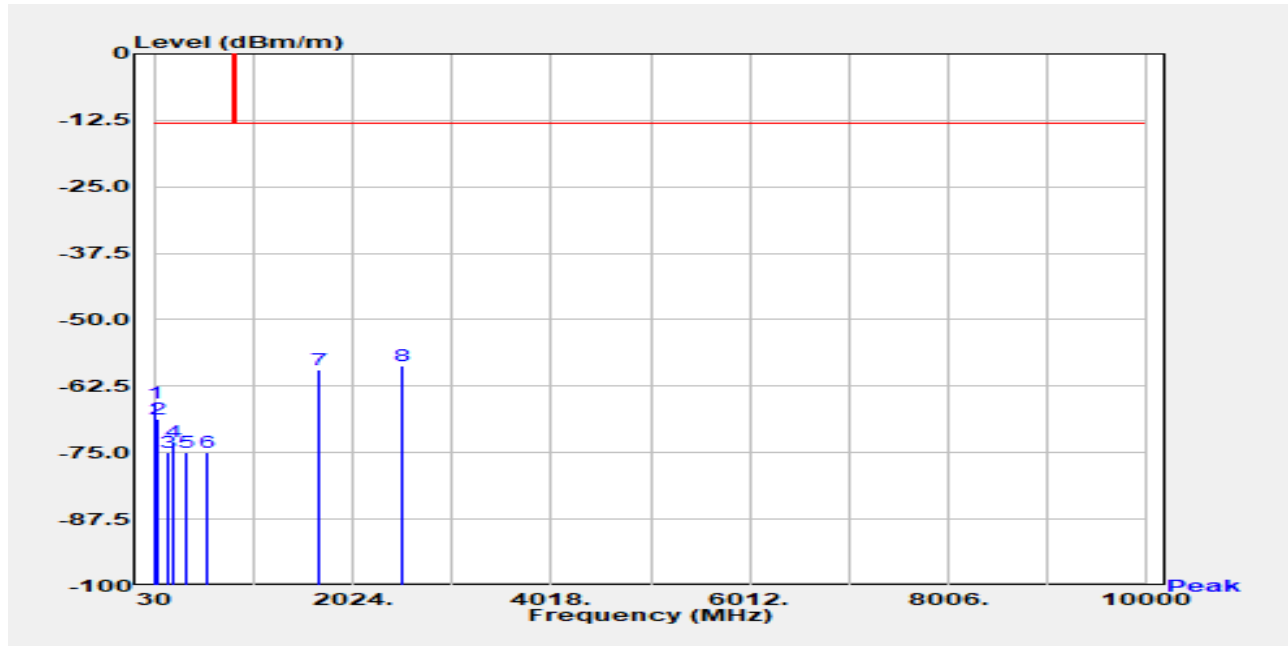

Freq. MHz	EIRP/ERP dBm	SG Output Level dBm	Antenna Gain dBi/dBd	Cable Loss dB	Limit dBm	Margin dB
35.820	-65.56	-54.19	-10.72	-0.65	-13.00	-52.56
75.590	-68.61	-65.37	-2.32	-0.92	-13.00	-55.61
180.350	-75.06	-77.29	3.66	-1.43	-13.00	-62.06
211.390	-72.89	-78.12	6.77	-1.54	-13.00	-59.89
348.160	-74.92	-79.44	6.60	-2.09	-13.00	-61.92
551.860	-74.90	-79.14	6.70	-2.45	-13.00	-61.90
1673.200	-59.43	-64.45	9.49	-4.47	-13.00	-46.43
2509.800	-58.60	-63.63	10.60	-5.57	-13.00	-45.60

Unless otherwise stated the results shown in this test report refer only to the sample(s) tested and such sample(s) are retained for 90 days only.

除非另有說明，此報告結果僅對測試之樣品負責，同時此樣品僅保留90天。本報告未經本公司書面許可，不可部份複製。
 This document is issued by the Company subject to its General Conditions of Service printed overleaf, available on request or accessible at <http://www.sgs.com.tw/Terms-and-Conditions> and for electronic format documents, subject to Terms and Conditions for Electronic Documents at <http://www.sgs.com.tw/Terms-and-Conditions>. Attention is drawn to the limitation of liability, indemnification and jurisdiction issues defined therein. Any holder of this document is advised that information contained hereon reflects the Company's findings at the time of its intervention only and within the limits of Client's instructions, if any. The Company's sole responsibility is to its Client and this document does not exonerate parties to a transaction from exercising all their rights and obligations under the transaction documents. This document cannot be reproduced except in full, without prior written approval of the Company. Any unauthorized alteration, forgery or falsification of the content or appearance of this document is unlawful and offenders may be prosecuted to the fullest extent of the law.

Report Number :TERF2305001075ER
 Operation Mode :WCDMA B5
 Test Mode :Tx
 EUT Pol :E1 Plane
 Test Frequency :846.6 MHz

Test Site :SAC 2
 Test Date :2023-06-27
 Temp./Humi. :25.9°C/55%
 Antenna Pol. :Vertical
 Engineer :Ricky Chen

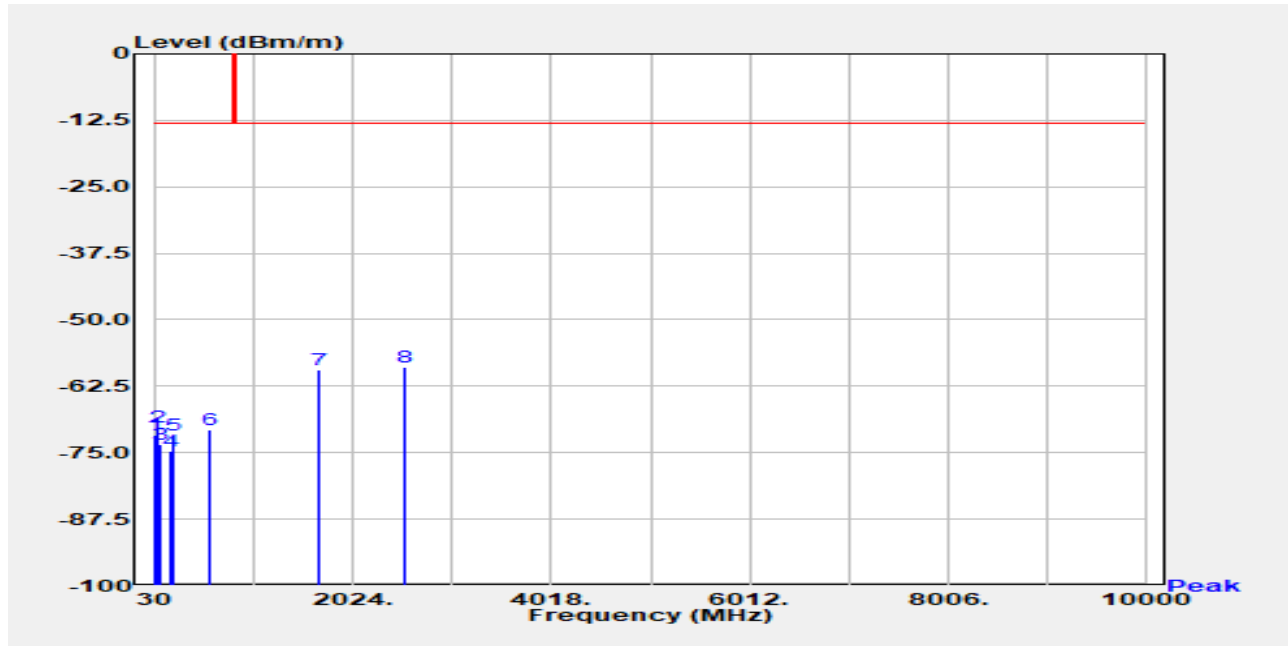

Freq. MHz	EIRP/ERP dBm	SG Output Level dBm	Antenna Gain dBi/dBd	Cable Loss dB	Limit dBm	Margin dB
32.910	-71.74	-60.06	-11.06	-0.62	-13.00	-58.74
75.590	-70.07	-66.82	-2.32	-0.92	-13.00	-57.07
101.780	-73.35	-73.58	1.30	-1.08	-13.00	-60.35
189.080	-74.62	-78.20	5.07	-1.49	-13.00	-61.62
212.360	-71.65	-76.88	6.77	-1.54	-13.00	-58.65
591.630	-70.62	-73.92	6.21	-2.92	-13.00	-57.62
1693.200	-59.51	-64.67	9.65	-4.49	-13.00	-46.51
2539.800	-59.01	-64.02	10.60	-5.59	-13.00	-46.01

Unless otherwise stated the results shown in this test report refer only to the sample(s) tested and such sample(s) are retained for 90 days only.

除非另有說明，此報告結果僅對測試之樣品負責，同時此樣品僅保留90天。本報告未經本公司書面許可，不可部份複製。
 This document is issued by the Company subject to its General Conditions of Service printed overleaf, available on request or accessible at <http://www.sgs.com.tw/Terms-and-Conditions> and for electronic format documents, subject to Terms and Conditions for Electronic Documents at <http://www.sgs.com.tw/Terms-and-Conditions>. Attention is drawn to the limitation of liability, indemnification and jurisdiction issues defined therein. Any holder of this document is advised that information contained hereon reflects the Company's findings at the time of its intervention only and within the limits of Client's instructions, if any. The Company's sole responsibility is to its Client and this document does not exonerate parties to a transaction from exercising all their rights and obligations under the transaction documents. This document cannot be reproduced except in full, without prior written approval of the Company. Any unauthorized alteration, forgery or falsification of the content or appearance of this document is unlawful and offenders may be prosecuted to the fullest extent of the law.

Report Number :TERF2305001075ER
 Operation Mode :WCDMA B5
 Test Mode :Tx
 EUT Pol :E1 Plane
 Test Frequency :846.6 MHz

Test Site :SAC 2
 Test Date :2023-06-27
 Temp./Humi. :25.9°C/55%
 Antenna Pol. :Horizontal
 Engineer :Ricky Chen

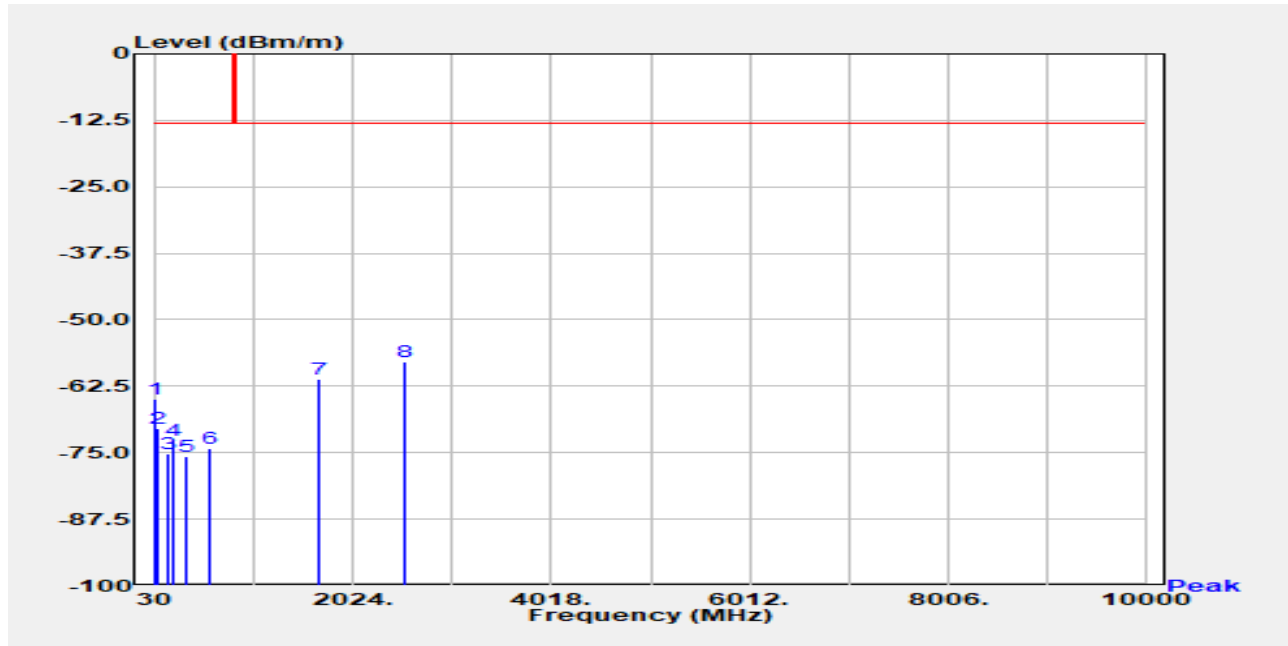

Freq. MHz	EIRP/ERP dBm	SG Output Level dBm	Antenna Gain dBi/dBd	Cable Loss dB	Limit dBm	Margin dB
31.940	-64.83	-52.54	-11.68	-0.61	-13.00	-51.83
69.770	-70.54	-65.11	-4.54	-0.89	-13.00	-57.54
181.320	-75.27	-77.73	3.90	-1.44	-13.00	-62.27
213.330	-72.67	-77.90	6.78	-1.55	-13.00	-59.67
365.620	-75.64	-80.23	6.67	-2.08	-13.00	-62.64
599.390	-74.10	-77.63	6.09	-2.57	-13.00	-61.10
1693.200	-61.07	-66.22	9.65	-4.49	-13.00	-48.07
2539.800	-57.96	-62.97	10.60	-5.59	-13.00	-44.96

Unless otherwise stated the results shown in this test report refer only to the sample(s) tested and such sample(s) are retained for 90 days only.

除非另有說明，此報告結果僅對測試之樣品負責，同時此樣品僅保留90天。本報告未經本公司書面許可，不可部份複製。

This document is issued by the Company subject to its General Conditions of Service printed overleaf, available on request or accessible at <http://www.sgs.com.tw/Terms-and-Conditions> and for electronic format documents, subject to Terms and Conditions for Electronic Documents at <http://www.sgs.com.tw/Terms-and-Conditions>. Attention is drawn to the limitation of liability, indemnification and jurisdiction issues defined therein. Any holder of this document is advised that information contained hereon reflects the Company's findings at the time of its intervention only and within the limits of Client's instructions, if any. The Company's sole responsibility is to its Client and this document does not exonerate parties to a transaction from exercising all their rights and obligations under the transaction documents. This document cannot be reproduced except in full, without prior written approval of the Company. Any unauthorized alteration, forgery or falsification of the content or appearance of this document is unlawful and offenders may be prosecuted to the fullest extent of the law.

12 FREQUENCY STABILITY MEASUREMENT

12.1 Standard Applicabl

The frequency stability shall be sufficient to ensure that the fundamental emission stays within the authorized frequency block.

12.2 Test Set-up

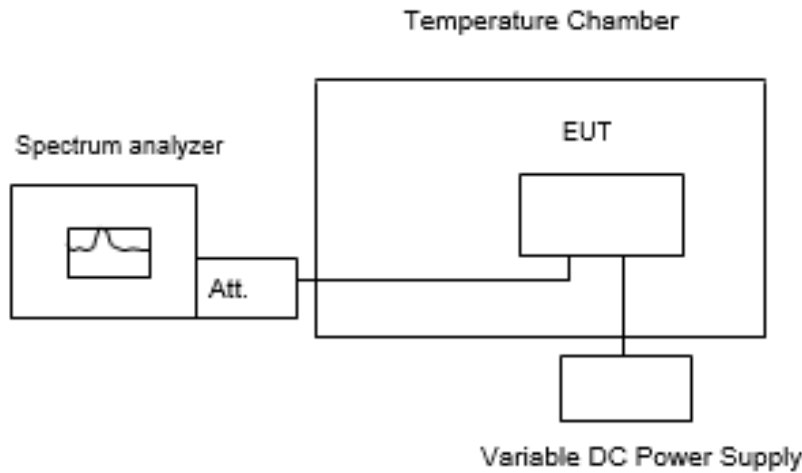

Note: Measurement setup for testing on Antenna connector

12.3 Measurement Procedure

The equipment under test was connected to an external AC or DC power supply and input rated voltage. RF output was connected to a frequency counter or spectrum analyzer via feed through attenuators. The EUT was placed inside the temperature chamber. Set the spectrum analyzer RBW low enough to obtain the desired frequency resolution and measure EUT 25°C operating frequency as reference frequency. Turn EUT off and set the chamber temperature to -30°C. After the temperature stabilized for approximately 30 minutes recorded the frequency. Repeat step measure with 10°C increased per stage until the highest temperature of +50°C reached.

Set chamber temperature to 25°C. Use a variable AC power supply / DC power source to power the EUT and set the voltage to rated voltage. Set the spectrum analyzer RBW low enough to obtain the desired frequency resolution and recorded the frequency.

Reduce the input voltage to specify extreme voltage variation (+/- 15%) and endpoint as declared by the manufacturer, record the maximum frequency change.

12.4 Measurement Result

Note: The battery is rated 3.89V dc.

Unless otherwise stated the results shown in this test report refer only to the sample(s) tested and such sample(s) are retained for 90 days only.

除非另有說明，此報告結果僅對測試之樣品負責，同時此樣品僅保留90天。本報告未經本公司書面許可，不可部份複製。
This document is issued by the Company subject to its General Conditions of Service printed overleaf, available on request or accessible at <http://www.sgs.com.tw/Terms-and-Conditions> and for electronic format documents, subject to Terms and Conditions for Electronic Documents at <http://www.sgs.com.tw/Terms-and-Conditions>. Attention is drawn to the limitation of liability, indemnification and jurisdiction issues defined therein. Any holder of this document is advised that information contained hereon reflects the Company's findings at the time of its intervention only and within the limits of Client's instructions, if any. The Company's sole responsibility is to its Client and this document does not exonerate parties to a transaction from exercising all their rights and obligations under the transaction documents. This document cannot be reproduced except in full, without prior written approval of the Company. Any unauthorized alteration, forgery or falsification of the content or appearance of this document is unlawful and offenders may be prosecuted to the fullest extent of the law.

GPRS 850 Mid Channel		836.6000	MHz	
Vdc	Temp. (°C)	Freq. (MHz)	(ppm)	Limit
FREQUENCY ERROR vs. VOLTAGE				
4.4735	20	836.6000111	0.0132	+/- 2.5 ppm
3.89	20	836.5999893	-0.0128	
3.3065	20	836.599995	-0.0060	
3.4 (End point)	20	836.5999909	-0.0109	
FREQUENCY ERROR vs. Temp.				
3.89	50	836.6000125	0.0149	+/- 2.5 ppm
3.89	40	836.5999897	-0.0123	
3.89	30	836.5999987	-0.0016	
3.89	20	836.6000053	0.0063	
3.89	10	836.5999956	-0.0053	
3.89	0	836.6000141	0.0168	
3.89	-10	836.5999862	-0.0165	
3.89	-20	836.5999951	-0.0059	
3.89	-30	836.6000055	0.0066	

GPRS 1900 Mid Channel		1880.0000	MHz	
Vdc	Temp. (°C)	Freq. (MHz)	(ppm)	Limit
FREQUENCY ERROR vs. VOLTAGE				
4.4735	20	1879.999987	-0.0070	+/- 2.5 ppm
3.89	20	1879.999989	-0.0058	
3.3065	20	1880.000007	0.0040	
3.4 (End point)	20	1880.000004	0.0023	
FREQUENCY ERROR vs. Temp.				
3.89	50	1879.999986	-0.0075	+/- 2.5 ppm
3.89	40	1879.999992	-0.0042	
3.89	30	1879.999987	-0.0071	
3.89	20	1880.000014	0.0072	
3.89	10	1880.00001	0.0055	
3.89	0	1879.999986	-0.0073	
3.89	-10	1879.999999	-0.0005	
3.89	-20	1880.000005	0.0025	
3.89	-30	1879.99999	-0.0052	

Unless otherwise stated the results shown in this test report refer only to the sample(s) tested and such sample(s) are retained for 90 days only.

除非另有說明，此報告結果僅對測試之樣品負責，同時此樣品僅保留90天。本報告未經本公司書面許可，不可部份複製。

This document is issued by the Company subject to its General Conditions of Service printed overleaf, available on request or accessible at <http://www.sgs.com.tw/Terms-and-Conditions> and for electronic format documents, subject to Terms and Conditions for Electronic Documents at <http://www.sgs.com.tw/Terms-and-Conditions>. Attention is drawn to the limitation of liability, indemnification and jurisdiction issues defined therein. Any holder of this document is advised that information contained hereon reflects the Company's findings at the time of its intervention only and within the limits of Client's instructions, if any. The Company's sole responsibility is to its Client and this document does not exonerate parties to a transaction from exercising all their rights and obligations under the transaction documents. This document cannot be reproduced except in full, without prior written approval of the Company. Any unauthorized alteration, forgery or falsification of the content or appearance of this document is unlawful and offenders may be prosecuted to the fullest extent of the law.

WCDMA II Mid Channel 1880.0000 MHz				
Vdc	Temp. (°C)	Freq. (MHz)	(ppm)	Limit
FREQUENCY ERROR vs. VOLTAGE				
4.4735	20	1879.999991	-0.0047	+/- 2.5 ppm
3.89	20	1879.99999	-0.0051	
3.3065	20	1880.000012	0.0066	
3.4 (End point)	20	1880.00001	0.0051	
FREQUENCY ERROR vs. Temp.				
3.89	50	1880.000002	0.0012	+/- 2.5 ppm
3.89	40	1880.000013	0.0069	
3.89	30	1880.000008	0.0041	
3.89	20	1880.00001	0.0051	
3.89	10	1880.000004	0.0020	
3.89	0	1879.999985	-0.0078	
3.89	-10	1879.999997	-0.0017	
3.89	-20	1880.000012	0.0066	
3.89	-30	1879.999995	-0.0026	

WCDMA IV Mid Channel 1732.6000 MHz				
Vdc	Temp. (°C)	Freq. (MHz)	(ppm)	Limit
FREQUENCY ERROR vs. VOLTAGE				
4.4735	20	1732.600012	0.0072	+/- 2.5 ppm
3.89	20	1732.599987	-0.0078	
3.3065	20	1732.600008	0.0049	
3.4 (End point)	20	1732.600005	0.0027	
FREQUENCY ERROR vs. Temp.				
3.89	50	1732.600014	0.0080	+/- 2.5 ppm
3.89	40	1732.599998	-0.0013	
3.89	30	1732.600006	0.0037	
3.89	20	1732.600009	0.0054	
3.89	10	1732.600001	0.0006	
3.89	0	1732.599996	-0.0026	
3.89	-10	1732.599986	-0.0081	
3.89	-20	1732.600009	0.0053	
3.89	-30	1732.600013	0.0073	

Unless otherwise stated the results shown in this test report refer only to the sample(s) tested and such sample(s) are retained for 90 days only.

除非另有說明，此報告結果僅對測試之樣品負責，同時此樣品僅保留90天。本報告未經本公司書面許可，不可部份複製。

This document is issued by the Company subject to its General Conditions of Service printed overleaf, available on request or accessible at <http://www.sgs.com.tw/Terms-and-Conditions> and for electronic format documents, subject to Terms and Conditions for Electronic Documents at <http://www.sgs.com.tw/Terms-and-Conditions>. Attention is drawn to the limitation of liability, indemnification and jurisdiction issues defined therein. Any holder of this document is advised that information contained hereon reflects the Company's findings at the time of its intervention only and within the limits of Client's instructions, if any. The Company's sole responsibility is to its Client and this document does not exonerate parties to a transaction from exercising all their rights and obligations under the transaction documents. This document cannot be reproduced except in full, without prior written approval of the Company. Any unauthorized alteration, forgery or falsification of the content or appearance of this document is unlawful and offenders may be prosecuted to the fullest extent of the law.

Vdc		Temp. (°C)	Freq. (MHz)	(ppm)	Limit
WCDMA V Mid Channel 836.6000 MHz					
FREQUENCY ERROR vs. VOLTAGE					
4.4735	20	836.5999945	-0.0065	+/- 2.5 ppm	
3.89	20	836.6000046	0.0054		
3.3065	20	836.5999874	-0.0150		
3.4 (End point)	20	836.599985	-0.0179		
FREQUENCY ERROR vs. Temp.					
3.89	50	836.5999942	-0.0069	+/- 2.5 ppm	
3.89	40	836.599997	-0.0036		
3.89	30	836.6000145	0.0173		
3.89	20	836.5999904	-0.0115		
3.89	10	836.6000041	0.0049		
3.89	0	836.5999892	-0.0129		
3.89	-10	836.6000114	0.0137		
3.89	-20	836.5999919	-0.0097		
3.89	-30	836.6000034	0.0040		

Unless otherwise stated the results shown in this test report refer only to the sample(s) tested and such sample(s) are retained for 90 days only.

除非另有說明，此報告結果僅對測試之樣品負責，同時此樣品僅保留90天。本報告未經本公司書面許可，不可部份複製。

This document is issued by the Company subject to its General Conditions of Service printed overleaf, available on request or accessible at <http://www.sgs.com.tw/Terms-and-Conditions> and for electronic format documents, subject to Terms and Conditions for Electronic Documents at <http://www.sgs.com.tw/Terms-and-Conditions>. Attention is drawn to the limitation of liability, indemnification and jurisdiction issues defined therein. Any holder of this document is advised that information contained hereon reflects the Company's findings at the time of its intervention only and within the limits of Client's instructions, if any. The Company's sole responsibility is to its Client and this document does not exonerate parties to a transaction from exercising all their rights and obligations under the transaction documents. This document cannot be reproduced except in full, without prior written approval of the Company. Any unauthorized alteration, forgery or falsification of the content or appearance of this document is unlawful and offenders may be prosecuted to the fullest extent of the law.

13 PEAK TO AVERAGE RATIO

13.1 Standard Applicable

The peak-to-average ratio (PAR) of the transmission may not exceed 13dB.

13.2 Test SET-UP

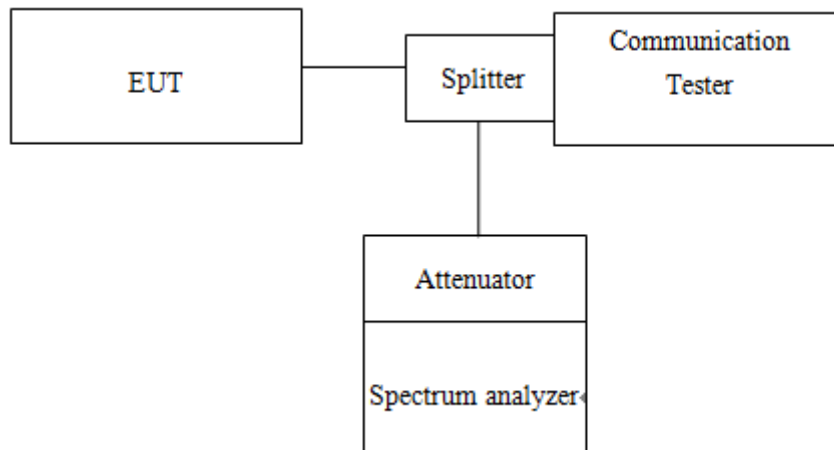

13.3 Measurement Procedure

1. KDB 971168 D01 is employed as the following procedure is proper adjusted accordingly:
2. Set resolution/measurement bandwidth \geq signal's occupied bandwidth; & internal =1ms
3. Set the number of counts to a value that stabilizes the measured CCDF curve.

13.4 Measurement Result

Freq. (MHz)	CH	Peak-to-Average Ratio (dB)		
		GSM 850	GPRS 850	EDGE 850
824.2	128	9.7	9.86	12.78
836.6	190	9.73	9.69	12.67
848.8	251	9.22	9.73	12.44
Freq. (MHz)	CH	Peak-to-Average Ratio (dB)		
		GSM 1900	GPRS 1900	EDGE 1900
1850.2	512	9.52	9.65	12.37
1880	661	9.85	9.41	12.12
1909.8	810	9.96	8.6	12.24

Unless otherwise stated the results shown in this test report refer only to the sample(s) tested and such sample(s) are retained for 90 days only.
除非另有說明，此報告結果僅對測試之樣品負責，同時此樣品僅保留90天。本報告未經本公司書面許可，不可部份複製。

This document is issued by the Company subject to its General Conditions of Service printed overleaf, available on request or accessible at <http://www.sgs.com.tw/Terms-and-Conditions> and for electronic format documents, subject to Terms and Conditions for Electronic Documents at <http://www.sgs.com.tw/Terms-and-Conditions>. Attention is drawn to the limitation of liability, indemnification and jurisdiction issues defined therein. Any holder of this document is advised that information contained hereon reflects the Company's findings at the time of its intervention only and within the limits of Client's instructions, if any. The Company's sole responsibility is to its Client and this document does not exonerate parties to a transaction from exercising all their rights and obligations under the transaction documents. This document cannot be reproduced except in full, without prior written approval of the Company. Any unauthorized alteration, forgery or falsification of the content or appearance of this document is unlawful and offenders may be prosecuted to the fullest extent of the law.

Freq. (MHz)	CH	Peak-to-Average Ratio (dB)		
		WCDMA II	HSDPA II	HSUPA II
1852.4	9262	2.94	3.82	3.89
1880	9400	2.79	3.61	3.63
1907.6	9538	2.86	3.69	3.96
Freq. (MHz)	CH	Peak-to-Average Ratio (dB)		
		WCDMA IV	HSDPA IV	HSUPA IV
1712.4	1312	2.74	3.62	3.95
1732.6	1413	2.81	3.80	3.59
1752.6	1513	2.87	3.63	3.71
Freq. (MHz)	CH	Peak-to-Average Ratio (dB)		
		WCDMA V	HSDPA V	HSUPA V
826.4	4132	2.85	3.74	3.70
836.6	4183	2.87	3.95	3.69
846.6	4233	2.88	3.82	3.87

Unless otherwise stated the results shown in this test report refer only to the sample(s) tested and such sample(s) are retained for 90 days only.
 除非另有說明，此報告結果僅對測試之樣品負責，同時此樣品僅保留90天。本報告未經本公司書面許可，不可部份複製。

This document is issued by the Company subject to its General Conditions of Service printed overleaf, available on request or accessible at <http://www.sgs.com.tw/Terms-and-Conditions> and for electronic format documents, subject to Terms and Conditions for Electronic Documents at <http://www.sgs.com.tw/Terms-and-Conditions>. Attention is drawn to the limitation of liability, indemnification and jurisdiction issues defined therein. Any holder of this document is advised that information contained hereon reflects the Company's findings at the time of its intervention only and within the limits of Client's instructions, if any. The Company's sole responsibility is to its Client and this document does not exonerate parties to a transaction from exercising all their rights and obligations under the transaction documents. This document cannot be reproduced except in full, without prior written approval of the Company. Any unauthorized alteration, forgery or falsification of the content or appearance of this document is unlawful and offenders may be prosecuted to the fullest extent of the law.

GSM 850MHz LowCH128-824.2

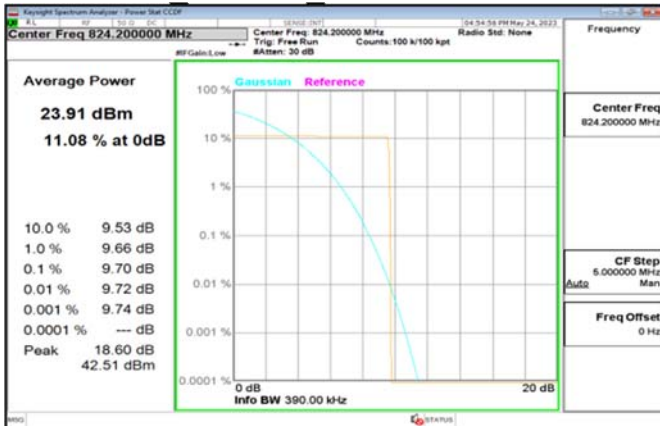

GPRS 850MHz LowCH128-824.2

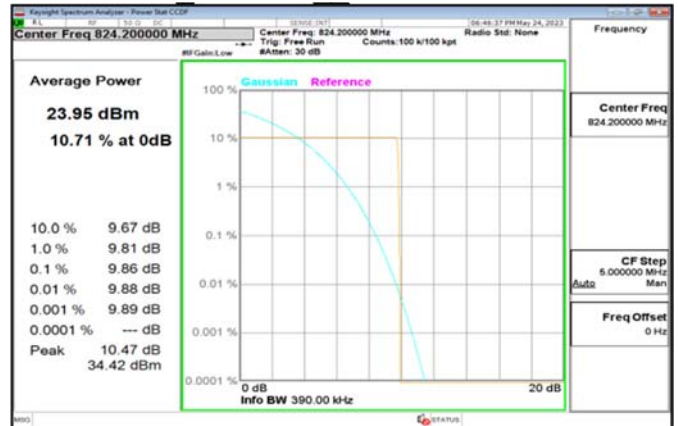

GSM 850MHz MidCH190-836.6

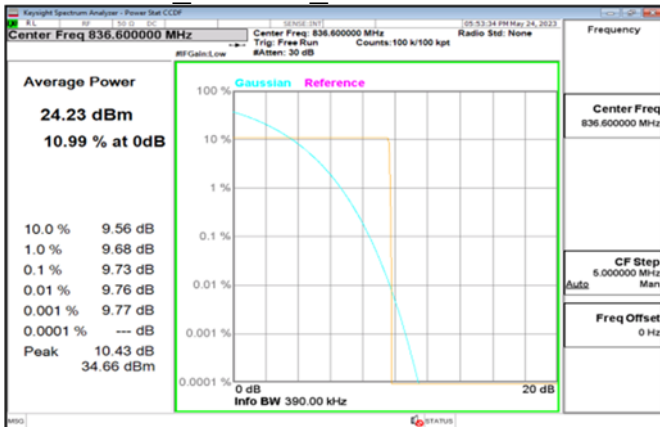

GPRS 850MHz MidCH190-836.6

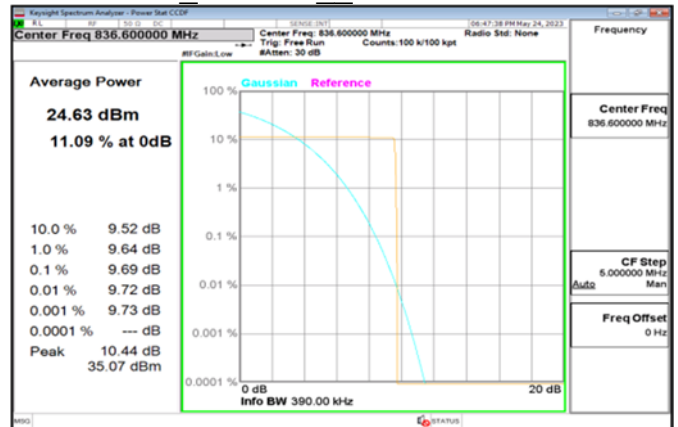

GSM 850MHz HighCH251-848.8

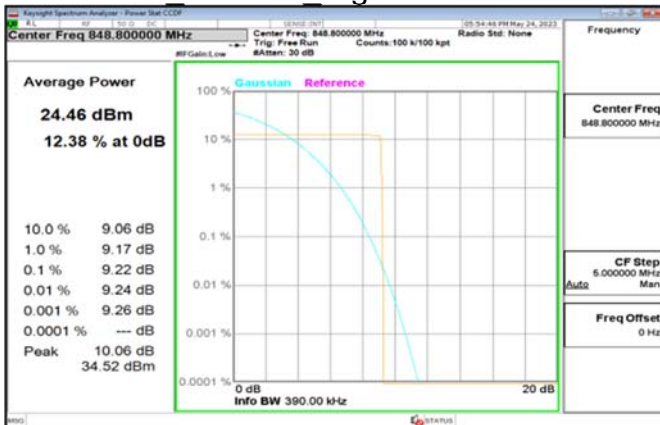

GPRS 850MHz HighCH251-848.8

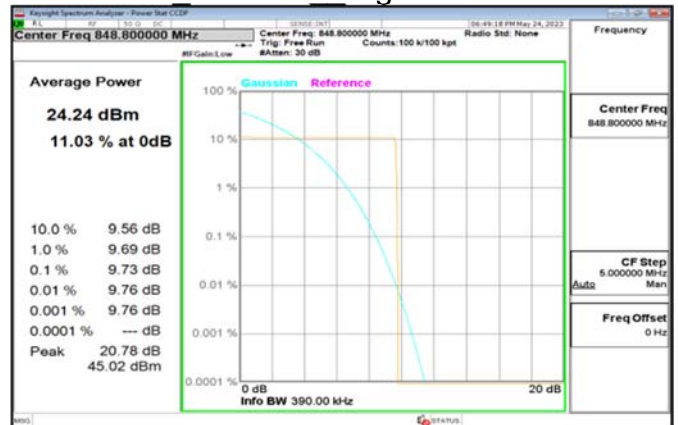

Unless otherwise stated the results shown in this test report refer only to the sample(s) tested and such sample(s) are retained for 90 days only.

除非另有說明，此報告結果僅對測試之樣品負責，同時此樣品僅保留90天。本報告未經本公司書面許可，不可部份複製。

This document is issued by the Company subject to its General Conditions of Service printed overleaf, available on request or accessible at <http://www.sgs.com.tw/Terms-and-Conditions> and for electronic format documents, subject to Terms and Conditions for Electronic Documents at <http://www.sgs.com.tw/Terms-and-Conditions>. Attention is drawn to the limitation of liability, indemnification and jurisdiction issues defined therein. Any holder of this document is advised that information contained hereon reflects the Company's findings at the time of its intervention only and within the limits of Client's instructions, if any. The Company's sole responsibility is to its Client and this document does not exonerate parties to a transaction from exercising all their rights and obligations under the transaction documents. This document cannot be reproduced except in full, without prior written approval of the Company. Any unauthorized alteration, forgery or falsification of the content or appearance of this document is unlawful and offenders may be prosecuted to the fullest extent of the law.

EDGE 850MHz LowCH128-824.2

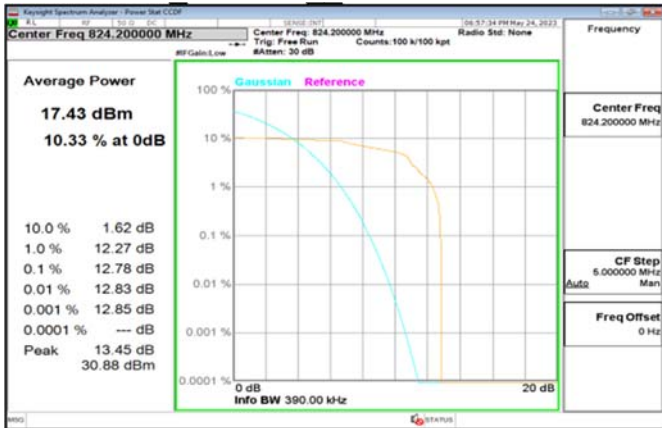

GSM 1900MHz LowCH512-1850.2

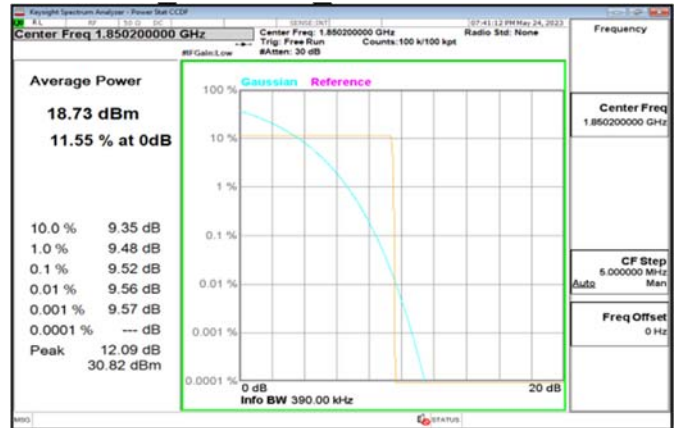

EDGE 850MHz MidCH190-836.6

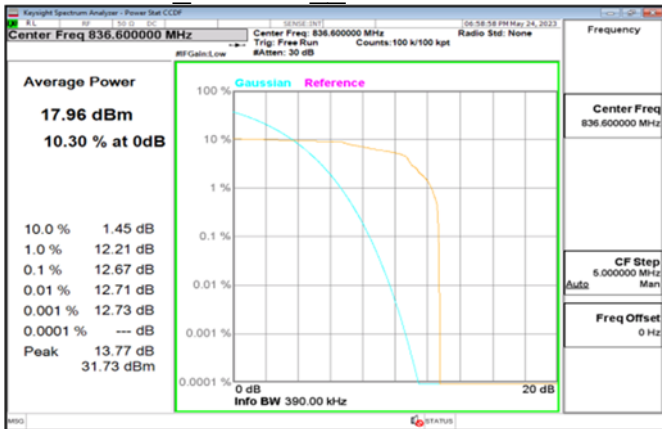

GSM 1900MHz MidCH661-1880

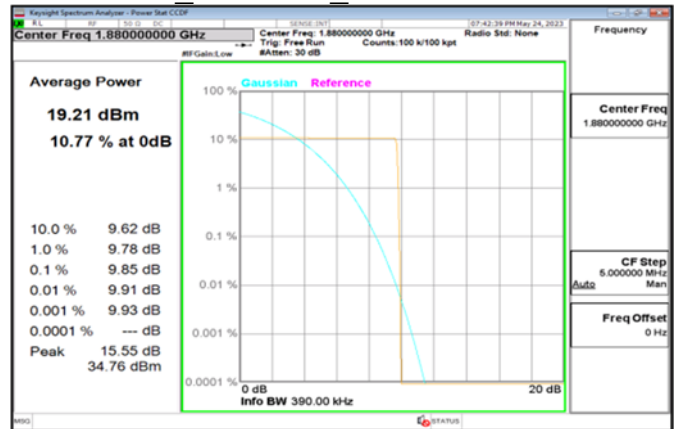

EDGE 850MHz HighCH251-848.8

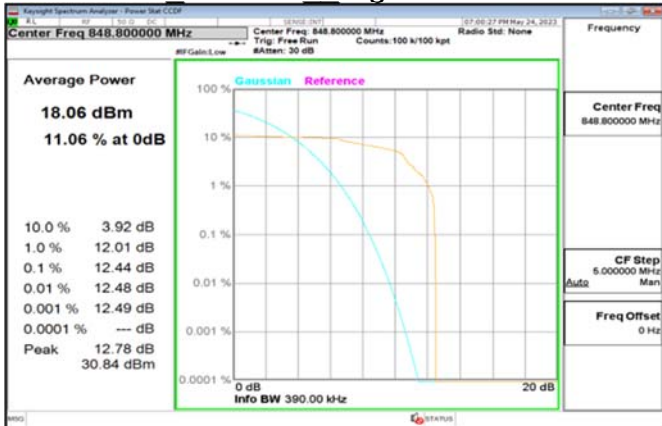

GSM 1900MHz HighCH810-1909.8

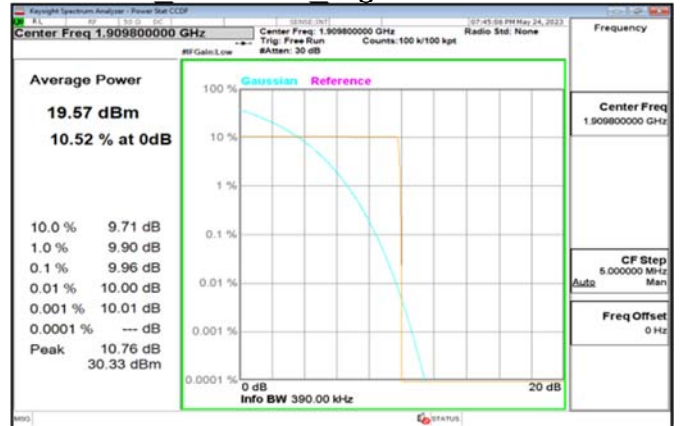

Unless otherwise stated the results shown in this test report refer only to the sample(s) tested and such sample(s) are retained for 90 days only.

除非另有說明，此報告結果僅對測試之樣品負責，同時此樣品僅保留90天。本報告未經本公司書面許可，不可部份複製。

This document is issued by the Company subject to its General Conditions of Service printed overleaf, available on request or accessible at <http://www.sgs.com.tw/Terms-and-Conditions> and for electronic format documents, subject to Terms and Conditions for Electronic Documents at <http://www.sgs.com.tw/Terms-and-Conditions>. Attention is drawn to the limitation of liability, indemnification and jurisdiction issues defined therein. Any holder of this document is advised that information contained hereon reflects the Company's findings at the time of its intervention only and within the limits of Client's instructions, if any. The Company's sole responsibility is to its Client and this document does not exonerate parties to a transaction from exercising all their rights and obligations under the transaction documents. This document cannot be reproduced except in full, without prior written approval of the Company. Any unauthorized alteration, forgery or falsification of the content or appearance of this document is unlawful and offenders may be prosecuted to the fullest extent of the law.

GPRS 1900MHz LowCH512-1850.2

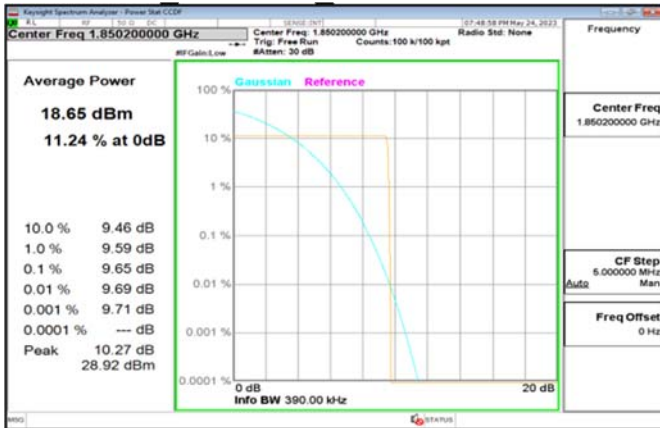

EDGE 1900MHz LowCH512-1850.2

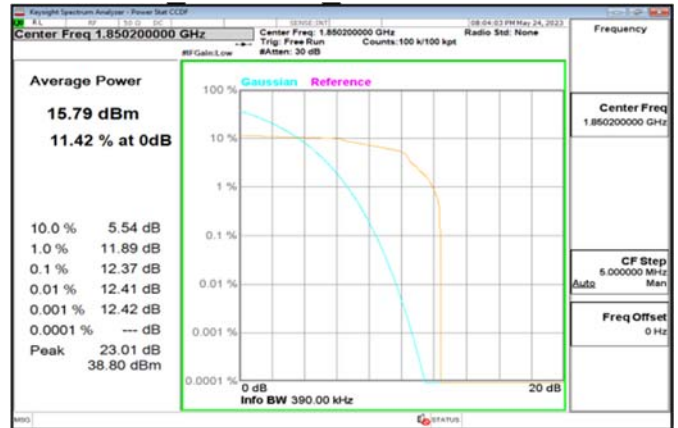

GPRS 1900MHz MidCH661-1880

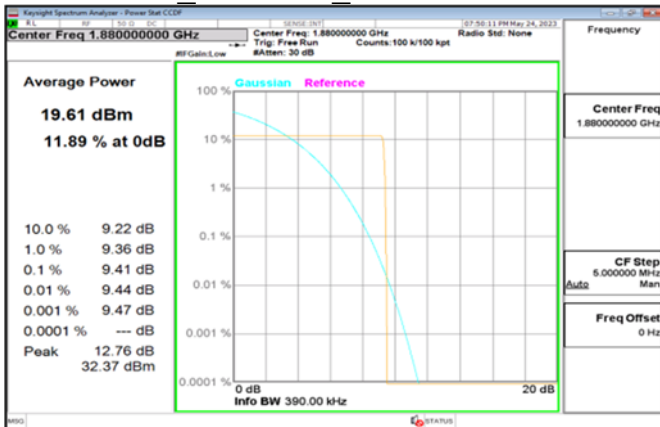

EDGE 1900MHz MidCH661-1880

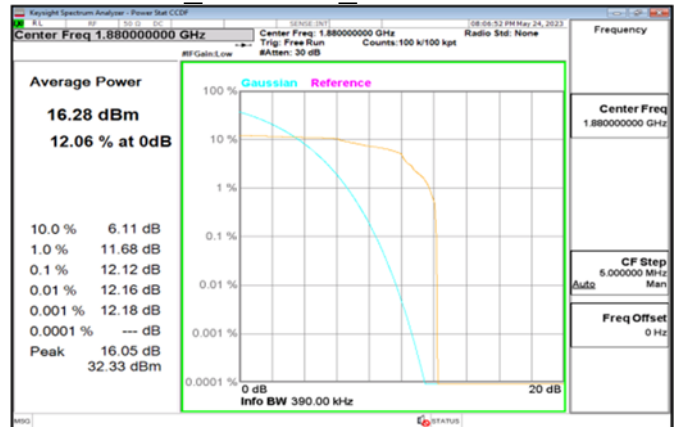

GPRS 1900MHz HighCH810-1909.8

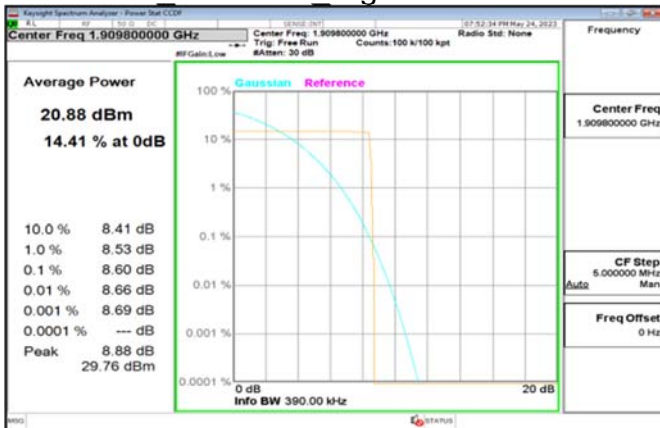

EDGE 1900MHz HighCH810-1909.8

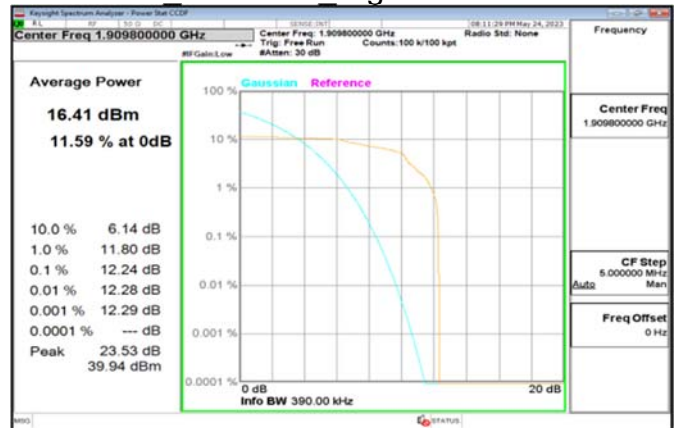

Unless otherwise stated the results shown in this test report refer only to the sample(s) tested and such sample(s) are retained for 90 days only.

除非另有說明，此報告結果僅對測試之樣品負責，同時此樣品僅保留90天。本報告未經本公司書面許可，不可部份複製。

This document is issued by the Company subject to its General Conditions of Service printed overleaf, available on request or accessible at <http://www.sgs.com.tw/Terms-and-Conditions> and for electronic format documents, subject to Terms and Conditions for Electronic Documents at <http://www.sgs.com.tw/Terms-and-Conditions>. Attention is drawn to the limitation of liability, indemnification and jurisdiction issues defined therein. Any holder of this document is advised that information contained hereon reflects the Company's findings at the time of its intervention only and within the limits of Client's instructions, if any. The Company's sole responsibility is to its Client and this document does not exonerate parties to a transaction from exercising all their rights and obligations under the transaction documents. This document cannot be reproduced except in full, without prior written approval of the Company. Any unauthorized alteration, forgery or falsification of the content or appearance of this document is unlawful and offenders may be prosecuted to the fullest extent of the law.

WCDMA B2 LowCH9262-1852.4

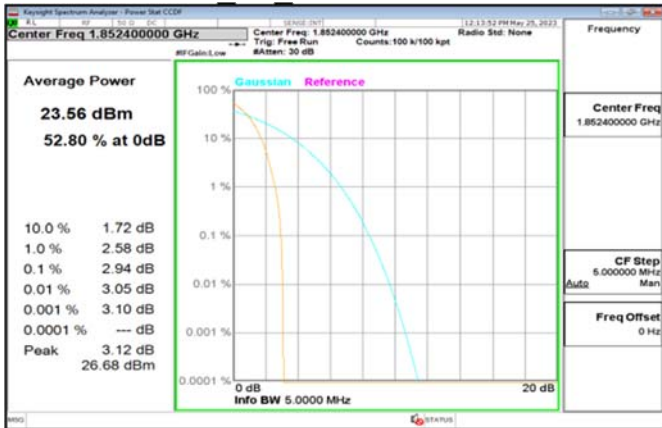

HSDPA B2 LowCH9262-1852.4

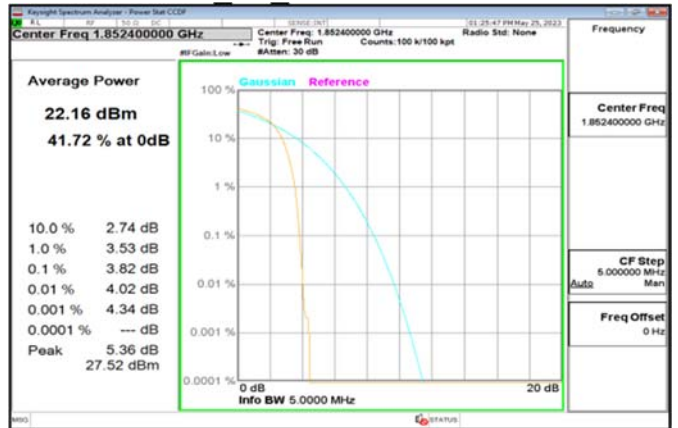

WCDMA B2 MidCH9400-1880

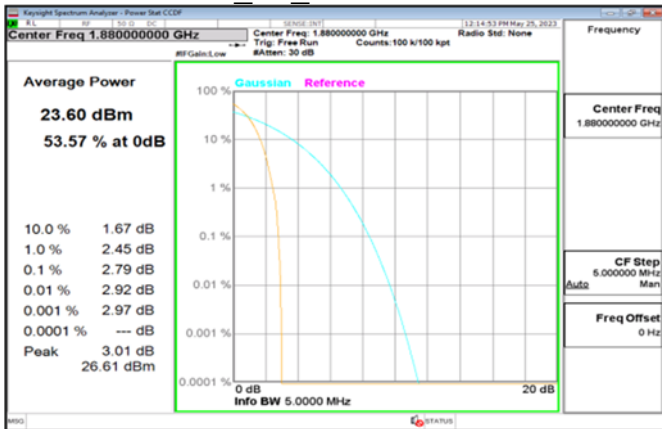

HSDPA B2 MidCH9400-1880

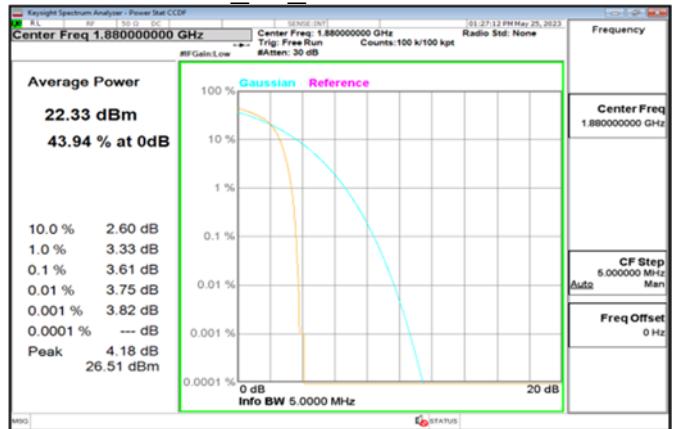

WCDMA B2 HighCH9538-1907.6

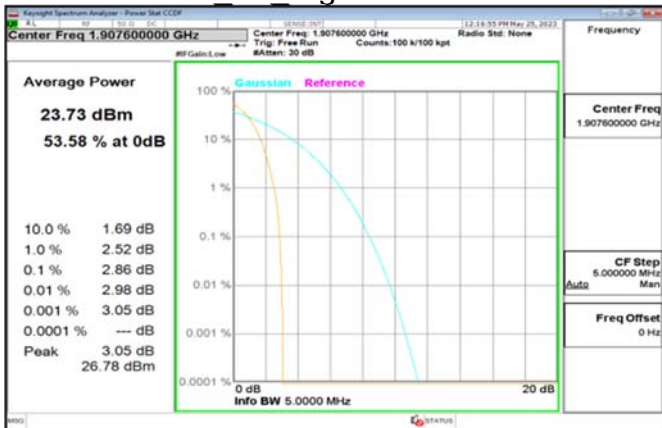

HSDPA B2 HighCH9538-1907.6

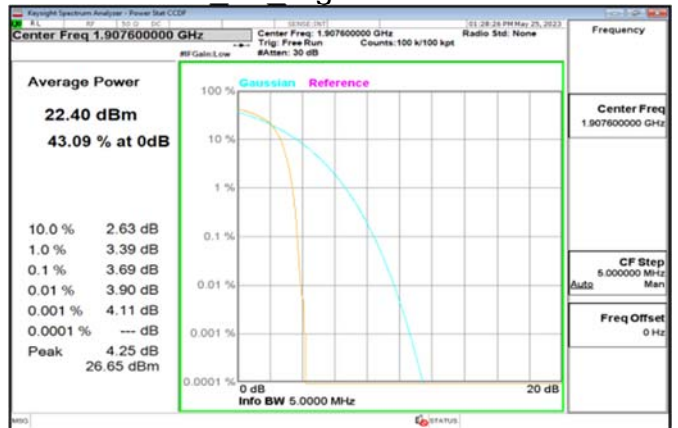

Unless otherwise stated the results shown in this test report refer only to the sample(s) tested and such sample(s) are retained for 90 days only.

除非另有說明，此報告結果僅對測試之樣品負責，同時此樣品僅保留90天。本報告未經本公司書面許可，不可部份複製。

This document is issued by the Company subject to its General Conditions of Service printed overleaf, available on request or accessible at <http://www.sgs.com.tw/Terms-and-Conditions> and for electronic format documents, subject to Terms and Conditions for Electronic Documents at <http://www.sgs.com.tw/Terms-and-Conditions>. Attention is drawn to the limitation of liability, indemnification and jurisdiction issues defined therein. Any holder of this document is advised that information contained hereon reflects the Company's findings at the time of its intervention only and within the limits of Client's instructions, if any. The Company's sole responsibility is to its Client and this document does not exonerate parties to a transaction from exercising all their rights and obligations under the transaction documents. This document cannot be reproduced except in full, without prior written approval of the Company. Any unauthorized alteration, forgery or falsification of the content or appearance of this document is unlawful and offenders may be prosecuted to the fullest extent of the law.

HSUPA B2 LowCH9262-1852.4

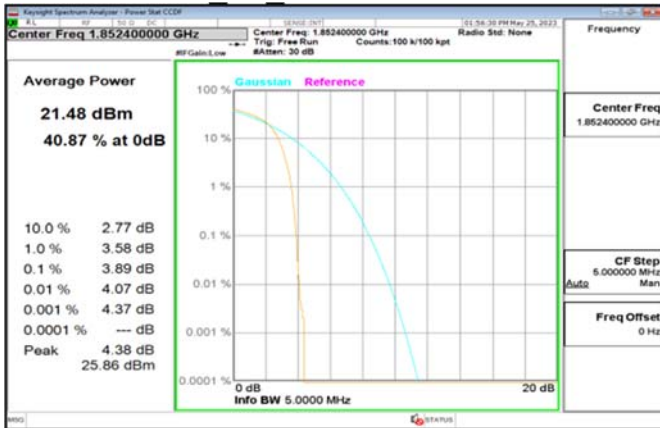

WCDMA B4 LowCH1312-1712.4

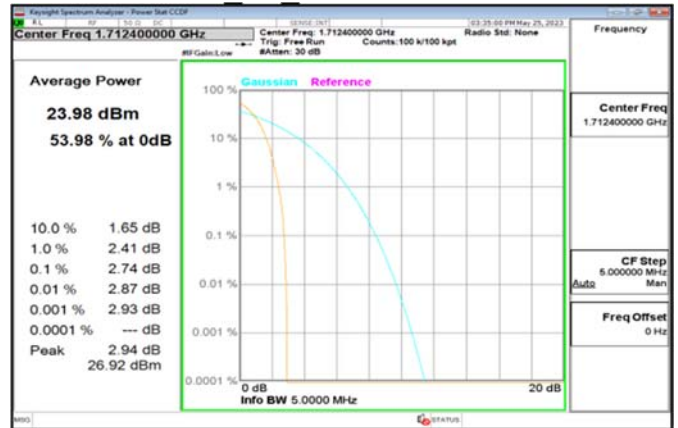

HSUPA B2 MidCH9400-1880

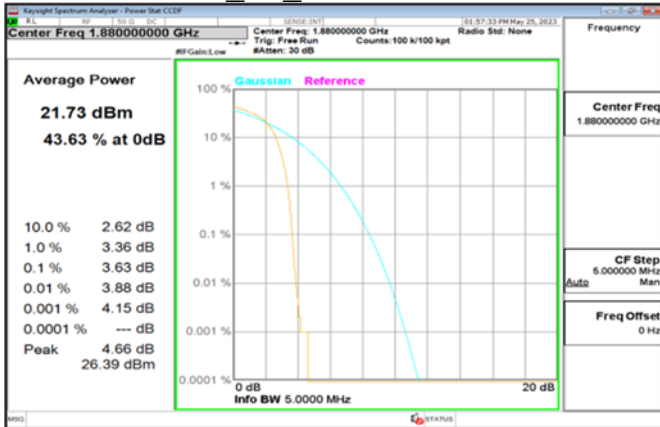

WCDMA B4 MidCH1413-1732.6

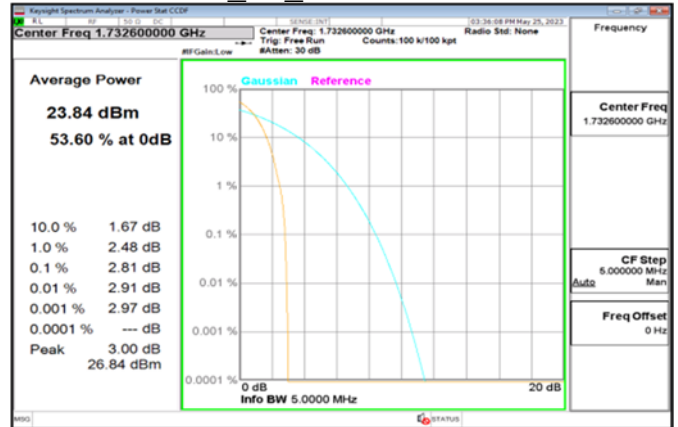

HSUPA B2 HighCH9538-1907.6

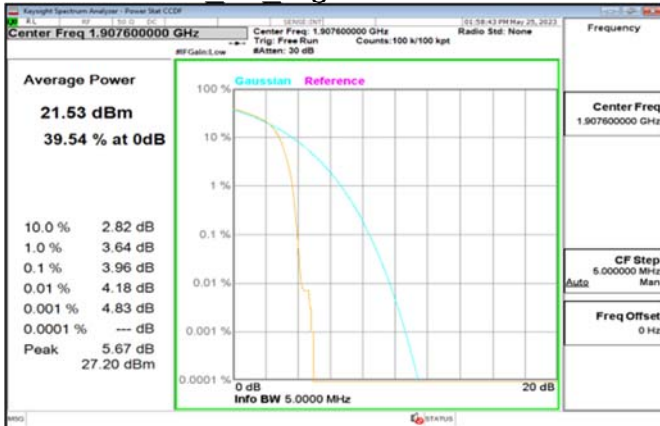

WCDMA B4 HighCH1513-1752.6

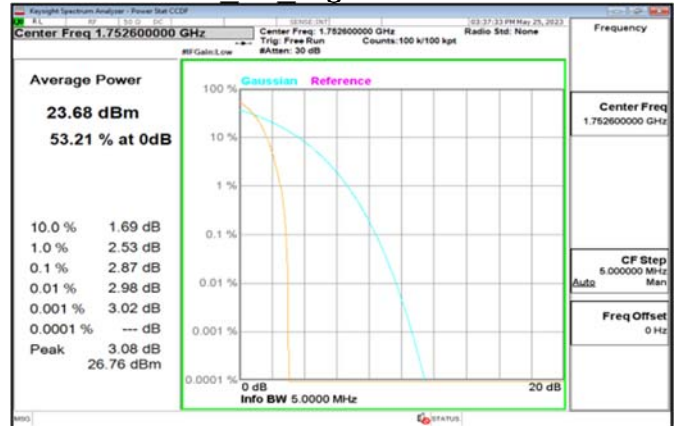

Unless otherwise stated the results shown in this test report refer only to the sample(s) tested and such sample(s) are retained for 90 days only.

除非另有說明，此報告結果僅對測試之樣品負責，同時此樣品僅保留90天。本報告未經本公司書面許可，不可部份複製。

This document is issued by the Company subject to its General Conditions of Service printed overleaf, available on request or accessible at <http://www.sgs.com.tw/Terms-and-Conditions> and for electronic format documents, subject to Terms and Conditions for Electronic Documents at <http://www.sgs.com.tw/Terms-and-Conditions>. Attention is drawn to the limitation of liability, indemnification and jurisdiction issues defined therein. Any holder of this document is advised that information contained hereon reflects the Company's findings at the time of its intervention only and within the limits of Client's instructions, if any. The Company's sole responsibility is to its Client and this document does not exonerate parties to a transaction from exercising all their rights and obligations under the transaction documents. This document cannot be reproduced except in full, without prior written approval of the Company. Any unauthorized alteration, forgery or falsification of the content or appearance of this document is unlawful and offenders may be prosecuted to the fullest extent of the law.

HSDPA B4 LowCH1312-1712.4

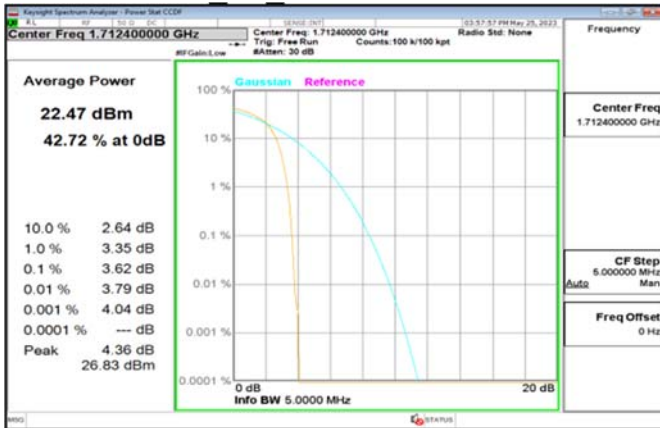

HSUPA B4 LowCH1312-1712.4

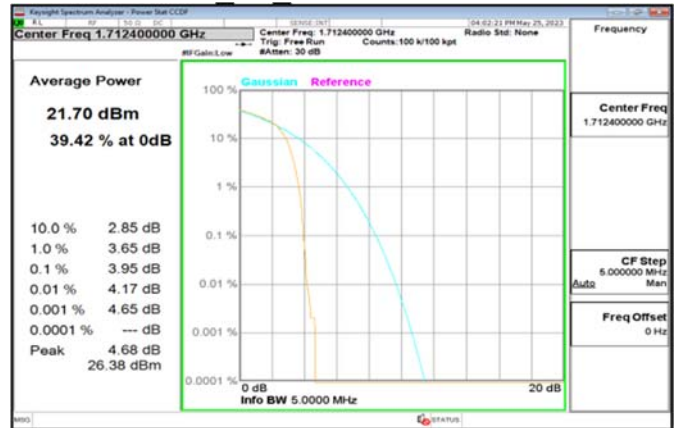

HSDPA B4 MidCH1413-1732.6

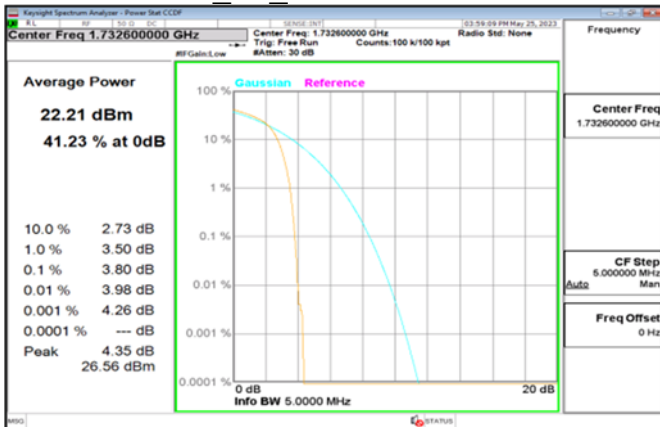

HSUPA B4 MidCH1413-1732.6

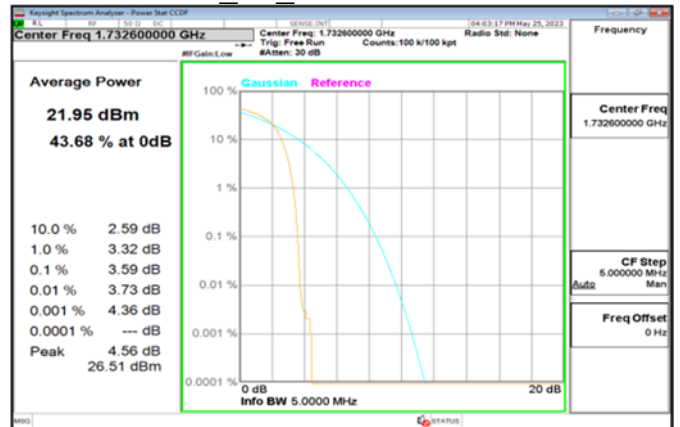

HSDPA B4 HighCH1513-1752.6

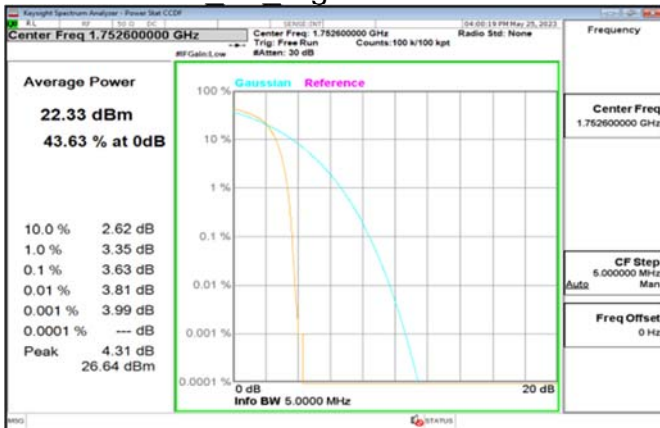

HSUPA B4 HighCH1513-1752.6

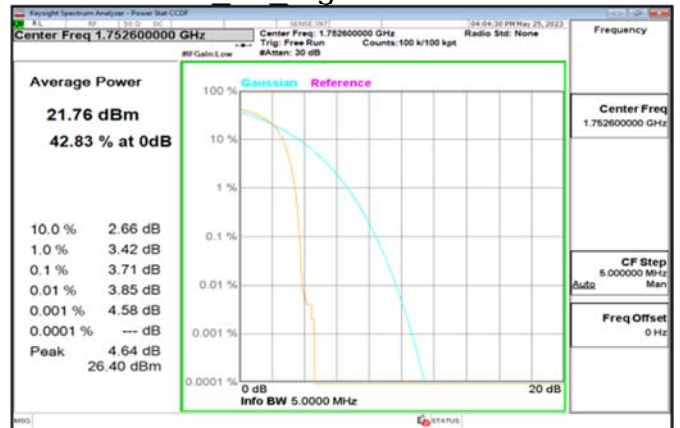

Unless otherwise stated the results shown in this test report refer only to the sample(s) tested and such sample(s) are retained for 90 days only.

除非另有說明，此報告結果僅對測試之樣品負責，同時此樣品僅保留90天。本報告未經本公司書面許可，不可部份複製。

This document is issued by the Company subject to its General Conditions of Service printed overleaf, available on request or accessible at <http://www.sgs.com.tw/Terms-and-Conditions> and for electronic format documents, subject to Terms and Conditions for Electronic Documents at <http://www.sgs.com.tw/Terms-and-Conditions>. Attention is drawn to the limitation of liability, indemnification and jurisdiction issues defined therein. Any holder of this document is advised that information contained hereon reflects the Company's findings at the time of its intervention only and within the limits of Client's instructions, if any. The Company's sole responsibility is to its Client and this document does not exonerate parties to a transaction from exercising all their rights and obligations under the transaction documents. This document cannot be reproduced except in full, without prior written approval of the Company. Any unauthorized alteration, forgery or falsification of the content or appearance of this document is unlawful and offenders may be prosecuted to the fullest extent of the law.

WCDMA B5 LowCH4132-826.4

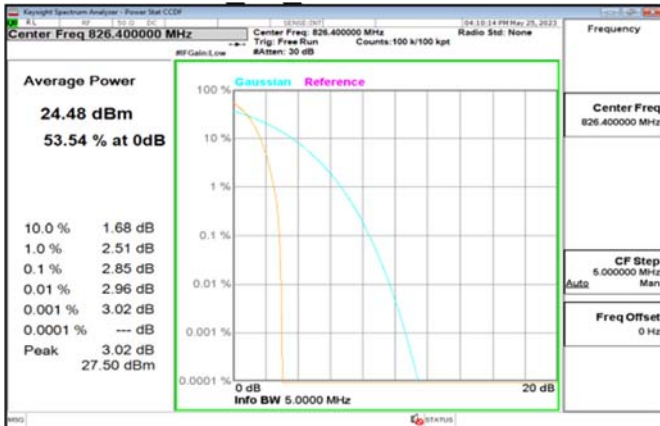

HSDPA B5 LowCH4132-826.4

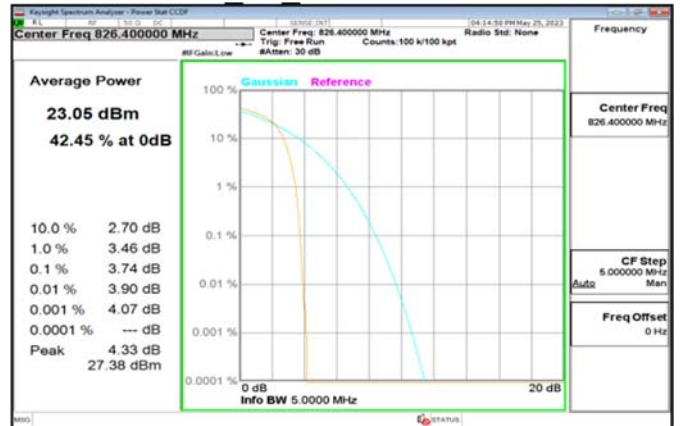

WCDMA B5 MidCH4183-836.6

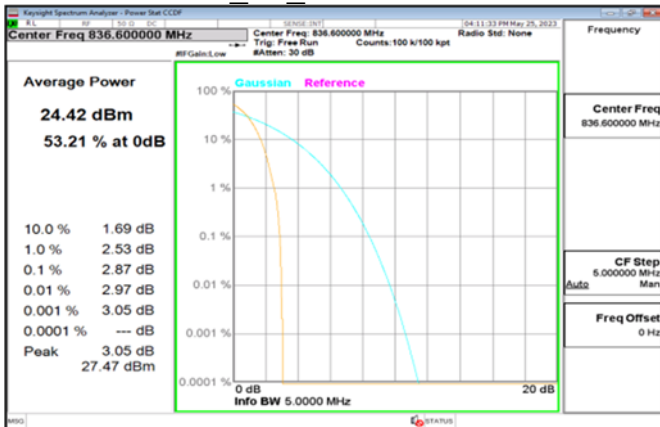

HSDPA B5 MidCH4183-836.6

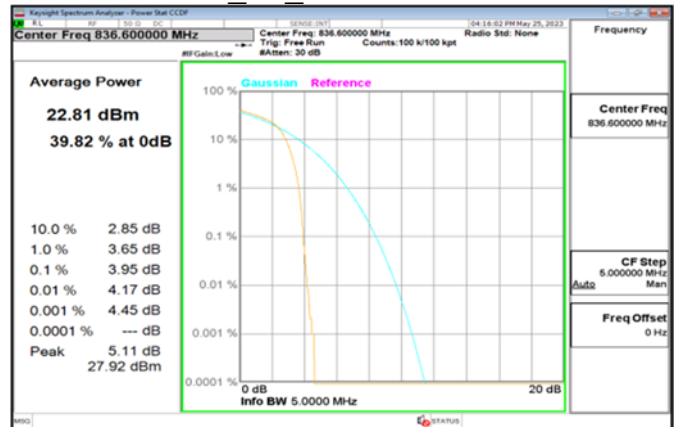

WCDMA B5 HighCH4233-846.6

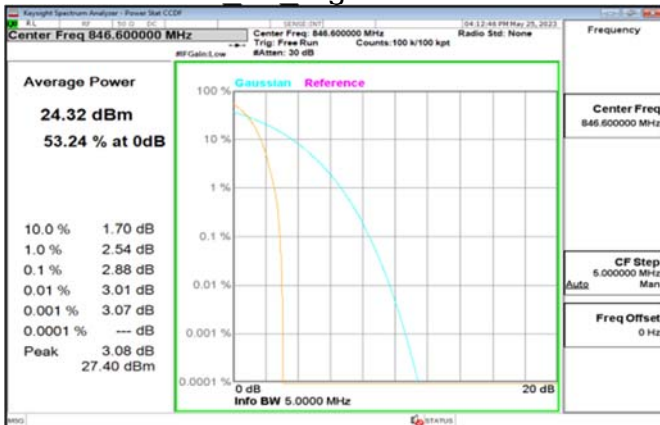

HSDPA B5 HighCH4233-846.6



Unless otherwise stated the results shown in this test report refer only to the sample(s) tested and such sample(s) are retained for 90 days only.

除非另有說明，此報告結果僅對測試之樣品負責，同時此樣品僅保留90天。本報告未經本公司書面許可，不可部份複製。

This document is issued by the Company subject to its General Conditions of Service printed overleaf, available on request or accessible at <http://www.sgs.com.tw/Terms-and-Conditions> and for electronic format documents, subject to Terms and Conditions for Electronic Documents at <http://www.sgs.com.tw/Terms-and-Conditions>. Attention is drawn to the limitation of liability, indemnification and jurisdiction issues defined therein. Any holder of this document is advised that information contained hereon reflects the Company's findings at the time of its intervention only and within the limits of Client's instructions, if any. The Company's sole responsibility is to its Client and this document does not exonerate parties to a transaction from exercising all their rights and obligations under the transaction documents. This document cannot be reproduced except in full, without prior written approval of the Company. Any unauthorized alteration, forgery or falsification of the content or appearance of this document is unlawful and offenders may be prosecuted to the fullest extent of the law.

HSUPA B5 LowCH4132-826.4

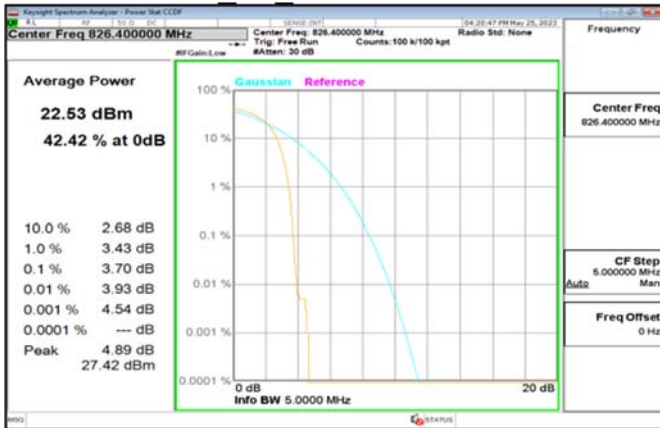

HSUPA B5 HighCH4233-846.6

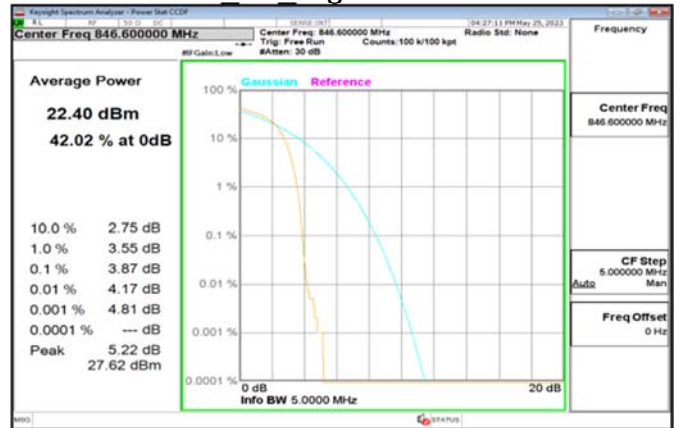

HSUPA B5 MidCH4183-836.6

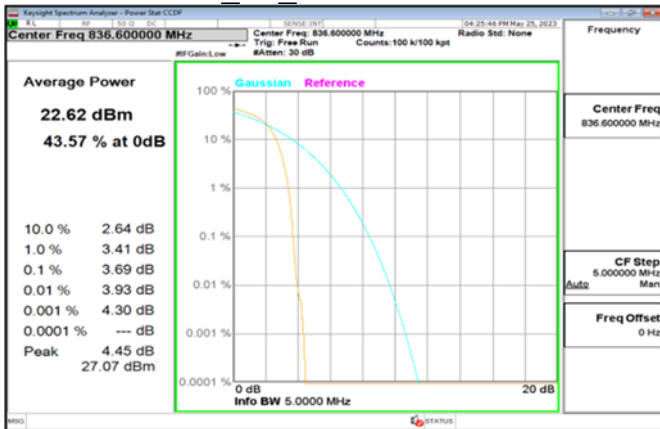

~ End of Report ~

Unless otherwise stated the results shown in this test report refer only to the sample(s) tested and such sample(s) are retained for 90 days only.

除非另有說明，此報告結果僅對測試之樣品負責，同時此樣品僅保留90天。本報告未經本公司書面許可，不可部份複製。

This document is issued by the Company subject to its General Conditions of Service printed overleaf, available on request or accessible at <http://www.sgs.com.tw/Terms-and-Conditions> and for electronic format documents, subject to Terms and Conditions for Electronic Documents at <http://www.sgs.com.tw/Terms-and-Conditions>. Attention is drawn to the limitation of liability, indemnification and jurisdiction issues defined therein. Any holder of this document is advised that information contained hereon reflects the Company's findings at the time of its intervention only and within the limits of Client's instructions, if any. The Company's sole responsibility is to its Client and this document does not exonerate parties to a transaction from exercising all their rights and obligations under the transaction documents. This document cannot be reproduced except in full, without prior written approval of the Company. Any unauthorized alteration, forgery or falsification of the content or appearance of this document is unlawful and offenders may be prosecuted to the fullest extent of the law.