

Band77-Part27_70MHz_DFT_s_OFDM_SCS30kHz_BPSK_RB180_0_CH632334

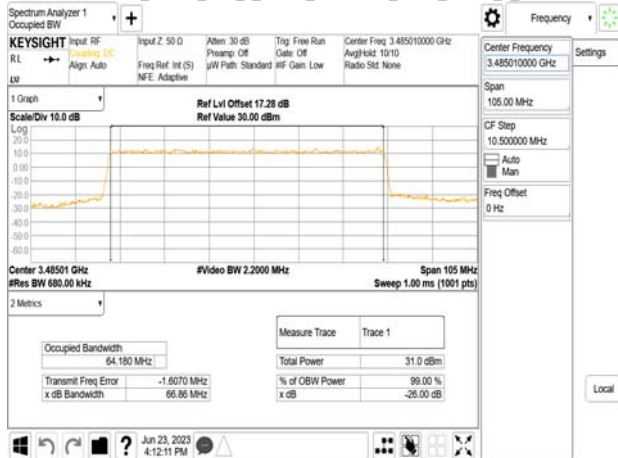

Band77-Part27_70MHz_DFT_s_OFDM_SCS30kHz_BPSK_RB180_0_CH649000

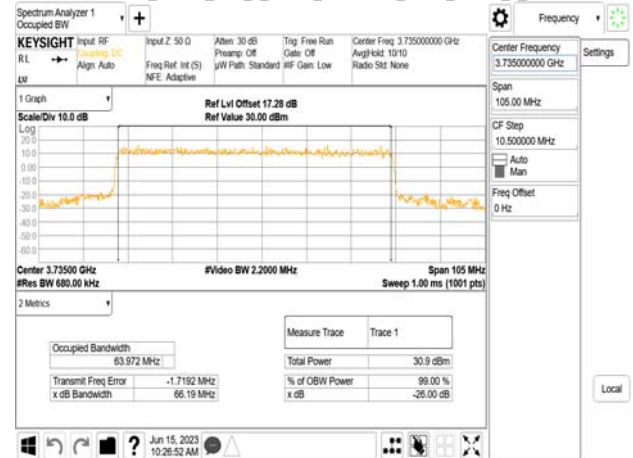

Band77-Part27_70MHz_DFT_s_OFDM_SCS30kHz_BPSK_RB180_0_CH633334

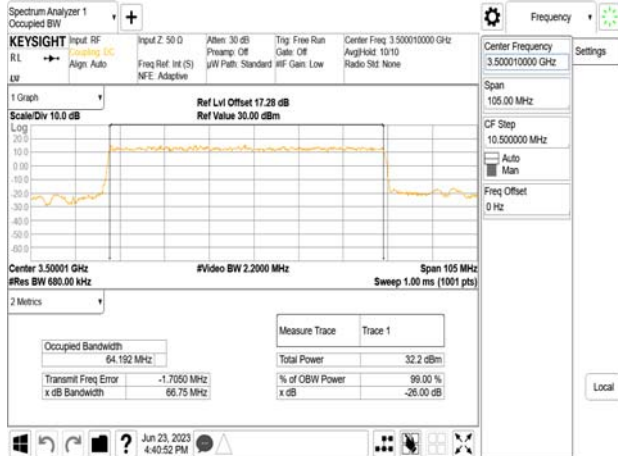

Band77-Part27_70MHz_DFT_s_OFDM_SCS30kHz_BPSK_RB180_0_CH656000

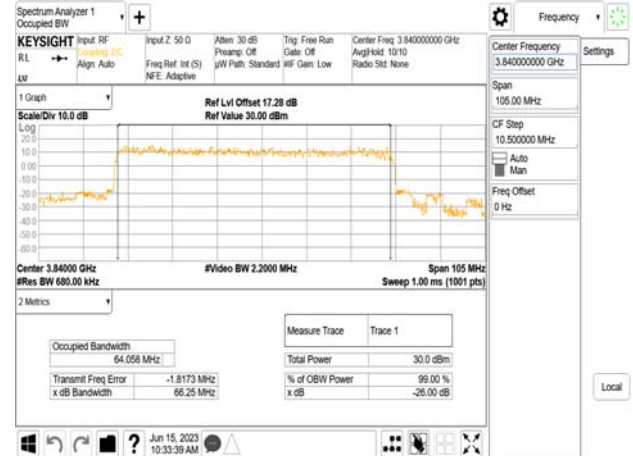

Band77-Part27_70MHz_DFT_s_OFDM_SCS30kHz_BPSK_RB180_0_CH634332



Band77-Part27_70MHz_DFT_s_OFDM_SCS30kHz_BPSK_RB180_0_CH663000

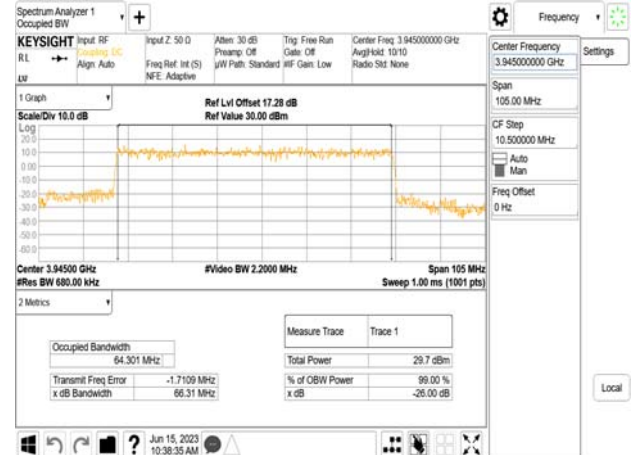

Unless otherwise stated the results shown in this test report refer only to the sample(s) tested and such sample(s) are retained for 90 days only.

除非另有說明，此報告結果僅對測試之樣品負責，同時此樣品僅保留90天。本報告未經本公司書面許可，不可部份複製。

This document is issued by the Company subject to its General Conditions of Service printed overleaf, available on request or accessible at <http://www.sgs.com.tw/Terms-and-Conditions> and for electronic format documents, subject to Terms and Conditions for Electronic Documents at <http://www.sgs.com.tw/Terms-and-Conditions>. Attention is drawn to the limitation of liability, indemnification and jurisdiction issues defined therein. Any holder of this document is advised that information contained hereon reflects the Company's findings at the time of its intervention only and within the limits of Client's instructions, if any. The Company's sole responsibility is to its Client and this document does not exonerate parties to a transaction from exercising all their rights and obligations under the transaction documents. This document cannot be reproduced except in full, without prior written approval of the Company. Any unauthorized alteration, forgery or falsification of the content or appearance of this document is unlawful and offenders may be prosecuted to the fullest extent of the law.

Band77-Part27_70MHz_DFT_s_OFDM_SCS30kHz_QPSK_RB180_0_CH632334

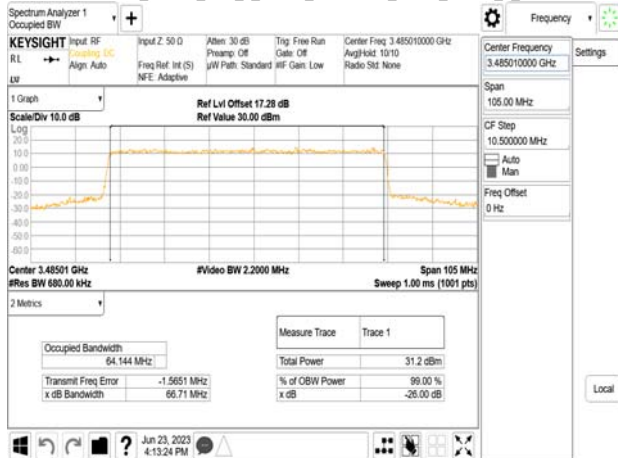

Band77-Part27_70MHz_DFT_s_OFDM_SCS30kHz_QPSK_RB180_0_CH649000

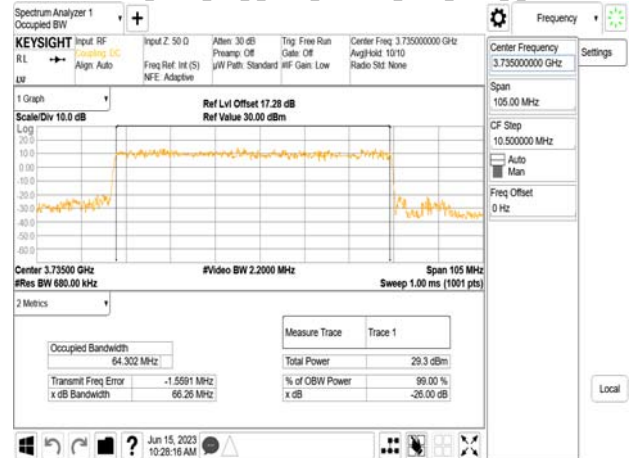

Band77-Part27_70MHz_DFT_s_OFDM_SCS30kHz_QPSK_RB180_0_CH633334

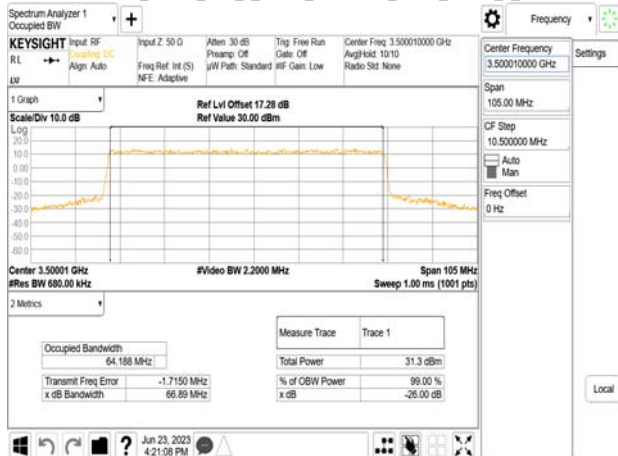

Band77-Part27_70MHz_DFT_s_OFDM_SCS30kHz_QPSK_RB180_0_CH656000

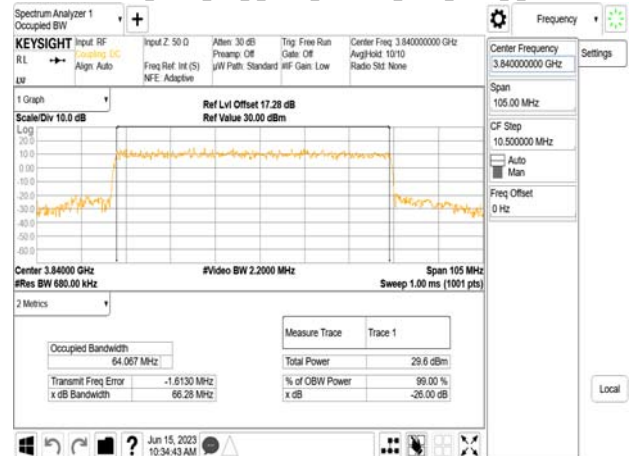

Band77-Part27_70MHz_DFT_s_OFDM_SCS30kHz_QPSK_RB180_0_CH634332

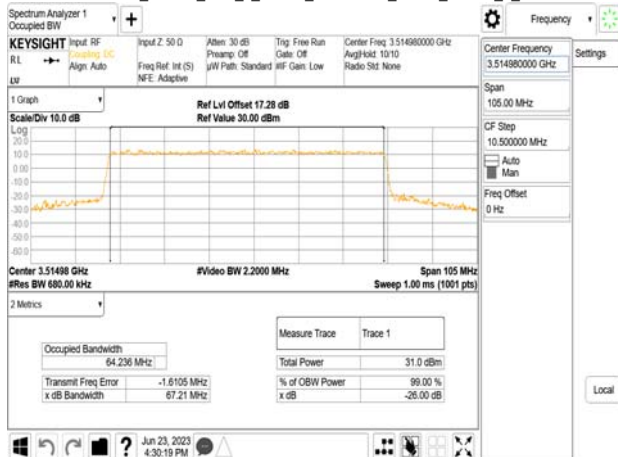

Band77-Part27_70MHz_DFT_s_OFDM_SCS30kHz_QPSK_RB180_0_CH663000

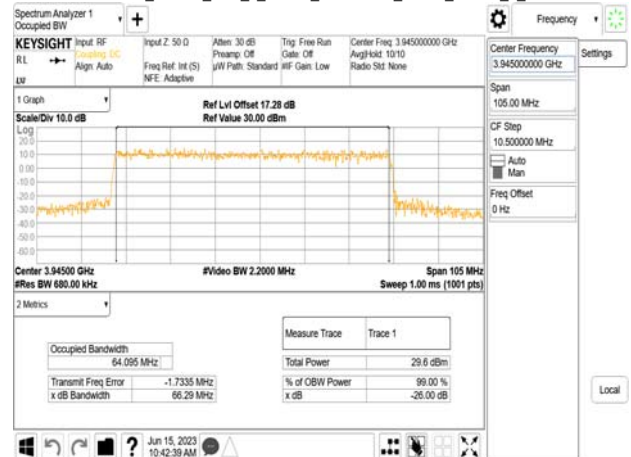

Unless otherwise stated the results shown in this test report refer only to the sample(s) tested and such sample(s) are retained for 90 days only.

除非另有說明，此報告結果僅對測試之樣品負責，同時此樣品僅保留90天。本報告未經本公司書面許可，不可部份複製。

This document is issued by the Company subject to its General Conditions of Service printed overleaf, available on request or accessible at <http://www.sgs.com.tw/Terms-and-Conditions> and for electronic format documents, subject to Terms and Conditions for Electronic Documents at <http://www.sgs.com.tw/Terms-and-Conditions>. Attention is drawn to the limitation of liability, indemnification and jurisdiction issues defined therein. Any holder of this document is advised that information contained hereon reflects the Company's findings at the time of its intervention only and within the limits of Client's instructions, if any. The Company's sole responsibility is to its Client and this document does not exonerate parties to a transaction from exercising all their rights and obligations under the transaction documents. This document cannot be reproduced except in full, without prior written approval of the Company. Any unauthorized alteration, forgery or falsification of the content or appearance of this document is unlawful and offenders may be prosecuted to the fullest extent of the law.

Band77-Part27_70MHz_DFT_s_OFDM_SCS30kHz_16QAM_RB180_0_CH633334

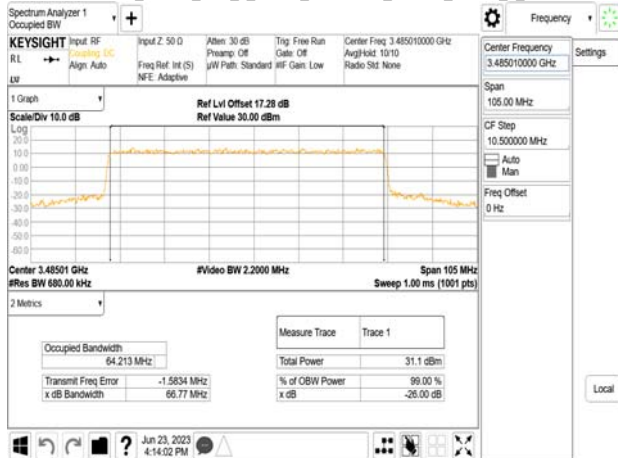

Band77-Part27_70MHz_DFT_s_OFDM_SCS30kHz_16QAM_RB180_0_CH649000

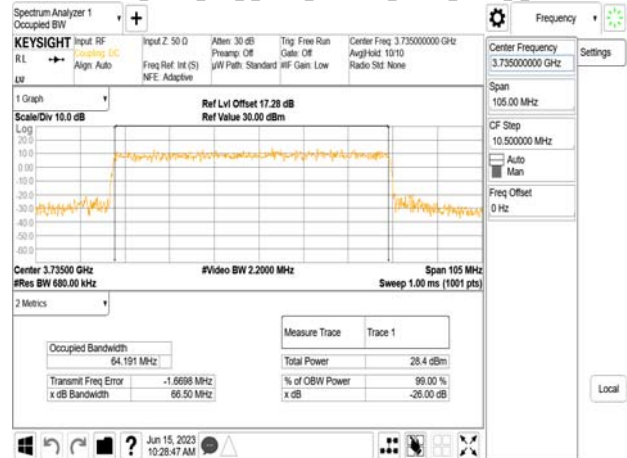

Band77-Part27_70MHz_DFT_s_OFDM_SCS30kHz_16QAM_RB180_0_CH633334

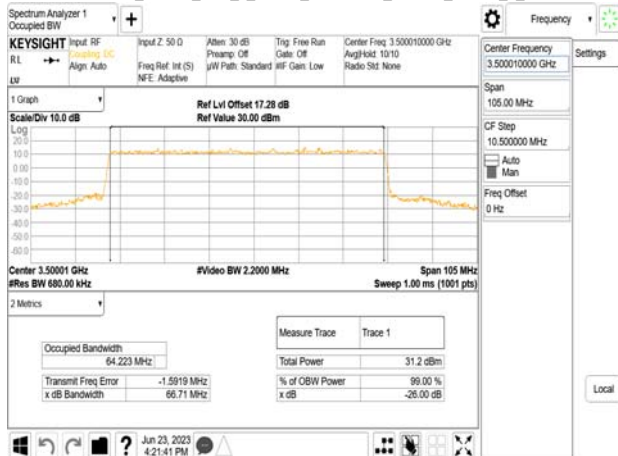

Band77-Part27_70MHz_DFT_s_OFDM_SCS30kHz_16QAM_RB180_0_CH656000



Band77-Part27_70MHz_DFT_s_OFDM_SCS30kHz_16QAM_RB180_0_CH634332

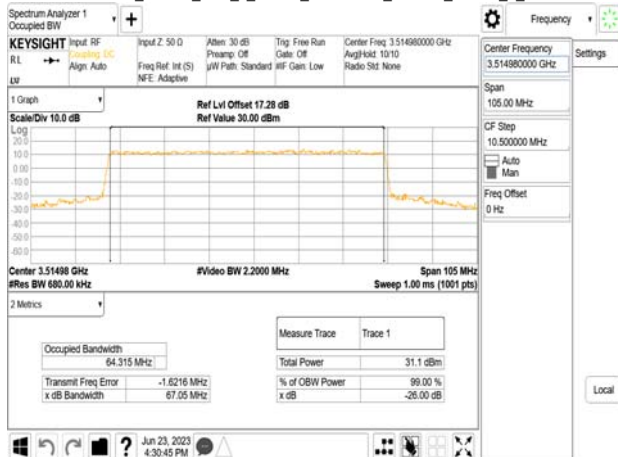

Band77-Part27_70MHz_DFT_s_OFDM_SCS30kHz_16QAM_RB180_0_CH663000

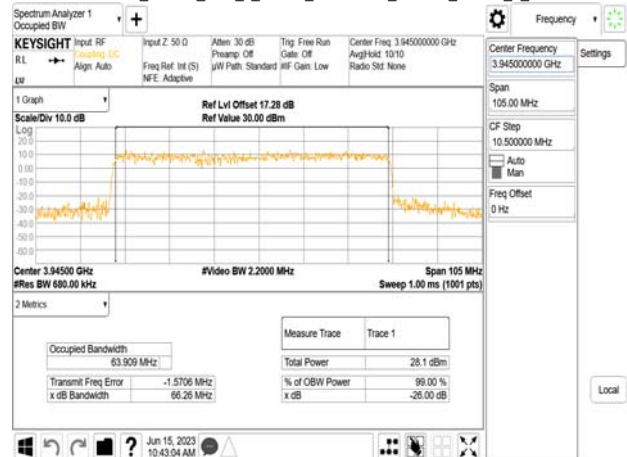

Unless otherwise stated the results shown in this test report refer only to the sample(s) tested and such sample(s) are retained for 90 days only.

除非另有說明，此報告結果僅對測試之樣品負責，同時此樣品僅保留90天。本報告未經本公司書面許可，不可部份複製。

This document is issued by the Company subject to its General Conditions of Service printed overleaf, available on request or accessible at <http://www.sgs.com.tw/Terms-and-Conditions> and for electronic format documents, subject to Terms and Conditions for Electronic Documents at <http://www.sgs.com.tw/Terms-and-Conditions>. Attention is drawn to the limitation of liability, indemnification and jurisdiction issues defined therein. Any holder of this document is advised that information contained hereon reflects the Company's findings at the time of its intervention only and within the limits of Client's instructions, if any. The Company's sole responsibility is to its Client and this document does not exonerate parties to a transaction from exercising all their rights and obligations under the transaction documents. This document cannot be reproduced except in full, without prior written approval of the Company. Any unauthorized alteration, forgery or falsification of the content or appearance of this document is unlawful and offenders may be prosecuted to the fullest extent of the law.

Band77-Part27_70MHz_DFT_s_OFDM_SCS30kHz_64QAM_RB180_0_CH633334

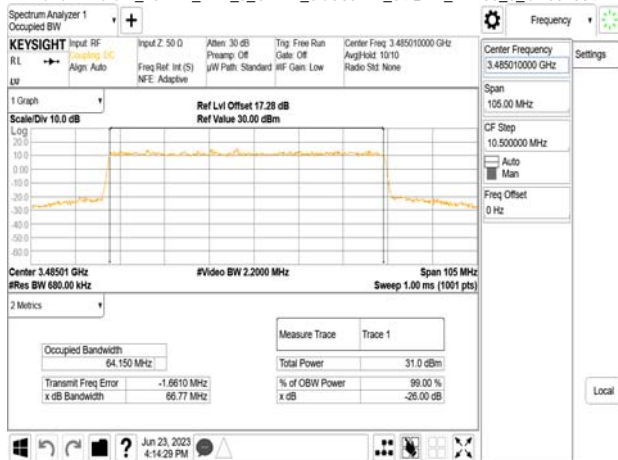

Band77-Part27_70MHz_DFT_s_OFDM_SCS30kHz_64QAM_RB180_0_CH649000

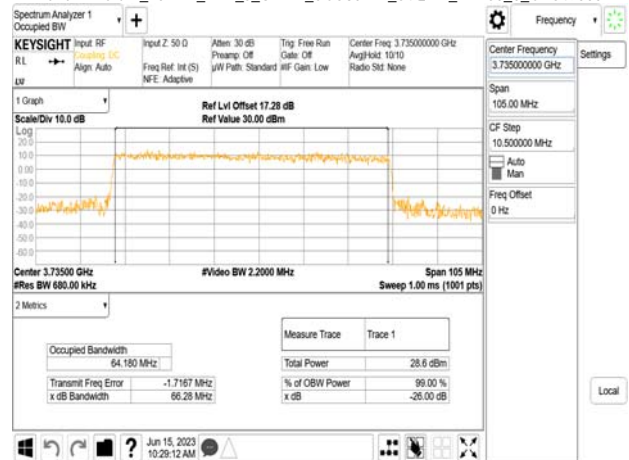

Band77-Part27_70MHz_DFT_s_OFDM_SCS30kHz_64QAM_RB180_0_CH633334

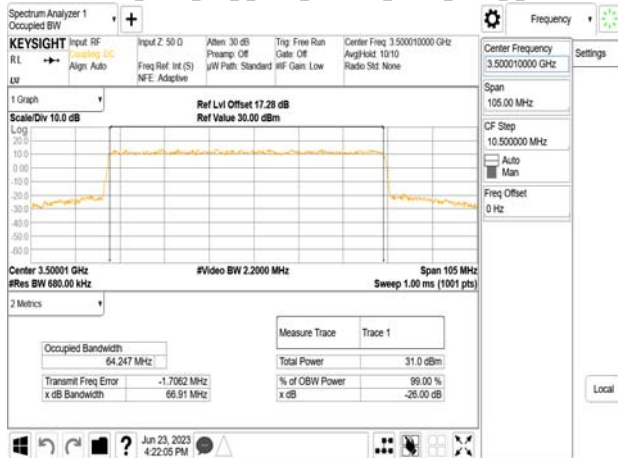

Band77-Part27_70MHz_DFT_s_OFDM_SCS30kHz_64QAM_RB180_0_CH656000



Band77-Part27_70MHz_DFT_s_OFDM_SCS30kHz_64QAM_RB180_0_CH634332

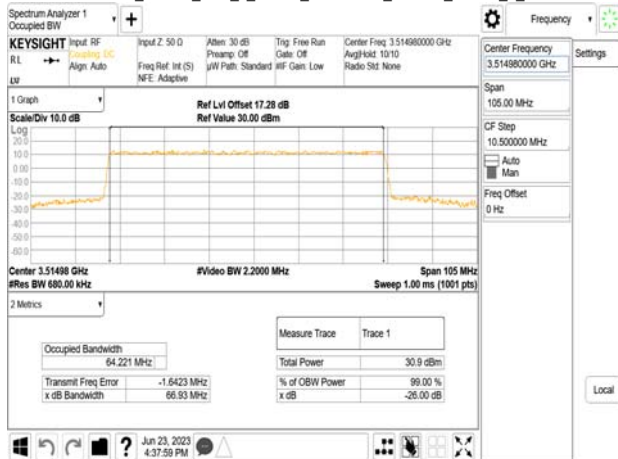

Band77-Part27_70MHz_DFT_s_OFDM_SCS30kHz_64QAM_RB180_0_CH663000



Unless otherwise stated the results shown in this test report refer only to the sample(s) tested and such sample(s) are retained for 90 days only.

除非另有說明，此報告結果僅對測試之樣品負責，同時此樣品僅保留90天。本報告未經本公司書面許可，不可部份複製。

This document is issued by the Company subject to its General Conditions of Service printed overleaf, available on request or accessible at <http://www.sgs.com.tw/Terms-and-Conditions> and for electronic format documents, subject to Terms and Conditions for Electronic Documents at <http://www.sgs.com.tw/Terms-and-Conditions>. Attention is drawn to the limitation of liability, indemnification and jurisdiction issues defined therein. Any holder of this document is advised that information contained hereon reflects the Company's findings at the time of its intervention only and within the limits of Client's instructions, if any. The Company's sole responsibility is to its Client and this document does not exonerate parties to a transaction from exercising all their rights and obligations under the transaction documents. This document cannot be reproduced except in full, without prior written approval of the Company. Any unauthorized alteration, forgery or falsification of the content or appearance of this document is unlawful and offenders may be prosecuted to the fullest extent of the law.

Band77-Part27_70MHz_DFT_s_OFDM_SCS30kHz_256QAM_RB180_0_CH632334

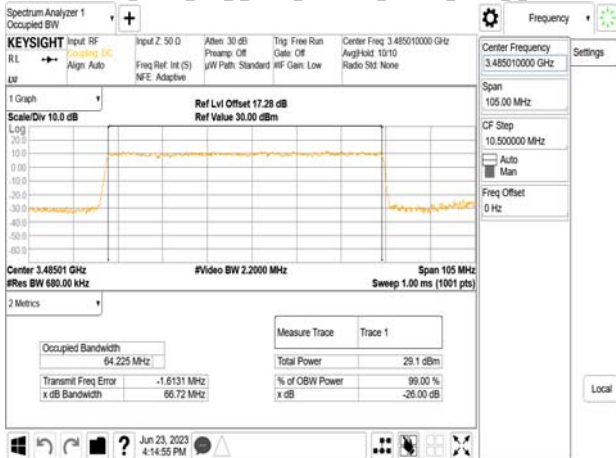

Band77-Part27_70MHz_DFT_s_OFDM_SCS30kHz_256QAM_RB180_0_CH649000



Band77-Part27_70MHz_DFT_s_OFDM_SCS30kHz_256QAM_RB180_0_CH633334

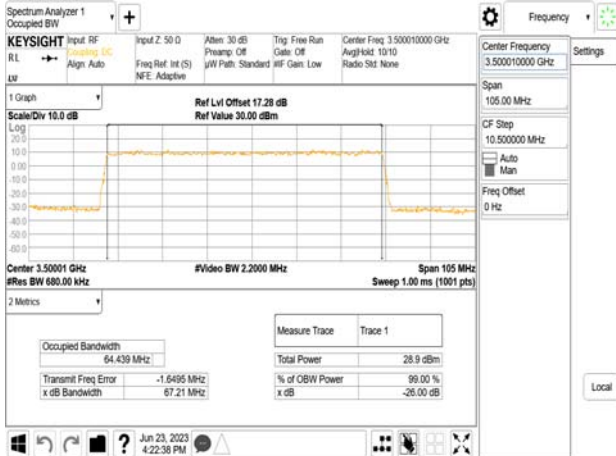

Band77-Part27_70MHz_DFT_s_OFDM_SCS30kHz_256QAM_RB180_0_CH656000



Band77-Part27_70MHz_DFT_s_OFDM_SCS30kHz_256QAM_RB180_0_CH634332

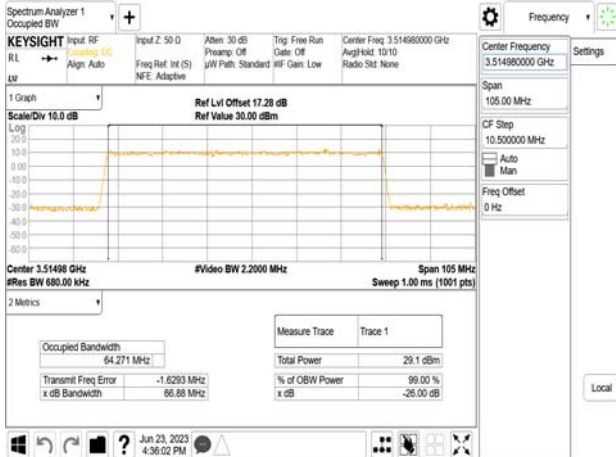

Band77-Part27_70MHz_DFT_s_OFDM_SCS30kHz_256QAM_RB180_0_CH636000



Unless otherwise stated the results shown in this test report refer only to the sample(s) tested and such sample(s) are retained for 90 days only.

除非另有說明，此報告結果僅對測試之樣品負責，同時此樣品僅保留90天。本報告未經本公司書面許可，不可部份複製。

This document is issued by the Company subject to its General Conditions of Service printed overleaf, available on request or accessible at <http://www.sgs.com.tw/Terms-and-Conditions> and for electronic format documents, subject to Terms and Conditions for Electronic Documents at <http://www.sgs.com.tw/Terms-and-Conditions>. Attention is drawn to the limitation of liability, indemnification and jurisdiction issues defined therein. Any holder of this document is advised that information contained hereon reflects the Company's findings at the time of its intervention only and within the limits of Client's instructions, if any. The Company's sole responsibility is to its Client and this document does not exonerate parties to a transaction from exercising all their rights and obligations under the transaction documents. This document cannot be reproduced except in full, without prior written approval of the Company. Any unauthorized alteration, forgery or falsification of the content or appearance of this document is unlawful and offenders may be prosecuted to the fullest extent of the law.

Band77-Part27_80MHz_DFT_s_OFDM_SCS30kHz_BPSK_RB216_0_CH632668

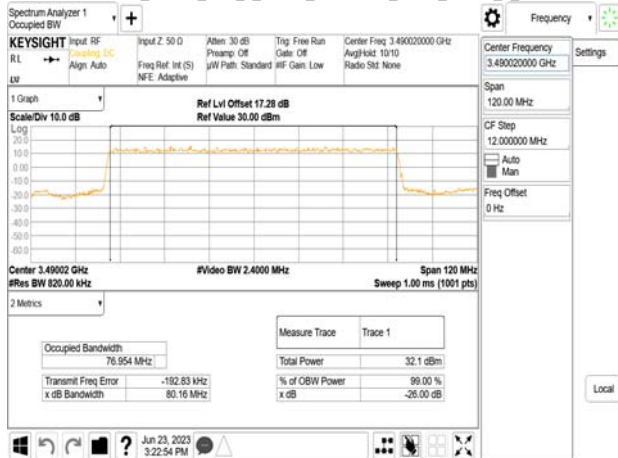

Band77-Part27_80MHz_DFT_s_OFDM_SCS30kHz_BPSK_RB216_0_CH649334

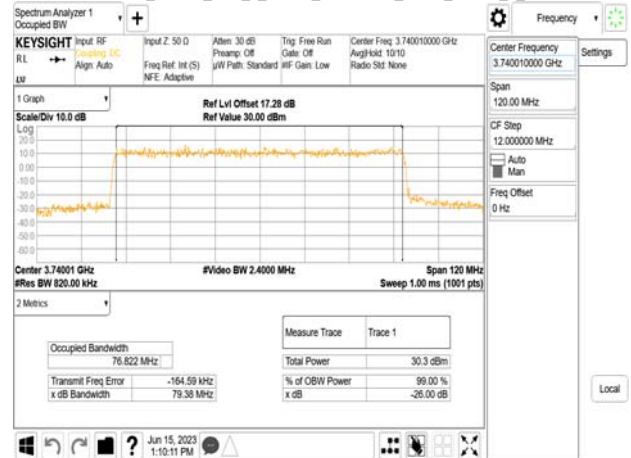

Band77-Part27_80MHz_DFT_s_OFDM_SCS30kHz_BPSK_RB216_0_CH633334

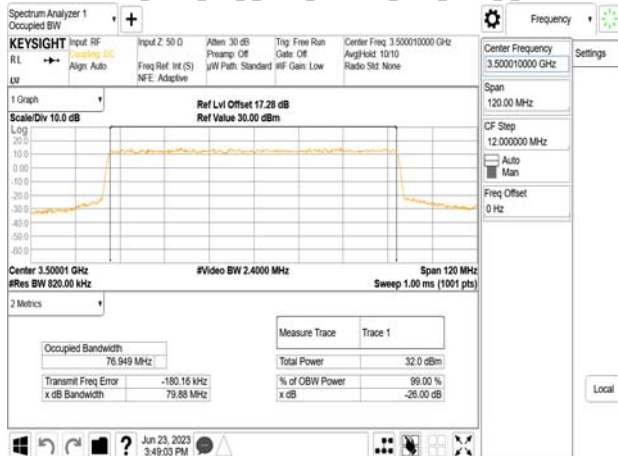

Band77-Part27_80MHz_DFT_s_OFDM_SCS30kHz_BPSK_RB216_0_CH656000

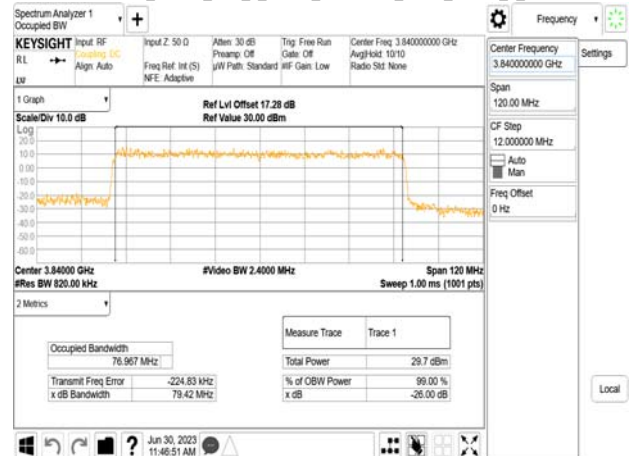

Band77-Part27_80MHz_DFT_s_OFDM_SCS30kHz_BPSK_RB216_0_CH634000

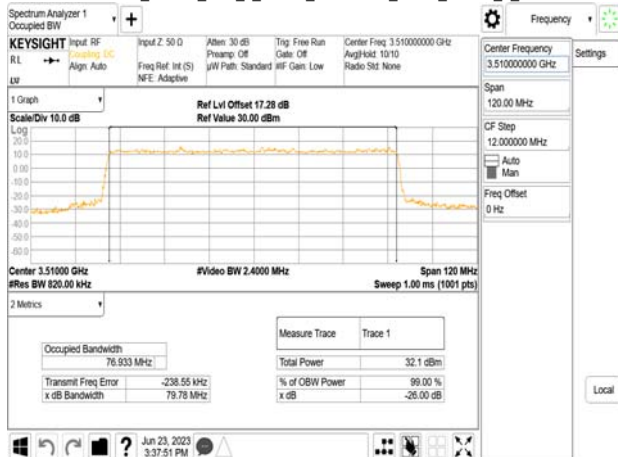

Band77-Part27_80MHz_DFT_s_OFDM_SCS30kHz_BPSK_RB216_0_CH662666

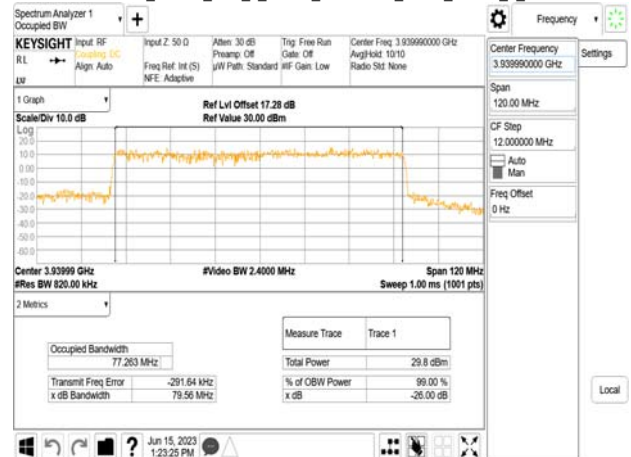

Unless otherwise stated the results shown in this test report refer only to the sample(s) tested and such sample(s) are retained for 90 days only.

除非另有說明，此報告結果僅對測試之樣品負責，同時此樣品僅保留90天。本報告未經本公司書面許可，不可部份複製。

This document is issued by the Company subject to its General Conditions of Service printed overleaf, available on request or accessible at <http://www.sgs.com.tw/Terms-and-Conditions> and for electronic format documents, subject to Terms and Conditions for Electronic Documents at <http://www.sgs.com.tw/Terms-and-Conditions>. Attention is drawn to the limitation of liability, indemnification and jurisdiction issues defined therein. Any holder of this document is advised that information contained hereon reflects the Company's findings at the time of its intervention only and within the limits of Client's instructions, if any. The Company's sole responsibility is to its Client and this document does not exonerate parties to a transaction from exercising all their rights and obligations under the transaction documents. This document cannot be reproduced except in full, without prior written approval of the Company. Any unauthorized alteration, forgery or falsification of the content or appearance of this document is unlawful and offenders may be prosecuted to the fullest extent of the law.

Band77-Part27_80MHz_DFT_s_OFDM_SCS30kHz_QPSK_RB216_0_CH632668

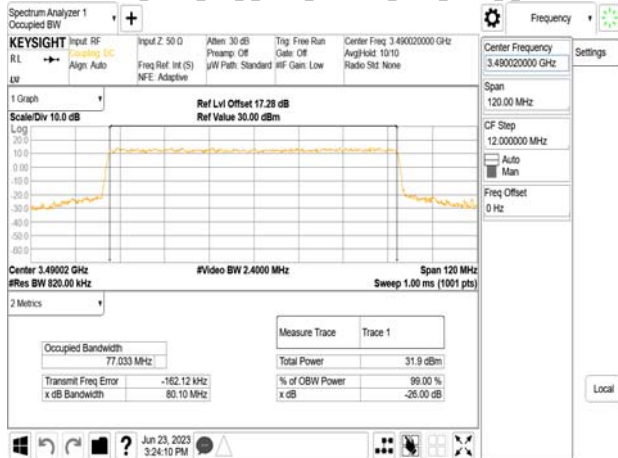

Band77-Part27_80MHz_DFT_s_OFDM_SCS30kHz_QPSK_RB216_0_CH649334

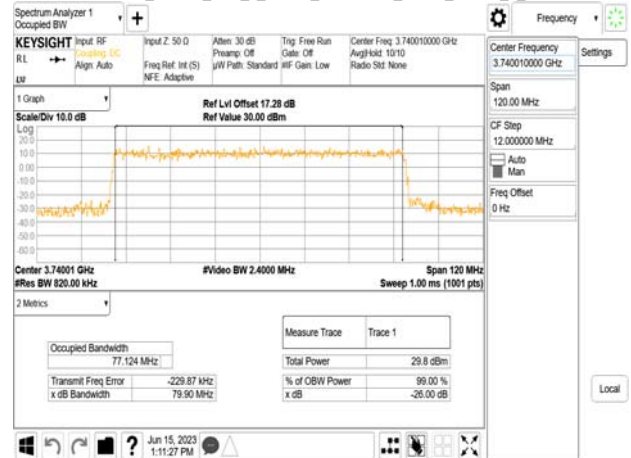

Band77-Part27_80MHz_DFT_s_OFDM_SCS30kHz_QPSK_RB216_0_CH633334



Band77-Part27_80MHz_DFT_s_OFDM_SCS30kHz_QPSK_RB216_0_CH656000



Band77-Part27_80MHz_DFT_s_OFDM_SCS30kHz_QPSK_RB216_0_CH634000

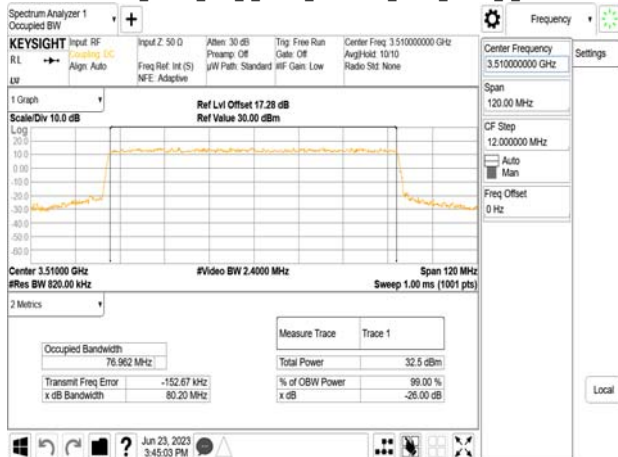

Band77-Part27_80MHz_DFT_s_OFDM_SCS30kHz_QPSK_RB216_0_CH662666

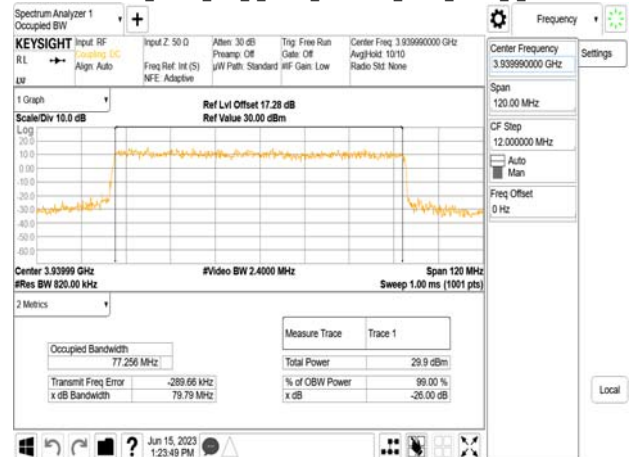

Unless otherwise stated the results shown in this test report refer only to the sample(s) tested and such sample(s) are retained for 90 days only.

除非另有說明，此報告結果僅對測試之樣品負責，同時此樣品僅保留90天。本報告未經本公司書面許可，不可部份複製。

This document is issued by the Company subject to its General Conditions of Service printed overleaf, available on request or accessible at <http://www.sgs.com.tw/Terms-and-Conditions> and for electronic format documents, subject to Terms and Conditions for Electronic Documents at <http://www.sgs.com.tw/Terms-and-Conditions>. Attention is drawn to the limitation of liability, indemnification and jurisdiction issues defined therein. Any holder of this document is advised that information contained hereon reflects the Company's findings at the time of its intervention only and within the limits of Client's instructions, if any. The Company's sole responsibility is to its Client and this document does not exonerate parties to a transaction from exercising all their rights and obligations under the transaction documents. This document cannot be reproduced except in full, without prior written approval of the Company. Any unauthorized alteration, forgery or falsification of the content or appearance of this document is unlawful and offenders may be prosecuted to the fullest extent of the law.

Band77-Part27_80MHz_DFT_s_OFDM_SCS30kHz_16QAM_RB216_0_CH632668

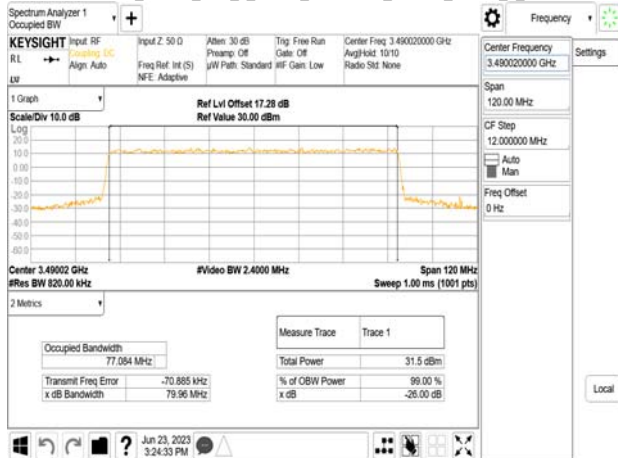

Band77-Part27_80MHz_DFT_s_OFDM_SCS30kHz_16QAM_RB216_0_CH649334



Band77-Part27_80MHz_DFT_s_OFDM_SCS30kHz_16QAM_RB216_0_CH633334

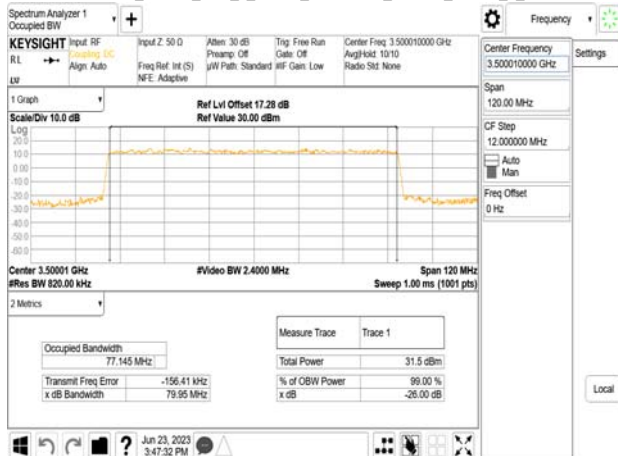

Band77-Part27_80MHz_DFT_s_OFDM_SCS30kHz_16QAM_RB216_0_CH656000

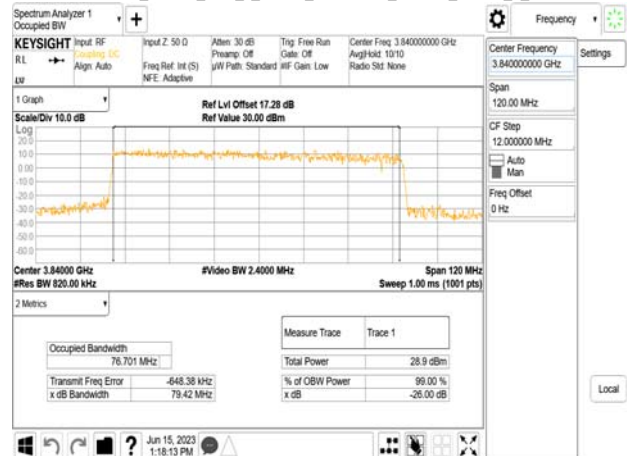

Band77-Part27_80MHz_DFT_s_OFDM_SCS30kHz_16QAM_RB216_0_CH634000

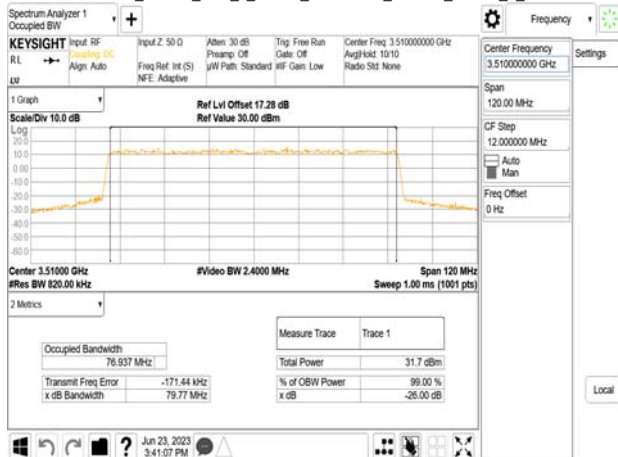

Band77-Part27_80MHz_DFT_s_OFDM_SCS30kHz_16QAM_RB216_0_CH662666



Unless otherwise stated the results shown in this test report refer only to the sample(s) tested and such sample(s) are retained for 90 days only.

除非另有說明，此報告結果僅對測試之樣品負責，同時此樣品僅保留90天。本報告未經本公司書面許可，不可部份複製。

This document is issued by the Company subject to its General Conditions of Service printed overleaf, available on request or accessible at <http://www.sgs.com.tw/Terms-and-Conditions> and for electronic format documents, subject to Terms and Conditions for Electronic Documents at <http://www.sgs.com.tw/Terms-and-Conditions>. Attention is drawn to the limitation of liability, indemnification and jurisdiction issues defined therein. Any holder of this document is advised that information contained hereon reflects the Company's findings at the time of its intervention only and within the limits of Client's instructions, if any. The Company's sole responsibility is to its Client and this document does not exonerate parties to a transaction from exercising all their rights and obligations under the transaction documents. This document cannot be reproduced except in full, without prior written approval of the Company. Any unauthorized alteration, forgery or falsification of the content or appearance of this document is unlawful and offenders may be prosecuted to the fullest extent of the law.

Band77-Part27_80MHz_DFT_s_OFDM_SCS30kHz_64QAM_RB216_0_CH632668

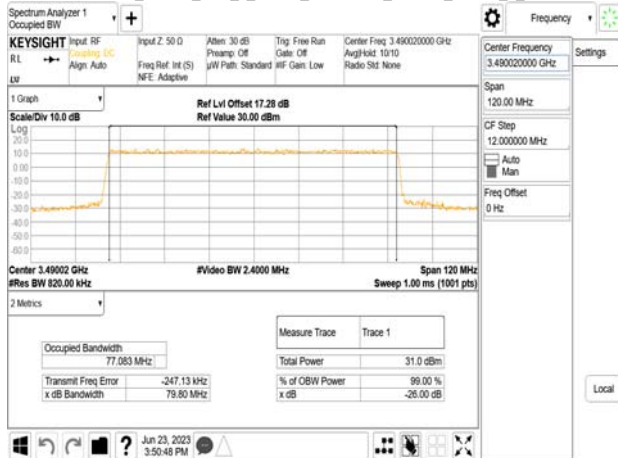

Band77-Part27_80MHz_DFT_s_OFDM_SCS30kHz_64QAM_RB216_0_CH649334

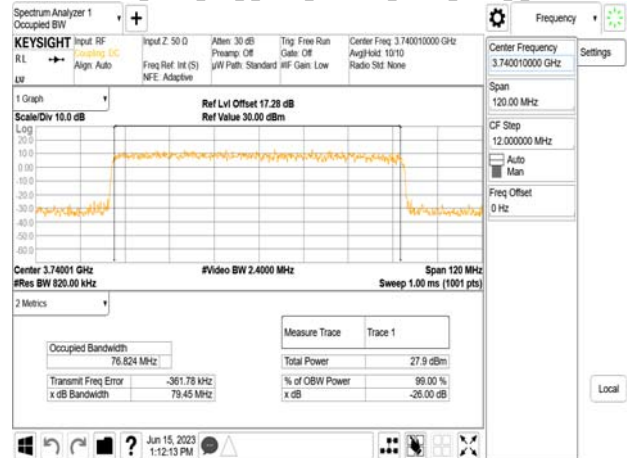

Band77-Part27_80MHz_DFT_s_OFDM_SCS30kHz_64QAM_RB216_0_CH633334

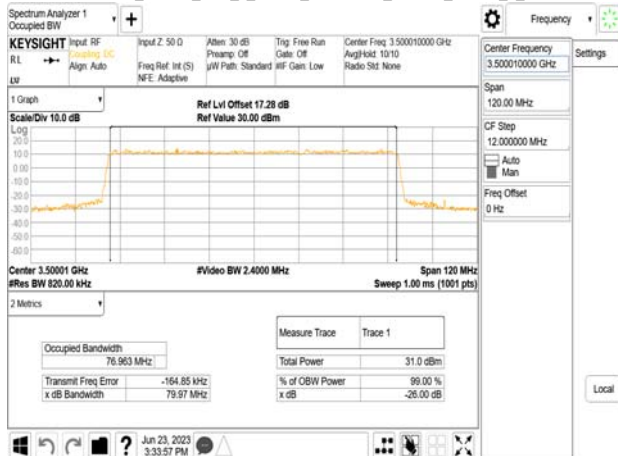

Band77-Part27_80MHz_DFT_s_OFDM_SCS30kHz_64QAM_RB216_0_CH656000



Band77-Part27_80MHz_DFT_s_OFDM_SCS30kHz_64QAM_RB216_0_CH634000

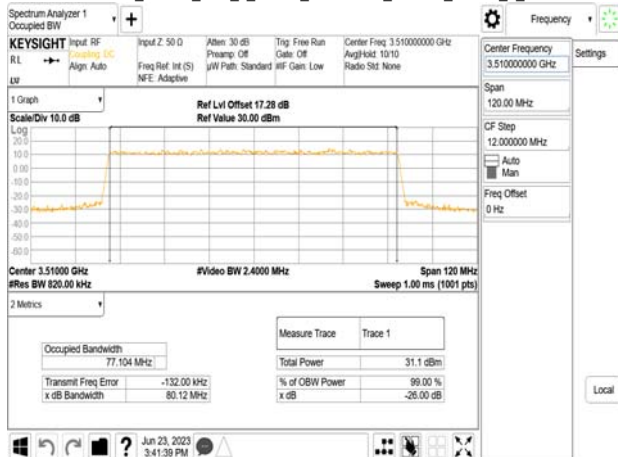

Band77-Part27_80MHz_DFT_s_OFDM_SCS30kHz_64QAM_RB216_0_CH662666



Unless otherwise stated the results shown in this test report refer only to the sample(s) tested and such sample(s) are retained for 90 days only.

除非另有說明，此報告結果僅對測試之樣品負責，同時此樣品僅保留90天。本報告未經本公司書面許可，不可部份複製。

This document is issued by the Company subject to its General Conditions of Service printed overleaf, available on request or accessible at <http://www.sgs.com.tw/Terms-and-Conditions> and for electronic format documents, subject to Terms and Conditions for Electronic Documents at <http://www.sgs.com.tw/Terms-and-Conditions>. Attention is drawn to the limitation of liability, indemnification and jurisdiction issues defined therein. Any holder of this document is advised that information contained hereon reflects the Company's findings at the time of its intervention only and within the limits of Client's instructions, if any. The Company's sole responsibility is to its Client and this document does not exonerate parties to a transaction from exercising all their rights and obligations under the transaction documents. This document cannot be reproduced except in full, without prior written approval of the Company. Any unauthorized alteration, forgery or falsification of the content or appearance of this document is unlawful and offenders may be prosecuted to the fullest extent of the law.

Band77-Part27_80MHz_DFT_s_OFDM_SCS30kHz_256QAM_RB216_0_CH632668

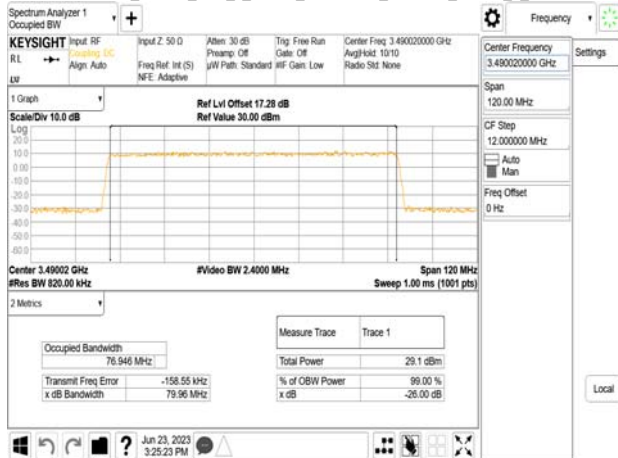

Band77-Part27_80MHz_DFT_s_OFDM_SCS30kHz_256QAM_RB216_0_CH649334



Band77-Part27_80MHz_DFT_s_OFDM_SCS30kHz_256QAM_RB216_0_CH633334



Band77-Part27_80MHz_DFT_s_OFDM_SCS30kHz_256QAM_RB216_0_CH656000



Band77-Part27_80MHz_DFT_s_OFDM_SCS30kHz_256QAM_RB216_0_CH634000

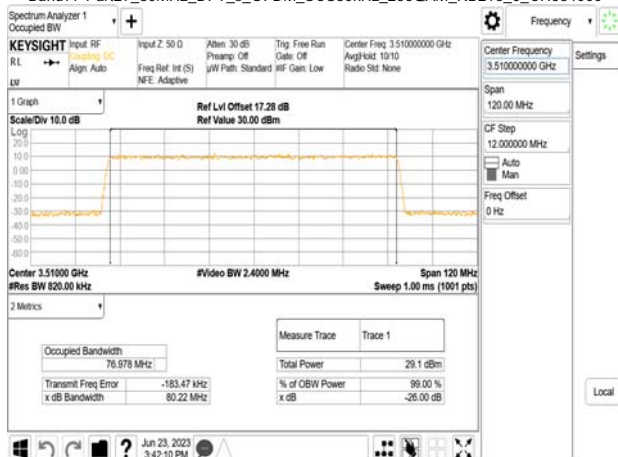

Band77-Part27_80MHz_DFT_s_OFDM_SCS30kHz_256QAM_RB216_0_CH662666



Unless otherwise stated the results shown in this test report refer only to the sample(s) tested and such sample(s) are retained for 90 days only.

除非另有說明，此報告結果僅對測試之樣品負責，同時此樣品僅保留90天。本報告未經本公司書面許可，不可部份複製。

This document is issued by the Company subject to its General Conditions of Service printed overleaf, available on request or accessible at <http://www.sgs.com.tw/Terms-and-Conditions> and for electronic format documents, subject to Terms and Conditions for Electronic Documents at <http://www.sgs.com.tw/Terms-and-Conditions>. Attention is drawn to the limitation of liability, indemnification and jurisdiction issues defined therein. Any holder of this document is advised that information contained hereon reflects the Company's findings at the time of its intervention only and within the limits of Client's instructions, if any. The Company's sole responsibility is to its Client and this document does not exonerate parties to a transaction from exercising all their rights and obligations under the transaction documents. This document cannot be reproduced except in full, without prior written approval of the Company. Any unauthorized alteration, forgery or falsification of the content or appearance of this document is unlawful and offenders may be prosecuted to the fullest extent of the law.

Band77-Part27_90MHz_DFT_s_OFDM_SCS30kHz_BPSK_RB243_0_CH633000

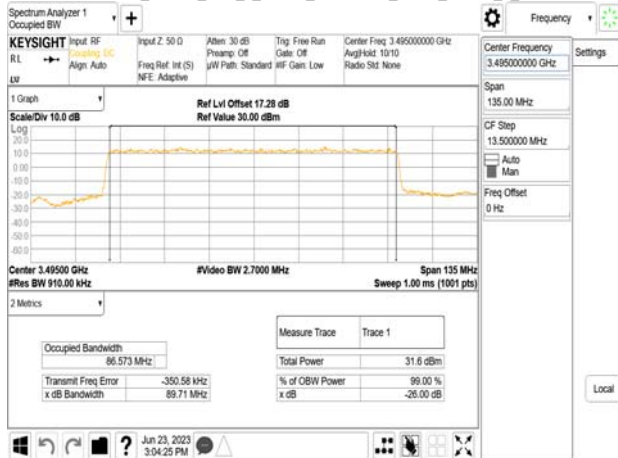

Band77-Part27_90MHz_DFT_s_OFDM_SCS30kHz_BPSK_RB243_0_CH649668

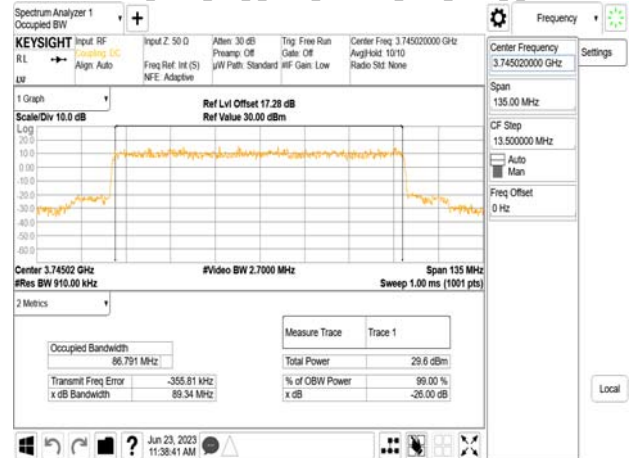

Band77-Part27_90MHz_DFT_s_OFDM_SCS30kHz_BPSK_RB243_0_CH633334

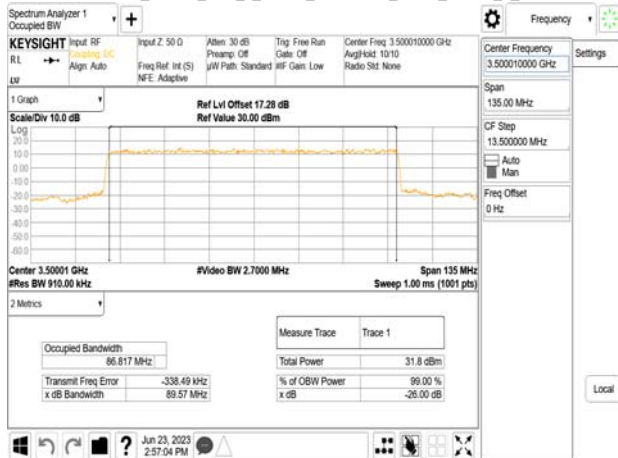

Band77-Part27_90MHz_DFT_s_OFDM_SCS30kHz_BPSK_RB243_0_CH656000

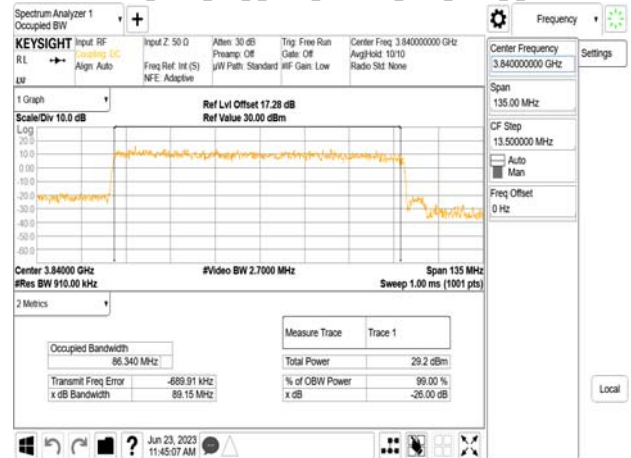

Band77-Part27_90MHz_DFT_s_OFDM_SCS30kHz_BPSK_RB243_0_CH633666



Band77-Part27_90MHz_DFT_s_OFDM_SCS30kHz_BPSK_RB243_0_CH662332



Unless otherwise stated the results shown in this test report refer only to the sample(s) tested and such sample(s) are retained for 90 days only.

除非另有說明，此報告結果僅對測試之樣品負責，同時此樣品僅保留90天。本報告未經本公司書面許可，不可部份複製。

This document is issued by the Company subject to its General Conditions of Service printed overleaf, available on request or accessible at <http://www.sgs.com.tw/Terms-and-Conditions> and for electronic format documents, subject to Terms and Conditions for Electronic Documents at <http://www.sgs.com.tw/Terms-and-Conditions>. Attention is drawn to the limitation of liability, indemnification and jurisdiction issues defined therein. Any holder of this document is advised that information contained hereon reflects the Company's findings at the time of its intervention only and within the limits of Client's instructions, if any. The Company's sole responsibility is to its Client and this document does not exonerate parties to a transaction from exercising all their rights and obligations under the transaction documents. This document cannot be reproduced except in full, without prior written approval of the Company. Any unauthorized alteration, forgery or falsification of the content or appearance of this document is unlawful and offenders may be prosecuted to the fullest extent of the law.

Band77-Part27_90MHz_DFT_s_OFDM_SCS30kHz_QPSK_RB243_0_CH633000

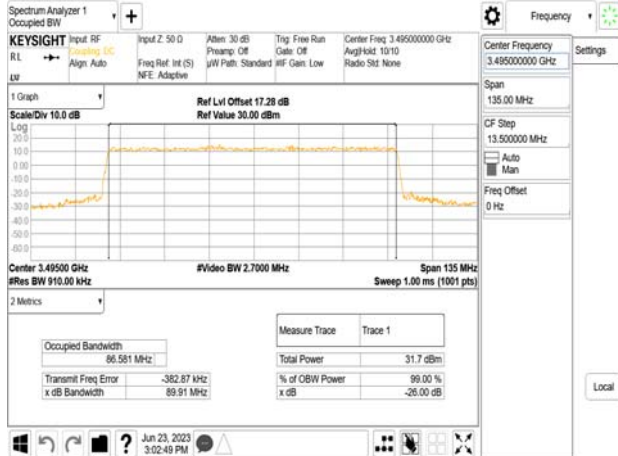

Band77-Part27_90MHz_DFT_s_OFDM_SCS30kHz_QPSK_RB243_0_CH649668

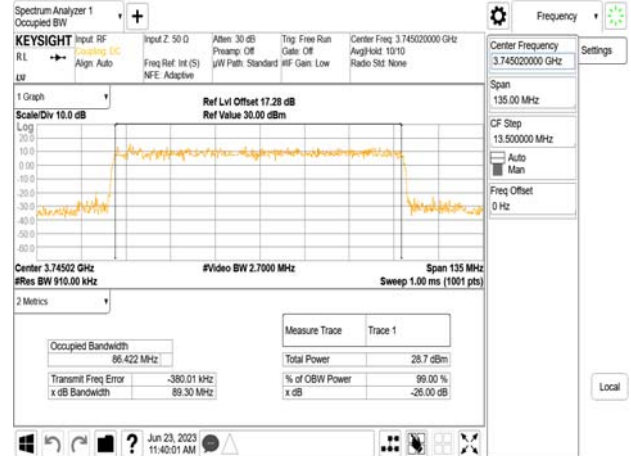

Band77-Part27_90MHz_DFT_s_OFDM_SCS30kHz_QPSK_RB243_0_CH633334

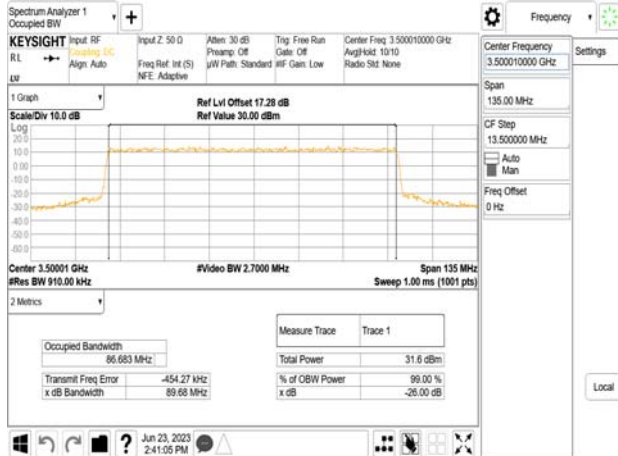

Band77-Part27_90MHz_DFT_s_OFDM_SCS30kHz_QPSK_RB243_0_CH656000



Band77-Part27_90MHz_DFT_s_OFDM_SCS30kHz_QPSK_RB243_0_CH633666



Band77-Part27_90MHz_DFT_s_OFDM_SCS30kHz_QPSK_RB243_0_CH662332



Unless otherwise stated the results shown in this test report refer only to the sample(s) tested and such sample(s) are retained for 90 days only.

除非另有說明，此報告結果僅對測試之樣品負責，同時此樣品僅保留90天。本報告未經本公司書面許可，不可部份複製。

This document is issued by the Company subject to its General Conditions of Service printed overleaf, available on request or accessible at <http://www.sgs.com.tw/Terms-and-Conditions> and for electronic format documents, subject to Terms and Conditions for Electronic Documents at <http://www.sgs.com.tw/Terms-and-Conditions>. Attention is drawn to the limitation of liability, indemnification and jurisdiction issues defined therein. Any holder of this document is advised that information contained hereon reflects the Company's findings at the time of its intervention only and within the limits of Client's instructions, if any. The Company's sole responsibility is to its Client and this document does not exonerate parties to a transaction from exercising all their rights and obligations under the transaction documents. This document cannot be reproduced except in full, without prior written approval of the Company. Any unauthorized alteration, forgery or falsification of the content or appearance of this document is unlawful and offenders may be prosecuted to the fullest extent of the law.

Band77-Part27_90MHz_DFT_s_OFDM_SCS30kHz_16QAM_RB243_0_CH633000

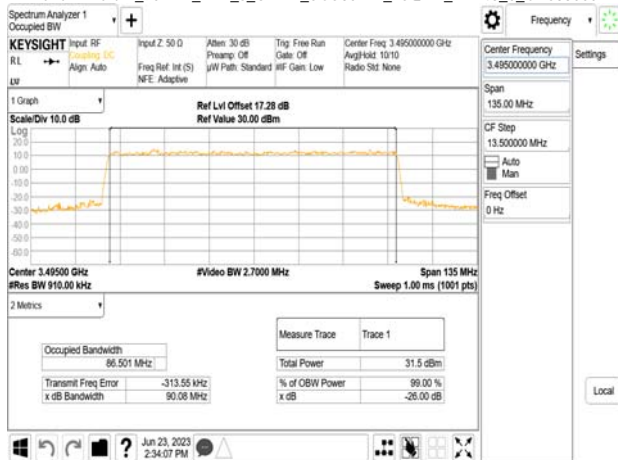

Band77-Part27_90MHz_DFT_s_OFDM_SCS30kHz_16QAM_RB243_0_CH649668

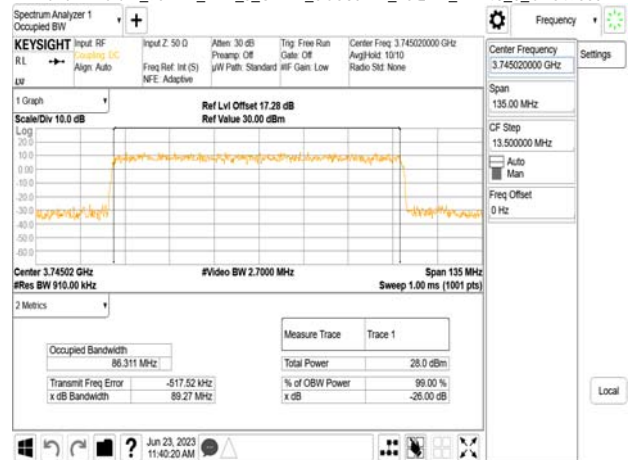

Band77-Part27_90MHz_DFT_s_OFDM_SCS30kHz_16QAM_RB243_0_CH633334

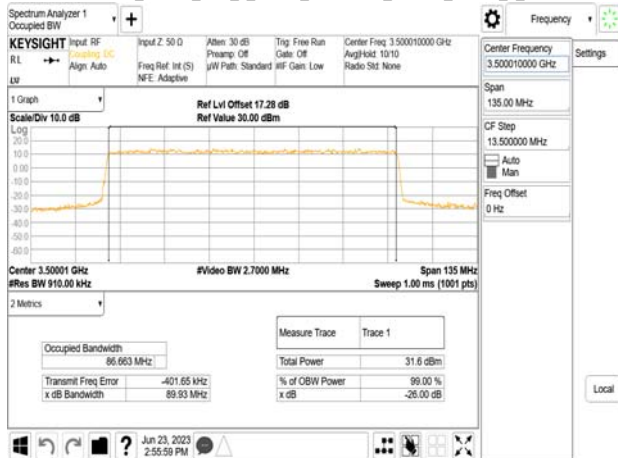

Band77-Part27_90MHz_DFT_s_OFDM_SCS30kHz_16QAM_RB243_0_CH656000

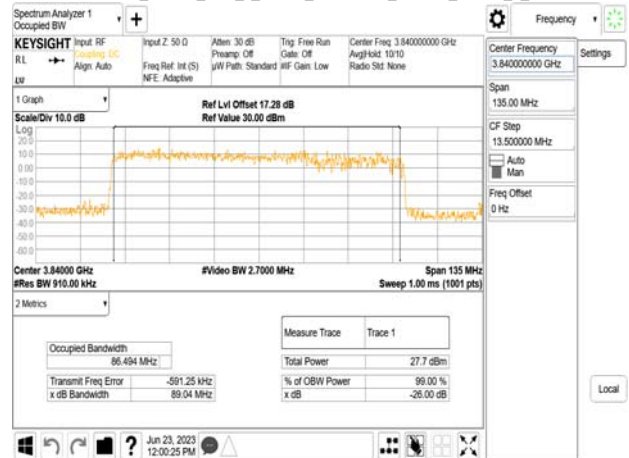

Band77-Part27_90MHz_DFT_s_OFDM_SCS30kHz_16QAM_RB243_0_CH633666

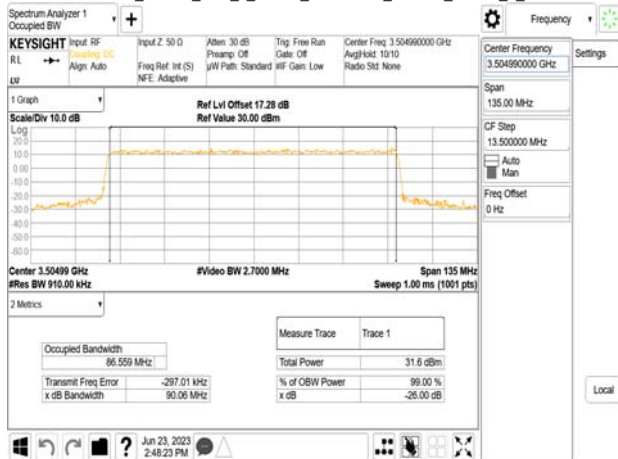

Band77-Part27_90MHz_DFT_s_OFDM_SCS30kHz_16QAM_RB243_0_CH662332

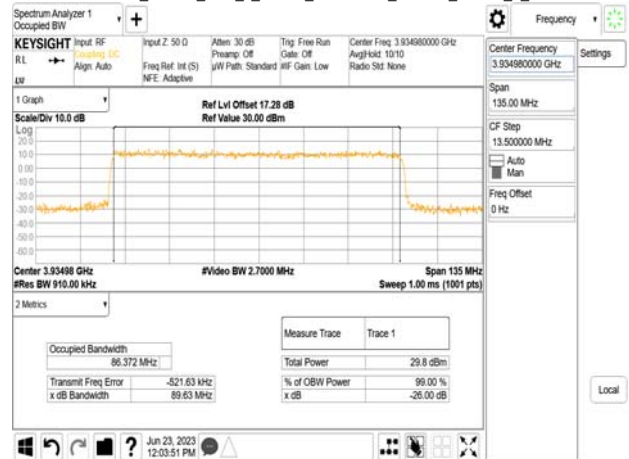

Unless otherwise stated the results shown in this test report refer only to the sample(s) tested and such sample(s) are retained for 90 days only.

除非另有說明，此報告結果僅對測試之樣品負責，同時此樣品僅保留90天。本報告未經本公司書面許可，不可部份複製。

This document is issued by the Company subject to its General Conditions of Service printed overleaf, available on request or accessible at <http://www.sgs.com.tw/Terms-and-Conditions> and for electronic format documents, subject to Terms and Conditions for Electronic Documents at <http://www.sgs.com.tw/Terms-and-Conditions>. Attention is drawn to the limitation of liability, indemnification and jurisdiction issues defined therein. Any holder of this document is advised that information contained hereon reflects the Company's findings at the time of its intervention only and within the limits of Client's instructions, if any. The Company's sole responsibility is to its Client and this document does not exonerate parties to a transaction from exercising all their rights and obligations under the transaction documents. This document cannot be reproduced except in full, without prior written approval of the Company. Any unauthorized alteration, forgery or falsification of the content or appearance of this document is unlawful and offenders may be prosecuted to the fullest extent of the law.

Band77-Part27_90MHz_DFT_s_OFDM_SCS30kHz_64QAM_RB243_0_CH633000

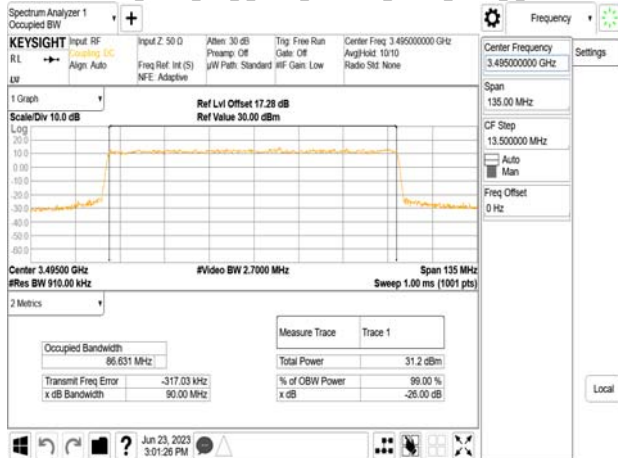

Band77-Part27_90MHz_DFT_s_OFDM_SCS30kHz_64QAM_RB243_0_CH649668



Band77-Part27_90MHz_DFT_s_OFDM_SCS30kHz_64QAM_RB243_0_CH633334

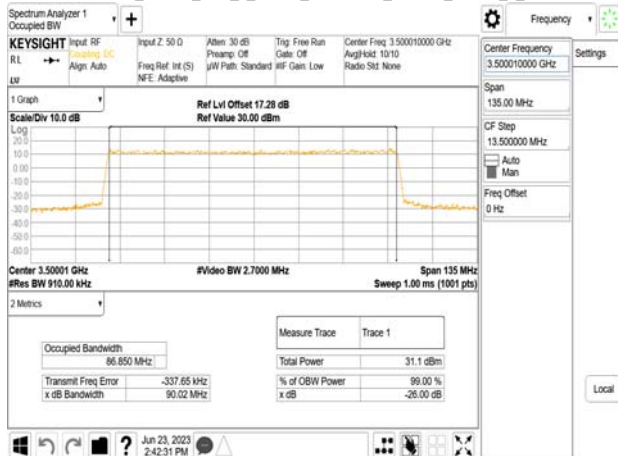

Band77-Part27_90MHz_DFT_s_OFDM_SCS30kHz_64QAM_RB243_0_CH656000



Band77-Part27_90MHz_DFT_s_OFDM_SCS30kHz_64QAM_RB243_0_CH633666

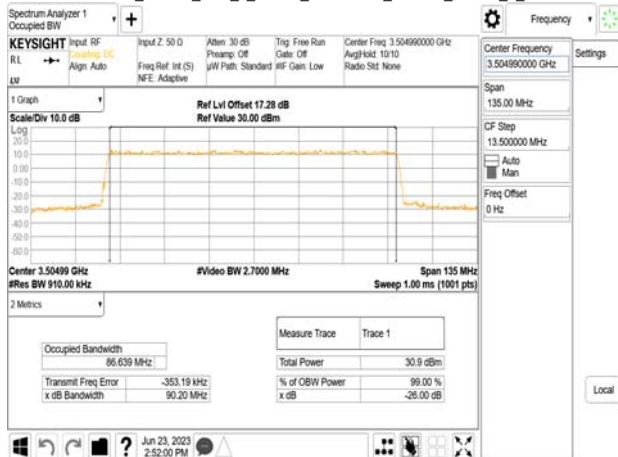

Band77-Part27_90MHz_DFT_s_OFDM_SCS30kHz_64QAM_RB243_0_CH662332



Unless otherwise stated the results shown in this test report refer only to the sample(s) tested and such sample(s) are retained for 90 days only.

除非另有說明，此報告結果僅對測試之樣品負責，同時此樣品僅保留90天。本報告未經本公司書面許可，不可部份複製。

This document is issued by the Company subject to its General Conditions of Service printed overleaf, available on request or accessible at <http://www.sgs.com.tw/Terms-and-Conditions> and for electronic format documents, subject to Terms and Conditions for Electronic Documents at <http://www.sgs.com.tw/Terms-and-Conditions>. Attention is drawn to the limitation of liability, indemnification and jurisdiction issues defined therein. Any holder of this document is advised that information contained hereon reflects the Company's findings at the time of its intervention only and within the limits of Client's instructions, if any. The Company's sole responsibility is to its Client and this document does not exonerate parties to a transaction from exercising all their rights and obligations under the transaction documents. This document cannot be reproduced except in full, without prior written approval of the Company. Any unauthorized alteration, forgery or falsification of the content or appearance of this document is unlawful and offenders may be prosecuted to the fullest extent of the law.

Band77-Part27_90MHz_DFT_s_OFDM_SCS30kHz_256QAM_RB243_0_CH633000

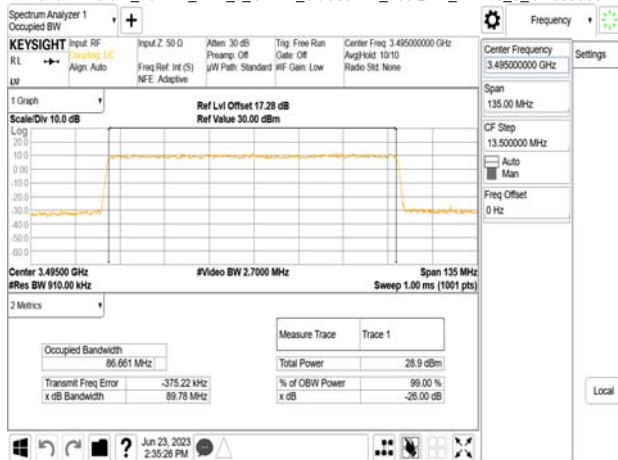

Band77-Part27_90MHz_DFT_s_OFDM_SCS30kHz_256QAM_RB243_0_CH649668



Band77-Part27_90MHz_DFT_s_OFDM_SCS30kHz_256QAM_RB243_0_CH633334



Band77-Part27_90MHz_DFT_s_OFDM_SCS30kHz_256QAM_RB243_0_CH656000



Band77-Part27_90MHz_DFT_s_OFDM_SCS30kHz_256QAM_RB243_0_CH633666



Band77-Part27_90MHz_DFT_s_OFDM_SCS30kHz_256QAM_RB243_0_CH662332



Unless otherwise stated the results shown in this test report refer only to the sample(s) tested and such sample(s) are retained for 90 days only.

除非另有說明，此報告結果僅對測試之樣品負責，同時此樣品僅保留90天。本報告未經本公司書面許可，不可部份複製。

This document is issued by the Company subject to its General Conditions of Service printed overleaf, available on request or accessible at <http://www.sgs.com.tw/Terms-and-Conditions> and for electronic format documents, subject to Terms and Conditions for Electronic Documents at <http://www.sgs.com.tw/Terms-and-Conditions>. Attention is drawn to the limitation of liability, indemnification and jurisdiction issues defined therein. Any holder of this document is advised that information contained hereon reflects the Company's findings at the time of its intervention only and within the limits of Client's instructions, if any. The Company's sole responsibility is to its Client and this document does not exonerate parties to a transaction from exercising all their rights and obligations under the transaction documents. This document cannot be reproduced except in full, without prior written approval of the Company. Any unauthorized alteration, forgery or falsification of the content or appearance of this document is unlawful and offenders may be prosecuted to the fullest extent of the law.

Band77-Part27_100MHz_DFT_s_OFDM_SCS30kHz_BPSK_RB270_0_CH633334

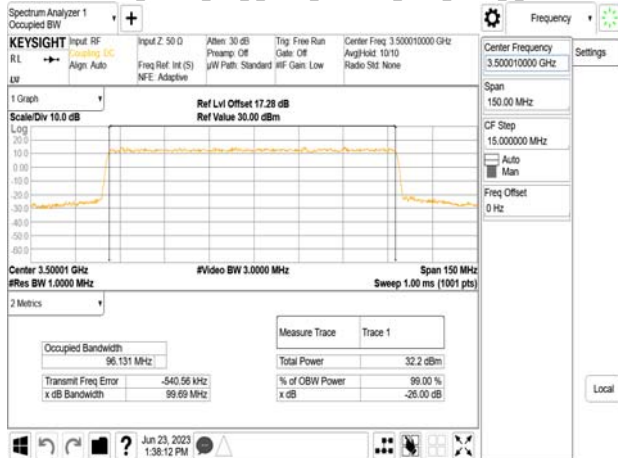

Band77-Part27_100MHz_DFT_s_OFDM_SCS30kHz_BPSK_RB270_0_CH662000

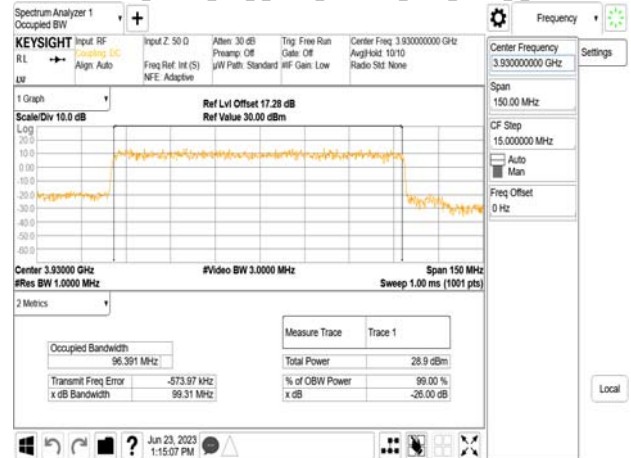

Band77-Part27_100MHz_DFT_s_OFDM_SCS30kHz_BPSK_RB270_0_CH650000

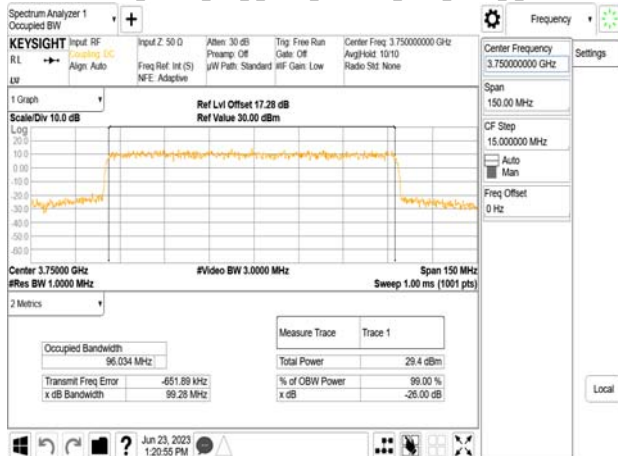

Band77-Part27_100MHz_DFT_s_OFDM_SCS30kHz_QPSK_RB270_0_CH633334

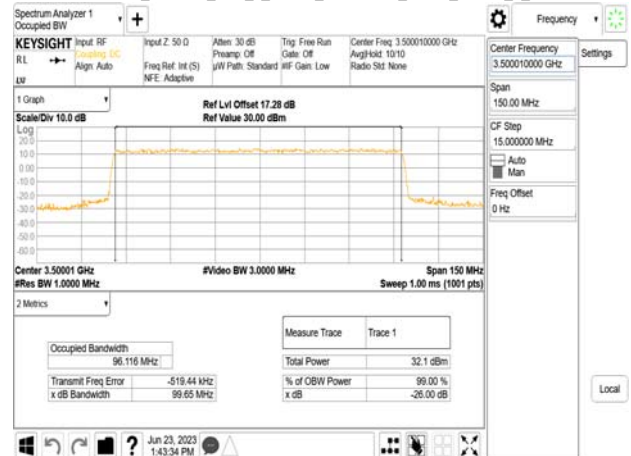

Band77-Part27_100MHz_DFT_s_OFDM_SCS30kHz_BPSK_RB270_0_CH656000

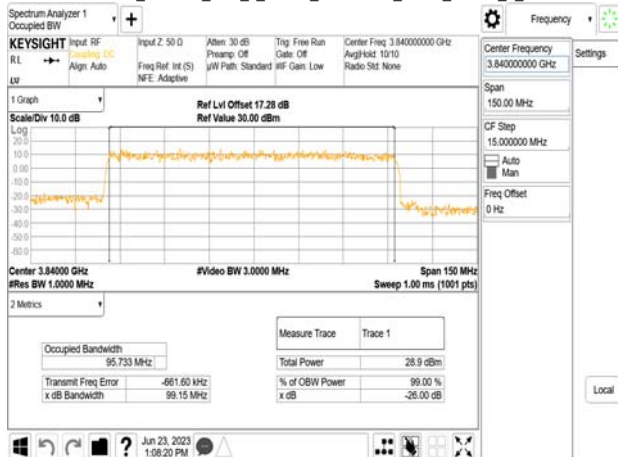

Band77-Part27_100MHz_DFT_s_OFDM_SCS30kHz_QPSK_RB270_0_CH650000



Unless otherwise stated the results shown in this test report refer only to the sample(s) tested and such sample(s) are retained for 90 days only.

除非另有說明，此報告結果僅對測試之樣品負責，同時此樣品僅保留90天。本報告未經本公司書面許可，不可部份複製。

This document is issued by the Company subject to its General Conditions of Service printed overleaf, available on request or accessible at <http://www.sgs.com.tw/Terms-and-Conditions> and for electronic format documents, subject to Terms and Conditions for Electronic Documents at <http://www.sgs.com.tw/Terms-and-Conditions>. Attention is drawn to the limitation of liability, indemnification and jurisdiction issues defined therein. Any holder of this document is advised that information contained hereon reflects the Company's findings at the time of its intervention only and within the limits of Client's instructions, if any. The Company's sole responsibility is to its Client and this document does not exonerate parties to a transaction from exercising all their rights and obligations under the transaction documents. This document cannot be reproduced except in full, without prior written approval of the Company. Any unauthorized alteration, forgery or falsification of the content or appearance of this document is unlawful and offenders may be prosecuted to the fullest extent of the law.

Band77-Part27_100MHz_DFT_s_OFDM_SCS30kHz_QPSK_RB270_0_CH656000

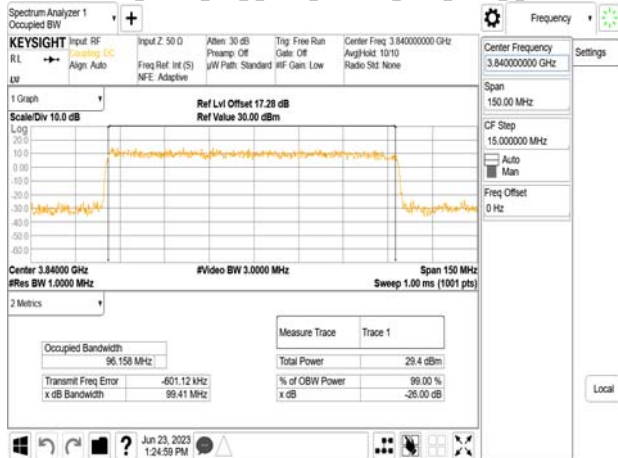

Band77-Part27_100MHz_DFT_s_OFDM_SCS30kHz_16QAM_RB270_0_CH650000



Band77-Part27_100MHz_DFT_s_OFDM_SCS30kHz_QPSK_RB270_0_CH662000



Band77-Part27_100MHz_DFT_s_OFDM_SCS30kHz_16QAM_RB270_0_CH656000

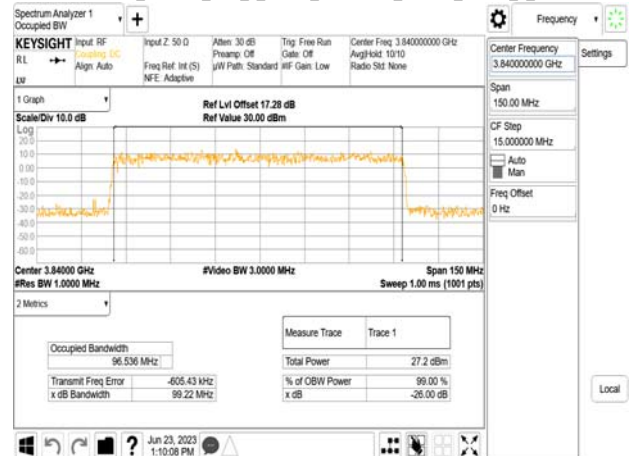

Band77-Part27_100MHz_DFT_s_OFDM_SCS30kHz_16QAM_RB270_0_CH633334

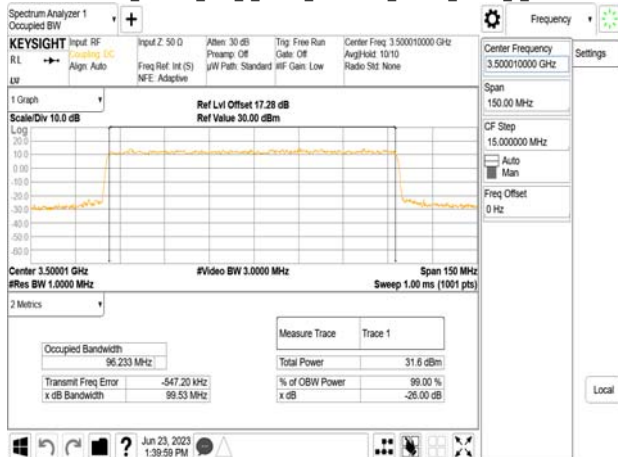

Band77-Part27_100MHz_DFT_s_OFDM_SCS30kHz_16QAM_RB270_0_CH662000



Unless otherwise stated the results shown in this test report refer only to the sample(s) tested and such sample(s) are retained for 90 days only.

除非另有說明，此報告結果僅對測試之樣品負責，同時此樣品僅保留90天。本報告未經本公司書面許可，不可部份複製。

This document is issued by the Company subject to its General Conditions of Service printed overleaf, available on request or accessible at <http://www.sgs.com.tw/Terms-and-Conditions> and for electronic format documents, subject to Terms and Conditions for Electronic Documents at <http://www.sgs.com.tw/Terms-and-Conditions>. Attention is drawn to the limitation of liability, indemnification and jurisdiction issues defined therein. Any holder of this document is advised that information contained hereon reflects the Company's findings at the time of its intervention only and within the limits of Client's instructions, if any. The Company's sole responsibility is to its Client and this document does not exonerate parties to a transaction from exercising all their rights and obligations under the transaction documents. This document cannot be reproduced except in full, without prior written approval of the Company. Any unauthorized alteration, forgery or falsification of the content or appearance of this document is unlawful and offenders may be prosecuted to the fullest extent of the law.

Band77-Part27_100MHz_DFT_s_OFDM_SCS30kHz_64QAM_RB270_0_CH633334

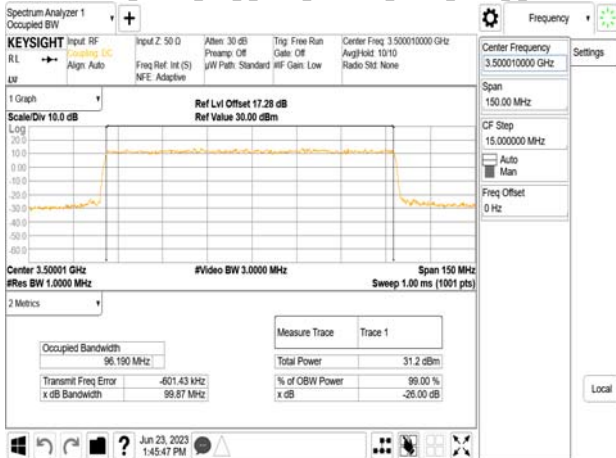

Band77-Part27_100MHz_DFT_s_OFDM_SCS30kHz_64QAM_RB270_0_CH662000



Band77-Part27_100MHz_DFT_s_OFDM_SCS30kHz_64QAM_RB270_0_CH650000



Band77-Part27_100MHz_DFT_s_OFDM_SCS30kHz_256QAM_RB270_0_CH633334

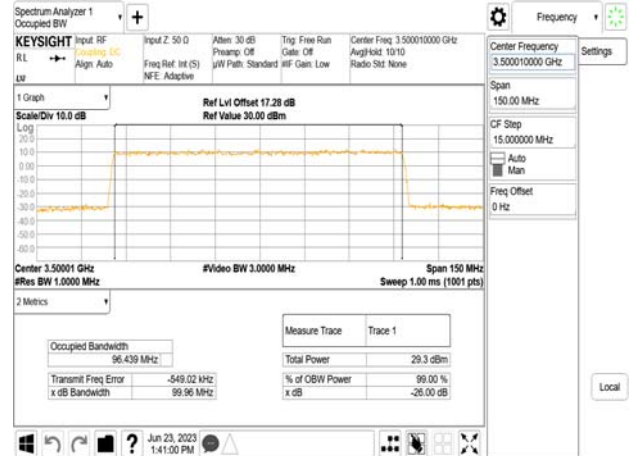

Band77-Part27_100MHz_DFT_s_OFDM_SCS30kHz_64QAM_RB270_0_CH656000



Band77-Part27_100MHz_DFT_s_OFDM_SCS30kHz_256QAM_RB270_0_CH650000



Unless otherwise stated the results shown in this test report refer only to the sample(s) tested and such sample(s) are retained for 90 days only.

除非另有說明，此報告結果僅對測試之樣品負責，同時此樣品僅保留90天。本報告未經本公司書面許可，不可部份複製。

This document is issued by the Company subject to its General Conditions of Service printed overleaf, available on request or accessible at <http://www.sgs.com.tw/Terms-and-Conditions> and for electronic format documents, subject to Terms and Conditions for Electronic Documents at <http://www.sgs.com.tw/Terms-and-Conditions>. Attention is drawn to the limitation of liability, indemnification and jurisdiction issues defined therein. Any holder of this document is advised that information contained hereon reflects the Company's findings at the time of its intervention only and within the limits of Client's instructions, if any. The Company's sole responsibility is to its Client and this document does not exonerate parties to a transaction from exercising all their rights and obligations under the transaction documents. This document cannot be reproduced except in full, without prior written approval of the Company. Any unauthorized alteration, forgery or falsification of the content or appearance of this document is unlawful and offenders may be prosecuted to the fullest extent of the law.

Band77-Part27_100MHz_DFT_s_OFDM_SCS30kHz_256QAM_RB270_0_CH656000



Band77-Part27_100MHz_DFT_s_OFDM_SCS30kHz_256QAM_RB270_0_CH662000



Unless otherwise stated the results shown in this test report refer only to the sample(s) tested and such sample(s) are retained for 90 days only.

除非另有說明，此報告結果僅對測試之樣品負責，同時此樣品僅保留90天。本報告未經本公司書面許可，不可部份複製。

This document is issued by the Company subject to its General Conditions of Service printed overleaf, available on request or accessible at <http://www.sgs.com.tw/Terms-and-Conditions> and for electronic format documents, subject to Terms and Conditions for Electronic Documents at <http://www.sgs.com.tw/Terms-and-Conditions>. Attention is drawn to the limitation of liability, indemnification and jurisdiction issues defined therein. Any holder of this document is advised that information contained hereon reflects the Company's findings at the time of its intervention only and within the limits of Client's instructions, if any. The Company's sole responsibility is to its Client and this document does not exonerate parties to a transaction from exercising all their rights and obligations under the transaction documents. This document cannot be reproduced except in full, without prior written approval of the Company. Any unauthorized alteration, forgery or falsification of the content or appearance of this document is unlawful and offenders may be prosecuted to the fullest extent of the law.

9 OUT OF BAND EMISSION AT ANTENNA TERMINALS

9.1 Standard Applicable

FCC §22.917(a), §24.238(a), §27.53(h)

Out of band emissions. The power of any emission outside of the authorized operating frequency ranges must be attenuated below the transmitting power (P) by a factor of at least $43 + 10 \log(P)$ dB.

FCC §27.53(g)

Compliance for operations in the 600 MHz, 698-746 MHz, 746-758 MHz and the 776-788 MHz band with this provision is based on the use of measurement instrumentation employing a resolution bandwidth of 100 kilohertz or greater. However, in the 100 kilohertz bands immediately outside and adjacent to a licensee's frequency block, a resolution bandwidth of at least 30 kHz may be employed.

- (2) On any frequency outside the 776-788 MHz band, the power of any emission shall be attenuated outside the band below the transmitter power (P) by at least $43 + 10 \log(P)$ dB;
- (3) On all frequencies between 763-775 MHz and 793-805 MHz, by a factor not less than $76 + 10 \log(P)$ dB in a 6.25 kHz band segment, for base and fixed stations;
- (4) On all frequencies between 763-775 MHz and 793-805 MHz, by a factor not less than $65 + 10 \log(P)$ dB in a 6.25 kHz band segment, for mobile and portable stations;

FCC §27.53(h)

(h) *AWS emission limits*—(1) *General protection levels*. Except as otherwise specified below, for operations in the 1695-1710 MHz, 1710-1755 MHz, 1755-1780 MHz, 1915-1920 MHz, 1995-2000 MHz, 2000-2020 MHz, 2110-2155 MHz, 2155-2180 MHz, and 2180-2200 bands, the power of any emission outside a licensee's frequency block shall be attenuated below the transmitter power (P) in watts by at least $43 + 10 \log_{10}(P)$ dB.

FCC §27.53(m) (4) (6)

For mobile digital stations, the attenuation factor shall be not less than $40 + 10 \log(P)$ dB on all frequencies between the channel edge and 5 megahertz from the channel edge, $43 + 10 \log(P)$ dB on all frequencies between 5 megahertz and X megahertz from the channel edge, and $55 + 10 \log(P)$ dB on all frequencies more than X megahertz from the channel edge, where X is the greater of 6 megahertz or the actual emission bandwidth as defined in paragraph (m)(6) of this section. In addition, the attenuation factor shall not be less than $43 + 10 \log(P)$ dB on all frequencies between 2490.5 MHz and 2496 MHz and $55 + 10 \log(P)$ dB at or below 2490.5 MHz. Mobile Satellite Service licensees operating on frequencies below 2495 MHz may also submit a documented interference complaint against BRS licensees operating on channel BRS Channel 1 on the same terms and conditions as adjacent channel BRS or EBS licensees.

Measurement procedure. Compliance with these rules is based on the use of measurement instrumentation employing a resolution bandwidth of 1 megahertz or greater. However, in the 1 MHz bands immediately outside and adjacent to the frequency block a resolution bandwidth of at least one percent of the emission bandwidth of the fundamental emission of the transmitter may be employed; for mobile digital stations, in the 1 megahertz bands immediately outside and adjacent to the frequency block a resolution bandwidth of at least two percent may be employed, except when the 1 megahertz band is 2495-2496 MHz, in which case a resolution bandwidth of at least one percent may be employed. A narrower resolution bandwidth is permitted in all cases to improve measurement accuracy provided the measured power is integrated over the full required measurement bandwidth (i.e. 1 megahertz or 1 percent of emission bandwidth, as specified; or 1 megahertz or 2 percent for mobile digital stations, except in the band 2495-2496 MHz). The emission bandwidth is defined as the width of the signal between two points, one below the carrier center frequency and

Unless otherwise stated the results shown in this test report refer only to the sample(s) tested and such sample(s) are retained for 90 days only.
除非另有說明，此報告結果僅對測試之樣品負責，同時此樣品僅保留90天。本報告未經本公司書面許可，不可部份複製。

This document is issued by the Company subject to its General Conditions of Service printed overleaf, available on request or accessible at <http://www.sgs.com.tw/Terms-and-Conditions> and for electronic format documents, subject to Terms and Conditions for Electronic Documents at <http://www.sgs.com.tw/Terms-and-Conditions>. Attention is drawn to the limitation of liability, indemnification and jurisdiction issues defined therein. Any holder of this document is advised that information contained herein reflects the Company's findings at the time of its intervention only and within the limits of Client's instructions, if any. The Company's sole responsibility is to its Client and this document does not exonerate parties to a transaction from exercising all their rights and obligations under the transaction documents. This document cannot be reproduced except in full, without prior written approval of the Company. Any unauthorized alteration, forgery or falsification of the content or appearance of this document is unlawful and offenders may be prosecuted to the fullest extent of the law.

one above the carrier center frequency, outside of which all emissions are attenuated at least 26 dB below the transmitter power. With respect to television operations, measurements must be made of the separate visual and aural operating powers at sufficiently frequent intervals to ensure compliance with the rules.

9.2 Test SET-UP

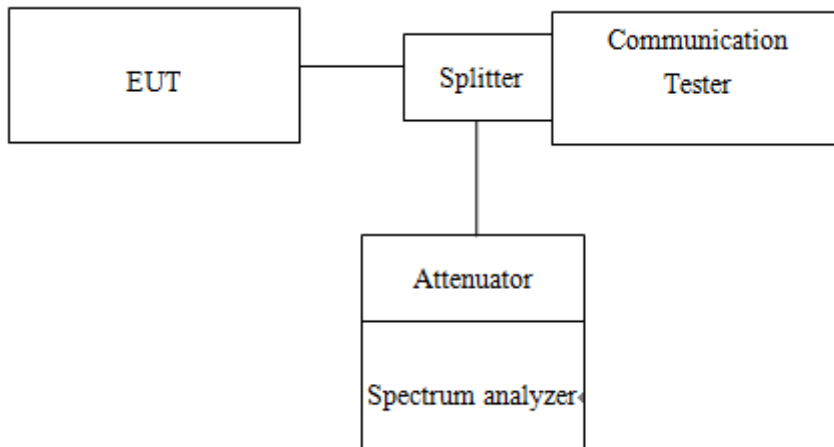

Unless otherwise stated the results shown in this test report refer only to the sample(s) tested and such sample(s) are retained for 90 days only.
除非另有說明，此報告結果僅對測試之樣品負責，同時此樣品僅保留90天。本報告未經本公司書面許可，不可部份複製。

This document is issued by the Company subject to its General Conditions of Service printed overleaf, available on request or accessible at <http://www.sgs.com.tw/Terms-and-Conditions> and for electronic format documents, subject to Terms and Conditions for Electronic Documents at <http://www.sgs.com.tw/Terms-and-Conditions>. Attention is drawn to the limitation of liability, indemnification and jurisdiction issues defined therein. Any holder of this document is advised that information contained hereon reflects the Company's findings at the time of its intervention only and within the limits of Client's instructions, if any. The Company's sole responsibility is to its Client and this document does not exonerate parties to a transaction from exercising all their rights and obligations under the transaction documents. This document cannot be reproduced except in full, without prior written approval of the Company. Any unauthorized alteration, forgery or falsification of the content or appearance of this document is unlawful and offenders may be prosecuted to the fullest extent of the law.

9.3 Measurement Procedure

9.3.1 Conducted Emission

The RF output of the transceiver was connected to a spectrum analyzer through appropriate attenuation. The resolution bandwidth of the spectrum analyzer was set at 1MHz, sufficient scans were taken to show the out of band Emissions if any up to 10th harmonic.

1. To connect Antenna Port of EUT to Spectrum.
2. Set RBW = 1MHz & VBW = 1MHz on Spectrum.
3. Allow trace to fully stabilize
4. Repeat above procedures until all default test channel measured were complete.

9.3.2 Band Edge

1. To connect Antenna Port of EUT to Spectrum.
2. The band edge of low and high channels for the highest RF powers was measured. Setting RBW \geq 1% EBW.
3. Allow trace to fully stabilize
4. Repeat above procedures until all default test channel measured were complete.

Correction factor $10\log [(reference\ bandwidth) / (resolution\ bandwidth)]$ is applied and compensate to the test results.

9.4 Band Edge Measurement Result:

Refer to next pages.

Unless otherwise stated the results shown in this test report refer only to the sample(s) tested and such sample(s) are retained for 90 days only.
除非另有說明，此報告結果僅對測試之樣品負責，同時此樣品僅保留90天。本報告未經本公司書面許可，不可部份複製。

This document is issued by the Company subject to its General Conditions of Service printed overleaf, available on request or accessible at <http://www.sgs.com.tw/Terms-and-Conditions> and for electronic format documents, subject to Terms and Conditions for Electronic Documents at <http://www.sgs.com.tw/Terms-and-Conditions>. Attention is drawn to the limitation of liability, indemnification and jurisdiction issues defined therein. Any holder of this document is advised that information contained hereon reflects the Company's findings at the time of its intervention only and within the limits of Client's instructions, if any. The Company's sole responsibility is to its Client and this document does not exonerate parties to a transaction from exercising all their rights and obligations under the transaction documents. This document cannot be reproduced except in full, without prior written approval of the Company. Any unauthorized alteration, forgery or falsification of the content or appearance of this document is unlawful and offenders may be prosecuted to the fullest extent of the law.

Band2_5MHz_DFT_s_OFDM_SCS15kHz_BPSK_RB1_0_CH370500

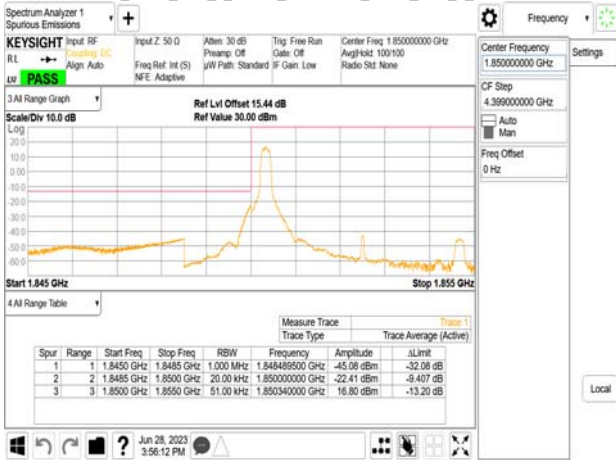

Band2_5MHz_DFT_s_OFDM_SCS15kHz_BPSK_RB25_0_CH381500

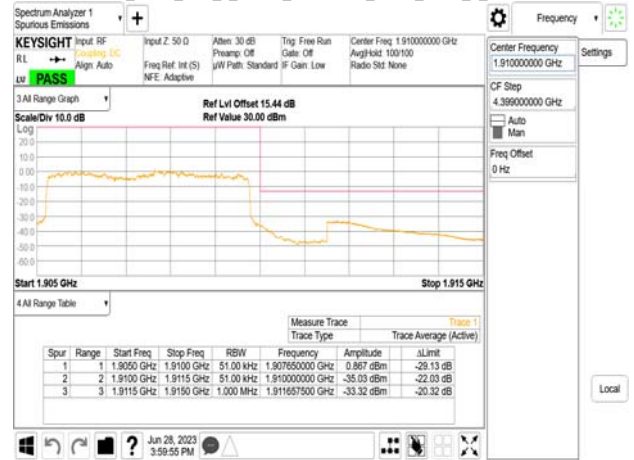

Band2_5MHz_DFT_s_OFDM_SCS15kHz_BPSK_RB1_24_CH381500

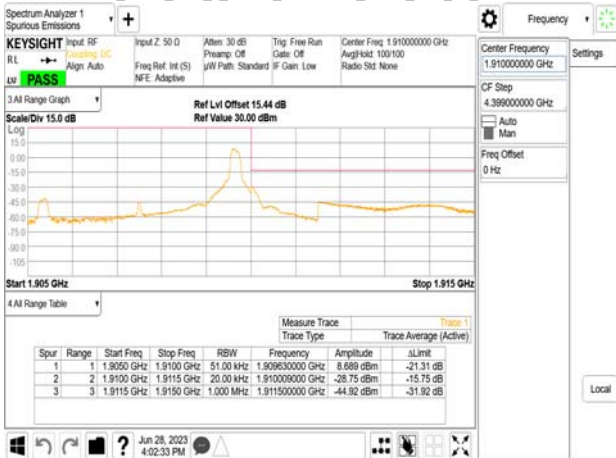

Band2_5MHz_CP_OFDM_SCS15kHz_QPSK_RB1_0_CH370500

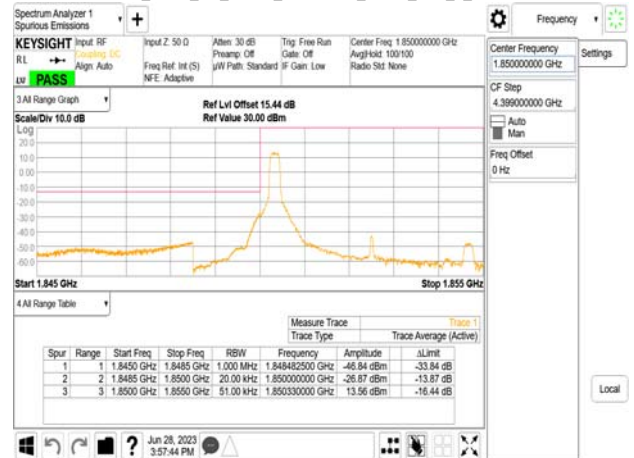

Band2_5MHz_DFT_s_OFDM_SCS15kHz_BPSK_RB25_0_CH370500



Band2_5MHz_CP_OFDM_SCS15kHz_QPSK_RB1_24_CH381500

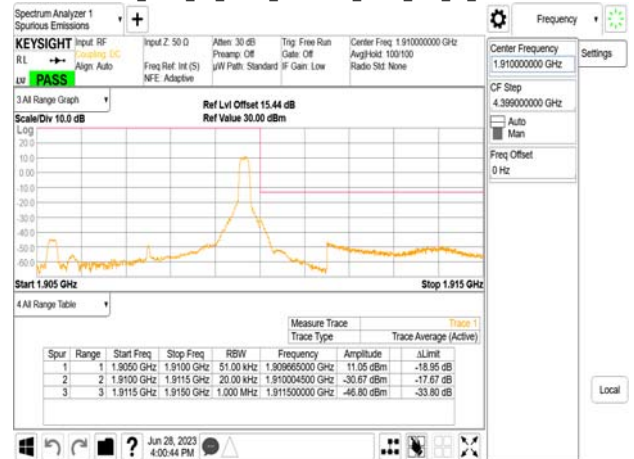

Unless otherwise stated the results shown in this test report refer only to the sample(s) tested and such sample(s) are retained for 90 days only.

除非另有說明，此報告結果僅對測試之樣品負責，同時此樣品僅保留90天。本報告未經本公司書面許可，不可部份複製。

This document is issued by the Company subject to its General Conditions of Service printed overleaf, available on request or accessible at <http://www.sgs.com.tw/Terms-and-Conditions> and for electronic format documents, subject to Terms and Conditions for Electronic Documents at <http://www.sgs.com.tw/Terms-and-Conditions>. Attention is drawn to the limitation of liability, indemnification and jurisdiction issues defined therein. Any holder of this document is advised that information contained hereon reflects the Company's findings at the time of its intervention only and within the limits of Client's instructions, if any. The Company's sole responsibility is to its Client and this document does not exonerate parties to a transaction from exercising all their rights and obligations under the transaction documents. This document cannot be reproduced except in full, without prior written approval of the Company. Any unauthorized alteration, forgery or falsification of the content or appearance of this document is unlawful and offenders may be prosecuted to the fullest extent of the law.

Band2_5MHz_CP_OFDM_SCS15kHz_QPSK_RB25_0_CH370500



Band2_10MHz_DFT_s_OFDM_SCS15kHz_BPSK_RB1_51_CH381000

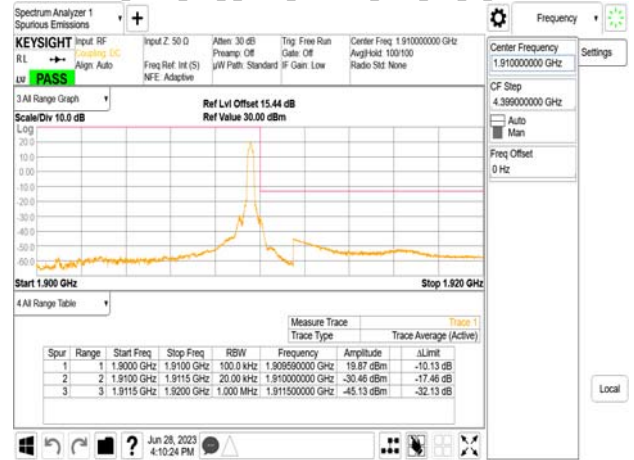

Band2_5MHz_CP_OFDM_SCS15kHz_QPSK_RB25_0_CH381500

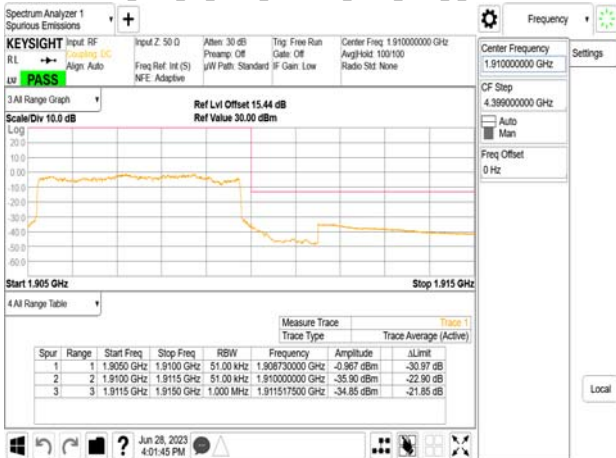

Band2_10MHz_DFT_s_OFDM_SCS15kHz_BPSK_RB50_0_CH371000



Band2_10MHz_DFT_s_OFDM_SCS15kHz_BPSK_RB1_0_CH371000

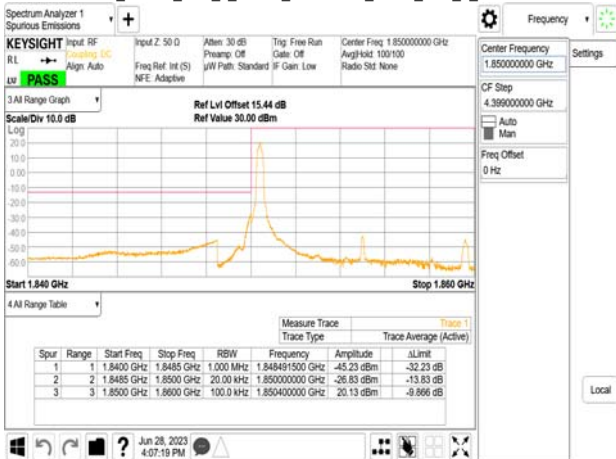

Band2_10MHz_DFT_s_OFDM_SCS15kHz_BPSK_RB50_0_CH381000



Unless otherwise stated the results shown in this test report refer only to the sample(s) tested and such sample(s) are retained for 90 days only.

除非另有說明，此報告結果僅對測試之樣品負責，同時此樣品僅保留90天。本報告未經本公司書面許可，不可部份複製。

This document is issued by the Company subject to its General Conditions of Service printed overleaf, available on request or accessible at <http://www.sgs.com.tw/Terms-and-Conditions> and for electronic format documents, subject to Terms and Conditions for Electronic Documents at <http://www.sgs.com.tw/Terms-and-Conditions>. Attention is drawn to the limitation of liability, indemnification and jurisdiction issues defined therein. Any holder of this document is advised that information contained hereon reflects the Company's findings at the time of its intervention only and within the limits of Client's instructions, if any. The Company's sole responsibility is to its Client and this document does not exonerate parties to a transaction from exercising all their rights and obligations under the transaction documents. This document cannot be reproduced except in full, without prior written approval of the Company. Any unauthorized alteration, forgery or falsification of the content or appearance of this document is unlawful and offenders may be prosecuted to the fullest extent of the law.

Band2_10MHz_CP_OFDM_SCS15kHz_QPSK_RB1_0_CH371000

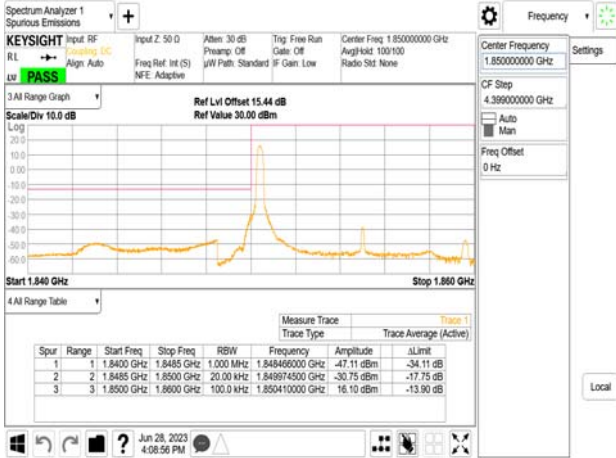

Band2_10MHz_CP_OFDM_SCS15kHz_QPSK_RB52_0_CH381000



Band2_10MHz_CP_OFDM_SCS15kHz_QPSK_RB1_51_CH381000

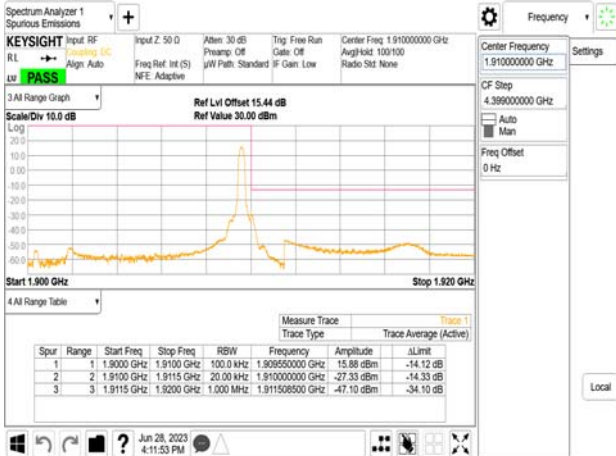

Band2_15MHz_DFT_s_OFDM_SCS15kHz_BPSK_RB1_0_CH371500

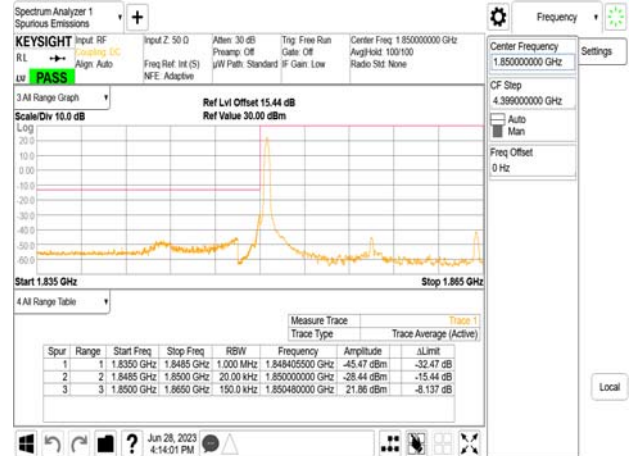

Band2_10MHz_CP_OFDM_SCS15kHz_QPSK_RB52_0_CH371000

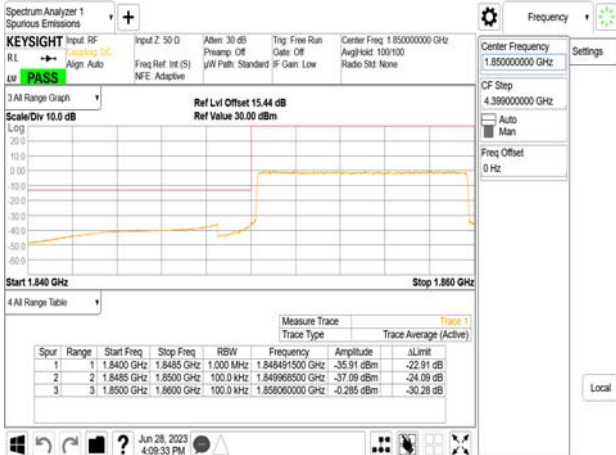

Band2_15MHz_DFT_s_OFDM_SCS15kHz_BPSK_RB1_78_CH380500

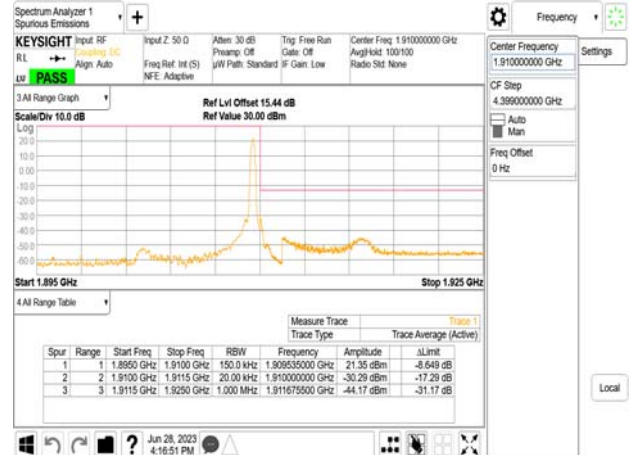

Unless otherwise stated the results shown in this test report refer only to the sample(s) tested and such sample(s) are retained for 90 days only.

除非另有說明，此報告結果僅對測試之樣品負責，同時此樣品僅保留90天。本報告未經本公司書面許可，不可部份複製。

This document is issued by the Company subject to its General Conditions of Service printed overleaf, available on request or accessible at <http://www.sgs.com.tw/Terms-and-Conditions> and for electronic format documents, subject to Terms and Conditions for Electronic Documents at <http://www.sgs.com.tw/Terms-and-Conditions>. Attention is drawn to the limitation of liability, indemnification and jurisdiction issues defined therein. Any holder of this document is advised that information contained hereon reflects the Company's findings at the time of its intervention only and within the limits of Client's instructions, if any. The Company's sole responsibility is to its Client and this document does not exonerate parties to a transaction from exercising all their rights and obligations under the transaction documents. This document cannot be reproduced except in full, without prior written approval of the Company. Any unauthorized alteration, forgery or falsification of the content or appearance of this document is unlawful and offenders may be prosecuted to the fullest extent of the law.

Band2_15MHz_DFT_s_OFDM_SCS15kHz_BPSK_RB75_0_CH371500



Band2_15MHz_CP_OFDM_SCS15kHz_QPSK_RB1_78_CH380500

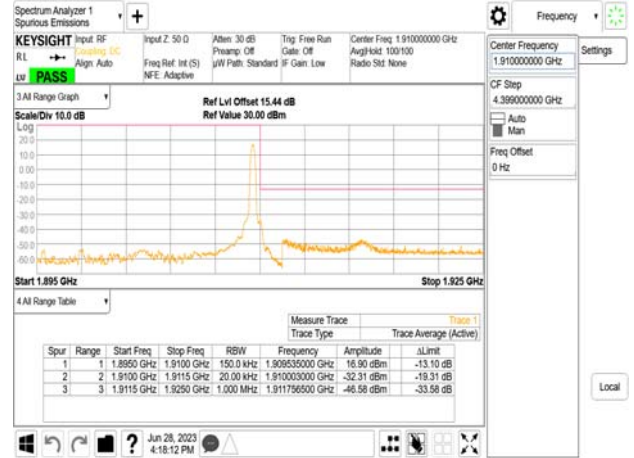

Band2_15MHz_DFT_s_OFDM_SCS15kHz_BPSK_RB75_0_CH380500



Band2_15MHz_CP_OFDM_SCS15kHz_QPSK_RB79_0_CH371500



Band2_15MHz_CP_OFDM_SCS15kHz_QPSK_RB1_0_CH371500

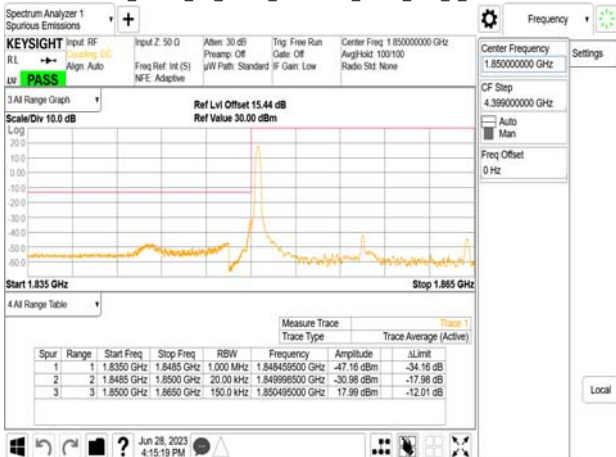

Band2_15MHz_CP_OFDM_SCS15kHz_QPSK_RB79_0_CH380500

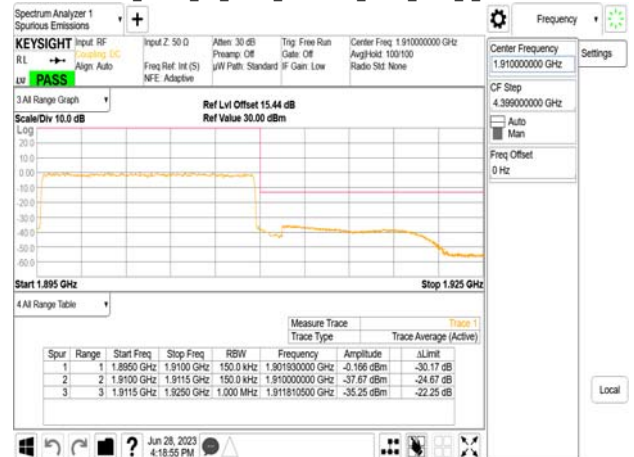

Unless otherwise stated the results shown in this test report refer only to the sample(s) tested and such sample(s) are retained for 90 days only.

除非另有說明，此報告結果僅對測試之樣品負責，同時此樣品僅保留90天。本報告未經本公司書面許可，不可部份複製。

This document is issued by the Company subject to its General Conditions of Service printed overleaf, available on request or accessible at <http://www.sgs.com.tw/Terms-and-Conditions> and for electronic format documents, subject to Terms and Conditions for Electronic Documents at <http://www.sgs.com.tw/Terms-and-Conditions>. Attention is drawn to the limitation of liability, indemnification and jurisdiction issues defined therein. Any holder of this document is advised that information contained hereon reflects the Company's findings at the time of its intervention only and within the limits of Client's instructions, if any. The Company's sole responsibility is to its Client and this document does not exonerate parties to a transaction from exercising all their rights and obligations under the transaction documents. This document cannot be reproduced except in full, without prior written approval of the Company. Any unauthorized alteration, forgery or falsification of the content or appearance of this document is unlawful and offenders may be prosecuted to the fullest extent of the law.

Band2_20MHz_DFT_s_OFDM_SCS15kHz_BPSK_RB1_0_CH372000

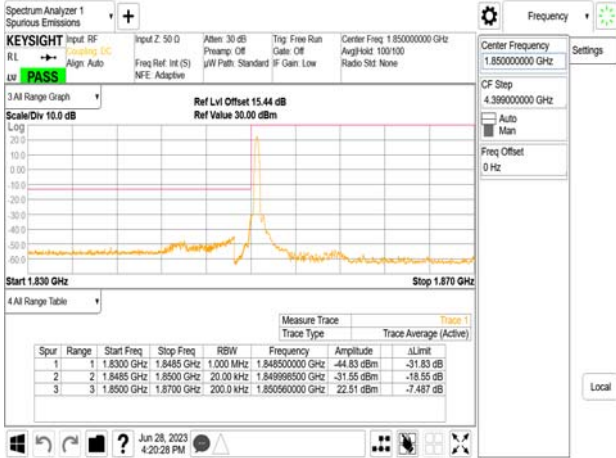

Band2_20MHz_DFT_s_OFDM_SCS15kHz_BPSK_RB100_0_CH380000



Band2_20MHz_DFT_s_OFDM_SCS15kHz_BPSK_RB1_105_CH380000

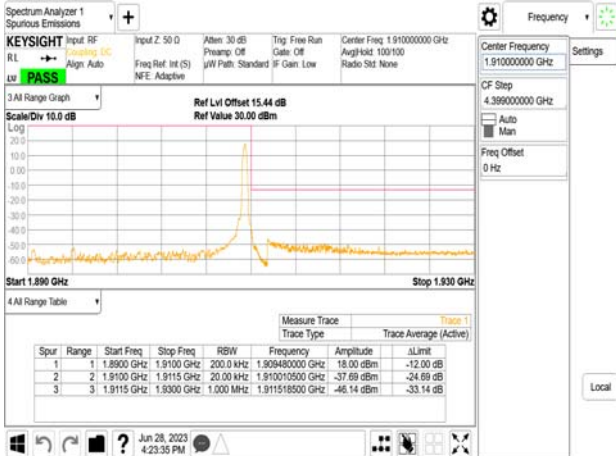

Band2_20MHz_CP_OFDM_SCS15kHz_QPSK_RB1_0_CH372000



Band2_20MHz_DFT_s_OFDM_SCS15kHz_BPSK_RB100_0_CH372000

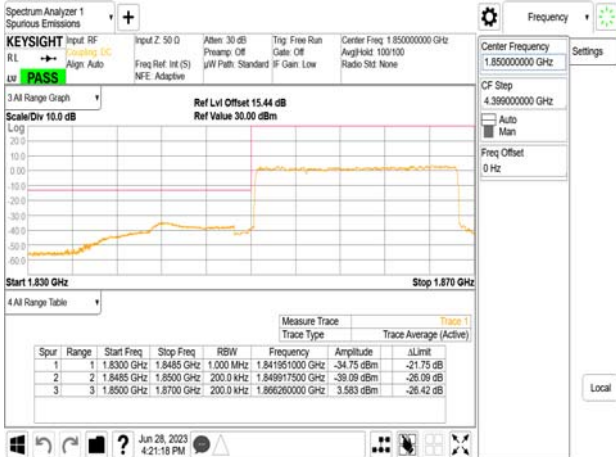

Band2_20MHz_CP_OFDM_SCS15kHz_QPSK_RB1_105_CH380000

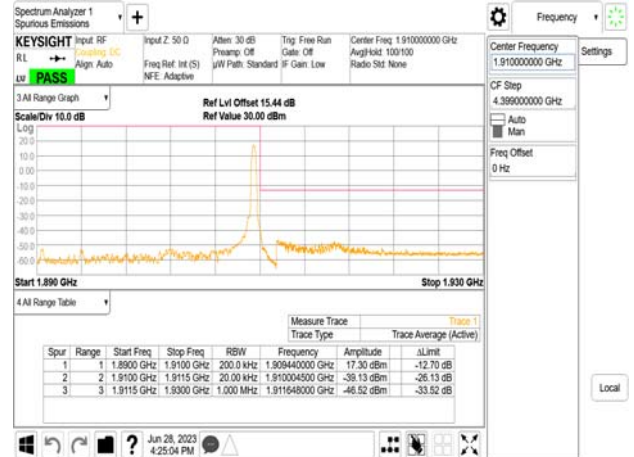

Unless otherwise stated the results shown in this test report refer only to the sample(s) tested and such sample(s) are retained for 90 days only.

除非另有說明，此報告結果僅對測試之樣品負責，同時此樣品僅保留90天。本報告未經本公司書面許可，不可部份複製。

This document is issued by the Company subject to its General Conditions of Service printed overleaf, available on request or accessible at <http://www.sgs.com.tw/Terms-and-Conditions> and for electronic format documents, subject to Terms and Conditions for Electronic Documents at <http://www.sgs.com.tw/Terms-and-Conditions>. Attention is drawn to the limitation of liability, indemnification and jurisdiction issues defined therein. Any holder of this document is advised that information contained hereon reflects the Company's findings at the time of its intervention only and within the limits of Client's instructions, if any. The Company's sole responsibility is to its Client and this document does not exonerate parties to a transaction from exercising all their rights and obligations under the transaction documents. This document cannot be reproduced except in full, without prior written approval of the Company. Any unauthorized alteration, forgery or falsification of the content or appearance of this document is unlawful and offenders may be prosecuted to the fullest extent of the law.

Band2_20MHz_CP_OFDM_SCS15kHz_QPSK_RB106_0_CH372000



Band5_5MHz_DFT_s_OFDM_SCS15kHz_BPSK_RB1_24_CH169300

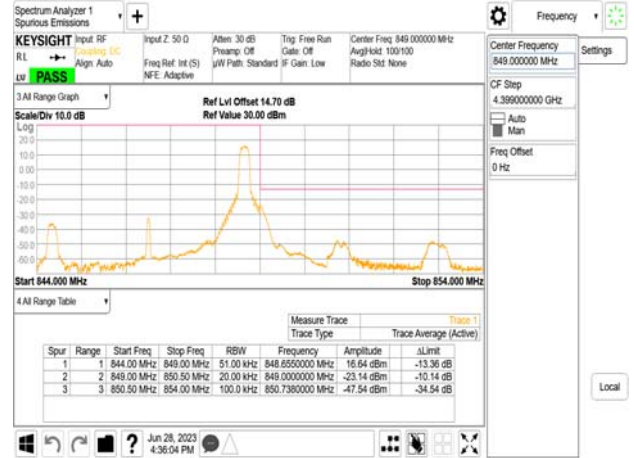

Band2_20MHz_CP_OFDM_SCS15kHz_QPSK_RB106_0_CH380000

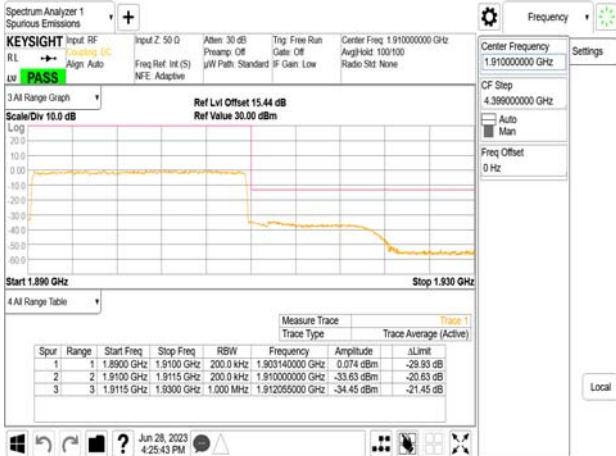

Band5_5MHz_DFT_s_OFDM_SCS15kHz_BPSK_RB25_0_CH165300

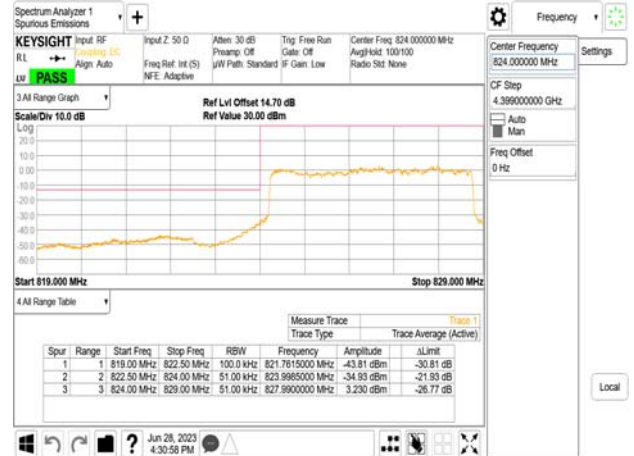

Band5_5MHz_DFT_s_OFDM_SCS15kHz_BPSK_RB1_0_CH165300

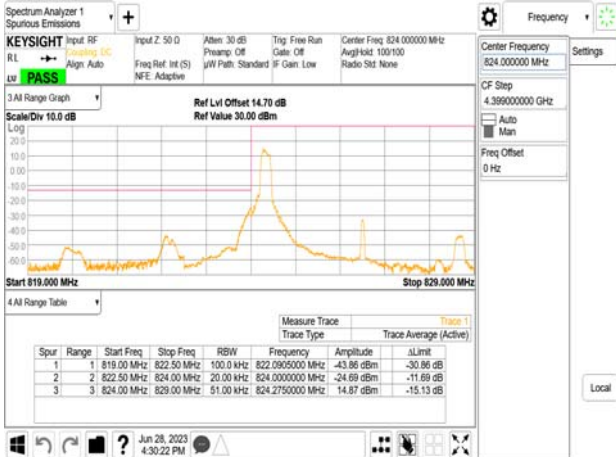

Band5_5MHz_DFT_s_OFDM_SCS15kHz_BPSK_RB25_0_CH169300



Unless otherwise stated the results shown in this test report refer only to the sample(s) tested and such sample(s) are retained for 90 days only.

除非另有說明，此報告結果僅對測試之樣品負責，同時此樣品僅保留90天。本報告未經本公司書面許可，不可部份複製。

This document is issued by the Company subject to its General Conditions of Service printed overleaf, available on request or accessible at <http://www.sgs.com.tw/Terms-and-Conditions> and for electronic format documents, subject to Terms and Conditions for Electronic Documents at <http://www.sgs.com.tw/Terms-and-Conditions>. Attention is drawn to the limitation of liability, indemnification and jurisdiction issues defined therein. Any holder of this document is advised that information contained hereon reflects the Company's findings at the time of its intervention only and within the limits of Client's instructions, if any. The Company's sole responsibility is to its Client and this document does not exonerate parties to a transaction from exercising all their rights and obligations under the transaction documents. This document cannot be reproduced except in full, without prior written approval of the Company. Any unauthorized alteration, forgery or falsification of the content or appearance of this document is unlawful and offenders may be prosecuted to the fullest extent of the law.

Band5_5MHz_CP_OFDM_SCS15kHz_OPSK_RB1_0_CH165300

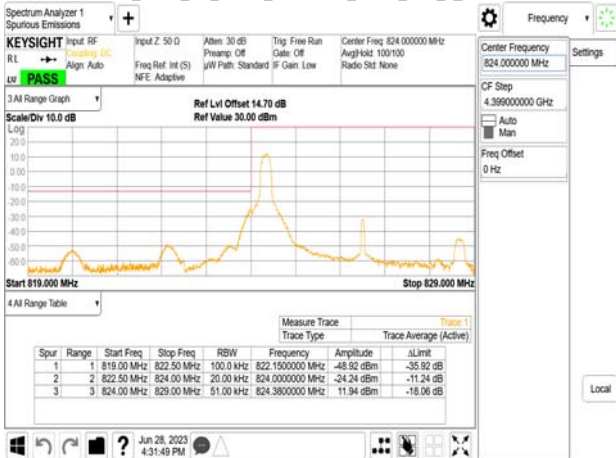

Band5_5MHz_CP_OFDM_SCS15kHz_OPSK_RB25_0_CH169300



Band5_5MHz_CP_OFDM_SCS15kHz_OPSK_RB1_24_CH169300

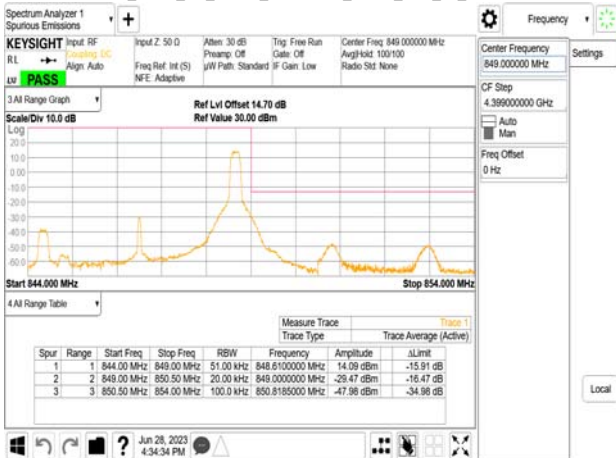

Band5_10MHz_DFT_s_OFDM_SCS15kHz_BPSK_RB1_0_CH165800

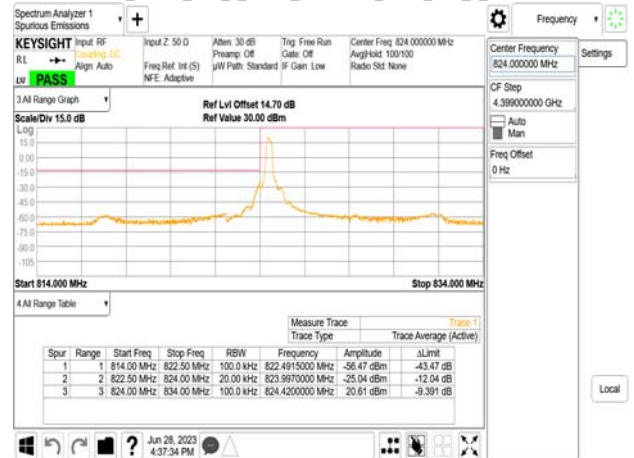

Band5_5MHz_CP_OFDM_SCS15kHz_OPSK_RB25_0_CH165300



Band5_10MHz_DFT_s_OFDM_SCS15kHz_BPSK_RB1_51_CH168800

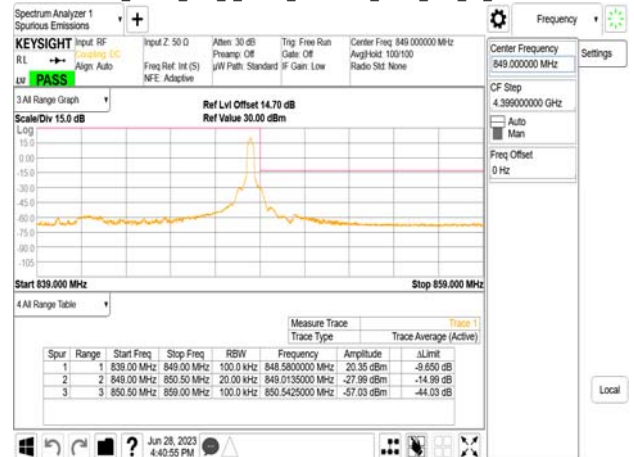

Unless otherwise stated the results shown in this test report refer only to the sample(s) tested and such sample(s) are retained for 90 days only.

除非另有說明，此報告結果僅對測試之樣品負責，同時此樣品僅保留90天。本報告未經本公司書面許可，不可部份複製。

This document is issued by the Company subject to its General Conditions of Service printed overleaf, available on request or accessible at <http://www.sgs.com.tw/Terms-and-Conditions> and for electronic format documents, subject to Terms and Conditions for Electronic Documents at <http://www.sgs.com.tw/Terms-and-Conditions>. Attention is drawn to the limitation of liability, indemnification and jurisdiction issues defined therein. Any holder of this document is advised that information contained hereon reflects the Company's findings at the time of its intervention only and within the limits of Client's instructions, if any. The Company's sole responsibility is to its Client and this document does not exonerate parties to a transaction from exercising all their rights and obligations under the transaction documents. This document cannot be reproduced except in full, without prior written approval of the Company. Any unauthorized alteration, forgery or falsification of the content or appearance of this document is unlawful and offenders may be prosecuted to the fullest extent of the law.

Band5_10MHz_DFT_s_OFDM_SCS15kHz_BPSK_RB50_0_CH165800



Band5_10MHz_CP_OFDM_SCS15kHz_QPSK_RB1_51_CH168800

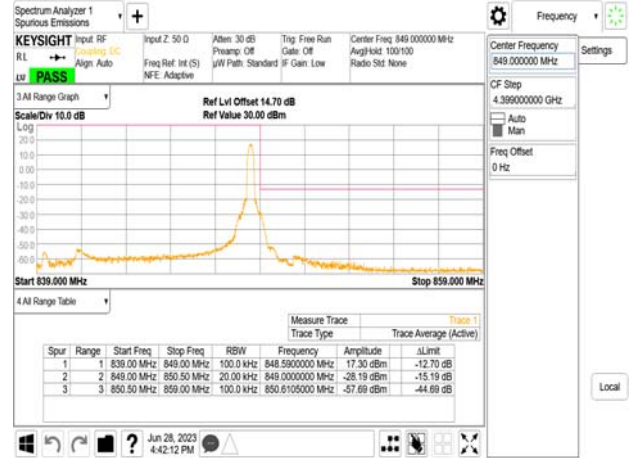

Band5_10MHz_DFT_s_OFDM_SCS15kHz_BPSK_RB50_0_CH168800



Band5_10MHz_CP_OFDM_SCS15kHz_QPSK_RB52_0_CH165800



Band5_10MHz_CP_OFDM_SCS15kHz_QPSK_RB1_0_CH165800

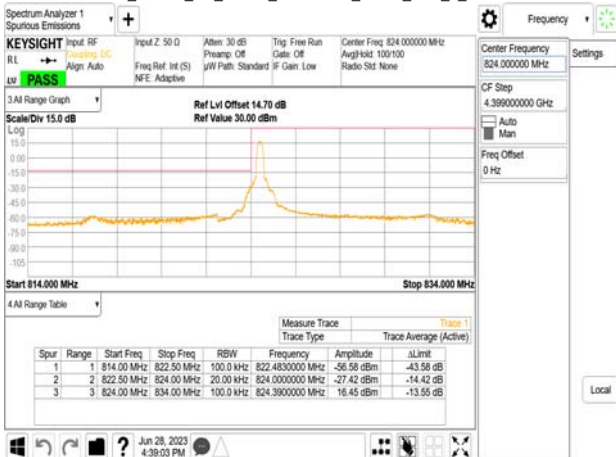

Band5_10MHz_CP_OFDM_SCS15kHz_QPSK_RB52_0_CH168800



Unless otherwise stated the results shown in this test report refer only to the sample(s) tested and such sample(s) are retained for 90 days only.

除非另有說明，此報告結果僅對測試之樣品負責，同時此樣品僅保留90天。本報告未經本公司書面許可，不可部份複製。

This document is issued by the Company subject to its General Conditions of Service printed overleaf, available on request or accessible at <http://www.sgs.com.tw/Terms-and-Conditions> and for electronic format documents, subject to Terms and Conditions for Electronic Documents at <http://www.sgs.com.tw/Terms-and-Conditions>. Attention is drawn to the limitation of liability, indemnification and jurisdiction issues defined therein. Any holder of this document is advised that information contained hereon reflects the Company's findings at the time of its intervention only and within the limits of Client's instructions, if any. The Company's sole responsibility is to its Client and this document does not exonerate parties to a transaction from exercising all their rights and obligations under the transaction documents. This document cannot be reproduced except in full, without prior written approval of the Company. Any unauthorized alteration, forgery or falsification of the content or appearance of this document is unlawful and offenders may be prosecuted to the fullest extent of the law.

Band5_15MHz_DFT_s_OFDM_SCS15kHz_BPSK_RB1_0_CH166300

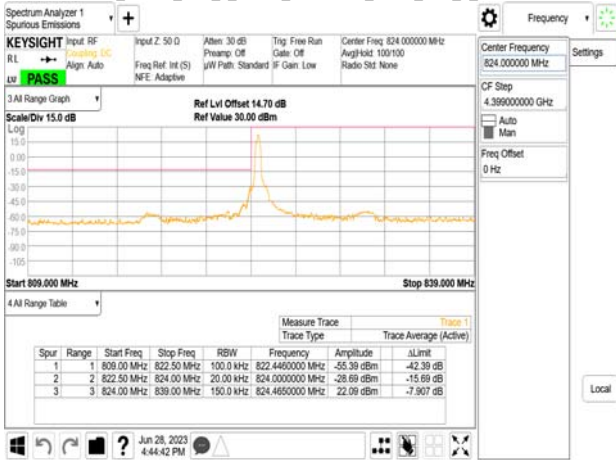

Band5_15MHz_DFT_s_OFDM_SCS15kHz_BPSK_RB75_0_CH168300

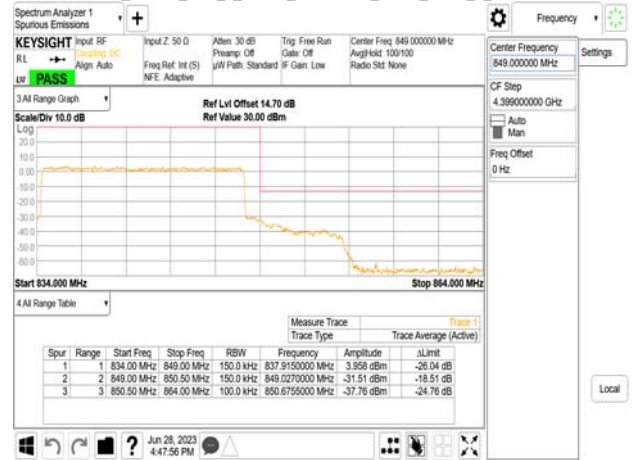

Band5_15MHz_DFT_s_OFDM_SCS15kHz_BPSK_RB1_78_CH168300

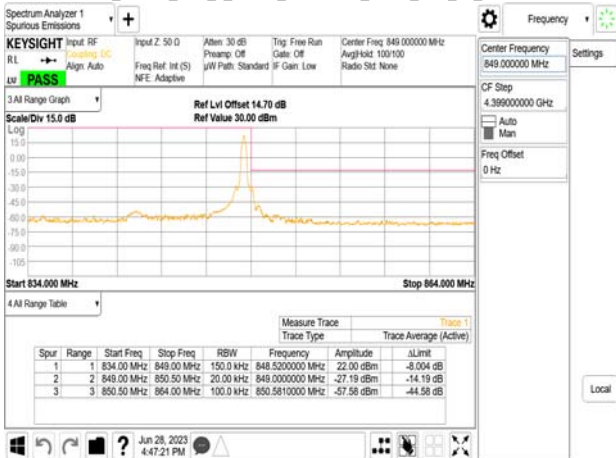

Band5_15MHz_CP_OFDM_SCS15kHz_QPSK_RB1_0_CH166300

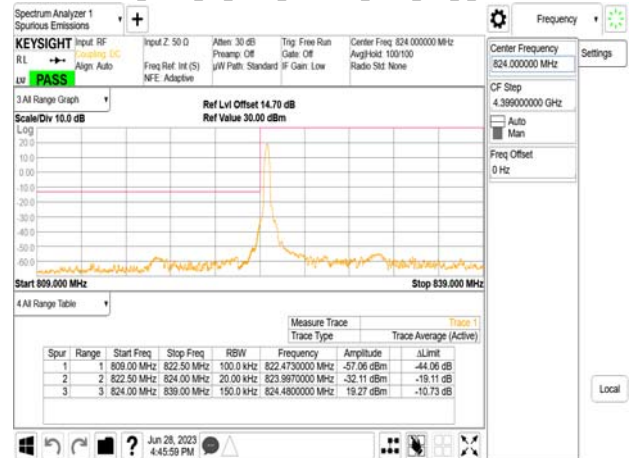

Band5_15MHz_DFT_s_OFDM_SCS15kHz_BPSK_RB75_0_CH168300

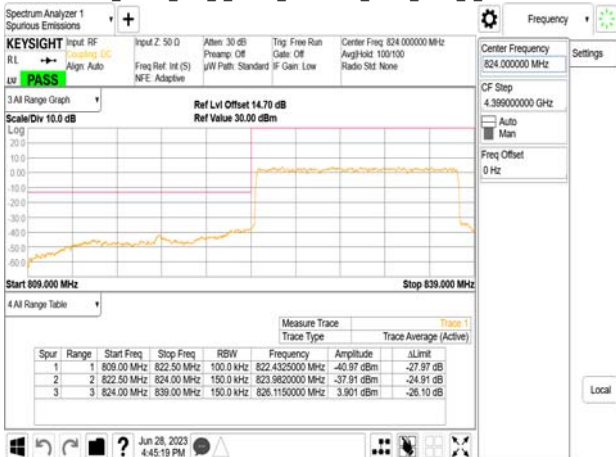

Band5_15MHz_CP_OFDM_SCS15kHz_QPSK_RB1_78_CH168300

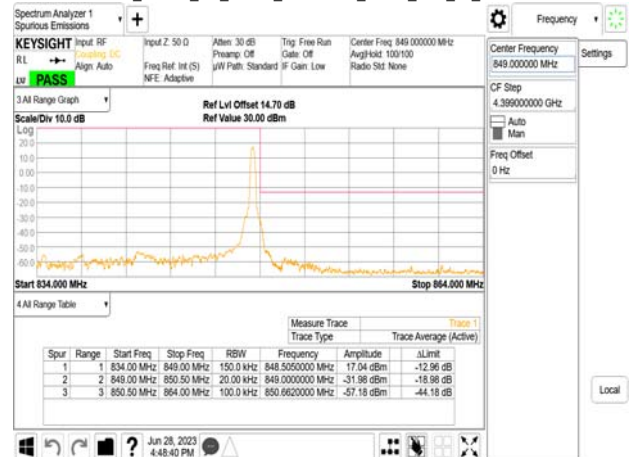

Unless otherwise stated the results shown in this test report refer only to the sample(s) tested and such sample(s) are retained for 90 days only.

除非另有說明，此報告結果僅對測試之樣品負責，同時此樣品僅保留90天。本報告未經本公司書面許可，不可部份複製。

This document is issued by the Company subject to its General Conditions of Service printed overleaf, available on request or accessible at <http://www.sgs.com.tw/Terms-and-Conditions> and for electronic format documents, subject to Terms and Conditions for Electronic Documents at <http://www.sgs.com.tw/Terms-and-Conditions>. Attention is drawn to the limitation of liability, indemnification and jurisdiction issues defined therein. Any holder of this document is advised that information contained hereon reflects the Company's findings at the time of its intervention only and within the limits of Client's instructions, if any. The Company's sole responsibility is to its Client and this document does not exonerate parties to a transaction from exercising all their rights and obligations under the transaction documents. This document cannot be reproduced except in full, without prior written approval of the Company. Any unauthorized alteration, forgery or falsification of the content or appearance of this document is unlawful and offenders may be prosecuted to the fullest extent of the law.

Band5_15MHz_CP_OFDM_SCS15kHz_OPSK_RB79_0_CH166300



Band5_20MHz_DFT_s_OFDM_SCS15kHz_BPSK_RB1_105_CH167800

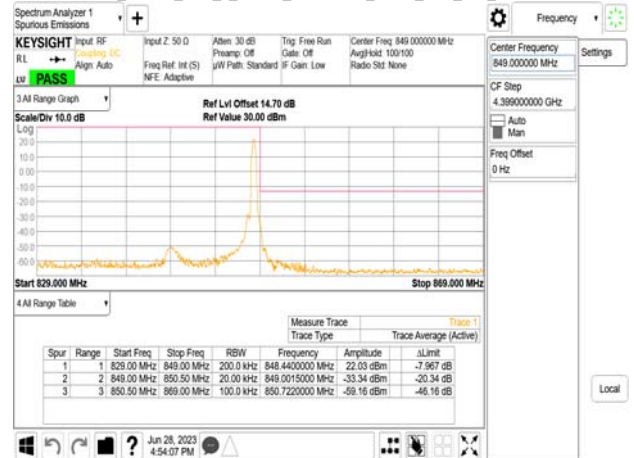

Band5_15MHz_CP_OFDM_SCS15kHz_OPSK_RB79_0_CH168300



Band5_20MHz_DFT_s_OFDM_SCS15kHz_BPSK_RB100_0_CH166800



Band5_20MHz_DFT_s_OFDM_SCS15kHz_BPSK_RB1_0_CH166800

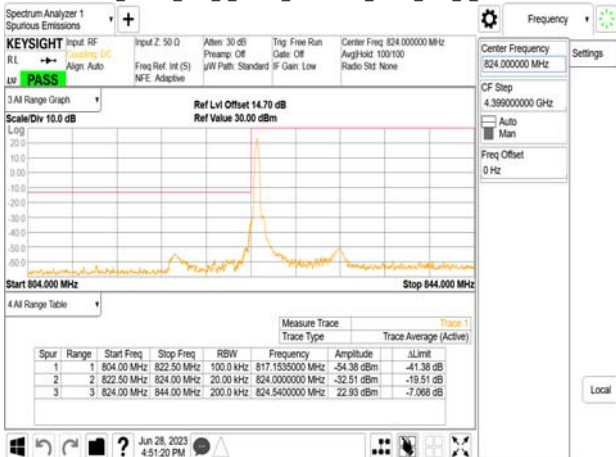

Band5_20MHz_DFT_s_OFDM_SCS15kHz_BPSK_RB100_0_CH167800



Unless otherwise stated the results shown in this test report refer only to the sample(s) tested and such sample(s) are retained for 90 days only.

除非另有說明，此報告結果僅對測試之樣品負責，同時此樣品僅保留90天。本報告未經本公司書面許可，不可部份複製。

This document is issued by the Company subject to its General Conditions of Service printed overleaf, available on request or accessible at <http://www.sgs.com.tw/Terms-and-Conditions> and for electronic format documents, subject to Terms and Conditions for Electronic Documents at <http://www.sgs.com.tw/Terms-and-Conditions>. Attention is drawn to the limitation of liability, indemnification and jurisdiction issues defined therein. Any holder of this document is advised that information contained hereon reflects the Company's findings at the time of its intervention only and within the limits of Client's instructions, if any. The Company's sole responsibility is to its Client and this document does not exonerate parties to a transaction from exercising all their rights and obligations under the transaction documents. This document cannot be reproduced except in full, without prior written approval of the Company. Any unauthorized alteration, forgery or falsification of the content or appearance of this document is unlawful and offenders may be prosecuted to the fullest extent of the law.