



FCC RF Test Report

APPLICANT : ASUSTeK COMPUTER INC.
EQUIPMENT : ASUS Phone (Mobile Phone)
BRAND NAME : ASUS
MODEL NAME : ASUS_AI2205_E, ASUS_AI2205_F
FCC ID : MSQAI2205
STANDARD : 47 CFR Part 2, 96
CLASSIFICATION : Citizens Band End User Devices (CBE)
EQUIPMENT TYPE : End User Equipment
TEST DATE(S) : Feb. 10, 2023 ~ Feb. 24, 2023

We, Sporton International Inc. (Shenzhen), would like to declare that the tested sample has been evaluated in accordance with the procedures given in ANSI C63.26 and shown compliance with the applicable technical standards.

The test results in this report apply exclusively to the tested model / sample. Without written approval of Sporton International Inc. (Shenzhen), the test report shall not be reproduced except in full.

Jason Jia



Approved by: Jason Jia

Sporton International Inc. (ShenZhen)

1/F, 2/F, Bldg 5, Shiling Industrial Zone, Xinwei Village, Xili, Nanshan, Shenzhen, 518055

People's Republic of China



Table of Contents

History of this test report..... 3

Summary of Test Result..... 4

1 General Description 5

 1.1 Applicant..... 5

 1.2 Manufacturer 5

 1.3 Feature of Equipment Under Test..... 5

 1.4 Maximum EIRP Power and Emission Designator 6

 1.5 Testing Site..... 7

 1.6 Test Software 7

 1.7 Applied Standards 7

2 Test Configuration of Equipment Under Test 8

 2.1 Test Mode..... 8

 2.2 Connection Diagram of Test System 9

 2.3 Support Unit used in test configuration 9

 2.4 Measurement Results Explanation Example 9

 2.5 Frequency List of Low/Middle/High Channels 10

3 Conducted Test Items 11

 3.1 Measuring Instruments..... 11

 3.2 Conducted Output Power 12

 3.3 EIRP 13

 3.4 Occupied Bandwidth 14

 3.5 Conducted Band Edge 15

 3.6 Conducted Spurious Emission 16

 3.7 Frequency Stability..... 17

4 Radiated Test Items 18

 4.1 Measuring Instruments..... 18

 4.2 Test Setup 18

 4.3 Test Result of Radiated Test..... 19

 4.4 Radiated Spurious Emission 20

5 List of Measuring Equipment..... 21

6 Uncertainty of Evaluation 22

Appendix A. Test Results of Conducted Test

Appendix B. Test Results of EIRP and Radiated Test

Appendix C. Test Setup Photographs



History of this test report

Report No.	Version	Description	Issued Date
FG2D3005K	01	Initial issue of report	Apr. 12, 2023



Summary of Test Result

Report Clause	Ref Std. Clause	Test Items	Result (PASS/FAIL)	Remark
3.2	§2.1046	Conducted Output Power	Reporting only	-
-	§96.41	Peak-to-Average Ratio	Not Applicable	Not applicable for End User Devices
3.3	§96.41	Maximum E.I.R.P	Pass	-
		Maximum Power Spectral Density	Not Applicable	Not applicable for End User Devices
3.4	§2.1049 §96.41	Occupied Bandwidth	Reporting only	-
3.5	§2.1051 §96.41	Conducted Band Edge Measurement Adjacent Channel Leakage Ratio	Pass	-
3.6	§2.1051 §96.41	Conducted Spurious Emission	Pass	
3.7	§2.1055	Frequency Stability for Temperature & Voltage	Pass	-
4.4	§2.1051 §96.41	Radiated Spurious Emission	Pass	Under limit 12.72 dB at 10819.20 MHz

Declaration of Conformity:
The test results with all measurement uncertainty excluded are presented in accordance with the regulation limits or requirements declared by manufacturers.
Comments and Explanations:
The declared of product specification for EUT presented in the report are provided by the manufacturer, and the manufacturer takes all the responsibilities for the accuracy of product specification.



1 General Description

1.1 Applicant

ASUSTeK COMPUTER INC.

1F., No. 15, Lide Rd., Beitou Dist., Taipei City 112, Taiwan

1.2 Manufacturer

ASUSTeK COMPUTER INC.

1F., No. 15, Lide Rd., Beitou Dist., Taipei City 112, Taiwan

1.3 Feature of Equipment Under Test

Product Feature	
Equipment	ASUS Phone (Mobile Phone)
Brand Name	ASUS
Model Name	ASUS_AI2205_E, ASUS_AI2205_F
FCC ID	MSQAI2205
Tx Frequency	5G NR n48: 3550 MHz ~ 3700 MHz
Rx Frequency	5G NR n48: 3550 MHz ~ 3700 MHz
Bandwidth	10MHz / 15MHz / 20MHz / 30MHz / 40MHz
SCS	30kHz
Antenna Gain / Type	<Ant.7>: -3.56 dBi / PIFA Antenna <Ant.8>: -2.71 dBi / PIFA Antenna <Ant.9>: -2.02 dBi / PIFA Antenna <Ant.10>: -3.3 dBi / PIFA Antenna
Type of Modulation	DFT-s-OFDM (PI/2 BPSK / QPSK / 16QAM / 64QAM / 256QAM) CP-OFDM (QPSK / 16QAM / 64QAM / 256QAM)
IMEI Code	Conducted: 355156850100810/355156850100828 Radiation: 355156850101156/355156850101164
HW Version	R2.0
SW Version	Android 13
EUT Stage	Identical Prototype

Remark:

1. The above EUT's information was declared by manufacturer. Please refer to the specifications or user's manual for more detailed description.
2. The maximum EIRP is calculated from max output power and antenna gain, only the maximum EIRP of Antenna 9 is shown in the report.
3. 5G NR n48 supports for SA mode only.
4. when temperature lower than -10 °C, EUT will be shut down automatically, thus Frequency Stability item only test -10~50 °C.
5. There are four SKUs of EUT for this project. The differences between them are summary below, According to the difference, we evaluate SKU1 (ASUS_AI2205_F) to perform RF test.



Sample list				
	SKU1	SKU2	SKU3	SKU4
Model name	ASUS_AI2205_F	ASUS_AI2205_E	ASUS_AI2205_F	ASUS_AI2205_E
Config.	US(Pro)	US(Entry)	US(Pro)	US(Entry)
RF module board	US(Pro)	US(Entry)	US(Pro)	US(Entry)
LCD+Touch front frame	AI2205 FRONT CASE ASSY WW	AI2205 FRONT CASE ASSY WW	AI2205 FRONT CASE ASSY WW	AI2205 FRONT CASE ASSY WW
DDR	16G(Micron) Micron / MT62F2G64D8CL-023 WT:B	16G(Micron) Micron / MT62F2G64D8CL-023 WT:B	16G(Micron) Micron / MT62F2G64D8CL-023 WT:B	16G(Micron) Micron / MT62F2G64D8CL-023 WT:B
UFS	512G(Kioxia)(UFS4.0) Kioxia / THGJFJT2T85BAT0	512G(Samsung)(UFS4.0) Samsung /KLUF8RHHD-B0G1	512G(Kioxia)(UFS4.0) Kioxia / THGJFJT2T85BAT0	512G(Samsung)(UFS4.0) Samsung /KLUF8RHHD-B0G1
MB	AI2205_MB	AI2205_MB	AI2205_MB	AI2205_MB
Back cover	WW-Dark-Ult	WW-Light-Entry	WW-Dark-Ult	WW-Light-Entry
Battery	SCUD / C21P2101	SWD / C21P2101	SWD / C21P2101	SCUD / C21P2101
Rear Camera 50+13M	SHINETECH/CDN60B	TRIPLEWIN/CASDA-002A 1	TRIPLEWIN/CASDA-002A 1	SHINETECH/CDN60B
Front Camera 32M	TSPRECISSION/TVHF2170	SHINETECH/ST-CMG07B	SHINETECH/ST-CMG07B	TSPRECISSION/TVHF2170
Rear Camera 5M	HUNAN KINGCOME/KBFE378	TSPRECISSION/TV8F2224	TSPRECISSION/TV8F2224	HUNAN KINGCOME/KBFE378
PCB	COMPEQ	COMPEQ	COMPEQ	COMPEQ
CPU	QUALCOMM MPSP1581 / SM-8550 MPSP1581 CS	QUALCOMM MPSP1581 / SM-8550 MPSP1581 CS	QUALCOMM MPSP1581 / SM-8550 MPSP1581 CS	QUALCOMM MPSP1581 / SM-8550 MPSP1581 CS

1.4 Maximum EIRP Power and Emission Designator

5G NR n48		PI/2 BPSK / QPSK		16QAM/64QAM/256QAM	
BW (MHz)	Frequency Range (MHz)	Maximum EIRP(W)	Emission Designator (99%OBW)	Maximum EIRP(W)	Emission Designator (99%OBW)
10	3555.00~3694.98	0.0665	8M58G7D	0.0538	8M59W7D
15	3557.52~3692.49	0.0689	13M6G7D	0.0545	13M6W7D
20	3560.01~3690.00	0.0687	18M2G7D	0.0553	18M3W7D
30	3565.02~3684.99	0.0705	27M9G7D	0.0570	27M9W7D
40	3570.00~3679.98	0.0706	37M8G7D	0.0573	37M9W7D

Note: All modulations have been tested, and only the worst test results of PSK & QAM are shown in the report.



1.5 Testing Site

Sporton International Inc. (ShenZhen) is accredited to ISO/IEC 17025:2017 by American Association for Laboratory Accreditation with Certificate Number 5145.01.

Test Firm	Sporton International Inc. (ShenZhen)		
Test Site Location	1/F, 2/F, Bldg 5, Shiling Industrial Zone, Xinwei Village, Xili, Nanshan, Shenzhen, 518055 People's Republic of China TEL: +86-755-86379589 FAX: +86-755-86379595		
Test Site No.	Sporton Site No.	FCC Designation No.	FCC Test Firm Registration No.
	TH01-SZ	CN1256	421272

Test Firm	Sporton International Inc. (ShenZhen)		
Test Site Location	101, 1st Floor, Block B, Building 1, No. 2, Tengfeng 4th Road, Fenghuang Community, Fuyong Street, Baoan District, Shenzhen City Guangdong Province China 518103 TEL: +86-755-33202398		
Test Site No.	Sporton Site No.	FCC Designation No.	FCC Test Firm Registration No.
	03CH01-SZ	CN1256	421272

1.6 Test Software

Item	Site	Manufacturer	Name	Version
1.	03CH01-SZ	AUDIX	E3	6.2009-8-24

1.7 Applied Standards

According to the specifications of the manufacturer, the EUT must comply with the requirements of the following standards:

- ♦ ANSI C63.26-2015
- ♦ 47 CFR Part 2, 96
- ♦ FCC KDB 971168 D01 Power Meas. License Digital Systems v03r01
- ♦ FCC KDB 940660 D01 Part 96 CBRS v03
- ♦ FCC KDB 412172 D01 Determining ERP and EIRP v01r01

Remark:

1. All test items were verified and recorded according to the standards and without any deviation during the test.
2. This EUT has also been tested and complied with the requirements of FCC Part 15, Subpart B, recorded in a separate test report.



2 Test Configuration of Equipment Under Test

2.1 Test Mode

Antenna port conducted and radiated test items listed below are performed according to KDB 971168 D01 Power Meas. License Digital Systems v03r01 with maximum output power.

For radiated measurement, pre-scanned in three orthogonal panels, X, Y, Z. The worst cases (Y plane) were recorded in this report.

Test Items	Band	Bandwidth (MHz)						Modulation					RB #		Test Channel			
		5	10	15	20	30	40	PI/2 BPSK	QPSK	16QAM	64QAM	256 QAM	1	Full	L	M	H	
Max. Output Power	n48	-	v	v	v	v	v	v	v	v	v	v	v	v	v	v	v	v
26dB and 99% Bandwidth	n48	-	v	v	v	v	v	v	v	v	v	v		v			v	
Adjacent Channel Leakage Ratio	n48	-	v	-	v		v	v	v				v	v	v	v	v	
Conducted Band Edge	n48	-	v	-	v		v	v	v				v	v	v	v	v	
Conducted Spurious Emission	n48	-	v	-	v		v	v	v				v	v	v	v	v	
E.I.R.P.	n48	-	v	v	v	v	v	v	v	v	v	v	v	v	v	v	v	
Frequency Stability	n48	-			v				v					v			v	
Radiated Spurious Emission	n48	Worst Case														v		
Remark	1. The mark "v" means that this configuration is chosen for testing 2. The mark "-" means that this bandwidth is not supported. 3. The device is investigated from 30MHz to 10 times of fundamental signal for radiated spurious emission test under different RB size/offset and modulations in exploratory test. Subsequently, only the worst case emissions are reported. 4. All test items are based on engineering evaluation. 5. Frequency Stability : Normal Voltage = 7.78V ; Low Voltage =7.3V ; High Voltage =8.7V																	

2.2 Connection Diagram of Test System

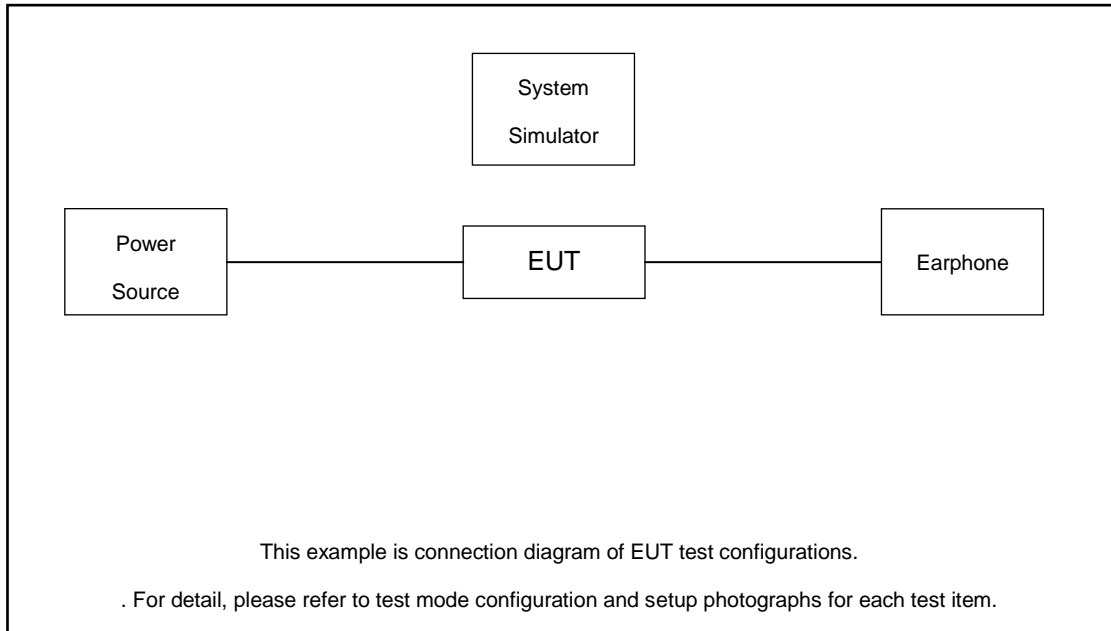

2.3 Support Unit used in test configuration

Item	Equipment	Trade Name	Model No.	FCC ID	Data Cable	Power Cord
1.	Power Supply	GWINSTEK	PSS-2002	N/A	N/A	Unshielded, 1.8 m
2.	NR Base Station	Anritsu	MT8000A	N/A	N/A	Unshielded, 1.8 m

2.4 Measurement Results Explanation Example

For all conducted test items:

The offset level is set in the spectrum analyzer to compensate the RF cable loss and attenuator factor between EUT conducted output port and spectrum analyzer. With the offset compensation, the spectrum analyzer reading level is exactly the EUT RF output level.

The spectrum analyzer offset is derived from RF cable loss and attenuator factor.

Offset = RF cable loss + attenuator factor.

Following shows an offset computation example with cable loss 5.68 dB and 10dB attenuator.

Example :

$$\begin{aligned} \text{Offset(dB)} &= \text{RF cable loss(dB)} + \text{attenuator factor(dB)}. \\ &= 5.68 + 10 = 15.68 \text{ (dB)} \end{aligned}$$



2.5 Frequency List of Low/Middle/High Channels

5G NR n48 Channel and Frequency List				
BW [MHz]	Channel/Frequency(MHz)	Lowest	Middle	Highest
40	Channel	638000	641666	645332
	Frequency	3570	3624.99	3679.98
30	Channel	637668	641666	645666
	Frequency	3565.02	3624.99	3684.99
20	Channel	637334	641666	646000
	Frequency	3560.01	3624.99	3690
15	Channel	637168	641666	646166
	Frequency	3557.52	3624.99	3692.49
10	Channel	637000	641666	646332
	Frequency	3555	3624.99	3694.98

3 Conducted Test Items

3.1 Measuring Instruments

See list of measuring instruments of this test report.

3.1.1 Test Setup

3.1.2 Conducted Output Power

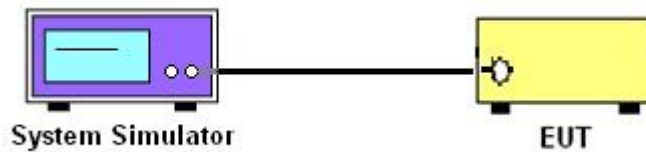

3.1.3 EIRP, Peak-to-Average Ratio, Occupied Bandwidth, Conducted Band-Edge and Conducted Spurious Emission

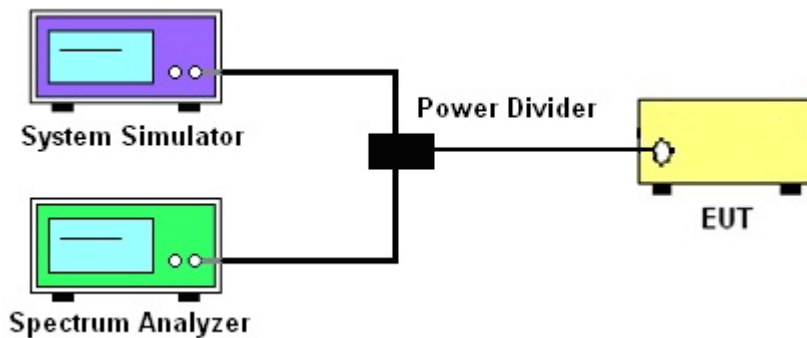

3.1.4 Frequency Stability

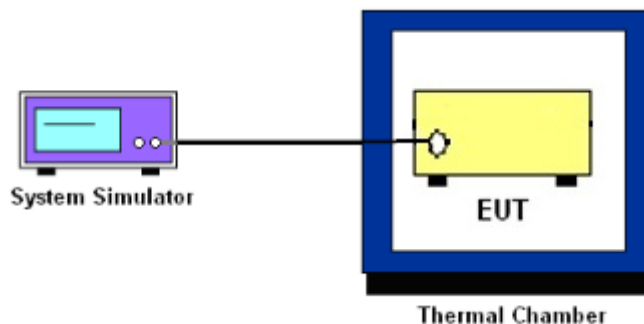

3.1.5 Test Result of Conducted Test

Please refer to Appendix A.



3.2 Conducted Output Power

3.2.1 Description of the Conducted Output Power Measurement

A system simulator was used to establish communication with the EUT. Its parameters were set to force the EUT transmitting at maximum output power. The measured power in the radio frequency on the transmitter output terminals shall be reported.

3.2.2 Test Procedures

1. The transmitter output port was connected to the system simulator.
2. Set EUT at maximum power through the system simulator.
3. Select lowest, middle, and highest channels for each band and different modulation.
4. Measure and record the power level from the system simulator.

3.3 EIRP

3.3.1 Description of the EIRP Measurement

EIRP limits for CBRS equipment as below table:

Device		Maximum EIRP (dBm/10 MHz)	Maximum PSD (dBm/MHz)
Applied	End User Device	23	n/a
<input type="checkbox"/>	Category A CBSD	30	20
<input type="checkbox"/>	Category B CBSD	47	37

Remark: The worst case EIRP shown in this section is found with LTE operating only using 1RB. As such, the EIRP/10MHz and full channel EIRP values will be identical since 1RB is fully contained within all available channel bandwidths for LTE Band 48 (i.e. 5, 10, 15, 20MHz)

3.3.2 Test Procedures for EIRP

1. Establishing a communications link with the call box (Base station) to measure the Maximum conducted power, the parameters were set to force the EUT transmitting at maximum output power level. Use the average power measurement function to measure total channel power of each channel bandwidth (per ANSI C63.26-2015 Section 5.2.1)
2. Determining ERP and/or EIRP from conducted RF output power measurements (Per ANSI C63.26-2015 Section 5.2.5.5)
 - EIRP = $P_T + G_T - L_C$, ERP = EIRP -2.15, where
 - P_T = transmitter output power in dBm
 - G_T = gain of the transmitting antenna in dBi
 - L_C = signal attenuation in the connecting cable between the transmitter and antenna in dB



3.4 Occupied Bandwidth

3.4.1 Description of Occupied Bandwidth Measurement

The occupied bandwidth is the width of a frequency band such that, below the lower and above the upper frequency limits, the mean powers emitted are each equal to a specified percentage 0.5% of the total mean transmitted power.

The 26 dB emission bandwidth is defined as the frequency range between two points, one above and one below the carrier frequency, at which the spectral density of the emission is attenuated 26 dB below the maximum in-band spectral density of the modulated signal. Spectral density (power per unit bandwidth) is to be measured with a detector of resolution bandwidth equal to approximately 1.0% of the emission bandwidth.

3.4.2 Test Procedures

The testing follows ANSI C63.26-2015 Section 5.4.3 (26dB) and Section 5.4.4 (99OB)

1. The EUT was connected to spectrum analyzer and system simulator via a power divider.
2. The spectrum analyzer center frequency is set to the nominal EUT channel center frequency. The span range for the spectrum analyzer shall be between two and five times the anticipated OBW.
3. The nominal resolution bandwidth (RBW) shall be in the range of 1 to 5 % of the anticipated OBW, and the VBW shall be at least 3 times the RBW.
4. Set the detection mode to peak, and the trace mode to max hold.
5. Determine the reference value: Set the EUT to transmit a modulated signal. Allow the trace to stabilize. Set the spectrum analyzer marker to the highest level of the displayed trace.
(this is the reference value)
6. Determine the “-26 dB down amplitude” as equal to (Reference Value – X).
7. Place two markers, one at the lowest and the other at the highest frequency of the envelope of the spectral display such that each marker is at or slightly below the “-X dB down amplitude” determined in step 6. If a marker is below this “-X dB down amplitude” value it shall be placed as close as possible to this value. The OBW is the positive frequency difference between the two markers.
8. Use the 99 % power bandwidth function of the spectrum analyzer and report the measured bandwidth.



3.5 Conducted Band Edge

3.5.1 Description of Conducted Band Edge Measurement

Part 96.41 (e) (1) (ii)

For End User Devices the emission limits outside the fundamental are as follows:

Within 0 MHz to B MHz above and below the assigned channel ≤ -13 dBm/MHz

Greater than B MHz above and below the assigned channel ≤ -25 dBm/MHz

where B is the bandwidth in megahertz of the assigned channel or multiple contiguous channels of the End User Device.

Notwithstanding the emission limits in this paragraph, the Adjacent Channel Leakage Ratio for End User Devices shall be at least 30 dB.

Part 96.41 (e) (2)

For CBSDs and End User Devices, the conducted power of emissions below 3540 MHz or above 3710 MHz shall not exceed -25 dBm/MHz, and the conducted power of emissions below 3530 MHz or above 3720 MHz shall not exceed -40 dBm/MHz

3.5.2 Test Procedures

The testing follows FCC KDB 971168 D01 v03r01 Section 6.1.

1. The EUT was connected to spectrum analyzer and system simulator via a power divider.
2. The band edges of low and high channels for the highest RF powers were measured.
3. Set RBW $\geq 1\%$ EBW in the 1MHz band immediately outside and adjacent to the band edge.
4. Beyond the 1 MHz band from the band edge, RBW=1MHz was used
5. Offset has included the duty factor for LTE Band 48. Duty factor $=10 \log (1/x)$, where x is the measured duty cycle.
6. Set spectrum analyzer with RMS detector.
7. The RF fundamental frequency should be excluded against the limit line in the operating frequency band.
8. When using the integration method, the starting frequency of the integration shall be centered at one-half of the RBW away from the band edge.



3.6 Conducted Spurious Emission

3.6.1 Description of Conducted Spurious Emission Measurement

96.41 (e)(2)

The conducted power of any emissions below 3530 MHz or above 3720 MHz shall not exceed -40dBm/MHz.

3.6.2 Test Procedures

The testing follows FCC KDB 971168 D01 v03r01 Section 6.1.

1. The EUT was connected to spectrum analyzer and system simulator via a power divider.
2. The RF output of EUT was connected to the spectrum analyzer by RF cable and attenuator. The path loss was compensated to the results for each measurement.
3. The middle channel for the highest RF power within the transmitting frequency was measured.
4. The conducted spurious emission for the whole frequency range was taken.
5. Make the measurement with the spectrum analyzer's RBW = 1MHz, VBW = 3MHz.
6. Set spectrum analyzer with RMS detector.
7. Taking the record of maximum spurious emission.
8. The RF fundamental frequency should be excluded against the limit line in the operating frequency band.
9. The limit line is -40dBm/MHz.



3.7 Frequency Stability

3.7.1 Description of Frequency Stability Measurement

The frequency stability shall be measured by variation of ambient temperature and variation of primary supply voltage to ensure that the fundamental emission stays within the authorized frequency block. The frequency stability of the transmitter shall be maintained within $\pm 0.00025\%$ ($\pm 2.5\text{ppm}$) of the center frequency

3.7.2 Test Procedures for Temperature Variation

The testing follows FCC KDB 971168 D01 v03r01 Section 9.0.

1. The EUT was set up in the thermal chamber and connected with the system simulator.
2. With power OFF, the temperature was decreased to -10°C and the EUT was stabilized before testing. Power was applied and the maximum change in frequency was recorded within one minute.
3. With power OFF, the temperature was raised in 10°C step up to 50°C . The EUT was stabilized at each step for at least half an hour. Power was applied and the maximum frequency change was recorded within one minute.

3.7.3 Test Procedures for Voltage Variation

The testing follows FCC KDB 971168 D01 v03r01 Section 9.0.

1. The EUT was placed in a temperature chamber at $25\pm 5^{\circ}\text{C}$ and connected with the system simulator.
2. The power supply voltage to the EUT was varied from 85% to 115% of the nominal value measured at the input to the EUT.
3. The variation in frequency was measured for the worst case.

4 Radiated Test Items

4.1 Measuring Instruments

See list of measuring instruments of this test report.

4.2 Test Setup

4.2.1 For radiated test below 30MHz

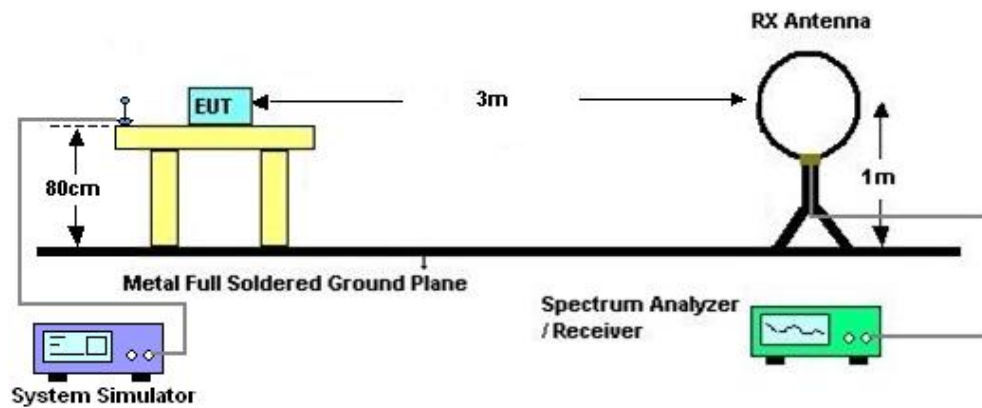

4.2.2 For radiated test from 30MHz to 1GHz

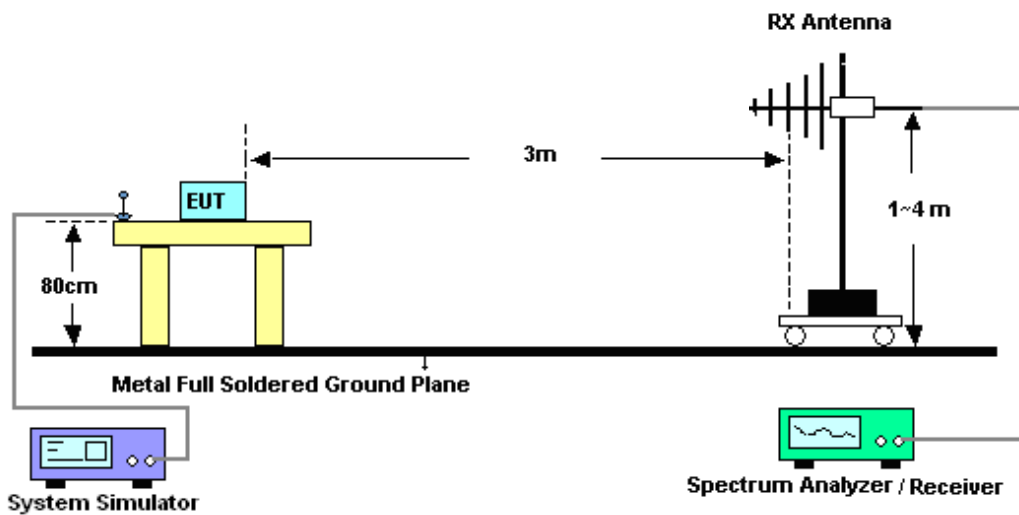

4.2.3 For radiated test above 1GHz

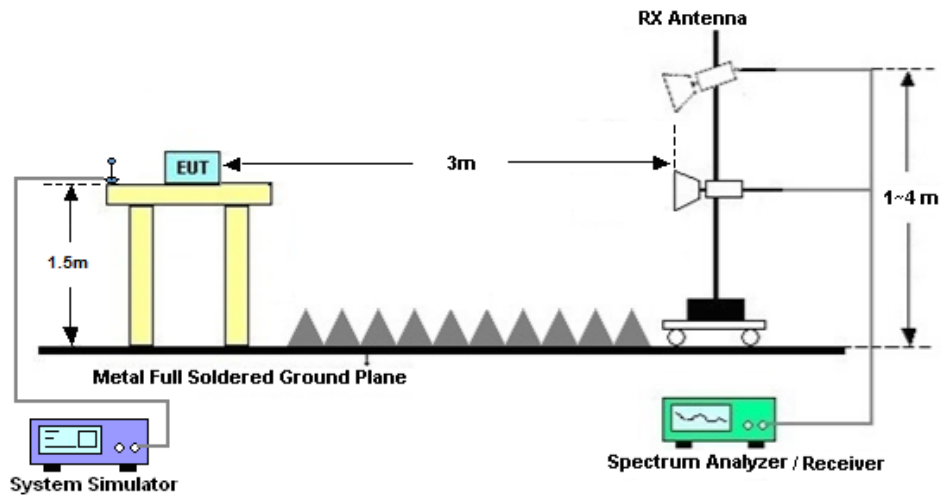

4.3 Test Result of Radiated Test

The low frequency, which started from 9 kHz to 30MHz, was pre-scanned and the result which was 20dB lower than the limit line was not reported.

Please refer to Appendix B.



4.4 Radiated Spurious Emission

4.4.1 Description of Radiated Spurious Emission Measurement

The radiated spurious emission was measured by substitution method according to ANSI C63.26. The power of any emission outside of the authorized operating frequency ranges must be attenuated below the transmitter power (P) by a factor of at least -40dBm / MHz.

The spectrum is scanned from 30 MHz up to a frequency including its 10th harmonic.

4.4.2 Test Procedures

1. The EUT was placed on a turntable with 0.8 meter height for frequency below 1GHz and 1.5 meter height for frequency above 1GHz respectively above ground.
2. The EUT was set 3 meters from the receiving antenna mounted on the antenna tower.
3. The table was rotated 360 degrees to determine the position of the highest spurious emission.
4. The height of the receiving antenna is varied between 1m to 4m to search the maximum spurious emission for both horizontal and vertical polarizations.
5. During the measurement, the system simulator parameters were set to force the EUT transmitting at maximum output power.
6. Make the measurement with the spectrum analyzer's RBW = 1MHz, VBW = 3MHz, taking the record of maximum spurious emission.
7. A horn antenna was substituted in place of the EUT and was driven by a signal generator. Tune the output power of signal generator to the same emission level with EUT maximum spurious emission.
$$\text{EIRP (dBm)} = \text{S.G. Power} - \text{Tx Cable Loss} + \text{Tx Antenna Gain}$$
$$\text{ERP (dBm)} = \text{EIRP} - 2.15$$
8. The RF fundamental frequency should be excluded against the limit line in the operating frequency band.
The limit line is -40dBm/MHz



5 List of Measuring Equipment

Instrument	Manufacturer	Model No.	Serial No.	Characteristics	Calibration Date	Test Date	Due Date	Remark
Spectrum Analyzer	R&S	FSV40	101078	10Hz~40GHz	Apr. 07, 2022	Feb. 21, 2023~ Feb. 24, 2023	Apr. 06, 2023	Conducted (TH01-SZ)
Power Divider	TOJOIN	PS-2SM-04 265	60.06.020.007 7	0.4GHz~26.5GHz	Dec. 25, 2022	Feb. 21, 2023~ Feb. 24, 2023	Dec. 24, 2023	Conducted (TH01-SZ)
Thermal Chamber	Ten Billion Hongzhangroup	LP-150U	H2014081803	-40~+150°C	Jul. 07, 2022	Feb. 21, 2023~ Feb. 24, 2023	Jul. 06, 2023	Conducted (TH01-SZ)
EMI Test Receiver&SA	Agilent	N9038A	MY52260185	20Hz~26.5GHz	Dec. 26, 2022	Feb. 10, 2023	Dec. 25, 2023	Radiation (03CH01-SZ)
EXA Spectrum Analyzer	KEYSIGHT	N9010A	MY55150213	10Hz~44GHz	Jul. 07, 2022	Feb. 10, 2023	Jul. 06, 2023	Radiation (03CH01-SZ)
Loop Antenna	R&S	HFH2-Z2	100354	9kHz~30MHz	Jul. 28, 2022	Feb. 10, 2023	Jul. 27, 2023	Radiation (03CH01-SZ)
Bilog Antenna	TeseQ	CBL6112D	35407	30MHz-2GHz	Sep. 28, 2022	Feb. 10, 2023	Sep. 27, 2023	Radiation (03CH01-SZ)
Double Ridge Horn Antenna	ETS-Lindgren	3117	00119436	1GHz~18GHz	Jul. 07, 2022	Feb. 10, 2023	Jul. 06, 2023	Radiation (03CH01-SZ)
SHF-EHF Horn	com-power	AH-840	101071	18Ghz-40GHz	Apr. 10, 2022	Feb. 10, 2023	Apr. 09, 2023	Radiation (03CH01-SZ)
LF Amplifier	Burgeon	BPA-530	102209	0.01~3000Mhz	Apr. 06, 2022	Feb. 10, 2023	Apr. 05, 2023	Radiation (03CH01-SZ)
HF Amplifier	MITEQ	AMF-7D-00 101800-30-1 0P-R	1943528	1GHz~18GHz	Oct. 19, 2022	Feb. 10, 2023	Oct. 18, 2023	Radiation (03CH01-SZ)
HF Amplifier	KEYSIGHT	83017A	MY53270105	0.5GHz~26.5Ghz	Oct. 19, 2022	Feb. 10, 2023	Oct. 18, 2023	Radiation (03CH01-SZ)
HF Amplifier	MITEQ	TTA1840-35 -HG	1871923	18GHz~40GHz	Jul. 06, 2022	Feb. 10, 2023	Jul. 05, 2023	Radiation (03CH01-SZ)
AC Power Source	Chroma	61601	61601000198 5	N/A	Nov. 10, 2022	Feb. 10, 2023	Nov. 09, 2023	Radiation (03CH01-SZ)
Turn Table	EM	EM1000	N/A	0~360 degree	NCR	Feb. 10, 2023	NCR	Radiation (03CH01-SZ)
Antenna Mast	EM	EM1000	N/A	1 m~4 m	NCR	Feb. 10, 2023	NCR	Radiation (03CH01-SZ)

NCR: No Calibration Required.



6 Uncertainty of Evaluation

Uncertainty of Conducted Measurement

Test Item	Uncertainty
Conducted Power	±1.34 dB
Conducted Emissions	±1.34 dB
Occupied Channel Bandwidth	±0.13 %

Uncertainty of Radiated Emission Measurement (30 MHz ~ 1000 MHz)

Measuring Uncertainty for a Level of Confidence of 95% (U = 2Uc(y))	2.48dB
---	--------

Uncertainty of Radiated Emission Measurement (1 GHz ~ 18 GHz)

Measuring Uncertainty for a Level of Confidence of 95% (U = 2Uc(y))	3.53dB
---	--------

Uncertainty of Radiated Emission Measurement (18 GHz ~ 40 GHz)

Measuring Uncertainty for a Level of Confidence of 95% (U = 2Uc(y))	4.02dB
---	--------

----- THE END -----



Appendix A. Test Results of Conducted Test

Test Engineer :	Jung Kuo	Temperature :	22~23°C
		Relative Humidity :	40~42%

FR1 N48

Transmitter Conducted Output Power And EIRP, (G_T - L_C)= -2.02dBi

NR Band	SCS (kHz)	Bandwidth (MHz)	Arfcn	Freq (MHz)	Modulation	RB	Conducted Power(dBm)	EIRP (dBm)	EIRP (W)
48	30	10	637000	3555	DFT-s-OFDM QPSK	1@1	20.25	18.23	0.0665
48	30	10	637000	3555	DFT-s-OFDM 16 QAM	1@1	19.33	17.31	0.0538
48	30	10	641666	3624.99	DFT-s-OFDM QPSK	1@1	20.09	18.07	0.0641
48	30	10	641666	3624.99	DFT-s-OFDM 16 QAM	1@1	19.19	17.17	0.0521
48	30	10	646332	3694.98	DFT-s-OFDM QPSK	1@1	20.19	18.17	0.0656
48	30	10	646332	3694.98	DFT-s-OFDM 16 QAM	1@1	19.25	17.23	0.0528
48	30	15	637168	3557.52	DFT-s-OFDM QPSK	1@1	20.4	18.38	0.0689
48	30	15	637168	3557.52	DFT-s-OFDM 16 QAM	1@1	19.38	17.36	0.0545
48	30	15	641666	3624.99	DFT-s-OFDM QPSK	1@1	20.24	18.22	0.0664
48	30	15	641666	3624.99	DFT-s-OFDM 16 QAM	1@1	19.27	17.25	0.0531
48	30	15	646166	3692.49	DFT-s-OFDM QPSK	1@1	20.32	18.3	0.0676
48	30	15	646166	3692.49	DFT-s-OFDM 16 QAM	1@1	19.34	17.32	0.0540
48	30	20	637334	3560.01	DFT-s-OFDM QPSK	1@1	20.39	18.37	0.0687
48	30	20	637334	3560.01	DFT-s-OFDM 16 QAM	1@1	19.45	17.43	0.0553
48	30	20	641666	3624.99	DFT-s-OFDM QPSK	1@1	20.21	18.19	0.0659
48	30	20	641666	3624.99	DFT-s-OFDM 16 QAM	1@1	19.2	17.18	0.0522
48	30	20	646000	3690	DFT-s-OFDM QPSK	1@1	20.31	18.29	0.0675
48	30	20	646000	3690	DFT-s-OFDM 16 QAM	1@1	19.29	17.27	0.0533
48	30	30	637668	3565.02	DFT-s-OFDM QPSK	1@1	20.5	18.48	0.0705
48	30	30	637668	3565.02	DFT-s-OFDM 16 QAM	1@1	19.58	17.56	0.0570
48	30	30	641666	3624.99	DFT-s-OFDM QPSK	1@1	20.39	18.37	0.0687
48	30	30	641666	3624.99	DFT-s-OFDM 16 QAM	1@1	19.32	17.3	0.0537
48	30	30	645666	3684.99	DFT-s-OFDM QPSK	1@1	20.44	18.42	0.0695
48	30	30	645666	3684.99	DFT-s-OFDM 16 QAM	1@1	19.45	17.43	0.0553
48	30	40	638000	3570	DFT-s-OFDM PI/2 BPSK	50@25	20.41	18.39	0.0690
48	30	40	638000	3570	DFT-s-OFDM PI/2 BPSK	1@1	20.45	18.43	0.0697
48	30	40	638000	3570	DFT-s-OFDM PI/2 BPSK	1@104	20.34	18.32	0.0679
48	30	40	638000	3570	DFT-s-OFDM QPSK	50@25	20.33	18.31	0.0678
48	30	40	638000	3570	DFT-s-OFDM QPSK	1@1	20.51	18.49	0.0706

48	30	40	638000	3570	DFT-s-OFDM QPSK	1@104	20.33	18.31	0.0678
48	30	40	638000	3570	DFT-s-OFDM 16 QAM	50@25	19.41	17.39	0.0548
48	30	40	638000	3570	DFT-s-OFDM 16 QAM	1@1	19.6	17.58	0.0573
48	30	40	638000	3570	DFT-s-OFDM 16 QAM	1@104	19.36	17.34	0.0542
48	30	40	638000	3570	DFT-s-OFDM 64 QAM	50@25	17.9	15.88	0.0387
48	30	40	638000	3570	DFT-s-OFDM 64 QAM	1@1	18	15.98	0.0396
48	30	40	638000	3570	DFT-s-OFDM 64 QAM	1@104	17.78	15.76	0.0377
48	30	40	638000	3570	DFT-s-OFDM 256 QAM	50@25	15.82	13.8	0.0240
48	30	40	638000	3570	DFT-s-OFDM 256 QAM	1@1	15.85	13.83	0.0242
48	30	40	638000	3570	DFT-s-OFDM 256 QAM	1@104	15.73	13.71	0.0235
48	30	40	638000	3570	CP-OFDM QPSK	53@26	18.85	16.83	0.0482
48	30	40	638000	3570	CP-OFDM QPSK	1@1	18.93	16.91	0.0491
48	30	40	638000	3570	CP-OFDM QPSK	1@104	18.79	16.77	0.0475
48	30	40	641666	3624.99	DFT-s-OFDM PI/2 BPSK	50@25	20.23	18.21	0.0662
48	30	40	641666	3624.99	DFT-s-OFDM PI/2 BPSK	1@1	20.4	18.38	0.0689
48	30	40	641666	3624.99	DFT-s-OFDM PI/2 BPSK	1@104	20.25	18.23	0.0665
48	30	40	641666	3624.99	DFT-s-OFDM QPSK	50@25	20.22	18.2	0.0661
48	30	40	641666	3624.99	DFT-s-OFDM QPSK	1@1	20.38	18.36	0.0685
48	30	40	641666	3624.99	DFT-s-OFDM QPSK	1@104	20.2	18.18	0.0658
48	30	40	641666	3624.99	DFT-s-OFDM 16 QAM	50@25	19.24	17.22	0.0527
48	30	40	641666	3624.99	DFT-s-OFDM 16 QAM	1@1	19.39	17.37	0.0546
48	30	40	641666	3624.99	DFT-s-OFDM 16 QAM	1@104	19.33	17.31	0.0538
48	30	40	641666	3624.99	DFT-s-OFDM 64 QAM	50@25	17.73	15.71	0.0372
48	30	40	641666	3624.99	DFT-s-OFDM 64 QAM	1@1	17.89	15.87	0.0386
48	30	40	641666	3624.99	DFT-s-OFDM 64 QAM	1@104	17.74	15.72	0.0373
48	30	40	641666	3624.99	DFT-s-OFDM 256 QAM	50@25	15.68	13.66	0.0232
48	30	40	641666	3624.99	DFT-s-OFDM 256 QAM	1@1	15.67	13.65	0.0232
48	30	40	641666	3624.99	DFT-s-OFDM 256 QAM	1@104	15.58	13.56	0.0227
48	30	40	641666	3624.99	CP-OFDM QPSK	53@26	18.71	16.69	0.0467
48	30	40	641666	3624.99	CP-OFDM QPSK	1@1	18.83	16.81	0.0480
48	30	40	641666	3624.99	CP-OFDM QPSK	1@104	18.7	16.68	0.0466
48	30	40	645332	3679.98	DFT-s-OFDM PI/2 BPSK	50@25	20.41	18.39	0.0690
48	30	40	645332	3679.98	DFT-s-OFDM PI/2 BPSK	1@1	20.41	18.39	0.0690
48	30	40	645332	3679.98	DFT-s-OFDM PI/2 BPSK	1@104	20.42	18.4	0.0692
48	30	40	645332	3679.98	DFT-s-OFDM QPSK	50@25	20.35	18.33	0.0681

48	30	40	645332	3679.98	DFT-s-OFDM QPSK	1@1	20.38	18.36	0.0685
48	30	40	645332	3679.98	DFT-s-OFDM QPSK	1@104	20.39	18.37	0.0687
48	30	40	645332	3679.98	DFT-s-OFDM 16 QAM	50@25	19.39	17.37	0.0546
48	30	40	645332	3679.98	DFT-s-OFDM 16 QAM	1@1	19.44	17.42	0.0552
48	30	40	645332	3679.98	DFT-s-OFDM 16 QAM	1@104	19.46	17.44	0.0555
48	30	40	645332	3679.98	DFT-s-OFDM 64 QAM	50@25	17.85	15.83	0.0383
48	30	40	645332	3679.98	DFT-s-OFDM 64 QAM	1@1	17.85	15.83	0.0383
48	30	40	645332	3679.98	DFT-s-OFDM 64 QAM	1@104	17.88	15.86	0.0385
48	30	40	645332	3679.98	DFT-s-OFDM 256 QAM	50@25	15.76	13.74	0.0237
48	30	40	645332	3679.98	DFT-s-OFDM 256 QAM	1@1	15.63	13.61	0.0230
48	30	40	645332	3679.98	DFT-s-OFDM 256 QAM	1@104	15.78	13.76	0.0238
48	30	40	645332	3679.98	CP-OFDM QPSK	53@26	18.84	16.82	0.0481
48	30	40	645332	3679.98	CP-OFDM QPSK	1@1	18.8	16.78	0.0476
48	30	40	645332	3679.98	CP-OFDM QPSK	1@104	18.87	16.85	0.0484

Frequency Stability

NR Band	SCS (kHz)	Bandwidth (MHz)	Arfcn	Freq (MHz)	Modulation	RB	Deviation (ppm)	Verdict	Environment
48	30	20	641666	3624.99	DFT-s-OFDM QPSK	50@0	0.0058	PASS	NV
48	30	20	641666	3624.99	DFT-s-OFDM QPSK	50@0	0.0048	PASS	LV
48	30	20	641666	3624.99	DFT-s-OFDM QPSK	50@0	0.0021	PASS	HV
48	30	20	641666	3624.99	DFT-s-OFDM QPSK	50@0	0.0037	PASS	-10°C
48	30	20	641666	3624.99	DFT-s-OFDM QPSK	50@0	0.0037	PASS	0°C
48	30	20	641666	3624.99	DFT-s-OFDM QPSK	50@0	0.0022	PASS	10°C
48	30	20	641666	3624.99	DFT-s-OFDM QPSK	50@0	0.0058	PASS	20°C
48	30	20	641666	3624.99	DFT-s-OFDM QPSK	50@0	0.0059	PASS	30°C
48	30	20	641666	3624.99	DFT-s-OFDM QPSK	50@0	0.0058	PASS	40°C
48	30	20	641666	3624.99	DFT-s-OFDM QPSK	50@0	0.0058	PASS	50°C

Occupied Bandwidth

NR Band	SCS (kHz)	Bandwidth (MHz)	Arfcn	Freq (MHz)	Modulation	RB	OBW (MHz)	26dB BW (MHz)
48	30	10	641666	3624.99	DFT-s-OFDM PI/2 BPSK	24@0	8.5832	9.633
48	30	10	641666	3624.99	DFT-s-OFDM QPSK	24@0	8.5781	9.288
48	30	10	641666	3624.99	CP-OFDM QPSK	24@0	8.5542	9.548
48	30	10	641666	3624.99	CP-OFDM 16 QAM	24@0	8.5788	9.783
48	30	10	641666	3624.99	CP-OFDM 64 QAM	24@0	8.59	9.28
48	30	10	641666	3624.99	CP-OFDM 256 QAM	24@0	8.5724	9.267
48	30	15	641666	3624.99	DFT-s-OFDM PI/2 BPSK	36@0	12.824	13.91
48	30	15	641666	3624.99	DFT-s-OFDM QPSK	36@0	12.821	13.96
48	30	15	641666	3624.99	CP-OFDM QPSK	38@0	13.583	14.59
48	30	15	641666	3624.99	CP-OFDM 16 QAM	38@0	13.622	14.5
48	30	15	641666	3624.99	CP-OFDM 64 QAM	38@0	13.536	14.85
48	30	15	641666	3624.99	CP-OFDM 256 QAM	38@0	13.582	14.69
48	30	20	641666	3624.99	DFT-s-OFDM PI/2 BPSK	50@0	17.796	19.11
48	30	20	641666	3624.99	DFT-s-OFDM QPSK	50@0	17.79	18.85
48	30	20	641666	3624.99	CP-OFDM QPSK	51@0	18.15	19.45
48	30	20	641666	3624.99	CP-OFDM 16 QAM	51@0	18.202	19.12
48	30	20	641666	3624.99	CP-OFDM 64 QAM	51@0	18.271	19.64
48	30	20	641666	3624.99	CP-OFDM 256 QAM	51@0	18.229	19.27
48	30	30	641666	3624.99	DFT-s-OFDM PI/2 BPSK	75@0	26.739	28.22
48	30	30	641666	3624.99	DFT-s-OFDM QPSK	75@0	26.719	28.04
48	30	30	641666	3624.99	CP-OFDM QPSK	78@0	27.867	29.5
48	30	30	641666	3624.99	CP-OFDM 16 QAM	78@0	27.907	29.22
48	30	30	641666	3624.99	CP-OFDM 64 QAM	78@0	27.785	29.06
48	30	30	641666	3624.99	CP-OFDM 256 QAM	78@0	27.864	29.23

48	30	40	641666	3624.99	DFT-s-OFDM PI/2 BPSK	100@0	35.678	37.23
48	30	40	641666	3624.99	DFT-s-OFDM QPSK	100@0	35.573	37.2
48	30	40	641666	3624.99	CP-OFDM QPSK	106@0	37.817	39.35
48	30	40	641666	3624.99	CP-OFDM 16 QAM	106@0	37.854	39.42
48	30	40	641666	3624.99	CP-OFDM 64 QAM	106@0	37.82	39.25
48	30	40	641666	3624.99	CP-OFDM 256 QAM	106@0	37.679	39.55

N48(10M)_DFT-s-OFDM_PI_2-BPSK_Outer_Full_Mid_CH

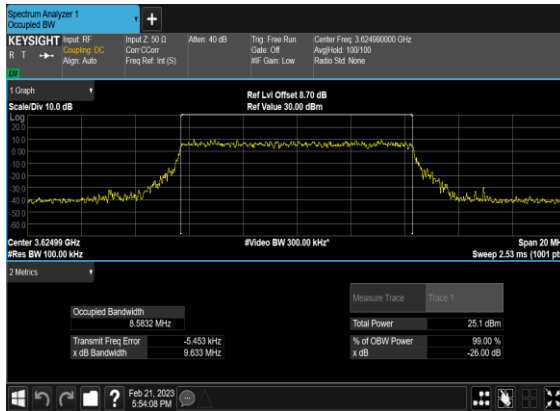

N48(10M)_DFT-s-OFDM_QPSK_Outer_Full_Mid_CH

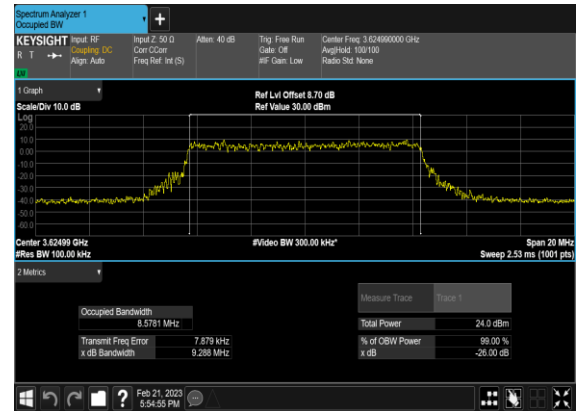

N48(10M)_CP-OFDM_QPSK_Outer_Full_Mid_CH

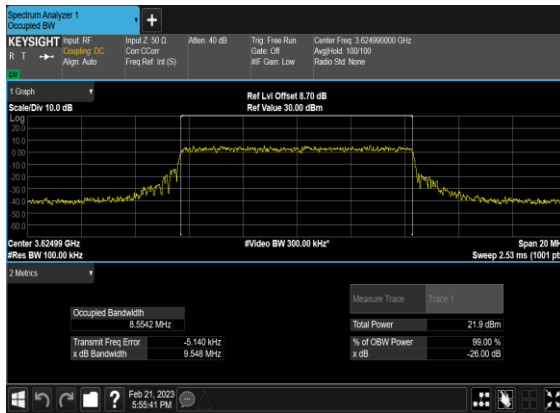

N48(10M)_CP-OFDM_16QAM_Outer_Full_Mid_CH

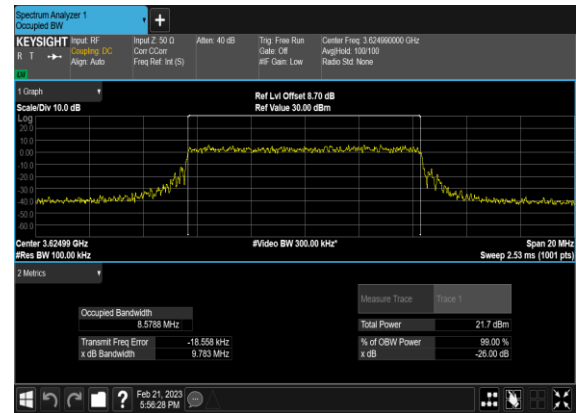

N48(10M)_CP-OFDM_64QAM_Outer_Full_Mid_CH

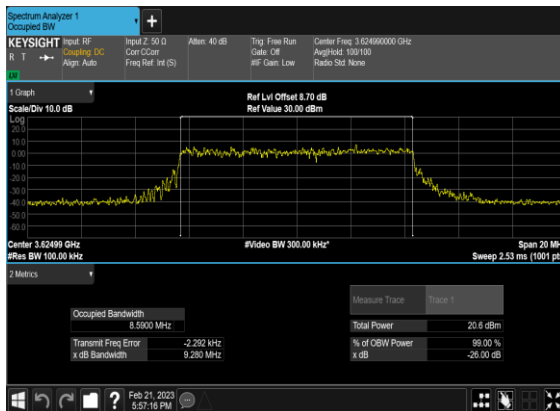

N48(10M)_CP-OFDM_256QAM_Outer_Full_Mid_CH

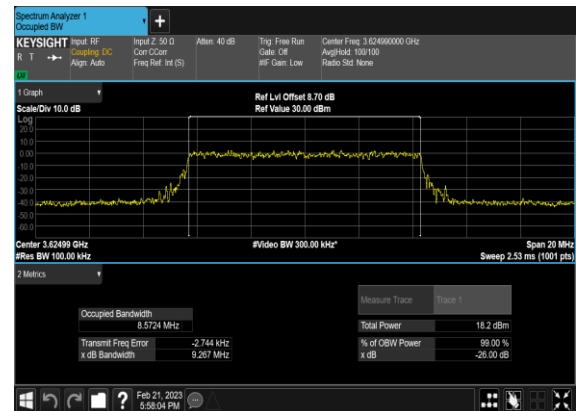

N48(15M)_DFT-s-OFDM_PI_2-BPSK_Outer_Full_Mid_CH

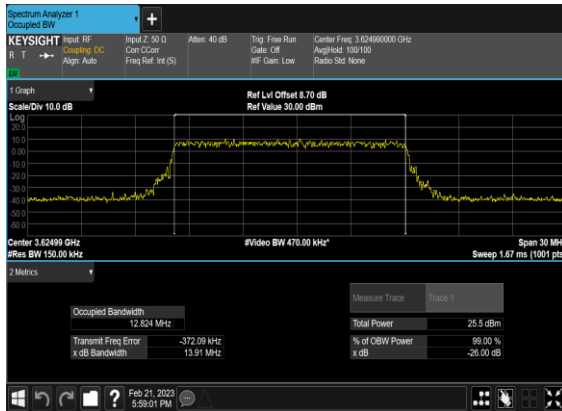

N48(15M)_DFT-s-OFDM_QPSK_Outer_Full_Mid_CH

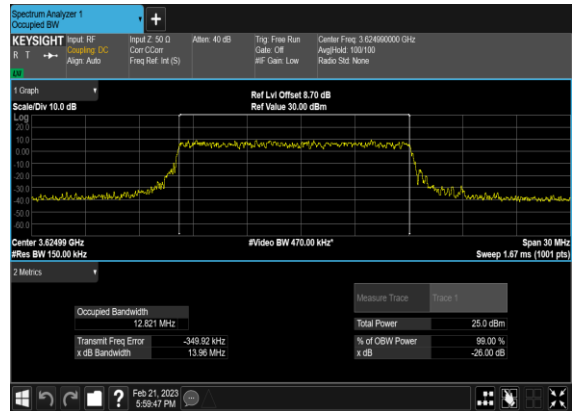

N48(15M)_CP-OFDM_QPSK_Outer_Full_Mid_CH

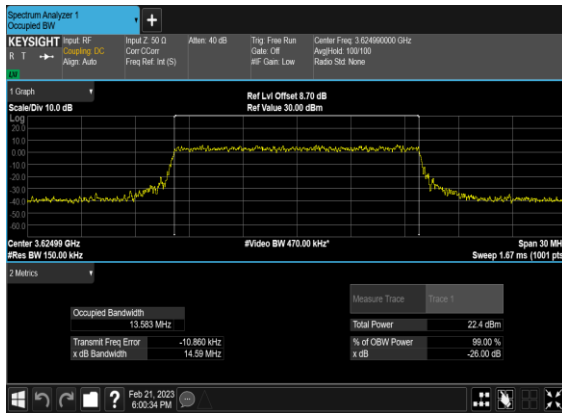

N48(15M)_CP-OFDM_16QAM_Outer_Full_Mid_CH

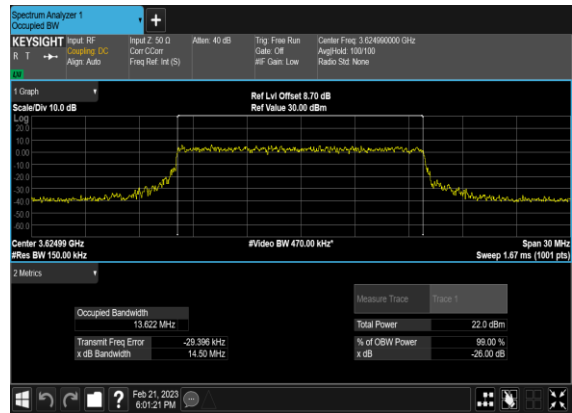

N48(15M)_CP-OFDM_64QAM_Outer_Full_Mid_CH

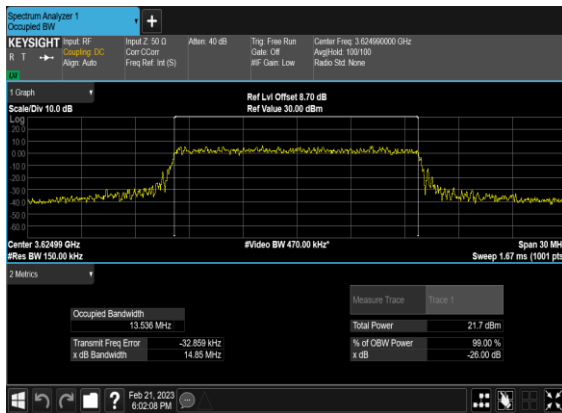

N48(15M)_CP-OFDM_256QAM_Outer_Full_Mid_CH

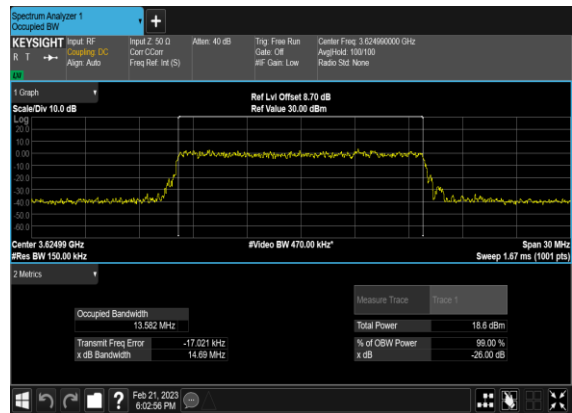

N48(20M)_DFT-s-OFDM_PI_2-BPSK_Outer_Full_Mid_CH

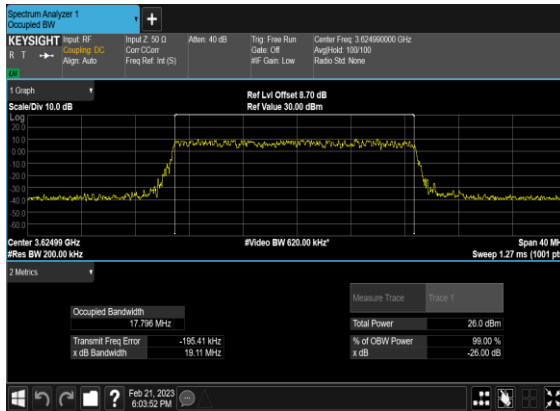

N48(20M)_DFT-s-OFDM_QPSK_Outer_Full_Mid_CH

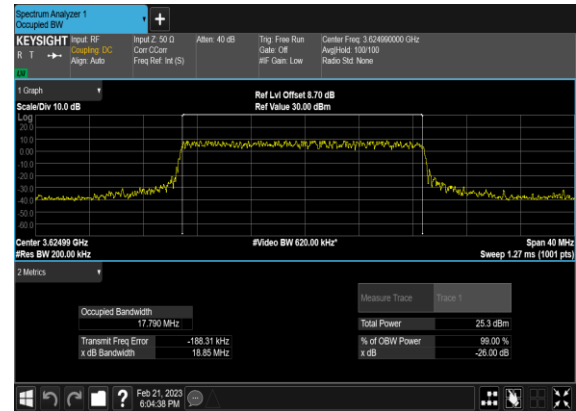

N48(20M)_CP-OFDM_QPSK_Outer_Full_Mid_CH

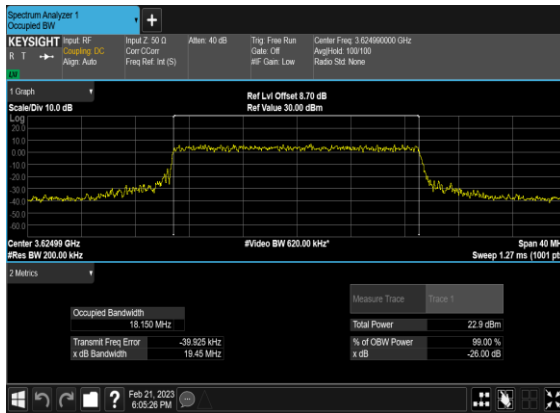

N48(20M)_CP-OFDM_16QAM_Outer_Full_Mid_CH

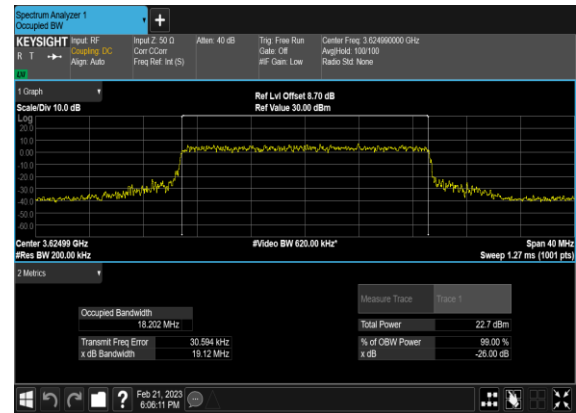

N48(20M)_CP-OFDM_64QAM_Outer_Full_Mid_CH

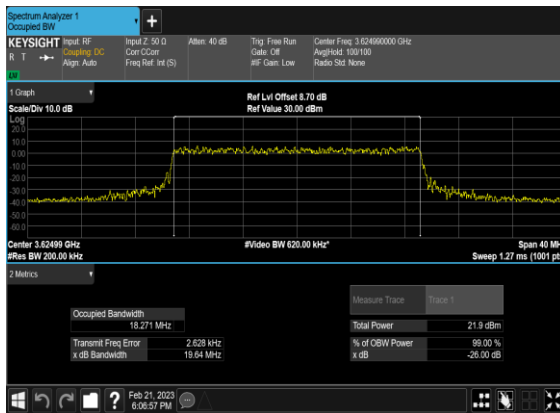

N48(20M)_CP-OFDM_256QAM_Outer_Full_Mid_CH

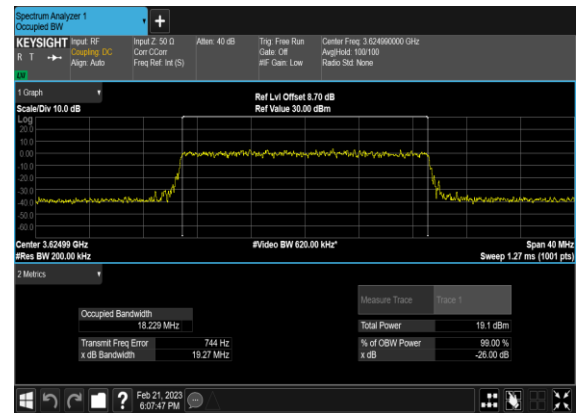

N48(30M)_DFT-s-OFDM_PI_2-BPSK_Outer_Full_Mid_CH

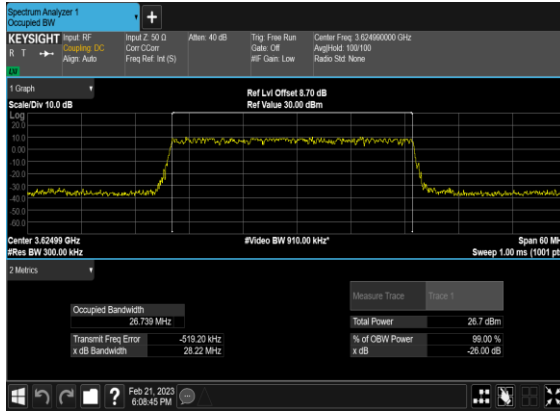

N48(30M)_DFT-s-OFDM_QPSK_Outer_Full_Mid_CH

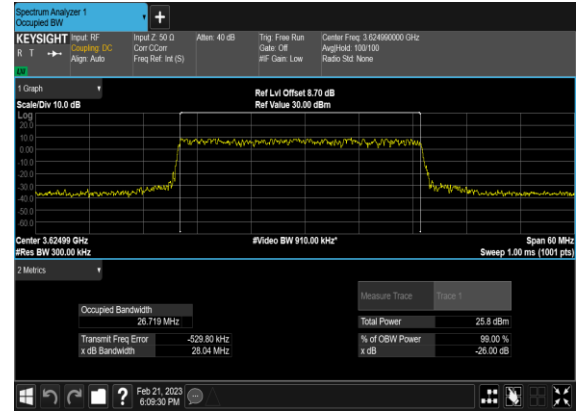

N48(30M)_CP-OFDM_QPSK_Outer_Full_Mid_CH

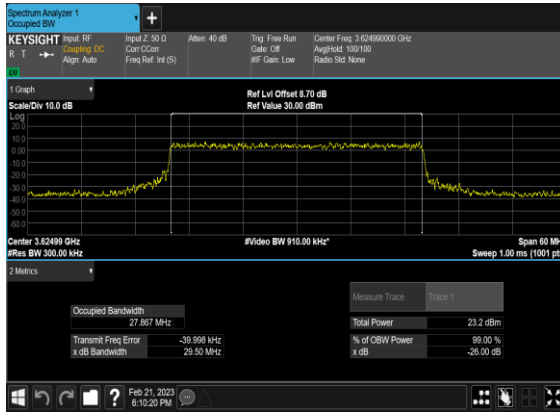

N48(30M)_CP-OFDM_16QAM_Outer_Full_Mid_CH



N48(30M)_CP-OFDM_64QAM_Outer_Full_Mid_CH

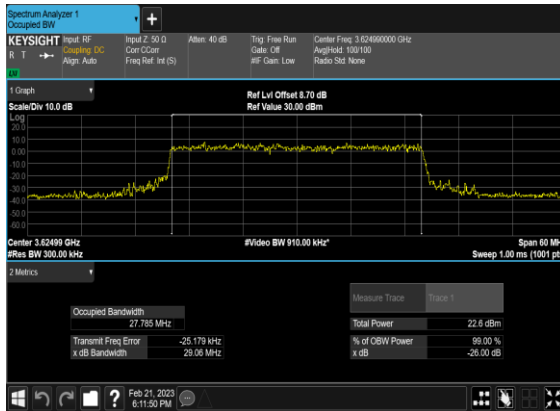

N48(30M)_CP-OFDM_256QAM_Outer_Full_Mid_CH

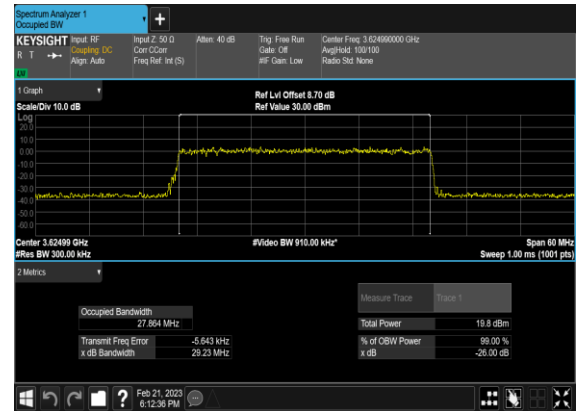

N48(40M)_DFT-s-OFDM_PI_2-BPSK_Outer_Full_Mid_CH

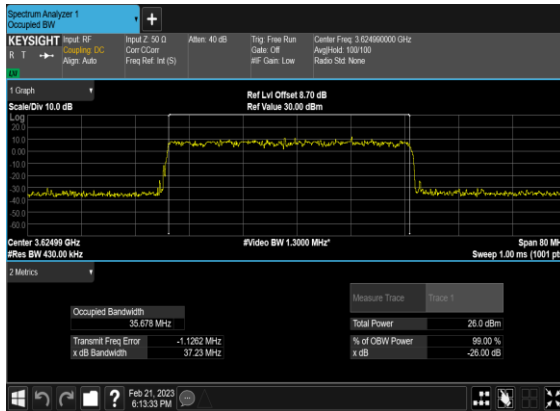

N48(40M)_DFT-s-OFDM_QPSK_Outer_Full_Mid_CH

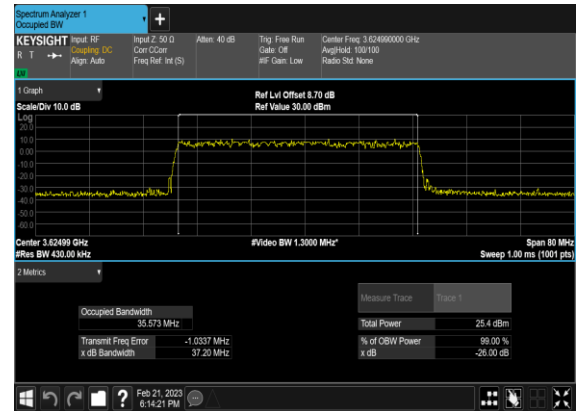

N48(40M)_CP-OFDM_QPSK_Outer_Full_Mid_CH

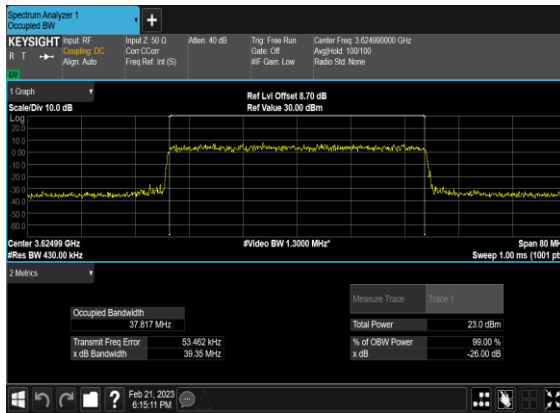

N48(40M)_CP-OFDM_16QAM_Outer_Full_Mid_CH

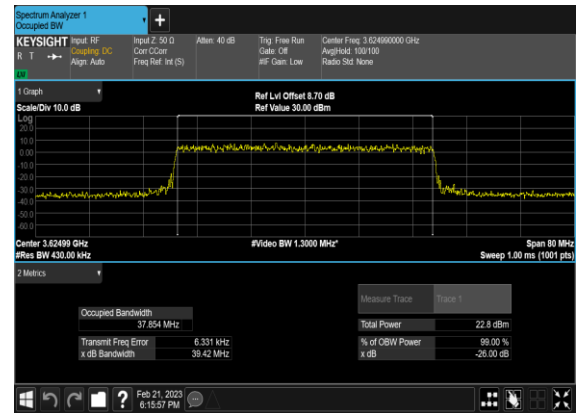

N48(40M)_CP-OFDM_64QAM_Outer_Full_Mid_CH

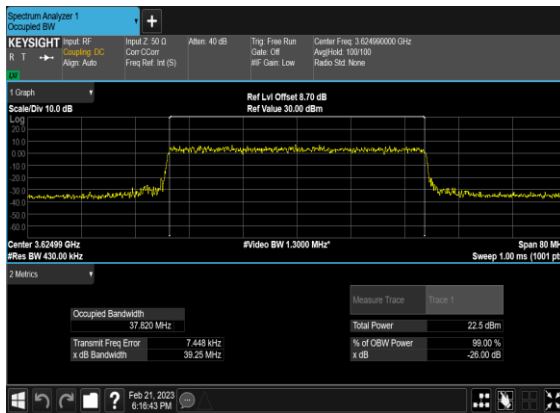

N48(40M)_CP-OFDM_256QAM_Outer_Full_Mid_CH

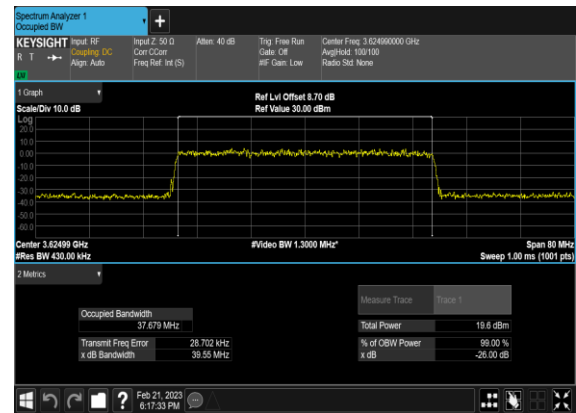

Adjacent Channel Leakage Ratio

NR Band	SCS (kHz)	Bandwidth (MHz)	Arfcn	Freq (MHz)	Modulation	RB	Lower Margin	Upper Margin	Result	Verdict
48	30	10	637000	3555.0	DFT-s-OFDM PI/2 BPSK	24@0	-15.56	-14.33	see graph	PASS
48	30	10	637000	3555.0	DFT-s-OFDM PI/2 BPSK	1@0	-10.03	-25.17	see graph	PASS
48	30	10	637000	3555.0	DFT-s-OFDM PI/2 BPSK	1@23	-25.18	-12.09	see graph	PASS
48	30	10	637000	3555.0	DFT-s-OFDM QPSK	24@0	-14.22	-14.46	see graph	PASS
48	30	10	637000	3555.0	DFT-s-OFDM QPSK	1@0	-11.1	-24.74	see graph	PASS
48	30	10	637000	3555.0	DFT-s-OFDM QPSK	1@23	-24.83	-11.63	see graph	PASS
48	30	10	641666	3624.99	DFT-s-OFDM PI/2 BPSK	24@0	-14.35	-13.92	see graph	PASS
48	30	10	641666	3624.99	DFT-s-OFDM PI/2 BPSK	1@0	-9.57	-20.2	see graph	PASS
48	30	10	641666	3624.99	DFT-s-OFDM PI/2 BPSK	1@23	-20.22	-11.9	see graph	PASS
48	30	10	641666	3624.99	DFT-s-OFDM QPSK	24@0	-13.64	-13.65	see graph	PASS
48	30	10	641666	3624.99	DFT-s-OFDM QPSK	1@0	-9.98	-19.08	see graph	PASS
48	30	10	641666	3624.99	DFT-s-OFDM QPSK	1@23	-21.95	-11.94	see graph	PASS
48	30	10	646332	3694.98	DFT-s-OFDM PI/2 BPSK	24@0	-15.66	-14.31	see graph	PASS
48	30	10	646332	3694.98	DFT-s-OFDM PI/2 BPSK	1@0	-10.37	-20.0	see graph	PASS
48	30	10	646332	3694.98	DFT-s-OFDM PI/2 BPSK	1@23	-21.02	-12.22	see graph	PASS
48	30	10	646332	3694.98	DFT-s-OFDM QPSK	24@0	-13.97	-13.77	see graph	PASS
48	30	10	646332	3694.98	DFT-s-OFDM QPSK	1@0	-9.8	-19.67	see graph	PASS
48	30	10	646332	3694.98	DFT-s-OFDM QPSK	1@23	-19.48	-12.16	see graph	PASS
48	30	20	637334	3560.01	DFT-s-OFDM PI/2 BPSK	50@0	-15.75	-17.25	see graph	PASS
48	30	20	637334	3560.01	DFT-s-OFDM PI/2 BPSK	1@0	-12.82	-22.38	see graph	PASS
48	30	20	637334	3560.01	DFT-s-OFDM PI/2 BPSK	1@50	-22.35	-13.19	see graph	PASS
48	30	20	637334	3560.01	DFT-s-OFDM QPSK	50@0	-14.41	-14.17	see graph	PASS

48	30	20	637334	3560.01	DFT-s-OFDM QPSK	1@0	-12.2	-21.95	see graph	PASS
48	30	20	637334	3560.01	DFT-s-OFDM QPSK	1@50	-21.96	-11.1	see graph	PASS
48	30	20	641666	3624.99	DFT-s-OFDM PI/2 BPSK	50@0	-15.32	-16.23	see graph	PASS
48	30	20	641666	3624.99	DFT-s-OFDM PI/2 BPSK	1@0	-12.65	-18.45	see graph	PASS
48	30	20	641666	3624.99	DFT-s-OFDM PI/2 BPSK	1@50	-18.64	-13.58	see graph	PASS
48	30	20	641666	3624.99	DFT-s-OFDM QPSK	50@0	-13.48	-13.47	see graph	PASS
48	30	20	641666	3624.99	DFT-s-OFDM QPSK	1@0	-12.01	-17.57	see graph	PASS
48	30	20	641666	3624.99	DFT-s-OFDM QPSK	1@50	-18.2	-12.9	see graph	PASS
48	30	20	646000	3690.0	DFT-s-OFDM PI/2 BPSK	50@0	-14.22	-14.68	see graph	PASS
48	30	20	646000	3690.0	DFT-s-OFDM PI/2 BPSK	1@0	-12.06	-17.26	see graph	PASS
48	30	20	646000	3690.0	DFT-s-OFDM PI/2 BPSK	1@50	-17.48	-11.63	see graph	PASS
48	30	20	646000	3690.0	DFT-s-OFDM QPSK	50@0	-12.65	-12.82	see graph	PASS
48	30	20	646000	3690.0	DFT-s-OFDM QPSK	1@0	-11.11	-17.31	see graph	PASS
48	30	20	646000	3690.0	DFT-s-OFDM QPSK	1@50	-17.63	-12.31	see graph	PASS
48	30	40	638000	3570.0	DFT-s-OFDM PI/2 BPSK	100@0	-14.07	-13.8	see graph	PASS
48	30	40	638000	3570.0	DFT-s-OFDM PI/2 BPSK	1@0	-13.47	-15.95	see graph	PASS
48	30	40	638000	3570.0	DFT-s-OFDM PI/2 BPSK	1@105	-17.23	-13.99	see graph	PASS
48	30	40	638000	3570.0	DFT-s-OFDM QPSK	100@0	-13.1	-12.91	see graph	PASS
48	30	40	638000	3570.0	DFT-s-OFDM QPSK	1@0	-13.35	-15.26	see graph	PASS
48	30	40	638000	3570.0	DFT-s-OFDM QPSK	1@105	-15.33	-12.67	see graph	PASS
48	30	40	641666	3624.99	DFT-s-OFDM PI/2 BPSK	100@0	-13.83	-13.73	see graph	PASS
48	30	40	641666	3624.99	DFT-s-OFDM PI/2 BPSK	1@0	-12.75	-14.11	see graph	PASS
48	30	40	641666	3624.99	DFT-s-OFDM PI/2 BPSK	1@105	-14.65	-12.48	see graph	PASS
48	30	40	641666	3624.99	DFT-s-OFDM QPSK	100@0	-13.01	-12.8	see graph	PASS

48	30	40	641666	3624.99	DFT-s-OFDM QPSK	1@0	-12.64	-14.19	see graph	PASS
48	30	40	641666	3624.99	DFT-s-OFDM QPSK	1@105	-15.28	-12.34	see graph	PASS
48	30	40	645332	3679.98	DFT-s-OFDM PI/2 BPSK	100@0	-13.06	-12.75	see graph	PASS
48	30	40	645332	3679.98	DFT-s-OFDM PI/2 BPSK	1@0	-13.44	-14.74	see graph	PASS
48	30	40	645332	3679.98	DFT-s-OFDM PI/2 BPSK	1@105	-15.9	-12.84	see graph	PASS
48	30	40	645332	3679.98	DFT-s-OFDM QPSK	100@0	-12.5	-11.73	see graph	PASS
48	30	40	645332	3679.98	DFT-s-OFDM QPSK	1@0	-12.57	-13.86	see graph	PASS
48	30	40	645332	3679.98	DFT-s-OFDM QPSK	1@105	-14.92	-12.17	see graph	PASS

N48(10M)_DFT-s-OFDM_PI_2-BPSK_Outer_Full_Low_CH

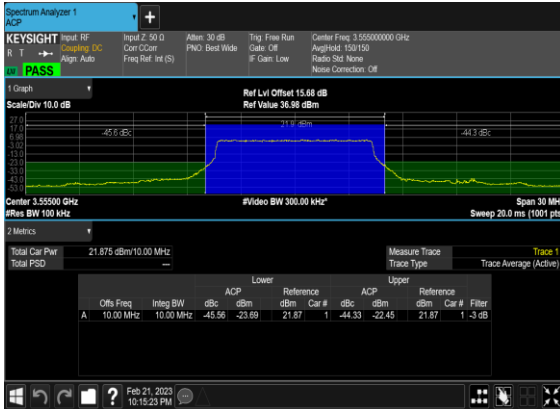

N48(10M)_DFT-s-OFDM_PI_2-BPSK_Edge_1RB_Left_Low_CH

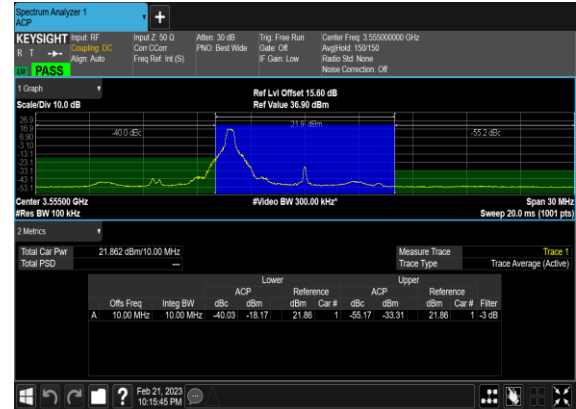

N48(10M)_DFT-s-OFDM_PI_2-BPSK_Edge_1RB_Right_Low_CH

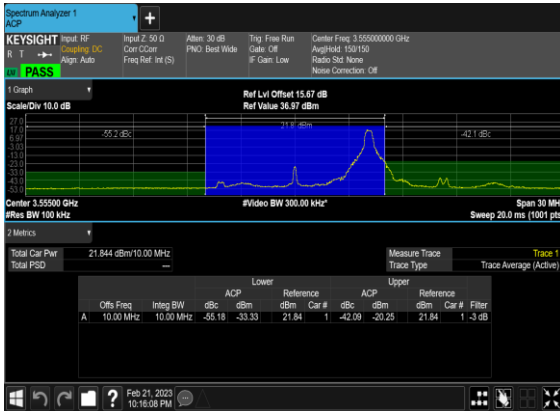

N48(10M)_DFT-s-OFDM_QPSK_Outer_Full_Low_CH

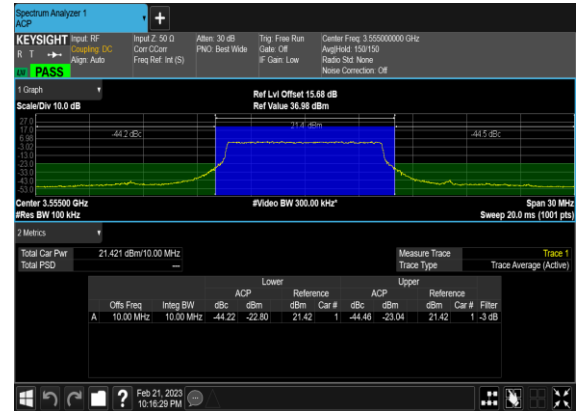

N48(10M)_DFT-s-OFDM_QPSK_Edge_1RB_Left_Low_CH

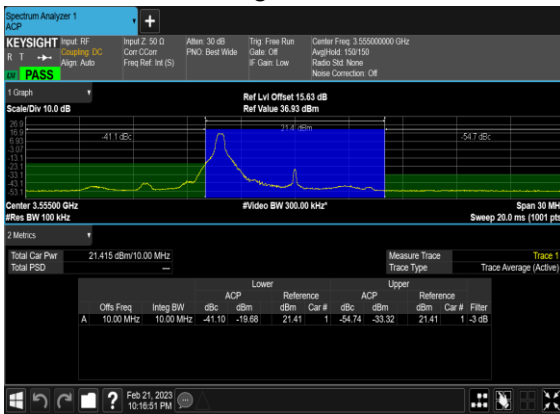

N48(10M)_DFT-s-OFDM_QPSK_Edge_1RB_Right_Low_CH

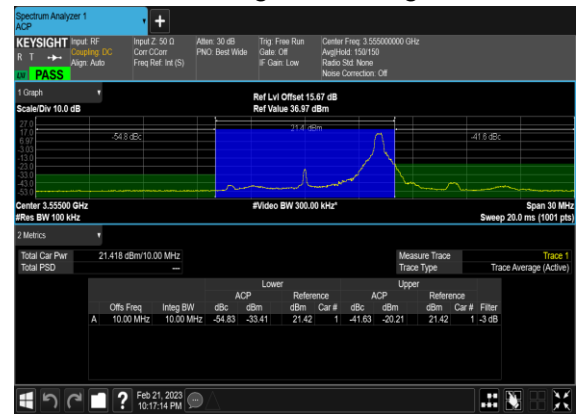

N48(10M)_DFT-s-OFDM_PI_2-BPSK_Outer_Full_Mid_CH

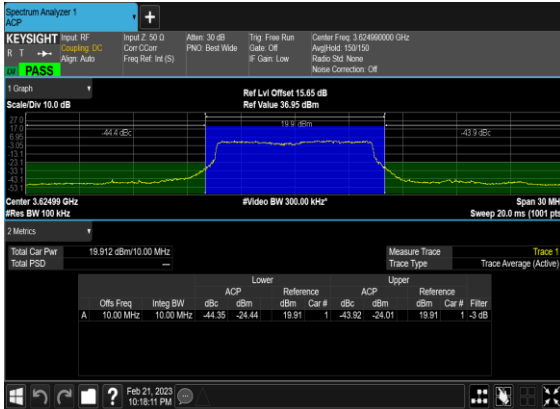

N48(10M)_DFT-s-OFDM_PI_2-BPSK_Edge_1RB_Left_Mid_CH

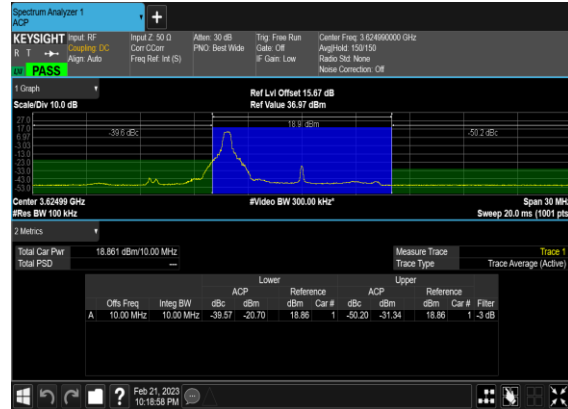

N48(10M)_DFT-s-OFDM_PI_2-BPSK_Edge_1RB_Right_Mid_CH

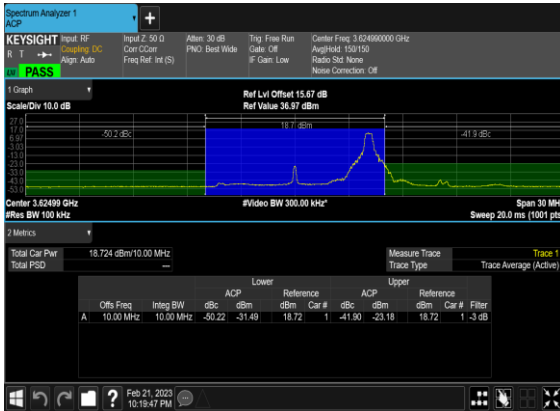

N48(10M)_DFT-s-OFDM_QPSK_Outer_Full_Mid_CH

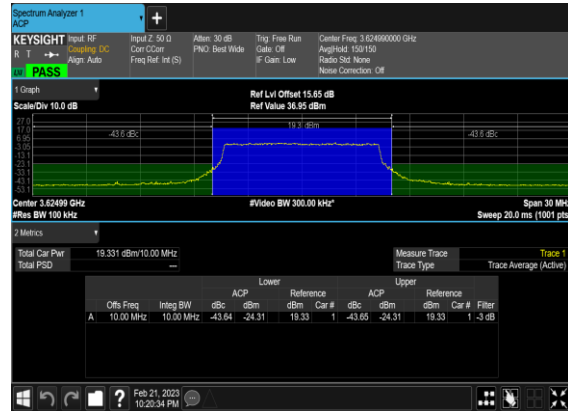

N48(10M)_DFT-s-OFDM_QPSK_Edge_1RB_Left_Mid_CH

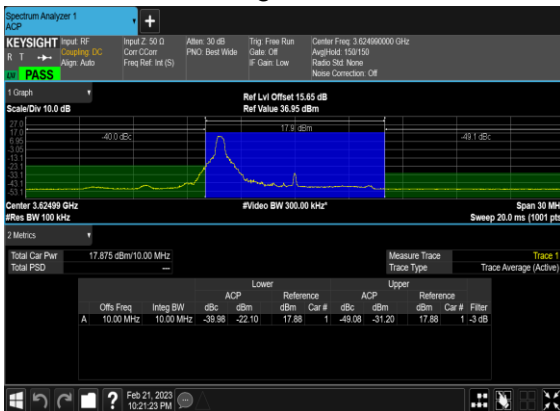

N48(10M)_DFT-s-OFDM_QPSK_Edge_1RB_Right_Mid_CH

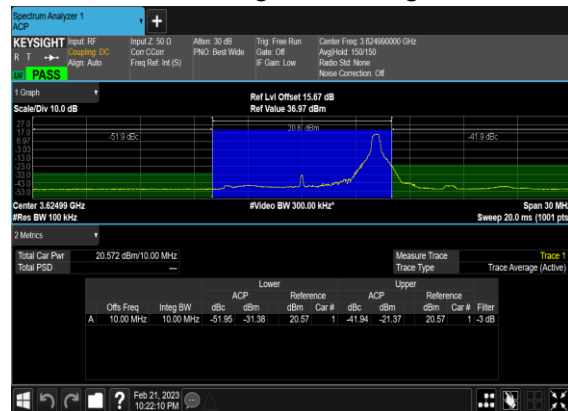

N48(10M)_DFT-s-OFDM_PI_2-BPSK_Outer_Full_High_CH



N48(10M)_DFT-s-OFDM_PI_2-BPSK_Edge_1RB_Left_High_CH

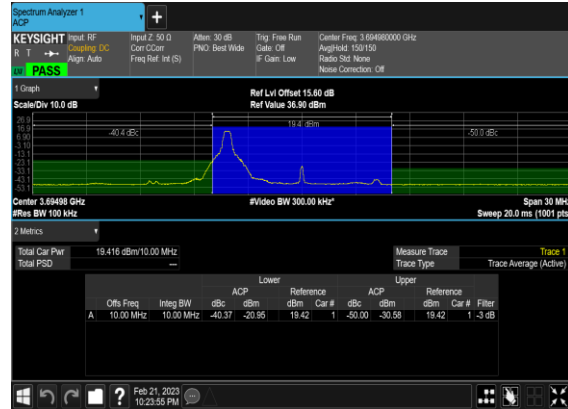

N48(10M)_DFT-s-OFDM_PI_2-BPSK_Edge_1RB_Right_High_CH

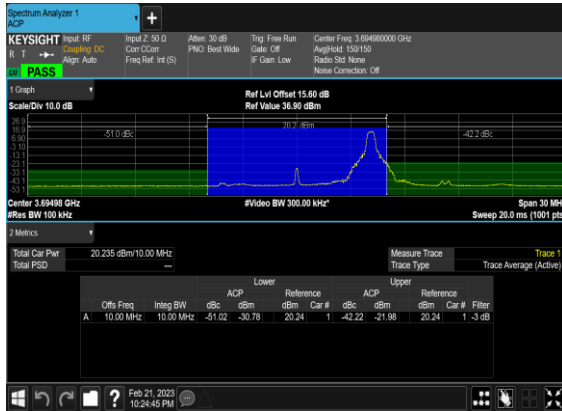

N48(10M)_DFT-s-OFDM_QPSK_Outer_Full_High_CH



N48(10M)_DFT-s-OFDM_QPSK_Edge_1RB_Left_High_CH

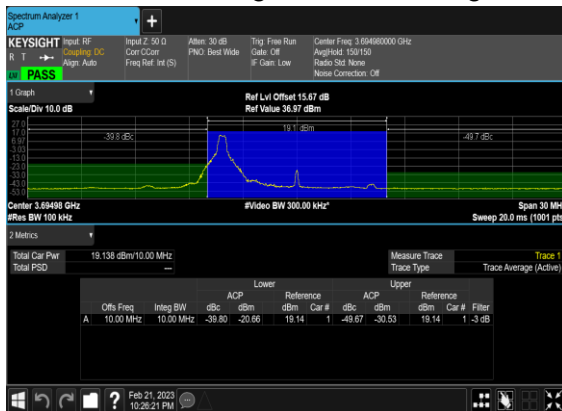

N48(10M)_DFT-s-OFDM_QPSK_Edge_1RB_Right_High_C
H

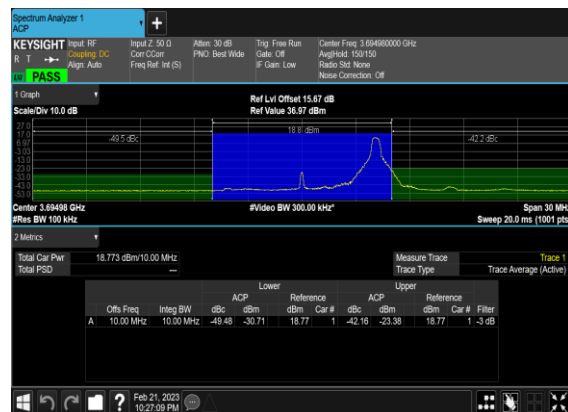

N48(20M)_DFT-s-OFDM_PI_2-BPSK_Outer_Full_Low_CH

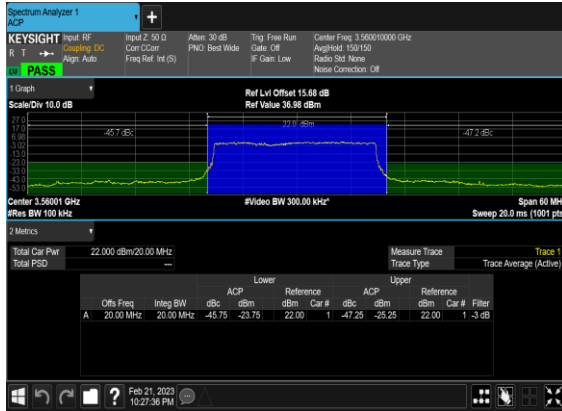

N48(20M)_DFT-s-OFDM_PI_2-BPSK_Edge_1RB_Left_Low_CH

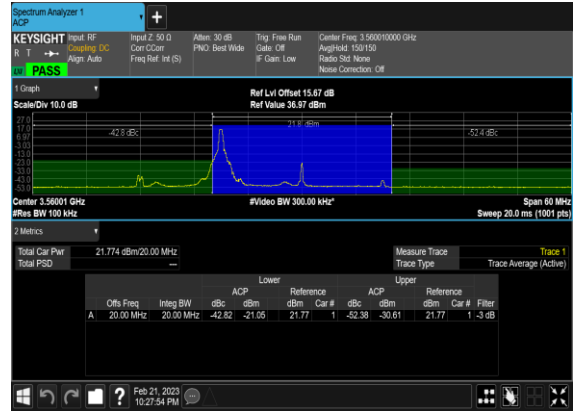

N48(20M)_DFT-s-OFDM_PI_2-BPSK_Edge_1RB_Right_Low_CH

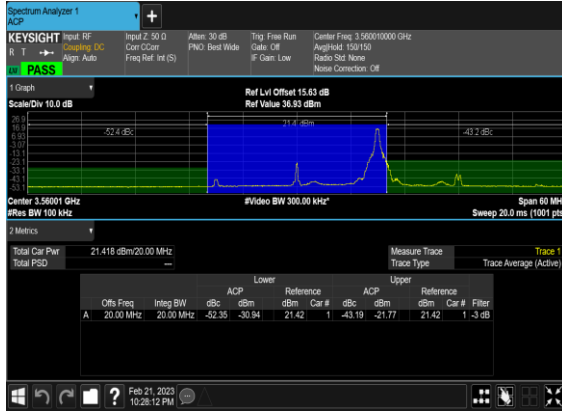

N48(20M)_DFT-s-OFDM_QPSK_Outer_Full_Low_CH

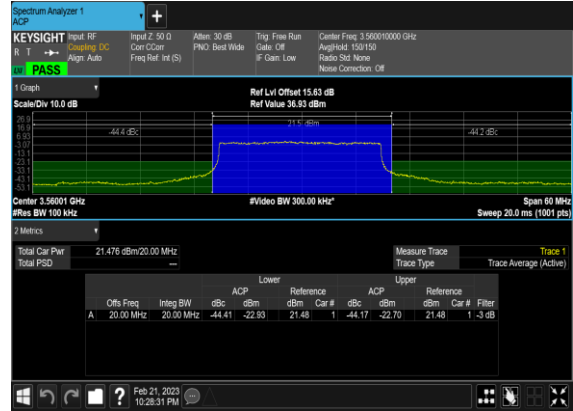

N48(20M)_DFT-s-OFDM_QPSK_Edge_1RB_Left_Low_CH

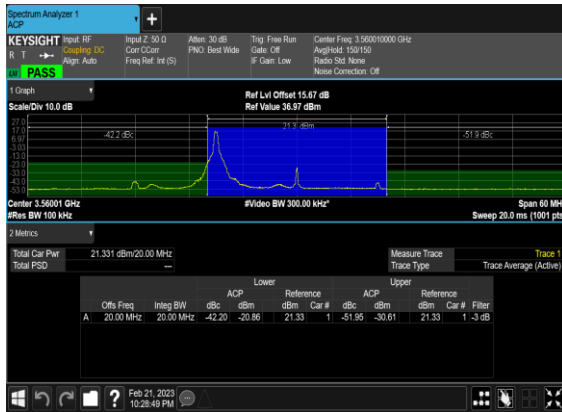

N48(20M)_DFT-s-OFDM_QPSK_Edge_1RB_Right_Low_CH



N48(20M)_DFT-s-OFDM_PI_2-BPSK_Outer_Full_Mid_CH

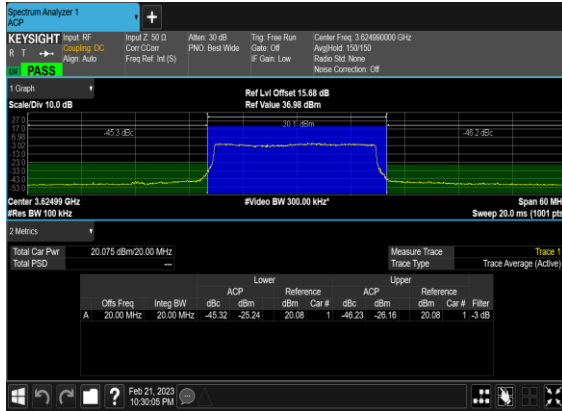

N48(20M)_DFT-s-OFDM_PI_2-BPSK_Edge_1RB_Left_Mid_CH

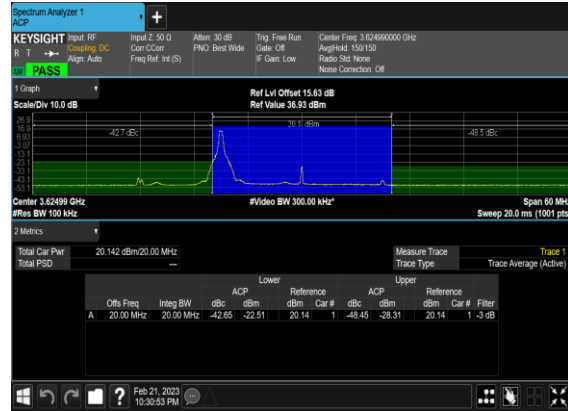

N48(20M)_DFT-s-OFDM_PI_2-BPSK_Edge_1RB_Right_Mid_CH

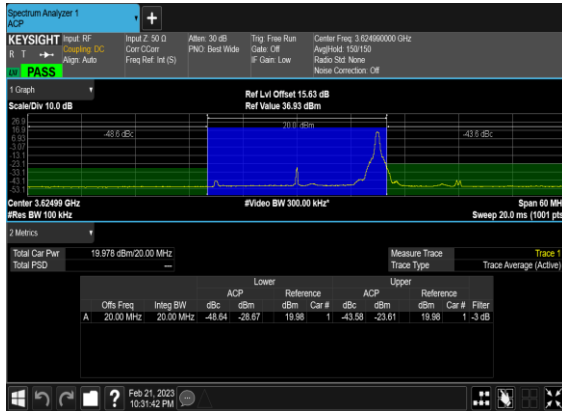

N48(20M)_DFT-s-OFDM_QPSK_Outer_Full_Mid_CH

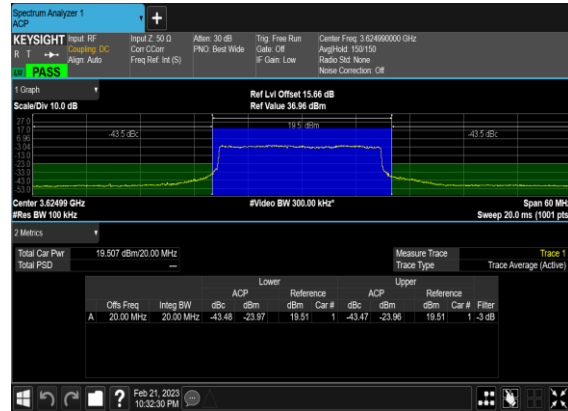

N48(20M)_DFT-s-OFDM_QPSK_Edge_1RB_Left_Mid_CH

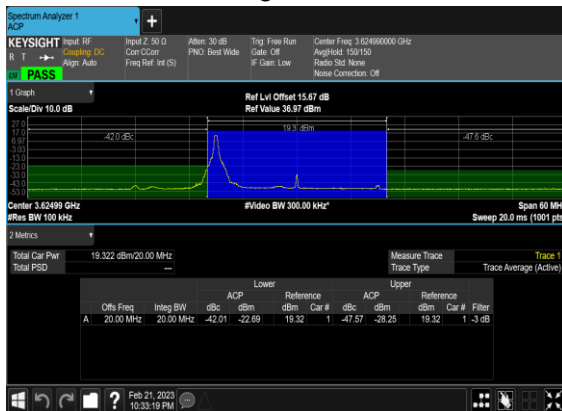

N48(20M)_DFT-s-OFDM_QPSK_Edge_1RB_Right_Mid_CH

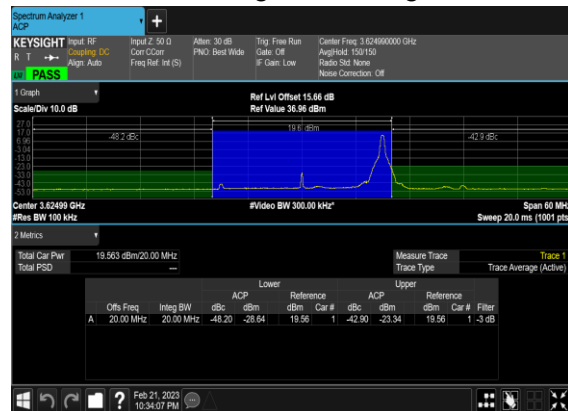

N48(20M)_DFT-s-OFDM_PI_2-BPSK_Outer_Full_High_CH

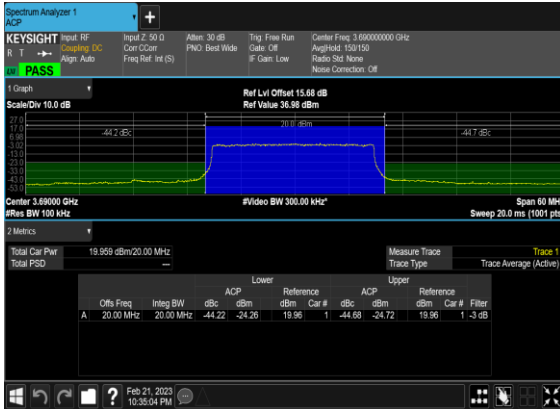

N48(20M)_DFT-s-OFDM_PI_2-BPSK_Edge_1RB_Left_High_CH

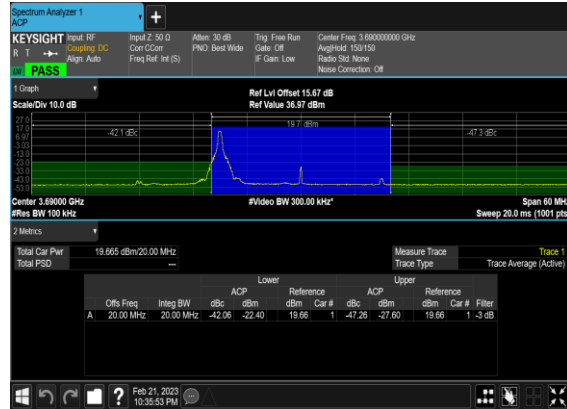

N48(20M)_DFT-s-OFDM_PI_2-BPSK_Edge_1RB_Right_High_CH



N48(20M)_DFT-s-OFDM_QPSK_Outer_Full_High_CH

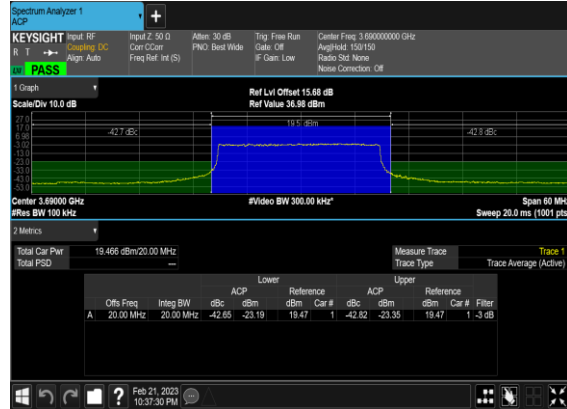

N48(20M)_DFT-s-OFDM_QPSK_Edge_1RB_Left_High_CH

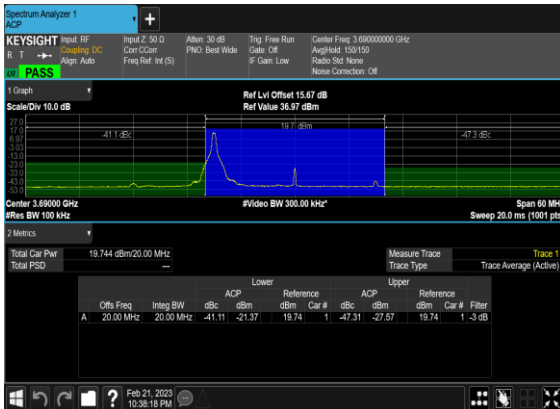

N48(20M)_DFT-s-OFDM_QPSK_Edge_1RB_Right_High_CH

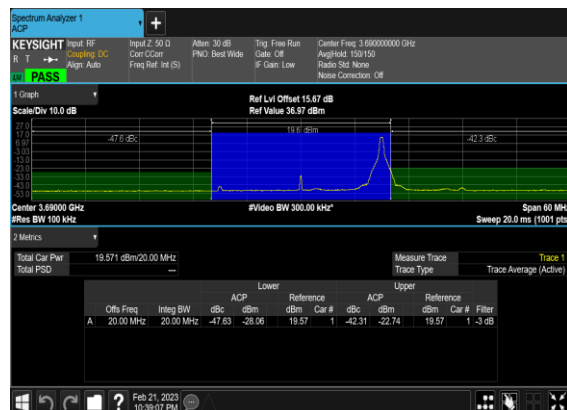

N48(40M)_DFT-s-OFDM_PI_2-BPSK_Outer_Full_Low_CH

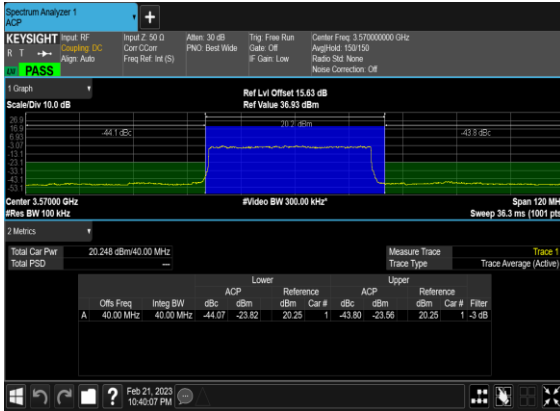

N48(40M)_DFT-s-OFDM_PI_2-BPSK_Edge_1RB_Left_Low_CH



N48(40M)_DFT-s-OFDM_PI_2-BPSK_Edge_1RB_Right_Low_CH



N48(40M)_DFT-s-OFDM_QPSK_Outer_Full_Low_CH

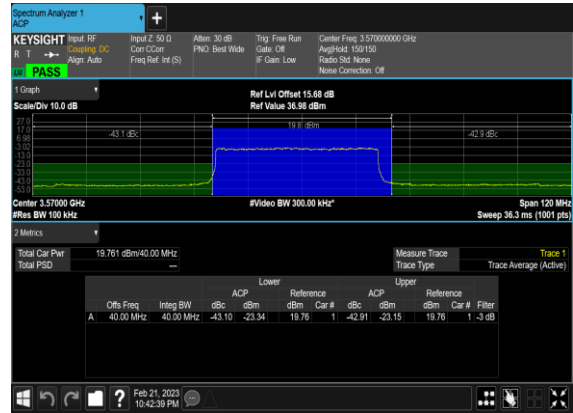

N48(40M)_DFT-s-OFDM_QPSK_Edge_1RB_Left_Low_CH

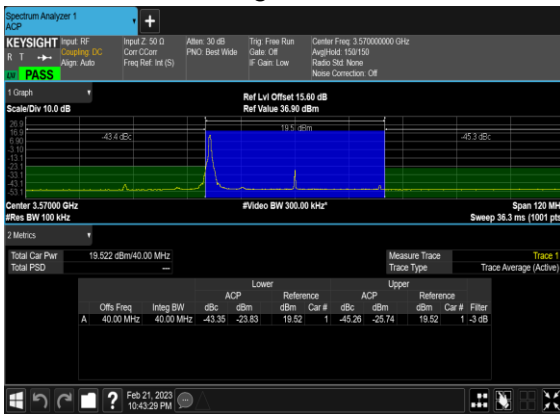

N48(40M)_DFT-s-OFDM_QPSK_Edge_1RB_Right_Low_CH

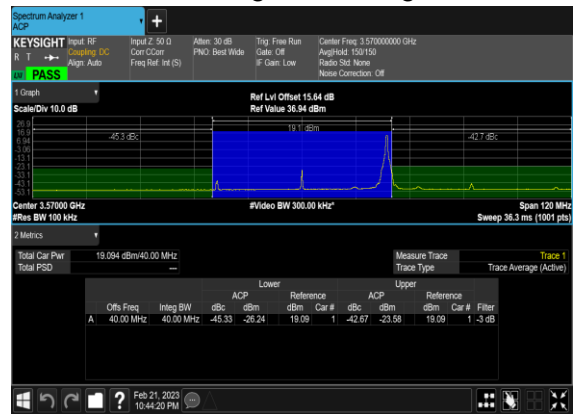

N48(40M)_DFT-s-OFDM_PI_2-BPSK_Outer_Full_Mid_CH

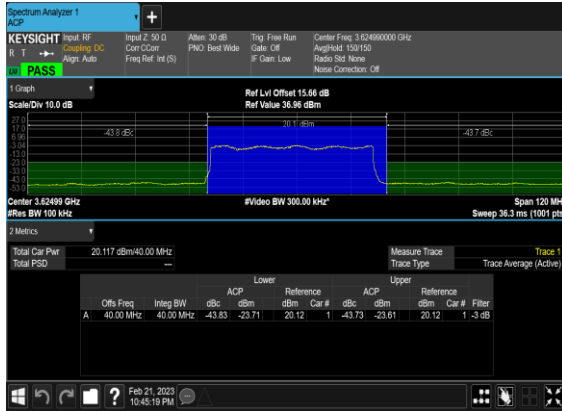

N48(40M)_DFT-s-OFDM_PI_2-BPSK_Edge_1RB_Left_Mid_CH

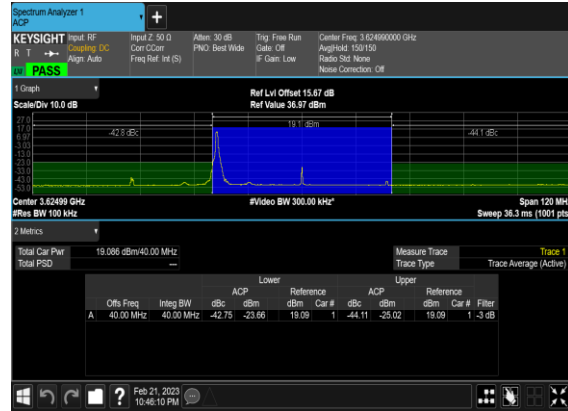

N48(40M)_DFT-s-OFDM_PI_2-BPSK_Edge_1RB_Right_Mid_CH



N48(40M)_DFT-s-OFDM_QPSK_Outer_Full_Mid_CH

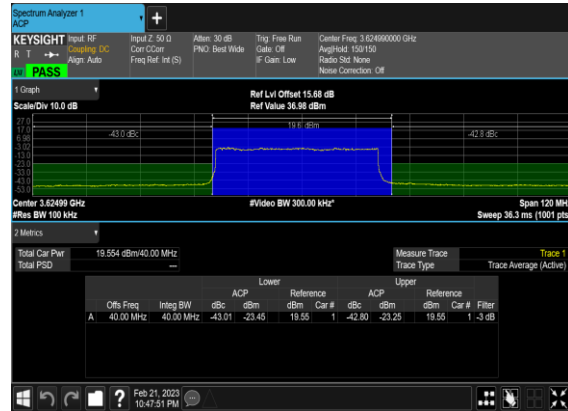

N48(40M)_DFT-s-OFDM_QPSK_Edge_1RB_Left_Mid_CH

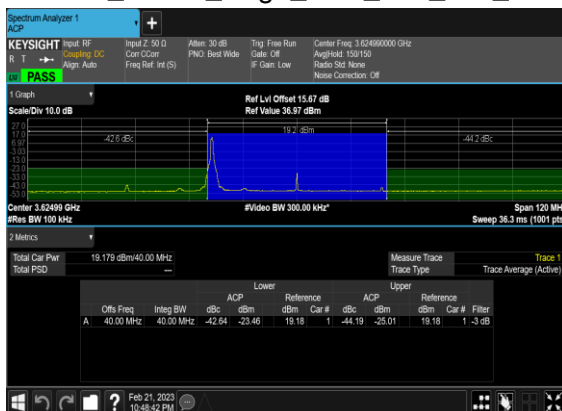

N48(40M)_DFT-s-OFDM_QPSK_Edge_1RB_Right_Mid_CH

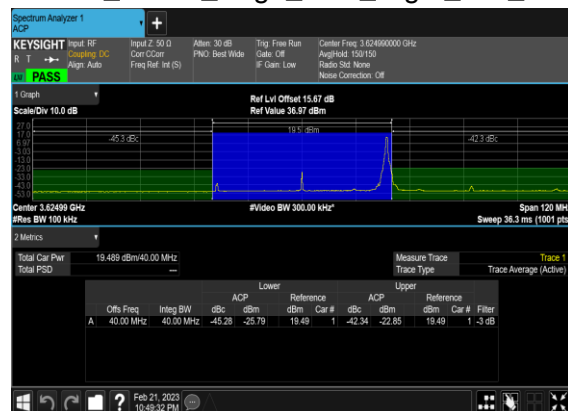

N48(40M)_DFT-s-OFDM_PI_2-BPSK_Outer_Full_High_CH

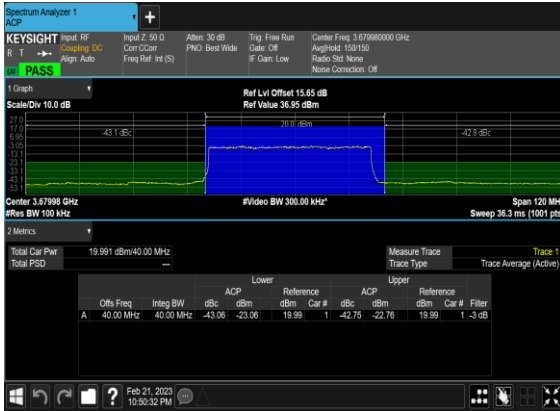

N48(40M)_DFT-s-OFDM_PI_2-BPSK_Edge_1RB_Left_High_CH

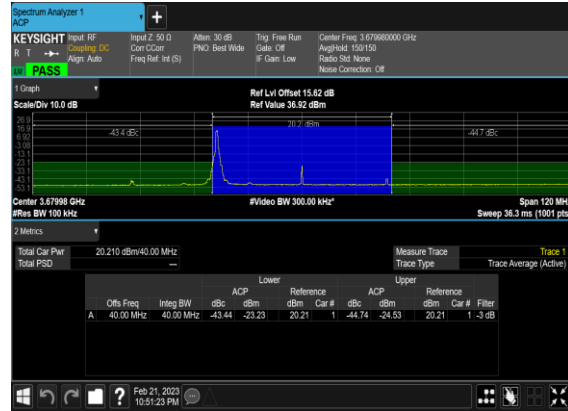

N48(40M)_DFT-s-OFDM_PI_2-BPSK_Edge_1RB_Right_High_CH

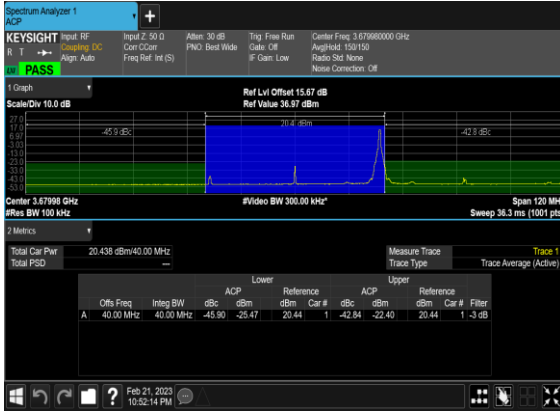

N48(40M)_DFT-s-OFDM_QPSK_Outer_Full_High_CH

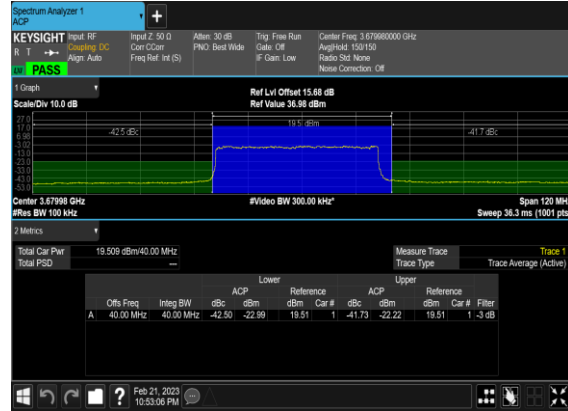

N48(40M)_DFT-s-OFDM_QPSK_Edge_1RB_Left_High_CH

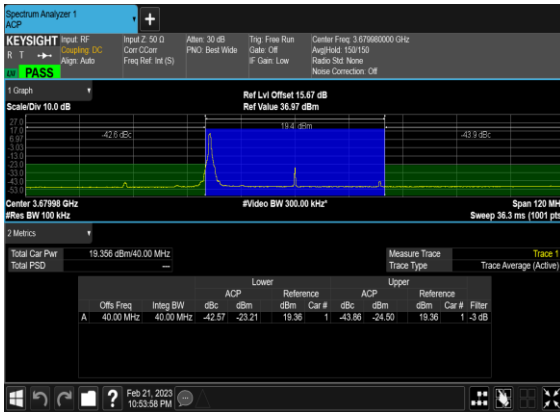

N48(40M)_DFT-s-OFDM_QPSK_Edge_1RB_Right_High_CH

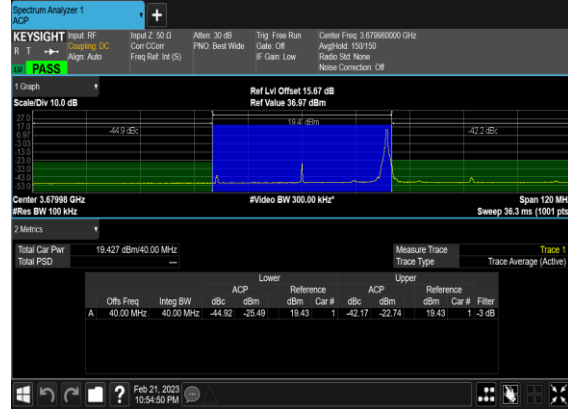

Conducted Spurious Emissions

NR Band	SCS (kHz)	Bandwidth (MHz)	Arfcn	Freq (MHz)	Modulation	RB	Result	Verdict
48	30	10	637000	3555.0	DFT-s-OFDM BPSK	1@0	see graph	---
48	30	10	637000	3555.0	DFT-s-OFDM BPSK	1@0	see graph	PASS
48	30	10	637000	3555.0	DFT-s-OFDM BPSK	1@0	see graph	PASS
48	30	10	637000	3555.0	DFT-s-OFDM QPSK	1@0	see graph	---
48	30	10	637000	3555.0	DFT-s-OFDM QPSK	1@0	see graph	PASS
48	30	10	637000	3555.0	DFT-s-OFDM QPSK	1@0	see graph	PASS
48	30	10	637000	3555.0	DFT-s-OFDM BPSK	1@23	see graph	---
48	30	10	637000	3555.0	DFT-s-OFDM BPSK	1@23	see graph	PASS
48	30	10	637000	3555.0	DFT-s-OFDM BPSK	1@23	see graph	PASS
48	30	10	637000	3555.0	DFT-s-OFDM QPSK	1@23	see graph	---
48	30	10	637000	3555.0	DFT-s-OFDM QPSK	1@23	see graph	PASS
48	30	10	637000	3555.0	DFT-s-OFDM QPSK	1@23	see graph	PASS
48	30	10	637000	3555.0	DFT-s-OFDM BPSK	24@0	see graph	---
48	30	10	637000	3555.0	DFT-s-OFDM BPSK	24@0	see graph	PASS
48	30	10	637000	3555.0	DFT-s-OFDM BPSK	24@0	see graph	PASS
48	30	10	637000	3555.0	DFT-s-OFDM QPSK	24@0	see graph	---
48	30	10	637000	3555.0	DFT-s-OFDM QPSK	24@0	see graph	PASS
48	30	10	637000	3555.0	DFT-s-OFDM QPSK	24@0	see graph	PASS
48	30	10	641666	3624.99	DFT-s-OFDM BPSK	1@0	see graph	---
48	30	10	641666	3624.99	DFT-s-OFDM BPSK	1@0	see graph	PASS
48	30	10	641666	3624.99	DFT-s-OFDM BPSK	1@0	see graph	PASS
48	30	10	641666	3624.99	DFT-s-OFDM QPSK	1@0	see graph	---

48	30	10	641666	3624.99	DFT-s-OFDM QPSK	1@0	see graph	PASS
48	30	10	641666	3624.99	DFT-s-OFDM QPSK	1@0	see graph	PASS
48	30	10	641666	3624.99	DFT-s-OFDM BPSK	1@23	see graph	---
48	30	10	641666	3624.99	DFT-s-OFDM BPSK	1@23	see graph	PASS
48	30	10	641666	3624.99	DFT-s-OFDM BPSK	1@23	see graph	PASS
48	30	10	641666	3624.99	DFT-s-OFDM QPSK	1@23	see graph	---
48	30	10	641666	3624.99	DFT-s-OFDM QPSK	1@23	see graph	PASS
48	30	10	641666	3624.99	DFT-s-OFDM QPSK	1@23	see graph	PASS
48	30	10	641666	3624.99	DFT-s-OFDM BPSK	24@0	see graph	---
48	30	10	641666	3624.99	DFT-s-OFDM BPSK	24@0	see graph	PASS
48	30	10	641666	3624.99	DFT-s-OFDM BPSK	24@0	see graph	PASS
48	30	10	641666	3624.99	DFT-s-OFDM QPSK	24@0	see graph	---
48	30	10	641666	3624.99	DFT-s-OFDM QPSK	24@0	see graph	PASS
48	30	10	641666	3624.99	DFT-s-OFDM QPSK	24@0	see graph	PASS
48	30	10	646332	3694.98	DFT-s-OFDM BPSK	1@0	see graph	---
48	30	10	646332	3694.98	DFT-s-OFDM BPSK	1@0	see graph	PASS
48	30	10	646332	3694.98	DFT-s-OFDM BPSK	1@0	see graph	PASS
48	30	10	646332	3694.98	DFT-s-OFDM QPSK	1@0	see graph	---
48	30	10	646332	3694.98	DFT-s-OFDM QPSK	1@0	see graph	PASS
48	30	10	646332	3694.98	DFT-s-OFDM QPSK	1@0	see graph	PASS
48	30	10	646332	3694.98	DFT-s-OFDM BPSK	1@23	see graph	---
48	30	10	646332	3694.98	DFT-s-OFDM BPSK	1@23	see graph	PASS
48	30	10	646332	3694.98	DFT-s-OFDM BPSK	1@23	see graph	PASS
48	30	10	646332	3694.98	DFT-s-OFDM QPSK	1@23	see graph	---

48	30	10	646332	3694.98	DFT-s-OFDM QPSK	1@23	see graph	PASS
48	30	10	646332	3694.98	DFT-s-OFDM QPSK	1@23	see graph	PASS
48	30	10	646332	3694.98	DFT-s-OFDM BPSK	24@0	see graph	---
48	30	10	646332	3694.98	DFT-s-OFDM BPSK	24@0	see graph	PASS
48	30	10	646332	3694.98	DFT-s-OFDM BPSK	24@0	see graph	PASS
48	30	10	646332	3694.98	DFT-s-OFDM QPSK	24@0	see graph	---
48	30	10	646332	3694.98	DFT-s-OFDM QPSK	24@0	see graph	PASS
48	30	10	646332	3694.98	DFT-s-OFDM QPSK	24@0	see graph	PASS
48	30	20	637334	3560.01	DFT-s-OFDM BPSK	1@0	see graph	---
48	30	20	637334	3560.01	DFT-s-OFDM BPSK	1@0	see graph	PASS
48	30	20	637334	3560.01	DFT-s-OFDM BPSK	1@0	see graph	PASS
48	30	20	637334	3560.01	DFT-s-OFDM QPSK	1@0	see graph	---
48	30	20	637334	3560.01	DFT-s-OFDM QPSK	1@0	see graph	PASS
48	30	20	637334	3560.01	DFT-s-OFDM QPSK	1@0	see graph	PASS
48	30	20	637334	3560.01	DFT-s-OFDM BPSK	1@50	see graph	---
48	30	20	637334	3560.01	DFT-s-OFDM BPSK	1@50	see graph	PASS
48	30	20	637334	3560.01	DFT-s-OFDM BPSK	1@50	see graph	PASS
48	30	20	637334	3560.01	DFT-s-OFDM QPSK	1@50	see graph	---
48	30	20	637334	3560.01	DFT-s-OFDM QPSK	1@50	see graph	PASS
48	30	20	637334	3560.01	DFT-s-OFDM QPSK	1@50	see graph	PASS
48	30	20	637334	3560.01	DFT-s-OFDM BPSK	50@0	see graph	---
48	30	20	637334	3560.01	DFT-s-OFDM BPSK	50@0	see graph	PASS
48	30	20	637334	3560.01	DFT-s-OFDM BPSK	50@0	see graph	PASS
48	30	20	637334	3560.01	DFT-s-OFDM QPSK	50@0	see graph	---

48	30	20	637334	3560.01	DFT-s-OFDM QPSK	50@0	see graph	PASS
48	30	20	637334	3560.01	DFT-s-OFDM QPSK	50@0	see graph	PASS
48	30	20	641666	3624.99	DFT-s-OFDM BPSK	1@0	see graph	---
48	30	20	641666	3624.99	DFT-s-OFDM BPSK	1@0	see graph	PASS
48	30	20	641666	3624.99	DFT-s-OFDM BPSK	1@0	see graph	PASS
48	30	20	641666	3624.99	DFT-s-OFDM QPSK	1@0	see graph	---
48	30	20	641666	3624.99	DFT-s-OFDM QPSK	1@0	see graph	PASS
48	30	20	641666	3624.99	DFT-s-OFDM QPSK	1@0	see graph	PASS
48	30	20	641666	3624.99	DFT-s-OFDM BPSK	1@50	see graph	---
48	30	20	641666	3624.99	DFT-s-OFDM BPSK	1@50	see graph	PASS
48	30	20	641666	3624.99	DFT-s-OFDM BPSK	1@50	see graph	PASS
48	30	20	641666	3624.99	DFT-s-OFDM QPSK	1@50	see graph	---
48	30	20	641666	3624.99	DFT-s-OFDM QPSK	1@50	see graph	PASS
48	30	20	641666	3624.99	DFT-s-OFDM QPSK	1@50	see graph	PASS
48	30	20	641666	3624.99	DFT-s-OFDM BPSK	50@0	see graph	---
48	30	20	641666	3624.99	DFT-s-OFDM BPSK	50@0	see graph	PASS
48	30	20	641666	3624.99	DFT-s-OFDM BPSK	50@0	see graph	PASS
48	30	20	641666	3624.99	DFT-s-OFDM QPSK	50@0	see graph	---
48	30	20	641666	3624.99	DFT-s-OFDM QPSK	50@0	see graph	PASS
48	30	20	641666	3624.99	DFT-s-OFDM QPSK	50@0	see graph	PASS
48	30	20	646000	3690.0	DFT-s-OFDM BPSK	1@0	see graph	---
48	30	20	646000	3690.0	DFT-s-OFDM BPSK	1@0	see graph	PASS
48	30	20	646000	3690.0	DFT-s-OFDM BPSK	1@0	see graph	PASS
48	30	20	646000	3690.0	DFT-s-OFDM QPSK	1@0	see graph	---

48	30	20	646000	3690.0	DFT-s-OFDM QPSK	1@0	see graph	PASS
48	30	20	646000	3690.0	DFT-s-OFDM QPSK	1@0	see graph	PASS
48	30	20	646000	3690.0	DFT-s-OFDM BPSK	1@50	see graph	---
48	30	20	646000	3690.0	DFT-s-OFDM BPSK	1@50	see graph	PASS
48	30	20	646000	3690.0	DFT-s-OFDM BPSK	1@50	see graph	PASS
48	30	20	646000	3690.0	DFT-s-OFDM QPSK	1@50	see graph	---
48	30	20	646000	3690.0	DFT-s-OFDM QPSK	1@50	see graph	PASS
48	30	20	646000	3690.0	DFT-s-OFDM QPSK	1@50	see graph	PASS
48	30	20	646000	3690.0	DFT-s-OFDM BPSK	50@0	see graph	---
48	30	20	646000	3690.0	DFT-s-OFDM BPSK	50@0	see graph	PASS
48	30	20	646000	3690.0	DFT-s-OFDM BPSK	50@0	see graph	PASS
48	30	20	646000	3690.0	DFT-s-OFDM QPSK	50@0	see graph	---
48	30	20	646000	3690.0	DFT-s-OFDM QPSK	50@0	see graph	PASS
48	30	20	646000	3690.0	DFT-s-OFDM QPSK	50@0	see graph	PASS
48	30	40	638000	3570.0	DFT-s-OFDM BPSK	1@0	see graph	---
48	30	40	638000	3570.0	DFT-s-OFDM BPSK	1@0	see graph	PASS
48	30	40	638000	3570.0	DFT-s-OFDM BPSK	1@0	see graph	PASS
48	30	40	638000	3570.0	DFT-s-OFDM QPSK	1@0	see graph	---
48	30	40	638000	3570.0	DFT-s-OFDM QPSK	1@0	see graph	PASS
48	30	40	638000	3570.0	DFT-s-OFDM QPSK	1@0	see graph	PASS
48	30	40	638000	3570.0	DFT-s-OFDM BPSK	1@105	see graph	---
48	30	40	638000	3570.0	DFT-s-OFDM BPSK	1@105	see graph	PASS
48	30	40	638000	3570.0	DFT-s-OFDM BPSK	1@105	see graph	PASS
48	30	40	638000	3570.0	DFT-s-OFDM QPSK	1@105	see graph	---

48	30	40	638000	3570.0	DFT-s-OFDM QPSK	1@105	see graph	PASS
48	30	40	638000	3570.0	DFT-s-OFDM QPSK	1@105	see graph	PASS
48	30	40	638000	3570.0	DFT-s-OFDM BPSK	100@0	see graph	---
48	30	40	638000	3570.0	DFT-s-OFDM BPSK	100@0	see graph	PASS
48	30	40	638000	3570.0	DFT-s-OFDM BPSK	100@0	see graph	PASS
48	30	40	638000	3570.0	DFT-s-OFDM QPSK	100@0	see graph	---
48	30	40	638000	3570.0	DFT-s-OFDM QPSK	100@0	see graph	PASS
48	30	40	638000	3570.0	DFT-s-OFDM QPSK	100@0	see graph	PASS
48	30	40	641666	3624.99	DFT-s-OFDM BPSK	1@0	see graph	---
48	30	40	641666	3624.99	DFT-s-OFDM BPSK	1@0	see graph	PASS
48	30	40	641666	3624.99	DFT-s-OFDM BPSK	1@0	see graph	PASS
48	30	40	641666	3624.99	DFT-s-OFDM QPSK	1@0	see graph	---
48	30	40	641666	3624.99	DFT-s-OFDM QPSK	1@0	see graph	PASS
48	30	40	641666	3624.99	DFT-s-OFDM QPSK	1@0	see graph	PASS
48	30	40	641666	3624.99	DFT-s-OFDM BPSK	1@105	see graph	---
48	30	40	641666	3624.99	DFT-s-OFDM BPSK	1@105	see graph	PASS
48	30	40	641666	3624.99	DFT-s-OFDM BPSK	1@105	see graph	PASS
48	30	40	641666	3624.99	DFT-s-OFDM QPSK	1@105	see graph	---
48	30	40	641666	3624.99	DFT-s-OFDM QPSK	1@105	see graph	PASS
48	30	40	641666	3624.99	DFT-s-OFDM QPSK	1@105	see graph	PASS
48	30	40	641666	3624.99	DFT-s-OFDM BPSK	100@0	see graph	---
48	30	40	641666	3624.99	DFT-s-OFDM BPSK	100@0	see graph	PASS
48	30	40	641666	3624.99	DFT-s-OFDM BPSK	100@0	see graph	PASS
48	30	40	641666	3624.99	DFT-s-OFDM QPSK	100@0	see graph	---

48	30	40	641666	3624.99	DFT-s-OFDM QPSK	100@0	see graph	PASS
48	30	40	641666	3624.99	DFT-s-OFDM QPSK	100@0	see graph	PASS
48	30	40	645332	3679.98	DFT-s-OFDM BPSK	1@0	see graph	---
48	30	40	645332	3679.98	DFT-s-OFDM BPSK	1@0	see graph	PASS
48	30	40	645332	3679.98	DFT-s-OFDM BPSK	1@0	see graph	PASS
48	30	40	645332	3679.98	DFT-s-OFDM QPSK	1@0	see graph	---
48	30	40	645332	3679.98	DFT-s-OFDM QPSK	1@0	see graph	PASS
48	30	40	645332	3679.98	DFT-s-OFDM QPSK	1@0	see graph	PASS
48	30	40	645332	3679.98	DFT-s-OFDM BPSK	1@105	see graph	---
48	30	40	645332	3679.98	DFT-s-OFDM BPSK	1@105	see graph	PASS
48	30	40	645332	3679.98	DFT-s-OFDM BPSK	1@105	see graph	PASS
48	30	40	645332	3679.98	DFT-s-OFDM QPSK	1@105	see graph	---
48	30	40	645332	3679.98	DFT-s-OFDM QPSK	1@105	see graph	PASS
48	30	40	645332	3679.98	DFT-s-OFDM QPSK	1@105	see graph	PASS
48	30	40	645332	3679.98	DFT-s-OFDM BPSK	100@0	see graph	---
48	30	40	645332	3679.98	DFT-s-OFDM BPSK	100@0	see graph	PASS
48	30	40	645332	3679.98	DFT-s-OFDM BPSK	100@0	see graph	PASS
48	30	40	645332	3679.98	DFT-s-OFDM QPSK	100@0	see graph	---
48	30	40	645332	3679.98	DFT-s-OFDM QPSK	100@0	see graph	PASS
48	30	40	645332	3679.98	DFT-s-OFDM QPSK	100@0	see graph	PASS