



# FCC RF Test Report

APPLICANT : ASUSTeK COMPUTER INC.  
EQUIPMENT : ASUS Phone(Mobile Phone)  
BRAND NAME : ASUS  
MODEL NAME : ASUS\_AI2202  
FCC ID : MSQAI2202  
STANDARD : 47 CFR Part 2, 22(H), 24(E), 27(H), 27(L), 27(N)  
CLASSIFICATION : PCS Licensed Transmitter Held to Ear (PCE)  
TEST DATE(S) : Apr. 27, 2022 ~ May 30, 2022

We, Sporton International Inc. (ShenZhen), would like to declare that the tested sample has been evaluated in accordance with the procedures given in ANSI C63.26-2015 and shown compliance with the applicable technical standards.

This report contains data that were produced under subcontract by Sporton International Inc. (Kunshan).

The test results in this report apply exclusively to the tested model / sample. Without written approval of Sporton International Inc. (Shenzhen), the test report shall not be reproduced except in full.

Jason Jia

Approved by: Jason Jia



**Sporton International Inc. (ShenZhen)**

**1/F, 2/F, Bldg 5, Shiling Industrial Zone, Xinwei Village, Xili, Nanshan, Shenzhen, 518055**

**People's Republic of China**



TABLE OF CONTENTS

REVISION HISTORY... 3
SUMMARY OF TEST RESULT ... 4
1 GENERAL DESCRIPTION ... 5
1.1 Applicant ... 5
1.2 Manufacturer ... 5
1.3 Product Feature of Equipment Under Test ... 5
1.4 Product Specification of Equipment Under Test ... 6
1.5 Modification of EUT ... 7
1.6 Maximum ERP/EIRP Power and Emission Designator ... 8
1.7 Testing Location ... 11
1.8 Test Software ... 11
1.9 Applicable Standards ... 12
2 TEST CONFIGURATION OF EQUIPMENT UNDER TEST ... 13
2.1 Test Mode ... 13
2.2 Connection Diagram of Test System ... 16
2.3 Support Unit used in test configuration and system ... 16
2.4 Measurement Results Explanation Example ... 16
2.5 Frequency List of Low/Middle/High Channels ... 17
3 CONDUCTED TEST ITEMS ... 21
3.1 Measuring Instruments ... 21
3.2 Test Setup ... 21
3.3 Test Result of Conducted Test ... 21
3.4 Conducted Output Power and ERP/EIRP ... 22
3.5 Peak-to-Average Ratio ... 23
3.6 Occupied Bandwidth ... 24
3.7 Conducted Band Edge ... 25
3.8 Conducted Spurious Emission ... 27
3.9 Frequency Stability ... 28
4 RADIATED TEST ITEMS ... 29
4.1 Measuring Instruments ... 29
4.2 Test Setup ... 29
4.3 Test Result of Radiated Test ... 30
4.4 Radiated Spurious Emission ... 31
5 LIST OF MEASURING EQUIPMENT ... 32
6 UNCERTAINTY OF EVALUATION ... 33
APPENDIX A. TEST RESULTS OF CONDUCTED TEST
APPENDIX B. TEST RESULTS OF RADIATED TEST
APPENDIX C. TEST SETUP PHOTOGRAPHS





## SUMMARY OF TEST RESULT

Report Section	FCC Rule	Description	Limit	Result	Remark
3.4	§2.1046	Conducted Output Power	-	Report Only	-
	§22.913(a)(5)	Effective Radiated Power (Band 5) (Band 26)	ERP < 7 Watt	PASS	-
	§27.50(c)(10)	Effective Radiated Power (Band 12) (Band 17)(Band 71)	ERP < 3 Watt		-
	§24.232(c)	Equivalent Isotropic Radiated Power (Band 2) (Band 25)	EIRP < 2Watt		-
	§27.50(d)(4)	Equivalent Isotropic Radiated Power (Band 4) (Band 66)	EIRP < 1Watt		-
3.5	§24.232(d)	Peak-to-Average Ratio	<13 dB	PASS	-
3.6	§2.1049	Occupied Bandwidth	-	Report Only	-
3.7	§2.1051 §22.917(a) §24.238(a) §27.53(g) §27.53(h)	Conducted Band Edge Measurement (Band 2) (Band 4) (Band 5) (Band 12) (Band 17) (Band 25) (Band 26) (Band 66) (Band 71)	< 43+10log10(P[Watts])	PASS	-
3.8	§2.1051 §22.917(a) §24.238(a) §27.53(g) §27.53(h)	Conducted Spurious Emission (Band 2) (Band 4) (Band 5) (Band 12) (Band 17) (Band 25) (Band 26) (Band 66) (Band 71)	< 43+10log10(P[Watts])	PASS	-
3.9	§2.1055 §22.355	Frequency Stability Temperature & Voltage	< 2.5 ppm for Part 22	PASS	-
	§2.1055 §24.235 §27.54		Within Authorized Band		
4.4	§2.1053 §22.917(a) §24.238(a) §27.53(f) §27.53(g) §27.53(h)	Radiated Spurious Emission (Band 2) (Band 4) (Band 5) (Band 12) (Band 17) (Band 25) (Band 26) (Band 66) (Band 71)	< 43+10log <sub>10</sub> (P[Watts])	PASS	Under limit 34.68 dB at 2504.000 MHz

**Declaration of Conformity:**

The test results with all measurement uncertainty excluded are presented in accordance with the regulation limits or requirements declared by manufacturers.

**Comments and Explanations:**

The declared of product specification for EUT presented in the report are provided by the manufacturer, and the manufacturer takes all the responsibilities for the accuracy of product specification.



# 1 General Description

## 1.1 Applicant

ASUSTeK COMPUTER INC.

1F., No. 15, Lide Rd., Beitou Dist., Taipei City 112, Taiwan

## 1.2 Manufacturer

ASUSTeK COMPUTER INC.

1F., No. 15, Lide Rd., Beitou Dist., Taipei City 112, Taiwan

## 1.3 Product Feature of Equipment Under Test

Product Feature	
Equipment	ASUS Phone(Mobile Phone)
Brand Name	ASUS
Model Name	ASUS_AI2202
FCC ID	MSQAI2202
IMEI Code	Conducted: 351694450115311/351694450115329 Radiation: 354283690001593/354283690001601
HW Version	AI2202_MB_ER2 R2.0
SW Version	Android R
EUT Stage	Production Unit



### 1.4 Product Specification of Equipment Under Test

Standards-related Product Specification	
<b>Tx Frequency</b>	LTE Band 2 : 1850 MHz ~ 1910 MHz LTE Band 4 : 1710 MHz ~ 1755 MHz LTE Band 5 : 824 MHz ~ 849 MHz LTE Band 12 : 699 MHz ~ 716 MHz LTE Band 17 : 704 MHz ~ 716 MHz LTE Band 25 : 1850 MHz ~ 1915 MHz LTE Band 26 : 824 MHz ~ 849 MHz LTE Band 66 : 1710 MHz ~ 1780 MHz LTE Band 71: 663 MHz ~ 698 MHz
<b>Rx Frequency</b>	LTE Band 2 : 1930 MHz ~ 1990 MHz LTE Band 4 : 2110 MHz ~ 2155 MHz LTE Band 5 : 869 MHz ~ 894 MHz LTE Band 12 : 729 MHz ~ 746 MHz LTE Band 17 : 734 MHz ~ 746 MHz LTE Band 25 : 1930 MHz ~ 1995 MHz LTE Band 26 : 869 MHz ~ 894 MHz LTE Band 66 : 2110 MHz~ 2200 MHz LTE Band 71: 617 MHz ~ 652 MHz
<b>Bandwidth</b>	LTE Band 2 : 1.4MHz / 3MHz / 5MHz / 10MHz / 15MHz / 20MHz LTE Band 4 : 1.4MHz / 3MHz / 5MHz / 10MHz / 15MHz / 20MHz LTE Band 5 : 1.4MHz / 3MHz / 5MHz / 10MHz LTE Band 12 : 1.4MHz / 3MHz / 5MHz / 10MHz LTE Band 17 : 5MHz / 10MHz LTE Band 25 : 1.4MHz / 3MHz / 5MHz / 10MHz / 15MHz / 20MHz LTE Band 26 : 1.4MHz / 3MHz / 5MHz / 10MHz / 15MHz LTE Band 66 : 1.4MHz / 3MHz / 5MHz / 10MHz / 15MHz / 20MHz LTE Band 71 : 5MHz / 10MHz / 15MHz / 20MHz
<b>Maximum Output Power to Antenna</b>	<b>&lt;Ant. 1&gt;</b> LTE Band 5 : 22.98 dBm LTE Band 12 : 23.09 dBm LTE Band 17 : 22.87 dBm LTE Band 26 : 22.99 dBm LTE Band 71 : 23.05 dBm <b>&lt;Ant. 2&gt;</b> LTE Band 2 : 23.13 dBm LTE Band 4 : 22.71 dBm LTE Band 25 : 23.28 dBm LTE Band 66 : 22.83 dBm <b>&lt;Ant. 3&gt;</b> LTE Band 5 : 22.50 dBm LTE Band 12 : 22.65 dBm LTE Band 17 : 22.60 dBm LTE Band 26 : 22.60 dBm LTE Band 71 : 22.60 dBm <b>&lt;Ant. 4&gt;</b> LTE Band 2 : 22.63 dBm LTE Band 4 : 22.74 dBm LTE Band 25 : 22.70 dBm LTE Band 66 : 22.80 dBm
<b>Antenna Gain</b>	<b>&lt;Ant. 1&gt;</b>



	LTE Band 5 : -6.04 dBi LTE Band 12 : -5.47 dBi LTE Band 17 : -5.47 dBi LTE Band 26 : -6.04 dBi LTE Band 71 : -6.02 dBi <b>&lt;Ant. 2&gt;</b> LTE Band 2 : -3.26 dBi LTE Band 4 : -4.71 dBi LTE Band 25 : -3.26 dBi LTE Band 66 : -4.71 dBi <b>&lt;Ant. 3&gt;</b> LTE Band 5 : -4.31 dBi LTE Band 12 : -8.64 dBi LTE Band 17 : -8.64 dBi LTE Band 26 : -4.31 dBi LTE Band 71 : -11.39 dBi <b>&lt;Ant. 4&gt;</b> LTE Band 2 : -6.66 dBi LTE Band 4 : -5.59 dBi LTE Band 25 : -6.66 dBi LTE Band 66 : -5.59 dBi
<b>Type of Modulation</b>	QPSK / 16QAM / 64QAM / 256QAM

**Note:** The maximum ERP/EIRP is calculated from max output power and max antenna gain, so only the maximum ERP/EIRP of Antenna 1 for LTE Band 12/17/71, Antenna 2 for LTE Band2/4/25/66 and Antenna 3 for LTE Band 5/26 are shown in the report.

### 1.5 Modification of EUT

No modifications are made to the EUT during all test items.



### 1.6 Maximum ERP/EIRP Power and Emission Designator

LTE Band 2		QPSK		16QAM/64QAM/256QAM	
BW (MHz)	Frequency Range (MHz)	Maximum EIRP(W)	Emission Designator (99%OBW)	Maximum EIRP(W)	Emission Designator (99%OBW)
1.4	1850.7 ~ 1909.3	0.0944	1M10G7D	0.0834	1M12W7D
3	1851.5 ~ 1908.5	0.0942	2M74G7D	0.0845	2M75W7D
5	1852.5 ~ 1907.5	0.0946	4M50G7D	0.0836	4M52W7D
10	1855.0 ~ 1905.0	0.0957	9M03G7D	0.0822	9M15W7D
15	1857.5 ~ 1902.5	0.0935	13M5G7D	0.0843	13M5W7D
20	1860.0 ~ 1900.0	0.0971	18M0G7D	0.0863	18M0W7D
LTE Band 25		QPSK		16QAM/64QAM/256QAM	
BW (MHz)	Frequency Range (MHz)	Maximum EIRP(W)	Emission Designator (99%OBW)	Maximum EIRP(W)	Emission Designator (99%OBW)
1.4	1850.7 ~ 1914.3	0.0998	1M10G7D	0.0853	1M12W7D
3	1851.5 ~ 1913.5	0.0973	2M74G7D	0.0828	2M75W7D
5	1852.5 ~ 1912.5	0.0986	4M50G7D	0.0839	4M52W7D
10	1855.0 ~ 1910.0	0.0995	9M03G7D	0.0847	9M15W7D
15	1857.5 ~ 1907.5	0.0993	13M5G7D	0.0843	13M5W7D
20	1860.0 ~ 1905.0	0.1005	18M0G7D	0.0863	18M0W7D
LTE Band 4		QPSK		16QAM/64QAM/256QAM	
BW (MHz)	Frequency Range (MHz)	Maximum EIRP(W)	Emission Designator (99%OBW)	Maximum EIRP(W)	Emission Designator (99%OBW)
1.4	1710.7 ~ 1754.3	0.0630	1M10G7D	0.0538	1M11W7D
3	1711.5 ~ 1753.5	0.0624	2M72G7D	0.0542	2M74W7D
5	1712.5 ~ 1752.5	0.0618	4M53G7D	0.0504	4M51W7D
10	1715.0 ~ 1750.0	0.0615	9M07G7D	0.0538	9M11W7D
15	1717.5 ~ 1747.5	0.0615	13M5G7D	0.0533	13M6W7D
20	1720.0 ~ 1745.0	0.0631	18M1G7D	0.0545	18M0W7D





LTE Band 5		QPSK		16QAM/64QAM/256QAM	
BW (MHz)	Frequency Range (MHz)	Maximum ERP(W)	Emission Designator (99%OBW)	Maximum ERP(W)	Emission Designator (99%OBW)
1.4	824.7 ~ 848.3	0.0399	1M10G7D	0.0383	1M12W7D
3	825.5 ~ 847.5	0.0400	2M74G7D	0.0380	2M76W7D
5	826.5 ~ 846.5	0.0401	4M52G7D	0.0382	4M51W7D
10	829.0 ~ 844.0	0.0402	9M03G7D	0.0378	9M07W7D
LTE Band 12		QPSK		16QAM/64QAM/256QAM	
BW (MHz)	Frequency Range (MHz)	Maximum ERP(W)	Emission Designator (99%OBW)	Maximum ERP(W)	Emission Designator (99%OBW)
1.4	699.7 ~ 715.3	0.0350	1M09G7D	0.0316	1M10W7D
3	700.5 ~ 714.5	0.0352	2M74G7D	0.0310	2M74W7D
5	701.5 ~ 713.5	0.0352	4M51G7D	0.0309	4M50W7D
10	704.0 ~ 711.0	0.0352	9M03G7D	0.0315	9M07W7D
LTE Band 17		QPSK		16QAM/64QAM/256QAM	
BW (MHz)	Frequency Range (MHz)	Maximum ERP(W)	Emission Designator (99%OBW)	Maximum ERP(W)	Emission Designator (99%OBW)
5	706.5 ~ 713.5	0.0334	4M51G7D	0.0298	4M50W7D
10	709.0 ~ 711.0	0.0335	9M03G7D	0.0291	9M07W7D
LTE Band 26		QPSK		16QAM/64QAM/256QAM	
BW (MHz)	Frequency Range (MHz)	Maximum ERP(W)	Emission Designator (99%OBW)	Maximum ERP(W)	Emission Designator (99%OBW)
1.4	824.7 ~ 848.3	0.0406	1M10G7D	0.0369	1M12W7D
3	825.5 ~ 847.5	0.0410	2M74G7D	0.0377	2M76W7D
5	826.5 ~ 846.5	0.0408	4M52G7D	0.0375	4M51W7D
10	829.0 ~ 844.0	0.0410	9M03G7D	0.0366	9M07W7D
15	831.5 ~ 841.5	0.0411	13M5G7D	0.0379	13M5W7D
CH26765	821.5	0.0406	13M6G7D	0.0370	13M5W7D



LTE Band 66		QPSK		16QAM/64QAM/256QAM	
BW (MHz)	Frequency Range (MHz)	Maximum EIRP(W)	Emission Designator (99%OBW)	Maximum EIRP(W)	Emission Designator (99%OBW)
1.4	1710.7 ~ 1779.3	0.0627	1M10G7D	0.0557	1M11W7D
3	1711.5 ~ 1778.5	0.0624	2M72G7D	0.0538	2M74W7D
5	1712.5 ~ 1777.5	0.0625	4M53G7D	0.0558	4M51W7D
10	1715.0 ~ 1775.0	0.0637	9M07G7D	0.0560	9M11W7D
15	1717.5 ~ 1772.5	0.0628	13M5G7D	0.0552	13M6W7D
20	1720.0 ~ 1770.0	0.0649	18M1G7D	0.0570	18M0W7D
LTE Band 71		QPSK		16QAM/64QAM/256QAM	
BW (MHz)	Frequency Range (MHz)	Maximum ERP(W)	Emission Designator (99%OBW)	Maximum ERP(W)	Emission Designator (99%OBW)
5	665.5 ~ 695.5	0.0303	4M53G7D	0.0260	4M52W7D
10	668.0 ~ 693.0	0.0304	9M03G7D	0.0251	9M11W7D
15	670.5 ~ 690.5	0.0301	13M5G7D	0.0254	13M5W7D
20	673.0 ~ 688.0	0.0308	17M9G7D	0.0256	17M9W7D

Note:

1. LTE Band 26 overlaps the entire frequency range of LTE Band 5. Therefore, the test results provided in this report covers Band 26 as well as Band 5.
2. LTE Band 66 overlaps the entire frequency range of LTE Band 4. Therefore, the test results provided in this report covers Band 66 as well as Band 4.
3. LTE Band 25 overlaps the entire frequency range of LTE Band 2. Therefore, the test results provided in this report covers Band 25 as well as Band 2.
4. LTE Band 12 overlaps the entire frequency range of LTE Band 17. Therefore, the test results provided in this report covers Band 12 as well as Band 17.
5. All modulations have been tested, and only the worst test results of PSK & QAM are shown in the report .



### 1.7 Testing Location

Sporton International Inc. (Kunshan) is accredited to ISO/IEC 17025:2017 by American Association for Laboratory Accreditation with Certificate Number 5145.02.

<b>Test Firm</b>	Sporton International Inc. (Kunshan)		
<b>Test Site Location</b>	No. 1098, Pengxi North Road, Kunshan Economic Development Zone Jiangsu Province 215300 People's Republic of China TEL : +86-512-57900158 FAX : +86-512-57900958		
<b>Test Site No.</b>	<b>Sporton Site No.</b>	<b>FCC Designation No.</b>	<b>FCC Test Firm Registration No.</b>
	03CH04-KS	CN1257	314309

Note: Test data subcontracted: Conducted test cases in section 4.4 of this report

Sporton International Inc. (Shenzhen) is accredited to ISO/IEC 17025:2017 by American Association for Laboratory Accreditation with Certificate Number 5145.01.

<b>Test Firm</b>	Sporton International Inc. (Shenzhen)		
<b>Test Site Location</b>	1/F, 2/F, Bldg 5, Shiling Industrial Zone, Xinwei Village, Xili, Nanshan, Shenzhen, 518055 People's Republic of China TEL: +86-755-86379589 FAX: +86-755-86379595		
<b>Test Site No.</b>	<b>Sporton Site No.</b>	<b>FCC Designation No.</b>	<b>FCC Test Firm Registration No.</b>
	TH01-SZ	CN1256	421272

### 1.8 Test Software

Item	Site	Manufacture	Name	Version
1.	03CH04-KS	AUDIX	E3	6.2009-8-24a



## 1.9 Applicable Standards

According to the specifications of the manufacturer, the EUT must comply with the requirements of the following standards:

- ♦ 47 CFR Part 2, 22(H), 24(E), 27(H), 27(L), 27(N)
- ♦ ANSI C63.26-2015
- ♦ FCC KDB 971168 D01 Power Meas License Digital Systems v03r01
- ♦ FCC KDB 412172 D01 Determining ERP and EIRP v01r01

**Remark:**

1. All test items were verified and recorded according to the standards and without any deviation during the test.
2. This EUT has also been tested and complied with the requirements of FCC Part 15, Subpart B, recorded in a separate test report.



## 2 Test Configuration of Equipment Under Test

### 2.1 Test Mode

Antenna port conducted and radiated test items listed below are performed according to KDB 971168 D01 Power Meas License Digital Systems v03r01 with maximum output power.

Radiated measurements are performed by rotating the EUT in three different orthogonal test planes to find the maximum emission.

Test Items	Band	Bandwidth (MHz)						Modulation				RB #			Test Channel			
		1.4	3	5	10	15	20	QPSK	16QAM	64QAM	256QAM	1	Half	Full	L	M	H	
Max. Output Power	2	v	v	v	v	v	v	v	v	v	v	v	v	v	v	v	v	v
	4	v	v	v	v	v	v	v	v	v	v	v	v	v	v	v	v	v
	5	v	v	v	v	-	-	v	v	v	v	v	v	v	v	v	v	v
	12	v	v	v	v	-	-	v	v	v	v	v	v	v	v	v	v	v
	17	-	-	v	v	-	-	v	v	v	v	v	v	v	v	v	v	v
	25	v	v	v	v	v	v	v	v	v	v	v	v	v	v	v	v	v
	26	v	v	v	v	v	-	v	v	v	v	v	v	v	v	v	v	v
	66	v	v	v	v	v	v	v	v	v	v	v	v	v	v	v	v	v
	71	-	-	v	v	v	v	v	v	v	v	v	v	v	v	v	v	v
Peak-to-Average Ratio	25						v	v	v	v		v		v	v	v	v	
	12				v	-	-	v	v	v		v		v	v	v	v	
	26				v		-	v	v	v		v		v	v	v	v	
	66						v	v	v	v		v		v	v	v	v	
	71	-	-				v	v	v	v		v		v	v	v	v	



Test Items	Band	Bandwidth (MHz)						Modulation				RB #			Test Channel		
		1.4	3	5	10	15	20	QPSK	16QAM	64QAM	256QAM	1	Half	Full	L	M	H
26dB and 99% Bandwidth	25	v	v	v	v	v	v	v	v	v				v	v	v	v
	12	v	v	v	v	-	-	v	v	v				v	v	v	v
	26	v	v	v	v	v	-	v	v	v				v	v	v	v
	66	v	v	v	v	v	v	v	v	v				v	v	v	v
	71	-	-	v	v	v	v	v	v	v				v	v	v	v
Conducted Band Edge	25	v	v	v	v	v	v	v	v	v		v		v	v		v
	12	v	v	v	v	-	-	v	v	v		v		v	v		v
	26	v	v	v	v	v	-	v	v	v		v		v	v		v
	66	v	v	v	v	v	v	v	v	v		v		v	v		v
	71	-	-	v	v	v	v	v	v	v		v		v	v		v
Conducted Spurious Emission	25	v	v	v	v	v	v	v	v	v		v			v	v	v
	12	v	v	v	v	-	-	v	v	v		v			v	v	v
	26	v	v	v	v	v	-	v	v	v		v			v	v	v
	66	v	v	v	v	v	v	v	v	v		v			v	v	v
	71	-	-	v	v	v	v	v	v	v		v			v	v	v
Frequency Stability	25				v			v						v		v	
	12				v	-	-	v						v		v	
	26				v		-	v						v		v	
	66				v			v						v		v	
	71	-	-		v			v						v		v	



Test Items	Band	Bandwidth (MHz)						Modulation				RB #			Test Channel			
		1.4	3	5	10	15	20	QPSK	16QAM	64QAM	256QAM	1	Half	Full	L	M	H	
E.R.P / E.I.R.P	2	v	v	v	v	v	v	v	v	v	v	v	v			v	v	v
	4	v	v	v	v	v	v	v	v	v	v	v	v			v	v	v
	5	v	v	v	v	-	-	v	v	v	v	v	v			v	v	v
	12	v	v	v	v	-	-	v	v	v	v	v	v			v	v	v
	17	-	-	v	v	-	-	v	v	v	v	v	v			v	v	v
	25	v	v	v	v	v	v	v	v	v	v	v	v			v	v	v
	26	v	v	v	v	v	-	v	v	v	v	v	v			v	v	v
	66	v	v	v	v	v	v	v	v	v	v	v	v			v	v	v
	71	-	-	v	v	v	v	v	v	v	v	v	v			v	v	v
Radiated Spurious Emission	12	Worst Case														v	v	v
	17	Worst Case														v	v	v
	25	Worst Case														v	v	v
	26	Worst Case														v	v	v
	66	Worst Case														v	v	v
	71	Worst Case														v	v	v
Note	<ol style="list-style-type: none"> <li>The mark "v" means that this configuration is chosen for testing</li> <li>The mark "-" means that this bandwidth is not supported.</li> <li>The device is investigated from 30MHz to 10 times of fundamental signal for radiated spurious emission test under different RB size/offset and modulations in exploratory test. Subsequently, only the worst case emissions are reported.</li> <li>For 256QAM, the conducted power lower than 16QAM/64QAM, thus 16QAM/64QAM has assessed to test.</li> </ol>																	

## 2.2 Connection Diagram of Test System

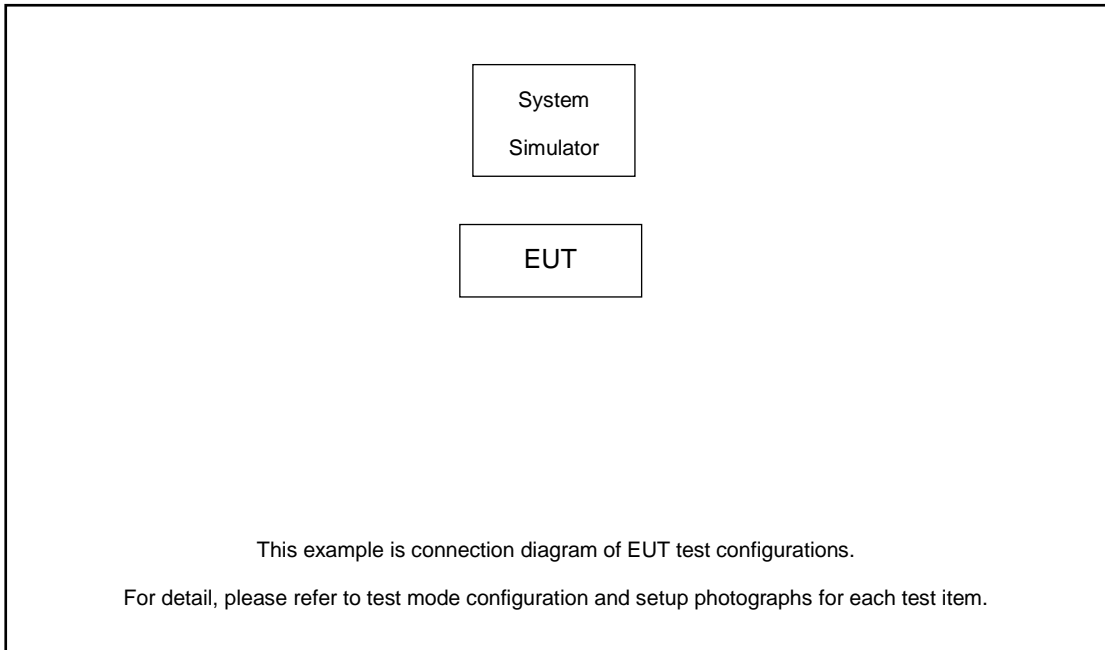

## 2.3 Support Unit used in test configuration and system

Item	Equipment	Trade Name	Model No.	FCC ID	Data Cable	Power Cord
1.	Power Supply	GWINSTEK	PSS-2002	N/A	N/A	Unshielded, 1.8 m
2.	LTE Base Station	Anritsu	MT8820/8821	N/A	N/A	Unshielded, 1.8 m

## 2.4 Measurement Results Explanation Example

### For all conducted test items:

The offset level is set in the spectrum analyzer to compensate the RF cable loss and attenuator factor between EUT conducted output port and spectrum analyzer. With the offset compensation, the spectrum analyzer reading level is exactly the EUT RF output level.

The spectrum analyzer offset is derived from RF cable loss and attenuator factor.

*Offset = RF cable loss + attenuator factor.*

Following shows an offset computation example with cable loss 4.5 dB and 10dB attenuator.

Example :

$$\begin{aligned} \text{Offset(dB)} &= \text{RF cable loss(dB)} + \text{attenuator factor(dB)}. \\ &= 4.5 + 10 = 14.5 \text{ (dB)} \end{aligned}$$





### 2.5 Frequency List of Low/Middle/High Channels

LTE Band 2 Channel and Frequency List				
BW [MHz]	Channel/Frequency(MHz)	Lowest	Middle	Highest
20	Channel	18700	18900	19100
	Frequency	1860	1880	1900
15	Channel	18675	18900	19125
	Frequency	1857.5	1880	1902.5
10	Channel	18650	18900	19150
	Frequency	1855	1880	1905
5	Channel	18625	18900	19175
	Frequency	1852.5	1880	1907.5
3	Channel	18615	18900	19185
	Frequency	1851.5	1880	1908.5
1.4	Channel	18607	18900	19193
	Frequency	1850.7	1880	1909.3

LTE Band 4 Channel and Frequency List				
BW [MHz]	Channel/Frequency(MHz)	Lowest	Middle	Highest
20	Channel	20050	20175	20300
	Frequency	1720	1732.5	1745
15	Channel	20025	20175	20325
	Frequency	1717.5	1732.5	1747.5
10	Channel	20000	20175	20350
	Frequency	1715	1732.5	1750
5	Channel	19975	20175	20375
	Frequency	1712.5	1732.5	1752.5
3	Channel	19965	20175	20385
	Frequency	1711.5	1732.5	1753.5
1.4	Channel	19957	20175	20393
	Frequency	1710.7	1732.5	1754.3



LTE Band 5 Channel and Frequency List				
BW [MHz]	Channel/Frequency(MHz)	Lowest	Middle	Highest
10	Channel	20450	20525	20600
	Frequency	829	836.5	844
5	Channel	20425	20525	20625
	Frequency	826.5	836.5	846.5
3	Channel	20415	20525	20635
	Frequency	825.5	836.5	847.5
1.4	Channel	20407	20525	20643
	Frequency	824.7	836.5	848.3

LTE Band 12 Channel and Frequency List				
BW [MHz]	Channel/Frequency(MHz)	Lowest	Middle	Highest
10	Channel	23060	23095	23130
	Frequency	704	707.5	711
5	Channel	23035	23095	23155
	Frequency	701.5	707.5	713.5
3	Channel	23025	23095	23165
	Frequency	700.5	707.5	714.5
1.4	Channel	23017	23095	23173
	Frequency	699.7	707.5	715.3

LTE Band 17 Channel and Frequency List				
BW [MHz]	Channel/Frequency(MHz)	Lowest	Middle	Highest
10	Channel	23780	23790	23800
	Frequency	709	710	711
5	Channel	23755	23790	23825
	Frequency	706.5	710	713.5



LTE Band 25 Channel and Frequency List				
BW [MHz]	Channel/Frequency(MHz)	Lowest	Middle	Highest
20	Channel	26140	26340	26590
	Frequency	1860	1880	1905
15	Channel	26115	26340	26615
	Frequency	1857.5	1880	1907.5
10	Channel	26090	26340	26640
	Frequency	1855	1880	1910
5	Channel	26065	26340	26665
	Frequency	1852.5	1880	1912.5
3	Channel	26055	26340	26675
	Frequency	1851.5	1880	1913.5
1.4	Channel	26047	26340	26683
	Frequency	1850.7	1880	1914.3

LTE Band 26 Channel and Frequency List				
BW [MHz]	Channel/Frequency(MHz)	Lowest	Middle	Highest
15	Channel	26865	26915	26965
	Frequency	831.5	836.5	841.5
10	Channel	26840	26915	26990
	Frequency	829	836.5	844
5	Channel	26815	26915	27015
	Frequency	826.5	836.5	846.5
3	Channel	26805	26915	27025
	Frequency	825.5	836.5	847.5
1.4	Channel	26797	26915	27033
	Frequency	824.7	836.5	848.3



LTE Band 66 Channel and Frequency List				
BW [MHz]	Channel/Frequency(MHz)	Lowest	Middle	Highest
20	Channel	132072	132322	132572
	Frequency	1720	1745	1770
15	Channel	132047	132322	132597
	Frequency	1717.5	1745	1772.5
10	Channel	132022	132322	132622
	Frequency	1715	1745	1775
5	Channel	131997	132322	132647
	Frequency	1712.5	1745	1777.5
3	Channel	131987	132322	132657
	Frequency	1711.5	1745	1778.5
1.4	Channel	131979	132322	132665
	Frequency	1710.7	1745	1779.3

LTE Band 71 Channel and Frequency List				
BW [MHz]	Channel/Frequency(MHz)	Lowest	Middle	Highest
20	Channel	133222	133322	133372
	Frequency	673.0	680.5	688.0
15	Channel	133197	133297	133397
	Frequency	670.5	680.5	690.5
10	Channel	133172	133272	133422
	Frequency	668.0	678.0	693.0
5	Channel	133147	133247	133447
	Frequency	665.5	675.5	695.5

### 3 Conducted Test Items

#### 3.1 Measuring Instruments

See list of measuring instruments of this test report.

#### 3.2 Test Setup

##### 3.2.1 Conducted Output Power



##### 3.2.2 Peak-to-Average Ratio, Occupied Bandwidth ,Conducted Band-Edge and Conducted Spurious Emission

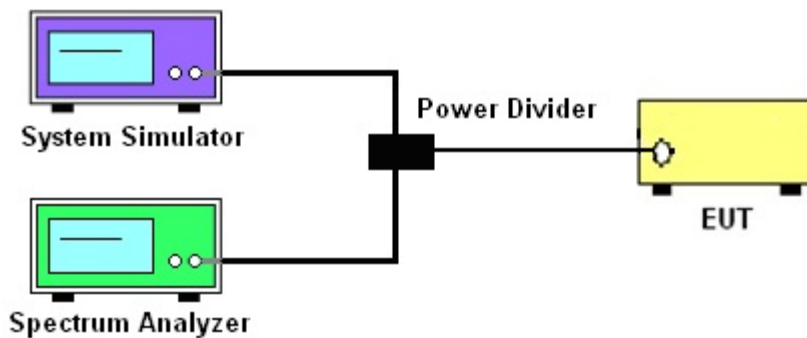

##### 3.2.3 Frequency Stability

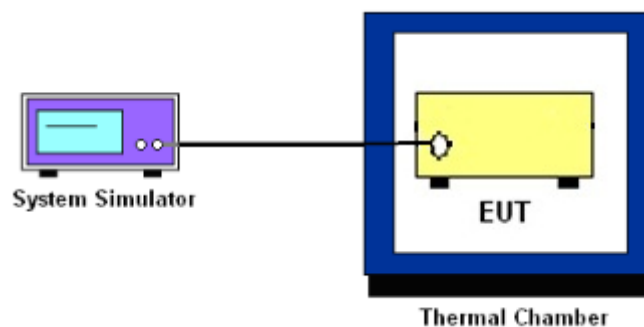

### 3.3 Test Result of Conducted Test

Please refer to Appendix A.



### 3.4 Conducted Output Power and ERP/EIRP

#### 3.4.1 Description of the Conducted Output Power Measurement and ERP/EIRP Measurement

A system simulator was used to establish communication with the EUT. Its parameters were set to force the EUT transmitting at maximum output power. The measured power in the radio frequency on the transmitter output terminals shall be reported.

The ERP of mobile transmitters must not exceed 7 Watts for LTE Band 5 and Band 26.

The ERP of mobile transmitters must not exceed 3 Watts for LTE Band 12 and Band 17 and Band 71.

The EIRP of mobile transmitters must not exceed 2 Watts for LTE Band 2 and Band 25.

The EIRP of mobile transmitters must not exceed 1 Watts for LTE Band 4 and Band 66.

According to KDB 412172 D01 Power Approach,

$EIRP = P_T + G_T - L_C$ ,  $ERP = EIRP - 2.15$ , where

$P_T$  = transmitter output power in dBm

$G_T$  = gain of the transmitting antenna in dBi

$L_C$  = signal attenuation in the connecting cable between the transmitter and antenna in dB

#### 3.4.2 Test Procedures

1. The testing follows ANSI C63.26 Section 5.2
2. The transmitter output port was connected to the system simulator.
3. Set EUT at maximum power through the system simulator.
4. Select lowest, middle, and highest channels for each band and different modulation.
5. Measure and record the power level from the system simulator.



## **3.5 Peak-to-Average Ratio**

### **3.5.1 Description of the PAR Measurement**

Power Complementary Cumulative Distribution Function (CCDF) curves provide a means for characterizing the power peaks of a digitally modulated signal on a statistical basis. A CCDF curve depicts the probability of the peak signal amplitude exceeding the average power level. Most contemporary measurement instrumentation include the capability to produce CCDF curves for an input signal provided that the instrument's resolution bandwidth can be set wide enough to accommodate the entire input signal bandwidth. In measuring transmissions in this band using an average power technique, the peak-to-average ratio (PAR) of the transmission may not exceed 13 dB.

### **3.5.2 Test Procedures**

1. The testing follows ANSI C63.26 Section 5.2.3.4 (CCDF).
2. The EUT was connected to spectrum and system simulator via a power divider.
3. Set the CCDF (Complementary Cumulative Distribution Function) option in spectrum analyzer.
4. The highest RF powers were measured and recorded the maximum PAPR level associated with a probability of 0.1 %.
5. Record the deviation as Peak to Average Ratio.



### 3.6 Occupied Bandwidth

#### 3.6.1 Description of Occupied Bandwidth Measurement

The occupied bandwidth is the width of a frequency band such that, below the lower and above the upper frequency limits, the mean powers emitted are each equal to a specified percentage 0.5% of the total mean transmitted power.

The 26 dB emission bandwidth is defined as the frequency range between two points, one above and one below the carrier frequency, at which the spectral density of the emission is attenuated 26 dB below the maximum in-band spectral density of the modulated signal. Spectral density (power per unit bandwidth) is to be measured with a detector of resolution bandwidth equal to approximately 1.0% of the emission bandwidth.

#### 3.6.2 Test Procedures

1. The testing follows ANSI C63.26 Section 5.4
2. The EUT was connected to spectrum analyzer and system simulator via a power divider.
3. The spectrum analyzer center frequency is set to the nominal EUT channel center frequency. The span range for the spectrum analyzer shall be between two and five times the anticipated OBW.
4. The nominal resolution bandwidth (RBW) shall be in the range of 1 to 5 % of the anticipated OBW, and the VBW shall be at least 3 times the RBW.
5. Set the detection mode to peak, and the trace mode to max hold.
6. Determine the reference value: Set the EUT to transmit a modulated signal. Allow the trace to stabilize. Set the spectrum analyzer marker to the highest level of the displayed trace.  
(this is the reference value)
7. Determine the “-26 dB down amplitude” as equal to (Reference Value – X).
8. Place two markers, one at the lowest and the other at the highest frequency of the envelope of the spectral display such that each marker is at or slightly below the “-X dB down amplitude” determined in step 6. If a marker is below this “-X dB down amplitude” value it shall be placed as close as possible to this value. The OBW is the positive frequency difference between the two markers.
9. Use the 99 % power bandwidth function of the spectrum analyzer and report the measured bandwidth.





### 3.7 Conducted Band Edge

#### 3.7.1 Description of Conducted Band Edge Measurement

22.917(a)

For operations in the 824 – 849 MHz band, the FCC limit is  $43 + 10\log_{10}(P[\text{Watts}])$  dB below the transmitter power  $P(\text{Watts})$  in a 100kHz bandwidth. However, in the 1MHz bands immediately outside and adjacent to the licensee's frequency block, a resolution bandwidth of at least one percent of the emission bandwidth of the fundamental emission of the transmitter may be employed.

24.238 (a)

For operations in the 1850-1910 and 1930-1990 MHz band, the FCC limit is  $43 + 10\log_{10}(P[\text{Watts}])$  dB below the transmitter power  $P(\text{Watts})$  in a 1MHz bandwidth. However, in the 1 MHz bands immediately outside and adjacent to the frequency block a resolution bandwidth of at least one percent of the emission bandwidth of the fundamental emission of the transmitter may be employed.

27.53 (g)

For operations in the 600MHz band and 698 -746 MHz band, the FCC limit is  $43 + 10\log_{10}(P[\text{Watts}])$  dB below the transmitter power  $P(\text{Watts})$  in a 100 kHz bandwidth. However, in the 100 kilohertz bands immediately outside and adjacent to a licensee's frequency block, a resolution bandwidth of at least 30 kHz may be employed.

27.53 (h)

For operations in the 1710 – 1755 MHz and 1710 – 1780 MHz band, the FCC limit is  $43 + 10\log_{10}(P[\text{Watts}])$  dB below the transmitter power  $P(\text{Watts})$  in a 1 MHz bandwidth. However, in the 1MHz bands immediately outside and adjacent to the licensee's frequency block, a resolution bandwidth of at least one percent of the emission bandwidth of the fundamental emission of the transmitter may be employed.



### 3.7.2 Test Procedures

1. The testing follows ANSI C63.26 section 5.7
2. The EUT was connected to spectrum analyzer and system simulator via a power divider.
3. The band edges of low and high channels for the highest RF powers were measured.
4. Set RBW  $\geq$  1% EBW in the 1MHz band immediately outside and adjacent to the band edge.
5. Beyond the 1 MHz band from the band edge, RBW=1MHz was used or a narrower RBW was used and the measured power was integrated over the full required measurement bandwidth of 1 MHz.
6. Set spectrum analyzer with RMS detector.
7. The RF fundamental frequency should be excluded against the limit line in the operating frequency band.
8. Checked that all the results comply with the emission limit line.

Example:

The limit line is derived from  $43 + 10\log(P)$ dB below the transmitter power P(Watts)

$$= P(W) - [43 + 10\log(P)] \text{ (dB)}$$

$$= [30 + 10\log(P)] \text{ (dBm)} - [43 + 10\log(P)] \text{ (dB)} = -13\text{dBm}.$$

9. When using the integration method, the starting frequency of the integration shall be centered at one-half of the RBW away from the band edge.



### 3.8 Conducted Spurious Emission

#### 3.8.1 Description of Conducted Spurious Emission Measurement

The power of any emission outside of the authorized operating frequency ranges must be lower than the transmitter power (P) by a factor of at least  $43 + 10 \log (P)$  dB.

It is measured by means of a calibrated spectrum analyzer and scanned from 30 MHz up to a frequency including its 10<sup>th</sup> harmonic.

#### 3.8.2 Test Procedures

1. The testing follows ANSI C63.26 section 5.7
2. The EUT was connected to spectrum analyzer and system simulator via a power divider.
3. The RF output of EUT was connected to the spectrum analyzer by RF cable and attenuator. The path loss was compensated to the results for each measurement.
4. The middle channel for the highest RF power within the transmitting frequency was measured.
5. The conducted spurious emission for the whole frequency range was taken.
6. Make the measurement with the spectrum analyzer's RBW = 1MHz, VBW = 3MHz.
7. Set spectrum analyzer with RMS detector.
8. Taking the record of maximum spurious emission.
9. The RF fundamental frequency should be excluded against the limit line in the operating frequency band.
10. The limit line is derived from  $43 + 10\log(P)$ dB below the transmitter power P(Watts)  
= P(W)- [43 + 10log(P)] (dB)  
= [30 + 10log(P)] (dBm) - [43 + 10log(P)] (dB)  
= -13dBm.



## 3.9 Frequency Stability

### 3.9.1 Description of Frequency Stability Measurement

The frequency stability shall be measured by variation of ambient temperature and variation of primary supply voltage to ensure that the fundamental emission stays within the authorized frequency block. The frequency stability of the transmitter shall be maintained within  $\pm 0.00025\%$  ( $\pm 2.5\text{ppm}$ ) of the center frequency.

### 3.9.2 Test Procedures for Temperature Variation

1. The testing follows ANSI C63.26 section 5.6.4
2. The EUT was set up in the thermal chamber and connected with the system simulator.
3. With power OFF, the temperature was decreased to  $-30^{\circ}\text{C}$  and the EUT was stabilized before testing. Power was applied and the maximum change in frequency was recorded within one minute.
4. With power OFF, the temperature was raised in  $10^{\circ}\text{C}$  step up to  $50^{\circ}\text{C}$ . The EUT was stabilized at each step for at least half an hour. Power was applied and the maximum frequency change was recorded within one minute.

### 3.9.3 Test Procedures for Voltage Variation

1. The testing follows ANSI C63.26 section 5.6.5
2. The EUT was placed in a temperature chamber at  $20\pm 5^{\circ}\text{C}$  and connected with the system simulator.
3. The power supply voltage to the EUT was varied from 85% to 115% of the nominal value for other than hand carried battery equipment.
4. For hand carried, battery powered equipment, reduce the primary ac or dc supply voltage to the battery operating end point, which shall be specified by the manufacturer.
5. The variation in frequency was measured for the worst case.

## 4 Radiated Test Items

### 4.1 Measuring Instruments

See list of measuring instruments of this test report.

### 4.2 Test Setup

#### 4.2.1 For radiated test below 30MHz

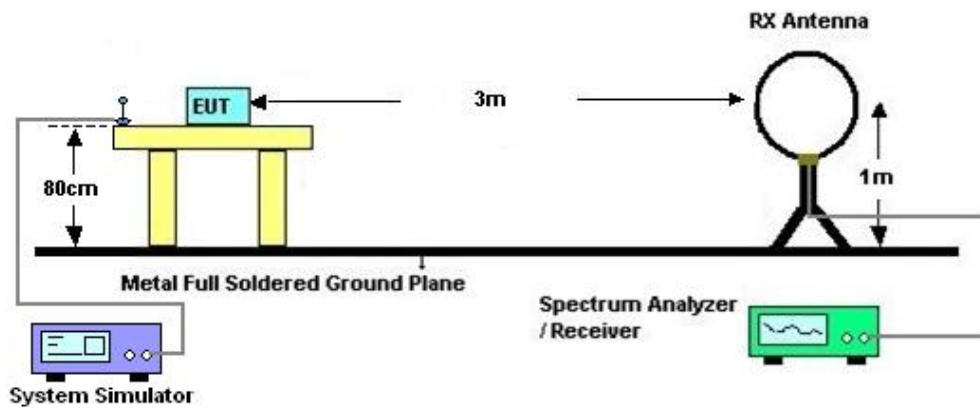

#### 4.2.2 For radiated test from 30MHz to 1GHz

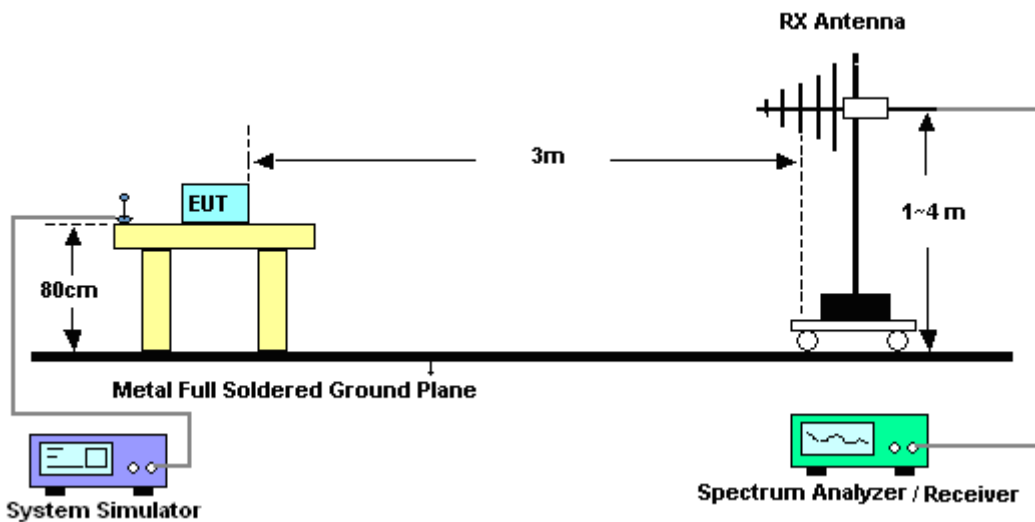

#### 4.2.3 For radiated test above 1GHz

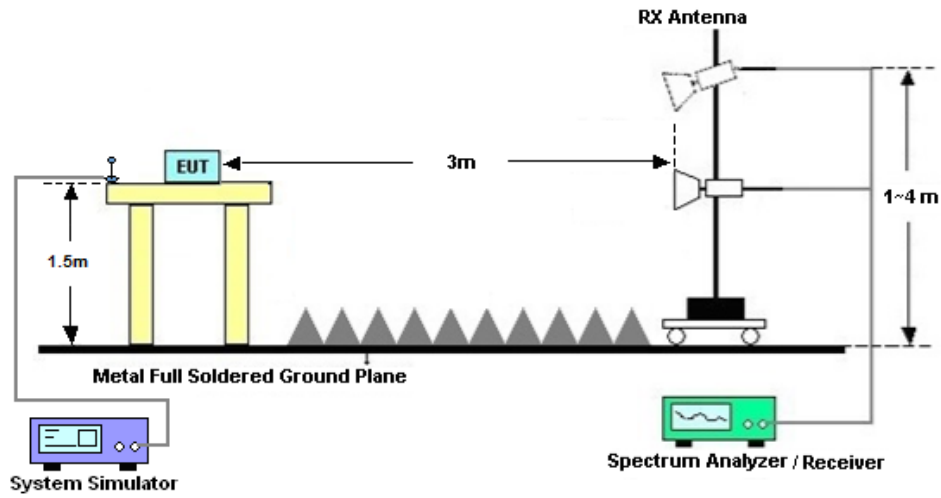

#### 4.3 Test Result of Radiated Test

The low frequency, which started from 9 kHz to 30MHz, was pre-scanned and the result which was 20dB lower than the limit line was not reported.

Please refer to Appendix B.



## 4.4 Radiated Spurious Emission

### 4.4.1 Description of Radiated Spurious Emission

The radiated spurious emission was measured by substitution method according to ANSI C63.26. The power of any emission outside of the authorized operating frequency ranges must be attenuated below the transmitter power (P) by a factor of at least  $43 + 10 \log (P)$  dB.

The spectrum is scanned from 30 MHz up to a frequency including its 10th harmonic.

### 4.4.2 Test Procedures

1. The testing follows ANSI C63.26 Section 5.5
2. The EUT was placed on a turntable with 0.8 meter height for frequency below 1GHz and 1.5 meter height for frequency above 1GHz respectively above ground.
3. The EUT was set 3 meters from the receiving antenna mounted on the antenna tower.
4. The table was rotated 360 degrees to determine the position of the highest spurious emission.
5. The height of the receiving antenna is varied between 1m to 4m to search the maximum spurious emission for both horizontal and vertical polarizations.
6. During the measurement, the system simulator parameters were set to force the EUT transmitting at maximum output power.
7. Make the measurement with the spectrum analyzer's RBW = 1MHz, VBW = 3MHz, taking the record of maximum spurious emission.
8. A horn antenna was substituted in place of the EUT and was driven by a signal generator.
9. Tune the output power of signal generator to the same emission level with EUT maximum spurious emission.
10.  $EIRP \text{ (dBm)} = S.G. \text{ Power} - Tx \text{ Cable Loss} + Tx \text{ Antenna Gain}$
11.  $ERP \text{ (dBm)} = EIRP - 2.15$
12. The RF fundamental frequency should be excluded against the limit line in the operating frequency band.

The limit line is derived from  $43 + 10\log(P)$ dB below the transmitter power P(Watts)  
 $= P(W) - [43 + 10\log(P)] \text{ (dB)}$   
 $= [30 + 10\log(P)] \text{ (dBm)} - [43 + 10\log(P)] \text{ (dB)}$   
 $= -13\text{dBm}.$

13. For Band 7, 38, 41:

The limit line is derived from  $55 + 10\log(P)$ dB below the transmitter power P(Watts)



## 5 List of Measuring Equipment

Instrument	Manufacturer	Model No.	Serial No.	Characteristics	Calibration Date	Test Date	Due Date	Remark
Spectrum Analyzer	R&S	FSV40	101078	10Hz~40GHz	Apr. 07, 2022	Apr. 27, 2022~ May 02, 2022	Apr. 06, 2023	Conducted (TH01-SZ)
Power Divider	TOJOIN	PS-2SM-04 265	60.06.020.007 7	0.4GHz~26.5GHz	Dec. 25, 2021	Apr. 27, 2022~ May 02, 2022	Dec. 24, 2022	Conducted (TH01-SZ)
Thermal Chamber	Ten Billion Hongzhangroup	LP-150U	H2014081803	-40~+150°C	Jul. 14, 2021	Apr. 27, 2022~ May 02, 2022	Jul. 13, 2022	Conducted (TH01-SZ)
EXA Spectrum Analyzer	Keysight	N9010A	MY55150244	10Hz-44G,MAX 30dB	Apr. 13, 2022	May 30, 2022	Apr. 12, 2023	Radiation (03CH04-KS)
Loop Antenna	R&S	HFH2-Z2	100321	9kHz~30MHz	Oct. 30, 2021	May 30, 2022	Oct. 29, 2022	Radiation (03CH04-KS)
Bilog Antenna	TeseQ	CBL6111D	49922	30MHz-1GHz	May 24, 2022	May 30, 2022	May 23, 2023	Radiation (03CH04-KS)
Horn Antenna	Schwarzbeck	BBHA9120D	1356	1GHz~18GHz	Apr. 18, 2022	May 30, 2022	Apr. 17, 2023	Radiation (03CH04-KS)
SHF-EHF Horn	Com-power	AH-840	101070	18GHz~40GHz	Jan. 05, 2022	May 30, 2022	Jan. 04, 2023	Radiation (03CH04-KS)
Amplifier	SONOMA	310N	187289	9KHz-1GHz	Jan. 05, 2022	May 30, 2022	Jan. 04, 2023	Radiation (03CH04-KS)
Amplifier	MITEQ	EM18G40G GA	060728	18~40GHz	Jan. 05, 2022	May 30, 2022	Jan. 04, 2023	Radiation (03CH04-KS)
high gain Amplifier	MITEQ	AMF-7D-00 101800-30-1 0P	2025788	1Ghz-18Ghz	Jul. 30, 2021	May 30, 2022	Jul. 29, 2022	Radiation (03CH04-KS)
Amplifier	Keysight	83017A	MY57280106	500MHz~26.5GHz	Oct. 13, 2021	May 30, 2022	Oct. 12, 2022	Radiation (03CH04-KS)
AC Power Source	Chroma	61601	F104090004	N/A	NCR	May 30, 2022	NCR	Radiation (03CH04-KS)
Turn Table	ChamPro	EM 1000-T	060762-T	0~360 degree	NCR	May 30, 2022	NCR	Radiation (03CH04-KS)
Antenna Mast	ChamPro	EM 1000-A	060762-A	1 m~4 m	NCR	May 30, 2022	NCR	Radiation (03CH04-KS)

NCR: No Calibration Required





## 6 Uncertainty of Evaluation

The measurement uncertainties shown below were calculated in accordance with the requirements of ANSI 63.26-2015. All the measurement uncertainty value were shown with a coverage K=2 to indicate 95% level of confidence. The measurement data show herein meets or exceeds the CISPR measurement uncertainty values specified in CISPR 16-4-2 and can be compared directly to specified limit to determine compliance.

### Uncertainty of Conducted Measurement

Test Item	Uncertainty
Conducted Power	1.34 dB
Conducted Emissions	1.34 dB
Occupied Channel Bandwidth	0.012MHz
Conducted Power Spectral Density	1.32 dB
Frequency tolerance	1.30 ppm

### Uncertainty of Radiated Emission Measurement (30 MHz ~ 1000 MHz)

Measuring Uncertainty for a Level of Confidence of 95% (U = 2Uc(y))	3.3dB
---	-------

### Uncertainty of Radiated Emission Measurement (1 GHz ~ 18 GHz)

Measuring Uncertainty for a Level of Confidence of 95% (U = 2Uc(y))	2.8dB
---	-------

### Uncertainty of Radiated Emission Measurement (18 GHz ~ 40 GHz)

Measuring Uncertainty for a Level of Confidence of 95% (U = 2Uc(y))	2.8dB
---	-------



### Appendix A. Test Results of Conducted Test

Test Engineer :	lei zhang	Temperature :	22~23°C
		Relative Humidity :	40~42%

### Conducted Output Power(Average power)

LTE Band 2-Ant 2						
BW [MHz]	Modulation	RB Size	RB Offset	Power Low Ch. / Freq.	Power Middle Ch. / Freq.	Power High Ch. / Freq.
Channel				18700	18900	19100
Frequency (MHz)				1860	1880	1900
20	QPSK	1	0	22.85	23.07	22.89
20	QPSK	1	49	22.88	23.13	22.98
20	QPSK	1	99	22.85	22.90	22.84
20	QPSK	50	0	21.95	22.07	22.00
20	QPSK	50	24	22.00	22.02	22.03
20	QPSK	50	50	21.92	22.02	22.00
20	QPSK	100	0	21.95	22.07	22.01
20	16QAM	1	0	22.21	22.39	22.19
20	16QAM	1	49	22.62	22.47	22.23
20	16QAM	1	99	22.23	22.41	22.16
20	16QAM	50	0	20.91	21.00	21.07
20	16QAM	50	24	21.00	21.00	21.06
20	16QAM	50	50	20.95	21.03	20.99
20	16QAM	100	0	20.97	21.04	21.11
20	64QAM	1	0	21.17	21.28	21.21
20	64QAM	1	49	21.22	21.22	21.14
20	64QAM	1	99	20.96	21.08	21.09
20	64QAM	50	0	19.85	20.04	20.10
20	64QAM	50	24	19.94	20.06	20.05
20	64QAM	50	50	19.94	20.03	20.02
20	64QAM	100	0	19.98	20.03	20.01
20	256QAM	1	0	18.07	17.89	18.25



20	256QAM	1	49	18.00	18.09	18.18
20	256QAM	1	99	18.15	17.94	18.23
20	256QAM	50	0	18.21	17.96	18.20
20	256QAM	50	24	18.28	18.27	18.31
20	256QAM	50	50	18.39	18.18	18.28
20	256QAM	100	0	18.16	18.03	18.28
Channel				18675	18900	19125
Frequency (MHz)				1857.5	1880	1902.5
15	QPSK	1	0	22.88	22.97	22.80
15	QPSK	1	37	22.95	22.91	22.95
15	QPSK	1	74	22.69	22.90	22.65
15	QPSK	36	0	21.84	21.86	21.97
15	QPSK	36	20	21.93	21.97	21.76
15	QPSK	36	39	21.83	21.87	21.83
15	QPSK	75	0	21.78	22.04	21.96
15	16QAM	1	0	22.23	22.40	22.02
15	16QAM	1	37	22.52	22.37	22.10
15	16QAM	1	74	22.21	22.37	22.10
15	16QAM	36	0	20.90	20.89	20.82
15	16QAM	36	20	20.96	20.82	20.96
15	16QAM	36	39	20.72	21.04	20.93
15	16QAM	75	0	20.89	20.84	20.93
15	64QAM	1	0	21.13	21.16	21.12
15	64QAM	1	37	21.21	21.17	21.14
15	64QAM	1	74	20.86	21.01	21.07
15	64QAM	36	0	19.80	19.92	19.85
15	64QAM	36	20	19.99	19.99	19.94
15	64QAM	36	39	19.83	19.93	19.92
15	64QAM	75	0	19.85	19.87	20.02
15	256QAM	1	0	18.09	17.76	18.17
15	256QAM	1	37	17.82	17.91	18.09
15	256QAM	1	74	17.95	17.84	18.19
15	256QAM	36	0	17.95	17.87	18.04
15	256QAM	36	20	18.23	18.06	18.22
15	256QAM	36	39	18.43	17.89	18.26
15	256QAM	75	0	18.13	18.05	18.23



Channel				18650	18900	19150
Frequency (MHz)				1855	1880	1905
10	QPSK	1	0	22.71	22.90	22.79
10	QPSK	1	25	22.84	23.07	22.80
10	QPSK	1	49	22.66	22.89	22.77
10	QPSK	25	0	21.77	21.96	21.98
10	QPSK	25	12	21.75	21.93	22.02
10	QPSK	25	25	21.83	21.98	21.87
10	QPSK	50	0	21.96	21.81	21.81
10	16QAM	1	0	22.16	22.22	22.08
10	16QAM	1	25	22.41	22.34	22.26
10	16QAM	1	49	22.05	22.39	22.03
10	16QAM	25	0	20.85	20.98	20.98
10	16QAM	25	12	20.84	20.96	21.00
10	16QAM	25	25	20.88	20.97	21.00
10	16QAM	50	0	20.84	20.93	21.02
10	64QAM	1	0	21.08	21.09	21.01
10	64QAM	1	25	21.16	21.19	21.07
10	64QAM	1	49	20.79	21.05	20.86
10	64QAM	25	0	19.73	20.05	20.05
10	64QAM	25	12	19.93	19.94	20.01
10	64QAM	25	25	20.02	19.96	19.95
10	64QAM	50	0	19.89	19.85	20.08
10	256QAM	1	0	17.90	17.71	18.23
10	256QAM	1	25	17.99	18.06	17.97
10	256QAM	1	49	18.06	17.85	18.07
10	256QAM	25	0	18.01	17.95	18.09
10	256QAM	25	12	18.30	18.22	18.15
10	256QAM	25	25	18.28	17.98	18.15
10	256QAM	50	0	18.11	17.93	18.20
Channel				18625	18900	19175
Frequency (MHz)				1852.5	1880	1907.5
5	QPSK	1	0	22.74	22.94	22.82
5	QPSK	1	12	22.83	23.02	22.84
5	QPSK	1	24	22.59	22.84	22.76
5	QPSK	12	0	21.85	21.85	21.95



5	QPSK	12	7	21.84	22.01	22.03
5	QPSK	12	13	21.83	22.00	21.90
5	QPSK	25	0	21.86	21.96	21.90
5	16QAM	1	0	22.09	22.31	22.06
5	16QAM	1	12	22.47	22.46	22.24
5	16QAM	1	24	22.03	22.48	21.98
5	16QAM	12	0	20.76	21.00	20.94
5	16QAM	12	7	20.87	20.97	20.99
5	16QAM	12	13	20.98	20.86	20.84
5	16QAM	25	0	20.98	20.77	20.95
5	64QAM	1	0	21.12	21.09	21.08
5	64QAM	1	12	21.05	21.06	21.06
5	64QAM	1	24	20.90	21.03	21.02
5	64QAM	12	0	19.77	19.99	19.91
5	64QAM	12	7	19.99	19.88	20.01
5	64QAM	12	13	19.92	19.87	19.95
5	64QAM	25	0	19.82	19.81	19.92
5	256QAM	1	0	18.00	17.77	18.15
5	256QAM	1	12	17.98	18.00	18.00
5	256QAM	1	24	17.99	17.77	18.10
5	256QAM	12	0	17.96	17.76	18.18
5	256QAM	12	7	18.21	18.17	18.25
5	256QAM	12	13	18.24	18.09	18.18
5	256QAM	25	0	18.02	17.95	18.14
Channel				18615	18900	19185
Frequency (MHz)				1851.5	1880	1908.5
3	QPSK	1	0	22.80	22.87	22.83
3	QPSK	1	8	22.75	23.00	22.80
3	QPSK	1	14	22.84	22.91	22.75
3	QPSK	8	0	21.77	21.98	21.81
3	QPSK	8	4	21.91	21.81	21.92
3	QPSK	8	7	21.91	22.00	21.96
3	QPSK	15	0	21.93	21.92	21.82
3	16QAM	1	0	22.03	22.32	22.08
3	16QAM	1	8	22.53	22.41	22.22
3	16QAM	1	14	22.13	22.27	22.03



3	16QAM	8	0	20.82	20.87	21.04
3	16QAM	8	4	20.78	20.90	21.07
3	16QAM	8	7	20.85	20.95	20.91
3	16QAM	15	0	20.93	20.81	20.86
3	64QAM	1	0	21.25	21.09	21.08
3	64QAM	1	8	21.05	21.12	21.10
3	64QAM	1	14	20.83	21.04	20.85
3	64QAM	8	0	19.71	19.82	19.90
3	64QAM	8	4	19.93	19.95	20.00
3	64QAM	8	7	19.81	19.89	19.76
3	64QAM	15	0	19.76	19.75	19.99
3	256QAM	1	0	18.11	17.93	18.25
3	256QAM	1	8	17.98	18.02	18.11
3	256QAM	1	14	18.04	17.69	18.08
3	256QAM	8	0	17.97	17.81	18.11
3	256QAM	8	4	18.10	18.19	18.07
3	256QAM	8	7	18.39	18.06	18.17
3	256QAM	15	0	18.03	17.98	18.27
Channel				18607	18900	19193
Frequency (MHz)				1850.7	1880	1909.3
1.4	QPSK	1	0	22.69	23.01	22.94
1.4	QPSK	1	3	22.81	22.89	22.97
1.4	QPSK	1	5	22.80	22.87	22.83
1.4	QPSK	3	0	22.92	22.88	22.78
1.4	QPSK	3	1	22.82	22.85	22.80
1.4	QPSK	3	3	22.67	22.85	22.88
1.4	QPSK	6	0	21.95	21.90	21.99
1.4	16QAM	1	0	22.03	22.18	22.10
1.4	16QAM	1	3	22.39	22.38	22.21
1.4	16QAM	1	5	22.22	22.40	21.94
1.4	16QAM	3	0	22.12	22.18	22.06
1.4	16QAM	3	1	22.47	22.35	22.12
1.4	16QAM	3	3	22.17	22.38	22.14
1.4	16QAM	6	0	20.89	21.01	20.86
1.4	64QAM	1	0	21.04	21.07	21.05
1.4	64QAM	1	3	21.19	21.06	21.14



1.4	64QAM	1	5	20.77	20.89	20.99
1.4	64QAM	3	0	20.99	21.24	20.99
1.4	64QAM	3	1	21.18	21.07	20.91
1.4	64QAM	3	3	20.95	20.92	21.01
1.4	64QAM	6	0	19.89	19.84	19.85
1.4	256QAM	1	0	17.95	17.81	18.12
1.4	256QAM	1	3	17.96	18.08	18.13
1.4	256QAM	1	5	17.95	17.68	18.19
1.4	256QAM	3	0	18.19	17.78	18.18
1.4	256QAM	3	1	18.23	18.14	18.25
1.4	256QAM	3	3	18.34	18.06	18.14
1.4	256QAM	6	0	17.94	17.92	18.24



LTE Band 4-Ant 2						
BW [MHz]	Modulation	RB Size	RB Offset	Power Low Ch. / Freq.	Power Middle Ch. / Freq.	Power High Ch. / Freq.
Channel				20050	20175	20300
Frequency (MHz)				1720	1732.5	1745
20	QPSK	1	0	22.58	22.53	22.49
20	QPSK	1	49	22.32	22.71	22.67
20	QPSK	1	99	22.64	22.44	22.53
20	QPSK	50	0	21.41	21.69	21.51
20	QPSK	50	24	21.59	21.68	21.61
20	QPSK	50	50	21.65	21.65	21.65
20	QPSK	100	0	21.58	21.59	21.57
20	16QAM	1	0	21.82	21.68	21.76
20	16QAM	1	49	21.80	22.07	21.89
20	16QAM	1	99	21.81	22.02	21.84
20	16QAM	50	0	20.65	20.56	20.60
20	16QAM	50	24	20.55	20.67	20.75
20	16QAM	50	50	20.58	20.63	20.83
20	16QAM	100	0	20.51	20.52	20.65
20	64QAM	1	0	20.44	20.55	20.83
20	64QAM	1	49	20.64	20.93	20.86
20	64QAM	1	99	20.73	20.66	20.66
20	64QAM	50	0	19.84	19.93	19.96
20	64QAM	50	24	19.65	19.76	19.94
20	64QAM	50	50	19.76	19.78	19.90
20	64QAM	100	0	19.65	19.84	19.92
20	256QAM	1	0	17.81	17.82	18.04
20	256QAM	1	49	17.91	17.69	18.06
20	256QAM	1	99	17.86	17.71	18.10
20	256QAM	50	0	17.75	17.79	18.07
20	256QAM	50	24	17.98	17.73	18.05
20	256QAM	50	50	18.02	18.11	17.90
20	256QAM	100	0	17.98	17.98	17.90
Channel				20025	20175	20325
Frequency (MHz)				1717.5	1732.5	1747.5





15	QPSK	1	0	22.55	22.49	22.31
15	QPSK	1	37	22.23	22.54	22.60
15	QPSK	1	74	22.50	22.36	22.38
15	QPSK	36	0	21.25	21.58	21.31
15	QPSK	36	20	21.39	21.44	21.50
15	QPSK	36	39	21.52	21.60	21.49
15	QPSK	75	0	21.46	21.46	21.38
15	16QAM	1	0	21.72	21.52	21.65
15	16QAM	1	37	21.80	21.98	21.70
15	16QAM	1	74	21.77	21.82	21.84
15	16QAM	36	0	20.59	20.38	20.57
15	16QAM	36	20	20.43	20.62	20.57
15	16QAM	36	39	20.41	20.43	20.69
15	16QAM	75	0	20.38	20.46	20.46
15	64QAM	1	0	20.43	20.50	20.70
15	64QAM	1	37	20.53	20.74	20.70
15	64QAM	1	74	20.63	20.55	20.50
15	64QAM	36	0	19.70	19.89	19.79
15	64QAM	36	20	19.51	19.62	19.81
15	64QAM	36	39	19.64	19.68	19.86
15	64QAM	75	0	19.62	19.80	19.75
15	256QAM	1	0	17.69	17.81	18.01
15	256QAM	1	37	17.78	17.58	17.98
15	256QAM	1	74	17.71	17.71	17.92
15	256QAM	36	0	17.57	17.64	17.96
15	256QAM	36	20	17.80	17.68	17.90
15	256QAM	36	39	17.94	17.93	17.72
15	256QAM	75	0	17.81	17.98	17.80
Channel				20000	20175	20350
Frequency (MHz)				1715	1732.5	1750
10	QPSK	1	0	22.44	22.45	22.31
10	QPSK	1	25	22.27	22.59	22.60
10	QPSK	1	49	22.50	22.34	22.42
10	QPSK	25	0	21.40	21.46	21.40
10	QPSK	25	12	21.49	21.55	21.50
10	QPSK	25	25	21.50	21.68	21.61



10	QPSK	50	0	21.43	21.46	21.44
10	16QAM	1	0	21.76	21.53	21.68
10	16QAM	1	25	21.76	22.02	21.88
10	16QAM	1	49	21.70	21.88	21.82
10	16QAM	25	0	20.49	20.51	20.46
10	16QAM	25	12	20.36	20.60	20.55
10	16QAM	25	25	20.57	20.57	20.70
10	16QAM	50	0	20.38	20.48	20.51
10	64QAM	1	0	20.35	20.37	20.64
10	64QAM	1	25	20.59	20.79	20.80
10	64QAM	1	49	20.65	20.50	20.64
10	64QAM	25	0	19.80	19.88	19.83
10	64QAM	25	12	19.64	19.71	19.94
10	64QAM	25	25	19.75	19.73	19.84
10	64QAM	50	0	19.57	19.70	19.77
10	256QAM	1	0	17.72	17.63	18.02
10	256QAM	1	25	17.87	17.56	17.88
10	256QAM	1	49	17.72	17.69	18.00
10	256QAM	25	0	17.75	17.73	18.02
10	256QAM	25	12	17.78	17.56	17.91
10	256QAM	25	25	18.01	17.98	17.88
10	256QAM	50	0	17.80	17.80	17.70
Channel				19975	20175	20375
Frequency (MHz)				1712.5	1732.5	1752.5
5	QPSK	1	0	22.39	22.40	22.47
5	QPSK	1	12	22.19	22.62	22.55
5	QPSK	1	24	22.55	22.24	22.45
5	QPSK	12	0	21.25	21.48	21.50
5	QPSK	12	7	21.44	21.52	21.53
5	QPSK	12	13	21.46	21.60	21.47
5	QPSK	25	0	21.47	21.47	21.45
5	16QAM	1	0	21.73	21.55	21.71
5	16QAM	1	12	21.78	21.89	21.76
5	16QAM	1	24	21.70	21.89	21.71
5	16QAM	12	0	20.45	20.46	20.60
5	16QAM	12	7	20.42	20.48	20.56



5	16QAM	12	13	20.44	20.59	20.82
5	16QAM	25	0	20.38	20.51	20.65
5	64QAM	1	0	20.32	20.45	20.74
5	64QAM	1	12	20.51	20.92	20.79
5	64QAM	1	24	20.68	20.47	20.55
5	64QAM	12	0	19.81	19.73	19.79
5	64QAM	12	7	19.63	19.72	19.75
5	64QAM	12	13	19.64	19.67	19.71
5	64QAM	25	0	19.58	19.78	19.72
5	256QAM	1	0	17.61	17.75	17.97
5	256QAM	1	12	17.76	17.64	18.05
5	256QAM	1	24	17.84	17.65	18.01
5	256QAM	12	0	17.65	17.73	18.07
5	256QAM	12	7	17.96	17.60	18.05
5	256QAM	12	13	17.82	17.95	17.79
5	256QAM	25	0	17.93	17.97	17.74
Channel				19965	20175	20385
Frequency (MHz)				1711.5	1732.5	1753.5
3	QPSK	1	0	22.58	22.47	22.30
3	QPSK	1	8	22.15	22.66	22.47
3	QPSK	1	14	22.64	22.37	22.36
3	QPSK	8	0	21.26	21.56	21.42
3	QPSK	8	4	21.48	21.40	21.59
3	QPSK	8	7	21.57	21.57	21.57
3	QPSK	15	0	21.55	21.47	21.57
3	16QAM	1	0	21.75	21.66	21.76
3	16QAM	1	8	21.68	22.05	21.84
3	16QAM	1	14	21.66	22.00	21.78
3	16QAM	8	0	20.48	20.37	20.55
3	16QAM	8	4	20.49	20.62	20.75
3	16QAM	8	7	20.49	20.53	20.80
3	16QAM	15	0	20.48	20.48	20.54
3	64QAM	1	0	20.34	20.45	20.63
3	64QAM	1	8	20.53	20.76	20.80
3	64QAM	1	14	20.55	20.51	20.47
3	64QAM	8	0	19.77	19.74	19.95



3	64QAM	8	4	19.51	19.67	19.76
3	64QAM	8	7	19.73	19.60	19.84
3	64QAM	15	0	19.63	19.69	19.78
3	256QAM	1	0	17.79	17.70	17.88
3	256QAM	1	8	17.77	17.68	17.92
3	256QAM	1	14	17.76	17.55	18.01
3	256QAM	8	0	17.60	17.68	18.03
3	256QAM	8	4	17.89	17.62	17.91
3	256QAM	8	7	17.94	18.11	17.79
3	256QAM	15	0	17.96	17.91	17.82
Channel				19957	20175	20393
Frequency (MHz)				1710.7	1732.5	1754.3
1.4	QPSK	1	0	22.40	22.37	22.32
1.4	QPSK	1	3	22.29	22.70	22.49
1.4	QPSK	1	5	22.51	22.30	22.50
1.4	QPSK	3	0	22.51	22.34	22.33
1.4	QPSK	3	1	22.19	22.69	22.67
1.4	QPSK	3	3	22.61	22.54	22.52
1.4	QPSK	6	0	21.71	21.65	21.63
1.4	16QAM	1	0	21.72	21.61	21.59
1.4	16QAM	1	3	21.76	21.97	21.89
1.4	16QAM	1	5	21.67	22.02	21.72
1.4	16QAM	3	0	21.63	21.66	21.73
1.4	16QAM	3	1	21.60	21.91	21.74
1.4	16QAM	3	3	21.80	21.99	21.72
1.4	16QAM	6	0	20.56	20.52	20.56
1.4	64QAM	1	0	20.51	20.55	20.83
1.4	64QAM	1	3	20.51	20.85	20.71
1.4	64QAM	1	5	20.65	20.48	20.46
1.4	64QAM	3	0	20.62	20.77	20.78
1.4	64QAM	3	1	20.72	20.52	20.64
1.4	64QAM	3	3	20.61	20.88	20.79
1.4	64QAM	6	0	19.77	19.76	19.95
1.4	256QAM	1	0	17.62	17.81	17.93
1.4	256QAM	1	3	17.78	17.57	18.04
1.4	256QAM	1	5	17.81	17.62	17.97



---

1.4	256QAM	3	0	17.63	17.77	18.02
1.4	256QAM	3	1	17.95	17.66	17.91
1.4	256QAM	3	3	17.90	17.94	17.90
1.4	256QAM	6	0	17.78	17.82	17.74



LTE Band 5- Ant 3						
BW [MHz]	Modulation	RB Size	RB Offset	Power Low Ch. / Freq.	Power Middle Ch. / Freq.	Power High Ch. / Freq.
Channel				20450	20525	20600
Frequency (MHz)				829	836.5	844
10	QPSK	1	0	22.36	22.50	22.38
10	QPSK	1	25	22.49	22.43	22.50
10	QPSK	1	49	22.48	22.49	22.39
10	QPSK	25	0	21.62	21.67	21.63
10	QPSK	25	12	21.54	21.45	21.51
10	QPSK	25	25	21.66	21.67	21.60
10	QPSK	50	0	21.51	21.85	21.54
10	16QAM	1	0	21.91	21.70	22.03
10	16QAM	1	25	21.94	22.23	21.90
10	16QAM	1	49	22.14	21.86	21.68
10	16QAM	25	0	20.58	20.61	20.55
10	16QAM	25	12	20.55	20.83	20.64
10	16QAM	25	25	20.71	20.82	20.63
10	16QAM	50	0	20.53	20.94	20.59
10	64QAM	1	0	20.61	21.13	20.87
10	64QAM	1	25	20.99	21.03	20.61
10	64QAM	1	49	20.63	20.80	20.65
10	64QAM	25	0	19.58	19.79	19.59
10	64QAM	25	12	19.76	19.70	19.52
10	64QAM	25	25	19.74	19.86	19.69
10	64QAM	50	0	19.52	19.77	19.68
10	256QAM	1	0	17.90	17.69	17.78
10	256QAM	1	25	17.78	17.76	17.80
10	256QAM	1	49	17.89	17.87	17.68
10	256QAM	25	0	17.84	17.69	17.58
10	256QAM	25	12	17.66	18.13	18.00
10	256QAM	25	25	18.03	17.93	17.70
10	256QAM	50	0	17.92	17.83	17.75
Channel				20425	20525	20625
Frequency (MHz)				826.5	836.5	846.5



5	QPSK	1	0	22.49	22.45	22.45
5	QPSK	1	12	22.43	22.47	22.43
5	QPSK	1	24	22.46	22.42	22.44
5	QPSK	12	0	21.63	21.80	21.75
5	QPSK	12	7	21.69	21.57	21.63
5	QPSK	12	13	21.65	21.67	21.69
5	QPSK	25	0	21.57	21.62	21.75
5	16QAM	1	0	22.28	22.12	22.10
5	16QAM	1	12	22.08	22.15	21.75
5	16QAM	1	24	21.82	22.08	22.11
5	16QAM	12	0	20.53	20.50	20.85
5	16QAM	12	7	20.70	20.73	20.88
5	16QAM	12	13	20.60	20.57	20.77
5	16QAM	25	0	20.73	20.59	20.73
5	64QAM	1	0	20.69	20.62	21.07
5	64QAM	1	12	20.73	20.56	21.07
5	64QAM	1	24	20.94	20.76	20.58
5	64QAM	12	0	19.68	19.52	19.63
5	64QAM	12	7	19.57	19.68	19.82
5	64QAM	12	13	19.65	19.71	19.77
5	64QAM	25	0	19.85	19.59	19.75
5	256QAM	1	0	17.62	17.50	17.67
5	256QAM	1	12	17.60	17.55	17.60
5	256QAM	1	24	17.62	17.61	17.58
5	256QAM	12	0	17.62	17.61	17.59
5	256QAM	12	7	17.58	17.64	17.67
5	256QAM	12	13	17.61	17.70	17.62
5	256QAM	25	0	17.60	17.60	17.69
Channel				20415	20525	20635
Frequency (MHz)				825.5	836.5	847.5
3	QPSK	1	0	22.45	22.48	22.44
3	QPSK	1	8	22.46	22.48	22.46
3	QPSK	1	14	22.46	22.45	22.42
3	QPSK	8	0	21.64	21.65	21.77
3	QPSK	8	4	21.60	21.56	21.72
3	QPSK	8	7	21.61	21.70	21.67



3	QPSK	15	0	21.73	21.67	21.80
3	16QAM	1	0	22.26	22.12	22.06
3	16QAM	1	8	21.95	22.14	21.91
3	16QAM	1	14	21.95	21.96	22.01
3	16QAM	8	0	20.69	20.60	20.70
3	16QAM	8	4	20.60	20.64	20.83
3	16QAM	8	7	20.77	20.74	20.73
3	16QAM	15	0	20.62	20.76	20.73
3	64QAM	1	0	20.75	20.75	21.17
3	64QAM	1	8	20.78	20.67	20.93
3	64QAM	1	14	20.86	20.80	20.63
3	64QAM	8	0	19.63	19.54	19.60
3	64QAM	8	4	19.63	19.76	19.73
3	64QAM	8	7	19.73	19.62	19.69
3	64QAM	15	0	19.81	19.62	19.83
3	256QAM	1	0	17.53	17.54	17.63
3	256QAM	1	8	17.57	17.63	17.68
3	256QAM	1	14	17.63	17.61	17.67
3	256QAM	8	0	17.57	17.50	17.62
3	256QAM	8	4	17.63	17.58	17.79
3	256QAM	8	7	17.56	17.62	17.58
3	256QAM	15	0	17.60	17.63	17.53
Channel				20407	20525	20643
Frequency (MHz)				824.7	836.5	848.3
1.4	QPSK	1	0	22.31	22.33	22.30
1.4	QPSK	1	3	22.35	22.38	22.38
1.4	QPSK	1	5	22.32	22.31	22.30
1.4	QPSK	3	0	22.44	22.47	22.39
1.4	QPSK	3	1	22.42	22.44	22.45
1.4	QPSK	3	3	22.34	22.47	22.42
1.4	QPSK	6	0	21.64	21.74	21.80
1.4	16QAM	1	0	22.29	22.23	21.97
1.4	16QAM	1	3	22.01	22.04	21.91
1.4	16QAM	1	5	21.80	22.11	22.03
1.4	16QAM	3	0	22.19	22.08	22.02
1.4	16QAM	3	1	21.93	22.15	21.86





1.4	16QAM	3	3	21.91	22.09	22.03
1.4	16QAM	6	0	20.65	20.65	20.70
1.4	64QAM	1	0	20.65	20.71	21.00
1.4	64QAM	1	3	20.79	20.72	20.94
1.4	64QAM	1	5	20.75	20.71	20.63
1.4	64QAM	3	0	20.60	20.55	21.04
1.4	64QAM	3	1	20.63	20.54	21.08
1.4	64QAM	3	3	20.89	20.74	20.63
1.4	64QAM	6	0	19.71	19.64	19.70
1.4	256QAM	1	0	17.64	17.58	17.59
1.4	256QAM	1	3	17.64	17.52	17.64
1.4	256QAM	1	5	17.55	17.66	17.73
1.4	256QAM	3	0	17.64	17.50	17.59
1.4	256QAM	3	1	17.60	17.56	17.67
1.4	256QAM	3	3	17.50	17.62	17.50
1.4	256QAM	6	0	17.57	17.61	17.71



LTE Band 12- Ant 1						
BW [MHz]	Modulation	RB Size	RB Offset	Power Low Ch. / Freq.	Power Middle Ch. / Freq.	Power High Ch. / Freq.
Channel				23060	23095	23130
Frequency (MHz)				704	707.5	711
10	QPSK	1	0	22.99	23.04	23.01
10	QPSK	1	25	23.04	23.09	23.04
10	QPSK	1	49	22.92	23.06	23.01
10	QPSK	25	0	22.06	22.15	22.08
10	QPSK	25	12	21.98	22.11	22.05
10	QPSK	25	25	22.05	22.08	22.03
10	QPSK	50	0	22.07	22.17	22.15
10	16QAM	1	0	22.42	22.53	22.42
10	16QAM	1	25	22.32	22.53	22.46
10	16QAM	1	49	22.48	22.60	22.56
10	16QAM	25	0	21.08	21.01	21.10
10	16QAM	25	12	21.14	21.14	21.13
10	16QAM	25	25	21.14	21.11	21.13
10	16QAM	50	0	21.15	21.08	21.14
10	64QAM	1	0	21.06	21.32	21.19
10	64QAM	1	25	21.27	21.18	21.32
10	64QAM	1	49	21.14	21.24	21.31
10	64QAM	25	0	20.12	20.08	20.00
10	64QAM	25	12	20.19	20.13	20.10
10	64QAM	25	25	20.12	20.17	20.07
10	64QAM	50	0	20.06	20.06	20.17
10	256QAM	1	0	18.11	18.26	18.14
10	256QAM	1	25	18.16	18.19	17.97
10	256QAM	1	49	18.11	18.18	18.14
10	256QAM	25	0	18.24	18.17	18.06
10	256QAM	25	12	18.08	18.21	18.20
10	256QAM	25	25	18.27	18.17	18.29
10	256QAM	50	0	18.08	18.08	18.43
Channel				23035	23095	23155
Frequency (MHz)				701.5	707.5	713.5



5	QPSK	1	0	22.82	23.04	22.97
5	QPSK	1	12	22.79	23.09	22.86
5	QPSK	1	24	22.85	22.80	22.81
5	QPSK	12	0	21.99	21.96	22.03
5	QPSK	12	7	21.94	22.14	21.96
5	QPSK	12	13	21.85	21.96	21.85
5	QPSK	25	0	22.00	21.99	21.99
5	16QAM	1	0	22.35	22.39	22.37
5	16QAM	1	12	22.24	22.47	22.45
5	16QAM	1	24	22.35	22.52	22.44
5	16QAM	12	0	21.05	20.83	21.05
5	16QAM	12	7	21.07	21.13	20.96
5	16QAM	12	13	21.00	21.11	20.96
5	16QAM	25	0	20.94	21.01	21.12
5	64QAM	1	0	20.95	21.08	20.98
5	64QAM	1	12	21.11	21.07	21.24
5	64QAM	1	24	20.99	21.07	21.37
5	64QAM	12	0	20.06	20.05	20.00
5	64QAM	12	7	20.11	19.91	20.01
5	64QAM	12	13	19.92	20.00	19.97
5	64QAM	25	0	19.99	20.10	20.11
5	256QAM	1	0	18.09	18.22	18.15
5	256QAM	1	12	18.14	18.11	17.97
5	256QAM	1	24	18.08	18.18	18.12
5	256QAM	12	0	18.15	18.18	18.07
5	256QAM	12	7	18.11	18.10	18.06
5	256QAM	12	13	18.08	18.05	18.11
5	256QAM	25	0	17.97	18.01	18.32
Channel				23025	23095	23165
Frequency (MHz)				700.5	707.5	714.5
3	QPSK	1	0	22.77	23.00	22.86
3	QPSK	1	8	23.02	22.95	22.83
3	QPSK	1	14	22.91	23.08	22.80
3	QPSK	8	0	22.03	21.95	21.98
3	QPSK	8	4	21.96	22.03	21.91
3	QPSK	8	7	21.86	21.85	21.98



3	QPSK	15	0	21.97	22.03	22.03
3	16QAM	1	0	22.31	22.38	22.27
3	16QAM	1	8	22.17	22.54	22.42
3	16QAM	1	14	22.34	22.42	22.43
3	16QAM	8	0	21.04	20.85	20.97
3	16QAM	8	4	21.00	21.14	21.12
3	16QAM	8	7	21.04	21.03	20.91
3	16QAM	15	0	21.08	21.10	21.06
3	64QAM	1	0	20.93	21.12	21.03
3	64QAM	1	8	21.23	21.05	21.24
3	64QAM	1	14	21.10	21.23	21.17
3	64QAM	8	0	19.97	19.90	19.96
3	64QAM	8	4	20.10	20.02	20.06
3	64QAM	8	7	19.98	20.02	20.14
3	64QAM	15	0	19.98	20.06	20.08
3	256QAM	1	0	17.95	18.27	18.06
3	256QAM	1	8	18.23	18.01	17.87
3	256QAM	1	14	18.03	18.03	18.20
3	256QAM	8	0	18.13	18.20	17.89
3	256QAM	8	4	18.04	18.09	18.12
3	256QAM	8	7	18.23	18.07	18.20
3	256QAM	15	0	17.94	17.98	18.27
Channel				23017	23095	23173
Frequency (MHz)				699.7	707.5	715.3
1.4	QPSK	1	0	22.89	22.90	22.89
1.4	QPSK	1	3	22.98	23.02	22.92
1.4	QPSK	1	5	22.77	23.06	22.85
1.4	QPSK	3	0	22.88	23.06	22.94
1.4	QPSK	3	1	22.88	22.98	22.94
1.4	QPSK	3	3	22.83	22.94	22.86
1.4	QPSK	6	0	21.97	22.14	21.97
1.4	16QAM	1	0	22.41	22.38	22.21
1.4	16QAM	1	3	22.11	22.37	22.40
1.4	16QAM	1	5	22.36	22.56	22.62
1.4	16QAM	3	0	22.41	22.52	22.24
1.4	16QAM	3	1	22.21	22.54	22.41



1.4	16QAM	3	3	22.32	22.53	22.53
1.4	16QAM	6	0	20.94	21.09	21.06
1.4	64QAM	1	0	20.95	21.08	21.03
1.4	64QAM	1	3	21.12	21.12	21.25
1.4	64QAM	1	5	20.95	21.21	21.27
1.4	64QAM	3	0	21.02	21.09	21.16
1.4	64QAM	3	1	21.25	21.06	21.31
1.4	64QAM	3	3	21.04	21.20	21.23
1.4	64QAM	6	0	20.03	19.96	20.13
1.4	256QAM	1	0	17.89	18.27	18.05
1.4	256QAM	1	3	18.11	18.26	17.93
1.4	256QAM	1	5	18.12	17.97	18.00
1.4	256QAM	3	0	18.03	18.11	17.95
1.4	256QAM	3	1	18.01	18.13	18.09
1.4	256QAM	3	3	18.13	18.09	18.20
1.4	256QAM	6	0	17.92	17.93	18.40



LTE Band 17- Ant 1						
BW [MHz]	Modulation	RB Size	RB Offset	Power Low Ch. / Freq.	Power Middle Ch. / Freq.	Power High Ch. / Freq.
Channel				23780	23790	23800
Frequency (MHz)				709	710	711
10	QPSK	1	0	22.74	22.82	22.83
10	QPSK	1	25	22.84	22.87	22.81
10	QPSK	1	49	22.71	22.85	22.75
10	QPSK	25	0	21.92	21.93	21.91
10	QPSK	25	12	21.74	21.88	21.80
10	QPSK	25	25	21.75	21.92	21.82
10	QPSK	50	0	21.79	22.00	21.91
10	16QAM	1	0	22.24	22.15	22.26
10	16QAM	1	25	22.18	22.13	22.35
10	16QAM	1	49	22.21	22.44	22.27
10	16QAM	25	0	20.97	20.89	20.91
10	16QAM	25	12	20.94	20.97	21.01
10	16QAM	25	25	20.91	20.92	20.97
10	16QAM	50	0	20.97	20.97	21.02
10	64QAM	1	0	20.84	20.88	21.02
10	64QAM	1	25	20.92	21.00	21.12
10	64QAM	1	49	21.01	21.11	21.24
10	64QAM	25	0	19.86	19.94	19.87
10	64QAM	25	12	19.98	19.99	20.00
10	64QAM	25	25	19.84	19.94	19.89
10	64QAM	50	0	19.86	19.95	19.98
10	256QAM	1	0	18.03	17.84	17.99
10	256QAM	1	25	17.93	17.81	18.13
10	256QAM	1	49	17.94	17.88	18.00
10	256QAM	25	0	17.94	17.95	18.06
10	256QAM	25	12	17.85	17.86	17.89
10	256QAM	25	25	18.11	17.85	18.17
10	256QAM	50	0	18.02	17.88	18.19
Channel				23755	23790	23825
Frequency (MHz)				706.5	710	713.5



5	QPSK	1	0	22.66	22.86	22.81
5	QPSK	1	12	22.75	22.82	22.85
5	QPSK	1	24	22.68	22.73	22.52
5	QPSK	12	0	21.87	21.89	21.81
5	QPSK	12	7	21.63	21.75	21.70
5	QPSK	12	13	21.65	21.67	21.90
5	QPSK	25	0	21.69	21.75	21.85
5	16QAM	1	0	22.25	22.10	22.20
5	16QAM	1	12	22.14	21.96	22.36
5	16QAM	1	24	22.18	22.35	22.30
5	16QAM	12	0	20.90	20.91	20.87
5	16QAM	12	7	20.72	20.94	20.80
5	16QAM	12	13	20.89	20.73	20.91
5	16QAM	25	0	20.95	20.91	20.92
5	64QAM	1	0	20.69	20.87	20.79
5	64QAM	1	12	20.84	20.95	21.07
5	64QAM	1	24	20.96	21.02	21.09
5	64QAM	12	0	19.75	19.73	19.93
5	64QAM	12	7	19.82	19.74	19.74
5	64QAM	12	13	19.73	19.86	19.71
5	64QAM	25	0	19.77	19.78	19.81
5	256QAM	1	0	18.00	17.81	17.98
5	256QAM	1	12	17.77	17.85	17.92
5	256QAM	1	24	17.75	17.81	17.86
5	256QAM	12	0	17.86	17.91	17.92
5	256QAM	12	7	17.88	17.72	17.75
5	256QAM	12	13	18.01	17.69	17.93
5	256QAM	25	0	18.05	17.83	18.09



LTE Band 25- Ant 2						
BW [MHz]	Modulation	RB Size	RB Offset	Power Low Ch. / Freq.	Power Middle Ch. / Freq.	Power High Ch. / Freq.
Channel				26140	26340	26590
Frequency (MHz)				1860	1880	1905
20	QPSK	1	0	22.89	23.22	23.17
20	QPSK	1	49	22.94	23.28	23.17
20	QPSK	1	99	22.93	23.10	23.03
20	QPSK	50	0	22.14	22.39	22.36
20	QPSK	50	24	22.15	22.30	22.22
20	QPSK	50	50	22.02	22.37	22.32
20	QPSK	100	0	22.05	22.32	22.16
20	16QAM	1	0	22.20	22.40	22.43
20	16QAM	1	49	22.57	22.62	22.50
20	16QAM	1	99	22.30	22.43	22.25
20	16QAM	50	0	21.08	21.25	21.40
20	16QAM	50	24	21.13	21.33	21.32
20	16QAM	50	50	21.11	21.36	21.33
20	16QAM	100	0	21.12	21.33	21.32
20	64QAM	1	0	21.13	21.36	21.45
20	64QAM	1	49	21.42	21.62	21.41
20	64QAM	1	99	21.26	21.37	21.27
20	64QAM	50	0	20.00	20.30	20.31
20	64QAM	50	24	20.10	20.41	20.29
20	64QAM	50	50	20.10	20.35	20.25
20	64QAM	100	0	20.13	20.23	20.38
20	256QAM	1	0	18.28	18.38	18.48
20	256QAM	1	49	18.43	18.34	18.44
20	256QAM	1	99	18.38	18.52	18.49
20	256QAM	50	0	18.32	18.36	18.45
20	256QAM	50	24	18.34	18.44	18.56
20	256QAM	50	50	18.67	18.63	18.57
20	256QAM	100	0	18.35	18.46	18.34
Channel				26115	26340	26615
Frequency (MHz)				1857.5	1880	1907.5





15	QPSK	1	0	22.68	23.22	23.10
15	QPSK	1	37	22.91	23.23	23.07
15	QPSK	1	74	22.82	22.98	22.86
15	QPSK	36	0	21.97	22.29	22.31
15	QPSK	36	20	22.00	22.09	22.10
15	QPSK	36	39	22.06	22.33	22.28
15	QPSK	75	0	22.01	22.22	22.11
15	16QAM	1	0	22.03	22.18	22.19
15	16QAM	1	37	22.52	22.44	22.32
15	16QAM	1	74	22.22	22.30	22.19
15	16QAM	36	0	21.07	21.19	21.17
15	16QAM	36	20	21.00	21.39	21.30
15	16QAM	36	39	21.17	21.19	21.22
15	16QAM	75	0	21.06	21.14	21.32
15	64QAM	1	0	21.14	21.36	21.41
15	64QAM	1	37	21.26	21.56	21.31
15	64QAM	1	74	21.11	21.30	21.19
15	64QAM	36	0	19.91	20.19	20.17
15	64QAM	36	20	19.93	20.29	20.27
15	64QAM	36	39	20.05	20.22	20.14
15	64QAM	75	0	19.97	20.15	20.20
15	256QAM	1	0	18.14	18.23	18.49
15	256QAM	1	37	18.21	18.26	18.34
15	256QAM	1	74	18.25	18.40	18.35
15	256QAM	36	0	18.10	18.24	18.28
15	256QAM	36	20	18.28	18.26	18.37
15	256QAM	36	39	18.52	18.45	18.44
15	256QAM	75	0	18.22	18.33	18.21
Channel				26090	26340	26640
Frequency (MHz)				1855	1880	1910
10	QPSK	1	0	22.83	23.23	23.05
10	QPSK	1	25	22.97	23.24	23.02
10	QPSK	1	49	22.89	23.01	22.87
10	QPSK	25	0	22.03	22.28	22.25
10	QPSK	25	12	21.85	22.26	22.20
10	QPSK	25	25	21.97	22.12	22.17



10	QPSK	50	0	21.95	22.28	22.11
10	16QAM	1	0	22.09	22.39	22.26
10	16QAM	1	25	22.34	22.54	22.46
10	16QAM	1	49	22.27	22.28	22.20
10	16QAM	25	0	20.93	21.09	21.28
10	16QAM	25	12	21.06	21.30	21.26
10	16QAM	25	25	21.06	21.20	21.28
10	16QAM	50	0	21.06	21.17	21.18
10	64QAM	1	0	21.10	21.23	21.44
10	64QAM	1	25	21.42	21.53	21.39
10	64QAM	1	49	21.10	21.20	21.21
10	64QAM	25	0	19.87	20.19	20.37
10	64QAM	25	12	20.08	20.23	20.23
10	64QAM	25	25	20.00	20.20	20.26
10	64QAM	50	0	20.09	20.23	20.20
10	256QAM	1	0	18.32	18.37	18.46
10	256QAM	1	25	18.33	18.31	18.36
10	256QAM	1	49	18.32	18.35	18.31
10	256QAM	25	0	18.10	18.30	18.26
10	256QAM	25	12	18.33	18.36	18.39
10	256QAM	25	25	18.48	18.58	18.42
10	256QAM	50	0	18.15	18.35	18.39
Channel				26065	26340	26665
Frequency (MHz)				1852.5	1880	1912.5
5	QPSK	1	0	22.73	23.20	22.97
5	QPSK	1	12	22.85	23.08	23.13
5	QPSK	1	24	22.89	23.03	22.96
5	QPSK	12	0	21.97	22.16	22.36
5	QPSK	12	7	22.04	22.25	22.09
5	QPSK	12	13	21.97	22.30	22.23
5	QPSK	25	0	21.94	22.31	22.07
5	16QAM	1	0	22.16	22.39	22.33
5	16QAM	1	12	22.50	22.42	22.43
5	16QAM	1	24	22.34	22.45	22.23
5	16QAM	12	0	20.98	21.22	21.23
5	16QAM	12	7	20.98	21.22	21.21



5	16QAM	12	13	21.11	21.34	21.24
5	16QAM	25	0	21.13	21.30	21.36
5	64QAM	1	0	21.16	21.31	21.46
5	64QAM	1	12	21.33	21.39	21.34
5	64QAM	1	24	21.12	21.23	21.19
5	64QAM	12	0	19.88	20.24	20.28
5	64QAM	12	7	19.97	20.36	20.27
5	64QAM	12	13	19.92	20.34	20.17
5	64QAM	25	0	20.00	20.21	20.34
5	256QAM	1	0	18.32	18.22	18.45
5	256QAM	1	12	18.16	18.28	18.43
5	256QAM	1	24	18.13	18.42	18.47
5	256QAM	12	0	18.09	18.37	18.35
5	256QAM	12	7	18.12	18.34	18.34
5	256QAM	12	13	18.65	18.52	18.49
5	256QAM	25	0	18.36	18.33	18.35
Channel				26055	26340	26675
Frequency (MHz)				1851.5	1880	1913.5
3	QPSK	1	0	22.83	22.96	23.05
3	QPSK	1	8	22.97	23.08	23.14
3	QPSK	1	14	22.84	22.96	22.94
3	QPSK	8	0	21.92	22.37	22.29
3	QPSK	8	4	22.02	22.25	22.14
3	QPSK	8	7	22.12	22.22	22.04
3	QPSK	15	0	22.05	22.33	22.04
3	16QAM	1	0	22.16	22.32	22.35
3	16QAM	1	8	22.41	22.42	22.44
3	16QAM	1	14	22.12	22.42	22.10
3	16QAM	8	0	20.99	21.19	21.21
3	16QAM	8	4	21.13	21.30	21.32
3	16QAM	8	7	21.09	21.23	21.32
3	16QAM	15	0	21.09	21.17	21.25
3	64QAM	1	0	20.96	21.21	21.38
3	64QAM	1	8	21.29	21.36	21.29
3	64QAM	1	14	21.08	21.21	21.22
3	64QAM	8	0	19.92	20.10	20.27



3	64QAM	8	4	20.08	20.33	20.31
3	64QAM	8	7	20.00	20.25	20.21
3	64QAM	15	0	20.03	20.14	20.36
3	256QAM	1	0	18.12	18.23	18.40
3	256QAM	1	8	18.28	18.32	18.30
3	256QAM	1	14	18.31	18.36	18.31
3	256QAM	8	0	18.13	18.26	18.33
3	256QAM	8	4	18.28	18.37	18.41
3	256QAM	8	7	18.60	18.59	18.54
3	256QAM	15	0	18.28	18.45	18.35
Channel				26047	26340	26683
Frequency (MHz)				1850.7	1880	1914.3
1.4	QPSK	1	0	22.69	23.23	23.12
1.4	QPSK	1	3	22.98	23.13	23.17
1.4	QPSK	1	5	22.96	22.95	22.99
1.4	QPSK	3	0	22.75	23.05	22.95
1.4	QPSK	3	1	22.90	23.14	23.25
1.4	QPSK	3	3	22.82	23.11	23.06
1.4	QPSK	6	0	22.05	22.20	22.08
1.4	16QAM	1	0	22.03	22.23	22.44
1.4	16QAM	1	3	22.47	22.42	22.43
1.4	16QAM	1	5	22.31	22.23	22.15
1.4	16QAM	3	0	22.03	22.30	22.30
1.4	16QAM	3	1	22.57	22.40	22.36
1.4	16QAM	3	3	22.22	22.25	22.20
1.4	16QAM	6	0	21.08	21.25	21.25
1.4	64QAM	1	0	21.02	21.34	21.42
1.4	64QAM	1	3	21.33	21.46	21.45
1.4	64QAM	1	5	21.08	21.29	21.32
1.4	64QAM	3	0	21.06	21.28	21.42
1.4	64QAM	3	1	21.22	21.37	21.22
1.4	64QAM	3	3	21.09	21.32	21.14
1.4	64QAM	6	0	20.16	20.17	20.27
1.4	256QAM	1	0	18.15	18.27	18.36
1.4	256QAM	1	3	18.26	18.26	18.30
1.4	256QAM	1	5	18.21	18.30	18.48



---

1.4	256QAM	3	0	18.21	18.24	18.33
1.4	256QAM	3	1	18.23	18.28	18.42
1.4	256QAM	3	3	18.59	18.57	18.41
1.4	256QAM	6	0	18.14	18.52	18.19



LTE Band 26- Ant 3						
BW [MHz]	Modulation	RB Size	RB Offset	Power Low Ch. / Freq.	Power Middle Ch. / Freq.	Power High Ch. / Freq.
Channel				26865	26915	26965
Frequency (MHz)				831.5	836.5	841.5
15	QPSK	1	0	22.53	22.57	22.50
15	QPSK	1	37	22.55	22.60	22.58
15	QPSK	1	74	22.52	22.50	22.53
15	QPSK	36	0	21.65	21.75	21.71
15	QPSK	36	20	21.59	21.63	21.66
15	QPSK	36	39	21.55	21.70	21.66
15	QPSK	75	0	21.68	21.98	21.69
15	16QAM	1	0	21.94	21.85	22.14
15	16QAM	1	37	22.14	22.25	21.96
15	16QAM	1	74	22.18	22.02	21.86
15	16QAM	36	0	20.70	20.78	20.70
15	16QAM	36	20	20.68	20.83	20.67
15	16QAM	36	39	20.77	20.94	20.78
15	16QAM	75	0	20.69	20.95	20.66
15	64QAM	1	0	20.67	21.25	20.89
15	64QAM	1	37	21.11	21.21	20.70
15	64QAM	1	74	20.79	20.85	20.80
15	64QAM	36	0	19.68	19.85	19.62
15	64QAM	36	20	19.76	19.85	19.71
15	64QAM	36	39	19.76	20.01	19.74
15	64QAM	75	0	19.71	19.96	19.72
15	256QAM	1	0	17.91	17.85	17.90
15	256QAM	1	37	17.80	17.83	17.82
15	256QAM	1	74	17.97	17.92	17.83
15	256QAM	36	0	17.88	17.88	17.73
15	256QAM	36	20	17.84	18.13	18.03
15	256QAM	36	39	18.12	18.09	17.89
15	256QAM	75	0	17.95	17.92	17.94
Channel				26840	26915	26990
Frequency (MHz)				829	836.5	844



10	QPSK	1	0	22.59	22.59	22.55
10	QPSK	1	25	22.51	22.55	22.52
10	QPSK	1	49	22.55	22.54	22.54
10	QPSK	25	0	21.64	21.57	21.67
10	QPSK	25	12	21.51	21.52	21.63
10	QPSK	25	25	21.52	21.69	21.62
10	QPSK	50	0	21.62	21.78	21.50
10	16QAM	1	0	21.90	21.68	22.03
10	16QAM	1	25	22.08	22.08	21.76
10	16QAM	1	49	22.10	21.90	21.67
10	16QAM	25	0	20.67	20.69	20.55
10	16QAM	25	12	20.65	20.79	20.51
10	16QAM	25	25	20.68	20.85	20.67
10	16QAM	50	0	20.50	20.89	20.57
10	64QAM	1	0	20.65	21.05	20.85
10	64QAM	1	25	21.05	21.14	20.58
10	64QAM	1	49	20.77	20.69	20.70
10	64QAM	25	0	19.52	19.75	19.59
10	64QAM	25	12	19.74	19.66	19.67
10	64QAM	25	25	19.70	19.94	19.66
10	64QAM	50	0	19.51	19.83	19.65
10	256QAM	1	0	17.75	17.72	17.73
10	256QAM	1	25	17.65	17.79	17.76
10	256QAM	1	49	17.87	17.74	17.71
10	256QAM	25	0	17.87	17.77	17.70
10	256QAM	25	12	17.65	18.04	17.85
10	256QAM	25	25	17.99	17.96	17.72
10	256QAM	50	0	17.78	17.77	17.76
Channel				26815	26915	27015
Frequency (MHz)				826.5	836.5	846.5
5	QPSK	1	0	22.55	22.53	22.50
5	QPSK	1	12	22.53	22.50	22.56
5	QPSK	1	24	22.57	22.54	22.50
5	QPSK	12	0	21.58	21.64	21.61
5	QPSK	12	7	21.50	21.52	21.50
5	QPSK	12	13	21.52	21.51	21.58



5	QPSK	25	0	21.58	21.94	21.52
5	16QAM	1	0	21.86	21.74	22.10
5	16QAM	1	12	22.05	22.20	21.86
5	16QAM	1	24	22.07	21.93	21.75
5	16QAM	12	0	20.55	20.74	20.64
5	16QAM	12	7	20.58	20.75	20.56
5	16QAM	12	13	20.74	20.92	20.75
5	16QAM	25	0	20.63	20.77	20.62
5	64QAM	1	0	20.51	21.23	20.79
5	64QAM	1	12	21.06	21.07	20.67
5	64QAM	1	24	20.66	20.74	20.60
5	64QAM	12	0	19.63	19.82	19.59
5	64QAM	12	7	19.64	19.74	19.64
5	64QAM	12	13	19.57	19.88	19.69
5	64QAM	25	0	19.56	19.80	19.68
5	256QAM	1	0	17.78	17.75	17.79
5	256QAM	1	12	17.76	17.73	17.75
5	256QAM	1	24	17.86	17.84	17.80
5	256QAM	12	0	17.78	17.77	17.62
5	256QAM	12	7	17.83	17.94	17.95
5	256QAM	12	13	18.08	17.89	17.87
5	256QAM	25	0	17.86	17.81	17.79
Channel				26805	26915	27025
Frequency (MHz)				825.5	836.5	847.5
3	QPSK	1	0	22.46	22.53	22.33
3	QPSK	1	8	22.41	22.59	22.48
3	QPSK	1	14	22.38	22.38	22.50
3	QPSK	8	0	21.64	21.64	21.63
3	QPSK	8	4	21.44	21.60	21.46
3	QPSK	8	7	21.37	21.52	21.55
3	QPSK	15	0	21.57	21.90	21.65
3	16QAM	1	0	21.90	21.69	22.04
3	16QAM	1	8	22.03	22.22	21.86
3	16QAM	1	14	22.06	22.01	21.74
3	16QAM	8	0	20.62	20.58	20.52
3	16QAM	8	4	20.59	20.72	20.52





3	16QAM	8	7	20.66	20.85	20.73
3	16QAM	15	0	20.59	20.82	20.62
3	64QAM	1	0	20.56	21.10	20.77
3	64QAM	1	8	21.03	21.01	20.66
3	64QAM	1	14	20.71	20.84	20.61
3	64QAM	8	0	19.48	19.74	19.53
3	64QAM	8	4	19.64	19.74	19.69
3	64QAM	8	7	19.58	19.88	19.55
3	64QAM	15	0	19.58	19.82	19.54
3	256QAM	1	0	17.78	17.82	17.80
3	256QAM	1	8	17.64	17.82	17.77
3	256QAM	1	14	17.96	17.82	17.68
3	256QAM	8	0	17.77	17.84	17.72
3	256QAM	8	4	17.73	18.07	17.88
3	256QAM	8	7	18.05	18.08	17.88
3	256QAM	15	0	17.89	17.90	17.92
Channel				26797	26915	27033
Frequency (MHz)				824.7	836.5	848.3
1.4	QPSK	1	0	22.33	22.55	22.36
1.4	QPSK	1	3	22.38	22.43	22.39
1.4	QPSK	1	5	22.42	22.44	22.39
1.4	QPSK	3	0	21.47	21.59	21.54
1.4	QPSK	3	1	21.40	21.50	21.63
1.4	QPSK	3	3	21.50	21.66	21.59
1.4	QPSK	6	0	21.52	21.97	21.67
1.4	16QAM	1	0	21.76	21.77	22.00
1.4	16QAM	1	3	22.13	22.09	21.91
1.4	16QAM	1	5	22.13	21.83	21.76
1.4	16QAM	3	0	20.52	20.60	20.60
1.4	16QAM	3	1	20.60	20.81	20.57
1.4	16QAM	3	3	20.70	20.92	20.74
1.4	16QAM	6	0	20.57	20.89	20.47
1.4	64QAM	1	0	20.52	21.16	20.86
1.4	64QAM	1	3	21.03	21.11	20.58
1.4	64QAM	1	5	20.68	20.83	20.72
1.4	64QAM	3	0	19.55	19.80	19.59



1.4	64QAM	3	1	19.59	19.81	19.67
1.4	64QAM	3	3	19.57	19.89	19.70
1.4	64QAM	6	0	19.68	19.85	19.57
1.4	256QAM	1	0	17.78	17.82	17.82
1.4	256QAM	1	3	17.77	17.77	17.62
1.4	256QAM	1	5	17.83	17.84	17.71
1.4	256QAM	3	0	17.80	17.79	17.71
1.4	256QAM	3	1	17.79	18.09	17.87
1.4	256QAM	3	3	18.06	18.05	17.69
1.4	256QAM	6	0	17.78	17.77	17.88



LTE Band 66- Ant 2						
BW [MHz]	Modulation	RB Size	RB Offset	Power Low Ch. / Freq.	Power Middle Ch. / Freq.	Power High Ch. / Freq.
Channel				132072	132322	132572
Frequency (MHz)				1720	1745	1770
20	QPSK	1	0	22.65	22.65	22.60
20	QPSK	1	49	22.51	22.83	22.69
20	QPSK	1	99	22.65	22.64	22.63
20	QPSK	50	0	21.53	21.76	21.70
20	QPSK	50	24	21.67	21.71	21.69
20	QPSK	50	50	21.69	21.72	21.67
20	QPSK	100	0	21.69	21.70	21.64
20	16QAM	1	0	21.88	21.81	21.92
20	16QAM	1	49	21.99	22.27	21.99
20	16QAM	1	99	21.90	22.02	22.04
20	16QAM	50	0	20.69	20.71	20.75
20	16QAM	50	24	20.56	20.75	20.80
20	16QAM	50	50	20.69	20.73	20.88
20	16QAM	100	0	20.69	20.63	20.85
20	64QAM	1	0	20.64	20.69	20.99
20	64QAM	1	49	20.73	21.11	21.04
20	64QAM	1	99	20.79	20.86	20.70
20	64QAM	50	0	19.89	19.97	20.02
20	64QAM	50	24	19.75	19.91	20.05
20	64QAM	50	50	19.80	19.96	20.07
20	64QAM	100	0	19.79	19.90	19.98
20	256QAM	1	0	17.85	17.92	18.11
20	256QAM	1	49	17.94	17.88	18.10
20	256QAM	1	99	17.95	17.87	18.21
20	256QAM	50	0	17.94	17.92	18.14
20	256QAM	50	24	18.13	17.78	18.09
20	256QAM	50	50	18.12	18.16	18.09
20	256QAM	100	0	17.99	18.14	18.01
Channel				132047	132322	132597
Frequency (MHz)				1717.5	1745	1772.5



15	QPSK	1	0	22.56	22.63	22.58
15	QPSK	1	37	22.69	22.64	22.67
15	QPSK	1	74	22.63	22.64	22.68
15	QPSK	36	0	21.58	21.71	21.54
15	QPSK	36	20	21.68	21.60	21.67
15	QPSK	36	39	21.53	21.65	21.65
15	QPSK	75	0	21.52	21.65	21.66
15	16QAM	1	0	21.56	21.60	21.68
15	16QAM	1	37	21.92	22.13	21.94
15	16QAM	1	74	21.64	21.97	21.87
15	16QAM	36	0	20.64	20.62	20.75
15	16QAM	36	20	20.54	20.61	20.80
15	16QAM	36	39	20.64	20.60	20.76
15	16QAM	75	0	20.68	20.62	20.58
15	64QAM	1	0	20.58	20.51	20.92
15	64QAM	1	37	20.70	20.95	21.00
15	64QAM	1	74	20.60	20.78	20.62
15	64QAM	36	0	19.52	19.58	19.82
15	64QAM	36	20	19.53	19.58	19.84
15	64QAM	36	39	19.57	19.64	19.69
15	64QAM	75	0	19.54	19.63	19.78
15	256QAM	1	0	17.65	17.82	17.95
15	256QAM	1	37	17.82	17.85	17.90
15	256QAM	1	74	17.81	17.78	18.01
15	256QAM	36	0	17.77	17.74	17.94
15	256QAM	36	20	18.12	17.59	18.09
15	256QAM	36	39	18.03	18.15	18.02
15	256QAM	75	0	17.82	17.94	17.94
Channel				132022	132322	132622
Frequency (MHz)				1715	1745	1775
10	QPSK	1	0	22.50	22.51	22.53
10	QPSK	1	25	22.58	22.75	22.63
10	QPSK	1	49	22.56	22.66	22.68
10	QPSK	25	0	21.60	21.72	21.51
10	QPSK	25	12	21.67	21.63	21.56
10	QPSK	25	25	21.57	21.68	21.50



10	QPSK	50	0	21.59	21.70	21.53
10	16QAM	1	0	21.61	21.50	21.60
10	16QAM	1	25	21.92	22.19	21.91
10	16QAM	1	49	21.77	21.98	21.93
10	16QAM	25	0	20.55	20.58	20.66
10	16QAM	25	12	20.52	20.64	20.72
10	16QAM	25	25	20.63	20.54	20.88
10	16QAM	50	0	20.57	20.52	20.74
10	64QAM	1	0	20.56	20.66	20.86
10	64QAM	1	25	20.62	20.96	20.91
10	64QAM	1	49	20.52	20.88	20.69
10	64QAM	25	0	19.54	19.53	19.76
10	64QAM	25	12	19.53	19.56	19.70
10	64QAM	25	25	19.54	19.58	19.72
10	64QAM	50	0	19.54	19.67	19.79
10	256QAM	1	0	17.70	17.73	18.09
10	256QAM	1	25	17.90	17.85	17.91
10	256QAM	1	49	17.87	17.69	18.07
10	256QAM	25	0	17.79	17.83	18.14
10	256QAM	25	12	18.07	17.71	18.04
10	256QAM	25	25	18.10	18.16	18.04
10	256QAM	50	0	17.91	18.05	18.01
Channel				131997	132322	132647
Frequency (MHz)				1712.5	1745	1777.5
5	QPSK	1	0	22.51	22.59	22.53
5	QPSK	1	12	22.66	22.67	22.59
5	QPSK	1	24	22.51	22.62	22.51
5	QPSK	12	0	21.54	21.71	21.63
5	QPSK	12	7	21.54	21.59	21.69
5	QPSK	12	13	21.52	21.59	21.64
5	QPSK	25	0	21.51	21.57	21.72
5	16QAM	1	0	21.70	21.56	21.66
5	16QAM	1	12	21.93	22.18	21.94
5	16QAM	1	24	21.62	21.94	22.03
5	16QAM	12	0	20.52	20.67	20.61
5	16QAM	12	7	20.57	20.65	20.64



5	16QAM	12	13	20.64	20.74	20.72
5	16QAM	25	0	20.58	20.57	20.77
5	64QAM	1	0	20.65	20.60	20.96
5	64QAM	1	12	20.63	21.02	20.88
5	64QAM	1	24	20.56	20.66	20.65
5	64QAM	12	0	19.67	19.63	19.64
5	64QAM	12	7	19.57	19.66	19.82
5	64QAM	12	13	19.52	19.67	19.73
5	64QAM	25	0	19.56	19.63	19.83
5	256QAM	1	0	17.81	17.86	17.93
5	256QAM	1	12	17.85	17.82	18.02
5	256QAM	1	24	17.79	17.84	18.17
5	256QAM	12	0	17.86	17.80	17.99
5	256QAM	12	7	18.03	17.62	18.01
5	256QAM	12	13	18.08	18.06	17.91
5	256QAM	25	0	17.99	18.04	18.00
Channel				131987	132322	132657
Frequency (MHz)				1711.5	1745	1778.5
3	QPSK	1	0	22.50	22.65	22.52
3	QPSK	1	8	22.66	22.66	22.61
3	QPSK	1	14	22.52	22.52	22.61
3	QPSK	8	0	21.60	21.69	21.63
3	QPSK	8	4	21.50	21.63	21.57
3	QPSK	8	7	21.51	21.59	21.59
3	QPSK	15	0	21.60	21.53	21.69
3	16QAM	1	0	21.62	21.72	21.67
3	16QAM	1	8	21.80	22.02	21.79
3	16QAM	1	14	21.62	21.98	21.99
3	16QAM	8	0	20.54	20.63	20.62
3	16QAM	8	4	20.50	20.67	20.77
3	16QAM	8	7	20.54	20.64	20.84
3	16QAM	15	0	20.63	20.66	20.86
3	64QAM	1	0	20.63	20.62	21.03
3	64QAM	1	8	20.81	20.89	20.94
3	64QAM	1	14	20.61	20.70	20.67
3	64QAM	8	0	19.55	19.69	19.67



3	64QAM	8	4	19.60	19.69	19.70
3	64QAM	8	7	19.68	19.67	19.74
3	64QAM	15	0	19.55	19.59	19.74
3	256QAM	1	0	17.75	17.73	17.93
3	256QAM	1	8	17.89	17.70	18.04
3	256QAM	1	14	17.75	17.81	18.16
3	256QAM	8	0	17.84	17.87	17.99
3	256QAM	8	4	17.95	17.63	18.03
3	256QAM	8	7	17.96	18.09	17.97
3	256QAM	15	0	17.96	17.97	17.84
Channel				131979	132322	132665
Frequency (MHz)				1710.7	1745	1779.3
1.4	QPSK	1	0	22.53	22.60	22.50
1.4	QPSK	1	3	22.54	22.63	22.52
1.4	QPSK	1	5	22.56	22.68	22.58
1.4	QPSK	3	0	22.57	22.53	22.55
1.4	QPSK	3	1	22.63	22.68	22.65
1.4	QPSK	3	3	22.65	22.67	22.66
1.4	QPSK	6	0	21.56	21.71	21.57
1.4	16QAM	1	0	21.53	21.75	21.60
1.4	16QAM	1	3	21.97	22.17	21.94
1.4	16QAM	1	5	21.80	22.01	22.06
1.4	16QAM	3	0	21.61	21.61	21.60
1.4	16QAM	3	1	21.97	22.11	21.90
1.4	16QAM	3	3	21.74	21.94	22.00
1.4	16QAM	6	0	20.54	20.64	20.68
1.4	64QAM	1	0	20.59	20.65	20.87
1.4	64QAM	1	3	20.59	21.04	20.97
1.4	64QAM	1	5	20.56	20.81	20.61
1.4	64QAM	3	0	20.67	20.63	20.91
1.4	64QAM	3	1	20.72	20.87	20.89
1.4	64QAM	3	3	20.65	20.71	20.64
1.4	64QAM	6	0	19.60	19.58	19.65
1.4	256QAM	1	0	17.75	17.73	17.99
1.4	256QAM	1	3	17.86	17.84	18.07
1.4	256QAM	1	5	17.91	17.86	18.13



---

1.4	256QAM	3	0	17.75	17.81	18.10
1.4	256QAM	3	1	17.98	17.61	18.08
1.4	256QAM	3	3	18.11	18.06	17.89
1.4	256QAM	6	0	17.90	18.01	17.81





LTE Band 71- Ant 1						
BW [MHz]	Modulation	RB Size	RB Offset	Power Low Ch. / Freq.	Power Middle Ch. / Freq.	Power High Ch. / Freq.
Channel				133222	133297	133372
Frequency (MHz)				673	680.5	688
20	QPSK	1	0	22.90	23.03	22.89
20	QPSK	1	49	22.95	23.05	22.87
20	QPSK	1	99	22.86	22.89	22.74
20	QPSK	50	0	21.98	22.10	21.88
20	QPSK	50	24	21.92	22.01	21.79
20	QPSK	50	50	22.06	22.03	21.86
20	QPSK	100	0	21.99	22.02	21.84
20	16QAM	1	0	22.07	22.10	21.96
20	16QAM	1	49	22.26	22.22	21.97
20	16QAM	1	99	22.04	22.05	21.81
20	16QAM	50	0	20.76	20.95	20.76
20	16QAM	50	24	21.13	21.05	20.84
20	16QAM	50	50	21.07	21.04	20.69
20	16QAM	100	0	21.07	21.07	20.78
20	64QAM	1	0	21.29	20.99	21.08
20	64QAM	1	49	21.29	21.10	20.82
20	64QAM	1	99	21.13	20.99	20.77
20	64QAM	50	0	20.04	19.92	19.91
20	64QAM	50	24	19.98	20.24	19.85
20	64QAM	50	50	20.02	20.05	19.68
20	64QAM	100	0	20.00	19.92	19.82
20	256QAM	1	0	18.06	18.00	17.90
20	256QAM	1	49	18.32	18.10	17.84
20	256QAM	1	99	18.13	18.19	17.73
20	256QAM	50	0	18.18	17.99	17.77
20	256QAM	50	24	18.04	17.90	17.90
20	256QAM	50	50	18.00	18.00	17.75
20	256QAM	100	0	17.96	17.98	17.82
Channel				133197	133297	133397
Frequency (MHz)				670.5	680.5	690.5



15	QPSK	1	0	22.93	22.88	22.87
15	QPSK	1	37	22.94	22.95	22.81
15	QPSK	1	74	22.82	22.87	22.57
15	QPSK	36	0	21.84	21.81	21.73
15	QPSK	36	20	21.91	22.09	21.96
15	QPSK	36	39	21.96	21.88	21.68
15	QPSK	75	0	22.04	22.06	21.73
15	16QAM	1	0	22.10	22.02	21.90
15	16QAM	1	37	22.22	22.22	22.05
15	16QAM	1	74	21.95	22.08	21.62
15	16QAM	36	0	20.67	20.87	20.72
15	16QAM	36	20	21.09	21.08	20.71
15	16QAM	36	39	20.83	21.04	20.71
15	16QAM	75	0	20.94	21.04	20.77
15	64QAM	1	0	21.26	21.03	21.03
15	64QAM	1	37	21.27	21.02	20.83
15	64QAM	1	74	21.15	20.87	20.68
15	64QAM	36	0	20.09	19.89	19.75
15	64QAM	36	20	20.00	20.16	19.76
15	64QAM	36	39	19.92	19.86	19.78
15	64QAM	75	0	20.00	19.88	19.83
15	256QAM	1	0	17.98	17.80	17.89
15	256QAM	1	37	18.26	18.05	17.80
15	256QAM	1	74	18.10	18.07	17.72
15	256QAM	36	0	18.05	18.05	17.72
15	256QAM	36	20	18.04	17.87	17.79
15	256QAM	36	39	17.85	17.77	17.65
15	256QAM	75	0	17.92	17.89	17.82
Channel				133172	133297	133422
Frequency (MHz)				668	680.5	693
10	QPSK	1	0	23.00	22.99	22.89
10	QPSK	1	25	22.92	22.99	22.77
10	QPSK	1	49	22.80	22.82	22.61
10	QPSK	25	0	21.90	21.84	21.80
10	QPSK	25	12	21.97	22.08	21.93
10	QPSK	25	25	22.00	21.97	21.80



10	QPSK	50	0	21.89	21.97	21.77
10	16QAM	1	0	21.97	22.16	21.96
10	16QAM	1	25	22.16	22.13	21.99
10	16QAM	1	49	21.91	22.06	21.81
10	16QAM	25	0	20.67	20.92	20.74
10	16QAM	25	12	21.07	21.07	20.71
10	16QAM	25	25	20.98	21.08	20.79
10	16QAM	50	0	20.96	21.01	20.88
10	64QAM	1	0	21.37	20.93	21.05
10	64QAM	1	25	21.19	21.12	20.70
10	64QAM	1	49	20.95	20.88	20.69
10	64QAM	25	0	20.03	19.90	19.70
10	64QAM	25	12	20.02	20.33	19.88
10	64QAM	25	25	19.89	19.99	19.78
10	64QAM	50	0	19.99	19.81	19.79
10	256QAM	1	0	17.91	17.83	17.84
10	256QAM	1	25	18.32	18.07	17.73
10	256QAM	1	49	18.11	18.18	17.55
10	256QAM	25	0	18.08	17.88	17.62
10	256QAM	25	12	17.95	18.02	17.86
10	256QAM	25	25	17.96	17.79	17.65
10	256QAM	50	0	18.01	17.95	17.83
Channel				133147	133297	133447
Frequency (MHz)				665.5	680.5	695.5
5	QPSK	1	0	22.96	22.87	22.78
5	QPSK	1	12	22.99	22.94	22.78
5	QPSK	1	24	22.74	22.81	22.62
5	QPSK	12	0	21.96	21.90	21.71
5	QPSK	12	7	22.02	22.09	21.89
5	QPSK	12	13	22.00	21.93	21.74
5	QPSK	25	0	21.79	21.89	21.78
5	16QAM	1	0	21.90	22.05	21.83
5	16QAM	1	12	22.32	22.22	22.01
5	16QAM	1	24	22.14	21.91	21.67
5	16QAM	12	0	20.70	21.01	20.69
5	16QAM	12	7	21.15	21.10	20.67



5	16QAM	12	13	20.93	21.10	20.79
5	16QAM	25	0	21.12	20.93	20.74
5	64QAM	1	0	21.32	21.00	21.12
5	64QAM	1	12	21.23	21.02	20.91
5	64QAM	1	24	21.13	20.90	20.80
5	64QAM	12	0	20.03	19.79	19.75
5	64QAM	12	7	19.93	20.09	19.95
5	64QAM	12	13	19.83	20.01	19.54
5	64QAM	25	0	19.84	19.88	19.86
5	256QAM	1	0	17.92	17.94	17.74
5	256QAM	1	12	18.29	18.18	17.69
5	256QAM	1	24	17.99	18.02	17.67
5	256QAM	12	0	18.12	18.03	17.67
5	256QAM	12	7	17.99	17.74	17.77
5	256QAM	12	13	17.96	17.88	17.76
5	256QAM	25	0	17.86	17.93	17.83



**ERP/EIRP**

LTE Band 2 (GT - LC = -3.26 dB) QPSK									
Bandwidth	1.4M			3M			5M		
Channel	18607	18900	19193	18615	18900	19185	18625	18900	19175
	(Low)	(Mid)	(High)	(Low)	(Mid)	(High)	(Low)	(Mid)	(High)
Frequency	1850.7	1880	1909.3	1851.5	1880	1908.5	1852.5	1880	1907.5
(MHz)									
Conducted Power (dBm)	22.69	23.01	22.94	22.75	23.00	22.80	22.83	23.02	22.84
Conducted Power (Watts)	0.1858	0.2000	0.1968	0.1884	0.1995	0.1905	0.1919	0.2004	0.1923
EIRP(dBm)	19.43	19.75	19.68	19.49	19.74	19.54	19.57	19.76	19.58
EIRP(Watts)	0.0877	0.0944	0.0929	0.0889	0.0942	0.0899	0.0906	0.0946	0.0908

LTE Band 2 (GT - LC = -3.26 dB) QPSK									
Bandwidth	10M			15M			20M		
Channel	18650	18900	19150	18675	18900	19125	18650	18900	19100
	(Low)	(Mid)	(High)	(Low)	(Mid)	(High)	(Low)	(Mid)	(High)
Frequency	1855	1880	1905	1857.5	1880	1902.5	1860	1880	1900
(MHz)									
Conducted Power (dBm)	22.84	23.07	22.80	22.88	22.97	22.80	22.88	23.13	22.98
Conducted Power (Watts)	0.1923	0.2028	0.1905	0.1941	0.1982	0.1905	0.1941	0.2056	0.1986
EIRP(dBm)	19.58	19.81	19.54	19.62	19.71	19.54	19.62	19.87	19.72
EIRP(Watts)	0.0908	0.0957	0.0899	0.0916	0.0935	0.0899	0.0916	0.0971	0.0938



LTE Band 2 (GT - LC = -3.26 dB) 16QAM									
Bandwidth	1.4M			3M			5M		
Channel	18607	18900	19193	18615	18900	19185	18625	18900	19175
	(Low)	(Mid)	(High)	(Low)	(Mid)	(High)	(Low)	(Mid)	(High)
Frequency (MHz)	1850.7	1880	1909.3	1851.5	1880	1908.5	1852.5	1880	1907.5
Conducted Power (dBm)	22.47	22.35	22.12	22.53	22.41	22.22	22.03	22.48	21.98
Conducted Power (Watts)	0.1766	0.1718	0.1629	0.1791	0.1742	0.1667	0.1596	0.1770	0.1578
EIRP(dBm)	19.21	19.09	18.86	19.27	19.15	18.96	18.77	19.22	18.72
EIRP(Watts)	0.0834	0.0811	0.0769	0.0845	0.0822	0.0787	0.0753	0.0836	0.0745

LTE Band 2 (GT - LC = -3.26 dB) 16QAM									
Bandwidth	10M			15M			20M		
Channel	18650	18900	19150	18675	18900	19125	18650	18900	19100
	(Low)	(Mid)	(High)	(Low)	(Mid)	(High)	(Low)	(Mid)	(High)
Frequency (MHz)	1855	1880	1905	1857.5	1880	1902.5	1860	1880	1900
Conducted Power (dBm)	22.41	22.34	22.26	22.52	22.37	22.10	22.62	22.47	22.23
Conducted Power (Watts)	0.1742	0.1714	0.1683	0.1786	0.1726	0.1622	0.1828	0.1766	0.1671
EIRP(dBm)	19.15	19.08	19.00	19.26	19.11	18.84	19.36	19.21	18.97
EIRP(Watts)	0.0822	0.0809	0.0794	0.0843	0.0815	0.0766	0.0863	0.0834	0.0789



LTE Band 2 (GT - LC = -3.26 dB) 64QAM									
Bandwidth	1.4M			3M			5M		
Channel	18607	18900	19193	18615	18900	19185	18625	18900	19175
	(Low)	(Mid)	(High)	(Low)	(Mid)	(High)	(Low)	(Mid)	(High)
Frequency	1850.7	1880	1909.3	1851.5	1880	1908.5	1852.5	1880	1907.5
(MHz)									
Conducted Power (dBm)	20.99	21.24	20.99	21.25	21.09	21.08	21.12	21.09	21.08
Conducted Power (Watts)	0.1256	0.1330	0.1256	0.1334	0.1285	0.1282	0.1294	0.1285	0.1282
EIRP(dBm)	17.73	17.98	17.73	17.99	17.83	17.82	17.86	17.83	17.82
EIRP(Watts)	0.0593	0.0628	0.0593	0.0630	0.0607	0.0605	0.0611	0.0607	0.0605

LTE Band 2 (GT - LC = -3.26 dB) 64QAM									
Bandwidth	10M			15M			20M		
Channel	18650	18900	19150	18675	18900	19125	18650	18900	19100
	(Low)	(Mid)	(High)	(Low)	(Mid)	(High)	(Low)	(Mid)	(High)
Frequency	1855	1880	1905	1857.5	1880	1902.5	1860	1880	1900
(MHz)									
Conducted Power (dBm)	21.16	21.19	21.07	21.21	21.17	21.14	21.17	21.28	21.21
Conducted Power (Watts)	0.1306	0.1315	0.1279	0.1321	0.1309	0.1300	0.1309	0.1343	0.1321
EIRP(dBm)	17.90	17.93	17.81	17.95	17.91	17.88	17.91	18.02	17.95
EIRP(Watts)	0.0617	0.0621	0.0604	0.0624	0.0618	0.0614	0.0618	0.0634	0.0624



LTE Band 2 (GT - LC = -3.26 dB) 256QAM									
Bandwidth	1.4M			3M			5M		
Channel	18607	18900	19193	18615	18900	19185	18625	18900	19175
	(Low)	(Mid)	(High)	(Low)	(Mid)	(High)	(Low)	(Mid)	(High)
Frequency (MHz)	1850.7	1880	1909.3	1851.5	1880	1908.5	1852.5	1880	1907.5
Conducted Power (dBm)	18.34	18.06	18.14	18.39	18.06	18.17	18.21	18.17	18.25
Conducted Power (Watts)	0.0682	0.0640	0.0652	0.0690	0.0640	0.0656	0.0662	0.0656	0.0668
EIRP(dBm)	15.08	14.80	14.88	15.13	14.80	14.91	14.95	14.91	14.99
EIRP(Watts)	0.0322	0.0302	0.0308	0.0326	0.0302	0.0310	0.0313	0.0310	0.0316

LTE Band 2 (GT - LC = -3.26 dB) 256QAM									
Bandwidth	10M			15M			20M		
Channel	18650	18900	19150	18675	18900	19125	18650	18900	19100
	(Low)	(Mid)	(High)	(Low)	(Mid)	(High)	(Low)	(Mid)	(High)
Frequency (MHz)	1855	1880	1905	1857.5	1880	1902.5	1860	1880	1900
Conducted Power (dBm)	18.30	18.22	18.15	18.43	17.89	18.26	18.39	18.18	18.28
Conducted Power (Watts)	0.0676	0.0664	0.0653	0.0697	0.0615	0.0670	0.0690	0.0658	0.0673
EIRP(dBm)	15.04	14.96	14.89	15.17	14.63	15.00	15.13	14.92	15.02
EIRP(Watts)	0.0319	0.0313	0.0308	0.0329	0.0290	0.0316	0.0326	0.0310	0.0318





LTE Band 4 (GT - LC = -4.71 dB) QPSK									
Bandwidth	1.4M			3M			5M		
Channel	19957	20175	20393	19965	20175	20385	19975	20175	20375
	(Low)	(Mid)	(High)	(Low)	(Mid)	(High)	(Low)	(Mid)	(High)
Frequency (MHz)	1710.7	1732.5	1754.3	1711.5	1732.5	1753.5	1712.5	1732.5	1752.5
Conducted Power (dBm)	22.29	22.70	22.49	22.15	22.66	22.47	22.19	22.62	22.55
Conducted Power (Watts)	0.1694	0.1862	0.1774	0.1641	0.1845	0.1766	0.1656	0.1828	0.1799
EIRP(dBm)	17.58	17.99	17.78	17.44	17.95	17.76	17.48	17.91	17.84
EIRP(Watts)	0.0573	0.0630	0.0600	0.0555	0.0624	0.0597	0.0560	0.0618	0.0608

LTE Band 4 (GT - LC = -4.71 dB) QPSK									
Bandwidth	10M			15M			20M		
Channel	20000	20175	20350	20025	20175	20325	20050	20175	20300
	(Low)	(Mid)	(High)	(Low)	(Mid)	(High)	(Low)	(Mid)	(High)
Frequency (MHz)	1715	1732.5	1750	1717.5	1732.5	1747.5	1720	1732.5	1745
Conducted Power (dBm)	22.27	22.59	22.60	22.23	22.54	22.60	22.32	22.71	22.67
Conducted Power (Watts)	0.1687	0.1816	0.1820	0.1671	0.1795	0.1820	0.1706	0.1866	0.1849
EIRP(dBm)	17.56	17.88	17.89	17.52	17.83	17.89	17.61	18.00	17.96
EIRP(Watts)	0.0570	0.0614	0.0615	0.0565	0.0607	0.0615	0.0577	0.0631	0.0625



LTE Band 4 (GT - LC = -4.71 dB) 16QAM									
Bandwidth	1.4M			3M			5M		
Channel	19957	20175	20393	19965	20175	20385	19975	20175	20375
	(Low)	(Mid)	(High)	(Low)	(Mid)	(High)	(Low)	(Mid)	(High)
Frequency (MHz)	1710.7	1732.5	1754.3	1711.5	1732.5	1753.5	1712.5	1732.5	1752.5
Conducted Power (dBm)	21.67	22.02	21.72	21.68	22.05	21.84	21.73	21.55	21.71
Conducted Power (Watts)	0.1469	0.1592	0.1486	0.1472	0.1603	0.1528	0.1489	0.1429	0.1483
EIRP(dBm)	16.96	17.31	17.01	16.97	17.34	17.13	17.02	16.84	17.00
EIRP(Watts)	0.0497	0.0538	0.0502	0.0498	0.0542	0.0516	0.0504	0.0483	0.0501

LTE Band 4 (GT - LC = -4.71 dB) 16QAM									
Bandwidth	10M			15M			20M		
Channel	20000	20175	20350	20025	20175	20325	20050	20175	20300
	(Low)	(Mid)	(High)	(Low)	(Mid)	(High)	(Low)	(Mid)	(High)
Frequency (MHz)	1715	1732.5	1750	1717.5	1732.5	1747.5	1720	1732.5	1745
Conducted Power (dBm)	21.76	22.02	21.88	21.80	21.98	21.70	21.80	22.07	21.89
Conducted Power (Watts)	0.1500	0.1592	0.1542	0.1514	0.1578	0.1479	0.1514	0.1611	0.1545
EIRP(dBm)	17.05	17.31	17.17	17.09	17.27	16.99	17.09	17.36	17.18
EIRP(Watts)	0.0507	0.0538	0.0521	0.0512	0.0533	0.0500	0.0512	0.0545	0.0522



LTE Band 4 (GT - LC = -4.71 dB) 64QAM									
Bandwidth	1.4M			3M			5M		
Channel	19957	20175	20393	19965	20175	20385	19975	20175	20375
	(Low)	(Mid)	(High)	(Low)	(Mid)	(High)	(Low)	(Mid)	(High)
Frequency (MHz)	1710.7	1732.5	1754.3	1711.5	1732.5	1753.5	1712.5	1732.5	1752.5
Conducted Power (dBm)	20.61	20.88	20.79	20.53	20.76	20.80	20.51	20.92	20.79
Conducted Power (Watts)	0.1151	0.1225	0.1199	0.1130	0.1191	0.1202	0.1125	0.1236	0.1199
EIRP(dBm)	15.90	16.17	16.08	15.82	16.05	16.09	15.80	16.21	16.08
EIRP(Watts)	0.0389	0.0414	0.0406	0.0382	0.0403	0.0406	0.0380	0.0418	0.0406

LTE Band 4 (GT - LC = -4.71 dB) 64QAM									
Bandwidth	10M			15M			20M		
Channel	20000	20175	20350	20025	20175	20325	20050	20175	20300
	(Low)	(Mid)	(High)	(Low)	(Mid)	(High)	(Low)	(Mid)	(High)
Frequency (MHz)	1715	1732.5	1750	1717.5	1732.5	1747.5	1720	1732.5	1745
Conducted Power (dBm)	20.59	20.79	20.80	20.53	20.74	20.70	20.64	20.93	20.86
Conducted Power (Watts)	0.1146	0.1199	0.1202	0.1130	0.1186	0.1175	0.1159	0.1239	0.1219
EIRP(dBm)	15.88	16.08	16.09	15.82	16.03	15.99	15.93	16.22	16.15
EIRP(Watts)	0.0387	0.0406	0.0406	0.0382	0.0401	0.0397	0.0392	0.0419	0.0412



LTE Band 4 (GT - LC = -4.71 dB) 256QAM									
Bandwidth	1.4M			3M			5M		
Channel	19957	20175	20393	19965	20175	20385	19975	20175	20375
	(Low)	(Mid)	(High)	(Low)	(Mid)	(High)	(Low)	(Mid)	(High)
Frequency (MHz)	1710.7	1732.5	1754.3	1711.5	1732.5	1753.5	1712.5	1732.5	1752.5
Conducted Power (dBm)	17.78	17.57	18.04	17.94	18.11	17.79	17.65	17.73	18.07
Conducted Power (Watts)	0.0600	0.0571	0.0637	0.0622	0.0647	0.0601	0.0582	0.0593	0.0641
EIRP(dBm)	13.07	12.86	13.33	13.23	13.40	13.08	12.94	13.02	13.36
EIRP(Watts)	0.0203	0.0193	0.0215	0.0210	0.0219	0.0203	0.0197	0.0200	0.0217

LTE Band 4 (GT - LC = -4.71 dB) 256QAM									
Bandwidth	10M			15M			20M		
Channel	20000	20175	20350	20025	20175	20325	20050	20175	20300
	(Low)	(Mid)	(High)	(Low)	(Mid)	(High)	(Low)	(Mid)	(High)
Frequency (MHz)	1715	1732.5	1750	1717.5	1732.5	1747.5	1720	1732.5	1745
Conducted Power (dBm)	17.72	17.63	18.02	17.69	17.81	18.01	18.02	18.11	17.90
Conducted Power (Watts)	0.0592	0.0579	0.0634	0.0587	0.0604	0.0632	0.0634	0.0647	0.0617
EIRP(dBm)	13.01	12.92	13.31	12.98	13.10	13.30	13.31	13.40	13.19
EIRP(Watts)	0.0200	0.0196	0.0214	0.0199	0.0204	0.0214	0.0214	0.0219	0.0208



LTE Band 5 (GT - LC = -4.31 dB) QPSK									
Bandwidth	1.4M			3M			5M		
Channel	20407	20525	20643	20415	20525	20635	20425	20525	20625
	(Low)	(Mid)	(High)	(Low)	(Mid)	(High)	(Low)	(Mid)	(High)
Frequency (MHz)	824.7	836.5	848.3	825.5	836.5	847.5	826.5	836.5	846.5
Conducted Power (dBm)	22.44	22.47	22.39	22.46	22.48	22.44	22.49	22.45	22.45
Conducted Power (Watts)	0.1754	0.1766	0.1734	0.1762	0.1770	0.1754	0.1774	0.1758	0.1758
ERP(dBm)	15.98	16.01	15.93	16.00	16.02	15.98	16.03	15.99	15.99
ERP(Watts)	0.0396	0.0399	0.0392	0.0398	0.0400	0.0396	0.0401	0.0397	0.0397

LTE Band 5 (GT - LC = -4.31 dB) QPSK			
Bandwidth	10M		
Channel	20450	20525	20600
	(Low)	(Mid)	(High)
Frequency (MHz)	829	836.5	844
Conducted Power (dBm)	22.36	22.50	22.38
Conducted Power (Watts)	0.1722	0.1778	0.1730
ERP(dBm)	15.90	16.04	15.92
ERP(Watts)	0.0389	0.0402	0.0391



LTE Band 5 (GT - LC = -4.31 dB) 16QAM									
Bandwidth	1.4M			3M			5M		
Channel	20407	20525	20643	20415	20525	20635	20425	20525	20625
	(Low)	(Mid)	(High)	(Low)	(Mid)	(High)	(Low)	(Mid)	(High)
Frequency (MHz)	824.7	836.5	848.3	825.5	836.5	847.5	826.5	836.5	846.5
Conducted Power (dBm)	22.29	22.23	21.97	22.26	22.12	22.06	22.28	22.12	22.10
Conducted Power (Watts)	0.1694	0.1671	0.1574	0.1683	0.1629	0.1607	0.1690	0.1629	0.1622
ERP(dBm)	15.83	15.77	15.51	15.80	15.66	15.60	15.82	15.66	15.64
ERP(Watts)	0.0383	0.0378	0.0356	0.0380	0.0368	0.0363	0.0382	0.0368	0.0366

LTE Band 5 (GT - LC = -4.31 dB) 16QAM			
Bandwidth	10M		
Channel	20450	20525	20600
	(Low)	(Mid)	(High)
Frequency (MHz)	829	836.5	844
Conducted Power (dBm)	21.94	22.23	21.90
Conducted Power (Watts)	0.1563	0.1671	0.1549
ERP(dBm)	15.48	15.77	15.44
ERP(Watts)	0.0353	0.0378	0.0350



LTE Band 5 (GT - LC = -4.31 dB) 64QAM									
Bandwidth	1.4M			3M			5M		
Channel	20407	20525	20643	20415	20525	20635	20425	20525	20625
	(Low)	(Mid)	(High)	(Low)	(Mid)	(High)	(Low)	(Mid)	(High)
Frequency (MHz)	824.7	836.5	848.3	825.5	836.5	847.5	826.5	836.5	846.5
Conducted Power (dBm)	20.63	20.54	21.08	20.75	20.75	21.17	20.73	20.56	21.07
Conducted Power (Watts)	0.1156	0.1132	0.1282	0.1189	0.1189	0.1309	0.1183	0.1138	0.1279
ERP(dBm)	14.17	14.08	14.62	14.29	14.29	14.71	14.27	14.10	14.61
ERP(Watts)	0.0261	0.0256	0.0290	0.0269	0.0269	0.0296	0.0267	0.0257	0.0289

LTE Band 5 (GT - LC = -4.31 dB) 64QAM			
Bandwidth	10M		
Channel	20450	20525	20600
	(Low)	(Mid)	(High)
Frequency (MHz)	829	836.5	844
Conducted Power (dBm)	20.61	21.13	20.87
Conducted Power (Watts)	0.1151	0.1297	0.1222
ERP(dBm)	14.15	14.67	14.41
ERP(Watts)	0.0260	0.0293	0.0276



LTE Band 5 (GT - LC = -4.31 dB) 256QAM									
Bandwidth	1.4M			3M			5M		
Channel	20407	20525	20643	20415	20525	20635	20425	20525	20625
	(Low)	(Mid)	(High)	(Low)	(Mid)	(High)	(Low)	(Mid)	(High)
Frequency	824.7	836.5	848.3	825.5	836.5	847.5	826.5	836.5	846.5
(MHz)									
Conducted Power (dBm)	17.55	17.66	17.73	17.63	17.58	17.79	17.61	17.70	17.62
Conducted Power (Watts)	0.0569	0.0583	0.0593	0.0579	0.0573	0.0601	0.0577	0.0589	0.0578
ERP(dBm)	11.09	11.20	11.27	11.17	11.12	11.33	11.15	11.24	11.16
ERP(Watts)	0.0129	0.0132	0.0134	0.0131	0.0129	0.0136	0.0130	0.0133	0.0131

LTE Band 5 (GT - LC = -4.31 dB) 256QAM			
Bandwidth	10M		
Channel	20450	20525	20600
	(Low)	(Mid)	(High)
Frequency	829	836.5	844
(MHz)			
Conducted Power (dBm)	17.66	18.13	18.00
Conducted Power (Watts)	0.0583	0.0650	0.0631
ERP(dBm)	11.20	11.67	11.54
ERP(Watts)	0.0132	0.0147	0.0143





LTE Band 12 (GT - LC = -5.47 dB) QPSK									
Bandwidth	1.4M			3M			5M		
Channel	23017	23095	23173	23025	23095	23165	23035	23095	23155
	(Low)	(Mid)	(High)	(Low)	(Mid)	(High)	(Low)	(Mid)	(High)
Frequency (MHz)	699.7	707.5	715.3	700.5	707.5	714.5	701.5	707.5	713.5
Conducted Power (dBm)	22.77	23.06	22.85	22.91	23.08	22.80	22.79	23.09	22.86
Conducted Power (Watts)	0.1892	0.2023	0.1928	0.1954	0.2032	0.1905	0.1901	0.2037	0.1932
ERP(dBm)	15.15	15.44	15.23	15.29	15.46	15.18	15.17	15.47	15.24
ERP(Watts)	0.0327	0.0350	0.0333	0.0338	0.0352	0.0330	0.0329	0.0352	0.0334

LTE Band 12 (GT - LC = -5.47 dB) QPSK			
Bandwidth	10M		
Channel	23060	23095	23130
	(Low)	(Mid)	(High)
Frequency (MHz)	704	707.5	711
Conducted Power (dBm)	23.04	23.09	23.04
Conducted Power (Watts)	0.2014	0.2037	0.2014
ERP(dBm)	15.42	15.47	15.42
ERP(Watts)	0.0348	0.0352	0.0348



LTE Band 12 (GT - LC = -5.47 dB) 16QAM									
Bandwidth	1.4M			3M			5M		
Channel	23017	23095	23173	23025	23095	23165	23035	23095	23155
	(Low)	(Mid)	(High)	(Low)	(Mid)	(High)	(Low)	(Mid)	(High)
Frequency (MHz)	699.7	707.5	715.3	700.5	707.5	714.5	701.5	707.5	713.5
Conducted Power (dBm)	22.36	22.56	22.62	22.17	22.54	22.42	22.35	22.52	22.44
Conducted Power (Watts)	0.1722	0.1803	0.1828	0.1648	0.1795	0.1746	0.1718	0.1786	0.1754
ERP(dBm)	14.74	14.94	15.00	14.55	14.92	14.80	14.73	14.90	14.82
ERP(Watts)	0.0298	0.0312	0.0316	0.0285	0.0310	0.0302	0.0297	0.0309	0.0303

LTE Band 12 (GT - LC = -5.47 dB) 16QAM			
Bandwidth	10M		
Channel	23060	23095	23130
	(Low)	(Mid)	(High)
Frequency (MHz)	704	707.5	711
Conducted Power (dBm)	22.48	22.60	22.56
Conducted Power (Watts)	0.1770	0.1820	0.1803
ERP(dBm)	14.86	14.98	14.94
ERP(Watts)	0.0306	0.0315	0.0312



LTE Band 12 (GT - LC = -5.47 dB) 64QAM									
Bandwidth	1.4M			3M			5M		
Channel	23017	23095	23173	23025	23095	23165	23035	23095	23155
	(Low)	(Mid)	(High)	(Low)	(Mid)	(High)	(Low)	(Mid)	(High)
Frequency (MHz)	699.7	707.5	715.3	700.5	707.5	714.5	701.5	707.5	713.5
Conducted Power (dBm)	21.25	21.06	21.31	21.23	21.05	21.24	20.99	21.07	21.37
Conducted Power (Watts)	0.1334	0.1276	0.1352	0.1327	0.1274	0.1330	0.1256	0.1279	0.1371
ERP(dBm)	13.63	13.44	13.69	13.61	13.43	13.62	13.37	13.45	13.75
ERP(Watts)	0.0231	0.0221	0.0234	0.0230	0.0220	0.0230	0.0217	0.0221	0.0237

LTE Band 12 (GT - LC = -5.47 dB) 64QAM			
Bandwidth	10M		
Channel	23060	23095	23130
	(Low)	(Mid)	(High)
Frequency (MHz)	704	707.5	711
Conducted Power (dBm)	21.06	21.32	21.19
Conducted Power (Watts)	0.1276	0.1355	0.1315
ERP(dBm)	13.44	13.70	13.57
ERP(Watts)	0.0221	0.0234	0.0228



LTE Band 12 (GT - LC = -5.47 dB) 256QAM									
Bandwidth	1.4M			3M			5M		
Channel	23017	23095	23173	23025	23095	23165	23035	23095	23155
	(Low)	(Mid)	(High)	(Low)	(Mid)	(High)	(Low)	(Mid)	(High)
Frequency (MHz)	699.7	707.5	715.3	700.5	707.5	714.5	701.5	707.5	713.5
Conducted Power (dBm)	17.92	17.93	18.40	17.94	17.98	18.27	17.97	18.01	18.32
Conducted Power (Watts)	0.0619	0.0621	0.0692	0.0622	0.0628	0.0671	0.0627	0.0632	0.0679
ERP(dBm)	10.30	10.31	10.78	10.32	10.36	10.65	10.35	10.39	10.70
ERP(Watts)	0.0107	0.0107	0.0120	0.0108	0.0109	0.0116	0.0108	0.0109	0.0117

LTE Band 12 (GT - LC = -5.47 dB) 256QAM			
Bandwidth	10M		
Channel	23060	23095	23130
	(Low)	(Mid)	(High)
Frequency (MHz)	704	707.5	711
Conducted Power (dBm)	18.08	18.08	18.43
Conducted Power (Watts)	0.0643	0.0643	0.0697
ERP(dBm)	10.46	10.46	10.81
ERP(Watts)	0.0111	0.0111	0.0121



LTE Band 17 (GT - LC = -5.47 dB) QPSK						
Bandwidth	5M			10M		
Channel	23755	23790	23825	23780	23790	23800
	(Low)	(Mid)	(High)	(Low)	(Mid)	(High)
Frequency	706.5	710	713.5	709	710	711
(MHz)						
Conducted Power (dBm)	22.66	22.86	22.81	22.84	22.87	22.81
Conducted Power (Watts)	0.1845	0.1932	0.1910	0.1923	0.1936	0.1910
ERP(dBm)	15.04	15.24	15.19	15.22	15.25	15.19
ERP(Watts)	0.0319	0.0334	0.0330	0.0333	0.0335	0.0330

LTE Band 17 (GT - LC = -5.47 dB) 16QAM						
Bandwidth	5M			10M		
Channel	23755	23790	23825	23780	23790	23800
	(Low)	(Mid)	(High)	(Low)	(Mid)	(High)
Frequency	706.5	710	713.5	709	710	711
(MHz)						
Conducted Power (dBm)	22.14	21.96	22.36	22.24	22.15	22.26
Conducted Power (Watts)	0.1637	0.1570	0.1722	0.1675	0.1641	0.1683
ERP(dBm)	14.52	14.34	14.74	14.62	14.53	14.64
ERP(Watts)	0.0283	0.0272	0.0298	0.0290	0.0284	0.0291



LTE Band 17 (GT - LC = -5.47 dB) 64QAM						
Bandwidth	5M			10M		
Channel	23755	23790	23825	23780	23790	23800
	(Low)	(Mid)	(High)	(Low)	(Mid)	(High)
Frequency	706.5	710	713.5	709	710	711
(MHz)						
Conducted Power (dBm)	20.96	21.02	21.09	21.01	21.11	21.24
Conducted Power (Watts)	0.1247	0.1265	0.1285	0.1262	0.1291	0.1330
ERP(dBm)	13.34	13.40	13.47	13.39	13.49	13.62
ERP(Watts)	0.0216	0.0219	0.0222	0.0218	0.0223	0.0230

LTE Band 17 (GT - LC = -5.47 dB) 256QAM						
Bandwidth	5M			10M		
Channel	23755	23790	23825	23780	23790	23800
	(Low)	(Mid)	(High)	(Low)	(Mid)	(High)
Frequency	706.5	710	713.5	709	710	711
(MHz)						
Conducted Power (dBm)	18.05	17.83	18.09	18.02	17.88	18.19
Conducted Power (Watts)	0.0638	0.0607	0.0644	0.0634	0.0614	0.0659
ERP(dBm)	10.43	10.21	10.47	10.40	10.26	10.57
ERP(Watts)	0.0110	0.0105	0.0111	0.0110	0.0106	0.0114



LTE Band 25 (GT - LC = -3.26 dB) QPSK									
Bandwidth	1.4M			3M			5M		
Channel	26407	26340	26683	26055	26340	26675	26065	26340	26665
	(Low)	(Mid)	(High)	(Low)	(Mid)	(High)	(Low)	(Mid)	(High)
Frequency (MHz)	1850.7	1880	1914.3	1851.5	1880	1913.5	1852.5	1880	1912.5
Conducted Power (dBm)	22.90	23.14	23.25	22.97	23.08	23.14	22.73	23.20	22.97
Conducted Power (Watts)	0.1950	0.2061	0.2113	0.1982	0.2032	0.2061	0.1875	0.2089	0.1982
EIRP(dBm)	19.64	19.88	19.99	19.71	19.82	19.88	19.47	19.94	19.71
EIRP(Watts)	0.0920	0.0973	0.0998	0.0935	0.0959	0.0973	0.0885	0.0986	0.0935

LTE Band 25 (GT - LC = -3.26 dB) QPSK									
Bandwidth	10M			15M			20M		
Channel	26090	26340	26640	26115	26340	26615	26140	26340	26590
	(Low)	(Mid)	(High)	(Low)	(Mid)	(High)	(Low)	(Mid)	(High)
Frequency (MHz)	1855	1880	1910	1857.5	1880	1907.5	1860	1880	1905
Conducted Power (dBm)	22.97	23.24	23.02	22.91	23.23	23.07	22.94	23.28	23.17
Conducted Power (Watts)	0.1982	0.2109	0.2004	0.1954	0.2104	0.2028	0.1968	0.2128	0.2075
EIRP(dBm)	19.71	19.98	19.76	19.65	19.97	19.81	19.68	20.02	19.91
EIRP(Watts)	0.0935	0.0995	0.0946	0.0923	0.0993	0.0957	0.0929	0.1005	0.0979



LTE Band 25 (GT - LC = -3.26 dB) 16QAM									
Bandwidth	1.4M			3M			5M		
Channel	26407	26340	26683	26055	26340	26675	26065	26340	26665
	(Low)	(Mid)	(High)	(Low)	(Mid)	(High)	(Low)	(Mid)	(High)
Frequency (MHz)	1850.7	1880	1914.3	1851.5	1880	1913.5	1852.5	1880	1912.5
Conducted Power (dBm)	22.57	22.40	22.36	22.41	22.42	22.44	22.50	22.42	22.43
Conducted Power (Watts)	0.1807	0.1738	0.1722	0.1742	0.1746	0.1754	0.1778	0.1746	0.1750
EIRP(dBm)	19.31	19.14	19.10	19.15	19.16	19.18	19.24	19.16	19.17
EIRP(Watts)	0.0853	0.0820	0.0813	0.0822	0.0824	0.0828	0.0839	0.0824	0.0826

LTE Band 25 (GT - LC = -3.26 dB) 16QAM									
Bandwidth	10M			15M			20M		
Channel	26090	26340	26640	26115	26340	26615	26140	26340	26590
	(Low)	(Mid)	(High)	(Low)	(Mid)	(High)	(Low)	(Mid)	(High)
Frequency (MHz)	1855	1880	1910	1857.5	1880	1907.5	1860	1880	1905
Conducted Power (dBm)	22.34	22.54	22.46	22.52	22.44	22.32	22.57	22.62	22.50
Conducted Power (Watts)	0.1714	0.1795	0.1762	0.1786	0.1754	0.1706	0.1807	0.1828	0.1778
EIRP(dBm)	19.08	19.28	19.20	19.26	19.18	19.06	19.31	19.36	19.24
EIRP(Watts)	0.0809	0.0847	0.0832	0.0843	0.0828	0.0805	0.0853	0.0863	0.0839





LTE Band 25 (GT - LC = -3.26 dB) 64QAM									
Bandwidth	1.4M			3M			5M		
Channel	26407	26340	26683	26055	26340	26675	26065	26340	26665
	(Low)	(Mid)	(High)	(Low)	(Mid)	(High)	(Low)	(Mid)	(High)
Frequency (MHz)	1850.7	1880	1914.3	1851.5	1880	1913.5	1852.5	1880	1912.5
Conducted Power (dBm)	21.33	21.46	21.45	20.96	21.21	21.38	21.16	21.31	21.46
Conducted Power (Watts)	0.1358	0.1400	0.1396	0.1247	0.1321	0.1374	0.1306	0.1352	0.1400
EIRP(dBm)	18.07	18.20	18.19	17.70	17.95	18.12	17.90	18.05	18.20
EIRP(Watts)	0.0641	0.0661	0.0659	0.0589	0.0624	0.0649	0.0617	0.0638	0.0661

LTE Band 25 (GT - LC = -3.26 dB) 64QAM									
Bandwidth	10M			15M			20M		
Channel	26090	26340	26640	26115	26340	26615	26140	26340	26590
	(Low)	(Mid)	(High)	(Low)	(Mid)	(High)	(Low)	(Mid)	(High)
Frequency (MHz)	1855	1880	1910	1857.5	1880	1907.5	1860	1880	1905
Conducted Power (dBm)	21.42	21.53	21.39	21.26	21.56	21.31	21.42	21.62	21.41
Conducted Power (Watts)	0.1387	0.1422	0.1377	0.1337	0.1432	0.1352	0.1387	0.1452	0.1384
EIRP(dBm)	18.16	18.27	18.13	18.00	18.30	18.05	18.16	18.36	18.15
EIRP(Watts)	0.0655	0.0671	0.0650	0.0631	0.0676	0.0638	0.0655	0.0685	0.0653



LTE Band 25 (GT - LC = -3.26 dB) 256QAM									
Bandwidth	1.4M			3M			5M		
Channel	26407	26340	26683	26055	26340	26675	26065	26340	26665
	(Low)	(Mid)	(High)	(Low)	(Mid)	(High)	(Low)	(Mid)	(High)
Frequency (MHz)	1850.7	1880	1914.3	1851.5	1880	1913.5	1852.5	1880	1912.5
Conducted Power (dBm)	18.59	18.57	18.41	18.60	18.59	18.54	18.65	18.52	18.49
Conducted Power (Watts)	0.0723	0.0719	0.0693	0.0724	0.0723	0.0714	0.0733	0.0711	0.0706
EIRP(dBm)	15.33	15.31	15.15	15.34	15.33	15.28	15.39	15.26	15.23
EIRP(Watts)	0.0341	0.0340	0.0327	0.0342	0.0341	0.0337	0.0346	0.0336	0.0333

LTE Band 25 (GT - LC = -3.26 dB) 256QAM									
Bandwidth	10M			15M			20M		
Channel	26090	26340	26640	26115	26340	26615	26140	26340	26590
	(Low)	(Mid)	(High)	(Low)	(Mid)	(High)	(Low)	(Mid)	(High)
Frequency (MHz)	1855	1880	1910	1857.5	1880	1907.5	1860	1880	1905
Conducted Power (dBm)	18.48	18.58	18.42	18.52	18.45	18.44	18.67	18.63	18.57
Conducted Power (Watts)	0.0705	0.0721	0.0695	0.0711	0.0700	0.0698	0.0736	0.0729	0.0719
EIRP(dBm)	15.22	15.32	15.16	15.26	15.19	15.18	15.41	15.37	15.31
EIRP(Watts)	0.0333	0.0340	0.0328	0.0336	0.0330	0.0330	0.0348	0.0344	0.0340



LTE Band 26 (GT - LC = -4.31 dB) QPSK									
Bandwidth	1.4M			3M			5M		
Channel	26797	26915	27033	26805	26915	27025	26815	26915	27015
	(Low)	(Mid)	(High)	(Low)	(Mid)	(High)	(Low)	(Mid)	(High)
Frequency	824.7	836.5	848.3	825.5	836.5	847.5	826.5	836.5	846.5
(MHz)									
Conducted Power (dBm)	22.33	22.55	22.36	22.41	22.59	22.48	22.57	22.54	22.50
Conducted Power (Watts)	0.1710	0.1799	0.1722	0.1742	0.1816	0.1770	0.1807	0.1795	0.1778
ERP(dBm)	15.87	16.09	15.90	15.95	16.13	16.02	16.11	16.08	16.04
ERP(Watts)	0.0386	0.0406	0.0389	0.0394	0.0410	0.0400	0.0408	0.0406	0.0402

LTE Band 26 (GT - LC = -4.31 dB) QPSK							
Bandwidth	10M			15M			15M
Channel	26840	26915	26990	26865	26915	26965	26765
	(Low)	(Mid)	(High)	(Low)	(Mid)	(High)	(Low)
Frequency	829	836.5	844	831.5	836.5	841.5	821.5
(MHz)							
Conducted Power (dBm)	22.59	22.59	22.55	22.55	22.60	22.58	22.55
Conducted Power (Watts)	0.1816	0.1816	0.1799	0.1799	0.1820	0.1811	0.1799
ERP(dBm)	16.13	16.13	16.09	16.09	16.14	16.12	16.09
ERP(Watts)	0.0410	0.0410	0.0406	0.0406	0.0411	0.0409	0.0406



LTE Band 26 (GT - LC = -4.31 dB) 16QAM									
Bandwidth	1.4M			3M			5M		
Channel	26797	26915	27033	26805	26915	27025	26815	26915	27015
	(Low)	(Mid)	(High)	(Low)	(Mid)	(High)	(Low)	(Mid)	(High)
Frequency	824.7	836.5	848.3	825.5	836.5	847.5	826.5	836.5	846.5
(MHz)									
Conducted Power (dBm)	22.13	22.09	21.91	22.03	22.22	21.86	22.05	22.20	21.86
Conducted Power (Watts)	0.1633	0.1618	0.1552	0.1596	0.1667	0.1535	0.1603	0.1660	0.1535
ERP(dBm)	15.67	15.63	15.45	15.57	15.76	15.40	15.59	15.74	15.40
ERP(Watts)	0.0369	0.0366	0.0351	0.0361	0.0377	0.0347	0.0362	0.0375	0.0347

LTE Band 26 (GT - LC = -4.31 dB) 16QAM							
Bandwidth	10M			15M			15M
Channel	26840	26915	26990	26865	26915	26965	26765
	(Low)	(Mid)	(High)	(Low)	(Mid)	(High)	(Low)
Frequency	829	836.5	844	831.5	836.5	841.5	821.5
(MHz)							
Conducted Power (dBm)	22.10	21.90	21.67	22.14	22.25	21.96	22.14
Conducted Power (Watts)	0.1622	0.1549	0.1469	0.1637	0.1679	0.1570	0.1637
ERP(dBm)	15.64	15.44	15.21	15.68	15.79	15.50	15.68
ERP(Watts)	0.0366	0.0350	0.0332	0.0370	0.0379	0.0355	0.0370



LTE Band 26 (GT - LC = -4.31 dB) 64QAM									
Bandwidth	1.4M			3M			5M		
Channel	26797	26915	27033	26805	26915	27025	26815	26915	27015
	(Low)	(Mid)	(High)	(Low)	(Mid)	(High)	(Low)	(Mid)	(High)
Frequency	824.7	836.5	848.3	825.5	836.5	847.5	826.5	836.5	846.5
(MHz)									
Conducted Power (dBm)	20.52	21.16	20.86	20.56	21.10	20.77	20.51	21.23	20.79
Conducted Power (Watts)	0.1127	0.1306	0.1219	0.1138	0.1288	0.1194	0.1125	0.1327	0.1199
ERP(dBm)	14.06	14.70	14.40	14.10	14.64	14.31	14.05	14.77	14.33
ERP(Watts)	0.0255	0.0295	0.0275	0.0257	0.0291	0.0270	0.0254	0.0300	0.0271

LTE Band 26 (GT - LC = -4.31 dB) 64QAM							
Bandwidth	10M			15M			15M
Channel	26840	26915	26990	26865	26915	26965	26765
	(Low)	(Mid)	(High)	(Low)	(Mid)	(High)	(Low)
Frequency	829	836.5	844	831.5	836.5	841.5	821.5
(MHz)							
Conducted Power (dBm)	21.05	21.14	20.58	20.67	21.25	20.89	20.67
Conducted Power (Watts)	0.1274	0.1300	0.1143	0.1167	0.1334	0.1227	0.1167
ERP(dBm)	14.59	14.68	14.12	14.21	14.79	14.43	14.21
ERP(Watts)	0.0288	0.0294	0.0258	0.0264	0.0301	0.0277	0.0264



LTE Band 26 (GT - LC = -4.31 dB) 256QAM									
Bandwidth	1.4M			3M			5M		
Channel	26797	26915	27033	26805	26915	27025	26815	26915	27015
	(Low)	(Mid)	(High)	(Low)	(Mid)	(High)	(Low)	(Mid)	(High)
Frequency	824.7	836.5	848.3	825.5	836.5	847.5	826.5	836.5	846.5
(MHz)									
Conducted Power (dBm)	17.79	18.09	17.87	18.05	18.08	17.88	18.08	17.89	17.87
Conducted Power (Watts)	0.0601	0.0644	0.0612	0.0638	0.0643	0.0614	0.0643	0.0615	0.0612
ERP(dBm)	11.33	11.63	11.41	11.59	11.62	11.42	11.62	11.43	11.41
ERP(Watts)	0.0136	0.0146	0.0138	0.0144	0.0145	0.0139	0.0145	0.0139	0.0138

LTE Band 26 (GT - LC = -4.31 dB) 256QAM							
Bandwidth	10M			15M			15M
Channel	26840	26915	26990	26865	26915	26965	26765
	(Low)	(Mid)	(High)	(Low)	(Mid)	(High)	(Low)
Frequency	829	836.5	844	831.5	836.5	841.5	821.5
(MHz)							
Conducted Power (dBm)	17.65	18.04	17.85	17.84	18.13	18.03	17.84
Conducted Power (Watts)	0.0582	0.0637	0.0610	0.0608	0.0650	0.0635	0.0608
ERP(dBm)	11.19	11.58	11.39	11.38	11.67	11.57	11.38
ERP(Watts)	0.0132	0.0144	0.0138	0.0137	0.0147	0.0144	0.0137



LTE Band 66 (GT - LC = -4.71 dB) QPSK									
Bandwidth	1.4M			3M			5M		
Channel	131979	132322	132665	131987	132322	132657	131997	132322	132647
	(Low)	(Mid)	(High)	(Low)	(Mid)	(High)	(Low)	(Mid)	(High)
Frequency (MHz)	1710.7	1745	1779.3	1711.5	1745	1778.5	1712.5	1745	1777.5
Conducted Power (dBm)	22.56	22.68	22.58	22.66	22.66	22.61	22.66	22.67	22.59
Conducted Power (Watts)	0.1803	0.1854	0.1811	0.1845	0.1845	0.1824	0.1845	0.1849	0.1816
EIRP(dBm)	17.85	17.97	17.87	17.95	17.95	17.90	17.95	17.96	17.88
EIRP(Watts)	0.0610	0.0627	0.0612	0.0624	0.0624	0.0617	0.0624	0.0625	0.0614

LTE Band 66 (GT - LC = -4.71 dB) QPSK									
Bandwidth	10M			15M			20M		
Channel	132022	132322	132622	132047	132322	132597	132072	132322	132572
	(Low)	(Mid)	(High)	(Low)	(Mid)	(High)	(Low)	(Mid)	(Mid)
Frequency (MHz)	1715	1745	1775	1717.5	1745	1772.5	1720	1745	1770
Conducted Power (dBm)	22.58	22.75	22.63	22.69	22.64	22.67	22.51	22.83	22.69
Conducted Power (Watts)	0.1811	0.1884	0.1832	0.1858	0.1837	0.1849	0.1782	0.1919	0.1858
EIRP(dBm)	17.87	18.04	17.92	17.98	17.93	17.96	17.80	18.12	17.98
EIRP(Watts)	0.0612	0.0637	0.0619	0.0628	0.0621	0.0625	0.0603	0.0649	0.0628



LTE Band 66 (GT - LC = -4.71 dB) 16QAM									
Bandwidth	1.4M			3M			5M		
Channel	131979	132322	132665	131987	132322	132657	131997	132322	132647
	(Low)	(Mid)	(High)	(Low)	(Mid)	(High)	(Low)	(Mid)	(High)
Frequency (MHz)	1710.7	1745	1779.3	1711.5	1745	1778.5	1712.5	1745	1777.5
Conducted Power (dBm)	21.97	22.17	21.94	21.80	22.02	21.79	21.93	22.18	21.94
Conducted Power (Watts)	0.1574	0.1648	0.1563	0.1514	0.1592	0.1510	0.1560	0.1652	0.1563
EIRP(dBm)	17.26	17.46	17.23	17.09	17.31	17.08	17.22	17.47	17.23
EIRP(Watts)	0.0532	0.0557	0.0528	0.0512	0.0538	0.0511	0.0527	0.0558	0.0528

LTE Band 66 (GT - LC = -4.71 dB) 16QAM									
Bandwidth	10M			15M			20M		
Channel	132022	132322	132622	132047	132322	132597	132072	132322	132572
	(Low)	(Mid)	(High)	(Low)	(Mid)	(High)	(Low)	(Mid)	(Mid)
Frequency (MHz)	1715	1745	1775	1717.5	1745	1772.5	1720	1745	1770
Conducted Power (dBm)	21.92	22.19	21.91	21.92	22.13	21.94	21.99	22.27	21.99
Conducted Power (Watts)	0.1556	0.1656	0.1552	0.1556	0.1633	0.1563	0.1581	0.1687	0.1581
EIRP(dBm)	17.21	17.48	17.20	17.21	17.42	17.23	17.28	17.56	17.28
EIRP(Watts)	0.0526	0.0560	0.0525	0.0526	0.0552	0.0528	0.0535	0.0570	0.0535





LTE Band 66 (GT - LC = -4.71 dB) 64QAM									
Bandwidth	1.4M			3M			5M		
Channel	131979	132322	132665	131987	132322	132657	131997	132322	132647
	(Low)	(Mid)	(High)	(Low)	(Mid)	(High)	(Low)	(Mid)	(High)
Frequency (MHz)	1710.7	1745	1779.3	1711.5	1745	1778.5	1712.5	1745	1777.5
Conducted Power (dBm)	20.59	21.04	20.97	20.63	20.62	21.03	20.63	21.02	20.88
Conducted Power (Watts)	0.1146	0.1271	0.1250	0.1156	0.1153	0.1268	0.1156	0.1265	0.1225
EIRP(dBm)	15.88	16.33	16.26	15.92	15.91	16.32	15.92	16.31	16.17
EIRP(Watts)	0.0387	0.0430	0.0423	0.0391	0.0390	0.0429	0.0391	0.0428	0.0414

LTE Band 66 (GT - LC = -4.71 dB) 64QAM									
Bandwidth	10M			15M			20M		
Channel	132022	132322	132622	132047	132322	132597	132072	132322	132572
	(Low)	(Mid)	(High)	(Low)	(Mid)	(High)	(Low)	(Mid)	(Mid)
Frequency (MHz)	1715	1745	1775	1717.5	1745	1772.5	1720	1745	1770
Conducted Power (dBm)	20.62	20.96	20.91	20.70	20.95	21.00	20.73	21.11	21.04
Conducted Power (Watts)	0.1153	0.1247	0.1233	0.1175	0.1245	0.1259	0.1183	0.1291	0.1271
EIRP(dBm)	15.91	16.25	16.20	15.99	16.24	16.29	16.02	16.40	16.33
EIRP(Watts)	0.0390	0.0422	0.0417	0.0397	0.0421	0.0426	0.0400	0.0437	0.0430



LTE Band 66 (GT - LC = -4.71 dB) 256QAM									
Bandwidth	1.4M			3M			5M		
Channel	131979	132322	132665	131987	132322	132657	131997	132322	132647
	(Low)	(Mid)	(High)	(Low)	(Mid)	(High)	(Low)	(Mid)	(High)
Frequency (MHz)	1710.7	1745	1779.3	1711.5	1745	1778.5	1712.5	1745	1777.5
Conducted Power (dBm)	17.76	17.66	17.98	17.62	17.69	17.99	17.64	17.60	17.91
Conducted Power (Watts)	0.0597	0.0583	0.0628	0.0578	0.0587	0.0630	0.0581	0.0575	0.0618
EIRP(dBm)	13.05	12.95	13.27	12.91	12.98	13.28	12.93	12.89	13.20
EIRP(Watts)	0.0202	0.0197	0.0212	0.0195	0.0199	0.0213	0.0196	0.0195	0.0209

LTE Band 66 (GT - LC = -4.71 dB) 256QAM									
Bandwidth	10M			15M			20M		
Channel	132022	132322	132622	132047	132322	132597	132072	132322	132572
	(Low)	(Mid)	(High)	(Low)	(Mid)	(High)	(Low)	(Mid)	(Mid)
Frequency (MHz)	1715	1745	1775	1717.5	1745	1772.5	1720	1745	1770
Conducted Power (dBm)	17.68	17.76	18.02	17.77	17.59	17.97	17.75	17.67	18.01
Conducted Power (Watts)	0.0586	0.0597	0.0634	0.0598	0.0574	0.0627	0.0596	0.0585	0.0632
EIRP(dBm)	12.97	13.05	13.31	13.06	12.88	13.26	13.04	12.96	13.30
EIRP(Watts)	0.0198	0.0202	0.0214	0.0202	0.0194	0.0212	0.0201	0.0198	0.0214



LTE Band 71 (GT - LC = -6.02 dB) QPSK									
Bandwidth	5M			10M			15M		
Channel	133147	133297	133447	133172	133297	133422	133197	133297	133397
	(Low)	(Mid)	(High)	(Low)	(Mid)	(High)	(Low)	(Mid)	(High)
Frequency (MHz)	665.5	680.5	695.5	668	680.5	693	670.5	680.5	690.5
Conducted Power (dBm)	22.99	22.94	22.78	23.00	22.99	22.89	22.94	22.95	22.81
Conducted Power (Watts)	0.1991	0.1968	0.1897	0.1995	0.1991	0.1945	0.1968	0.1972	0.1910
ERP(dBm)	14.82	14.77	14.61	14.83	14.82	14.72	14.77	14.78	14.64
ERP(Watts)	0.0303	0.0300	0.0289	0.0304	0.0303	0.0296	0.0300	0.0301	0.0291

LTE Band 71 (GT - LC = -6.02 dB) QPSK			
Bandwidth	20M		
Channel	133222	133297	133372
	(Low)	(Mid)	(High)
Frequency (MHz)	673	680.5	688
Conducted Power (dBm)	22.95	23.05	22.87
Conducted Power (Watts)	0.1972	0.2018	0.1936
ERP(dBm)	14.78	14.88	14.70
ERP(Watts)	0.0301	0.0308	0.0295



LTE Band 71 (GT - LC = -6.02 dB) 16QAM									
Bandwidth	5M			10M			15M		
Channel	133147	133297	133447	133172	133297	133422	133197	133297	133397
	(Low)	(Mid)	(High)	(Low)	(Mid)	(High)	(Low)	(Mid)	(High)
Frequency	665.5	680.5	695.5	668	680.5	693	670.5	680.5	690.5
(MHz)									
Conducted Power (dBm)	22.32	22.22	22.01	21.97	22.16	21.96	22.22	22.22	22.05
Conducted Power (Watts)	0.1706	0.1667	0.1589	0.1574	0.1644	0.1570	0.1667	0.1667	0.1603
ERP(dBm)	14.15	14.05	13.84	13.80	13.99	13.79	14.05	14.05	13.88
ERP(Watts)	0.0260	0.0254	0.0242	0.0240	0.0251	0.0239	0.0254	0.0254	0.0244

LTE Band 71 (GT - LC = -6.02 dB) 16QAM			
Bandwidth	20M		
Channel	133222	133297	133372
	(Low)	(Mid)	(High)
Frequency	673	680.5	688
(MHz)			
Conducted Power (dBm)	22.26	22.22	21.97
Conducted Power (Watts)	0.1683	0.1667	0.1574
ERP(dBm)	14.09	14.05	13.80
ERP(Watts)	0.0256	0.0254	0.0240



LTE Band 71 (GT - LC = -6.02 dB) 64QAM									
Bandwidth	5M			10M			15M		
Channel	133147	133297	133447	133172	133297	133422	133197	133297	133397
	(Low)	(Mid)	(High)	(Low)	(Mid)	(High)	(Low)	(Mid)	(High)
Frequency	665.5	680.5	695.5	668	680.5	693	670.5	680.5	690.5
(MHz)									
Conducted Power (dBm)	21.32	21.00	21.12	21.37	20.93	21.05	21.27	21.02	20.83
Conducted Power (Watts)	0.1355	0.1259	0.1294	0.1371	0.1239	0.1274	0.1340	0.1265	0.1211
ERP(dBm)	13.15	12.83	12.95	13.20	12.76	12.88	13.10	12.85	12.66
ERP(Watts)	0.0207	0.0192	0.0197	0.0209	0.0189	0.0194	0.0204	0.0193	0.0185

LTE Band 71 (GT - LC = -6.02 dB) 64QAM			
Bandwidth	20M		
Channel	133222	133297	133372
	(Low)	(Mid)	(High)
Frequency	673	680.5	688
(MHz)			
Conducted Power (dBm)	21.29	20.99	21.08
Conducted Power (Watts)	0.1346	0.1256	0.1282
ERP(dBm)	13.12	12.82	12.91
ERP(Watts)	0.0205	0.0191	0.0195



LTE Band 71 (GT - LC = -6.02 dB) 256QAM									
Bandwidth	5M			10M			15M		
Channel	133147	133297	133447	133172	133297	133422	133197	133297	133397
	(Low)	(Mid)	(High)	(Low)	(Mid)	(High)	(Low)	(Mid)	(High)
Frequency	665.5	680.5	695.5	668	680.5	693	670.5	680.5	690.5
(MHz)									
Conducted Power (dBm)	18.29	18.18	17.69	18.32	18.07	17.73	18.26	18.05	17.80
Conducted Power (Watts)	0.0675	0.0658	0.0587	0.0679	0.0641	0.0593	0.0670	0.0638	0.0603
ERP(dBm)	10.12	10.01	9.52	10.15	9.90	9.56	10.09	9.88	9.63
ERP(Watts)	0.0103	0.0100	0.0090	0.0104	0.0098	0.0090	0.0102	0.0097	0.0092

LTE Band 71 (GT - LC = -6.02 dB) 256QAM			
Bandwidth	20M		
Channel	133222	133297	133372
	(Low)	(Mid)	(High)
Frequency	673	680.5	688
(MHz)			
Conducted Power (dBm)	18.32	18.10	17.84
Conducted Power (Watts)	0.0679	0.0646	0.0608
ERP(dBm)	10.15	9.93	9.67
ERP(Watts)	0.0104	0.0098	0.0093



# LTE Band 12

## Peak-to-Average Ratio

Mode	LTE Band 12 / 10MHz				
Mod.	QPSK		16QAM		Limit: 13dB
RB Size	1RB	Full RB	1RB	Full RB	Result
Lowest CH	3.68	4.52	4.46	5.48	PASS
Middle CH	3.45	4.55	4.17	5.57	
Highest CH	3.51	4.46	4.38	5.39	
Mode	LTE Band 12 / 10MHz				
Mod.	64QAM				Limit: 13dB
RB Size	1RB	Full RB			Result
Lowest CH	5.25	6.14	-	-	PASS
Middle CH	5.19	6.20	-	-	
Highest CH	5.33	5.97	-	-	



LTE Band 12 / 10MHz / QPSK

Lowest Channel / 1RB

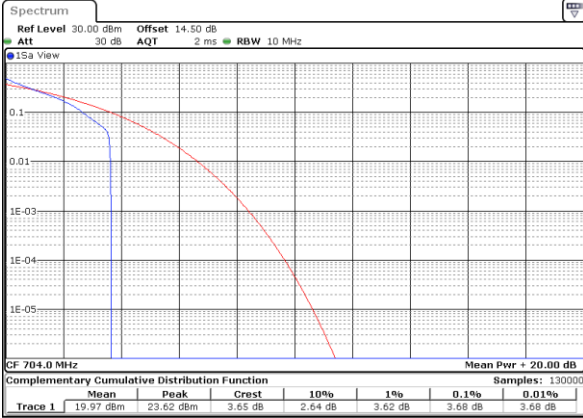

Date: 28.APR.2022 19:37:43

Lowest Channel / Full RB

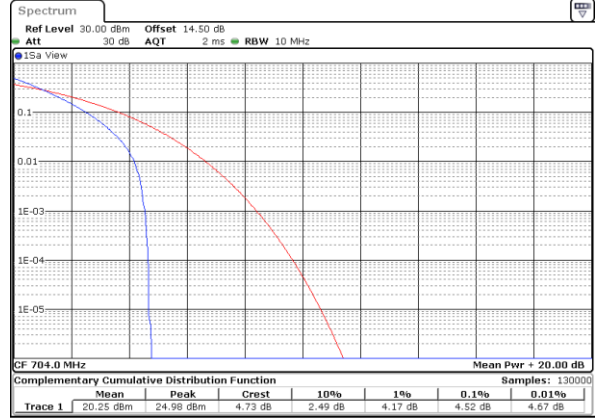

Date: 28.APR.2022 19:37:18

Middle Channel / 1RB

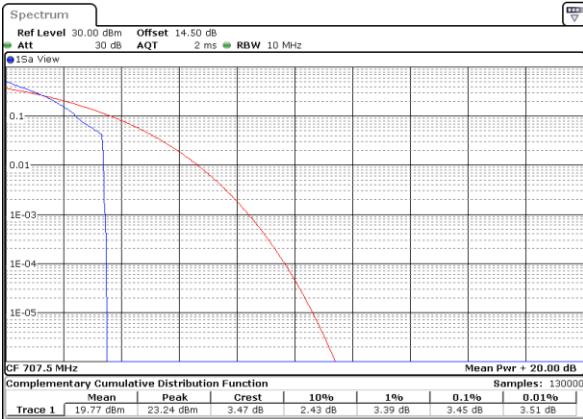

Date: 28.APR.2022 19:38:07

Middle Channel / Full RB

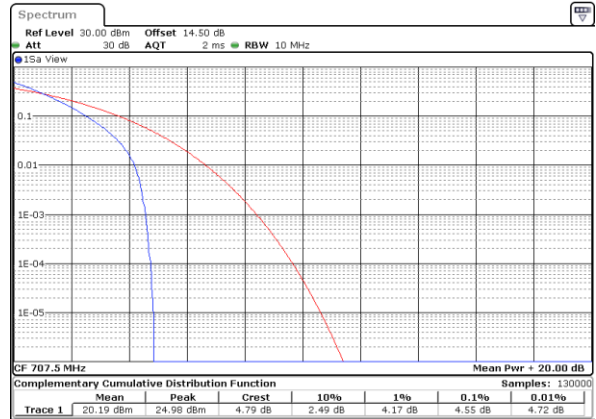

Date: 28.APR.2022 19:38:32

Highest Channel / 1RB

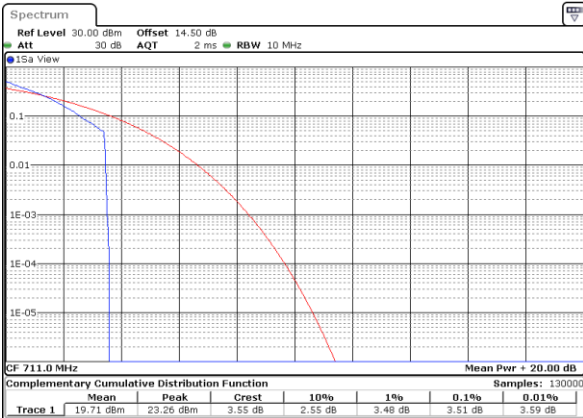

Date: 28.APR.2022 19:39:22

Highest Channel / Full RB

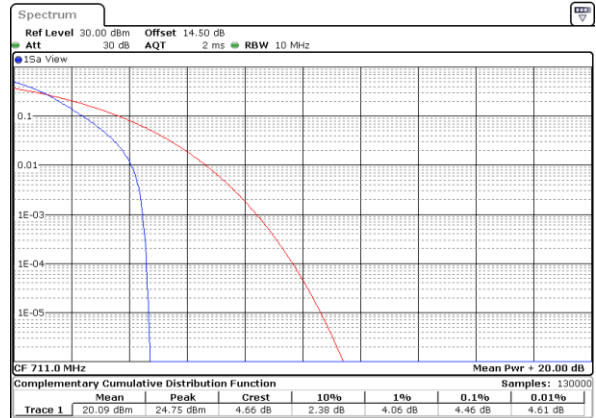

Date: 28.APR.2022 19:38:57





LTE Band 12 / 10MHz / 16QAM

Lowest Channel / 1RB

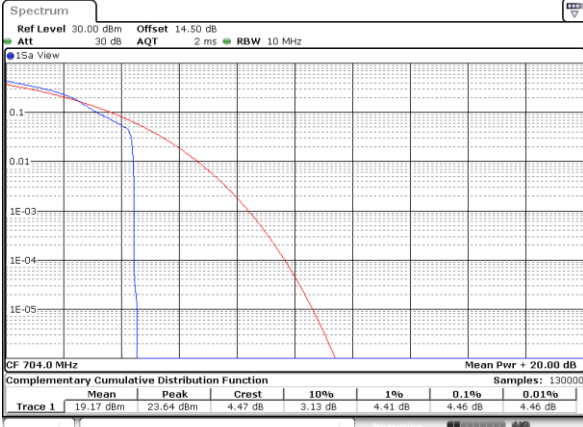

Date: 28.APR.2022 19:35:14

Lowest Channel / Full RB

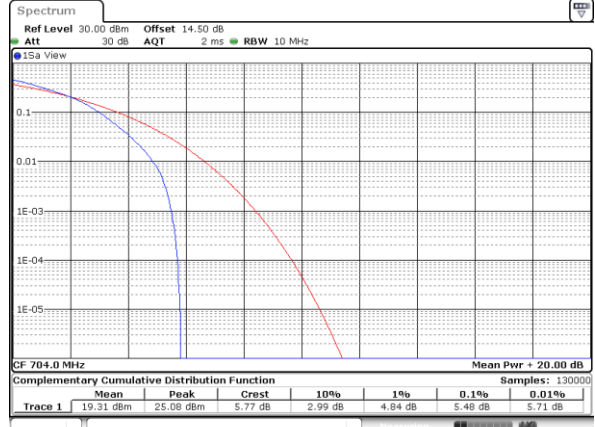

Date: 28.APR.2022 19:34:49

Middle Channel / 1RB

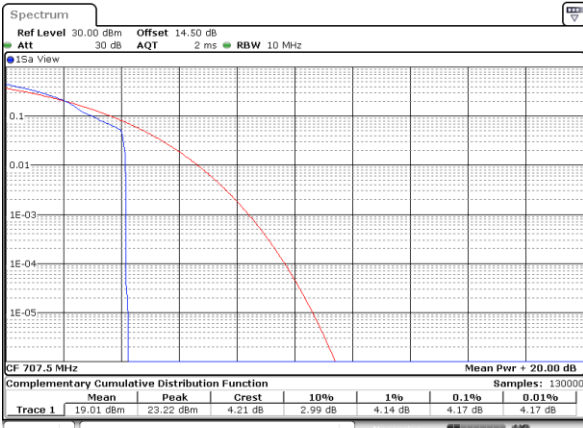

Date: 28.APR.2022 19:35:08

Middle Channel / Full RB

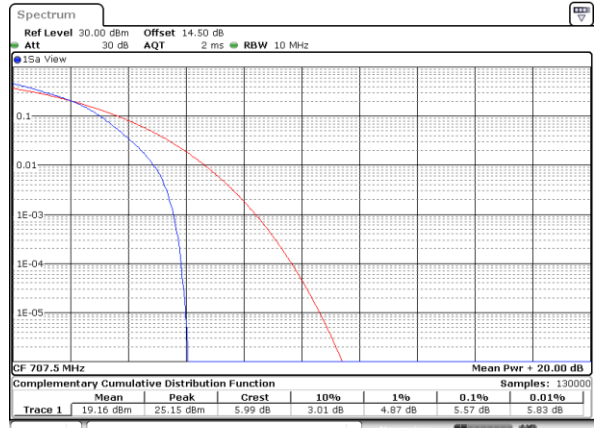

Date: 28.APR.2022 19:36:03

Highest Channel / 1RB

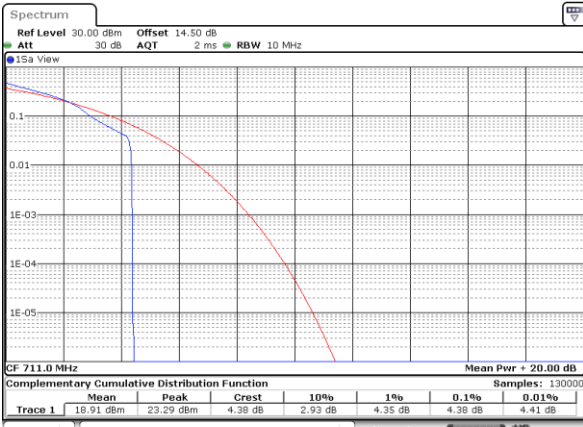

Date: 28.APR.2022 19:36:53

Highest Channel / Full RB

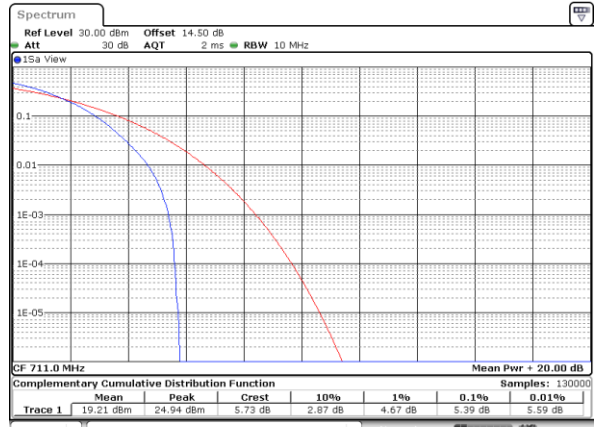

Date: 28.APR.2022 19:36:28



LTE Band 12 / 10MHz / 64QAM

Lowest Channel / 1RB

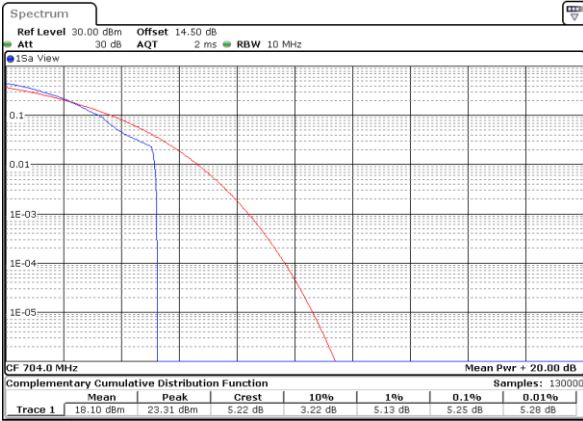

Date: 28.APR.2022 19:32:45

Lowest Channel / Full RB

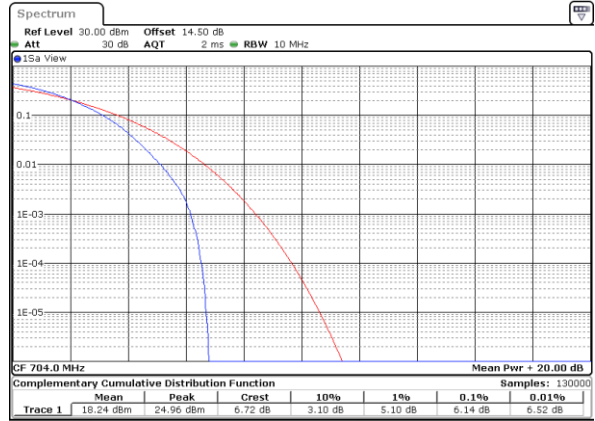

Date: 28.APR.2022 19:32:120

Middle Channel / 1RB



Date: 28.APR.2022 19:33:09

Middle Channel / Full RB

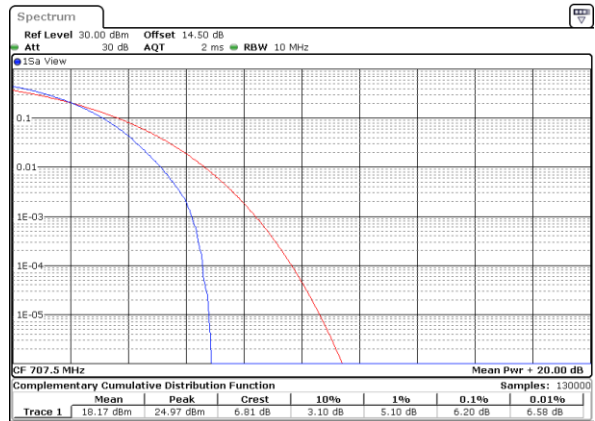

Date: 28.APR.2022 19:33:134

Highest Channel / 1RB



Date: 28.APR.2022 19:34:24

Highest Channel / Full RB



Date: 28.APR.2022 19:33:159



26dB Bandwidth

Mode	LTE Band 12 : 26dB BW(MHz)											
BW	1.4MHz		3MHz		5MHz		10MHz		15MHz		20MHz	
Mod.	QPSK	16QAM	QPSK	16QAM	QPSK	16QAM	QPSK	16QAM	QPSK	16QAM	QPSK	16QAM
Lowest CH	1.36	1.33	3.07	3.16	4.88	4.96	9.95	9.81	-	-	-	-
Middle CH	1.31	1.40	3.09	3.15	5.04	5.05	9.85	9.87	-	-	-	-
Highest CH	1.32	1.37	3.09	3.04	5.02	4.91	10.03	9.95	-	-	-	-
Mode	LTE Band 12 : 26dB BW(MHz)											
BW	1.4MHz		3MHz		5MHz		10MHz		15MHz		20MHz	
Mod.	64QAM		64QAM		64QAM		64QAM		64QAM		64QAM	
Lowest CH	1.23	-	3.08	-	5.01	-	9.89	-	-	-	-	-
Middle CH	1.36	-	3.08	-	5.09	-	9.73	-	-	-	-	-
Highest CH	1.30	-	3.06	-	5.11	-	9.99	-	-	-	-	-



LTE Band 12

Lowest Channel / 1.4MHz / QPSK

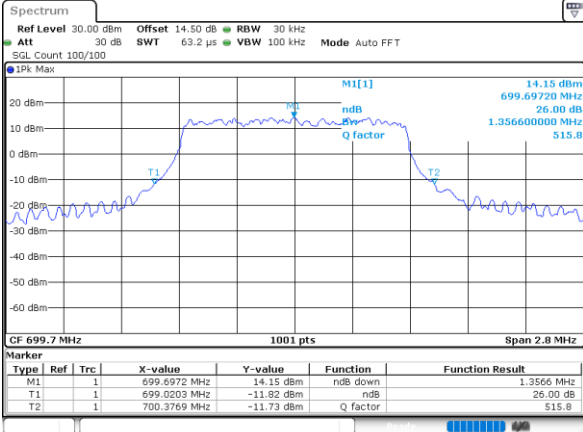

Date: 28\_APR.2022 19:00:55

Lowest Channel / 1.4MHz / 16QAM

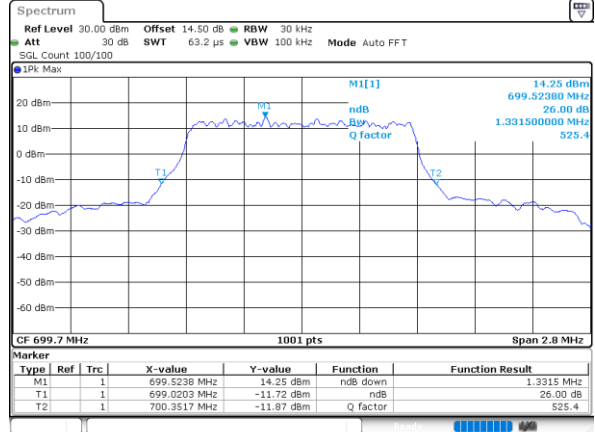

Date: 28\_APR.2022 19:00:32

Middle Channel / 1.4MHz / QPSK

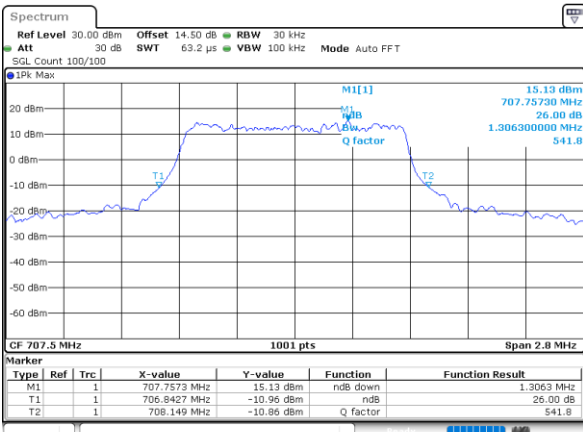

Date: 28\_APR.2022 19:09:30

Middle Channel / 1.4MHz / 16QAM

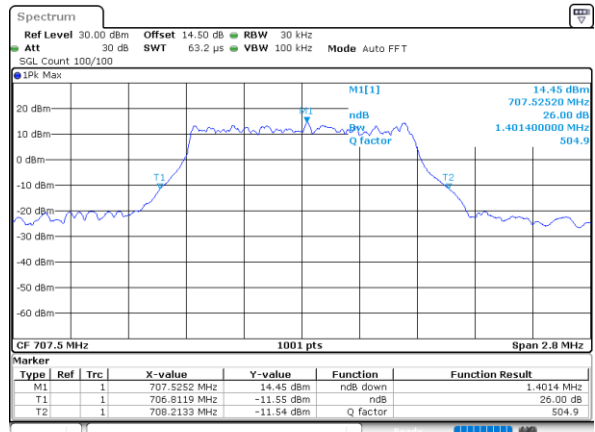

Date: 28\_APR.2022 19:09:53

Highest Channel / 1.4MHz / QPSK

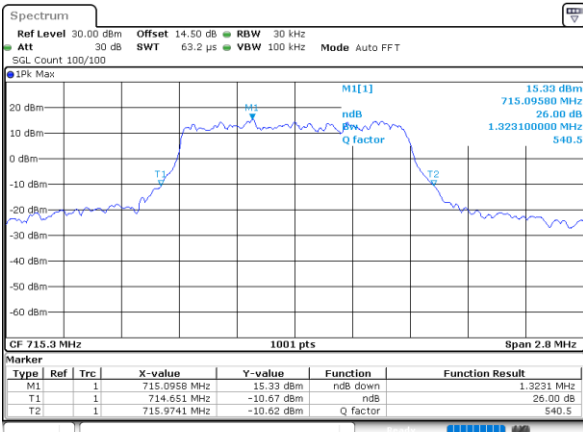

Date: 28\_APR.2022 19:13:41

Highest Channel / 1.4MHz / 16QAM

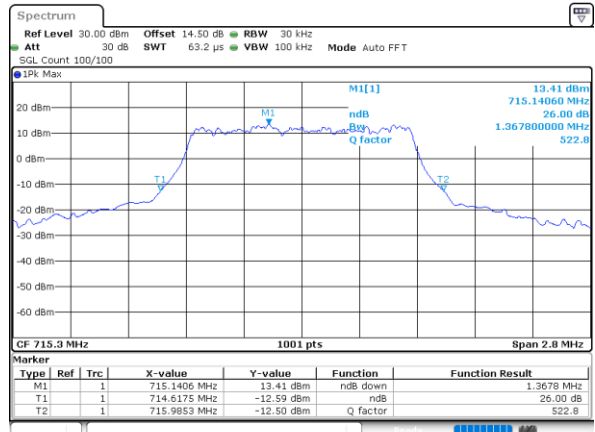

Date: 28\_APR.2022 19:13:17



LTE Band 12

Lowest Channel / 3MHz / QPSK

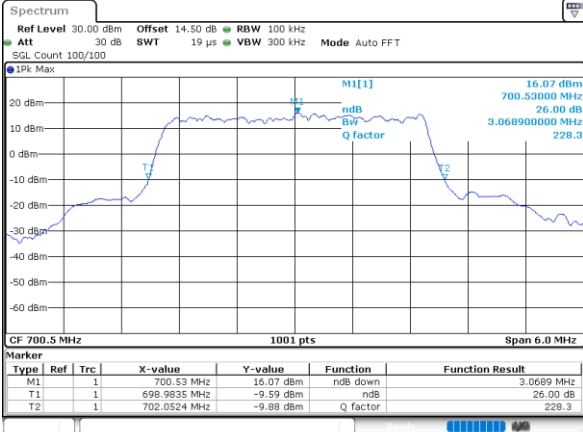

Date: 28.APR.2022 17:22:13

Lowest Channel / 3MHz / 16QAM

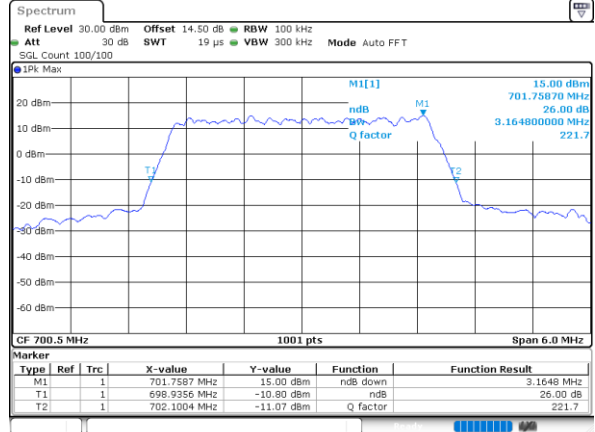

Date: 28.APR.2022 17:22:08

Middle Channel / 3MHz / QPSK

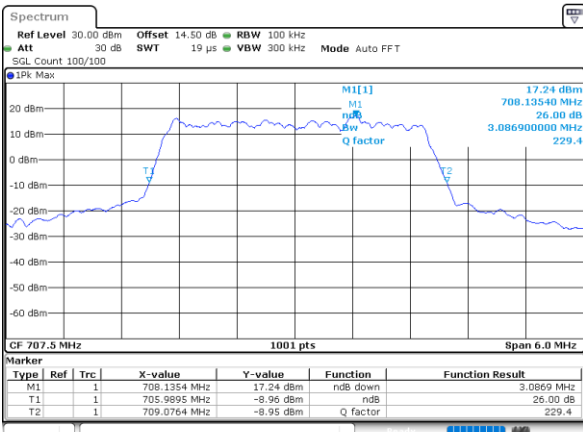

Date: 28.APR.2022 17:31:06

Middle Channel / 3MHz / 16QAM

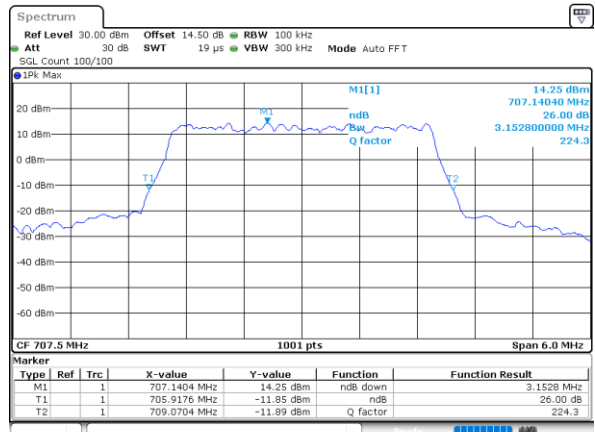

Date: 28.APR.2022 17:31:29

Highest Channel / 3MHz / QPSK

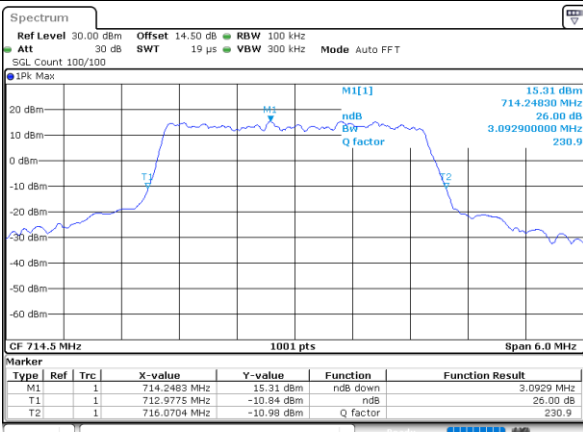

Date: 28.APR.2022 17:35:18

Highest Channel / 3MHz / 16QAM

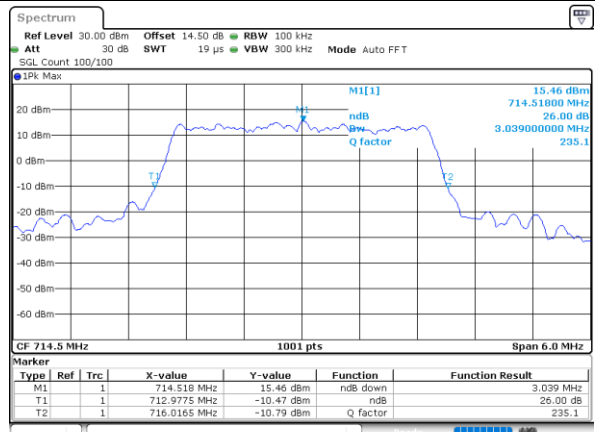

Date: 28.APR.2022 17:34:54



LTE Band 12

Lowest Channel / 5MHz / QPSK

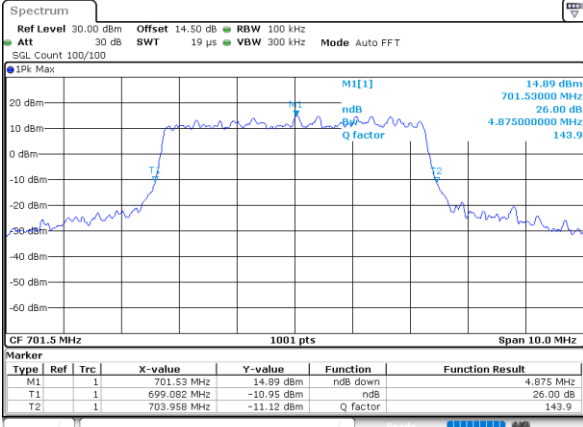

Date: 28.APR.2022 18:05:28

Lowest Channel / 5MHz / 16QAM

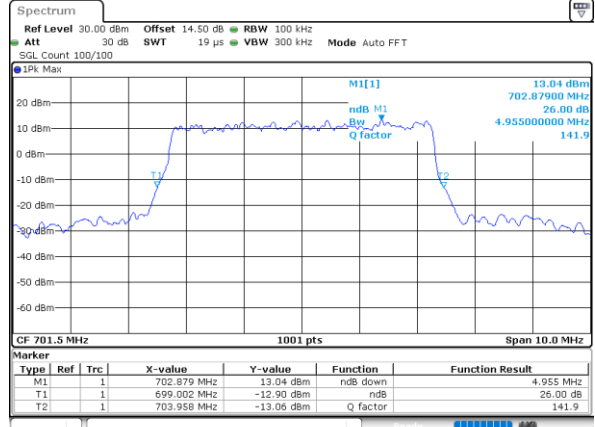

Date: 28.APR.2022 18:05:04

Middle Channel / 5MHz / QPSK

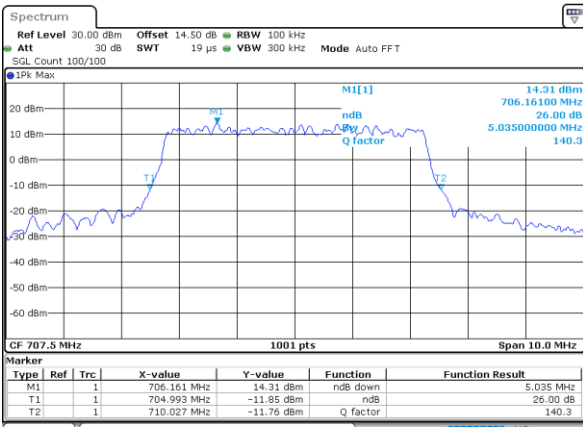

Date: 28.APR.2022 18:14:02

Middle Channel / 5MHz / 16QAM

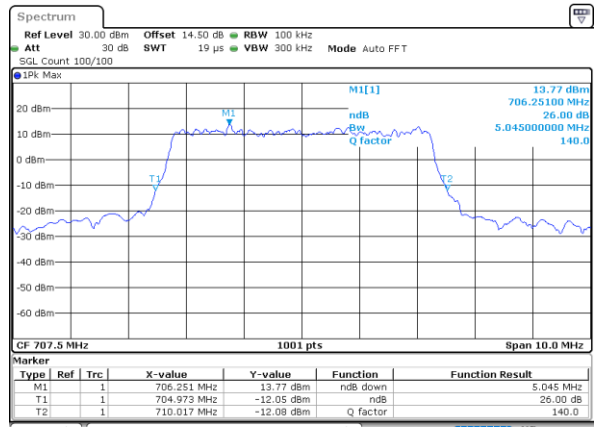

Date: 28.APR.2022 18:14:25

Highest Channel / 5MHz / QPSK

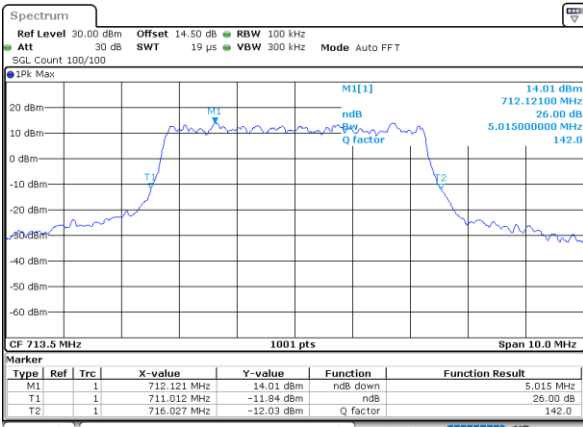

Date: 28.APR.2022 18:18:14

Highest Channel / 5MHz / 16QAM

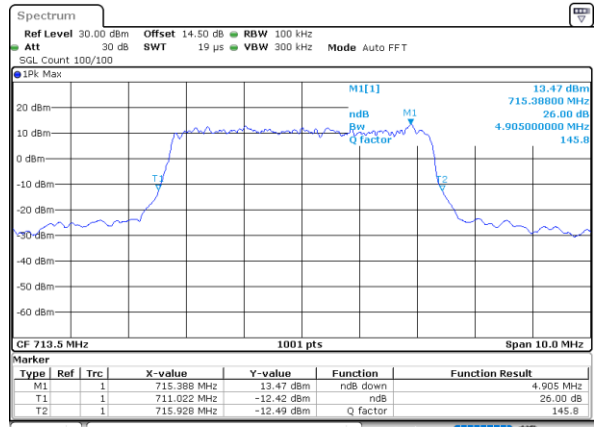

Date: 28.APR.2022 18:17:50



LTE Band 12

Lowest Channel / 10MHz / QPSK

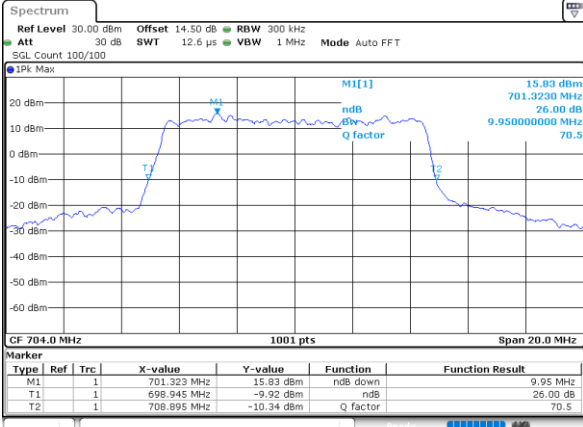

Date: 28\_APR\_2022 18:27:23

Lowest Channel / 10MHz / 16QAM

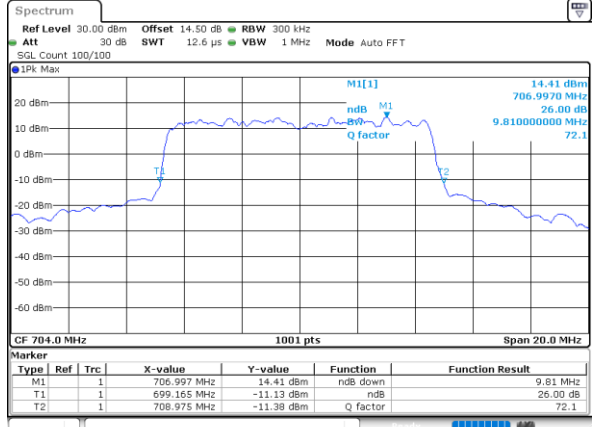

Date: 28\_APR\_2022 18:26:59

Middle Channel / 10MHz / QPSK

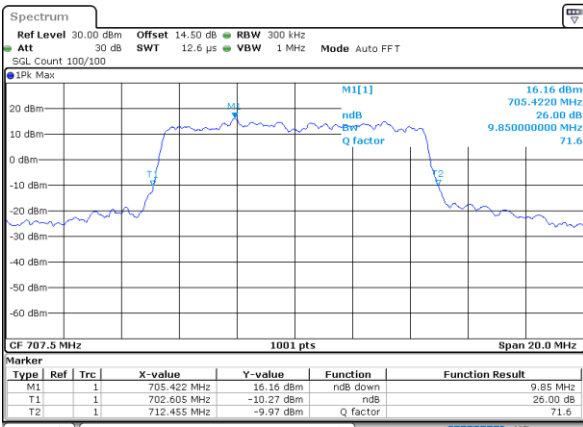

Date: 28\_APR\_2022 18:35:58

Middle Channel / 10MHz / 16QAM

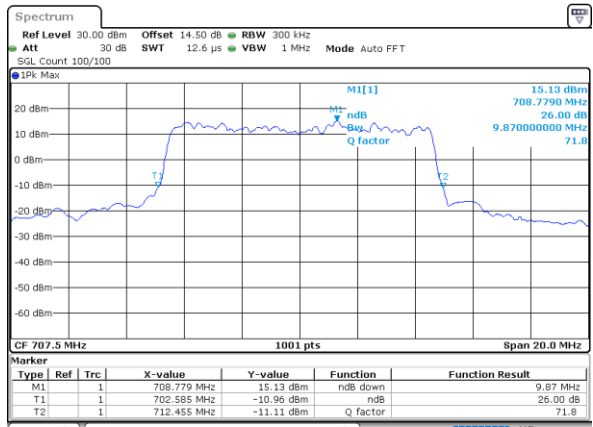

Date: 28\_APR\_2022 18:36:21

Highest Channel / 10MHz / QPSK

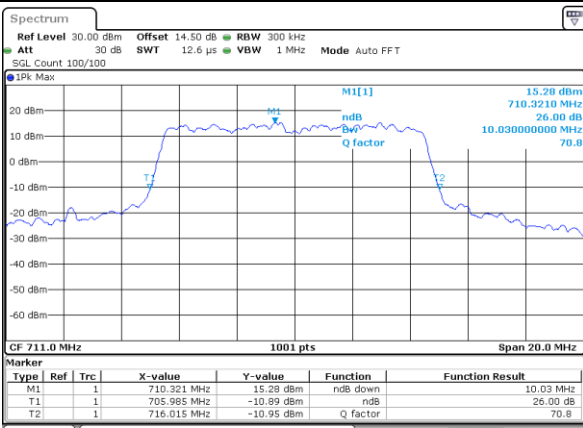

Date: 28\_APR\_2022 18:40:09

Highest Channel / 10MHz / 16QAM

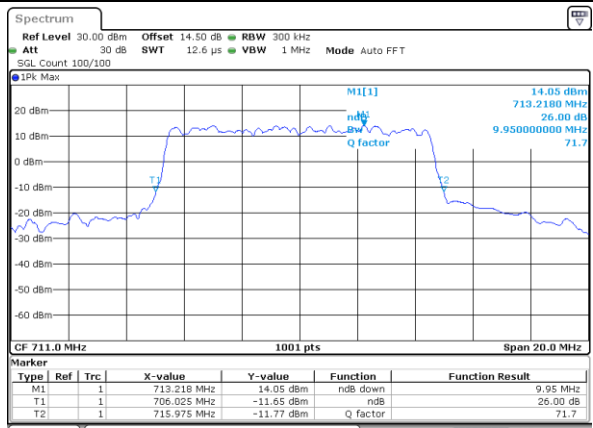

Date: 28\_APR\_2022 18:39:46



LTE Band 12

Lowest Channel / 1.4MHz / 64QAM

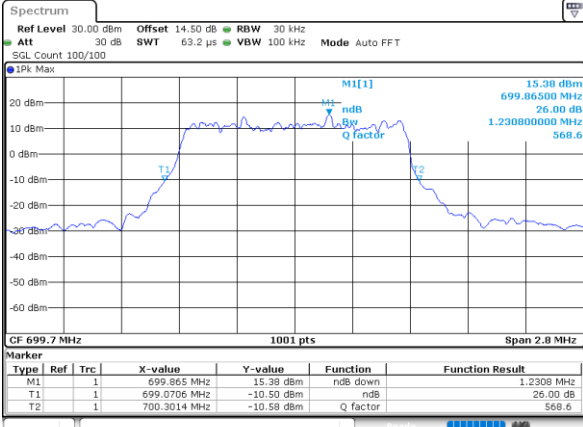

Date: 28.APR.2022 19:22:02

Lowest Channel / 3MHz / 64QAM

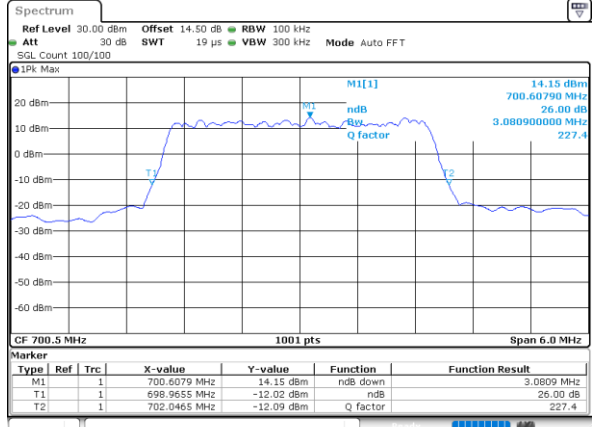

Date: 28.APR.2022 17:43:39

Middle Channel / 1.4MHz / 64QAM

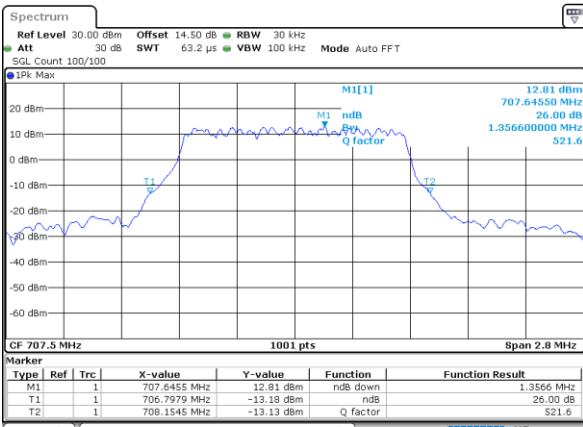

Date: 28.APR.2022 19:26:18

Middle Channel / 3MHz / 64QAM

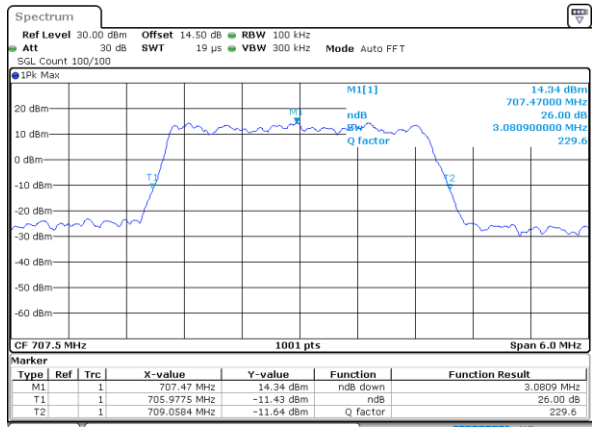

Date: 28.APR.2022 17:47:55

Highest Channel / 1.4MHz / 64QAM

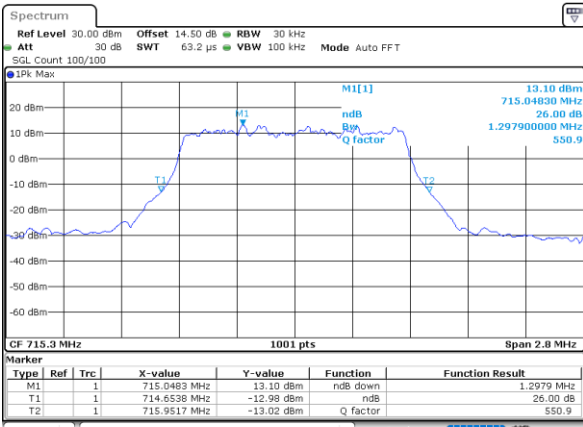

Date: 28.APR.2022 19:28:07

Highest Channel / 3MHz / 64QAM

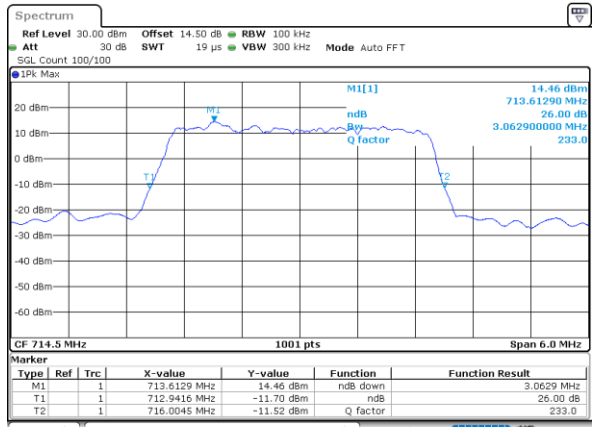

Date: 28.APR.2022 17:49:44





LTE Band 12

Lowest Channel / 5MHz / 64QAM

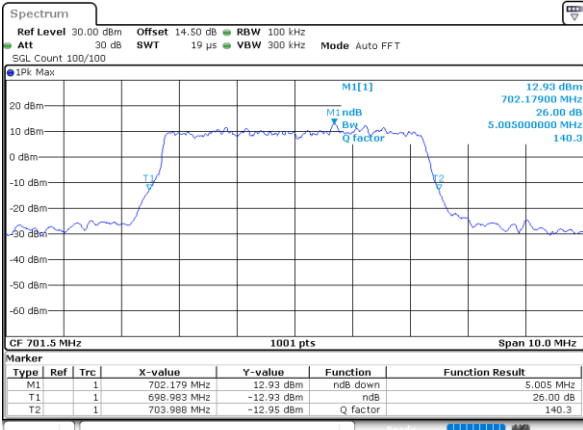

Date: 28.APR.2022 17:54:10

Lowest Channel / 10MHz / 64QAM

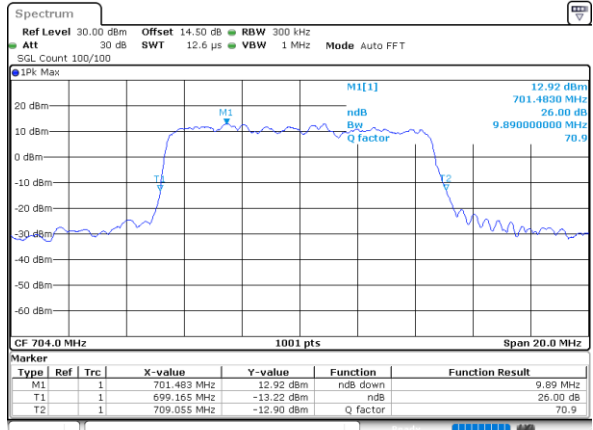

Date: 28.APR.2022 18:48:31

Middle Channel / 5MHz / 64QAM

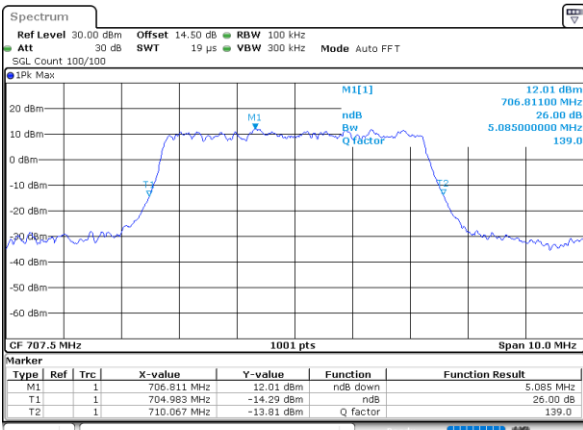

Date: 28.APR.2022 17:58:26

Middle Channel / 10MHz / 64QAM

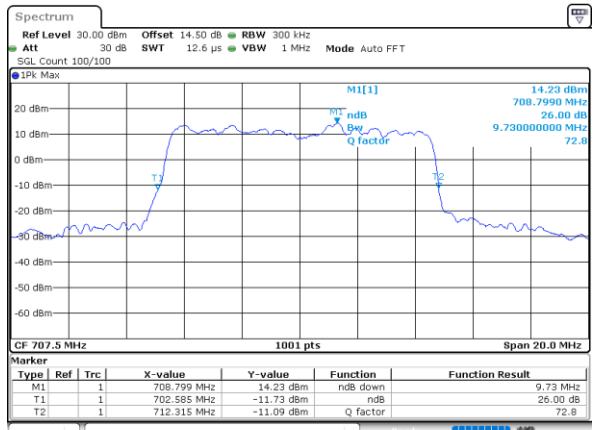

Date: 28.APR.2022 18:52:46

Highest Channel / 5MHz / 64QAM

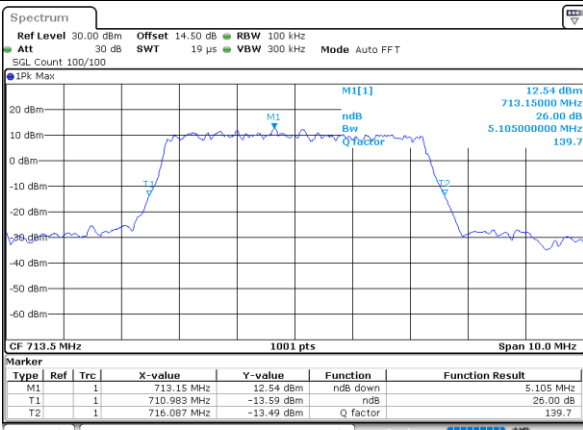

Date: 28.APR.2022 18:00:15

Highest Channel / 10MHz / 64QAM

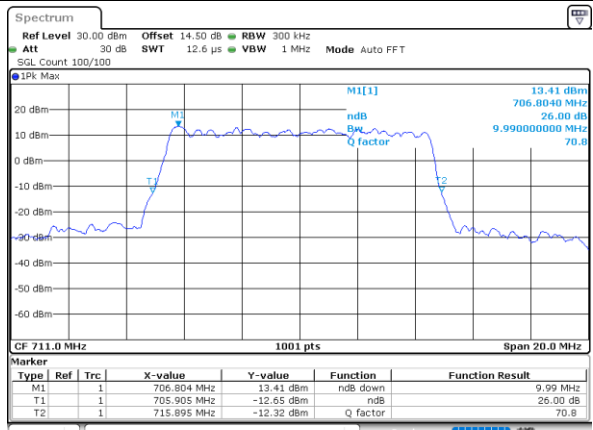

Date: 28.APR.2022 18:54:36



### Occupied Bandwidth

Mode	LTE Band 12 : 99%OBW(MHz)											
BW	1.4MHz		3MHz		5MHz		10MHz		15MHz		20MHz	
Mod.	QPSK	16QAM	QPSK	16QAM	QPSK	16QAM	QPSK	16QAM	QPSK	16QAM	QPSK	16QAM
Lowest CH	1.09	1.10	2.73	2.73	4.49	4.48	9.01	9.01	-	-	-	-
Middle CH	1.09	1.09	2.74	2.74	4.51	4.49	9.03	9.01	-	-	-	-
Highest CH	1.09	1.10	2.73	2.72	4.50	4.50	9.03	9.01	-	-	-	-
Mode	LTE Band 12 : 99%OBW(MHz)											
BW	1.4MHz		3MHz		5MHz		10MHz		15MHz		20MHz	
Mod.	64QAM		64QAM		64QAM		64QAM		64QAM		64QAM	
Lowest CH	1.10	-	2.72	-	4.47	-	9.05	-	-	-	-	-
Middle CH	1.09	-	2.72	-	4.48	-	9.07	-	-	-	-	-
Highest CH	1.09	-	2.73	-	4.49	-	9.01	-	-	-	-	-



LTE Band 12

Lowest Channel / 1.4MHz / QPSK

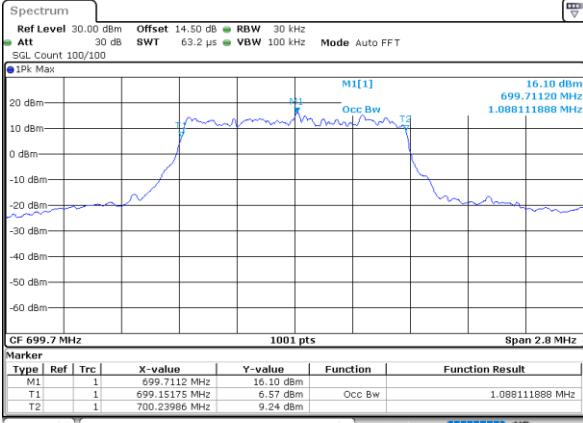

Date: 28.APR.2022 19:59:54

Lowest Channel / 1.4MHz / 16QAM

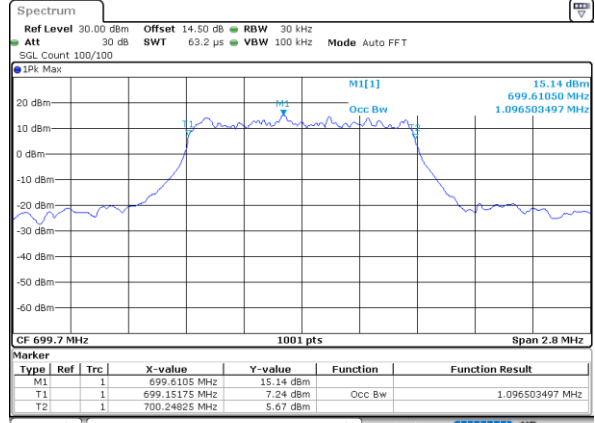

Date: 28.APR.2022 19:00:17

Middle Channel / 1.4MHz / QPSK

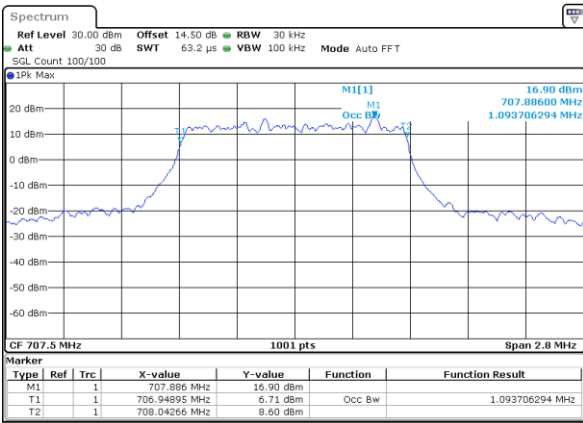

Date: 28.APR.2022 19:09:15

Middle Channel / 1.4MHz / 16QAM

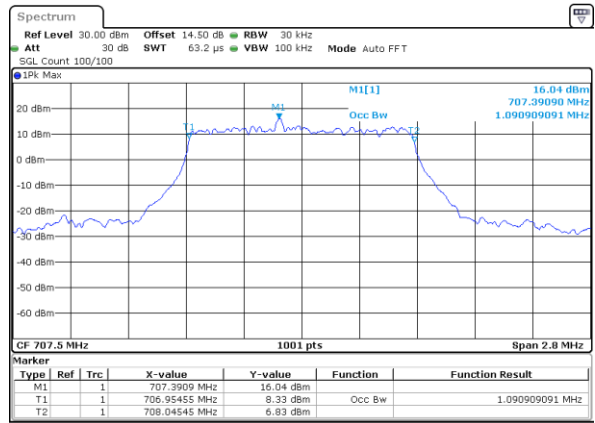

Date: 28.APR.2022 19:08:52

Highest Channel / 1.4MHz / QPSK

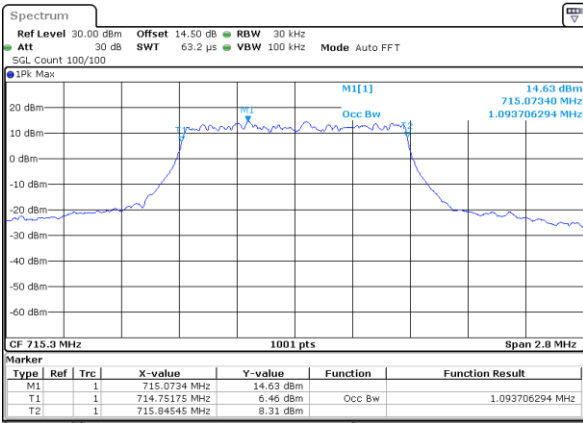

Date: 28.APR.2022 19:12:39

Highest Channel / 1.4MHz / 16QAM

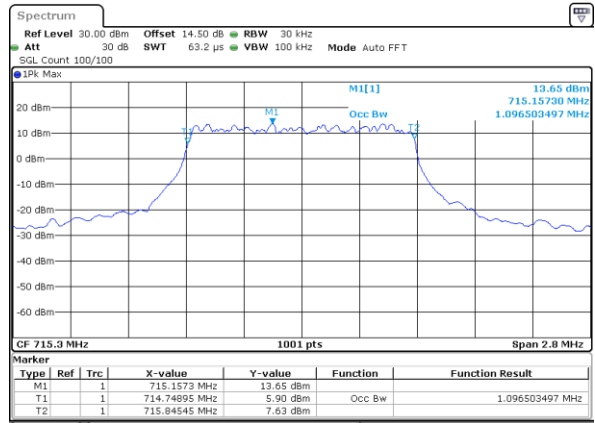

Date: 28.APR.2022 19:13:03



LTE Band 12

Lowest Channel / 3MHz / QPSK

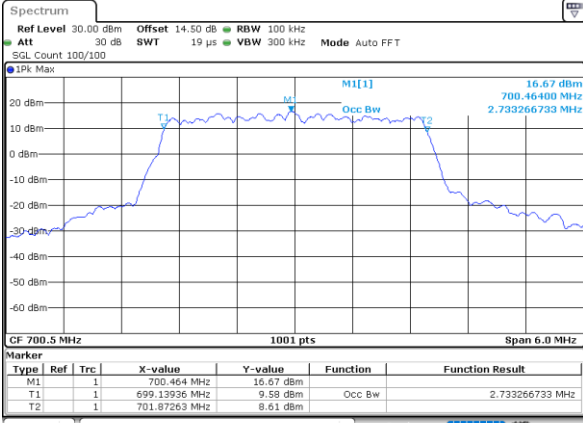

Date: 28.APR.2022 17:21:30

Lowest Channel / 3MHz / 16QAM

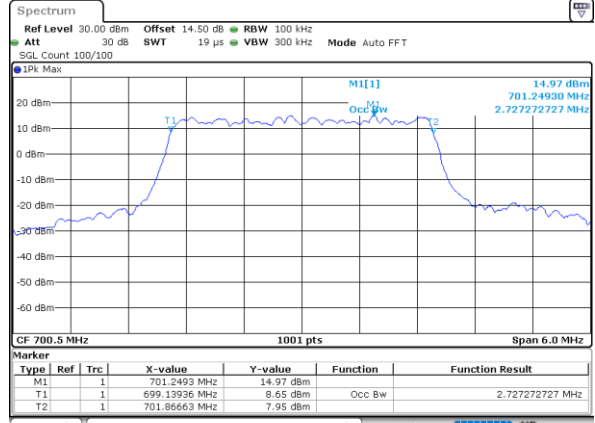

Date: 28.APR.2022 17:21:53

Middle Channel / 3MHz / QPSK

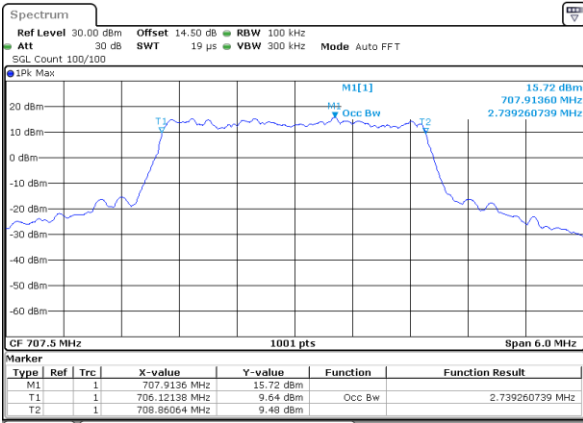

Date: 28.APR.2022 17:30:52

Middle Channel / 3MHz / 16QAM

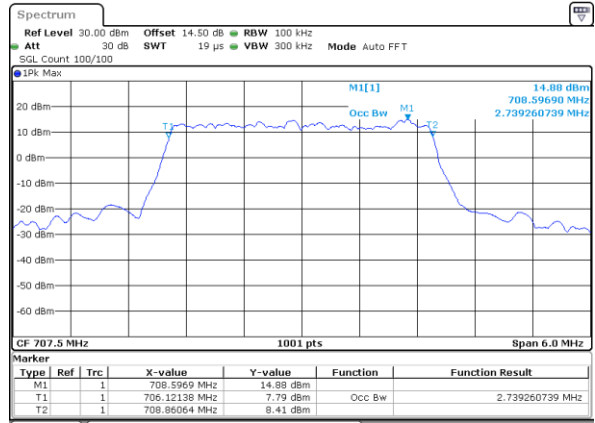

Date: 28.APR.2022 17:30:29

Highest Channel / 3MHz / QPSK

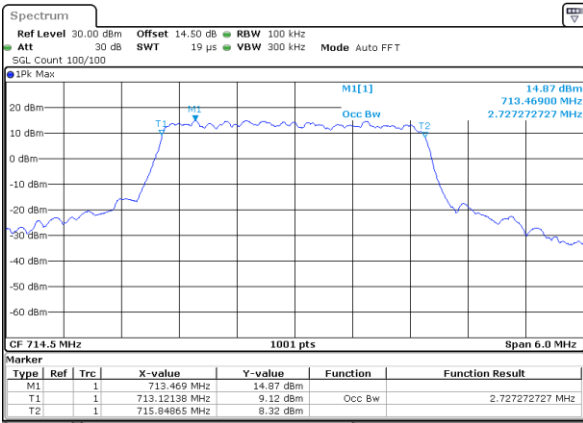

Date: 28.APR.2022 17:34:16

Highest Channel / 3MHz / 16QAM

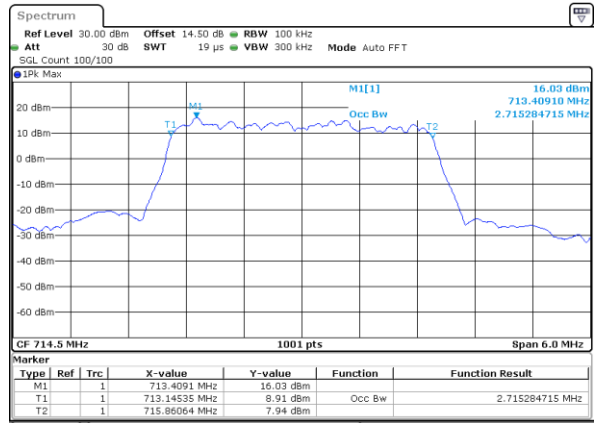

Date: 28.APR.2022 17:34:40



LTE Band 12

Lowest Channel / 5MHz / QPSK

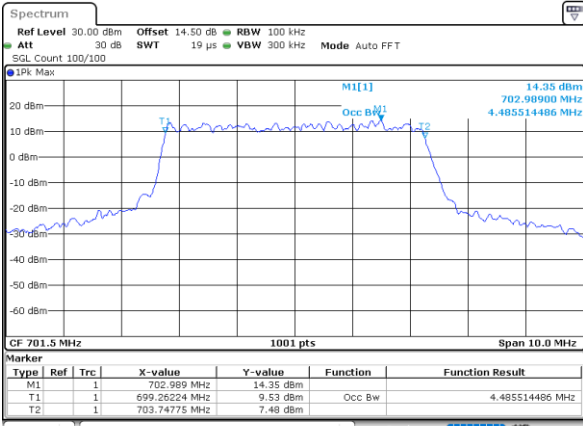

Date: 28\_APR.2022 18:04:26

Lowest Channel / 5MHz / 16QAM

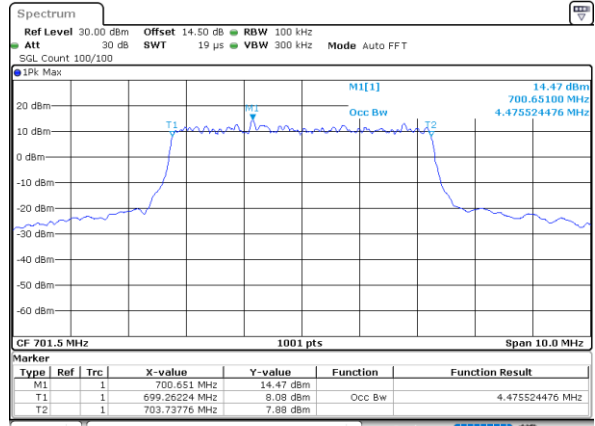

Date: 28\_APR.2022 18:04:50

Middle Channel / 5MHz / QPSK

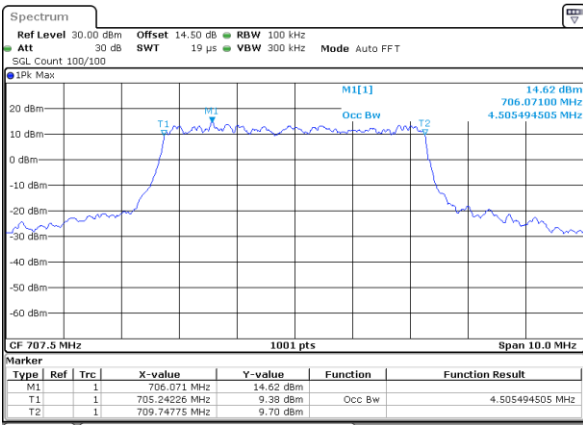

Date: 28\_APR.2022 18:13:48

Middle Channel / 5MHz / 16QAM

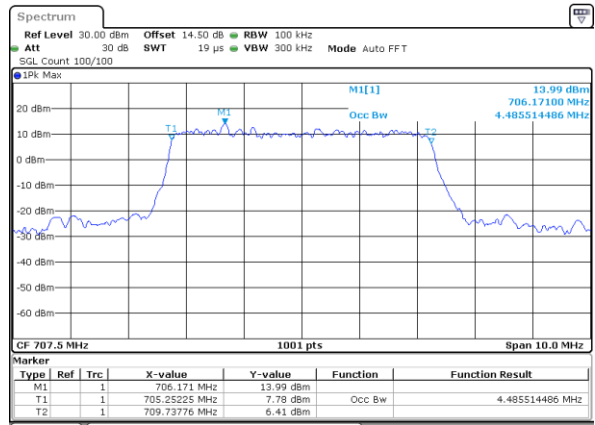

Date: 28\_APR.2022 18:13:25

Highest Channel / 5MHz / QPSK

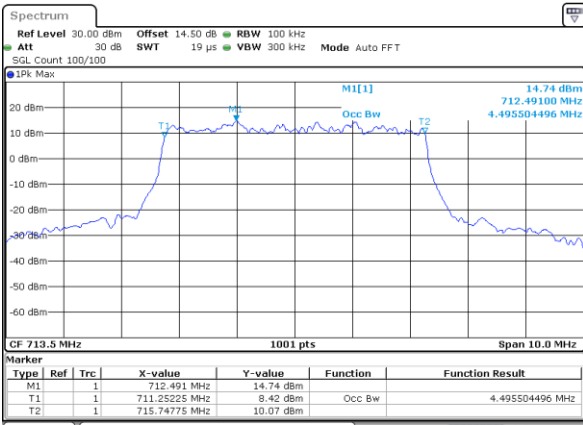

Date: 28\_APR.2022 18:17:12

Highest Channel / 5MHz / 16QAM

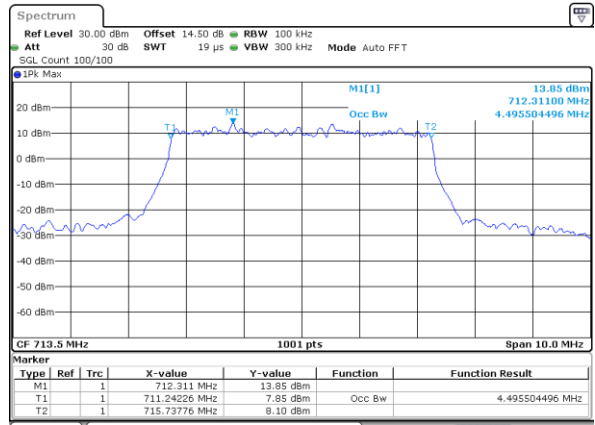

Date: 28\_APR.2022 18:17:36



LTE Band 12

Lowest Channel / 10MHz / QPSK

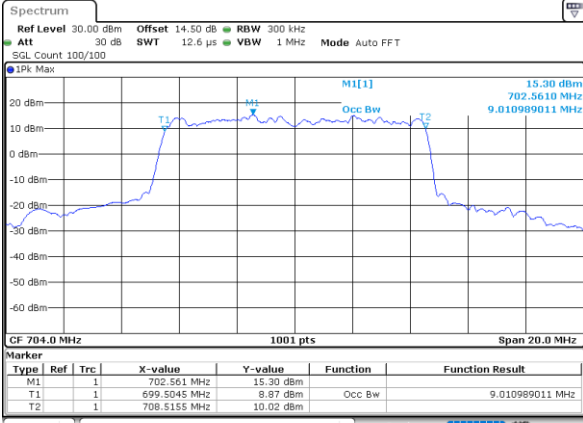

Date: 28\_APR.2022 18:26:21

Lowest Channel / 10MHz / 16QAM

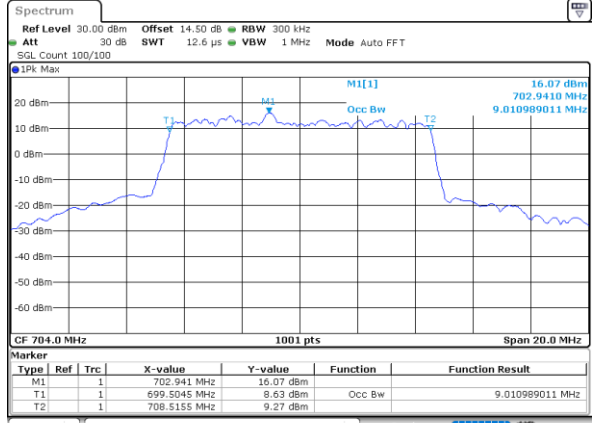

Date: 28\_APR.2022 18:26:45

Middle Channel / 10MHz / QPSK

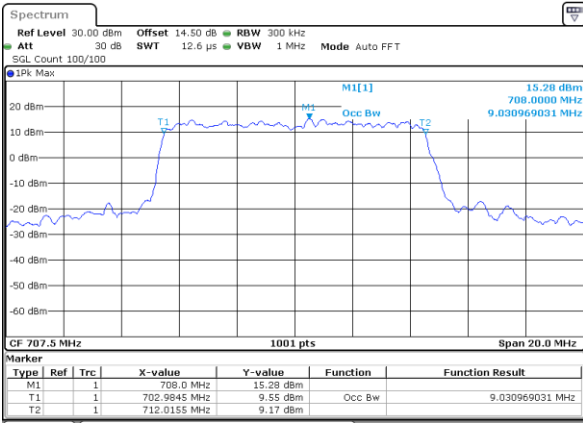

Date: 28\_APR.2022 18:35:43

Middle Channel / 10MHz / 16QAM

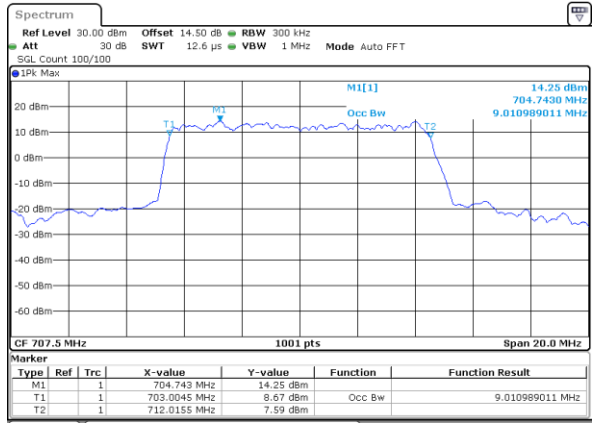

Date: 28\_APR.2022 18:35:20

Highest Channel / 10MHz / QPSK

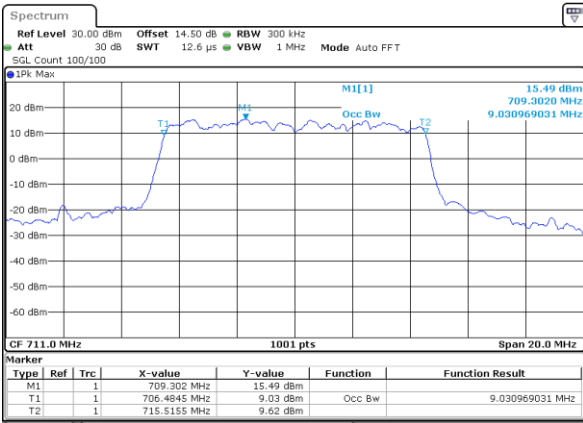

Date: 28\_APR.2022 18:39:08

Highest Channel / 10MHz / 16QAM

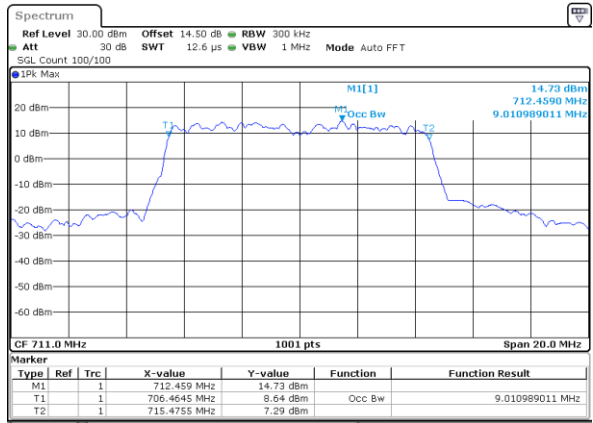

Date: 28\_APR.2022 18:39:31



LTE Band 12

Lowest Channel / 1.4MHz / 64QAM

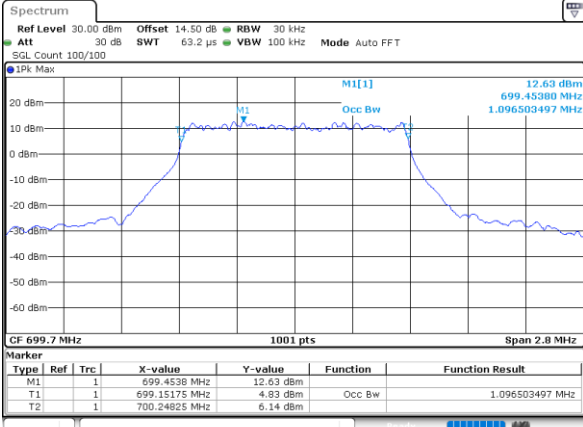

Date: 28\_APR.2022 19:21:48

Lowest Channel / 3MHz / 64QAM

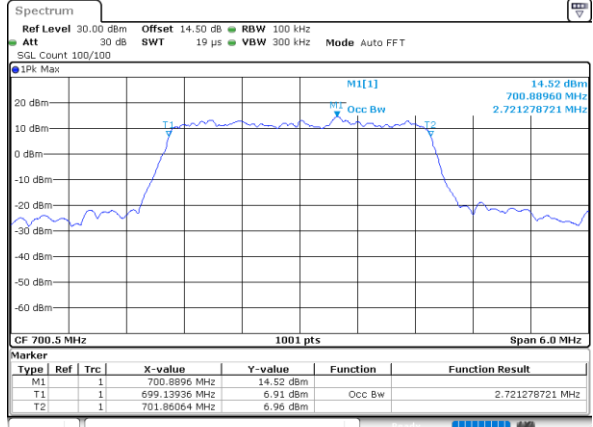

Date: 28\_APR.2022 17:43:25

Middle Channel / 1.4MHz / 64QAM

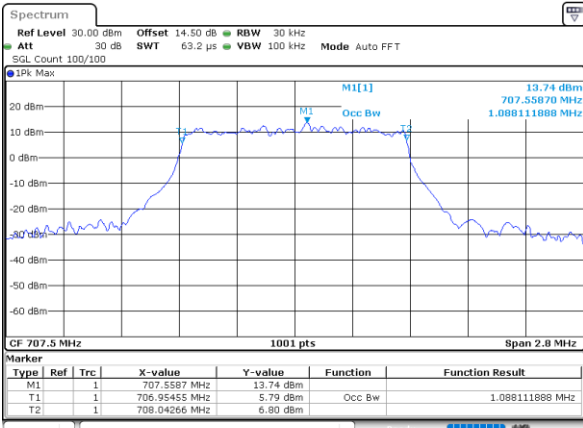

Date: 28\_APR.2022 19:26:03

Middle Channel / 3MHz / 64QAM

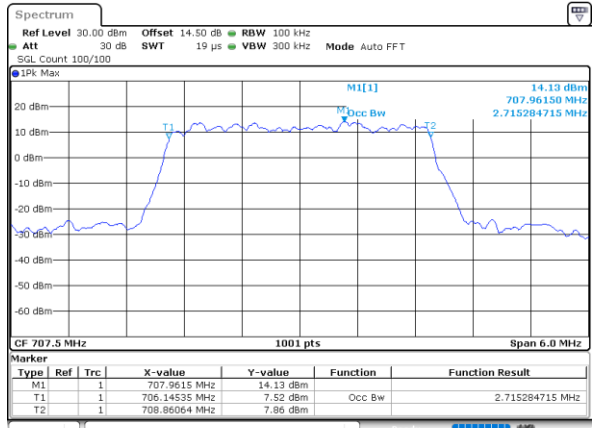

Date: 28\_APR.2022 17:47:40

Highest Channel / 1.4MHz / 64QAM

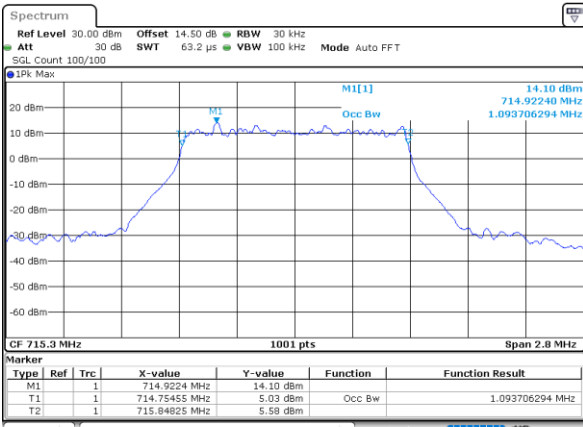

Date: 28\_APR.2022 19:27:53

Highest Channel / 3MHz / 64QAM

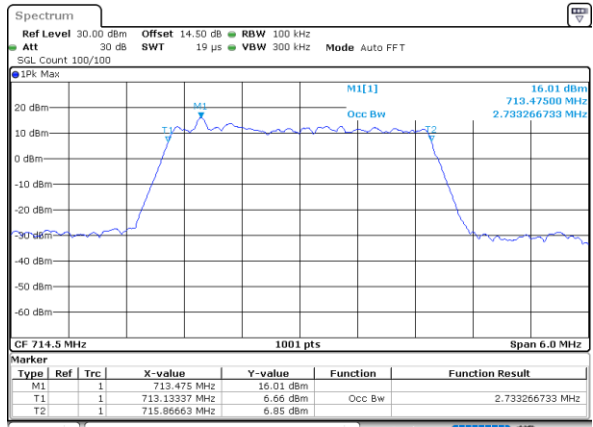

Date: 28\_APR.2022 17:49:30