



FCC RF Test Report

APPLICANT : ASUSTeK COMPUTER INC.
EQUIPMENT : ASUS Phone(Mobile Phone)
BRAND NAME : ASUS
MODEL NAME : ASUS_AI2201_F, ASUS_AI2201_D
FCC ID : MSQAI2201
STANDARD : 47 CFR Part 2, 27
CLASSIFICATION : PCS Licensed Transmitter Held to Ear (PCE)
TEST DATE(S) : Apr. 01, 2022 ~ May 24, 2022

We, Sporton International Inc. (ShenZhen), would like to declare that the tested sample has been evaluated in accordance with the procedures given in ANSI C63.26-2015 and shown compliance with the applicable technical standards.

The test results in this report apply exclusively to the tested model / sample. Without written approval of Sporton International Inc. (ShenZhen), the test report shall not be reproduced except in full.

Jason Jia

Approved by: Jason Jia



Sporton International Inc. (ShenZhen)

1/F, 2/F, Bldg 5, Shiling Industrial Zone, Xinwei Village, Xili, Nanshan, Shenzhen, 518055

People's Republic of China



TABLE OF CONTENTS

REVISION HISTORY... 3
SUMMARY OF TEST RESULT ... 4
1 GENERAL DESCRIPTION ... 5
1.1 Applicant ... 5
1.2 Manufacturer ... 5
1.3 Product Feature of Equipment Under Test ... 5
1.4 Product Specification of Equipment Under Test ... 5
1.5 Modification of EUT ... 7
1.6 Maximum ERP/EIRP Power and Emission Designator ... 7
1.7 Testing Location ... 9
1.8 Test Software ... 9
1.9 Applicable Standards ... 9
2 TEST CONFIGURATION OF EQUIPMENT UNDER TEST ... 10
2.1 Test Mode ... 10
2.2 Connection Diagram of Test System ... 12
2.3 Support Unit used in test configuration and system ... 12
2.4 Measurement Results Explanation Example ... 12
2.5 Frequency List of Low/Middle/High Channels ... 13
3 CONDUCTED TEST ITEMS ... 15
3.1 Measuring Instruments ... 15
3.2 Test Setup ... 15
3.3 Test Result of Conducted Test ... 15
3.4 Conducted Output Power and ERP/EIRP ... 16
3.5 Peak-to-Average Ratio ... 17
3.6 Occupied Bandwidth ... 18
3.7 Conducted Band Edge ... 19
3.8 Conducted Spurious Emission ... 21
3.9 Frequency Stability ... 22
4 RADIATED TEST ITEMS ... 23
4.1 Measuring Instruments ... 23
4.2 Test Setup ... 23
4.3 Test Result of Radiated Test ... 24
4.4 Radiated Spurious Emission ... 25
5 LIST OF MEASURING EQUIPMENT ... 26
6 UNCERTAINTY OF EVALUATION ... 27
APPENDIX A. TEST RESULTS OF CONDUCTED TEST
APPENDIX B. TEST RESULTS OF RADIATED TEST
APPENDIX C. TEST SETUP PHOTOGRAPHS



REVISION HISTORY

REPORT NO.	VERSION	DESCRIPTION	ISSUED DATE
FG230112K	Rev. 01	Initial issue of report	Jul. 28, 2022



SUMMARY OF TEST RESULT

Report Section	FCC Rule	Description	Limit	Result	Remark
3.4	§2.1046	Conducted Output Power	Reporting Only	PASS	-
	§27.50(c)(10)	Effective Radiated Power (5G NR n71)	ERP < 3 Watt		
	§27.50(h)(2)	Equivalent Isotropic Radiated Power (5G NR n7, n41, n38)	EIRP < 2Watt		
3.5	N/A	Peak-to-Average Ratio	<13 dB	PASS	-
3.6	§2.1049	Occupied Bandwidth	Reporting Only	PASS	-
3.7	§2.1051 §27.53(g)	Conducted Band Edge Measurement (5G NR n71)	< 43+10log ₁₀ (P[Watts])	PASS	-
	§27.53(m)(4)	Conducted Band Edge Measurement (5G NR n7, n41, n38)	§27.53(m)(4)		
3.8	§2.1051 §27.53(g)	Conducted Spurious Emission (5G NR n71)	< 43+10log ₁₀ (P[Watts])	PASS	-
	§2.1051 §27.53(m)(4)	Conducted Spurious Emission (5G NR n7, n41, n38)	< 55+10log ₁₀ (P[Watts])		
3.9	§2.1055 §27.54	Frequency Stability Temperature & Voltage	Within Authorized Band	PASS	-
4.4	§2.1053 §27.53(g)	Radiated Spurious Emission (5G NR n71)	< 43+10log ₁₀ (P[Watts])	PASS	Under limit 26.99 dB at 10063.680 MHz
	§2.1053 §27.53(m)(4)	Radiated Spurious Emission (5G NR n7, n41, n38)	< 55+10log ₁₀ (P[Watts])		

Declaration of Conformity:

The test results with all measurement uncertainty excluded are presented in accordance with the regulation limits or requirements declared by manufacturers.

Comments and Explanations:

The declared of product specification for EUT presented in the report are provided by the manufacturer, and the manufacturer takes all the responsibilities for the accuracy of product specification.



1 General Description

1.1 Applicant

ASUSTeK COMPUTER INC.

1F., No. 15, Lide Rd., Beitou Dist., Taipei City 112, Taiwan

1.2 Manufacturer

ASUSTeK COMPUTER INC.

1F., No. 15, Lide Rd., Beitou Dist., Taipei City 112, Taiwan

1.3 Product Feature of Equipment Under Test

Product Feature	
Equipment	ASUS Phone(Mobile Phone)
Brand Name	ASUS
Model Name	ASUS_AI2201_F, ASUS_AI2201_D
FCC ID	MSQAI2201
IMEI Code	Conducted : 359157510101814/359157510101822 Radiation : 353700810106011/353700810106029
HW Version	R3.0
SW Version	Android 12
EUT Stage	Production Unit

1.4 Product Specification of Equipment Under Test

Standards-related Product Specification	
Tx Frequency	5G NR n7 : 2500 MHz ~ 2570 MHz 5G NR n38 : 2570 MHz ~ 2620 MHz 5G NR n41 : 2496 MHz ~ 2690 MHz 5G NR n71: 663 MHz ~ 698 MHz
Rx Frequency	5G NR n7 : 2620 MHz ~ 2690 MHz 5G NR n38: 2570 MHz ~ 2620 MHz 5G NR n41 : 2496 MHz ~ 2690 MHz 5G NR n71: 617 MHz ~ 652 MHz
SCS	n7, n71: 15kHz n38, n41: 30kHz
Bandwidth	n7: 5MHz / 10MHz / 15MHz / 20MHz / 25MHz / 30MHz / 40MHz n38: 10MHz / 15MHz / 20MHz / 30MHz / 40MHz n41: 20MHz / 30MHz / 40MHz / 50MHz / 60MHz / 70MHz / 80MHz / 90MHz / 100MHz n71: 5MHz / 10MHz / 15MHz / 20MHz
Antenna Gain	<Ant. 0> n71: -2.91 dBi <Ant. 1> n7: 0.39 dBi n38: 0.39 dBi n41: 0.39 dBi <Ant. 2>



	n7: -3.8 dBi n38: -3.8 dBi n41: -3.8 dBi n71: -8.7 dBi <Ant. 7> n41: -2.52 dBi <Ant. 8> n41: -1.93 dBi
Type of Modulation	CP-OFDM: QPSK / 16QAM / 64QAM / 256QAM DFT-s-OFDM: PI/2 BPSK / QPSK / 16QAM / 64QAM / 256QAM

Remark:

1. The maximum ERP/EIRP is calculated from max output power and max antenna gain, only the maximum ERP/EIRP are shown in the report, 5G NR n41 for Ant. 8 and n7/n38 for Ant. 1 and n71 for Ant. 0 and n41_UL MIMO for Ant.(8+1).
2. All the supported ENDC combinations are verified conducted power, only the ENDC combination with highest power are shown in the report.
3. 5G NR support SA (n7/n38/n41/n71) mode and NSA(n7/n71) mode. According to the maximum power between SA and NSA mode, SA covers NSA mode for (n7/n71).
4. 5G NR n41 supports UL MIMO mode (the two antennas are completely uncorrelated).
5. The EN-DC mode combination could be referred to the product spec.
6. The device supports HPUE mode for 5G NR n41.
7. For n41 MIMO mode, the conducted BE/Spurious are tested at single antenna port and add $10 \cdot \log(N_{ANT})$ according to KDB 662911 D01.

All the test were performed by SKU 2

Sample Information		
SKU	SKU 1	SKU 2
Build Stage	PR	
Config.	WW-High (with LGF)	WW-High (with PMOLED)
RF module board	WW-High(Entry)	WW-PRO
LCD + Touch front frame	AI2201 FRONT CASE ASSY WW	AI2201 FRONT CASE ASSY WW
DDR	16G (Samsung) LPDDR5 SAMSUNG/K3LK6K60BM-BGCP	18G(HYNIX) LPDDR5 HYNIX/H58GU6MK6HX042
UFS	512G (HYNIX) HYNIX HN8T25DEHKX077	512G (HYNIX) HYNIX HN8T25DEHKX077
MB	AI2201_MB	AI2201_MB
Battery	SCUD/C21P2101	SWD/C21P2101
Rear Camera 50+13M	PRIMAX/50-704JQASC8	TRIPLEWIN/CASAF-001A
Front Camera 12M	TSPRECISSION/TNBF1166	LUXVISIONS/FRA-00000658
Rear Camera 5M	SHINE PHOTICS/BF515B	TSPRECISSION/O5F9323 VERA1
PCB	COMPEQ	COMPEQ
CPU	QUALCOMM MPSP1518B / SM-8475-1 MPSP1518B ES	QUALCOMM MPSP1518B / SM-8475-1 MPSP1518B ES



1.5 Modification of EUT

No modifications are made to the EUT during all test items.

1.6 Maximum ERP/EIRP Power and Emission Designator

5G NR n7		PI/2 BPSK / QPSK		16QAM / 64QAM / 256QAM	
BW (MHz)	Frequency Range (MHz)	Maximum EIRP(W)	Emission Designator (99%OBW)	Maximum EIRP(W)	Emission Designator (99%OBW)
5	2502.5 ~ 2567.5	0.3334	4M48G7D	0.2612	4M50W7D
10	2505.0 ~ 2565.0	0.3281	9M27G7D	0.2594	9M29W7D
15	2507.5 ~ 2562.5	0.3365	14M1G7D	0.2679	14M1W7D
20	2510.0 ~ 2560.0	0.3357	18M9G7D	0.2649	19M0W7D
25	2512.5 ~ 2557.5	0.3428	23M8G7D	0.2716	23M8W7D
30	2515.0 ~ 2555.0	0.3436	28M6G7D	0.2761	28M6W7D
40	2520.0 ~ 2550.0	0.3412	38M6G7D	0.2742	38M6W7D

5G NR n38		PI/2 BPSK / QPSK		16QAM / 64QAM / 256QAM	
BW (MHz)	Frequency Range (MHz)	Maximum EIRP(W)	Emission Designator (99%OBW)	Maximum EIRP(W)	Emission Designator (99%OBW)
10	2575.0 ~ 2615.0	0.3342	8M63G7D	0.2667	8M60W7D
15	2577.5 ~ 2612.5	0.3428	13M6G7D	0.2698	13M6W7D
20	2580.0 ~ 2610.0	0.3381	18M2G7D	0.2685	18M2W7D
30	2585.0 ~ 2605.0	0.3428	27M8G7D	0.2729	27M9W7D
40	2590.0 ~ 2600.0	0.3436	37M9G7D	0.2673	37M9W7D

5G NR n41		PI/2 BPSK / QPSK		16QAM / 64QAM / 256QAM	
BW (MHz)	Frequency Range (MHz)	Maximum EIRP(W)	Emission Designator (99%OBW)	Maximum EIRP(W)	Emission Designator (99%OBW)
20	2506.02 ~ 2679.99	0.2748	18M2G7D	0.2084	18M3W7D
30	2511.00 ~ 2674.98	0.2851	27M9G7D	0.2143	27M9W7D
40	2516.01 ~ 2670.00	0.2864	37M8G7D	0.2188	37M9W7D
50	2521.02 ~ 2664.99	0.2884	47M5G7D	0.2148	47M6W7D
60	2526.00 ~ 2659.98	0.2877	57M9G7D	0.2203	57M9W7D
70	2531.01 ~ 2655.00	0.2692	67M4G7D	0.2089	67M6W7D
80	2536.02 ~ 2649.99	0.2754	77M6G7D	0.2143	77M6W7D
90	2541.00 ~ 2644.98	0.2742	87M5G7D	0.2168	87M4W7D
100	2546.01 ~ 2640.00	0.2786	97M5G7D	0.2198	97M5W7D



5G NR n41 UL MIMO		QPSK		16QAM / 64QAM / 256QAM	
BW (MHz)	Frequency Range (MHz)	Maximum EIRP(W)	Emission Designator (99%OBW)	Maximum EIRP(W)	Emission Designator (99%OBW)
20	2506.02 ~ 2679.99	0.4619	18M2G7D	0.4126	18M2W7D
30	2511.00 ~ 2674.98	0.4777	27M9G7D	0.4214	27M9W7D
40	2516.01 ~ 2670.00	0.4691	37M9G7D	0.4193	37M9W7D
50	2521.02 ~ 2664.99	0.4754	47M5G7D	0.4276	47M6W7D
60	2526.00 ~ 2659.98	0.4792	57M8G7D	0.4222	57M9W7D
70	2531.01 ~ 2655.00	0.4571	67M5G7D	0.4043	67M5W7D
80	2536.02 ~ 2649.99	0.4515	77M4G7D	0.4051	77M6W7D
90	2541.00 ~ 2644.98	0.4515	87M4G7D	0.4049	87M8W7D
100	2546.01 ~ 2640.00	0.4570	97M6G7D	0.4075	97M7W7D

5G NR n71		PI/2 BPSK / QPSK		16QAM / 64QAM / 256QAM	
BW (MHz)	Frequency Range (MHz)	Maximum ERP(W)	Emission Designator (99%OBW)	Maximum ERP(W)	Emission Designator (99%OBW)
5	665.5 ~ 695.5	0.0944	4M49G7D	0.0736	4M49W7D
10	668.0 ~ 693.0	0.0931	9M29G7D	0.0741	9M30W7D
15	670.5 ~ 690.5	0.0966	14M1G7D	0.0767	14M1W7D
20	673.0 ~ 688.0	0.0955	18M9G7D	0.0752	18M9W7D

Note: All modulations have been tested, only the worst test results of PSK & QAM are shown in the report.



1.7 Testing Location

Sporton International Inc. (Shenzhen) is accredited to ISO/IEC 17025:2017 by American Association for Laboratory Accreditation with Certificate Number 5145.01.

Test Firm	Sporton International Inc. (Shenzhen)		
Test Site Location	1/F, 2/F, Bldg 5, Shiling Industrial Zone, Xinwei Village, Xili, Nanshan, Shenzhen, 518055 People's Republic of China TEL: +86-755-86379589 FAX: +86-755-86379595		
Test Site No.	Sporton Site No.	FCC Designation No.	FCC Test Firm Registration No.
	TH01-SZ	CN1256	421272

Test Firm	Sporton International Inc. (Shenzhen)		
Test Site Location	101, 1st Floor, Block B, Building 1, No. 2, Tengfeng 4th Road, Fenghuang Community, Fuyong Street, Baoan District, Shenzhen City Guangdong Province China 518103 TEL: +86-755-33202398		
Test Site No.	Sporton Site No.	FCC Designation No.	FCC Test Firm Registration No.
	03CH04-SZ	CN1256	421272

1.8 Test Software

Item	Site	Manufacturer	Name	Version
1.	03CH04-SZ	AUDIX	E3	6.2009-8-24

1.9 Applicable Standards

According to the specifications of the manufacturer, the EUT must comply with the requirements of the following standards:

- 47 CFR Part 2, 27
- ANSI C63.26-2015
- FCC KDB 971168 D01 Power Meas License Digital Systems v03r01
- FCC KDB 412172 D01 Determining ERP and EIRP v01r01

Remark: All test items were verified and recorded according to the standards and without any deviation during the test.



2 Test Configuration of Equipment Under Test

2.1 Test Mode

Antenna port conducted and radiated test items are performed according to KDB 971168 D01 Power Meas License Digital Systems v03r01 with maximum output power.

For radiated measurement, pre-scanned in three orthogonal panels, X, Y, Z. The worst cases (Y plane) were recorded in this report.

The device is investigated from 30MHz to 10 times of fundamental signal for radiated spurious emission test under different RB size/offset and modulations in exploratory test. Subsequently, only the worst case emissions are reported.

Orthogonal Planes of EUT	X Plane	Y Plane	Z Plane
			

Test Items	5G NR	Bandwidth (MHz)										Modulation					RB #		Test Channel		
		5	10/15	20	25	30	40	50	60	70-90	100	PI/2 BPSK	QPSK	16QAM	64QAM	256 QAM	1	Full	L	M	H
Max. Output Power	n7	v	v	v	v	v	v	-	-	-	-	v	v	v	v	v	v	v	v	v	v
	n38	-	v	v	-	v	v	-	-	-	-	v	v	v	v	v	v	v	v	v	v
	n41	-	-	v	-	v	v	v	v	v	v	v	v	v	v	v	v	v	v	v	v
	n71	v	v	v	-	-	-	-	-	-	-	v	v	v	v	v	v	v	v	v	v
Peak-to-Average Ratio	n7			v				-	-	-	-	v	v				v	v	v	v	v
	n38	-		v								v	v				v	v	v	v	v
	n41	-	-	v	-							v	v				v	v	v	v	v
	n71			v	-	-	-	-	-	-	-	v	v				v	v	v	v	v
26dB and 99% Bandwidth	n7	v	v	v	v	v	v	-	-	-	-	v	v	v	v	v		v		v	
	n38	-	v	v		v	v					v	v	v	v	v		v		v	
	n41	-	-	v	-	v	v	v	v	v	v	v	v	v	v	v		v		v	
	n71	v	v	v	-	-	-	-	-	-	-	v	v	v	v	v		v		v	
Conducted Band Edge	n7	v		v			v	-	-	-	-	v	v				v	v	v		v
	n38	-	v	v			v					v	v				v	v	v		v
	n41	-	-	v	-					v		v	v				v	v	v		v
	n71	v	v	v	-	-	-	-	-	-	-	v	v				v	v	v		v



Test Items	5G NR	Bandwidth (MHz)										Modulation					RB #		Test Channel		
		5	10/15	20	25	30	40	50	60	70-90	100	PI/2 BPSK	QPSK	16QAM	64QAM	256 QAM	1	Full	L	M	H
Conducted Spurious Emission	n7	v		v			v	-	-	-	-	v	v				v		v	v	v
	n38	-	v	v			v	v	v	v		v	v				v		v	v	v
	n41	-	-	v	-				v		v	v	v				v		v	v	v
	n71	v	v	v	-	-	-	-	-	-	-	v	v				v		v	v	v
Frequency Stability	n7			v				-	-	-	-		v					v		v	
	n38	-		v									v					v		v	
	n41	-	-	v	-								v					v		v	
	n71			v	-	-	-	-	-	-	-		v					v		v	
E.R.P / E.I.R.P	n7	v	v	v	v	v	v	-	-	-	-	v	v	v	v	v	v	v	v	v	v
	n38	-	v	v	-	v	v	-	-	-	-	v	v	v	v	v	v	v	v	v	v
	n41	-	-	v	-	v	v	v	v	v	v	v	v	v	v	v	v	v	v	v	v
	n71	v	v	v	-	-	-	-	-	-	-	v	v	v	v	v	v	v	v	v	v
Radiated Spurious Emission	n7	Worst Case																	v	v	v
	n38	Worst Case																	v	v	v
	n41	Worst Case																	v	v	v
	n71	Worst Case																	v	v	v
Note	1. The mark "v " means that this configuration is chosen for testing 2. The mark "- " means that this bandwidth is not supported. 3. The device is investigated from 30MHz to 10 times of fundamental signal for radiated spurious emission test under different RB size/offset and modulations in exploratory test. Subsequently, only the worst case emissions are reported. 4. Based on engineering evaluation, only the worst modulations test results are shown in the report. 5. Nominal Voltage: 7.78Vdc, Maximum Voltage: 7.3Vdc, Minimum Voltage: 8.7Vdc																				

2.2 Connection Diagram of Test System

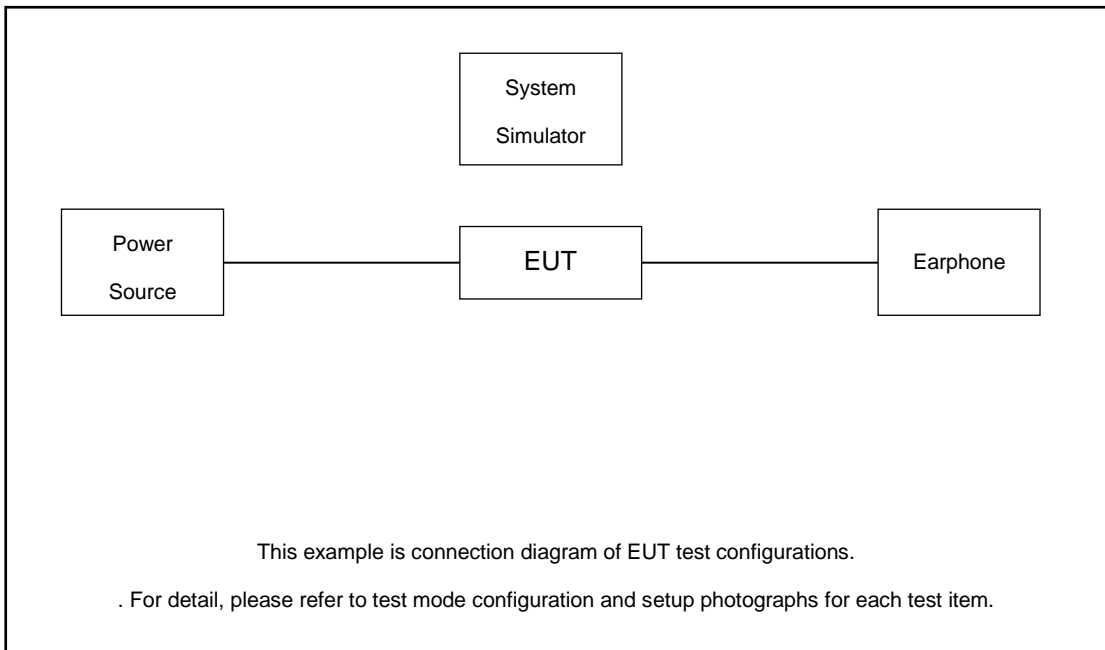

2.3 Support Unit used in test configuration and system

Item	Equipment	Trade Name	Model No.	FCC ID	Data Cable	Power Cord
1.	DC Power Supply	GW	GPS-3030D	N/A	N/A	Unshielded, 1.8 m
2.	LTE Base Station	Anritsu	MT8821C	N/A	N/A	Unshielded, 1.8 m
3.	NR Base Station	Anritsu	MT8000A	N/A	N/A	Unshielded, 1.8 m

2.4 Measurement Results Explanation Example

For all conducted test items:

The offset level is set in the spectrum analyzer to compensate the RF cable loss and attenuator factor between EUT conducted output port and spectrum analyzer. With the offset compensation, the spectrum analyzer reading level is exactly the EUT RF output level.

The spectrum analyzer offset is derived from RF cable loss and attenuator factor.

Offset = RF cable loss + attenuator factor.

Following shows an offset computation example with cable loss 7.98 dB and 10dB attenuator.

Example :

$$\begin{aligned} \text{Offset(dB)} &= \text{RF cable loss(dB)} + \text{attenuator factor(dB)}. \\ &= 7.98 + 10 = 17.98 \text{ (dB)} \end{aligned}$$



2.5 Frequency List of Low/Middle/High Channels

5G NR n7 Channel and Frequency List				
BW [MHz]	Channel/Frequency(MHz)	Lowest	Middle	Highest
40	Channel	528000	531000	534000
	Frequency	2520	2535	2550
30	Channel	527000	531000	535000
	Frequency	2515	2535	2555
25	Channel	526500	531000	535500
	Frequency	2512.5	2535	2557.5
20	Channel	526000	531000	536000
	Frequency	2510	2535	2560
15	Channel	525500	531000	536500
	Frequency	2507.5	2535	2562.5
10	Channel	525000	531000	537000
	Frequency	2505	2535	2565
5	Channel	524500	531000	537500
	Frequency	2502.5	2535	2567.5

5G NR n38 Channel and Frequency List				
BW [MHz]	Channel/Frequency(MHz)	Lowest	Middle	Highest
40	Channel	518000	519000	520000
	Frequency	2590	2595	2600
30	Channel	517000	519000	521000
	Frequency	2585	2595	2605
20	Channel	516000	519000	522000
	Frequency	2580	2595	2610
15	Channel	515500	519000	522500
	Frequency	2577.5	2595	2612.5
10	Channel	515000	519000	523000
	Frequency	2575	2595	2615



5G NR n41 Channel and Frequency List				
BW [MHz]	Channel/Frequency(MHz)	Lowest	Middle	Highest
100	Channel	509202	518598	528000
	Frequency	2546.01	2592.99	2640
90	Channel	508200	518598	528996
	Frequency	2541	2592.99	2644.98
80	Channel	507204	518598	529998
	Frequency	2536.02	2592.99	2649.99
70	Channel	506202	518598	531000
	Frequency	2531.01	2592.99	2655
60	Channel	505200	518598	531996
	Frequency	2526	2592.99	2659.98
50	Channel	504204	518598	532998
	Frequency	2521.02	2592.99	2664.99
40	Channel	503202	518598	534000
	Frequency	2516.01	2592.99	2670
30	Channel	502200	518598	534996
	Frequency	2511	2592.99	2674.98
20	Channel	501204	518598	535998
	Frequency	2506.02	2592.99	2679.99

5G NR n71 Channel and Frequency List				
BW [MHz]	Channel/Frequency(MHz)	Lowest	Middle	Highest
20	Channel	125400	126900	128400
	Frequency	673	680.5	688
15	Channel	124900	126900	128900
	Frequency	670.5	680.5	690.5
10	Channel	124400	126900	129400
	Frequency	668	680.5	693
5	Channel	123900	126900	129900
	Frequency	665.5	680.5	695.5

3 Conducted Test Items

3.1 Measuring Instruments

See list of measuring instruments of this test report.

3.2 Test Setup

3.2.1 Conducted Output Power

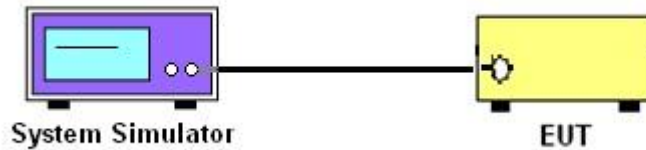

3.2.2 Peak-to-Average Ratio, Occupied Bandwidth, Conducted Band-Edge and Conducted Spurious Emission



3.2.3 Frequency Stability

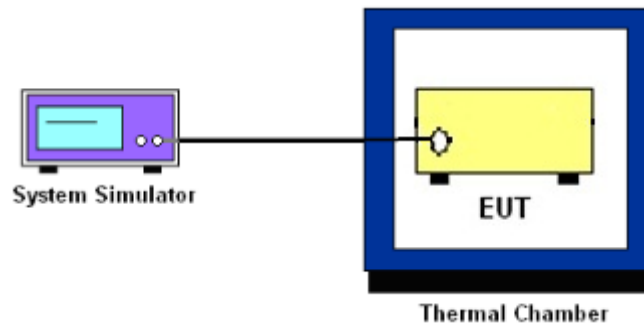

3.3 Test Result of Conducted Test

Please refer to Appendix A.



3.4 Conducted Output Power and ERP/EIRP

3.4.1 Description of the Conducted Output Power Measurement and ERP/EIRP Measurement

A system simulator was used to establish communication with the EUT. Its parameters were set to force the EUT transmitting at maximum output power. The measured power in the radio frequency on the transmitter output terminals shall be reported.

The ERP of mobile transmitters must not exceed 3 Watts for 5G NR n71.

The EIRP of mobile transmitters must not exceed 2 Watts for 5G NR n7, n38 and n41.

According to KDB 412172 D01 Power Approach,

$EIRP = P_T + G_T - L_C$, $ERP = EIRP - 2.15$, where

P_T = transmitter output power in dBm

G_T = gain of the transmitting antenna in dBi

L_C = signal attenuation in the connecting cable between the transmitter and antenna in dB

3.4.2 Test Procedures

1. The testing follows ANSI C63.26 Section 5.2
2. The transmitter output port was connected to the system simulator.
3. Set EUT at maximum power through the system simulator.
4. Select lowest, middle, and highest channels for each band and different modulation.
5. Measure and record the power level from the system simulator.



3.5 Peak-to-Average Ratio

3.5.1 Description of the PAR Measurement

Power Complementary Cumulative Distribution Function (CCDF) curves provide a means for characterizing the power peaks of a digitally modulated signal on a statistical basis. A CCDF curve depicts the probability of the peak signal amplitude exceeding the average power level. Most contemporary measurement instrumentation include the capability to produce CCDF curves for an input signal provided that the instrument's resolution bandwidth can be set wide enough to accommodate the entire input signal bandwidth. In measuring transmissions in this band using an average power technique, the peak-to-average ratio (PAR) of the transmission may not exceed 13 dB.

3.5.2 Test Procedures

1. The testing follows ANSI C63.26 Section 5.2.3.4 (CCDF).
2. The EUT was connected to spectrum and system simulator via a power divider.
3. Set the CCDF (Complementary Cumulative Distribution Function) option in spectrum analyzer.
4. The highest RF powers were measured and recorded the maximum PAPR level associated with a probability of 0.1 %.
5. Record the deviation as Peak to Average Ratio.



3.6 Occupied Bandwidth

3.6.1 Description of Occupied Bandwidth Measurement

The occupied bandwidth is the width of a frequency band such that, below the lower and above the upper frequency limits, the mean powers emitted are each equal to a specified percentage 0.5% of the total mean transmitted power.

The 26 dB emission bandwidth is defined as the frequency range between two points, one above and one below the carrier frequency, at which the spectral density of the emission is attenuated 26 dB below the maximum in-band spectral density of the modulated signal. Spectral density (power per unit bandwidth) is to be measured with a detector of resolution bandwidth equal to approximately 1.0% of the emission bandwidth.

3.6.2 Test Procedures

1. The testing follows ANSI C63.26 Section 5.4
2. The EUT was connected to spectrum analyzer and system simulator via a power divider.
3. The spectrum analyzer center frequency is set to the nominal EUT channel center frequency. The span range for the spectrum analyzer shall be between two and five times the anticipated OBW.
4. The nominal resolution bandwidth (RBW) shall be in the range of 1 to 5 % of the anticipated OBW, and the VBW shall be at least 3 times the RBW.
5. Set the detection mode to peak, and the trace mode to max hold.
6. Determine the reference value: Set the EUT to transmit a modulated signal. Allow the trace to stabilize. Set the spectrum analyzer marker to the highest level of the displayed trace.
(this is the reference value)
7. Determine the “-26 dB down amplitude” as equal to (Reference Value – X).
8. Place two markers, one at the lowest and the other at the highest frequency of the envelope of the spectral display such that each marker is at or slightly below the “-X dB down amplitude” determined in step 6. If a marker is below this “-X dB down amplitude” value it shall be placed as close as possible to this value. The OBW is the positive frequency difference between the two markers.
9. Use the 99 % power bandwidth function of the spectrum analyzer and report the measured bandwidth.



3.7 Conducted Band Edge

3.7.1 Description of Conducted Band Edge Measurement

27.53 (g)

For operations in the 600MHz band and 698 -746 MHz band, the FCC limit is $43 + 10\log_{10}(P[\text{Watts}])$ dB below the transmitter power $P(\text{Watts})$ in a 100 kHz bandwidth. However, in the 100 kilohertz bands immediately outside and adjacent to a licensee's frequency block, a resolution bandwidth of at least 30 kHz may be employed.

27.53(m)(4)

For mobile digital stations, the attenuation factor shall be not less than $40 + 10 \log (P)$ dB on all frequencies between the channel edge and 5 megahertz from the channel edge, $43 + 10 \log (P)$ dB on all frequencies between 5 megahertz and X megahertz from the channel edge, and $55 + 10 \log (P)$ dB on all frequencies more than X megahertz from the channel edge, where X is the greater of 6 megahertz or the actual emission bandwidth as defined in paragraph (m)(6) of this section. In addition, the attenuation factor shall not be less that $43 + 10 \log (P)$ dB on all frequencies between 2490.5 MHz and 2496 MHz and $55 + 10 \log (P)$ dB at or below 2490.5 MHz. Mobile Satellite Service licensees operating on frequencies below 2495 MHz may also submit a documented interference complaint against BRS licensees operating on channel BRS Channel 1 on the same terms and conditions as adjacent channel BRS or EBS licensees.



3.7.2 Test Procedures

1. The testing follows ANSI C63.26 section 5.7
2. The EUT was connected to spectrum analyzer and system simulator via a power divider.
3. The band edges of low and high channels for the highest RF powers were measured.
4. Set RBW \geq 1%/2% EBW in the 1MHz band immediately outside and adjacent to the band edge.
5. Beyond the 1 MHz band from the band edge, RBW=1MHz was used.
6. Set spectrum analyzer with RMS detector.
7. Offset has included the duty factor for Band n38/n41. Duty factor = $10 \log(1/x)$, where x is the measured duty cycle.
8. The RF fundamental frequency should be excluded against the limit line in the operating frequency band.
9. Checked that all the results comply with the emission limit line.

Example:

The limit line is derived from $43 + 10\log(P)$ dB below the transmitter power P(Watts)

$$= P(W) - [43 + 10\log(P)] \text{ (dB)}$$

$$= [30 + 10\log(P)] \text{ (dBm)} - [43 + 10\log(P)] \text{ (dB)} = -13\text{dBm}.$$

10. For 5G NR n7/n38/n41, the other 40 dB, and 55 dB have additionally applied same calculation above.
11. When using the integration method, the starting frequency of the integration shall be centered at one-half of the RBW away from the band edge.



3.8 Conducted Spurious Emission

3.8.1 Description of Conducted Spurious Emission Measurement

The power of any emission outside of the authorized operating frequency ranges must be lower than the transmitter power (P) by a factor of at least $43 + 10 \log (P)$ dB.

For 5G NR n7/n38/n41:

The power of any emission outside of the authorized operating frequency ranges must be lower than the transmitter power (P) by a factor of at least $55 + 10 \log (P)$ dB.

It is measured by means of a calibrated spectrum analyzer and scanned from 30 MHz up to a frequency including its 10th harmonic.

3.8.2 Test Procedures

1. The testing follows ANSI C63.26 section 5.7
2. The EUT was connected to spectrum analyzer and system simulator via a power divider.
3. The RF output of EUT was connected to the spectrum analyzer by RF cable and attenuator. The path loss was compensated to the results for each measurement.
4. The middle channel for the highest RF power within the transmitting frequency was measured.
5. The conducted spurious emission for the whole frequency range was taken.
6. Make the measurement with the spectrum analyzer's RBW = 1MHz, VBW = 3MHz.
7. Set spectrum analyzer with RMS detector.
8. Offset has included the duty factor for Band n38/n41. Duty factor = $10 \log (1/x)$, where x is the measured duty cycle.
9. Taking the record of maximum spurious emission.
10. The RF fundamental frequency should be excluded against the limit line in the operating frequency band.
11. The limit line is derived from $43 + 10 \log (P)$ dB below the transmitter power P(Watts)
= $P(W) - [43 + 10 \log (P)]$ (dB)
= $[30 + 10 \log (P)]$ (dBm) - $[43 + 10 \log (P)]$ (dB)
= -13dBm.
12. For 5G NR n7/n38/n41
The limit line is derived from $55 + 10 \log (P)$ dB below the transmitter power P(Watts)
= $P(W) - [55 + 10 \log (P)]$ (dB)
= $[30 + 10 \log (P)]$ (dBm) - $[55 + 10 \log (P)]$ (dB)
= -25dBm.



3.9 Frequency Stability

3.9.1 Description of Frequency Stability Measurement

The frequency stability shall be measured by variation of ambient temperature and variation of primary supply voltage to ensure that the fundamental emission stays within the authorized frequency block. The frequency stability of the transmitter shall be maintained within $\pm 0.00025\%$ ($\pm 2.5\text{ppm}$) of the center frequency.

3.9.2 Test Procedures for Temperature Variation

1. The testing follows ANSI C63.26 section 5.6.4
2. The EUT was set up in the thermal chamber and connected with the system simulator.
3. With power OFF, the temperature was decreased to -30°C and the EUT was stabilized before testing. Power was applied and the maximum change in frequency was recorded within one minute.
4. With power OFF, the temperature was raised in 10°C step up to 50°C . The EUT was stabilized at each step for at least half an hour. Power was applied and the maximum frequency change was recorded within one minute.

3.9.3 Test Procedures for Voltage Variation

1. The testing follows ANSI C63.26 section 5.6.5
2. The EUT was placed in a temperature chamber at $20\pm 5^{\circ}\text{C}$ and connected with the system simulator.
3. The power supply voltage to the EUT was varied from 85% to 115% of the nominal value for other than hand carried battery equipment.
4. For hand carried, battery powered equipment, reduce the primary ac or dc supply voltage to the battery operating end point, which shall be specified by the manufacturer.
5. The variation in frequency was measured for the worst case.

4 Radiated Test Items

4.1 Measuring Instruments

See list of measuring instruments of this test report.

4.2 Test Setup

4.2.1 For radiated test below 30MHz

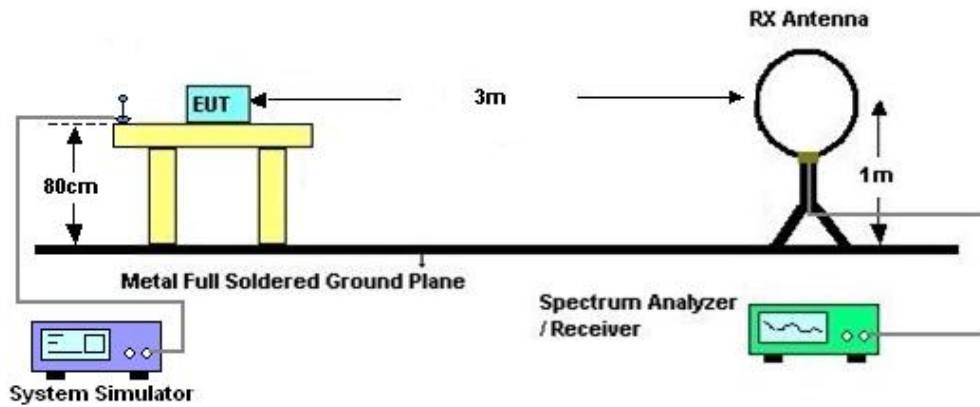

4.2.2 For radiated test from 30MHz to 1GHz

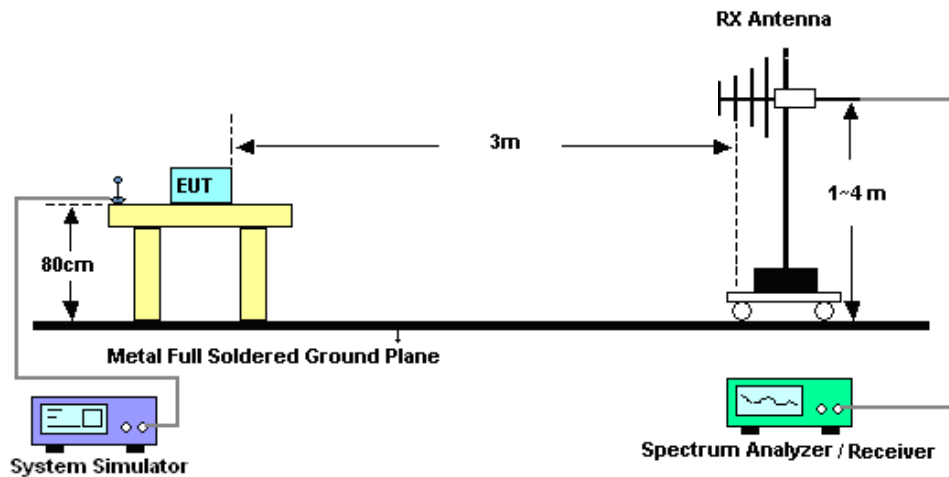

4.2.3 For radiated test above 1GHz

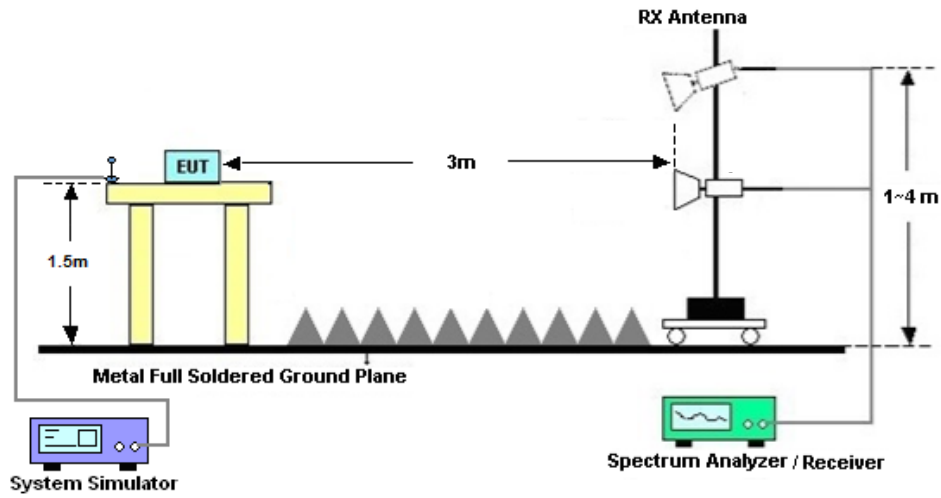

4.3 Test Result of Radiated Test

The low frequency, which started from 9 kHz to 30MHz, was pre-scanned and the result which was 20dB lower than the limit line was not reported.

Please refer to Appendix B.



4.4 Radiated Spurious Emission

4.4.1 Description of Radiated Spurious Emission

The radiated spurious emission was measured by substitution method according to ANSI C63.26. The power of any emission outside of the authorized operating frequency ranges must be attenuated below the transmitter power (P) by a factor of at least $43 + 10 \log (P)$ dB.

For 5G NR n7/n38/n41

The power of any emission outside of the authorized operating frequency ranges must be attenuated below the transmitter power (P) by a factor of at least $55 + 10 \log (P)$ dB.

The spectrum is scanned from 30 MHz up to a frequency including its 10th harmonic.

4.4.2 Test Procedures

1. The testing follows ANSI C63.26 Section 5.5
2. The EUT was placed on a turntable with 0.8 meter height for frequency below 1GHz and 1.5 meter height for frequency above 1GHz respectively above ground.
3. The EUT was set 3 meters from the receiving antenna mounted on the antenna tower.
4. The table was rotated 360 degrees to determine the position of the highest spurious emission.
5. The height of the receiving antenna is varied between 1m to 4m to search the maximum spurious emission for both horizontal and vertical polarizations.
6. During the measurement, the system simulator parameters were set to force the EUT transmitting at maximum output power.
7. Make the measurement with the spectrum analyzer's RBW = 1MHz, VBW = 3MHz, taking the record of maximum spurious emission.
8. A horn antenna was substituted in place of the EUT and was driven by a signal generator.
9. Tune the output power of signal generator to the same emission level with EUT maximum spurious emission.
10. $EIRP (dBm) = S.G. Power - Tx Cable Loss + Tx Antenna Gain$
11. $ERP (dBm) = EIRP - 2.15$
12. The RF fundamental frequency should be excluded against the limit line in the operating frequency band.

The limit line is derived from $43 + 10\log(P)$ dB below the transmitter power P(Watts)
 $= P(W) - [43 + 10\log(P)] (dB)$
 $= [30 + 10\log(P)] (dBm) - [43 + 10\log(P)] (dB)$
 $= -13dBm.$

13. For 5G NR n7/n38/n41:

The limit line is derived from $55 + 10\log(P)$ dB below the transmitter power P(Watts)The limit line is derived from $55 + 10\log(P)$ dB below the transmitter power P(Watts)



5 List of Measuring Equipment

Instrument	Manufacturer	Model No.	Serial No.	Characteristics	Calibration Date	Test Date	Due Date	Remark
EMI Test Receiver&SA	Agilent	N9038A	MY52260185	20Hz~26.5GHz	Dec. 27, 2021	Apr. 01, 2022~ Apr. 07, 2022	Dec. 26, 2022	Conducted (TH01-SZ)
Power Divider	TOJOIN	PS-2SM-04 265	60.06.020.007 7	0.4GHz~26.5GHz	Dec. 25, 2021	Apr. 01, 2022~ Apr. 07, 2022	Dec. 24, 2022	Conducted (TH01-SZ)
Thermal Chamber	Ten Billion Hongzhangroup	LP-150U	H2014081803	-40~+150°C	Jul. 14, 2021	Apr. 01, 2022~ Apr. 07, 2022	Jul. 13, 2022	Conducted (TH01-SZ)
EMI Test Receiver	R&S	ESR7	101404	9kHz~7GHz	Oct. 22, 2021	May 22, 2022~ May 24, 2022	Oct. 21, 2022	Radiation (03CH04-SZ)
EXA Spectrum Analyzer	KEYSIGHT	N9010A	MY55150213	10Hz~44GHz	Jul. 20, 2021	May 22, 2022~ May 24, 2022	Jul. 19, 2022	Radiation (03CH04-SZ)
Loop Antenna	R&S	HFH2-Z2	100354	9kHz~30MHz	Jun. 22, 2020	May 22, 2022~ May 24, 2022	Jun. 21, 2022	Radiation (03CH04-SZ)
Bilog Antenna	TeseQ	CBL6111D	41909	30MHz~1GHz	Oct. 22, 2021	May 22, 2022~ May 24, 2022	Oct. 21, 2022	Radiation (03CH04-SZ)
Double Ridge Horn Antenna	SCHWARZBECK	BBHA9120D	9120D-1474	1GHz~18GHz	Jul. 15, 2021	May 22, 2022~ May 24, 2022	Jul. 14, 2022	Radiation (03CH04-SZ)
Horn Antenna	SCHWARZBECK	BBHA9170	9170#679	15GHz~40GHz	Jul. 25, 2021	May 22, 2022~ May 24, 2022	Jul. 24, 2022	Radiation (03CH04-SZ)
Amplifier	Burgeon	BPA-530	102211	0.01Hz ~3000MHz	Oct. 22, 2021	May 22, 2022~ May 24, 2022	Oct. 21, 2022	Radiation (03CH04-SZ)
HF Amplifier	MITEQ	AMF-7D-00 101800-30-1 0P-R	1943528	1GHz~18GHz	Oct. 22, 2021	May 22, 2022~ May 24, 2022	Oct. 21, 2022	Radiation (03CH04-SZ)
HF Amplifier	MITEQ	TTA1840-35 -HG	1871923	18GHz~40GHz	Jul. 20, 2021	May 22, 2022~ May 24, 2022	Jul. 19, 2022	Radiation (03CH04-SZ)
Amplifier	Agilent Technologies	83017A	MY53270156	500MHz~26.5GHz	Oct. 22, 2021	May 22, 2022~ May 24, 2022	Oct. 21, 2022	Radiation (03CH04-SZ)
AC Power Source	Chroma	61601	N/A	N/A	NCR	May 22, 2022~ May 24, 2022	NCR	Radiation (03CH04-SZ)
Turn Table	EM	EM1000	N/A	0~360 degree	NCR	May 22, 2022~ May 24, 2022	NCR	Radiation (03CH04-SZ)

NCR: No Calibration Required



6 Uncertainty of Evaluation

The measurement uncertainties shown below were calculated in accordance with the requirements of ANSI 63.26-2015. All the measurement uncertainty value were shown with a coverage K=2 to indicate 95% level of confidence. The measurement data show herein meets or exceeds the CISPR measurement uncertainty values specified in CISPR 16-4-2 and can be compared directly to specified limit to determine compliance.

Uncertainty of Radiated Emission Measurement (30 MHz ~ 1000 MHz)

Measuring Uncertainty for a Level of Confidence of 95% (U = 2Uc(y))	2.8dB
---	-------

Uncertainty of Radiated Emission Measurement (1 GHz ~ 18 GHz)

Measuring Uncertainty for a Level of Confidence of 95% (U = 2Uc(y))	3.1dB
---	-------

Uncertainty of Radiated Emission Measurement (18 GHz ~ 40 GHz)

Measuring Uncertainty for a Level of Confidence of 95% (U = 2Uc(y))	3.9dB
---	-------

----- THE END -----



Appendix A. Test Results of Conducted Test

Test Engineer :	Jung Guo	Temperature :	22~23°C
		Relative Humidity :	40~42%

FR1 N7 (ANT1)

Transmitter Conducted Output Power And EIRP, ($G_T - L_C$)= 0.39dB

NR Band	SCS (kHz)	Bandwidth (MHz)	Arfcn	Freq (MHz)	Modulation	RB	Conducted Power(dBm)	EIRP (dBm)	EIRP (W)
7	15	5	524500	2502.5	DFT-s-OFDM PI/2 BPSK	12@6	24.54	24.93	0.3112
7	15	5	524500	2502.5	DFT-s-OFDM PI/2 BPSK	1@1	24.4	24.79	0.3013
7	15	5	524500	2502.5	DFT-s-OFDM PI/2 BPSK	1@23	24.43	24.82	0.3034
7	15	5	524500	2502.5	DFT-s-OFDM QPSK	12@6	24.53	24.92	0.3105
7	15	5	524500	2502.5	DFT-s-OFDM QPSK	1@1	24.58	24.97	0.3141
7	15	5	524500	2502.5	DFT-s-OFDM QPSK	1@23	24.69	25.08	0.3221
7	15	5	524500	2502.5	DFT-s-OFDM 16 QAM	12@6	23.39	23.78	0.2388
7	15	5	524500	2502.5	DFT-s-OFDM 16 QAM	1@1	23.53	23.92	0.2466
7	15	5	524500	2502.5	DFT-s-OFDM 16 QAM	1@23	23.65	24.04	0.2535
7	15	5	524500	2502.5	DFT-s-OFDM 64 QAM	12@6	22.03	22.42	0.1746
7	15	5	524500	2502.5	DFT-s-OFDM 64 QAM	1@1	22.06	22.45	0.1758
7	15	5	524500	2502.5	DFT-s-OFDM 64 QAM	1@23	22.1	22.49	0.1774
7	15	5	524500	2502.5	DFT-s-OFDM 256 QAM	12@6	19.81	20.2	0.1047
7	15	5	524500	2502.5	DFT-s-OFDM 256 QAM	1@1	19.68	20.07	0.1016
7	15	5	524500	2502.5	DFT-s-OFDM 256 QAM	1@23	19.72	20.11	0.1026
7	15	5	524500	2502.5	CP-OFDM QPSK	13@6	23.01	23.4	0.2188
7	15	5	524500	2502.5	CP-OFDM QPSK	1@1	23.02	23.41	0.2193
7	15	5	524500	2502.5	CP-OFDM QPSK	1@23	22.73	23.12	0.2051
7	15	5	531000	2535	DFT-s-OFDM PI/2 BPSK	12@6	24.64	25.03	0.3184
7	15	5	531000	2535	DFT-s-OFDM PI/2 BPSK	1@1	24.57	24.96	0.3133
7	15	5	531000	2535	DFT-s-OFDM PI/2 BPSK	1@23	24.56	24.95	0.3126
7	15	5	531000	2535	DFT-s-OFDM QPSK	12@6	24.65	25.04	0.3192
7	15	5	531000	2535	DFT-s-OFDM QPSK	1@1	24.67	25.06	0.3206
7	15	5	531000	2535	DFT-s-OFDM QPSK	1@23	24.84	25.23	0.3334
7	15	5	531000	2535	DFT-s-OFDM 16 QAM	12@6	23.49	23.88	0.2443
7	15	5	531000	2535	DFT-s-OFDM 16 QAM	1@1	23.68	24.07	0.2553
7	15	5	531000	2535	DFT-s-OFDM 16 QAM	1@23	23.78	24.17	0.2612
7	15	5	531000	2535	DFT-s-OFDM 64 QAM	12@6	22.16	22.55	0.1799
7	15	5	531000	2535	DFT-s-OFDM 64 QAM	1@1	22.18	22.57	0.1807

7	15	5	531000	2535	DFT-s-OFDM 64 QAM	1@23	22.24	22.63	0.1832
7	15	5	531000	2535	DFT-s-OFDM 256 QAM	12@6	19.78	20.17	0.1040
7	15	5	531000	2535	DFT-s-OFDM 256 QAM	1@1	19.79	20.18	0.1042
7	15	5	531000	2535	DFT-s-OFDM 256 QAM	1@23	19.86	20.25	0.1059
7	15	5	531000	2535	CP-OFDM QPSK	13@6	23.16	23.55	0.2265
7	15	5	531000	2535	CP-OFDM QPSK	1@1	23.2	23.59	0.2286
7	15	5	531000	2535	CP-OFDM QPSK	1@23	22.88	23.27	0.2123
7	15	5	537500	2567.5	DFT-s-OFDM PI/2 BPSK	12@6	24.63	25.02	0.3177
7	15	5	537500	2567.5	DFT-s-OFDM PI/2 BPSK	1@1	24.54	24.93	0.3112
7	15	5	537500	2567.5	DFT-s-OFDM PI/2 BPSK	1@23	24.51	24.9	0.3090
7	15	5	537500	2567.5	DFT-s-OFDM QPSK	12@6	24.65	25.04	0.3192
7	15	5	537500	2567.5	DFT-s-OFDM QPSK	1@1	24.69	25.08	0.3221
7	15	5	537500	2567.5	DFT-s-OFDM QPSK	1@23	24.79	25.18	0.3296
7	15	5	537500	2567.5	DFT-s-OFDM 16 QAM	12@6	23.53	23.92	0.2466
7	15	5	537500	2567.5	DFT-s-OFDM 16 QAM	1@1	23.68	24.07	0.2553
7	15	5	537500	2567.5	DFT-s-OFDM 16 QAM	1@23	23.7	24.09	0.2564
7	15	5	537500	2567.5	DFT-s-OFDM 64 QAM	12@6	22.13	22.52	0.1786
7	15	5	537500	2567.5	DFT-s-OFDM 64 QAM	1@1	22.18	22.57	0.1807
7	15	5	537500	2567.5	DFT-s-OFDM 64 QAM	1@23	22.23	22.62	0.1828
7	15	5	537500	2567.5	DFT-s-OFDM 256 QAM	12@6	19.82	20.21	0.1050
7	15	5	537500	2567.5	DFT-s-OFDM 256 QAM	1@1	19.67	20.06	0.1014
7	15	5	537500	2567.5	DFT-s-OFDM 256 QAM	1@23	19.73	20.12	0.1028
7	15	5	537500	2567.5	CP-OFDM QPSK	13@6	23.11	23.5	0.2239
7	15	5	537500	2567.5	CP-OFDM QPSK	1@1	23.16	23.55	0.2265
7	15	5	537500	2567.5	CP-OFDM QPSK	1@23	22.87	23.26	0.2118
7	15	10	525000	2505	DFT-s-OFDM PI/2 BPSK	25@12	24.55	24.94	0.3119
7	15	10	525000	2505	DFT-s-OFDM PI/2 BPSK	1@1	24.39	24.78	0.3006
7	15	10	525000	2505	DFT-s-OFDM PI/2 BPSK	1@50	24.54	24.93	0.3112
7	15	10	525000	2505	DFT-s-OFDM QPSK	25@12	24.49	24.88	0.3076
7	15	10	525000	2505	DFT-s-OFDM QPSK	1@1	24.49	24.88	0.3076
7	15	10	525000	2505	DFT-s-OFDM QPSK	1@50	24.77	25.16	0.3281
7	15	10	525000	2505	DFT-s-OFDM 16 QAM	25@12	23.46	23.85	0.2427
7	15	10	525000	2505	DFT-s-OFDM 16 QAM	1@1	23.58	23.97	0.2495
7	15	10	525000	2505	DFT-s-OFDM 16 QAM	1@50	23.7	24.09	0.2564

7	15	10	525000	2505	DFT-s-OFDM 64 QAM	25@12	22.1	22.49	0.1774
7	15	10	525000	2505	DFT-s-OFDM 64 QAM	1@1	22.05	22.44	0.1754
7	15	10	525000	2505	DFT-s-OFDM 64 QAM	1@50	22.08	22.47	0.1766
7	15	10	525000	2505	DFT-s-OFDM 256 QAM	25@12	19.91	20.3	0.1072
7	15	10	525000	2505	DFT-s-OFDM 256 QAM	1@1	19.69	20.08	0.1019
7	15	10	525000	2505	DFT-s-OFDM 256 QAM	1@50	19.83	20.22	0.1052
7	15	10	525000	2505	CP-OFDM QPSK	26@13	22.95	23.34	0.2158
7	15	10	525000	2505	CP-OFDM QPSK	1@1	23.05	23.44	0.2208
7	15	10	525000	2505	CP-OFDM QPSK	1@50	22.94	23.33	0.2153
7	15	10	531000	2535	DFT-s-OFDM PI/2 BPSK	25@12	24.62	25.01	0.3170
7	15	10	531000	2535	DFT-s-OFDM PI/2 BPSK	1@1	24.54	24.93	0.3112
7	15	10	531000	2535	DFT-s-OFDM PI/2 BPSK	1@50	24.58	24.97	0.3141
7	15	10	531000	2535	DFT-s-OFDM QPSK	25@12	24.63	25.02	0.3177
7	15	10	531000	2535	DFT-s-OFDM QPSK	1@1	24.64	25.03	0.3184
7	15	10	531000	2535	DFT-s-OFDM QPSK	1@50	24.7	25.09	0.3228
7	15	10	531000	2535	DFT-s-OFDM 16 QAM	25@12	23.63	24.02	0.2523
7	15	10	531000	2535	DFT-s-OFDM 16 QAM	1@1	23.62	24.01	0.2518
7	15	10	531000	2535	DFT-s-OFDM 16 QAM	1@50	23.71	24.1	0.2570
7	15	10	531000	2535	DFT-s-OFDM 64 QAM	25@12	22.28	22.67	0.1849
7	15	10	531000	2535	DFT-s-OFDM 64 QAM	1@1	22.08	22.47	0.1766
7	15	10	531000	2535	DFT-s-OFDM 64 QAM	1@50	22.23	22.62	0.1828
7	15	10	531000	2535	DFT-s-OFDM 256 QAM	25@12	19.83	20.22	0.1052
7	15	10	531000	2535	DFT-s-OFDM 256 QAM	1@1	19.72	20.11	0.1026
7	15	10	531000	2535	DFT-s-OFDM 256 QAM	1@50	19.7	20.09	0.1021
7	15	10	531000	2535	CP-OFDM QPSK	26@13	23.07	23.46	0.2218
7	15	10	531000	2535	CP-OFDM QPSK	1@1	23.25	23.64	0.2312
7	15	10	531000	2535	CP-OFDM QPSK	1@50	22.91	23.3	0.2138
7	15	10	537000	2565	DFT-s-OFDM PI/2 BPSK	25@12	24.68	25.07	0.3214
7	15	10	537000	2565	DFT-s-OFDM PI/2 BPSK	1@1	24.47	24.86	0.3062
7	15	10	537000	2565	DFT-s-OFDM PI/2 BPSK	1@50	24.59	24.98	0.3148
7	15	10	537000	2565	DFT-s-OFDM QPSK	25@12	24.57	24.96	0.3133
7	15	10	537000	2565	DFT-s-OFDM QPSK	1@1	24.53	24.92	0.3105
7	15	10	537000	2565	DFT-s-OFDM QPSK	1@50	24.74	25.13	0.3258
7	15	10	537000	2565	DFT-s-OFDM 16 QAM	25@12	23.57	23.96	0.2489

7	15	10	537000	2565	DFT-s-OFDM 16 QAM	1@1	23.63	24.02	0.2523
7	15	10	537000	2565	DFT-s-OFDM 16 QAM	1@50	23.75	24.14	0.2594
7	15	10	537000	2565	DFT-s-OFDM 64 QAM	25@12	22.18	22.57	0.1807
7	15	10	537000	2565	DFT-s-OFDM 64 QAM	1@1	22.1	22.49	0.1774
7	15	10	537000	2565	DFT-s-OFDM 64 QAM	1@50	22.21	22.6	0.1820
7	15	10	537000	2565	DFT-s-OFDM 256 QAM	25@12	19.93	20.32	0.1076
7	15	10	537000	2565	DFT-s-OFDM 256 QAM	1@1	19.77	20.16	0.1038
7	15	10	537000	2565	DFT-s-OFDM 256 QAM	1@50	19.83	20.22	0.1052
7	15	10	537000	2565	CP-OFDM QPSK	26@13	23.02	23.41	0.2193
7	15	10	537000	2565	CP-OFDM QPSK	1@1	23.14	23.53	0.2254
7	15	10	537000	2565	CP-OFDM QPSK	1@50	22.93	23.32	0.2148
7	15	15	525500	2507.5	DFT-s-OFDM PI/2 BPSK	36@18	24.72	25.11	0.3243
7	15	15	525500	2507.5	DFT-s-OFDM PI/2 BPSK	1@1	24.64	25.03	0.3184
7	15	15	525500	2507.5	DFT-s-OFDM PI/2 BPSK	1@77	24.63	25.02	0.3177
7	15	15	525500	2507.5	DFT-s-OFDM QPSK	36@18	24.73	25.12	0.3251
7	15	15	525500	2507.5	DFT-s-OFDM QPSK	1@1	24.73	25.12	0.3251
7	15	15	525500	2507.5	DFT-s-OFDM QPSK	1@77	24.79	25.18	0.3296
7	15	15	525500	2507.5	DFT-s-OFDM 16 QAM	36@18	23.71	24.1	0.2570
7	15	15	525500	2507.5	DFT-s-OFDM 16 QAM	1@1	23.84	24.23	0.2649
7	15	15	525500	2507.5	DFT-s-OFDM 16 QAM	1@77	23.75	24.14	0.2594
7	15	15	525500	2507.5	DFT-s-OFDM 64 QAM	36@18	22.25	22.64	0.1837
7	15	15	525500	2507.5	DFT-s-OFDM 64 QAM	1@1	22.27	22.66	0.1845
7	15	15	525500	2507.5	DFT-s-OFDM 64 QAM	1@77	22.27	22.66	0.1845
7	15	15	525500	2507.5	DFT-s-OFDM 256 QAM	36@18	19.91	20.3	0.1072
7	15	15	525500	2507.5	DFT-s-OFDM 256 QAM	1@1	19.95	20.34	0.1081
7	15	15	525500	2507.5	DFT-s-OFDM 256 QAM	1@77	19.9	20.29	0.1069
7	15	15	525500	2507.5	CP-OFDM QPSK	39@19	23.26	23.65	0.2317
7	15	15	525500	2507.5	CP-OFDM QPSK	1@1	23.33	23.72	0.2355
7	15	15	525500	2507.5	CP-OFDM QPSK	1@77	22.99	23.38	0.2178
7	15	15	531000	2535	DFT-s-OFDM PI/2 BPSK	36@18	24.76	25.15	0.3273
7	15	15	531000	2535	DFT-s-OFDM PI/2 BPSK	1@1	24.72	25.11	0.3243
7	15	15	531000	2535	DFT-s-OFDM PI/2 BPSK	1@77	24.67	25.06	0.3206
7	15	15	531000	2535	DFT-s-OFDM QPSK	36@18	24.8	25.19	0.3304
7	15	15	531000	2535	DFT-s-OFDM QPSK	1@1	24.8	25.19	0.3304

7	15	15	531000	2535	DFT-s-OFDM QPSK	1@77	24.88	25.27	0.3365
7	15	15	531000	2535	DFT-s-OFDM 16 QAM	36@18	23.75	24.14	0.2594
7	15	15	531000	2535	DFT-s-OFDM 16 QAM	1@1	23.86	24.25	0.2661
7	15	15	531000	2535	DFT-s-OFDM 16 QAM	1@77	23.89	24.28	0.2679
7	15	15	531000	2535	DFT-s-OFDM 64 QAM	36@18	22.28	22.67	0.1849
7	15	15	531000	2535	DFT-s-OFDM 64 QAM	1@1	22.33	22.72	0.1871
7	15	15	531000	2535	DFT-s-OFDM 64 QAM	1@77	22.3	22.69	0.1858
7	15	15	531000	2535	DFT-s-OFDM 256 QAM	36@18	19.88	20.27	0.1064
7	15	15	531000	2535	DFT-s-OFDM 256 QAM	1@1	19.98	20.37	0.1089
7	15	15	531000	2535	DFT-s-OFDM 256 QAM	1@77	19.98	20.37	0.1089
7	15	15	531000	2535	CP-OFDM QPSK	39@19	23.31	23.7	0.2344
7	15	15	531000	2535	CP-OFDM QPSK	1@1	23.23	23.62	0.2301
7	15	15	531000	2535	CP-OFDM QPSK	1@77	23	23.39	0.2183
7	15	15	536500	2562.5	DFT-s-OFDM PI/2 BPSK	36@18	24.72	25.11	0.3243
7	15	15	536500	2562.5	DFT-s-OFDM PI/2 BPSK	1@1	24.61	25	0.3162
7	15	15	536500	2562.5	DFT-s-OFDM PI/2 BPSK	1@77	24.59	24.98	0.3148
7	15	15	536500	2562.5	DFT-s-OFDM QPSK	36@18	24.71	25.1	0.3236
7	15	15	536500	2562.5	DFT-s-OFDM QPSK	1@1	24.75	25.14	0.3266
7	15	15	536500	2562.5	DFT-s-OFDM QPSK	1@77	24.73	25.12	0.3251
7	15	15	536500	2562.5	DFT-s-OFDM 16 QAM	36@18	23.7	24.09	0.2564
7	15	15	536500	2562.5	DFT-s-OFDM 16 QAM	1@1	23.85	24.24	0.2655
7	15	15	536500	2562.5	DFT-s-OFDM 16 QAM	1@77	23.76	24.15	0.2600
7	15	15	536500	2562.5	DFT-s-OFDM 64 QAM	36@18	22.22	22.61	0.1824
7	15	15	536500	2562.5	DFT-s-OFDM 64 QAM	1@1	22.26	22.65	0.1841
7	15	15	536500	2562.5	DFT-s-OFDM 64 QAM	1@77	22.24	22.63	0.1832
7	15	15	536500	2562.5	DFT-s-OFDM 256 QAM	36@18	19.66	20.05	0.1012
7	15	15	536500	2562.5	DFT-s-OFDM 256 QAM	1@1	19.97	20.36	0.1086
7	15	15	536500	2562.5	DFT-s-OFDM 256 QAM	1@77	19.95	20.34	0.1081
7	15	15	536500	2562.5	CP-OFDM QPSK	39@19	23.22	23.61	0.2296
7	15	15	536500	2562.5	CP-OFDM QPSK	1@1	22.99	23.38	0.2178
7	15	15	536500	2562.5	CP-OFDM QPSK	1@77	22.83	23.22	0.2099
7	15	20	526000	2510	DFT-s-OFDM PI/2 BPSK	50@25	24.68	25.07	0.3214
7	15	20	526000	2510	DFT-s-OFDM PI/2 BPSK	1@1	24.65	25.04	0.3192
7	15	20	526000	2510	DFT-s-OFDM PI/2 BPSK	1@104	24.71	25.1	0.3236

7	15	20	526000	2510	DFT-s-OFDM QPSK	50@25	24.76	25.15	0.3273
7	15	20	526000	2510	DFT-s-OFDM QPSK	1@1	24.76	25.15	0.3273
7	15	20	526000	2510	DFT-s-OFDM QPSK	1@104	24.45	24.84	0.3048
7	15	20	526000	2510	DFT-s-OFDM 16 QAM	50@25	23.67	24.06	0.2547
7	15	20	526000	2510	DFT-s-OFDM 16 QAM	1@1	23.83	24.22	0.2642
7	15	20	526000	2510	DFT-s-OFDM 16 QAM	1@104	23.82	24.21	0.2636
7	15	20	526000	2510	DFT-s-OFDM 64 QAM	50@25	22.25	22.64	0.1837
7	15	20	526000	2510	DFT-s-OFDM 64 QAM	1@1	22.31	22.7	0.1862
7	15	20	526000	2510	DFT-s-OFDM 64 QAM	1@104	22.34	22.73	0.1875
7	15	20	526000	2510	DFT-s-OFDM 256 QAM	50@25	20.16	20.55	0.1135
7	15	20	526000	2510	DFT-s-OFDM 256 QAM	1@1	19.97	20.36	0.1086
7	15	20	526000	2510	DFT-s-OFDM 256 QAM	1@104	20.01	20.4	0.1096
7	15	20	526000	2510	CP-OFDM QPSK	53@26	23.25	23.64	0.2312
7	15	20	526000	2510	CP-OFDM QPSK	1@1	23.02	23.41	0.2193
7	15	20	526000	2510	CP-OFDM QPSK	1@104	23.13	23.52	0.2249
7	15	20	531000	2535	DFT-s-OFDM PI/2 BPSK	50@25	24.79	25.18	0.3296
7	15	20	531000	2535	DFT-s-OFDM PI/2 BPSK	1@1	24.72	25.11	0.3243
7	15	20	531000	2535	DFT-s-OFDM PI/2 BPSK	1@104	24.72	25.11	0.3243
7	15	20	531000	2535	DFT-s-OFDM QPSK	50@25	24.8	25.19	0.3304
7	15	20	531000	2535	DFT-s-OFDM QPSK	1@1	24.84	25.23	0.3334
7	15	20	531000	2535	DFT-s-OFDM QPSK	1@104	24.87	25.26	0.3357
7	15	20	531000	2535	DFT-s-OFDM 16 QAM	50@25	23.73	24.12	0.2582
7	15	20	531000	2535	DFT-s-OFDM 16 QAM	1@1	23.84	24.23	0.2649
7	15	20	531000	2535	DFT-s-OFDM 16 QAM	1@104	23.83	24.22	0.2642
7	15	20	531000	2535	DFT-s-OFDM 64 QAM	50@25	22.28	22.67	0.1849
7	15	20	531000	2535	DFT-s-OFDM 64 QAM	1@1	22.33	22.72	0.1871
7	15	20	531000	2535	DFT-s-OFDM 64 QAM	1@104	22.35	22.74	0.1879
7	15	20	531000	2535	DFT-s-OFDM 256 QAM	50@25	20.06	20.45	0.1109
7	15	20	531000	2535	DFT-s-OFDM 256 QAM	1@1	19.98	20.37	0.1089
7	15	20	531000	2535	DFT-s-OFDM 256 QAM	1@104	19.98	20.37	0.1089
7	15	20	531000	2535	CP-OFDM QPSK	53@26	23.24	23.63	0.2307
7	15	20	531000	2535	CP-OFDM QPSK	1@1	23.1	23.49	0.2234
7	15	20	531000	2535	CP-OFDM QPSK	1@104	23.03	23.42	0.2198
7	15	20	536000	2560	DFT-s-OFDM PI/2 BPSK	50@25	24.75	25.14	0.3266

7	15	20	536000	2560	DFT-s-OFDM PI/2 BPSK	1@1	24.64	25.03	0.3184
7	15	20	536000	2560	DFT-s-OFDM PI/2 BPSK	1@104	24.58	24.97	0.3141
7	15	20	536000	2560	DFT-s-OFDM QPSK	50@25	24.76	25.15	0.3273
7	15	20	536000	2560	DFT-s-OFDM QPSK	1@1	24.73	25.12	0.3251
7	15	20	536000	2560	DFT-s-OFDM QPSK	1@104	24.75	25.14	0.3266
7	15	20	536000	2560	DFT-s-OFDM 16 QAM	50@25	23.67	24.06	0.2547
7	15	20	536000	2560	DFT-s-OFDM 16 QAM	1@1	23.79	24.18	0.2618
7	15	20	536000	2560	DFT-s-OFDM 16 QAM	1@104	23.72	24.11	0.2576
7	15	20	536000	2560	DFT-s-OFDM 64 QAM	50@25	22.24	22.63	0.1832
7	15	20	536000	2560	DFT-s-OFDM 64 QAM	1@1	22.33	22.72	0.1871
7	15	20	536000	2560	DFT-s-OFDM 64 QAM	1@104	22.23	22.62	0.1828
7	15	20	536000	2560	DFT-s-OFDM 256 QAM	50@25	19.81	20.2	0.1047
7	15	20	536000	2560	DFT-s-OFDM 256 QAM	1@1	19.93	20.32	0.1076
7	15	20	536000	2560	DFT-s-OFDM 256 QAM	1@104	19.88	20.27	0.1064
7	15	20	536000	2560	CP-OFDM QPSK	53@26	23.22	23.61	0.2296
7	15	20	536000	2560	CP-OFDM QPSK	1@1	23.03	23.42	0.2198
7	15	20	536000	2560	CP-OFDM QPSK	1@104	22.93	23.32	0.2148
7	15	25	526500	2512.5	DFT-s-OFDM PI/2 BPSK	64@32	24.77	25.16	0.3281
7	15	25	526500	2512.5	DFT-s-OFDM PI/2 BPSK	1@1	24.66	25.05	0.3199
7	15	25	526500	2512.5	DFT-s-OFDM PI/2 BPSK	1@131	24.78	25.17	0.3289
7	15	25	526500	2512.5	DFT-s-OFDM QPSK	64@32	24.81	25.2	0.3311
7	15	25	526500	2512.5	DFT-s-OFDM QPSK	1@1	24.69	25.08	0.3221
7	15	25	526500	2512.5	DFT-s-OFDM QPSK	1@131	24.92	25.31	0.3396
7	15	25	526500	2512.5	DFT-s-OFDM 16 QAM	64@32	23.71	24.1	0.2570
7	15	25	526500	2512.5	DFT-s-OFDM 16 QAM	1@1	23.87	24.26	0.2667
7	15	25	526500	2512.5	DFT-s-OFDM 16 QAM	1@131	23.94	24.33	0.2710
7	15	25	526500	2512.5	DFT-s-OFDM 64 QAM	64@32	22.3	22.69	0.1858
7	15	25	526500	2512.5	DFT-s-OFDM 64 QAM	1@1	22.34	22.73	0.1875
7	15	25	526500	2512.5	DFT-s-OFDM 64 QAM	1@131	22.37	22.76	0.1888
7	15	25	526500	2512.5	DFT-s-OFDM 256 QAM	64@32	20.21	20.6	0.1148
7	15	25	526500	2512.5	DFT-s-OFDM 256 QAM	1@1	20	20.39	0.1094
7	15	25	526500	2512.5	DFT-s-OFDM 256 QAM	1@131	20.04	20.43	0.1104
7	15	25	526500	2512.5	CP-OFDM QPSK	67@33	23.24	23.63	0.2307
7	15	25	526500	2512.5	CP-OFDM QPSK	1@1	23.05	23.44	0.2208

7	15	25	526500	2512.5	CP-OFDM QPSK	1@131	23.18	23.57	0.2275
7	15	25	531000	2535	DFT-s-OFDM PI/2 BPSK	64@32	24.83	25.22	0.3327
7	15	25	531000	2535	DFT-s-OFDM PI/2 BPSK	1@1	24.75	25.14	0.3266
7	15	25	531000	2535	DFT-s-OFDM PI/2 BPSK	1@131	24.72	25.11	0.3243
7	15	25	531000	2535	DFT-s-OFDM QPSK	64@32	24.79	25.18	0.3296
7	15	25	531000	2535	DFT-s-OFDM QPSK	1@1	24.96	25.35	0.3428
7	15	25	531000	2535	DFT-s-OFDM QPSK	1@131	24.9	25.29	0.3381
7	15	25	531000	2535	DFT-s-OFDM 16 QAM	64@32	23.75	24.14	0.2594
7	15	25	531000	2535	DFT-s-OFDM 16 QAM	1@1	23.95	24.34	0.2716
7	15	25	531000	2535	DFT-s-OFDM 16 QAM	1@131	23.93	24.32	0.2704
7	15	25	531000	2535	DFT-s-OFDM 64 QAM	64@32	22.3	22.69	0.1858
7	15	25	531000	2535	DFT-s-OFDM 64 QAM	1@1	22.4	22.79	0.1901
7	15	25	531000	2535	DFT-s-OFDM 64 QAM	1@131	22.34	22.73	0.1875
7	15	25	531000	2535	DFT-s-OFDM 256 QAM	64@32	20.02	20.41	0.1099
7	15	25	531000	2535	DFT-s-OFDM 256 QAM	1@1	20.05	20.44	0.1107
7	15	25	531000	2535	DFT-s-OFDM 256 QAM	1@131	19.97	20.36	0.1086
7	15	25	531000	2535	CP-OFDM QPSK	67@33	23.29	23.68	0.2333
7	15	25	531000	2535	CP-OFDM QPSK	1@1	23.23	23.62	0.2301
7	15	25	531000	2535	CP-OFDM QPSK	1@131	23.14	23.53	0.2254
7	15	25	535500	2557.5	DFT-s-OFDM PI/2 BPSK	64@32	24.77	25.16	0.3281
7	15	25	535500	2557.5	DFT-s-OFDM PI/2 BPSK	1@1	24.68	25.07	0.3214
7	15	25	535500	2557.5	DFT-s-OFDM PI/2 BPSK	1@131	24.72	25.11	0.3243
7	15	25	535500	2557.5	DFT-s-OFDM QPSK	64@32	24.74	25.13	0.3258
7	15	25	535500	2557.5	DFT-s-OFDM QPSK	1@1	24.85	25.24	0.3342
7	15	25	535500	2557.5	DFT-s-OFDM QPSK	1@131	24.83	25.22	0.3327
7	15	25	535500	2557.5	DFT-s-OFDM 16 QAM	64@32	23.74	24.13	0.2588
7	15	25	535500	2557.5	DFT-s-OFDM 16 QAM	1@1	23.87	24.26	0.2667
7	15	25	535500	2557.5	DFT-s-OFDM 16 QAM	1@131	23.84	24.23	0.2649
7	15	25	535500	2557.5	DFT-s-OFDM 64 QAM	64@32	22.3	22.69	0.1858
7	15	25	535500	2557.5	DFT-s-OFDM 64 QAM	1@1	22.36	22.75	0.1884
7	15	25	535500	2557.5	DFT-s-OFDM 64 QAM	1@131	22.31	22.7	0.1862
7	15	25	535500	2557.5	DFT-s-OFDM 256 QAM	64@32	19.91	20.3	0.1072
7	15	25	535500	2557.5	DFT-s-OFDM 256 QAM	1@1	19.95	20.34	0.1081
7	15	25	535500	2557.5	DFT-s-OFDM 256 QAM	1@131	19.92	20.31	0.1074

7	15	25	535500	2557.5	CP-OFDM QPSK	67@33	23.23	23.62	0.2301
7	15	25	535500	2557.5	CP-OFDM QPSK	1@1	23.06	23.45	0.2213
7	15	25	535500	2557.5	CP-OFDM QPSK	1@131	22.96	23.35	0.2163
7	15	30	527000	2515	DFT-s-OFDM PI/2 BPSK	80@40	24.79	25.18	0.3296
7	15	30	527000	2515	DFT-s-OFDM PI/2 BPSK	1@1	24.67	25.06	0.3206
7	15	30	527000	2515	DFT-s-OFDM PI/2 BPSK	1@158	24.77	25.16	0.3281
7	15	30	527000	2515	DFT-s-OFDM QPSK	80@40	24.74	25.13	0.3258
7	15	30	527000	2515	DFT-s-OFDM QPSK	1@1	24.79	25.18	0.3296
7	15	30	527000	2515	DFT-s-OFDM QPSK	1@158	24.42	24.81	0.3027
7	15	30	527000	2515	DFT-s-OFDM 16 QAM	80@40	23.65	24.04	0.2535
7	15	30	527000	2515	DFT-s-OFDM 16 QAM	1@1	23.78	24.17	0.2612
7	15	30	527000	2515	DFT-s-OFDM 16 QAM	1@158	23.88	24.27	0.2673
7	15	30	527000	2515	DFT-s-OFDM 64 QAM	80@40	22.23	22.62	0.1828
7	15	30	527000	2515	DFT-s-OFDM 64 QAM	1@1	22.29	22.68	0.1854
7	15	30	527000	2515	DFT-s-OFDM 64 QAM	1@158	22.34	22.73	0.1875
7	15	30	527000	2515	DFT-s-OFDM 256 QAM	80@40	20.16	20.55	0.1135
7	15	30	527000	2515	DFT-s-OFDM 256 QAM	1@1	19.98	20.37	0.1089
7	15	30	527000	2515	DFT-s-OFDM 256 QAM	1@158	20.05	20.44	0.1107
7	15	30	527000	2515	CP-OFDM QPSK	80@40	23.21	23.6	0.2291
7	15	30	527000	2515	CP-OFDM QPSK	1@1	23.36	23.75	0.2371
7	15	30	527000	2515	CP-OFDM QPSK	1@158	23.21	23.6	0.2291
7	15	30	531000	2535	DFT-s-OFDM PI/2 BPSK	80@40	24.77	25.16	0.3281
7	15	30	531000	2535	DFT-s-OFDM PI/2 BPSK	1@1	24.76	25.15	0.3273
7	15	30	531000	2535	DFT-s-OFDM PI/2 BPSK	1@158	24.8	25.19	0.3304
7	15	30	531000	2535	DFT-s-OFDM QPSK	80@40	24.77	25.16	0.3281
7	15	30	531000	2535	DFT-s-OFDM QPSK	1@1	24.92	25.31	0.3396
7	15	30	531000	2535	DFT-s-OFDM QPSK	1@158	24.97	25.36	0.3436
7	15	30	531000	2535	DFT-s-OFDM 16 QAM	80@40	23.72	24.11	0.2576
7	15	30	531000	2535	DFT-s-OFDM 16 QAM	1@1	23.95	24.34	0.2716
7	15	30	531000	2535	DFT-s-OFDM 16 QAM	1@158	24.02	24.41	0.2761
7	15	30	531000	2535	DFT-s-OFDM 64 QAM	80@40	22.27	22.66	0.1845
7	15	30	531000	2535	DFT-s-OFDM 64 QAM	1@1	22.37	22.76	0.1888
7	15	30	531000	2535	DFT-s-OFDM 64 QAM	1@158	22.43	22.82	0.1914
7	15	30	531000	2535	DFT-s-OFDM 256 QAM	80@40	19.82	20.21	0.1050

7	15	30	531000	2535	DFT-s-OFDM 256 QAM	1@1	20.05	20.44	0.1107
7	15	30	531000	2535	DFT-s-OFDM 256 QAM	1@158	20.09	20.48	0.1117
7	15	30	531000	2535	CP-OFDM QPSK	80@40	23.17	23.56	0.2270
7	15	30	531000	2535	CP-OFDM QPSK	1@1	23.29	23.68	0.2333
7	15	30	531000	2535	CP-OFDM QPSK	1@158	23.44	23.83	0.2415
7	15	30	535000	2555	DFT-s-OFDM PI/2 BPSK	80@40	24.84	25.23	0.3334
7	15	30	535000	2555	DFT-s-OFDM PI/2 BPSK	1@1	24.73	25.12	0.3251
7	15	30	535000	2555	DFT-s-OFDM PI/2 BPSK	1@158	24.79	25.18	0.3296
7	15	30	535000	2555	DFT-s-OFDM QPSK	80@40	24.75	25.14	0.3266
7	15	30	535000	2555	DFT-s-OFDM QPSK	1@1	24.8	25.19	0.3304
7	15	30	535000	2555	DFT-s-OFDM QPSK	1@158	24.86	25.25	0.3350
7	15	30	535000	2555	DFT-s-OFDM 16 QAM	80@40	23.83	24.22	0.2642
7	15	30	535000	2555	DFT-s-OFDM 16 QAM	1@1	23.87	24.26	0.2667
7	15	30	535000	2555	DFT-s-OFDM 16 QAM	1@158	23.92	24.31	0.2698
7	15	30	535000	2555	DFT-s-OFDM 64 QAM	80@40	22.35	22.74	0.1879
7	15	30	535000	2555	DFT-s-OFDM 64 QAM	1@1	22.31	22.7	0.1862
7	15	30	535000	2555	DFT-s-OFDM 64 QAM	1@158	22.39	22.78	0.1897
7	15	30	535000	2555	DFT-s-OFDM 256 QAM	80@40	19.71	20.1	0.1023
7	15	30	535000	2555	DFT-s-OFDM 256 QAM	1@1	20	20.39	0.1094
7	15	30	535000	2555	DFT-s-OFDM 256 QAM	1@158	20.09	20.48	0.1117
7	15	30	535000	2555	CP-OFDM QPSK	80@40	23.3	23.69	0.2339
7	15	30	535000	2555	CP-OFDM QPSK	1@1	23.08	23.47	0.2223
7	15	30	535000	2555	CP-OFDM QPSK	1@158	23.17	23.56	0.2270
7	15	40	528000	2520	DFT-s-OFDM PI/2 BPSK	108@54	24.81	25.2	0.3311
7	15	40	528000	2520	DFT-s-OFDM PI/2 BPSK	1@1	24.7	25.09	0.3228
7	15	40	528000	2520	DFT-s-OFDM PI/2 BPSK	1@214	24.79	25.18	0.3296
7	15	40	528000	2520	DFT-s-OFDM QPSK	108@54	24.87	25.26	0.3357
7	15	40	528000	2520	DFT-s-OFDM QPSK	1@1	24.89	25.28	0.3373
7	15	40	528000	2520	DFT-s-OFDM QPSK	1@214	24.9	25.29	0.3381
7	15	40	528000	2520	DFT-s-OFDM 16 QAM	108@54	23.85	24.24	0.2655
7	15	40	528000	2520	DFT-s-OFDM 16 QAM	1@1	23.87	24.26	0.2667
7	15	40	528000	2520	DFT-s-OFDM 16 QAM	1@214	23.91	24.3	0.2692
7	15	40	528000	2520	DFT-s-OFDM 64 QAM	108@54	22.36	22.75	0.1884
7	15	40	528000	2520	DFT-s-OFDM 64 QAM	1@1	22.3	22.69	0.1858

7	15	40	528000	2520	DFT-s-OFDM 64 QAM	1@214	22.36	22.75	0.1884
7	15	40	528000	2520	DFT-s-OFDM 256 QAM	108@54	20.33	20.72	0.1180
7	15	40	528000	2520	DFT-s-OFDM 256 QAM	1@1	20.08	20.47	0.1114
7	15	40	528000	2520	DFT-s-OFDM 256 QAM	1@214	20.12	20.51	0.1125
7	15	40	528000	2520	CP-OFDM QPSK	108@54	23.3	23.69	0.2339
7	15	40	528000	2520	CP-OFDM QPSK	1@1	23.35	23.74	0.2366
7	15	40	528000	2520	CP-OFDM QPSK	1@214	23.14	23.53	0.2254
7	15	40	531000	2535	DFT-s-OFDM PI/2 BPSK	108@54	24.79	25.18	0.3296
7	15	40	531000	2535	DFT-s-OFDM PI/2 BPSK	1@1	24.78	25.17	0.3289
7	15	40	531000	2535	DFT-s-OFDM PI/2 BPSK	1@214	24.83	25.22	0.3327
7	15	40	531000	2535	DFT-s-OFDM QPSK	108@54	24.79	25.18	0.3296
7	15	40	531000	2535	DFT-s-OFDM QPSK	1@1	24.91	25.3	0.3388
7	15	40	531000	2535	DFT-s-OFDM QPSK	1@214	24.94	25.33	0.3412
7	15	40	531000	2535	DFT-s-OFDM 16 QAM	108@54	23.83	24.22	0.2642
7	15	40	531000	2535	DFT-s-OFDM 16 QAM	1@1	23.99	24.38	0.2742
7	15	40	531000	2535	DFT-s-OFDM 16 QAM	1@214	23.96	24.35	0.2723
7	15	40	531000	2535	DFT-s-OFDM 64 QAM	108@54	22.32	22.71	0.1866
7	15	40	531000	2535	DFT-s-OFDM 64 QAM	1@1	22.36	22.75	0.1884
7	15	40	531000	2535	DFT-s-OFDM 64 QAM	1@214	22.48	22.87	0.1936
7	15	40	531000	2535	DFT-s-OFDM 256 QAM	108@54	19.9	20.29	0.1069
7	15	40	531000	2535	DFT-s-OFDM 256 QAM	1@1	20.11	20.5	0.1122
7	15	40	531000	2535	DFT-s-OFDM 256 QAM	1@214	20.2	20.59	0.1146
7	15	40	531000	2535	CP-OFDM QPSK	108@54	23.25	23.64	0.2312
7	15	40	531000	2535	CP-OFDM QPSK	1@1	23.12	23.51	0.2244
7	15	40	531000	2535	CP-OFDM QPSK	1@214	23.18	23.57	0.2275
7	15	40	534000	2550	DFT-s-OFDM PI/2 BPSK	108@54	24.48	24.87	0.3069
7	15	40	534000	2550	DFT-s-OFDM PI/2 BPSK	1@1	23.63	24.02	0.2523
7	15	40	534000	2550	DFT-s-OFDM PI/2 BPSK	1@214	23.47	23.86	0.2432
7	15	40	534000	2550	DFT-s-OFDM QPSK	108@54	24.92	25.31	0.3396
7	15	40	534000	2550	DFT-s-OFDM QPSK	1@1	24.89	25.28	0.3373
7	15	40	534000	2550	DFT-s-OFDM QPSK	1@214	24.9	25.29	0.3381
7	15	40	534000	2550	DFT-s-OFDM 16 QAM	108@54	23.9	24.29	0.2685
7	15	40	534000	2550	DFT-s-OFDM 16 QAM	1@1	23.89	24.28	0.2679
7	15	40	534000	2550	DFT-s-OFDM 16 QAM	1@214	23.92	24.31	0.2698

7	15	40	534000	2550	DFT-s-OFDM 64 QAM	108@54	22.42	22.81	0.1910
7	15	40	534000	2550	DFT-s-OFDM 64 QAM	1@1	22.34	22.73	0.1875
7	15	40	534000	2550	DFT-s-OFDM 64 QAM	1@214	22.38	22.77	0.1892
7	15	40	534000	2550	DFT-s-OFDM 256 QAM	108@54	20.35	20.74	0.1186
7	15	40	534000	2550	DFT-s-OFDM 256 QAM	1@1	20.12	20.51	0.1125
7	15	40	534000	2550	DFT-s-OFDM 256 QAM	1@214	20.2	20.59	0.1146
7	15	40	534000	2550	CP-OFDM QPSK	108@54	23.39	23.78	0.2388
7	15	40	534000	2550	CP-OFDM QPSK	1@1	23.15	23.54	0.2259
7	15	40	534000	2550	CP-OFDM QPSK	1@214	23.15	23.54	0.2259

Frequency Stability

NR Band	SCS (kHz)	Bandwidth (MHz)	Arfcn	Freq (MHz)	Modulation	RB	Deviation (ppm)	Verdict	Environment
7	15	20	531000	2535.0	DFT-s-OFDM QPSK	100@0	0.00412	PASS	NV
7	15	20	531000	2535.0	DFT-s-OFDM QPSK	100@0	0.00501	PASS	LV
7	15	20	531000	2535.0	DFT-s-OFDM QPSK	100@0	0.00448	PASS	HV
7	15	20	531000	2535.0	DFT-s-OFDM QPSK	100@0	0.00385	PASS	-30°C
7	15	20	531000	2535.0	DFT-s-OFDM QPSK	100@0	0.00529	PASS	-20°C
7	15	20	531000	2535.0	DFT-s-OFDM QPSK	100@0	0.00069	PASS	-10°C
7	15	20	531000	2535.0	DFT-s-OFDM QPSK	100@0	0.00504	PASS	0°C
7	15	20	531000	2535.0	DFT-s-OFDM QPSK	100@0	0.00068	PASS	10°C
7	15	20	531000	2535.0	DFT-s-OFDM QPSK	100@0	0.00225	PASS	20°C
7	15	20	531000	2535.0	DFT-s-OFDM QPSK	100@0	0.00603	PASS	30°C
7	15	20	531000	2535.0	DFT-s-OFDM QPSK	100@0	0.00494	PASS	40°C
7	15	20	531000	2535.0	DFT-s-OFDM QPSK	100@0	0.00614	PASS	50°C

Peak to Average Ratio

NR Band	SCS (kHz)	Bandwidth (MHz)	Arfcn	Freq (MHz)	Modulation	RB	Result (dB)	Limit (dB)	Verdict
7	15	20	526000	2510.0	DFT-s-OFDM PI/2 BPSK	100@0	4.12	13	PASS
7	15	20	526000	2510.0	DFT-s-OFDM PI/2 BPSK	1@0	4.31	13	PASS
7	15	20	526000	2510.0	DFT-s-OFDM QPSK	100@0	5.71	13	PASS
7	15	20	526000	2510.0	DFT-s-OFDM QPSK	1@0	6.1	13	PASS
7	15	20	531000	2535.0	DFT-s-OFDM PI/2 BPSK	100@0	4.26	13	PASS
7	15	20	531000	2535.0	DFT-s-OFDM PI/2 BPSK	1@0	4.4	13	PASS
7	15	20	531000	2535.0	DFT-s-OFDM QPSK	100@0	5.6	13	PASS
7	15	20	531000	2535.0	DFT-s-OFDM QPSK	1@0	6.17	13	PASS
7	15	20	536000	2560.0	DFT-s-OFDM PI/2 BPSK	100@0	4.22	13	PASS
7	15	20	536000	2560.0	DFT-s-OFDM PI/2 BPSK	1@0	4.33	13	PASS
7	15	20	536000	2560.0	DFT-s-OFDM QPSK	100@0	5.53	13	PASS
7	15	20	536000	2560.0	DFT-s-OFDM QPSK	1@0	6.06	13	PASS

N7(20M)_DFT-s-OFDM_PI_2-BPSK_Outer_Full_Low_CH



N7(20M)_DFT-s-OFDM_PI_2-BPSK_Edge_1RB_Left_Low_CH



N7(20M)_DFT-s-OFDM_QPSK_Outer_Full_Low_CH



N7(20M)_DFT-s-OFDM_QPSK_Edge_1RB_Left_Low_CH



N7(20M)_DFT-s-OFDM_PI_2-BPSK_Outer_Full_Mid_CH

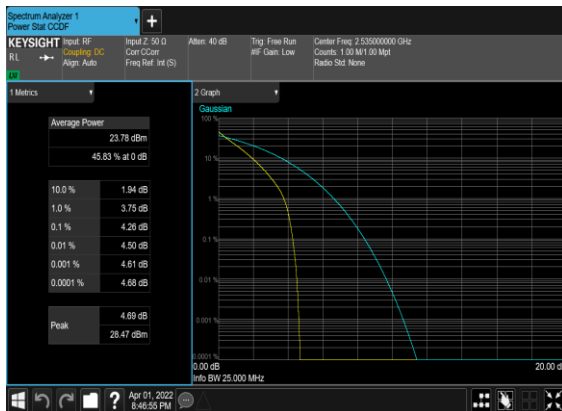

N7(20M)_DFT-s-OFDM_PI_2-BPSK_Edge_1RB_Left_Mid_CH



N7(20M)_DFT-s-OFDM_QPSK_Outer_Full_Mid_CH



N7(20M)_DFT-s-OFDM_QPSK_Edge_1RB_Left_Mid_CH



N7(20M)_DFT-s-OFDM_PI_2-BPSK_Outer_Full_High_CH



N7(20M)_DFT-s-OFDM_PI_2-BPSK_Edge_1RB_Left_High_CH

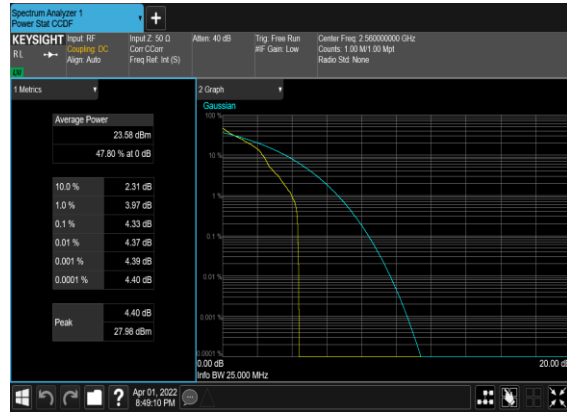

N7(20M)_DFT-s-OFDM_QPSK_Outer_Full_High_CH



N7(20M)_DFT-s-OFDM_QPSK_Edge_1RB_Left_High_CH

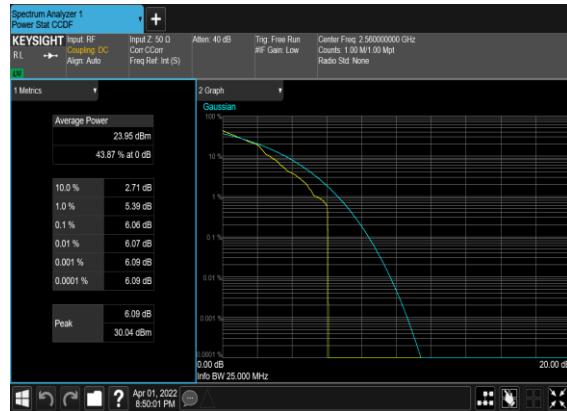

Occupied Bandwidth

NR Band	SCS (kHz)	Bandwidth (MHz)	Arfcn	Freq (MHz)	Modulation	RB	OBW (MHz)	26dB OBW (MHz)
7	15	5	531000	2535.0	DFT-s-OFDM PI/2 BPSK	25@0	4.4828	5.01
7	15	5	531000	2535.0	DFT-s-OFDM QPSK	25@0	4.4824	5.159
7	15	5	531000	2535.0	CP-OFDM QPSK	25@0	4.4695	5.027
7	15	5	531000	2535.0	CP-OFDM 16 QAM	25@0	4.5032	5.181
7	15	5	531000	2535.0	CP-OFDM 64 QAM	25@0	4.4619	5.008
7	15	5	531000	2535.0	CP-OFDM 256 QAM	25@0	4.4846	5.107
7	15	10	531000	2535.0	DFT-s-OFDM PI/2 BPSK	50@0	8.8977	9.585
7	15	10	531000	2535.0	DFT-s-OFDM QPSK	50@0	8.9316	9.751
7	15	10	531000	2535.0	CP-OFDM QPSK	52@0	9.2727	10.06
7	15	10	531000	2535.0	CP-OFDM 16 QAM	52@0	9.2916	10.08
7	15	10	531000	2535.0	CP-OFDM 64 QAM	52@0	9.2763	10.08
7	15	10	531000	2535.0	CP-OFDM 256 QAM	52@0	9.283	10.06
7	15	15	531000	2535.0	DFT-s-OFDM PI/2 BPSK	75@0	13.391	14.4
7	15	15	531000	2535.0	DFT-s-OFDM QPSK	75@0	13.444	14.34
7	15	15	531000	2535.0	CP-OFDM QPSK	79@0	14.095	14.97
7	15	15	531000	2535.0	CP-OFDM 16 QAM	79@0	14.096	14.92
7	15	15	531000	2535.0	CP-OFDM 64 QAM	79@0	14.116	14.98
7	15	15	531000	2535.0	CP-OFDM 256 QAM	79@0	14.081	14.98
7	15	20	531000	2535.0	DFT-s-OFDM PI/2 BPSK	100@0	17.908	18.81
7	15	20	531000	2535.0	DFT-s-OFDM QPSK	100@0	17.867	18.87
7	15	20	531000	2535.0	CP-OFDM QPSK	106@0	18.917	20.06
7	15	20	531000	2535.0	CP-OFDM 16 QAM	106@0	18.949	19.9
7	15	20	531000	2535.0	CP-OFDM 64 QAM	106@0	18.928	20.39
7	15	20	531000	2535.0	CP-OFDM 256 QAM	106@0	18.954	19.95

7	15	25	531000	2535.0	DFT-s-OFDM PI/2 BPSK	128@0	22.856	23.99
7	15	25	531000	2535.0	DFT-s-OFDM QPSK	128@0	22.877	23.95
7	15	25	531000	2535.0	CP-OFDM QPSK	133@0	23.755	24.9
7	15	25	531000	2535.0	CP-OFDM 16 QAM	133@0	23.736	24.89
7	15	25	531000	2535.0	CP-OFDM 64 QAM	133@0	23.774	24.73
7	15	25	531000	2535.0	CP-OFDM 256 QAM	133@0	23.762	24.83
7	15	30	531000	2535.0	DFT-s-OFDM PI/2 BPSK	160@0	28.612	29.72
7	15	30	531000	2535.0	DFT-s-OFDM QPSK	160@0	28.537	29.69
7	15	30	531000	2535.0	CP-OFDM QPSK	160@0	28.554	29.76
7	15	30	531000	2535.0	CP-OFDM 16 QAM	160@0	28.571	29.64
7	15	30	531000	2535.0	CP-OFDM 64 QAM	160@0	28.598	29.71
7	15	30	531000	2535.0	CP-OFDM 256 QAM	160@0	28.561	29.67
7	15	40	531000	2535.0	DFT-s-OFDM PI/2 BPSK	216@0	38.557	40.1
7	15	40	531000	2535.0	DFT-s-OFDM QPSK	216@0	38.502	40.02
7	15	40	531000	2535.0	CP-OFDM QPSK	216@0	38.559	39.96
7	15	40	531000	2535.0	CP-OFDM 16 QAM	216@0	38.579	40.1
7	15	40	531000	2535.0	CP-OFDM 64 QAM	216@0	38.587	40.01
7	15	40	531000	2535.0	CP-OFDM 256 QAM	216@0	38.546	40.02

N7(5M)_DFT-s-OFDM_PI_2-BPSK_Outer_Full_Mid_CH

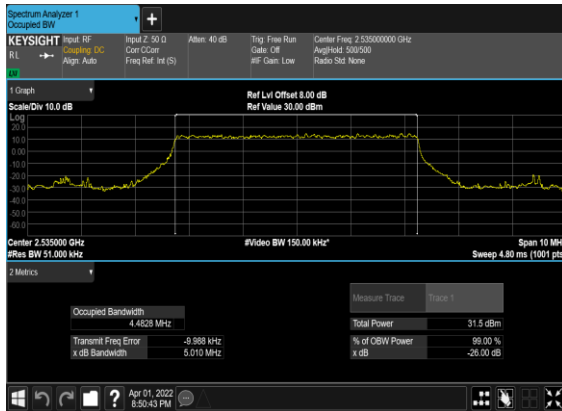

N7(5M)_DFT-s-OFDM_QPSK_Outer_Full_Mid_CH

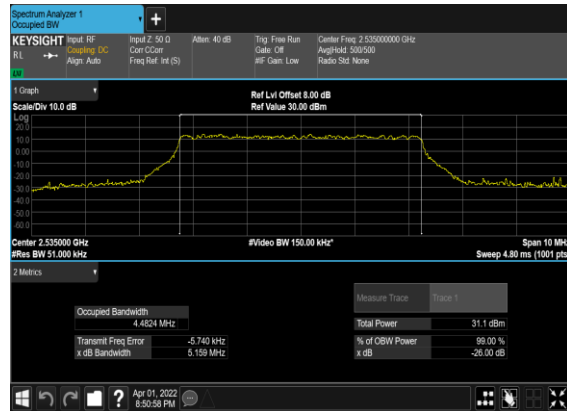

N7(5M)_CP-OFDM_QPSK_Outer_Full_Mid_CH



N7(5M)_CP-OFDM_16QAM_Outer_Full_Mid_CH



N7(5M)_CP-OFDM_64QAM_Outer_Full_Mid_CH

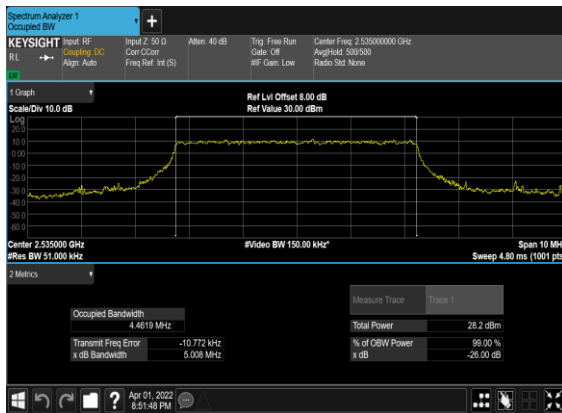

N7(5M)_CP-OFDM_256QAM_Outer_Full_Mid_CH

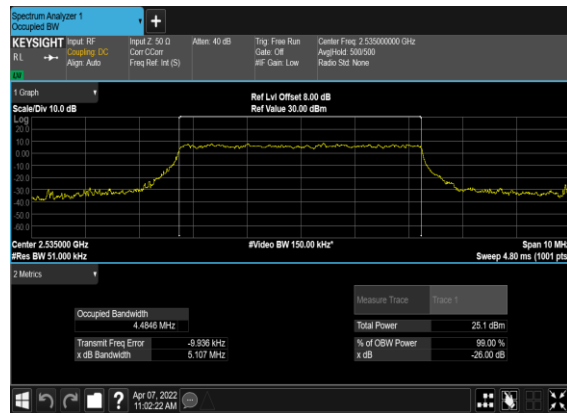

N7(10M)_DFT-s-OFDM_PI_2- BPSK_Outer_Full_Mid_CH

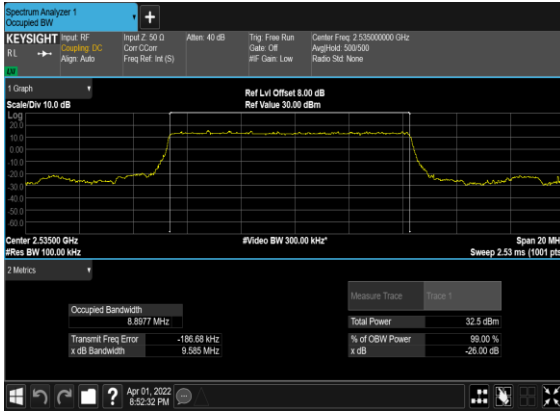

N7(10M)_DFT-s- OFDM_QPSK_Outer_Full_Mid_CH



N7(10M)_CP- OFDM_QPSK_Outer_Full_Mid_CH

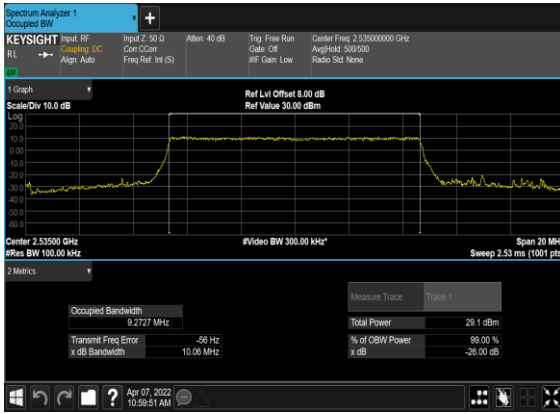

N7(10M)_CP-OFDM_16 QAM_Outer_Full_Mid_CH

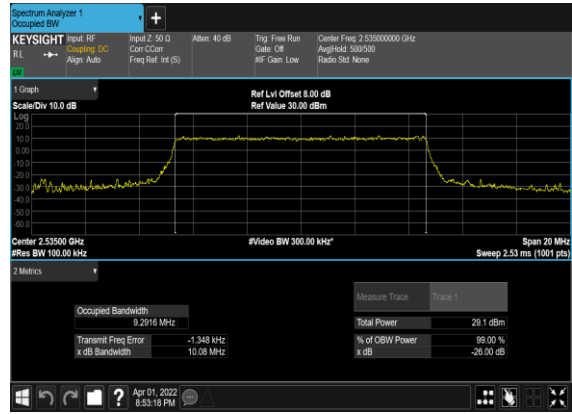

N7(10M)_CP-OFDM_64 QAM_Outer_Full_Mid_CH

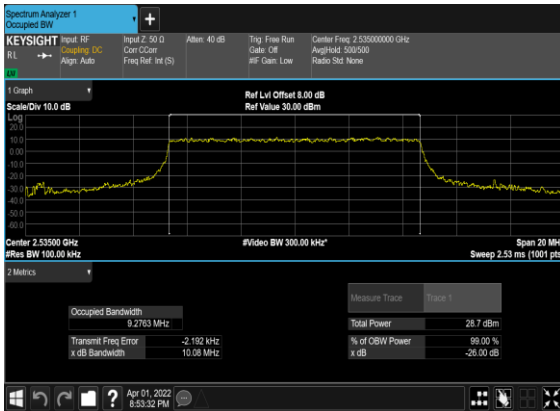

N7(10M)_CP-OFDM_256 QAM_Outer_Full_Mid_CH

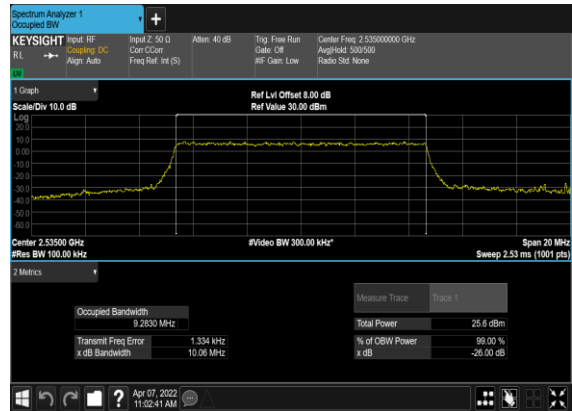

N7(15M)_DFT-s-OFDM_PI_2- BPSK_Outer_Full_Mid_CH

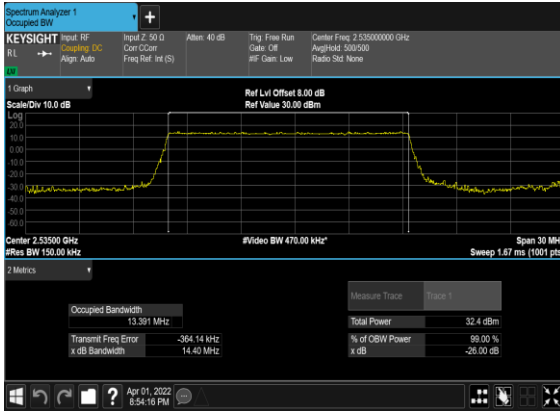

N7(15M)_DFT-s- OFDM_QPSK_Outer_Full_Mid_CH

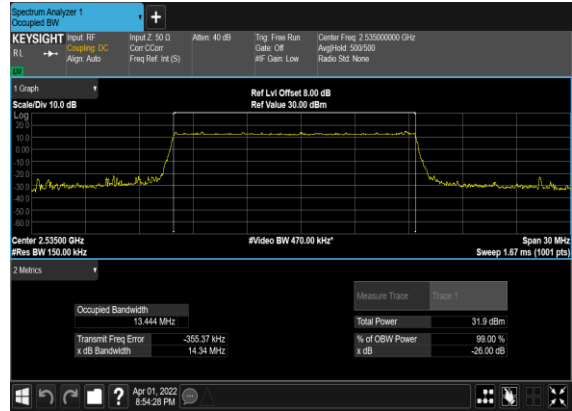

N7(15M)_CP- OFDM_QPSK_Outer_Full_Mid_CH



N7(15M)_CP-OFDM_16 QAM_Outer_Full_Mid_CH

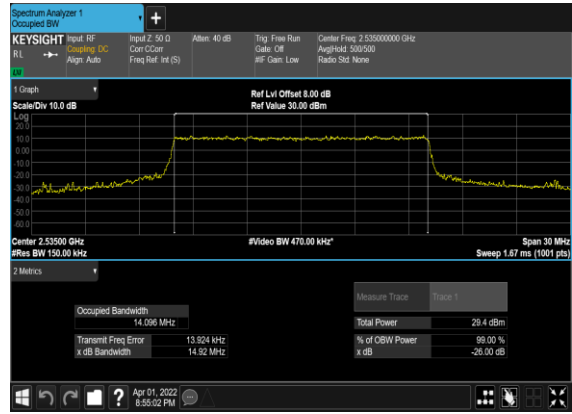

N7(15M)_CP-OFDM_64 QAM_Outer_Full_Mid_CH

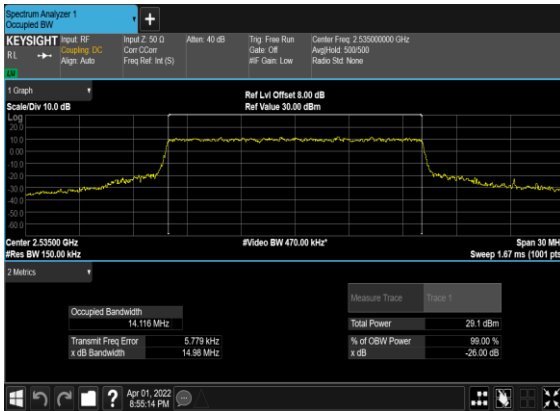

N7(15M)_CP-OFDM_256 QAM_Outer_Full_Mid_CH

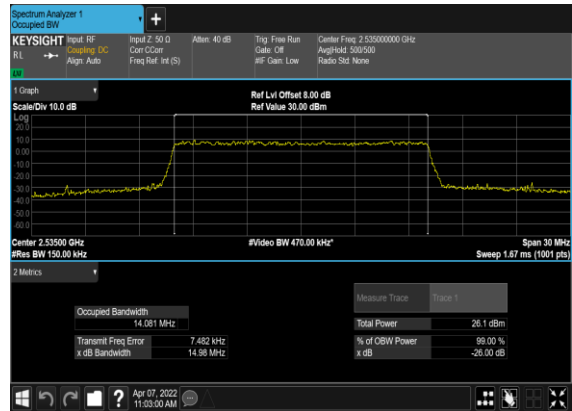

N7(20M)_DFT-s-OFDM_PI_2- BPSK_Outer_Full_Mid_CH

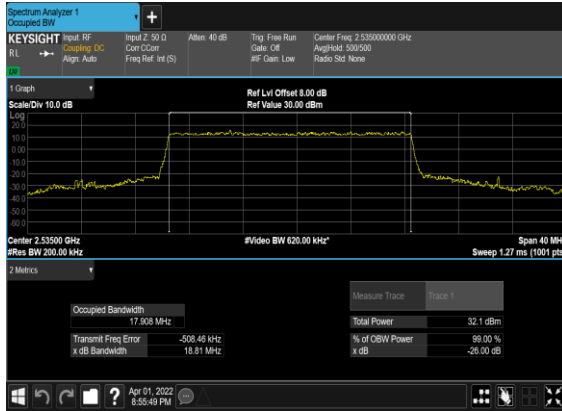

N7(20M)_DFT-s- OFDM_QPSK_Outer_Full_Mid_CH

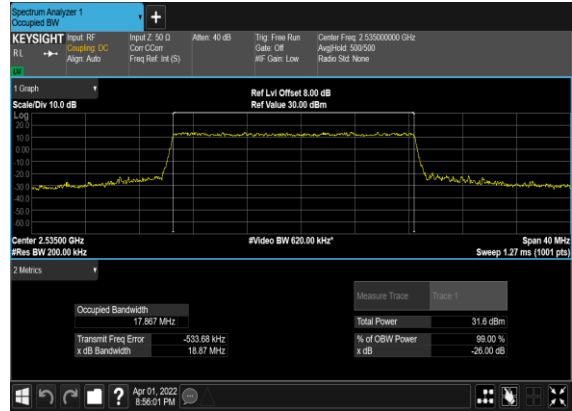

N7(20M)_CP- OFDM_QPSK_Outer_Full_Mid_CH

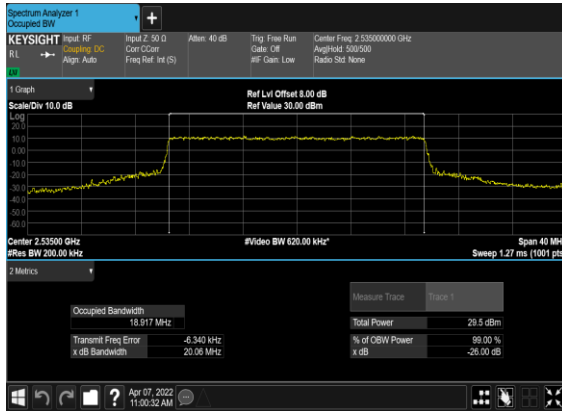

N7(20M)_CP-OFDM_16 QAM_Outer_Full_Mid_CH



N7(20M)_CP-OFDM_64 QAM_Outer_Full_Mid_CH

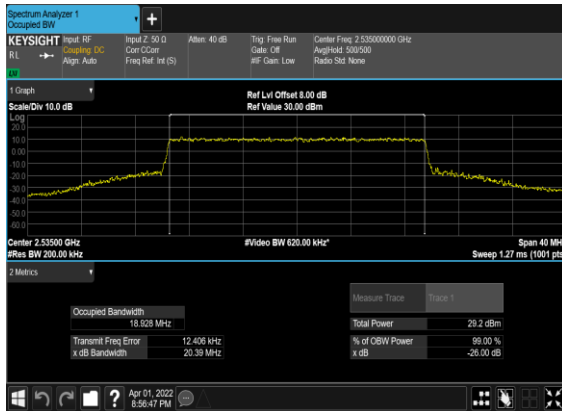

N7(20M)_CP-OFDM_256 QAM_Outer_Full_Mid_CH

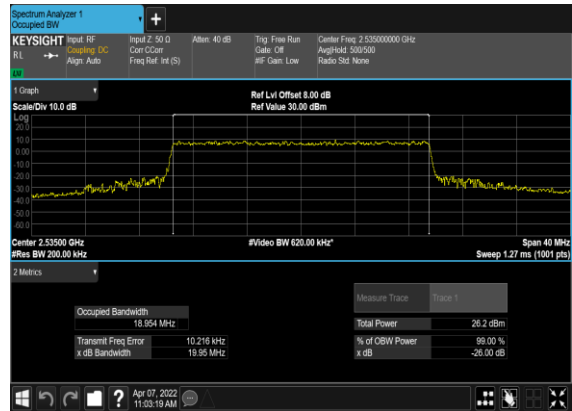

N7(25M)_DFT-s-OFDM_PI_2- BPSK_Outer_Full_Mid_CH

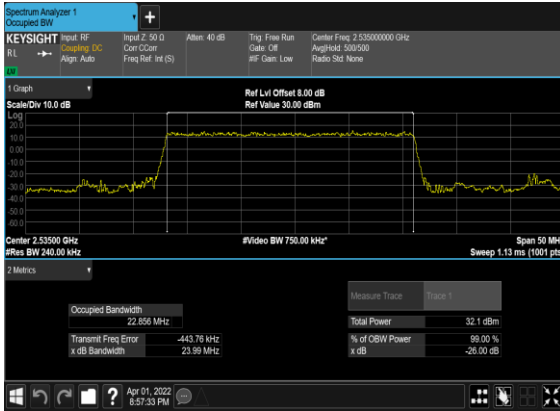

N7(25M)_DFT-s- OFDM_QPSK_Outer_Full_Mid_CH

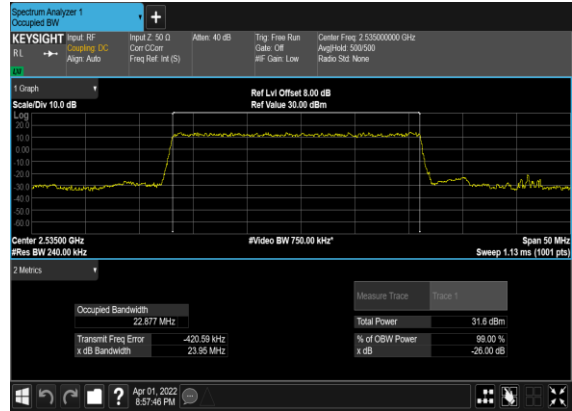

N7(25M)_CP- OFDM_QPSK_Outer_Full_Mid_CH

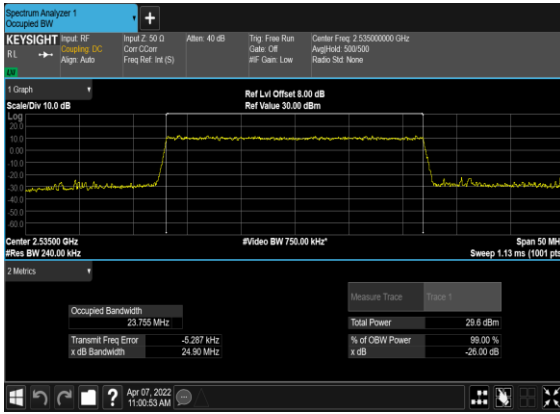

N7(25M)_CP-OFDM_16 QAM_Outer_Full_Mid_CH

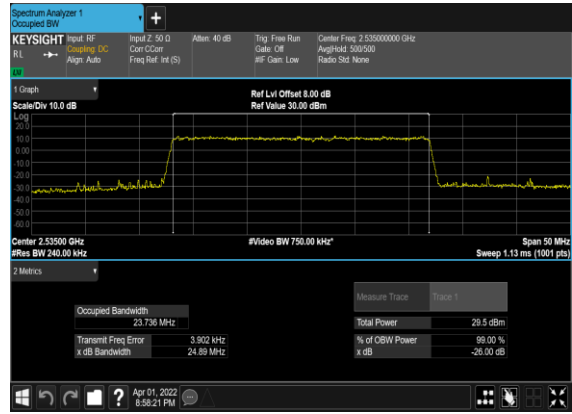

N7(25M)_CP-OFDM_64 QAM_Outer_Full_Mid_CH

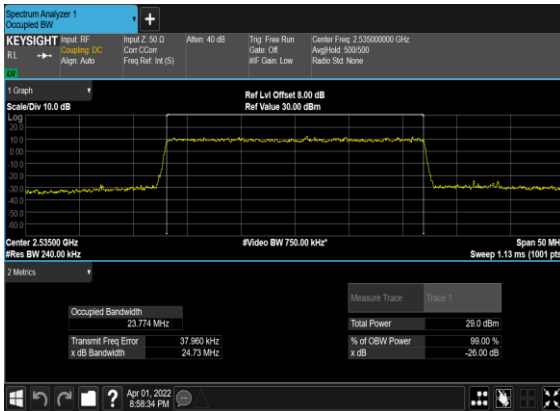

N7(25M)_CP-OFDM_256 QAM_Outer_Full_Mid_CH

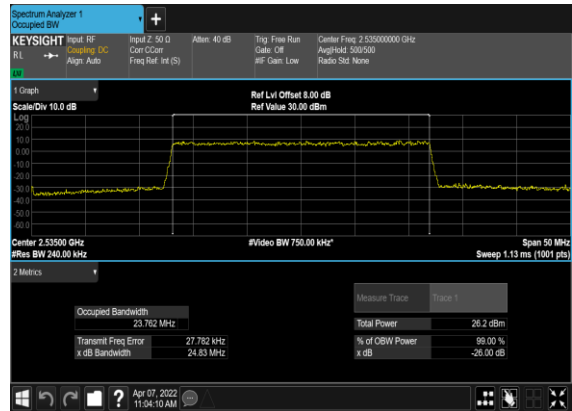

N7(30M)_DFT-s-OFDM_PI_2- BPSK_Outer_Full_Mid_CH

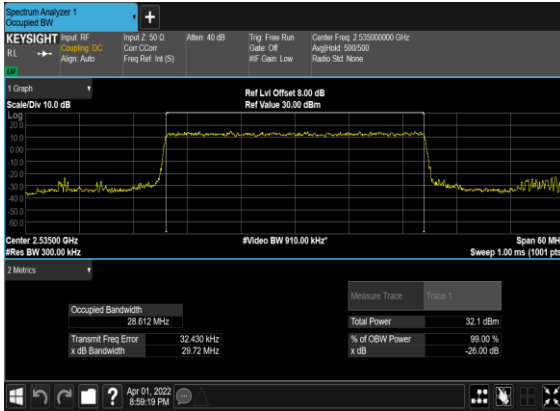

N7(30M)_DFT-s- OFDM_QPSK_Outer_Full_Mid_CH

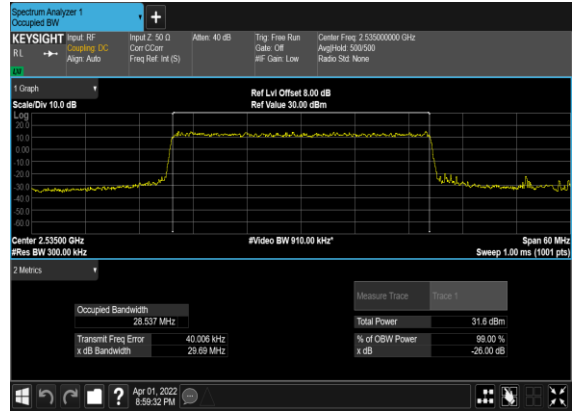

N7(30M)_CP- OFDM_QPSK_Outer_Full_Mid_CH

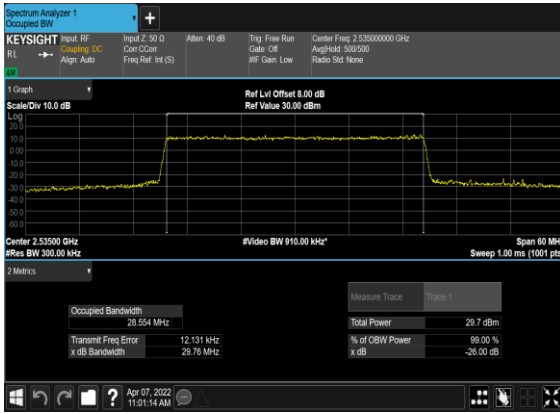

N7(30M)_CP-OFDM_16 QAM_Outer_Full_Mid_CH

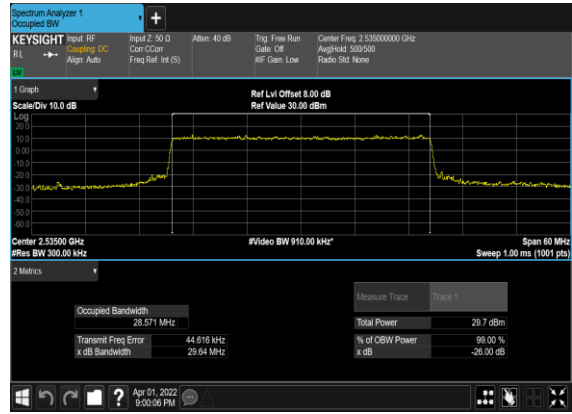

N7(30M)_CP-OFDM_64 QAM_Outer_Full_Mid_CH

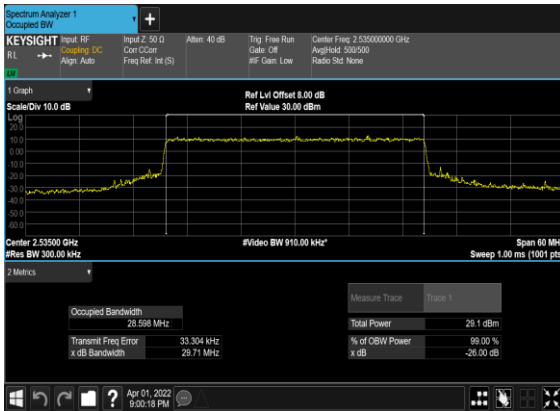

N7(30M)_CP-OFDM_256 QAM_Outer_Full_Mid_CH

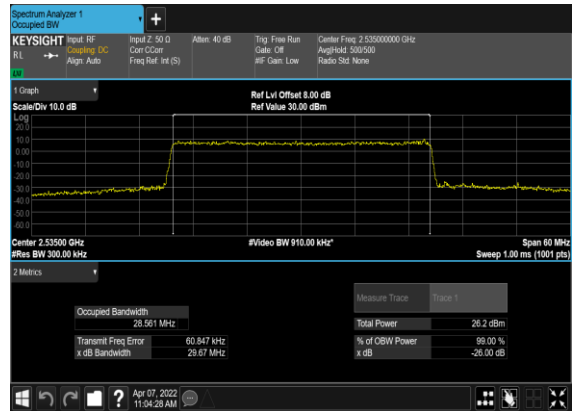

N7(40M)_DFT-s-OFDM_PI_2- BPSK_Outer_Full_Mid_CH

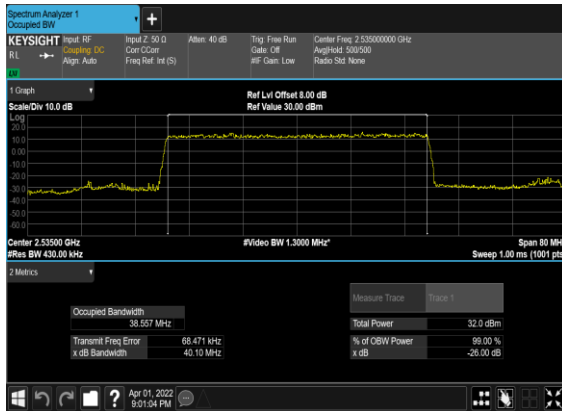

N7(40M)_DFT-s- OFDM_QPSK_Outer_Full_Mid_CH

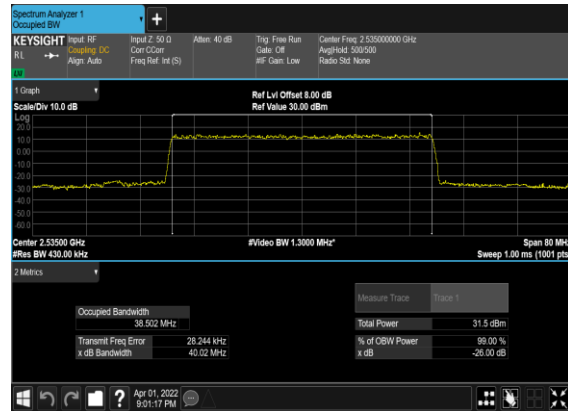

N7(40M)_CP- OFDM_QPSK_Outer_Full_Mid_CH

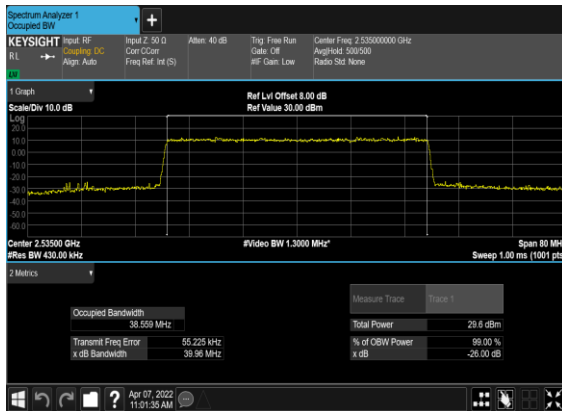

N7(40M)_CP-OFDM_16 QAM_Outer_Full_Mid_CH

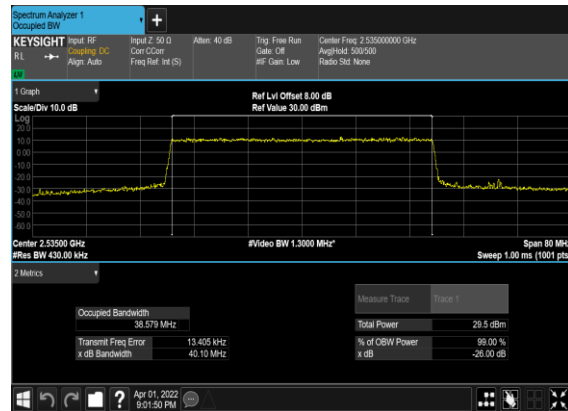

N7(40M)_CP-OFDM_64 QAM_Outer_Full_Mid_CH

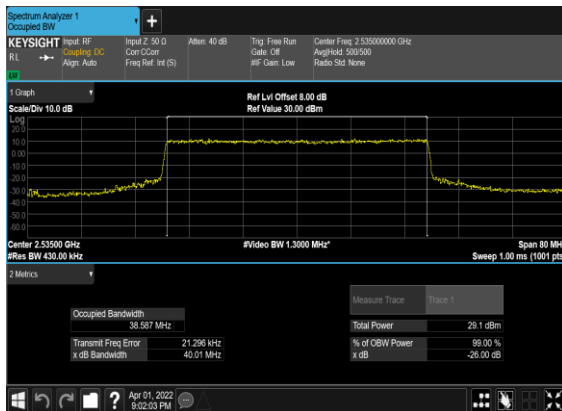

N7(40M)_CP-OFDM_256 QAM_Outer_Full_Mid_CH

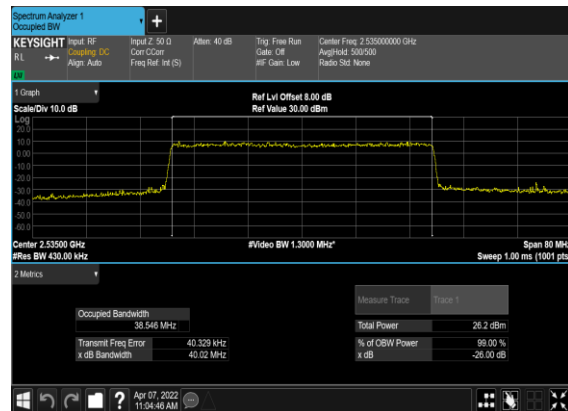

Conducted Spurious Emissions

NR Band	SCS (kHz)	Bandwidth (MHz)	Arfcn	Freq (MHz)	Modulation	RB	Result	Verdict
7	15	5	524500	2502.5	DFT-s-OFDM BPSK	1@0	see graph	---
7	15	5	524500	2502.5	DFT-s-OFDM BPSK	1@0	see graph	PASS
7	15	5	524500	2502.5	DFT-s-OFDM BPSK	1@0	see graph	PASS
7	15	5	524500	2502.5	DFT-s-OFDM QPSK	1@0	see graph	---
7	15	5	524500	2502.5	DFT-s-OFDM QPSK	1@0	see graph	PASS
7	15	5	524500	2502.5	DFT-s-OFDM QPSK	1@0	see graph	PASS
7	15	5	531000	2535.0	DFT-s-OFDM BPSK	1@0	see graph	---
7	15	5	531000	2535.0	DFT-s-OFDM BPSK	1@0	see graph	PASS
7	15	5	531000	2535.0	DFT-s-OFDM BPSK	1@0	see graph	PASS
7	15	5	531000	2535.0	DFT-s-OFDM QPSK	1@0	see graph	---
7	15	5	531000	2535.0	DFT-s-OFDM QPSK	1@0	see graph	PASS
7	15	5	531000	2535.0	DFT-s-OFDM QPSK	1@0	see graph	PASS
7	15	5	537500	2567.5	DFT-s-OFDM BPSK	1@0	see graph	---
7	15	5	537500	2567.5	DFT-s-OFDM BPSK	1@0	see graph	PASS
7	15	5	537500	2567.5	DFT-s-OFDM BPSK	1@0	see graph	PASS
7	15	5	537500	2567.5	DFT-s-OFDM QPSK	1@0	see graph	---
7	15	5	537500	2567.5	DFT-s-OFDM QPSK	1@0	see graph	PASS
7	15	5	537500	2567.5	DFT-s-OFDM QPSK	1@0	see graph	PASS
7	15	20	526000	2510.0	DFT-s-OFDM BPSK	1@0	see graph	---
7	15	20	526000	2510.0	DFT-s-OFDM BPSK	1@0	see graph	PASS
7	15	20	526000	2510.0	DFT-s-OFDM BPSK	1@0	see graph	PASS
7	15	20	526000	2510.0	DFT-s-OFDM QPSK	1@0	see graph	---

7	15	20	526000	2510.0	DFT-s-OFDM QPSK	1@0	see graph	PASS
7	15	20	526000	2510.0	DFT-s-OFDM QPSK	1@0	see graph	PASS
7	15	20	531000	2535.0	DFT-s-OFDM BPSK	1@0	see graph	---
7	15	20	531000	2535.0	DFT-s-OFDM BPSK	1@0	see graph	PASS
7	15	20	531000	2535.0	DFT-s-OFDM BPSK	1@0	see graph	PASS
7	15	20	531000	2535.0	DFT-s-OFDM QPSK	1@0	see graph	---
7	15	20	531000	2535.0	DFT-s-OFDM QPSK	1@0	see graph	PASS
7	15	20	531000	2535.0	DFT-s-OFDM QPSK	1@0	see graph	PASS
7	15	20	536000	2560.0	DFT-s-OFDM BPSK	1@0	see graph	---
7	15	20	536000	2560.0	DFT-s-OFDM BPSK	1@0	see graph	PASS
7	15	20	536000	2560.0	DFT-s-OFDM BPSK	1@0	see graph	PASS
7	15	20	536000	2560.0	DFT-s-OFDM QPSK	1@0	see graph	---
7	15	20	536000	2560.0	DFT-s-OFDM QPSK	1@0	see graph	PASS
7	15	20	536000	2560.0	DFT-s-OFDM QPSK	1@0	see graph	PASS
7	15	40	528000	2520.0	DFT-s-OFDM BPSK	1@0	see graph	---
7	15	40	528000	2520.0	DFT-s-OFDM BPSK	1@0	see graph	PASS
7	15	40	528000	2520.0	DFT-s-OFDM BPSK	1@0	see graph	PASS
7	15	40	528000	2520.0	DFT-s-OFDM QPSK	1@0	see graph	---
7	15	40	528000	2520.0	DFT-s-OFDM QPSK	1@0	see graph	PASS
7	15	40	528000	2520.0	DFT-s-OFDM QPSK	1@0	see graph	PASS
7	15	40	531000	2535.0	DFT-s-OFDM BPSK	1@0	see graph	---
7	15	40	531000	2535.0	DFT-s-OFDM BPSK	1@0	see graph	PASS
7	15	40	531000	2535.0	DFT-s-OFDM BPSK	1@0	see graph	PASS
7	15	40	531000	2535.0	DFT-s-OFDM QPSK	1@0	see graph	---

7	15	40	531000	2535.0	DFT-s-OFDM QPSK	1@0	see graph	PASS
7	15	40	531000	2535.0	DFT-s-OFDM QPSK	1@0	see graph	PASS
7	15	40	534000	2550.0	DFT-s-OFDM BPSK	1@0	see graph	---
7	15	40	534000	2550.0	DFT-s-OFDM BPSK	1@0	see graph	PASS
7	15	40	534000	2550.0	DFT-s-OFDM BPSK	1@0	see graph	PASS
7	15	40	534000	2550.0	DFT-s-OFDM QPSK	1@0	see graph	---
7	15	40	534000	2550.0	DFT-s-OFDM QPSK	1@0	see graph	PASS
7	15	40	534000	2550.0	DFT-s-OFDM QPSK	1@0	see graph	PASS

N7(5M)_DFT-s-OFDM_BPSK_Edge_1RB_Left_Low_CH

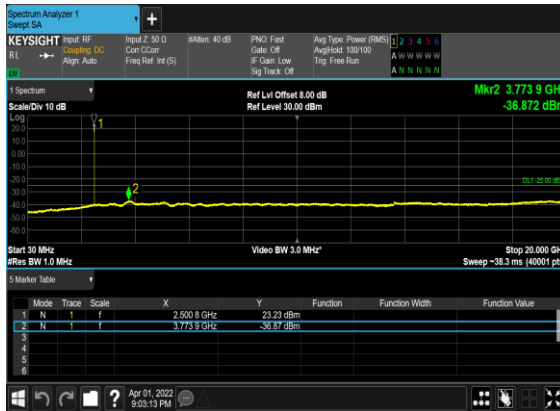

N7(5M)_DFT-s-OFDM_BPSK_Edge_1RB_Left_Low_CH

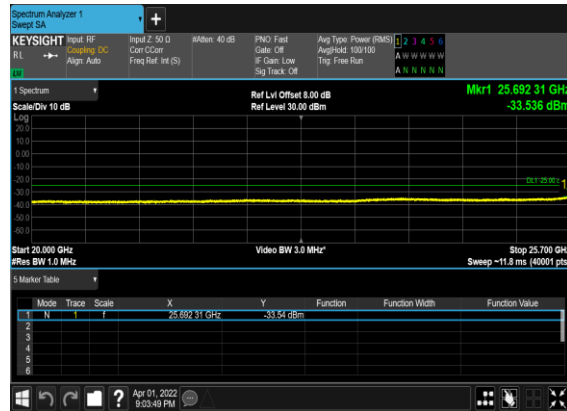

N7(5M)_DFT-s-OFDM_QPSK_Edge_1RB_Left_Low_CH

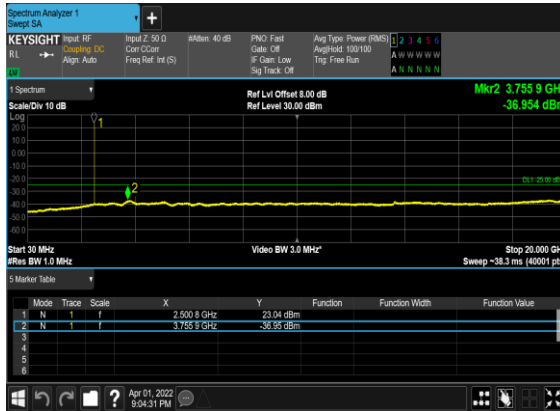

N7(5M)_DFT-s-OFDM_QPSK_Edge_1RB_Left_Low_CH

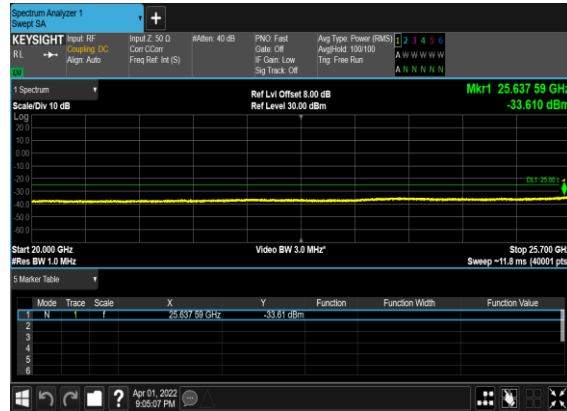

N7(5M)_DFT-s-OFDM_BPSK_Edge_1RB_Left_Mid_CH

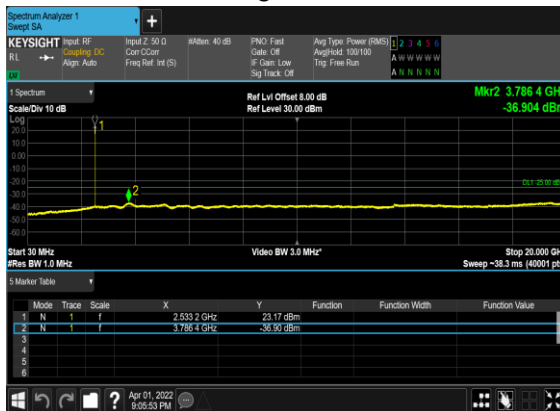

N7(5M)_DFT-s-OFDM_BPSK_Edge_1RB_Left_Mid_CH

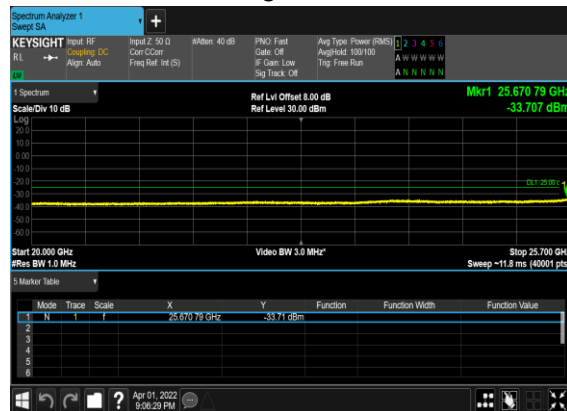

N7(5M)_DFT-s-OFDM_QPSK_Edge_1RB_Left_Mid_CH

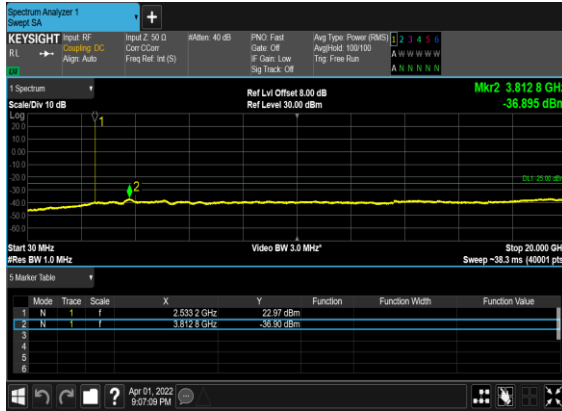

N7(5M)_DFT-s-OFDM_QPSK_Edge_1RB_Left_Mid_CH

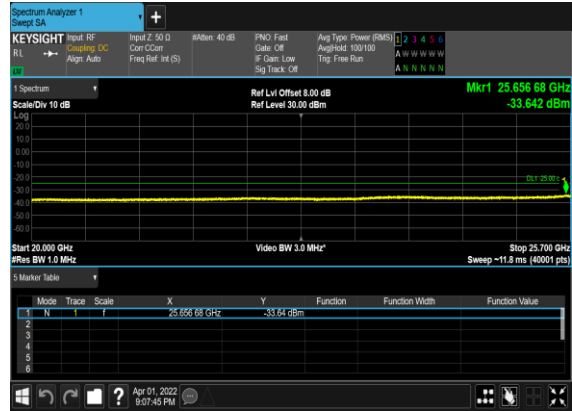

N7(5M)_DFT-s-OFDM_BPSK_Edge_1RB_Left_High_CH

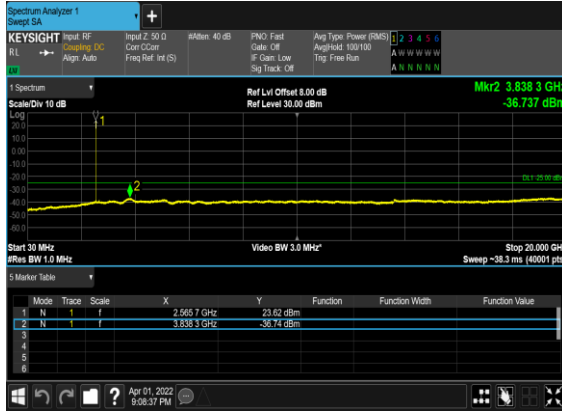

N7(5M)_DFT-s-OFDM_BPSK_Edge_1RB_Left_High_CH

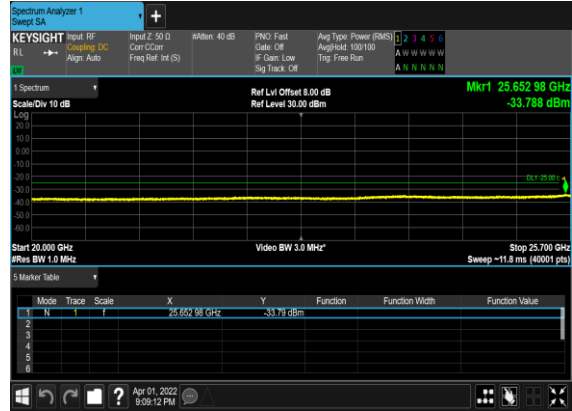

N7(5M)_DFT-s-OFDM_QPSK_Edge_1RB_Left_High_CH

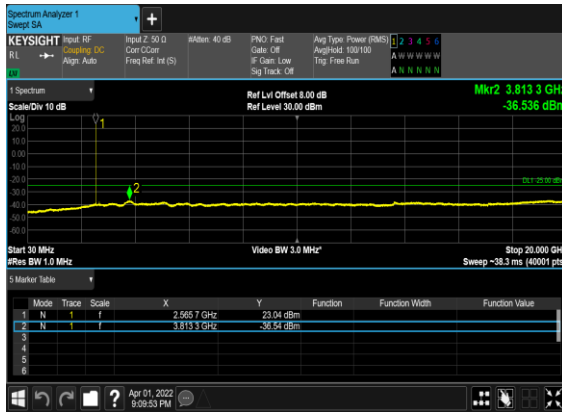

N7(5M)_DFT-s-OFDM_QPSK_Edge_1RB_Left_High_CH

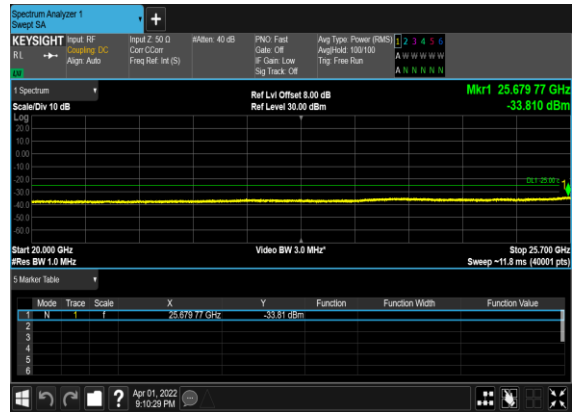

N7(20M)_DFT-s-
OFDM_BPSK_Edge_1RB_Left_Low_CH

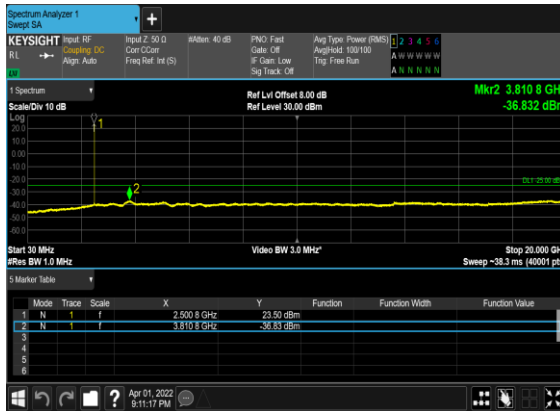

N7(20M)_DFT-s-
OFDM_BPSK_Edge_1RB_Left_Low_CH

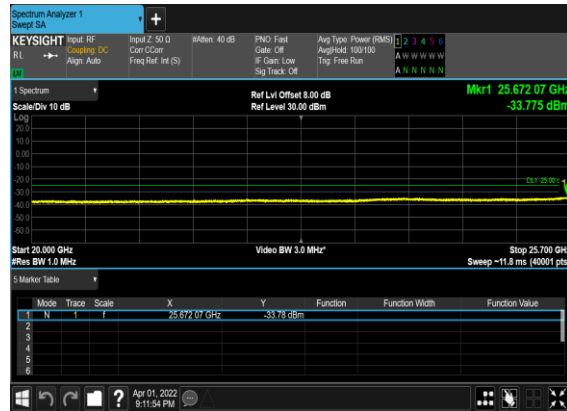

N7(20M)_DFT-s-
OFDM_QPSK_Edge_1RB_Left_Low_CH

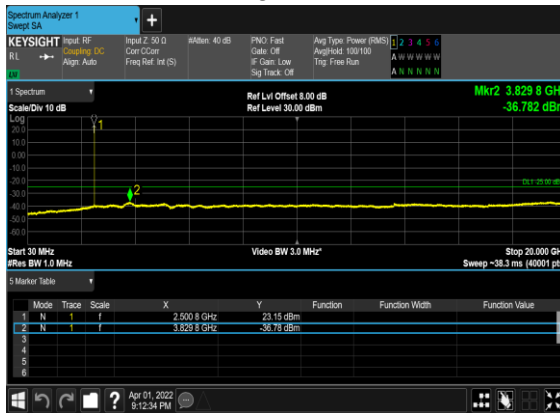

N7(20M)_DFT-s-
OFDM_QPSK_Edge_1RB_Left_Low_CH

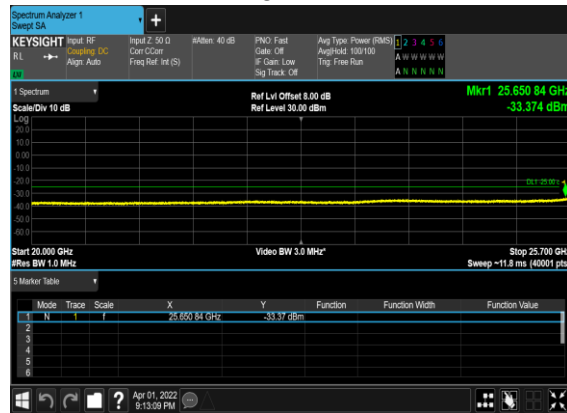

N7(20M)_DFT-s-
OFDM_BPSK_Edge_1RB_Left_Mid_CH

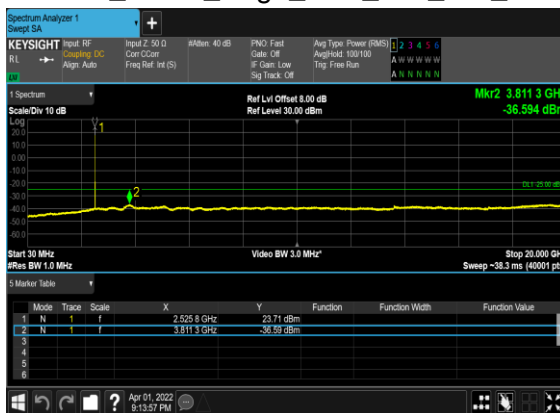

N7(20M)_DFT-s-
OFDM_BPSK_Edge_1RB_Left_Mid_CH

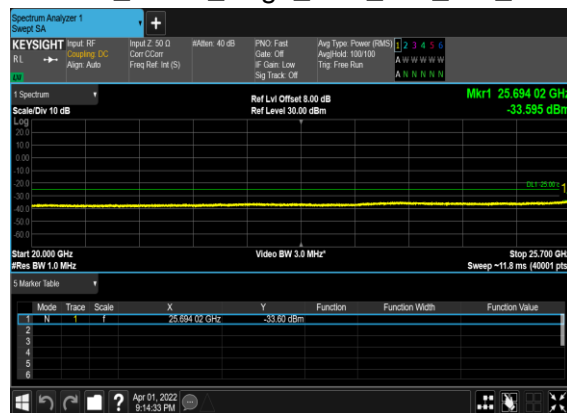

N7(20M)_DFT-s-OFDM_QPSK_Edge_1RB_Left_Mid_CH

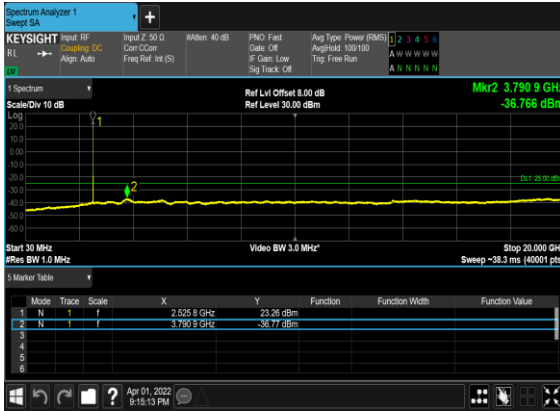

N7(20M)_DFT-s-OFDM_QPSK_Edge_1RB_Left_Mid_CH

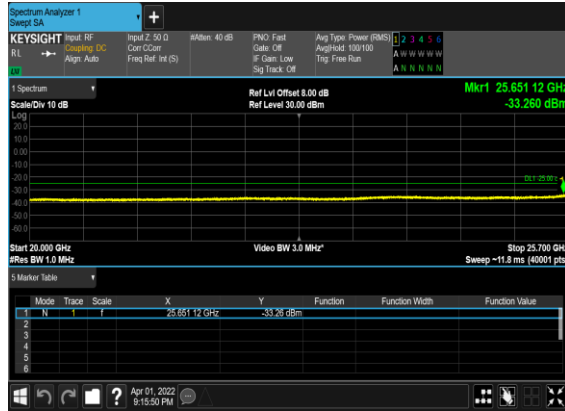

N7(20M)_DFT-s-OFDM_BPSK_Edge_1RB_Left_High_CH

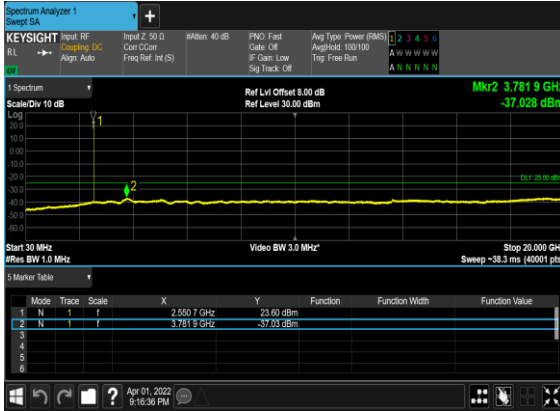

N7(20M)_DFT-s-OFDM_BPSK_Edge_1RB_Left_High_CH

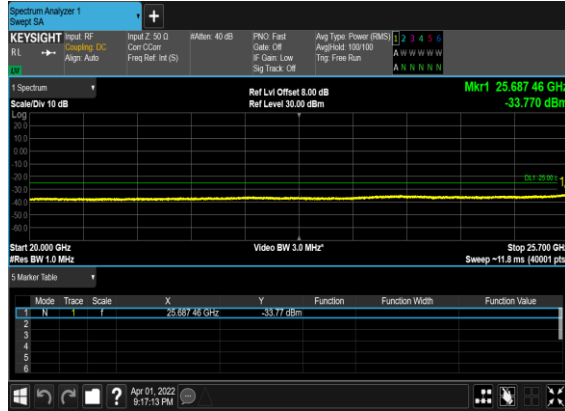

N7(20M)_DFT-s-OFDM_QPSK_Edge_1RB_Left_High_CH

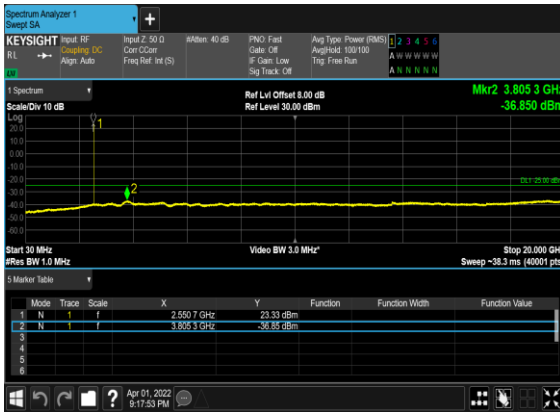

N7(20M)_DFT-s-OFDM_QPSK_Edge_1RB_Left_High_CH

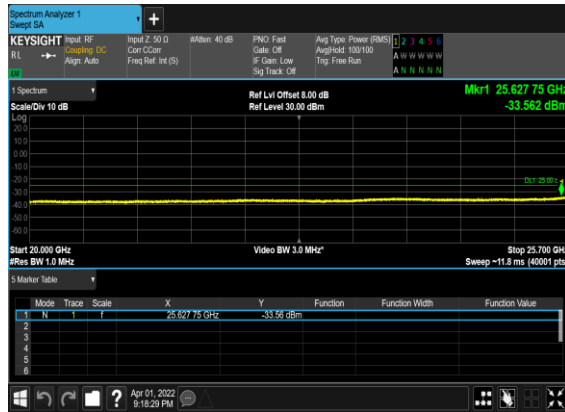

N7(40M)_DFT-s-OFDM_BPSK_Edge_1RB_Left_Low_CH

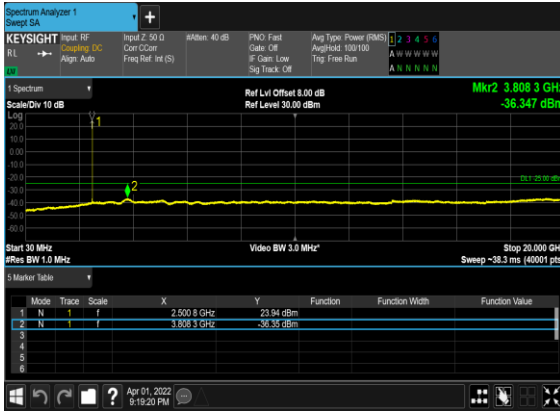

N7(40M)_DFT-s-OFDM_BPSK_Edge_1RB_Left_Low_CH

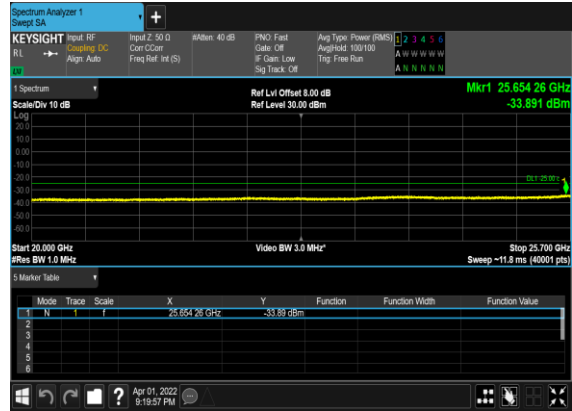

N7(40M)_DFT-s-OFDM_QPSK_Edge_1RB_Left_Low_CH

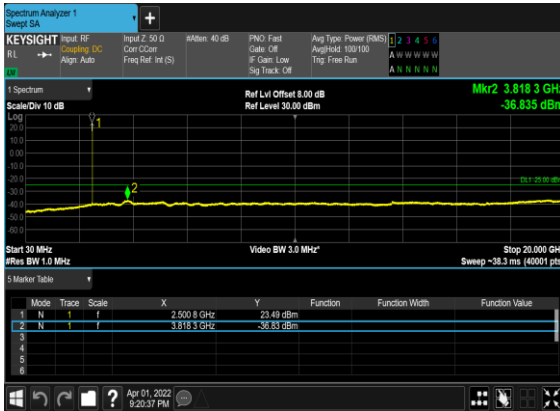

N7(40M)_DFT-s-OFDM_QPSK_Edge_1RB_Left_Low_CH

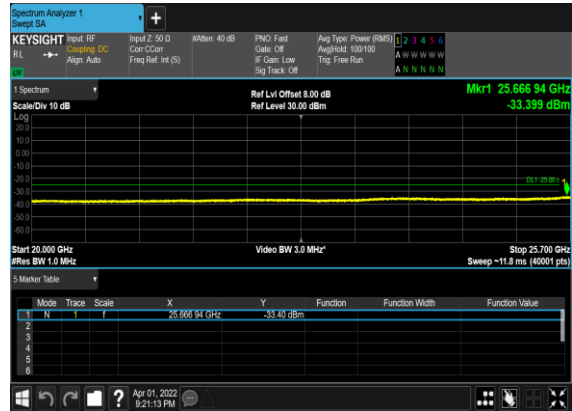

N7(40M)_DFT-s-OFDM_BPSK_Edge_1RB_Left_Mid_CH

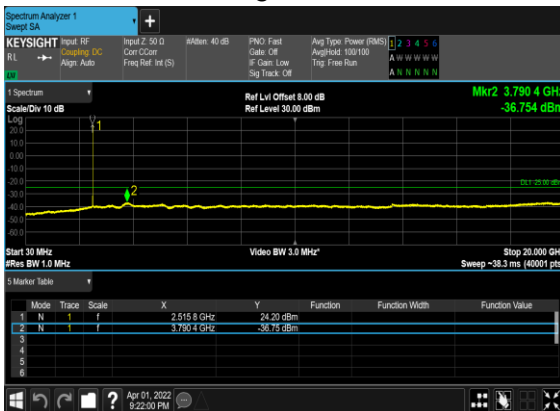

N7(40M)_DFT-s-OFDM_BPSK_Edge_1RB_Left_Mid_CH

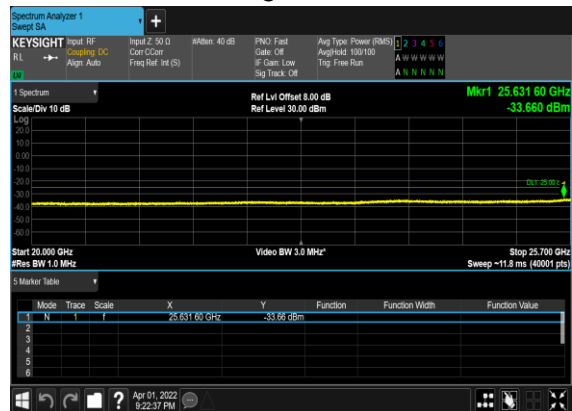

N7(40M)_DFT-s-OFDM_QPSK_Edge_1RB_Left_Mid_CH

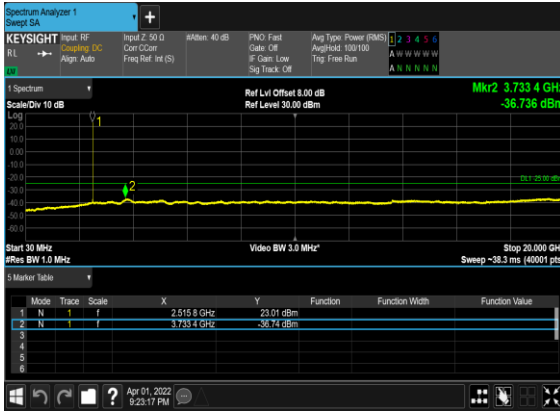

N7(40M)_DFT-s-OFDM_QPSK_Edge_1RB_Left_Mid_CH

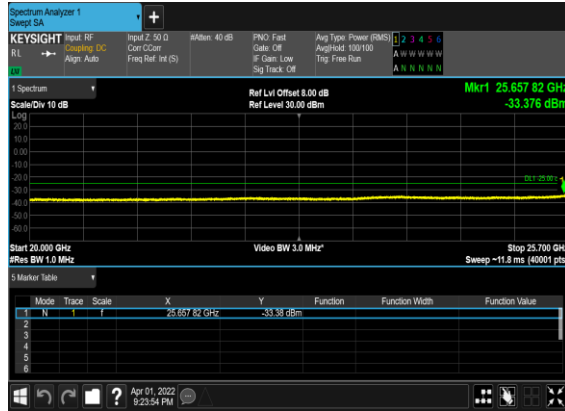

N7(40M)_DFT-s-OFDM_BPSK_Edge_1RB_Left_High_CH

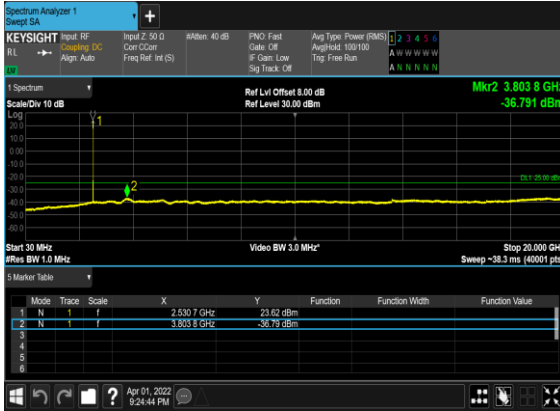

N7(40M)_DFT-s-OFDM_BPSK_Edge_1RB_Left_High_CH

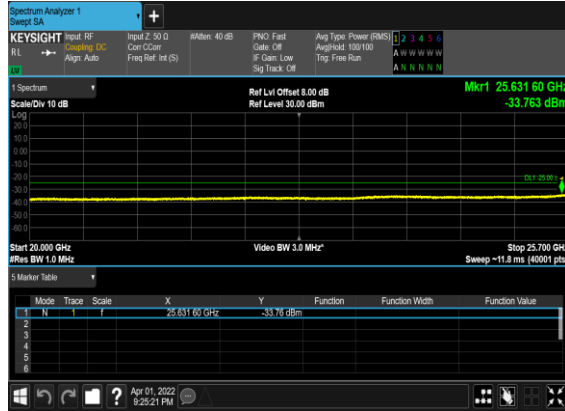

N7(40M)_DFT-s-OFDM_QPSK_Edge_1RB_Left_High_CH

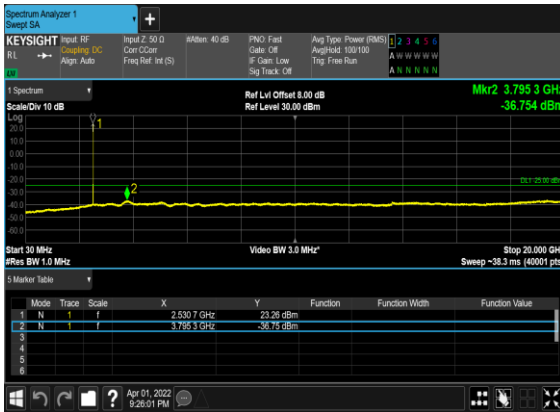

N7(40M)_DFT-s-OFDM_QPSK_Edge_1RB_Left_High_CH

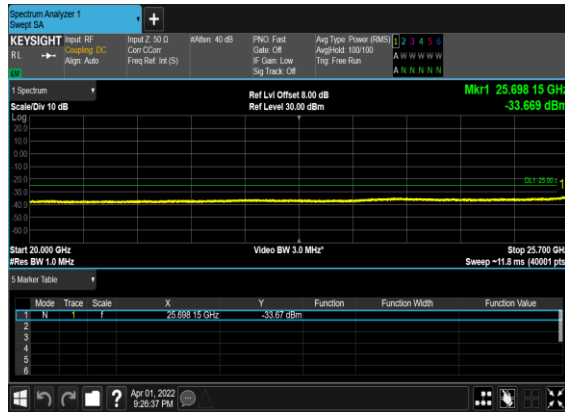

Conducted Band Edge

NR Band	SCS (kHz)	Bandwidth (MHz)	Arfcn	Freq (MHz)	Modulation	RB	Result	Verdict
7	15	5	524500	2502.5	DFT-s-OFDM BPSK	1@0	see graph	PASS
7	15	5	524500	2502.5	DFT-s-OFDM QPSK	1@0	see graph	PASS
7	15	5	524500	2502.5	DFT-s-OFDM BPSK	25@0	see graph	PASS
7	15	5	524500	2502.5	DFT-s-OFDM QPSK	25@0	see graph	PASS
7	15	5	537500	2567.5	DFT-s-OFDM BPSK	1@24	see graph	PASS
7	15	5	537500	2567.5	DFT-s-OFDM QPSK	1@24	see graph	PASS
7	15	5	537500	2567.5	DFT-s-OFDM BPSK	25@0	see graph	PASS
7	15	5	537500	2567.5	DFT-s-OFDM QPSK	25@0	see graph	PASS
7	15	20	526000	2510.0	DFT-s-OFDM BPSK	1@0	see graph	PASS
7	15	20	526000	2510.0	DFT-s-OFDM QPSK	1@0	see graph	PASS
7	15	20	526000	2510.0	DFT-s-OFDM BPSK	100@0	see graph	PASS
7	15	20	526000	2510.0	DFT-s-OFDM QPSK	100@0	see graph	PASS
7	15	20	536000	2560.0	DFT-s-OFDM BPSK	1@105	see graph	PASS
7	15	20	536000	2560.0	DFT-s-OFDM QPSK	1@105	see graph	PASS
7	15	20	536000	2560.0	DFT-s-OFDM BPSK	100@0	see graph	PASS
7	15	20	536000	2560.0	DFT-s-OFDM QPSK	100@0	see graph	PASS
7	15	40	528000	2520.0	DFT-s-OFDM BPSK	1@0	see graph	PASS
7	15	40	528000	2520.0	DFT-s-OFDM QPSK	1@0	see graph	PASS
7	15	40	528000	2520.0	DFT-s-OFDM BPSK	216@0	see graph	PASS
7	15	40	528000	2520.0	DFT-s-OFDM QPSK	216@0	see graph	PASS
7	15	40	534000	2550.0	DFT-s-OFDM BPSK	1@215	see graph	PASS
7	15	40	534000	2550.0	DFT-s-OFDM QPSK	1@215	see graph	PASS
7	15	40	534000	2550.0	DFT-s-OFDM BPSK	216@0	see graph	PASS
7	15	40	534000	2550.0	DFT-s-OFDM QPSK	216@0	see graph	PASS