

MEASUREMENT REPORT
of
ASUS MyPal A686 Pocket PC
for
Class II permissive change

Applicant : ASUSTek Computer Inc.
EUT : ASUS MyPal A686 Pocket PC
Model : A686
FCC ID : MSQA686
Report No. : A5415060855

Tested by :

Training Research Co., Ltd.

TEL : 886-2-26935155

FAX : 886-2-26934440

No. 255, Nanyang Street, Shijr, Taipei Hsien 221, Taiwan, R.O.C.

CERTIFICATION

We here by verify that:

The test data, data evaluation, test procedures and equipment configurations shown in this report were made mainly in accordance with the procedures given in ANSI C63.4 (1992) as a reference. All test were conducted by *Training Research Co., Ltd.*, No. 255, Nanyang Street, Shijr, Taipei Hsien 221, Taiwan, R.O.C. Also, we attest to the accuracy of each.

We further submit that the energy emitted by the sample EUT tested as described in the report is **in compliance with** the technical requirements set forth in the FCC Rules Part 15 Subpart B (Declaration of Conformity) and C Section 15.247.

Applicant : ASUSTek Computer Inc.
Applicant address : 4Fl., No. 150, Li-Te Rd., Peitou, Taipei, Taiwan
Product Name : ASUS MyPal A686 Pocket PC
Model Name : A686
FCC ID : MSQA686
Report No. : A5415060855
Test Date : November 17, 2006

Prepared by: Jack Tsai Approved by: Frank Tsai
Jack Tsai *Frank Tsai*

Conditions of issue :

- (1) **This test report shall not be reproduced except in full, without written approval of TRC. And the test result contained within this report only relate to the sample submitted for testing.**
- (2) **This report must not be used by the client to claim product endorsement by NVLAP or any agency of U.S. Government.**
- (3) **This test report, measurements made by TRC are traceable to the NIST only Conducted and Radiated Method.**



Federal Communications Commission **Declaration of Conformity** **(DoC)**

For the Following Equipment:

Product name : ASUS Mypal A686 Pocket PC
Model name : A686
Trade name : ASUS

Is herewith confirmed and found to comply with the requirements of CFR 47 part15 Subpart B - Unintentional Radiators regulation. The results of electromagnetic mission evaluation are shown in the report number : A5415060855

This device complies with Part 15 of the FCC Rules. Operation is subject to the following two conditions:

- (1) This device may not cause harmful interference, and
- (2) This device must accept any interference received, including interference that may cause undesired operation

<i>Manufacturer</i>	<i>USA local representative</i>
Company name: ASUSTeK Computer Inc.	To be determined
Computer address: 4/F, 150, Li-Te Rd., Peitou, Taipei, Taiwan	
ZIP / Postal code: 112	
Contact person: Lawrence Yu	
Title: Manager	
Internet e-mail address: Lawrence_yu@asus.com.tw	
Tel / Fax: 886-2-28943447 / 886-2-28950113	

Tables of Contents

I. GENERAL	6
1.1 Introduction	6
1.2 Description of EUT	6
1.3 Test method	7
1.4 Description of Support Equipment	8
1.5 Configuration of System Under Test	10
1.6 Verify the Frequency and Channel	13
1.7 Test Procedure	14
1.8 Location of the Test Site	14
1.9 General Test Condition	14
II. Section 15.101(a): Equipment authorization of unintentional radiators	15
III. Section 15.203 : Antenna Requirement	16
IV. Section 15.207 : Power Line Conducted Emissions for AC Powered Units	17
4.1 Test Condition & Setup	17
4.2 List of Test Instruments	18
4.3 Test Results of Conducted Emissions	19
V. Section 15.247(a) : Technical Description of the EUT	34
VI. Section 15.247(a)(1) : Carrier Frequency Separation	35
6.1 Test Condition	35
6.2 Test Instruments Configuration	35
6.3 List of Test Instruments	36
6.4 Test Results	36
VII. Section 15.247(a)(1)(ii) : Number of Hopping Frequencies	40
7.1 Test Condition	40
7.2 List of Test Instruments	40
7.3 Test Instruments Configuration	40
7.4 Test Results	41

VIII. Section 15.247(a)(1)(ii) : Time of Occupancy (Dwell time)	45
8.1 Test Condition	45
8.2 List of Test Instruments	45
8.3 Test Instruments Configuration	46
8.4 Test Results	46
IX. Section 15.247(a)(1)(ii) : 20dB Bandwidth	53
9.1 Test Condition	53
9.2 Test Instruments Configuration	53
9.3 List of Test Instruments	54
9.4 Test Results	54
X. Section 15.247(b) : Peak Output Power	58
10.1 Test Condition & Setup	58
10.2 List of Test Instruments	58
10.3 Test Results	58
XI. Section 15.247(c) : Band-edge Compliance	59
11.1 Test Condition & Setup.....	59
11.2 List of Test Instruments.....	59
11.3 Test Instruments Configuration	60
11.4 Test Results	60
XII. Section 15.247(c) : Spurious Radiated Emissions	65
12.1 Test Condition & Setup.....	65
12.2 List of Test Instruments.....	67
12.3 Test Results of Spurious Radiated Emissions	68
XIII. Section 15.247(d) : Power Spectral Density	86
13.1 Test Condition & Setup	86
13.2 Test Instruments Configuration	86
13.3 List of Test Instruments.....	86
13.4 Test Result of Power Spectral Density	87

I . GENERAL

1.1 Introduction

The following measurement report is submitted on behalf of applicant in support that the certification in accordance with Part 2 Subpart J and Part 15 Subpart A, B and C of the Commission's Rules and Regulations.

1.2 Description of EUT

FCC ID	:	MSQA686
Product Name	:	ASUS Mypal A686 Pocket PC
Model Name	:	A686
Frequency Range	:	2402MHz to 2480MHz
Support Channel	:	79 Channels
Channel Spacing	:	1 MHz
Modulation Skill	:	GFSK, $\pi/4$ -DQPSK, 8DPSK
Power Type	:	(1) Battery-powered by the client's device, or (2) Power adapter (a) Mfg.: PIE Model: P005WA05OW I/P: 100-240VAC, 50-60Hz, 0.15A ; O/P: 5VDC, 1.0A 154cm length, shielded, without ferrite core (b) Mfg.: TPT Model: JSP050090UU I/P: 100-240VAC, 50-60Hz, 0.3A ; O/P: 5VDC, 0.9A, 4.5W 154cm length, shielded, without ferrite core 2) Car charger by vehicle battery 180cm length, non-shielded, without ferrite core
Data Cable	:	USB cable: (USB to mini USB) 69cm length, shielded, ferrite core

1.3 Test method

A) PDA connected to PC by USB cable:

- (1) The POWER jack (Mini USB) of PDA is connected with the AC power source via a power adaptor.
- (2) The Mini-USB jack of PDA is connected with the USB cable to USB port of PC.
- (3) The HEADPHONE jack of PDA is connected with the earphone.

B) PDA connected to Vehicle Battery by Car charger:

- (1) The POWER jack (Mini USB) of PDA is connected with Vehicle Battery via a Car charger.
- (2) The HEADPHONE jack of PDA is connected with the earphone.

C) PDA with AC Adaptor (EUT Stand on three orthogonal planes respectively, record worst-case in report):

- (1) The POWER jack (Mini USB) of PDA is connected with the AC power source via a power adaptor.
- (2) The HEADPHONE jack of PDA is connected with the earphone.

Notes: A, B and C modes were pre-tested, the C mode worst case one, was chosen for final test.

:

Test setting:

:

- (1) Using software provided by the applicant to linking EUT. The software is operated under the Windows to control the EUT in the unintentional and intentional test.
- (2) Set different channel <CH1/CH40/CH79 including normal and enhance data rate (E.D.R.) mode> being tested and repeat the procedures above.
 - (a) Radiated for intentional test:
making EUT to the mode of continuous TX or RX
 - (b) Conducted and radiated for unintentional test:
making EUT to the linking mode with another PDA.

1.4 Description of Support Equipment

In order to construct the minimum testing, following equipment were used as the support units.

PC : **IBM 8434**
Model No : IVG
Serial No. : 99CCZG9
FCC ID : Doc Approved
BSMI : R33026
Power type : 100 ~ 127VAC/200 ~ 240VAC, 6A/3A, 50 ~ 60Hz, Switching
Power cord : Non-shielded, 1.8m long, Plastic hood, No ferrite core

Flat Panel Monitor : **IBM**
Model No : 6636-AB1
Serial No : 23T5592
FCC ID : Doc Approved
BSMI : R33037
Data cable : Shielded, 1.170 m length, Plastic hood, two ferrite cores
Power type : 100 ~ 240VAC, 1.5A, 50/60Hz, Switching
Power cord : Non-shielded, 1.80 m length, Plastic hood, without ferrite core

Keyboard : **HP**
Model No. : 5181
Serial No. : BE21700405
FCC ID : Doc Approved
BSMI : 3892C981
Power type : By PC
Data cable : Shielded, 1.70m length, with ferrite core

Mouse : **HP**
Model No. : M-UR89
Serial No. : LZS21750238
FCC ID : Doc Approved
檢磁 : 3892D767
Power type : By PC
Power cord : Shielded, 1.80m length, No ferrite core

Fax/Modem : **Acceex**
Model No. : DM-1414
Serial No. : 9010582
FCC ID : IFAXDM1414
Power type : 110 VAC / 50 ~ 60 Hz, Switching
Power Cord : Non-shielded, 1.90m long, Plastic hoods, and no ferrite bead
Data Cable : RS-232→Shielded, 1.30m long, Metal hoods , No bead
RJ-11Cx2→Non-shielded, 7' long, Plastic hoods, No bead

Printer : **HP**
Model No. : C6464A
Serial No. : TH16LEB5PK
FCC ID : N/A, DoC Approved
檢磁 : 3892H381
Power type : Switching adaptor
Power cord : Non-shielded, 173cm long, No ferrite core
(between adaptor and AC source)
Non-shielded, 180cm long, with ferrite core
(between printer and adaptor)
Data cable : Shielded, 1.70m long, No ferrite core

Earphones : **PHILIPS**
Model No : SBC-HE033
Serial No. : 670904
Power type : By EUT
Data Cable : Non-shielded, 1.05 m length, Plastic hood, No ferrite core

CF card : **NIKON**
Model No. : EC-16CF
Serial No. : 4027012
FCC ID : N/A (CE approval)
Power type : By PDA

1.5 Configuration of System Under Test

1.5.1 Conducted and Radiated of Unintentional

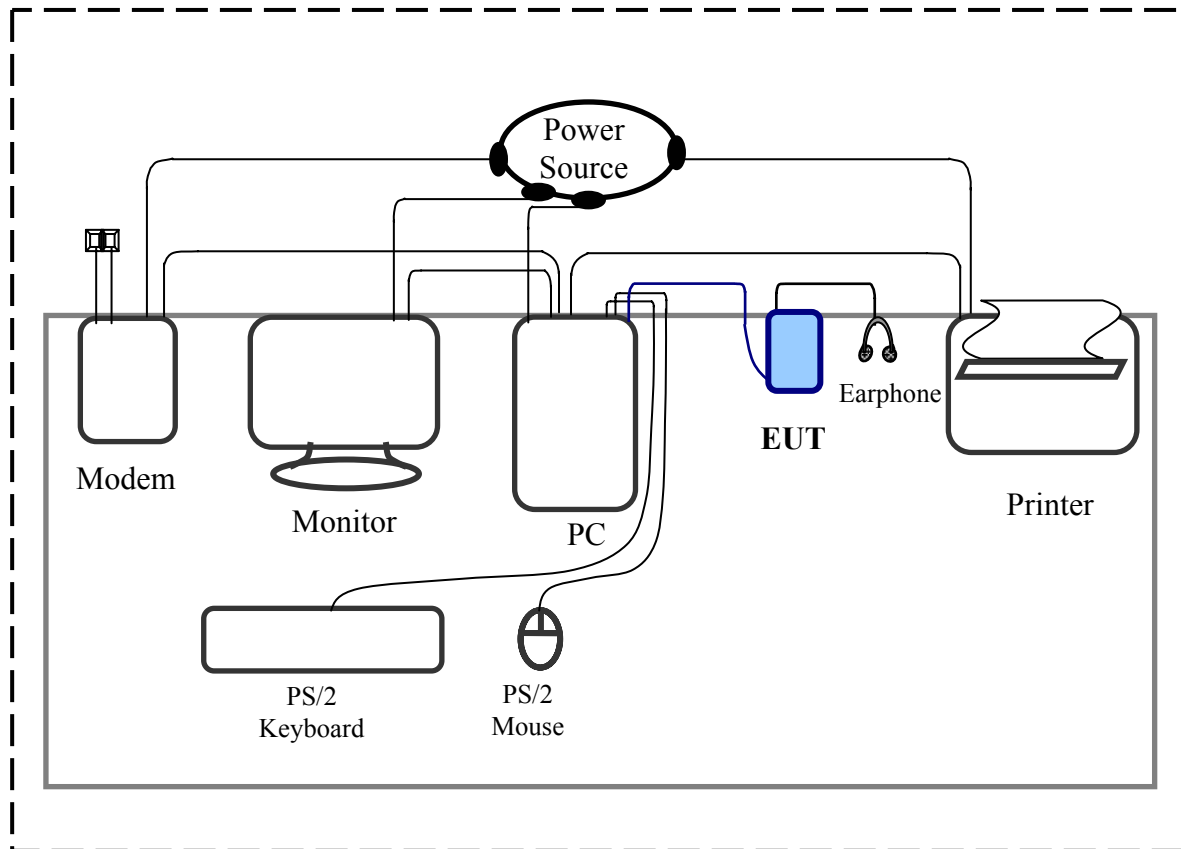

Connections of Equipment

PC:

- *VGA Port --- a monitor
- *Serial A-Port --- an external modem
- *Parallel Port --- a printer
- *PS/2 Ports --- a PS/2 keyboard and PS/2 mouse
- *USB B-Port --- EUT

EUT:

Earphone:

- *Data cable x 1 --- 105cm length, non-shielded, no ferrite core

CF socket:

- *CF Card

1.5.2 Radiated of Unintentional

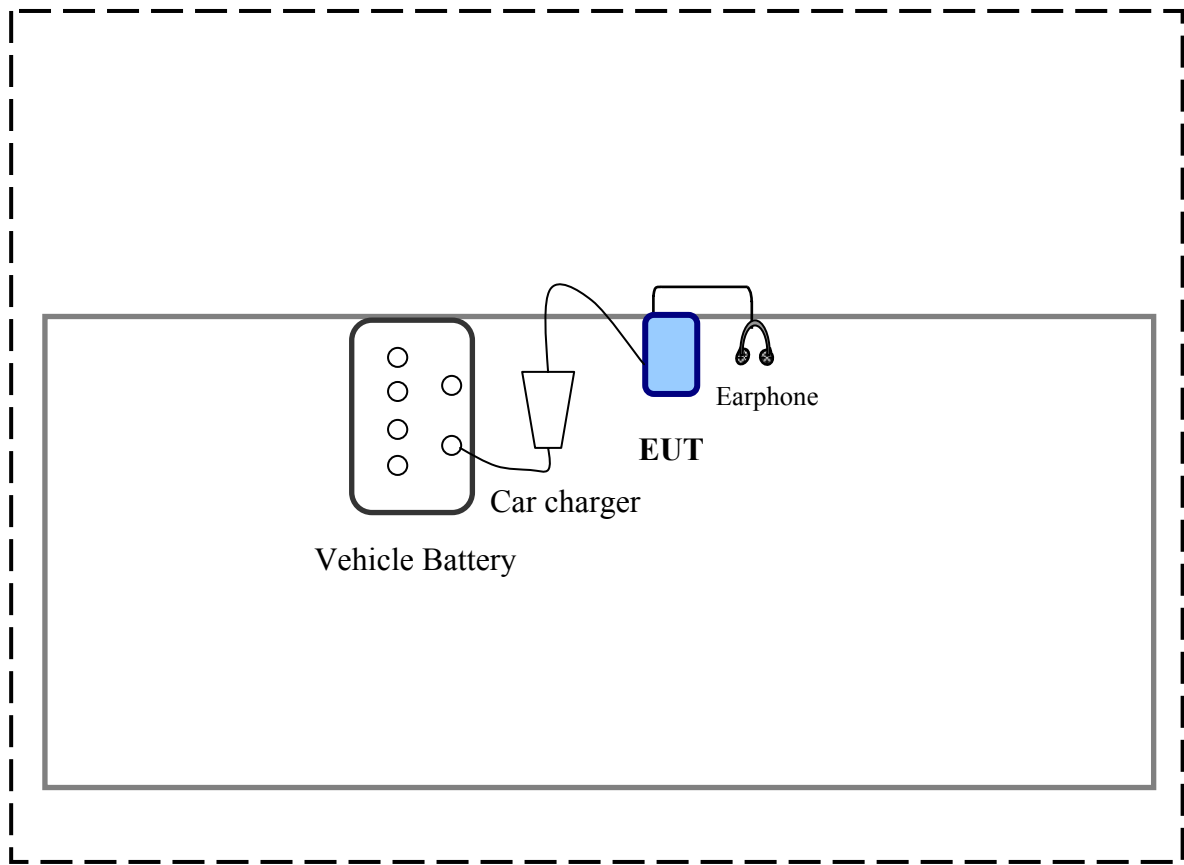

1.5.3 Conducted and Radiated of Intentional

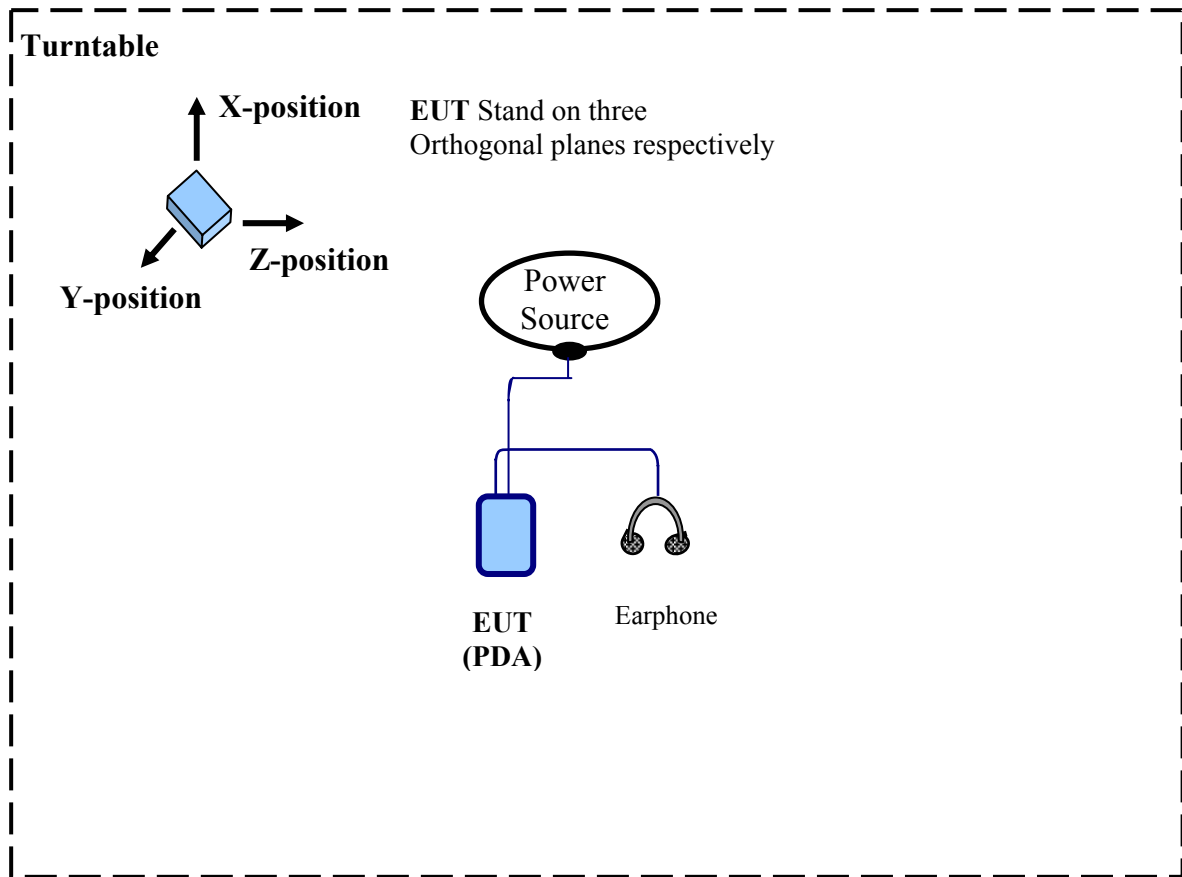

1.6 Verify the Frequency and Channel

CH	0	1	2	3	4	5	6	7	8	9
0		2402	2403	2404	2405	2406	2407	2408	2409	2410
1	2411	2412	2413	2414	2415	2416	2417	2418	2419	2420
2	2421	2422	2423	2424	2425	2426	2427	2428	2429	2430
3	2431	2432	2433	2434	2435	2436	2437	2438	2439	2440
4	2441	2442	2443	2444	2445	2446	2447	2448	2449	2450
5	2451	2452	2453	2454	2455	2456	2457	2458	2459	2460
6	2461	2462	2463	2464	2465	2466	2467	2468	2469	2470
7	2471	2472	2473	2474	2475	2476	2477	2478	2479	2480

Note:

1. This is for confirming that all frequencies are in 2.402GHz to 2.480GHz.
2. Section 15.31(m): Measurements on intentional radiators or receivers shall be performed at three frequencies for operating frequency range over 10 MHz.
(The locations of these frequencies one near the top, one near the middle and one near the bottom.)
3. After test, the EUT operating frequencies are in 2.402GHz to 2.480GHz. So all the items as followed in testing report are need to test these three frequencies:
Top: Channel – 01; Middle: Channel – 40; Bottom: Channel – 79.

1.7 Test Procedure

All measurements contained in this report were performed mainly according to the techniques described in ANSI C63.4 (1992) and the pre-setup was written on 1.3 test method, the detail setup was written on each test item.

1.8 Location of the Test Site

The radiated emissions measurements required by the rules were performed on the **three-meter, Anechoic Chamber (FCC Registration Number: 93906)** maintained by *Training Research Co., Ltd.* 1F, No. 255 Nanyang Street, Shijr, Taipei Hsien 221, Taiwan, R.O.C. Complete description and measurement data have been placed on file with the commission. The conducted power line emissions tests and other test items were performed in a anechoic chamber also located at Training Research Co., Ltd.

No. 255 Nanyang Street, Shijr, Taipei Hsien 221, Taiwan, R.O.C. *Training Research Co., Ltd.* is listed by the FCC as a facility available to do measurement work for others on a contract basis.

1.9 General Test Condition

The conditions under which the EUT operates were varied to determine their effect on the equipment's emission characteristics. The final configuration of the test system and the mode of operation used during these tests were chosen as that which produced the highest emission levels. However, only those conditions, which the EUT was considered likely to encounter in normal use were investigated.

There is a test condition apply in this test item, the test procedure description as <1.3 test method>. Three channels were tested, one in the top (CH1), one in the middle (CH40) and the other in bottom (CH79).

II. Section 15.101(a): Equipment authorization of unintentional radiators

The EUT equipped with a USB interface and should be operated with the computer. It was categorized to *Class B personal computers and peripherals* as cannot be operated stand-alone. The authorization requires **Declaration of Conformity (DoC)** and the items required such as Section 15.107 (Conducted limits) and Section 15.109 (Radiated emission limits) is same as Section 15.207 and 15.247(C).

III. Section 15.203: Antenna requirement

The EUT can be equipped with undetachable antenna. The internal antenna is affixed to the EUT using a unique connector, there is no external antenna or external connector employed. The antenna requirement stated in Section 15.203 is inapplicable to this EUT.

The custom antenna specification of list as below:

Manufacturer : WAVEFAR TECHNOLOGY CO., LTD.
Model : WTE06011
Antenna Type : Chip Antenna Module
Antenna Gain : 0.5 dBi (Max.)

IV. Section 15.207: Power Line Conducted Emissions for AC Powered Units

4.1 Test Condition & Setup

The power line conducted emission measurements were performed in an anechoic chamber. The EUT was assembled on a wooden table, which is 80 centimeters high, was placed 40 centimeters from the backwall and at least 1 meter from the sidewall.

Power was fed to the EUT from the public utility power grid through a line filter and Line Impedance Stabilization Networks (LISNs). The LISN housing, measuring instrumentation case, ground plane, etc., were electrically bonded together at the same RF potential. The Spectrum analyzer (or EMI receiver) was connected to the AC line through an isolation transformer. The 50-ohm output of the LISN was connected to the spectrum analyzer directly. Conducted emission levels were in the CISPR quasi-peak and average detection mode. The analyzer's 6 dB bandwidth was set to 9 KHz. No post-detector video filter was used.

The spectrum was scanned from 150KHz to 30MHz. The physical arrangement of the test system and associated cabling was varied (within the scope of arrangements likely to be encountered in actual use) to determine the effect on the unit's emanations in amplitude and frequency. All spurious emission frequencies were observed. The highest emission amplitudes relative to the appropriate limit were measured and have been recorded in paragraph 4.3

There is a test condition apply in this test item, the test procedure description as <1.3 test method>. Three channels were tested, one in the top (CH1), one in the middle (CH40) and the other in bottom (CH79).

4.2 List of Test Instruments

Instrument Name	Model	Brand	Serial No.	Calibration Date
				Next time
EMI Receiver	8546A	HP	3520A00242	12/01/06
RF Filter Section	85460A	HP	3448A00217	12/01/06
LISN (EUT)	LISN-01	TRC	99-05	12/10/06
LISN (Support E.)	LISN-01	TRC	9912-03, 04	11/26/06
Pre-amplifier	15542 ZFL-500	Mini – Circuits	0 0117	05/20/07
6dB Attenuator	MCL BW-S6W2	Mini – Circuits	9915 – Conducted	05/20/07
10dB Attenuator	A5542 VAT010	Mini – Circuits	0215 – Conducted	05/20/07
Coaxial Cable (2 meter)	A30A30-0058-50FS-2M	Jyebao	SMA-08	05/20/07
Coaxial Cable (1.1 meter)	A30A30-0058-50FS-1M	Jyebao	SMA-09	05/20/07
Coaxial Cable (20 meter)	RG-214/U	Jyebao	NP-01	05/20/07
Coaxial Cable (20 meter)	RG-214/U	Jyebao	NP-02	05/20/07
Auto Switch Box (< 30MHz)	ASB-01	TRC	9904-01	05/20/07

4.3 Test Results of Conducted Emissions

The following table shows a summary of the highest emissions of power line conducted emissions on the LIVE and NETURAL conductors of the EUT power cord. The test data only recorded worst case in report.

Test Conditions: Temperature : 25.0 °C Humidity : 73.0 % RH

Test Mode: (A) mode for USB LINK

<i>Power Connected Emissions</i>					<i>FCC Class B</i>		
<i>Conductor</i>	<i>Frequency (KHz)</i>	<i>Peak (dBµV)</i>	<i>QP (dBµV)</i>	<i>Average (dBµV)</i>	<i>QP-limit (dBµV)</i>	<i>AVG-limit (dBµV)</i>	<i>Margin (dB)</i>
Line 1	169.000	39.69	---	---	65.46	55.46	-15.77
	250.000	33.14	---	---	63.14	53.14	-20.00
	499.000	28.72	---	---	56.03	46.03	-17.31
	1424.000	28.25	---	---	56.00	46.00	-17.75
	7810.050	30.37	---	---	60.00	50.00	-19.63
	9640.000	32.45	---	---	60.00	50.00	-17.55
	15270.000	33.18	---	---	60.00	50.00	-16.82
	23350.000	35.78	---	---	60.00	50.00	-14.22
	26810.000	35.12	---	---	60.00	50.00	-14.88
Line 2	166.000	35.10	---	---	65.54	55.54	-20.44
	195.000	34.23	---	---	64.71	54.71	-20.48
	323.000	24.41	---	---	61.06	51.06	-26.65
	1333.000	25.69	---	---	56.00	46.00	-20.31
	7810.000	34.29	---	---	60.00	50.00	-15.71
	11560.000	34.16	---	---	60.00	50.00	-15.84
	17530.000	33.84	---	---	60.00	50.00	-16.16
	27470.000	34.52	---	---	60.00	50.00	-15.48

NOTE:

- (1)Margin = Peak Amplitude – Limit, *The reading amplitudes are all under limit.*
- (2)A "+" sign in the margin column means the emission is OVER the Class B Limit and "-" sign of means UNDER the Class B limit

Adapter (a) model: P005WA050W

Test Mode: (C) mode for RX

<i>Power Connected Emissions</i>					<i>FCC Class B</i>		
<i>Conductor</i>	<i>Frequency (KHz)</i>	<i>Peak (dBµV)</i>	<i>QP (dBµV)</i>	<i>Average (dBµV)</i>	<i>QP-limit (dBµV)</i>	<i>AVG-limit (dBµV)</i>	<i>Margin (dB)</i>
Line 1	208.000	35.86	---	---	64.34	54.34	-18.48
	255.000	36.51	---	---	63.00	53.00	-16.49
	461.000	37.43	---	---	57.11	47.11	-9.68
	604.000	35.79	---	---	56.00	46.00	-10.21
	1208.000	36.35	---	---	56.00	46.00	-9.65
	10290.000	36.42	---	---	60.00	50.00	-13.58
	15640.000	41.51	---	---	60.00	50.00	-8.49
	24560.000	42.24	---	---	60.00	50.00	-7.76
Line 2	456.000	35.47	---	---	57.26	47.26	-11.79
	598.000	34.32	---	---	56.00	46.00	-11.68
	1198.000	37.60	---	---	56.00	46.00	-8.40
	1613.000	41.68	---	---	56.00	46.00	-4.32
	2094.000	35.03	---	---	56.00	46.00	-10.97
	6080.000	35.45	---	---	60.00	50.00	-14.55
	15640.000	37.76	---	---	60.00	50.00	-12.24

Test Mode: Normal Mode for BT CH01

Power Connected Emissions					FCC Class B		
Conductor	Frequency (KHz)	Peak (dBμV)	QP (dBμV)	Average (dBμV)	QP-limit (dBμV)	AVG-limit (dBμV)	Margin (dB)
Line 1	158.000	37.38	---	---	65.77	55.77	-18.39
	439.000	35.55	---	---	57.74	47.74	-12.19
	592.000	36.16	---	---	56.00	46.00	-9.84
	745.000	35.01	---	---	56.00	46.00	-10.99
	824.000	34.64	---	---	56.00	46.00	-11.36
	2265.000	35.03	---	---	56.00	46.00	-10.97
	3285.000	34.69	---	---	56.00	46.00	-11.31
	10950.000	34.00	---	---	60.00	50.00	-16.00
	21410.000	34.84	---	---	60.00	50.00	-15.16
Line 2	152.000	39.86	---	---	65.94	55.94	-16.08
	443.000	35.52	---	---	57.63	47.63	-12.11
	598.000	35.60	---	---	56.00	46.00	-10.40
	674.000	31.94	---	---	56.00	46.00	-14.06
	902.000	31.17	---	---	56.00	46.00	-14.83
	3221.000	31.05	---	---	56.00	46.00	-14.95
	20010.000	31.73	---	---	60.00	50.00	-18.27
	20300.000	32.67	---	---	60.00	50.00	-17.33
	20770.000	32.28	---	---	60.00	50.00	-17.72

Test Mode: Normal Mode for BT CH40

Power Connected Emissions					FCC Class B		
Conductor	Frequency (KHz)	Peak (dBμV)	QP (dBμV)	Average (dBμV)	QP-limit (dBμV)	AVG-limit (dBμV)	Margin (dB)
Line 1	155.000	39.53	---	---	65.86	55.86	-16.33
	226.000	36.44	---	---	63.83	53.83	-17.39
	452.000	39.03	---	---	57.37	47.37	-8.34
	674.000	35.55	---	---	56.00	46.00	-10.45
	832.000	35.81	---	---	56.00	46.00	-10.19
	902.000	36.19	---	---	56.00	46.00	-9.81
	1049.000	35.26	---	---	56.00	46.00	-10.74
	1977.000	35.88	---	---	56.00	46.00	-10.12
Line 2	150.000	39.46	---	---	66.00	56.00	-16.54
	226.000	35.88	---	---	63.83	53.83	-17.95
	447.000	37.04	---	---	57.51	47.51	-10.47
	587.000	36.51	---	---	56.00	46.00	-9.49
	954.000	32.70	---	---	56.00	46.00	-13.30
	2051.000	30.30	---	---	56.00	46.00	-15.70
	3285.000	30.30	---	---	56.00	46.00	-15.70
	10950.000	32.61	---	---	60.00	50.00	-17.39
	19920.000	31.45	---	---	60.00	50.00	-18.55

Test Mode: Normal Mode for BT CH79

<i>Power Connected Emissions</i>					<i>FCC Class B</i>		
<i>Conductor</i>	<i>Frequency (KHz)</i>	<i>Peak (dBμV)</i>	<i>QP (dBμV)</i>	<i>Average (dBμV)</i>	<i>QP-limit (dBμV)</i>	<i>AVG-limit (dBμV)</i>	<i>Margin (dB)</i>
Line 1	208.000	36.21	---	---	64.34	54.34	-18.13
	461.000	36.83	---	---	57.11	47.11	-10.28
	598.000	36.04	---	---	56.00	46.00	-9.96
	674.000	34.96	---	---	56.00	46.00	-11.04
	989.000	33.98	---	---	56.00	46.00	-12.02
	2793.000	31.90	---	---	56.00	46.00	-14.10
	11060.000	34.76	---	---	60.00	50.00	-15.24
	12130.000	34.21	---	---	60.00	50.00	-15.79
Line 2	214.000	34.91	---	---	64.17	54.17	-19.26
	466.000	36.39	---	---	56.97	46.97	-10.58
	604.000	33.39	---	---	56.00	46.00	-12.61
	681.000	31.74	---	---	56.00	46.00	-14.26
	989.000	29.83	---	---	56.00	46.00	-16.17
	1678.000	29.21	---	---	56.00	46.00	-16.79
	10390.000	31.37	---	---	60.00	50.00	-18.63
	11670.000	31.42	---	---	60.00	50.00	-18.58

Test Mode: E.D.R. Mode for BT CH01

Power Connected Emissions					FCC Class B		
Conductor	Frequency (KHz)	Peak (dBμV)	QP (dBμV)	Average (dBμV)	QP-limit (dBμV)	AVG-limit (dBμV)	Margin (dB)
Line 1	224.000	37.99	---	---	63.89	53.89	-15.90
	466.000	37.81	---	---	56.97	46.97	-9.16
	604.000	35.76	---	---	56.00	46.00	-10.24
	1198.000	36.44	---	---	56.00	46.00	-9.56
	1598.000	41.45	---	---	56.00	46.00	-4.55
	2394.000	34.60	---	---	56.00	46.00	-11.40
	3126.000	32.66	---	---	56.00	46.00	-13.34
	10630.000	35.28	---	---	60.00	50.00	-14.72
	15640.000	35.47	---	---	60.00	50.00	-14.53
Line 2	212.000	37.55	---	---	64.23	54.23	-16.68
	461.000	35.72	---	---	57.11	47.11	-11.39
	598.000	33.96	---	---	56.00	46.00	-12.04
	1198.000	36.21	---	---	56.00	46.00	-9.79
	1598.000	34.85	---	---	56.00	46.00	-11.15
	2394.000	32.08	---	---	56.00	46.00	-13.92
	10780.000	31.70	---	---	60.00	50.00	-18.30
	15640.000	32.45	---	---	60.00	50.00	-17.55
	19520.000	29.33	---	---	60.00	50.00	-20.67

Test Mode: E.D.R. Mode for BT CH40

<i>Power Connected Emissions</i>					<i>FCC Class B</i>		
<i>Conductor</i>	<i>Frequency (KHz)</i>	<i>Peak (dBμV)</i>	<i>QP (dBμV)</i>	<i>Average (dBμV)</i>	<i>QP-limit (dBμV)</i>	<i>AVG-limit (dBμV)</i>	<i>Margin (dB)</i>
Line 1	224.000	38.30	---	---	63.89	53.89	-15.59
	461.000	37.88	---	---	57.11	47.11	-9.23
	604.000	35.95	---	---	56.00	46.00	-10.05
	668.000	35.38	---	---	56.00	46.00	-10.62
	1678.000	35.79	---	---	56.00	46.00	-10.21
	3094.000	31.65	---	---	56.00	46.00	-14.35
	11060.000	35.54	---	---	60.00	50.00	-14.46
	20680.000	33.90	---	---	60.00	50.00	-16.10
Line 2	216.000	37.01	---	---	64.11	54.11	-17.10
	461.000	36.49	---	---	57.11	47.11	-10.62
	604.000	33.53	---	---	56.00	46.00	-12.47
	1198.000	34.71	---	---	56.00	46.00	-11.29
	1566.000	32.75	---	---	56.00	46.00	-13.25
	2394.000	30.48	---	---	56.00	46.00	-15.52
	10730.000	31.51	---	---	60.00	50.00	-18.49
	15640.000	29.81	---	---	60.00	50.00	-20.19

Test Mode: E.D.R. Mode for BT CH79

Power Connected Emissions					FCC Class B		
Conductor	Frequency (KHz)	Peak (dBμV)	QP (dBμV)	Average (dBμV)	QP-limit (dBμV)	AVG-limit (dBμV)	Margin (dB)
Line 1	212.000	35.12	---	---	64.23	54.23	-19.11
	461.000	37.76	---	---	57.11	47.11	-9.35
	604.000	35.65	---	---	56.00	46.00	-10.35
	998.000	34.26	---	---	56.00	46.00	-11.74
	1598.000	33.84	---	---	56.00	46.00	-12.16
	2136.000	32.20	---	---	56.00	46.00	-13.80
	3004.000	32.10	---	---	56.00	46.00	-13.90
	3780.000	30.96	---	---	56.00	46.00	-15.04
	11000.000	36.53	---	---	60.00	50.00	-13.47
Line 2	210.000	38.36	---	---	64.29	54.29	-15.93
	222.000	38.16	---	---	63.94	53.94	-15.78
	456.000	36.25	---	---	57.26	47.26	-11.01
	604.000	33.98	---	---	56.00	46.00	-12.02
	1198.000	33.30	---	---	56.00	46.00	-12.70
	1550.000	31.28	---	---	56.00	46.00	-14.72
	2394.000	28.11	---	---	56.00	46.00	-17.89
	11170.000	32.01	---	---	60.00	50.00	-17.99

Adapter (b) model: JSP050090UU

Test Mode: (C) mode for RX

<i>Power Connected Emissions</i>					<i>FCC Class B</i>		
<i>Conductor</i>	<i>Frequency (KHz)</i>	<i>Peak (dBµV)</i>	<i>QP (dBµV)</i>	<i>Average (dBµV)</i>	<i>QP-limit (dBµV)</i>	<i>AVG-limit (dBµV)</i>	<i>Margin (dB)</i>
Line 1	175.000	57.80	57.05	47.05	65.29	55.29	-8.24
	289.875	49.34	48.12	43.08	61.97	51.97	-8.89
	463.795	47.66	46.72	42.27	56.97	46.97	-4.70
	579.740	47.75	46.82	39.22	56.00	46.00	-6.78
	1218.280	48.35	46.66	39.07	56.00	46.00	-6.93
	1854.990	45.86	44.10	36.46	56.00	46.00	-9.54
	2661.315	54.10	51.51	40.45	56.00	46.00	-4.49
	2896.230	47.50	44.42	35.24	56.00	46.00	-10.76
	4805.590	52.95	49.96	38.68	56.00	46.00	-6.04
	10478.910	48.76	42.85	34.13	60.00	50.00	-15.87
Line 2	174.055	52.64	51.94	42.24	65.29	55.29	-13.05
	463.160	47.30	45.61	40.00	57.11	47.11	-7.11
	1327.645	46.12	42.76	35.25	56.00	46.00	-10.75
	2658.245	51.26	48.18	40.99	56.00	46.00	-5.01
	2832.535	45.10	41.90	34.91	56.00	46.00	-11.09
	4625.190	50.69	46.51	39.03	56.00	46.00	-6.97
	10830.000	48.58	---	---	60.00	50.00	-1.42
	19820.000	40.91	---	---	60.00	50.00	-9.09

Test Mode: Normal Mode for BT CH01

Power Connected Emissions					FCC Class B		
Conductor	Frequency (KHz)	Peak (dBμV)	QP (dBμV)	Average (dBμV)	QP-limit (dBμV)	AVG-limit (dBμV)	Margin (dB)
Line 1	174.000	51.93	---	---	65.31	55.31	-3.38
	350.250	51.70	50.36	42.17	60.34	50.34	-8.17
	641.160	47.80	46.91	40.01	56.00	46.00	-5.99
	932.455	49.41	48.29	40.78	56.00	46.00	-5.22
	2503.090	48.42	46.31	37.39	56.00	46.00	-8.61
	4603.210	53.30	49.21	36.82	56.00	46.00	-6.79
	4841.890	54.00	47.83	35.39	56.00	46.00	-8.17
	6980.000	47.48	---	---	60.00	50.00	-2.52
	10480.000	43.08	---	---	60.00	50.00	-6.92
Line 2	174.000	53.44	---	---	65.31	55.31	-1.87
	352.000	45.98	---	---	60.23	50.23	-4.25
	639.000	44.72	---	---	56.00	46.00	-1.28
	930.250	47.20	44.26	35.57	56.00	46.00	-10.43
	1282.000	42.96	---	---	56.00	46.00	-3.04
	2437.000	42.59	---	---	56.00	46.00	-3.41
	4716.395	51.73	46.35	36.72	56.00	46.00	-9.28
	6460.000	47.13	---	---	60.00	50.00	-2.87
	9010.000	42.92	---	---	60.00	50.00	-7.08

Test Mode: Normal Mode for BT CH40

Power Connected Emissions					FCC Class B		
Conductor	Frequency (KHz)	Peak (dBμV)	QP (dBμV)	Average (dBμV)	QP-limit (dBμV)	AVG-limit (dBμV)	Margin (dB)
Line 1	174.000	51.93	---	---	65.31	55.31	-3.38
	350.925	51.81	50.05	41.86	60.34	50.34	-8.48
	582.710	48.54	47.57	41.53	56.00	46.00	-4.47
	991.565	48.76	46.76	39.62	56.00	46.00	-6.38
	2446.720	48.97	46.47	36.65	56.00	46.00	-9.35
	4598.710	52.95	49.62	37.53	56.00	46.00	-6.38
	4936.720	53.04	45.97	32.94	56.00	46.00	-10.03
	6710.000	47.27	---	---	60.00	50.00	-2.73
	11560.000	42.96	---	---	60.00	50.00	-7.04
Line 2	174.000	53.09	---	---	65.31	55.31	-2.22
	348.000	49.11	---	---	60.34	50.34	-1.23
	581.900	47.27	45.18	34.45	56.00	46.00	-9.55
	928.000	44.61	---	---	56.00	46.00	-1.39
	1333.000	43.72	---	---	56.00	46.00	-2.28
	2437.000	43.77	---	---	56.00	46.00	-2.23
	4655.560	51.98	45.61	35.46	56.00	46.00	-10.39
	5006.820	51.52	46.05	36.87	60.00	50.00	-13.13
	8000.000	44.03	---	---	60.00	50.00	-5.97

Test Mode: Normal Mode for BT CH79

Power Connected Emissions					FCC Class B		
Conductor	Frequency (KHz)	Peak (dBμV)	QP (dBμV)	Average (dBμV)	QP-limit (dBμV)	AVG-limit (dBμV)	Margin (dB)
Line 1	177.000	51.17	---	---	65.23	55.23	-4.06
	231.000	49.64	---	---	63.69	53.69	-4.05
	409.000	49.69	47.58	38.44	58.60	48.60	-10.16
	582.035	48.49	47.48	41.45	56.00	46.00	-4.55
	932.545	49.52	48.19	40.63	56.00	46.00	-5.37
	2444.975	48.72	46.71	37.21	56.00	46.00	-8.79
	4608.085	53.49	46.96	32.54	56.00	46.00	-9.04
	11290.000	42.92	---	---	60.00	50.00	-7.08
Line 2	175.000	53.21	---	---	65.29	55.29	-2.08
	348.000	49.25	---	---	60.34	50.34	-1.09
	640.845	46.72	44.05	35.22	56.00	46.00	-10.78
	1049.000	43.53	---	---	56.00	46.00	-2.47
	2437.000	42.33	---	---	56.00	46.00	-3.67
	4540.970	50.09	45.28	35.15	56.00	46.00	-10.72
	5000.000	47.46	---	---	60.00	50.00	-2.54
	6980.000	47.32	---	---	60.00	50.00	-2.68
	8870.000	43.06	---	---	60.00	50.00	-6.94

Test Mode: E.D.R. Mode for BT CH01

Power Connected Emissions					FCC Class B		
Conductor	Frequency (KHz)	Peak (dBμV)	QP (dBμV)	Average (dBμV)	QP-limit (dBμV)	AVG-limit (dBμV)	Margin (dB)
Line 1	182.000	53.75	---	---	65.09	55.09	-1.34
	305.000	48.47	---	---	61.57	51.57	-3.10
	668.075	46.74	44.94	33.99	56.00	46.00	-11.06
	968.445	46.32	43.58	34.82	56.00	46.00	-11.18
	1157.745	45.33	41.12	29.12	56.00	46.00	-14.88
	2428.470	48.97	46.99	37.56	56.00	46.00	-8.44
	4135.975	51.13	46.49	34.99	56.00	46.00	-9.51
	5860.000	46.12	---	---	60.00	50.00	-3.88
	9680.000	42.92	---	---	60.00	50.00	-7.08
Line 2	182.000	52.76	---	---	65.09	55.09	-2.33
	302.000	49.43	---	---	61.66	51.66	-2.23
	480.000	44.66	---	---	56.57	46.57	-1.91
	850.000	43.93	---	---	56.00	46.00	-2.07
	1208.000	43.25	---	---	56.00	46.00	-2.75
	2351.000	44.03	---	---	56.00	46.00	-1.97
	4066.615	48.23	44.51	34.23	56.00	46.00	-11.49
	5940.000	44.77	---	---	60.00	50.00	-5.23
	8650.000	42.12	---	---	60.00	50.00	-7.88

Test Mode: E.D.R. Mode for BT CH40

Power Connected Emissions					FCC Class B		
Conductor	Frequency (KHz)	Peak (dBμV)	QP (dBμV)	Average (dBμV)	QP-limit (dBμV)	AVG-limit (dBμV)	Margin (dB)
Line 1	180.000	52.95	---	---	65.14	55.14	-2.19
	607.645	46.39	44.51	37.15	56.00	46.00	-8.85
	670.160	46.37	43.51	32.66	56.00	46.00	-12.49
	841.000	44.33	---	---	56.00	46.00	-1.67
	1208.000	43.64	---	---	56.00	46.00	-2.36
	2429.325	49.04	46.99	37.11	56.00	46.00	-8.89
	4250.135	51.88	48.47	38.71	56.00	46.00	-7.29
	5800.000	46.48	---	---	60.00	50.00	-3.52
	8000.000	44.42	---	---	60.00	50.00	-5.58
Line 2	182.790	53.79	52.76	40.76	65.14	55.14	-12.38
	300.000	48.61	---	---	61.71	51.71	-3.10
	604.000	44.70	---	---	56.00	46.00	-1.30
	972.000	43.48	---	---	56.00	46.00	-2.52
	2351.000	44.47	---	---	56.00	46.00	-1.53
	4005.845	48.10	44.76	34.42	56.00	46.00	-11.24
	5800.000	44.72	---	---	60.00	50.00	-5.28
	10890.000	39.96	---	---	60.00	50.00	-10.04

Test Mode: E.D.R. Mode for BT CH79

Power Connected Emissions					FCC Class B		
Conductor	Frequency (KHz)	Peak (dBμV)	QP (dBμV)	Average (dBμV)	QP-limit (dBμV)	AVG-limit (dBμV)	Margin (dB)
Line 1	182.000	53.65	---	---	65.09	55.09	-1.44
	302.000	49.34	---	---	61.66	51.66	-2.32
	605.575	58.36	44.34	36.72	56.00	46.00	-9.28
	665.840	46.83	44.47	33.07	56.00	46.00	-11.53
	1274.895	46.27	45.07	37.19	56.00	46.00	-8.81
	2423.985	49.32	46.27	35.97	56.00	46.00	-9.73
	4368.270	50.64	47.41	37.65	56.00	46.00	-8.35
	5680.000	48.58	---	---	60.00	50.00	-1.42
	15640.000	46.23	---	---	60.00	50.00	-3.77
Line 2	182.000	53.51	---	---	65.09	55.09	-1.58
	305.000	47.68	---	---	61.57	51.57	-3.89
	547.000	42.61	---	---	56.00	46.00	-3.39
	1216.640	43.77	40.82	29.47	56.00	46.00	-3.39
	2480.000	43.11	---	---	56.00	46.00	-2.89
	4255.960	48.97	43.34	31.77	56.00	46.00	-12.66
	5800.000	44.56	---	---	60.00	50.00	-5.44
	10240.000	40.57	---	---	60.00	50.00	-9.43
	15570.000	41.15	---	---	60.00	50.00	-8.85

V. Section 15.247 (a): Technical description of the EUT

Based on the Section 2.1, *Frequency Hopping Spectrum System* is a spread spectrum system in which the carrier has been modulated by a *high speed spreading code* and an *information data stream* with its *known hopping algorithm* and *avoidance method*. The high speed code sequence dominates the “modulating function” and is the direct cause of the wide spreading of the transmitted signal. In the *operational description* demonstrates the operation principles of the base-band processor employed by the EUT, shows that which is a complete FHSS base-band processor and meets the definition of the *Frequency Hopping Spectrum System*.

VI. Section 15.247(a)(1): Carrier Frequency Separation

6.1 Test Condition

The EUT must have its hopping function enabled. Use the following spectrum analyzer setting

Span = wide enough to capture the peaks of two adjacent channels

Resolution (or IF) bandwidth (RBW) \geq 1% of the span

Video (or Average) Bandwidth (VBW) \geq RBW

Sweep = Auto

Detector Function = peak

Trace = max hold

Setting up procedure is written on 1.3 test method.

Allow the trace to stabilize. Use the marker-delta function to determine the separation between the peaks of the adjacent channel. The limit is specified in one of the subparagraphs of this section. Submit this plot.

6.2 Test Instruments Configuration

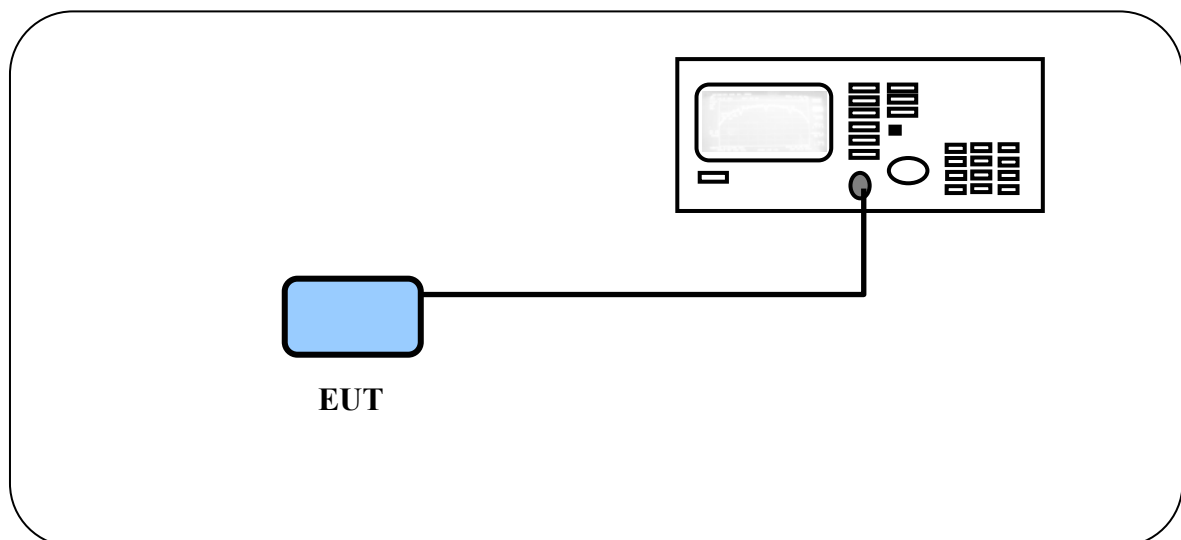

Test Configuration of carrier frequency separation

6.3 List of Test Instruments

Instrument Name	Model No.	Brand	Serial No.	Next time
Spectrum Analyzer	MS2665C	ANRITSU	6200175476	02/15/07

6.4 Test Results

Channel	Normal mode	E.D.R mode
01	996 kHz	990 kHz
40	996 kHz	990 kHz
79	990 kHz	990 kHz

Carrier Frequency Separation for CH01



Normal mode

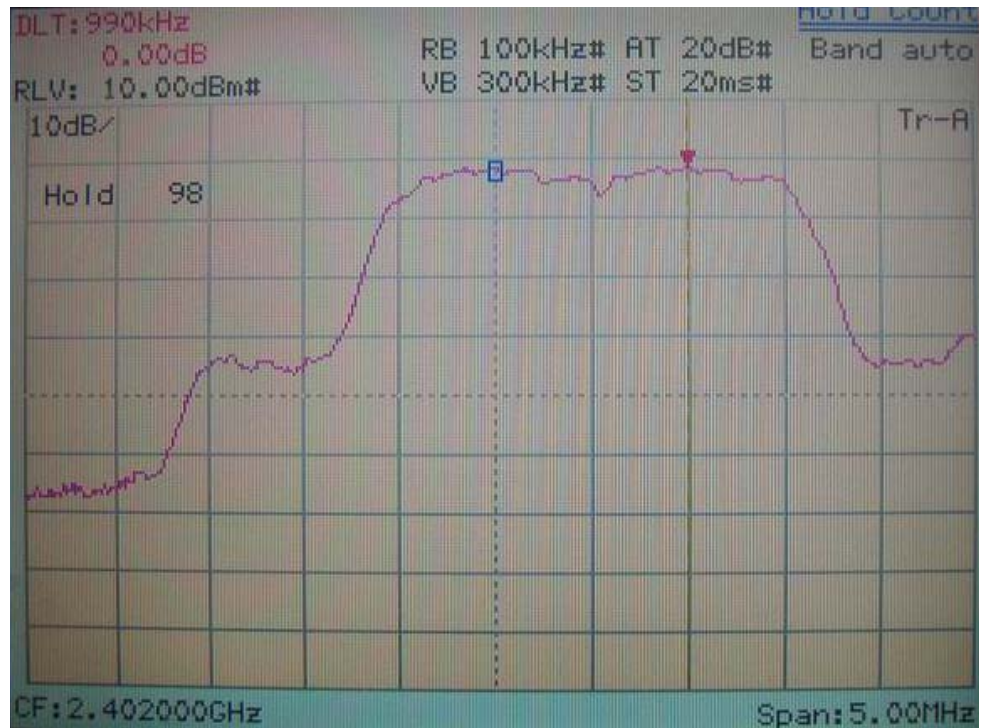

E.D.R. mode

Carrier Frequency Separation for CH40

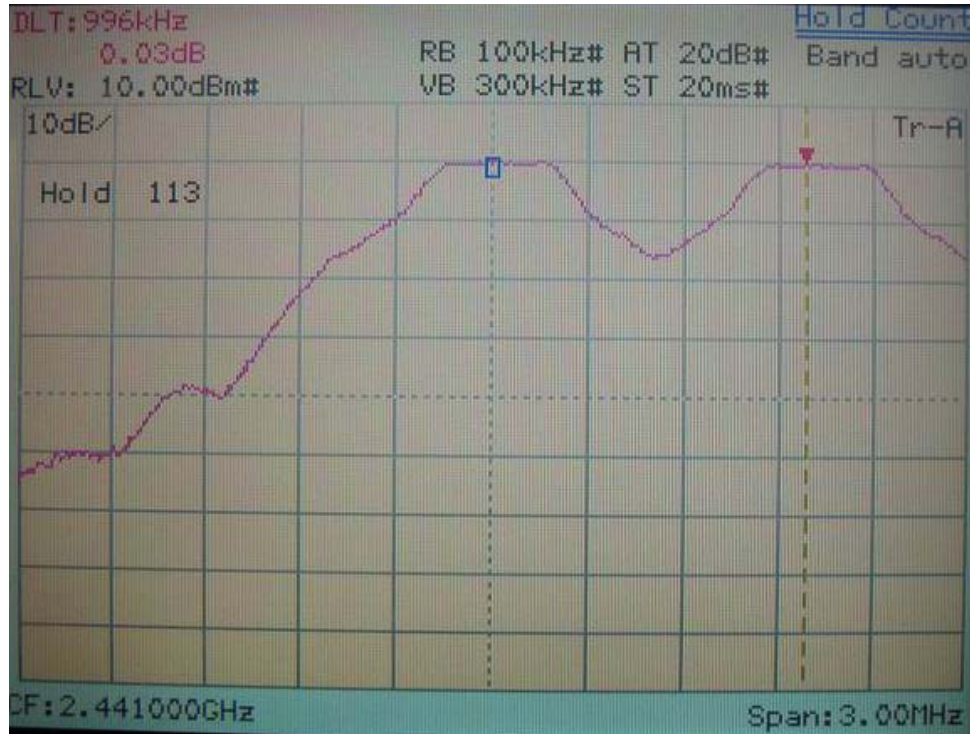

Normal mode

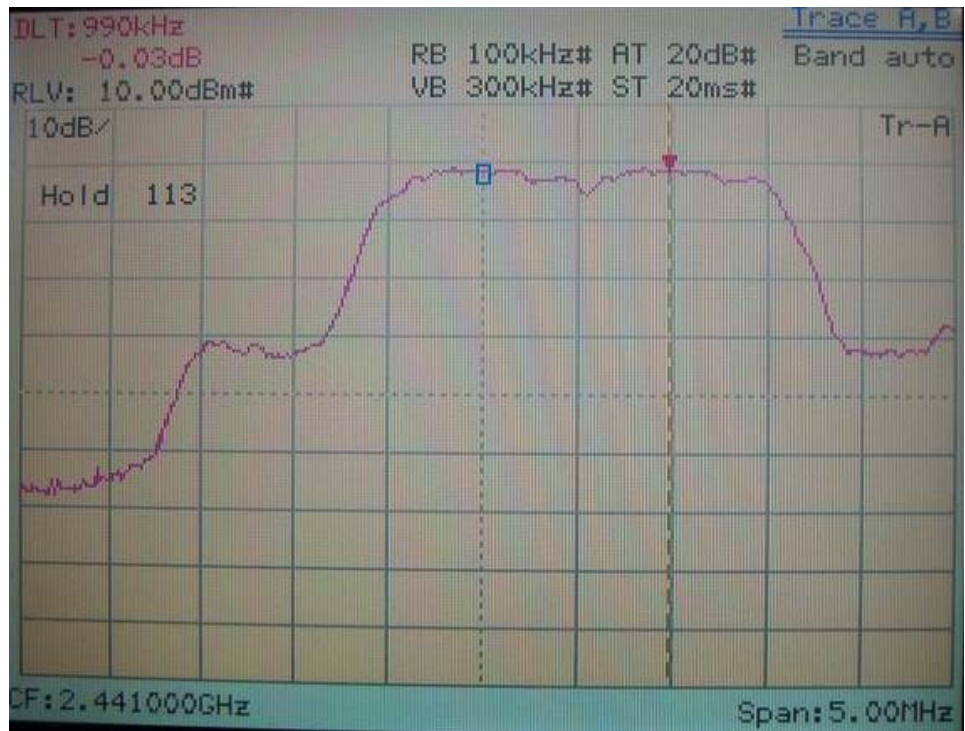

E.D.R. mode

Carrier Frequency Separation for CH79



Normal mode



E.D.R. mode

VII. Section 15.247(a)(1)(ii) Number of Hopping Frequencies

7.1 Test Condition

The EUT must have its Hopping function enabled. Use the following spectrum analyzer setting:

Span = the frequency band of operation

RBW \geq 1% of the span

VBW \geq RBW

Sweep = auto

Detector function = peak

Trace = max hold

Allow the trace to stabilize. It may prove necessary to break the span up to sections. In order to clearly show all of the hopping frequencies. The limit is specified in one of the subparagraphs of this section. Submit this plots.

7.2 List of Test Instruments

Instrument Name	Model No.	Brand	Serial No.	Next time
Spectrum Analyzer	MS2665C	ANRITSU	6200175476	02/15/07

7.3 Test Instruments Configuration

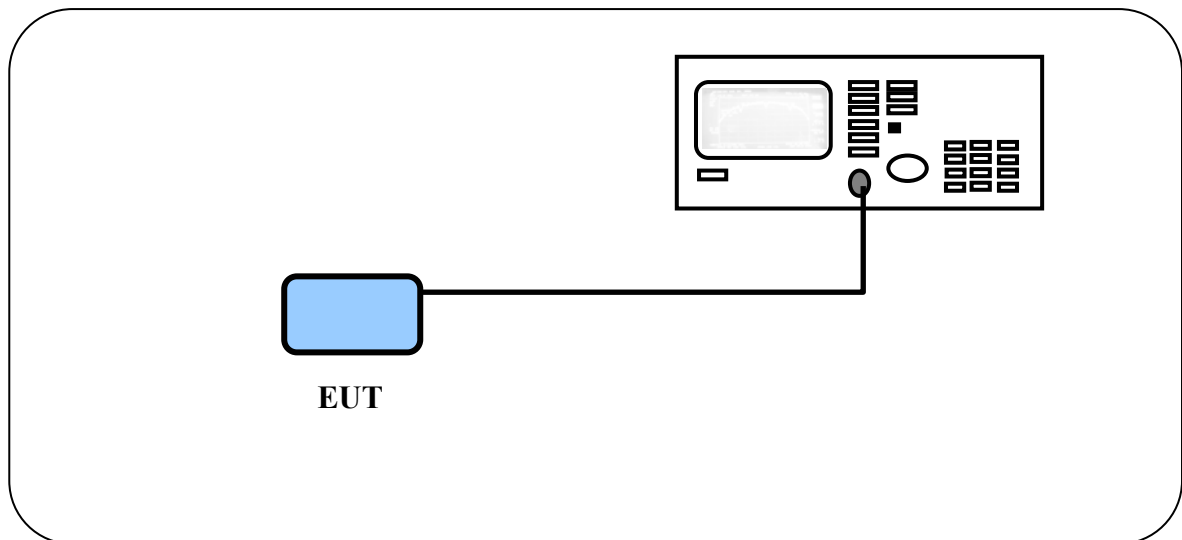

Test Configuration for number of hopping frequencies

7.4 Test Results

Normal mode

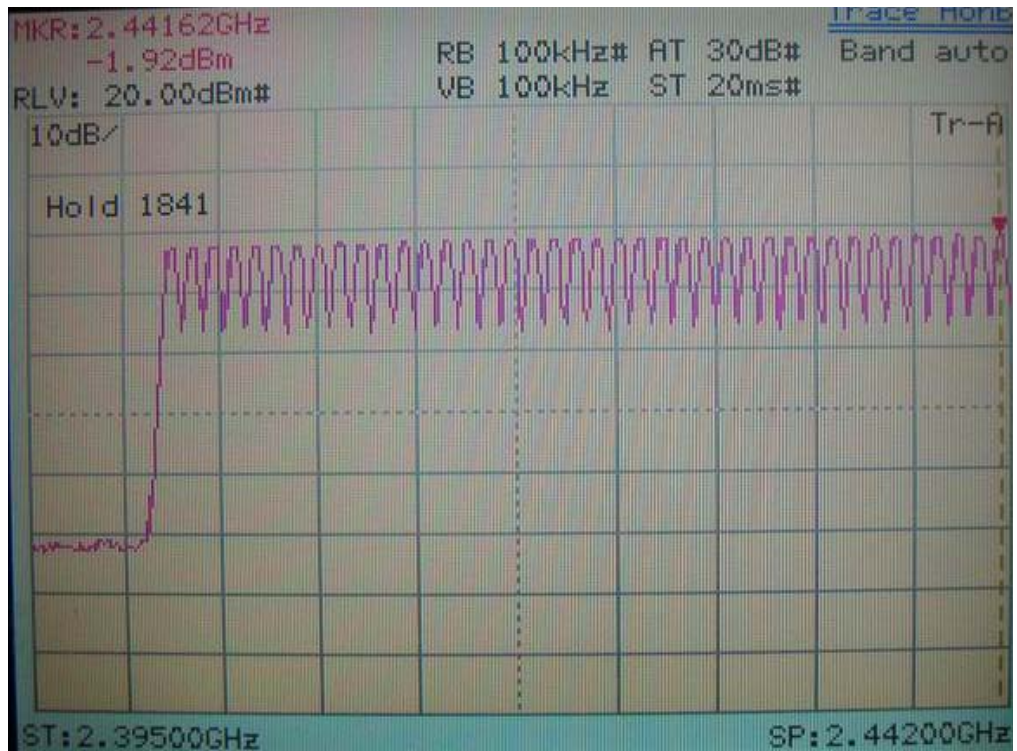
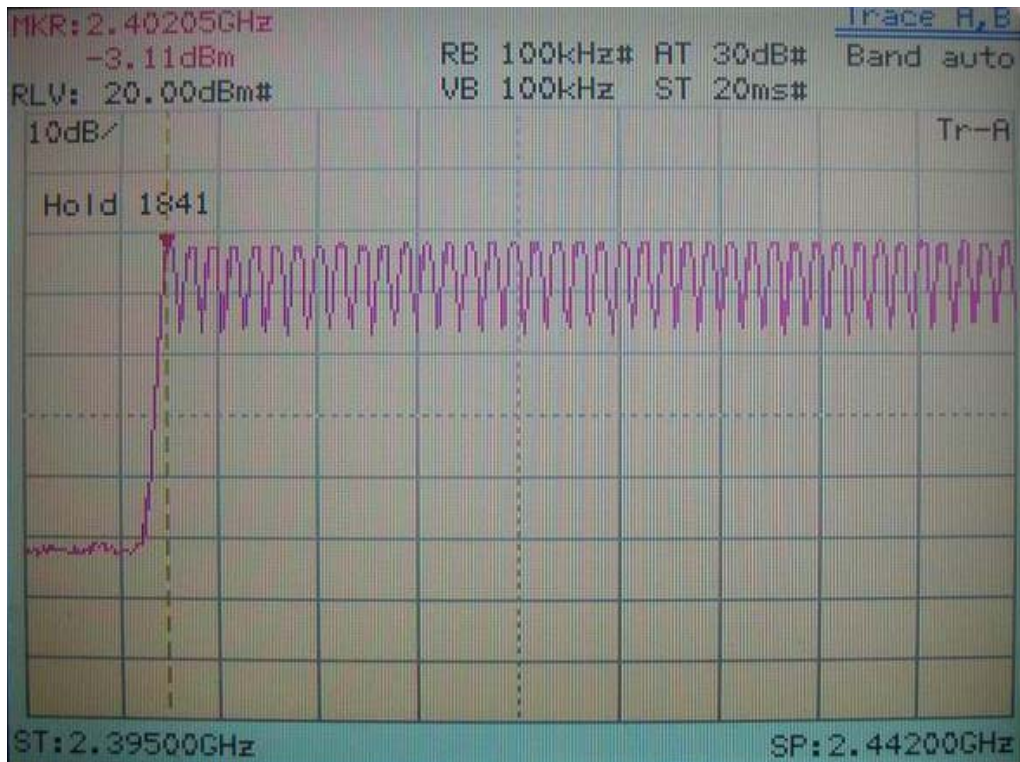

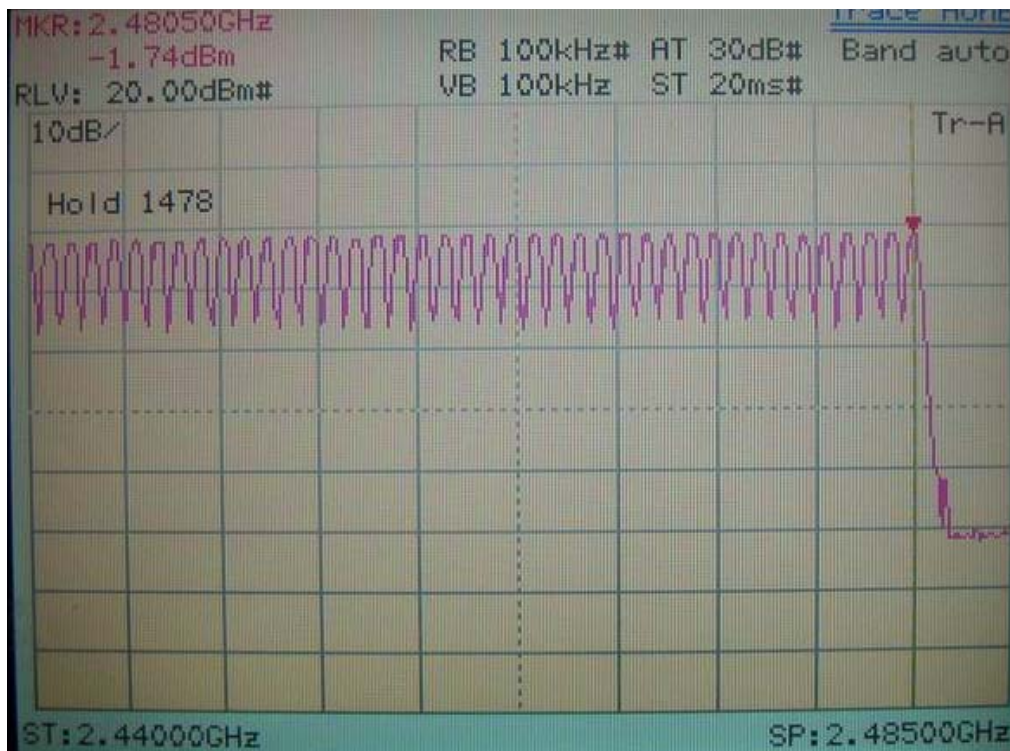
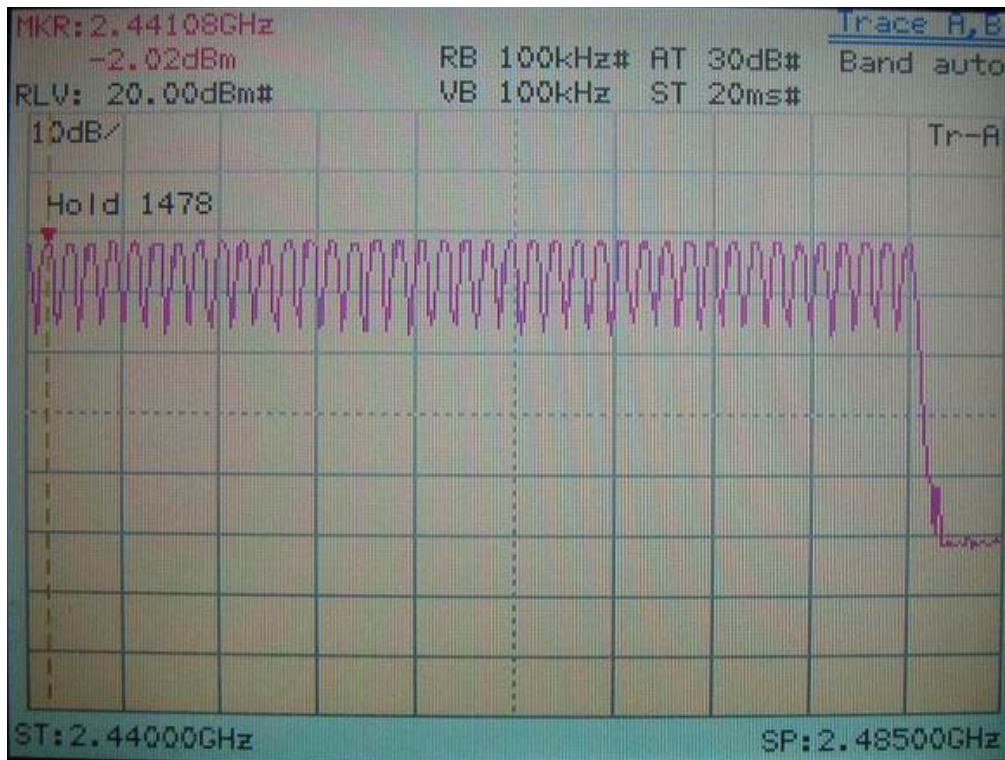

E.D.R. mode

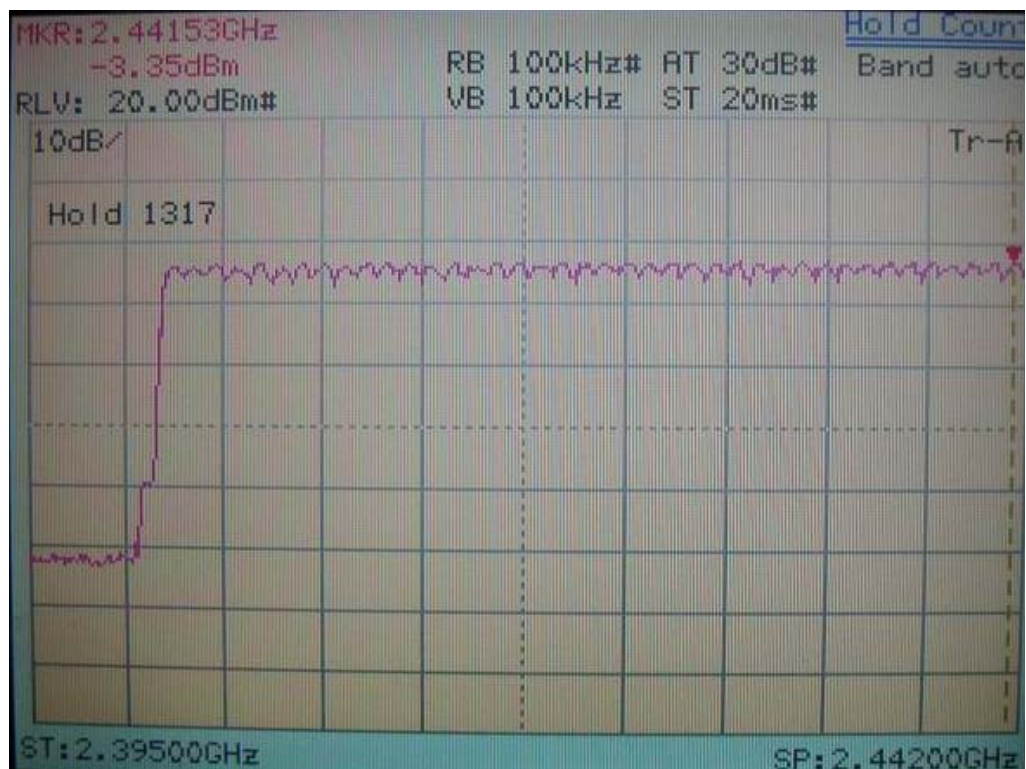
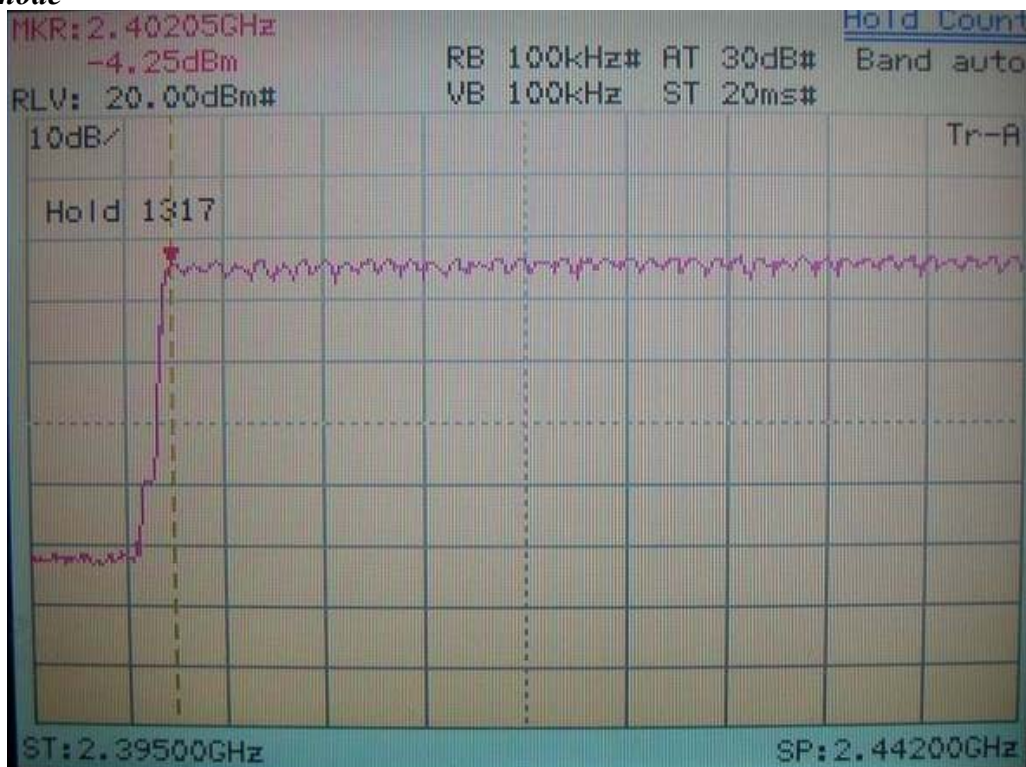

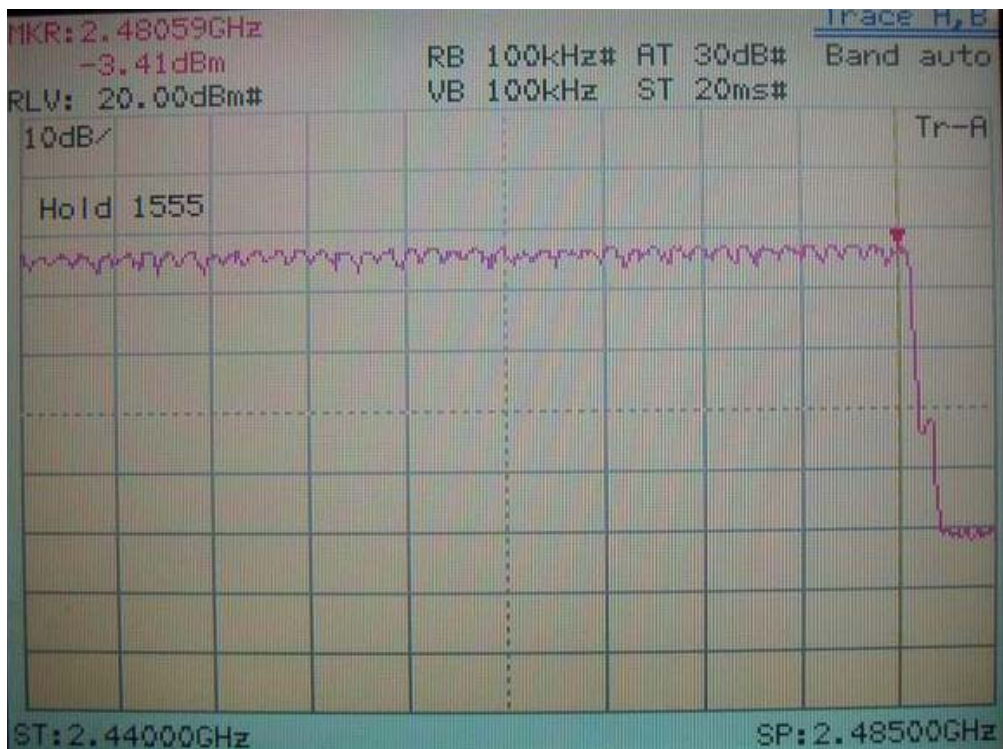
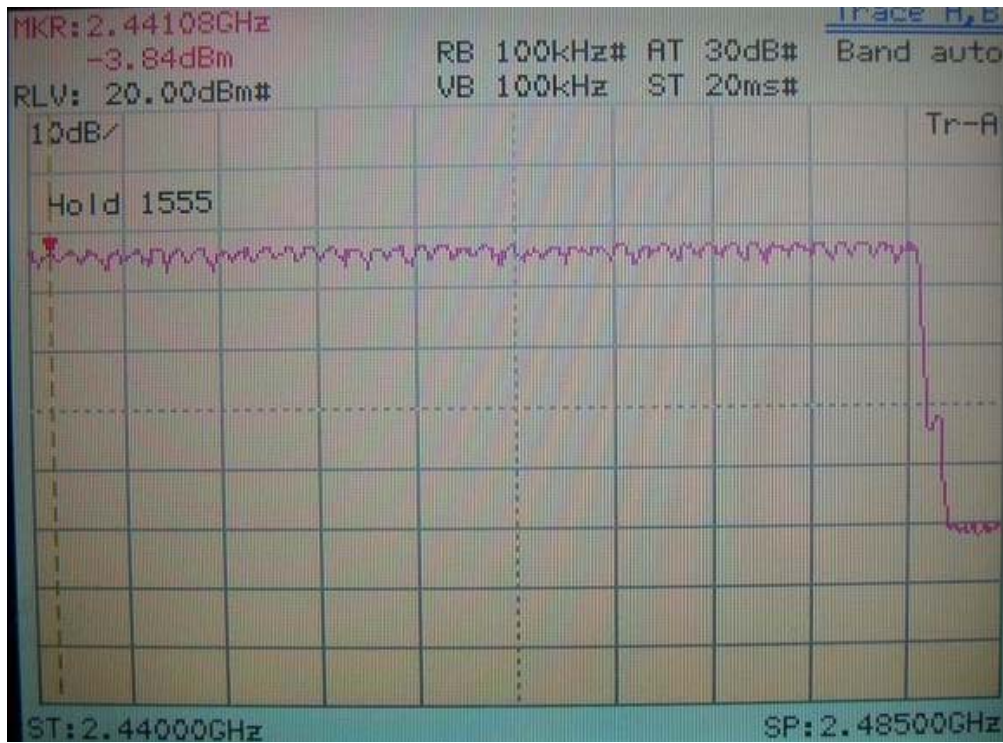

VIII. Section 15.247(a)(1)(ii) Time of Occupancy (Dwell Time)

8.1 Test Condition

The EUT must have its hopping function enabled. Use the following spectrum analyzer setting:

Span = zero span, centered on a hopping channel

RBW = 1M

VBW \geq RBW

Sweep = as necessary to capture the entire dwell time per hopping channel

Detector function = peak

Trace = max hold

If possible, use the marker-delta function to determine the dwell time. If this value varies with different modes of operation (e.g., data rate, modulation format, etc.), repeat this test for each variation. The limit is specified in one of the subparagraphs of this section. Submit this plot(s). An oscilloscope may be used instead of a spectrum analyzer.

8.2 List of Test Instruments

<u>Instrument Name</u>	<u>Model No</u>	<u>Brand</u>	<u>Serial No.</u>	<u>Next time</u>
Spectrum Analyzer	8564E	H P	3720A00840	02/07/07
Spectrum Analyzer	MS2665C	ANRITSU	6200175476	02/15/07
Microwave Preamplifier	84125C	HP	US36433002	02/07/07
Horn Antenna	3115	EMCO	9704 – 5178	01/26/07

8.3 Test Instruments Configuration

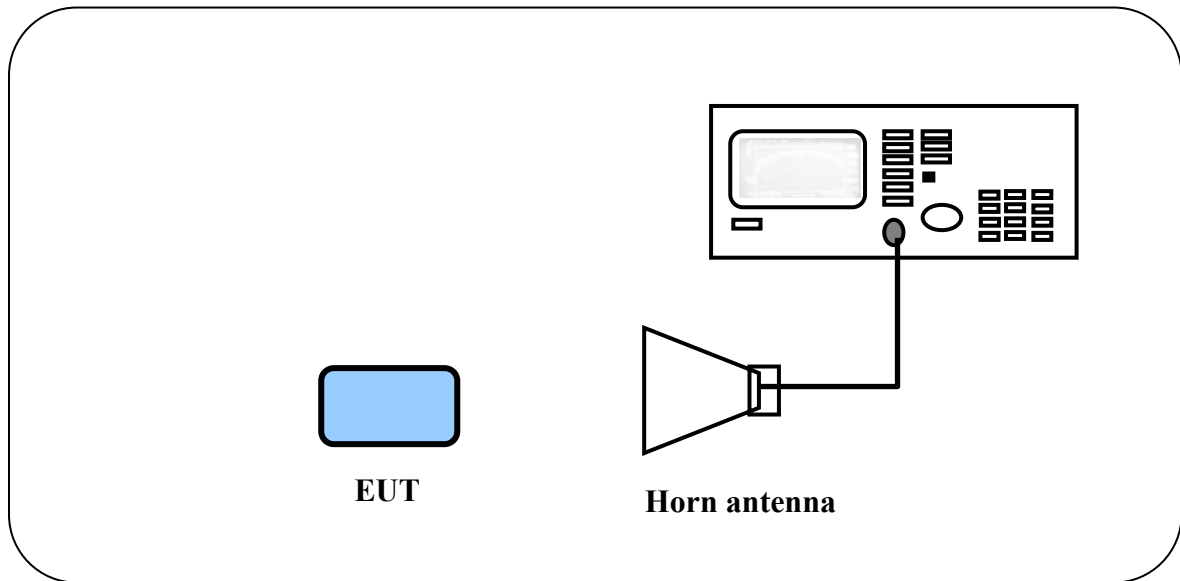

8.4 Test Results

Normal mode

CH	DH1-Packet (ms)	DH3-Packet (ms)	DH5-Packet (ms)
01	$0.566 \times 31.6 \times 10.12 = 181.00$	$1.810 \times 31.6 \times 5.06 = 289.41$	$3.040 \times 31.6 \times 3.37 = 323.74$
40	$0.566 \times 31.6 \times 10.12 = 184.20$	$1.810 \times 31.6 \times 5.06 = 289.41$	$3.040 \times 31.6 \times 3.37 = 323.74$
79	$0.568 \times 31.6 \times 10.12 = 181.64$	$1.800 \times 31.6 \times 5.06 = 287.81$	$3.040 \times 31.6 \times 3.37 = 323.74$

E.D.R. mode

CH	DH1-Packet (ms)	DH3-Packet (ms)	DH5-Packet (ms)
01	$0.572 \times 31.6 \times 10.12 = 182.92$	$1.810 \times 31.6 \times 5.06 = 289.41$	$3.060 \times 31.6 \times 3.37 = 325.87$
40	$0.572 \times 31.6 \times 10.12 = 182.92$	$1.810 \times 31.6 \times 5.06 = 289.41$	$3.040 \times 31.6 \times 3.37 = 323.74$
79	$0.574 \times 31.6 \times 10.12 = 183.56$	$1.820 \times 31.6 \times 5.06 = 291.01$	$3.060 \times 31.6 \times 3.37 = 325.87$

備註：1. $0.4 \times 79 = 31.6$ s

2. DH1: $1600 \div 79 \div 2 = 10.12$ ms

3. DH3: $1600 \div 79 \div 4 = 5.06$ ms

4. DH5: $1600 \div 79 \div 6 = 3.37$ ms

5. Show as following page.

DH1-Packet : (Normal mode)

Ch01

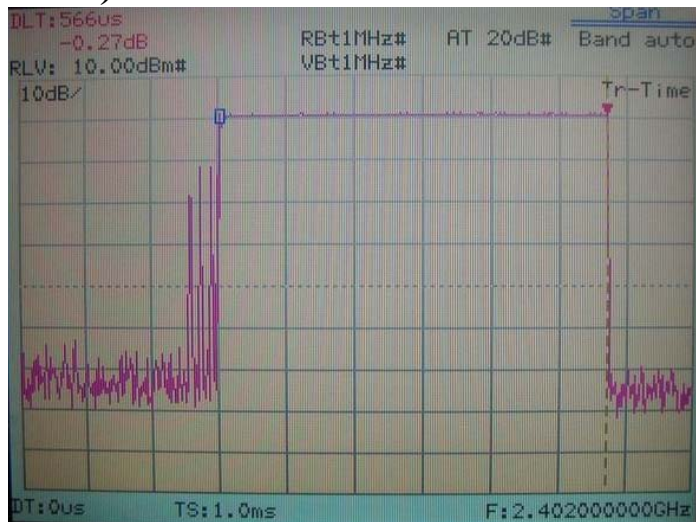

Ch40

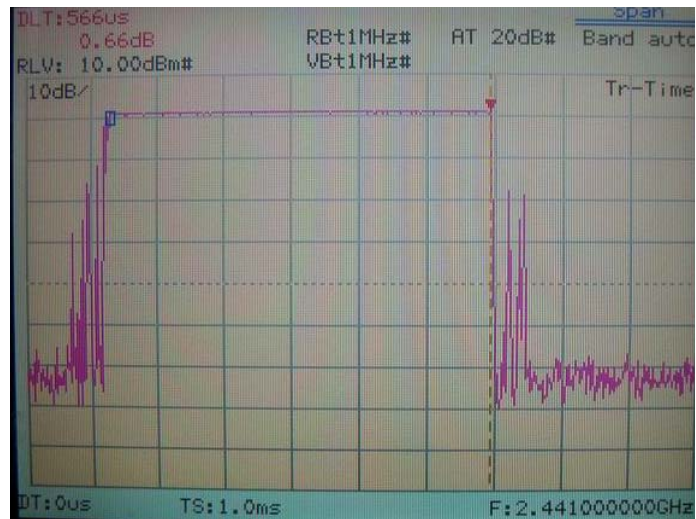

Ch79

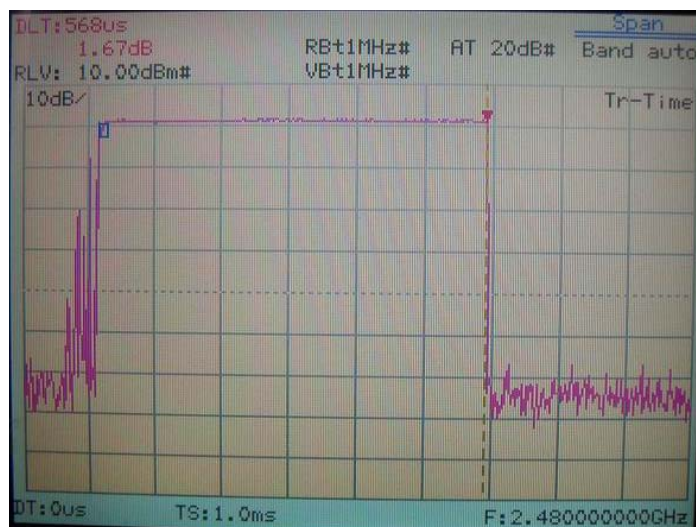

DH1-Packet : (E.D.R. mode)

Ch01

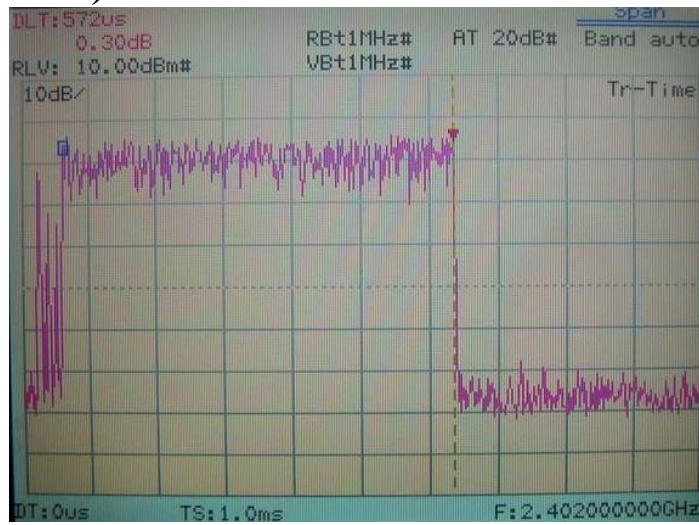

Ch40

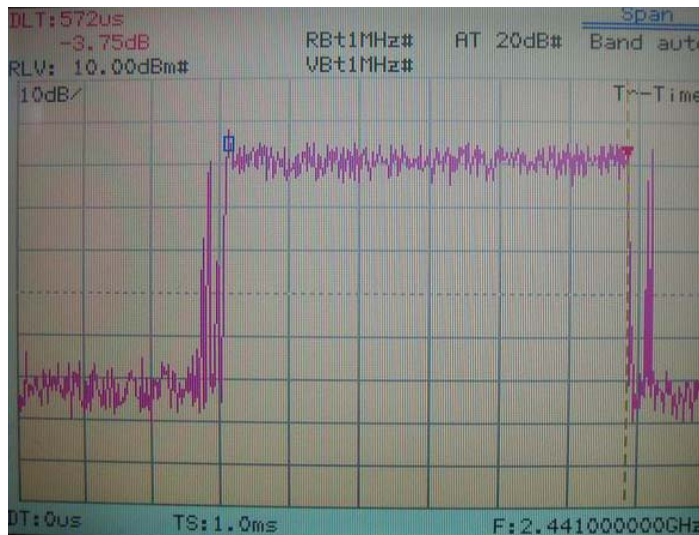

Ch79

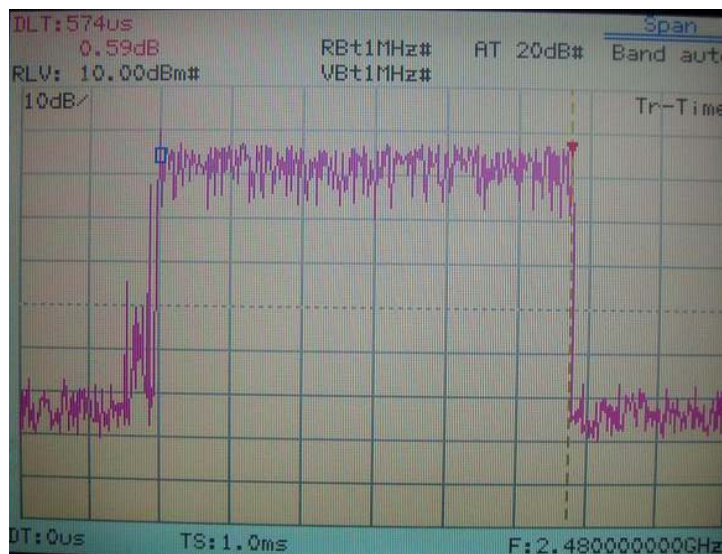

DH3-Packet : (Normal mode)

Ch01

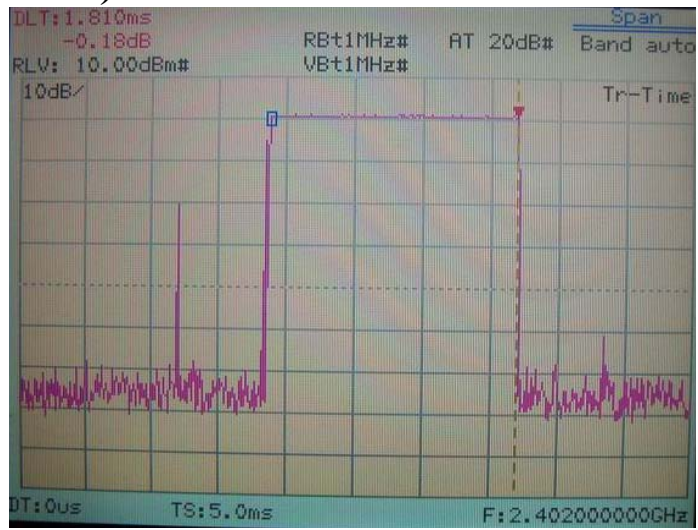

Ch40

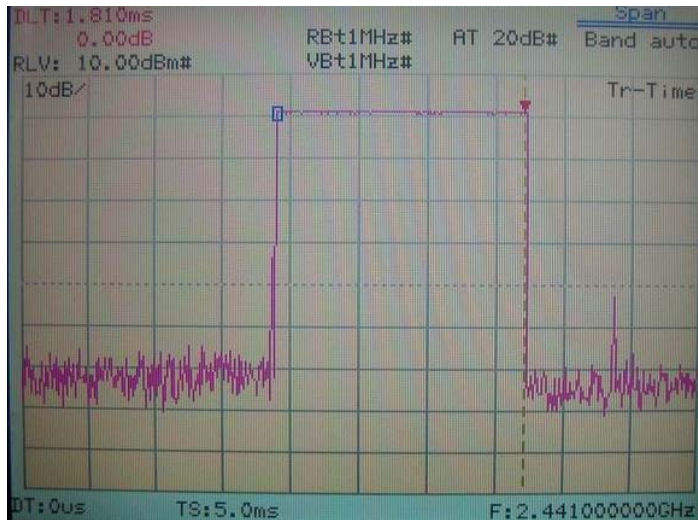

Ch79

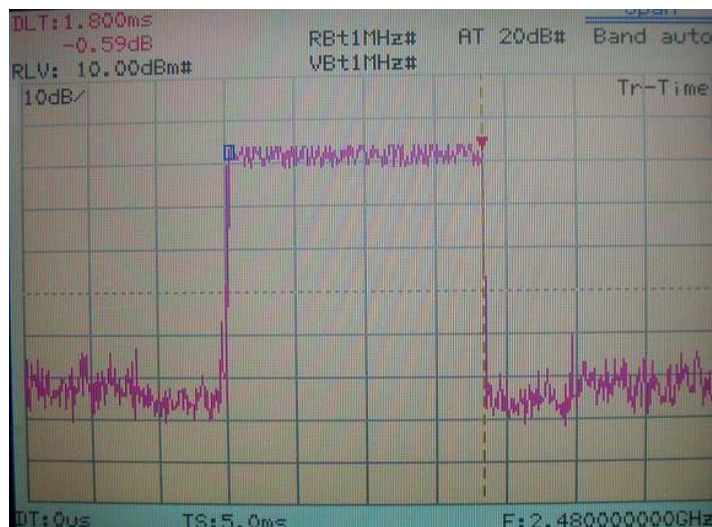

DH3-Packet : (E.D.R. mode)

Ch01

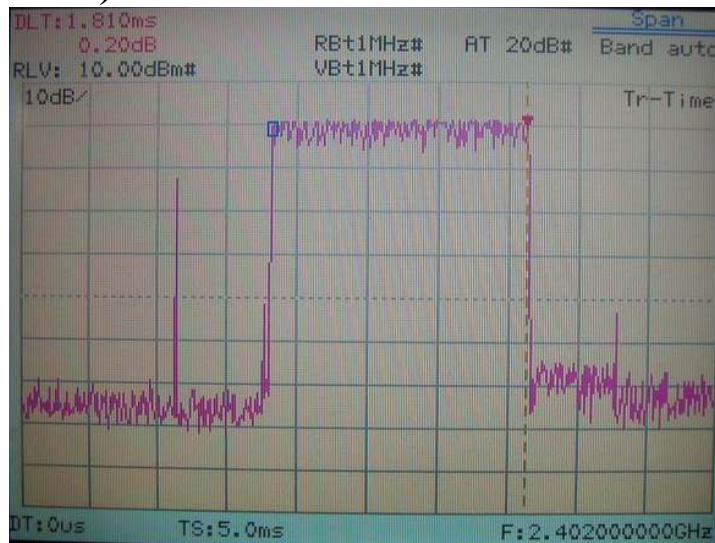

Ch40

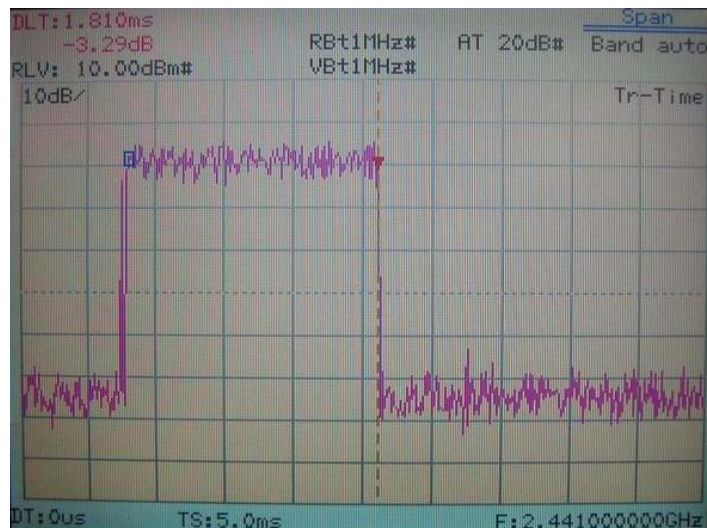

Ch79



DH5-Packet : (Normal mode)

Ch01

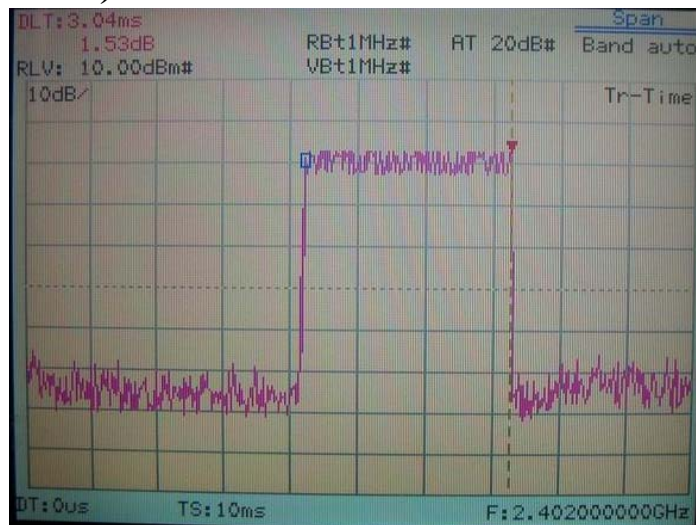

Ch40

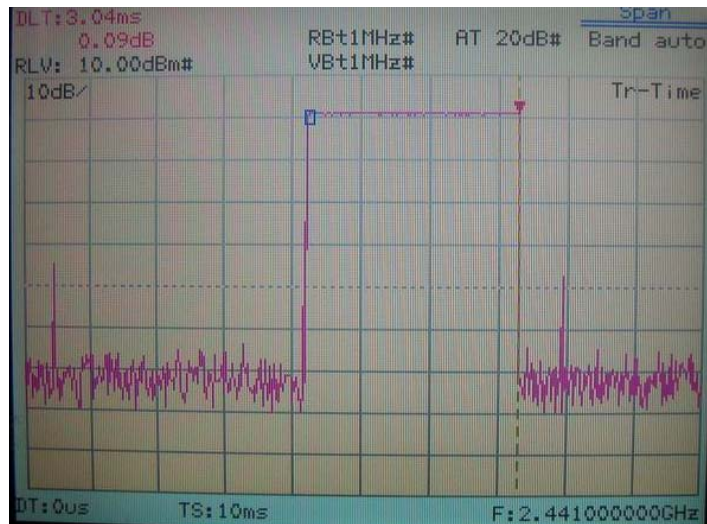

Ch79

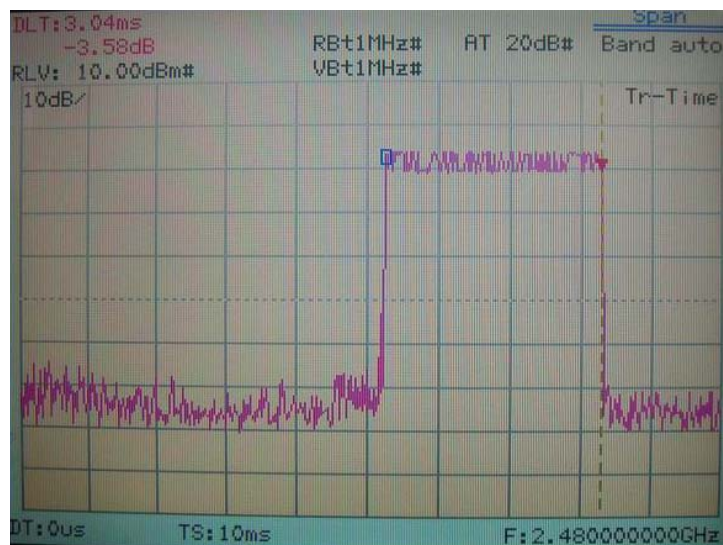

DH5-Packet : (E.D.R. mode)

Ch01

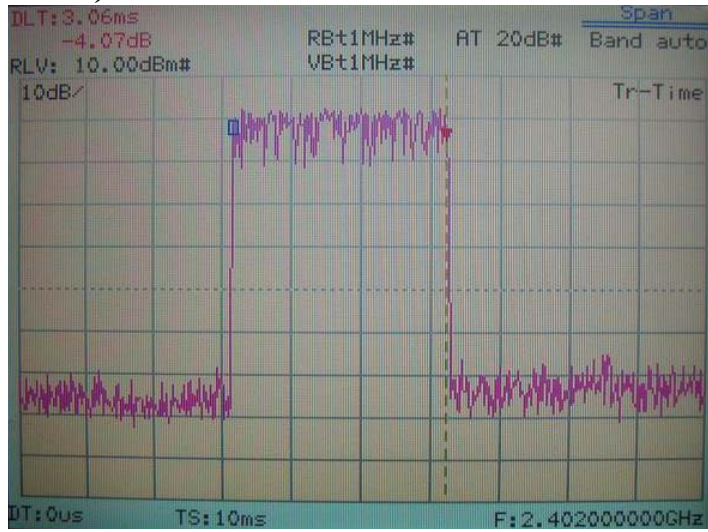

Ch40

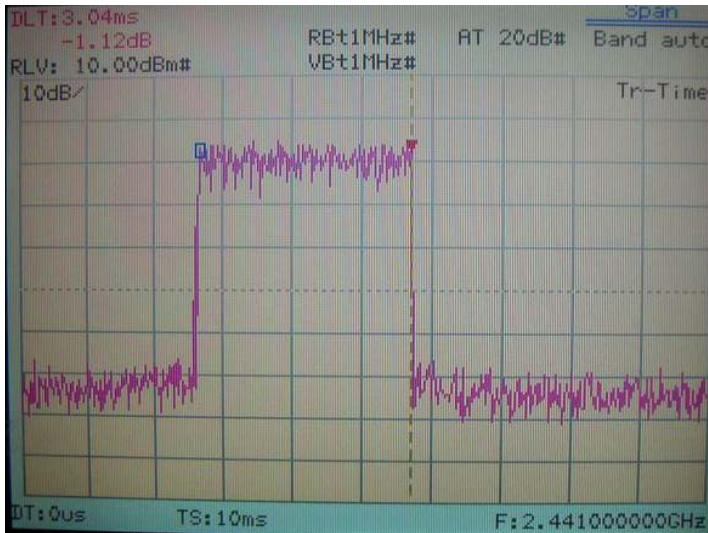

Ch79

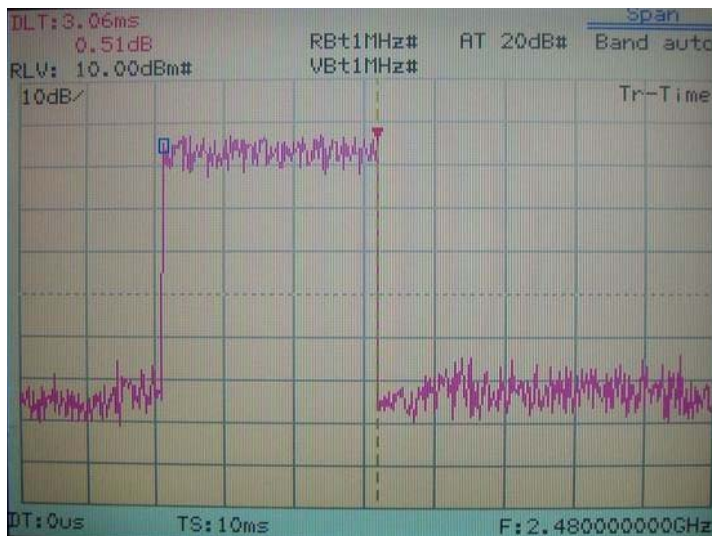

IX. Section 15.247(a)(1)(ii) 20dB Bandwidth

9.1 Test Condition

Use the following spectrum analyzer setting:

Span = the frequency band of operation

RBW \geq 1% of the emission bandwidth

VBW \geq RBW

Sweep = auto

Detector function = peak

Trace = max hold

The EUT should be transmitting at its maximum data rate. Allow the trace to stabilize. Use the marker-to-peak function to set the marker to the peak of emission. Use the marker-delta function to measure 20dB down one side of the emission. Reset the marker-delta function, and move the marker to the other side of the emission, until it is (as close as possible to) even with the reference marker level. The marker-delta reading at this point is the 20dB bandwidth of the emission. If this value varies with different modes of operation (e.g., data rate, modulation format, etc.), repeat this test for each variation. The limit is specified in one of the subparagraphs of this section. Submit this plot(s).

9.2 Test Instruments Configuration

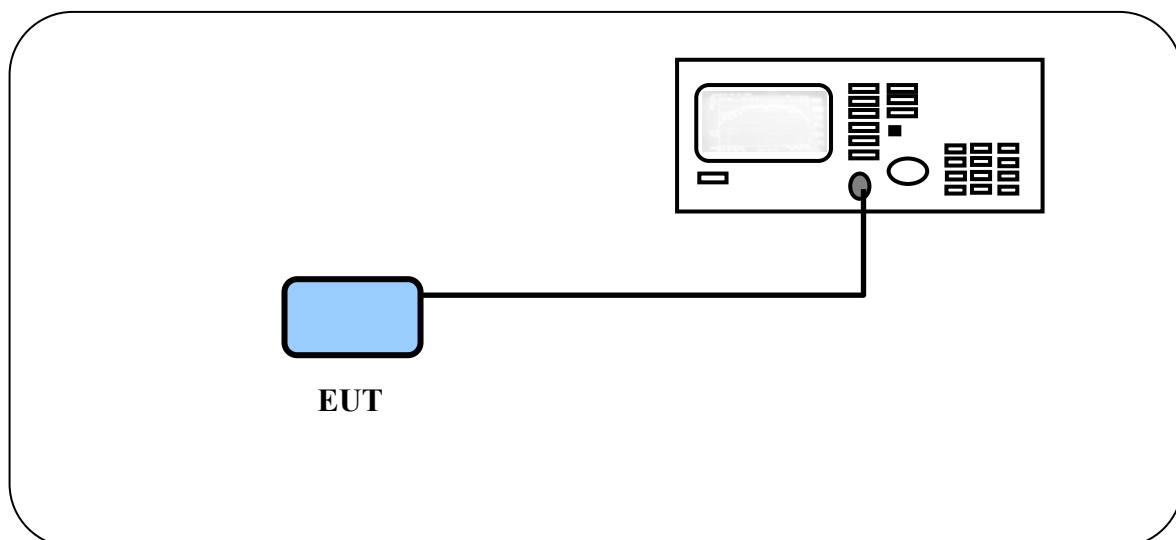

Test Configuration of Bandwidth for Frequency Hopping Spread Spectrum System

9.3 List of Test Instruments

Instrument Name	Model No.	Brand	Serial No.	Next time
Spectrum Analyzer	MS2665C	ANRITSU	6200175476	02/15/07

9.4 Test Results

Channel	Normal mode	E.D.R mode
01	972 kHz	1386 MHz
40	972 kHz	1392 MHz
79	966 kHz	1398 MHz

Note: The data in the above table are summarizing the following attachment spectrum analyzer.

Bandwidth of Channel 1:

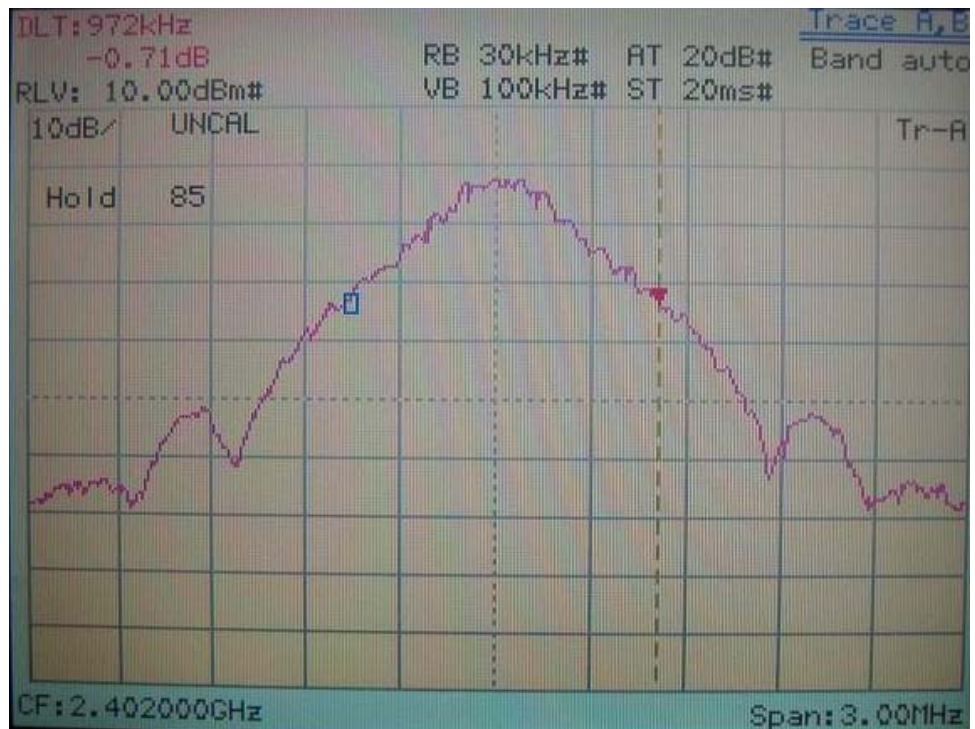

Normal mode

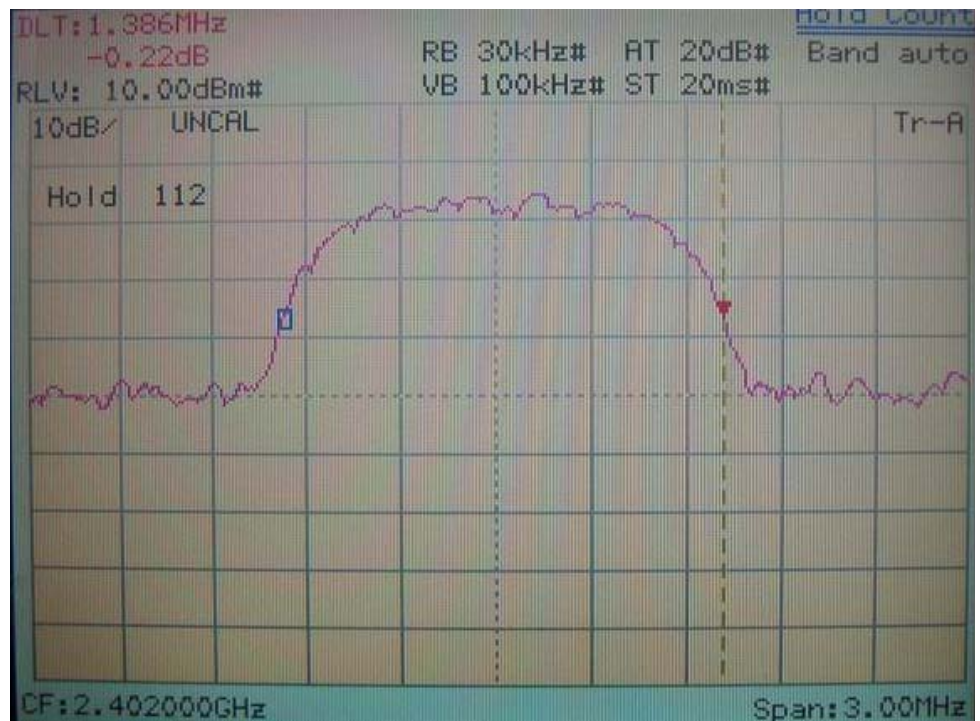

E.D.R mode

Bandwidth of Channel 40:

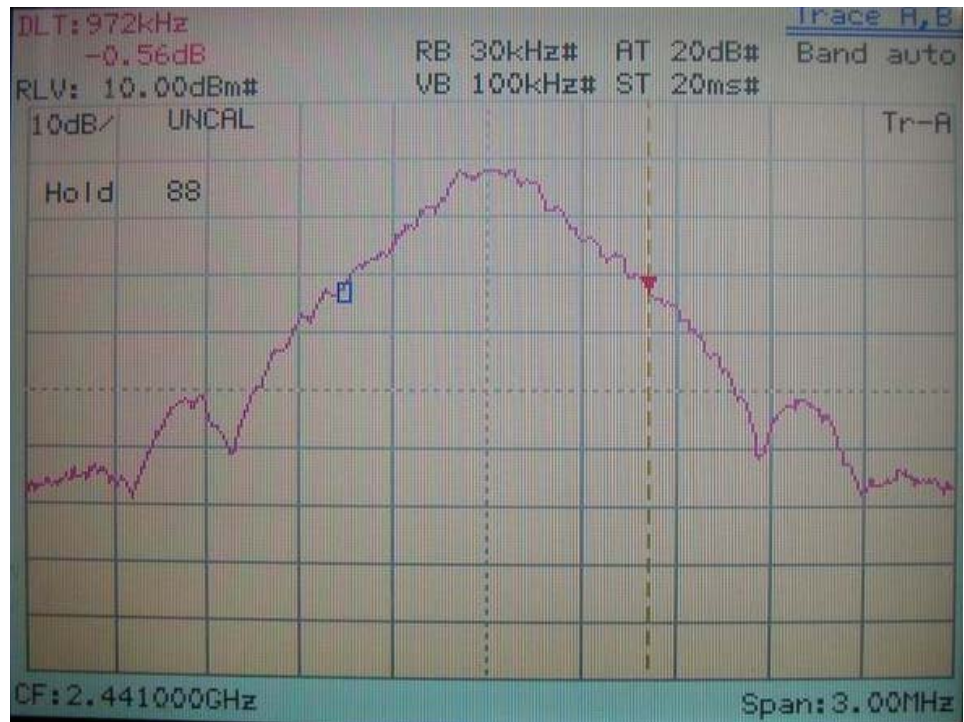

Normal mode



E.D.R mode

Bandwidth of Channel 79:



Normal mode

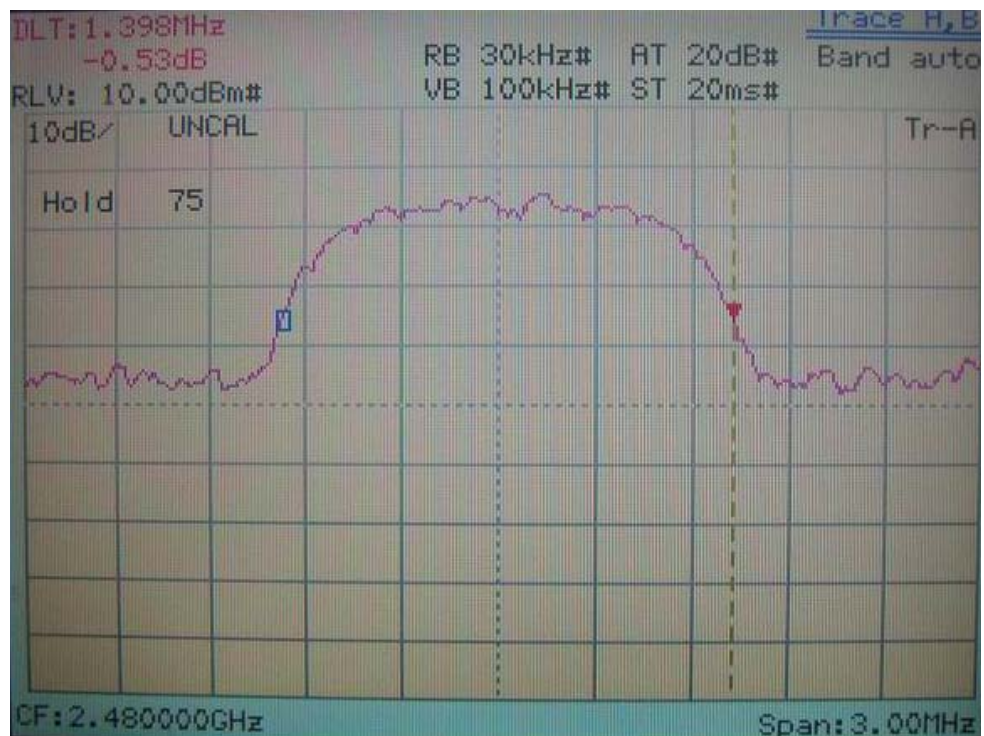

E.D.R mode

X. Section 15.247(b) Peak Output Power

10.1 Test Condition & Setup

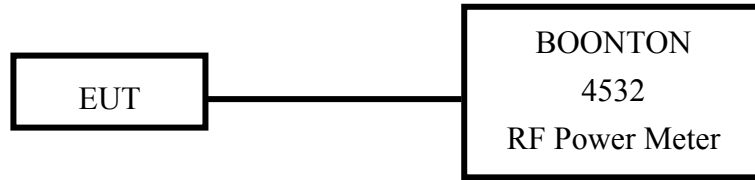

1. The output of the transmitter is connected to the BOONTON RF Power Meter.
2. The calibration is performed before every test. The values of the output power of the EUT will shown in the dBm directly are the transmitter output peak power. Recording as follows.

10.2 List of Test Instruments

Instrument Name	Model	Brand	Serial No.	Next time
RF Power Meter	4532	BOONTON	117501	05/18/07
Peak Power Sensor	57340	BOONTON	2698	05/18/07

10.3 Test Result

Formula:
 RF output power of EUT + |Cable loss| = Output peak power

Channel	RF Output	Cable Loss	Output Peak Power	
	dBm	dBm	dBm	mW
Normal mode CH01	1.51	1.00	2.51	1.78
Normal mode CH40	1.81	1.00	2.81	1.91
Normal mode CH79	1.89	1.00	2.89	1.95
E.D.R. mode CH01	3.23	1.00	4.23	2.65
E.D.R mode. CH40	3.36	1.00	4.36	2.73
E.D.R. mode CH79	3.46	1.00	4.46	2.79

XI. Section 15.247(c) Band-edge Compliance

11.1 Test Condition

If any 100 kHz bandwidth outside these frequency bands, the radio frequency power that is produced by the modulation products of the spreading sequence, the information sequence and the carrier frequency shall be either *at least 20 dB below that in any 100 kHz bandwidth within the band that contains the highest level of the desired power or shall not exceed the general levels specified in §15.209(a)*,

We perform this section by the *radiated manner*, the RBW is set to 100kHz and VBW>RBW. We'd made the observation *up to 10th harmonics and the criterion is all the harmonic/spurious emissions must be 20dB below the highest emission level measured*. If the emissions fall in the restricted bands stated in the Part15.205(a) must also *comply with the radiated emission limits specified in Part15.209(a)*. (Peak mode: RBW=1MHz; VBW=10Hz, Average mode: RBW=1MHz; VBW=10Hz)

11.2 List of Test Instruments

Instrument Name	Model No	Brand	Serial No.	Next time
Spectrum Analyzer	8564E	H P	3720A00840	02/07/07
Spectrum Analyzer	MS2665C	ANRITSU	6200175476	02/15/07
Microwave Preamplifier	84125C	HP	US36433002	02/07/07
Horn Antenna	3115	EMCO	9704 – 5178	01/26/07

11.3 Test Instruments Configuration

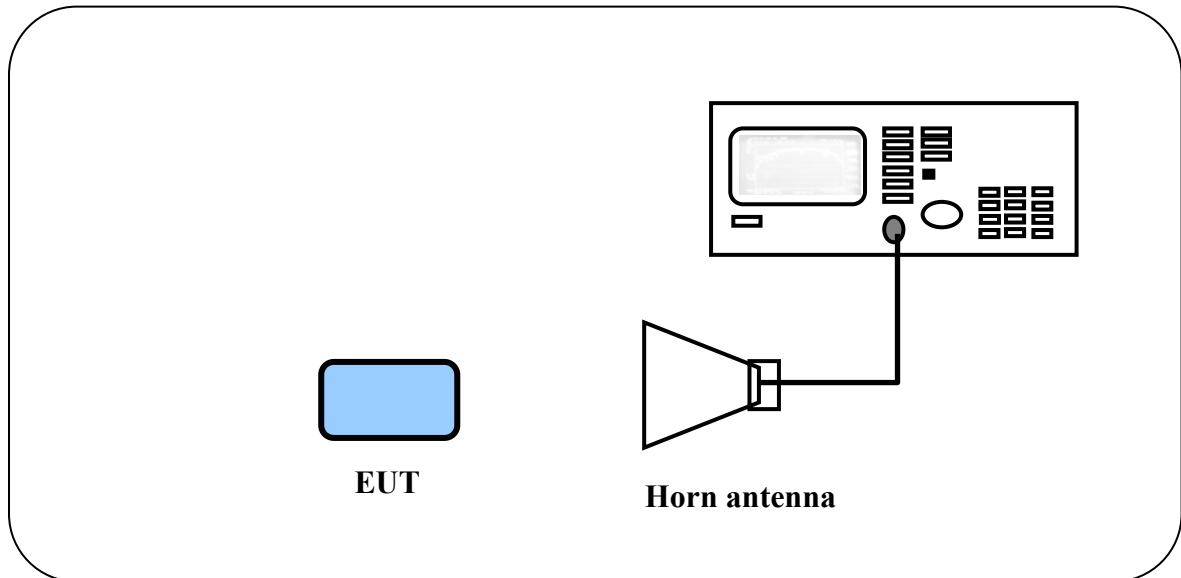

11.4 Test Result of the Bandedge

The following pages show our observations referring to the channel 1 and 79 respectively.

Normal mode Channel 1

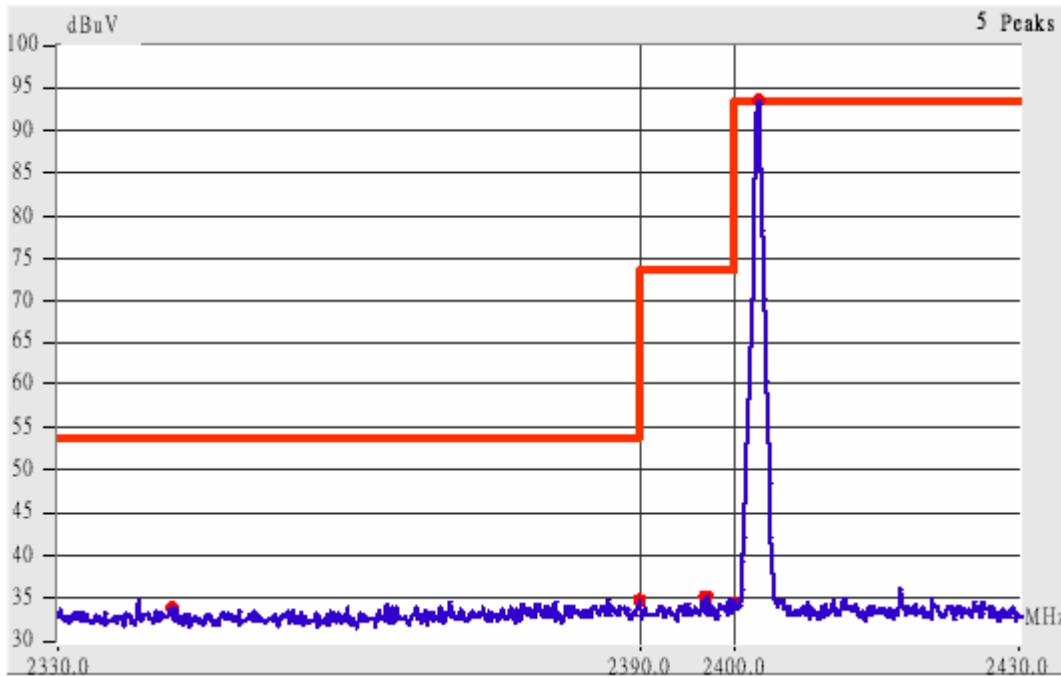

This is the hard copy of our bandedge measurement generated by our bandedge testing program. The plot shown above is the bandedge of channel 1.

1. The lobe left by the fundamental side is already 20dB below the highest emission level.
2. The emissions recorded in the restricted band is do comply with the Part 15.209(a) – as below.

<i>Radiated Emission</i>					<i>Corrected Amplitude (dBµV/m)</i>		<i>Class B</i>		
<i>Frequency (MHz)</i>	<i>Ant. P.</i>	<i>Ant. H. (m)</i>	<i>Table ()</i>	<i>Factors (dB)</i>	<i>Peak</i>	<i>Average</i>	<i>Limit (dBµV/m)</i>		<i>Margin (dB)</i>
							<i>Peak</i>	<i>Ave.</i>	
2367.00	Hor	1.00	14	9.12	44.45	---	74.00	53.96	-9.51
2390.02	Hor	1.00	306	9.18	44.52	---	74.00	53.96	-9.44
2363.69	Ver	1.00	5	9.11	44.61	---	74.00	53.96	-9.35
2390.02	Ver	1.00	214	9.18	43.68	---	74.00	53.96	-10.28

Normal mode Channel 79

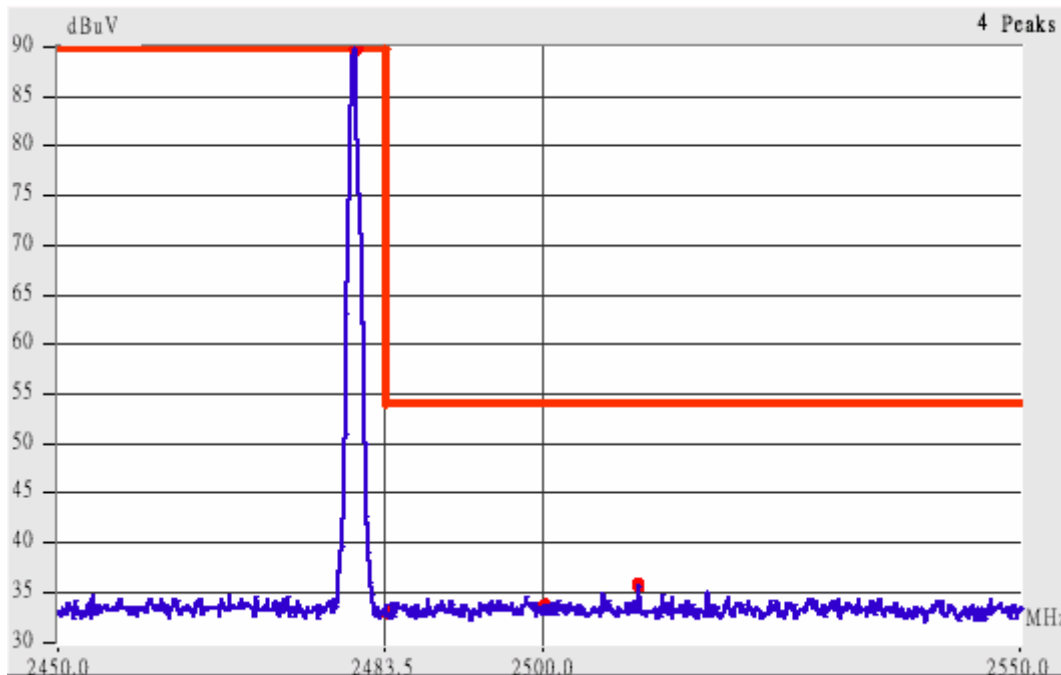

This is the hard copy of our bandedge measurement generated by our bandedge testing program. The plot shown above is the bandedge of channel 79.

- 3. The lobe left by the fundamental side is already 20dB below the highest emission level.
- 4. The emissions recorded in the restricted band is do comply with the Part 15.209(a) – as below.

<i>Radiated Emission</i>					<i>Corrected Amplitude (dBμV/m)</i>		<i>Class B</i>		
<i>Frequency (MHz)</i>	<i>Ant. P.</i>	<i>Ant. H. (m)</i>	<i>Table ()</i>	<i>Factors (dB)</i>	<i>Peak</i>	<i>Average</i>	<i>Limit (dBμV/m)</i>		<i>Margin (dB)</i>
							<i>Peak</i>	<i>Ave.</i>	
2483.50	Hor	1.00	356	9.44	44.44	---	74.00	53.96	-9.52
2493.82	Hor	1.00	247	9.47	44.97	---	74.00	53.96	-8.99
2500.01	Hor	1.00	256	9.49	43.49	---	74.00	53.96	-10.47
2512.26	Hor	1.00	265	9.51	44.85	---	74.00	53.96	-9.11
2483.50	Ver	1.00	336	9.44	45.61	---	74.00	53.96	-8.35
2493.77	Ver	1.00	172	9.47	44.64	---	74.00	53.96	-9.32
2500.01	Ver	1.00	176	9.49	43.16	---	74.00	53.96	-10.80
2505.55	Ver	1.00	344	9.50	45.17	---	74.00	53.96	-8.79

E.D.R. mode Channel 1

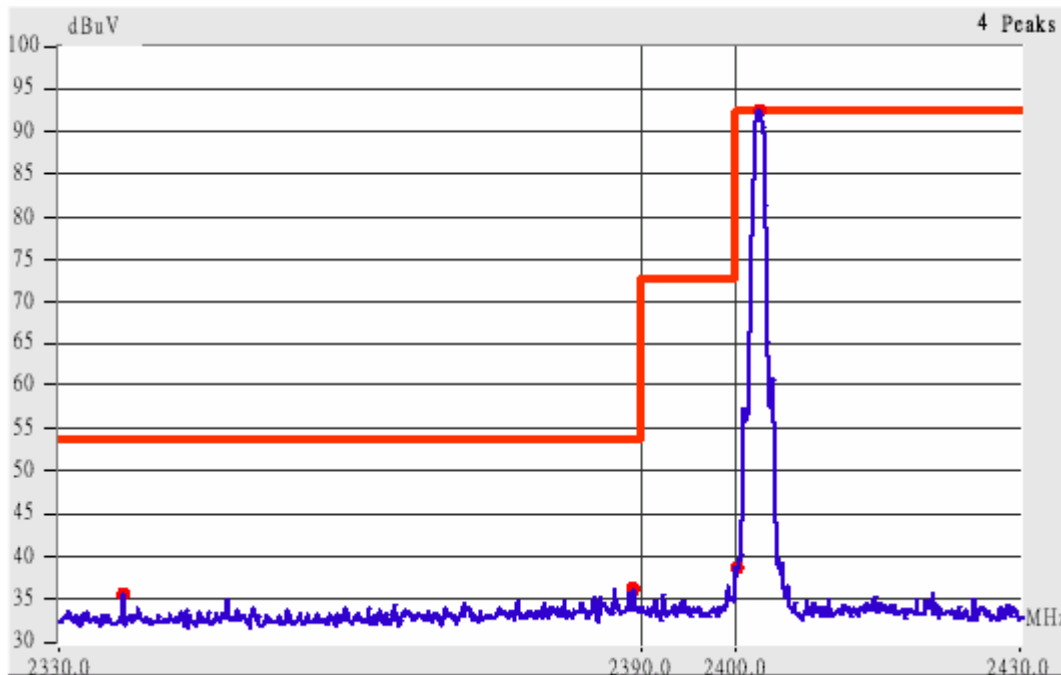

This is the hard copy of our bandedge measurement generated by our bandedge testing program. The plot shown above is the bandedge of channel 1.

- 5. The lobe left by the fundamental side is already 20dB below the highest emission level.
- 6. The emissions recorded in the restricted band is do comply with the Part 15.209(a) – as below.

<i>Radiated Emission</i>					<i>Corrected Amplitude (dBµV/m)</i>		<i>Class B</i>		
<i>Frequency (MHz)</i>	<i>Ant. P.</i>	<i>Ant. H. (m)</i>	<i>Table (°)</i>	<i>Factors (dB)</i>	<i>(dBµV/m)</i>		<i>Limit (dBµV/m)</i>		<i>Margin (dB)</i>
					<i>Peak</i>	<i>Average</i>	<i>Peak</i>	<i>Ave.</i>	
2375.39	Hor	1.00	115	9.14	45.14	---	74.00	53.96	-8.82
2390.02	Hor	1.00	20	9.18	44.52	---	74.00	53.96	-9.44
2358.11	Ver	1.00	342	9.09	44.59	---	74.00	53.96	-9.37
2390.02	Ver	1.00	44	9.18	43.02	---	74.00	53.96	-10.94

E.D.R. mode Channel 79

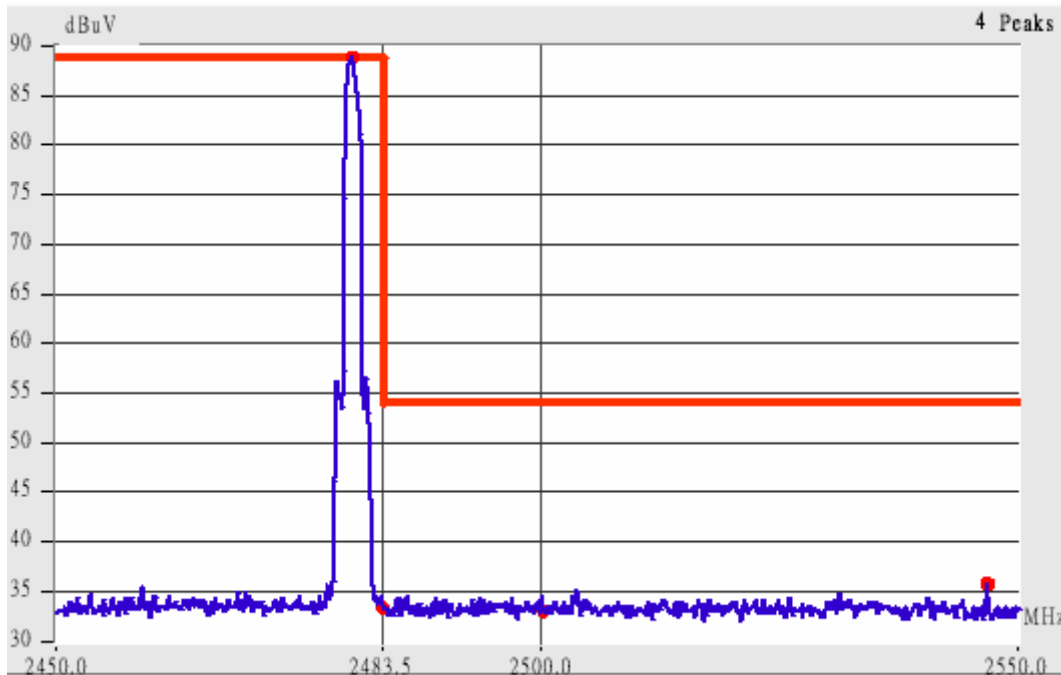

This is the hard copy of our bandedge measurement generated by our bandedge testing program. The plot shown above is the bandedge of channel 79.

- 7. The lobe left by the fundamental side is already 20dB below the highest emission level.
- 8. The emissions recorded in the restricted band is do comply with the Part 15.209(a) – as below.

<i>Radiated Emission</i>					<i>Corrected Amplitude (dBµV/m)</i>		<i>Class B</i>		
<i>Frequency (MHz)</i>	<i>Ant. P.</i>	<i>Ant. H. (m)</i>	<i>Table ()</i>	<i>Factors (dB)</i>	<i>Peak</i>	<i>Average</i>	<i>Limit (dBµV/m)</i>		<i>Margin (dB)</i>
							<i>Peak</i>	<i>Ave.</i>	
2483.50	Hor	1.00	359	9.44	47.28	---	74.00	53.96	-6.68
2493.53	Hor	1.00	153	9.47	45.31	---	74.00	53.96	-8.65
2500.01	Hor	1.00	270	9.49	42.99	---	74.00	53.96	-10.97
2530.46	Hor	1.00	229	9.55	44.71	---	74.00	53.96	-9.25
2483.50	Ver	1.00	327	9.44	47.78	---	74.00	53.96	-6.18
2491.08	Ver	1.00	295	9.47	44.97	---	74.00	53.96	-8.99
2500.01	Ver	1.00	279	9.49	43.66	---	74.00	53.96	-10.30
2512.32	Ver	1.00	312	9.51	45.18	---	74.00	53.96	-8.78

XII. Section 15.247(c) Spurious Radiated Emissions

12.1 Test Condition and Setup

We'd performed the test by the *radiated emission* skill: The EUT was placed in an anechoic chamber, and set the EUT transmitting continuously and scanned at 3-meter distance to determine its emission characteristics. The physical arrangement of the EUT was varied (within the scope of arrangements likely to be encountered in actual use) to determine the effect on the unit's emanations in amplitude, directivity, and frequency. The exact system configuration, which produced the highest emissions was noted so it could be reproduced later during the final tests. For the measurement above 1GHz, according to the guidance we'd set the spectrum analyzer's 6dB bandwidth RBW to 1MHz.

This was done to ensure that the final measurements would demonstrate the worst-case interference potential of the EUT. Final radiation measurements were made on a three-meter, anechoic chamber. The EUT system was placed on a nonconductive turntable, which is 0.8 meters height, top surface 1.0 x 1.5 meter.

The spectrum was examined from 30 MHz to 1000 MHz using an Hewlett Packard 85460A EMI Receiver, SCHWARZECK whole range Small Biconical Antenna (Model No.: UBAA9114 & BBVU9135) is used to measure frequency from 30 MHz to 1GHz. The final test is used the HP 85460A spectrum and 8564E spectrum was examined from 1GHz to 25GHz using an Hewlett Packard Spectrum Analyzer, EMCO/HP Horn Antenna (Model 3115 / 84125-80008) for 1G - 25GHz.

At each frequency, the EUT was rotated 360 degrees, stand on three orthogonal planes respectively and the antenna was raised and lowered from one to four meters to find the maximum emission levels. Measurements were taken using both horizontal and vertical antenna polarization.

Appropriate preamplifiers were used for improving sensitivity and precautions were taken to avoid overloading or desensitizing the spectrum analyzer. There are two spectrum analyzers use on this testing, HP 85460A for frequency 30MHz to 1000MHz, and 8564E for frequency 1GHz to 25GHz. No post-detector video filters were used in the test. The spectrum analyzer's 6dB bandwidth was set to 120KHz (spectrum was examined from 30 MHz to 1000 MHz), the spectrum analyzer's 6 dB bandwidth was set to 1 MHz (spectrum was examined from 1GHz to 25GHz) and the analyzer was operated in the maximum hold mode. There is a test condition applies in this test item, the test procedure description as the following:

Three channels were tested, one in the top (CH1), one in the middle (CH40) and the other in bottom (CH79). The setting up procedure is recorded on <1.3 test method>

With the transmitter operating from a AC source and using the internal of EUT, radiates spurious emissions falling within the restricted bands of 15.209 were measured at operating frequencies corresponding to upper, middle and bottom channels in the 2400 ~ 2483.5 MHz band.

The actual field intensity in decibels referenced to 1 microvolt per meter (dB μ V/m) is determined by algebraically adding the measured reading in dB μ V, the antenna factor (dB), and cable loss (dB) at the appropriate frequency. Since the EUT was set to transmit continuously, no *duty cycle* is present.

For frequency between 30MHz to 1000MHz

$$F_{Ia} \text{ (dBuV/m)} = F_{Ir} \text{ (dB}\mu\text{V)} + \text{Correction Factors}$$

F_{Ia} : Actual Field Intensity

F_{Ir} : Reading of the Field Intensity

$$\text{Correction Factors} = \text{Antenna Factor} + \text{Cable Loss} - \text{Amplifier Gain}$$

For frequency between 1GHz to 25GHz

$$F_{Ia} \text{ (dB}\mu\text{V/m)} = F_{Ir} \text{ (dB}\mu\text{V)} + \text{Correction Factor}$$

F_{Ia} : Actual Field Intensity

F_{Ir} : Reading of the Field Intensity

$$\text{Correction Factors} = \text{Antenna Factor} + \text{Cable Loss} - \text{Amplifier Gain}$$

12.2 List of Test Instruments

Instrument Name	Model	Brand	Serial No.	Calibration Date
				Next time
EMI Receiver	8546A	HP	3520A00242	12/01/06
RF Filter Section	85460A	HP	3448A00217	12/01/06
Small Biconical Antenna	UBAA9114 & BBVU9135	SCHWARZECK	127	02/17/07
Pre-amplifier	PA1F	TRC	1FAC	05/20/07
Auto Switch Box (>30MHz)	ASB-01	TRC	9904-01	05/20/07
Coaxial Cable (Double shielded, 15 meter)	A30A30-0058-50FS-15M	JYEBAO	SMA-01	05/20/07
Coaxial Cable (1.1 meter)	A30A30-0058-50FS-1M	JYEBAO	SMA-02	05/20/07
Spectrum Analyzer	8564E	HP	3720A00840	02/07/07
Microwave Preamplifier	84125C	HP	US36433002	02/07/07
Horn Antenna	3115	EMCO	9104-3668	01/23/07
Standard Guide Horn Antenna	84125-80008	HP	18-26.5GHz	02/09/07
Standard Guide Horn Antenna	84125-80001	HP	26.5-40GHz	02/09/07
Pre-amplifier	84125C	HP	US36433002	02/07/07
Horn Antenna	1196E (3115)	HP (EMCO)	9704-5178	01/26/07
Pre-amplifier	PA2F	TRC	2F1GZ	06/20/07
Coaxial Cable (3 miter)	A30A30-0058-50FS T118	JYEBAO	MSA-05	06/20/07
Coaxial Cable (1 meter)	A30A30-0058-50FS T118	JYEBAO	MSA-04	06/20/07

12.3 Test Result of Spurious Radiated Emissions

The highest peak values of radiated emissions from the EUT at various antenna heights, antenna polarizations, EUT orientation, etc. are recorded on the following. (worst case)

Test Conditions: Temperature : 25.0 ° C Humidity : 73.0 % RH

Test mode: (A) mode of USB LINK for 30MHz to 1GHz [Horizontal]

Radiated Emission				Correction Factors (dB)	Corrected Amplitude (dBµV/m)	Class B (3 m)	
Frequency (MHz)	Amplitude (dBµV)	Ant. H. (m)	Table ()			Limit (dBµV/m)	Margin (dB)
202.17	35.73	1.00	107	-3.56	32.17	43.50	-11.33
267.65	42.68	1.00	160	-4.26	38.42	46.00	-7.58
356.16	37.72	1.00	10	-2.52	35.20	46.00	-10.80
368.29	38.75	1.00	97	-2.15	36.60	46.00	-9.40
461.65	32.60	1.00	267	1.18	33.78	46.00	-12.22
501.66	31.15	1.00	33	2.36	33.51	46.00	-12.49

Test mode: (A) mode of USB LINK for 30MHz to 1GHz [Vertical]

Radiated Emission				Correction Factors (dB)	Corrected Amplitude (dBµV/m)	Class B (3 m)	
Frequency (MHz)	Amplitude (dBµV)	Ant. H. (m)	Table ()			Limit (dBµV/m)	Margin (dB)
37.27	23.75	1.00	193	5.98	29.73	40.00	-10.27
70.01	25.03	1.00	83	1.31	26.34	40.00	-13.66
461.65	29.87	1.00	343	1.18	31.05	46.00	-14.95
547.74	27.58	1.00	233	4.49	32.07	46.00	-13.93
729.61	30.51	1.00	240	9.82	40.33	46.00	-5.67
832.67	24.77	1.00	254	12.71	37.48	46.00	-8.52

Note:

1. Margin = Amplitude – limit, if margin is minus means under limit.
2. Corrected Amplitude = Reading Amplitude + Correction Factors
3. Correction factor = Antenna factor + (Cable Loss – Amplitude gain) + Switching Box Loss

Test mode: (A) mode of USB LINK for 1GHz to 25GHz [Horizontal]

Frequency	Ant. H.	Table	Amplitude		Correction Factor	Corrected Amplitude		Limit		Margin
			Peak / Ave.			Peak / Ave.		Peak / Ave.		
MHz	m	degree	dBμV		dB/m	dBμV/m		dBμV/m		dB
7559.17	1.00	320	23.41	---	22.28	45.69	---	73.96	53.96	-8.27
10675.83	1.00	243	22.58	---	22.43	45.01	---	73.96	53.96	-8.95
19381.25	1.00	326	47.00	---	1.60	48.60	---	73.96	53.96	-5.36
21166.25	1.00	43	45.83	---	2.56	48.39	---	73.96	53.96	-5.57
24537.92	1.00	88	47.33	---	2.43	49.76	---	73.96	53.96	-4.20

Test mode: (A) mode of USB LINK for 1GHz to 25GHz [Vertical]

Frequency	Ant. H.	Table	Amplitude		Correction Factor	Corrected Amplitude		Limit		Margin
			Peak / Ave.			Peak / Ave.		Peak / Ave.		
MHz	m	degree	dBμV		dB/m	dBμV/m		dBμV/m		dB
5993.75	1.00	131	24.25	---	17.98	42.23	---	73.96	53.96	-11.73
10109.17	1.00	199	21.24	---	22.73	43.97	---	73.96	53.96	-9.99
19600.83	1.00	223	48.16	---	1.70	49.86	---	73.96	53.96	-4.10
21902.92	1.00	211	46.99	---	3.04	50.03	---	73.96	53.96	-3.93
23974.79	1.00	250	47.32	---	2.96	50.28	---	73.96	53.96	-3.68

Note:

1. Margin = Corrected - Limit.
2. The EUT utilizes a *permanently attached antenna*. In addition the spurious RF radiated emissions levels do comply with the *20dBc limit* both at its bandedges and other spurious emissions.
3. As stated in Section 15.35(b), for any frequencies above 1000MHz, radiated limits shown are based upon the use of measurement instrumentation employing an average detector function. As the results of our test, the peak amplitudes are already below the FCC limit. Thus the average amplitudes of the rest are omitted.

Test mode: (B) mode of Vehicle Battery for 30MHz to 1GHz [Horizontal]

Radiated Emission				Correction Factors	Corrected Amplitude	Class B (3 m)	
Frequency (MHz)	Amplitude (dBμV)	Ant. H. (m)	Table (°)			Limit (dBμV/m)	Margin (dB)
40.91	24.80	1.00	258	5.35	30.15	40.00	-9.85
123.36	33.71	1.00	271	-2.36	31.35	43.50	-12.15
142.76	40.67	1.00	33	-3.09	37.58	43.50	-5.92
193.69	39.49	1.00	281	-3.61	35.88	43.50	-7.62
207.02	36.91	1.00	281	-3.79	33.12	43.50	-10.38
941.80	21.26	1.00	79	15.58	36.84	46.00	-9.16

Test mode: (B) mode of Vehicle Battery for 30MHz to 1GHz [Vertical]

Radiated Emission				Correction Factors	Corrected Amplitude	Class B (3 m)	
Frequency (MHz)	Amplitude (dBμV)	Ant. H. (m)	Table (°)			Limit (dBμV/m)	Margin (dB)
31.21	22.33	1.00	260	7.79	30.12	40.00	-9.88
89.41	27.18	1.00	343	0.01	27.19	43.50	-16.31
290.69	28.06	1.00	177	-3.75	24.31	46.00	-21.69
369.50	26.11	1.00	357	-2.11	24.00	46.00	-22.00
941.80	21.73	1.00	271	15.58	37.31	46.00	-8.69
981.81	20.17	1.00	195	16.80	36.97	54.00	-17.03

Test mode: (B) mode of Vehicle Battery for 1GHz to 25GHz [Horizontal]

<i>Frequency</i>	<i>Ant. H.</i>	<i>Table</i>	<i>Amplitude</i>		<i>Correction Factor</i>	<i>Corrected Amplitude</i>		<i>Limit</i>		<i>Margin</i>
			<i>Peak / Ave.</i>			<i>Peak / Ave.</i>		<i>Peak / Ave.</i>		
<i>MHz</i>	<i>m</i>	<i>degree</i>	<i>dBμV</i>		<i>dB/m</i>	<i>dBμV/m</i>		<i>dBμV/m</i>		<i>dB</i>
7920.42	1.00	45	22.08	---	22.27	44.35	---	73.96	53.96	-9.61
11787.92	1.00	143	23.90	---	21.33	45.23	---	73.96	53.96	-8.73
19636.25	1.00	154	46.83	---	1.71	48.54	---	73.96	53.96	-5.42
22111.87	1.00	73	46.00	---	3.07	49.07	---	73.96	53.96	-4.89
24442.29	1.00	250	48.16	---	2.88	51.04	---	73.96	53.96	-2.92

Test mode: (B) mode of Vehicle Battery for 1GHz to 25GHz [Vertical]

<i>Frequency</i>	<i>Ant. H.</i>	<i>Table</i>	<i>Amplitude</i>		<i>Correction Factor</i>	<i>Corrected Amplitude</i>		<i>Limit</i>		<i>Margin</i>
			<i>Peak / Ave.</i>			<i>Peak / Ave.</i>		<i>Peak / Ave.</i>		
<i>MHz</i>	<i>m</i>	<i>degree</i>	<i>dBμV</i>		<i>dB/m</i>	<i>dBμV/m</i>		<i>dBμV/m</i>		<i>dB</i>
6078.75	1.00	70	26.57	---	18.00	44.57	---	73.96	53.96	-9.39
9570.83	1.00	198	21.41	---	23.17	44.58	---	73.96	53.96	-9.38
19168.75	1.00	325	47.83	---	1.56	49.39	---	73.96	53.96	-4.57
21113.12	1.00	249	48.33	---	2.45	50.78	---	73.96	53.96	-3.18
24892.08	1.00	156	46.49	---	2.54	49.03	---	73.96	53.96	-4.93

Test mode: (C) mode of RX for 30MHz to 25GHz [Horizontal]

Radiated Emission				Correction Factors	Corrected Amplitude	Class B (3 m)	
Frequency (MHz)	Amplitude (dBμV)	Ant. H. (m)	Table ()			Limit (dBμV/m)	Margin (dB)
32.42	19.95	1.00	167	7.34	27.29	40.00	-12.71
84.56	26.77	1.00	207	0.39	27.16	40.00	-12.84
289.47	29.37	1.00	223	-3.79	25.58	46.00	-20.42
314.94	29.78	1.00	223	-3.15	26.63	46.00	-19.37
941.80	21.18	1.00	346	15.58	36.76	46.00	-9.24

Test mode: (C) mode of RX for 30MHz to 25GHz [Vertical]

Radiated Emission				Correction Factors	Corrected Amplitude	Class B (3 m)	
Frequency (MHz)	Amplitude (dBμV)	Ant. H. (m)	Table ()			Limit (dBμV/m)	Margin (dB)
42.12	43.31	1.00	170	-5.12	38.19	40.00	-1.81
124.57	24.20	1.00	40	-2.42	21.78	43.50	-21.72
288.26	29.30	1.00	257	-3.82	25.48	46.00	-20.52
308.87	28.14	1.00	230	-3.23	24.91	46.00	-21.09
989.09	20.34	1.00	157	17.04	37.38	54.00	-16.62

Test mode: (C) mode of RX for 1GHz to 25GHz [Horizontal]

<i>Frequency</i>	<i>Ant. H.</i>	<i>Table</i>	<i>Amplitude</i>		<i>Correction Factor</i>	<i>Corrected Amplitude</i>		<i>Limit</i>		<i>Margin</i>
			<i>Peak / Ave.</i>			<i>Peak / Ave.</i>		<i>Peak / Ave.</i>		
<i>MHz</i>	<i>m</i>	<i>degree</i>	<i>dBμV</i>		<i>dB/m</i>	<i>dBμV/m</i>		<i>dBμV/m</i>		<i>dB</i>
6128.33	1.00	261	24.57	---	18.02	42.59	---	73.96	53.96	-11.37
9570.83	1.00	0	22.08	---	23.17	45.25	---	73.96	53.96	-8.71
19388.33	1.00	335	45.72	---	1.60	47.32	---	73.96	53.96	-6.64
21747.08	1.00	341	46.46	---	2.80	49.26	---	73.96	53.96	-4.70
24024.37	1.00	252	46.20	---	3.16	49.36	---	73.96	53.96	-4.60

Test mode: (C) mode of RX for 1GHz to 25GHz [Vertical]

<i>Frequency</i>	<i>Ant. H.</i>	<i>Table</i>	<i>Amplitude</i>		<i>Correction Factor</i>	<i>Corrected Amplitude</i>		<i>Limit</i>		<i>Margin</i>
			<i>Peak / Ave.</i>			<i>Peak / Ave.</i>		<i>Peak / Ave.</i>		
<i>MHz</i>	<i>m</i>	<i>degree</i>	<i>dBμV</i>		<i>dB/m</i>	<i>dBμV/m</i>		<i>dBμV/m</i>		<i>dB</i>
6248.75	1.00	106	26.74	---	18.69	45.43	---	73.96	53.96	-8.53
9160.00	1.00	82	20.91	---	23.15	44.06	---	73.96	53.96	-9.90
19568.96	1.00	167	47.02	---	1.70	48.72	---	73.96	53.96	-5.24
21995.00	1.00	345	46.24	---	2.82	49.06	---	73.96	53.96	-4.90
24746.87	1.00	154	48.70	---	2.34	51.04	---	73.96	53.96	-2.92

Test mode: BT (normal mode) CH01 for 30MHz to 1GHz [Horizontal]

Radiated Emission				Correction Factors	Corrected Amplitude	Class B (3 m)	
Frequency (MHz)	Amplitude (dBμV)	Ant. H. (m)	Table ()			Limit (dBμV/m)	Margin (dB)
151.25	36.24	1.00	343	-3.61	32.63	43.50	-10.87
200.96	31.21	1.00	190	-3.50	27.71	43.50	-15.79
280.99	32.58	1.00	213	-3.99	28.59	46.00	-17.41
467.71	24.29	1.00	327	1.36	25.65	46.00	-20.35
993.94	20.93	1.00	62	17.20	38.13	54.00	-15.87

Test mode: BT (normal mode) CH01 for 30MHz to 1GHz [Vertical]

Radiated Emission				Correction Factors	Corrected Amplitude	Class B (3 m)	
Frequency (MHz)	Amplitude (dBμV)	Ant. H. (m)	Table ()			Limit (dBμV/m)	Margin (dB)
51.83	26.38	1.00	30	3.57	29.95	40.00	-10.05
167.01	34.71	1.00	54	-3.72	30.99	43.50	-12.51
174.29	34.54	1.00	215	-3.81	30.73	43.50	-12.77
208.24	29.78	1.00	104	-3.85	25.93	43.50	-17.57
311.30	31.32	1.00	87	-3.20	28.12	46.00	-17.88
981.81	21.17	1.00	159	16.80	37.97	54.00	-16.03

Test mode: BT (normal mode) CH01 for 1GHz to 25GHz [Horizontal]

Frequency	Ant. H.	Table	Amplitude		Correction Factor	Corrected Amplitude		Limit		Margin
			Peak / Ave.			Peak / Ave.		Peak / Ave.		
MHz	m	degree	dBµV		dB/m	dBµV/m		dBµV/m		dB
4805.00	1.00	223	48.06	---	3.69	51.75	---	73.96	53.96	-2.21
9608.12	1.00	91	35.74	---	11.47	47.21	---	73.96	53.96	-6.75
12012.71	1.00	248	38.73	---	10.01	48.74	---	73.96	53.96	-5.22
19214.79	1.00	351	48.75	---	1.60	50.35	---	73.96	53.96	-3.61
21619.58	1.00	113	46.66	---	2.79	49.45	---	73.96	53.96	-4.51
24020.83	1.00	250	44.78	---	3.14	47.92	---	73.96	53.96	-6.04

Test mode: BT (normal mode) CH01 for 1GHz to 25GHz [Vertical]

Frequency	Ant. H.	Table	Amplitude		Correction Factor	Corrected Amplitude		Limit		Margin
			Peak / Ave.			Peak / Ave.		Peak / Ave.		
MHz	m	degree	dBµV		dB/m	dBµV/m		dBµV/m		dB
4803.80	1.00	269	50.62	49.28	3.68	54.30	52.96	73.96	53.96	-1.00
9608.12	1.00	88	35.54	---	11.47	47.01	---	73.96	53.96	-6.95
12012.71	1.00	57	39.07	---	10.01	49.08	---	73.96	53.96	-4.88
19214.79	1.00	346	49.18	---	1.60	50.78	---	73.96	53.96	-3.18
21619.58	1.00	90	46.47	---	2.79	49.26	---	73.96	53.96	-4.70
24020.83	1.00	251	44.72	---	3.14	47.86	---	73.96	53.96	-6.10

Test mode: BT (normal mode) CH40 for 30MHz to 1GHz [Horizontal]

Radiated Emission				Correction Factors	Corrected Amplitude	Class B (3 m)	
Frequency (MHz)	Amplitude (dBμV)	Ant. H. (m)	Table ()			Limit (dBμV/m)	Margin (dB)
89.41	23.33	1.00	112	0.01	23.34	43.50	-20.16
168.22	32.70	1.00	350	-3.76	28.94	43.50	-14.56
305.24	32.26	1.00	106	-3.27	28.99	46.00	-17.01
597.45	21.83	1.00	103	6.17	28.00	46.00	-18.00
893.30	21.27	1.00	48	14.53	35.80	46.00	-10.20
987.87	20.25	1.00	312	17.00	37.25	54.00	-16.75

Test mode: BT (normal mode) CH40 for 30MHz to 1GHz [Vertical]

Radiated Emission				Correction Factors	Corrected Amplitude	Class B (3 m)	
Frequency (MHz)	Amplitude (dBμV)	Ant. H. (m)	Table ()			Limit (dBμV/m)	Margin (dB)
50.61	28.11	1.00	197	3.79	31.90	40.00	-8.10
89.41	27.69	1.00	357	0.01	27.70	43.50	-15.80
152.46	30.68	1.00	30	-3.60	27.08	43.50	-16.42
167.01	34.64	1.00	190	-3.72	30.92	43.50	-12.58
350.24	33.50	1.00	63	-3.27	30.23	46.00	-15.77
952.71	21.21	1.00	154	15.83	37.04	46.00	-8.96

Test mode: BT (normal mode) CH40 for 1GHz to 25GHz [Horizontal]

Frequency	Ant. H.	Table	Amplitude		Correction Factor	Corrected Amplitude		Limit		Margin
			Peak / Ave.			Peak / Ave.		Peak / Ave.		
MHz	m	degree	dBμV		dB/m	dBμV/m		dBμV/m		dB
4883.54	1.00	229	44.90	---	3.99	48.89	---	73.96	53.96	-5.07
7324.37	1.00	57	36.47	---	10.33	46.80	---	73.96	53.96	-7.16
12206.04	1.00	118	39.01	---	9.79	48.80	---	73.96	53.96	-5.16
19526.46	1.00	308	48.33	---	1.70	50.03	---	73.96	53.96	-3.93
21970.21	1.00	296	46.24	---	2.95	49.19	---	73.96	53.96	-4.77
24410.42	1.00	15	46.97	---	3.10	50.07	---	73.96	53.96	-3.89

Test mode: BT (normal mode) CH40 for 1GHz to 25GHz [Vertical]

Frequency	Ant. H.	Table	Amplitude		Correction Factor	Corrected Amplitude		Limit		Margin
			Peak / Ave.			Peak / Ave.		Peak / Ave.		
MHz	m	degree	dBμV		dB/m	dBμV/m		dBμV/m		dB
3079.17	1.00	155	36.50	---	10.81	47.31	---	73.96	53.96	-6.65
4883.54	1.00	207	45.11	---	3.99	49.10	---	73.96	53.96	-4.86
12206.04	1.00	115	38.91	---	9.79	48.70	---	73.96	53.96	-5.26
19526.46	1.00	306	48.37	---	1.70	50.07	---	73.96	53.96	-3.89
21970.21	1.00	297	46.49	---	2.95	49.44	---	73.96	53.96	-4.52
24410.42	1.00	17	47.18	---	3.10	50.28	---	73.96	53.96	-3.68

Test mode: BT (normal mode) CH79 for 30MHz to 1GHz [Horizontal]

Radiated Emission				Correction Factors	Corrected Amplitude	Class B (3 m)	
Frequency (MHz)	Amplitude (dBμV)	Ant. H. (m)	Table ()			Limit (dBμV/m)	Margin (dB)
31.21	19.97	1.00	0	7.79	27.76	40.00	-12.24
167.01	32.79	1.00	53	-3.72	29.07	43.50	-14.43
305.24	31.65	1.89	66	-3.27	28.38	46.00	-17.62
467.71	24.80	1.00	343	1.36	26.16	46.00	-19.84
637.46	21.33	1.00	89	7.62	28.95	46.00	-17.05
1000.00	20.08	1.00	120	17.40	37.48	54.00	-16.52

Test mode: BT (normal mode) CH79 for 30MHz to 1GHz [Vertical]

Radiated Emission				Correction Factors	Corrected Amplitude	Class B (3 m)	
Frequency (MHz)	Amplitude (dBμV)	Ant. H. (m)	Table ()			Limit (dBμV/m)	Margin (dB)
50.61	26.87	1.00	297	3.79	30.66	40.00	-9.34
70.01	27.40	1.00	189	1.31	28.71	40.00	-11.29
187.62	32.00	1.00	318	-3.72	28.28	43.50	-15.22
317.36	33.64	1.00	80	-3.12	30.52	46.00	-15.48
650.80	21.32	1.00	100	8.10	29.42	46.00	-16.58
866.62	20.73	1.00	264	13.64	34.37	46.00	-11.63

Test mode: BT (normal mode) CH79 for 1GHz to 25GHz [Horizontal]

Frequency	Ant. H.	Table	Amplitude		Correction Factor	Corrected Amplitude		Limit		Margin
			Peak / Ave.			Peak / Ave.		Peak / Ave.		
MHz	m	degree	dBμV		dB/m	dBμV/m		dBμV/m		dB
2970.83	1.00	61	35.16	---	10.38	45.54	---	73.96	53.96	-8.42
9922.29	1.00	135	35.51	---	11.66	47.17	---	73.96	53.96	-6.79
12399.37	1.00	191	37.87	---	9.02	46.89	---	73.96	53.96	-7.07
19799.17	1.00	298	46.35	---	1.90	48.25	---	73.96	53.96	-5.71
22320.83	1.00	190	45.45	---	3.33	48.78	---	73.96	53.96	-5.18
24800.00	1.00	210	46.07	---	2.22	48.29	---	73.96	53.96	-5.67

Test mode: BT (normal mode) CH79 for 1GHz to 25GHz [Vertical]

Frequency	Ant. H.	Table	Amplitude		Correction Factor	Corrected Amplitude		Limit		Margin
			Peak / Ave.			Peak / Ave.		Peak / Ave.		
MHz	m	degree	dBμV		dB/m	dBμV/m		dBμV/m		dB
2152.08	1.00	55	37.00	---	8.52	45.52	---	73.96	53.96	-8.44
4962.08	1.00	257	46.36	---	4.25	50.61	---	73.96	53.96	-3.35
9922.29	1.00	139	35.89	---	11.66	47.55	---	73.96	53.96	-6.41
19799.17	1.00	302	46.37	---	1.90	48.27	---	73.96	53.96	-5.69
22320.83	1.00	192	45.25	---	3.33	48.58	---	73.96	53.96	-5.38
24800.00	1.00	192	45.95	---	2.22	48.17	---	73.96	53.96	-5.79

Test mode: BT (E.D.R. mode) CH01 for 30MHz to 1GHz [Horizontal]

Radiated Emission				Correction Factors	Corrected Amplitude	Class B (3 m)	
Frequency (MHz)	Amplitude (dBμV)	Ant. H. (m)	Table ()			Limit (dBμV/m)	Margin (dB)
32.42	19.56	1.00	100	7.34	26.90	40.00	-13.10
167.01	31.88	1.00	73	-3.72	28.16	43.50	-15.34
280.99	34.61	1.00	67	-3.99	30.62	46.00	-15.38
311.30	34.74	1.00	0	-3.20	31.54	46.00	-14.46
330.70	32.68	1.00	47	-2.95	29.73	46.00	-16.27
974.54	20.79	1.00	202	16.55	37.34	54.00	-16.66

Test mode: BT (E.D.R. mode) CH01 for 30MHz to 1GHz [Vertical]

Radiated Emission				Correction Factors	Corrected Amplitude	Class B (3 m)	
Frequency (MHz)	Amplitude (dBμV)	Ant. H. (m)	Table ()			Limit (dBμV/m)	Margin (dB)
50.61	28.41	1.00	200	3.79	32.20	40.00	-7.80
167.01	35.77	1.00	213	-3.72	32.05	43.50	-11.45
207.02	31.93	1.00	63	-3.79	28.14	43.50	-15.36
266.44	34.44	1.00	7	-4.26	30.18	46.00	-15.82
305.24	37.13	1.00	87	-3.27	33.86	46.00	-12.14
815.70	21.01	1.00	233	12.34	33.35	46.00	-12.65

Test mode: BT (E.D.R. mode) CH01 for 1GHz to 25GHz [Horizontal]

Frequency	Ant. H.	Table	Amplitude		Correction Factor	Corrected Amplitude		Limit		Margin
			Peak / Ave.			Peak / Ave.		Peak / Ave.		
MHz	m	degree	dB μ V		dB/m	dB μ V/m		dB μ V/m		dB
2547.92	1.00	294	34.17	---	9.58	43.75	---	73.96	53.96	-10.21
4805.00	1.00	215	48.13	---	3.69	51.82	---	73.96	53.96	-2.14
12012.71	1.00	258	38.57	---	10.01	48.58	---	73.96	53.96	-5.38
19214.79	1.00	347	49.10	---	1.60	50.70	---	73.96	53.96	-3.26
21619.58	1.00	89	46.25	---	2.79	49.04	---	73.96	53.96	-4.92
24020.83	1.00	270	44.45	---	3.14	47.59	---	73.96	53.96	-6.37

Test mode: BT (E.D.R. mode) CH01 for 1GHz to 25GHz [Vertical]

Frequency	Ant. H.	Table	Amplitude		Correction Factor	Corrected Amplitude		Limit		Margin
			Peak / Ave.			Peak / Ave.		Peak / Ave.		
MHz	m	degree	dB μ V		dB/m	dB μ V/m		dB μ V/m		dB
2152.08	1.00	47	38.50	---	8.52	47.02	---	73.96	53.96	-6.94
4803.80	1.00	253	50.23	48.83	3.68	53.91	52.51	73.96	53.96	-1.45
12012.71	1.00	46	38.68	---	10.01	48.69	---	73.96	53.96	-5.27
19799.17	1.00	101	46.95	---	1.90	48.85	---	73.96	53.96	-5.11
22320.83	1.00	256	44.64	---	3.33	47.97	---	73.96	53.96	-5.99
24800.00	1.00	200	47.50	---	2.22	49.72	---	73.96	53.96	-4.24

Test mode: BT (E.D.R. mode) CH40 for 30MHz to 1GHz [Horizontal]

Radiated Emission				Correction Factors	Corrected Amplitude	Class B (3 m)	
Frequency (MHz)	Amplitude (dBμV)	Ant. H. (m)	Table ()			Limit (dBμV/m)	Margin (dB)
32.42	20.07	1.00	357	7.34	27.41	40.00	-12.59
168.22	31.53	1.00	73	-3.76	27.77	43.50	-15.73
278.56	35.70	1.00	53	-4.05	31.65	46.00	-14.35
318.57	32.94	1.00	96	-3.10	29.84	46.00	-16.16
467.71	23.29	1.00	294	1.36	24.65	46.00	-21.35
936.95	20.88	1.00	158	15.48	36.36	46.00	-9.64

Test mode: BT (E.D.R. mode) CH40 for 30MHz to 1GHz [Vertical]

Radiated Emission				Correction Factors	Corrected Amplitude	Class B (3 m)	
Frequency (MHz)	Amplitude (dBμV)	Ant. H. (m)	Table ()			Limit (dBμV/m)	Margin (dB)
50.61	28.39	1.00	89	3.79	32.18	40.00	-7.82
154.89	33.98	1.00	112	-3.56	30.42	43.50	-13.08
169.44	37.81	1.00	33	-3.80	34.01	43.50	-9.49
280.99	35.01	1.00	56	-3.99	31.02	46.00	-14.98
306.45	34.27	1.00	343	-3.26	31.01	46.00	-14.99
951.50	21.34	1.00	38	15.79	37.13	46.00	-8.87

Test mode: BT (E.D.R. mode) CH40 for 1GHz to 25GHz [Horizontal]

Frequency	Ant. H.	Table	Amplitude		Correction Factor	Corrected Amplitude		Limit		Margin
			Peak / Ave.			Peak / Ave.		Peak / Ave.		
MHz	m	degree	dBμV		dB/m	dBμV/m		dBμV/m		dB
2552.08	1.00	134	34.83	---	9.59	44.42	---	73.96	53.96	-9.54
4883.54	1.00	244	47.23	---	3.99	51.22	---	73.96	53.96	-2.74
12206.04	1.00	186	39.24	---	9.79	49.03	---	73.96	53.96	-4.93
19526.46	1.00	311	46.27	---	1.70	47.97	---	73.96	53.96	-5.99
21970.21	1.00	30	47.03	---	2.95	49.98	---	73.96	53.96	-3.98
24410.42	1.00	184	46.60	---	3.10	49.70	---	73.96	53.96	-4.26

Test mode: BT (E.D.R. mode) CH40 for 1GHz to 25GHz [Vertical]

Frequency	Ant. H.	Table	Amplitude		Correction Factor	Corrected Amplitude		Limit		Margin
			Peak / Ave.			Peak / Ave.		Peak / Ave.		
MHz	m	degree	dBμV		dB/m	dBμV/m		dBμV/m		dB
2150.00	1.00	187	39.67	---	8.51	48.18	---	73.96	53.96	-5.78
4883.54	1.00	240	46.88	---	3.99	50.87	---	73.96	53.96	-3.09
12206.04	1.00	200	39.57	---	9.79	49.36	---	73.96	53.96	-4.60
19526.46	1.00	325	45.90	---	1.70	47.60	---	73.96	53.96	-6.36
21970.21	1.00	16	46.78	---	2.95	49.73	---	73.96	53.96	-4.23
24410.42	1.00	211	46.64	---	3.10	49.74	---	73.96	53.96	-4.22

Test mode: BT (E.D.R. mode) CH79 for 30MHz to 1GHz [Horizontal]

Radiated Emission				Correction Factors	Corrected Amplitude	Class B (3 m)	
Frequency (MHz)	Amplitude (dBμV)	Ant. H. (m)	Table (°)			Limit (dBμV/m)	Margin (dB)
37.27	20.05	1.00	219	5.98	26.03	40.00	-13.97
168.22	34.23	1.00	192	-3.76	30.47	43.50	-13.03
272.50	34.76	1.89	64	-4.20	30.56	46.00	-15.44
310.09	36.31	1.00	84	-3.21	33.10	46.00	-12.90
644.74	21.82	1.00	213	7.89	29.71	46.00	-16.29
940.59	20.83	1.00	264	15.55	36.38	46.00	-9.62

Test mode: BT (E.D.R. mode) CH79 for 30MHz to 1GHz [Vertical]

Radiated Emission				Correction Factors	Corrected Amplitude	Class B (3 m)	
Frequency (MHz)	Amplitude (dBμV)	Ant. H. (m)	Table (°)			Limit (dBμV/m)	Margin (dB)
50.61	27.66	1.00	268	3.79	31.45	40.00	-8.55
152.46	40.99	1.00	350	-3.60	37.39	43.50	-6.11
170.65	36.48	1.00	251	-3.82	32.66	43.50	-10.84
213.09	33.29	1.00	92	-3.96	29.33	43.50	-14.17
278.56	35.44	1.00	122	-4.05	31.39	46.00	-14.61
305.24	36.16	1.00	66	-3.27	32.89	46.00	-13.11

Test mode: BT (E.D.R. mode) CH79 for 1GHz to 25GHz [Horizontal]

<i>Frequency</i>	<i>Ant. H.</i>	<i>Table</i>	<i>Amplitude</i>		<i>Correction Factor</i>	<i>Corrected Amplitude</i>		<i>Limit</i>		<i>Margin</i>
			<i>Peak / Ave.</i>			<i>Peak / Ave.</i>		<i>Peak / Ave.</i>		
<i>MHz</i>	<i>m</i>	<i>degree</i>	<i>dBμV</i>		<i>dB/m</i>	<i>dBμV/m</i>		<i>dBμV/m</i>		<i>dB</i>
2912.50	1.00	206	35.33	---	10.27	45.60	---	73.96	53.96	-8.36
9922.29	1.00	137	35.69	---	11.66	47.35	---	73.96	53.96	-6.61
12399.37	1.00	178	37.38	---	9.02	46.40	---	73.96	53.96	-7.56
19799.17	1.00	294	46.56	---	1.90	48.46	---	73.96	53.96	-5.50
22320.83	1.00	169	45.47	---	3.33	48.80	---	73.96	53.96	-5.16
24800.00	1.00	188	45.97	---	2.22	48.19	---	73.96	53.96	-5.77

Test mode: BT (E.D.R. mode) CH79 for 1GHz to 25GHz [Vertical]

<i>Frequency</i>	<i>Ant. H.</i>	<i>Table</i>	<i>Amplitude</i>		<i>Correction Factor</i>	<i>Corrected Amplitude</i>		<i>Limit</i>		<i>Margin</i>
			<i>Peak / Ave.</i>			<i>Peak / Ave.</i>		<i>Peak / Ave.</i>		
<i>MHz</i>	<i>m</i>	<i>degree</i>	<i>dBμV</i>		<i>dB/m</i>	<i>dBμV/m</i>		<i>dBμV/m</i>		<i>dB</i>
2152.08	1.00	169	38.00	---	8.52	46.52	---	73.96	53.96	-7.44
4962.08	1.00	260	45.83	---	4.25	50.08	---	73.96	53.96	-3.88
9922.29	1.00	140	36.11	---	11.66	47.77	---	73.96	53.96	-6.19
19799.17	1.00	297	46.78	---	1.90	48.68	---	73.96	53.96	-5.28
22320.83	1.00	175	45.62	---	3.33	48.95	---	73.96	53.96	-5.01
24800.00	1.00	185	45.91	---	2.22	48.13	---	73.96	53.96	-5.83

XIII. Section 15.247(d): Power Spectral Density

13.1 Test Condition & Setup

The tests below are running with the EUT transmitter set at high power in TDD mode. The EUT is needed to force selection of output power level and channel number. While testing, the EUT was set to transmit continuously and to be tested by the contact manner with the spectrum analyzer.

13.2 Test Instruments Configuration

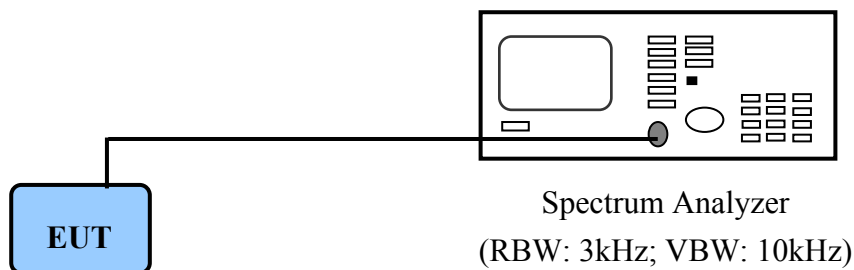

PC to control the EUT at maximal power output and channel number and set antenna kit

13.3 List of Test Instruments

<u>Instrument Name</u>	<u>Model No.</u>	<u>Brand</u>	<u>Serial No.</u>	<u>Calibration Date</u>
Spectrum Analyzer	MS2665C	ANRITSU	6200175476	Next time 02/15/07

13.4 Test Result of Power spectral density

The following table shows a summary of the test results of the Power Spectral Density.

Normal mode

<i>Channel</i>	<i>Ppr (dBm)</i>	<i>Cable Loss (dB)</i>	<i>Ppq (dBm)</i>	<i>Limit (dB)</i>	<i>Margin (dB)</i>
CH 01	-10.21	1.00	-9.21	8.00	-17.21
CH 40	-9.62	1.00	-8.62	8.00	-16.62
CH 79	-9.30	1.00	-8.30	8.00	-16.30

E.D.R.mode

<i>Channel</i>	<i>Ppr (dBm)</i>	<i>Cable Loss (dB)</i>	<i>Ppq (dBm)</i>	<i>Limit (dB)</i>	<i>Margin (dB)</i>
CH 01	-15.60	1.00	-14.60	8.00	-22.60
CH 40	-15.04	1.00	-14.04	8.00	-22.04
CH 79	-14.75	1.00	-13.75	8.00	-21.75

Note:

1. The following pages show the results of spectrum reading.
2. Ppr: spectrum read power density (using peak search mode),
Ppq: actual peak power density in the spread spectrum band.
3. $Ppq = Ppr + |Cable Loss|$

Power Spectral Density for CH01

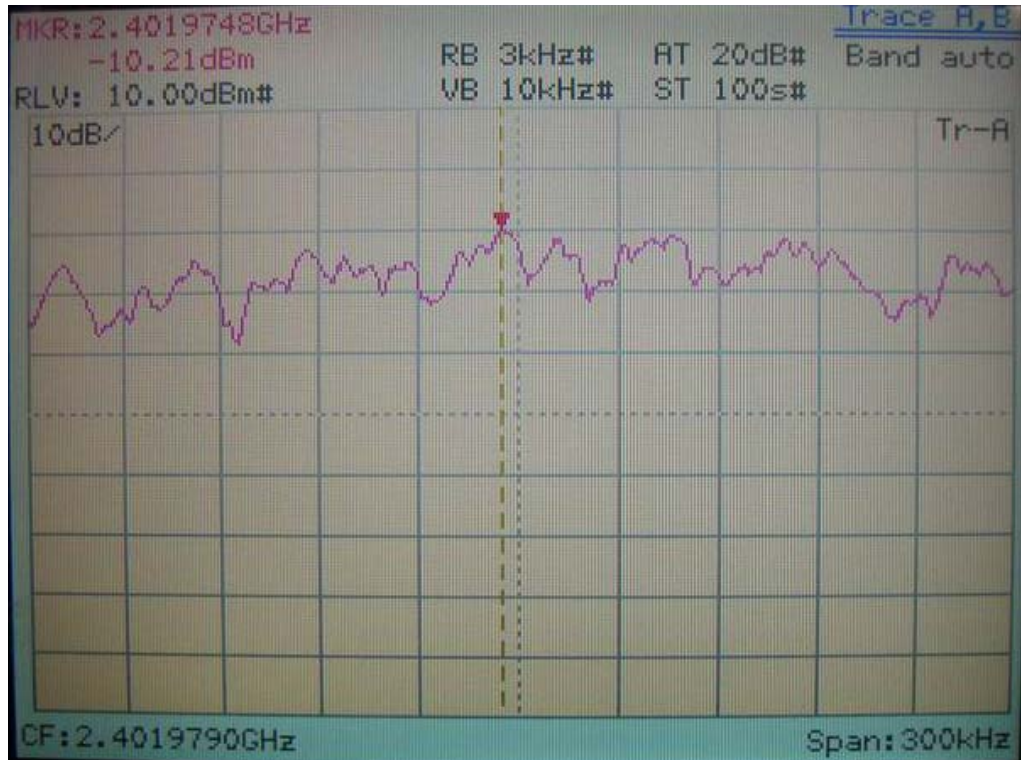

Normal mode



E.D.R. mode

Power Spectral Density for CH40

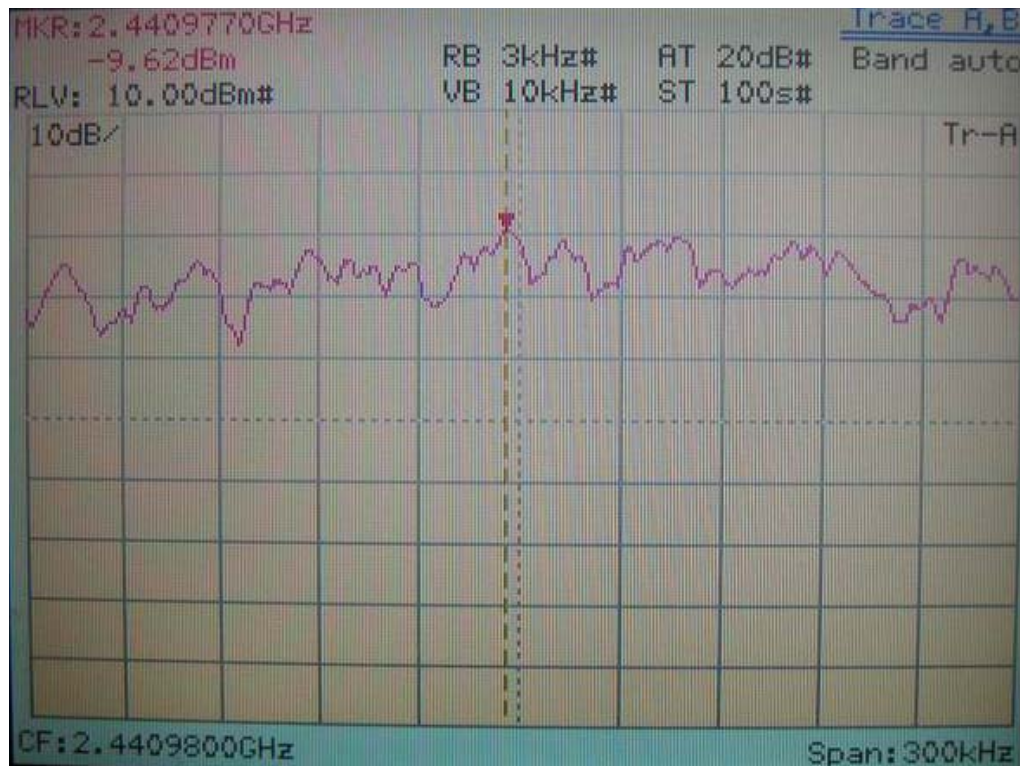

Normal mode

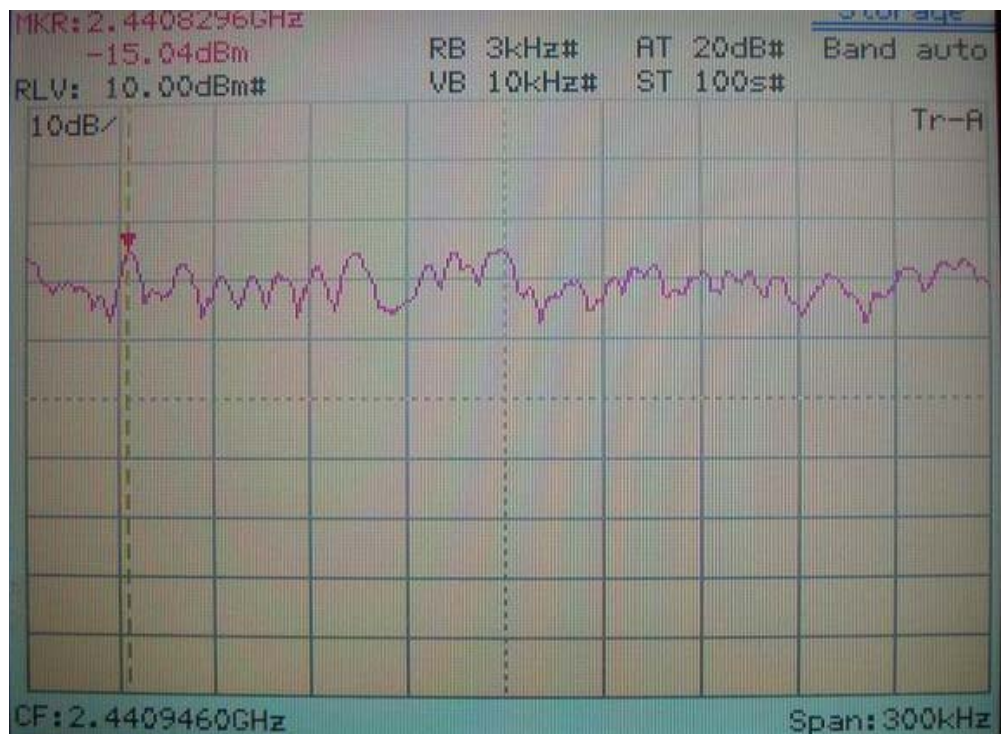

E.D.R. mode

Power Spectral Density for CH79

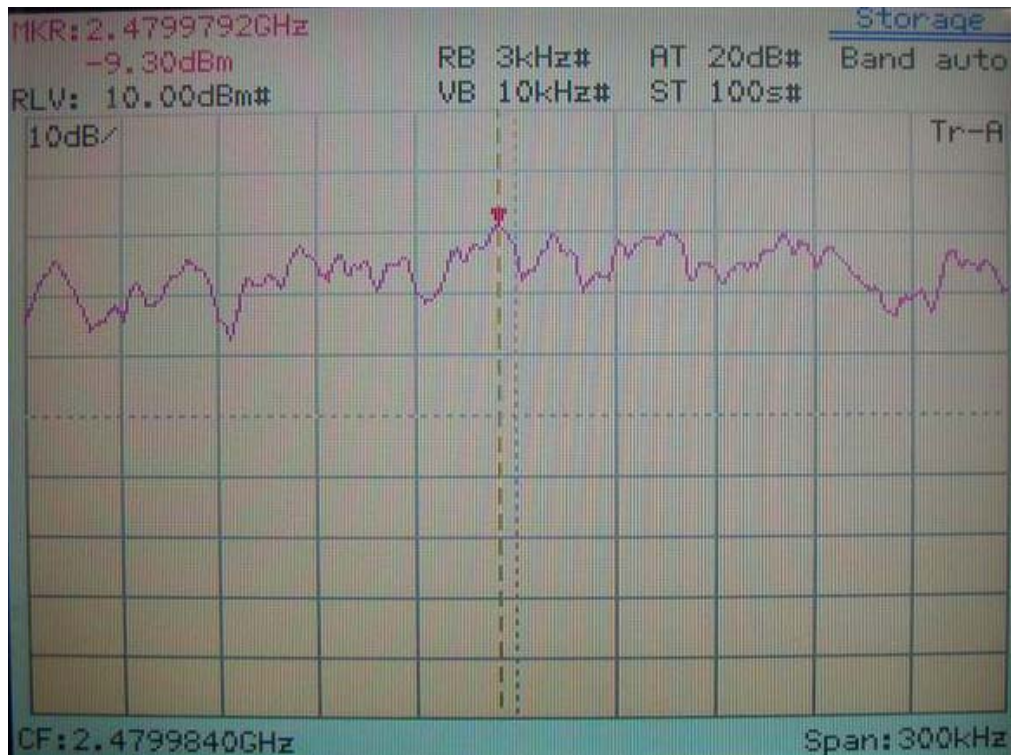

Normal mode



E.D.R. mode